

Under the sponsorship of IUPAC

INTERNATIONAL SYMPOSIUM

**NEW APPROACHES
IN POLYMER SYNTHESIS AND
MACROMOLECULAR FORMATION**



June 16-20, 1997
Saint-Petersburg

BOOK OF ABSTRACTS

DISTRIBUTION STATEMENT
Approved for public release;
Distribution Unlimited

19970728 127

Under the sponsorship of IUPAC

INTERNATIONAL SYMPOSIUM

NEW APPROACHES
IN POLYMER SYNTHESIS AND
MACROMOLECULAR FORMATION

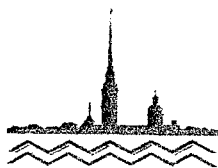

June 16-20, 1997
Saint-Petersburg

DTIC QUALITY INSPECTED 4

PROGRAM

Organized by:

Institute of Macromolecular Compounds
Russian Academy of Sciences

Chemistry Department
Saint-Petersburg State University

Supported by:

Russian Foundation for Basic Research

St.Petersburg Research Centre RAS

St.Petersburg Telephone Network

The European Research Office of the US Army

Promoted through:
Business Bureaus International, Inc., USA

International Scientific Advisory Board

Honorary Chairman: J.Economy, USA
E.Chiellini, Italy
H.Gibson, USA
H.Höcker, Germany
W.Heitz, Germany
J.-I.Jin, Korea
V.Kabanov, Russia
E.Maréchal, France
O.Nuyken, Germany
E.Panarin, Russia
N.Platé, Russia
S.Russo, Italy
T.Saegusa, Japan

Organizing Committee

Co-Chairmen: A.Bilibin, S.Skorokhodov

B.Erussalimsky	N.Domnina
A.Koltsov	I.Kovalenko
D.Korol'kov	T.Meleshko
M.Koton	G.Polotskaya
M.Krakoviak	L.Shurko
V.Kudriavtsev	A.Tenkovtsev
V.Pautov	V.Ushakova

Scientific Program Information

- ◆ The venue of the Symposium -

June 16, 17, 18 and 20

Great Duke Vladimir's Palace (Dom Učenyh) - consult a map.
Address: Dvortsovaya naberezhnaya, 26

June 19 (Thursday)

Chemistry Department, Saint-Petersburg State University,
Peterhof

- ◆ Participants are transferred to lecture halls by buses from the hotel "Russ"
- ◆ The Symposium program includes plenary lectures, oral communications and poster sessions.
- ◆ Speakers are requested to adhere strictly to the time indicated in the time-table.
Presentation time for plenary lectures is 35 minutes including 5 minutes for discussion.
Presentation time for oral communications is 20 minutes including 5 minutes for discussion.
- ◆ A slide projector and a projector for overhead transparencies are available in the lecture hall.
The speakers are asked kindly to hand the slides to the projectionist 15 minutes before the beginning of the session.
- ◆ Posters will be on display for the poster sessions. Authors are requested to mount their posters on the panel with the number which is identical to the number of the abstract in the Symposium Book of Abstracts (the abstract number corresponds with the page number). Assistance will be available in the poster hall, participants may get thumbtacks and tapes if necessary.

Time-Table

Sunday, June 15

- 10.00 - 22.00 - registration at the Hotel "Russ"
address: Artilleriyskaya str., 1
Phone: 273-46-83

Monday, June 16

- 8.00 - 9.00 - Registration (continued)
Great Duke Vladimir's Palace (Dom Učenyh) - consult a map
address: Dvortsovaya naberezhnaya, 26
- 9.00 - 9.30 - Opening ceremony
- 9.30 - 11.40 - Morning session
- 11.40 - 12.00 - Coffee break
- 12.00 - 13.00 - Poster presentations P-001 - P-045
- 13.00 - 15.00 - Lunch
- 15.00 - 17.30 - Evening session
- 18.00 - 20.30 - Welcome Cocktail Party
(Included in Registration fee)

Tuesday, June 17

- 9.00 - 11.05 - Morning session
- 11.05 - 11.30 - Coffee break
- 11.30 - 13.00 - Poster presentations P-046 - P-066
- 13.00 - 15.00 - Lunch
- 15.00 - 17.30 - Evening session

Wednesday, June 18

- 9.00 - 11.25 - Morning session
- 11.25 - 11.45 - Coffee break
- 11.45 - 13.00 - Poster presentations P-067 - P-102
- 13.00 - 15.00 - Lunch
- 15.00 - 17.10 - Evening session

Thursday, June 19

*Chemistry Department, Saint-Petersburg State University,
Peterhof*

- 9.30 - 11.50 - Morning session
- 11.50 - 12.20 - Coffee break
- 12.20 - 13.00 - Morning session (continued)
- 13.00 - 15.00 - Lunch
- 15.00 - 18.00 - The excursion around Peterhof
(Included in Registration fee)
- 19.00 - 22.00 - Conference Dinner

Friday, June 20

- 9.00 - 11.05 - Morning session
- 11.05 - 11.30 - Coffee break
- 11.30 - 12.30 - Poster presentations P-103 - P-131
- 12.30 - 13.10 - Morning session (continued)
- 13.10 - 13.30 - Closing ceremony

Monday, June 16

9.00 - 9.30 - OPENING CEREMONY

MORNING SESSION

Chairmen: W. Heitz and V.P. Shibaev

PLENARY LECTURES

9.30 - 10.05 - **J. Economy** (USA)

*Solid State Interchain Transesterification Reactions
(ITR) in Macromolecules*

10.05 - 10.40 - **S. Penczek** (Poland)

Controlled Polymerization of Cyclic Esters

ORAL PRESENTATIONS

10.40 - 11.00 - **J. Springer** (Germany)

*New Redoxactive Polymethacrylates with
Phenylazoanthraquinone Units in the Side Group*

11.00 - 11.20 - **V.N. Zgonnik** (Russia)

*New Approach to Forming Polymers Architecture Using
Fullerene C₆₀*

11.20 - 11.40 - **K.L. Makovetsky** (Russia)

*Addition Polymerization of Norbornene and Its
Derivatives by Nickel-Based Catalysts*

11.40 - 12.00 - COFFEE BREAK

POSTER PRESENTATIONS

12.00 - 13.00 - **Posters P-001 - P-045**

13.00 - 15.00 - LUNCH

Monday, June 16

EVENING SESSION

Chairmen: S. Penczek and K. Kazansky

PLENARY LECTURES

- 15.00 - 15.35 - **N. Spassky** (France)
Stereochemical Aspects of the Controlled Ring-Opening Polymerization of Chiral Cyclic Esters
- 15.35 - 16.10 - **M. Fontanille** (France)
Amphiphilic Polymacromonomers by Ring-Opening Metathesis Polymerization

ORAL PRESENTATIONS

- 16.10 - 16.30 - **A.A. Kuznetsov** (Russia)
Acid Catalysis in Synthesis of Polyimides
- 16.30 - 16.50 - **S.N. Salazkin** (Russia)
The Ring-Chain Tautomerism and/or Isomerism of Monomers in Polycondensation by Electrophilic Aromatic Substitution Reaction
- 16.50 - 17.10 - **B.A. Zaitsev** (Russia)
Novel Approach to the Chemistry and Technology of High-Temperature, High-Strength, Self-Healing, and Other Specialty Thermosetting Polymers, Advanced Polymer Materials and Composites Minimizing Environmental Impact
- 17.10 - 17.30 - **V.V. Shaposhnikova** (Russia)
New Approaches to Synthesis of Amorphous and Crystalline Cardo Polyaryleneetherketones

Tuesday, June 17

MORNING SESSION

Chairmen: S. Russo and M. Krakowiak

PLENARY LECTURES

9.00 - 9.35 - **W. Heitz** (Germany)
*Metal Catalysis: Similarities and Differences in
Polycondensation and Polymerisation*

9.35 - 10.10 - **L. Porri** (Italy)
*Polymerization of 1,3-Dienes with Neodymium
Catalysts*

10.10 - 10.45 - **T. Saegusa** (Japan)
Organic/Inorganic Polymer Hybrids

ORAL PRESENTATION

10.45 - 11.05 - **R. Deschenaux** (France)
Ferrocene - Based Metallomesogenic Polymers

11.05 - 11.30 - COFFEE BREAK

POSTER PRESENTATIONS

11.30 - 13.00 - **Posters P-046 - P-066**

13.00 - 15.00 - LUNCH

Tuesday, June 17

EVENING SESSION

Chairmen: H.R. Kricheldorf and T. Saegusa

PLENARY LECTURES

- 15.00 - 15.35 - **Ya.S. Vygodskii** (Russia)
Reactions with Samarium Diiodide in Polymer Synthesis
- 15.35 - 16.10 - **S.S. Skorokhodov** (Russia)
The Synthesis of Mesogenic Polymers Provoked by Molecular Mobility. Polysilarylenes

ORAL PRESENTATIONS

- 16.10 - 16.30 - **V.V. Kireev** (Russia)
Synthesis of Syloxane-Containing Block Copolymers Using Siliconorganic Iniferters
- 16.30 - 16.50 - **V.A. Vasnev** (Russia)
Macromolecular Design in Polycondensation
- 16.50 - 17.10 - **Z.M. Sabirov** (Russia)
Mechanism of Regio- and Stereocontrol in Diene Polymerization under the Effect of Lanthanide Catalytic System. The Role of Diene Structure
- 17.10 - 17.30 - **D.F. Grishin** (Russia)
The Controlled Radical Polymerization of Vinyl Monomers in the Presence of Organometallic Compounds as the Living Polymerization

Wednesday, June 18

MORNING SESSION

Chairmen: H. Gibson and K. Makovetsky

PLENARY LECTURES

9.00 - 9.35 - **N.A. Platé** (Russia)

Current Aspects of the Theory of Macromolecular Reactions

9.35 - 10.10 - **K. Mullen** (Germany)

Linear, Hyperbranched and Dendritic Polyphenylenes - from Benzene to Shape-Persistent Nanostructures

10.10 - 10.45 - **J.-I. Jin** (Korea)

PPV Derivatives - Synthesis, Structure, and Properties

ORAL PRESENTATION

10.45 - 11.05 - **V.P. Shibaev** (Russia)

Design of New Chiral Liquid Crystalline (LC) Polymers and LC Dendrimers with Tailored Supramolecular Structure

11.05 - 11.25 - **W.T. Ford** (USA)

Incorporation of C₆₀ into Poly(methyl methacrylate) and Polystyrene by Radical Chain Polymerization Produces Branched Structures

11.25 - 11.45 - COFFEE BREAK

POSTER PRESENTATIONS

11.45 - 13.00 - **Posters P-067 - P-102**

13.00 - 15.00 - LUNCH

Wednesday, June 18

EVENING SESSION

Chairmen: Ch. Tsvetanov and V. Vasnev

PLENARY LECTURES

15.00 - 15.35 - **E. Maréchal** (France)
*Macrocycles Prepared by Polycondensation.
Synthesis and Characterization*

15.35 - 16.10 - **H.R. Kricheldorf** (Germany)
Macrocyclic Polymerization

ORAL PRESENTATIONS

16.10 - 16.30 - **V.V. Shilov** (The Ukraine)
*Effect of Chain Architecture on the Morphology and
Properties of Model Telechelic Ionomers and
Related Systems*

16.30 - 16.50 - **F. Navarro** (Spain)
*Liquid Crystalline Polyesters and Cyclic
Oligoesters with Main-Chain Ortho-Linked Units
Substituted with Alkyl Side Chains*

16.50 - 17.10 - **F. Böhme** (Germany)
*Cyclization Reaction during the Synthesis of
Aromatic Polyformamidines*

Thursday, June 19

MORNING SESSION ***
Chairmen: K. Müllen and Ya. Vygodsky

PLENARY LECTURES

- 9.30 - 10.05 - **H. Gibson** (USA)
New Polymer Architectures: Recent Results with Polyrotaxanes
- 10.05 - 10.40 - **S. Russo** (Italy)
Linear and Hyperbranched Aromatic Polyamides Synthesized by Direct Method
- 10.40 - 11.15 - **A.Yu. Bilibin** (Russia)
Synthons as Building Blocks in Synthesis of Hybrid Liquid Crystalline Polymers
- 11.15 - 11.50 - **M. Laus** (Italy)
Design and Preparation of Mesomorphic Block Copolymers
- 11.50 - 12.20 - COFFEE BREAK

ORAL PRESENTATIONS

- 12.20 - 12.40 - **T. Endo** (Japan)
Synthesis of Novel Block Copolymers through Electron Transfer System by SmI_2
- 12.40 - 13.00 - **W. Mormann** (Germany)
"Liquid Crystal" Thermosets from Mesogenic Dicyanates-Organisation, Kinetics, and Network Formation
- 13.40 - 15.00 - LUNCH

*** The session takes place at Saint-Petersburg State University, Chemistry Department (Peterhof)

Friday, June 20

MORNING SESSION

Chairmen: N. Spassky and S.S. Skorokhodov

PLENARY LECTURES

- 9.00 - 9.35 - **B. L. Erussalimsky** (Russia)
*Synthesis of Living Poly(vinyl pyridine) Chains
and Their Use for Construction of Homo- and
Hybrid Polymers Having Complex Architecture*
- 9.35 - 10.10 - **K.S. Kazansky** (Russia)
*New Aspects in Chemistry and Characterization
of Poly(ethylene oxide) Hydrogels*
- 10.10 - 10.45 - **Ch. Tsvetanov** (Bulgaria)
Intelligent Networks Based on PEO

ORAL PRESENTATION

- 10.45 - 11.05 - **H.- J. Adler** (Germany)
*Novel Branched Block Copolymers from
Poly(vinyl pyridine) by Chromium Allyl
Compounds*

11.05 - 11.30 - COFFEE BREAK

POSTER PRESENTATIONS

11.30 - 12.30 - **Posters P-103 - P-131**

ORAL PRESENTATIONS

- 12.30 - 12.50 - **I.M. Papisov** (Russia)
*On Structural Effects in Matrix
Polycondensation*
- 12.50 - 13.10 - **V.I. Nedel'kin** (Russia)
*Macrocyclisation in Chemistry of Aromatic
Sulfur-Containing Polymers*
- 13.10 - 13.30 - CLOSING CEREMONY

CONTENTS

Plenary lectures	L-001 - L-021
Oral communications	O-001 - O-022
Poster presentations	P-001 - P-131
Index	I-001 - I-006

ORGANIZED BY:

Institute of Macromolecular Compounds
Russian Academy of Sciences

Saint-Petersburg State University
Chemistry Department

INTERNATIONAL SCIENTIFIC ADVISORY BOARD

the Honorary Chairman - J.Economy, USA

E.Chiellini, Italy	E.Maréchal, France
H.Gibson, USA	O.Nuyken, Germany
H.Höcker, Germany	E.Panarin, Russia
W.Heitz, Germany	N.Platé, Russia
J.-I.Jin, Korea	S. Russo, Italy
V.Kabanov, Russia	T.Saegusa, Japan

ORGANIZING COMMITTEE

Co-Chairmen

A.Bilibin	S.Skorokhodov
B.Erussalimsky	N.Domnina
A.Koltsov	I.Kovalenko
D.Korol'kov	T.Meleshko
M.Koton	G.Polotskaya
M.Krakoviak	L.Shurko
V.Kudriavtsev	A.Tenkovtsev
V.Pautov	V.Ushakova

SUPPORTED BY:

Russian Foundation for Basic Research

St.Petersburg Telephone Network

St.Petersburg Research Centre RAS

The European Research Office of the US Army

Promoted through: Business Bureaus International, Inc., USA

SOLID STATE INTERCHAIN TRANSESTERIFICATION REACTIONS (ITR) IN MACROMOLECULES

J. Economy, L. Schneggenburger

1304 W. Green Street Urbana IL, 61801, USA

ITR has long been recognized to play a critical role in the polymerization of polymers such as polyethylene terephthalate. What has not been recognized until recently is the fact that ITR can strongly influence the sequence ordering vs randomization of aromatic copolyesters depending on the temperature. Since ITR can occur at very rapid rates at elevated temperatures one can use such reactions to obtain very high strength adhesive bonds between two polyester surfaces. Finally, this knowledge of ITR has led us to the design of a completely new family of cross-linkable aromatic copolyesters with a number of unique properties.

In this paper recent progress on our new thermosetting copolyesters is described and compared to earlier work on the liquid crystalline copolyesters. Data are then presented to provide definitive evidence for ITR induced sequence ordering based on ^{13}C NMR and for adhesion bond formation based on SIMS and neutron reflection techniques.

CONTROLLED POLYMERIZATION OF CYCLIC ESTERS

Stanisław Penczek, Andrzej Duda

*Center of Molecular and Macromolecular Studies
Polish Academy of Sciences
90-363 Lodz, Sienkiewicza 112, Poland*

Polymerization of cyclic esters (e.g. ϵ -caprolactone and lactides) can either proceed as an ionic or as pseudoionic process. The major side reaction in these polymerizations is chain transfer to polymer, either the unimolecular back-biting or the bimolecular chain transfer to foreign macromolecules with chain scission. Among covalent initiators to be discussed, two classes of Al-derivatives, based on dialkylalkoxy aluminum and trialkoxy aluminum are often used giving much better control of polymerization than anionic systems. It has been shown in our earlier work, that these two groups of initiators provide active centres behaving differently. For the former ones one chain grows from one aluminum atom, chains are aggregated and the extent of aggregation depends on the alkyl substituents on the Al atom. According to the ^{27}Al NMR spectra, Al atoms are solvated, most probably by the first unit of the chain. Penta- (aggregated) and tetraordinated (deaggregated) Al active species interexchange in the chain growth.

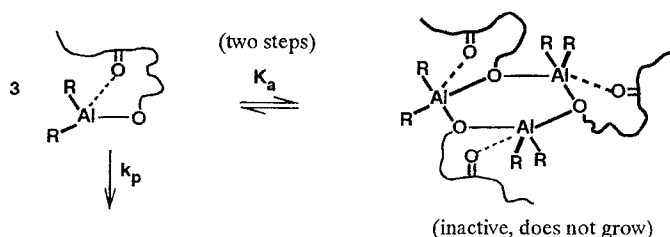

Kinetic and ^{27}Al NMR studies allowed determination of the corresponding rate constants k_p and aggregation equilibrium constants K_a .

The other group of initiators - trialkoxy aluminums - is known to form rather strong aggregates when the substituents are small enough (e.g. CH_3O -, $\text{C}_2\text{H}_5\text{O}$ -, or $^i\text{C}_3\text{H}_7\text{O}$ -). They eventually provide active centres with three chains, growing from one aluminum atom. This was clearly shown by studying the growing (living) system by MALLS. M_n determined this way was three times larger than M_n of single chains formed after deactivating of the growing species. Active species, according to the ^{27}Al NMR spectra, are internally solvated by polymer units, giving mostly tetra- and hexacoordinated species. Crowding of the growing chains - large substituents - around the Al atoms prevents aggregation in the propagation step. This crowding does not influence k_p but slows down transfer to polymer and gives much better controlled polymerization than the dialkylalkoxy initiators.

More recently a number of other alcoholates were studied, (e.g. Fe, Ti, La). Correlation between the molecular structure of the active species based on these alcoholates and their reactivity was established and will be discussed.

STEREOCHEMICAL ASPECTS OF THE CONTROLLED RING-OPENING POLYMERIZATION OF CHIRAL CYCLIC ESTERS

Nicolas SPASSKY

*Laboratoire de Chimie Macromoléculaire, Université Pierre et Marie Curie,
4, place Jussieu, 75252 Paris Cedex 05, France*

Poly lactides and polyhydroxybutyrates are polymers bearing asymmetric carbon atoms in the main chain. Their physicochemical properties are strongly depending on the stereochemical structure of the chain. These aliphatic polyesters are biodegradable materials having applications in biomedical, pharmaceutical and environmental fields.

The chemical synthesis of these polymers proceeds by ring-opening polymerization of the corresponding cyclic esters. In order to obtain polymers with defined and controlled characteristics (structure, molecular weight) initiators allowing the stereocontrol of the synthesis and leading to living type process are suitable.

Aluminium complexes derived from various achiral and chiral Schiff's bases are among initiators able to satisfy to such requirements. Using achiral Schiff's base aluminium alkoxide initiators, lactide stereocopolymers with different enantiomeric excesses were prepared. They exhibited enhanced thermal properties due to the presence of long stereoblocks in the macromolecular chain. In the course of polymerization of polymerization of racemic lactide with chiral initiator containing (R)-binaphthyl moieties in the Schiff's base, a significant preferential choice for (D)-lactide enantiomer was observed leading to polymers of high optical purity. The polydispersity remained narrow ($\overline{M}_w/\overline{M}_n < 1.2$) till almost quantitative conversion, indicating a strong limitation of transesterification reactions. Stereocomplexes between (L) and (D) enantiomerically enriched poly lactides were obtained and their thermal properties studied.

With β -butyrolactone the previous initiators led also to enantiomerically enriched stereocopolymers but the stereoelective efficiency was much less pronounced. It was increased when replacing Al-OR reactive group by Al-Cl.

Aluminium derivatives are selective but not very reactive initiators. Some acceleration can be obtained by addition of basic compounds such as pyridine, but the effect is limited.

Recently rare-earth alkoxides were shown to have a very high reactivity and a living type behaviour in the polymerization of different cyclic esters. Different homopolymers and block-copolymers were prepared from β -butyrolactone, lactide and ϵ -caprolactone. Some examples of polymerizations using these initiators are discussed.

AMPHIPHILIC POLYMACROMONOMERS BY RING-OPENING METATHESIS POLYMERIZATION

Yves GNANOU, Valerie HEROGUEZ and Michel FONTANILLE

Laboratoire de Chimie des Polymères Organiques - UMR CNRS - ENSCPB - Université Bordeaux-1 Avenue Pey-Berland 33402 Talence Cedex - FRANCE

The discovery in the 50's that the properties of a surfactant can dramatically be changed by substituting its hydrophobic and hydrophilic moieties with polymeric counterparts has stimulated intense academic and industrial interest in amphiphilic copolymers. Of the various amphiphilic copolymers that have been synthesized, those based on poly(ethyleneoxide) (PEO) are certainly the most notorious because of their miscellaneous applications in the surfactant industry.

For the new applications that could be contemplated from PS-PEO copolymers, one major challenge lies in the design and synthesis of novel architectures, exhibiting quite different topological arrangement of their hydrophobic and hydrophilic blocks from that usually seen in PEO-PS block and graft copolymers.

In this study, emphasis is placed on the preparation of three different topologies of PS/PEO copolymers, all of them derived by ring-opening metathesis polymerization (ROMP) of miscellaneous macromonomers.

The synthesis of these various macromonomers as well as the preparation and the molecular characterization of the three types of amphiphilic polymacromonomers will be described and commented upon.

The ring-opening metathesis homopolymerization of macromonomers is being looked into as a powerful method to derive macromolecular structures that could be regular and highly dense. Depending upon the size of the precursor macromonomer and the \overline{DP}_n of the polymacromonomer obtained, rigid globular macromolecules or bottle-brush type structures were shown to form. Polymacromonomers of PS and PEO were prepared by ROMP of PS and PEO macromonomers and the two families of regularly branched structures were subsequently characterized in solution. Another feature which deserves to be stressed is the living character of these homopolymerizations that systematically yielded 100% conversion.

The experience gained with PS and PEO macromonomers prompted us to apply the same ROMP technique to the preparation of novel amphiphilic macromolecular structures by copolymerization of macromonomers.

With the ROMP of miscellaneous macromonomers, new patterns and shapes can be contemplated for PS-PEO copolymers from various architectures which were obtained by ring-opening metathesis polymerization:

- by sequential polymerizations of ω -norbornenyl PS and α -norbornenyl PEO macromonomers,
- by polymerization of α -norbornenyl-(PS-b-PEO) macromonomers,
- by polymerization of ω -norbornenyl-(PEO-b-PS) block macromonomers.

The corresponding graft-copolymers were characterized by SEC with LS detection, showing that the polymerization of macromonomers can be obtained in a "living" mode.

The versatility of the ROMP of macromonomers as a powerful tool of macromolecular engineering was demonstrated in this study. Amphiphilic polymacromonomers based on PS and PEO were prepared with a wealth of topologies within narrow distributions of size and composition. Of the miscellaneous amphiphilic structures proposed, the Janus-type topology of PS and PEO blocks is certainly the most innovating and noteworthy.

METAL CATALYSIS: SIMILARITIES AND DIFFERENCES IN POLYCONDENSATION AND POLYMERISATION

Walter Heitz

Philipps-Universität Marburg, Fachbereich Physikalische Chemie, Polymere, Hans-Meerwein-Straße, D-35032 Marburg, Germany

Metal catalysed polymerisations are chain reactions with a constant valency state of the metal. This is in contrast to metal catalysed polycondensations which have a step growth with a change in the oxidation state of the metal. The essential structure conditions of the catalyst are discussed using as an example the Pd-catalysed vinyl polymerisation of norbornene and the Heck reaction. Metal catalysed polycondensations can run through one or two-electron processes.

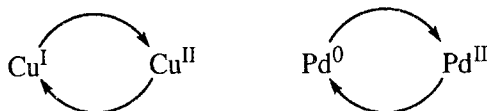

The Pd catalysed reaction of halogenoarenes with ethylene is a source for the effective synthesis of styrene derivatives, of stilbenes, and of substituted poly(phenylene vinylene)s. The knowledge of side reactions is important with respect to the limitation of molecular weight in polymer synthesis as well as structural defects in the chain. The most serious side reaction is the 1,1-disubstitution of ethylene resulting in a kink in the polymer chain. This side reaction is influenced by the substituent to be replaced at the aromatic unit as well as other reaction conditions. The synthesis of poly(phenylene vinylene) is viewed from their molecular conformation resulting in LC behaviour and their optical properties useful for electrooptical applications.

Soluble derivatives of polyphenylene ethynylene are obtained in a Pd/Cu catalysed reaction starting from dibromobenzene derivatives and the acetone educt of acetylene. Again the side reactions are investigated by model reactions. These polymers show similar behaviour in electrooptical applications as poly(phenylene vinylene)s.

Tractable polyphenylenes are obtained either in a Pd catalysed reaction of phenylboronic acid with halogenoarenes or in the Ni catalysed reductive coupling of dihalogenoarenes. The Ni(I/III) cycle is the basis of this catalytic process. Phenyl substituted polyphenylene is thermally stable till 600 °C. The fluorescence spectra of poly(phenylene vinylene)s can be tuned by variation of the primary structure.

In the Heck reaction the educt participates in the oxidative addition but the reductive elimination does not involve the product. In the Ni catalysed synthesis of polyphenylenes the product is included in the reductive elimination and halogen is removed in another pathway of the reaction. Products of other structure are to be expected if the oxidative addition and the reductive elimination involves the fragments of the product and no halogen participates in the reaction. Results of ArH-activated reactions are discussed in model reactions and applied to polymer synthesis.

Ni allows for a [2+2] cyclo addition of olefins. The active catalyst is a phosphine stabilised Ni(0) species. Starting from norbornadiene a polymer is obtained. The stereo selectivity of the reaction is influenced by the ligands. Without ligands 92 % of exo-trans-exo addition is observed. With two triphenyl phosphine ligands the exo-endo ratio is about 1 : 1. This give rise to the formation of a two dimensional polymer coil.

POLYMERIZATION OF 1,3-DIENES WITH NEODYMIUM CATALYSTS

Lido Porri, Giovanni Ricci, Nikolai Shubin

Polytechnic of Milan, Piazza L. da Vinci 32, 20132, Milan (Italy)

Neodymium catalysts give polymers of 1,3-dienes consisting almost exclusively of cis-1,4 units. The conventional Nd catalysts are prepared by reacting a soluble Nd compound (usually a carboxylate) with a chlorine donor (AlEtCl_2 , *t*-BuCl) in an aliphatic solvent and then by adding $\text{Al}(\text{iBu})_3$ or $\text{AlH}(\text{iBu})_2$ to the finely subdivided suspension of NdCl_3 so obtained. Catalysts of this type are currently used for the manufacture of cis-1,4 polybutadiene (PB). Determination of the number of active centers has shown that only a small part (6-8%) of Nd is active in these systems [1]. This is due to two facts: a) the reaction between $\text{Al}(\text{iBu})_3$ and NdCl_3 is slow because it takes place only at the outer part of the NdCl_3 insoluble particles; b) the reaction produces species containing a Nd-C bond of σ type (eg, NdCl_2iBu), which are unstable at room temperature. If the catalysts are prepared and aged at -20°C their activity increases continuously with the aging time [2a]. Catalysts aged at -20°C for three years showed an activity significantly higher than those aged for only 2-3 months. Evidently, the Nd-C bonds, which form rather slowly because of the insolubility of NdCl_3 , are stable at -20°C , and their number increases with time. Nd-C bonds of the η^3 -allylic type are much more stable than those of σ type, as shown by the fact that the polymerization of butadiene and other 1,3-dienes can be effected even at 50°C or at higher temperature maintaining a high stereospecificity. We decided, therefore, to synthesize allyl derivatives of Nd and to use them, instead of NdCl_3 , for the preparation of the catalysts. Reaction of $\text{Mg}(\text{allyl})\text{Cl}$ with NdCl_3 in THF gave a green powder (I) from which we were unable to isolate well defined compounds [2b]. It was later demonstrated by Chinese authors that (I) contains the compound $(\text{allyl})_2\text{NdCl}\cdot 2\text{MgCl}_2$ complexed with THF [3]. I gives, in combination with an aluminum alkyl, catalysts that are much more active than the conventional ones [2b,c]. The activity increases in the order: $\text{AlMe}_3 \approx \text{Al}(\text{iBu})_3 < \text{TIBAO} < \text{MAO}$. Some allyl derivatives of Nd have been recently prepared by Taube [4] and used for the preparation of polymerization catalysts; the most active and stereospecific systems are those obtained from MAO and $(\text{allyl})_2\text{NdCl}$, which is the Nd compound present in (I). Neodymium catalysts give cis polymers also from isoprene, 2,3-dimethylbutadiene, 1,3-pentadiene, 1,3-hexadiene, 2-methyl-1,3-pentadiene, 3-methyl-1,3-pentadiene. The polymers from terminally substituted monomers have an isotactic structure.

References

- 1) Yu. B. Monakov et al. Doklad. Akad. Nauk SSSR, **1982**, 265,1431.
- 2) L. Porri et al. a) Polymer Commun. **28**, 223 (1987); b) It. Patent 1228442 (1991); Application Febr. 21, 1989; c) Macromol. Symp. **66**, 231 (1993).
- 3) W.Wu et al, Organometallics **1991**, *10*, 98.
- 4) R.Taube et al., Macromol. Symp. **89**, 393 (1995); J. Organomet. Chem. **513**, 37(1996).

ORGANIC/INORGANIC POLYMER HYBRIDS

Takeo Saegusa

Kansai Research Institute(KRI)
Kyoto Research Park, Shimogyo-ku, Kyoto 600 Japan

Professor Emeritus, Kyoto University

The entitled materials represent a group of homogeneous and transparent glass materials in which an organic polymer molecule is being blended at a level of molecular dispersion with metal oxide (an inorganic three dimensional polymer) as exemplified by silica.

The hybrid is prepared by sol-gel reaction of the corresponding metal alkoxide, which is to be carried out in the homogeneous solution of an organic polymer. Unless the interaction between metal oxide and organic molecular is strong enough, phase separation takes place as the sol-gel process progresses.

The most suitable organic polymers for the formation of hybrids are those which consist of repeating unit containing N-alkyl and N,N-dialkyl carboxylamide groups ("Amide Polymers"). Typical examples are poly (N-Vinylpyrrolidone)(PVP), poly (N-acetylenimine)(polymer of 2-methyl-2-oxazoline), and poly (N,N-dimethyl-acrylamide). In addition, polyamide and polyurethane of lower molecular weights were found to form transparent hybrid materials with silica.

By means of FT-IR spectrum, the interaction due to hydrogen-bond between silanol group in silica and amide group of the organic polymer component has been manifested by the shift of $\nu_{C=O}$ to a longer wave length. With the hybrid of PVP/Silica, Atomic Force Microscopy showed a surface structure consisting of silica whose voids (a size of 10-30Å) are filled up with PVP. The same conclusion concerning the structure of the hybrids of PVP-Silica was derived by the BET measurements of total pore volume and of surface area of inner pores.

Transparent hybrids materials with alumina, silica/alumina, and silica/titania have also been prepared by the sol-gel reaction of the corresponding metal alkoxides or their mixtures in the presence of an amide polymer.

Potential application of these hybrid materials are to be described in the lecture.

REACTIONS WITH SAMARIUM DIIODIDE IN POLYMER SYNTHESIS

Yakov S.Vygodskii

*A.N.Nesmeyanov Institute of Organoelement Compounds RAS
Vavilov str. 28, Moscow, 117813, Russia*

Reactions induced by SmI_2 , such as reduction, coupling and cyclization are occurred with high yield upon mild conditions. It is due to high redox potential of divalent samarium.

Now reactions with SmI_2 are used in the polymer synthesis as well.

By the coupling reaction of various diacid chlorides poly- α -diketones having molecular weight up to 20000 have been obtained at room temperature with quantitative yield.

Isomeric difluorobenzils prepared by the one step reaction of SmI_2 and relevant fluorobenzoic acid chlorides have been used in the nucleophilic substitution reaction with bisphenols. The film-forming high molecular weight copolyetherketone- α -diketones have been synthesized when such difluorobenzils have been used as comonomers in the polycondensation of difluorobenzophenone and bisphenols. All these polymers containing α -diketogroups have been transformed into linear and net work polyquinoxalines by the reaction with aromatic (bis)o-diamines.

Aromatic polypinacols have been synthesized by the reaction of dialdehydes and SmI_2 in THF under mild conditions. The availability of the reactive α -hydroxy groups made it possible to carry out the reactions into polymer chains.

It was stated that imide cycle is reduced by SmI_2 at room temperature. The treatment of polyimides by SmI_2 leads to the change of polymer properties, mainly heat resistance and solubility.

The possibility of the formation of Si-Si bonds by the reductive coupling of organichlorosilanes with the usage of SmI_2 instead of Na has been shown. It was found that the reaction of diorganodichlorosilanes with SmI_2 easily proceeds in the THF solution at room temperature to yield α,ω -dichlorooligosilanes.

THE SYNTHESIS OF MESOGENIC POLYMERS
PROVOKED BY MOLECULAR MOBILITY.
POLYSILARYLENES

Sergei Skorokhodov

*Institute of Macromolecular Compounds RAS
Bolshoy pr. 31, St.Petersburg, 199004 Russia*

The approach to the synthesis of potentially thermotropic liquid crystalline polymers based on parallel investigation of their molecular mobility was realized. The initial idea was provoked by observation that some correspondence of molecular mobility data and ability of a polymer for liquid crystalline state formation exists. Previously this phenomenon was demonstrated on the example of a series of thermotropic main chain polymers with flexible dimethylsiloxane spacers of variable length.

The relation between the structure of the main chain and local molecular mobility of different fragments was investigated in a series of regular polysiloxane-silarylenes containing rigid aromatic sequences. Molecular mobility was studied by dielectric spectroscopy in solution and in solid state. The structure of the main chain has been changed by variation of the repeated fragments length, substituents and joint groups.

The data of molecular mobility and their conformity with the chain structure were used for directed synthetic search of desired mesogenic polymers.

CURRENT ASPECTS OF THE THEORY OF MACROMOLECULAR REACTIONS

N.A. Platé, A.D. Litmanovich, V.V. Yashin

*A.V. Topchiev Institute of Petrochemical Synthesis, Russian Academy of Sciences
Leninsky pr., 29, 117912, Moscow B-71, Russia*

The theory of macromolecular reactions (MR), during early period of its development, considered reactions of quasi isolated macromolecules in diluted solutions. The main achievements of that period were: a) descriptions of both the reactions kinetics and unit's distribution in chain and compositional heterogeneity of reaction product; b) elaboration of approaches to estimate individual rate constants. Adequacy of the theory has been proved experimentally using simple reaction models.

Now it is expedient to employ the approaches of the theory to studying the complex processes of practical significance. As an example, chemical modification of dextran is considered. By means of a mutual analysis of kinetical and NMR data individual rate coefficients for the dextran carboxymetylation were estimated and the product structure was established. Using these data and Monte Carlo simulations, it has been shown how to testify various hypotheses concerning the relations between primary structure of modified dextran and its biospecific properties.

In a more late period a theory has been elaborated which took into account interchain effects and thus permitted to study MR in a bulk state of a polymer. One of the most interesting directions of a development of the theory, both in fundamental and in practical aspects, is a studying MR in polymer blends. Here we consider the problem and the first attempts of the theoretical analysis of reacting polymer blends.

The following most important factor affect the MR in a polymer blend: a) an interchain effect, i.e., direct influence of the interchain interaction on the reactivity of polymer functional groups; b) the initial structure of the blend; c) the interdiffusion. So the new task arises: to describe the interdiffusion in reacting polymer blends.

A simple model system is considered. In a spatially non-homogeneous blends of compatible homopolymers A and B, the MR reaction $A \rightarrow B$ (A units transform into B ones) proceeds, B units accelerating the reaction (interchain effect). While interdiffusion in binary blend without a reaction is characterized by the time-dependent profile of the A chains volume fraction ϕ , the MR involves the new factors in the problem. As a consequence there are two types of diffusive movements in the system: 1) opposite flows of reacting and non-reacting components, 2) diffusive intermixing of reacting chains of different structures.

An evolution of the blend structure under the concerted action of the MR and interdiffusion has been described by methods of linear non-equilibrium therinodynamics. The set of reaction-diffusion equations derived permits to calculate not only ϕ and ρ (volume fraction of A units) profiles but also some parameters characterizing compositional heterogeneity and units' distribution of the reacting chains in any local region of the blend. Numerical calculations show: a) diffusive intermixing may affect the reaction rate and the local compositional heterogeneity of the reacting chains; b) an autowave-like regime of the MR may exist under certain conditions.

Most urgent problems are to test the equation derived experimentally and to extend the theory to incompatible systems.

LINEAR, HYPERBRANCHED AND DENDRITIC POLYPHENYLENES - FROM BENZENE TO SHAPE- PERSISTENT NANOSTRUCTURES

Frank Morgenroth, Klaus Muellen

Max-Planck-Institut für Polymerforschung Ackermannweg 10, D-55128 Mainz

New structural types of benzene-derived polymers can be designed which bear a formal resemblance to conventional materials, such as poly(para-phenylene) (PPP), poly(para-phenylenevinylene) (PPV) and polyphenylenesulfide (PPS), but produce a whole range of unconventional properties. Key steps of the syntheses are the suitable chemical functionalization of simple benzenoid building blocks and the invention of novel coupling reactions for CC- and CS-bonds.

A particularly powerful approach for the synthesis of PPP-type polymers is the Diels-Alder reaction between functionalized tetraphenylcyclopentadienones and ethynyl-substituted aromatic cores leading to highly branched polyphenylenes with pentaphenylbenzene repeat units. Both the step-wise synthesis of monodisperse dendrimers and the one-pot synthesis of their polydisperse hyperbranched analogues are possible. The latter have molecular weights as high as $M_w=100\ 000$ and are, nevertheless, solution processable. The dendrimers allow the careful control of size and shape of nanoparticles which, as a result of the closely packed phenyl units, exhibit a high degree of shape-persistence. Functionalization of these structures, e.g. introduction of electronically active moieties, is readily accomplished in the final cycloaddition step.

PPV DERIVATIVES - SYNTHESIS, STRUCTURE, AND PROPERTIES

Jung-Il Jin

*Department of Chemistry and
Advanced Materials Chemistry Research Center
Korea University, Seoul 136-701, Korea*

A series of substituted PPVs were prepared and their electrical conductivity, nonlinear optical properties, and luminescence characters were investigated in order to establish relationships between their structures and the properties.

1. **Electrical Conductivity** : PPV itself is hardly doped with I₂, but PPV derivatives carrying one or two electron donating groups such as alkoxy substituents can easily be doped with I₂ leading to an electrical conductivity of 10² Scm⁻¹. However, tetrasubstituted PPVs carrying methoxy or methyl groups on the phenylene ring are not doped with I₂. When the phenylene ring is tetrasubstituted, the coplanarity between the phenylene rings and the vinylene groups along the chain is disrupted due to steric effect exerted by the substituents.
2. **The 2nd Order Nonlinear Optical Properties** : Thin films of PPV derivatives carrying electron-donor group and electron-acceptor substituent can be prepared in a poled state by conducting thermolysis of organic soluble precursor polymers in a poling electric field. Due to the inherent rigidity of the main chain, the poled polymers prepared in this manner reveal excellent temporal stability even at elevated temperatures.
Optimization of simultaneous poling and thermolysis conditions is required for this process to be successful.
3. **Photo- and Electroluminescence** : PPV derivatives carrying anthracene, cabarzole and PBD moieties have been prepared and their luminescence properties were studied. Some of the polymers reveal PL and EL covering the whole range of visible light. When the anthracene moiety is directly attached to the phenylene ring, the excited state energy seems to readily migrate between the main chain and the pendent group. Such an interaction is strongly dependent on the length of the polymethylene spacers existing between the main chain and the anthracene pendent. Time-resolved spectroscopy of the polymers will also be discussed.

MACROCYCLES PREPARED BY POLYCONDENSATION.
SYNTHESIS AND CHARACTERIZATION.

P.J. MADEC and E. MARECHAL

Laboratoire de Synthèse Macromoléculaire (URA 24, CNRS) .
Université P.M. Curie, 4 Place Jussieu, 75252 Paris France

Cycles often accompany the formation of linear polycondensates whatever the catalyst (chemical or enzymatic). The preparation and the study of macrocyclic polymers raise a great interest. Three main preparation methods are used (i) coupling and condensation reactions in solution , (ii) polymer-supported reagents , (iii) ring-chain equilibration reactions. Only method (iii) will be developed in this lecture; it was particularly studied by Madec et al. (1- 3) in our laboratory, particularly the equilibria between linear poly[polyazomethines - *block* - polysiloxanes]

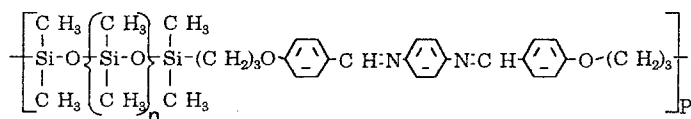

and the corresponding cycles

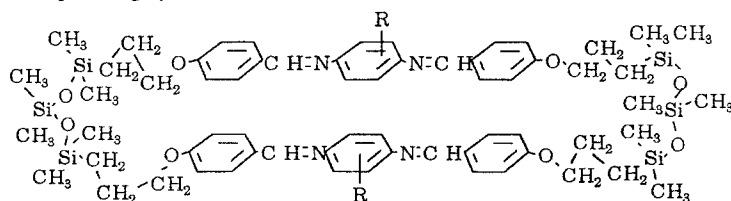

Both structures are formed of flexible blocks (polysiloxane) and rigid mesogenic blocks (polyazomethines). We will successively examine the following points:

- 1- Preparation and characterization of the linear polymers.
- 2- Structure of the macrocycles
 - Solution ^1H and ^{13}C NMR
 - Solid state ^{13}C NMR
 - Solid state ^{29}Si NMR
 - X- ray diffractometry
- 3- Study of the mechanism of the cyclization (Intratransimination).
- 4- Characteristics of the macrocycles.

References:

- 1- P.J. Madec,R.Pérès,E. Maréchal, *Makromol. Chem.,Macromol. Symp.* **47**,357 (1991).
- 2- E. Borgès,P.J. Madec,E. Maréchal, *Polym. Bull.* **34**, 523 (1995).
- 3- (a) R.Pérès (1990); (b) E.Lopès-Borgès (1995); (c) V. Jeanne Rose, (1995),Theses.- Paris.

MACROCYCLIC POLYMERIZATION

Hans R. Kricheldorf, Soo-Ran Lee, Svan Eggerstedt, Karsten Hauser

*Institut für Technische und Makromolekulare Chemie
Bundesstr. 45, D-20146 Hamburg, Federal Republic of Germany*

2,2-Dibutyl-2-stanna-1,3-dioxacycloalkanes can be used as cyclic initiators for the ring-opening polymerizations of lactones and cyclic carbonates. This process is self-catalysed fusion of heterocycles which exclusively yields supermacrocycles without any competition with linear polymers. Depending on the reactivity of the initiator these macrocyclic polymerizations follow more or less the "living pattern". The reactive covalent "endgroups" may be used for a variety of modifications such as the batchwise copolymerization of another comonomer yielding macrocyclic block copolyesters. Furthermore, the tin containing supermacrocycles are suitable for the synthesis of telechelic oligo- and polylactones by ring-opening with various functional acid chlorides, anhydrides or thioesters.

- 1) H.R. Kricheldorf, S.R. Lee, *Macromolecules* 28, 6718 (1995)
- 2) H.R. Kricheldorf, S.R. Lee, S. Busch, *Macromolecules* 29, 1375 (1996)
- 3) H.R. Kricheldorf, S.R. Lee, *Macromolecules* 29, 8689 (1996)

NEW POLYMER ARCHITECTURES: RECENT RESULTS WITH POLYROTAXANES

Harry W. Gibson, Shu Liu, Devdatt Nagvekar and Caiguo Gong

Department of Chemistry
Virginia Polytechnic Institute & State University
Blacksburg, Virginia, USA 24061

Polyrotaxanes consist of macromolecules which contain rotaxane units; rotaxanes are molecular composites which consist of a linear species threaded through the cavity of a cyclic species with no covalent bond between the two components. As noted below a number of types of polyrotaxane structures are possible: main chain and side chain, in which either the linear component or the cyclic species (or both) are part of a covalent macromolecule, as well as those without "stoppers" or "blocking groups" (polypseudorotaxanes) and those with such bulky moieties to prevent dissociation of the rotaxane structure (true polyrotaxanes).

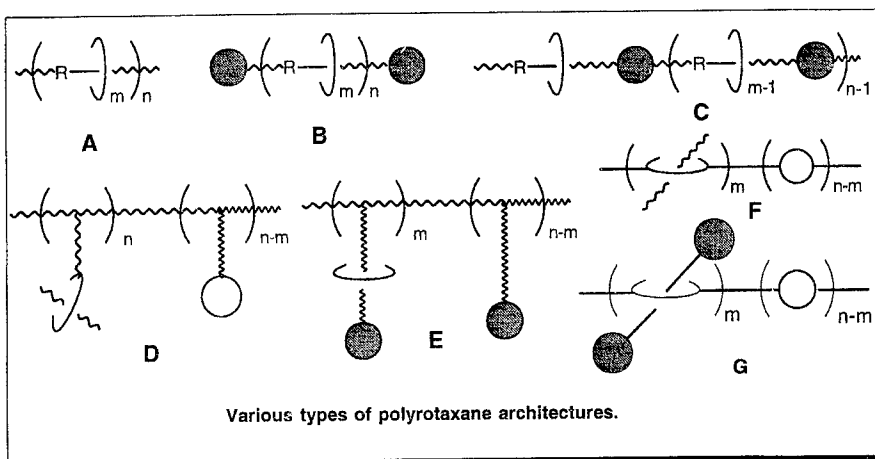

This area, which is an actively growing part of the field of supramolecular chemistry, has recently been reviewed^{1,2} to update earlier reviews.^{3,4}

In this presentation we will describe recent results from our laboratory directed toward syntheses of polyrotaxanes of types **A**, **C**, **D**, **E**, **F** and **G**. We will describe work with polyester and polyurethane backbones, as well as polymethacrylate side chain systems, among other topics.

1. H. W. Gibson, in *Large Ring Molecules*, J. A. Semlyen, ed., J. Wiley and Sons, New York, 1996, chapter 6, pp. 191-262; H. W. Gibson, M. C. Bheda and P. T. Engen, *Prog. Polym. Sci.*, **1994**, *19*, 843-945.
2. D. B. Ambalino, J. F. Stoddart, *Chem. Revs.*, **1995**, *95*, 2725.
3. Y. S. Lipatov, T. E. Lipatova, L. F. Kosyanchuk, *Adv. Polym. Sci.*, **1989**, *88*, 49.
4. G. Schill, *Catenanes, Rotaxanes and Knots*, Academic Press, New York, 1971.

**LINEAR AND HYPERBRANCHED AROMATIC POLYAMIDES
SYNTHESIZED BY DIRECT METHOD**

**Saverio Russo¹, Alya Boulares¹, Giuseppina Conio², Alberto Mariani³,
Massimiliano Martinelli¹**

¹ *Dipartimento di Chimica e Chimica Industriale, via Dodecaneso 31, 16146 Genova, Italy*

² *IMAG-CNR, via De Marini 6, 16149 Genova, Italy*

³ *Dipartimento di Chimica, via Vienna 2, 07100 Sassari, Italy*

The synthesis of high molecular weight aromatic polyamides is generally carried out by means of the reaction between aromatic amines and activated derivatives of carboxylic acid, namely their chlorides. In particular, with this method, poly(*p*-phenylene terephthalamide) (PPDT) of intrinsic viscosity, $[\eta]$, equal to 6-7 dl/g is industrially obtained.

On laboratory scale, the above reaction is often replaced by the *direct synthesis* in which aromatic carboxylic acids, activated by triphenyl phosphite and pyridine, are directly used. In our laboratory this alternative route was thoroughly developed and the best reaction conditions were found. Indeed, PPDT of $[\eta]$ up to 10.1 dl/g was obtained (Refs. 1-3). When a matrix-assisted synthesis was carried out, PPDT of $[\eta]$ up to 15.8 dl/g was obtained (Ref. 4).

After this successful result, we tried to apply the above method to the synthesis of hyperbranched aromatic polyamides having a molecular structure related to that of the linear aramids of our interest, in particular PPDT and poly(*p*-benzamide).

These macromolecular compounds have shown some peculiar features which are now under investigation. Because of the high degree of branching and the high number of terminal groups (micellar-like structure), the solubility of these systems resulted increased. GPC measurements in DMF + 3% LiCl have been made and other characterization techniques in solution performed. Furthermore, a functionalization of the terminal groups with both lyotropic units and catalytic sites is in progress.

In this work we present our results on the synthesis and characterization of linear aromatic polyamides and our preliminary data about the hyperbranched structures.

- References:**
- 1) S. Russo, A. Mariani, V.N. Ignatov and I.I. Ponomarev *Macromolecules* 1993, 26, 4984
 - 2) A. Mariani, S.L.E. Mazzanti and S. Russo *Can. J. Chem.* 1995, 73, 1960
 - 3) S. Russo, A. Mariani, S.L.E. Mazzanti, G. Ruggeri and G. Conio *Makromol. Chem., Macromol. Symp.* in press
 - 4) S. Russo, A. Mariani, G. Conio and A. Tealdi to be published

SYNTHONS AS BUILDING BLOCKS IN SYNTHESIS OF HYBRID LIQUID CRYSTALLINE POLYMERS

A. Yu. Bilibin

*Department of Chemistry, Saint-Petersburg State University,
University pr., 2, Peterhof, 198904, Saint-Petersburg, Russia*

Synthesis of linear macromolecules with a predetermined sequence, like the synthesis of proteins and nucleic acids is a major challenge to polymer science that will occupy many years.

The approach based on use of preliminary prepared fragments of macromolecule which incorporate definite sequence of single structural units is considered as very fruitful. First the complex monomers - synthons - containing the triad sequence (*p*-phenylene diamine)-terephthalic acid-(*p*-phenylene diamine) was used for synthesis of "ordered" polyamides by R. Porter /1/ in the late seventies. At the same time syntheses of main-chain liquid crystalline (LC) polymers were started. They required insertion of rather complex chemical structures of low molecular weight (LMW) liquid crystals in polymer chains.

Two approaches worked out formerly were developed and applied to the synthesis of hybrid liquid crystalline polymers. One of them consists in the synthesis of triad type complex acid dichlorides — aroyl-dioxydiaroyl dichlorides. Very simple and standardized procedure of their synthesis enables to vary their structure in a wide range. Another approach deals with synthesis of triad type diphenols with central poly(oxy ethylene) unit. It consists in synthesis of special triad type synthon whose central unit plays a role of bifunctional protective group. Selective hydrolysis of the intermediate polymer prepared from this synthon gives a new triad type synthon whose structure differs from that of starting monomers. Poly(oxy ethylenes) can be used as central units of these synthons. New triad type synthons containing optically active amino acids were prepared as potential carriers of chirality.

Polycondensation of the synthons discussed above gives a wide variety of polymers and multiblock copolymers with definite sequence of several single structural units along rather long repeating unit of these polymers. Investigation of their structure-properties relationships gives new information about the influence of fine chemical structure on thermal behaviour and properties of the polymers.

(1) J. Preston, W.L. Hofferbert Jr., J. Polym. Sci., Polym. Symp., 65, 13 (1978)

DESIGN AND PREPARATION OF MESOMORPHIC BLOCK COPOLYMERS

Emo Chiellini¹, Michele Laus²

*1. Dipartimento di Chimica e Chimica Industriale, Università di Pisa
Via Risorgimento 35, 56126 Pisa, Italy*

*2. Dipartimento di Chimica Industriale e dei Materiali, Università di
Bologna, Viale Risorgimento 4, 40136 Bologna, Italy*

Intensified technological interest is nowadays addressed to the preparation and study of multicomponent polymer systems. These materials are of relevant practical importance because their unique multiphase structure often allows for non-linear and synergistic behavior. Among them, a particular place is held by block copolymers. Block copolymers consisting of incompatible polymer blocks are able to self-assemble into a variety of ordered nanoscale morphologies. Recently, liquid crystalline (LC) block copolymers, that is copolymers incorporating one or more LC polymer segments, have been developed [1] that combine in a single structure the molecular order of liquid crystals and the supramolecular order of block copolymers. The morphologies and phase transitions of these materials should reflect an interplay of different structuring effects, since on the one hand, the immiscibility of the polymer blocks drives a microphase separation, and, on the other hand, the ordering field of the LC mesophase facilitates a spontaneous orientation of the mesogens in a microseparated phase. Several new questions arise relating to how the morphology and the LC phase interact in reaching their respective equilibrium states, or to what extent correlations can be established between the nature and stability of the mesophase of the LC block and the overall topological characteristics of the block copolymer.

In general, there are several synthetic routes to obtain mesomorphic block copolymers as for example the classical living anionic and cationic polymerizations, the relatively new living radical polymerization, the GTP (group transfer polymerization), the use of microinitiators or a combination of these techniques including also polymer analog. Indeed, each of these polymerization techniques presents definite advantages and drawbacks. Their potential in the preparation of mesomorphic block copolymers will be discussed.

1. E. Chiellini, G. Galli, A. S. Angeloni, M. Laus, Trends Polym.Sci., 2, 244 (1994).

**SYNTHESIS OF LIVING POLY(VINYL PYRIDINE) CHAINS AND
THEIR USE FOR CONSTRUCTION OF HOMO- AND HYBRID
POLYMERS HAVING COMPLEX ARCHITECTURE**

Boris L. Erussalimsky, Lyubov A. Fedorova, Stanislav I. Klenin, and Lev A. Shibaev

**Institute of Macromolecular Compounds RAS
Bolshoi pr. 31, St. Petersburg, 199004 Russia**

In the present report are described experimental conditions ensuring the formation of living poly(2- and 4-vinyl pyridine) chains in the vinyl pyridine - allyl derivatives of chromium, molybdenum and tungsten system. Variation of the reagents nature, polarity of the solvent permits to obtain polymers differing in their structural and molecular parameters.

Synthesized polymers contain block and graft sequences, as well as macrocyclic fragments.

Living chains under consideration were applied for polymerization of acrylonitrile. Hybrid polymers obtained by this way were studied in detail by the same methods as the homo polymers.

NEW ASPECTS IN CHEMISTRY AND CHARACTERIZATION OF POLY(ETHYLENE OXIDE) HYDROGELS

Konstantin S.Kazanskii

*N.N.Semenov Institute of Chemical Physics, Russian Academy of Sciences
Kosygina ul. 4, Moscow, 117977 Russia*

Poly(ethylene oxide) (PEO) is one of the most available water-soluble polymers and attracts permanent interest as a base of hydrophilic networks. They are obtained most commonly by the radiation crosslinking of PEO in aqueous media or via the reaction of poly(ethylene glycol) (PEG) with isocyanates. Swelling behaviour of these typical non-ionic hydrogels is reviewed.

To extend the variability of PEO hydrogels in their swelling, ability to chemical reactions as well as possible applications the following new synthetic approaches have been analyzed and elaborated recently.

1. Partly charged PEO networks have been prepared by curing of PEG polyphosphates by the reaction of P-OH groups with diepoxide. They display all the features of swelling behaviour typical of polyelectrolyte networks: the swelling degree varies from 16-95 (water) to 11-45 (0.1 M sodium chloride) and 7-20 ml/ml (0.52 M potassium sulfate as a θ -solvent for PEO). The structure parameters of the network are evaluated from the swelling data. Some anomalies in gelation are observed and discussed. The free P-OH groups of hydrogels can be used for binding of some agents.

2. PEO hydrogels of controlled structure are obtained in aqueous media by radical polymerization of methacrylate macromonomers of various molecular weight (4000-20000) and average functionality (0.99-1.85). The networks prepared are characterized by the measurements of swelling pressure and elastic modulus as well as with the help of luminescent probe. Polymethacrylate chains as multifunctional network junctions are shown to make a significant hydrophobic contribution to the swelling behaviour of these gels. This synthetic procedure has been used in the immobilization of liquid-crystalline particles of DNA, which in turn are considered as microparticles sensitive to the network structure and state.

3. The hydrogels with ionic and reactive groups can be obtained by radical alternating copolymerization of PEO macromonomers (methacrylate, vinyl ether) and maleic anhydride (MA) with simultaneous or subsequent crosslinking. The preliminary results and perspectives of this approach are discussed. As is shown, the hydrogel synthesis is significantly complicated by the reaction of MA with terminal OH-groups of macromonomers even at ambient temperatures.

References: K.S.Kazanskii et al. *Polymer Science*, **35**, 945-951 (1993); *Polymer Gels and Networks*, **4**, 335-349 (1996); *Polymer Science*, **38**, 570-577 (1996); *Vysokomol. Soed. Ser. A*, **39** (in print).

INTELLIGENT NETWORKS BASED ON PEO

**Christo B. Tsvetanov, R. Stamenova, D. Dotcheva, M. Doytcheva
and N. Belcheva**

Institute of Polymers, Bulgarian Academy of Sciences, 1113 Sofia, Bulgaria

Films of PEO and PEO blends can be efficiently crosslinked by UV-irradiation in the presence of hydrogen-abstracting photoinitiator. The UV-irradiation method provides possibilities for the formation of new materials based on PEO.

Ultraviolet induced crosslinking of PEO in the presence of potassium salts (thiocyanate, perchlorate and triflate) as templates showed enhanced cation binding ability for Li^+ and Na^+ cations.

PEO blend with tetraalkylammonium salts produces cationic PEO networks.

Combinations of PEO and poly-N-isopropyl amide, polyvinylmethyl ether, polyvinyl acetate and poly-2-vinyl pyridine subjected to UV cross-linking provide stimuli-sensitive hydrogels (pH and temperature).

The new materials can be effectively used as phase transfer catalysts, drug delivery systems, polymer electrolytes and sensors.

NEW REDOXACTIVE POLYMETHACRYLATES WITH PHENYLAZOANTHRAQUINONE UNITS IN THE SIDE GROUP

J. Springer, M.B. Leitner, R. Ruhmann[†]

Technische Universität Berlin, Institut für Technische Chemie, Fachgebiet Makromolekulare Chemie, Straße des 17. Juni 124, D-10623 Berlin

[†]Institut für Angewandte Chemie Berlin-Adlershof, Rudower Chaussee 5, D-12484 Berlin

Functionalized dye compounds are discussed as organic molecular transducers, which might be used in the computer technology for storing and processing of information. Dynamic systems with combined photochromic and electrochromic properties have higher information processing abilities than systems with only photochromic properties.^[1] Comparing low molecular weight compounds with polymeric systems containing the dye by covalent incorporation the polymers offer some advantages. The material can be used intrinsically as a film without the typical problems of guest host systems like diffusion, separation or sublimation of the dye. Therefore, we synthesized polymethacrylates, which are substituted with the electro- and photochromic phenylazoanthraquinone unit in the side group, applying the radical polymerization.^[2] Polymers consisting of the repeating unit **1** show irreversible behaviour during electrochemical redox reactions, which was indicated by cyclic voltammetrical and spectroelectrochemical investigations of thin films.^[3]

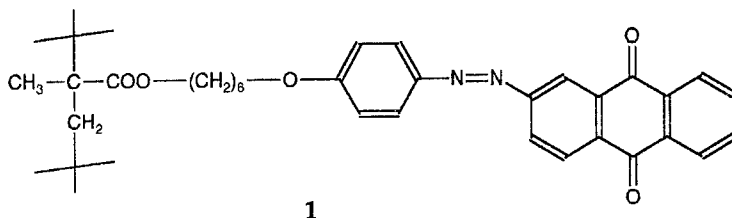

Random copolymers consisting of **1** and methyl- or benzylmethacrylate repeating units showed irreversible processes during the cyclic voltammetric studies of thin films, too, probably due to their low molar masses of $M_n \approx 10\,000$ g/mol. To obtain copolymethacrylates of **1** with higher molar masses, we developed a new polymer reaction method for the esterification of polymethacrylic acid.^[4] Depending on the molar mass, the concentration of **1** in the copolymer and the kind of the comonomer various redox mechanisms were found. Two copolymer systems show reversible redox behaviour in the solid state, which is necessary for the reliable working of chemical transducer systems based on electrochromism. In future, these systems have to be characterized by spectroelectrochemical experiments to prove the electrochromic properties of the materials.

[1] T. Saika, T. Iyoda, K. Honda, T. Shimidzu, *J. Chem. Soc., Perkin Trans. II* **1993**, 1181

[2] M.B. Leitner, R. Ruhmann, J. Springer, *Macromol. Chem. Phys.* **197**, 237 (1996)

[3] M.B. Leitner, R. Ruhmann, J. Springer, *Polym. Adv. Technol.* **7**, 437 (1996)

[4] M.B. Leitner, G. Schinkel, J. Springer, R. Ruhmann, G. Schulz, F.T. Niesel, *Reactive & Functional Polymers*, in press (1997)

**NEW APPROACH TO FORMING POLYMERS ARCHITECTURE USING
FULLERENE C₆₀**

**Vladimir N. Zgonnik, Ludmila V. Vinogradova, Elena Yu. Melenevskaya,
Alexander S. Khachaturov, and Stanislav I. Klenin**

**Institute of Macromolecular Compounds RAS
Bolshoi pr. 31, St. Petersburg, 199004 Russia**

The reaction of living chains with C₆₀ based on the fullerene double bond opening is followed by the polymer chain addition to a cluster. We developed synthetic methods of preparation of fullerene-containing polymers (FCP) with different structures: linear, star and network polymers (polystyrene, polyisoprene, and polyethylene oxide). The FCP structure depends on the nature of living chains (mono- or bifunctional) and the C₆₀/living chains ratio. The synthesis of well-defined, almost monodisperse star FCP polystyrenes with a high degree of molecular and compositional homogeneity was developed.

The C-alkali metal (Mt) bond formed on the fullerene molecule as a result of C₆₀ reaction with alkali metals, alkoxy- and alkyl organometal compounds or living chains is active in polymerization. This activated fullerene is used as polymerization initiator of different monomers (tert-butyl acrylate and ethylene oxide). Star copolymers with different arms (styrene and tert-butyl acrylate) were prepared using this activated C₆₀ as initiator. Network polymer were synthesized by the reaction of activated C₆₀ with poly(N-vinylpyrrolidone).

To obtain water-soluble FCP based on N-vinylpyrrolidone (which does not polymerise by anionic mechanism) free-radical polymerization was used.

It was established that the FCP can form intra- and intermacromolecular complexes. The results demonstrated the C₆₀ ability (both in C₆₀-polymer complex and in FCP) to form associated structures depending on the nature of bonds between fullerene and the polymer chain.

ADDITION POLYMERIZATION OF NORBORNENE AND ITS DERIVATIVES BY NICKEL-BASED CATALYSTS

Kiryll L.Makovetsky, Lyudmila I.Gorbacheva, Tatyana G.Golenko, Galina N.Bondarenko, Irina Ya.Ostrovskaya

*A.V.Topchiev Institute of Petrochemical Synthesis RAS
Leninsky pr. 29, Moscow, 117912 Russia*

It was shown recently that addition type polymers and copolymers of norbornene represent a new class of transparent thermoplastics and may be considered as very promising materials for the use in optical electronics. The first efficient catalysts for preparation of high molecular weight, addition-type polynorbornenes were chiral zirconocenes in combination with methylaluminumoxane proposed by W.Kaminsky in 1989 [1]. Two years later Risse [2] used some particular palladium complexes for the same purpose. Both types of catalysts were rather expensive and had some other drawbacks.

Recently, we discovered that easily available Ni-based systems may be used as active catalysts for the addition polymerization of norbornene and its derivatives [3]. The complexes formed in the interaction of allylnickel chlorides and electronoacceptors as well as nickel carboxylates in conjunction with alkylaluminum chlorides induced norbornene polymerization at room temperature. The high yields of amorphous polymers soluble in chlorobenzene and cyclohexane were obtained. According to IR and NMR spectra, these polymers had completely saturated main chain consisting of bicyclic units. DSC data showed the absence of any glass transitions up to the beginning of thermal decomposition at ~400 °C. As far as NMR spectra of polynorbornene were too complicated for any interpretation, a combination of the experimental and theoretical methods of vibrational spectroscopy was used for the elucidation of the polymer microstructure. It was shown that polymers obtained with Ni catalysts composed preferentially of exo,exo-diads whereas polynorbornenes prepared in the presence of Risse Pd and Zr (not metallocene) catalysts and used for comparison had the chains with exo,endo- and endo,endo-diads, respectively.

Nickel-based catalysts were employed also for addition polymerization of several norbornene derivatives (dicyclopentadiene, tetracyclododecene, 5-decyl- and 5-trimethylsilylnorbornenes, norbornadiene). The activity of these monomers in polymerization as well as molecular weights of polymers produced depended strongly on their conformations. So, endo-dicyclopenta-diene polymerized slowly to give only oligomeric products whereas the polymerization rate of its exo-conformer was comparable with that of norbornene, and polymer obtained had high molecular weight.

[1] W. Kaminsky et al., Proc.Int.Symp.Rec.Dev.Olefin Polym.,Catal., Tokyo,1989, p.425.

[2] C.Mehler, W.Risse, Makromol.Chem., Rapid Commun., 12, 255 (1991).

[3] K.L.Makovetsky et al., Polym.Sci. (Rus), Ser.A, 38, 255 (1996).

ACID-CATALYTIC REACTIONS IN POLYIMIDE SYNTHESIS

Alexander A. Kuznetsov, Boris V. Kotov

Karpov Institute of Physical Chemistry. Vorontsovo pole, 10, Moscow, 103064, Russia

Results are presented of the research having been executed in Karpov Institute with the goal of creation of high efficient one-pot method of polyetherimide synthesis. The key problem was searching for new catalytic system for imidization reaction of trancient polyamic acids (poly-AA).

Analysis of the experimental data on imidization kinetics of several model low molecular and oligomeric amic acids (AA) in concentrated solutions in N-MP at 140-150°C has shown that the dependence of relative imidization rate (% conv./min) vs. AA/N-MP ratio possessed a sharp maximum near the stoichometric ratio 1:1, the imidization rate at the point of the maximum being by an order of magnitude as higher as for diluted solution. A scheme is proposed which includes the opportunity of two reaction channels to occur: the usual one (I) and the catalytic one (II). In diluted solutions and in solid phase experiments with easily evacuation of the volatile products the role of the catalytic channel (II) is low. In a contrary, in high concentrated solutions or in solid phase experiments at the conditions preventing volatile products evacuation the catalytic channel becomes the key one. It is proposed that the catalytic reaction carries out via common acid catalysis mechanism and includes the formation of trancient protonated active complex followed by its transformation and proton transfer with participation of the anion. The fact of the presence of definite region of AA/N-MP ratios in which the imidization rate increases with the increase of solvent content evidently demonstrates that the acting acid catalyst is not AA itself, but rather its stoichometric complex with N-MP or, more probably, the ionic products of its dissociation. The formation of such 1:1 H-bond complexes is well known in literature. It could be thought that the formation of such a complex facilitates the dissociation of AA.

The assumption about "dissociation" mechanism of the catalysis is in accordance with our new experimental data on solid-phase imidization process. It was shown that the water released in a course of the solid phase imidization of phtalamic acid at 140°C at the conditions preventing vaporization causes a sharp autocatalytic effect after initial 20%-conversion induction period to obtain fully imidized product.

One more new variant of acid-catalized process is carrying out the imidization reaction in the melts of aromatic caroxylic acids (benzoic acid etc.), which were found to be exellent solvents for some of the final polyimide products. Carrying out the imidization stage in a catalytic regime has allowed us to overcome the usual difficulties connected with the reversible character of poly-AA formation and to develop new efficient one-pot synthesis of fully imidized high molecular weight polyimides and polyeterimides from corresponding diamines and dianhydrides. One of the most interesting additional effects have been observed was smoothing reactivity of low-and high reactive diamines in acid media. This can be used in synthesis of new copolyimides.

The ring - chain tautomerism and / or isomerism of monomers in polycondensation by electrophilic aromatic substitution reaction.

Sergei N. Salazkin

Institute of Organoelement Compounds, Russian Academy of Science, 28 Vavilov St., Moscow 117813, Russia

In this report we review the investigations of untraditional selective synthesis of high macromolecules by electrophilic aromatic substitution reaction of monomers including to tautomerism and / or isomerism. This is polycondensation of pseudochlorides of o-dicarboxylic acids and o-ketocarboxylic acids :

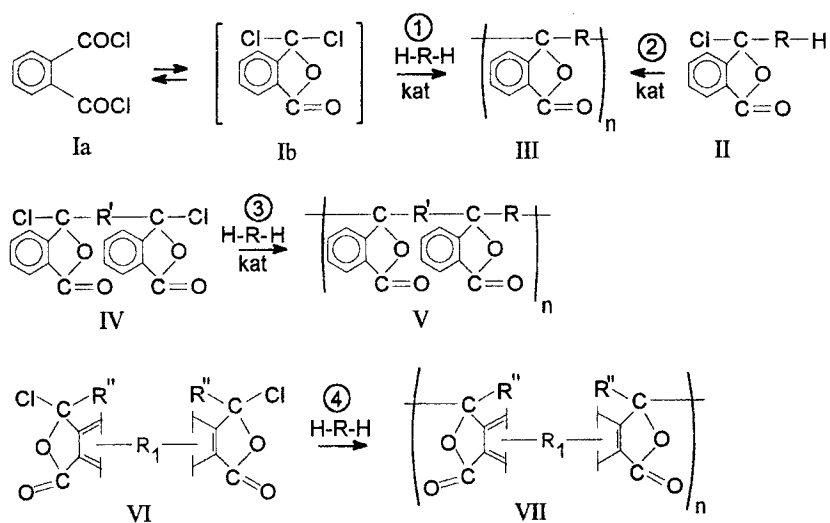

H-R-H and H-R'-H : aromatic nuclear hydrocarbon

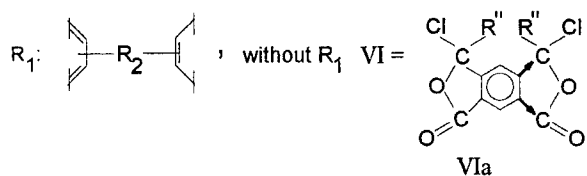

R'' = aromatic radicals, for example phenyl

This is next schemes for isomeric chlorides :

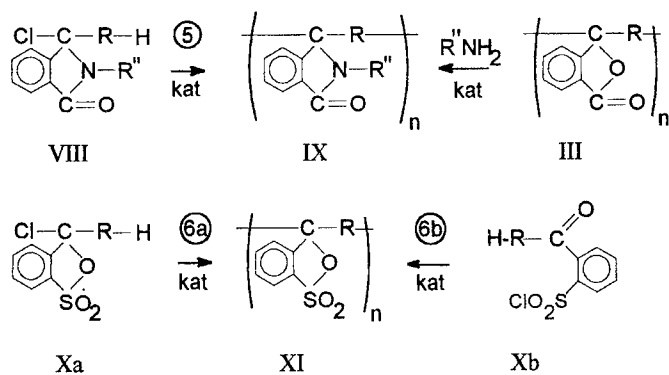

NOVEL APPROACH TO THE CHEMISTRY AND TECHNOLOGY OF HIGH-TEMPERATURE, HIGH-STRENGTH, SELF-HEALING, AND OTHER SPECIALTY THERMOSETTING POLYMERS, ADVANCED POLYMER MATERIALS AND COMPOSITES MINIMIZING ENVIRONMENTAL IMPACT

Boris A. Zaitsev

*Institute of Macromolecular Compounds RAS
Bolshoy pr. 31, St.Petersburg, 199004 Russia*

While significant progress has been made in the research and development of high-temperature and other specialty polymers and plastics with a unique set of properties, simultaneously urgent ecological and processing problems, which are related to their production appear and are still unsolved.

Our investigations have been directing to solution of the following extremely urgent ecological and technical problems:

- A drastic decrease in danger for men engaged in the production and use of high-temperature and other specialty thermosetting polymers (thermosets) causing health hazards and leading to severe carcinogenic, bronchal, allergic, and other diseases.
- A decrease in emissions of toxic volatile by-products resulting in environmental pollution.
- The attainment of excellent processing properties of reactive resins and the high-level maintenance or improvement of the end-use properties of thermosets and composites obtained.

The concept of extraordinary ecologically safe chemistry for high-temperature and other thermosets and advanced composites is proposed. These thermosets are obtained from unusual end-reactive resins not involving any solvents, toxic precursors, and volatile by-products in their easy-processing.

The key idea is the unexpected choice and use of several specific functionalities, such as:

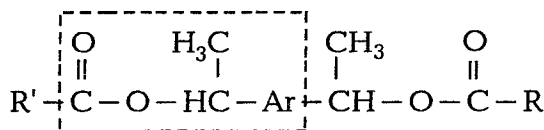

and/or

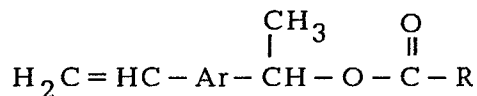

inducing cascades of targeted chemical reactions and resulting in peculiar crosslinked polymers with changeable and controlled structure and a unique set of properties. **The most unusual feature of this approach is the development of transformations of specific inconspicuous ester groups exhibiting temporary flexibility which have never been used in high-temperature polymers synthesis.**

Thus, this approach proposes tailoring different classes of polyfunctional aromatics available in organic, macromolecular, and supramolecular chemistry to a template (pattern) satisfying this concept.

NEW APPROACHES TO SYNTHESIS OF AMORPHOUS AND CRYSTALLINE CARDO POLYARYLENEETHERKETONES

Sergei N. Salazkin, K.I. Donetskii, G.V. Gorshkov, Vera V. Shaposhnikova

*A.N. Nesmeyanov Institute of Organo-Element Compounds of Russian Academy of
Sciences 28, Vavilova Street, V-334, GSP-1, Moscow, 117813, Russia*

The first cardo polyaryleneetherketones (PAEK) have been synthesized by polycondensation of cardo difluoroderivative. This opens wide possibilities for preparation of amorphous polymers having high heat resistance and new properties:

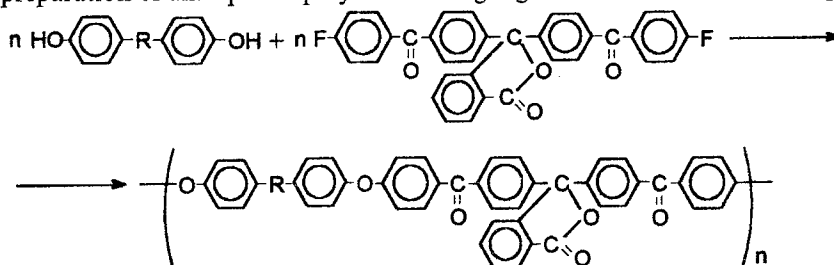

The first crystallizable cardo co-PAEK have been synthesized:

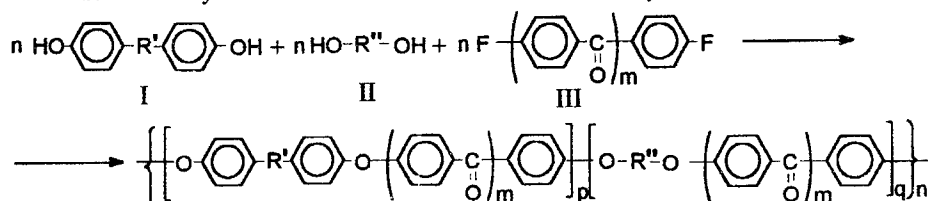

$m=1-4$

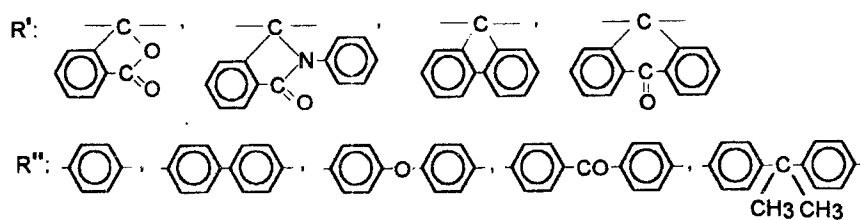

The influence of structure of R' and R'' , m in III, relation p/q on an ability of PAEK to crystallization have been investigated.

Ferrocene-Based Metallomesogenic Polymers

Robert Deschenaux

*Institut de Chimie, Université de Neuchâtel, Av. de Bellevaux 51,
2000 Neuchâtel, Switzerland*

Metallomesogenic polymers (metal-containing liquid-crystalline polymers) are currently a field of intense activity [1]. The combination of the properties of metals (color, polarisability, magnetism, redox activity) with those of polymers (processability) and liquid-crystals (organization) is expected to lead to anisotropic materials which should play a keyrole in the development of new electro-optical devices.

Our interest in the design and study of ferrocene-containing thermotropic liquid crystals [2] prompted us to consider the ferrocene core as a valuable molecular unit to be incorporated into side-chain polymers. Its high thermal stability, good solubility in common organic solvents, three-dimensional structure (which offers the possibility for synthesizing multiple derivatives), and redox activity is expected to lead to promising materials with a view to developing electro-active mesomorphic polymers.

In this communication, we present the design, synthesis, and thermal and mesomorphic properties of ferrocene-containing liquid-crystalline side-chain polysiloxanes [3] and polymethacrylates [4], which are the first metallomesogenic polymers with appended mesomorphic organometallic units. A special attention will be devoted to emphasize the *structure-mesomorphic properties* relationship for this class of polymers, and the key-role played by the three-dimensional structure of the ferrocene unit on the liquid-crystalline phase engineering.

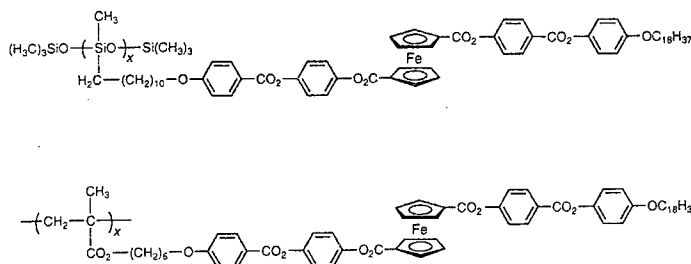

[1] Oriol, L.; Serrano, J.L. *Adv. Mater.* **1995**, *7*, 348.

[2] Deschenaux, R.; Goodby, J.W., in *Ferrocenes*; Togni, A. and Hayashi, T. eds; VCH; 1995; Chap. 9.

[3] Deschenaux, R.; Kosztics, I.; Scholten, U.; Guillon, D.; Ibn-Elhaj, M. *J. Mater. Chem.* **1994**, *4*, 1351.

[4] Deschenaux, R.; Izvolenski, V.; Turpin, F.; Guillon, D.; Heinrich, B. *Chem. Commun.* **1996**, 439.

SYNTHESIS OF SYLOXANECONTAINING BLOCKCOPOLYMERES USING SILICONORGANIC INIFERTERS.

Kireev V.V., Prudskov B.M., Komarova M.U., Korotkov A.K.

Mendeleev University of Chemical Technology of Russia.
(125047, Moscow, Miuskaya Sq. 9)

In order to obtain multiblock siloxane blockcopolymers (SBCP) the polymerisation of styrene and methylmetacrilate (MMA) in presence of α,ω -bis-(chloralkyl)organosiloxanes (CAS) was investigated. It was supposed that CAS can take part in reaction of termination chains and transference during interaction of growing macroradicals with end ClCH₂-bonds of CAS; the initiation was carried out using carbonyls of metals (Mo, Cr, Mn), which are able to generate radicals in reaction with the same ClCH₂-bonds of CAS.

It was shown using bis-(chloromethyl)tetramethyldisiloxane as an example that at conditions of common polymerisation (initiator AIBN) CAS exhibit slightly retarding effect: yield and molecular mass of obtaining polymers decrease and they practically do not contain any silicon.

In the presence of CAS-metal carbonyl system the retarding effect is more sharp, but at carbonyl concentration higher 0.015 mol/l the fraction of autoinhibiting processes begins to increase. At optimum conditions (for styrene 3 $\cdot 10^{-4}$ mol/l Mo(CO)₆, 100°C; for MMA 0.015 mol/l Cr(CO)₆, 80°C) and content of CAS around 5-15% of monomers mass the highmolecular multiblock SBCP are produced, with content 0.5-5.0% of silicon depending from the siloxane chain length of CAS.

The existence of dominating of unimodal character of MMD of curves produced from SBCP was found; molecular mass of SBCP is slightly influenced by conversion, concentration of initiating system and process duration.

Chain transference of CAS in contrast with common radical polymerisation promotes the molecular mass growth due to the reinitiation which leads to the consequent elongation of chains with tail Cl-C bonds. That is why the elongation of vinyl monomers block length in SBCP during the increase of content of CAS in initial mixture takes place.

SBCP on the basis of styrene and MMA with short siloxane blocks are optically transparent, homogeneous substances; for the length of above mentioned blocks more than 15 siloxy-chains the microphase separation takes place. The presence of even significant number of short siloxane blocks in SBCP chains exhibits no influence on the glass-transition temperature of organic blocks, but causes substantial effect on the impact-strength properties of SBCP.

Acknowledgements-This work is sponsored by Russian Fund of Fundamental Research (grant 97-03-32774a).

MACROMOLECULAR DESIGN IN POLYCONDENSATION

**Valerii A. Vasnev, Gali. D. Markova, Svetlana. V. Vinogradova, Vladislav V. Istratov,
Alexander I. Tarasov**

*Nesmeyanov Institute of Organoelement Compounds RAS
Vavilov str. 28, Moscow, 117813 Russia*

The problem of macromolecular design in polycondensation is one of the fundamental problems of polymer chemistry connected with tailor-made polymer synthesis. In the case of non-equilibrium polycondensation this problem was solved on the basis of low-temperature copolyesterification of intermonomer with two comonomers and polyesterification of symmetric monomer with non-symmetric one having "head" and "tail".

It was found that:

-statistical copolymers or "head" and "tail" polymers were formed when all starting monomers are present in solution at the beginning of polycondensation. Deviation from statistical microstructure was determined by variation of the second functional groups activity of intermonomer or symmetric monomer after the first ones has entered to reaction;

-a stepwise introduction of comonomers in polycondensation is not a sufficient condition for block-copolymer formation. The gradual introduction of intermonomer or symmetric monomer in one stage process is a necessary factor for block-copolymer or "head-to-head"/"tail-to-tail" polymer synthesis. The length of block depends on difference in comonomers or "head" and "tail" monomer functional groups reactivity;

-the transition from one stage to two stage and step-by-step copolycondensations significantly extends the available control and enables block-copolymers of appropriate length to be obtained;

-polycondensation in a presence of polymer matrix will be allowed to extend the limits of macromolecular design. Copolymer microstructure depends both type and amount of polymeric matrix.

Mechanism of Regio- and Stereocontrol in Diene Polymerization under the Effect of Lanthanide Catalytic System. The Role of Diene Structure.

Yuri B. Monakov, Zufar M. Sabirov, Vadim N. Urazbaev

Institute of Organic Chemistry, Ufa Division, Russian Academy of Sciences, pr. Oktyabrya 71, Ufa, 450054, Russia

The role of the π - σ -rearrangement in the mechanism of stereoregulation upon of diene polymerization has been investigated.

It was established that in cases where the terminal unit of the growing polymer chain has the form of a stable π -allylic structure (i.e., when the time spent by the terminal unit in σ -form is much shorter than the characteristic time of the elementary act of insertion), only the **cisoid** conformer of diene molecule can convert the terminal unit from π - to σ -form and then insert into the metal-carbon σ -bond. During the insertion, the active centre remains in the σ -form. This result does not depend on the overall geometry of the active centre (i.e., whether it is octahedral, tetrahedral, etc.) and is explained exclusively by the presence of a stable, long-lived π -allyl terminal unit. It has been assumed that it is the latter factor, i.e., the presence of a long-lived terminal unit, that explains the fact that in some cases polydienes are formed with an exceptionally high content of **cis**-units.

Regioselectivity by piperylene polymerization (addition of 1,4-units as "head-to-tail") is caused by the fact, that with metal-carbon σ -bond of active centre interacts only diene double bond without methyl substituent. The participation of piperylene double bonds having methyl substituent in insertion reaction is hindered considerably because of steric repulsion between terminal unit methyl groups in growing chain and in diene. An increased life time of active centre in σ -form, in which Nd atom is bounded with C_γ -atom resulting in higher content of 1,2- and 1,4- in polypiperylene is caused by lower energetic difference between two σ -forms of terminal units in piperylene polymerization (comparing with butadiene). Both high regioselectivity by isoprene polymerization and the absent of 1,4-trans-units in polymer is caused by hindered rotation of isoprene $C(CH_3)=CH_2$ double bond in a complex with active centre.

THE CONTROLLED RADICAL POLYMERIZATION OF VINYL MONOMERS IN THE PRESENCE OF ORGANOMETALLIC COMPOUNDS AS THE LIVING POLYMERIZATION

Dmitry F.Grishin, Alexey A.Moykin, Ilij S.Ilichev

*Research Institute of Chemistry, Lobachevsky State University,
23 Gagarin Av., Nizhny Novgorod, 603600 Russia*

Homo- and especially copolymerization of different vinyl monomers in the presence of organometallic compounds (OMC) of group II, III and V elements has been studied.

It has been shown that some OMC form complexes not only with monomers but with growing macroradicals too and thus take immediate part in growing chain stage. Such interaction enhances the electron-accepting properties (electrophilicity) of the growing macroradical and increases its reactivity relative to the double bond of the monomer. This increases the propagation rate constant.

The organometallic compounds of II, III and V group elements exert most accelerating influence on the polymerization of butyl acrylate, acrylamide and acrylonitrile. The rate of polymerization of unpolarized monomers (alkenes, dienes and styrene) in the presence of nontransitional organometallic compounds of group II-V elements does not increase.

In contrast to metal halides (Lewis acids), organometallic additives have a catalytic effect on chain propagation when they are introduced into the system in amounts comparable to the initiator concentration (0.01-1.0 mol.% relative to monomers).

Taking into account the foregoing, one may postulate that the same OMC molecule, functioning as a complex forming agent, can participate in several consecutive chain propagation stages, permanently retaining the growing macroradical in its coordination sphere. Chain propagation then occurs in a six-membered reaction complex, which includes the growing macroradical, the monomer, and the complex forming agent.

The catalytic amounts of some OMC exert an active influence not only on the rate of polymerization of polar vinyl monomers but on the composition of copolymers too. In the presence of organoelement compounds the composition curve of different copolymers (for example, methyl methacrylate - methacrylic acid, butyl acrylate - methacrylic acid, vinyl acetate - acrylonitrile) is S-shaped and relative reactivities of both monomers are significantly less than unity. The product of the copolymerisation constants tends to zero, which indicates the alternation of the monomer units in the copolymer.

Such polymerisation may be regarded as one of the original examples of the living radical polymerisation.

DESIGN OF NEW CHIRAL LIQUID CRYSTALLINE (LC) POLYMERS AND LC DENDRIMERS WITH TAILORED SUPRAMOLECULAR STRUCTURE

Valery P. Shibaev

*Chemistry Department, Moscow State University,
Vorob'evy Gory, Moscow, 119899 Russia*

In the past two decades there has been a lot of interest in research committed to the synthesis and study of side chain liquid crystalline (LC) polymers. A large number of LC polymers with different molecular architecture have been synthesized and studied [1,2]. At the present time new LC systems include more and more complex and, as a rule, more sophisticatedly organized objects, in particular, multifunctional LC systems, such as metal-containing LC polymers, photochromic and ionogenic LC polymers, LC ferroelectrics, LC networks, LC dendrimers etc.

In this talk we present and discuss our recent data concerning synthesis and study of two new types of chiral LC polymers and LC dendrimers.

Today, chirality has become one of the most important topics in liquid crystal research, that is explained by the several factors. First of all the chiral compounds play the important role in the functioning of biological objects; secondly, synthesis of chiral LC synthetic polymers brightly has shown the prospects of their application in designing new promising materials such as ferroelectrics, cholesterics, pyro- and piezoelectrics, etc [3]. And finally the discovery of new mesophase types in the liquid crystals and LC polymers (e.g. blue phases, twisted smectics and other types of helical structures (Twist Grain Boundary-Phases) also stimulated the great scientific interest to these unusual helicoidal structures.

The first part of the talk is concerned with the synthesis and study of the two novel families of menthyl- and binaphthyl LC side chain polymers, chirality of which originates from the asymmetric carbon atom existence (menthyl derivatives) and the so-called atropisomerism of binaphthyl-containing polymers. In the latter case chirality is result from restricted rotation about the C-C bond connecting the two naphthalene rings; this leads to two optical antipodes (*cisoid* and *transoid*) defined by the dihedral angle between the two naphthyl moieties.

The synthetic pathways of preparation of a novel series of optically active menthyl and binaphthyl acrylic monomers of the various structure (with different spacer length, and the length of rigid aromatic fragments in the side chain) were elaborated and realized.

On the base of these chiral monomers and nematogenic methoxy-phenylbenzoate acrylic monomers a several series of new chiral copolymers were synthesized and their supromolecular structures were studied. The phase diagrams and temperature ranges of LC phase formation as well as mesophase types of copolymers (chiral N^* , N_B^* , S_A^* , blue phases etc.) were determined.

The optical properties of all chiral compounds, helical twisting power (HTP) of different chiral units and temperature dependence of HTP were studied and interpreted.

A new approach to the synthesis of polysiloxane and polycarbosilane LC dendrimers was elaborated and molecular packings of these compounds were analyzed.

This research was supported by RFFR (grant 96-03-33820 and HCM Programme of the EC Commission (PECO 940602).

REFERENCES:

1. Liquid Crystal Polymers (Ed. by Plate N.A.) Plenum Press, New York-London, 1993
2. Liquid Crystalline and Mesomorphic Polymers (Ed. by Shibaev V.P. and Lui Lam), Springer-Verlag, New York, 1994
3. Polymers as Electrooptical and Photooptical Active Media (Ed. by Shibaev V.P.) Springer-Verlag, Berlin-Heidelberg, 1996

INCORPORATION OF C60 INTO POLY(METHYL METHACRYLATE) AND POLYSTYRENE BY RADICAL CHAIN POLYMERIZATION PRODUCES BRANCHED STRUCTURES

Warren T. Ford^a, Tammy Graham^a, Thomas H. Mourey^b

a. Department of Chemistry, Oklahoma State University, Stillwater, Oklahoma, 74078, USA

b. Analytical Technology Division, Research Laboratories B-82, Eastman Kodak Company, Rochester, New York, 14650-2136, USA

Polymerizations of styrene and methyl methacrylate (MMA) containing 1 weight percent C60 initiated by 5 or 10 moles of azobis(isobutyronitrile) (AIBN) per mole of C60 in 1,2-dichlorobenzene (oDCB) solution produce brown polymers in 41-97% yield with all of the C60 incorporated and linear polystyrene equivalent molecular weights measured by size exclusion chromatography (SEC) of $M_n = 14000-42000$ and $M_w/M_n < 2$. There is no significant induction period before MMA polymerization and only a short induction period before styrene polymerization. All of the C60 is incorporated into polymer after low conversion of monomer. Multidetector SEC analyses measured polymer mass by differential refractive index (DRI), M_w by two angle laser light scattering (TALLS), intrinsic viscosity by differential viscometer, and mass of only C60 derivatives by UV at 270 or 330 nm. Molar chromatograms calculated from experimental chromatograms show that the high end of the molecular weight distributions all contain C60 and that the lower end contains sizeable amounts of linear polymer. The high molecular weight polystyrenes contain as many as 10-100 C60 units, but the high molecular weight PMMAs contain only an average of one C60 unit per macromolecule. All of the polymers have lower intrinsic viscosities and higher M_w than linear standards of the same retention volume. Calculations from a random branching model of Zimm and Stockmayer indicate that the PMMAs have an average branch number of 5 over the entire molecular weight distribution and systematically increasing average branch lengths with increasing degree of conversion. In contrast, the polystyrenes have an average branch number of 3 in the range of $M = 10^4-10^5$ and rapidly increasing branch numbers at higher M . We propose a model in which the C60 is first incorporated by addition of initiator and polymer radicals to C60, the C60 radicals propagate by additions to C60 and C60 derivatives, C60-C60 bonds break homolytically to reduce the number of C60 units per macromolecule at higher conversions, C60-to-polymer C-C bonds cleave reversibly to allow controlled radical polymerization, and eventually the C60 units have an average of 6 bonds to alkyl groups. The model is consistent with reasonable values of microscopic rate constants for the individual steps.

EFFECT OF CHAIN ARCHITECTURE ON THE MORPHOLOGY AND PROPERTIES OF MODEL TELECHELIC IONOMERS AND RELATED SYSTEMS

**Valerii V. Shilov, Valerii V. Shevchenko, Yurii P. Gomza, Nina S. Klimenko,
Stanislav D. Nesin, Sergii I. Skiba**

**Institute of Macromolecular Chemistry, National Academy of Sciences,
Kyiv, Ukraine**

Telechelic ionomers and related model polymers with charged groups arranged in an appropriated pattern are the convenient model compounds for the more complex ionomer systems [1,2]. Over the past 2 decades there have been intensive studies directed at understanding the relationship between ionomer chain and counter ion characteristics with the ion aggregation. In this connection special attention has been paid to the synthesis and characterization of corresponding model compounds including the simplest short linear chains end-capped by an ionic group [3,4]. The small-angle X-ray scattering (SAXS) patterns exhibit a characteristic maximum or a so-called "ionomer peak" at a scattering corresponding to Bragg spacing of 2-6 nm. This peak is the most direct evidence of the ionic aggregation in the model halato-telechelic polymers and related ionomers. The values and regularity of the ionic aggregate arrangement have been determined as a function of counter ion species, degree of neutralization, swelling by both polar and nonpolar solvents, molecular weight, and temperature. However, until present time, effect of disposition of ionic groups (disposed bilaterally along the chain or centrally located) has not been studied.

Ionic-group-terminated oligoethers of various chain lengths, oligoethers with centrally located ionic groups and related long chain ionomers have been synthesized. Infrared spectroscopy (IFS), differential scanning calorimetry (DSC) and SAXS techniques have been used for characterization of the model ionomers.

The experimental data shows that the halato-telechelic short chain ionomers are characterized by a less pronounced ionic aggregate morphology than ionomers with centrally located ionic groups. A long chain ionomer based on the ion-containing model oligomers are morphologically close to the latter.

1. Moudden A., Levelut A.M. *J. Polym. Sci.: Polym. Phys. Ed.*, 1977, 15, 1707
2. Broze G., Jerome R., Teyssie Ph. *J. Polym. Sci.: Polym. Lett. Ed.*, 1981, 19, 415
3. Williams C.E., Russel T.R., Jerome R., Horrión J. *Macromolecules*, 1986, 19, 2877
4. Johansson R., Chassenieux Ch., Durand D., Nicolai T., Vanhoorne P., Jerome R., *Macromolecules* 1995, 28, 8504

**LIQUID CRYSTALLINE POLYESTERS AND CYCLIC OLIGOESTERS
WITH MAIN-CHAIN ORTHO-LINKED UNITS SUBSTITUTED WITH
ALKYL SIDE CHAINS.**

Fernando Navarro

*Química Orgánica, Escuela Universitaria Politécnica de Huesca, Universidad
de Zaragoza, Ctra. de Zaragoza, s/n, 22071 Huesca, Spain.*

A new serie of soluble, low transition temperature, high molecular weight ($M_n=20.000$) main-chain liquid crystalline polyesters and their related LC model compounds were synthesized and characterized by FTIR, ^1H NMR, gel permeation chromatography (GPC), DSC analysis and hot-stage polarized microscopy. These polyesters were formed by the polycondensation of 4,4'-[1-10-Decamethylenebis-(oxy)]bis(cinnamic acid) with monosubstituted catechols which are alkyl esters of 3,4-dihydroxybenzoic acid. Low molecular weight compounds extracted from the mixtures of reaction of these polycondensations had been identified by ^1H NMR and GPC as being cyclic dimers and tetramers. These cyclic oligoesters are thermotropic and formed nematic mesophases stable over broad ranges of temperature. The cyclic tetramers display mesophases whose isotropization temperatures are higher than that of their linear high molecular mass homologues.

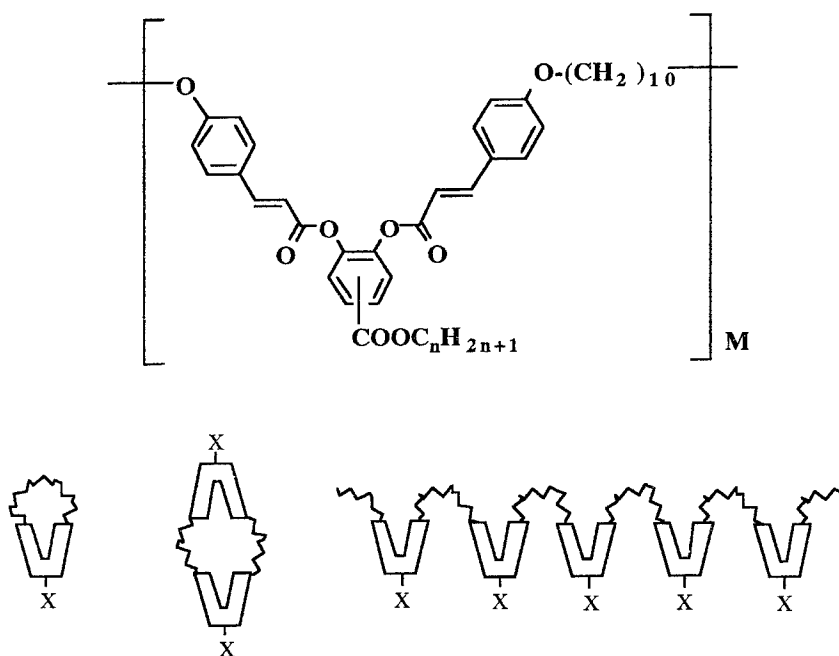

Figure. (a, top) Illustration of the structure of the U-shaped rigid units of these oligoesters and polyesters. (b, bottom) Schematic illustration of the structure of the cyclic dimers, cyclic tetramers and linear polyesters in which the mesogenic units are represented as "U" with a side chain represented by X. ($X = \text{COOC}_n\text{H}_{2n+1}$. $n = 1,2,3,4,5,6,7,8,9,10$ and 11).

CYCLIZATION REACTION DURING THE SYNTHESIS OF AROMATIC POLYFORMAMIDINES

**Christoph Kunert, Hartmut Komber, Dieter Jehnichen, Dieter Voigt,
Frank Boehme**

Institute of Polymer Research, Hohe Str. 6, D - 01069 Dresden, Germany

Cyclic formamidines can be synthesized by the solution condensation reaction of 2,6-diaminopyridine with triethyl orthoformate (TEOF). The reaction between the structurally similar monomer 1,3-phenylenediamine and TEOF results in an oligomeric polyformamidine. (1)

Here we present the condensation reaction of

- 1,3-phenylenediamine (a)
- 2,6-diaminopyridine (b)
- 2,4-diamino-6-methyl-1,3,5-triazine (c)

with TEOF.

The ratio of cyclization and polymerisation differs with the heteroaromatic character of the diamine.

The steric hindrance between the aromatic ring and the formamidine group in case of (a) forces the molecule into a conformation that makes cyclization impossible. The reaction leads to a polycondensate. In case of (b) this steric hindrance does only exist in two directions. Hence cyclization is favoured. In case of (c) no steric hindrance is displayed by the 2,4-diamino-6-methyl-1,3,5-triazine. Neither cyclization nor polycondensation is favoured and the reaction product is a mixture of a polycondensate and a cyclic trimer.

Reference:

(1) - F.Boehme, M. Rillich, H. Komber, *Macromol. Chem. Phys.* 196, 3209-3216, (1995)

**SYNTHESIS OF NOVEL BLOCK COPOLYMERS THROUGH ELECTRON
TRANSFER SYSTEM BY SmI₂**

Takeshi Endo, and Ryoji Nomura

*Research Laboratory of Resources Utilization,
Tokyo Institute of Technology
Nagatsuta, Midori-ku, Yokohama 226, Japan*

Transformation of growing centers enables the formation of block copolymers consisting of plural types of monomers with different polymerization mechanisms. The traditional transformations, however, require complicated multistep paths and often result in multimodal polymers due to the low transformation efficiency. The authors would like to report the simplest and the most convenient method for the transformation of a cationic growing center into an anionic one through the electron transfer process induced by samarium iodide (SmI₂).

One of our approach relies upon the reduction of the growing center of living poly(THF) by SmI₂. This novel method enabled the quantitative two-electron reduction of the growing center into a terminal carbanion (Scheme, **path A**). The terminal carbanion reacted with a variety of electrophiles; the formal end capping of a cationic polymerization with electrophiles was accomplished. The produced terminal carbanion initiated the polymerization of ϵ -caprolactone, δ -valerolactone, and *tert*-butyl methacrylate with quantitative initiation efficiency, leading to the selective formation of the corresponding block copolymers. The most superior point of this transformation to the traditional ones is that the one-pot polarity inversion of the growing center proceeds quantitatively under mild conditions.

The control of the reactivity of the terminal nucleophile is also feasible by the appropriate design of this transformation reaction. For instance, the end capping of living poly(THF) with *N-tert*-butylaziridine or sodium 2-bromoisobutyrate followed by the reduction with samarium iodide gave terminal samarium amide or enolate, respectively (**paths B and C**). They were active for the polymerization of methyl methacrylate, whereas the terminal carbanion obtained by **path A** could not. Especially, the high efficiency of the transformation into the terminal enolate is capable of the selective formation of the block copolymer of THF with MMA with low polydispersity.

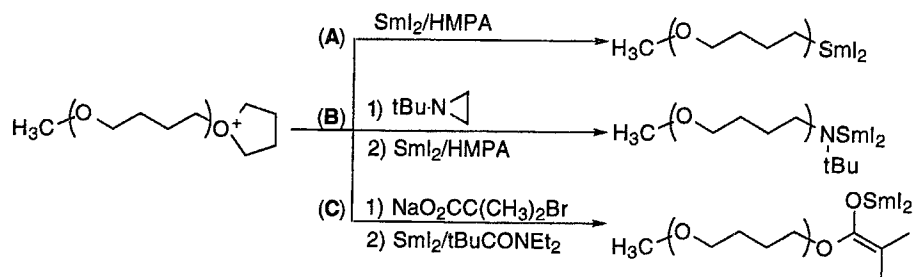

"LIQUID CRYSTAL" THERMOSETS FROM MESOGENIC DICYANATES
 - ORGANISATION, KINETICS AND NETWORK FORMATION -

Werner Mormann, Christian Kuckertz

Universität-GH Siegen, Laboratorium f. Makromolekulare Chemie,
 Adolf-Reichwein-Str. 2, D-57068 Siegen, Germany

Cyanates are of commercial interest as thermoset polymers due to a number of useful properties. The clean cyclotrimerisation reaction, the ease with which this reaction can be monitored e.g. by infrared spectroscopy make cyanates probably the best suited model networks for highly cross-linked materials.

Three monomers were used to study the phase behaviour, the reaction kinetics, the network formation (critical conversion) and their mutual influence. The triaromatic monomers have an enantiotropic nematic mesophase, while the diaromatic monomer 1 melts to an isotropic phase.

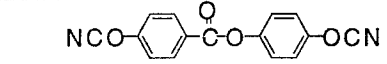
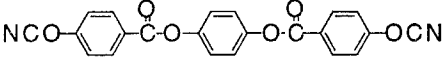
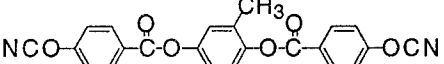
No.	Monomer	T _m / °C	T _i / °C
1		138	i -
2		196	n 237
3		187	n 212

The reaction kinetics of the cyclotrimerisation was studied for all monomers. Different reactivity of the two cyanate groups in 1 was found, while clean first order kinetics were observed for the two triaromatic dicyanates proving equal reactivity of the two cyanate groups.

Monomer 2 undergoes a mesophase transition from nematic to smectic, if it is cyclotrimerised under isothermal conditions. This transition is accompanied by an increase in reaction rate, while monomer 3 reacts uniformly in the nematic phase.

The gel point of cyanurate networks from all monomers was studied and gave surprising results. Due to the different reactivity of the cyanate groups of 1 the chemical gel point was found to be at 62 % conversion in agreement with prediction on the basis of the kinetic analysis. This is close to the transition from the isotropic to the nematic phase at a curing temperature of 160 °C. The gel point as determined by rheology shows temperature dependence. This is explained by some kind of pretransitional association, which increases the apparent functionality and molecular weight, causing gelation to occur at lower conversion.

The networks from the two triaromatic monomers have gel points at 50 % conversion in agreement with theory and independent of the type of mesophase formed. The nematic/smectic transition of 2 which occurs at roughly 30 % conversion has no effect on the gel point in the rheological experiment.

W. Mormann *Trends in Polymer Science*, **3**, (8) 255 - 261 (1995)

W. Mormann and J. G. Zimmermann *Macromolecules* **29**, 1105 (1996)

NOVEL BRANCHED BLOCKCOPOLYMERS FROM POLY(VINYLPYRIDINE) BY CHROMIUM ALLYL COMPOUNDS

Novakov P.¹; Kuckling D.¹; Fedorova L.²; Adler H.-J.¹

¹ Institute of Macromolecular Chemistry and Textile Chemistry,
Dresden University of Technology, D - 01062 Dresden, Germany

² Institute of Macromolecular Compounds,
Russian Academy of Sciences, Bolshoi Prospect 31, St. Petersburg W - 4, Russia

Polyvinylpyridines activated by *tris* (π - allyl) chromium (TPC) and by *tetrakis* (π - allyl) tungsten (TPT), complexed with tetrahydrofuran, were used for grafting with dimethyl acrylamide (DMAA) and *tert* - butyl acrylate (t - BA).

TPC and TPT complexes were formed in the course of the syntheses by the interaction of the corresponding metal chlorides with allyl magnesium chloride in tetrahydrofuran/diethyl ether (1). The activation of poly(vinylpyridine) (PVP) was carried out in toluene by TPC and TPT under argon at a room temperature. This reaction leads to the formation of (π -N - Mt) complexes. The complete interaction between the reagents in the activation stage was assured by the long reaction times. These active forms (π -N - Mt) were able to react with polar compounds (DMAA, t-BA) (2). The mechanism of the activation stage is shown below through the example of PVP activated by TPC („grafting from,- method).

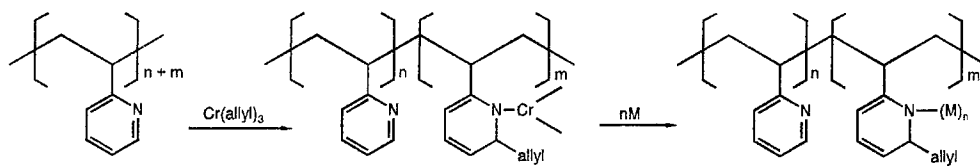

where $M = \text{DMAA}, t - \text{BA}$.

Another possibility for the formation of graft copolymers is to polymerise DMAA with TPC before reaction with PVP („grafting onto,-method).

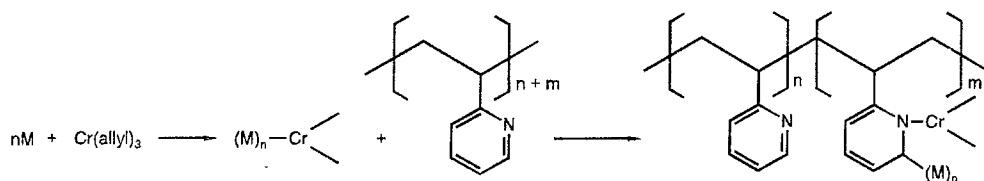

The products were characterized by ¹H NMR, DSC and their intrinsic viscosities.

References

- (1) B. L. Erussalimsky, L. A. Fedorova, L. V. Vinogradova, S. I. Klenin, I. A. Baranovskaya, M. Beck, *Makromol. Chem., Suppl.* **1989**, *15*, 39 - 47.
- (2) L. A. Shibaev, T. A. Antonova, S. I. Klenin, L. A. Fedorova, P. P. Novakov, D. Kuckling, H.-J. P. Adler, *Zn. Prikl. Khim. i Phis.* in press.

ON STRUCTURAL EFFECTS IN MATRIX POLYCONDENSATION

Ivan M.Papisov

*Moscow State Automobile & Road Technical University,
Leningradsky Prosp. 64, Moscow, 125829 Russia*

In conventional matrix polycondensation, matrix control over the growth of a daughter chain turns out possible after mutual recognition (i.e. formation of relatively stable complex) of a matrix chain and species able to participate in the growth. In case of polyfunctional monomer(s) the last may be (with decrease in the energy of interaction ΔG_I between structural unite of matrix chain and that of the specie) either monomers or grown independently on the matrix short linear oligomers, branched and/or cyclocontaining chains, and even particles (microgels).

The lower polymerization degree of recognised species, the higher the portion of elementary acts of propagation taking place under control of the matrix. If the matrix is able to controle the direction of the acts thus affecting chemical structure of growing chains, the variation in ΔG_I provides to change the perfectness of the controle and, then, to obtain daughter polymers of various chemical structures using the same sistem matrix - monomer(s).

The topology of daughter chain should reflects that of the species having been recognised. Then, the variation in ΔG_I (e.g., by change in the reaction medium or temperature) provides, theoretically, to obtain linear, branched/cyclocontaining or even bead-like daughter macromolecules.

The possibility of control of as chemical structure so topology of daughter macromolecules provides variation in composition, structure and properties of interpolymer complexes (or composites including the complexes) which can be prepared using matrix polymerization technique. This is demonstrated using experimental data concerning matrix polycondensation of silicic acid and available in literature data dealing with matrix polycondensation of other monomers.

Taking as an example matrix polycondensation of silicic acid in benzene solutions of poly(ethylene glicole), the effect of concentration of the matrix on structural organisation of products including respective interpolymer complex and the excess of the matrix is considered. The organisation is shown to be dependent on whether the initial solution of the matrix was dilute or semidilute. Dalute solutions are favorable to formation of mixtures of insoluble stoichiometric interpolymer complex and the matrix. In semidalute solutions, due to crossover of matrix chains, the particles of final product represent micels composed of the complex as compact nuclei and free fragments of matrix chains providing the lyophilicity of the product. At initial concentrations of the matrix not highly exceeding the crossover concentration, transparent solutions are formed in the end of the process, but at moderately high, transparent gels.

The work was supported by the Russian Fondation for Fundamental Investigations, project 96-03-32133.

MACROCYCLISATION IN CHEMISTRY OF AROMATIC SULFUR-CONTAINING POLYMERS

Vladimir I. Nedel'kin

*A.N. Nesmeyanov Institute of Organoelement Compounds Russian Academy of
Sciences, 28, Vavilov Str., 117813 Moscow, Russia*

Investigation of cyclic aromatic oligomers was initiated several years ago to determine whether aromatic macrocycles might be useful as polymerizable monomers for the preparation of high molecular weight thermoplastics. So, Brunelle has developed the process for preparation of bisphenol A cyclic oligomeric carbonates and industrial polycarbonate on their base. Macrocyclic phenylene sulfides (MPS) were first detected by mass-spectrometry in the low-molecular-weight polycondensation products of 1,4-dichlorobenzene with sodium sulfide and have received little attention. From the low-molecular weight products of this reaction we have separated a number of MPS containing 3-8 phenylene sulfide units. Structure of cyclotris- and tetra-1,3-phenylene sulfides, cyclotetra- and penta-1,4-phenylene sulfides, cyclohexa-, hepta- and octa-1,4-phenylene sulfides and cyclotris (4,4'-benzophenone sulfide) were confirmed by X-ray diffraction analysis. The diversity of observed conformations of these macrocycles of the general formula $[-(C_6H_4-S)]_{n-1}$, when $n > 5$, indicates that there are no noticeable steric strains connected with the high flexibility of the sulfide linkages and favors macrocyclization processes. The ratio of linear polymer and MPS can vary by polymerization conditions. The relative role of macrocyclization in the synthesis of poly(arylene sulfides) is so great, that under certain conditions macrocyclization predominates over linear polycondensation and the yield of the individual macrocycles reaches 73%. It has been founded that tendency to macrocyclization in the polycondensation of dihaloarenes with Na_2S depends on such factors as: 1) isomerism of aromatic moieties and their number; 2) presence of other "bridges"; 3) synthesis conditions. Polymerisability of macrocycles in different conditions (nucleophilic attack, high temperature, mechanical deformation etc.) is also studied. The equilibrium macrocyclization-polymerization in chemical, thermo- and mechanochemical destruction processes of aromatic polymers has been ascertained. It was discussed there is dependence between aromatic polymers stability to certain kinds of destruction and relative stability of macrocycles formed: with increasing of the latter the destruction degree grows.

YOUR SOURCE FOR HIGH TEMPERATURE PERFORMANCE
Thermcraft
incorporated



TURN UP THE HEAT

THERMCRAFT HAS THE FURNACES, HEATERS AND COMPONENTS TO MEET ALL OF YOUR CERAMIC AND INDUSTRIAL NEEDS

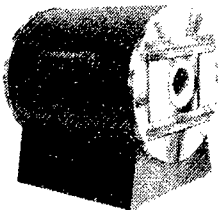

• **Horizontal Solid Tube Furnaces** featuring bored ends to accept ceramic process tubes are available in single and three zone.

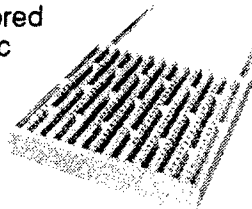

• **Fibercraft Heaters** are available in temperatures up to 1204°C and can be designed to meet your custom specifications.

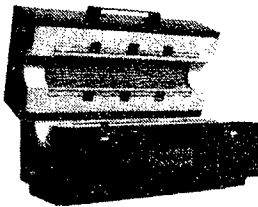

• **Hinged Split Tube Furnaces** feature silicon carbide elements for temperatures up to 1500°C. These systems can be used for vertical or horizontal operation.



• **Ceramic Heaters** featuring various insulating packages.

CALL TODAY FOR COMPLETE PRODUCT INFORMATION AND CATALOGS

P.O. Box 12037 • Winston Salem, NC 27117
Phone 910-784-4800 • Fax 910-784-0634



POLYIMIDES DERIVED FROM MULTIFUNCTIONAL REACTIVE PRECURSORS.

Arlen Y. Volozhin, Elvira T. Krutko, Alexander P. Solntsev

*Institute of Physical Organic Chemistry Belarus Academy of Sciences
13 Surganov St., Minsk 220072, Republic of Belarus*

This paper describes synthesis of aromatic polyamines, oligoaminephenylenes (OAP) and their use in obtaining both the filmforming polyimides and oligoimidephenylenes (OIP) utilized for linear polyimides chemical modification. In the synthesis of OAP a mixture of oligomers with a wide MW distribution is formed. OAP was synthesized by high temperature polycondensation of p-aminephenol. The OAP fraction used to synthesize polyimides has the following characteristics: melting point 190-200°C; average molecular weight - 350-370; content of aminogroups -4,3/mole; concentration of paramagnetic centres - 5×10^{18} spin/g. OAP used as monomers and comonomers were characterized by polyfunctionality, conjugation system of aromatic cycles and absence of aliphatic groups and „pin-joint” heteroatoms. It was assumed that the above-mentioned features of OAP will allow obtaining cross-linked polymers of higher thermostability and strength on their base. The cross-linked polyimides containing units may be obtained by two methods: using OAP as a comonomer for the polyimide synthesis and incorporation of OIP containing reactive groups in the polyamic acid solution before thermal imidization. This paper describes both these methods, their advantage and shortcomings as well as properties and application of the obtained polymeric materials. OIP were synthesized by a two-step method on the reaction of OAP acylation with maleic (OIP-1) and nadic (OIP-2) anhydrides respectively followed by chemical cyclodehydration with acetic anhydride. The isotropic polyimide films were obtained by casting the 6-10% polyamic acid solution in DMF on glass substrates. After the solvent was partially removed under vacuum, the films were removed from substrates and subjected to the thermal imidization under vacuum with the temperature gradually increased from 100 to 350°C for 2-4 hours.

Under the thermal treatment of polyamic acid films containing OIP besides the cyclodehydration in the polymer-OIP system series of reactions are possible to occur including the reactions of OIP homopolymerization and nucleophilic addition of amide and end-aminogroups of polyamic acid to OIP double bonds. It may result in polymer molecular weight increasing due to both of end-aminogroups addition and the network structure formation.

Both methods of oligophenylene units incorporation into polyimide results in obtaining of polymers with three-dimensional structure possessing higher strength and thermostability.

The tests showed that OAP offer promise and can be used as comonomers in the synthesis of polyimides. By using OAP the filmy polyimide materials have been prepared having higher strength characteristics, thermo- and chemical stability. The data obtained are explained by the chemical structure features of OAP leading to formation of cross-linked polyimide due to intermolecular bonds formed with participation of free aminogroups.

The developed polyimides containing oligoimidephenylenes may find application in the microelectronics industry to obtain polyimide materials with controllable complex of exploitation properties (filmy materials having exclusively high resistance to acids and alkalies with high adhesion to semiconductor supports).

NEW METHODS OF PROGNOSTICATION OPTIMUM CONDITIONS OBTAINING OF OPTOELECTRONIC MATERIALS ON THE BASIS OF ACRYLATES AND EPOXY

E.S.Klimov, O.A.Davidova, V.I.Filonenko

Ulyanovsk State University, L.Tolstogo Str., 42, Ulyanovsk, 432700, Russia

The direct observation paramagnetic particles is the better evidence of effectiveness initiator system by the radicals photo-thermopolymerization. The function of the dioxide in the generation active radicals practically unknown, that it is very important for prognostication conditions obtaining of polymer materials.

The mixture containing dimethylacrylat of triethylenglycole, trimethylolpropantriacylat, diacrylat of the diglycyl ether of dioxipropyldiphenylolpropan was harden by application of model binary photoinitiator (isobutyl ether of benzoine-tetramethyl phenylendiamine) for obtaining of glasses with high coefficients of refraction. Generation of active radicals to studied by the ESR method on the concentration death of 2,2',6,6'-tetramethyl piperidone-1-oxil in dioxide presence and in vacuum. For fixation of short-life radicals was applied method of spin trap (in solutions of 2,4,6-tri-tret-butylnitrozobenzol).

From the kinetic data it follows, that efficiency of generation active radicals is the more order on air than in vacuum. Propose scheme of process includes stage obtaining of triple transitional superoxide complex, in that the disactivation of electronically excited state occurs by means of unreversible electronic transfer from amine to ether of benzoine through anion-radical of dioxide.

Analogous approach was applied for optimization of solidification conditions of epoxy monomers containing no fragments with unlimited bonds. As a basis diglycidic ether of diphenylolpropane and diglycidic ether of D,L-camphoric acid, and donor-acceptor couple 2,4,6-tri-tret-butylnitrobenzene - modify diethylentriamine was the initiator.

Propose system permit to obtain optoelectronic epoxy as at photoirradiation, as at thermoinitiation.

NEW AROMATIC POLYOXADIAZOLES FOR LIGHT EMITTING DIODES

P.N. Lavrenko*, B. Schulz**, Y. Kaminorz**

* Institute of Macromolecular Compounds, Bolshoy pr. 31, St.Petersburg, 199004 Russia

** University Potsdam, Institute of Solid State Physics; c/o Institute of Thin Film Technology and Microsensoric, Kantstrasse 55, D - 14513 Teltow, Germany

Low molecular weight aromatic 1,3,4-oxadiazoles are scintillators and laser dyes with high photoluminescent efficiency and they have attracted much interest as electron-injection layers in light emitting diodes [1-3]. Very recently, the capability of both main chain and side chain oxadiazole polymers [4-7] was shown to be blue emitting layer in electroluminescent devices.

Although, poly(arylene-1,3,4-oxadiazole)s have a combination of excellent properties their application is rather limited due to their poor solubility in organic solvents. Therefore, the syntheses and characterisation of new aromatic poly(1,3,4-oxadiazole)s which are soluble in common organic solvents are described:

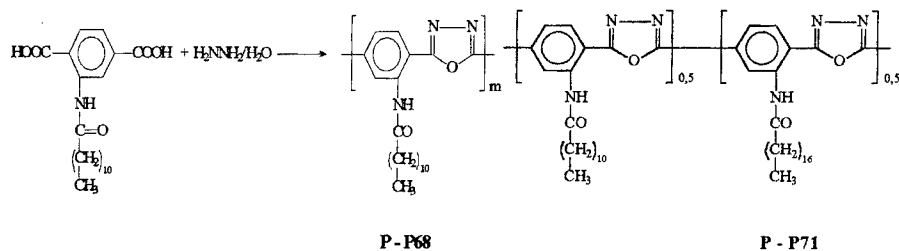

The N-acyl derivatives of 2-aminoterephthalic acid were synthesised by their acylation with fatty acid chlorides in DMAc using pyridine as catalyst and as an acceptor for hydrochloride. The one-step polycondensation of the aromatic dicarboxylic acids with hydrazine hydrate was run in polyphosphoric acid which acts both as solvent and dehydration agent.

The new aromatic poly(1,3,4-oxadiazole)s can be used as emission material in single layer light emitting diodes showing an emission in the range between blue and yellow. The external quantum efficiency of a single POD-layer was estimated to be 0.01 - 0.05 % and can be enhanced when blends with 50 wt.-% 2,5-bis[4-(N-diethyl)amino phenyl]-1,3,4-oxadiazole (DEAPO) are used. In cases of poly(N-vinyl carbazole) (PVK) as hole transport component in the polymer blends, the turn-on voltage is decreased up to 4V.

1. Birks, J.B., 1970, *Photophysics of aromatic molecules*, Interscience, London, 134.
2. Hayes, F.N., Rogers, B.S., and Ott, D.G., 1955 *J. Amer. Chem. Soc.*, 77, 1850.
3. Adachi, C., Tsutsui, T., and Saito, S., 1990, *Appl Phys. Lett.*, 57, 531.
4. Pei, Q., and Yang, Y., 1995, *Chem. Mater.*, 7, 1568.
5. Cacialli, F., Li, X.-C., Friend, R.H., Moratti, S.C., and Holmes, A.B., 1995, *Synthetic Metals*, 75, 161.
6. Meier, M., Buchwald, E., Karg, S., Pösch, P., Greczmiel, M., Strohrigel, P., and Riess, W., 1996, *Synthetic Metals*, 76, 95.
7. B. Schulz, Y. Kaminorz, L. Brehmer, 1997, *Synthetic Metals*, in press

**DIRECTION OF PHOTOREACTIONS IN SOLUTIONS AND FILMS
OF CHALCONE CONTAINING POLYAMIC ACIDS AND
POLYAMIDOIMIDES**

**Galina I. Nosova, Vladislav V. Kudryavtsev, Nina A. Solovskaya,
Anatoli V. Dobrodumov, Valentina A. Lukyashina**

*Institute of Macromolecular Compounds of RAS,
Bolshoy pr. 31, St.-Petersburg 199004, Russia*

New polyimides and polyamidoimides highly sensitive to UV-irradiation have been synthesized on the basis of aromatic chalcone-containing diamines. When solutions of model compounds of polyamic acids (PAA) and polyamidoimides (PAI) are irradiated, either cis-trans isomerization of chalcone groups or [2+2] cycloaddition reaction takes place. The direction of the photoreaction depends on the nature of solvents used and the wavelength of the exciting light. During PAA and PAI irradiation in films only cycloaddition occurs, leading to polymer crosslinking, as a result of cyclobutane rings formation.

Sensitometric analysis was used to determine the threshold photosensitivity of polymers. We have demonstrated, that PAA exhibit higher photosensitivity than PAI because their orthocarboxamide group can form complexes with amide solvents, in which mutual arrangement of double bonds is convenient for cycloaddition. In the case PAI the optimum results of photo-crosslinking of films were observed for copolymers containing chalcone groups not only in the main chain but also in side chains. It was shown, that multilayer films can be obtained on the basis of salts of chalcone-containing PAA by Langmuir-Blodgett method. That is it is possible to obtain multilayers of thermally stable polymers containing photo-crosslinked functional groups in the main chain.

**AN OPTIMIZATION OF THE PROCESS OF CYCLIZATION OF
POLYAMIC ACIDS IS A REAL WAY OF IMPROVEMENT PROPERTIES OF
POLYIMIDES**

Tatjana I. Oranova, Abdulakh K. Mikitaev

***Kabardino-Balkarian State university, Tschernyshevskogo 173, Nalchik,
360004, Russia***

The solid-phase thermal cyclization of polyamic acids in the presence of different additives both low-molecular compound and polymers (*i. e.* organic and inorganic acids, amines) have been investigated. The heterocyclic tertiary amines - azoles are the most optimal for ecology and efficiency objects.

The objects have been studied by following methods: infrared and ultraviolet spectroscopy, X-ray diffraction analysis, gas chromatography, thermogravimetric analysis, differential thermal analysis, thermomechanical analysis et al.

The positive influence of the tertiary amines used for polyamic acids cyclization consists of process acceleration first of all which are observed in a starting period. The kinetic investigation of polyamic acid based on the condensation of pyromellitic acid dianhydride with 4,4'-diaminodiphenylether show that the reaction rate constants increases about one-two orders in the presence of azoles, and an activation energy decreases 1,5-2 times.

Besides the acceleration decreasing of temperature ring-forming interval (by 50-70^o) and the increasing of final degree of the polyamic acid conversion to the polyimide (by 5-10%) are observed.

The increasing of cyclization degree has positive influence on the polyimide properties such as thermal stability and chemical resistance, strength, dielectric parameters. The fact of increasing of the thermal stability under ageing at the dynamical and static conditions is most essential. The mass loss beginning of the polyimides which were obtained by cyclization in the azoles presence is higher (80 - 100^o) than well-known methods obtained polyimides (on data of dynamical thermogravimetric analysis). Above mentioned polyimides lose the mass two times as large than investigated objects under long-time ageing (100 hours, 573K) on the air.

The polyamic acid with azoles interaction mechanism have been studied. Both the charge transfer complexes and salts may be created depends on the azoles basicity. It is shown that the salt-formation essentially increases the hydrolytical resistance of films of polyamic acids.

The azoles influence complicated character on the polyamic acid cyclization process was brought to light. The main importance on the starting period of cyclization has amines basicity and the confirmation of that consists of correlation between the amines basicity and the cyclization speed velocity. The good accordance between the degree and speed of cyclization have the place on the starting stage from that priority ring-forming not complicated by side reactions is followed. The following amines action is connected with the o-carboxamide groups reactivity stabilisation and plasticization furthered diffusion of reaction centres.

REACTIONS FOR SELECTIVE ELIMINATION OF TEMPO- ENDGROUPS IN POLYSTYRENE

H.Malz, H.Komber, D.Voigt, J.Pionteck

Institute for Polymer Research, Hohe Strasse 6, 01069 Dresden, Germany

In 1993 Georges et al [1] reported the generation of a narrow molecular weight resin by polymerization of styrene in the presence of a stable free radical, 2,2,6,6-tetramethylpiperidinyloxy (TEMPO). The obtained polystyrene had a polydispersity of 1.26 that is well below the theoretical value for a radical polymerization of 1.5. Since then this method has drawn the attention of research groups all over the world and many variations have been reported. [2,3]. Because the TEMPO method is also suitable for the preparation of telechelics [4] we used this method to prepare end-group functionalized polystyrene for a reactive compatibilization process. However, the temperatures required in the processing of a blend are well above the cleaving temperature of the polystyrene-TEMPO bond of about 100 °C. The free radicals yielded can engage in undesired side reactions such as crosslinking or degradation. To avoid this several methods were tried to remove the TEMPO group from the polystyrene end. Reactions were performed with polystyrene polymerized by thermal self-initiation [5]. It was found that *m*-chloroperbenzoic acid (MCPBA) could remove the TEMPO group quantitatively at room temperatures resulting in a polystyrene with a keto-endgroup. MALDI and ¹H NMR could verify this result.

A method to avoid the reactive MCPBA is the heating of a polystyrene solution to 140 °C in the presence of a radical scavenger such as 2,6-ditert. butyl-4-methylphenol (IONOL). After homolytic cleavage of the TEMPO group the styryl radical is deactivated by the IONOL. The emergence of free TEMPO in the polystyrene solution could be proven by thin layer chromatography. No increase in molecular weight caused by radical recombination or by crosslinking could be observed. However, the chemistry of this is not yet fully understood since the ¹H NMR resonances of the obtained polymer resemble those obtained by the oxidation of the TEMPO group by MCPBA.

¹H NMR of the TEMPO-free thermally self-initiated polystyrene still displayed a resonance at 4 ppm. This peak belongs to the Diels Alder adduct of the self-initiation [6]. However, the methin proton of the styryl-end attached to the TEMPO group appears in this region, as well [7]. Therefore, it has to be concluded that the peak at 4 ppm should not be used to calculate the molecular weight of the polystyrene since thermal self-initiation is a significant side reaction of the styrene polymerization at temperatures above 100 °C. On the other hand the facile removal of the TEMPO group gives the possibility to analyze the extent of thermal self initiation during a "living" radical polymerization process.

1. Georges M. K., Veregin R., Kazmaier P., Hamer G.. *Macromolecules*. 1993; 26:2987
2. Hawker C. J., Elce E., Dao J., Volksen W., Russel T. P., Barclay G. G.. *Macromolecules*. 1996; 29:2686
3. Yoshida E., Takashi I., Hirao A., Nakahama S., Takata T., Endo T.. *Macromolecules*. 1994; 27(12):3119
4. Hawker C. J., Barclay G. G., Orellana A., Dao J., Devenport W.. *Macromolecules*. 1996; 16(29):5245
5. Matyjaszewski K., Mardare D.. *Polym Prep*. 1994(1):778
6. KurzeJ., Stein D. J., Simak P., Kaiser R.. *Die Angewandte Makromolekulare Chemie*. 1970; 12:25
7. Georges M. K., Veregin R. P. N., Kazmaier P. M.. *Trends in Polymer Science* . 1994; 2(2):66

LIGAND-SEPARATED ION PAIRS AS ACTIVE SITES OF ANIONIC POLYMERIZATION: QUANTUM CHEMICAL ESTIMATION OF THEIR STABILITY IN POLAR SOLVENTS

Alexander V. Yakimansky* and Axel H. E. Müller†

**Institute of Macromolecular Compounds of Russian Academy of Sciences,
31 Bolshoi prospect, St.-Petersburg, 199004 Russia*

†*Institute of Physical Chemistry, Johannes Gutenberg University,
Welderweg 15, D-55099 Mainz, Germany*

Semiempirical quantum chemical studies by the MNDO method of the stabilities of different aggregates of methyl α -lithio-isobutyrate (MIB-Li), $(\text{CH}_3)_2\text{C}=\text{C}(\text{OCH}_3)\text{OLi}$, specifically solvated with either THF (bulk solvent) or 2,1,1-cryptand (C211) or 12-crown-4 (C124) (additives) molecules was carried out. Non-specific solvation effects were taken into account within the model [1], treating the solvent as a continuous medium with the dielectric constant ϵ . The geometries of all studied structures of the general type $(\text{MIB-Li})_n \cdot x\text{L}$ (n is the aggregation degree of MIB-Li in a complex with x molecules of a ligand $\text{L} = \text{THF}$ or C211 or C124) were completely optimized. For these structures, the values of a single stability parameter were calculated. It is an averaged energy E of one MIB-Li molecule in a complex $(\text{MIB-Li})_n \cdot x\text{L}$:

$$E = \{\Delta H_f[(\text{MIB-Li})_n \cdot x\text{L}] - x \cdot \Delta H_f(\text{L})\}/n$$

where ΔH_f is the calculated heat of formation.

In the absence of additives, the most stable form of MIB-Li is $(\text{MIB-Li})_2 \cdot 2\text{THF}$ ($E = -566.3$ and -585.1 kJ/mol at $\epsilon=1$ (vacuum) and 12.13 (THF at -78°C), respectively). In the presence of C211, the most stable MIB-Li form is its dimeric complex with one C211 molecule ($n=2$, $x=1$), which may exist as either a contact ion pair $(\text{MIB-Li})_2 \cdot \text{C211}$ ($E = -538.5$ ($\epsilon=1$) and -568.9 kJ/mol ($\epsilon=12.13$)) or a ligand-separated ion pair $(\text{MIB-Li-MIB})^- \cdot (\text{C211-Li})^+$ ($E = -542.1$ ($\epsilon=1$) and -604.5 kJ/mol ($\epsilon=12.13$)). Thus, the ligand-separated ion pair is more preferable, especially in a polar medium. The ligand-separated ion pair possesses a strongly negatively charged C_α -atom ($q=-0.5$) which correlates with the extremely fast methyl methacrylate polymerization by MIB-Li in the presence of C211.

In the presence of C124, the most stable form of MIB-Li is a contact ion pair $(\text{MIB-Li})_2 \cdot \text{C124}$ ($E = -552.0$ ($\epsilon=1$) and -586.7 kJ/mol ($\epsilon=12.13$)). The ligand-separated ion pair $(\text{MIB-Li-MIB})^- \cdot (\text{C124-Li-C124})^+$ is less stable ($E = -518.1$ ($\epsilon=1$) and -573.1 kJ/mol ($\epsilon=12.13$)), which agrees with a slower polymerization by MIB-Li/C124 initiator.

Reference

1. G. E. Chudinov, D. V. Napolov, M. V. Basilevsky, *Chem. Phys.*, **1992**, *160*, 41.

NEW CONCEPTION OF LOW-TEMPERATURE RADICAL-COORDINATIVE POLYMERIZATION

Viktor A. Dodonov, Yulya L. Kuznetsova

*Nizhegorodsky State University
Gagarin pr. 23, Nizhny Novgorod, 603600 Russia*

Availability of organoelement compound was shown in a number of papers on methylmethacrylate radical polymerization in the presence of alkylborane to have an influence on both kinetic of process and the formation of macromolecules. Boron atom, keeping the growing macroradical in its coordinative sphere, pulls electron density to itself. As a result, a double bond becomes located, the formation of Hückel six-electron system with advantage in energy occurs, and reaction proceeds by pericyclic mechanism.

Chain break was shown to take place by both radical combination, radical disproportion and organoboron compounds. When alkylborane, hydroquinone (HQ) or benzoquinone (BQ) mixed together, an inhibitor takes an active part in radical polymerization.

The growing radical interacts with BQ and HQ, forming corresponding aryloxyradicals. The latter interact with boron atom by S_N2 -mechanism, it is followed by the carbon-centered radical formation and increasing the reaction rate.

If BQ is present in reaction mixture, concentration of alkylborane reduces very quickly, and it is followed by termination of polymerization.

If HQ is present in reaction mixture in low concentration, perceptible increasing of polymerization rate is observed. If a value of HQ concentration is close to that of an initiator, the growing polymethylmethacrylate radicals are coordinated by alkylborane and don't interact with HQ. Polymerization rate doesn't change.

CONSIDERATION OF THE ELEMENTARY CHEMICAL PROCESSES IN POLYMERIZATION

K.K.Kalninh

Institute of Macromolecular Compounds RAS

Bolshoy pr., St. Petersburg, 199004 Russia

The current theory of polymerization is based on the concept of the transition state which is commonly accepted in chemistry. The elementary chemical processes are considered to proceed in the ground electronic state, without electron transfer between the reagent molecules being suggested. From this standpoint it is rather difficult to explain the observation of radical species in the diverse reactions. In this report a novel general approach to the mechanism of polymerization reactions is presented [1].

Each of the reactions - anionic, cationic or polycondensation - displays a peculiar molecular mechanism, while a common elementary stage may be revealed for all of them. This is the thermal electron excitation of the reaction complex or the single molecule into a low-lying excited state, most often of charge transfer character, followed by the rearrangement of the molecular structure. Of most severity is the matter of low-lying states origination. The report concerns the nature of excited states of molecular electron-donor-acceptor (EDA) complexes in polymer reactions.

The radical species are observed in the non-catalytic and catalytic polycondensation of aromatic amines with anhydrides and quinones [2]. The ground state of complexes was shown not to take part in the reaction. It is suggested that electron or hydrogen atom transfer occur via excited state of EDA complexes with hydrogen bond. The reactive excited states are the thermo-exciplexes with hydrogen bond and are non-luminescent because of quenching due to proton transfer. The investigation of the excited states with hydrogen bond by steady state and time-resolved spectroscopy on the solid-state quinhydrone complexes was undertaken. The drastic lowering of the excited state energy of EDA complexes due to hydrogen bond (> 1.5 eV) was observed.

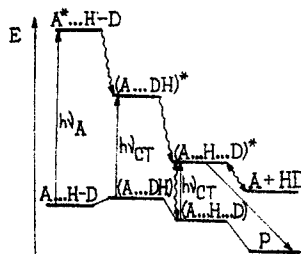

Anionic polymerization of styrene, butadiene etc is suggested to occur through the triplet excited states of the complex between the ionic pairs of "living" polymer and the monomer molecules. It is shown by quantum-chemical calculations that monomer separated ionic pairs are highly reactive, the triplet energy being less than 1 eV. This provides the thermal population of the reactive triplet state which is responsible for electron transfer from the anionic fragment of the "living" polymer to the monomer molecule.

The present approach is applied with success to the different types of polymerization and a number of reactions of small molecules and now is of profound importance for the theory of polymerization.

References

1. Kalninh K.K. J. Chem. Soc., Faraday Trans. 1., 77, 227 (1981).
2. Kalninh K.K., Panarin E.F. Dokl. Akad. Nauk RAN., 339, 358 (1994).

NEW APPROACH TO CONTROLLED SYNTHESIS OF COPOLYMERS BY
MEANS OF RADICAL POLYMERISATION

M. Yu. Zaremski, J. I. Stojachenko, V. A. Hrenov,
O. A. Kononenko, N. V. Alexeev, E.S. Garina, V.B. Golubev

*Moscow State University, Chemistry Department,
Vorob'evy Gory, Moscow, 119899 Russia*

In present work the possibility of controlled synthesis of random, gradient and alternating copolymers via nitroxide-mediated free radical copolymerisation is firstly demonstrated.

The copolymerisations of styrene with butyl acrylate (BA), N-vinylpyrrolidone (NVP) and maleic anhydride (MA) were carried out in bulk or solution at 120°C in presence of AIBN or benzoyl peroxide as initiators and TEMPO as nitroxide radical. Combination of a few experimental techniques: isothermal calorimetry, ESR, GPC, UV and IR- spectroscopy is proposed for the investigation of reaction kinetics and mechanism.

TEMPO concentration rapidly decreases in the beginning of the reaction and then copolymerisation proceeds in presence of constant TEMPO concentration (10^{-4} - 10^{-5} mole/l).

Molecular weight of the copolymers obtained in the systems: styrene/BA 4:1 (azeotropic) and styrene/NVP 1:1 were found to increase linearly with conversion that confirmed quasi-living mechanism of the reaction. Reduced rate of copolymerisation decreases slowly during the course of the process nevertheless the reaction continues up to high conversions.

The decrease of the styrene content in monomer mixture leads to decrease of the copolymerisation rate and copolymer yield.

The quasi-living mechanism of the reaction in combination with different reactivity ratio of comonomers allow to synthesise gradient copolymers.

Preliminary results suggested quasi-living alternating styrene-MA copolymerisation are revealed.

This work was supported by the RFFR (grant 96-03-33860a).

**IDENTIFICATION OF PRODUCTS OF CHEMICAL
INTERACTION BETWEEN FULLERENES C₆₀ AND VARIOUS
AGENTS BY ¹³C NMR HR SS SPECTROSCOPY.**

**Maxim V. Mokeev , Ludmila V. Vinogradova , Vladimir N. Zgonnik,
Alexander V. Gribanov**

***Institute of Macromolecular Compounds RAS
Bolshoy pr.31, St.Petersburg, 199004 Russia***

The range of practical use of fullerene C₆₀ is continuously increasing because its new derivatives are being formed. They are synthesized by the modification of C₆₀ with low molecular weight compounds or polymers. In some cases low molecular weight compounds in which its molecule is covalently bound to several organic groups are insoluble which makes it difficult to study them by traditional methods. An example of these derivatives is the product of monoacetylpropylendiamine attachment to C₆₀, which was obtained by us. The same problem arises in the study of fullerene containing polymers. This is especially characteristic of polymers with a complex architecture, for example having the structure of a regular network. These polymers were obtained by allowing a bifunctional active polyethylene oxide to react with C₆₀. Fullerene-containing polymers based on polyvinyl-pyrrolidone also exhibit low obtained solubility. These polymer was obtained by the reaction of fullerene activated by potassium tert-butoxide with a ready-made polyvinylpyrrolidone sample. In this case a cross linked polymer with an irregular structure is formed. We have shown that in all stage of this work it is possible to apply for the analysis ¹³C NMR high resolution in solid state (HR SS) spectroscopy. The spectra of both the initial C₆₀ and the product of its interaction with various agents are presented. Thus, in the case of monoacetylpropylendiamine grafting, the signals of carbon atoms directly bound to this group were assigned. The spectra of samples of fullerene-containing polyethyleneoxide and polyvinylpyrrolidone with C₆₀ molecules in interchain junctions were identified. Spectral information concerning the structural peculiarities of these compounds was analyzed.

THE NEW METHOD OF SYNTHESIS OF GRADIENT HOMOGENEOUS
COPOLYMERS OF STYRENE WITH METHYL ACRYLATE

Alex A. Louzine, Mikhail Yu. Zaremski, Elizabeth S. Garina,
Alexander V. Olenin, Mickhail B. Lachinov

*Moscow State University, Chemistry Department,
Vorob'evy Gory, Moscow, 119899 Russia*

Random free radical copolymerization of styrene (ST) with methyl acrylate (MA) is known to result incompatible products with wide chemical composition distribution. In this work the possibility of obtaining the gradient copolymers with low composition inhomogeneity using iniferter technique is revealed.

The copolymerization of ST and MA (1:4) in the presence of iniferter O,O'-diisopropylxanthogen disulfide in bulk at 100 - 140 C proceeds up to high conversions without phase separation. The copolymers synthesised are optically transparent as distinguished from turbid copolymers obtained with common initiator benzoyl peroxide.

Copolymerization at 120 C is found to proceed with constant reduced rate starting from 20 % conversion. The reaction rate weakly depends on the iniferter concentration.

M_n of copolymers grows linearly with conversion that confirms quasi-living reaction mechanism. Concentration of growing chains is constant in stationary region while the content of ST in copolymer decreases. This leads to the formation of gradient macromolecules which composition changes persistently from one end of chain to another. The result product as shown by means of fractionation according to composition and turbidimetry has narrow chemical composition distribution in comparison with wide distribution for random copolymer at the same conditions.

The increase of temperature up to 140 C leads to deviation from quasi-living mechanism of the copolymerization.

This work was supported by the RFFR (grant 96-03-33860a).

**DETERMINATION OF FULLERENES C₆₀ AND C₇₀ RATIO BY
¹³C NMR HR SS IN SOOT COMPOSITION.**

Maxim V. Mokeev , Tatiana D.Ananieva, Alexander V.Gribanov

***Institute of Macromolecular Compounds RAS
Bolshoy pr.31, St.Petersburg, 199004 Russia***

Fullerenes are obtained by a thermochemical reaction: high-temperature graphite evaporation. The reaction product is soot containing a mixture of fullerenes, mainly C₆₀ and C₇₀. An important stage of this reaction is the analysis of soot content in different steps of fullerenes isolation and the determination of the content and quantitative ratio of fullerenes C₆₀ and C₇₀. Several independent analytical methods making it possible both to identify the presence of fullerene in soot and to determine their ratio are known. However, a nondestructive procedure permitting the determination of this ratio in reasonable terms and of sufficient precise must be of greatest interest. It is known that ¹³C NMR signals of both fullerenes are stable and make it possible to determine the ratio of C₆₀ and C₇₀ in initial soot by integral relationship. Poor fullerenes solubility, in particular in non-masking solvents, makes it difficult to obtain their NMR spectra. Inverse, HR Solid State ¹³C NMR spectroscopy presents a considerable advantage for solving this problem.

We obtained NMR spectra in the solid phase of the soots different with respect to fullerene composition. Different procedures were used with variable acquisition parameters and pulse programs in order to determine more precisely the most objective conditions for recording the spectra from the standpoint of obtaining reliable quantitative values. According to our evaluations, the precision of the determination of these fullerenes is higher than 3%. The data obtained by us were compared with the results of other analytical methods.

Special acknowledgments to "Fulleren Technology Company" (St.Petersburg) kindly supplied us all soots and fullerenes samples.

**THE INFLUENCE OF PARAMAGNETIC COMPLEX OF
1,2-DIPHENYLETHYLENE ON ANIONIC POLYMERIZATION OF
 α -METHYLSTYRENE**

Irina Yu. Sapurina, Aleksey F. Podol'skiy, Valeriy V. Shamanin

*The Institute of Macromolecular Compounds RAS
St.-Petersburg, Bol'choy pr.,31, 199004 Russia*

The competing complexing of trans-1,2 diphenylethylene (DPE) and α -methylstyrene (α -MSt) in tetrahydrofuran was discovered and studied in accordance with a principle of intermediate [1] which states that the most of the polymerization processes must proceed through a stage of formation of a *monomer - active center* complex.

It was found that α -MSt destroys the paramagnetic complex of DPE with diphenylethylen active center (DPE⁻) resulting in decomplexing of DPE at 20C. Though the thermodynamic equilibrium is established slowly. It is an evidence of high level of activation energy of decomplexing that can be explained by the great value of correlation Fermi triplet state energy.

It was shown:

- a) the process of destroying of paramagnetic complex is almost stops at -78C;
- b) paramagnetic complex of DPE don't participate in polymerization;
- c) decomplexing of DPE by α -MSt leads to a complete regeneration of reactivity of anionic centers.
- d) the initiating system with anionic active centers blocked by DPE can be used for preparing high molecular weight samples with a low polydispersity. This method don't need a low concentrations of initiator because the most part of the active centers are reversibly deactivated by the processes of complexing and association. This make the synthesis more simple.

I. Shamanin V.V. // Adv. Polym. Sci. 1994. V.112. P.135.

THE FEATURES OF ANIONIC POLYMERIZATION OF 1,2-DIPHENYLETHYLENE

Irina Yu. Sapurina, Alexander G. Boldyrev, Aleksey F. Podol'skiy,
Valeriy V. Shamanin

*The Institute of Macromolecular Compounds RAS
St.-Petersburg, Bol'shoy pr.,31, 199004 Russia*

In accordance with the postulates of the axiomatic theory of polymerization [1] the following points must be typical for anionic polymerization of symmetric vinyl monomers:

- a) polymerization proceeds through a stage of formation of diamagnetic complex of a monomer with an active center (from the principle of intermediate);
- b) when attacked by its own free anion, the monomer forms a paramagnetic complex and gets down into a «spin trap» (from the principle of local symmetry and the spin exclusion principle);
- c) the highest chemical reactivity must be observed when polymerization proceed on contact ionic pairs (from the principle of correspondence).

The experimental proof of the above statements is necessary to support the new qualitative quantum chemical conceptions of elementary act of addition polymerization of uncyclic monomers. A reaction of symmetrical trans-1,2 diphenylethylene (DPE) with it's own diphenylethylene active center (DPE^-) and with α -methylstyrene active center ($\alpha\text{-MSt}^-$) in tetrahydrofufan was investigated in this work.

The following results were obtained:

- a) the electronic- and IR-spectroscopy and thin-layer chromatography show that one molecule of DPE can add to ($\alpha\text{-MSt}^-$) with the formation of (DPE^-). It was found that the addition of DPE proceeds through a stage of formation of diamagnetic π -complex DPE with ($\alpha\text{-MSt}^-$).
- b) the competing complexing of DPE and α -methylstyrene ($\alpha\text{-MSt}$) with an anionic active center was discovered and studied by electronic- and ESR-spectroscopy. The terminal state of the system is independent from the method of components mixing, it suggests that thermodynamic equilibrium is realized.
- c) the electronic- and ESR-spectroscopy, chemical analysis and conductometric method show that the product formed in reaction of DPE with (DPE^-) is a paramagnetic complex.
- d) the results suggest that a long time reaction of DPE with butyl lithium at low temperature leads to formation of a DPE polymer with a low yield. The polymer don't contain vinylene bonds and is identical to polybenzyliden in chemical composition, heat-resisting and very bad soluble.

THE MECHANISM OF STEREOREGULAR POLYMERS FORMATION FROM DIENE MONOMERS

Valeriy V. Shamanin

*The Institute of Macromolecular Compounds RAS,
Bol'shoy Pr. 31, St.-Petersburg, 199004 Russia*

Previously by the author within the framework of the axiomatic theory of addition polymerization [1] a hypothesis was proposed that the reason of the high contents of vinyl structure in anionic polydienes can be explained by the triplet state of local-symmetric intermediate, formed by symmetric or quasisymmetric diene with their own active center. In this connection special attention was paid to the difference of chemical behavior of paramagnetic complexes of transitional metals and of their structure controlling properties from behavior and properties of their diamagnetic analogues. In particular a correlation between a spin state of anionic-coordination active centers and contents of vinyl structure in received polydienes was predicted. Besides it was shown, that the reason of high cis-, trans-regulating ability of anionic active centers in diene polymerization first of all is determined by covalent or polar character of the carbon - metal bond. In the case of covalent bond the cis-conformation of monomer have essentially higher reactivity under equal conditions (effect of "conformation scissors").

In development of the formulated positions it is demonstrated:

- a) Data on copolymerization of butadiene with cyclohexadiene testify the existence of "conformation scissors" in anionic-coordination polymerization;
- b) From existence of "conformation scissors" follows, that the polymerization rate and the polymer structure will be influenced by the same factors, as the equilibrium of conformers. Thus butadienes cis-substituted at first carbon by bulky group should have lower reactivity in polymerization. On the contrary, in case of 2-substituted butadienes the increase of the substituent size should displace balance to the party of s-cis conformer formation and increase the reactivity and raise cis-stereospecificity of the process;
- c) In contrary to vinyl monomers the polymerization of nonpolar symmetric or quasisymmetric dienes on diamagnetic complexes of transitional metals proceeds not by the mechanism of migration ligand reaction (i.e. not through a bidentate coordination stage of diene on transitional metal), but by the mechanism of introduction reaction of a monomer directly in a carbon - transitional metal bond with formation of a "classical" six-membered intermediate;
- d) The influence of various types of ligands on polymerization stereospecificity is reasonable to explain by their influence on polarity of the carbon - transitional metal bond;
- e) In contrast to anionic polymerization in the case of anionic-coordination polymerization on paramagnetic complexes of transitional metals there is the opportunity of formation of tactic polydienes with vinyl structure of polymer chain.

1. Shamanin V.V. // Adv. Polym. Sci. 1994. V. 112. P. 135.

THE MECHANISM OF STEREOREGULAR POLYMERS FORMATION FROM VINYL MONOMERS

Valeriy V. Shamanin

*The Institute of Macromolecular Compounds RAS,
Bol'shoy Pr. 31, St.-Petersburg, 199004 Russia*

As it is known, iso- and syndiotactic polymers will be formed by polymerization on cationic, anionic, anionic-coordination active centers, and also by Ziegler-Natta catalysts and by metallocene catalysis. Despite unity and generality of final results, the appearing in the literature mechanisms of stereoregular polymers formation are unduly highly specialized. Previously by the author in the framework of the axiomatic theory of polymerization [1] a hypothesis was proposed that formation and character of stereoregular tactic polymers are determined by the disrotatory or conrotatory type of isomerization of cyclic intermediate. Thus an explanation of the tendency by polymerization of nonpolar vinyl monomers to produce racemic diads on the way of radical and anionic processes and meso-diads by cationic process was given.

In the present report:

- a) The counterion was demonstrated can play the role of an external "symmetry switch" changing the stereospecificity of active centers, thus effective switches of symmetry are for cationic processes - soft Lewis bases; for anionic processes - rigid Lewis acids;
- b) On the basis of regularity of erythro- and threo-structures formation from 1,2-disubstituted ethenes a conclusion about coexistence in cationic and anionic processes of thermodynamic equilibrium intermediates of three kinds is made: 1) an ionic pair "half-separated" by monomer, 2) a ionic pair separated by monomer and 3) a "free" cyclic intermediate, i.e. a free ion complexed by monomer;
- c) An explanation of the polymers stereostructure dependence from the kinetic factors and of the isotactic polymer formation mechanism in relation to α -carbon atom and of stereoblock-polymer in relation to β -carbon atom at polymerization of 1,2-disubstituted ethenes is given;
- d) It is shown, that the nature of high catalytic activity of transitional metals complexes in the polymerization of nonpolar vinyl monomers, such as ethylene or propylene, is caused by petal-shaped structure of d-orbital and its key contribution to the carbon - transitional metal bond as a necessary condition for realization of catalytic potency. If s-orbital is predominant in the carbon - transitional metal bond, the polymerization process is forbidden (provided that the reaction proceeds through the mechanism of ligand migration reaction);
- e) The failure of the Cossee-Arman mechanism including its modifications identifying the active center with «Procrustean bed» to interpret the mechanism of the stereoregular polymerization on achiral active centers is manifested. A improved Cossee-Arman mechanism modernization by adding the cyclic intermediate is suggested. Low polymerization rate of symmetric or quasisymmetric vinyl monomers by paramagnetic complexes of transitional metals is proposed;
- f) It is proposed also that the high efficiency of chiral metallocene catalysts is caused by the joined electronic and steric factors influence on the stereocontrol (only one from four of pairs of mirror-symmetric coordinates of reaction is realized) and in some cases by the transition from the anionic-coordination to the cationic-coordination mechanism of polymer chain propagation.

NEW ASPECTS OF INIFERTER POLYMERIZATION

Alexander V. Olenin, Mikhail Yu. Zaremski

Moscow State University, Vorobiyevy Gory,

Moscow, 119899 Russia

The typical photoiniferters such as benzyl N,N-diethylthiocarbamate, tetraethylthiuram disulfide and O,O'-diisopropylxanthogen disulfide have been found to give an ability to produce radical polymerization of styrene, methyl methacrylate, acrylamide and vinyl acetate under the influence not only of UV-, but visible light as well. In the latter case the contribution of the reinitiation reaction to the process of forming of molecular weights of the polymers decreases. This approach enables us to prepare low-weight macroiniferters. Atmosphere oxygen inhibits dramatically photopolymerization of all vinyl monomers, but not the reaction of decomposition of initial photoiniferters. These phenomena should be taken into account in the processes of preparing reactional systems with photoiniferters.

THERMAL DEGRADATION OF PARA-SUBSTITUTED POLYSTYRENES. CORRELATION ANALYSIS

Vladislav V. Zuev, Peter V. Zgonnik, Liudmila D. Turkova,
Enev E. Kever, Vladimir V. Nesterov

*Institute of Macromolecular Compounds RAS
Bolshoy pr. 31, St. Petersburg, 199004, Russia*

The investigation of para-substituted polystyrenes (PSS) is of interest with respect to both the preparation and the study of theoretical aspects of thermal degradation and thermal stability of polymers. Organic glasses obtained from these polymers exhibit higher thermal characteristics than those of previously known organic glasses, and it is proposed to use in the production of video and audio disks for the recording, storage and reproduction of information with application of laser procedures.

PSS (X= H, Alk, Cl, OMe, NH₂, NO₂) were synthesized and characterized. In the present paper the thermal behavior of the PSS series was investigated with the following aims:

- (1) to establish the temperature ranges in which thermal transformations of these polymers take place;
- (2) to compare the thermal stability of PSS and to determine the order of thermal stability in the investigated series;
- (3) to carry out initial investigations of the mechanism of thermal transformations of polymers and the dependence of this mechanism on the condition of thermal treatment, in particular the heating rate;
- (4) to establish new relationships which make it possible to develop general concept of mechanism of thermal degradation of polymers.

Thermolysis of these polymers was studied using pyrolysis gas chromatography at 200-600 °C. Thermal degradation of PSS mainly follows the radical depolymerization mechanism give monomer, is a rule, in 50-80% yield, but forms also some other products. The fraction of these products is small, but they appear upon degradation of all PSS (benzene, toluene, substituted benzenes etc.). Chemical reactions at temperatures as high as 450-550 °C are caused by thermodynamic reason. It is the energy characteristics of resultant compounds that determine what the products formed would be. A linear correlation is observed between the resonance σ constant of substituents and thermostability of polymer, fractions of monomer and minor products.

CATIONIC POLYMERIZATION OF AROMATIC HYDROCARBONS IN THE PRESENCE OF $AlCl_3$ COMPLEXED WITH POLYMERS

Olga Butufei, Cristina Miritescu, Magdalena Mazare

*Institute of Chemical Research
Splaiul Independentei 202, Bucharest, Sector 6, 77208 Romania*

Among the most used catalysts in the cationic polymerization of aromatic hydrocarbons are Lewis acids, especially anhydrous $AlCl_3$ or $AlCl_3$ complexed with water, aliphatic or aromatic chlorides, phenols, alcohols.

Because their instability in air and insolubility in aromatic solvents, anhydrous $AlCl_3$ is more efficient in cationic polymerization systems like complexes with good solubility, leading to a homogenous catalysis.

The physico-chemical properties of polymers obtained using complexation catalysts, that are consumed in the process of polymerization, underwent some modifications.

This paper is focused on the study of catalytic activity of complexes established between $AlCl_3$ and polymers with low molecular weights in the cationic polymerization of aromatic hydrocarbons. They are formed like a consequence of interaction between the unsaturated end of polymer chain and $AlCl_3$.

The polymer used for $AlCl_3$ complexation has chosen to have a similar structure to the polymer to be synthesized, in order to avoid any chemical modification due to the cocatalyst insertion in the polymer backbone.

For the cationic polymerization of styrene we synthesized the complexes between $AlCl_3$ and polystyrene with molecular weights of 800-1200 and between $AlCl_3$ and polystyrene with molecular weights of 200000-300000.

Complexes between $AlCl_3$ and polymers of higher molecular weights are partially insoluble in the reaction medium and behave as heterogenous catalysts.

The cationic polymerization of alphas-methylstyrene occurred in the presence of a catalytic system formed between $AlCl_3$ and polyalphamethylstyrene with low molecular weights ($M=900-19000$).

The polymerization of oil fraction C_9 (that contains polymerizable compounds like styrene, alphas-methylstyrene, vinyltoluene, indene, methylindene) which resulted at the pyrolysis of gasoline, was promoted with a complex formed between $AlCl_3$ and a polymer with low molecular weights ($M=800-2200$). This polymer has been synthesized from the same oil fraction C_9 using another Lewis acid catalyst.

We noticed that the complexes between $AlCl_3$ and polymers with low molecular weights are soluble in the reaction system (toluene). This is a consequence on the stability in time of catalyst and also on the synthesis of polymers with reproducible yields and properties. The explanation of this phenomenon is the hydrophobicity of the hydrocarbon polymer that protect $AlCl_3$ against the action of moisture and conserve its catalytic activity in the polymerization.

This type of catalyst lead us to low molecular weights polymers (no more than 19000) prepared in air conditions (no need inert atmosphere).

**BASES OF THE AXIOMATIC THEORY
OF ADDITION POLYMERIZATION
THE LAW OF CONSERVATION OF PARITY
AND THE STEREOISOMERISM**

Valeriy V. Shamanin

*The Institute of Macromolecular Compounds RAS,
Bol'shoy pr.. 31, St.-Petersburg, 199004 Russia*

The symmetry between "left" and "right", i.e. the spatial parity, characterizes behavior of a physical quantity at mirror reflection: if in a nature some process is possible, the mirror reflected process is possible too, and all characteristics of both processes (cross sections, energy spectra, angular distributions, spin correlations and etc.) are identical — the parity of closed system is kept. As applied to stereoisomerism this law can be formulated in the following kind: the symmetry between "left" and "right" in closed polymerizing system cannot spontaneously be broken in result of processes occurring in it

Previously the author formulated basic principles of the axiomatic theory of addition polymerization [1], the basis of which is built up from 5 postulates, namely: the principle of the intermediate, the principle of intermediate cyclicality, the principle of correspondence, the principle of local symmetry and the spin exclusion principle. One of additions and expansions of bases of the axiomatic theory of polymerization is invoking of the law of conservation of parity for discussion of the mechanism of stereospecific polymerization. In this report the preliminary analysis of the mechanism of formation of iso- and syndiotactic polymers is spent in the context of parity conservation.

The notion of mirror-symmetric and mirror-asymmetric polymerizing systems, to which corresponds a mirror-symmetric or mirror-asymmetric type of the stereocontrol, is entered. The given classification of the stereocontrol is more strict, more physical and more consecutive, than classification Bernoullian statistical model (a chain-end stereochemical control) — non-Bernoullian model (an enantiomorphic-site stereochemical control) of chain propagation. In case of the mirror-symmetric stereocontrol the law of conservation of parity and the Murrell-Laidler theorem (stating that only one reaction coordinate corresponds to each transition state) require presence in the mechanism of formation stereoregular polymers as a minimum four in pairs of mirror-symmetric coordinates of reaction. The last conclusions, obviously, show some formal requirements to formulated mechanisms of polymerization - they are obliged to ensure fulfilment of the law of conservation of parity. First of all it concerns to presence in any offered and deserving attention mechanism the necessary amount in pairs of mirror-symmetric coordinates of reaction. As it is strange, but many (if not all!) from the considered in the literature circuits of stereoregular iso- or syndiotactic polymers formation in mirror-symmetric polymerizing systems do not satisfy to this elementary criterion. Thus they are not at all correct a priori and demand specifications.

1. Shamanin V.V. // Adv. Polym. Sci. 1994. V. 112. P. 135.

**NEW APPROACH TO THE SYNTHESIS OF POLYMETHYLMETHACRYLATES
WITH VARIED STEREOREGULARITY AND TO THE FORMATION OF THEIR
STEREOPOLYCOMPLEXES**

**Mark G. Krakovyak, Tatyana N. Nekrasova, Rouslan Yu. Smyslov, Victor M. Denisov,
Tatyana D. Ananieva, Vanda B. Lushchic, Elizaveta V. Anufrieva**

*Institute of Macromolecular Compounds RAS
Bolshoy pr. 31, St. Petersburg, 199004 Russia*

The interaction between stereoisomer molecules of iso- and syndiotactic polymethylmethacrylate (iso- and syndio-PMMA) is one of the most outstanding examples of the effect of polymer stereochemical structure on intermolecular interactions and the formation of supermolecular structures — stereopolycomplexes (SPC).

A profound investigation of factors affecting SPC formation and, in particular, their structure, involves the development of the synthesis of PMMA with varied types and content of stereotactic sequences. The present paper deals with a new approach to the synthesis of syndio-PMMA, which makes it possible to obtain polymers with smoothly changing stereotacticity in the range of syndio-triads content from 45 to 80 %. This approach is based on complete methylation of carboxylic groups of polymethacrylic acids (PMAA) with different syndiotacticities by treatment with diazomethane. To obtain syndio-PMMA with a varied degree of stereoregularity, free-radical polymerization of MAA in different organic solvents or in aqueous media at different pH and temperatures is used.

In order to study the stereoassociation phenomenon on the molecular level, it is necessary to apply methods making it possible to investigate mixed iso- and syndio-PMMA solutions at very low concentrations at which the probability of gel formation or phase separation is virtually excluded. We used a highly sensitive method of polarized luminescence based on the application of polymers with covalently bound luminescent markers. This method enabled us to obtain information about each of the interacting PMMA stereopolymers which are alternatively distinguished by attaching markers with the anthracene structure.

This investigation provided data on the effect of various factors on SPC formation and their structure. Data are obtained on the formation of stereoassociates when syndio-PMMA is replaced by syndio-PMAA with the same stereoregularity and molecular weight.

N-VINYLCAPROLACTAM (VCL): CONFORMATIONS AND RADICAL POLYMERIZATION

Yurii E. Kirsh, Nataly A. Yanul, Karl K. Kalninsk

Karpov Institute of Physical Chemistry, Vorontzovo pole, 10, Moscow, 103064, * Institute of Macromolecular Compounds RAS, Bolshoy pr. 31, St. Petersburg, 199004 Russia

The structural ring VCL performance were determined by two approaches. The first is theoretical one, using the methods of molecular mechanics (PC Model under MMX software) and quantum chemistry PM3 under the AMPAC software). The second is X-ray analysis of VCL crystals. Theoretical calculations allowed one to determine VCL conformation and bond length, valent and torsion angles and charge distribution. The calculations confirmed that the "chair" conformation of VCL is the most stable whereas the "bath" one is energetically unfavourable.

The same conformation was determined experimentally by X-ray analysis of VCL crystals by a "Syntex-P2₁" diffractometer with Cu K α -radiation. A unit cell consists of two VCL molecules packed as two "chairs" placed on one another with opposite directed "backs".

It is essential that the performance data (the length of valent bonds, valent and torsion angles and so on) obtained by X-ray analysis and quantum-chemical calculations coincide. Some difference in length of valent bonds found by the two methods is observed only for amide group. Close values of structural parameters (experimental and theoretical) allow one to apply theoretical approach in charge distribution estimation on atoms of VCL and other N-vinylamide monomers. So, the charge value on oxygen atom of C=O makes - 0.362.

The VCL conformation was found to affect radical reaction between a terminal chain radical and double bond of a monomer molecule. The addition of VCL to a propagating chainlink is most suitable in syndiotactic sequences in a polymer chain where the hindrances are minimal. In fact, the carbon atom signal of methine group in the ¹³C NMR spectrum of PVCL obtained by free radical polymerisation with AIBN in isobutanol consists of two peaks, not of three as is characteristic of atactic microstructure. Proton resonance of the same group in ¹H NMR spectrum of PVCL in D₂O gives also two peaks. The position of peaks in these spectra is a sure proof of the presence of triads of two types in polymer chain indicating in principle the syndiotactic configuration.

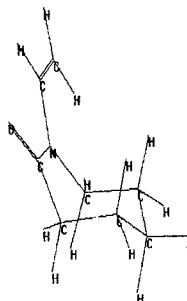

ADVANTAGES OF γ -INDUCED POLYMERIZATION IN
THE SYNTHESIS OF WATERSOLUBLE POLYMERS

Ushakova V.N., Kuznetsov D.S., Savinov A.G., Persinen A.A.

*Institute of Macromolecular Compounds RAS
Bolshoy pr.31, St.Petersburg, 199004 Russia*

γ -Induced polymerization is known to have some advantages in comparison with traditional methods of synthesis with polymerization initiators. High purity of synthesized polymers owing to the absence of initiator or catalyst residuum in macromolecular chain, high polymerization rate, a possibility to obtain polymers from monomers being inactive in polymerization make this method attractive in polymer synthesis.

γ -Induced polymerization was used for synthesis of watersoluble functional N-vinylpyrrolidone (VP) and acryloylmorpholine (AM) polymers. We have studied the influence of the solvent (ethanol and water) on γ -induced homopolymerization of (VP) and copolymerization of VP with allylic monomers - allylthiourea and allylthioacetic acid.

Due to the radiolysis of all components of the system in γ -irradiation process radicals which were formed from the solvent play an active role in polymerization process, thus giving an excellent possibility to regulate molecular mass characteristics of the polymer and to introduce into macromolecular chain functional groups directly from the solvent:

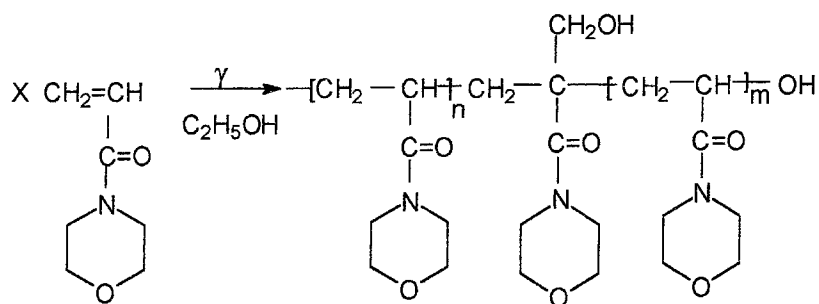

The study of γ -induced copolymerization of VP with allylthiourea and allylthioacetic acid and of AM with allylthiourea has shown, that radiation-chemical method of synthesis gives a possibility to obtain watersoluble functional polymers with high polymer output in wide molecular mass interval even on the basis of low active in polymerization allylic monomers with 5-40 mol.% content of a functional comonomer in polymer chain depending on the absorbed irradiation dose, nature of solvent and concentration of monomers in solution.

RADIATION CHEMICAL SYNTHESIS AND PROPERTIES OF POLYANIONS ON THE BASIS OF N-VINYLAMIDES

Ushakova V.N., Samarova O.E., Kipper A.I., Kuksilin E.V., Panarin E.F.

*Institute of Macromolecular Compounds RAS
Bolshoy pr.31, St.Petersburg, 199004 Russia*

Watersoluble polymers of N-vinylpyrrolidone (VP), containing functional groups are of interest for medical and pharmaceutical utilizations. Conjugates of such polymers with biologically active compounds give a possibility to prolong therapeutic effect of biologically active compounds, to lower their toxicity, etc. In this case macromolecular hydrophilic-hydrophobic balance strongly influences the behavior of macromolecules in solution and their interaction with biologically active compounds.

Together with polymerization in γ -induced polymerization sterilization process takes place thus making radiation-chemical synthesis to be one of the perspective methods for medical polymer preparation.

Watersoluble copolymers of VP and N-vinylcaprolactam (VC) with unsaturated acids were synthesized. The influence of the structure of the unsaturated acid on γ -induced copolymerization of VP with acrylic (AA), vinylacetic, 4-pentenic and undecylenic acid and a number of methylenic groups of lactam cycle on copolymerization process and properties of synthesized polymers, as well as interaction of polyanions with quarternary ammonium base - dimethylbenzylaurilammoniumbromide were studied.

The copolymerization rate decreases with the increase of the substitute alkyl radical length of the unsaturated acid. In the absorbed dose 2-50 kGr interval the monomer conversion is about 100%. In this acid raw we observed the decrease of carboxy group content in polyanion at the same absorbed dose, as well as the decrease of macromolecule M_w , determined by light-scattering method. In water solutions polymerization rates and M_w of synthesized polyanions are higher, than that in alcohol solutions due to association of monomers and a solvent.

The copolymerization rate of more hydrophobic N-vinylamide -VC with acrylic acid (AA) is lower than that of VP with AA and M_w of copolymers VC with AA is lower, than M_w of VP-AA at the same polymerization conditions.

The studied interaction of synthesized polyanions with quarternary ammonium base - dimethylbenzylaurilammoniumbromide decreased with the increase of the substitute alkyl radical length of the above mentioned unsaturated acids and seems to be negligible in the case of copolymer of VP with undecylenic acid.

INFLUENCE OF BENZIMIDAZOLE ON THE STRUCTURE AND PROPERTIES OF POLYIMIDE FILMS

Tatiana A.Kostereva, Yulia G.Baklagina, Elena V.Beloborodova,
Galina N.Fedorova, and Yury N.Sazanov

*Institute of Macromolecular Compounds RAS
Bolshoi pr.31, St.Petersburg, 199004 Russia*

The influence of benzimidazole (BI) and imidization temperature on the structure, physical and thermal properties of poly((oxydiphenylene)pyromellitimide (PI) films has been studied.

The PI films obtained in the presence of BI demonstrate the increase in ordering as compared to that of thermally and chemically imidized films. This was confirmed by electron microscopy and X-ray diffraction methods.

At low temperature imidization (150^o C) BI is completely removed only from thin (<5mkm) films. In thick films BI forms a strong complex with PI, which contains 0.25 moles of BI per elementary PI units. Its composition does not depend on the initial amount of BI. This complex is degraded at 279-290^o C. This was first shown by mass-spectrometric thermal analysis and thermogravimetric method. It should be mentioned that the imidization degree of both films is 100% (according to IRS).

In contrast to films obtained without BI, a simultaneous increase in the mechanical parameters (E, σ , ε) of PI films obtained at high temperatures (300, 350^o C) and in the presence of BI takes place. However, the densities of all films are equal.

The increase in the ordering of PI films at the equimolar ratio of BI and carboxylic groups of polyamic acid was confirmed by differential thermal analysis.

A slight stabilization of catalytically obtained PI films was observed during vacuum carbonization at 500 and 700^o C. TGA method under the conditions of self-generated atmosphere was used to show that the coke residue of these films at 1000^o C is higher than that for films obtained in the absence of BI. This is caused by the decrease in the degradation rate of PI film.

**EFFECT OF IMIDIZATION CONDITIONS ON
THE SUPERMOLECULAR STRUCTURE OF POLYIMIDE
BASED ON 3,3'-DIAMINOBENZOPHENONE AND
3,3',4,4'-BENZOPHENONTETRACARBOXYLIC
DIANHYDRIDE (BTDA-DABP)**

**Andrey G.Kalbin, Tamara K.Meleshko, Vladislav V.Kudryavtsev,
Natalija N.Bogorad, Sergei V.Lukasjv, YulijaG.Baklagina**

**Institute of Macromolecular Compounds RAS
Bolshoy pr.31, St.Petersburg, 199004 Russia**

There is investigated the effect of thermal and of chemical imidization conditions of polyamic acid (PAA) on the value of melting point (T_m) and on the level of crystallinity of semicrystalline polyimide (PI) BTDA-DABP. Prepolymer-PAA was synthesised in amide solvent (NMP and DMA) and then was imidized either thermally in thick films or chemically - dissolved in amide solvents. Polyimide samples obtained were investigated by mean of viscosimetry, IR-spectroscopy, DSC, TGA, and wide-angle X-Ray diffraction.

Thermal imidization results in semicrystalline PI with $T_m=350^{\circ}\text{C}$ close to equilibrium value. Practically useful is PI with low value of T_m . Chemical imidization in solution results in semicrystalline PI with observed $T_m=270^{\circ}\text{C}$, which is substantially lower than the equilibrium value. The difference between positions of crystallographic reflections in X-RAY diffractograms of polyimides with $T_m=350^{\circ}\text{C}$ and that with $T_m=270^{\circ}\text{C}$ allow to suppose formation of different crystallographic forms.

The increase of the temperature of chemical imidization process the crystallinity level of PI decreases from 40% (at 20°C) down to 8% (at 125°C).

This can be explained reasonably as effect of suppression of nucleation at high temperatures. Chemical imidization allows to obtain samples of semicrystalline PI with decreased molecular weight. The decrease was ensured by aid of dilution of the reaction solution for the prepolymer synthesis. Insofar as molecular weight of PI decreases a multimodality of melting displays. Besides low temperature peak in DSC thermogram curves the peaks display corresponding to melting in the temperature range close to equilibrium T_m . General level of crystallinity remains approximately constant.

ROLE OF PYRIMIDINE RINGS IN THE FORMATION OF POLYIMIDE FIBERS

Elena V.Beloborodova, Yury N.Sazanov, Gennady M.Mikhailov,
Alexander V.Gribanov

*Institute of Macromolecular Compounds RAS
Bolshoy pr.31, St.Petersburg, 199004 Russia*

Fibers based on pyromellite dianhydride and a mixture of aromatic diamines: diaminodiphenyl ethes (DADPE) and 2,5-bis-(aminophenyl) pyrimidine (2,5PRM) (the ratio of which in the reaction mixture ranged from 0 to 100 mole %) were formed by the standard technology of polyimide fiber preparation. The data of mechanical tests showed that the copolyimide fibers (CPiF) exceed in mechanical strength and elasticity polyimide fibers formed under similar conditions from homopolyimides. X-ray and microscopic investigations of CPiF made it possible to determine the optimum amount of 2,5 PRM (about 30-40%) ensuring a two-fold increase in the mechanical strength of these fibers and it made possible to explain the role of the pyrimidine containing fragments of the main polymer chains. It gives a possibility to form without special orientation the structure with less defective supermolecular organization due to thermodynamical reasons and hence higher values of the thermal and mechanical properties. The thermal analysis (TGA and DTA) of CPiF showed a considerable increase in their thermal stability over that of homopolyimides and also established the extreme dependence of CPiF thermal stability on the amount of 2,5 PRM units. The dependence of CPiF thermal stability on the composition the surrounding gas medium was also found. Initial data on vacuum carbonization of CPiF in the temperature range of 500-800°C in the quasi-isothermal regime were obtained. Direct relationships between the carbonization temperature, the amount of the coke residue, and the quantity of the structural nitrogen in the CPiF investigated were established.

According to the results of the study of CPiF thermal transformations by NMR ¹³C high resolution in solid state (HR SS), ESHA and elemental analysis over the above temperature range, the mechanism of copolyimides carbonization was proposed and the determining role of nitrogen in the formation of polycyclic carbonize structures was shown.

**INVESTIGATION AND COMPARATIVE ANALYSIS OF THE FORMATION
MECHANISMS OF POLYMERIZING OLIGOIMIDES IPO AND
POLYIMIDES BASED ON ACID DIESTERS OF TETRACARBOXYLIC
ACIDS**

**Vera N. Artemyeva, Vladislav V. Kudryavtsev, Aleksandr V. Yakimansky,
Nina V. Kukarkina, Pelageya I. Chupans**

*Institute of Macromolecular Compounds RAS
Bolshoy pr. 31, St.Petersburg, 199004. Russia*

The preparation of polyimides based on a diester of 3,3',4,4'-benzophenone tetracarboxylic acid (BTE) and methyldianilin (MDA) and that of polymerizing oligoimides based on BTE, MDA and monoester of norbornene acid (NE) was investigated. It was shown that in both cases after mixing the initial reagents, hydrogen bonds are formed between the aminogroups of MDA and the carboxylic groups of BTE and NE. As a result, relatively stable pseudopolymer H-complexes which exhibit a certain supermolecular structure are formed.

The thermal imidization of H-complexes was investigated by NMR and IR spectroscopy, gas chromatography, thermal mass spectrometric and thermogravimetric analysis and by dielectric method. It was shown that the reaction is described a first-order equation and the rate determining stage is the formation of the transition state in which the nucleophilic attack of the diamine nitrogen on the carbonyl carbon atom of the BTE ester group is preceded by the intramolecular proton transfer from the carboxyl group of BTE to the carbonyl oxygen of its ester group. The proposed mechanism was confirmed by the quantum-mechanical calculation carried out by the AM1 method using the following model system: monomethyl ester of maleic acid - ammonia, monomethyl ester of phthalic acid - methyl amine in vacuum and in solvent medium.

The comparison of the results obtained in the study of polymer systems without NE and oligomer systems with NE shows that the insertion of sterically hinderer NE into the H-complex distorts the supermolecular structure of H-complexes and thus favours their dissociation. The dissociation of the H-complex, in turn, leads to the energetically less advantageous reaction mechanism in which an anhydride is formed as an intermediate. Hence, under the conditions favouring the dissociation of H-complexes, thermal imidization proceeds by two simultaneous mechanisms: by direct thermocyclization of the undissociated H-complex into an imide by the suggested mechanism and via the anhydride formed after dissociation of this complex and its interaction with the amine by the known mechanism. In the latter case the reaction is difficult and is completed at much higher temperatures.

INVESTIGATION OF THE ROLE OF THE PYRIMIDINE RING IN THE FORMATION OF SUPERMOLECULAR STRUCTURE OF PYRIMIDINE-CONTAINING POLYIMIDES

**Vera N. Artemyeva, Vladislav V. Kudryavtsev, Yuliya G. Baklagina,
Vladislav P. Borovik, Oleg P. Shkurko**
*Institute of Macromolecular Compounds RAS
Bolshoy pr. 31, St.Petersburg. 199004. Russia*

In the investigation of the structure and properties of polyimides (PI) based on pyrimidine-containing diamines and of the imidization of pyrimidine-containing polyamic acids (PAA) some specific features have been detected. They are due to the basicity of pyrimidine ring which is higher than that of the aromatic ring.

The supermolecular structure of PAA was studied taking as an example polypyromellitic acid based on 2,5-bis(p-aminophenyl)pyrimidine (PAA PM-2,5PRM). An aromatic analog in which 2,5PRM is replaced by 4,4'-diaminoterphenyl (PAA PM-TP) was taken for comparison. Light scattering method and X-ray analysis, as well as indirectly by thermogravimetric analysis, thermal mass spectroscopy and the method of vapor sorption by film samples were used to prove that in PAA PM-2,5PRM in addition to layer packing of polymer chain shear packing also exists in which the pyrimidine ring of one chain is specially near the amic acid fragment of the neighbouring macromolecule because of its high basicity.

Kinetic investigations show that the steric proximity of the pyrimidine ring to the reaction center of solid phase PAA thermocyclization leads to the catalytic effect and to a decrease in the activation energy E_A of PAA imidization. In this case the E_A value is in agreement with the pyrimidine ring basicity which depends on the nature of pyrimidine-containing diamine.

The shear packing of PAA chains is retained in imidization and probably exists in pyrimidine-containing PI. The presence of shear structure in PI PM-2,5PRM results of mesomorphic transition regions between the crystalline and perturbs rigid packing inside the crystallite. This fact leads to the formation of a more homogeneous structure of PI PM-2,5PRM than that of its aromatic analogue. This, in turn, is manifested in higher values of modulus, mechanical strength and elongation at break of films and fibers based on PI PM-2,5PRM than those for the aromatic analogue PI PM-TP.

The thermal stability of PI PM-2,5PRM must be specially considered. It would seem that this stability should be lower than that of PI PM-TP because of the lower thermal stability of pyrimidine than that of benzene [1]. However, experiment shows opposite phenomenon. According to the data in ref.[1,2], the E_A values of the thermal decomposition of the pyrimidine and imide rings are very close to each other. Taking into account their steric proximity in the shear packing of PI PM-2,5PRM chains, it may be assumed that the free radicals formed after their degradation recombine and, as a result, the thermal stability of PI PM-2,5,PRM is higher than that of PI PM-TP.

1. V.A.Zubkov, A.V.Yakimansky, S.E.Bogdanova, V.V.Kudryavtsev, *Macromol. Theory Simul.*, 1994, v.3,p.511-522.
2. V.A.Zubkov, A.V.Yakimansky, S.E.Bogdanova, V.V.Kudryavtsev, *Macromol. Theory Simul.*, 1994, v.3,p.497-509.

SYNTHESIS OF NEW POLY(AMID-IMIDAZOPYRROLONE)S

D. Sęk, E. Schab-Balcerzak, E. Grabiec

Institute of Polymer Chemistry, Polish Academy of Science

34 M. Curie-Skłodowska sts., 41-800 Zabrze, Poland

Poly(amid-imidazopyrrolone)s which may be considered as semiladder polymers are new group of polymers.

In our work we have synthesized a series of poly(amid-imidazopyrrolone)s having the structure shown below:

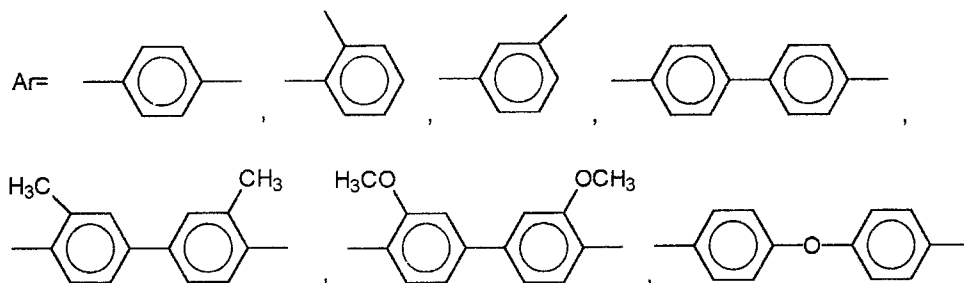
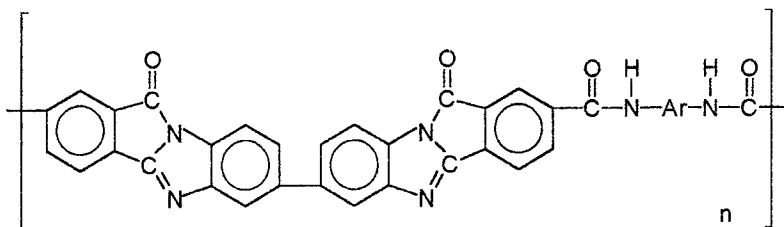

Polycondensation of the dianhydrides with 3,3'-diaminobenzidine carried out in *m*-cresol at 180°C and also as two-step process in DMA. The influence of the reaction conditions and monomers structure (-Ar) on the polymer properties was investigated.

**“FAST” CYCLODEHYDRATATION REACTION OF POLYAMIC ACID IN
CONCENTRATED SOLUTION AND IN SOLID PHASE.**

Alexsander A. Kuznetsov, Anna Yu. Tsegelskaya., Anatoly L. Izyumnikov

Karpov Institute of Physical Chemistry . Vorontsovo Pole, 10, Moscow, 103064, Russia.

The kinetic of cyclodehydration (CD) of polyamic acid (PAA) based on m-phenylenediamine (m-PDA) and 2,2-bis[(3,4-dicarboxyphenoxy)phenyl]propane dianhydride (BPADA) in N-methylpyrrolidone (N-MP) at 150°C was investigated. The PAA:N-MP ratio was varied in a range from 1.00:0 to 0.15:0.85. Solid oligomeric PAA powder with $\eta=0.13$ dl/g was obtained by polycondensation of m-PDA and BPADA in chloroform . PAA precipitate was filtered, poured and dried in vacuo. The kinetics data were obtained by comparison of intensities of the bands 620 (imide cycle) and 690 cm^{-1} in standard IR-spectra (Nicollet Impact FTIR spectrometer).

It was found that increasing of starting PAA concentration from 0.15:0.85 to 0.80:0.20 increases the relative initial reaction rate (conversion per minute). The efficient first order rate constant at a point of maximum is about an order of magnitude as higher as for dilute solution.

By means of GPC (in DMAA in presence of LiCl) it was shown that MW of PAA doesn't decrease ; so depolymerization reaction can be ignored and the dependence of the CD kinetics on PAA concentration is not a consequence of reversibility of PAA synthesis reaction.

The dependence of efficient “first order” rate constant on PAA concentration can be explained by self-catalysis of CD reaction with PAA. Additional introduction of benzoic acid into reaction mixture resulted in corresponding acceleration of CD reaction. The second order of CD reaction was proposed also by the authors [1].

It should be noted that the initial rate observed for concentrated solution is much higher as compared with solid phase (10 μm film). So in a region of the PAA:N-MP ratios from 1.00:0 to 0.8:0.2 the CD rate increases with increasing of solvent concentration. This acceleration is not connected with “plastification” effect because the resulting rate values is much higher then in a case of dilute solution.

A mechanism is discussed including the opportunity of general acid catalysis of CD reaction in concentrated solution; the solvent playing the role of dissociation medium. In the absence of the solvent the catalytical channel is closed and CD kinetics becomes of usual type . It has been shown that the water can play the role of “accelerating” solvent too in solid phase CD process - in a case of restriction for evolution of the water from the sample.

This work was fulfilled at financial support by ISTC (project # 193).

References.

1. Kim I.G., Glass T.E., Lyli J.D., Mc.Grath G.E. *Macromolecules*, 1993, V.26,N6, pp. 1344-1358.

POLYESTERIFICATION IN THE PRESENCE OF MACROMOLECULAR FILLERS

V.V. Istratov, V.A. Vasnev, A.I. Tarasov, A.L. Rusanov, I.I. Ponomarev,
N.M. Belomoina

Institute of Organoelement Compounds RAS

Vavilov str. 28 Moscow 117813 Russia

Polycondensation in the presence of a polymer filler is one of ways to produce composite materials with enhanced specific and conventional properties. Besides that, it allows us to influence the process of polymer formation by changing the sequence of units and other parameters of the forming polymer.

Was examined the low-temperature copolyesterification of terephthalic acid dichloride with bisphenol A derivatives and hexamethylene glycole. As fillers Poly(phenylquinoxaline) (I), poly(naphthoylene imidobenzimidazole) (II) and cross-linked polystyrenes (III) of different sorption abilities were used:

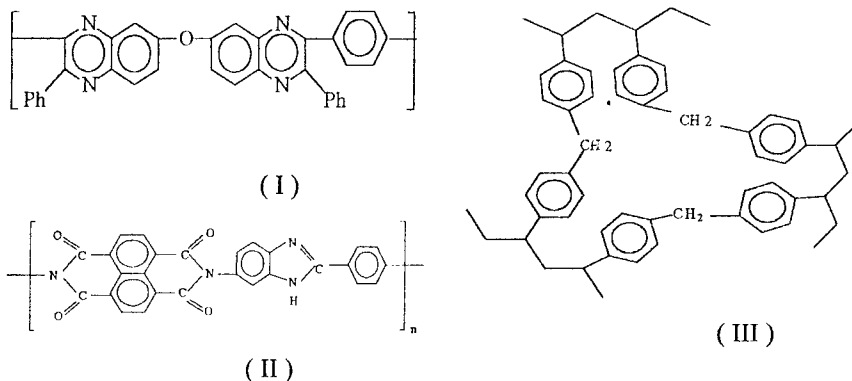

It was found that effect of filler on the copolymer microstructure depends both on the presence of active atoms in the filler structure, which are able to form hydrogen bonds with the growing polymer chains, and on the sorption ability of the polymer filler used. The effect of the polymer filler increases with its content in the reaction medium rising.

References

V.A. Vasnev, A.I. Tarasov, V.V. Istratov, A.P. Krasnov, A.I. Kuznetsov, I.N. Surkova, *Reactive & Functional Polymers*, 26, 177, 1995

**SYNTHESIS OF ANTHRACENE-CONTAINING
POLYPYROMELLITIMIDES BY MEANS OF
DESUBLIMATION POLYCONDENSATION.
INVESTIGATION OF PHOTOELECTRIC PROPERTIES OF
THE POLYIMIDE FILMS AND BILEVEL MOLECULAR
STRUCTURES ON THEIR BASE**

Dmitriy V. Pebalk, Irina V. Bulgarovskaya, Valeriy M. Vozzhennikov, Victoria M. Schechka

*Russian State Research Center, Karpov Institute of Physical Chemistry ul. Vorontsovo
Pole 10, Moscow, 103064 Russia*

The new method of synthesis of aromatic polypyromellitimides (PI) was developed by the desublimation polycondensation in vacuum of vapours of preliminary prepared monomers mixture of pyromellitic dianhydride and diamines (9,10-bis(4-aminophenyl)anthracene (PI1) and 9,10-bis(4-amino-phenylthio)anthracene (PI2)) on heated solid substrates. During the process of synthesis the PI films without defects, homogeneous, with high electric strength and thickness, from parts of micrometers to 1-2, are formed.

Photoelectric properties of these polymers were investigated in sandwich-cells at stationary photoconductive conditions in spectral range from 300 to 600 nm. Strong nonlinear dependence of quantum photoconductive efficiency as a function of applied electric field was determined. Such a pattern of the spectral and electric field dependences probably caused by a multi-step photogeneration process of thermal dissociation of excited CT-electron-hole pairs. It was established that in electric fields, approximately 106 V/cm, photosensitivity of these polymer films is about 0,01 A/W.

Double-layered planar cells consisting of molecular semiconductorperylene tetracarboxylic dianhydride (PTCDA) and PI1 were fabricated on SnO₂ glass substrate by the vacuum evaporation technique. The I-V characteristics of SnO₂/PTCDA/PI1/Al cell in the dark and under dc illumination show rectifying effect in spite of the small difference between the work functions of SnO₂ and Al. The spectral dependence of photocurrent of double-layered cell resembles the superposition of absorption spectra of PTCDA and polymer PI film. The photosensitivity of the bilevel PI1-PTCDA structures in visible region at electric field *10⁵ V/cm reaches 0.05 A/W. The sensitivity values of PI films and bilevel molecular structure are only one order of magnitude less than that for well known Si-photodetectors.

The authors acknowledge the financial support provided by the Russian Science Foundation (Grant No 95-03-09264).

**THE EFFECT OF DIAMINE ISOMERY ON MICRO- AND
SUPERMOLECULAR STRUCTURE OF
COPOLYPYROMELLITIMIDES**

**Victor K.Lavrentjev, Vladislav V.Kudryavtsev, Valentina P.Sklizkova, Andrey
G.Kalbin, Yulija G.Baklagina, Natalija D.Kozhurnikova**

*Institute of Macromolecular Compounds RAS
Bolshoy pr. 31, St.Petersburg, 199004 Russia*

The influence of diamine isomery on micro- and supermolecular structure of copolyimides based on pyromellitic dianhydride (PM) has been investigated by small- and wide- angle X-ray scattering techniques. Copolymers based on 4,4 -diaminoterphenyl (TP) and, correspondingly, 4,4 - and 3,3 -diaminodiphenyl ester (DADPE) have been used.

It has been shown for the first copolymer that the bundle type structure where PM-TP and PM-4,4 -DADPE microblocks change alternately along the bundles are formed. At not so high degree of extension strongly oriented systems, including fibers, with a good thermal and mechanical properties are easily obtained. As for the second copolymer, the composite-like structure with microblocks PM-3,3 -DADPE as weakly ordered matrix and hard microblocks of PM-TP as reinforced elements is formed.

Thus, supermolecular structure which has been observed for these copolymers with the identical chemical compositions are extremely different.

It may be explained by the great differens between parameters of cristalline cells for PM-TP and PM-3,3 -DADPE while these parameters for PM-3,3 DADPE and PM-TP practically concide.

NEW METHODS OF CROSS-LINKED POLYIMIDES OBTAINING

A.P. Krasnov, V.A. Mit', L.S. Fedorova, I.I. Kashleva,
D.S. Kudasheva, I.I. Dubovik

*Nesmeyanov Institute of Organo-Element Compounds RAS
Vavilova Str.28, Moscow, B-334, 117813, RUSSIA*

Thermosetting unsaturated polyimides are traditionally obtained by mixing bisimides of dicarboxylic acids with aliphatic or aromatic diamines. Investigations of cross-linked polymers with pyromellitinide fragments have not gained much ground owing to the difficulty in proceeding block cyclodehydration with the use of amidoacids. Another reason is the complexity of nonmelting and nonsoluble pyromellitimides introduction to the reactive system.

The given work considers new methods for obtaining thermostable copolyimides with cross-linked structure based on bis-(maleimido)diphenylmethane and oxi(diphenylene)-pyromellitamidoacids. The study of nontraditional synthesis of forpolymers for cross-links polyimides has been started. The products of bis-maleimidodiphenylmethane interaction with low-molecular-weight pyromellitimides and pyromellitamidoacids have been obtained by tribochemical method at room temperature and appeared to be of higher reactivity.

Cross-linked copolyimides with the controlled size of fragments between cross-links were obtained in thin films (15-20 mcm). The processes of migratory copolymerization, cyclodehydration and radical polymerization were examined by IR spectroscopy, functional groups titration and sol-gel analysis. It was shown that the presence of amidoacids fragments in the reaction mixture reduces the temperature of interaction between amine groups and the double bonds from 150°C to 80-100°C. It was also observed that the heating above 150°C catalyzed the polymerization of maleimide cycle's double bonds.

The formation of cross-linked polyimides structure with pyromellitimide fragments between cross-links was studied by thermomechanical and dynamic mechanical analyses. The quantitatively assessment of cross-links degree indicated the fact that maximum size of the fragment between cross-links in the polymer network could be attained by means of technical parameters changing.

The tribological properties of antifrictional thin-layer coatings based on the obtained copolyimides have been investigated. Those investigations revealed the fact that the increasing of thermal stability and molecular mass of the fragment between cross-links of polymer binder causes the twice wear enhancement compare to industrial coatings and provides thermofriction stability up to 400°C.

POLYNAPHTHALIMIDES SYNTHESIS IN THE PRESENCE OF BASES.

D. Sęk and A. Wanic

Institute of Polymer Chemistry, Polish Academy of Sciences,

34 M. Curie-Skłodowska St., 41-800 Zabrze, Poland

Polynaphthalimides are synthesized at high temperature polycondensation of six membered naphthalene anhydrides and aromatic diamines. This reaction is usually catalysed by acids. We have found that in the presence of acids at the first step cis and trans isoimide structures are formed [1]. Isomerization of the isoimide to the imide was observed only for trans isoimide in the presence of tertiary amine (isoquinoline). Thus, the polymer exhibited mixtured poly(imide-isoimide) structure. To overwork this problem we tried to find other, more effective catalyst for this reaction. Good result was obtained when NaOH was used as a catalyst in the reaction of the naphthalene dianhydrides with aromatic diamines in protic solvents of phenolic type.

The work is focused on the mechanism of high temperature polycondensation in the presence of NaOH and considers the similarity and differences between the mechanism of the reaction in the presence of acids and bases.

References:

1. D. Sęk, A. Wanic, E. Schab-Balcerzak, *J. Polym. Sci. Part A: Polym. Chem.*, **33**, 547 (1995).

CATALYTIC ONE -POT POLYIMIDE SYNTHESIS IN THE MELT OF AROMATIC CARBOXYLIC ACIDS.

Alexander A. Kuznetsov, Vladimir I. Berendyaev, Sergey V.Lavrov,
Boris V.Kotov

*Karpov Institute of Physical Chemistry, Vorontsovo Pole, 10, Moscow, 103064,
Russia.*

It has been established that the melts of aromatic carboxylic acids (benzoic, chlorbenzoic, etc.) at 140-160°C can be applied as efficient catalytic media in synthesis of polyimides (PIs) of different chemical structure from corresponding diamines and dianhydrides. Reaction is carried out for 0.5-1.0 hour to obtain fully cyclized high molecular weight products with logarithmic viscosity $\eta=0.7-0.9$ dl/g. In dependence on their chemical structure the final PIs can precipitate or retain in a reaction mixture. In both the cases after cooling carboxylic acid crystallizes out and then it can be separated easily by extraction with acetone. Such a technique allows to obtain PIs having low enough content of residual solvent (50-100 ppm); the latter fact having positive influence on thermostability of PIs [1].

It was known from literature [2] that addition of small quantities of benzoic acid to the system containing polyamic acid (PAA) in amide solvents or nitrobenzene accelerates the cyclization reaction of PAA. The opportunity of application of benzoic acid as catalytic reaction medium for one-pot PI synthesis has been demonstrated by us for the first time.

The dependence of MW of PIs obtained vs total comonomers content in starting reaction mixture have been investigated. Also the influence of mono-functional additives on the final MW level was studied. The optimal conditions of the synthesis have been found for the case of thermoplastic polyetherimide (PEI).

It has been shown that the melts of aromatic carboxylic acids can be applied as catalytic media for so-called « direct » cyclopolycondensation of diamines and tetracarboxylic acids. In such systems the reaction kinetics was found to be slower as compared with the analogous reaction including dianhydride. The effect of «smoothing» reactivity was found for low- and high-reactive diamines in acid melt media. This effect can be useful for obtaining new PIs and copolyimides which cannot be obtained with other methods.

The method offered is protected by Russian Patent [3].

References.

1. A.V.Antonov, A.A.Kuznetsov, V.I.Berendyaev at al., *Vysokomolek.Soed.*, , Ser.A, 1994, Vol.36, No.1, pp. 20-25.
2. Ya.S.Vygodskii. *Diss...doc.khim nauk. INEOS, Moscow, 1980*
3. Russian Pat. N 1809612, 1995.

THE INFLUENCE OF CHANGING OF THE
FUNCTIONAL COMPOSITION OF
MACROMOLECULES ON THEIR INTERACTIONS
WITH THE SOLVENT

**A.M.Bochek, G.A.Petropavlovsky, L.I.Kutsenko,
E.B.Karetnikova**

*Institute of Macromolecular Compounds RAN
Bolshoy pr.31, St.Petersburg 199004, Russia*

The reaction of the partially cyanethylation of the water soluble methylcellulose (MC with DS=1.62) was carried out. The influence of the quantity of cyanethyl groups in anhydroglucose unit on the solubility of cyanethyl-methylcellulose (CEMC), on the rheological properties of the aqueous solutions, on the gelation temperature (GT, as determined by viscometry) and cloud point temperature (CPT, as determined by photolorimetry) were studied.

It has been shown that with the increase of degree of substitution of cyanethyl-group (DS_{CEG}) the intrinsic viscosity $[\eta]$ of the polymer decreases. The viscosity of 2% (w) aqueous solutions increases at $DS_{CEG} \geq 0.4$ and total DS=2.0.

It has been shown that with the increase of DS_{CEG} the GT and CPT decrease. But the changes of GT and CPT are different.

**SYNTHESIS AND CHARACTERIZATION OF NEW FILM-FORMING
POLYIMIDES BASED ON
1,2,3,4-CYCLOHEXANTETRACARBOXYLIC ACID,
2,3,5,6-BICYCLO/2,2,2/-OCT-7-ENE-
2,3,5,6-TETRACARBOXYLIC ACID DIANHYDRIDES AND SOME
DIAMINES**

E.Krutko¹⁾, I.Izri²⁾, A.I.Volozhin³⁾, M.Abadie²⁾, N.Prokopchuk¹⁾,
I.M.Zharsky¹⁾,

1) Belorussian State Technological University
13^a Sverdlov st., 220630, Minsk, Republic of Belarus

2) Laboratoire d'Etudes des Matériaux Polymères / Matériaux Avancés Organiques -
LEMP/MAO Université 2, Place Eugène Bataillon - 34095 Montpellier France

3) Institute of Physico-Organic Chemistry of the Academy of Science of Belarus
13 Sarganov st., 220070, Minsk, Republic of Belarus

New cycloaliphatic polyimides based on 1,2,3,4-cyclohexantetracarboxylic-, 2,3,5,6-bicyclo/2,2,2/-oct-7-ene-2,3,5,6-tetracarboxylic acid dianhydrides and aromatic diamines were obtained by two- and one-step methods. The two step polymerization involving the ring opening polyaddition and subsequent cyclodehydration synthesis of polyimides was carried out by polycondensation of equimolar quantities of 1,2,3,4-cyclohexantetracarboxylic acid, 2,3,5,6-bicyclo/2,2,2/-oct-7-ene-2,3,5,6-tetracarboxylic acid dianhydrides with 4,4'-diaminodicyclohexylmethane (DDHM), 2,2-bis-(4-aminophenyl)hexafluoropropane in dimethylformamide (DMF), dimethylacetamide (DMA), N-methylpyrrolidone (NMP), dimethylsulfoxide (DMSO) at room temperature.

A typical preparation was as follows: the dianhydride was added to a solution of diamine in DMF at 20°C. The concentration of solid monomers was 15-25% by weight in the DMF as solvent. These mixtures were allowed to stir with magnetic stirring for two hours to allow for molecular weight build up. At this stage the polymer in solution was polyamic acid (PAA).

Films were prepared from the polymers by spreading the PAA solutions onto glass plate. The films were dried under vacuum overnight. The films were further cyclodehydrated to the polyimides in nitrogen at 20-300°C.

High temperature synthesis of polyimides was carried out by polycondensation of equimolar quantities of dianhydrides with diamines in solution of m-cresol at temperature 180-190°C with the catalytic amounts of some aliphatic and cyclic tertiary amines. On the base of determined data (concentration of catalyst, reaction time, temperature and molecular weight) the reaction conditions optimization had been done. It has been shown that the utilization of the catalysts proposed is most effective for the polycondensation reaction because permits to obtain polymers of high molecular weight. These polyimides exhibit good solubility in polar solvents like NMP, DMF, DMSO, DMA.

Utilization of these polyimide films allows to open prospective pathway to creating of novel materials in microelectronics.

ARYLENESULFIDE-CONTAINING POLYMALEINEIMIDES

VLADIMIR I. NEDEL'KIN

*Institute of Organoelement Compounds Russian Academy of Sciences,
Moscow 117813, 28 Vavilov str., Russia*

Thermosetting and thermoplastic arylsulfide-containing polymaleineimides of different structure have been prepared by three ways:

1. Polyimidosulfides of the formula (I) were synthesized by polyaddition reaction of dithiophenoles with bismaleineimides (BMI) or by interaction of dithiophenoles with maleic anhydride and polycondensation of the sulfur-containing dianhydride intermediate with an aromatic diamine and following thermal cyclisation of the polyamidoacid.

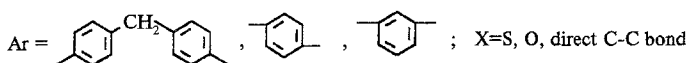
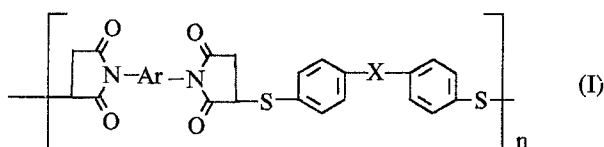

2. Starting from sulfur-containing diamines we have prepared the number of sulfur-containing BMI of the formula (II) with successively increasing number of phenylsulfide units between maleinimide groups. By thermal polymerisation of double bonds in BMI or by polyaddition reaction with the same diamines we obtained network polyimides or linear polyaminoimides respectively.

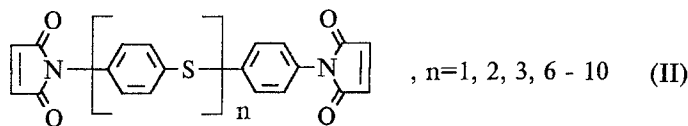

Available polyimide-type thermosetting binders were obtained by interaction of commercial BMI with oligophenolesulfides or polyaminophenylene sulfides of the formula (III) in the melt. (These oligomers were obtained by direct polycondensation of phenole or aniline with elemental sulfur).

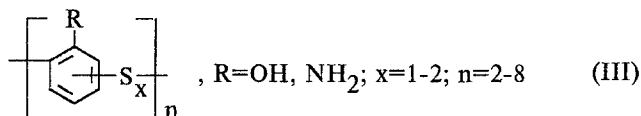

The thermal and dielectric properties of the cured polyimides and composites on their base have been discussed.

**SYNTHESIS AND PROPERTIES OF NOVEL POLYIMIDES PREPARED BY THE
1,3-DIPOLAR CYCLOADDITION REACTION**

I. Globa¹⁾, N.Prokopchuk¹⁾, E.Krutko¹⁾

1) Belorussian State Technological University
13^a Sverdlov st., 220630, Minsk, Republic of Belarus

A series of novel polyimides from N, N'-bismaleinimides and azines by the 1,3-dipolar addition reaction have been synthesized:

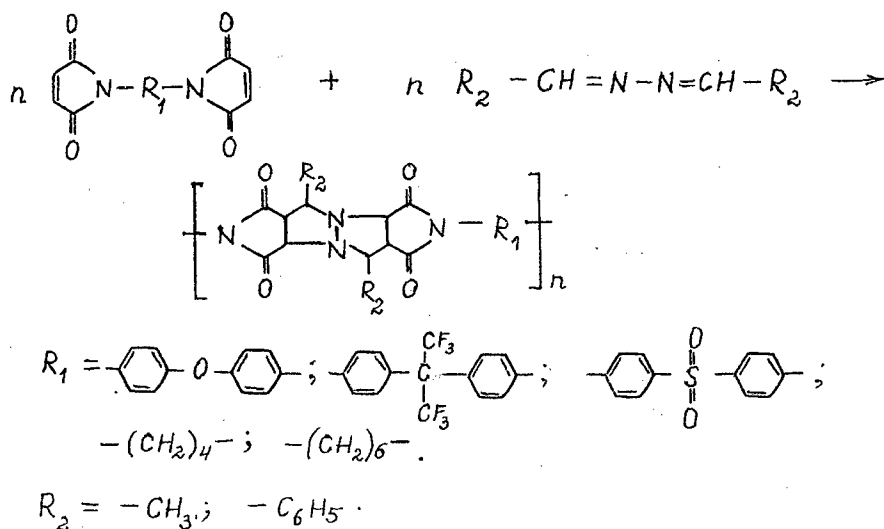

The influence of the solvents and temperature conditions of synthesis on the molecular weight, chemical structure and on the thermal-, mechanical and dielectric characteristics of prepared polyimides have been investigated.

It has been shown that from indicated monomers is possible to prepared a new melt formable polyimides.

The polymers was clearly melt-processable at temperatures well below 300° C. A great deal of research has been devoted to defining the relationship of chemical structure to such properties as T_g, T_m, solubility, color and moldability.

Increased of the internal mobility will decrease crystallinity, increase solubility and increase moldability. Note should be made of the change of color with chemical structure. It should be noted that color of the prepared polyimides range from deep yellow-orange to colorless.

This research indicated that it is possible to prepared soluble and melt polyimides with the different chemical structures and high molecular weight by the 1,3-dipolar cycloaddition reaction.

The molecular weight of the polyimide obtained it depends on various factors such as: process, molecular ratio, effect of water, cycle of reaction temperatures, choice of solvent, purity of monomers.

CATALYTIC EFFECTS IN CYCLODEHYDRATATION REACTION OF PHENYLPHALMIC ACID IN CONCENTRATED SOLUTION AND IN SOLID PHASE.

Alexander A. Kuznetsov, Michael Yu. Belov.

Karpov Institute of Physical Chemistry, Vorontsovo Pole, 10, Moscow, 103064, Russia.

The potentiometric titration and GLC techniques were used for investigation the kinetics of model cyclodehydration (CD) reaction of phenylphthalamic acid (PPAA) in N-methylpyrrolidone (N-MP) in a region of PPAA concentration $C_0=10-90\%$ - weight, and in solid phase at 140°C . The reaction was carried out at conditions of two types: with evacuation of the volatile products and without evacuation. The method of PT allows to determine the current concentration of PPAA and also the concentration of phthalic acid (PA) which is a product of by-reaction (decay of PPAA). The CD process in solid phase with evacuation of the water was found to have the initial rate (V_0 value) 0.4% per minute and to reach its upper conversion limit at conversion about 40% . In a contrary, in an analogous experiment in a closed system a sharp acceleration of the reaction has been found after reaching 20% conversion. In a several minutes reaction has finished to obtain 100% cyclized product. This effect obviously is connected with autocatalysis of CD reaction with the water evolved at the initial stage of the process.

The V_0 value of CD reaction of PPAA in N-MP is much more higher as compared with solid phase reaction. For example, at $C_0=76\%$ the V_0 value in N-MP is 40 times as higher as for solid phase. The curve of the dependence of $V_0=f(C_0)$ possess the maximum at $C_0=76\%$. The increase of the reaction rate with increasing C_0 can be explained with catalysis of CD reaction with PPAA itself. At $C_0>82\%$ V_0 decreases sharply; this effect can be partially be explained with limiteded solubility of PPAA. The sharp increasing of V_0 value in a region of $C_0=40-65\%$ can be connected with the changing the properties of the medium due to increase of the water content, which is evolved at the initial stage of the reaction in a quantity proportional to C_0 . The small additives of the water ($1-3\%$) introduced into the system resulted in sharp acceleration of the reaction (in a closed system). In a additional control experiment the catalytic effect observed was shown to be due to the presence of water but not of PA.

Also the CD process of PPAA has been investigated in a concentrated system PPAA-water instead of N-MP (in a closed system). It was established that at the same weight ratio PPAA/solvent the CD reaction rate is even higher in water than in MP solution, in both the cases the final conversion of CD reaction is about 100% .

So, the solvent and the water evolved during CD reaction in definite conditions can transfer the CD process in a regime of superfast catalytic reaction.

Polyimides for ultra-thin gas separation layers of composite membranes

Miroslav Marek, Eduard Brynda, Zbyněk Pientka

**Institute of Macromolecular Chemistry, Academy of Sciences
of the Czech Republic, 162 06, Prague 6, Czech Republic**

Langmuir Blodgett technique is a promising way of preparation of polyimide film as a gas separation layer for composite membranes which leads to high permeation rates and good selectivity. In order to improve mechanical properties of ultra-thin polyimide layer by two dimensional photocuring we synthesized salt of polyamic acid containing methacrylate side group in the repeating unit (Scheme I). This polymer was irradiated on the argon/water interface after compression and then deposited onto a) fluorocarbon macroporous membrane FP-010 (Sumitomo Electric), b) poly(phenyleneoxide) asymmetric membrane of 18 nm maximum skin pore size. 30 monomolecular layers were deposited onto the substrates and cyclized by heating. Composite membrane with macroporous support layer showed permeation rate $P/l = 5.2 \cdot 10^{-2} \text{ cm}^3 \text{ (STP)/(cm}^2 \text{ s cmHg)}$ for N_2 and $P/l = 6.76 \cdot 10^{-6} \text{ cm}^3 \text{ (STP)/(cm}^2 \text{ s cmHg)}$ for O_2 . The separation factor $\alpha = 0.77$, close to its theoretical value 0.83 for Knudsen diffusion, suggests that the gases mostly permeate through defects (observable by SEM). The composite membrane with asymmetric support showed permeation rates for CO_2 , $P/l = 11.5 \cdot 10^{-6} \text{ cm}^3 \text{ (STP)/(cm}^2 \text{ s cmHg)}$, for O_2 , $P/l = 4.2 \cdot 10^{-6} \text{ cm}^3 \text{ (STP)/(cm}^2 \text{ s cmHg)}$, and for N_2 , $P/l = 1.8 \cdot 10^{-6} \text{ cm}^3 \text{ (STP)/(cm}^2 \text{ s cmHg)}$. Separation factors for CO_2/N_2 , $\alpha = 6.4$ and for CO_2/O_2 , $\alpha = 2.4$ indicated an efficient covering of pores in asymmetric support layer by polyimide film.

Fully cyclized polyimides (Scheme II) forming stable monolayers on the air/water interface were deposited (15-30 monolayers) by Langmuir-Blodgett technique onto poly(1-trimethylsilyl - 1 - propyne) support layer ($\sim 30 \mu\text{m}$ thick). Permeation properties are summarized in Table I.

Table I

Polymer	Permeation rate P/l $10^6 \text{ cm}^3 \text{ (STP)/(cm}^2 \text{ s cm Hg)}$				Selectivity α		
	N_2	O_2	CO_2	H_2	O_2/N_2	CO_2/N_2	H_2/N_2
$\text{X}=\text{O}, n=15$	0.28	0.91	5.02	2.76	3.25	17.9	9.86
$\text{X}=\text{O}, n=17$	0.64	2.27	12.3	7.20	3.55	19.2	11.2
$\text{X}=(\text{CF}_3)_2 \text{C}$ $n=17$	0.25	0.84	4.35	2.39	3.36	17.4	9.56

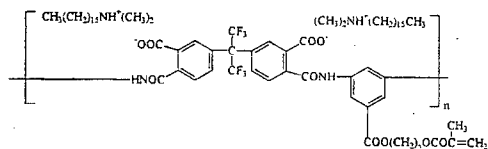

Scheme I

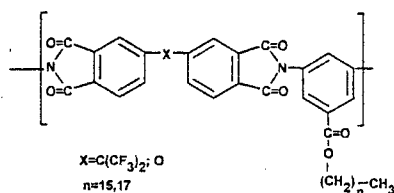

Scheme II

SYNTHESIS OF POLY(PYRROLO-[4'',5''-b]-QUINOXALINO-[2'',3'':5',4']- BENZO-[1',2':2,3]-PYRROLO-[4,5-b]-QUINOXALINES) AND POLY(BENZO-[1',2':2,3]-PYRROLO-[4,5-b]-QUINOXALINES) FOR APPLICATIONS AS NON-LINEAR MEDIA FOR THIRD HARMONICS GENERATION

Mikhail Ya. Goikhman, Andrei V. Tenkovtsev, Alexander V. Yakimansky,
Nina V. Agrinskaya[†], and Vladislav V. Kudryavtsev

*Institute of Macromolecular Compounds of Russian Academy of Sciences,
31 Bolshoy prospect, St.-Petersburg, 199004 Russia*

[†]*Ioffe Physico-Technical Institute of Russian Academy of Sciences,
26 Polytechnicheskaya str., St.-Petersburg, 194021 Russia*

Polymers with elongated π -conjugation systems are of extreme importance for applications in opto-electronics, especially for devices based on third harmonics generation (THG) processes. The synthesis of typical polyconjugated polymers as poly-p-phenylene, poly-pyrrole etc., is usually quite difficult and the resulting polymers are of rather low molecular weight. Here, we present an easier and more convenient approach to the synthesis of similar polyconjugated polymers.

Direct polycondensation of several bis-isatines with 3,3',4,4'-tetraaminobiphenyl

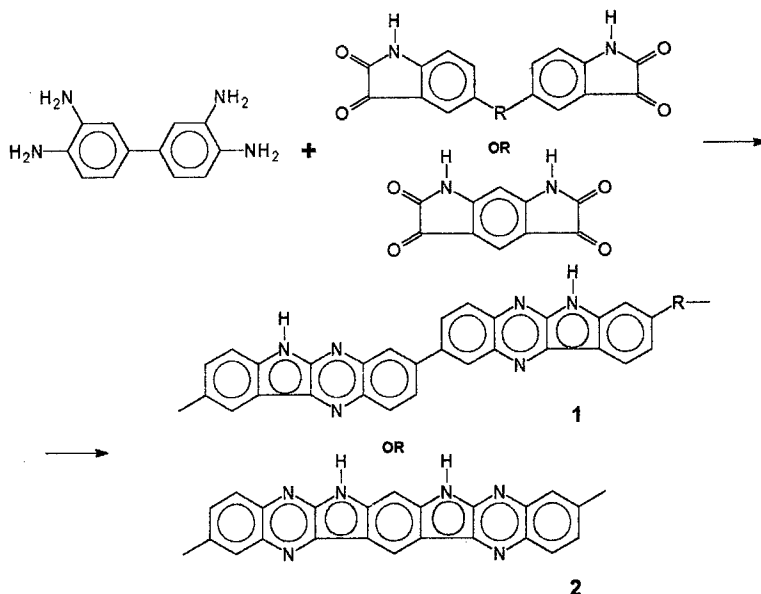

where R = —, —CH₂—, —O—, leads to poly(pyrrolo-[4'',5''-b]-quinoxalino-[2'',3'':5',4']- benzo-[1',2':2,3]-pyrrolo-[4,5-b]-quinoxalines) (1) and poly(benzo-[1',2':2,3]-pyrrolo-[4,5-b]-quinoxalines) (2).

It was shown that these polymers display THG properties being dispersed in a poly(methyl methacrylate) matrix. The typical efficiency of THG is comparable to that characteristic of polydiacetylenes frequently used in THG applications.

POLYDIMETHYLSILOXANE-POLYLACTIDE BLOCK COPOLYMERS. SYNTHESIS AND STEREOCOMPLEX FORMATION

M.-P. Dedieu-Berkoukchi, N. Lotfi, G. B elorgey and G. Sauvet

Laboratoire de Recherches sur les Macromol cules. URA 502.
Institut Galil e. Universit  Paris-XIII, 93430 Villetaneuse (France)

Poly(L-lactide) (PLLA) and poly(D-lactide) (PDLA) are semi-crystalline polymers. Blending of the two enantiomers leads to the formation of racemic crystals (stereocomplex), preferentially to the separate crystallization of each constituent. Stereocomplex can be obtained from the melt and by precipitation from a solution. Its melting temperature (220-225 C) is 50 C higher than those of PLLA and PDLA crystals. Thus, introduction of stereoregular polylactide blocks in copolymers may lead to thermoplastic elastomers with improved thermo-mechanical properties.

For this purpose, multiblock and triblock copolymers associating polydimethylsiloxane (PDMS) and PLLA or PDLA have been prepared. Multiblock copolymers were obtained by polycondensation of α,ω -diallyl PLLA (or PDLA) and α,ω -dihydrogenosilyl PDMS using hydrosilylation. Triblock copolymers were obtained from ring-opening polymerization of L or D-lactide initiated by α,ω -diol PDMS. Block copolymers of various molar masses were synthesized. Their thermal characteristics and ability to stereocomplexation were studied using differential scanning calorimetry.

Crystallization. As-prepared multiblock copolymers are semi-crystalline ($T_f = 118^\circ\text{C}$, $\Delta H_f = 32 \text{ J/g}$ for a copolymer (PLLA2800-b-PDMS2600)_n), but crystallization from the melt is only observed after isothermal treatment.

Triblock copolymers are more crystalline and melt at higher temperatures than multiblock copolymers ($T_f = 152^\circ\text{C}$, $\Delta H_f = 56 \text{ J/g}$ for a triblock PLLA3500-b-PDMS2000-b-PLLA3500) and a partial crystallization is observed from the melt, even for the largest cooling rates ($\geq 100^\circ\text{C/min}$). In this case, a complementary "cold crystallization" takes place during the following heating run.

Stereocomplexation. Both types of copolymers give stereocomplex when blended with the enantiomeric homopolylactide. The amount of stereocomplex which is formed on cooling rapidly from the melt ($\geq 100^\circ\text{C/min}$) is similar to that obtained for homopolymer blends. The melting temperature is slightly lower for the multiblock copolymers ($T_f = 185\text{-}200^\circ\text{C}$) than for the triblock copolymers of similar molar masses ($T_f = 200\text{-}210^\circ\text{C}$). It is noteworthy that, in the case of multiblock copolymers, racemic crystals are easily formed on cooling from the melt whereas the copolymer alone is not able to crystallize. Furthermore, stereocomplexation is observed for non stoichiometric blends. The amount of complex increases proportionally to the fraction of the minor constituent (homopolymer or copolymer), which tends to demonstrate that the amount of complex formed is in any case close to the maximum.

Copolymer-copolymer blends were also investigated. Remarkably, the ability to form stereocomplex is practically maintained. The rate of stereocomplexation and the amount of complex are similar to that observed in the case of homopolymer-copolymer blends and the melting temperatures are only 10-20 C lower.

NEW ADVANCES IN THE MOLECULAR DESIGN OF CYCLOLINEAR POLYORGANOSILOXANES: FROM 2-DIMENSIONAL COLUMNAR MESOPHASE TO 1-DIMENSIONAL NOVEL MESOPHASE STRUCTURE

Elena V. Matukhina*, **Nataliya N. Makarova****, **Yuli K. Godovsky*****

**Moscow State Pedagogical University, st. Malaya Pirogovskaya 1, Moscow, 119882 Russia*

***Nesmeyanov Institute of Organoelement Compounds, Russian Academy of Sciences, st. Vavilova 28, Moscow, 1117813 Russia*

****Karpov Institute of Physical Chemistry, st. Vorontsovo Pole 10, 103064 Russia*

Cyclolinear polyorganosiloxanes (CS) comprising tetrasiloxane ring fragments, poly[oxy(organocyclo-tetrasiloxane-2,6-diyl)]s [TCS], substituted with ethyl, propyl, phenyl groups were observed to display columnar mesomorphic behaviour as well as their linear analogues, polydi-n-alkylsiloxanes [1]. The similar properties are inherent to CS with pentasiloxane ring units [PCS], poly[oxy(ethylcyclopentasiloxane-2,6-diyl)] and its copolymer with polydiethylsiloxane. Moreover, contrary to polydimethylsiloxane (PDMS), which reveals no mesomorphic behaviour, formation of two columnar mesophase modifications have been observed in TCS with methyl side groups when TCS's chains were enriched by *trans*-units [2]. Self-organization of TCS and PCS into a 2D-columnar mesophase implies the self-coordinated ordering on intra- and intermolecular levels. Siloxane ring fragments tend to correlate on molecular level packing one on top of the other. The ordering of siloxane rings within a molecule enables for organic side substituents to wrap around the siloxane chain. This arrangement of organic chains corresponds to their best overlap. On the other hand intramolecular ring ordering itself gains stability due to the interactions between organic groups on inter- and intramolecular levels.

Formation of novel mesophase with 1D-order have been discovered for a series of CS containing cyclohexasiloxane chain fragments substituted with methyl groups (HCS): namely oligo- and poly[oxy(methylcyclohexasiloxane-2,8-diyl)]s as well as copolymers and block-copolymers comprising cyclohexasiloxane and PDMS fragments. The most probable arrangement of the HCS molecules in the mesophase is a layer packing formed by monomolecular layers stacked with a good long-range order. The chemical modification of the HCS chain does not influence on the main structural parameter of 1D-mesophase being connected with the stacking periodicity related to the layer thickness. So, within a layer the cyclohexasiloxane fragments are arranged with a strong tendency to lie on their flat sides along the planes of the layer. However the temperature region of 1D-mesophase existence can be directly regulated by the chemical modification of the HCS. The structure of HCS mesophase cannot be described in terms of the conventional classification used for organic mesophase polymers. On our opinion HCS are the novel class of mesomorphic systems. Self-organization of HCS into the 1D-mesophase directly associated with formation of supramolecular elements – monomolecular layers. This phenomenon is caused by conformational peculiarities of HCS molecules that outcome from the properties of cyclohexasiloxane fragments. Contrary to rigid tetra- and pentasiloxane rings, flexible hexasiloxane rings have no ability to correlate within a molecule. As a result, the siloxane HCS chain is unable to wrap itself by organic side groups. However, amphiphilic constitution and anisotropic form of hexasiloxane ring promote microphase separation exclusively on the intermolecular level.

The work has been supported by INTAS (grant 93-753) and by the program "Universities of Russia"

1. N.N.Makarova, Yu.K.Godovsky, B.D.Lavrukhin // *Polymer Science (Russia)* 1995, V.37A, N3, P.375.

2. E.V.Matukhina, E.E.Boda, T.V.Timofeeva, Yu.K.Godovsky, N.N.Makarova, I.M.Petrova, B.D.Lavrukhin // *Polymer Science (Russia)* 1996, V.38A, N9, P.1545.

FROM POLYSYLARYLENE- TO POLYSYLBENZYLYDENE - ESTERS (METHYLENE GROUP EFFECT).

Anatoliy Yu. Osadchey , **Nina A. Andreeva** , **Anatoliy I. Grigor'ev**
Sergey V. Zhukov , **Vera P. Malinovskaya** , **Sergey S. Skorokhodov**.

*Institute of Macromolecular Compounds RAS,
Bol'shoy Pr. 31, St. Petersburg, 199004 Russia*

Last decade numerous polysiloxane-arylenes were synthesized. Combination of silarylene group with rigid aromatic fragment seems to be mesogenic but most of the polymers prepared do not form liquid crystalline phase. Possible explanation is based on assumption of the prevention of the ordering because of steric hindrances produced by substituents at Si - atom. We have prepared a series of polymers containing methylene group separating Si - atom and phenylene nucleus :

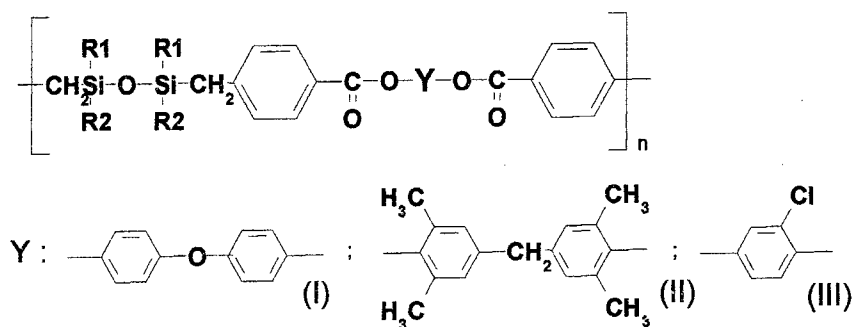

R1 ; R2 = CH₃ ; C₂H₅ ; C₆H₅

X-Ray measurements show high degree of ordering of all the polymers. Polymers of series (I) have high crystallinity and decompose before melting. Introduction of the substituents in rigid fragment (II) leads to lowering of melting points and ordering. Mesomorphic polymer was obtained with polar substituent (III) . The relaxation properties of polymers were determined by dielectric spectroscopy. In conclusion the change of the structure of the main chain really enhance the ordering and in particular the mesogeneity .

*) This material is based upon work supported by Basic Research Foundation
(Grant 96-03-33849).

POLYMERIZATION OF STYRENE WITH NICKEL, COBALT
AND PALLADIUM CATALYSTS

Riccardo Po', Nicoletta Cardi, Roberto Santi, Anna Maria Romano, Carla Zannoni

EniChem S.p.A. - Istituto Guido Donegani
Via Giacomo Fauser, 4 - 28100 Novara (Italy)

Nickel and palladium based catalytic systems have been recently developed for olefin polymerization¹. Such catalysts allow a good control of polymer branching and a fairly good activity, especially in the case of nickel. Nickel derivatives, namely Ni(AcAc)₂ were also found to be active in the polymerization of styrene^{2,3}. In this case the polymer obtained is partially isotactic, and its stereoregularity can be somewhat modulated by using suitable Lewis bases². Moreover, the activity depends markedly on the kind of methylaluminoxane (MAO) used as a cocatalyst; the higher values of activities were observed by using a MAO treated in such a way to drive off the excess of trimethylaluminum³, either by precipitation with an aliphatic solvent or by devolatilization *in vacuo* (MAOs).

In this work we report on the polymerization of styrene with different nickel derivatives combined with MAOs. Reactions were carried out at 70°C for 2 h both in toluene and in bulk. Among the nickel compounds, Ni(AcAc)₂, Cp₂Ni, Ni(S₂C₂Ph₂)₂, (Ph₃P)₂NiCl₂ and (C₁₂H₈N₂)NiCl₂ were chosen for the tests. The yields vary in dependence of the metal ligands, and are particularly high with Ni(AcAc)₂; all the polystyrenes have a degree of stereoregularity of about 70% of *meso* diads (isotactic structure).

Palladium complexes (Pd(AcAc)₂, (2,9-Ph₂-C₁₂H₆N₂)PdCl₂, (C₁₀H₆N₂)PdCl₂(C₆F₅)₂) are inactive, and neither isotactic nor atactic polystyrene was obtained, while Co(AcAc)₂ afford atactic polystyrene in low yields.

With all the metals a marked reduction of the metal to the zero-valent state occurs, as revealed by the slow change of the reaction mixture from colourless to yellow to black.

REFERENCES

1. L.K. Johnson, C.M. Killian, M. Brookhart, *J. Am. Chem. Soc.*, **117**, 6414 (1995)
2. P. Longo, A. Grassi, L. Oliva, P. Ammendola, *Makromol.Chem.*, **191**, 237 (1990)
3. G.L. Crossetti, C. Bormioli, A. Giarrusso, A. Ripa, L. Porri, *10th Italian Symposium of Catalysis - Proceedings*, L'Aquila, 1996

BICENTRIC METAL COMPLEX CATALYSTS FOR POLYMERIZATION OF OLEFINS AND DIENES

Evgeniya A. Mushina, Inna F. Gavrilenko, Elena I. Tinyakova, Yuri Ya. Podolsky, Vadim M. Frolov, Boris A. Krentsel, Evgeni M. Antipov

*A.V. Topchiev Institute of Petrochemical Synthesis RAS
Leninsky pr. 29, Moscow, 117912 Russia*

The bicentric catalysts (BC), which we created recently, represent an assemblage of two metallic complex compounds, deposited on the surface of an inorganic carrier. The method of preparation of these catalysts includes the sequential precipitation of titanium-magnesium compound and oligodienyl complex of nickel or zirconium on dehydrated microspheric silica gel. The oligodienyl complex is the product of the reaction between chloride of corresponding metal and tri-*iso*-butylaluminium (TIBA) in the presence of diene (butadiene, isoprene, allene, etc.) in the aliphatic hydrocarbon. The structure and composition of these complexes were studied by chromatomass spectrometry and by the IR spectroscopy as well as by chromatographic analysis of their decomposition products. It was shown that the oligodienyl compounds of nickel (or zirconium) form with $(i-C_4H_9)_2AlCl$ complexes, which contain bridge structures with metal-chloride bonds:

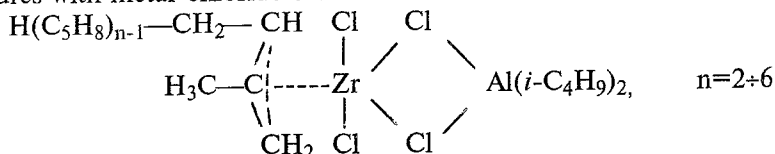

Prepared catalytic systems have been used to produce medium density polyethylene (PE) by gas phase polymerization of ethene without addition of comonomers. It turned out that the oligomers of ethene (1-butene, 1-hexene, etc.), formed *in situ* under the action of oligodienyl complexes, undergo the co-polymerization with ethene on the titanium-magnesium compound of catalyst. It was found that within the investigated catalysts the most active in the ethene polymerization is the titanium-magnesium catalyst, modified by oligodienyl complex of zirconium. An increase of the ratio between two metals in the catalyst (Zr/Ti or Ni/Ti) leads to rise of the branching of polyethylene macromolecules with the simultaneous decrease of a density up to 0.940-0.945 g/cm³. The PE obtained is characterized by relatively narrow molecular-mass distribution ($M_w/M_n=4-7$), the molecular mass of polymer being depended on the nature of metal in oligodienyl complex.

It was firstly demonstrated that the titanium-magnesium catalyst, deposited on silica gel, in a combination with TIBA is effective catalyst for *trans*-polymerization of butadiene and isoprene. In the presence of the same catalyst, modified by oligodienyl complexes of nickel or zirconium, the blend of *cis*- and *trans*- polymers is formed, the ratio between these isomers being determined by the composition of catalyst and the polymerization temperature. In the case of propylene and higher olefines (4-methylpenten-1) the BC display not only high activity, but the stereospecificity of action as well.

FORMATION OF MAGNETIC STRUCTURE OF POLYMETALORGANOSILOXANES

Mikhail M. Levitsky^{*}, Anatoly L. Buchachenko[#], Alexandr Ju. Dyakonov^{*}

^{*}*A.N. Nesmeyanov Institute of Organoelement
Compounds, Russian Academy of Science, Vavilova str. 28, 117813 Moscow,
Russia.*

[#]*N.N. Semenov Institute of Chemical Physics, Russian Academy of Science, Ko-
sygina str. 4, 117977 Moscow, Russia.*

Polymeric polymetalorganosiloxanes (PMOS) of general formula: $[(R_3SiO_{1.5})_x(MO_y)_z]_w$
R=Ph, Vin; M=Fe, Co; Cu; $z/x=M/Si$; y - valence of M, were synthesized. It was shown that
besides the metalsiloxane clusters M-O-M, formed in polymer at rearrangement, the

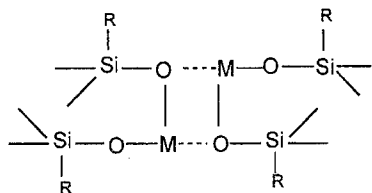

coordinating clusters originate in polymer structure at the expense of intercoordination.

We succeed to divide the influence on magnetic properties of intrachain clusters (originated in the course of synthesis) and of interchain clusters (coordinating) by imitating of dilution of Fe atoms by organosiloxane fragments. The

analysis of magnetic properties shows that the dependence χ from T can be divided on two components: antiferromagnetic component - connects with interchain coordinating clusters, and ferromagnetic component connected with the polymer composition (the higher Fe/Si value the more intensive it expresses). Both components were characterized quantitatively.

The value of exchange magnetic interaction constant J_f for all investigated compounds are practically by a factor of 10 higher than antiferromagnetic contribution J_{af} . It is explained by decrease of part of ionic pairs $Fe^{+3}-Fe^{+3}$ with short interionic distance. For Co - containing PMOS (in contrast to Fe-PMOS) the dependence of magnetic susceptibility from content of Co is absent.

Investigation of PMOS, containing Cu atoms and alternating Cu and Zn atoms showed that Cu atoms are united in clusters with spin-spin exchange. The values of effective magnetic moments (μ_{eff}) in these compounds increase with the drop of temperature approximating to μ_{theor} what is point to the lowering of antiferromagnetic contribution.

This work is supported by Russian Foundation for Basic Research (project 97-03-33724).

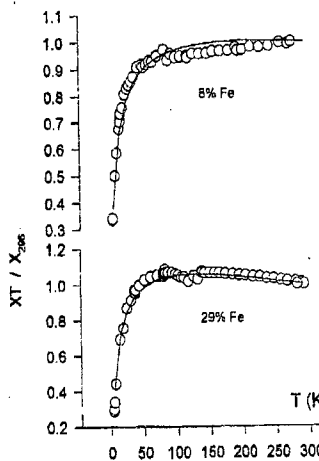

MODIFICATION OF CONDENSATION POLYMERS BY ORGANOELEMENT COMPOUNDS

Nina A. Vasneva, Galina L. Berestneva, Valerii A. Vasnev, Natalia V. Retush

Nesmeyanov Institute of Organoelement Compounds RAS Vavilov str. 28, Moscow, 117815 Russia

It was found that organoelement compounds-silicone and germanium ethynyl derivatives are effective modifier-extenders of condensation polymers (polyesters and polyamides) chains. Introduction of small amount (< 5%) of diethynyldiphenyl-silane (DEDPS) or germane (DEDPG) to polyethylterephthalate (PET) increases significantly both polymer molecular weight characteristics and temperature properties. Heating of bicomponent mixtures at the melting point or higher temperature results in decrease of volatile destruction products (water, acetaldehyde, carbon dioxide, etc.) and increase of macromolecules molecular weight. So PET heating with 2% DEDPS or DEDPG at 280 °C during 30 minutes results in increase of polymer intrinsic viscosity from 0,61 to 0,79 or 0,72 dl/g accordingly. Without modifiers PET heating leads to decrease of intrinsic viscosity to 0,48 dl/g.

Polycaproatamide heating with 2% DEDPS at 280 °C during 30 minutes results in significantly decrease of water in system and increase of intrinsic viscosity from 1,26 to 2,16 dl/g.

Using of organic diethynyl compounds, para-diethynylbenzene (DEB), instead of silicon or germanium diethynyl derivatives doesn't lead to analogous effects. So after heating PET with 5% DEB at 280 °C during 30 minutes results in decrease of intrinsic viscosity from 0,61 to 0,53 dl/g.

Reason of these effects is high chemical activity of silicon and germanium diethynyl derivatives connected with conjugation of triple bonds with metal atoms.

INFLUENCE OF OLYGOETHERKETONS ON THE MMD AND
CARBONILE GROUPS CONTENT IN HDPE

Azamat U. Bedanokov, Abubekir Ch. Shaov, Igor V. Dolbin,
Gennadi B. Shustov
Kabardino-Balkarian State university,
ul. Chernyshevskogo 173, Nal'chik, 360004, Russia

Olygoketons as intermediate unities for obtaining block-copolyetherketons synthesized on digalogenbenzophenon and diphenilolpropane are of definite scientific and practical interest as modifiers of polyolephin structures, High Density Polyethylene in particular.

The modifying effect of oligomers on HDPE as compared with the industrial stabilize Irganoks-1010 was estimated by change of \bar{M}_w and \bar{M}_n samples values, computed proceeding from the results of the determination of index melt(IM) at fivefold extruding.

The appearance of carbonile groups, alongside with the peroxide and hydroperoxide in a polyethylene speaks about thermooxidating destruction so, the change of the absorption intensity on the IRS at 1720 cm^{-1} indicates the effectiveness of the influence of the modifcator as a thermostabilizer.

The percent content of $=C=O$ -groups in the sampls has been determined by means of "base lines".

The data obtained are shown in the table:

№ n/n	Composition	$\bar{M}_w \cdot 10^3$			$\bar{M}_n \cdot 10^3$			$M_{CO}, \%$		
		n ₁	n ₃	n ₅	n ₁	n ₃	n ₅	n ₁	n ₃	n ₅
1.	HDPE	263,03	354,81	295,12	11,75	2,14	4,47	0,25	0,49	0,09
2.	HDPE+0,1% Irganoks-1010	588,84	524,81	316,23	0,16	0,30	1,99	0,09	0,31	0,12
3.	HDPE+0,1% OK-1D*	190,55	194,48	194,48	8,13	6,46	7,59	0,24	0,75	0,12
4.	HDPE+0,1% OK-10 D*	223,87	218,78	208,93	7,94	7,08	6,17	0,68	0,08	0,46
5.	HDPE+0,1% OK-20 D*	234,42	229,09	208,93	8,13	5,75	4,17	0,72	0,39	0,50

* olygoketons on diphenylolpropane with condensation degrees of 1,10, 20;
n₁, n₃, n₅- number of extrusion;
 \bar{M}_{CO} - carbonile groups contend.

SYNTHESIS AND SOME PROPERTIES OF OLYGO- AND
POLYETHERKETONS ON DIFENILOLPROPANE BASIS

Azamat U. Bedanokov, Abubekir Ch. Shaov, Arsen M. Charaev,
Nurali I. Mashukov
Kabardino-Balkarian State university,
ul. Chernyshevskogo 173, Nal'chik, 360004, Russia

Polyetherketones are now one of the most perspective new polymer systems used as construction materials. These polymers are mainly synthesized from digalogenbenzophenons and various bisphenols at high temperatures in the medium of high-boiling solvents. The obtained products are practically insoluble in ordinary organic solvents and have relatively small molecular mass.

With the purpose of removing the above obstacles and drawbacks polyetherketon (PEK) synthesis was performed at two levels- at the first olygoketons with condensation degrees of 1, 5, 10, 20 have been obtained. They were obtained by the interaction of dichlorbenzophenon with diphenilolpropane in dimethylsulphoxide medium at 180°C in the nitrogen atmosphere. The structure of olygoketons has been confirmed by IRS methodice and determination terminal hydroxide groups; at the second stage- we obtained polyepherketons(blockcopolyetherketons) by means of low temperature accept-catalitic polycondensation of olygoketons with the mixture of equimolar quantities of dichloranhydrides of iso-and terephtal acids in a dichlorethan medium. The PEK structure is proved by means of element analysis, IRS and turbidimetric titrating. Their molecular masses are within the range of 60-250 thou, a.u.m. They solute well in chlorated organic solvents.

Olygoetherketons have been used as modifications of high-density polyethylene (HDPE). The optimal concentration of oligomers is their 0,1% addition to HDPE. The composition have been prepared by extruding of the initial mixtures components at 200°C. The modifying effect of olygoketons on HDPE has been estumated by index melt(IM, g/ 10min) at two loadings(2,16 and 21,6 kg) at 190°C after each extruding (n=1-5). The data obtained showed that all olygoetherketons somehow increase the value of IM polyethylene (table):

№ п/ п	Composition	n ₁	n ₃	n ₅	n ₁	n ₃	n ₅
		IM _{2,16}	IM _{2,16}	IM _{2,16}	IM _{21,6}	IM _{21,6}	IM _{21,6}
1.	HDPE	0,066	0,021	0,041	6,88	8,80	9,08
2.	HDPE+0,1%Irganoks-1010	0,003	0,005	0,033	10,92	10,96	13,60
3.	HDPE+0,1% OK-1D*	0,227	0,195	0,216	24,72	24,72	24,92
4.	HDPE+0,1% OK-10 D*	0,122	0,140	0,160	15,05	18,28	22,46
5.	HDPE+0,1% OK-20 D*	0,105	0,110	0,129	13,14	17,14	23,88

POLYESTERIFICATION IN A PRESENCE OF METAL OXIDES.

Alexander I. Tarasov, Lubov Ch. Nafadzokova, Valerii A. Vasnev, Irina N. Surcova, Abdullach K. Mikitaev, Olga L. Lependina.

*Nesmeynov Institute of Organoelement Compounds RAS
Vavilov str. 28, Moscow, 117813 Russia*

One of the promising ways for the creation of composite materials with perspective properties is the synthesis of polymers in a presence of fillers. This approach allow to influence on the reaction catalysis and kinetics, molecular weight of polymers, structure and properties composites. High temperature bulk polyesterification in a presence of inorganic fillers was investigated. The polybutylene terephthalate (PBT) was synthesized from dimethylterephthalate and 1,4-buthylene glycol at 525K and reduced pressure in a presence of metal oxides (10% from PBT). Metal of II-VI and VIII Groups of Periodic Table was used.

It was found that catalyte activity of metal oxides in the model system (reaction of methylbenzoate with n-heptanol at 443 K) decrease in the order:

Ca > Pb(II) > Ba > Zn > Co(II) > Mg > Cu(II) > Al > Ce > La > Fe(III) > Ti(IV) > Zr > Be

High activity of some metal oxides allow to carry out the PBT synthesis with ones without of the special catalysts (tetrabutoxytitanium).

It was found that both distribution of metal oxides particles and mechanical properties of composites are better than ones obtained by traditional method (mixing of PBT with metal oxides in a melt). In particular, the value of the specific impact strength of a "synthetic" sample is about 2.5 times higher.

UNUSUAL INITIATING SYSTEMS FOR RADICAL POLYMERIZATION OF VINYL MONOMERS

Dmitry F.Grishin, Aleksey A.Moykin, Lydmila L.Semyonycheva,
Elena V.Koliakina

*Research Institute of Chemistry, Lobachevsky State University,
23 Gagarin Av., Nizhny Novgorod, 603600 Russia*

Quinones, hydroquinones, nitrosocompounds and nitrones is known to be efficient inhibitors of the radical polymerization of vinyl monomers.

It has been established that benzoquinone and 1,3-bis(tert-butyl)quinone in the presence of organoelement compounds of III group elements not only don't inhibit the radical polymerization of methyl methacrylate but on the contrary effectively initiate proceses of homo- and copolymerization of vinyl monomers in the energy advantageous conditions (at temperature 293-313 K). The sterically hindered 1,3-bis(tert-butyl)quinone is most effective as a coinitiator of acrylic monomers polymerization.

The kinetic characteristics of polymerization has been studied and the influence of polymerization temperature, the concentration of the quinone and organoelement compounds on the rate of polymerization and also moleculare mass of methyl methacrylate, styrene and butyl acrylate polymers has been estimated. The activation energy of the polymerization of methyl methacrylate in the presence triisobutylborane and 1,3-bis(tert-butyl)quinone has been estimated. The polymethylmethacrylate with different moleculare mass from 20000 to 500000 may be prepare by exchanging of initiating components concentrations (quinone and organoelement compound).

It has been established that organoelement compounds and quinones take direct part in elementary stages of radical polymerisation of vinyl monomers.

The radical polymerization of methyl methacrylate in the presence of nitrisocompounds and nitrones has been studied. On example of 2-methyl-2-nitrosopropane and phenyl(tert-butyl)nitrone has been shown, that nitroso compounds and nitrones in the presence organoboron compounds do not exert inhibiting effect on radical polymerization of acrylic monomers and can regulate moleculare mass of polymers.

Mechanism of acrylic monomers polymerization in the presence binary initiators on the base of organoelement compounds and quinone, and also nitrosocompounds and nitrone has been studied and scheme the generation of radicals has been suggested. Unusual mechanism of chain propagation, transfer and termination in the presence of organoelement compounds by type of living free radical polymerization has been discussed.

STUDY OF NEW POLYAMIDES CONTAINING SILICON IN THE MAIN CHAIN

Maria Bruma*, Ion Sava*, Burkhard Schulz**, Frank W. Mercer***,
Marta Szesztay****, Nataliya M. Belomoina*****

**Institute of Macromolecular Chemistry, Aleea Gr. Ghica Voda, 41A, Iasi, Romania*

***University of Potsdam, Institute of Solid State Physics, Potsdam, Germany*

****Raychem Corporation, Menlo Park, CA 94025, USA*

*****Central Research Institute for Chemistry, Budapest, Hungary*

******Institute of Element-Organic Compounds, Moskow, Russia*

Two series of aromatic polyamides incorporating silicon together with phenylquinoxaline rings (I) or with hexafluoroisopropylidene groups (II) have been synthesized by solution polycondensation of a silicon-containing diacid chloride with aromatic diamines having preformed phenylquinoxaline rings or hexafluoroisopropylidene units. These polymers are easy soluble in tetrahydrofuran, and in polar amidic solvents such as N-methylpyrrolidinone and dimethylformamide, and can be cast into thin transparent films from solutions. The polyamides have molecular weight values M_w in the range of 10000-40000 and M_n in the range of 3000-6000, and polydispersity in the range of 3-10. They show glass transition temperature in the range of 236°C-275°C and decomposition temperature above 400°C. The polymer films have low dielectric constant, in the range of 3.26-3.68, and good mechanical properties with tensile strength of 74-100 MPa and tensile modulus of 180-386 MPa. The improved solubility of these polymers compared to the classical aromatic polyamides which do not contain silicon and the large interval between glass transition and decomposition temperature makes them easy processable into useful articles having high thermal resistance, good electroinsulating and mechanical properties, thus being promising for advanced applications in microelectronics or in related fields.

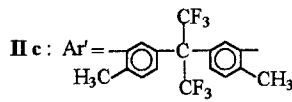
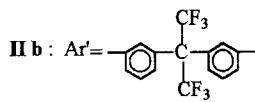
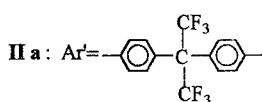
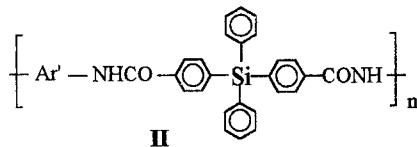
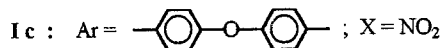
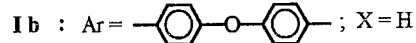
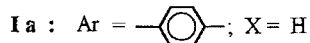
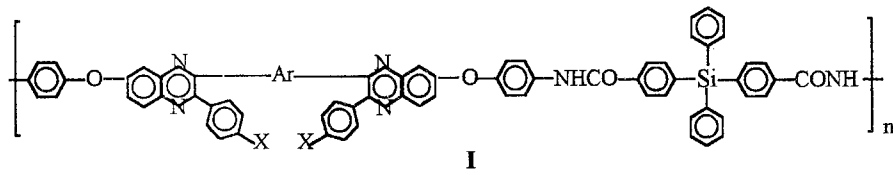

BIMODAL SILOXANE BLOCK - COPOLYMER AND NETWORKS ON THEIR BASE

Anna Yu. Rabkina, Boris G. Zavin, Lidija I. Kuteinikova, Irina I. Dubovic,
Marina N. Il'ina, Vladimir S. Papkov

**A.N. Nesmeyanov Institute of Organoelement
Compounds, Russian Academy of Science, Vavilova str. 28, 117813 Moscow,
Russia.*

Preparation of heterogenous structures - polymodal networks, maked possible to influence on the properties of materials resulting, is of great interest. Polymodal networks, obtained by cross-linking of two or more oligodimethylsiloxanes having very short chains and very long chains, are widely investigated [1].

The goal of present investigation is development of the principles of synthesis and study of the properties of siloxane bimodal block - copolymers (BC) and bimodal networks on their base. Macromolecules of such BC contain alternating linear oligodiorganosiloxane and polycyclic phenylsilsesquioxane blocks. Bimodal distribution by the lengths of linear blocks in macromolecule chain of BC and, respectively, in bimodal networks obtained on their base is provided by using of mixture of oligomers of controlled molecular mass.

The scheme of the synthesis:

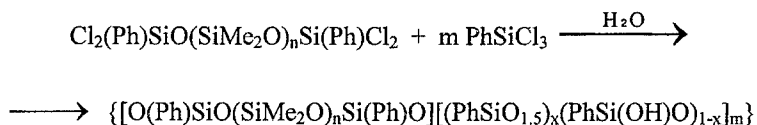

Next parameters were held out in the synthesis: (i) average length of linear oligomer chains differ more than on order, (ii) molar contain of long - chain oligomer was less than 10%, (iii) average content of BC (relation n:m) was held out constant.

Composition and molecular - mass characteristics of BC obtained were studied by NMR - spectroscopy and GPC methods.

Study of phase content of mono- and bimodal BC synthesized was investigated by X-ray, thermomechanical analysis and DSC. It was shown that introduction of a small amounts of long - chain linear oligomer in the BC chain results in a higher lever of phase separation of polydimethylsiloxane and phenylsilsesquioxane blocks. This is influenced on the topology and mechanical properties of the networks obtained on the base of such BC and appeared, in particular, in significant increase of modul of elasticity at elongation and tensile strength in the networks in comparison with the networks obtained on the base of monomodal BC.

This work is supported by Russian Foundation for Basic Research (project 96-03-32608).

[1] J.E. Mark. Acc. Chem. Res., 1994, 27, 271-278.

POLYMERANALOGOUS REACTIONS IN POLYSILARYLENES.

Anatoliy Yu. Osadchey, Valeriy V. Shamanin, Sergey V. Zhukov,
Vera P. Malinovskaya, Sergey S. Skorokhodov

*Institute of Macromolecular Compounds RAS,
Bol'shoy pr. 31, St. Petersburg, 199004 Russia*

A series of polyesters containing oligosiloxane fragments was prepared in the presence of cationic catalysts by the way of octamethylcyclotetrasiloxanes reaction with the polyesters containing short siloxanes fragments. The reacting system is in an equilibrium between polymer and cyclic siloxanes.

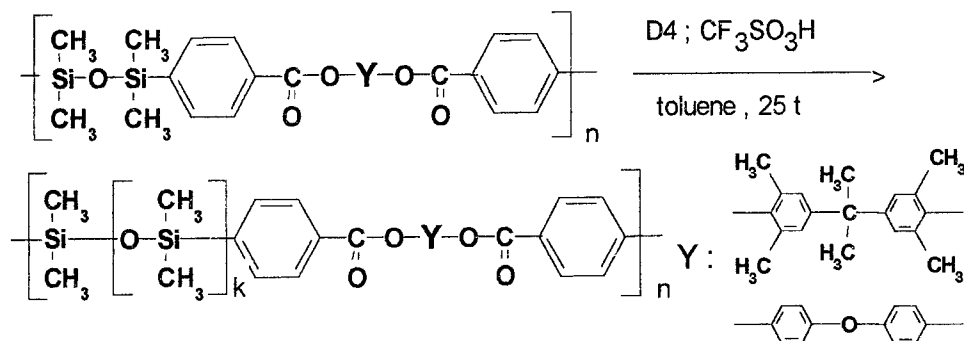

It was established by ¹H-NMR-spectra that the distribution of the values of K is of the form of geometrical one:

$$P(k) = \frac{1}{k} \left(1 - \frac{1}{k}\right)^{k-1} \quad \bar{k} = 3 \div 8$$

The study of dielectric relaxation shows, that investigated polymers in bulk are characterized by the several dielectric transitions: a glass transition (α) and two subglass processes: β_1 and β_2 . The two processes are caused by the reorientation of polar groups of ester- aromatic fragment. The parameters of segmental mobility are strongly dependent on the value of K.

These polymers in dilute solution have three regions of dielectric relaxation which reflect the mobility of definite fragments of chain. The parameters of molecular mobility for all the processes aren't influenced by the length of the chain.

*) This material is based upon work supported by Basic Research Foundation (Grant 96-03-33849).

UNUSUAL NMR-SPECTRA OF SILICONCONTAINING DICARBOXYLIC ACIDS

Anatoliy Yu. Osadchev, Valeriy V. Shamanin, Sergey S. Skorokhodov

*The Institute of Macromolecular Compounds RAS
Bol'shoy Pr. 31, St.-Petersburg, 199004 Russia*

The new monomeric siloxane fragment containing dicarboxylic acid was prepared. In attempt to either support or disprove their structure $^1\text{H-NMR}$ spectra were measured, it was found, that as for acid (I) in pyridine, and for their potassium salt in dimethylformamide, dimethylsulfoxide and water in spectra are absolutely absent (or are strongly broadened with

significant loss of peak intensity) all expected $^1\text{H-NMR}$ -signals, including signals of methyl protons at silicon atom. On the other hand, the $^1\text{H-NMR}$ -spectra of acid chlorides, received directly from the acids, do not show any anomalies. They correspond to the structure (I) completely. The presence in acid of silicon fragments is supported by IR-spectra. For a comparison and for an understanding of this paradoxical phenomenon there was synthesized the well known acid (II). Its spectrum in dimethylsulfoxide corresponds to structure (II) precisely. However at stoichiometric titration of acid (II) in dimethylformamide by a water solution KOH the intensity of its $^1\text{H-NMR}$ -spectrum signals

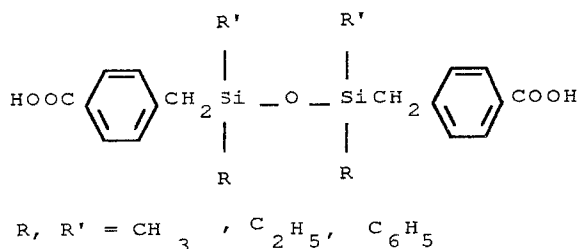

I

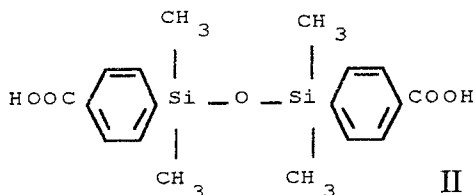

II

falls in comparison with the internal standard (hexamethylphosphorotriamide), on about 30 %.

In the NMR theory for interpretation both of chemical shift, and constants of nuclear spin - spin interactions in the framework of the perturbation theory it is necessary to add to the basic singlet molecular state S_0 a small impurity of the first triplet state T_1 . If T_1 is a thermic achievable state, however, it is possible not virtual, and real transition of the molecule in the triplet state, at which will take place reduction of wave function. It will lead to dramatic change of chemical shift (Knight shift), and spin relaxation times (signal width). The transition discussed organosilicon diacids and their salts in the triplet state in polar solutions, apparently, promotes by their dianionic form, and by presence of vacant d-orbitals on silicon atom. We shall stress, that organic dianion with a basic or by thermic achievable triplet state in the literature are well known.

**SYNTHESIS AND COMPLEXING PROPERTIES OF MONOMER AND
POLYMER 4,4'-DIBENZO-18-CROWN-6-KETOALKYLENEESTERS.
ODD-EVEN EFFECT OF COMPLEXING ABILITY**

A.V.Ovchinnikov and V.V.Zuev

*Institute of Macromolecular Compounds RAS
Bolshoy pr.31, St.Petersburg, 199004, Russia*

During the last decades the synthesis and physico-chemical investigation of crowns have been greatly developed. Great attention has also been devoted to the study of complexing properties of these systems including those in the polymer form]. The interest in these objects is due to the possibility of developing on their basis self-organizing systems representing important biological and other (e.g. liquid crystalline (LC)) systems. The aim of this paper was the synthesis and investigation of the influence of these fragments on the complexing ability of series of monomer 4,4'- dibenzo- 18-crown-6-ketoalkyleneesters I and main chain polymers II based on them, as well the comparative study of the complexing ability of the crown fragment in the polymer chain and of that in the monomer form.

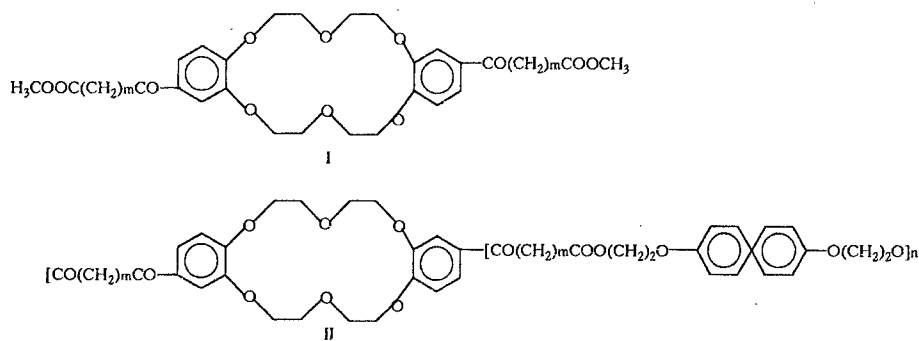

Main chain polymers with the degree of polycondensation 10-25 were obtained by copolycondensation with 4,4'-bis-(2-hydroxyethoxy)-biphenyl on the basis of these monomers. The complexing properties of monomers and polymers with alkali metal chlorides in methanol-chloroform (1:1) solution were investigated. The stability constants for the complexes exhibit the odd-even effect depending on the number of methylene groups in the spacer. The stability constants of complexes in solution are lower for polymers than for the corresponding monomers.

SYNTHESIS AND PROPERTIES
POLYORGANOCARBORANYLMETHYLSILOXANES WITH
CARBONYLHYDROZYDE AND 1,3,4 -OXY - DIAZHOLE UNITS

Boris A. Izmailov, Valeri N. Spector, Boris A. Kamaritsky, Ravel S. Sharaphiev.
Institute of Biocemical Physics RAS,
4 Kosygin Street, 11-226, Moscow, 117334, Russia
Moscow State Textile Academy,
1 Malay Kalouzhskaya Street, 117918, Moscow, Russia

The method of synthesis of the polyorganocarboranylmethylsiloxanes with carbonylhydrozide units on the base of the polycondensation of siloxane dicarboxylic acid (1) with hydrozide dicarboxylic acid (2) was developed

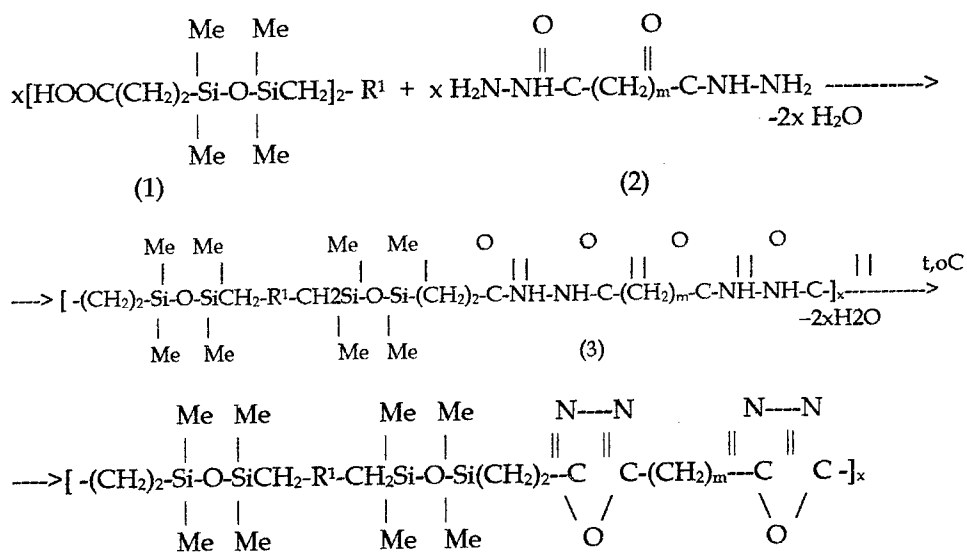

$\text{R}^1 = \text{---C} \begin{array}{c} \diagdown \quad / \\ \text{O} \end{array} \text{---C}_6\text{H}_4\text{---C} \begin{array}{c} \diagdown \quad / \\ \text{O} \end{array} \text{---}$, $\text{---C}_6\text{H}_4\text{---C} \begin{array}{c} \diagdown \quad / \\ \text{O} \end{array} \text{---C}_6\text{H}_4\text{---}$, $\text{---CB}_{10}\text{H}_{10}\text{C---}$, $\text{---CB}_{10}\text{H}_{10}\text{C}$.
 $m = 2, 4, 8.$

After heating polymer (3) eliminated water and transformed in the polymer (4) with 1,3,4-oxydiazhole units.
Polymers (3,4) are soluble in aromatic and chlorine contained hydrocarbons. They have high thermostability.

SYNTHESIS AND PROPERTIES OF OLYGOORGANOSILOXANES WITH
1,4- BIS(DIMETHYLSILYLMETHYL-O-CARBORANYLENE)PHENYLENE UNITS

Boris A. Izmailov, Val. N. Spector, Boris A. Kamaritsky.

Institute of Biocemical Physics RAS

4 Kosygin Street, 11-226, Moscow, 117334, Russia

Moscow State Textile Academy

1 Malay Kalouzhskaya Street, 117918, Moscow, Russia

The method of synthesis of the polyorganosiloxanes with 1,4-bis(dimethylsilylmethyl-o-carboranylene)phenylene units on the base of the polycondensation of 1,4-bis(hydroxydimethylsilylmethyl-o-carboranylene)phenylene (1) [1], 1,4-bis(3-hydroxy-1,1-dimethyl-3,3-diorganodisiloxanylmethyl-o-carboranylene)phenylene (2), with bis(N,N1-dimethylamino)diorganosilanes (3 a,b) was developed

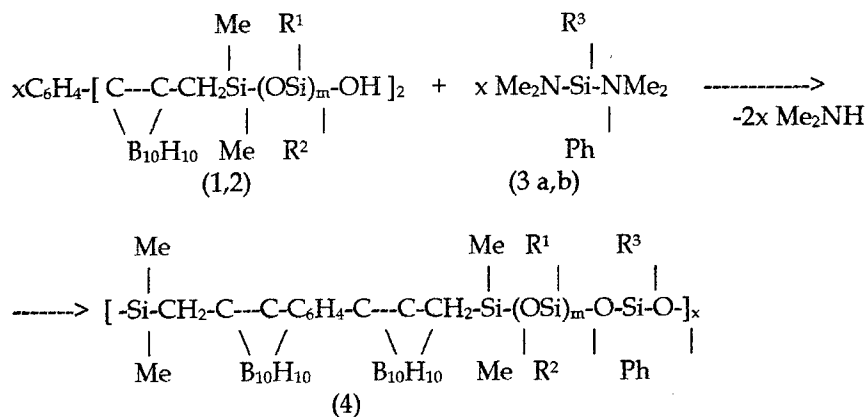

R¹, R² are the same or different H, -CH₃, -CH=CH₂, -CH₂CH₂CF₃, -C₆H₅, Cl_nC₆H_{4-n}, n=1-4; FC₆H₄, CF₃C₆H₄, C₆F₅, CH₂CH₂C=N, C₄H₉S, CH₂OPO(OR₄)₂, CH₂OPS(SR⁴)₂, R³=-CH₃, -C₂H₅, i-C₄H₉; m = 0(1), 1(2); R³ = CH₃(3a), C₆H₅(3b).

Polymers (4) are elastic waxy compounds with M_w below 20000 soluble in aromatic and chlorine contained hydrocarbons. They have high thermostability.

1. Kalinin V.N., Izmailov B.A., Kazanthev A.A., Zhaharkin L.I., Andrianov K.A., Doklady AN SSSR, 1979, V.246, # 3, p.616.

SYNTHESIS AND PROPERTIES OF POLY-B(AL,Ti)-ORGANOSILOXANES WITH
1,7- BIS(DIMETHYLSILYLMETHYL)-M(P)-CARBORANYLENE UNITS

Boris A. Izmailov, Valeri N. Spector, Boris A. Kamaritsky, Elena N. Zhabrodsкая
Institute of Biocemical Physics RAS
4 Kosygin Street, 11-226, Moscow, 117334, Russia
Moscow State Textile Academy
1 Malay Kalouzhskaya Street, 117918, Moscow, Russia

The method of synthesis of the poly-B(AL,Ti)-organosiloxanes with 1,7-
bis(dimethylsilylmethyl)-m(p)-carboranylene units on the base of the
polycondansation of oligomers (1) with B(OC₄H₉)₃ (2), Al(OC₄H₉)₃ (3), Ti(OC₄H₉)₄ (4)
was developed

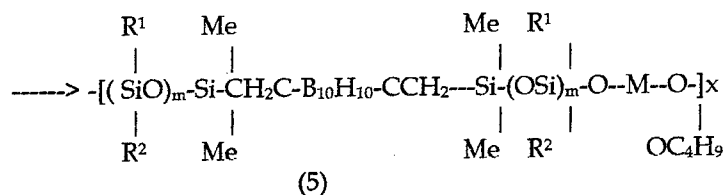
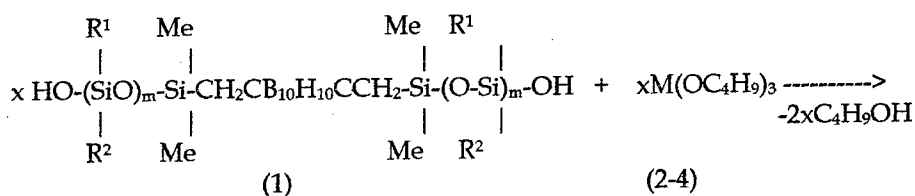

M=B, Al, Ti(C₄H₉)

R¹, R² are the same or different H, -CH₃, -CH=CH₂, CH₂CH₂CF₃, C₆H₅, Cl_nC₆H_{4-n},
n=1-4; -C₆H₄F, -C₆H₄CF₃, -C₆F₅, -C₄H₃S, -CH₂CH₂C=N, CH₂OPO (OR³)₂,
CH₂OPS(OR³)₂, CH₂OPS(SR³)₂, R³= -CH₃, -C₂H₅, -i-C₄H₉; m=1-5,10.

Polymers (5) are elastic waxen compounds with M_w below 50000 soluble in
aromatic and chlorine contained hydrocarbons. They have high thermostability.

SYNTHESIS AND PROPERTIES OF POLYORGANOSILOXANES WITH
1,2-(o-CARBORANYLENE)-4,6-DISILA-4,6-DIMETHYL-5-OXY-
CYCLOPENTANE UNITS

Boris A. Izmailov, Valeri N. Spector, Boris A. Kamaritsky, Andrei Y. Kamilov
Institute of Biocemical Physics RAS
4 Kosygin Street, 11-226, Moscow, 117334, Russia
Moscow State Textile Academy
1 Malay Kalouzhskaya Street, 117918, Moscow, Russia

The method of synthesis of the polyorganosiloxanes with 1,2-(o-carboranylene)-4,6-disila-4,6-dimethyl-5-oxy-cycloheptane units on the base of the polycondensation of oligomers (1) with bis (N,N¹-dimethylamino)diorganosilanes (2) was developed

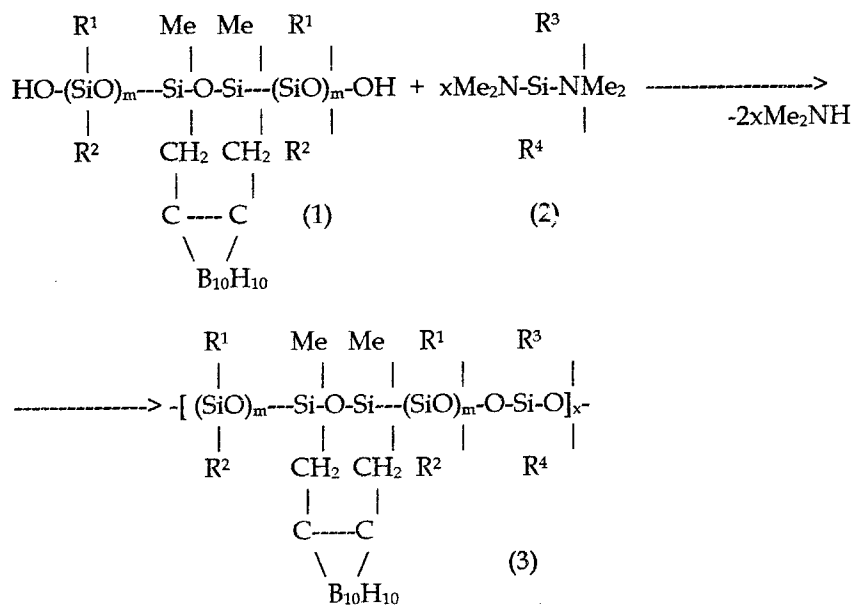

R¹, R², R³, R⁴ are the same or different H, -CH, -CH=CH₂, -CH₂CH₂CF₃, -C₆H₅, Cl_nC₆H₄_n, n=1-4; -C₆H₄F, -C₆F₅, -C₄H₃S, -CH₂CH₂C=N, -CH₂OPO(OR⁵)₂, CH₂OPS(SR⁵)₂, R⁵= -CH₃, -C₂H₅, -i-C₄H₉; m=1,2,3,4,5,10.

Polymers (3) are elastic waxy compounds with M_w below 250000 soluble in aromatic and chlorine contained hydrocarbons. They have high thermostability.

STRUCTURE AND THERMAL STABILITY OF
OLYBORONMETHYLSILSESQUIOXANE.

Boris A. Kamaritsky*, Ludmila F. Komolova**, Ravel S. Sharaphiev,
Valeri N. Spector

**Institute of Biocemical Physics RAS,*

4 Kosygin Street, 11-226, Moscow, 117334, Russia

***Moscow Pedagogical State University, Department of Physics
109831, Malaya Pirogovskaya street, 29, Moscow, Russia*

The electron structure and molecular structure of oligoboronmethyilsilses-quioxane (OBMSSO) with relative concentration B/Si ranged in 1:2; 1:3; 1:5; 1:100 were investigated by means of XPS, TGA, X-ray diffraction method and mass spectroscopy at the room temperature and during the heat treatment of OBMSSO both in air and in vacuum. It was shown that the structure of oligomer consists in the cycles of different configurations. The B atoms in such cyclic fragments are existed in two states, their difference of binding energy of B 1S being about 1 eV thereby. The thermal sublimation of oligomer (vacuum, 300°C, 3 hours) results in its decomposition. The sublimed part of oligomer consisting of low-molecular fragments has a crystal structure and its binding energy of B 1S is smaller than that of residual part. The oligomer of residual part has the amorphous structure. Both two parts of material have the similar valence band spectra, but only for the sublimated part the fine structure is observed in the valence band spectra. The obtained results indicate the fact, that the present B atoms influence essentially upon the structural organisation of oligomer. The redistribution of electron density of Si-O-Si bridges in siloxane chains between the boron and oxygen atoms and their donor-acceptor interaction resulted in stabilization of siloxane chains and structure formation. The structure rearrangements of the boron containing oligomer were studied during the heat treatment both in air and in vacuum. There were the temperature intervals of structure rearrangements and also the content of reaction products established.

SYNTHESIS AND THERMAL PROPERTIES OF MAIN-CHAIN LIQUID CRYSTALLINE POLYMERS WITH CENTROSYMMETRICAL MESOGENIC GROUPS

Alexander Yu. Bilibin, Janna V. Solovjeva, Irina S. Anikina, Irina G. Ivanova,
Nina V. Girbasova

*Department of Chemistry, Saint-Petersburg State University,
University pr., 2, Peterhof, 198904, Saint-Petersburg, Russia*

The aim of the present work is to continue the study of structure-properties relationship in series of main-chain liquid crystalline polymers. Two series of polymers with aroyl-bis-oxyarylate groups and flexible spacers in main chain were synthesized. Their thermal properties were investigated by polarizing optical microscopy, differential scanning calorimetry and compared with those of LC polymers with mesogenic groups 1 and 4 prepared and studied formerly [1,2]. The main structural theme in this investigation was symmetry of mesogenic group and study the influence of its decrease on phase transition temperatures and mesophase types of the polymers. The decrease of symmetry was attained by introducing of substituents in central unit or kinks in terminal units of highly symmetrical terephthaloyl-bis-4-oxyarylate groups (1 and 4):

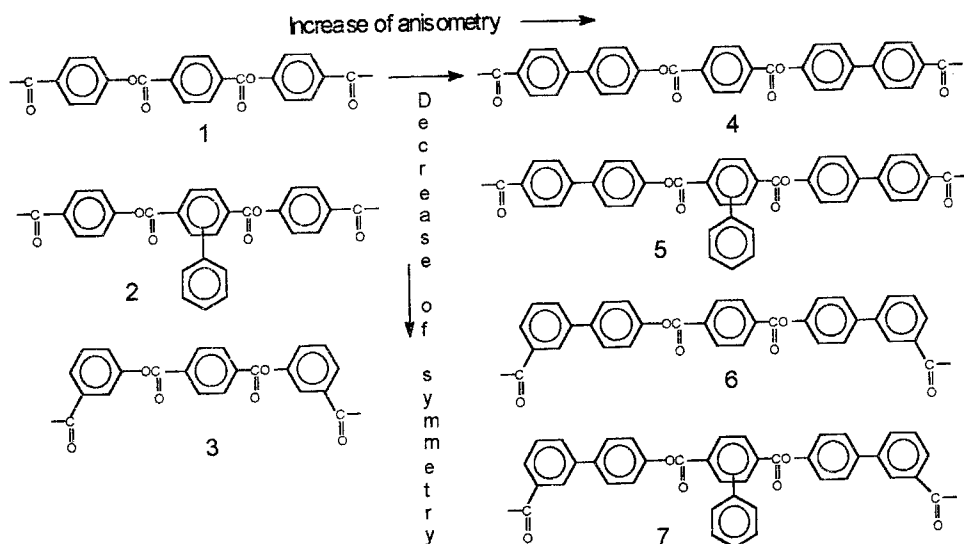

New synthons — complex acid dichlorides of 2; 3; 5; 6 and 7 were synthesized in order to prepare the polymers. Polymers with groups 2; 3 and 7 were found to be non-mesogenic whereas polymers 5 and 6 formed anisotropic melts in a broad temperature range. Difference in their thermal behaviour and that of polymers with groups 1 and 4 is discussed.

1. A. Yu. Bilibin, A. V. Tenkovtsev, O. N. Piraner, S. S. Skorokhodov, *Makromol. Chem.*, **186**, 1575 (1985)
2. A. Yu. Bilibin, A. V. Tenkovtsev, A. R. Stepanova, *Liq. Cryst.*, **14**, 1661 (1993)

Authors thank the Russian Foundation of Basic Researches for the financial support (Grant 96-03-32430a)

**SYNTHESIS AND THERMAL PROPERTIES OF
MAIN-CHAIN LIQUID CRYSTALLINE POLYMERS WITH
NON-CENTROSYMMETRICAL MESOGENIC GROUPS**

Alexander Yu. Bilibin*, Janna V. Solovjeva*, Sergey G. Koshel**, Nina V. Girbasova*,
Irina G. Ivanova***

*Department of Chemistry, Saint-Petersburg State University,
University pr., 2, Peterhof, 198904, Saint-Petersburg, Russia

**Yaroslavl State Technical University, Moskovsky pr., 88, 150053, Yaroslavl, Russia

***Institute of Macromolecular Compounds of RAS, Bolshoy 31, 199004
Saint-Petersburg, Russia

Several series of main-chain liquid crystalline polymers were synthesized in order to study influence of symmetry of mesogenic groups and macromolecules as whole on their thermal properties and mesophase types. The approach to preparation of the polymers consists in preliminary synthesis of synthons with dihydroxy-diphenylene and diacid dichloride terminal groups and aliphatic spacers. The subsequent polycondensation of these complex monomers gives the desired polymers. Various combinations of synthons in pairs of monomers for polycondensation enable to synthesize a vast set of LC polymers with variations of structure of their mesogenic groups.

The polymers were designed by combination of two synthons in polycondensation procedure:

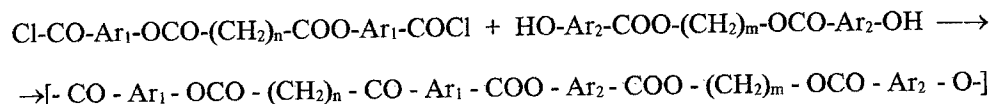

Where:

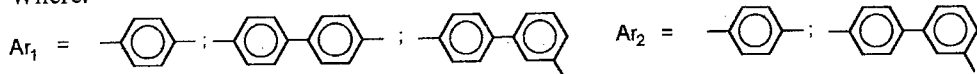

A group of the polymers with biphenylene units consists of mesogens with three p-phenylene groups what makes correct to compare their thermal properties with those of polymers studied formerly [1]. The difference between the polymers under discussion and polymers described in [1] consists in direction of ester bonds. This is the first route to decrease the symmetry. Another route is insertion of meta-phenylene units in terminal or central positions of the aromatic block.

The polymers were studied by polarizing optical microscopy and differential scanning calorimetry. The decrease of anisometry causes decrease of crystallizability, melting temperatures and smectogenity of the polymers as compared to polymers described in [1].

I. A. Yu. Bilibin, A. V. Tenkovtsev, O. N. Piraner, S. S. Skorokhodov, *Makromol. Chem.*, **186**, 1575 (1985)

Authors thank the Russian Foundation of Basic Researches for the financial support (Grant 96-03-32430a)

SYNTHESIS OF HYBRID POLYMERS FOR ANTICORROSIVE COATINGS

Ludmila A. Onosova, Genrih M. Tseitlin, Tatiana V. Popova

Russian chemico-technological University named after D. I. Mendeleev
Miuskaja sq. 9, Moskow, 125047 Russia

Principles designing oligomers with parts of various chemical structures were built. That oligomers contain such functional groups as epoxy, urethane, amine and (methyl)acrylate therefore that oligomers are named "hybrid oligomers". Availability functional groups various nature allowed to combine methods of formation three-regular structure of such oligomers (by mechanism of polycondensation and by mechanism of polymerization) and it allowed accordingly to change properties materials on their base .

Influence of structure of oligomer-monomer compositions were studied and conditions of formation of coatings (temperature, effect of UV-radiation and relative humidity) on contents of gel-fraction, hardness and permeability of vapours through lacquered coatings were studied.

Density of cross-linked structures were valued and physico-mechanical indexes of films made by hybrid oligomers were valued too. It is shown that application of hybrid oligomers of two-stage curing results in considerable reduction of permeability of coatings.

Rates chemical reactions proceeding under cross-linked modified epoxy/amine compositions in thin films on substrate with IR-spectrum were valued.

Ways of increase performance properties of coatings by change conditions their formation were suggested.

THE PHASE EQUILIBRIUM AND MASS TRANSFER IN SYSTEMS OF CROSS-LINKED POLY(URETHANE METHACRYLATE) AND ALKYL METHACRYLATES

Tatyana B.Repina, Svetlana S.Shevchenko, Alla V.Kotova, Boris I. Zapadinskii

*D.Mendeleev University of Chemical Technology of Russia,
Miusskaya pl.9, Moscow, 125820 Russia
N.Semenov Institute of Chemical Physics, Russian Academy of Sciences,
ul. Kosygina, 4, Moscow, 117977 Russia*

The phase separation in the process of chemical curing of blends of monomers and polymerisable oligomers is one of the determining factors of the formation of their structure and complex of physico-mechanical properties of materials on their basis. The phase equilibrium and mass transfer kinetics in systems of cross-linked poly(urethane methacrylate) (PUMA) and alkylmethacrylates (AMA), modelling deep stages of oligomer-monomer blends conversion, were investigated by interferometric micromethod in the wide range of temperatures and the whole region of concentration. These data can also be used to predict the morphological structure of subsequent semi-interpenetrating networks.

It has been shown that compatibility limits of cross-linked PUMA with AMA insignificantly depend on the mixing temperature and decrease with the increase in diffusant molecular masses in accordance with reduction of the thermodynamic affinity of the components in mixtures of AMA with oligo(urethane methacrylate).

Mixtures of cross-linked PUMA and AMA approach to the state of thermodynamic ideality only at low diffusant volume contents (up to $j = 0,1$). A further increase of volume concentrations is accompanied by segregated diffusant molecules domain formation, resulting in the system thermodynamic non-ideality. It is in agreement with the sharp decrease in mass transfer coefficients values in the vicinity of binodal and the increase in the temperature diffusion coefficients.

The enlargement of the diffusant molecules size regularly results in the deterioration of the rate of thermodynamic equilibration and the increase in temperature diffusion coefficients; it can be analytically described by equations of the Auerbach type, which allows us to predict diffusion characteristics in the investigated range of temperatures and concentrations.

SYNTHESIS OF LIQUID CRYSTALLINE MULTI-BLOCK CO-POLYMERS

Nina V. Girbasova*, **Anatoly I. Grigorjev****, **Irina G. Ivanova****, **Alexander Yu. Bilibin***

**Department of Chemistry, Saint-Petersburg State University,
University pr., 2, Peterhof, 198904, Saint-Petersburg, Russia*

***Institute of Macromolecular Compounds of RAS, Bolshoy 31, 199004
Saint-Petersburg, Russia*

Liquid crystalline (LC) block and multi-block co-polymers are of interest due to their potential capability to undergo microphase separation to isotropic and anisotropic microphases. Moreover, one can expect that such separation may take place at relatively low molecular weight of the blocks. The present work deals with the synthesis and study of LC multiblock copolymers containing flexible polyoxyethylene (POE) and *p*-aromatic polyester rigid blocks.

The copolymers were synthesized by polycondensation of two complex monomers — synthons which were prepared preliminary:

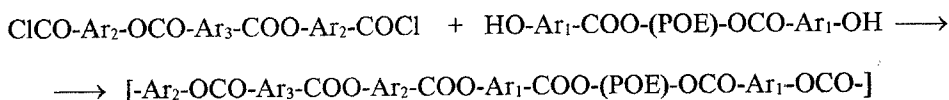

Where Ar₁ and Ar₂ = 1,4-phenylene
4,4'-biphenylene
2,6-naphthylene
4-vinyl-phenylene

Ar₃ = 1,4-phenylene
2,5-biphenylene

Complex acid dichlorides were synthesized in traditional way by interfacial condensation of terephthalic or phenylterephthalic acids dichlorides with sodium salts of corresponding hydroxy aromatic acids and subsequent transformation of the resulting complex acid to chloride. Synthesis of other synthon — di-hydroxyaroyl derivatives of poly ethylene glycols was realized in non-traditional route.

Triad type complex monomer whose central unit plays a role of bifunctional protective group was synthesized at the first step. Oxalyl group was used as protective one in this synthon. Polycondensation of the latter with poly(ethylene glycol) (PEG) of appropriate molecular weight gives intermediate polymer at the second step. Selective hydrolysis of this polymer gives the desired dihydroxyaroyl derivatives of PEG:

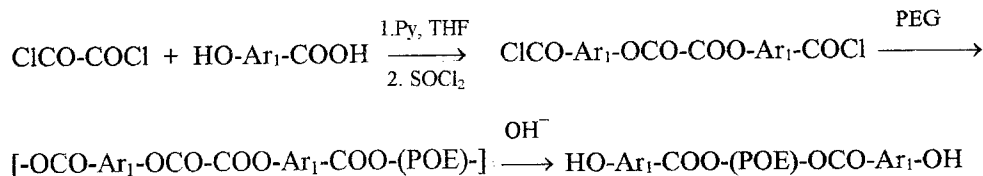

A series of copolymers containing different aromatic units in mesogenic block was prepared. The synthesized multiblock copolymers were characterized and studied by viscometry, polarizing optical microscopy, differential scanning calorimetry and X-ray diffraction methods. Unusual features of their thermal behaviour are discussed.

**SYNTHESIS OF LINEAR POLYMER WITH TRIACYLMETHANE GROUPS
AND STUDY OF KETO-ENOL TAUTOMERISM IN THE MAIN CHAIN**

Sergey S. Skorokhodov, Anatoly I. Koltsov, Inna L. Ushakova,

Aleksander S. Khachaturov

*Institute of Macromolecular compounds RAS,
Bolshoi pr., 31, St.-Petersburg, 199004 Russia*

C-acylation reaction was first used for polymer synthesis. At first the polymer with triacylmethane units was obtained. It was found by means of ^1H and ^{13}C NMR that polymer repeating unit has a structure similar to that of dibenzoylacetic ester and exists in three tautomeric forms: ketone and two enol forms with intramolecular hydrogen bonds of enol group with ester group (in the main tautomer) and with benzoyl group. Judging from enol signals chemical shifts hydrogen bond strength in polymer is the same as in monomer model compound. Measurements show decrease of enol fraction when passing from solid polymer to its solution in chloroform and especially in dimethylsulfoxide.

FUNCTIONALISATION OF RESORCARENES BY AMINOMETHYLATION

Thomas Straub, Dezső Falábu and Kari Rissanen

Department of Chemistry, University of Jyväskylä, PO Box 35, 40351 Jyväskylä, Finland
e-mail: straub@jykem.jyu.fi, rissanen@jykem.jyu.fi

Resorcarenes of type I are conveniently derived from the acid-catalysed condensation of resorcinol with various aldehydes. Diverse properties can be induced by the introduction of distinct functionalities, thus reacting the resorcarene with primary amines in presence of excess formaldehyde. This procedure yields, under the regio-selective formation of benzodihydro-1,3-oxazines and the enlargement of the cavity, the aminomethylated compounds of type II, bearing the chosen functional group R_2 at the nitrogen atoms.

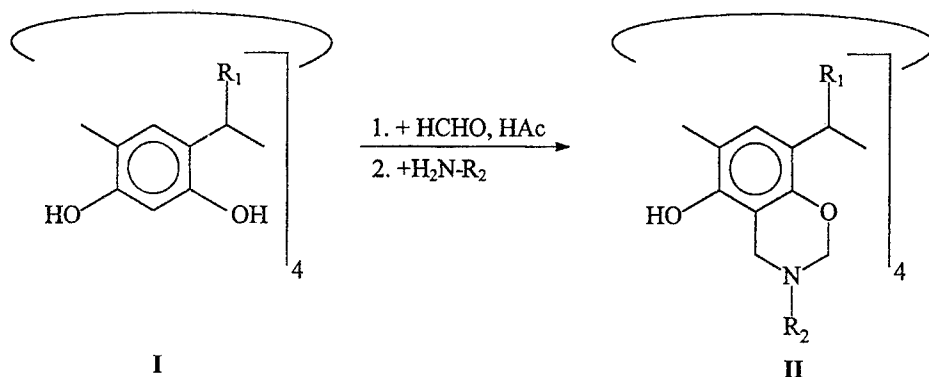

Several novel compounds of type I and II were synthesised (R_1 = Et, Hex; R_2 = alkyl, cycloalkyl, aryl, propargyl) and their inclusion/coordination behaviour toward different solvent molecules investigated. Their full characterisation includes NMR spectroscopy and X-ray crystallography.

Acknowledgement

T. S. thanks the Center for International Mobility, Helsinki, for a CIMO postdoctoral fellowship.

THERMOSYNTHESIS AS A METHOD OF CREATING NEW POLYMERS

Henry M. Tseitlin, Konstantin A. Voloschuc

Russian chemico-technological University named after D. I. Mendeleev
Miuskaja sq. 9, Moskow, 125047 Russia

The long-term objective purpose of this Russia work is the creation of the overall theory of regulation of chemical processes which take place in polymers under the action of high temperatures and aggressive media. The solution of this problem makes it possible to produce the "secondary" polymers (the product of transformation of initial polymers) which can be more thermostable than the first and would be worth-while from the environmental point of view because the thermal destruction of polymers gives a lot of waste not, only toxic gases or solid products.

For instance, under heating polyphenylquinoxaline, the evolution of volatile products is proceeded by the polymerisation reaction due to the opening of double bonds of quinoxaline cycle. This process is defined by the liability of hydrogen atom of benzene ring being in the alpha-position to quinoxaline heterocycle. At the second stage, the pyrolysis of the network obtained is proved to proceed by pyrazine ring destruction. It is accompanied by the evolution of volatile products - toluene, benzene, benzonitrile and hydrogen.

For the first time it has been shown that during thermal treatment the quinoxaline structures are transformed into benzimidazole ones. The Radical-chain mechanism of the thermal destruction of polyphenylquinoxaline in vacuum has been proposed. It has been supported by the increase in the rate constants of intermediate formation in the presence of radical initiators. To develop these results it seems to be appropriate to test aromatic polyamides. Polyamides in multistage synthesis of polyheteroarilene is an intermediate products of polybenzoxasoles, polybenzimidazoles, polyquinoxalines, polyimides and others. The investigation of benzanilide as a model of a polyamide unit made it possible to propose the scheme of the thermo-oxidation of the aromatic amide system.

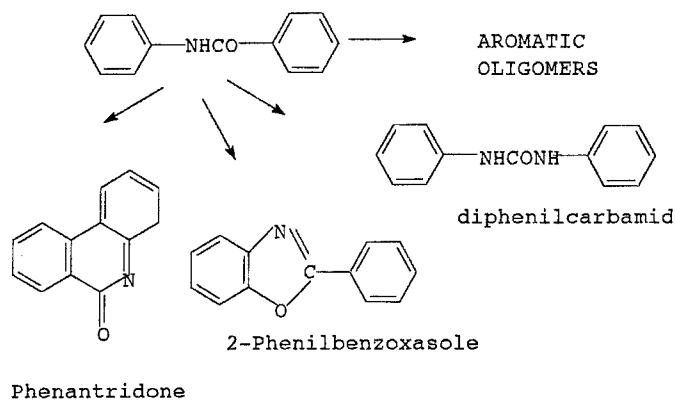

From this scheme it follows that when heated, aromatic amides are transformed into more stable cyclic structures.

AN ATTEMPT OF THE SYNTHESIS OF REACTIVE POLYMERS WITH BENZOPHENONE GROUPS.

Ludmila I. Rudaja, Natalia V. Klimova, Sergei S. Skorokhodov
Institute of Macromolecular Compounds RAS
Bolshoj pr. 31, St.Petersburg, 199004, Russia

The reactivity of aromatic carbonyl group especially incorporated in photoactive benzophenone structure make it attractive to synthesize corresponding macromolecular reagents. There were several attempts to prepare such polymers [1,2].

We try to prepare a rigid monomeric triad by the reaction of 2,5-benzophenone-dicarboxylic acid dichloride with p-hydroxybenzoic acid. It was shown that the product obtained undergoes ring-chain tautomeric transformation giving cyclic tautomer in solution. Open-chain tautomer is stable only in the solid state.

To avoid the rearrangement the synthesis of polyesters were prepared going from dipotassium salt of 2,5-benzophenone-dicarboxylic acid and aliphatic and siliconorganic dihalogenides. Series of new polyesters were obtained and characterized.

References

1. M.A.Abd-Alla // Makromol.Chem. 1991. B 192. S 277-283
2. L.Pouliqueu, X.Caqueret// Makromol.Chem. 1996. B 197. S 40-45

SYNTHESIS OF SEGMENTED COPOLYMERS FROM
DIOLIC PERFLUOROETHER MACROMONOMERS AND
FORMALDEHYDE

Marinella Levi and Stefano Turri

*Dipartimento di Chimica Industriale e Ingegneria Chimica "G.Natta" - Politecnico
di Milano - Piazza L.da Vinci, 32 - 20133 Milano - Italy*

**Ausimont S.p.A., Centro Ricerche e Sviluppo CRS - Via S.Pietro,
50 - 20021 Bollate - Italy*

Perfluoropolyethers are very interesting innovative compounds for their advanced applications both as stable fluids in various advanced applications and as macromonomers when their end units are suitably derivatized.

In particular diolic oligo fluoroethers having the following structure:
 $\text{HOCH}_2\text{CF}_2(\text{OCF}_2\text{CF}_2)_p(\text{OCF}_2)_q\text{CF}_2\text{CH}_2\text{OH}$ (ZDOL by Ausimont S.p.A)
are suitable to the synthesis and modification of various polymeric materials.

In this work a process, having unusual characteristics, to obtain copolymers of ZDOL and formaldehyde, in a wide range of molecular weights, is described, together with the main characteristics of this new class of materials. This can also be considered as a basis for the study of structure-property relationship of the more general class of perfluoropolyethers.

The copolymerization is carried out in sulfuric acid, using paraformaldehyde as source of formaldehyde *in situ*. The main features of the process are discussed, showing as in very short reaction times (from a few minutes to some hours) and with the appropriate choice and optimization of variables, like the quantity and the concentration of the acid and the ratio between formaldehyde and ZDOL, is possible to control the molecular weight, and consequently the properties of the copolymers from liquid oligomers to rubbery polymers.

Structure analyses are mainly based on Differential Scanning Calorimetry, Static Light Scattering and ^1H , ^{13}C and ^{19}F NMR spectroscopy with a specific assignments study.

POLYMERIZATION OF ANILINE AND PREPARATION OF POLYANILINE DISPERSIONS

Jaroslav Stejskal and Milena Špírková

*Institute of Macromolecular Chemistry, Academy of Sciences of the Czech Republic,
162 06 Prague 6, Czech Republic*

Polyaniline¹ is one of the electrically conducting polymers. It exists in a variety of forms² which differ in degree of oxidation or extent of protonation and, consequently, in the electrical conductivity and other physical properties. The most important stable form, protonated emeraldine, is green and its electrical conductivity is of the order of 10^{-1} – 10^1 S cm⁻¹.

Polyaniline is typically prepared by the oxidation of aniline in acidic aqueous medium (dilute hydrochloric acid) with ammonium peroxydisulfate. Anilinium cation is oxidized at first to aniline cation radical, which polymerizes to the protonated pernigraniline form of polyaniline. After all peroxydisulfate has been consumed, pernigraniline is reduced by the residual aniline to the final product, protonated emeraldine. The overall reaction can be summarized as³:

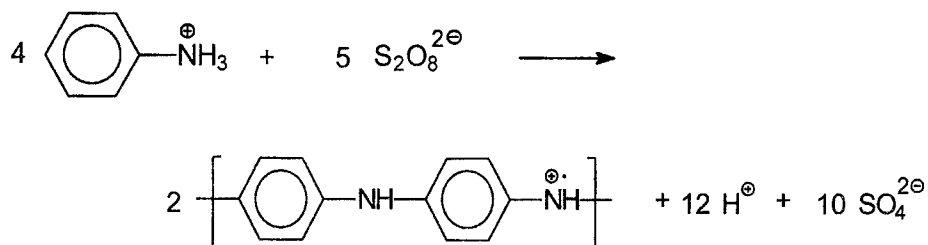

The course of the oxidation can be monitored by various physico-chemical methods, e.g., by acidity changes⁴.

If polyaniline is prepared in the presence of a steric stabilizer, polyaniline dispersions are obtained. These are formed by spherical or globular polyaniline particles of typical size 300–600 nm covered by an overlayer of a steric stabilizer, which prevents their aggregation. Both water-soluble polymers, e.g. poly(vinyl alcohol) or poly(*N*-vinylpyrrolidone)⁵, and colloidal particles, e.g. ultra-fine silica⁶, were used for steric stabilization. Dispersions can be used in processing or characterization of this intractable polymer.

1. Syed, A.A. and Dinesan, M.K. *Talanta* **38**, 815 (1991).
2. Stejskal, J., Kratochvíl, P. and Jenkins, A.D. *Collect. Czech. Chem. Commun.* **60**, 1747 (1995).
3. Stejskal, J., Kratochvíl, P. and Jenkins, A.D. *Polymer* **37**, 367 (1996).
4. Stejskal, J., Špírková, M., Kratochvíl, P. *Acta Polym.* **45**, 385 (1994).
5. Stejskal, J., Kratochvíl, P. and Helmstedt, M. *Langmuir* **12**, 3389 (1996).
6. Stejskal, J., Kratochvíl, P., Armes, S.P., Lascelles, S., Helmstedt, M., Riede, A., Prokeš, J. and Křivka I. *Macromolecules* **29**, 6814 (1996).

**Synthesis of aromatic polyaryleneethers
(polyaryleneetherketones and polyaryleneethersulfones)
with the side carboxylic groups and their chemical transformation.**

*K.I. Donetskii, S.N. Salazkin, G.V. Gorshkov, V.V. Shaposhnikova,
I.M. Kislyak*

**Nesmeyanov Institute of Organoelement Compounds
28 Vavilov St., Moscow 117813, Russia**

High molecular ($M_w \geq 70000$) non cross linking polyaryleneetherketones (PAEK) and polyaryleneethersulfones (PAES) with free side carboxylic groups have been synthesized by interaction 4,4'-difluorobenzophenone or 4,4'-difluorodiphenylsulphone with K-diphenate of 4,4'-dihydroxy-2''-carboxythreephenylmethan in N,N-dimethylacetamid.

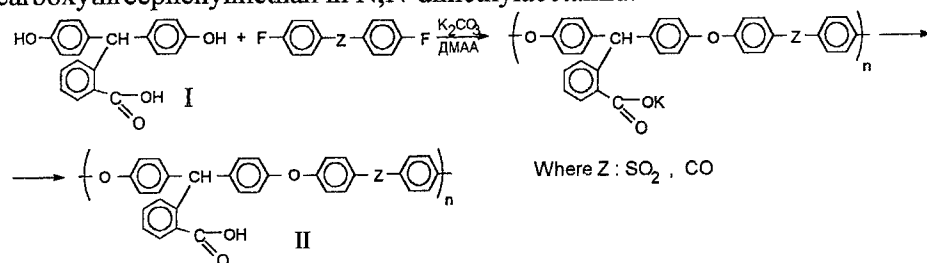

The possibility of destruction of ether-bond at influence of carboxylate groups have been found. In accordance with IR - and elemet analysis the side carboxylic is remained the polycondensation. The synthesized homo- and copolymer (on a basic of mixture I with bisphenol A (III) or phenolphtalein (IV)) are amorphous. These polymers have T_g from 215⁰ to 230⁰ (for homo-PAEK and PAES is respectively) and are soluble in the DMAA, dioxan, THPH, m-cresol and cyclohexanon. The availability of the side COOH - groups in the macromolecule of PAEK and PAES inhibits solubility in the chlorinated hydrocarbon (chloroform, methylen chloride) in comparison with the PAEK and PAES on a basic of III and IV.

Some chemical reactions by COOH - groups have been conducted :

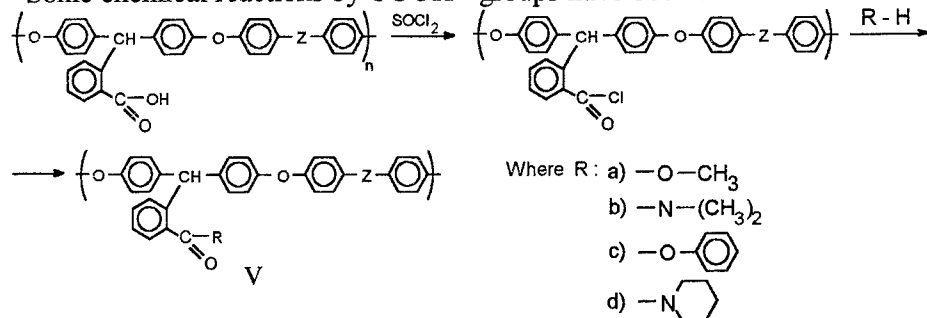

Influence R to the properties (T_g and solubility) of V have been investigated.

BECKMANN REARRANGEMENT AS NEW SYNTHETIC WAY TO POLY(1,4-PHENYLENE SULFIDE AMIDE)

Eugeny D. Savin, Vladimir I. Nedel'kin, Boris A. Zachernyuk

*A. N. Nesmeyanov Institute of Organoelement Compounds RAS
ul. Vavilova 28, Moscow, 117813 Russia*

The introduction of polar bridges, in particular, amide group, into the chain of poly(1,4-phenylene sulfide) is used for regulation of thermal properties, phase state, solubility of the polymer. At the same time traditional methods of polyarylenes synthesis are usually inapplicable for poly(1,4-phenylene sulfide amide) (PPSA) preparation. For instance, the polycondensation of 4,4'-dichlorobenzanilide with sodium sulfide results in dimer formation due to the different reactivity of chlorine atoms. The reaction of 4,4'-diaminodiphenyl sulfide with 4,4'-dicarboxydiphenyl sulfide or homopolycondensation of 4-amino-4'-carboxydiphenyl sulfide is conducted in tough conditions and often accompanied by decarboxylation of monomers.

Here we propose new method for PPSA preparation consisting in polycondensation of 4,4'-dichlorobenzophenone oxime (I) with sodium sulfide and following sulfuric acid - mediated Beckmann rearrangement of polymeric oxime (II):

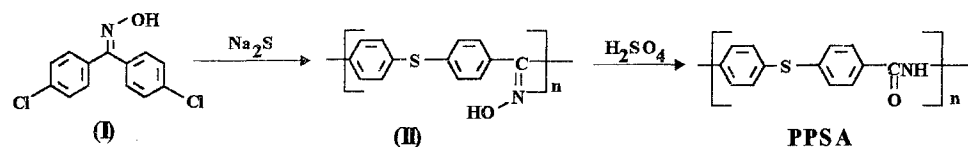

Poly(1,4-phenylene sulfide ketone) also can be transformed in boiling pyridine with nearly quantitative yield into the oxime (II), which rearranges into PPSA in concentrated acids.

The comparison of PPSA and isomeric polyoxime, obtained by two different ways, by spectral and physical methods have been carried out.

This work was supported by research grant № 96-03-33864 from Russian Foundation of Fundamental Investigations

POLY(INDENOFLUORENE) (PIF), A NOVEL LOW BAND GAP POLYHYDROCARBON

Helge Reisch and Ulrich Scherf

Max-Planck-Institut für Polymerforschung, Ackermannweg 10, D-55128 MAINZ, Germany

The lecture describes the synthesis of a novel low band gap hydrocarbon polymer, poly(indenofluorene) (PIF) **2**, composed of 3,9-di-*t*-butylindeno[1,2-*b*]fluorene building blocks. The polymer, with high degrees of polymerization ($DP \geq 20$), was generated by coupling alkylated 6,6,12,12-tetrachloro-6,12-dihydroindeno[1,2-*b*]fluorene **1** monomers by means of low valent transition metal [e. g. chromium(0) and nickel(0)] compounds as dehalogenating agents. The UV/VIS spectra of **2** show the occurrence of the conjugated one-dimensional π -system, clearly indicated by the sharp absorption edge and the 0-0-transition (λ_{\max} : 781-799 nm) as most intense absorption band, escorted by its vibrational replica (shoulder at ca. 710 nm). Particularly noteworthy is the position of the longest wavelength absorption band, widely red shifted into the NIR region. Compared to polyacetylene and polydiacetylenes as other typical hydrocarbon polymers with low band gap energies, the λ_{\max} of PIF **2** is red shifted by more than 100 nm. This fact can be interpreted as resulting from the contribution of quinoid states to the electronic ground state.

Polymer	Coupling agent	Yield [%]	M_n (GPC) [M_n (VPO)]	M_w (GPC)	λ_{\max} [nm]
2a	$\text{Co}_2(\text{CO})_8$	93	17000 [8700]	40000	795
2b	$\text{Cr}(\text{CO})_6$	95	12000	28000	781
2c	$(\text{C}_6\text{H}_6)_2\text{Cr}$	90	19500	46000	799
2d	$[(\text{C}_6\text{H}_5)_3\text{P}]_2\text{Ni}(\text{CO})_2$	91	12000	27000	792

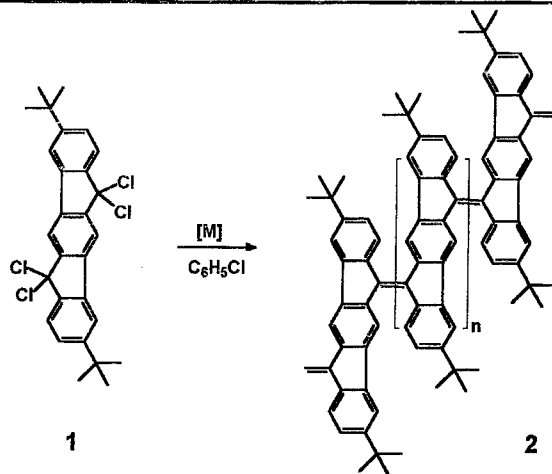

SYNTHESIS OF LIQUID CRYSTALLINE COPOLYESTERS CONTAINING MESOGENIC AND β -KETOESTER GROUP IN THE MAIN CHAIN AND THEIR TAUTOMERIZATION

Nina M. Geller, Alexander V.Gribanov, Victor M. Denisov,
Anatolii I.Koltsov, Sergej S.Skorokhodov, Svetlana V.Fedorova

*Institute of Macromolecular Compounds RAS
Bolshoj pr. 31, St.Petersburg, Russia*

Only few examples of the polymers including β -ketoester groups in the main chain are described [1, 2]. The tautomeric equilibrium was not studied. We have prepared new liquid crystalline polymers by polycondensation of mixture of bis-(6-hydroxyhexyl ester 2,5-cyclohexandione-1,4-dicarboxylic acid) (I) and 1,6-hexanediol (II) with terephthaloyl-bis(4-hydroxybenzoylchloride). The ratio of I to II was varied from 1:0 to 0.2:0.8. The temperatures of isotropization of copolyesters depends on their composition and are varied from 175 °C to 235°C. The enolization degree α was determined by ^1H and ^{13}C NMR spectroscopy. The polymer obtained from I and terephthaloyl-bis(hydroxybenzoylchloride) has not formed the LQ state. It was shown that α value is lower for polymer than for model compounds. It depends on the polarity of solvent. The value of α raises going from solution to solid polymers.

References:

1. S.L. Davydova, N.A. Plate, Dokl. Acad. Nauk SSSR, 1966, 169, 378.
2. S.S. Skorokhodov, N.M. Geller, V.A. Gindin, A.I. Koltsov, A.V. Purkina, Mendeleev. Commun. 1994, 148.

DILUTE SOLUTION PROPERTIES OF LACTODENDRIMERS

Pavlov G.M.^{a,b}, Korneeva E.V.^c, Jumel K.^b, Harding S.E.^b,
Nepogodiev S.A.^d, Stoddart J.F.^d, Meijer B.^e, and Peerlings R.^e

- a. Institute of Physics, St.Petersburg University, Russia;*
b. National Centre for Macromolecular Hydrodynamics, Nottingham University, UK;
c. Institute of Macromolecular Compounds, St.Petersburg, Russia;
d. School of Chemistry, University of Birmingham, UK;
e. Eindhoven University of Technology, Eindhoven, the Netherlands

Carbohydrate-coated dendrimers (glycodendrimers) [1,2] which could be prepared either by the modification of performed dendrimers [3] or by applying the convergent approach [4] are a new type of neoglycoconjugates. Recently the construction of galacto- and lacto- dendrimers (LD, Figure) based on poly(propylene imine) dendrimer cores (DAB-dendr-(NH₂)_x) has been reported [3]. These glycodendrimers possess perfectly symmetrical structures which are very promising as multivalent ligands for carbohydrate-protein interactions. In addition, these dendrimers are interesting objects for the physical studies. In order to determine the hydrodynamic properties of LD they were studied by the translational diffusion, velocity sedimentation and intrinsic viscosity. The values of their buoyancy factors were determined. Measurements were carried out in aqueous NaCl. The experimental values were obtained for LD of generation one to five and corresponding molecular weights and hydrodynamic radii were evaluated for all these glycodendrimers. The hydrodynamic results revealed that the LD structure is peculiar in that about 80% of LD mass is concentrated at the ends of LD.

Acknowledgement

PGM and KEV are grateful to RFFI (96-03-33847a) for partial support.

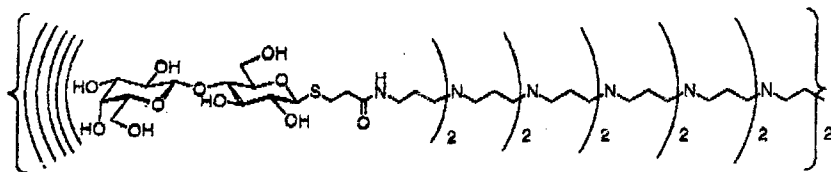

Figure. Five generation lacto-dendrimers containing 64 terminal lactose residues

References

1. Roy, R., *Polymer News* 1996, 21, 226-232.
2. Jayaraman, N., Nepogodiev, S.A., Stoddart, J.F., *Chem. Eur. J.* 1997, in press.
3. Ashton, P.R., Boyd, S.E., Brown, C.L., Nepogodiev, S.A., Meijer, E.W., Peerling, H.W.I., Stoddart, J.F., *Chem. Eur. J.* 1997, in press.
4. Ashton, P.R., Boyd, S.E., Brown, C.L., Jayaraman, N., Nepogodiev, S.A., Stoddart, J.F., *Chem. Eur. J.* 1996, 2, 1115-1128.

STUDIES ON THE SYNTHESIS AND PROPERTIES OF FERROELECTRIC SIDE CHAIN LIQUID CRYSTALLINE POLYOXETANES

Li-Ling Hsu, Teh-Chou Chang

*Department of Chemical Engineering, Chung Yuan Christian University, Chung Li,
Taiwan 32023, Republic of China*

Two series of novel ferroelectric liquid crystalline (FLC) monomers were derived from 3-(hydroxymethyl)-3-methyloxetane, used as the backbone unit, and 2(s)-[2(s)-methylbutoxy]propionic acid, as a chiral moiety. The corresponding polyoxetanes were prepared by ring-opening polymerization using $\text{BF}_3\text{-OEt}_2$ as an initiator. In addition to the structure identification, their liquid crystal phase behavior and electrical properties are also studied.

Before connecting with chiral molecular moiety, two series of carboxylic acids, 4{6-[(3-methyloxetane-3-yl)methoxy]alkoxy}benzoic acids and 4,4*-{6-[3-methyloxetane-3-yl]alkoxy}biphenyl carboxylic acids, show the phase sequence K-Sc-I, respectively. After connection, the phase behavior of the corresponding chiral monomers is changed from K-Sc-I to K-Sc*-N*-I as well as from K-Sc-N-I to K-Sc*-Sa-I. Only the phase sequence K-Sc*-Sa-I is observed in both series of polyoxetanes.

All of the synthesized monomers exhibited enantiotropic chiral smectic C (Sc*) phase. The monomers, with the biphenyl unit linked directly with a chiral center, possessed higher spontaneous polarization (P_s) values. Polyoxetanes possess a wide temperature range of liquid crystal phase, about 120 °C, and the Sc* phase range can be up to 95 °C. However, the position of biphenyl unit will not affect the spontaneous polarization of the synthesized side chain FLC polyoxetanes.

STRUCTURAL CHANGES IN POLYIMIDE PRECURSOR DILUTE SOLUTIONS USED FOR FORMING LANGMUIR-BLODGETT FILMS

**Natalija A.Kalinina, Valentina P.Sklizkova, Vladislav V.Kudryavtsev,
Irina G.Silinskaya**

*Institute of Macromolecular Compounds RAS
Bolshoy pr. 31, St-Petersburg, 199004 Russia*

Structure of dilute solution of polyamic acid (PA) amphiphilic salt based on dianhydride of biphenyltetracarboxylic acid and o-tolidine (BPDA-TD) in a mixed solvent DMAA:benzene was studied by both polarized light scattering (PLS) and viscometry. These solutions are used for formation of Langmuir-Blodgett films.

To evaluate the dimensions of scattering elements and their order in solution, the Debay-Stain statistical theory was used. Mean-square polarizability fluctuation, $\langle \eta^2 \rangle$ correlation radius of polarizability fluctuation a_v , mean-square density of the optical anisotropy of a scattering element δ^2 and F_v as a local orientation factor.

PLS experiments showed that there was an initial stage of the supermolecular fluctuation associated formation (FAF) with a strongly pronounced microanisotropic structure in dilute solutions of PA BPDA-TD in DMAA:benzene 50:50. The dimensions of FAF, which were described by parameter a_v , had no changes in the concentration C range 0,035-0,1 g/dl, but its internal ordering characterised by F_v increases with concentration decrease (0,5 - 0,035 g/dl).

In the solution of $C=0,5$ g/dl which was stored 3 days at room temperature, a_v value and relative viscosity reduced on 20% and 15%, correspondingly, as compared with the initial values. At the same time, the stored solution microheterogeneity $\langle \eta^2 \rangle$ sufficiently increased and the anisotropic structure has changed by ordering of FAF scattering elements, so that F values became $\sim 0,7$.

Structural features of the solution behaviour upon storage and dilution observed by PLS, are connected with the capacity of the system to change conformation and orientation ordering due to redistribution of complication architecture fragments of macromolecules included in FAF.

NOVEL CHIRAL 1-PHENYL-ETHYLAMINOCONTAINING LIQUID CRYSTALLINE COPOLYMERS

Zhu Xiaomin, Natalia I. Boiko, Valery P. Shibaev.

Chemistry Department, Moscow State University, 119899, Moscow, Russia.

In this work we discuss our experimental results concerning synthesis and study of the novel chiral liquid crystalline (LC) copolymers. On the base of optically pure (-)-1-phenyl-ethylamine three new acrylic monomers differed in the length of rigid aromatic fragment have been synthesized:

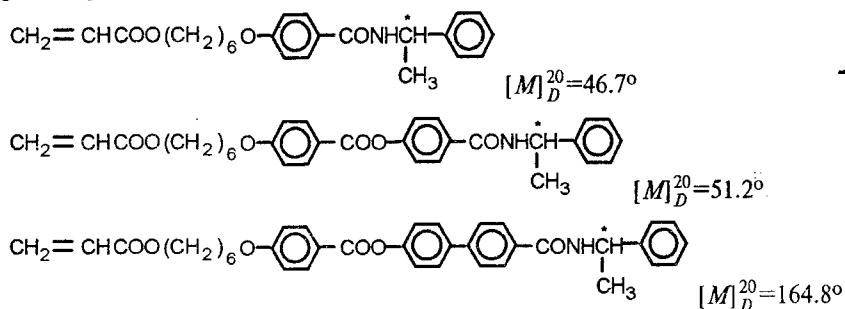

The protection-deprotection method was used for synthesis of the 1-phenyl-ethylamine derivatives. All monomers synthesized have been characterized by IR- and ^1H NMR-spectroscopy, values of their optical purity are shown above as a molar optical rotation $[M]_D^{20}$. These monomers were radically copolymerized with nematogenic methoxy-phenylbenzoate acrylic monomer:

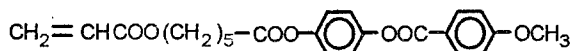

It was shown that one can easily regulate the physical properties of these systems varying copolymer composition and chemistry structure of chiral monomer units. A number of helical mesophases, such as N^* , N_B^* , N_{cyb}^* and S^* were identified and their phase transition temperatures were determined. Most of the synthesized copolymers are characterized by selective reflection of the light in visible and IR-region of the spectrum. The helical twisting power (HTP) of chiral units was determined, and the temperature dependence of wavelength of light selective reflection has also been studied.

By analysis of the experimental data we can make the following conclusions:

- 1) The lengthening of the rigid aromatic fragments leads to stabilization of the induced mesophase and HTP increasing.
- 2) The concentration growth of chiral component increases its helical twisting ability, that may be explained by the enhanced interaction between mesogenic groups (hydrogen bonds formation). The effect becomes more pronounced with the rigid aromatic fragment lengthening.

This work was supported by the Russian Foundation of Fundamental Research (Grant 96-03-33820) and HCM Programme of the EC Commission (Contract ERBCIPDCT 940602).

**STUDY OF THE NEW DOPANT-SOLVENT SYSTEMS FOR
CONDUCTIVE POLYANILINE FILMS PRODUCTION**

Sergei A. Arnautov, Valerii M. Kobryanskii

Institute of Chemical Physics Russian Academy of Sciences

Kosygin st. 4, Moscow 117977, Russia (arnautov@lx.ispm.ac.ru)

We have offered a new pathway for preparation of the water-soluble polyaniline using sulfonic acid with long fluorinated substituent. This allowed us to apply UV-vis and ESR-spectroscopy to the study of the mechanism of polyaniline formation. New two-stage mechanism of polyaniline formation is suggested. At the first stage aniline is oxidized giving pernigraniline oligomers. At the second one they react between each other leading to emeraldine salt. New hypothesis on the nature of defects in polyaniline is discussed. In all cases in the absence of oxygen the process of polymerization is accompanied by increasing of intensity and decreasing of peak-to-peak linewidth of ESR signal with formation more than 95% Lorentzian signal. Obtained results allow to assume that linewidth of emeraldine salt ESR signal in the absence of oxygen is determined by intramolecular spin-exchange narrowing.

The same acid was used for solubilization of polyaniline in suitable mixture of solvents. We found that in the presence of $\text{CF}_3\text{-CF}_2\text{-O-CF}_2\text{-CF}(\text{CF}_3)\text{-O-CF}_2\text{-CF}_2\text{-SO}_3\text{H}$ emeraldine base becomes soluble in the mixture of *m*-cresol and hexafluor-*iso*-propanol. High quality films were casted from this solution. Their conductivity reached 10 S/cm. For comparison, we have prepared well-known system "camphorsulfonic acid - *m*-cresol" with the same sample of polyaniline and obtained high-quality films with conductivity of ca. 200 S/cm.

LCP GRAFTING ONTO FUNCTIONALIZED POLYPROPYLENE

D. Sek, B. Kaczmarczyk

*Institute of Polymer Chemistry, Polish Academy of Sciences,
34 M. Curie-Skłodowska St., 41-800 Zabrze, Poland*

L.L. Minkova, Ts. Miteva

*Institute of Polymers, Bulgarian Academy of Sciences,
Acad. G. Bontchev St., 103 A, 1113 Sofia, Bulgaria*

P.L. Magagnini, M. Pracella

*Department of Chemical Engineering, University of Pisa,
Via Diotisalvi 2, 50126 Pisa, Italy*

A series of graft copolymers of functionalized polypropylene and liquid crystalline polymer (LCP) has been prepared. Polypropylene functionalized by 6% w/w of acrylic acid (PPAA) was condensed with the LCP monomers, i.e. sebacic acid (S), biphenyldiol (B) and hydroxybenzoic acid (H). The polycondensation was carried out in melt, under nitrogen, by increasing gradually the temperature from 200 to 280°C over a 3-4 h period. The system was finally evacuated for 1 h to complete the reaction. The polycondensation products, containing a theoretical amount of PPAA of 50 wt% (COPP50) and 70 wt% (COPP70) were fractionated with boiling toluene and xylene.

The graft copolymers PPAA/SBH (COPP50 and COPP70) and fractionated products were accurately characterized by FTIR spectroscopy, differential scanning calorimetry (DSC), scanning electron microscopy (SEM) and x-ray diffraction (WAXS). It was shown that some PP-g-SBH copolymer is really formed, but unreacted PPAA and SBH are also present in these products together with the copolymer: the carboxyl groups of PPAA are only partly used up by the transesterification. The new PP-g-SBH copolymers are of high molar mass and they are constructed of relatively long PP segments and SBH grafts. Preliminary experiments have shown that COPP50 and COPP70 display compatibilization activity towards blends of i-polypropylene and SBH.

SYNTHESIS OF NOVEL POLYURETHANE IONOMERS

Valery V. Shevchenko, Nina S. Klimenko, Valery V. Shilov

*Institute of Macromolecular Chemistry NASUA
Kharkovskoe sh., 48, Kiev, 253160 Ukraine*

There are two basic ways for preparing polyurethane ionomers (ionic segmented polyurethanes). These comprise interaction of ionogenic compounds with either isocyanate prepolymers and their derivatives accompanied by a polymer chain formation, or with polyurethanes prepared beforehand. The incorporation of ionic functionalities into urethane hard segment units is the result of both these methods. To the best of our knowledge, the polyurethane ionomers with the ionic functionalities in the soft polyether segment units practically have not been described.

We developed the method to prepare polyurethane ionomers with anionoactive groups in polyether segment units. It consists of the following steps:

--synthesis of oligoether diols containing two carboxylic groups in the middle of a chain (soft ionogenic segment precursor);

--synthesis of carboxylcontaining polyurethanes by reaction of these oligoether diols with a) a diisocyanate and low molecular weight diol or with b) an isocyanate adduct (hard segment precursor);

--neutralization of carboxylic groups by bases.

Six series of carboxylcontaining polyurethanes and their Li-, Na, and K-salts were synthesized. They are characterized by various concentrations of hard segment units. More characterizable samples were prepared by using the hard segment precursors. Their structure is the following:

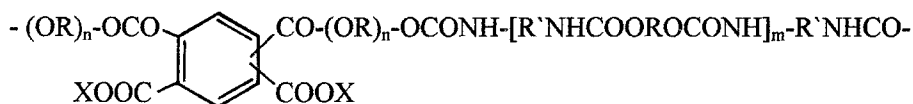

where $R = (\text{CH}_2)_4$; $R' = 4,4'\text{-C}_6\text{H}_4\text{CH}_2\text{C}_6\text{H}_4$; $X = \text{H, Li, Na, K}$; $m = 0; 1; 2; 3; 4; 5$;
 $n = 14$.

The influence of synthetic conditions on the molecular weight of carboxylcontaining oligoether diols, isocyanate adducts, and polyurethane ionomers was investigated. COO⁻ groups content in the ionomers are 2.1-3.6% wt., and hard segment units 10-47% wt. These polyurethane ionomers are capable of producing stable water dispersions and elastic films from water dispersions and organic solutions. Some properties of polyurethane ionomers were investigated. From the SAXS data their structure are determined by competitive processes forming of hard segment domains and of ionic clusters.

STUDY OF NEW POSSIBILITIES OF POLY(*p*-PHENYLENE) SYNTHESIS

Sergei A. Arnautov and Valerii M. Kobryanskii

Semenov Institute of Chemical Physics, Russian Academy of Sciences,
ul. Kosygina 4, Moscow, 117977 Russia (arnautov@lx.ispm.ac.ru)

In this communication, we present the generalized results of our research of new possibilities in the synthesis of poly(*p*-phenylene) (PP), the simplest representative of aromatic polymers. It is known that the molecular weight of PP is limited by the precipitation of oligomers formed. We attacked this problem in two ways. To enhance the solubility of oligomers, we used new efficient solvents, on the one hand, and modified the catalytic system for PP synthesis by sterically hindered cocatalysts-dopants, on the other hand.

We first suggested that the ionic liquid based on butylpyridinium chloride and aluminum chloride (in 1:2 molar ratio) be used as a medium for oxidative dehydropolycondensation of benzene by the Kovacic method. It was shown that the molecular weight of the polymer changed with a change in the benzene concentration. Mixed aluminum alcoholates AlCl_2OR , where $\text{R} = -\text{OC}_9\text{H}_{19}$, $-\text{OC}_2\text{H}_5$, $-\text{OCH}_2\text{CF}_2\text{CF}_2\text{H}$, and $-\text{OCH}(\text{CF}_3)_2$, were first used as cocatalysts instead of AlCl_3 . It turned out that only the last compound led to the formation of the polymer. Another version of this method consisted in the addition of fluorinated sulfoacid $\text{CF}_3\text{-CF}_2\text{-O-CF}_2\text{-CF}(\text{CF}_3)\text{-O-CF}_2\text{-CF}_2\text{-SO}_3\text{H}$ to the conventional $\text{AlCl}_3\text{-CuCl}_2$ catalyst. The acid reacted *in situ* with aluminum chloride giving a mixed salt, which was an efficient dopant of growing PP chains, and thus preventing the formation of a solid phase. As a result, we managed to increase the molecular weight of the polymer formed by 40%. The investigations on the oxidative dehydropolycondensation of benzene available allowed us to draw the conclusion that this method cannot as yet prevent the forming of polycyclic fragments, which significantly affect all the properties of the polymer.

In order to obtain a regular polymer in the form of films, we suggested the electrochemical oxidation of benzene in the ionic liquid, whose properties allowed the parameters of the process to be widely varied. As a result, we obtained high-quality flexible PP films. The formal degree of polycondensation calculated from IR spectra by the known formulas was extremely high. This points to the fact that the structure of thus obtained polymer most closely approaches to the ideal structure in the form of a long linear chain of *p*-substituted phenyl rings. The effect of the conditions for electrochemical synthesis on the properties of products was studied. It was shown that an increase in the current density up to the values close to critical (over 130 mA/cm^2) improved the quality of the films obtained. It was also shown that PP films obtained at superhigh potentials exhibited a strong luminescence in the blue-green region of spectrum. The intensity of this luminescence was several orders of magnitude higher than that of usual films. An increase in the average conjugation length was accompanied by a bathochromic shift of the maximum in the luminescence spectrum.

It was first shown that the mixed aluminum alcoholate $\text{AlCl}_2(\text{OC}_2\text{H}_5)$ can be used instead of AlCl_3 as a component of the ionic liquid (electrolyte).

Our investigations essentially elucidated the mechanism of benzene oxidative dehydropolycondensation. The use of the highly polar liquid and low concentrations of benzene allowed us to study the first stage of the reaction. Evidently, benzene formed a stable complex with copper chloride. A hypothesis allowing for the doping of the growing macromolecules during the synthesis of PP was first proposed. It follows from it that the deep efficient doping of the growing conjugated macromolecule is a necessary condition for obtaining a high-molecular polymer.

POLYROTAXANES HAVING THREADED CROWN-ETHER CYCLES

A.R.Korigodski, R.A.Kozlovsky, V.V.Kireev, V.V.Yakshin

Mendeleyev University of Chemical Technology of Russia, Miusskaya sq.9, Moscow, 125047 Russia

Polyrotaxanes consisting of polymeric backbones and threaded macrocycles of different nature are a new class of polymer materials significant both from purely scientific and practical points of view. As a rule polyrotaxanes display properties which strongly differ from ones of each of their components as well as from their blends [1]. Rather attractive for polyrotaxanes synthesis as macrocyclic compounds are different crown-ethers because of their availability, diversity of their nature and size as well as well-known complexforming abilities.

This work presents some methods of polyrotaxanes synthesis which allow to prepare systems having comparatively high concentration of threaded macrocycles, i.e. derivatives of 24-crown-8 per polymeric repeat unit. For this purpose preliminary fixation of the above mentioned crown-ethers on different initial monomers containing ammonium groups by means of ion-dipole interaction has been carried out. Afterwards these intermediate rotaxane compounds were used for obtaining of different polyrotaxanes, mainly of polyurethane type. Have been found optimal conditions for obtaining of such polymers. Composition of these systems has been usually confirmed by data of ^1H NMR and IR-spectroscopy for reprecipitated samples.

Has been investigated influence of initial components nature and concentration of threaded crown-ether cycles on basic properties of polyrotaxanes including their sorption properties towards different ions of metals. Such materials might be of potential interest, e.g. for creation of selective membranes, sensors and various molecular devices.

This work was supported by the Russian Found of Basic Research (N 95-03-09630).

1. H.W.Gibson and S.Liu. *Macromol.Symp.*, 102, 55-61 (1996)

POLYURETHANE IONOMER-POLYACRYLATE LATEX BLENDS

Tamara V. Travinskaya, Svetlana A. Sukhorukova, Anatolii P. Grekov

**Institute of Macromolecular Chemistry NAS of Ukraine
Kharkovskoe sh., 48, Kiev, 253160 Kiev**

Aqueous polyurethane latexes are of increasing interest due to their pollution-free status, significant differences in terms of colloid stability characteristics and particle morphology in comparison with typical emulsion polymers [1-3]. There are only a few papers devoted to studying mixtures of polyurethane latexes and other polymers in a form of water dispersions. Among them the mixtures of polyurethane and polyacrylate water dispersions are especially promising from fundamental and practical points of view.

Mixtures of polyurethane ionomer and polyacrylate (both in the form of water dispersions) obtained by two methods have been investigated. The first method is the mechanical mixing of two already formed colloidal systems. The second one is putting different quantities of polyacrylate dispersion into acetone solution of preformed (from amorphous soft segments and aromatic diisocyanate) anionic polyurethane. The differences in structure and properties of these systems vs. method of their preparation were observed.

It was shown that the systems prepared by the second method are characterized by the morphology of type "polyurethane core - polyacrylate surrounded". The size of polyurethane particles is an order higher than surrounding polyacrylate particles. These systems are steady in a wide region of temperatures and compositions.

The boundaries of thermodynamic compatibility of polyurethane and polyacrylate components in the mixtures have been defined: between 0 and 20% content of PA. The free energy of mixing is negative in this region. The broad glass transition region in pure PU indicates a strong interaction between soft and hard segments, causing a partial phase mixing of various segments. Small additives of PA initiate a process of microphase separation between the hard and soft segments of PU improving the mechanical properties.

1. D.Dietrich, W.Keberle, and H.Wott, *Angew.Chem.Int.*, 9(1), 40 (1970).
2. B.K.Kim and Y.M.Lee, *Colloid & Polym. Sci.*, 270, 956-961 (1992).
3. H.Xiao, H.X.Xiao, K.C.Frisch, and N.Malwitz, *J.Macromol.Sci.-Pure Appl. Chem.*, A32(2), 169 (1995)

TYPES OF ORIENTATIONAL ORDER IN SUPRAMOLECULAR EXTENDED
AND LAYER DOMAINS.

A.V. Maximov, Yu.Ya.Gotlib[♥], O.G. Maximova, V.A. Soloukhin and S.S.
Vanjugina

Department of Mathematics and Natural Sciences, Cherepovets State University,
Soviet Prospect 8, Cherepovets, 162600 Russia

[♥]Institute of Macromolecular Compounds of the Russia Academy of Sciences, Bolshoi
Prospect 31, St. Petersburg, 199004 Russia

The theory of the orientational order and conformational properties of the extended and layer domains consisting of semirigid polymer chains is considered. Layered domains can simulate the interchain order of side chains in concentrated solutions and melts of comb-shaped polymers, e.g. polysilarylenes with ester or amidoaromatic fragments. Bending fluctuations of the extended ordered domains are similar to conformational ones of polymer supramolecular structures of "curvilinear crystal" type, where the distortions of parallelity of the first kind are possible.

It is shown, that conformational properties of the domains depend on the bending rigidity of the chains, on the orientational interactions between neighbouring chains, on the number of chains in the cross-section of the domains and on the ratio of the length and the thickness of the domains. The orientational correlations in extended domains with many chains in the cross-section are similar to those for "thick" persistent chain with the total bending constant proportional to the number of chains in its cross-section.

For the layer domains the effective bending rigidity depends on the length (molecular weigh) of the chains normal to the cross-section of the domain. At given bending rigidity of the chain and the constant of orientational interactions between the chains the elongation of chains results in the increase of the short-range orientational order in the domain.

The susceptibility of low-dimensional domains (two-dimensional "strips") subjected to different external fields of dipole type is considered.

A NEW APPROACH IN THE SYNTHESIS OF CHIRAL POLYMERS BASED ON THE ATROPENANTIOMERISM PHENOMENON OF 1,1'-BINAPHTHALENE DERIVATIVES.

Ivan O. Kalinovskii, Natalia I. Boiko, Peter V. Shibaev*, Valery P. Shibaev

Chemistry and Physics Departments, Moscow State University,
Vorob'evy Gory, Moscow, 119899 Russia*

A new optically active 1,1'-binaphthalene (BN) containing acrylic monomer (1) was synthesized via the direct esterification reaction of enantiomerically pure (S)-(+)-1,1'-binaphthalene-2,2'-diyl hydrogen phosphate (BNHP) with 2-hydroxyethyl acrylate in boiling toluene in the absence of an acidic catalyst for avoiding possible racemization. (The homopolymer of (1) is amorphous).

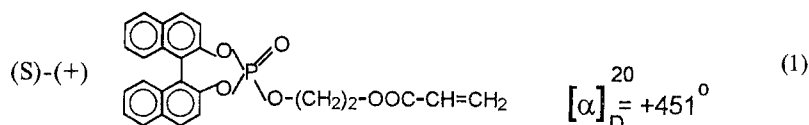

A series of copolymers of different composition were obtained by the radical polymerization of the BN-containing monomer (1) with the nematogenic methoxyphenylbenzoate acrylic monomer (2)

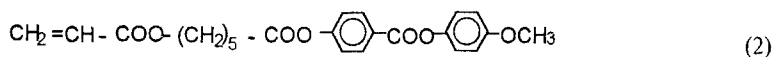

All the copolymers with the molar fraction of the BNHP-based side groups less than 12% were found to form a cholesteric mesophase, selectively reflecting light in the IR-VIS-regions (in dependence of the copolymer composition).

The helical twisting power of the BNHP-based chiral fragment in the copolymers obtained, in comparison with that of the cholesterol containing copolymer, was determined as being thrice as much and better as that of the latter.

One can suppose that the weak temperature dependence of the selectively reflected light wavelength maximum is predetermined by the rigidity of the BN-fragment in its "closed" form as compared with the strong one in its "open" form described by us recently [1].

For explaining the regularities found, the modelling of the conformational states of the "open" form and of the "closed" one in a liquid crystal matrix was carried out by the molecular dynamics method. It was shown that under the temperature rising from 70°C up to 120°C the increase of the settling of the cisoid conformations takes place at the expense of the decrease of that of the transoid ones. Under the same conditions the "closed" form remains almost unchanged.

This work was supported by the RFFR 96-03-33820 and HCM Programme of the EC Commission (940602)

References:

1. V.P.Shibaev, H.-J. Deußen, A.Yu. Bobrovskii, P.V. Shibaev, K.Schaumburg, T. Bjornholm, N.I. Boiko, K. Bechgaard, *Polymer Science*, 1997, vol.39, №1 (to be published); and *Polym. Eng. and Science*, 1997 (in press)

**PREPARATION AND STRUCTURE CHARACTERISTICS ON LANGMUIR-
BLODGETT POLYIMIDE FILMS BASED ON RIGIT ROD-LIKE POLYAMIC
ACID SALTS**

Vladislav V. Kudryavtsev, Valentina P. Sklizkova, Yulija G. Baklagina, Yurii N.

Sazanov, Lev A. Shibaev

Institute of Macromolecular Compounds RAC

Bolshoy pr. 31, S.Petersburg, 199004 Russia

Nina D. Stiopina, Lev A. Feigin, Vera V. Klechkovskaya

Institute of Crystallography RAC,

Leninsky pr.59, Moscow, 117333 Russia

Mono- and multilayer films (40-120 layers) of amphiphilic alkylammonium salts of polyamic acids (PAA) based on dianhydride of biphenyltetracarboxylic acid and, correspondingly, p-phenylenediamine, and o-tolidine (BPDA-PDA and BPDA-oTD) were obtained.

Comparatively study of processes developing during the thermal imidization of films of PAA BPDA-oTD and its salt with tert-dimethylhexadecylamine was carried out by thermal (MTA, TGA, and DTA) and X-ray analysis. The long-chain tertiary amine exerts catalytic effect on imidization and decreases the temperature range of the process. This amine destroys the solvate complexes of the carboxylic PAA group with the amide solvent even in the initial imidization stage and favors the removal of DMAA from the film. Further decrease in cyclodehydration temperature is obtained when benzimidazole is added to the PAA salt.

The structure of precursors and polyimide LB films was investigated by small-angle X-ray scattering and electron diffraction.

It is shown, that the formation and structural organization of macromolecules in LB films of BPDA-PDA and BPDA-oTD PAA salts are profoundly affected by both the structure and conformation of the main polymer chain and the nature of the solvent used for the PAA synthesis. The BPDA-oTD precursor layer thickness which was determined more precisely according to the results of diffraction from the superlattice is about 24 Å, the BPDA-PDA is 26 Å.

LIQUID CRYSTALLINE POLYESTERS WITH NEW MOLECULAR ARCHITECTURE OF THE POLYMER CHAIN.

**Konstantin V. Shataev, Andrey V. Tenkovtsev, Irina G. Ivanova, Svetlana N. Okuneva,
Alexander Yu. Bilibin**

*Institute of Macromolecular Compounds RAS
199004, St.-Petersburg, Bolshoy pr., 31, Russia*

The new type of liquid crystalline polymers with tangential position of the mesogenic block in relation to a main chain was synthesized. 4,4''-disubstituted derivatives of p-quaterphenylene inserted into polymer chain in positions 2',3''' were used as a mesogenic unit.

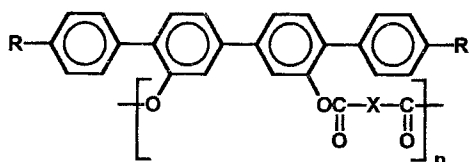

$R = H, CH_3, C_2H_5$

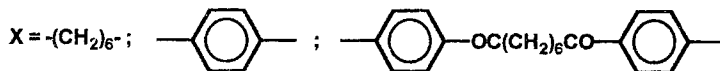

The polymers were investigated by the methods of viscometry, polarizing optical microscopy, DSC, X-ray analysis and dielectrospectroscopy. It was shown, that the mesogenic ability of quaterphenylene group in this case is lower in comparison with a traditional insertion of rigid moiety into a polymer chain.

The work is carried out at financial support of Russian Fund of Fundamental researches (codes of the projects 93-03-5872, 97-03-32752a).

LANGMUIR-BLODGETT FILMS OF FLUORINATED COPOLYMERS CONTAINING CHROMOPHORE GROUPS

Vladislav V. Kudryavtsev*, Galina K. Lebedeva*,
Ylia G. Baklagina*, Vera N. Ivanova*, Victor V. Safronov**,
Lev A. Feigin***, Artur N. Frolov****

**Institute of Macromolecular Compounds RAS, Bolshoi prosp. 31, S-Petersburg 199004, RUSSIA*

***Institute of Crystallography- Kaluga Branch RAS, Academicheskaya ul. 2, Kaluga 248640, RUSSIA*

****Institute of Crystallography RAS, Leninsky prosp. 59, Moskow 117333, RUSSIA*

*****Institute of Technology (Technology University), Zagorodny prosp. 49, S-Petersburg 198013, RUSSIA*

Three-component random copolymers containing different portions of N-(2-chlorophenyl)-N-6(oxyhexyl)amino-4,6-dimethylpyrimidinemethacrylate, octafluoroamylmethacrylate and methacrylic acid comonomers were obtained by radical polymerization. One of them was used for Langmuir-Blodgett (LB) film fabrication.

Such composition is based on our previous experience with more simple two-component copolymers (1).

In the present paper comonomers with chromophore groups which exhibit photoluminescent properties were used. The irradiation of o-chlorophenylpyrimidylamines containing an alkyl or oxyhexyl substituent at the nitrogen atom leads to the formation of luminophores with emission at the maximum of about 480 nm (quantum yield of the reaction is about 0,2 and that of luminescence is 0,15-0,3). The inversion of macromolecules similar to chromophores into the side chain enables us to obtain L-B polymer films in which similar processes are possible.

The copolymers obtained are characterized by IR-, UV-, NMR- spectroscopy and their intrinsic viscosity in cyclohexanone was measured ($0,05 \cdot 10^2$ sm/g)

The contents of chromophore groups in the copolymer corresponds to that in solution of comonomers. These copolymers are amphiphilic and can form thin polymer films on the water surface. The monolayer was transferred onto a hydrophobized substrate at $\pi = 25$ mN/m. Transfer ratio was equal to 0,91.

In the X-ray diffraction pattern of L-B films consists of 22 monolayers of the copolymer containing 30% chromophore groups, distinct Bragg peaks are absent but Kossel oscillations showing the formation of a smooth and homogeneous surface 36 nm thick can be seen.

The work was supported by the Russian Foundation for Basic Research.

Reference

1. V. Safronov, L.A. Feigin, L.D. Budovskaya, V.N. Ivanova "Langmuir-Blodgett Films of random copolymers of fluoroalkyl(meth)acrylate and methacrylic acid: fabrication and X-ray diffraction study". Materials Science and Engineering, C2(1995)205-207.

HEAT - RESISTANT POLYMERIC MATERIALS OF POLYAMIDE TYPE FOR THE FORMATION OF DIELECTRIC LAYERS

Ludmila I.Rudaya, Natalia V.Klimova, Svetlana S.Bogolubova,
Galina K.Lebedeva, Andrei V. Elt'sov

*St.Petersburg State Technological Institute
Moscow pr. 26, St.Petersburg 198013, Russia*

The heat-resistant polymeric compositions comprised of poly-o-hydroxyamides of the different structure and the aromatic and Si-contained 2,1-diazonaphthalenones as the light-sensitive compound are researched. These materials are very attractive and valuable for the formation of dielectric layers in the multilevel devices for the planar technology.

Si-Contained compositions have good adhesion to silicon substrates, glass and polymer surfaces.

The heat-resistant positive relief in the film is formed by well known operations, imaging is formed by development by water-alkaline solutions (stop-bath -the water) and postbake at 350°C (30 min).

Thermostability of the formed layers or reliefs is 450°C (in the inert atmosphere) and 400°C (in the air); images are not destroyed by action of acids, bases and oils; for 1.5 mkm layer voltage of dielectric break down is 300-400 V; dielectric loss tangent is 0.02 - 0.002 (1 kHz); dielectric constant is 3.5 - 4.5 (1 kHz). For the light - sensitive layers the spectral sensitivity region is 250 - 406 nm, the light sensitivity is 75-80 mJ/cm .

This light-sensitive composition and its modifications may be used for the forming the reversible image too. The qualitative negative image with good parameters may be formed by the change of the usual sequence of the operations in the lithographic process.

The heat - resistant polymeric compositions are stable more than 6 months at the room temperature.

The authors thank Russian Program "Theoretical and Applied Photochemistry" for the financial support of this work.

REDOX DISPERSION POLYMERIZATION OF PYRROL

Anastasiya Yu. Menshikova, Boris M. Shabsels, Tatyana G. Evseeva, and
Guennady P. Vlasov

*Institute of Macromolecular Compounds of RAS
Bolshoy pr. 31, St.-Petersburg, 199004 Russia*

The purpose of this work is the synthesis of polypyrrol monosize particles in the range of 20-100 nm. Polypyrrol exhibits pronounced electroconducting properties, and its blends and dispersions are black. Recently these dispersions have found application for the modification of membranes for ultrafiltration and gas separation, for marking biologically active substances in immunoanalysis as a substitute of colloid gold, etc.

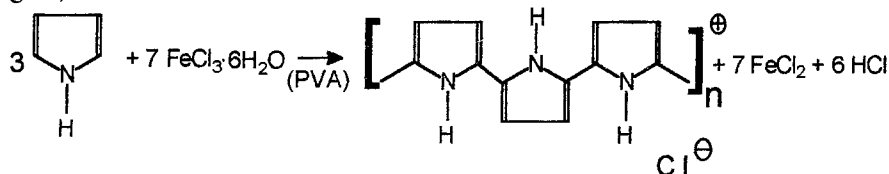

Polypyrrol dispersions were obtained by pyrrol polymerization in aqueous solutions of polyvinyl alcohol (PVA) in the presence of an oxidizing agent (FeCl₃). The influence of PVA molecular weight, the number of residual acetyl groups, PVA concentration, and reaction temperature on the polymerization kinetics and size distributions of polypyrrol particles is investigated. Monomer conversion was studied by gas chromatography. The data obtained are compared with absorption spectra of dispersions by testing during synthesis in the visible and near IR range. It was shown that good correlation between optical density of the system at λ=1000 nm on the one hand, and the degree of monomer conversion, on the other, allow easy control of synthesis by optical methods.

It was found that polymerization kinetics strongly depend on temperature but the average particle sizes are almost identical at temperatures from 0 to 25°C, although polydispersity of microspheres synthesized at room temperature is slightly higher. Increasing PVA concentration leads to finer particles and synthesis rate variations. This is probably caused by the strengthening of PVA structural-mechanical barrier at particle surface, and by increasing viscosity of the medium, which prevent particles aggregation. It is shown that this method makes it possible to obtain polypyrrol monosize particles in the range from 50 to 100 nm.

In order to decrease particle size, core-shell polymerization of pyrrol on particles of a magnetic liquid (Fe₃O₄) was applied. Magnetic particles with a size of about 10 nm, were stabilized by PVA. In the presence of HCl these particles slowly dissolve with FeCl₃ formation. In this case the process rate is limited by FeCl₃ diffusion to particle surface through a layer of polypyrrol already formed. This method allows us to reduce the particle size to 20-30 nm.

RIGID-FLEXIBLE POLYESTERS WITH UNUSUAL MOLECULAR ARCHITECTURE

Galina N.Khimich, Andrey V.Tenkovtsev, Alexander Yu.Bilibin

*Institute of Macromolecular Compounds RAS
199004 St. Petersburg, Bolshoy 31, Russia*

During the last decade a new branch of polymer science appeared which is being intensively developed, i.e. synthesis and study of polymers with extended π -conjugation. This interest deal with the usefulness of such type polymers as material for non-linear optics and other applications.

Unfortunately the majority of polymers that have extended π -conjugated blocks are not or very poor soluble and have very high flow temperatures. Due to this their investigation and processing are extremely difficult. In our opinion it is possible to avoid these difficulties by changing the molecular architecture of polymer.

For example a rigid block can be inserted tangentially into main chain. In this paper 4,4'-distylylbiphenylene unit was chosen as a π -conjugated aromatic block because it is known that polymers thereof capable to exhibit non-linear optical and light emitting properties. Synthetic route is given below:

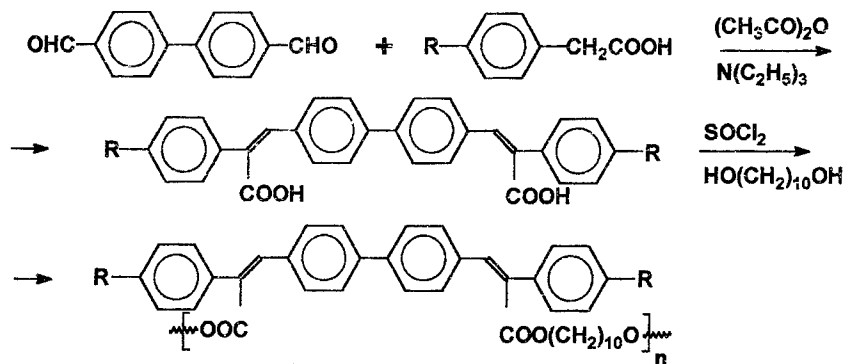

It is interesting to point out that inspite of the enough high anisometry of aromatic moiety the polymers have low tendency to exhibit liquid crystalline melt. It is possible to assume that this is the fact of conformational transformation of 4,4'-distylylbiphenylene moiety that leads to the change of the position of rigid blocks to polymer chain. This type of conformational transformation now is under investigation.

SYNTHESIS OF CARDO POLYARYLENEETHERKETONES BY NUCLEOPHILIC SUBSTITUTION REACTION OF ACTIVATED AROMATIC DIHALIDES AND METHODS OF REGULATIONS OF POLYMERS PROPERTIES

**Vera V. Shaposhnikova, Sergei M. Salazkin, Vladimir A. Sergeev, Andrei A. Askadskii,
Kapitolina A. Bychko, Valentina V. Kazantseva, Alexander V. Samoryadov, Alexander P.
Krasnov, Boris S. Lioznov**

*A.N. Nesmeyanov Institute of Organo-Element Compounds of Russian Academy of
Sciences 28, Vavilova Street, V-334, GSP-1, Moscow, 117813, Russia*

The general features of synthesis of amorphous cardo polyaryleneetherketones (PAEK) have been investigated. PAEK was synthesized by the following scheme:

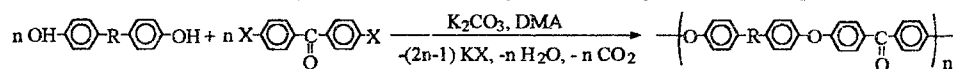

X=F, Cl

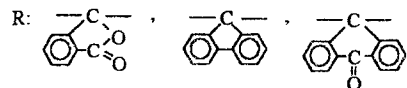

The influence of polycondensation conditions (reaction time, adding of monofunctional reagent) on reduced viscosity (η_{red}) of cardo PAEK has been studied. The conditions of regulation of molecular weight in wide range (\bar{M}_w from 10000 to 200000) have been found.

The influence of molecular weight on the number of cardo PAEK properties (heat resistance, mechanical properties, melting viscosity) has been investigated and methods of regulation of cardo PAEK properties were found. The range of optimum molecular weights ($\bar{M}_w = 40000 - 60000$) providing maximum properties (heat resistance, mechanical properties) and moderate melting viscosity of amorphous cardo PAEK with various chemical structure was established.

The high molecular weight (\bar{M}_w from 30000 to ≥ 100000) amorphous cardo PAEK with various chemical structure were synthesized. It was shown that amorphous cardo PAEK have $T_g = 225-240^\circ\text{C}$ and exceeds majority of known PAEK by T_g .

Plastics prepared by hot pressing and injection molding, films having good mechanical properties were prepared on a basis of amorphous cardo PAEK. Plastics (non-filled and filled by shot glass- and carbon fiber) have high impact strength (unnotched samples are not destroyed).

SYNTHESIS AND MESOMORPHIC PROPERTIES OF POLYESTERS BASED ON TEREPHTHALOYL-BIS-(3- METHOXY-4-OXYBENZOIC) ACID

**Mikhail .Ya. Goykhman, Gennadiy. M. Mikhailov, Irina. V. Podeshvo,
Galina. N. Matveeva, Andrey. V. Tenkovtsev, Anatoliy. I. Grigor'ev and
Vladislav .V. Kudryavtsev**

*Institute of Macromolecular Compounds RAS, 199004, Bolshoy pr. 31,
St.Petersburg, Russia.*

In order to synthesize liquid crystalline polymers, a mesogenic triad is used. It is terephthaloyl-bis-(4-oxybenzoic) acid that is a product of the reaction between 4-hydroxybenzoic acid and terephthaloyl dichloride. It is not only of theoretical but also of practical interest to synthesize this mesogenic triad with the replacement of 4-hydroxybenzoic acid by vanilic acid and to study the changes in polymer properties after the introduction of side substituents into the mesogenic moiety. The acid and the dichloroanhydride were synthesized according to the following scheme:

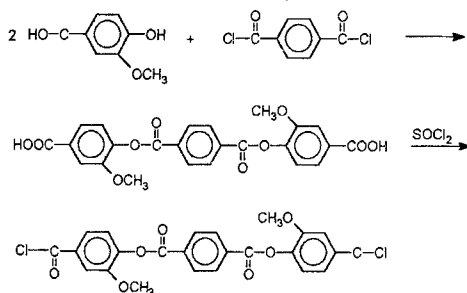

Polyesters were synthesized by high temperature polycondensation according to the following scheme:

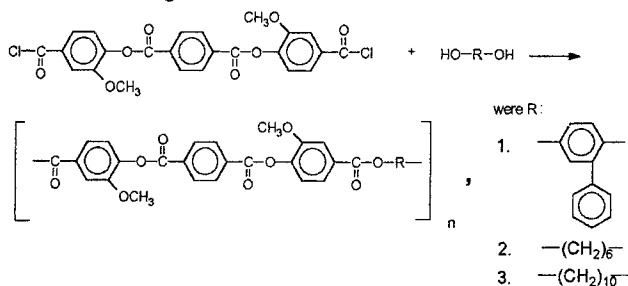

The polymers were investigated by X-ray analysis, DSC and polarizing microscopy. It was shown that all polymers are capable to exhibit liquid crystalline properties, but the stability of mesophases is much lower then that of linear LC polyesters that have no side substituents in the mesogenic groups.

References

1. A.Yu.Bilibin, A.V.Tenkovtsev, O.N.Piraner, S.S.Skorokhodov // Vysokomol. Soedin. 1984, V.26A, №10, P.2570.
2. A.Yu.Bilibin // Vysokomol. Soedin. 1989, V.31B, №3, P.163-164.

NEW POLYAZOMETHINE-ESTERS

Nina M. Geller, Sergei S. Skorokhodov, Svetlana V. Fedorova

Institute of Macromolecular Compounds RAS

Bolshoj pr. 31, St. Petersburg, Russia

One of the common methods of variation of the structure and consequently the phase transition temperature of the thermotropic main chain polymers is an introducing of nonlinear groups into rigid mesogenic fragment. We have used this method for preparation of new polyazomethine-esters. Initial o-diphenoles was synthesized by condensation salicylic aldehyde with o-aminophenole, p-phenylenediamine or benzidine. The diphenoles were used in polycondensation reaction with acid dichlorides. The preliminary data show that polymer with selected length of the mesogen and selected length of spacer is able to form thermotropic polymers, for example polyazomethine-esters obtained from N,N'-bis(salizilidene)-benzidine and heptamethyleneoxy-bis(4-benzoylchloride)

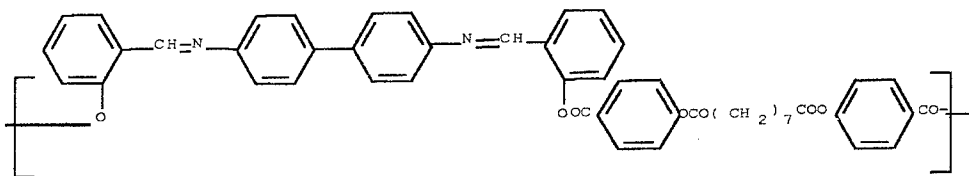

has the temperatures of phase transition

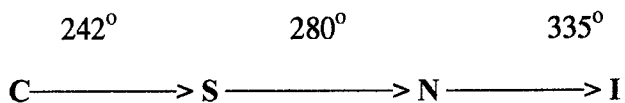

STRUCTURING IN ULTRA-HIGH-MOLECULAR-WEIGHT-POLYETHYLENE BASED SYSTEMS FILLED WITH DISPERSED FILLERS.

Ponomarev I.N., Lapshova O.A., Grinenko E.S., Kerber M.L., Lapshin S.V.

*D.Mendeleev University of Chemical Technology of Russia
125190 Miusskaya pl., 9, Moscow, Russia*

Gel-technology is a promising method for Ultra-High-Molecular-Weight-Polyethylene (UHMW-PE) based composites production, which considerably facilitates processing of UHMW composites. The properties of UHMW composites are determined by the structuring processes in filled systems.

The structure of UHMW-PE based gelling systems was studied by DSC, X-ray analysis and electron microscopy. It has been found, that filled UHMW-PE solutions and gels structuring depends polymer-solvent and polymer-filler interaction. Using a solvent with less thermodynamic activity promotes structuring processes of the polymer and filler. Structure of filled gels consists of filler's carcass, which is held by macromolecular spatial network. Morphology of crystallites, induced in gel's network depends on gelling conditions (type of a solvent, polymer and filler concentration, temperature).

Rheological properties of filled UHMW-PE were studied by capillary viscometry. The flow of the systems under study is stratified. The structure of extrudates of filled UHMW-PE gels presents a "core-shell" type one. While stretching the "shell" of a sample destructs and the structure of the "core" transforms into fibrillar one.

Forming of a porous structure of gelling composites takes place in the stage of eliminating of a solvent. The dimensions of forming pores depends on surface tension of including liquids. The use of extracting agents with high surface tension enables us to obtain UHMW-PE based composite materials with microporous structure.

**SYNTHESIS OF HYDROPHILIC INTERPOLYMERS WITH
AZOMETHINE AND AMIDE INTERCHAIN BONDS**

**Olga V. Nazarova, Evgenij F. Panarin, Nina G. Belnikevich,
Olga P. Gorbunova, Irina I. Gavrilova, Elena V. Afanas`eva**

*Institute of Macromolecular Compounds RAS
Bolshoy pr. 31, St. Petersburg, 199004 Russia*

In contrast to polymer-polymer complexes, interpolymers formed as a result of interchain covalent reactions of hydrophilic polymers with mutually reactive groups have not been studied in detail. In this work interchain reactions of water-soluble amine-containing copolymers of N-vinylpyrrolidone (VP) with water-soluble VP or N-2-(hydroxypropyl)methacrylamide copolymers which contain aldehyde or p-nitrophenyl ester groups were used to synthesize conjugates with azomethine or amide interchain bonds. These interpolymers differ in the main chain structure of initial copolymers (nature of hydrophilic and functional comonomer, reactive units distribution, and molecular weight parameters), the presence and structure of spacers separating functional groups from polymer chains, as well as the type and stability of interchain covalent bonds. The effect of these factors, the process conditions and the conformational states of initial polymers in different solvents on the kinetics of interchain covalent reactions was studied by potentiometric titration, UV spectroscopy, and viscosimetry. The conditions making it possible to obtain both branched soluble and crosslinked interpolymers were determined. It was shown that for the polymers investigated these conditions do not depend on the interchain reaction type but are determined by initial polymers characteristics and process conditions.

**SYNTHESIS AND PROPERTIES OF COPOLYMERS BASED ON THE
 γ -BENZYL-L-GLUTAMATES AND γ -ALKYL-L-GLUTAM(IN)ATES.**

Elena N. Vlasova, Gennady P. Vlasov, Alla V. Purkina, and Boris Z. Volchek

***Institute of Macromolecular Compounds of RAS
 31 Bolshoi, St.-Petersburg, 199004 Russia***

According to theoretical predictions, rigid chain polymers are capable to form both lyo- and thermotropic liquid crystalline (LC) order. However, for the majority of 'extra-rigid' polymers thermotropic LC order was not demonstrated experimentally because the transition temperatures to LC state for this kind of polymers are higher than those of their thermal degradation. Decreasing transition temperatures while conserving rigidity of the main chain can be achieved by introducing into the side chain of such polymers long flexible alkyl groups playing the role of solvent in lyotropic LC. For example, thermotropic mesophases were successfully produced in homopolyglutamates with n-alkyl groups longer than decyl and in copolymers (CPL) of γ -benzyl-L-glutamate (BG) and alkyl-L-glutamates (where alkyl were dodecyl-, hexadecyl- and octadecyl fragments). In the present communication we report synthesis of another group of CPLs of L-glutamic acid with general formula

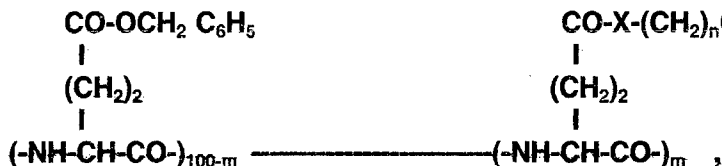

where $n = 11, 15, 17$; $m = 30-95$ (molar %), $X = \text{O}$ or NH .

Copolyglutamates ($X = \text{O}$) were prepared by ester interchange reaction of PBG with appropriate alcohol ($\text{CH}_3\text{-(CH}_2)_n\text{-OH}$) and p-toluenesulfonic acid as a catalyst. CPLs of glutamates-glutaminates ($X = \text{NH}$) were prepared by reaction of PBG with appropriate amine $\text{CH}_3\text{-(CH}_2)_n\text{-NH}_2$. These new polymers were employed for continuation of research concerning the effect of alkyl chains length and CPLs composition on possibility of LC order formation. In addition, the role of the type of side-chain-to-main-chain attachment in thermotropic LC order ($X = \text{O}$ or $X = \text{NH}$) formation was studied. It was found that CPLs with $X = \text{O}$ and $X = \text{NH}$ form lyotropic LC order in appropriate solvents. But only CPLs with $X = \text{O}$ and $n \geq 11$, $m \geq 30$ form thermotropic LC state. Finally, effect of LC order on conformation of alkyl side chain was investigated. Conformational and orientational parameters of separate chain fragments were measured in both bulk and LC state. It was discovered that alkyl side chains in copolymers with $n = 16$ and the high m values in the bulk state are oriented mostly normally to the main chain, while the transition to LC state (starting from 50°C) destroys this orientation completely.

UV-SPECTROSCOPY STUDY OF HYDROPHOBICALLY MODIFIED POLY-4-VINYL PYRIDINE IN DILUTE SOLUTIONS

Lijiang Yang and Yajiang Yang*

Department of Chemistry, Huazhong University of
Science and Technology, Wuhan 430074, P.R.China

The UV-vis absorption spectroscopy of cationic polysoaps (hydrophobically modified poly-4-vinyl pyridine, N-methyl for QPVP1-3; N-dodecyl for QPVP4-3 or QPVP4-2), Benzyl Dimethyl Dodecyl Ammonium Chloride (BDDAC) and Sodium Dodecyl Sulfonate (SDS) at present of low concentration of Methyl Orange was studied on a UV-vis spectrophotometer. The significant property of the polysoap is the formation of hydrophobic microdomains by the aggregation of hydrophobic alkyl groups in polysoap solution. Such hydrophobic microdomains also are so-called micelles which are similar to the surfactant. It was found that the presence of Methyl Orange is favourable to form hydrophobic microdomains of polysoap solutions because opposite charges on their headgroups reduced electrostatic repulsion between headgroups in mixed micelles.

Methyl Orange is a hydrophobic molecule with sulfonic group at the terminal of the molecule. The maximum absorption of Methyl Orange is about 460nm (pH=9.4). Figure 1 shows λ_{max} shift of Methyl Orange at the different concentrations of polysoaps. Distinct λ_{max} shifts (blue shifts) occurred after polysoap (QPVP4-2 or QPVP4-3) were added. In contrast with that, there was no distinct effect for the absorption of Methyl Orange after QPVP1-3 was added. λ_{max} of Methyl Orange is much dependent on the microenvironment in aqueous solution. λ_{max} will shift to blue band in non-polar hydrophobic environment. Therefore it indicates that there was no distinct interaction between QPVP1-3 and Methyl Orange. Hydrophobic interaction occurred to Methyl Orange and QPVP4-2 or QPVP4-3 due to the certain amount of hydrophobic groups (n-dodecyl groups) on the main chains of polysoap. The tendency of λ_{max} shift can be explained through the hydrophobic interaction of them. UV absorption of Methyl Orange has almost no change when the concentration of polysoap is too low to form efficient hydrophobic microdomains in aqueous solution. To discuss more clearly interaction between QPVP and Methyl Orange. Methyl Orange - Sodium Dodecyl Sulfonate (SDS) and Methyl Orange - Benzyl Dimethyl Dodecyl Ammonium Chloride (BDDAC) were studied, respectively. The results were summarized in Figure 2. Though with same n-dodecyl groups, the effect of SDS with the charge as same as Methyl Orange on the λ_{max} was very poor. The λ_{max} of Methyl Orange was strongly influenced by the BDDAC with contrary charge and the shift tendency of λ_{max} was similar to QPVP4-3. That not only indicates that the formation of mixed micelles was strongly influenced by the charge of headgroups, but also indicates that QPVP4-3 and BDDAC have some characters in common.

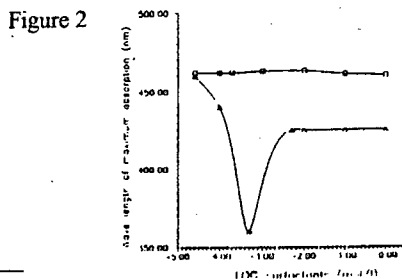
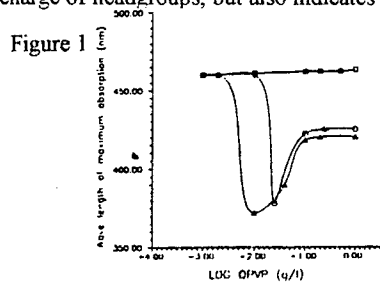

* To whom all correspondence should be addressed.

POLYMERS ON BASE OF NEW N-SUBSTITUTED ACRYLAMIDE WITH SULFOLANE FRAGMENT AND SULFO-ACID GROUP

Oleg A. Kazantsev¹, Konstantin V. Shirshin¹, Sergey A. Kazakov¹,
Klavdia P. Papukova²

1 - Nizhegorodsky Technical University,

Str. Gajdara 49, Dzerzhinsk, 606026, Russia

2 - Institute of Macromolecular Compounds RAS,

Bolshoy pr. 31, St. Peterburg, 199004, Russia

The use of polyfunctional monomers is a perspective direction for obtaining new polymers with interesting properties. We synthesied new N-substituted acrilamid with sulfolane fragment and sulpho-acid group - 4-acrilamido-4-methyl-tetrahydrothiophen-1,1-dioxide-3-sulfo-acid (ASA).

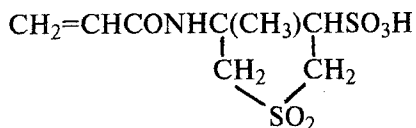

ASA was obtained by reaction of acrylonitrile, 3-methyl-3-thiolen-1,1-dioxide and oleum. The yield is 90-95 %.

ASA is a stable monomer in neutral and acid water solution, but it hydrolyzes when heating in base water solutions with the following secondary transformations: the formation of ammonia and its addition to C=C-bounds of initial monomer and of product of hydrolysis - acrylic acid. It must be taken into account when choosing the method of (co)polymerization of ASA.

ASA is active monomer for radical gomo- and copolymerization in the presence of peroxide initiators (persulfates has been used) or azoinitiators (4,4-azo-bis-4-cyanopentanoat of sodium has been used). The conversion of ASA in water (50⁰ C) in the presence of ammonium persulfate (0.15 % mol.) is about 97% after 4 h.

The speed of ASA gomopolymerization is of the same order (in identical conditions) as the speed of gomopolymerization of industrial sulpho-acid acrylamide - 2-acrylamido-2methyl-propanosulphonic acid (AMPSA). Copolymers of ASA with acrylamide, methacrylamide and acrylonitrile were synthesized. The influence of nature and concentration of initiators of conversion was studied.

AN ATTEMPT OF THE SYNTHESIS OF REACTIVE POLYMERS WITH BENZOPHENONE GROUPS.

Ludmila I. Rudaja, Natalia V. Klimova, Sergei S. Skorokhodov

*Institute of Macromolecular Compounds RAS
Bolshoy pr. 31, St.Petersburg, 199004, Russia*

The reactivity of aromatic carbonyl group especially incorporated in photoactive benzophenone structure make it attractive to synthesize corresponding macromolecular reagents. There were several attempts to prepare such polymers [1,2].

We try to prepare a rigid monomeric triad by the reaction of 2,5-benzophenone-dicarboxylic acid dichloride with p-hydroxybenzoic acid. It was shown that the product obtained undergoes ring-chain tautomeric transformation giving cyclic tautomer in solution. Open-chain tautomer is stable only in the solid state.

To avoid the rearrangement the synthesis of polyesters were prepared going from dipotassium salt of 2,5-benzophenone-dicarboxylic acid and aliphatic and siliconorganic dihalogenides. Series of new polyesters were obtained and characterized.

References

1. M.A.Abd-Alla // Makromol.Chem. 1991. B 192. S 277-283
2. L.Pouliqueu, X.Caqueret// Makromol.Chem. 1996. B 197. S 40-45

METHODS OF SYNTHESIS OF SUPERHIGHMOLECULAR HYDROPHILIC POLYMERS

V.I.Kurlyankina, V.A.Molotkov, N.A.Matveeva, A.I.Kipper., G.V.Shishkina,
E.N.Chlebosolova, L.D.Ostrovskaya, N.V.Rumyantseva

*Institute of Macromolecular Compounds, RAS
Bolshoy pr. 31, 199004 St.Petersburg, Russia*

A new method of obtaining the polymers of superhigh molecular mass (10-30) mln based on the formation of polymerization centers by splitting the monomer under the action of protons is developed. The mechanism of this reaction is established on an example of N-metacryloyloxyethyl-N,N,N-trimethylammonium methylsulfate (DMAEM-DMS). Proceeding of this process through radical formation is proved. Activation energy of the process was estimated from kinetic studies using nitroxyl radicals. It occurred to be 63.5 KJ/mole \times $^{\circ}$ C which is considerably lower than that for splitting of peroxide compounds. Catalytic role of protons in this process is shown. It was confirmed also by the existing of isotopic effect in deuterated water, which is caused by the changes in energy of interaction of monomer with deuteron as compared to proton. Kinetic scheme, based on the results of these studies permitted to establish the product of constants of monomer protonization and the splitting of protonated form with the formation of radicals. In the temperature region 50-90 $^{\circ}$ C it is equal $(0.21-2.5)\times 10^{-6}$ l/mol \times s and the rate of radical generation will be about 1×10^{-8} mole/l \times s.

For the studying of peculiarities of polymerization in this process it was compared with Co(III)-glycine - initiated polymerization of DMAEM-DMS. This initiating system is also developed by us and permits to obtain polymers with molecular mass 10-30 mln. It is shown that compared reactions proceed according to quite different rules. In the first case the process develops in complete agreement with initiation mechanism data. Yield of the polymer, its MM and the number of appearing macromolecules increased linearly with monomer concentration, and increasing proton concentration additionally increased the yield of the polymer and the amount of macromolecules, but slightly influenced the MM of the polymer.

In the second case, when initiation of polymerization was performed by Co(III)-glycine system, monomer conversion reached 75-80%, but for obtaining the polymers of superhigh molecular mass by this method high concentration of monomer is necessary as well as accurate coincidence between the rate of radical generation and the monomer concentration, while in the above-mentioned method it is naturally established.

FORMATION, STRUCTURE AND PROPERTIES OF CELLULOSE-POLY-(ACRYLIC ACID) INTERPENETRATING POLYMER NETWORK MEMBRANES

Alexander L.Buyanov¹, Ludmila G.Revel'skaya¹, Albert K.Khripunov¹,
Yurii P.Kuznetsov¹, Vasilii T.Lebedev², Gyula Torok³, and Laszlo Cser³.

1. Institute of Macromolecular Compounds RAS

Bolshoy pr.31, St.Petersburg, 199004 Russia

2. Petersburg Nucl. Phys. Institute, 188350 Gatchina, St.Petersburg dist., Russia

3. KFKI Research Inst. for Solid State Physics, POB 49, Budapest, Hungary

A new type of interpenetrating polymer network membranes (IPNM) based on cellulose and acrylic polymer was developed. The swelling behaviour of these IPNM in water-ethanol mixtures, their pervaporation properties and structural particularity were investigated. It was found that separation characteristics of cellulose membranes were low: the separation factor (α) and permeability (P) did not exceed 10 and 0.1 kg/m²·h, respectively (86 wt% EtOH, 50°C). The formation of the acrylic network within the cellulose physical network led to a sharp increase in both α and P of IPNM up to 7000 and 2 kg/m²·h, respectively.

This behaviour shows that cellulose membranes contain large "pores" which correspond to amorphous regions. In IPNM synthesis, synthetic chains fill these regions and as a result selectivity increases. The large level of IPNM permeability can be explained by a relatively high degree of their swelling (Q), which was due to the polyelectrolyte effect. Simultaneously, the size of the "pores" of the cellulose matrix limited the polyelectrolyte chains swelling, which in the absence of this matrix would have been too great for pervaporation purposes. Good agreement between P and Q was found for all types of membranes under investigation.

The results are also in agreement with experimental data obtained by small angle neutron scattering method. It was shown that cellulose membrane contains large "pores" with radius of gyration $R_g = 114 \pm 2$ Å and small inhomogeneities with $R_g^* = 32 \pm 2$ Å. The first scale should be related to amorphous regions in cellulose saturated by heavy water as far as the second scale corresponds to a polymer segment. In IPNM the scattering corresponding to large "pores" in cellulose disappears, but the intensity of the "segment" component becomes higher and the radius slightly decreases to $R_g^* = 27 \pm 1$ Å.

NEW METALLIC COMPLEXES OF CELLULOSE. SILVER INTERCALATION INTO CELLULOSE MATRIX.

**Nina E.Kotelnikova^a, Gerd Wegener^b, Timo Paakkari^c, Ritva Serimaa^c, Valery
P.Kotelnikov^d, Elisabeth Windeisen^b, Victor N.Demidov^e, Andrei V.Shchukarev^f,
Alexander V.Gribanov^a**

^a *Institute of Macromolecular Compounds RAS, Bolshoy pr. 31,
St. Petersburg 199004, Russia*

^b *Institute for Wood Research, University of Munich, 80797 Munich, Germany*

^c *Department of Physics, FIN-00014 University of Helsinki, Helsinki, Finland*

^d *"Thesa" Co. Ltd., St. Petersburg 197198, Russia*

^e *State Technological Institute, St.Petersburg 198013, Russia*

^f *Joint Stock Company "Mekhanobr-Analyt", St. Petersburg 199026, Russia*

The intercalation of metals into polymeric system has been shown to generate specific features that can lead to various applications. Compounds of metals, metal clusters and colloids with native polymers including cellulose have not yet been studied in detail. The use of silver for this purpose is, without of doubt, of interest because cellulose-silver compounds can be applied in medicine and in some other fields. In the present study we are currently engaged in the investigation of the intercalation of metals into microcrystalline cellulose (MCC) that was employed as polymer matrix.

The intercalation of silver clusters into the MCC matrix was carried out by the reduction of silver salts immobilised in cellulose substrate either by using different reducers or the reducing properties of cellulose itself.

According to ESCA data, MCC samples with silver clusters are characterised by higher metal content on the surface than in bulk. In the cellulose matrix in the macroligand cluster environment the following interaction takes place:

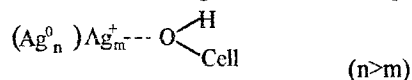

This is in agreement with current concepts on the interaction character of metal clusters with donor groups of multidentate polymer ligands.

According to X-ray and FTIR data, MCC supramolecular structure is not changed. The size of silver crystal aggregates in the MCC matrix was also estimated by X-ray data. Direct study of metal clusters formation on the surface and in the matrix was observed by SEM and TEM. Their shape and size were estimated by statistical mathematical methods. The results obtained and possible variants of explanation of these phenomena will be discussed from the standpoint of modern understanding of cellulose structure and the coordination chemistry of transfer metals.

**NEW APPROACHES TO THE PREPARATION OF MACROMOLECULAR
METAL COMPLEXES***

**Elizaveta V.Anufrieva, Raisa A.Gromova, Tatyana N.Nekrasova, Tatyana D.Ananieva,
Mark G.Krakovyak, Vanda B.Lushchic, Tamara V.Sheveleva**

*Institute of Macromolecular Compounds RAS
Bolshoy pr. 31, St.Petersburg, 199004 Russia*

In performing the tasks related to the practical application and functioning of macromolecular metal complexes (MMC), the problem of direct variation of their stability can be essential. To solve this problem, it is necessary to find methods for quantitative evaluation of metal binding ability of polymers, and a possibility for comparative investigation of the stability of different (various) MMC, and to establish on this basis the factors affecting this stability.

For the quantitative evaluation of parameters characterizing MMC stability, for ions of polyvalent (Fe^{3+}) metals, a method based on using a system of reversed micelles of surfactants in organic solvents and luminescently marked polymers was employed. This method is interesting because polymer coil compactization in the micelle precedes MMC formation. Thus, the effect of polyvalent metal ion on the structural organization of the macromolecule and the resulting change in MMC stability are taken into account.

For the comparative investigation of the stability of various MMC in solution (not in a micelle), a method was developed based on the use of a competing polymer and on the study of changes in the nanosecond dynamics of polymer, which are related to metal ion transition from the polymer carrier to the competing polymer. The polymer being investigated is distinguished by a luminescent marker¹.

Both methods give similar results for MMC the stability parameters of which differ greatly.

For MMC formed by water-soluble polymers and copolymers based on N-vinylamides, N-alkylmethacrylamides and N-arylmethacrylamides and ions of polyvalent metal ions (Al^{3+} and Fe^{3+}) the following factors changing MMC stability were established: the chemical structure of (co)polymers and their molecular structural organization, the pH and ionic strength of solution, the medium temperature, and time of interaction between the macromolecule and ions of polyvalent metals.

¹ E.V.Anufrieva & Yu.Ya.Gotlib, *Adv.Polym.Sci.*, **40** (1981) 1.

.....
* This work has been supported by the Russian Foundation of the fundamental Investigations, grant 97-03 32682.

MOLECULAR AND MORPHOLOGICAL ARCHITECTURE OF ADSORBATES OF MICROCRYSTALLINE CELLULOSE AND BIOLOGICALLY ACTIVE COMPOUNDS BASED ON POLY-VINYLPYRROLIDONE

Nina E.Kotelnikova, Evgeny F.Panarin, Andrei V.Shchukarev, Nataly P.Kudina, Song Jie, Irine S.Kochetkova, Sergey V.Shilov, Hou Yongfa, Yuri V.Brestkin

*Institute of Macromolecular Compounds RAS
Bolshoy pr. 31, St. Petersburg, 199004 Russia*

In order to obtain multicomponent polymer systems exhibiting biological activity, we have previously carried out adsorption modification of powder microcrystalline cellulose (MCC) by biologically active compounds (BAC) based on polyvinylpyrrolidone (PVP). A copolymer of N-vinylpyrrolidone and crotonic acid (sovikan) and catapol, a complex of sovikan and dimethylbenzylalkylammonium chloride (katamin) were investigated. The relationships of adsorption interaction of these polymers and katamin with MCC, the conditions of the most complete desorption of BAC from MCC, and the antimicrobial activity of the adsorbates were established.

This work presents adsorbates characteristics obtained by electron spectroscopy for chemical analysis (ESCA), raster electron microscopy, and IR spectroscopy.

The molecular structure of the adsorbates is determined by chemical interaction between MCC and katamin which is a salt of quaternary ammonium base. This is indicated by the isotherms of katamin adsorption on MCC and by the electron and IR spectra of katamin desorbed from the MCC-katamin adsorption complex. This conclusion is confirmed on the morphological level by the electron microscopy of MCC-katamin samples. The micrographs show that katamin is inserted into the cellulose fiber structure, MCC is partially dissolved, and a new morphological design of the fiber with a porous structure is formed. Hence, the chemical interaction of katamin with MCC forms a new labile morphological cellulose structure accessible to reagents. The interaction between catapol and MCC is carried out with porous structure already formed. As a result, catapol, a multicomponent polymer complex is readily adsorbed on MCC yielding adsorbates with catapol content up to 0.2 mole/mole of MCC. Adsorption is not reversible: the maximum value of catapol desorption depending on pH is 85 mass%. PVP desorption depends on its MM and ranges from 50% for low molecular weight samples to 80% for high molecular weight samples. In this case sovikan desorption is reversible almost by 100%. In contrast, katamin desorption amounts only to 20-25%. Consequently, the adsorbates of MCC and the above compounds are compatible labile complexes the structure of which depends on the chemical structure of the compounds adsorbed. Moreover, some of these compounds are bound with cellulose by covalent bonds which is confirmed by ESCA data.

**POLARIZED NEUTRON STUDY
OF MAGNETIC ORDERING IN FERROGEL**

**Vasili T. Lebedev¹, Gyula Torok², Laszlo Cser²,
Alexander L. Buyanov³, and Ludmila G. Revel'skaya³**

¹Petersburg Nucl. Phys. Inst., 188350 Gatchina, St. Petersburg dist., Russia

²KFKI Research Inst. for Solid State Phys., POB 49, Budapest, Hungary

*³Institute of Macromolecular Compounds, 199004, Bolshoi prosp. 31,
St. Petersburg, Russia*

A new chemically crosslinked magnitosensitive polymer hydrogel containing ferromagnetic monodomain Fe₃O₄-particles has been synthesized and investigated by the technique of polarized neutron with reversing neutron spin direction at the sample. This enabled us to observe for the behaviour of magnetic particles confined in the network. They serve as microprobes to test the intrinsic properties of the network (homogeneity, junctions density and elasticity).

The specimen swollen in H₂O (degree of swelling 10 g/g) at room temperature and in a weak applied field H=65 Oe demonstrates the significant effect of nuclear-magnetic interference in scattering at momentum transfer $q \sim 0.01-0.03 \text{ \AA}^{-1}$, which corresponds to spatial particles correlations at distances of the order of inverse particle diameter $D \sim 200 \text{ \AA}$. This is an evidence of the existence of particles ordering due to dipolar coupling as a result of polymerization. At the same time, the strong field H=4 kOe applied to the sample induces a high interference effect (ten times stronger) which reveals a long increase (relaxation for $\sim 10 \text{ h}$). This shows the existence of the ordering process in ferrogel related to particles diffusion in the network. This process is characterised by viscosity of the order of 10^5 higher than that for water. This ordering is reversible and disappears after the external field is switched off.

**SYNTHESIS AND STRUCTURE OF WATER-SOLUBLE
POLYMERS BASED ON N-VINYLLACETAMIDE AND
N-VINYLPYRROLIDONE**

**Andrei Y. Ershov, Irina I. Gavrilova, Anatoly I. Rodionov,
and Evgeny F. Panarin**

***Institute of Macromolecular Compounds RAS
Bolshoy pr., 31, St.-Petersburg, 199004, Russia***

N-Vinylamides attract considerable attention as monomers for the synthesis of water-soluble polymer carriers of biologically active compounds exhibiting their own pharmacological activity. Among them N-vinylpyrrolidone (VP) and N-vinylcaprolactame have been investigated in greatest detail, whereas N-vinylamides of carboxylic acids of fatty series have not been investigated because until recently universal methods of their synthesis did not exist.

Therefore, the development of available methods of N-vinylacetamide (NVA) synthesis and its copolymerization with different vinyl comonomers is a topical problem because it becomes possible to synthesize a wide range of new water-soluble polymers.

We have shown that NVA can easily be obtained by the pyrolysis of the corresponding N-(α -carboxyethyl)acetamides in 75-85 % yield and with 95-97% purity. NVA homopolymerization proceeding in ethanol at 60°C in the presence of 1% AIBN gives polyvinylacetamide (PVAA) in high yield with molecular weights ranging from 50 to 200 · 10³.

NVA copolymerization with VP in the presence of AIBN gave water-soluble random copolymers with different composition ranging from 80/20 to 10/90 (NVA/VP). The composition of copolymers and the reactivity constants of NVA and VP was established by ¹H and ¹³C NMR spectroscopy.

The acid hydrolysis of PVAA and NVA-VP copolymers was investigated. After polymers boiling in concentrated hydrochloric acid for 15 h, quantitative removal of the acetyl group without the opening of the lactame ring takes place, which leads to the formation of polyvinylamine hydrochloride PVA·HCl and the copolymer PVA·HCl-VP.

DYNAMICS OF WATER MOLECULES IN SUPERGEL

Gyula Torok¹, Vasilii T. Lebedev², Laszlo Cser¹, Alexander L. Buyanov³

*¹ KFKI Research Inst. for Solid State Physics, POB 49,
Budapest, Hungary*

*² Petersburg Nuclear Physics Inst., 188350, Gatchina,
St. Petersburg dist., Russia*

*³ Institute of Macromolecular Compounds, 199004,
Bolshoi prosp. 31, St. Petersburg, Russia*

Supergels are polyionic polymer networks having a very high swelling ability. In our experiments the samples consist of a sodium polyacrylate polymer crosslinked by allyldextran. We studied the quasielastic scattering from water in supergels with different degrees of swelling. The polymer chains are surrounded by a hydration shell, and water dynamics in supergels reveal strong localization effects which can be treated in terms of the Singwi-Sjolander model.

The q - dependence of characteristic energy transfer $\hbar\omega(q) \leq 0.1$ meV in the experimental range of momentum transfer $q = 0.2-2 \text{ \AA}^{-1}$ is described by a universal scaling law for various degrees of swelling if we take into account the time of interaction of water molecules with the network $\tau \sim \xi/V$ where $\xi \approx b/C^{3/4}$ is the size of network cell depending on polymer concentration in the gel and b - the monomer length. Here V is the sound velocity in this medium. Hence, it was found that the relaxation rate is determined by the correlation length of the network which increases by swelling.

The Coil-Globule Transition of Polyelectrolytes in Salt-free Mixtures of Water and Acetone

Vladimir O. Aseyev*, Stanislav I. Klenin**, Inga A. Baranovskaya**, Heikki Tenhu*

* - University of Helsinki, PB 55, FIN-00014 HY, Helsinki Finland

** - Institute of Macromolecular Compounds, Russian Academy of Science
Bolshoi Prospect 31, 199004, St.Petersburg Russia

Three samples of a super high molar mass polyelectrolyte poly(methacryloylethyl-N,N,N,-trimethylammonium sulphate), pDMAEMA, with molar masses $23\text{-}30 \times 10^6$ g/mol were examined by viscosity, static light scattering, and conductivity measurements to determine the influence of the polymer concentration, solvent composition, the presence of ions and the hydrodynamic field on the conformation of the polymer in a water-acetone solvent.

If $\gamma = \gamma_t \approx 0.80$ (γ - the mass fraction of acetone) a reversible conformational change of macromolecules in the solution occurs following an abrupt decrease in solution viscosity and conductivity, an increase in light scattering intensity, as well as a decrease in R_g and R_h and the second virial coefficient A_2 . The correlation function measured by DLS changes from a bimodal into a unimodal one indicating the formation of compact globular structures.

A similar conformational transformation while $\gamma < \gamma_t$ can be achieved by dilution. Since acetone acts as a non-solvent for the polymer, the concentration dependence of the intrinsic viscosity of polymer was investigated as a function of varying γ in a broad range of shear rates. With $\gamma < 0.5$ the solution shows an usual behaviour. When $0.60 \leq \gamma < 0.80$, a sudden decrease of viscosity is observed while decreasing the polymer concentration.

With $\gamma \geq 0.80$ the polymer adopts another, a compact conformation. In very dilute solutions the polymer also has a compact conformation different from that in more concentrated solutions. This phenomenon can be explained by the change of the complex balance of inter- and intramolecular interactions.

The effect of ionic additives on the polymer was also studied.

**PARTIALLY DEUTERATED IN C2 POSITION
CHITIN-GLUCAN COMPLEX FROM *ASPERGILLUS NIGER*.**

**L.A.Nudga¹, V.A.Petrova¹, S.I.Ganicheva², T.V.Vybornova², E.B.Lvova²,
V.L.Alexeev³, G.A.Evmenenko³, G.A.Petropavlovsky¹.**

1 - Institute of Macromolecular Compounds, Russian Academy of Sciences, 31 Bolshoi pr., 199004, St.-Petersburg, Russia

2 - All-Russian Scientific Research Institute of Food Aromatisers, Acids and Dyes, 55 Liteyny pr., 191104, St.-Petersburg, Russia

3 - Petersburg Nuclear Physics Institute, 188350, Gatchina, Leningrad distr., Russia.

Chitin-glucan complex from *Aspergillus niger* has valuable physico-chemical properties, particularly, good sorption ability, and it is very promising for different applications including biomedicine. But so far, nor its chemical structure, nor conformation properties in solutions and solid state are known. To determine the type of bond between chitin and glucan in the complex and its supermolecular structure by modern methods of investigations (SANS, NMR) one needs to introduce deuterium label in macrochain of the complex. With this aim in view the biosynthesis of deuterated chitin-glucan complex of *Aspergillus niger* grown on heavy water medium has been done. It has been shown that in heavy water medium the biosynthesis proceeds with lower rate than in usual conditions. Chemical composition and supermolecular structure of the complex were studied. NMR-¹H shows that deuterium incorporates with a high degree of substitution only in C2 position of N-acetylglucosamine ring of chitin macrochain.

CHROMATOGRAPHIC INVESTIGATION OF PRODUCTS OF FULLERENE REACTION WITH VINYLPIRROLIDONE AND POLYVINYLPIRROLIDONE

Larissa S. Litvinova, Jenő J. Kever, Elena Yu. Melenevskaya, Ludmila V. Vinogradova, and Vladimir N. Zgonnik

*Institute of Macromolecular Compounds RAS,
Bolshoi pr. 31, St. Petersburg 199004, Russia*

The practical use of recently detected fullerene biological activity is hindered by the insolubility of carbon clusters in water and aqueous solutions. Therefore, the synthesis and analysis of water-soluble fullerene derivatives including the products of fullerene interaction with polymers (for example with poly(N-vinylpyrrolidone, PVP) are very topical. In this case water-soluble fullerene derivatives can be obtained both by complexation and copolymerization of fullerene with N-vinylpyrrolidone (VP).

The complexes of fullerene with PVP containing ~ 1% fullerene and the copolymers of fullerene C₆₀ with VP, which are characterized by light-scattering and NMR and UV spectroscopy were analyzed by thin-layer chromatography (TLC) and by dual-detector microcolumn size-exclusion chromatography.

In adsorption TLC, fullerene-containing PVP (FPVP) and homo-PVP are characterized by different retention indexes. In contrast, fullerene complex with PVP exhibits the same chromatographic mobility as homo-PVP but differs from it by its UV-absorption. It is detected on the TLC-plate from luminescence quenching at $\lambda = 254$ nm.

Column chromatography with the comparison of results of refractometric and photometric detection showed that the apparent polydispersity of fullerene-containing FPVP fractions is much lower than that of the entire sample. This result can be explained from the standpoint of internal complexation of the PVP chain already bound to the fullerene molecule. Internal complexation is also confirmed by the fact that the addition of C₆₀ to FPVP does not lead to the formation of an intermolecular complex (TLC data).

**AMINO ACID BASED BIOANALOGOUS POLYMERS.
NEW SYNTHESIS OF AABBP_s via N,N'-DIACYL-BIS- α -AMINO ACIDS.**

D.Kharadze, N.Medzmariashvili*, L.Kirmelashvili, R.Katsarava.

*Inst. of Molec. Biol & Biophys., Georgian Acad.Sci., *Georgian Technical University,
P.O. Box 24, 380079 Tbilisi-79, Georgia.*

AA-BB type bioanalogous polymers composed of "physiological" building blocks-naturally occurring α -amino acids (AABBP_s) are promising as biodegradable materials for biomedical engineering use [1]. The major merits of these amino acid derived polymers as compared with AB type conventional poly(α -amino acid)s are: lower cost, versatility in material properties and processability, and versatility in polymerization techniques.

The present work deals with some new synthesis of AABBP_s using N,N'-diacyl-bis- α -amino acids (1, X=H) as starting monomers. These latter have been prepared in nearly quantitative yields by interaction of corresponding dichloroanhydrides with hydrophobic α -amino acids under Shotten-Baumann reaction conditions.

AABBP_s containing tripeptide links ($\eta_{red} \leq 0,44$ dL/g) have been synthesized from 1 used as bis-azlactones (when R=1,4-C₆H₄) [2] or active diesters [3], and L-lysine alkyl esters used as N,N'-bis-trimethylsilylated diamine 2.

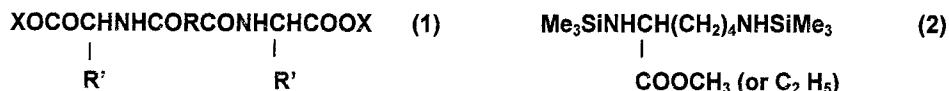

R = (CH₂)₄, 1,4-C₆H₄; X = H, K, Me₃Si



AABBP-poly(ester amide)s ($\eta_{red} \leq 0,28$ dL/g) have been prepared by solution polycondensation of the potassium salts of 1 (R'=CH₂Ph, X=K) with 1,2-dibromoethane 3.

The first attempts for preparing AABBP-polydepsipeptides ($\eta_{red} \leq 0,20$ dL/g) from 1 (R=(CH₂)₄, R'=CH₂Ph) by solution polycondensation of its salt (X=K) or O,O'-bis-trimethylsilyl derivative (X=Me₃Si) with 1,3-propylene-bis-bromoacetate 4 have been made as well.

R e f e r e n c e s

- 1) T. Kartvelishvili, G. Tsitlanadze, et al. *Macromol. Chem. Phys.* (To be published).
- 2) R. Katsarava, D. Kharadze, et al., *Makromol. Chem.*, **194**, 143 (1993).
- 3) D. Kharadze, T. Omiadze, et al., *Vysokomol. Soed.*, Ser. A, **36**, 1462 (1994).

MONO- AND MULTIMOLECULAR LAYERS
FROM MIXED CELLULOSE ESTERS OBTAINED BY USING
THE ANHYDRIDE OF TRIFLUOROACETIC ACID

Albert K. Khripunov¹, Yulia G. Baklagina¹, Victor M. Denisov¹, Anatoly Ya. Volkov¹,
Victor K. Lavrent'ev¹, Nina D. Stepina², Vera V. Klechkovskaya², Alla L. Tolstihina²,
Valery V. Belyaev², and Lev A. Feigin²

¹ *Institute of Macromolecular Compounds RAS
Bolshoy pr. 31, St. Petersburg, 199004 Russia*

² *Institute of Crystallography RAS Leninsky pr. 59, Moscow, 117333 Russia*

The application of mixed anhydrides, in particular those containing trifluoroacetic anhydride (ATFAA), is known to have several advantages over the usual methods of obtaining cellulose (C) esters [1-4, 6]. By taking into account changing molecular characteristics of C in TFAA [5] and carrying out the synthesis of mixed C esters via ATFAA in the TFAA medium [6], it is possible to unify the preparation of C derivatives with various chemical structures and with the required molecular parameters: degree of substitution (DS), molecular weight (MW) and molecular weight distribution (MWD) for a more systematic study of this polymer class in the preparation of Langmuir-Blodgett films [7]. When ATFAA is used, highly substituted C derivatives over a wide range of MW and MWD can be obtained [2, 6, 8]. We prepared mixed C esters containing not only acetic acid but also acids residues which impart amphiphilic properties to the C derivatives. Thus, it becomes possible to form successfully mono- and multilayers, e.g. from isomer C acetoverates (CAV).

The results of structural changes on passing from CAV in bulk to LB films are reported. For in-bulk CAV isomers the mean interchain distance was calculated for the hexagonal packing of the mesomorphic character: $L = 1.76$ nm for CA_nV , $L = 1.32$ nm for $CA_{iso}V$ and $L = 1.2-1.5$ nm for C acetopivalinate. The position of Bragg peaks on X-ray patterns of the LB film correspond to the interlayer distance of 1.55 nm for CA_nV and 1.21 nm for $CA_{iso}V$. The analysis of electronographic data showed that LB films exhibit the polycrystalline structure with domain size of 120-200 nm. After precipitation on a support by the vertical sheet method, predominant molecular model for CAV molecules packing in LB films of the Y type is proposed.

References:

- [1] E. Ott et al., Cellulose and cell. derivatives, **2**, 815 (1954); [2] E.J. Bourne et al., J. Chem. Soc., 2976 (1949); [3] J.M. Tedder, Chem. Rev., **55**, 5, 587 (1955); [4] C. Hamalainen et al., Text. Res. J., **27**, 168 (1957); [5] S.I. Klenin et al., Khimiya Drevesiny (Rus.), **6**, 8 (1986); [6] A.K. Khripunov et al., Zh. Prikl. Khim. (Rus.), **43**, 11, 2581 (1970); [7] V.V. Arslanov, Uspekhi Khim. (Rus.), **63**, 1, 3 (1994); [8] V.N. Tsvetkov et al., Vysokomol. Soedin. (Rus.), **A35**, 10, 1632 (1993).

**CROSS - LINKED POLYBASES PREPARED BY COPOLYMERIZATION
OF N-DIMETHYLAMINOALKYL(METH)ACRYLAMIDES WITH
POLYVINIL COMPOUNDS: SYNTHESIS AND PROPERTIES**

**Klavdia P.Papukova, Elena S.Nikiforova, Alexander A.Solov'ev,
Alexander A.Demin, George V.Samsonov**

*Institute of Macromolecular Compounds RAS
Bolshoy pr. 31, St.Petersburg, 199004 Russia*

A method for the preparation of cross-linked polybases (CPB) by copolymerization of N-(1,1-dimethyl-3-dimethylaminopropyl)acrylamide or N-dimethylamino-propylmethacrylamide with N,N'-hexamethyldimethacrylamide or hexahydro-1,3,5-triacryloyl triazine in the solution was proposed. By varying comonomers and conditions of synthesis it is possible to obtain CPBs swelling degree of which is hardly influenced by the content of the cross - linking agent. The spatial structure of these polyelectrolites is composed of highly cross - linked domains, including microcoils, and lightly cross - linked fragments with a low cross - linking content. This structure retains a considerable amount of solvent, which provides for the transfer of macromolecules to sorption sites. Reactions of CPBs with fusidic acid, insulin and heparin were studied. Varying the structure of a monomer unit in the CPB allows one to control the sorption capacity with respect to organic counterion and sorption selectivity.

**FORMATION OF BRANCHED POLYMER STRUCTURES IN THE
COURSE OF SEPARATE AND SIMULTANEOUS
POLYMERIZATION OF 2-VINYLPYRIDINE AND
ACRYLONITRILE BY TRIBUTYLDIMAGNESIUMIODIDE**

**Inna G.Krasnosel'skaya, Natalya V. D'akonova, Ludmila D. Turkova,
Lev A. Shibaev, Aleksandr V.Adamov, Stanislav I. Klenin,
Boris L.Erusalimskii**

*Institute of Macromolecular Compounds, Russian Academy of Sciences, Bolshoy pr.
31, 199004 St.Petersburg, Russia*

The peculiarities of the formation of polymers and copolymers of 2-VP and AN with a complex branched structure were investigated. Secondary reactions the degree and the course of which depend on reaction condition and initial reagent concentration were also studied. This study was carried out in the following directions: the homopolymerization of 2-VP, the polymerization of AN in the presence of PVP, and the copolymerization of 2-VP and AN by $\text{Bu}_3\text{Mg}_2\text{J}$. The kinetic data and structural determinations of the resulting polymers led to the conclusion about the course of competitive reactions which are responsible for the characteristics of final products. In this system simultaneous reactions of classic polymerization and the interactions of the organomagnesium compound with the N atom of pyridine rings as well as with the tertiary H atom of oligomers and polymers take place. The N-mg bond is not active with respect to the monomers, whereas this mg-C bond is active. A large number of these bonds is formed on a single chain, which is leading to strong branching of the macromolecule. Under certain conditions insoluble fractions are formed. It was shown that the low monomer/initiator ratio ensured a high degree of branching. Similar reactions proceed during the polymerization of the AN in the presence of PVP. In this case the Mw copolymer can 10^6 obtain. In the case of 2VP-AN- $\text{Bu}_3\text{Mg}_2\text{J}$ system complex branched structures are formed.

Partial financial support of the Russian Foundation for Fundamental Research (Grant N 96-03-33851) is gratefully acknowledged.

**CROSS-LINKED POLYELECTROLITES OF METHACRILIC ACID AND
BIS-VINYLAROMATIC COMPOUNDS WITH VARIOUS CHAIN
STRUCTURE INCLUDED BETWEEN AROMATIC CYCLES**

Nadezhda M.Ezhova, Klavdia P.Papukova, Elena S.Nikiforova

***Institute of Macromolecular Compounds RAS
Bolshoy pr. 31, St.Petersburg, 199004 Russia***

A number of the new cross-linked polyelectrolites of the methacrylic acid and bis-vinylaromatic compounds with various structures of alkyl chains included between two aromatic cycles have been synthesized. The influence of chemical structure and concentration of cross-linking agent, the solvent quality and monomer mixture concentration was estimated according to varieties in swelling of networks in process of ionization, according to value of constants of ionization and the total sorption capacity of network for hemoglobin and terrilytin.

MACROMOLECULAR DESIGN OF EFFECTIVE ANTIMUTAGENIC SYSTEMS ON THE BASIS OF NATURAL POLYCATION CHITOSAN

Valentina A. Alexandrova*, **Nina S. Domnina****, **Dmitrii V. Ryzhkov***,
Galina V. Obukhova*, **Dmitrii A. Topchiev***

**Topchiev Institute of Petrochemical Synthesis RAS, Leninsky pr. 29, Moscow, 117912, Russia*

*** Chemistry department of St.-Petersburg University, Universitetskii pr.2, Peterhof, St.-Petersburg, 198904, Russia.*

A new approach to the creation of effective antimutagenic polymeric compounds using synthetic polycations of polydiallyldialkylammonium type as models is proposed [1-3]. It is proved that combination of cationic nature of a polymeric matrix with antiradical activity of side group fragment results in enhancement antimutagenic properties of the copolymers. At the same time it helps to overcome certain drawbacks of low-molecular weight inhibitors of radical processes, such as insolubility in water, narrow concentration interval in antimutagenic effect development and the others.

With a help of discovered effects the macromolecular design of polymeric system using as a matrix a natural biodegradable nontoxic polycation - chitosan was performed.

High efficiency of protection (93%) both before and after gamma-irradiation is achieved due to effective microion charge - partly quaternized chitosan. This affords electrostatic polymer adsorption on the surface of cell and realizes ability of sterically - hindered phenols, being introduced in the polymer side chain, to participate in inactivation of both short - lived radicals and lipid membranes peroxy radicals formed under irradiation.

It is proved, that partial chitosan quaternization and introduction of 2-3 mol.% sterically - hindered phenol fragments in its structure results in appearance of pronounced antioxidant activity of polymeric system, contrary to initial chitosan, for which this activity is equal to zero.

[1] Odin A. P., Alexandrova V. A., Sokolov V. S., Topchiev D. A., // *Biolog. Membrans.* 1995, v.12, N 2, p.185 -190.

[2] Alexandrova V. A., Belevskii V. N., Odin A. P., Topchiev D. A., // *Dokl. Acad.Nauk RAS*, 1996, v. 348, N 1, p. 51-56.

[3] Alexandrova V. A., KotljaroVA E. V., Odin A. P., Domnina N. S., Shevchenko V. A., Topchiev D. A. // *Radiat. biology. Radioecology.* 1995, v.35, N 5, p. 746-752.

NEW APPROACH TO CREATION OF HIGHLY EFFECTIVE POLYMERIC SYSTEMS, COMBINING ANTIRADICAL AND ANTIMUTAGENIC ACTIVITY.

**Valentina A. Alexandrova*, Nina S. Domnina **,Andrey P. Odin*,
Dmitrii A. Topchiev*, Elena B. Kotljarova***, Vladimir A. Shevchenko*****

**Topchiev Institute of Petrochemical Synthesis RAS, Leninsky pr.29, Moscow, 117912, Russia*

***Chemistry department of St.-Petersburg University, Universitetskii pr.2, Peterhof, St.-Petersburg, 198904, Russia*

**** Vavilov Institute of General Genetics RAS, Gubkin st.3, Moscow, 117809, Russia*

It is known that gallic acid derivatives, being effective inhibitors of radical reactions, exhibit under gamma- radiation both protective and sensitizing effects in dependence on the conditions. The dual action character of these compounds is connected with the formation of products of radical and molecular nature at their oxydation [1].

Hypothesis is proposed, that stabilization of gallic acid derivatives may be reached by their introduction in the polymeric matrix, for instance in polycation composition.

To confirm this suggestion on the basis of N,N-diallyl-N,N-dimethylammonium chloride and acrylic acid copolymers triple copolymers with different content of gallic acid fragments in the side chain (TCP-GA) were synthesised. The selection of these copolymers as polymeric base is grounded on the ability of this type polycations to scavenge short - lived water radicals at radiolysis [2].

It is shown, that TCP-GA exhibit pronounced antioxidant activity, contrary to GA derivative, for which evident prooxidant activity is observed. Besides this, the introduction of gallic acid fragments in quantaty of 1 mol% in the copolymer structure results in substantial increase of antimutagenic effect (91%) under gamma-irradiation in comparison with the protective effect of the initial copolymer (52%). In the experiments on the plant cells it was proved, that high efficiency of TCP-GA is retained in a wide range of copolymer concentrations, as well as at preliminary (3 hours before irradiation) introduction of the copolymer in the medium with a plant test-system.

Thus, combination of polycationic nature of polymeric matrix and structural fragment of gallic acid in the polymer side chain allows to create the polymeric systems with both substantial antiradical activity and high antimutagenic effect.

[1] Odintzova S. P.,Krugljakova K. E. // Dokl. Akad.Nauk SSSR , 1976, v. 226, N 2, p.456-459.

[2] Alexandrova V. A., Belevskii V. N., Odin A. P., Topchiev D. A., // Dokl. Akad. Nauk RAS, 1996, v. 348, N 1,p. 51-56.

DETERMINATION OF BONDING CHARACTER THE IMMOBILIZED DRUG INTO POLYMER MATRIX BASED ON THERMODYNAMIC PARAMETERS

Rinat M. Iskakov^a, Erkesh O. Batyrbekov^a, Bulat A. Zhubanov^a, Marina Volkova^b

a. Institute of Chemical Sciences, 106 Valikhanov Street, Almaty, Kazakhstan

b. Institute of Eye Diseases, Almaty, Kazakhstan

The bonding character between drugs, such as isoniazidum, cyclophosphanum, clophelinum and pectin, collagen, polyvinyl alcohol, polyurethane matrix of hydrogel and film forms was studied due to investigate the release dynamics of an immobilized drug from polymer. Bonding character of immobilized drug/polymer system was examined on the base of thermodynamic release parameters of drug device from system. Study of release dynamic dependence from temperature is carried out with ultraviolet spectrometer, in that drug solution passes through thermostatic flowing cells in various temperatures.

Enthalpy, entropy, energy of activation and Gibbs function of drug release on the base of experimental data have been determined. The main stages of device release from polymer forms differed for film and hydrogel were stated. It was shown former a swelling of film, and second a diffusion of drug in water are the limited stage of release mechanism. Type and character bond between the incorporated drug and polymer were estimated.

THERMOTROPIC ALKYLENE-AROMATIC HALOGEN CONTAINING POLYESTERS

Ivan M. Zorin, Eugeny A. Antonov, Olga S. Sokolova, Alexander Yu. Bilibin

*St.-Petersburg State University, Department of Chemistry, 2 University ave. ,
Peterhof, St.-Petersburg, 198904, Russia*

Two series of the liquid crystalline main-chain polyesters, containing chlorine and bromine atoms in mesogenic groups and hydrocarbon and fluorocarbon spacers have been synthesized:

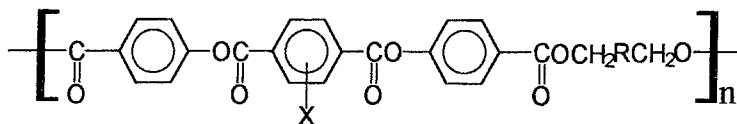

X=1) Cl; 2) Br

R= a) (CH₂)₄; b) (CH₂)₈; c) (CF₂)₄; d) (CF₂)₆; e) (CF₂)₈; f) CF(CF₃)O(CF₂)₃OCF(CF₃)

The synthesis of the polyesters was carried out in two stages: synthesis of a complex monomer and its acceptorless high temperature polycondensation in solution with the corresponded diols, which results in the formation of a polymer.

Fluorinated diols due to the electron withdrawing effect of fluorine atoms have reduced reactivity in the polycondensation reaction. So the condition of polycondensation (time and temperature of the reaction) was optimized in order to obtain polyesters with higher molecular weight. The synthesized polymers were characterized by viscometry, elemental analysis data and spectral methods (IR and NMR ¹H).

Some fractions of polyesters 1c and 2c were obtained by the fractional precipitation method. For all fractions the values of intrinsic viscosity were found to be in range from 0.08 to 0.42dl/g. These values of [η] corresponded to molecular weights 6000-25000, which were determined by diffusion method.

The polyesters were studied by polarizing optical microscopy and differential scanning calorimetry methods. The influence of halogen atoms locating in different positions of macromolecule (mesogenic group or spacer) is discussed.

SYNTHESIS AND PHOTOPHYSICAL PROPERTIES OF LUMINESCENT POLYETHERIMIDES CONTAINING ANTHRACENE UNITS IN THE MAIN POLYMER CHAINS

**Boris V. Kotov, Vladimir I. Berendyaev, Elena V. Lunina, Alexander M. Sergeev,
Boris M. Rumyantsev, Leonid A. Derevyagin, Ivan L. Belaits, Ravil N.
Nurmukhametov**

*State Center of Russian Federation L. Ya. Karpov Institute of Physical Chemistry
10 Vorontsovo pole ul., Moscow, 103064 Russia*

Aromatic polyimides (PIs) displaying own luminescence are interesting as active materials for polymeric scintillators, electroluminescent devices and other applications. In this work the soluble and thermoplastic polyetherimides (PEIs) containing 9,10-disubstituted anthracene units in their backbones based on a series of anthracene-containing diamines: 9,10-bis(4-aminophenyl)anthracene (I), 9,10-bis(3-aminophenylthio)-anthracene (II) and 9,10-bis(4-aminophenoxy)anthracene (III), and also corresponding copolyetherimides (CPEIs) containing also *m*-phenylene units, are synthesized and studied.

Although the 9,10-diphenylanthracene (DPA) and diphenylthio- and diphenoxy-anthracenes are known as effective luminophors and have high fluorescence quantum yields in solutions the corresponding PEIs display low fluorescence yields with wide bands and significant Stokes' shifts of maxima in fluorescence spectra of films. It's explained by exciplex formation on interaction of excited anthracene units as electron donors with electron acceptor imide fragments of PEI chains [1]. Other possible causes of low fluorescent activity of these PEIs are discussed also in particular the intercombination S-T conversion with formation of phthalimide fragments triplet states. For CPEIs with various content of DPA and other anthracene units it's found the regular displacement of fluorescence spectral maxima to long wave-length side with an increase of anthracene units content; that's explained by excimer or excimer exciplex formation in anthracene units stacking structures which were found early [2] at X-ray diffraction study of some crystalline PIs based on I.

The important evidence of exciplex nature of excited states in PEIs and CPEIs studied is the quenching of observed fluorescence by the external electric field; regularities of this phenomenon and its connection with the charge carrier photogeneration are investigated. It's found an effective excitation energy transfer from exciplex states in studied polymers to some added luminophores such as coumarins; it's shown that energy transfer takes place not only from emitting exciplex states but also from exciplexes that in other case decay by non-radiative ways in these PEIs. These results demonstrate an approach to design of effective polyimide luminescent materials for mentioned above applications.

This work was fulfilled at financial support by International Science and Technology Center (Project № 193).

References: 1. Kapustin G.V., Tilika V.J., Berendyaev V.I. et al. // *Vysokomolek. Soedin.*, Ser. B, 1988, **30**, № 9, 653; 2. Kotov B.V., Kapustin G.V., Chvalun S.N. et al. // *ibid*, Ser. A, 1994, **36**, № 12, 1972 (Engl. transl. in: *Polymer Sci.*, Ser. A, 1994, Vol. 36, No. 12, p. 1666).

**SYNTHESIS AND PROPERTIES OF COVALENTLY BONDED
CONJUGATES OF DEXTRAN AND STERICALLY HINDERED
PHENOLS**

**Denis V. Arefjev, Nina S. Domnina, Elena A. Komarova,
Galina V. Arefjeva, Alexander Yu. Bilibin**

***Department of Chemistry, Saint-Petersburg State University,
University pr., 2, Peterhof, 198904, Saint-Petersburg, Russia***

Some antioxidants applied for stabilization of rubbers and plastics were found recently to possess biological activity - to control a rate of free radical processes. Several series of covalently bonded conjugates of dextran and antioxidants (sterically hindered phenols - SHP) were synthesized in order to increase hydrophylity of SHP and to study influence of bonding to dextran on their antiradical activity. The samples differed in nature of chemical bond between 2,6-di-*tert*-butyl phenol residue and glycoside groups of dextran and content of the attached phenol.

The prepared conjugates were characterized by viscometry, IR and UV spetroscopy. Content of the attached phenol was determined by UV spectrometry at wave length 275 nm. Ranges of solubility of the samples in various solvents were determined. Non-linear dependence of intrinsic viscosity of conjugates on content of SHP was estimated.

Method for measuring of antiradical activity of the conjugates and their low molecular weight analogs was developed. Primary measurments of antiradical activity of the samples were made.

SYNTHESIS OF MONOMER AND POLYMERS CONTAINING CHROMOPHORES AND PHOTOLABILE CHEMICAL BONDS

Alexander Yu. Bilibin, Asja A. Krasnoperova, Viktor E. Kukkonen

*Department of Chemistry, Saint-Petersburg State University,
University pr., 2, Peterhof, 198904, Saint-Petersburg, Russia*

Method of chemical amplification is widely used in development of new highly sensitive resist compositions. It consists in photodegradation of photo-active compound to form strong protonic acid. The latter produces a number of proton-catalysed chemical transformations which change solubility of the polymer. One of the ideas in this area is to combine photo-sensitive and acid degradable groups in one macromolecule. Some polymers containing photo acid generating and acid degradable groups were described recently. Usually the strong acid formed as a result of photo irradiation is eliminated as low molecular weight compound.

We have synthesized polymers and co-polymers which contain chromophore group and photo-labile chemical bond. After irradiation of these polymers the sulfonic group remains covalently bonded to polymer chain. New vinyl monomer was synthesized on a base of 4-vinylbenzene sulfonic acid — 2,3-diphenyl-N-oxymaleimido-4'-vinylbenzene sulfonate:

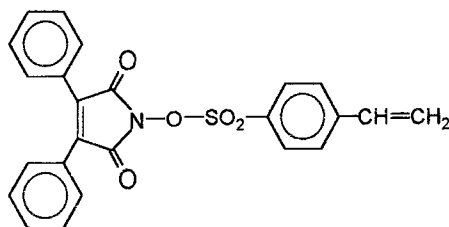

The monomer was polymerized and co-polymerized with another monomers in radical process with use of AIBN as initiator. The resulting polymers were characterized and exposed to irradiation by UV mercury lamp. Products of photolysis were identified by chromatographic methods.

APPENDIX

INFLUENCE OF CHAIN LINEAR TERMINATION ON MOLECULAR WEIGHT DISTRIBUTIONS FORMED UNDER RADICAL POLYMERIZATION INITIATED BY LASER PULSES.

A.N. NIKITIN and A.V. EVSEEV

NICTL - Laser Research Center, Russian Academy of Sciences,
Shatura, Moscow Region, 140700, Russia

The scheme of radical polymerization which takes into account the reactions of polymer chains initiation, propagation, termination by disproportionation and combination and chain linear termination processes (inhibition, retardation and chain transfer to monomer) is investigated theoretically. For chain-length-independent termination (by disproportionation and/or combination) case the analytical expressions are derived to calculate the molecular weight distributions (MWDs) formed under the initiation by arbitrary sequence of short laser pulses. The new relatively simple numerical technique for MWDs calculation is proposed for the chain-length-dependent termination case. The new method for determination of the rate constant of linear termination (as well as the constant of chain transfer to monomer) is proposed. The methods of the termination rate constants determination (measurement of monomer-to-polymer conversion for different initiation and polymerization by packets of pulses) are considered and the limits of application of these methods are determined. The MWDs calculated for methyl methacrylate and styrene bulk polymerization are presented.

NEW APPROACHES IN POLYMER ON THE BASE OF ALIPHATIC DIAMINES AND ALICYCLIC DIANHYDRIDES

**Bulat A.ZHUBANOV, Valentina D.KRAVTSOVA,
Kuralai H. BEKMAGAMBETOVA**

*Institute of Chemical Sciences Academy of Sciences RK,
106 Sh.Valihanov Str., Almaty, 480100 Kazakhstan*

Polyimides on the basis of aliphatic diamines and dianhydrides of alicyclic structure are practically important polymers because of high dielectric and antifrictional properties and a possibility to be processed by pressure casting. Up to now two-step polycondensation was the main method of the synthesis of polyimides on the basis of alicyclic dianhydrides of tetracarboxylic acids and high basic aliphatic diamines. However the salt formation reaction doesn't allow to obtain high molecular polymers. So, we studied the possibility of polyimide formation on the basis of aliphatic diamines by one-step polycondensation. The reaction study allowed to determine the optimal conditions of polyimides synthesis. Polyimides synthesized by one-step method have characteristic viscosity three times greater than one for synthesized by two-step polycondensation. The 70% imidisation degree can be obtained in the amidic solvents and monomer concentration 40% during 1.5-2 hours in the presence of 1-2 mol.% of carboxylic acids as catalyst. Further transformation of noncyclized carboxyamidic groups into the imide cycles was conducted by thermal and laser imidisation.

The main properties of synthesized polyimides very studied. It was shown that they softened at temperatures (85-90 °C) that gives a possibility to process such polyimides in this temperature interval. Polyimide films were obtained from the reaction solutions. For these films tensile at break achieves 80 MPa and elongation is 60-70%.

Our results permit to recommend synthesized polyimides with high dielectric properties as perspective materials for electronics.

SYNTHESIS OF POLYIMIDES ON THE BASE OF ALICYCLIC DIANHYDRIDES IN WATER-ORGANIC MIXTURES

Vladimir V. Lyapunov, Victor A. Solomin, Bulat A. Zhubanov

*Institute of Chemical Sciences Kazak Academy of Sciences,
Ch. Ualikhanov str. 106, Almaty 480100, Kazakstan*

Alicyclic dianhydrides have rather low activity in acylation reactions with diamines compared to aromatic dianhydrides. Most usual way of improving reaction rate for such compounds is increasing of interaction temperature. Besides, dianhydrides of tricyclodecene carboxylic acids have unusual peculiarity to form in the course of polycondensation with 4,4'-diaminodiphenyloxyde in water-organic mixture mesomorphic-like associates between components of the reaction media. These associates significantly influenced the rate of polycondensation and gave possibility to decrease reaction temperature from usual 160-180 °C for one-step reaction till 30-70 °C.

The reactions in water-organic mixtures between dianhydrides of tricyclodecene tetracarboxylic acids and aromatic diamines demonstrated increasing of rate as for first step - polyacilation, so for second step - imidization. Investigation of kinetics of interaction between dianhydride of tricyclodecene tetracarboxylic acid and 4,4'-diaminodiphenyloxide showed that presence of water and acetic acid in N,N'-dimethylformamide simultaneously was most successful. Neither water, nor acetic acid could improve polyacilation as their mixture. The same activation was watched in the case of polycyclodehydration.

Activity of diamines in reactions with dianhydrides of tricyclodecene tetracarboxylic acids diminished in the next sequence: 4,4'-diaminodiphenylamine > 4,4'-diaminodiphenyloxide > 1,2-bis-(4-aminophenoxy)-ethane > 4,4'-diaminodiphenylamine-2-sulphonic acid. This succession was in good agreement with pK of corresponding amino groups.

The polymers received on the base of dianhydrides tetracarboxylic acids and aromatic diamines had intrinsic viscosity 0.8-2.6 dl/g, molecular weight 20000-70000. They were film-castable and formed films with tensile strength 80-140 MPa (relative elongation - 5-15%).

POLYGLYDIN - NEW POLYMERIC DRUG AND METHODS OF ITS PREPARATION

**Bulat A.ZHUBANOV, Galina I.BOIKO, Maira B.Umerzakova,
Zhanara G. MUSTAFINA, Makhmud P.IRISMETOV, Bulat Zh.DZHIEMBAEV,
Zhanna K. MUSTAFINA, Olga V.KHUTORYANSKAYA, Ardak KAIROV**

*Institute of Chemical Sciences MS-AS RK,
106 Ch.Valikhanov Str., 480100, Almaty, Kazakhstan*

New highly effective medicine "polyglydin" has been obtained and methods of its synthesis have been developed. The basis of the synthesis is reaction of immobilization of 18-dehydroglycyrrhetic acid (glyderenine) and its Na-salt to polymers of natural and synthetic origin. Glyderenine is highly effective antiinflammatory, antitumor, antiulcer and hypokholinesteric drug surpassing 2,5 times hydrocortisone by therapeutic action. Glyderenine was synthesized by chemical modification of glycyrrhetic acid obtained from radix glycyrrhiza L.

With the purpose of prolongation action of glyderenine and its Na-salt the immobilization on different polymers was carried out. Polyvinyl alcohol (PVA), methylcellulose (MC), Na-carboxymethyl-cellulose (Na-CMC), polyvinylpyrrolidone (PVP) and combination PVA:PVP=1:1 were used as polymeric carriers.

Interaction of Na-glyderenine with above mentioned polymers was studied by equilibrium dialysis, conductometry, viscosimetry methods. It was found that nonionogenic polymers (MC, PVA, PVP) weakly interact with anionic Na-glyderenine at the expense of was established that the composition of obtained complex Na-glyderenine with these polymers 1:2. Na-CMC is not formed complex with drug in consequence of pushing away identical-charged groups. Pharmaceutical formulations of "polyglydin" in the forms of eye polymeric drops and films were obtained. In the experiments on animals polymeric drugs were shown high efficiency and prolongation of action by using as antiinflammatory drugs in after-operation period.

SYNTHESIS AND MODIFICATION OF POLYIMIDES FOR NONLINEAR OPTICS

Saule K.Kudaikulova, Irina D.Shalabaeva, Galina I.Boiko, Bulat A.Zhubanov

*Institute of Chemical Sciences, NAS of RK,
106 Valihanov, 480100 Almaty, Kazakstan*

Polymers doped by the azo compounds are efficient materials for nonlinear optical devices. Two methods of producing of azo doped polyimides have been developed in this work.

Catalytic synthesis of polyimides on the basis of alicyclic dianhydrides and aromatic diamines by one step polycyclocondensation. Addition of azo dyes with chlorotriazinic fragments (active group azo dyes) in catalytic quantities (0,5-3,5 mol.%) to the reaction system allows to increase the molecular weights of polyimides from 45000 up to 350000.

Investigation of optimal conditions of synthesis of polyimides in the presence of active azo dyes and their model compounds shows that concentration of the catalyst in the main determines high molecular weights of polyimides. The catalytic activity is provided by the azo group. Study of the reaction in the presence of inactive forms of azo dyes and IR-, UV-spectroscopic data allowed to state that active azo dyes are chemically bonded to the end amine groups.

The second way of formation of azo doped polyimides is the modification of polyimideacids. Polyimideacids have been synthesized on the basis of aromatic, alicyclic dianhydrides and methylenebisanthranilic acid. The treatment of polyimideacids in the solution of thionyl chloride in benzene in the presence of acceptor resulted in formation of chlorides of polyimideacids. The obtained chlorides are very active in the reactions with different amine azo compounds. Data of elemental analysis and IR-, UV-spectroscopies give an evidence that polyimideacids are chemically doped by the azo compounds with practically 100% conversion degree.

Azo dopants chemically bonded to the polyimide matrix are efficient stabilizers against photodestruction.

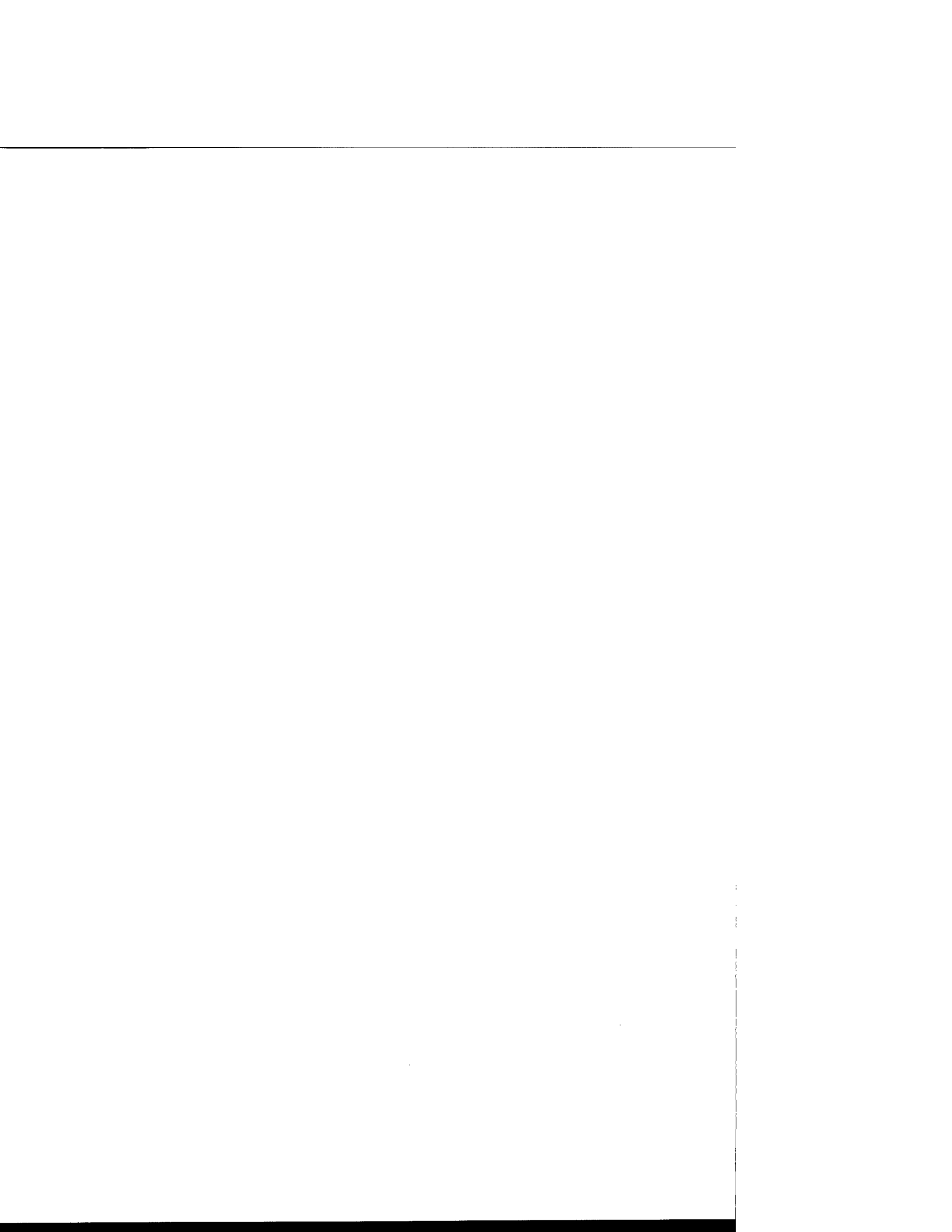

AUTHOR INDEX

Abadie M.	P-040	Boldyrev A.G.	P-015
Adamov A.V.	P-123	Bondarenko G.N.	O-003
Adler H.J.	O-020	Borovik V.P.	P-030
Afanas'eva E.V.	P-104	Boulares A.	L-016
Agrinskaya N.V.	P-045	Brestkin Yu.V.	P-113
Alexandrova V.A.	P-125, P-126	Bruma M.	P-057
Alexeev N.V.	P-010	Brynda E.	P-044
Alexeev V.L.	P-118	Buchachenko A.L.	P-051
Ananieva T.D.	P-013, P-022, P-112	Bulgarovskaya I.V.	P-034
Andreeva N.A.	P-048	Butufei O.	P-020
Anikina I.S.	P-067	Buyanov A.L.	P-110, P-114, P-116
Antipov E.M.	P-050	Bychko K.A.	P-100
Antonov E.A.	P-128	Caiguo Gong	L-015
Anufrieva E.V.	P-022, P-112	Cardi N.	P-049
Arefjev D.V.	P-130	Charaev A.M.	P-054
Arefjeva G.V.	P-130	Chebosolova E.N.	P-109
Arnautov S.A.	P-086, P-089	Chiellini E.	L-018
Artemyeva V.N.	P-029, P-030	Chupans P.I.	P-029
Aseyev V.O.	P-117	Conio G.	L-016
Askadskii A.A.	P-100	Cser L.	P-110, P-114, P-116
Baklagina Yu.G.	P-026, P-027, P-030, P-035, P-094, P-096, P-121	D'akonova N.V.	P-123
Baranovskaya I.A.	P-117	Davidova O.A.	P-002
Batyrbekov E.O.	P-127	Dedieu-Berkoukchi M.-P.	P-046
Bedanokov A.U.	P-053, P-054	Demidov V.N.	P-111
Belaits I.L.	P-129	Demin A.A.	P-122
Belcheva N.	L-021	Denisov V.M.	P-022, P-081, P-121
Belnikevich N.G.	P-104	Derevyagin L.A.	P-129
Beloborodova E.V.	P-026, P-028	Deschenaux R.	O-008
Belomoina N.M.	P-033, P-057	Dobrodumov A.V.	P-004
Belorgey G.	P-046	Dodonov V.A.	P-008
Belov M. Yu.	P-043	Dolbin I.V.	P-053
Belyaev V.V.	P-121	Domnina N.S.	P-125, P-126, P-130
Berendyaev V.I.	P-038, P-129	Donetskii K.I.	O-007, P-078
Berestneva G.L.	P-052	Dotcheva D.	L-021
Bilibin A. Yu.	L-017, P-067, P-068, P-071, P-095, P-099, P-128, P-130, P-131	Doytcheva M.	L-021
Bochek A.M.	P-039	Dubovic I.I.	P-058
Boehme F.	O-017	Dubovik I.I.	P-036
Bogolubova S.S.	P-097	Duda A.	L-002
Bogorad N.N.	P-027	Dyakonov A. Ju.	P-051
Boiko N.I.	P-085, P-093	Economy J.	L-001
		Elt'sov A. V.	P-097
		Endo T.	O-018
		Ershov A. Y.	P-115
		Erussalimsky B.L.	L-019, P-123

Evmenenko G.A.	P-118	Ilichev I.S.	O-012
Evseeva T.G.	P-098	Iskakov R.M.	P-127
Ezhova N.M.	P-124	Istratov V.V.	O-010, P-033
Falabu D.	P-073	Ivanova I.G.	P-067, P-068, P-095
Fedorova G.N.	P-026		P-096
Fedorova L.A.	L-019, O-020	Ivanova V.N.	P-062, P-063, P-064, P-065
Fedorova L.S.	P-036	Izmailov B.A.	P-040
Fedorova S.V.	P-081, P-102		P-032
Feigin L.A.	P-094, P-096, P-121	Izri I.	O-017
	P-002	Izyumnikov A.L.	P-082
Filonenko V.I.	L-004	Jehnichen D.	L-012
Fontanille M.	O-014	Jumel K.	P-087
Ford W.T.	P-096	Jung-Il Jin	P-027, P-035
Frolov A.N.	P-050	Kaczmarczyk B.	P-084
Frolov V.M.	P-118	Kalbin A.G.	P-093
Ganicheva S.I.	P-010, P-012	Kalinina N.A.	P-009, P-023
Garina E.S.	P-050	Kalinovskii I.O.	P-062, P-063, P-064, P-065, P-066
Gavrilenko I.F.	P-104, P-115	Kalninsh K.K.	P-065
Gavrilova I.I.	P-081, P-102	Kamaritsky B.A.	P-003
Geller N.M.	L-015		P-039
Gibson H.W.	P-067, P-068, P-071	Kamilov A.Y.	P-036
Girbasova N.V.	P-042	Kaminorz Y.	P-120
	L-004	Karetnikova E.B.	P-107
Globa I.	P-047	Kashleva I.I.	L-020
Gnanou Y.	O-003	Katsarava R.	P-107
Godovsky Yu.K.	P-010	Kazakov S.A.	P-100
Golenko T.G.	O-015	Kazanskii K.S.	P-103
Golubev V.B.	O-003	Kazantsev O.A.	P-019, P-119
Gomza Yu. P.	P-104	Kazantseva V.V.	O-002, P-072
Gorbacheva L.I.	O-007, P-078	Kerber M.L.	P-120
Gorbunova O.P.	P-092	Kever E.E.	P-099
Gorshkov G.V.	P-045, P-101	Khachaturov A.S.	P-110, P-121
Gotlib Yu.Ya.	P-031	Kharadze D.	P-025, P-109
Goykhman M.Ya.	O-014	Khimich G.N.	O-009, P-090
Grabiec E.	P-091	Khripunov A.K.	P-120
Graham T.	P-011, P-013, P-028, P-081, P-111	Kipper A.I.	P-023
Grekov A.P.	P-048, P-071, P-101	Kireev V.V.	P-078
Gribanov A.V.	P-103	Kirmelashvili L.	P-094, P-121
	O-012, P-056	Kirsh Yu.E.	L-019, O- 002, P-117, P-123
	P-112	Kislyak I.M.	O-015, P-088
Grigor'ev A.I.	P-082	Klechkovskaya V.V.	P-002
	L-005	Klenin S.I.	P-075, P-097, P-108
Grinenko E.S.	L-004		P-086, P-089
Grishin D.F.	P-113	Klimenko N.S.	P-113
Gromova R.A.	P-010	Klimov E.S.	
Harding S.E.	P-058	Klimova N.V.	
Heitz W.			
Heroguez V.		Kobryanskii V.M.	
Hou Yongfa		Kochetkova I.S.	
Hrenov V.A.			
Il'ina M.N.			

Koliakina E.V.	P-056	Laus M.	L-018
Koltsov A.I.	P-072, P-081	Lavrenko P.N.	P-003
Komarova E.A.	P-130	Lavrent'ev V.K.	P-035, P-121
Komarova M.U.	O-009	Lavrov S.V.	P-038
Komber H.	O-017, P-006	Lebedev V.T.	P-110, P-114, P-116
Komolova L.F.	P-066	Lebedeva G.K.	P-096, P-097
Kononenko O.A.	P-010	Leitner M.B.	O-001
Korigodski A.R.	P-090	Lependina O.L.	P-055
Korneeva E.V.	P-082	Levi M.	P-076
Korotkov A.K.	O-009	Levitsky M.M.	P-051
Koshel S.G.	P-068	Li-Ling Hsu	P-083
Kostereva T.A.	P-026	Lijiang Yang	P-106
Kotelnikov V.P.	P-111	Lioznov B.S.	P-100
Kotelnikova N.E.	P-113	Litvinova L.S.	P-119
Kotljarova E.B.	P-126	Lotfi N.	P-046
Kotov B.V.	O-004, P-038, P-129	Louzine A.A.	P-012
Kotova A.V.	P-070	Lukasov S.V.	P-027
Kozhurnikova N.D.	P-035	Lukyashina V.A.	P-004
Kozlovsky R.A.	P-090	Lunina E.V.	P-129
Krakovyak M.G.	P-022, P-112	Lushchic V.B.	P-022, P-112
Krasnosel'skaya I.G.	P-123	Lvova E.B.	P-118
Krasnov A.P.	P-036, P-100	Madec P.J.	L-013
Krentsel B.A.	P-050	Magagnini P.L.	P-087
Kricheldorf H.R.	L-014	Makarova N.N.	P-047
Krutko E.T.	P-001, P-040, P-042	Makovetsky K.L.	O-003
Kuchling D.	O-020	Malinovskaya V.P.	P-048, P-059
Kuckertz C.	O-019	Malz H.	P-006
Kudasheva D.S.	P-036	Marechal E.	L-013
Kudina N.P.	P-113	Marek M.	P-044
Kudryavtsev V.V.	P-004, P-027, P-029, P-030, P-035, P-045, P-084, P-094, P-096, P-101	Mariani A.	L-016
Kukarkina N.V.	P-029	Markova G.D.	O-010
Kukkonen V.E.	P-131	Martinelli M.	L-016
Kuksilin E.V.	P-025	Mashukov N.I.	P-054
Kunert C.	O-017	Matukhina E.V.	P-047
Kurlyankina V.I.	P-109	Matveeva G.N.	P-101
Kuteinikova L.I.	P-058	Matveeva N.A.	P-109
Kutsenko L.I.	P-039	Maximov A.V.	P-092
Kuznetsov A.A.	O-004, P-032, P-038, P-043	Maximova O.G.	P-092
Kuznetsov D.S.	P-024	Mazare M.	P-020
Kuznetsova Yu.L.	P-008	Medzmariashvili N.	P-120
Kuznetzov Yu.P.	P-110	Meijer B.	P-082
Lachinov M.B.	P-012	Melenevskaya E. Yu.	O-002, P-119
Lapshin S.V.	P-103	Meleshko T.K.	P-027
Lapshova O.A.	P-103	Menshikova A. Yu.	P-098
		Mercer F.W.	P-057
		Mikhailov G.M.	P-028, P-101
		Mikitaev A.K.	P-005, P-055
		Minkova L.I.	P-087
		Miritescu C.	P-020
		Mit' V.A.	P-036

Miteva Ts.	P-087	Petrova V.A.	P-118
Mokeyev M.V.	P-011, P-013	Pientka Z.	P-044
Molotkov V.A.	P-109	Pionteck J.	P-006
Monakov Yu.B.	O-011	Plate N.A.	L-010
Morgenroth F.	L-011	Po R.	P-049
Mormann W.	O-019	Podeshvo I.V.	P-101
Mourey T.H.	O-014	Podol'skiy A.F.	P-014, P-015
Moykin A.A.	O-012, P-056	Podolsky Yu.Ya.	P-050
Muellen K.	L-011	Ponomarev I.I.	P-033
Muller A.H.E.	P-007	Ponomarev I.N.	P-103
Mushina E.A.	P-050	Popova T.V.	P-069
Nafadzokova L.Ch.	P-055	Porri L.	L-006
Nagvekar D.	L-015	Pracella M.	P-087
Navarro F.	O-016	Prokopchuk N.	P-040, P-042
Nazarova O.V.	P-104	Prudskov B.M.	O-009
Nedel'kin V.I.	O-022, P-041, P-079	Purkina A.V.	P-105
Nekrasova T.N.	P-022, P-112	Rabkina A.Yu.	P-058
Nepogodiev S.A.	P-082	Reisch H.	P-080
Nesin S.D.	O-015	Repina T.B.	P-070
Nesterov V.V.	P-019	Retush N.V.	P-052
Nikiforova E.S.	P-122, P-124	Revel'skaya L.G.	P-110, P-114
Nomura R.	O-018	Ricci G.	L-006
Nosova G.I.	P-004	Rissanen K.	P-073
Novakov P.	O-020	Rodionov A.I.	P-115
Nudga L.A.	P-118	Romano A.M.	P-049
Nurmukhamedov R.N.	P-129	Rudaja L.I.	P-075, P-108
Obukhova G.V.	P-125	Rudaya L.I.	P-097
Odin A.P.	P-126	Ruhmann R.	O-001
Okuneva S.N.	P-095	Rumyantsev B.M.	P-129
Olenin A.V.	P-012, P-018	Rumyantseva N.V.	P-109
Onosova L.A.	P-069	Rusanov A.L.	P-033
Oranova T.I.	P-005	Russo S.	L-016
Osadchev A. Yu.	P-048, P-059, P-060	Ryzhkov D.V.	P-125
Ostrovskaya I.Ya.	O-003	Sabirov Z.M.	O-011
Ostrovskaya L.D.	P-109	Safronov V.V.	P-096
Ovchinnikov A.V.	P-061	Salazkin S.N.	O-005, O- 007, P-078, P-100
Paakkari T.	P-111	Samarova O.E.	P-025
Panarin E.F.	P-025, P-104, P-113, P-115	Samoryadov A.V.	P-100
Papisov I.M.	O-021	Samsonov G.V.	P-122
Papkov V.S.	P-058	Santi R.	P-049
Papukova K.P.	P-107, P-122, P-124	Sapurina I.Yu.	P-014, P-015
Pavlov G.M.	P-082	Sauvet G.	P-046
Pebalk D.V.	P-034	Sava I.	P-057
Peerlings R.	P-082	Savin E.D.	P-079
Penczek S.	L-002	Savinov A.G.	P-024
Persinen A.A.	P-024	Sazanov Yu.N.	P-026, P-028, P-094
Petropavlovsky G.A.	P-039, P-118	Schab-Balcerzak E.	P-031
		Schechka V.M.	P-034

Scherf U.	P-080	Solovjeva J.V.	P-067, P-068
Schneggenburger L.	L-001	Solovskaya N.A.	P-004
Schulz B.	P-003, P-057	Song Jie	P-113
Sek D.	P-031, P-037, P-087	Spassky N.	L-003
Semyonycheva L.L.	P-056	Spector V.N.	P-062, P-063, P-064, P-065, P-066
Sergeev A.M.	P-129	Špírková M.	P-077
Sergeev V.A.	P-100	Springer J.	O-001
Serima R.	P-111	Stamenova R.	L-021
Shabsels B.M.	P-098	Stejskal J.	P-077
Shamanin V.V.	P-014, P-015, P-016, P-017, P-021, P-059, P-060	Stepina N.D.	P-094, P-121
Shaov A.Ch.	P-053, P-054	Stoddart J.F.	P-082
Shaposhnikova V.V.	O-007, P-078, P-100	Stojachenko J.I.	P-010
Sharaphiev R.S.	P-062, P-066	Straub T.	P-073
Shataev K.V.	P-095	Sukhorukova S.A.	P-091
Shchukarev A.V.	P-111, P-113	Surcova I.N.	P-055
Shevchenko S.S.	P-070	Szesztay M.	P-057
Shevchenko V.A.	P-126	Takeo Saegusa	L-007
Shevchenko V.V.	O-015, P-088	Tarasov A.I.	O-010, P-033, P-055
Sheveleva T.V.	P-112	Teh-Chou Chang	P-083
Shibaev L.A.	L-019, P-094, P-123	Tenhu H.	P-117
Shibaev P.V.	P-093	Tenkovtsev A.V.	P-045, P-095, P-099, P-101
Shibaev V.P.	O-013, P-085, P-093	Tinyakova E.I.	P-050
Shilov S.V.	P-113	Tolstihina A.L.	P-121
Shilov V.V.	O-015, P-088	Topchiev D.A.	P-125, P-126
Shirshin K.V.	P-107	Torok G.	P-110, P-114, P-116
Shishkina G.V.	P-109	Travinskaya T.V.	P-091
Shkurko O.P.	P-030	Tsegelskaya A.Yu.	P-032
Shu Liu	L-015	Tseitlin H.M.	P-069, P-074
Shubin N.	L-006	Tsvetanov C.B.	L-021
Shustov G.B.	P-053	Turkova L.D.	P-019, P-123
Silinskaya I.G.	P-084	Turri S.	P-076
Skiba S.I.	O-015	Urazbaev V.N.	O-011
Sklizkova V.P.	P-035, P-084, P-094	Ushakova I.L.	P-072
Skorokhodov S.S.	L-009, P-048, P-059, P-060, P-072, P-075, P-081, P-102, P-108	Ushakova V.N.	P-024, P-025
Smyslov R.Yu.	P-022	Vanjugina S.S.	P-092
Sokolova O.S.	P-128	Vasnev V.A.	O-010, P-033, P-052, P-055
Solntsev A.P.	P-001	Vasneva N.A.	P-052
Soloukhin V.A.	P-092	Vinogradova L.V.	O-002, P-011, P-119
Solov'ev A.A.	P-122	Vinogradova S.V.	O-010
		Vlasov G.P.	P-098, P-105
		Vlasova E.N.	P-105
		Voigt D.	O-017, P-006
		Volchek B.Z.	P-105
		Volkov A.Ya.	P-121

Volkova M.	P-127	Zannoni C.	P-049
Voloschuc K.A.	P-074	Zapadinskii B.I.	P-070
Volozhin A.Y.	P-001, P-040	Zaremski M.Yu.	P-010, P-012,
Vozzhennikov V.M.	P-034		P-018
Vybornova T.V.	P-118	Zavin B.G.	P-058
Vygodskii Ya.S.	L-008	Zgonnik P.V.	P-019
Wanic A.	P-037	Zgonnik V.N.	O-002, P-011,
Wegener G.	P-111		P-119
Windeisen E.	P-111	Zhabrodsкая E.N.	P-064
Yajiang Yang.	P-106	Zharsky I.M.	P-040
Yakimansky A.V.	P-007, P-029,	Zhu Xiaomin	P-085
	P-045	Zhubanov B.A.	P-127
Yakshin V.V.	P-090	Zhukov S.V.	P-048, P-059
Yanul N.A.	P-023	Zorin I.M.	P-128
Zachernyuk B.A.	P-079	Zuev V.V.	P-019, P-061
Zaitsev B.A.	O-006		