

Eule & Partners

International Consulting S.P.R.L.

Maritime Conferences

• The Maritime Environment •

International Conference and Exhibition

“Waste Water Treatment Technologies for Ships”

Conference Proceedings



**DEERBERG
SYSTEMS**

18th-20th November 1998
at the
City Club Hotel
Oldenburg i.O., Germany

DTIC QUALITY INSPECTED 2

19990401 092

REPORT DOCUMENTATION PAGE			Form Approved OMB No. 0704-0188	
Public reporting burden for this collection of information is estimated to average 1 hour per response, including the time for reviewing instructions, searching existing data sources, gathering and maintaining the data needed, and completing and reviewing the collection of information. Send comments regarding this burden estimate or any other aspect of this collection of information, including suggestions for reducing this burden, to Washington Headquarters Services, Directorate for Information Operations and Reports, 1215 Jefferson Davis Highway, Suite 1204, Arlington, VA 22202-4302, and to the Office of Management and Budget, Paperwork Reduction Project (0704-0188), Washington, DC 20503.				
1. AGENCY USE ONLY (Leave blank)	2. REPORT DATE 1998	3. REPORT TYPE AND DATES COVERED Conference Proceedings 18 - 20 November 1998		
4. TITLE AND SUBTITLE The Maritime Environment, International Conference and Exhibition "Waste Water Treatment Technologies for Ships"			5. FUNDING NUMBERS N00014-99-1-1007	
6. AUTHOR(S) Editor Klaus D. Eule				
7. PERFORMING ORGANIZATION NAME(S) AND ADDRESS(ES) Klaus D. Eule Eule & Partners International Consulting S.P.R.L. Leeuwerikenlaan 21 B-3080 Tervuren, Belgium			8. PERFORMING ORGANIZATION REPORT NUMBER	
9. SPONSORING/MONITORING AGENCY NAME(S) AND ADDRESS(ES) Technical Director Office of Naval Research International Field Office (ONRIFO) PSC 802 Box 39 FPO AE 09499-0700			10. SPONSORING/MONITORING AGENCY REPORT NUMBER	
11. SUPPLEMENTARY NOTES				
12a. DISTRIBUTION AVAILABILITY STATEMENT Approved for public release, distribution is unlimited			12b. DISTRIBUTION CODE	
13. ABSTRACT (Maximum 200 words) Compilation of abstracts from the conference entitled "Waste Water Treatment Technologies for Ships" held in Oldenburg, Germany, 18 - 20 November 1998.				
14. SUBJECT TERMS Keywords: maritime, environmental protection, waste water management, water treatment, bilge water, filters, membrane technology, sewage, biological waste, ships, shipyards			15. NUMBER OF PAGES	
			16. PRICE CODE	
17. SECURITY CLASSIFICATION OF REPORT	18. SECURITY CLASSIFICATION OF THIS PAGE	19. SECURITY CLASSIFICATION OF ABSTRACT	20. LIMITATION OF ABSTRACT	

CONFERENCE PROCEEDINGS

WASTE WATER TREATMENT TECHNOLOGIES
FOR SHIPS

International Conference and Exhibition sponsored by the

United States Navy
Office of Naval Research European Office
and
DEERBERG SYSTEMS



**DEERBERG
SYSTEMS**

on 18-20 November 1998
at the
City Club Hotel
Oldenburg i.O., Germany

organized by

Eule & Partners
International Consulting S.P.R.L.
Leeuwerikenlaan 21
B-3080 Tervuren, Belgium
Tel +32-2-768 05 08
Fax +32-2-768 05 25
e-mail: eulekd@compuserve.com

Additional copies of these Proceedings may be obtained from Eule & Partners
at a price of US\$ 100,00 per copy plus postage and handling charges.

• The Maritime Environment • International Conference and Exhibition

„Waste Water Treatment Technologies for Ships“

Table of Contents

<u>Title</u>	<u>File-Name</u>	<u>Pages</u>
Cover Sheets	COVER.DOC	
<u>Introduction</u>		
Table of Contents	CONTENTS.DOC	1 – 6
Executive Summary	EXECSUM.DOC	7 – 10
Conference Objectives	SCOPE.DOC	11 - 12
Conference Schedule	SCHEDULE.DOC	13 – 16
Welcome and Introduction	WELCOME.DOC	17 - 18
<u>SESSION 1</u>		
Cover Sheet	1SESSION.DOC	19 - 20
Introduction of the Speakers	1SPEAKERS.DOC	21 – 22
Paper 1: Navy Maritime Environmental Protection – Opportunity for Success <i>Joel Krinsky, US Navy – NAVSEA, USA</i>		
Abstract	P1_KRIABSTR.DOC	23 - 24
Overheads	P1_KRINSKY.PPT	25 – 42
Paper 2: IMO Requirements and Their National Implementation <i>Klaas Jan Bolt, Ministry of Transport And Public Works, Netherlands</i>		
Abstract	P2_BOLABSTR.DOC	43 - 44
Text	P2_BOLT.DOC	45 – 54
Overheads	P2_BOLTPICT.PPT	55 – 68

<u>Title</u>	<u>File-Name</u>	<u>Pages</u>
Paper 3: Requirements for Waste Management for Ships in Shipyards <i>Clàudia Spanger, LISNAVE, Portugal</i>		
Abstract	P3_SPRABSTR.DOC	69 - 80
Text	P3_SPRANGER.DOC	81 - 82
Overheads	P3_SPRPICT.PPT	83 - 116
Paper 4: Computational Fluid Dynamics Modelling of Compensated Fuel/Ballast Systems to Minimise the Overboard Discharge of Fuel Oil <i>Peter Chang III and Ivan L. Caplan, Carderock Division, NSWC, USA</i>		
Abstract	P4_CAPABSTR.DOC	117 - 118
Text and Overheads	P4_CAPLAN.PDF	119 - 142
<u>SESSION 2</u>		
Coversheet	2SESSION.DOC	143 - 144
Introduction of the Speakers	2SPEAKERS.DOC	145 - 148
Paper 1: Total Waste Water Management <i>Professor Alfredo Riva, University of Bologna, Italy</i>		
Abstract	P1_RIVABSTR.DOC	149 - 150
Text	P1_RIVASP.DOC	151 - 156
Overheads	P1_RIVPICT.DOC	157 - 160
Paper 2: Economical and Ecological Treatment of Grey Water - Recovery, Discharge i.a.w. Marpol Rules <i>Massimo Visibelli, ATHANOR, Italy</i>		
Abstract	P2_VISABSTR.DOC	161 - 162
Overheads	P2_VISIBELLI.PPS	163 - 186
Paper 3: Development of a 75 Person Prototype Tubular Membrane Grey Water Treatment System <i>Rachel Jacobs, Carderock Division, NSWC, USA</i>		
Abstract	P3_JACABSTR.DOC	187 - 188
Text	P3_JACOBS.DOC	189 - 214
Overheads	P3_JACPICT.PPT	215 - 236

Title	File-Name	Pages
Paper 4: Conceptual Studies on Treatment Of Oily Water and Sludge Aboard Ships <i>Anders Pallmar Alfa Laval, Sweden</i>		
Abstract	P4_PALABSTR.DOC	237 – 238
Text	P4_PALLMAR.DOC	239 – 244
Overheads	P4_PALPICT.PUB	245 – 250
Information about Bilge Water Processing With Membrane Filtration <i>B+V Industrietechnik GmbH, Germany</i>	B+V.DOT	251 – 252
Paper 5: Mechanical Bilge Water Treatment - Conventional and Membrane Filters <i>Andy H.H.Hein, Facet Intenational BV, Netherlands</i>		
Abstract	P5_HEIABSTR.DOC	253 – 254
Paper 6: Mechanical Bilge Water Treatment System Developed for the German Navy <i>Rolf Ebus, Facet Deutschland GmbH, Germany</i>		
Abstract	P6_EBUABSTR.DOC	255 – 256
Text and Overhead	P6_EBUS.DOC	257 – 262
Paper 7: Membrane Technology – The Optimal Technology for Splitting Bilge Water Emulsion <i>Andreas Fleischer, GOODTECH BETEX, Norway</i>		
Text	P7_FLEISCHER.DOC	263 – 264
Overheads	P7_FLEISPICT.DOC	265 – 272
Paper 8: Proven Technologies for Ad- vanced Bilge-Water Treatment PROMAC AQUACLEANER-C-BW <i>ValeIntlijn Korteling, PROMAC BV, Netherlands</i>		
Abstract	P8_KORABSTR.DOC	273 – 274
Text	P8_KORTELING.DOC	275 – 278
Overheads	P8_KORPICT.DOC	279 – 292

<u>Title</u>	<u>File-Name</u>	<u>Pages</u>
SESSION 3		
Coversheet	3SESSION.DOC	293 – 294
Introduction of the Speakers	3SPEAKERS.DOC	295 – 298
Paper 1: Potential Future Strategies for the Management of Liquid Waste Streams <i>Denise L. Oakley, AEA Technology Environment, United Kingdom</i>		
Abstract	P1_OAKABSTR.DOC	299 – 300
Overheads	P1_OAKLEY.PPT	301 – 322
Paper 2: Testing of Biological Waste Water Treatment Plants for Ships and other Applications – Test Conditions and Results <i>Bettina Schürmann, RWTH Aachen, Germany</i>		
Abstract	P2_SCHUEABSTR.DOC	323 – 324
Text and Overheads	P2_SCHUERMANN.DOC	325 – 328
Paper 3: Optimised Sewage Treatment Plants for Ships – Combination of Activated Sludge Process and Membrane Technology <i>Ulrich Brüß, Dr. Weßling Beratende Ingenieure GmbH, Germany</i>		
Abstract	P3_BRUABSTR.DOC	329 – 330
Text and Overheads	P3_BRUESS.DOC	331 – 344
Paper 4: Biological Sewage Waste Water Treatment on Ships <i>Dr. Fausto Strozzi, TAN, Italy</i>		
Abstract	P4_STROABSTR.DOC	345 – 346
Text	P4_STROZZI.DOC	347 – 356
Overheads	P4_STROZZPICT.DOC	357 – 362
Paper 5: Cleaning of Bilge Waters from Ship Discharges by Planted-Soil-Filters <i>Dr. Volker Schulz-Berendt, Umweltschutz Nord, Germany</i>		
Abstract	P5_SCHULABSTR.DOC	363 – 364
Text	P5_SCHULT.DOC	365 – 372
Overhead	P5_SCHUPICT01.XLS	373 – 380
Overheads	P5_SCHUPICT02.XLS	
Overhead	P5_SCHUPICT03.PPT	

Title	File-Name	Pages
<u>SESSION 4</u>		
Coversheet	4SESSION.DOC	381 – 382
Introduction of the Speakers	4SPEAKERS.DOC	383 – 386
Paper 1: Waste Management Onboard Ships Including Liquid Waste <i>Jochen Deerberg, Deerberg Systems, Germany</i>		
Abstract	P1_DEEABSTR.DOC	387 – 388
Text + Overheads	P1_DEERBERG.DOC	389 – 410
Paper 2: State of the Art Fresh Water Evaporators <i>Greg Wilbur, Aqua Chem, USA</i>		
Abstract	P2_WILABSTR.DOC	411 – 412
Text	P2_WILBRUR.DOC	413 – 416
Overheads	P2_WILPICT.DOC	417 – 420
Paper 3: Control of the Total Waste Water Chain (Evac Oy) <i>Ari Nylund, Evac Oy, Finland</i>		
Abstract	P3_NYLABSTR.DOC	421 – 422
Overheads	P3_NYLP ICT.PPT	423 – 438
Paper 4: Vacuum and Sewage Treatment <i>Klaus Maschow, Triton-Format, Germany</i>		
Abstract	P4_MASABSTR.DOC	439 – 440
Text and Overheads	P4_MASCOW.DOC	441 – 460
Paper 5: Oily Water Separators <i>Michael Fröhlich, Norddeutsche Filter</i>		
Abstract	P5_FROABSTR.DOC	461 – 462
Text		
Paper 6: AQUATECTOR Microfloat – An Innovative Conception to Upgrade and Improve Marine Sewage Treatment Systems <i>Roland Damann, ENVI-PLAN Engenieur GmbH, Germany</i>		
Abstract	P6_DAMABSTR.DOC	463 – 464
Text and Overheads (in German language)	P6_DAMANN.DOC	465 – 488

Title	File-Name	Pages
Paper 7: Innovative Waste Water Treatment on Ships with the WABAG Membrane Bio-Reactor System <i>Dr. Angelika Kraft and Dr. Martin Brockmann, WABAG Esmil GmbH, Germany</i>		
Abstract	P7_KRAABSTR.DOC	489 – 490
Text and Overheads (in German language)	P7_KRAFT.DOC	491 – 500
Paper 8: Requirements for Waste Management for Ships in Shipyards – Part II		
Abstract	P8_WRIABSTR.DOC	501 – 502
Overheads	P8_WRIGHT.PPT	503 – 524
SUPPLEMENT		
List of Participants	ATTENDANTS.DOC	525 – 528
Future Meetings	CONF1999.DOC	529 – 530

EXECSUM.DOC

Summary

The International Conference on "Waste Water Treatment Technologies for Ships" was held on 18th – 20th November 1998 in the City Club Hotel in Oldenburg i.O., Germany.

The Conference had been initiated and was organised by Eule & Partners International Consulting SPRL, Tervuren, Belgium.

The Conference was sponsored by the US Office of Naval Research Europe (ONR Europe) in London, UK and Deerberg-Systems in Oldenburg, GE.

ONR Europe is committed to fostering and facilitating collaboration in Science, Technology, Research and Development between the United States and their professional counterparts in Europe, Africa and the Middle East. ONR Europe liaises with international scientists and engineers through conferences, workshops, visits and personal research to identify key opportunities in S&T, to assess S&T activities and accomplishments and to exchange information and ideas in areas of mutual interest. ONR Europe is based in London.

In the world of maritime application of waste management systems Deerberg-Systems is a well-known company and the worldwide leading supplier for Total Waste Management Systems for the Cruise Line Industry. Up to now Deerberg-Systems has been supplying 98 systems to large passenger vessels. Mr. Deerberg will host our dinner tomorrow evening.

The Conference objectives were:

- To provide a forum for representatives from governments, international maritime and harbour authorities, ship owners, industry and academia to exchange information on the latest maritime environmental technologies, national and international policies and regulations for IMO compliance
- To discuss current requirements and trends for future maritime pollution abatement standards
- To present and discuss advanced waste water treatment technologies, future research and adaptation of current and future technologies for ship systems
- To develop recommendations for latest technology for shipboard and harbour applications
- To develop recommendations to industries and governments for policies and international collaboration
- To exhibit waste water treatment technologies applicable to a shipboard employment

100 Experts in this area from 12 different Nations (Denmark, France, Finland, Germany, Greece, Italy, Netherlands, Norway, Portugal, Sweden, the United Kingdom and the United States) attended the conference. They represented the whole range of interested groups in this field, i.e. Cruise Lines and Shipping Industry, Shipyards, Navies, System Engineering Companies, Equipment Manufacturers, Universities and Regulation Authorities.

The Conference was organised in four Sessions:

Session 1 – Waste Water Treatment Policies

Session Chairman Mr. Joel Krinsky, US Navy, US

Session 2 – Mechanical Waste Water Treatment

Session Chairman Prof. Alfredo Riva, University of Bologna, IT

Session 3 – Biological and Chemical Waste Water Treatment

Session Chairwoman, Mrs. Denise Oakley, AEA Technology, UK

Session 4 – System Engineering for Waste Water Treatment on Ships

Session Chairman Mr. Jochen Deerberg, Deerberg-Systems, GE

In addition two Luncheon Speakers addressed the conference:

Captain Werner Lüders, the responsible Officer in the German Navy for Environmental Protection Policies and Equipment. He presented the German Navy's Plans and Implementation of Waste Treatment Technologies aboard their Ships.

Mr. Rainer Beckershaus from the EXPO 2000 Staff in Wilhelmshaven, who presented the plans and ideas for the "EXPO 2000 by the Sea", which will be held in Wilhelmshaven from June to September 2000.

The Session Chairpersons provided an introductory paper in their respective areas before the Speakers from Governments, Industry and Academia presented the papers on their different subjects.

The guiding principles for all presentations during the conference were "Zero Discharge" and "Compliance with IMO Regulations".

It has become obvious, that further work needs to be done on regulations for greywater standards and the ship/shore interface, as discharge facilities between ships and shore facilities very often do not match, both technically and organisationally.

A wide range of equipment and technology to treat waste water (black-, grey-, and oily water) is already available. It is a matter of which combinations thereof should and can be treated together to increase efficiency and benign effluents as well as its further technological development, especially to increase throughput for large volume applications.

Biological and membrane technologies seem to provide very promising capabilities, and products are already very advanced.

More and more it is essential to take a total systems approach to waste management including liquid waste treatment. It appears, that incineration technology is a significant possibility to eliminate sludge resulting from waste water and sewage treatment on ships. This on the other hand means, that equipment dealing with a particular aspect of the waste treatment process, whether it is waste water or solid waste, must have the inherent capability of being integrated in a total waste management process and system.

Waste treatment of waste imported by ships entering shipyards is becoming an increasing concern, especially the cost associated with it. This new cost creates an additional burden on the competitiveness for shipyards, that abide to the laws and regulations.

Last, but not least this whole industry is very much cost driven, both in capital investment and in operating cost. Systems, that do not meet these goals to a satisfactory cost efficiency level, have no chance of being installed on merchant ships.

Overall the papers covered a good range of applicable technologies and equipment, and the conference participants have learned much about the capabilities of the manufacturers as well as the requirements of the customers.

The exhibitions by Umweltschutz Nord/EPE, FACET, Scanship Engineering and Deerberg-Systems have helped visualising the systems, technologies and products addressed during the conference.

Organisationally and socially the conference worked well. The City Club Hotel in Oldenburg offered very good conference facilities and support.

The conference was extensively used by the participants to conduct business discussions.

The social events, the luncheons, the reception hosted by the Organiser and the dinner hosted by Deerberg-Systems offered many additional opportunities for discussions amongst the delegates.

In summary the conference was received very well by the Participants, who expressed their desire, to participate in future conferences in the area of environmental technologies for ships and other maritime applications.

• The Maritime Environment •

"Waste Water Treatment Technologies for Ships"

Objectives of the Conference

Conference Objectives

- Provide a forum for representatives from governments, international maritime and harbour authorities, ship owners, industry and academia to exchange information on the latest maritime environmental technologies, national and international policies and regulations for IMO compliance
- Discussion of current requirements and trends for future maritime pollution abatement standards
- Presentation and discussion of advanced waste water treatment technologies, future research and adaptation of current and future technologies for ship systems
- Recommendations for latest technology for shipboard and harbour applications
- Recommendations to industries and governments for policies and international collaboration
- Exhibition of waste water treatment technologies applicable to a shipboard employment

Organisation

Sessions will consist of an introductory and technical overview talk by the Session Chairman and 20 to 40 min (+ 5 min questions) technical papers; there will be 30 minutes general discussion at the end of each session.

The Conference is sponsored by:



SCOPE.DOC



**DEERBERG
SYSTEMS**

• **The Maritime Environment** •

“Waste Water Treatment Technologies for Ships”

Conference Schedule

Wednesday, 18th November 1998

Time	Event
09.30h – 10.30h	Check in, Welcome Coffee
10.30h – 10.45h	Welcome and Introduction <i>Mr. Klaus Eule, Eule & Partners, BE</i>

Session 1 – Waste Water Treatment Policies

Time	Event
10.45h - 11.15h	Paper 1 on Requirements for the Environmentally Sound Ship of the 21st Century <i>Session Chairman Mr. Joel Krinsky, USN</i>
11.15h – 12.00h	Paper 2 on IMO Requirements and Their National Implementation <i>Mr. Klaas J. Bolt, Ministry of Transport and Public Works, NL</i>
12.00h – 12.15h	Administration <i>Mr. Karl M. Scheuch, Eule & Partners, GE</i>
12.30h – 14.30h	Luncheon at "Teeraum" LUNCHEON SPEAKER: <i>Capt.(GEN) Werner Lüders,</i> GENavSuppComd on Present Implementation of Waste Water Treatment Plants in the German Navy and Outlook
14.30h – 15.15h	Paper 3 on Requirement for Waste Management for Ships in Shipyards <i>Mrs. Cláudia Spranger, LISNAVE, PO</i>
15.15h – 15.45h	Coffee Break

- 15.45h – 16.15h Paper 4 on **Computational Fluid Dynamic Modelling of Compensated Fuel /Ballast System to Minimise the Overboard Discharge of Oil**
Mr. Ivan Caplan, Carderock Div., Naval Surface Warfare Center, US
- 16.15h – 17.00h **Discussion and Conclusion Session 1**
- 17.30h – 19.00h **Reception at "Teeraum"**

Thursday, 19th November 1998

Session 2 – Mechanical Waste Water Treatment

- | Time | Event |
|-----------------|---|
| 09.00h – 09.30h | Paper 1 on Total Waste Water Management
<i>Session Chairman Prof. Alfredo Riva,</i> University of Bologna, IT
Paper 2 on Economical and Ecological Treatment of Grey Water – Recovery, Discharge in Protected Areas
<i>Mr. Massimo Visibelli,</i> ATHANÒR, IT |
| 09.30h – 09.50h | Paper 3 on Development of a 75-Person Prototype Tubular Membrane Grey Water Treatment System
<i>Mrs. Rachel Jacobs,</i> Carderock Div., Naval Surface Warfare Center, US |
| 09.50h – 10.20h | Paper 4 on Conceptual Studies on Treatment of Oily Water and Sludge Aboard Ships
<i>Mr. Anders Pallmar,</i> Alfa Laval Marine & Power AB, SW |
| 10.20h – 10.45h | Coffee Break |
| 10.45h – 11.15h | Paper 5 on Mechanical Bilge Water Treatment - Conventional and Membrane Separators
<i>Mr. Andy H.H. Hein.,</i> FACET FCE, NL
Paper 6 on Mechanical Bilge Water Treatment System Developed for the German Navy
<i>Mr. Rolf Ebus,</i> FACET Deutschland GmbH, GE |
| 11.15h – 11.45h | Paper 7 on Membrane Technology – The Optimal Technology for Splitting Bilge Water Emulsions
<i>Mr. Andreas Fleischer.</i> Goodtech Betex A/S, NO |
| 11.45h – 12.15h | Paper 8 on Proven Technologies for Advanced Bilge Water Treatment
<i>Mr. Valentijne Korteling,</i> Promac BV, NL |
| 12.15h – 12.30h | Discussion and Conclusion Session 2 |
| 12.30h – 14.00h | Luncheon at "Teeraum"
LUNCHEON SPEAKER: <i>Mr. Rainer Beckershaus,</i> EXPO 2000 Staff,
Wilhelmshaven on EXPO 2000 By The Sea |

Session 3 – Biological and Chemical Waste Water Treatment

Time	Event
14.00h – 14.30h	Paper 1 on Potential Future Strategies for the Management of Liquid Waste Streams <i>Session Chairwoman, Mrs. Denise Oakley, AEA Technology, UK</i>
14.30h – 15.00h	Paper 2 on Testing of Biological Waste Water Treatment Plants for Ships and Other Applications – Test Conditions and Results <i>Mrs. Bettina Schürmann, TH Aachen, GE</i>
15.00h – 15.30h	Coffee Break at "Teeraum"
15.30h – 16.00h	Paper 3 on Optimised Sewage Treatment Plants for Ships - Combination of Activated Sludge Process and Membrane Technology <i>Mr. Ulrich Brüß, Dr. Weßling-Gruppe, GE</i>
16.00h – 16.30h	Paper 4 on Biological Sewage Waste Water Treatment on Ships <i>Dr. Fausto Strozzi, TAN, IT</i>
16.30h – 17.00h	Paper 5 on Cleaning of Bilge Waters from Ship Discharges by Planted-Soil Filters <i>Dr. Volker Schulz-Berendt, Umweltschutz Nord, GE</i>
17.00h – 17.30h	Discussion and Conclusion Session 3
20.00h	Dinner hosted by DEERBERG-SYSTEMS

Friday, 20th November 1998

Session 4 – System Engineering for Waste Water Treatment on Ships

Time	Event
09.00h – 09.30h	Paper 1 on Waste Management Aboard Ships Including Liquid Waste <i>Session Chairman Mr. Jochen Deerberg, DEERBERG-SYSTEMS, GE</i>
09.30h – 09.50h	Paper 2 on State of the Art Fresh Water Evaporators <i>Mr. Greg Wilbur, AQUA-Chem, US</i>
09.50h – 10.10h	Paper 3 on EVAC – Control of Total Waste Water Chain <i>Mr. Ari Nylund, EVAC OY, FIN</i>
10.10h – 10.30h	Paper 4 on Vacuum and Sewage Treatment System <i>Mr. Klaus Mascow, Triton-Format, GE</i>
10.30h – 11.00h	Coffee Break

- 11.00h – 11.30h **Paper 5 on Oily Water Separators**
Dipl.Ing. Michael Fröhlich, Norddeutsche Filter, GE
- 11.30h – 12.15h **Paper 6 on AQUATECTOR Microfloat – An Innovative Conception to
Upgrade and Improve Marine Sewage Treatment Systems**
Mr. Roland Damann, ENVIPLAN, GE
- Paper 7 on Innovative Waste Water Treatment on Ships with the
WABAG Membrane Bio-Reactor System**
Dr. Angelika Kraft, WABAG Esmil GmbH, GE
- 12.15h – 12.30h **Paper 8 on Requirements for Waste Management for Ships in
Shipyards (Part 2)** *Mr. John Wright, LISNAVE, PO*
- 12.30h – 12.45h **Discussion and Conclusion Session 4**
- 12.45h – 13.00h **Conference Conclusion**
Mr. Klaus Eule, Eule & Partners, BE
- 13.00h – 14.00h **Luncheon at "Teeraum"**
- 14.00h **Departure**

Conference Proceedings are included in the Conference Fees and will be delivered as CD-ROM.

Conference Proceedings can also be obtained as hard copies at an additional cost of US \$ 100 each.

WELCOME.DOC

Welcome and Introduction

Ladies and Gentlemen,

My name is Klaus Eule. I am the Organiser of this conference and I have the pleasure to welcome you to our Conference on WASTE WATER TREATMENT TECHNOLOGIES FOR SHIPS here at the City Club Hotel in Oldenburg.

I would like to extend a special welcome to our Sponsors, the US Navy Office of Naval Research Europe, represented here by its Associate Director Dr. Igor Vodyanoy from London and the Oldenburg based Waste Management Systems company DEERBERG-SYSTEMS, represented by its CEO Jochen Deerberg.

ONR Europe is committed to fostering and facilitating collaboration in Science, Technology, Research and Development between the United States and their professional counterparts in Europe, Africa and the Middle East. ONR Europe liases with international scientists and engineers through conferences, workshops, visits and personal research to identify key opportunities in S&T, to assess S&T activities and accomplishments and to exchange information and ideas in areas of mutual interest.

ONR Europe is based in London.

In the world of maritime application of waste management systems DEERBERG-SYSTEMS is a well known company and the world-wide leading supplier for Total Waste Management Systems for the Cruise Line Industry. Up to now DEERBERG-SYSTEMS has been supplying 98 systems to large passenger vessels. Mr. Deerberg will host our dinner tomorrow evening.

As stated in our programme the objectives for this Conference are :

- To provide a forum for representatives from governments, international maritime and harbour authorities, ship owners, industry and academia to exchange information on the latest maritime environmental technologies, national and international policies and regulations for IMO compliance
- To discuss current requirements and trends for future maritime pollution abatement standards
- To present and discuss advanced waste water treatment technologies, future research and adaptation of current and future technologies for ship systems
- To develop recommendations for latest technology for shipboard and harbour applications
- To develop recommendations to industries and governments for policies and international collaboration
- To exhibit waste water treatment technologies applicable shipboard employment

The marketing aspects and opportunities, that are inherent in a conference and a forum like this, are intended, and we recommend to use them extensively. We are about 90 participants from 12 nations covering the whole range of interest in this subject, i.e. the Cruise Lines, Shipyards, Navies, System Engineering Companies, Equipment Manufacturers, Universities and Regulation Authorities.

As you have noticed from the Agenda for this conference, we have a full programme of interesting papers on the various aspects pertaining to the scope of shipboard applications of waste water treatment technologies, and it will take some discipline by the Speakers to keep their allocated time, so that everyone is devoted the same attention and appreciation by the conference.

In addition we have Luncheon Speakers today and tomorrow. Today we will hear Captain Werner Lüders, who is the responsible Officer in the German Navy for Environmental Protection Policies and Equipment. He will speak about the German Navy's Plans and Implementation of Waste Treatment Technologies aboard their Ships.

Tomorrow we have Mr. Rainer Beckershaus from the EXPO 2000 Staff in Wilhelmshaven, who will present to us the plans and ideas for the "EXPO 2000 by the Sea". Wilhelmshaven has been chosen as the external site of the EXPO 2000 in Hannover presenting the Maritime Aspects of the EXPO under its Theme "Man, Environment, Technology". It will be of great interest for us, as we are planning a major Symposium on Maritime Environmental Technologies, including conferences, workshops, exhibitions and demonstrations during the EXPO in Wilhelmshaven.

You have found in your folder a paper indicating our conferences planned for 1999, which also mentions the EXPO 2000 event.

It is our intention to continue this series of conferences workshops and exhibitions on various aspects of environmental technologies applicable to ships, ports and tourism, as well as environmental protection and surveillance of our maritime regions and sea areas. We will continue to provide our fora as marketing opportunities for the international industry in this segment of the market.

Finally, I would like to introduce to you our Conference Team, who the one or the other of you have already met or talked to on the telephone:

Mr. Karl Scheuch, our Director Conferences,
Mrs. Elke Lonicer, our Conference Manager and
Mr. Heinz Bach, our Director for the Exhibitions.

All of us will be available to you during this conference and assist you in any matters, where you feel, that we could be of help. So, please do not hesitate to call on us for assistance.

Before we break for lunch today, Karl Scheuch will brief you on some administrative details and will clarify any questions you may have on the organisation and proceedings of our conference.

With this I will conclude my opening remarks and introduce our first Session Chairman, Mr. Joel Krinsky from the US Navy in Washington.

Eule & Partners

International Consulting S.P.A.

Maritime Conferences

• The Maritime Environment •

”Waste Water Treatment Technologies for Ships”

Session 1

Waste Water Treatment Policies

Session Chairman: Mr. Joel Krinsky, Naval Sea Systems Command, USA

1SPEAKERS.DOC

Session 1 – Waste Water Treatment Policies

Session Chairman Mr. Joel Krinsky, USN - NAVSEA

Mr. Joel Krinsky graduated from US Merchant Marine Academy in 1960 as BS Marine Engineer.

1966 he graduated from American University as MBA Production Management..

He worked in computer industry for IBM and other companies and has been associated with the US Navy for 30 years as Project engineer, program manager, deputy director for Auxiliary Systems, division director for HVAC and Submarine Life Support Systems. His present posting is division director Environmental Protection Systems.

Mr. Krinsky will chair session 1 on Waste Water Treatment Policies and present Paper 1 on

Requirements for the Environmentally Sound Ship of the 21st Century

Mr. Klaas Jan Bolt, Ministry of Transport and Public Works, NL

Mr. Klaas Jan Bolt graduated from the Nautical College as Master Mariner and served almost 20 years in the Merchant Navy as Deck Officer and Master on board different types of ships.

He than served as North Sea Pilot in the English Channel, the North Sea and in the Baltic Sea.

After some years as a Professor at the Nautical College he became a civil servant working for the NL Ministry of Transport and Public Works. His specialisation is the protection of the maritime environment in relation to shipping. He is active also in international maritime fields, both within the IMO and the European Union.

Mr. Bolt will now present Paper 2 on

IMO Requirements and Their National Implementation

Mrs. Cláudia Spranger, LISNAVE, PO

Mrs. Claudia Spranger graduated from the School of Science and Technology of the University Nova de Lisboa.

She has worked for a project for landscape recovery and for the Environment Department of an insurance company. In the later job she had to cooperate with Tecnologias Ambientais, S.A. in environmental audits to industries including ship yards.

Mrs. Spranger heads LISNAVE environment department since early 1998. She is involved in the implementation of an environmentally friendly policy in LISNAVE shipyards.

She will now present Paper 3 on

Requirement for Waste Management for Ships in Shipyards

Mr. Ivan Caplan, Carderock Div., Naval Surface Warfare Center, US

Mr. Ivan Caplan graduated from Drexel University (Philadelphia, Pa.) with a BS in Metallurgical Engineering and was awarded a MS degree from Johns Hopkins University (Baltimore, Ma.) in Mechanics and Materials Science.

He managed the US Navy's Applied Research Program in Ship and Submarine Materials Technology. He was Manager of the US Navy's Titanium Technology Program Office. He also held external program manager positions at NAVSEA and at the Airforce Office of Scientific Research.

Mr. Caplan has spent most of his career at the Carderock Division, Naval Surface Warfare Center (NSWC) and is currently Head of the Wastewater Management Branch in its Environmental Quality Department.

He will now present a paper 4 prepared by himself and Mr. Peter Chang III on

**Computational Fluid Dynamic Modelling of Compensated Fuel /Ballast System
to Minimise he Overboard Discharge of Oil**

Navy Maritime Environmental Protection - Opportunity for Success!

*By Mr. Joel Krinsky
US NAVY
Naval Sea Systems Command
Director, NAVSEA 03L1*

ABSTRACT

Navies of the future will face increasingly stringent environmental regulations, however, forecasting these regulations and their impacts is somewhat problematic.

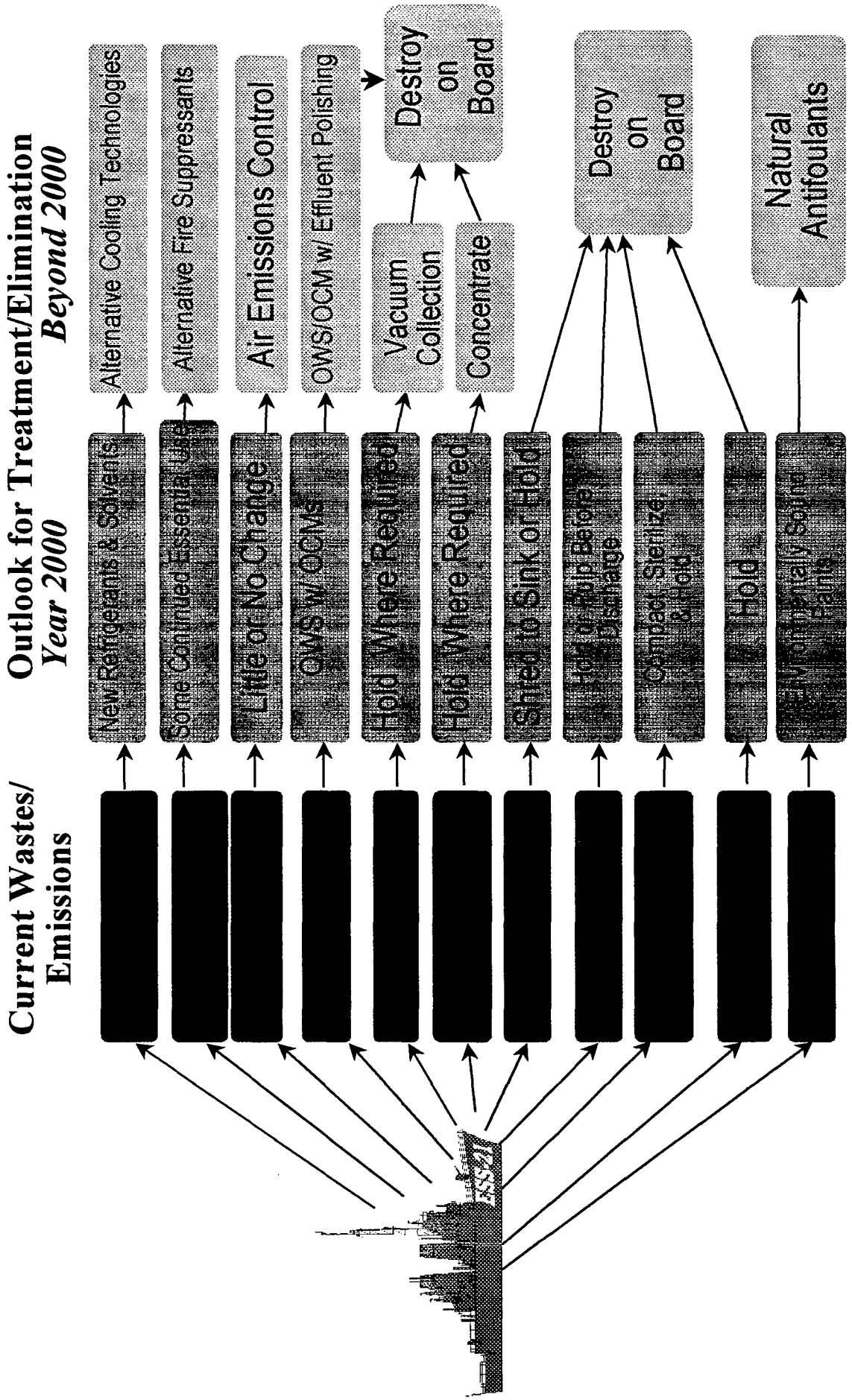
Investment in research and development of technologies to meet emerging requirements is necessary to meet the unique challenges faced by warships. Integration of systems should be pursued where practicable to improve performance and reduce cost.

Cooperation among nations and among industries is essential for reliable, maintainable, and affordable systems and equipment to meet future requirements.

Ultimately, navies will have environmentally sound ships, supported by environmentally sound logistics, integrated into environmentally sound operations.

The presentation will address these issues as follows: Environmentally Sound Ships, Challenges for the Future, Environmentally Sound Logistics, Environmentally Sound Operations, and Conclusions.

NATO Strategy for ESS-21





Outline

- ❖ **Environmentally Sound Ships**
- ❖ **Challenges for the Future**
- ❖ **Environmentally Sound Logistics**
- ❖ **Environmentally Sound Operations**
- ❖ **Conclusions**

***Navy Maritime
Environmental Protection
- Opportunity for Success!***

Mr. Joel Krinsky

**Director, Environmental Protection Systems
Division (SEA 03L1)**

Naval Sea Systems Command

(703) 602-0547 x250

FAX (703) 602-8010

E-mail: krinsky_joel@hq.navsea.navy.mil



Challenges for the Future

- ❖ **Shore Infrastructure or Shipboard Capability?**
- ❖ **Regulatory Trends: International and National**
 - ✧ **More Stringent?**
 - ✧ **Media or Contaminant?**
 - ✧ **At Sea**
 - ✧ **In Port**
- ❖ **New or Existing Ships?**

In Civilian Ports



❖ Port Authority Requirements

✧ Known or Unknown?

❖ Discharge Restrictions

✧ Standards or No Discharge?

❖ Reception Facilities

✧ Fixed or Mobile or None Provided?

❖ Off-Load Costs

✧ Stable or Increasing or Unpredictable?

Littoral Operations



- ❖ **Logistic Complexities**
 - ✧ **Worldwide Operations or Near Home Port?**
- ❖ **Discharge or Hold?**
 - ✧ **Technology or Tankage?**
- ❖ **Effect on Mission Performance or Endurance?**

On-Board Treatment Requires Technology

❖ **Solid Waste**

✧ **Volume Reduction**

✧ **Thermal Treatment**

❖ **Liquid Waste**

✧ **Minimization**

✧ **Concentration**

✧ **Thermal Destruction**

❖ **Integration**

✧ **Full**

✧ **Partial**

✧ **Independent**

Oil Waste



- ❖ **Bilgewater Containing Emulsions a Challenge**
 - ❖ **Membrane Micro/Ultrafiltration Shown Effective**
 - ❖ **Physical Barrier Separation by Droplet Size**
- ❖ **Need for Oil-Content Monitors?**
 - ❖ **Other Failure-Detection Devices**
- ❖ **Thermal Destruction**
 - ❖ **Integrated or Stand Alone?**

Blackwater and Graywater: Perhaps Our Greatest Challenge

❖ **Blackwater**

- ✧ Vacuum Collection
- ✧ Biological Conditioning with Membrane Filtration
- ✧ Thermal Destruction of Concentrate

❖ **Graywater**

- ✧ Source Reduction through Minimization Technologies
- ✧ Biological Conditioning with Membrane Filtration
- ✧ Thermal Destruction of Concentrate

❖ **Thermal Destruction Integration**

- ✧ AH Liquid Wastes
- ✧ Combine with Solid Waste

Ship-to-Shore Interface and ESS-21

❖ **Shore Support Will Be Essential**

✧ **Hotel Services**

✧ **Maintenance**

✧ **Corrosion Control**

✧ **Waste Reception**



21st Century Logistics

❖ **Support for Environmentally Sound Ships in the 21st Century**

Must Be:

- ❖ **Effective**
- ❖ **Efficient**
- ❖ **Environmentally Friendly**

Environmentally Sound Logistics



- ❖ **Smart Business Practices**
- ❖ **Minimal Packaging**
- ❖ **Just-in-Time Delivery**
 - ❖ **Spill Prevention Incorporated into Delivery Systems**
- ❖ **Minimal Storage/Transshipment/ Handling**
- ❖ **Improved Personnel Safety and Health through Pollution Prevention**



***Environmentally Sound Logistics:
Benefits***

- ❖ **Save Money**
- ❖ **Ensure the Correct Material Is
Delivered Where Needed and When
Required at the Lowest Cost**
- ❖ **Protect Our People**

Environmentally Sound Operations: ESO-21



❖ Supports Full Mission Readiness

❖ Integrates Environmental

Considerations into All Aspects of

Operations

✧ Planning

✧ Mission Accomplishment

✧ Logistic Support

✧ Post Mission Analysis

© Feedback/Lessons Learned



Environmentally Sound Operations

- ❖ **Environmental Planning Integrated into Operational Planning**
- ❖ **Potential Impacts on the Environment Considered**
- ❖ **Appropriate Mitigation Measures**
- ❖ **Mission Accomplishment Is the Priority**

Environmentally Sound Operations: Benefits

- ❖ **Maintain Readiness**
- ❖ **Maintain Access**
- ❖ **Enhance Mission Accomplishment**
- ❖ **Reduce Costs**
 - ✧ **Waste Disposal**
 - ✧ **Remediation**
 - ✧ **Liability**
- ❖ **Maintain Public Support**

Affordable Environmental Systems as Force Multipliers

- ❖ **Reduced Life-Cycle Cost Saves Operating Funds**
- ❖ **Readiness Linked to Training Area Access**
- ❖ **Energy Efficiency Means More Bang for the Buck**
- ❖ **Ability to Process Waste on Board Enhances Endurance**

Conclusion



- ❖ **Environmentally Sound Ships, Logistics, and Operations: the Vision of the Future**
- ✧ **Mission Effectiveness through Design, Planning and Risk Mitigation**
- ✧ **Readiness through Access to Training/Support Areas**
- ✧ **Affordability through Smart Business Practices**
- ✧ **Safety and Health and Environmental Protection through Training and Materiel**

IMO Requirements and Their National Implementation

Klaas Jan Bolt

Ministry of Transport and Public Works
Den Hague, Netherlands

ABSTRACT

Mr. Bolt will address the implementation of Marpol 73/78 and its present Annexes. He will give a general impression of the possibilities and the difficulties for national administrations of implementing the convention in national law, of implementation by the industry and of the enforcement of the regulations.

Mr. Bolt will also give an impression of the future Annexes of Marpol 73/78 which are presently under development and the aspects of implementation of these Annexes.

Mr. Bolt will end his presentation with a future view in relation to the environment and shipping.

IMO REQUIREMENTS AND THEIR NATIONAL IMPLEMENTATION

IMO REQUIREMENTS

The International Maritime Organization has developed and adopted several conventions and other formal treaty instruments and also several hundred recommendations dealing with a wide range of subjects in the maritime field.

The conventions of the IMO are legally binding instruments for Governments after having ratified a particular convention. The convention contain in many cases a technical part and a more procedural part.

The technical part provides details for the Governments and for the industry for the implementation of the regulations.

The procedural part regulates entering into force, procedures for amendments and possible disputes. Such regulations are less relevant for the shipping industry.

The responsible Administration for the implementation is referred to as the Flag State (the country which flag the ship is entitled to fly).

This Administration shall as a first step incorporate the ratified convention in national law since conventions are binding instruments. Also, the regulations of a convention need measures for enforcement and sanctions, which can only be achieved by law.

Other instruments of the IMO constitute codes, guidelines or recommended practices on important matters not considered suitable for regulation by formal treaty instruments. Recommendations - whether in the form of codes or otherwise - are not usually binding on Governments, but they provide guidance for the implementation into national regulations and requirements.

Many Governments do in fact apply the provisions of the recommendations by incorporating them, in whole or in part, into national legislation or regulations. In some cases, important codes have been made mandatory by including appropriate references in a convention. Although the legal status of such a code is sometimes questioned since there may be a reference in the convention to a particular code but the text of the code as such is not part of the convention and therefore has legally another status than the text of the convention itself.

The recommendations are generally intended to supplement or assist the implementation of the relevant provisions of the conventions and, in some cases, the principal codes and guidelines, etc.

In appropriate cases the recommendations may incorporate further requirements which have been found to be useful or necessary in the light of experience gained in the application of the previous mentioned provisions. In other cases the recommendations clarify various questions which arise in connection with specific measures and thereby ensure their uniform interpretation and application in all countries.

Examples of subjects which are regulated by the principal recommendations, codes etc. are:

- carriage of dangerous goods
- practice for solid bulk cargoes
- signals
- carriage of chemicals
- carriage of timber on deck
- safety for fishing vessels
- carriage of grain
- etc. etc. etc.

Other important recommendations dealt with matters as traffic separation schemes, adoption of technical manuals, crews training performance standards, standards for ships equipment, etc. etc. and many other matters.

There are also guidelines to help the implementation of particular conventions and instruments.

For example, for MARPOL the IMO developed the publication "*MARPOL how to do it*".

The provisions of recommendations are sometimes incorporated into amendments to the relevant conventions. Recommendations enable provisions or requirements to be suggested relatively quickly to Governments for consideration and action. It is also easier for Governments to act on such matters than in respect of provisions in formal treaty instruments, which involve international legal obligations.

IMO TECHNICAL ASSISTANCE

While the development and adoption of conventions, codes and recommendations has in the past been IMO's most important function, in recent years the Organization has devoted increasing attention to securing the effective implementation of these measures throughout the world.

Sometime ago it became apparent that the increasing amount of rules and regulations more or less an overkill had for both safety and environmental aspects.

As a result, the Organization's technical assistance activities have become more and more important and therefore the IMO has institutionalised a committee - the Technical Co-operation Committee.

The purpose of the technical assistance programme is to help States, many of them developing countries, to ratify IMO Conventions and to reach standards contained in the IMO instruments. As part of this programme, a number of advisers and consultants are employed by IMO to give advice to Governments and each year the Organization arranges or participates in numerous seminars, workshops and other events which are designed to assist in the implementation of IMO measures. Some are held in IMO headquarters or in developed countries, others in the developing countries themselves.

In the field of environmental protection, which is the subject of this conference here in Oldenburg, IMO has actively co-operated with the Regional Seas Programme of the United Nations Environment Programme in the development of regional anti-pollution arrangements.

However, the most important subject of all is training. IMO measures can only be implemented effectively if those responsible are fully trained and IMO has helped to develop or improve maritime training academies in many countries around the world. Some of them cater pure for national needs. Others have been developed to deal with the requirements of a region - a very useful approach where the demand for trained personnel in individual countries is not sufficient to justify the considerable financial outlet needed to establish such institutions. Imo has also developed a series of model courses for use in training academies.

For example, during the last meeting of the Facilitation Committee in September of this year it was discussed in the so-called Ship Port Interface Working Group to develop an IMO model training course for port reception facilities for ships' waste under MARPOL 73/78.

While IMO supplies the expertise for these projects, the finance comes from various sources. The United Nations Development Programme is the most important of these, with other international bodies such as the United Nations Environment Programme (as mentioned before) contributing in some cases. Individual countries also provide generous funds or help in other ways - for example, by providing training opportunities for cadets and personnel from developing countries.

The most ambitious and exciting of all IMO's technical assistance projects is the World Maritime University in Sweden. Its objective is to provide high-level training facilities for people from developing countries who have already reached a relatively high standard in their own countries but who would benefit from further intensive training.

The IMO Maritime Law Institute in Malta provides specialist training courses for maritime lawyers.

ENTERING INTO FORCE

The conventions of the IMO are developed by the Member States of the Organization. Normally, the idea of developing such an instrument is a serious accident. In other situations the trigger for developing a new instrument is not necessarily an accident.

An example under the MARPOL Convention is the discussion within the IMO in relation to ballastwater. It has been established that so-called "alien" ballastwater is responsible for the introduction of unwanted micro-organisms in certain regions like the Great Barrier Reef in Australia. Therefore, the IMO is now preparing a new Annex, which will probably become Annex VII, under the MARPOL Convention.

Each draft convention has to go through a standard procedure before it can be adopted by the Member States.

After that procedure the convention will enter into force on a specific day which depends on what has been agreed upon between the Member States and is reflected in the convention itself.

Many IMO conventions will only enter into force when certain criteria are fulfilled. These criteria are in many cases a number of countries and a certain percentage of the world tonnage fleet.

For example, for entering into force MARPOL required the ratification of at least 15 countries and these countries should present at least 50 % of the world tonnage.

This is required for the MARPOL Convention itself and also for an optional annex, like Annex IV.

It means that before Annex IV can enter into force, this annex should be ratified by at least 15 countries who represent 50 % of the world tonnage.

The present situation is:

71 countries
42 % of the world tonnage.¹

It seems to be difficult for some countries to ratify this Annex of MARPOL, for various reasons, I will come back to that later. Anyway, Annex IV is not in force yet because the 50 % tonnage criterion has not been met.

The Organization has been using the tonnage criterion since a long time for obvious reasons since it makes sense that a certain percentage of the world tonnage will comply with the requirements of that particular convention. Having a convention into force and being complied with by, lets say 10 % tonnage seems strange, to say the least.

On the other hand, waiting many years before an instrument enters into force, like Annex IV, seems also strange.

One could argue that instruments aiming at technical standards on board of a ship, for example for safety reasons, should be related to the tonnage of the world fleet as it is now.

But one could also argue that instruments aiming at the protection of the marine environment should not be required to enter into force by the criterion of the world tonnage.

Environmental aspects are more relevant for coastal states and port states, as they may be affected directly by marine pollution from ships. The flag is irrelevant for those states.

Based on this and based on the past experience, I dare say that the tonnage criterion should not be used for instruments related to marine pollution. I am of the opinion that the increased interests of port- and coastal states should be more adequately reflected in the IMO process with respect to entering into force of international instruments for the protection of the marine environment.

Do not ask me, at this moment in time, what exactly such a system should be or how it should look like. That is something for further discussions and developments. My main message to this auditorium here in Oldenburg is that the principle should be considered.

Another element in relation to entering into force are the non-convention instruments like resolutions, codes, recommendations etc. The Organization is

¹ Status at 6 November 1998

using a variety of methods and procedures for these instruments to enter into force and the legal status is in many instances not clear.

It seems sometimes difficult to keep track of the developments and it seems very difficult for the industry to anticipate implementation measures on the basis of draft instruments.

Therefore, I would promote the idea of a more transparent and clear system for all IMO instruments, both for conventions and for non-convention instruments.

I have included this paragraph in my speech since an IMO instrument can only be implemented after it has entered into force and since it is relevant for MARPOL and for Annex IV of MARPOL.

MARPOL 73/78

This IMO convention is dealing with the prevention of marine pollution. It is in force now for more than 15 years and ratified by almost every Administration with a maritime interest.

The basic principles of MARPOL are contained in the Convention itself while the technical details are reflected in the annexes to the Convention. Presently there are five Annexes, which I assume you all know.

There are two new Annexes being developed now. A new Annex VI for Air Pollution which has been adopted by the Organisation but is not yet in force and may take a long time before it will enter into force because

The other new Annex was mentioned before, Annex VII for ballastwater. This new Annex is to a certain extent still under consideration.

The MARPOL Convention addresses the Parties to the Convention and addresses the Administration. The latter is defined in Article of the Convention and is connected to the flag of the ship, the flag state.

The articles of MARPOL contain various obligations for the Administration, I mention just a few:

- ensure compliance for flag ships
- issue certificates
- carry out inspections
- prohibit violations
- collect evidence
- establish sanctions

- communicate to the Organization
- investigate casualties
- promote and support technical assistance.

This is a long list of obligations for the Administrations. Relevant for the industry are of course the technical aspects on board the ships. For that purpose we should take a look at Annex IV.

ANNEX IV of MARPOL 73/78

The title of Annex IV is 'Regulations for the Prevention of Pollution by Sewage from Ships'.

Annex IV is an optional Annex and, as I mentioned before, the criteria for entering into force have not been fulfilled, the Annex is not in force yet.

There are two reasons for this.

First, many countries were, and still are, of the opinion that Annex IV should have a low priority if compared with other Annexes of MARPOL.

It seems that pollution of the sea by sewage is not the most serious threat to the marine environment and that the prevention of pollution by the other Annexes is more important. I leave it up to you whether this is true or not, fact is that many Administrations are hesitant to ratify Annex IV.

The second reason is the application of the Annex. Regulation 2 of the present text of the annex contains the provisions for which ships it should apply.

- There are three criteria:
1. Tonnage (now 200 tons, proposed 400 tons);
 2. Number of persons on board (now 10 proposed 15); and
 3. Existing or new ship.

The text of Annex IV was drafted in the beginning of the seventies, including the above mentioned application.

After the entering into force of MARPOL in 1983 it became apparent that it would take a long time before Annex IV would also enter into force. The number of countries was pretty soon more than 15 but the percentage of world tonnage has been between 30 and 40 % for many years. Only recently has this figure gone up but it is still speculation on which date it will actually enter into force.

Many countries have the position that the criteria for application should be reconsidered since they are outdated. Unfortunately an Annex of MARPOL which has not entered into force can not be amended.

But despite that, some years ago the IMO has started the process of amending the text of Annex IV. A correspondence group was established with Germany in the lead. Is it a coincidence that we are in Germany today ?

The correspondence group has drafted a new text for the Annex and also has drafted a new Regulation 2 with the application. I have mentioned the amendments for the application before.

The principle of Annex IV is relatively simple, the ship may discharge the sewage into the sea under conditions and/or after treatment. The text is rather vague if it comes to standards for the effluent which may be discharged into the sea. For example, *the discharge rate shall be approved by the Administration based upon standards developed by the Organization*. Until now such standards have not been developed by the IMO.

Annex IV requires Governments to provide reception facilities for ships' sewage in appropriate places and without causing undue delay, a standard text for other annexes of MARPOL if it comes to reception facilities. Such a requirement should create the possibility for ships to discharge the sewage to the shore.

Although this requirement is contained in Annex IV, it is difficult to understand since all sewage from ships may be discharged into the sea under conditions. Complying with those conditions is not so complicated as it requires only sewage treatment and a certain distance from the shore. Ships having the need for the use of port reception facilities seem to be small in numbers and surely no justification to provide facilities which are rarely used.

In my view the Annex should more try to tackle the problem of sewage on board. I am convinced that with the techniques of today it is not difficult to find technical solutions on board itself by treatment or any other way. Such a solution is also more in line with the *precautionary approach principle* and can be seen as a long-term approach.

I am sure that you are all aware of the problem of providing reception facilities under the other Annexes of Marpol. It is a very important obligation for Governments but even after 15 years the situation is not promising. Although not officially, many ships and shipowners complain about the lack of facilities and also about the provided service. I could give you many examples in which the 'Marpol Government' was failing by not ensuring the needed facilities for the ships. And I am afraid that this might be the same for the next decade.

Therefore, the approach as prescribed above could also be an approach for the other Annexes of Marpol. I call this the closed loop concept. In such a concept the sector, here the maritime sector, should be no burden at all for the environment, neither by discharging at sea nor by needing shore reception facilities.

Of course I am aware of the long road we have to go before such a concept is fully implemented and operational, it may take more than ten years. But the revision of Annex IV of Marpol could be a good example to trigger the new approach also for other waste and residues from ships, both ship-generated and cargo residues.

I am convinced that the maritime sector itself has to be active in this area together with institutes for the development of treatment techniques and technologies for the closed loop concept.

I would like to challenge the industry to take this up and not wait for any new legislation from the IMO.

We know that quality shipping will always have a considerable part of the market as a whole and environmental performance is an integral part of quality shipping.

Therefore I conclude my speech with a strong appeal on the maritime sector to take this challenge and to show that the responsibility for the protection of the environment a serious element is in their policies.



IMO requirements

national implementation

IMO requirements

- ◆ conventions
- ◆ codes
- ◆ recommendations
- ◆ resolutions
- ◆ circulars
- ◆ guidelines



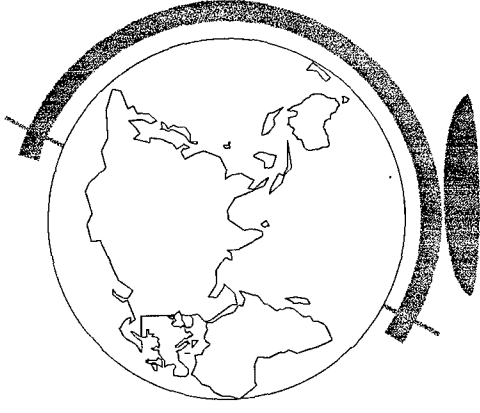
IMO requirements

- ◆ carriage of dangerous goods
- ◆ practice for solid bulk cargoes
- ◆ carriage of chemicals
- ◆ safety for fishing vessels
- ◆ carriage of grain
- ◆ etc. etc. etc.



IMO requirements

- ◆ technical assistance
- ◆ training - regional - national
- ◆ model courses
- ◆ World Maritime University



IMO requirements

entering into force :

in the CONVENTION

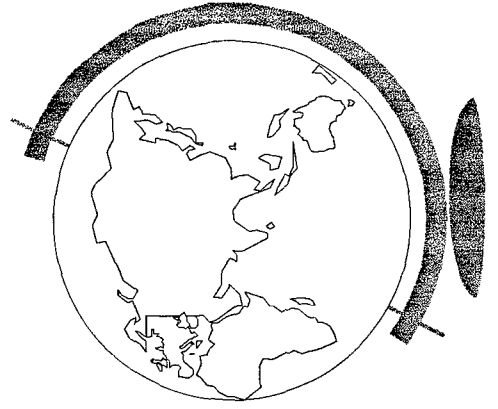


IMO requirements

MARPOL 73/78

15 countries

50 %

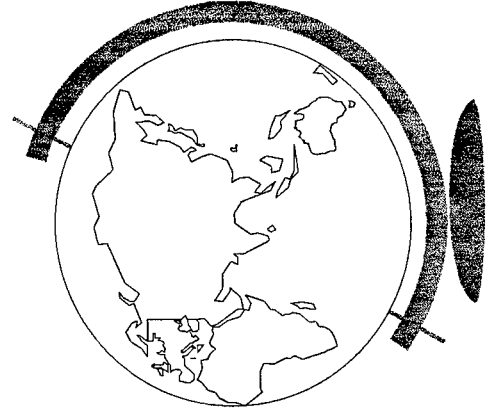


IMO requirements

ANNEX IV

71 countries

42,5 %



IMO requirements

FLAG state

COAST state

PORT state



MARPOL requirements

MARPOL 73/78

compliance

certificates

inspections

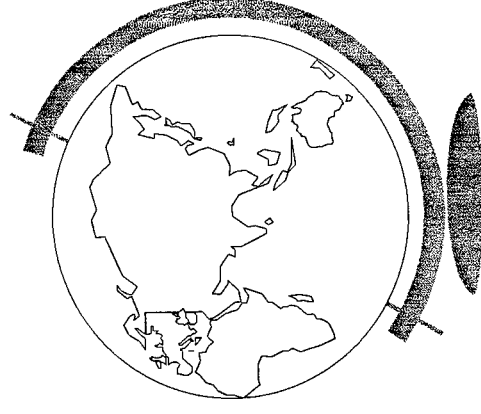
violations

evidence

sanctions

communicate

investigate



MARPOL requirements

Annex IV

priority
applicable

tonnage

persons

new/existing



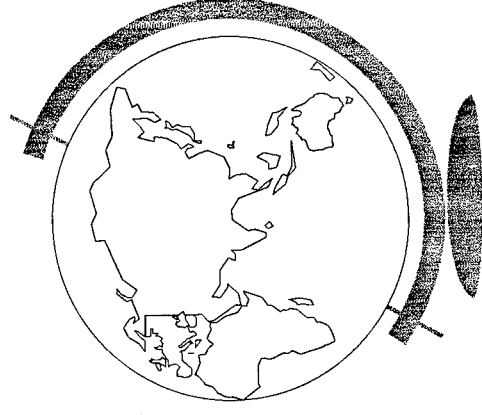
MARPOL requirements

Annex IV

treatment

discharge at sea

ashore



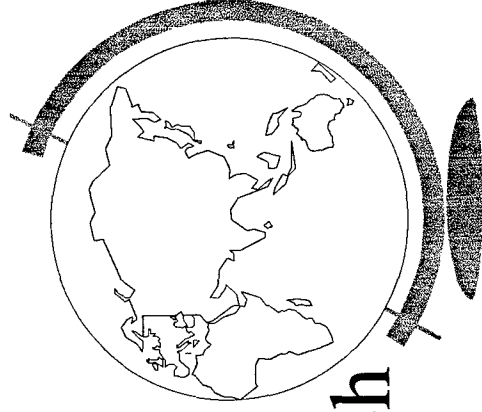
MARPOL requirements

now :

discharge at sea
shore reception facilities

better :

sustainable
“closed loop” approach

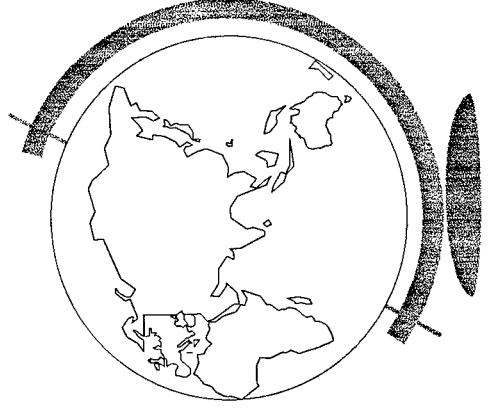


MARPOL requirements

QUALITY

“CLOSED LOOP”

INDUSTRY



**REQUIREMENTS FOR WASTE MANAGEMENT FOR SHIPS IN SHIPYARDS
(PART 1)**

Cláudia Spranger

LISNAVE
Environment Department

ABSTRACT

The subject is very complex and involves not only shipyards but also ship owners and international policy.

The presentation is stating what problems shipyards have when they are facing wastes left by ships in repair or conversion and which solutions to those problems.

LISNAVE is going through some major changes towards an environmental friendly industry. Margeira Yard is going to be closed down and the activity will move to Setúbal, to Mitrena Yard situated in a natural reserve.

The major question is whether the market will permit LISNAVE, or any other shipyard, to be an environmental friendly industry or whether the environment has to be neglected because of commercial reasons.

Requirement for Waste Management for Ships in Shipyards

Cláudia Spranger
LISNAVE
Portugal

Overhead 01

Lisnave Estalieros Navais is currently going under a major restructuring programme and an essential aspect of this programme is the environmental issues and the aspects to be addressed by a major ship repair and conversion shipyard.

Overhead 02

The topics being discussed at this exhibition mainly deal with waste management for ships but I would like to bring to your attention the waste management and treatment required for the ships themselves when they are in a shipyard.

Overhead 03

Lisnave currently operates from two shipyards, the Marguiera yard located on the River Tagus at Lisbon

Overhead 04

And the Mitrena shipyard which is located about 40 kilometres south on the River Sado near Setubal. shipyard year 2000 all activities will Lisnave is presently undergoing a major restructuring and by the be transferred to the Mitrena

Overhead 05

Although only one year in existence in its present format, and taking into consideration the restructuring within the company, Lisnave has retained is the leading position of being one of ship repair yards in the world.

Overhead 06

The position it holds is not made easier by the fierce competition in Europe and the financial input required to meet the environmental demands will make this already tight market even harder for Lisnave to hold its place

Overhead 07

As number 1 in Europe. However ship repair is a sector whereby a quick turnaround is essential and the success of a contract is focussed on meeting the deadline projected for the ship owner within the predicted cost to a high standard.

Overhead 08

This high standard of work has always been the trademark of the Margueira shipyard. Standards and costs however now have to take more into account the environmental issues which are being presented at an increasing rate. But most ship owners do not consider these issues when a contract is awarded.

Overhead 09

Margueira shipyard has excellent drydock facilities but through governmental decisions, it was decided to transfer the activities to Mitrena. The Margueira shipyard is located in a heavily populated district of Almada and when the shipyard was originally constructed this area was

a vast open space. The developments through time has resulted in the yard being now located on a busy street and this is one of the reasons that the shipyard is to be closed

Overhead 10

So with its impressive drydock facilities and basically ideal location in terms of shipping routes, Margueira shipyard has been able to turn out 117 ships in its first year of present arrangement. The majority of ships repaired are oil tankers and usually above 30000 tons deadweight

Overhead 11

Which leads to a wide range of waste materials. The actual repair work itself also involves an accumulation of waste and this is mainly from the blasting activities.

Overhead 12

Most ship owners prefer to have the method of blasting which they have always had in the past, namely grit blasting. Although there are several new technologies for blasting on the market, our experience is that ship owners are reluctant to change resulting in a huge amount of grit which has to be treated.

Overhead 13

But grit is not the only residue generated from a typical repair job. Other wastes are evident and have to be treated individually

Overhead 14

These day to day problems are normal for the successful completion of ship repair work. But government pressure deemed that these activities and works could no longer be carried out at Margueira and the shipyard has to close by the year 2000.

Overhead 15

The Margueira activities are to be transferred to Mitrena shipyard but it is physically impossible to transfer the facilities. Therefore the Mitrena 2000 project was initiated to maintain the Lisnave position of a major ship repair yard.

Overhead 16

The Mitrena docks are also impressive and can accommodate most ship sizes.

Overhead 17

However there has to be further developments and modernisation within the shipyard and these modifications have to take into consideration that the shipyard is situated on a peninsula adjacent to a nature reserve.

Overhead 18

The shipyard access leads through a nesting area for protected birds and care must be taken to keep this balance of industry and nature.

Overhead 19

The marshlands and tide flows are essential for the well being of the neighbouring areas and careful planning is made to keep this area in tact

Overhead 20

A further aspect which has to be considered is Lisnaves involvement in the offshore conversion industry at Mitrena.

Overhead 21

The Mitrena shipyard has successfully converted the semi submersible rig for Petrobras. This type of work adds a new dimension to the waste accumulation as the vessels are at the shipyard for much longer periods than the average docking period of 12 days.

Overhead 22

Therefore after the completion of the Petrobras X it was apparent that the plans for waste disposal and treatment should now consider this, for Lisnave, new type of contract.

Overhead 23

The accumulated waste is generated at totally different values than those of the typical repair work. There is a lot more metal required as there are major structural modifications and a lot of grit and paint as the vessels receive a material protection which has to withstand longer periods of service than the usual ship repair cycle. Also for the offshore industry we have to consider the exotic wastes such as barite and bentonite which sometime arrive at the yard with the vessel.

Overhead 24

These aspects have to be taken into account in the planning and restructuring of the Mitrena shipyard.

Overhead 25

All of these previously mentioned factors were taken into consideration for the modernisation and modifications to the Mitrena shipyard. The major changes being the addition of new hydrolifts, the upgrading of the existing docks, the addition of new piers and of a new viaduct. All in all these are the main physical modifications which form Mitrena 2000

Overhead 26

The viaduct ensures that the tide flows which are effected by the construction of the hydrolifts are guaranteed. The plant and bird life are maintained through this construction

Overhead 27

As already stated hydrolifts are required to increase the dock capacity to make Mitrena competitive within the ship repair sector. The construction of these platforms are underway and through the addition of the viaduct the water flow which would normally be affected by the hydrolifts, is successfully dealt with

Overhead 28

The hydrolifts are a modern construction for the docking of ships. They differ from the conventional graving dock by having an entrance basin

Overhead 29

Once a ship has entered the basin the water is pumped into the required level to allow access to the selected dock platform.

Overhead 30

This system enables the quick discharge of the water in the dock platform and a ship can be situated after 1.5 hours. This allows for the quick entrance of the necessary equipment through the aft gate to start the repair work.

Overhead 31

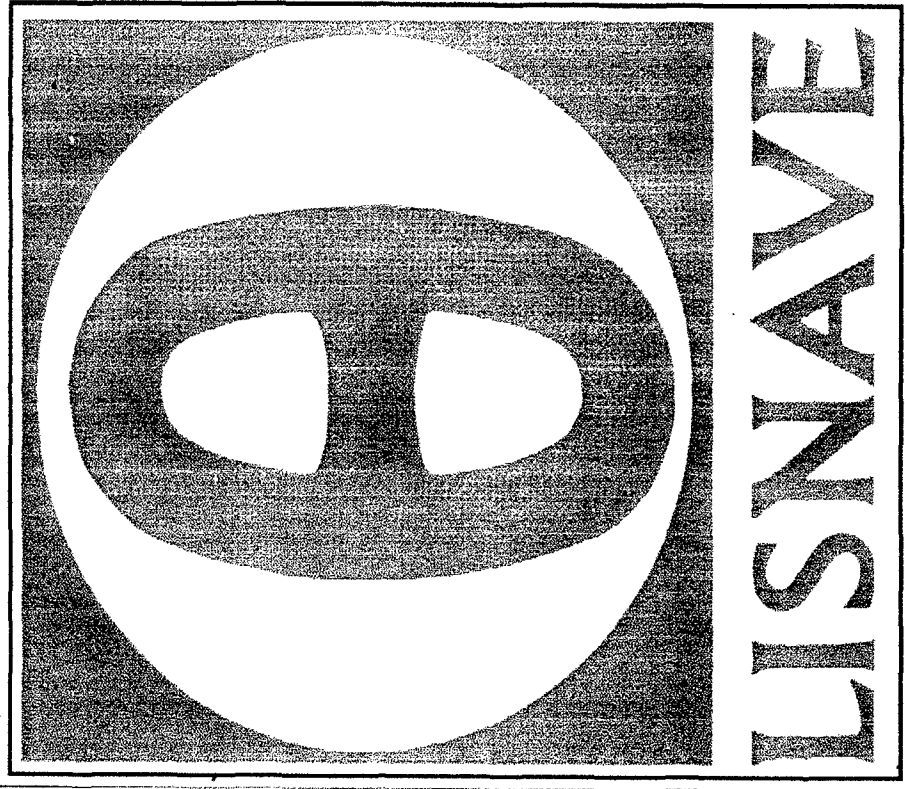
The water from the hydrolifts is not however discharged directly into the river Sado. A new waste treatment plant is being planned to treat the dock water as well as the domestic waste. This will keep Lisnave in line with the specified limits for discharging its treated water into the River. However compared to our competitors in Europe and in the middle and far east, few of them comply with these standards.

Overhead 32

Maintaining a secure environment is a goal that every shipyard should try to meet, however with the stringent guidelines set by the authorities, very few try to accomplish this goal. The ship repair and conversion market is governed by dollars and cents.

Overhead 33

More effort should be made to gain conformity within the shipbuilding industry in regards to environmental aspects. Therefore there would be an equal basis for bidding for future contracts and the financial impact would be taken into account for the total work to be done. In this manner Lisnave wishes to be considered as a leading ship repair yard but also an environmental friendly.

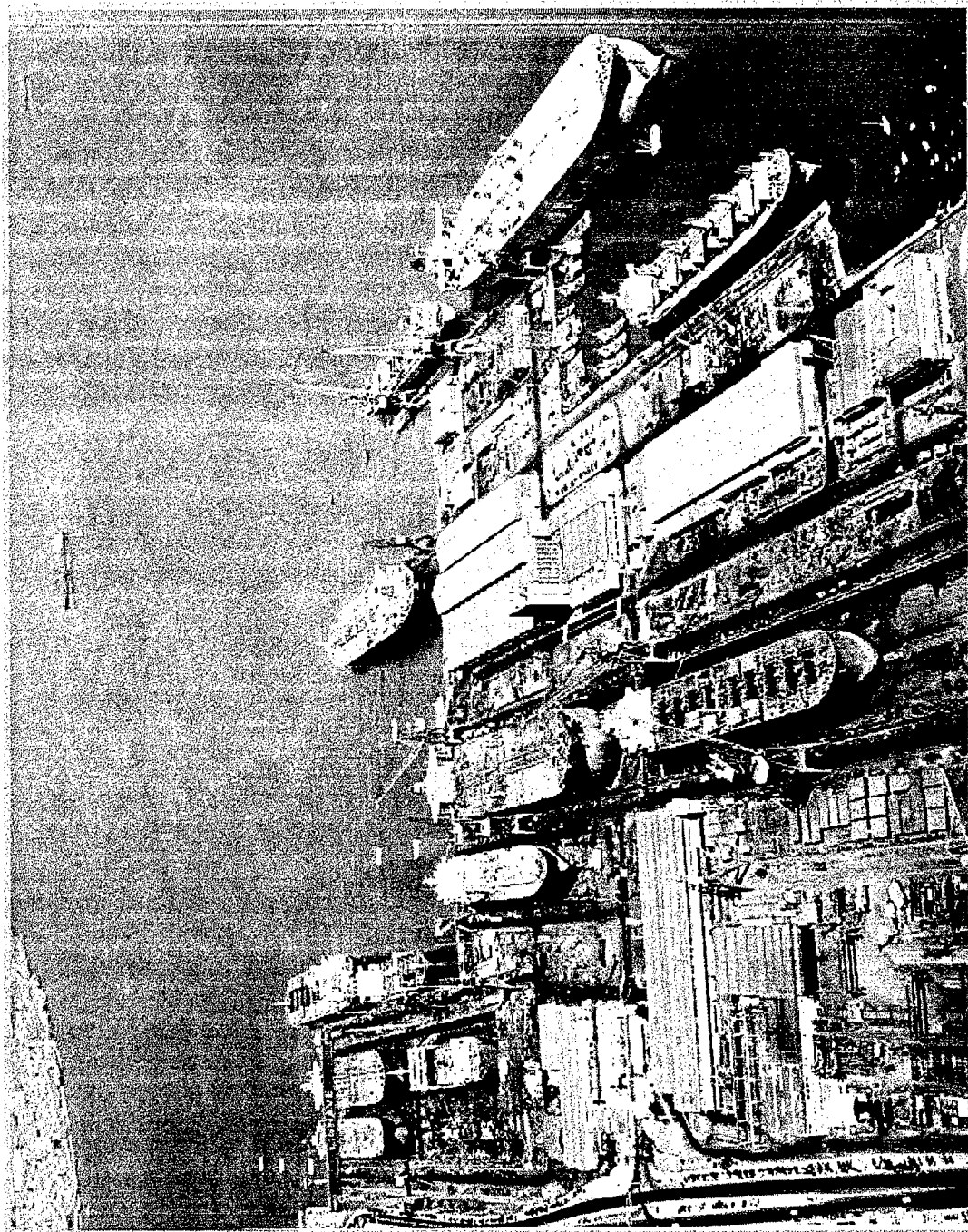


Requirements for Waste Management for Ships in Shipyards

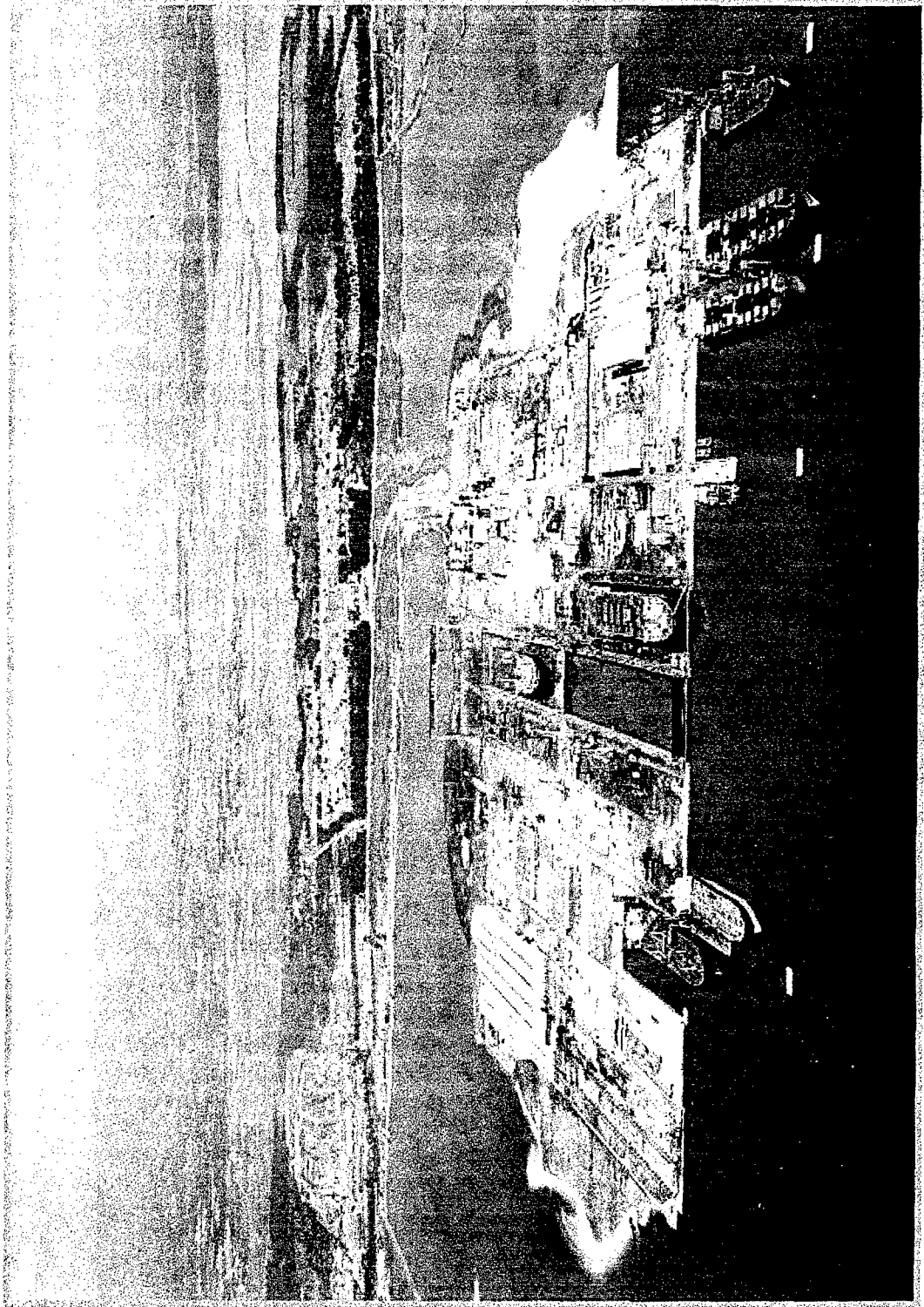
by Cláudia Spranger

LISNAVE - ESTALEIROS NAVAIS, SA

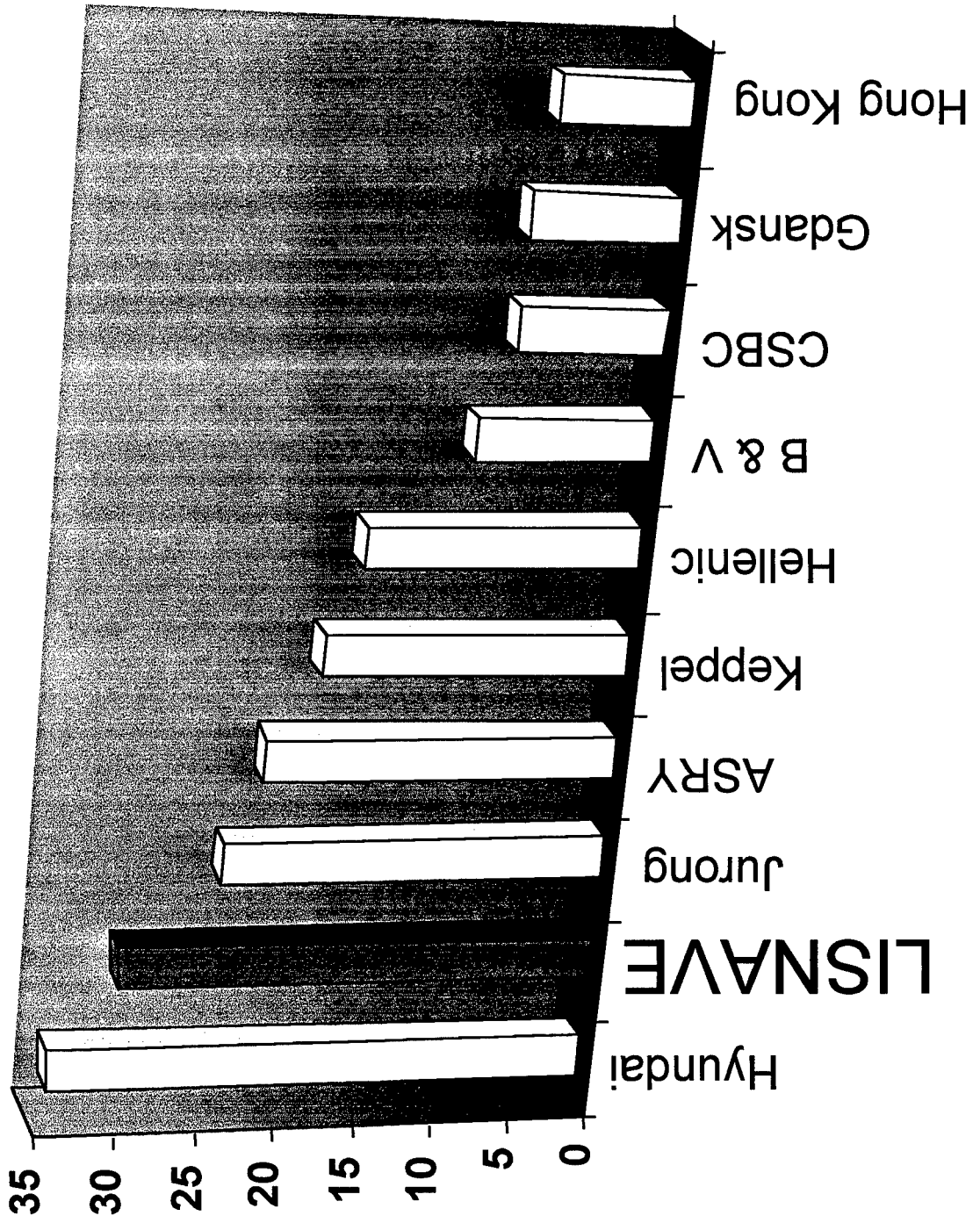
Margueira shipyard



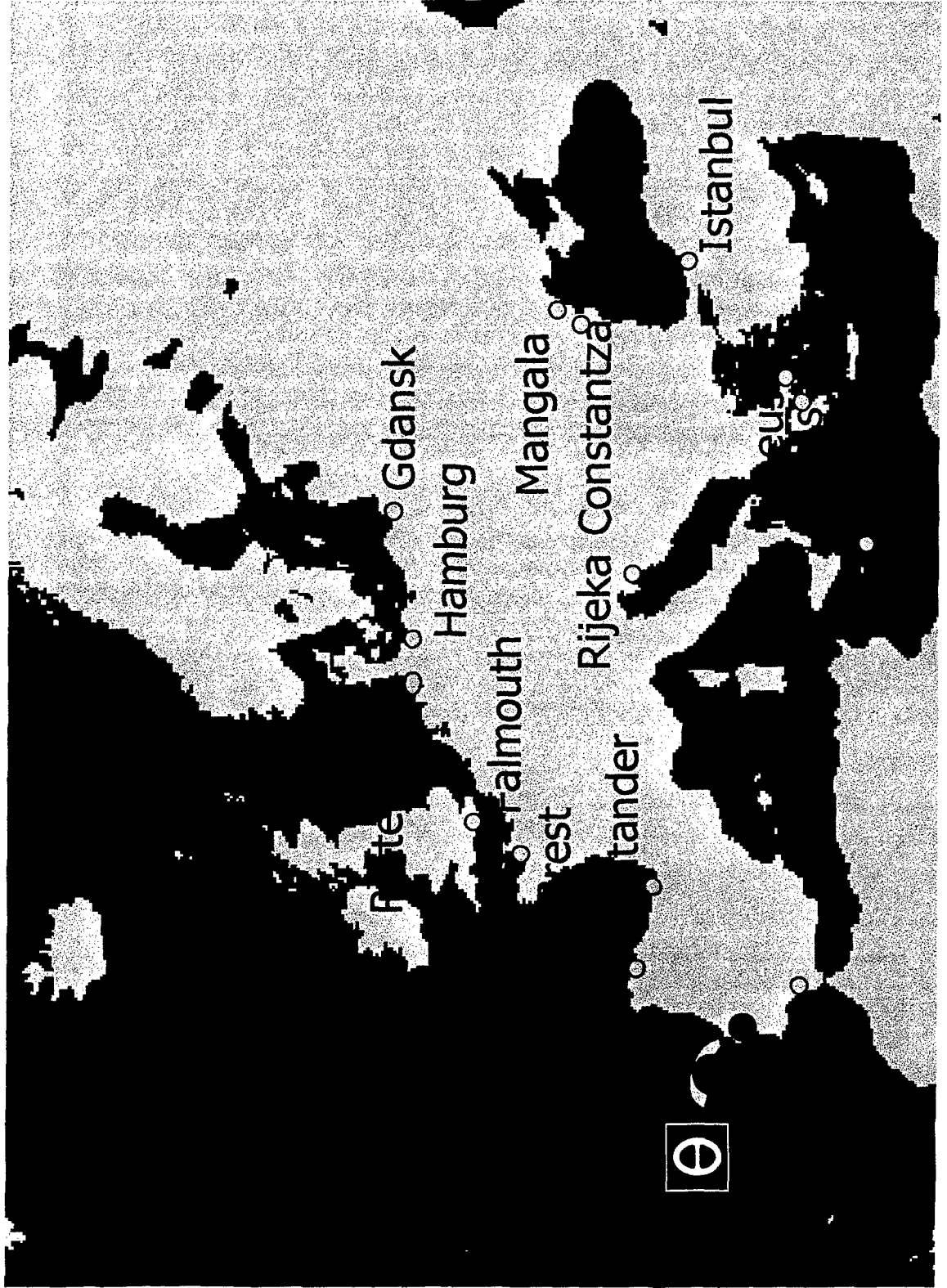
Mitrena shipyard



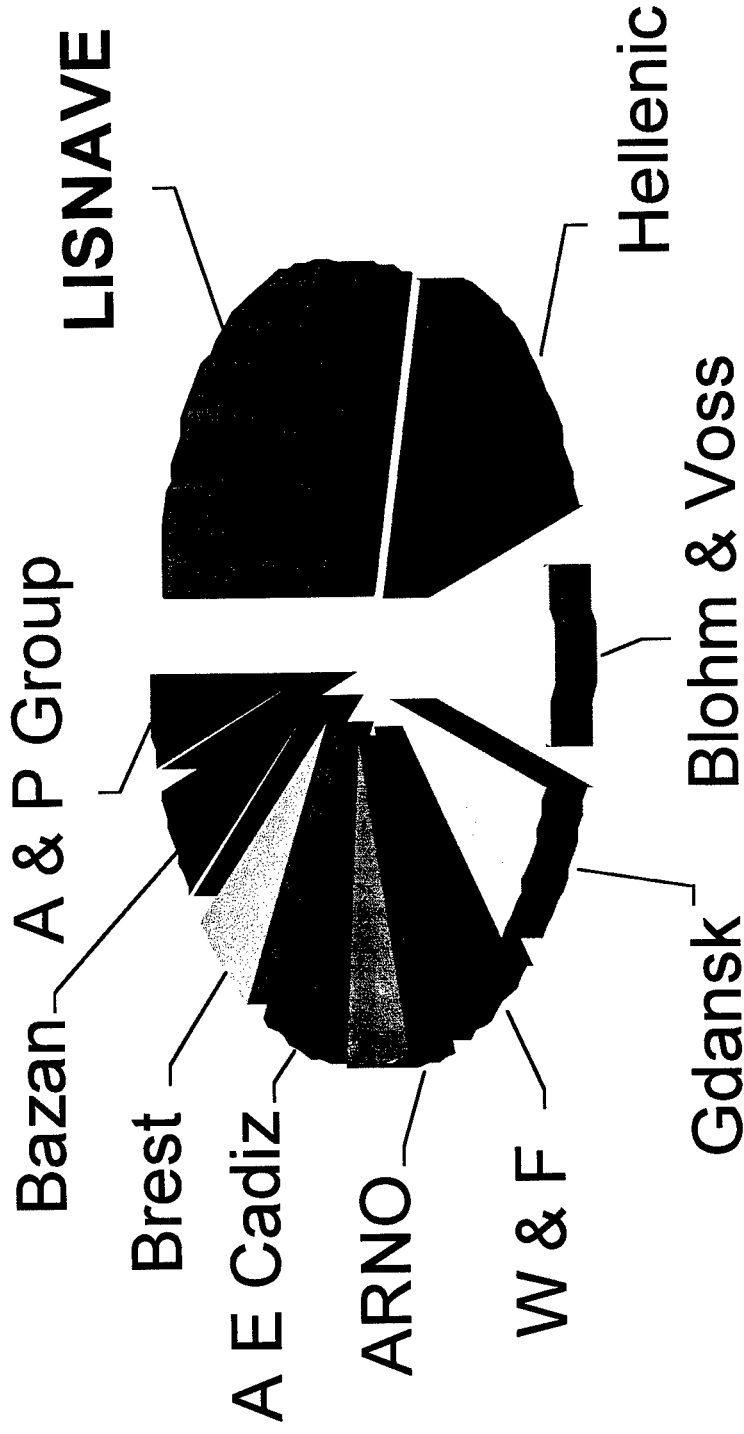
LISNAVE - No. 2 Worldwide



Location of main competitors in Europe

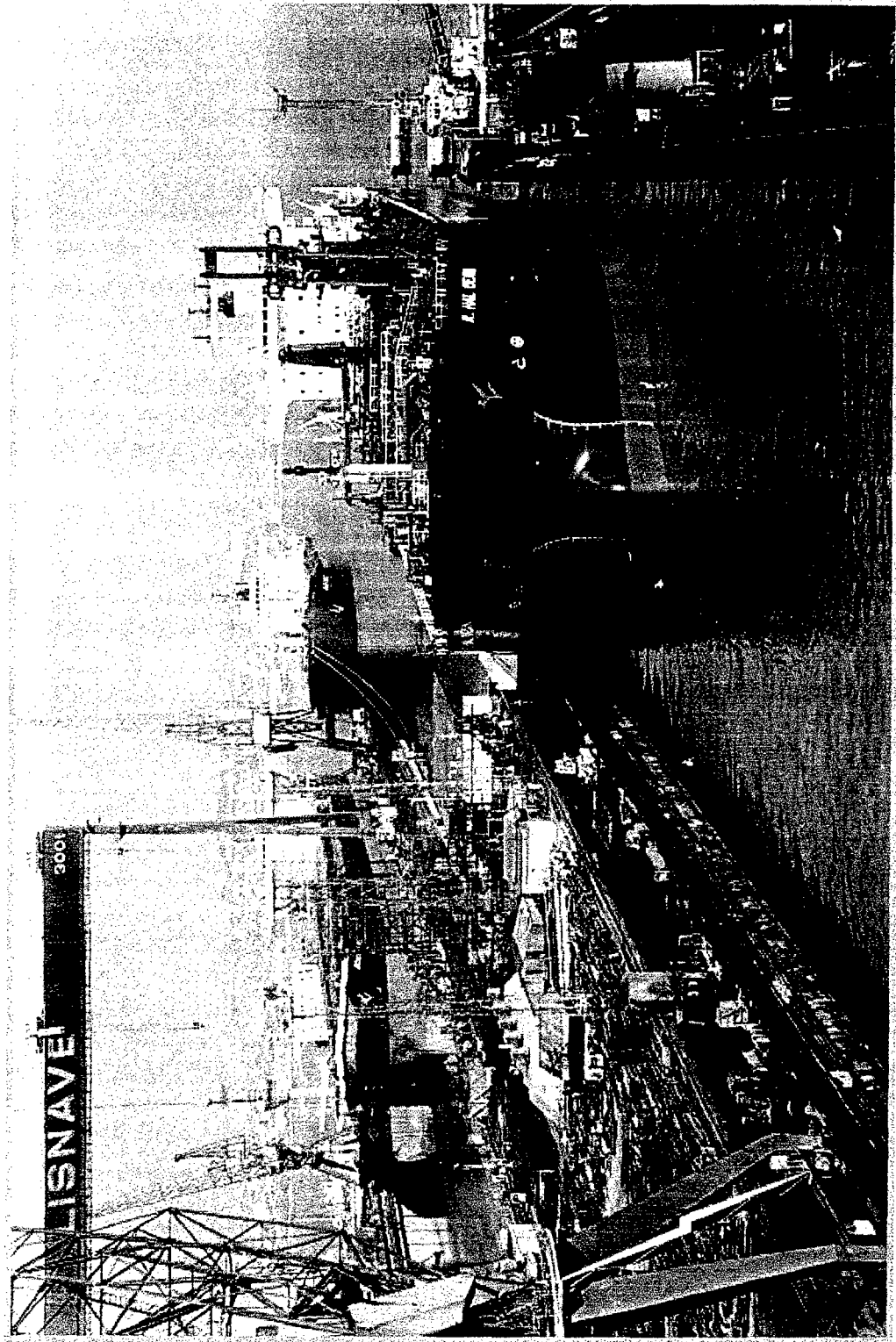


LISNAVE - No. 1 in Europe



**Ships are movable assets.
Ship repair is a global market.**

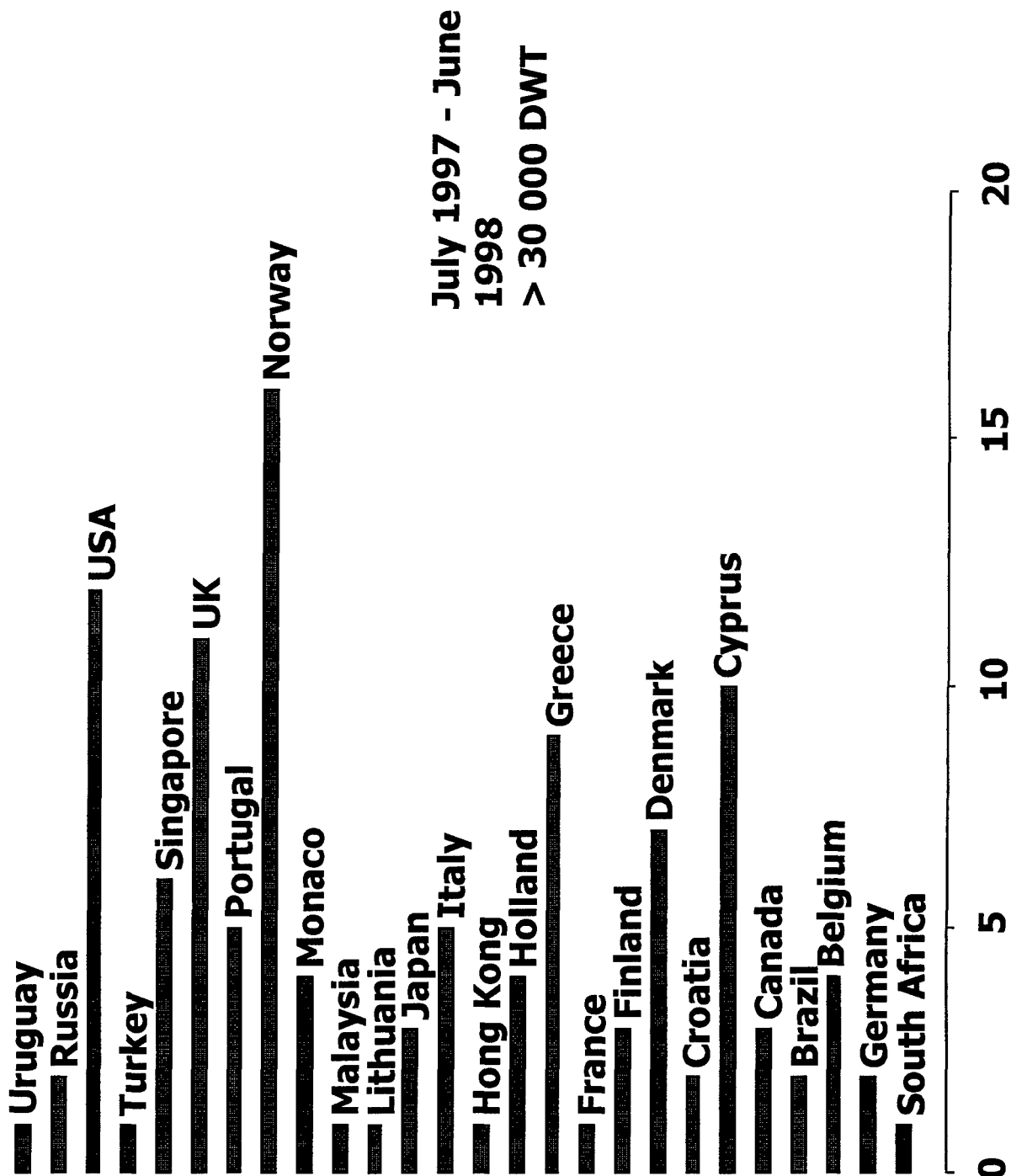
Margueira shipyard



Margueira Drydocks

Dock nº	DWT	Length (m)	Width (m)
10	325 000	360	54
11	325 000	350	54
12	100 000	265	42
13	1 000 000	520	90

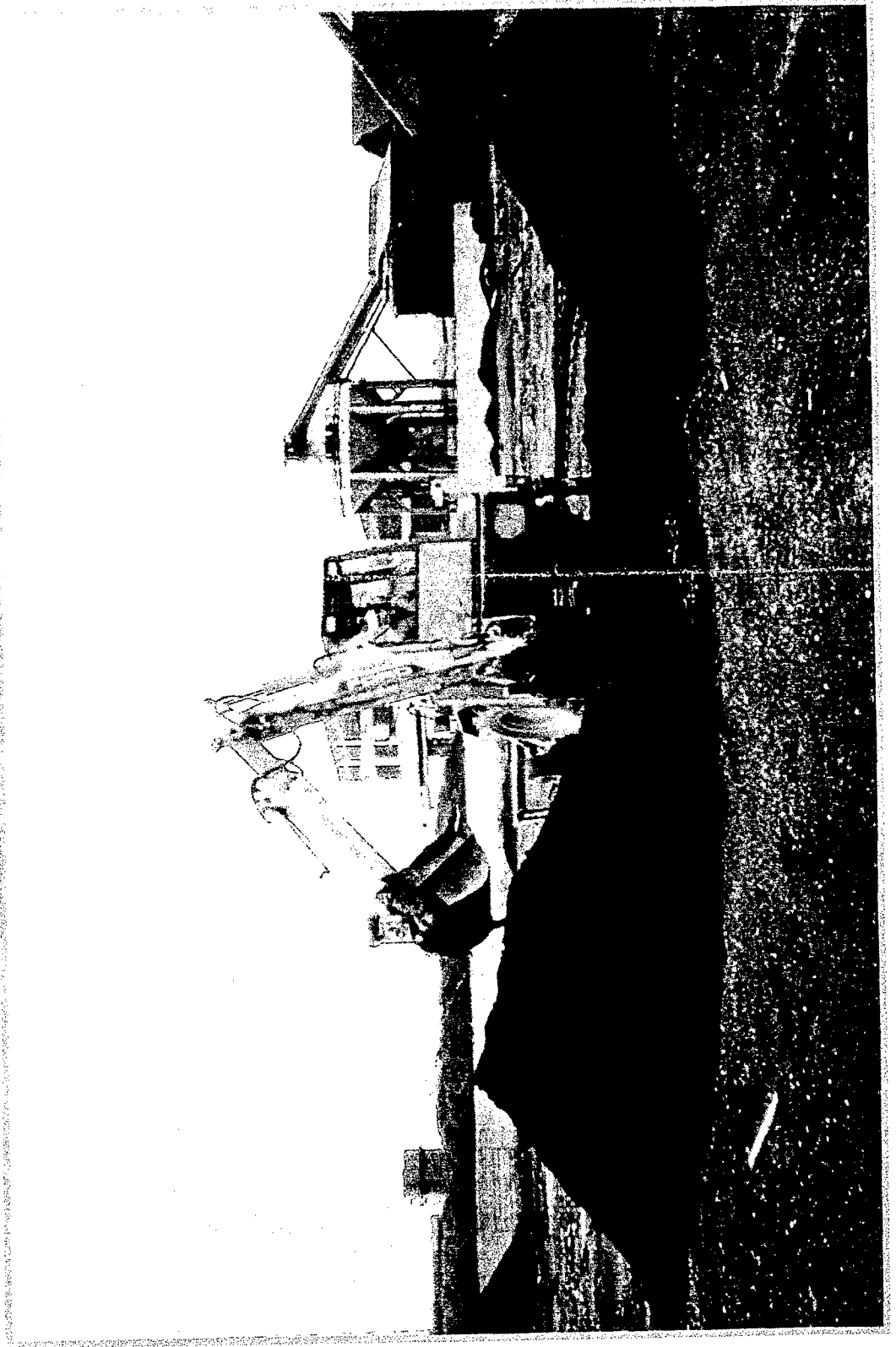
Margueira repairs



Repair Wastes

- GRIT
- METAL SCRAP
- OILY WASTES
- OILY WATER
- OILY SLUDGES
- URBAN WASTES
- INSULATION MATERIAL (INCLUDING ASBESTOS)
- BATTERIES

Grit disposal



Repair Wastes

Grit - Cement factories

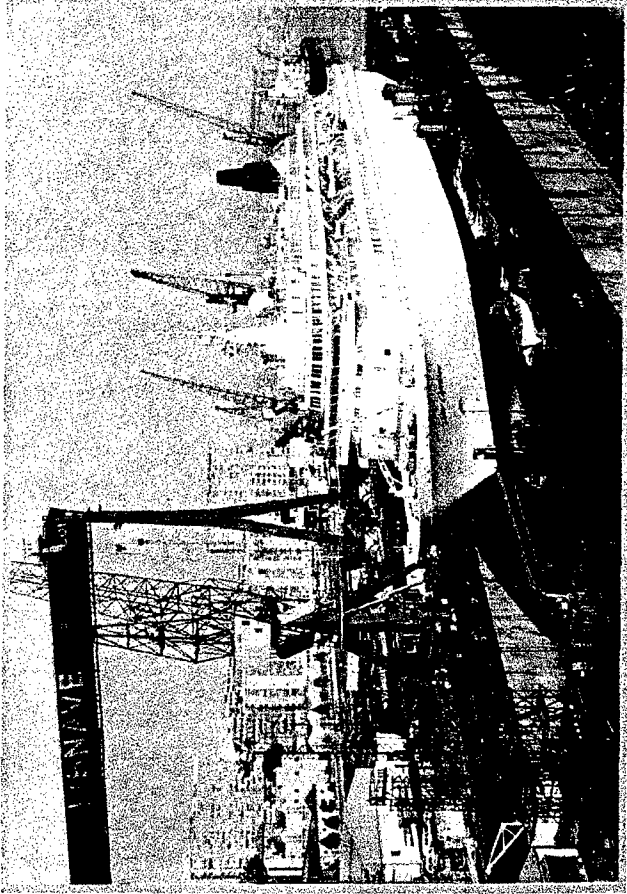
Metal Scrap - Recycle

Oily Wastes - Treatment and stabilization

Urban Wastes - Landfill

Insulation material - Landfill

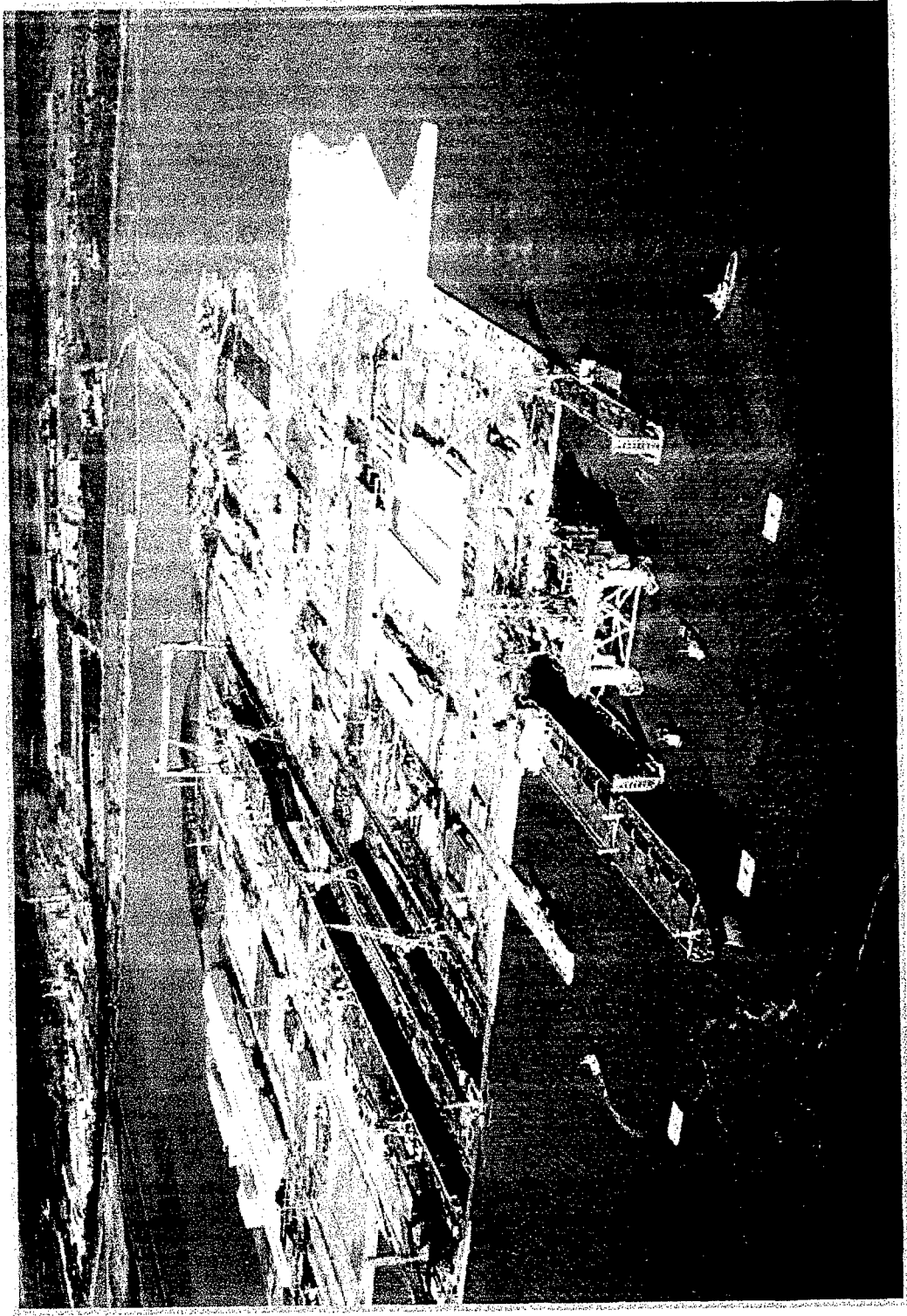
Margueira shipyard



**Margueira Yard has
to close**

**All activity will be transferred to Mitrena
Yard**

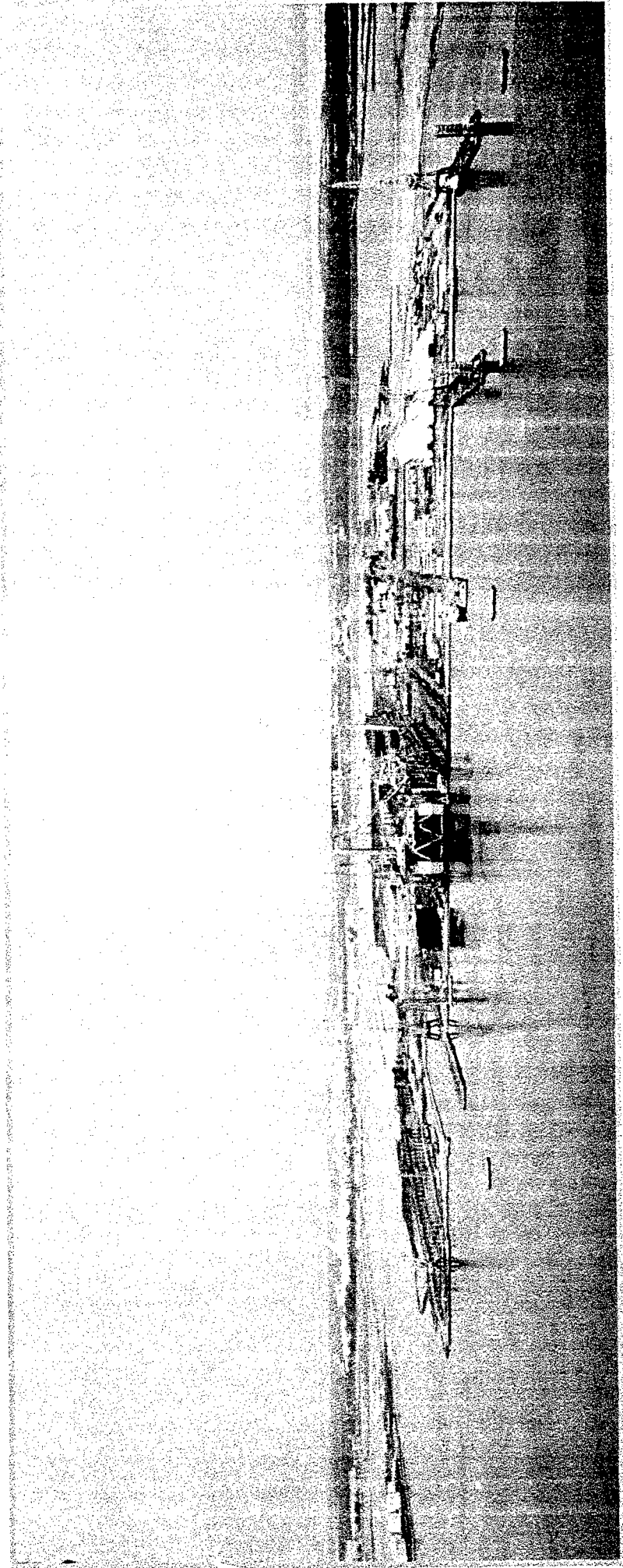
Mitrena shipyard



Mitrena Docks

Dock nº	DWT	Length (m)	Width (m)
20	700 000	420	75
21	700 000	450	75
22	300 000	350	55

Shipyard and Surrounding Area



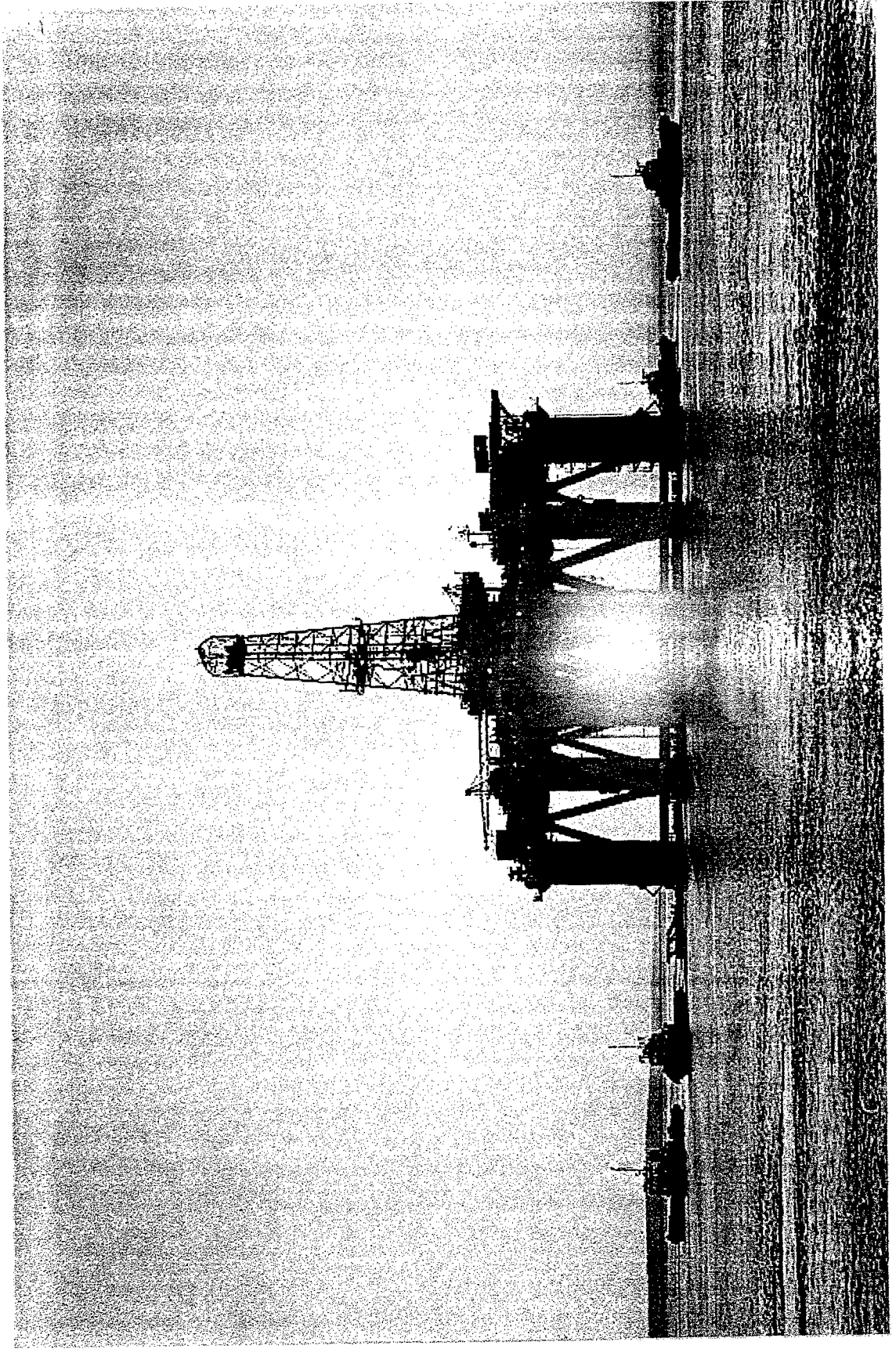
Sado's Estuary - access to shipyard



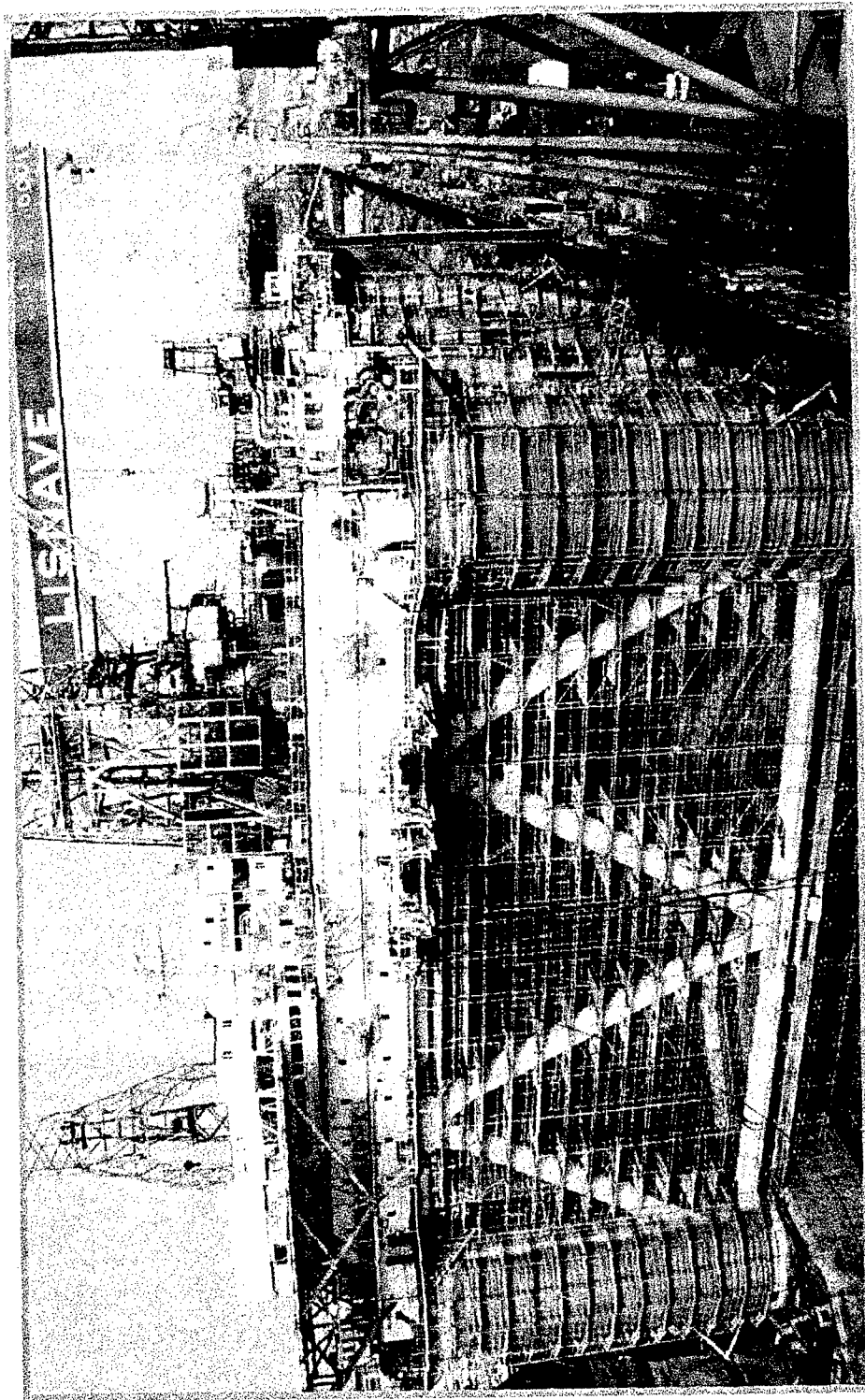
Sado's Estuary - access to shipyard



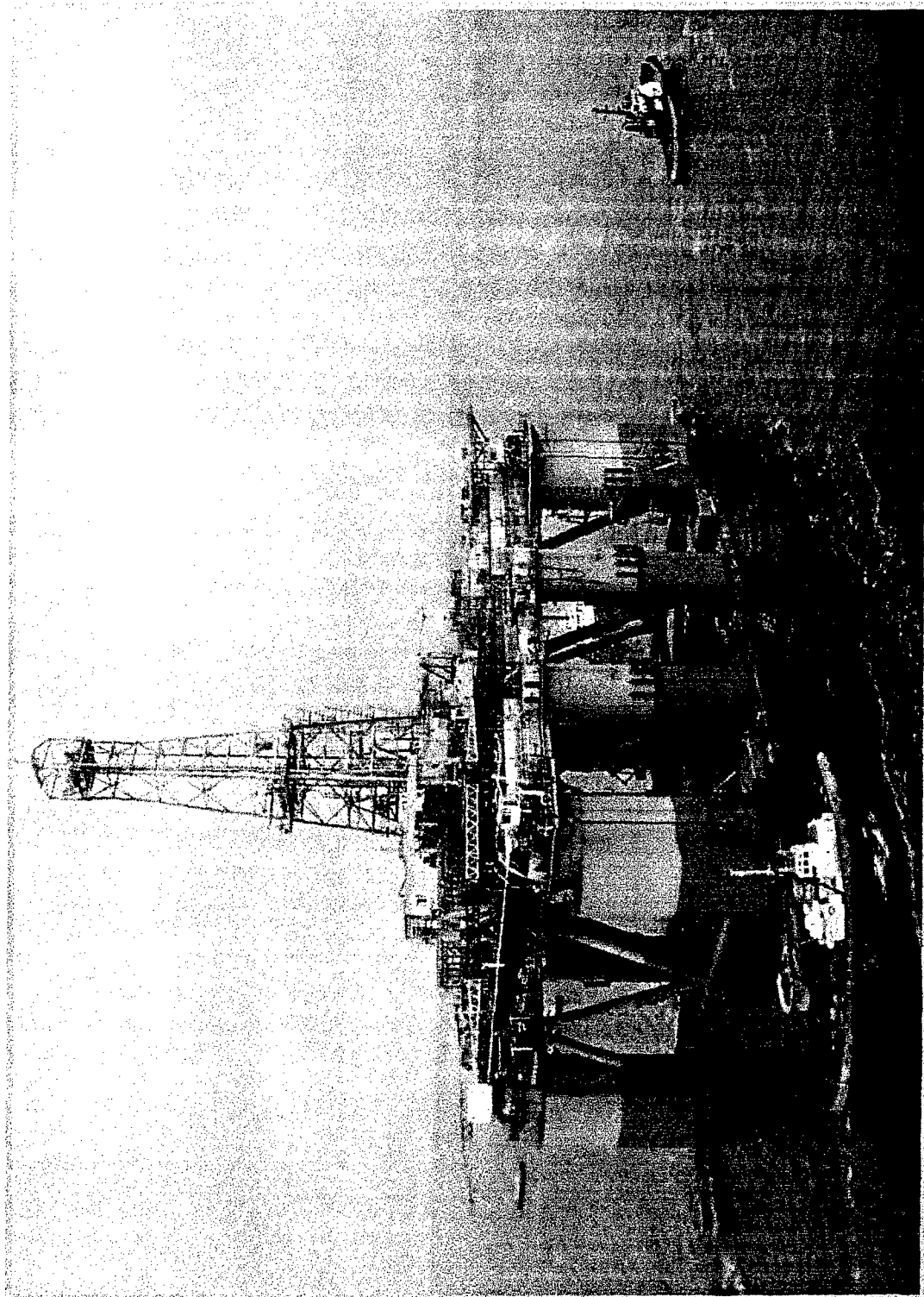
The conversion market



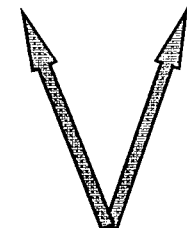
Petrobrás P-X



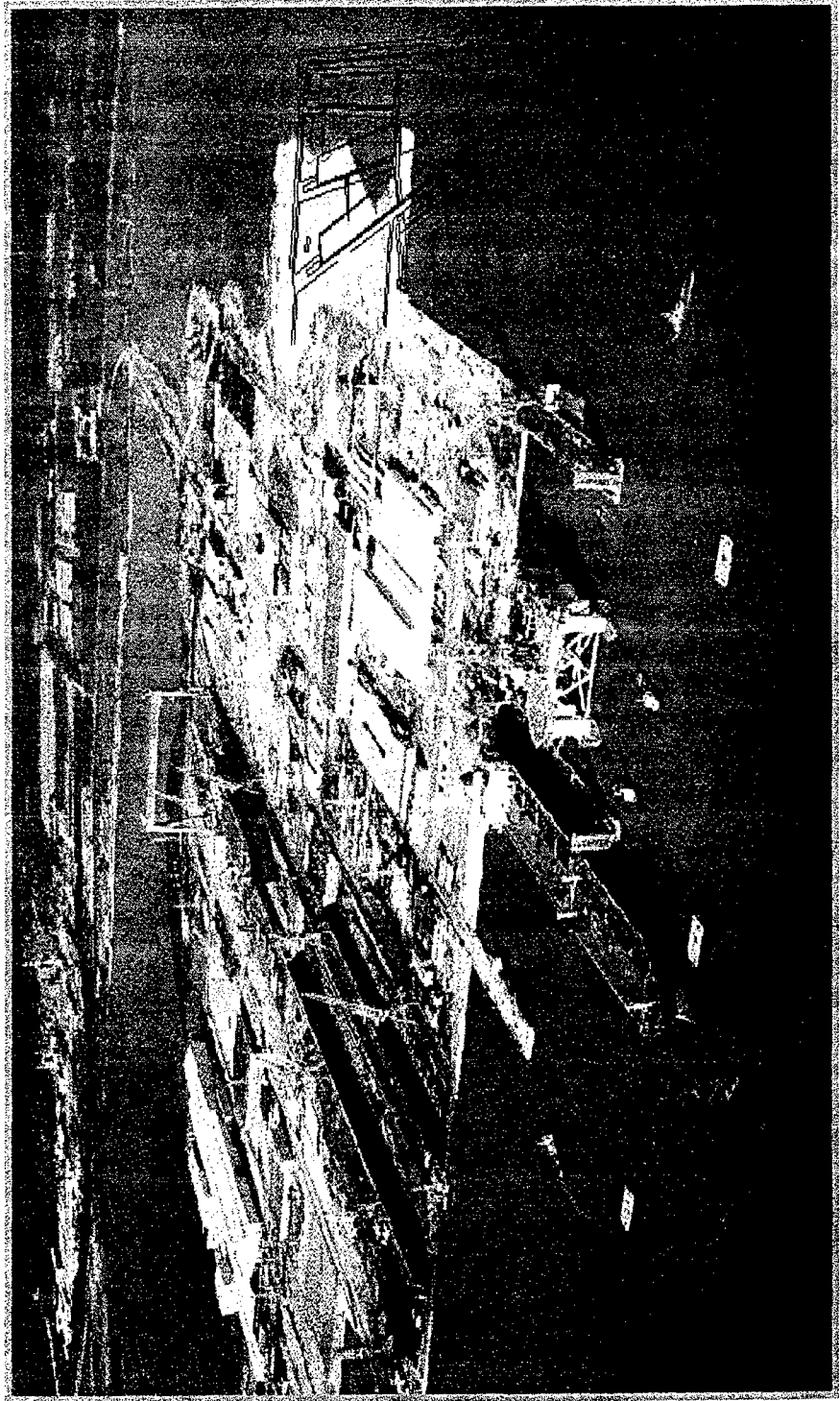
Petrobrás P-X



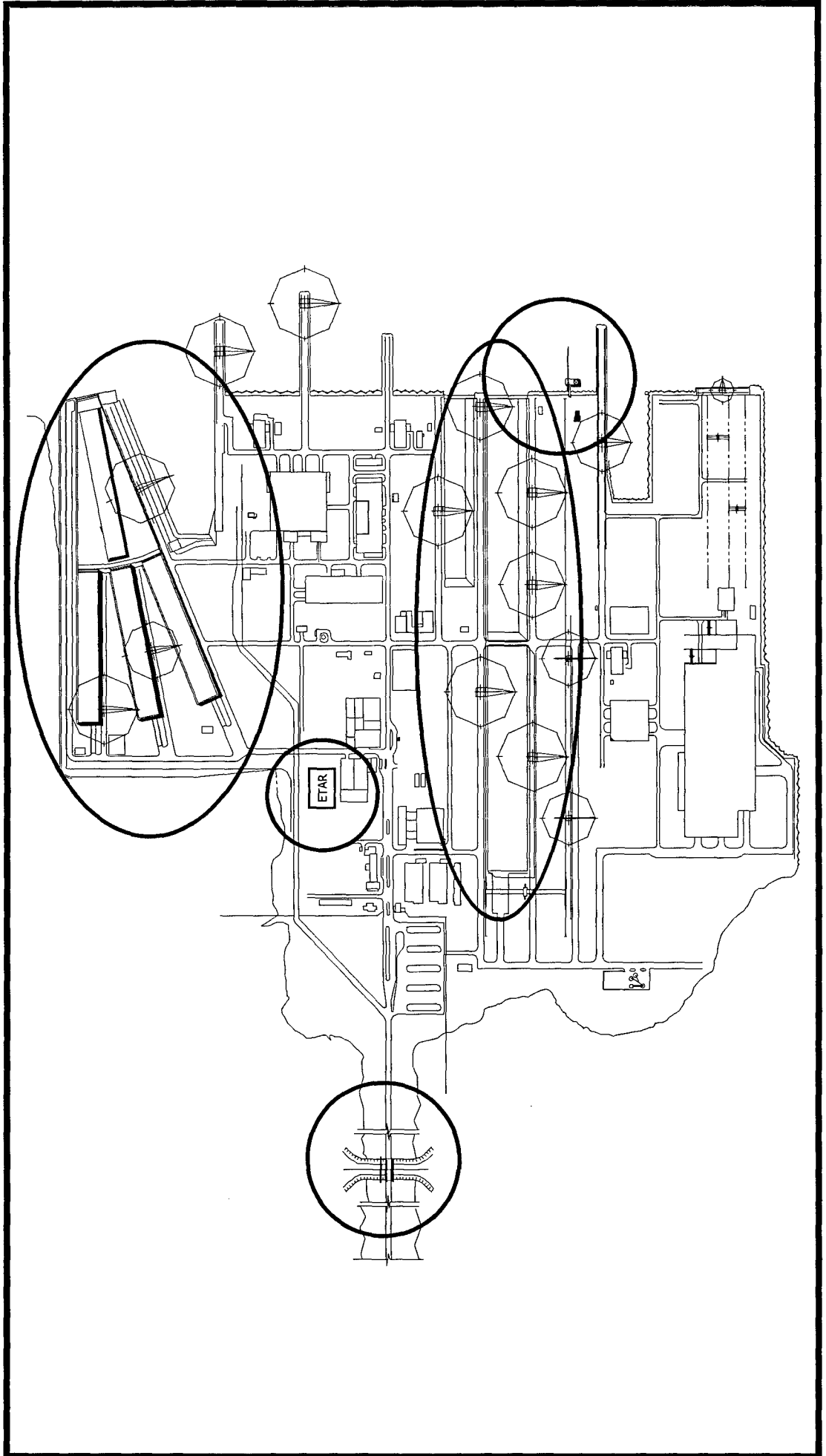
Conversion wastes

- GRIT
 - METAL SCRAP
 - INSULATION MATERIAL (INCLUDING ASBESTOS)
 - URBAN WASTES
 - OILY WASTES
 - BATTERIES
 - OFFSHORE INDUSTRY
- OILY WATER
- OILY SLUDGES
- 
- ```
graph TD; OW[OILY WASTES] --> OWater[OILY WATER]; OW --> OS[OILY SLUDGES];
```

# *New Mitrena shipyard*



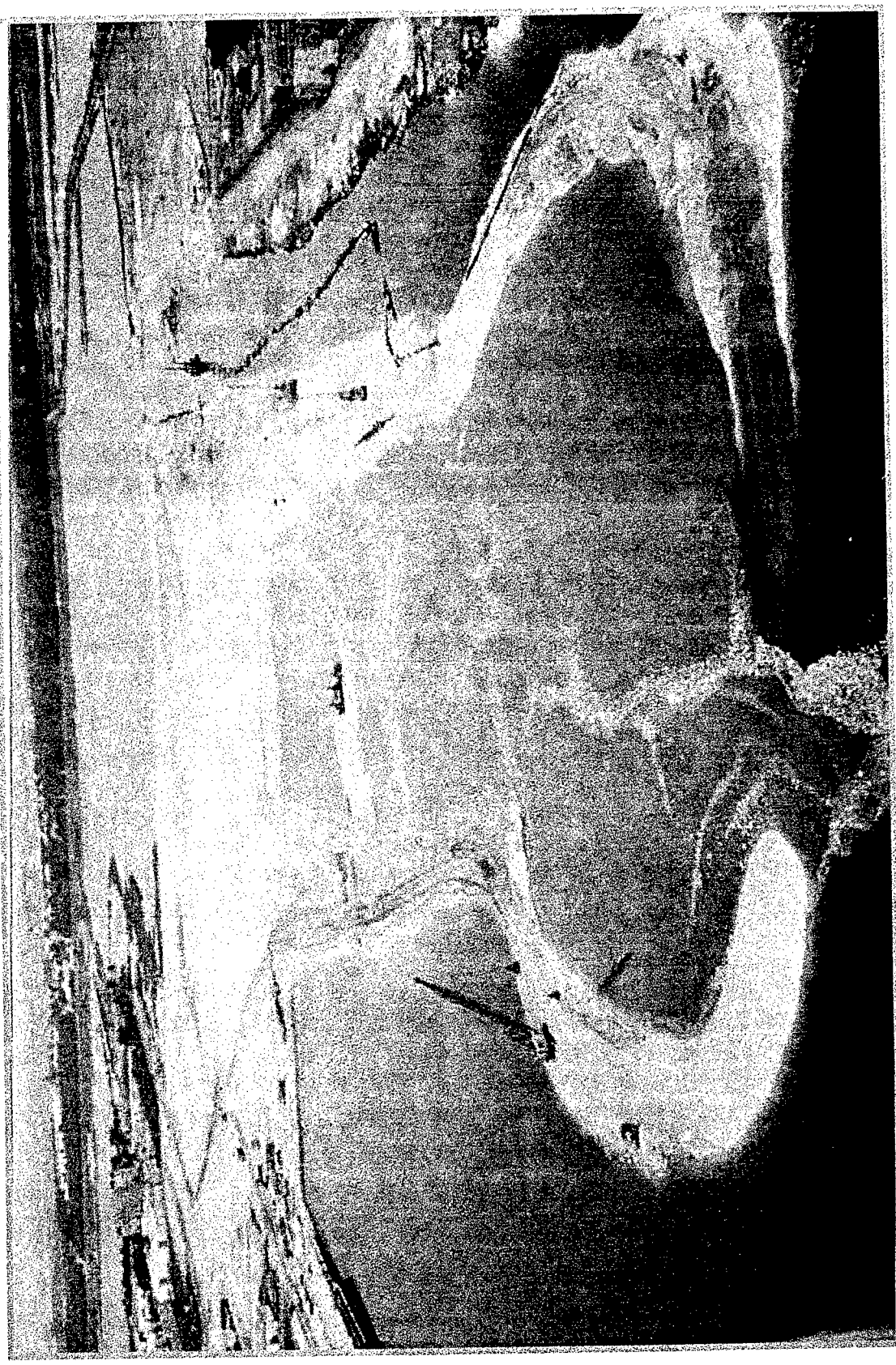
# *Master plan*



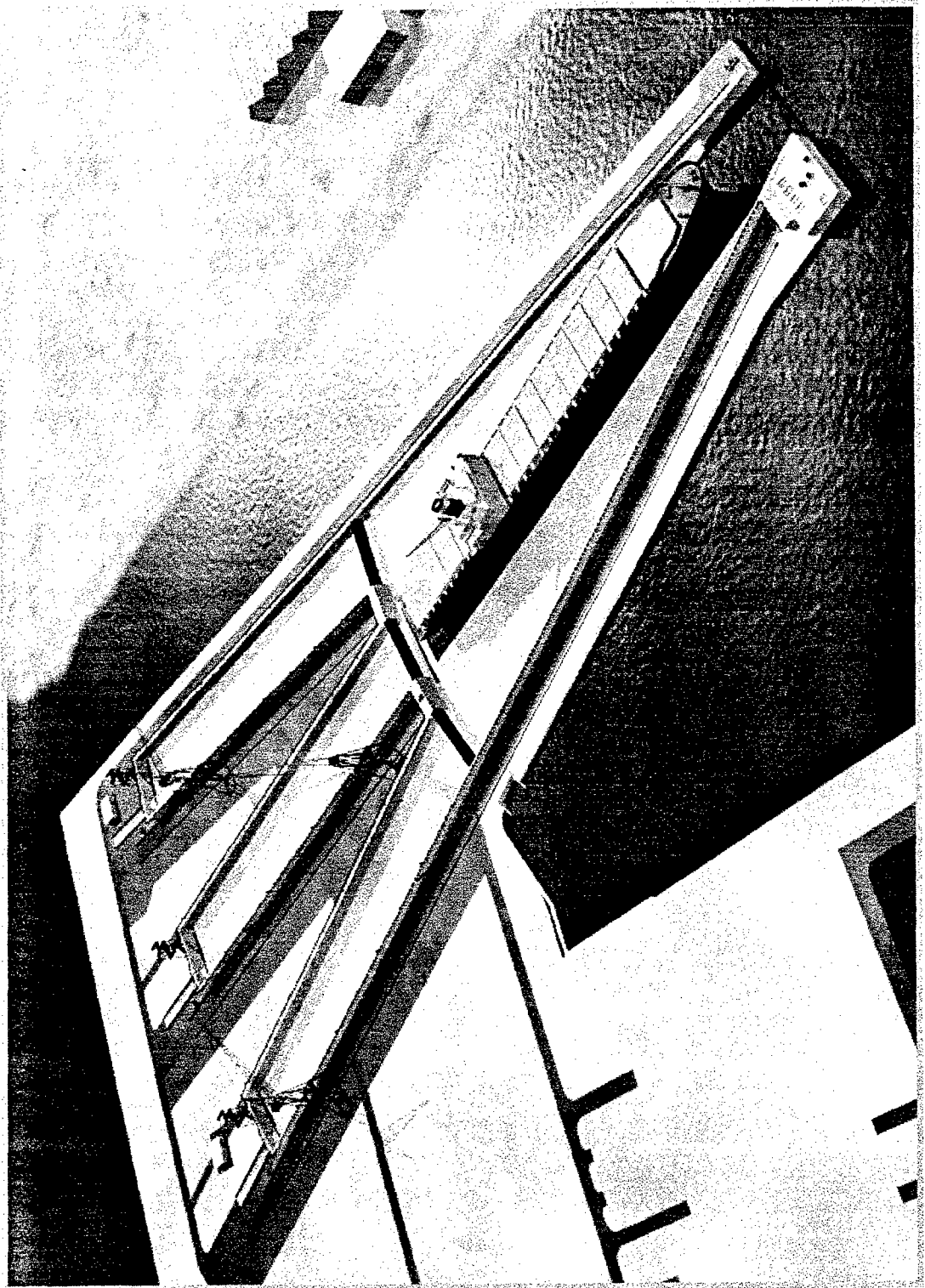
# ***New Viaduct***



# ***Aerial View of Hydrolift Area***

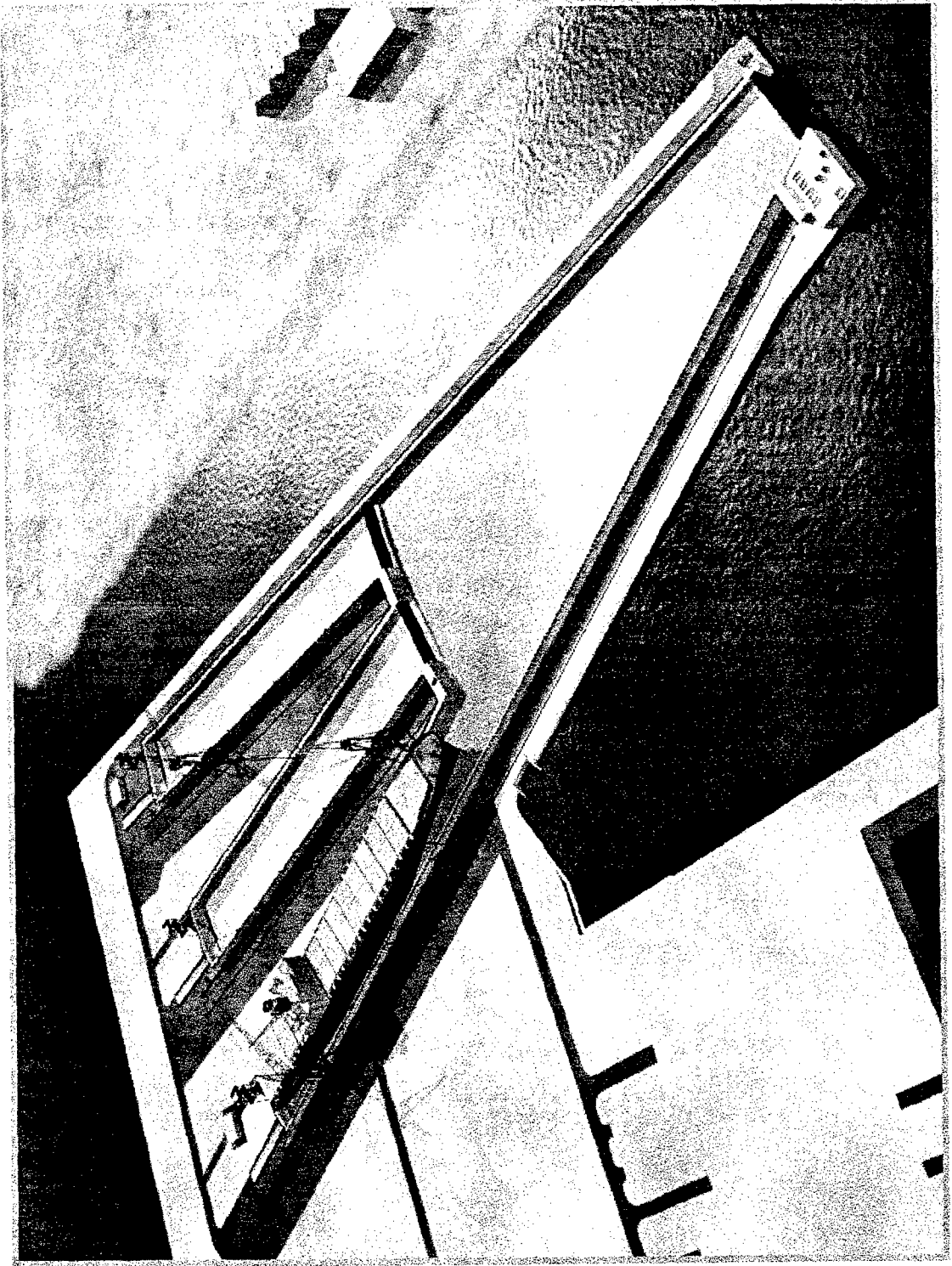


# *Hydrolift*



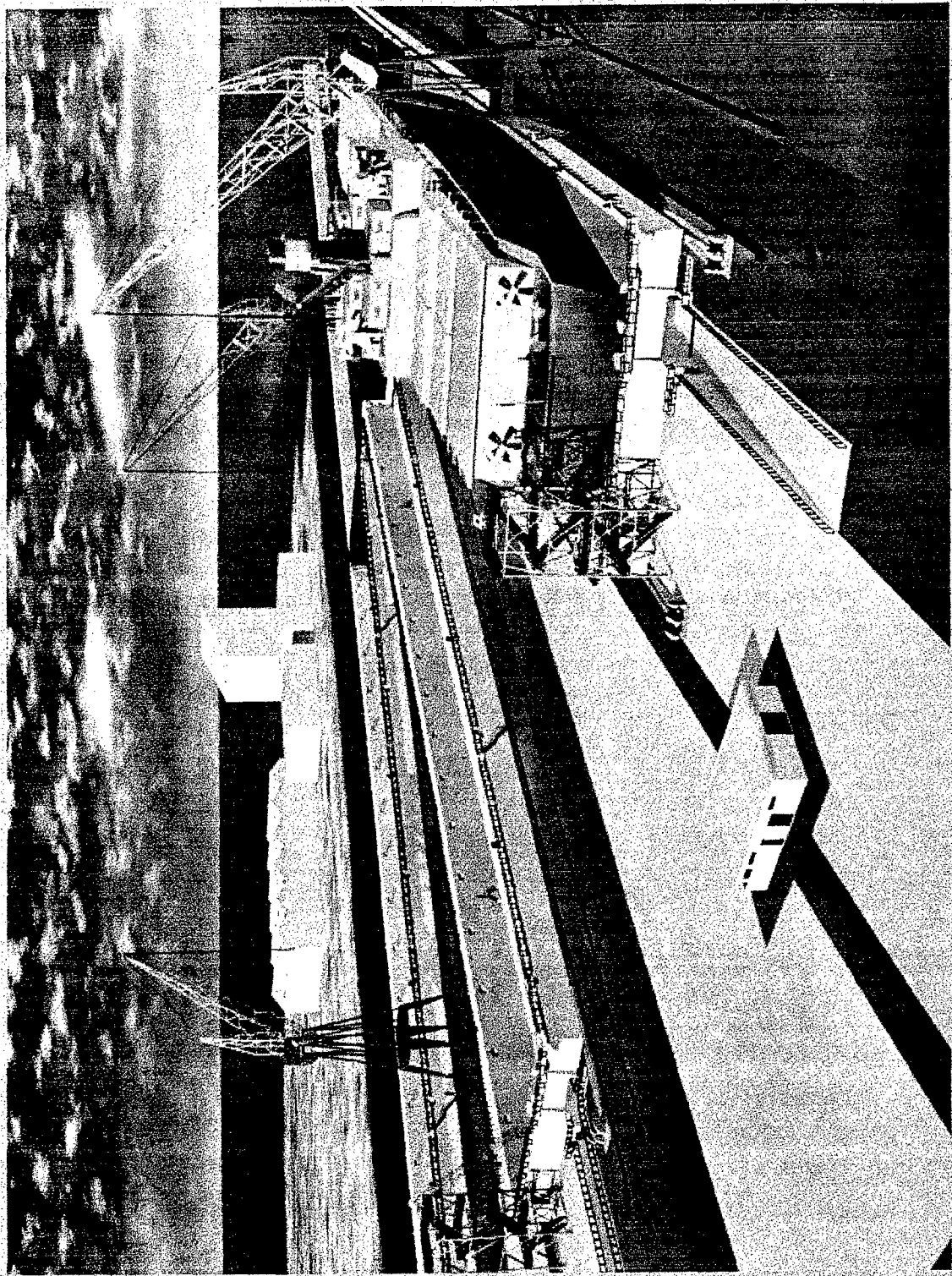


# Hydrolift

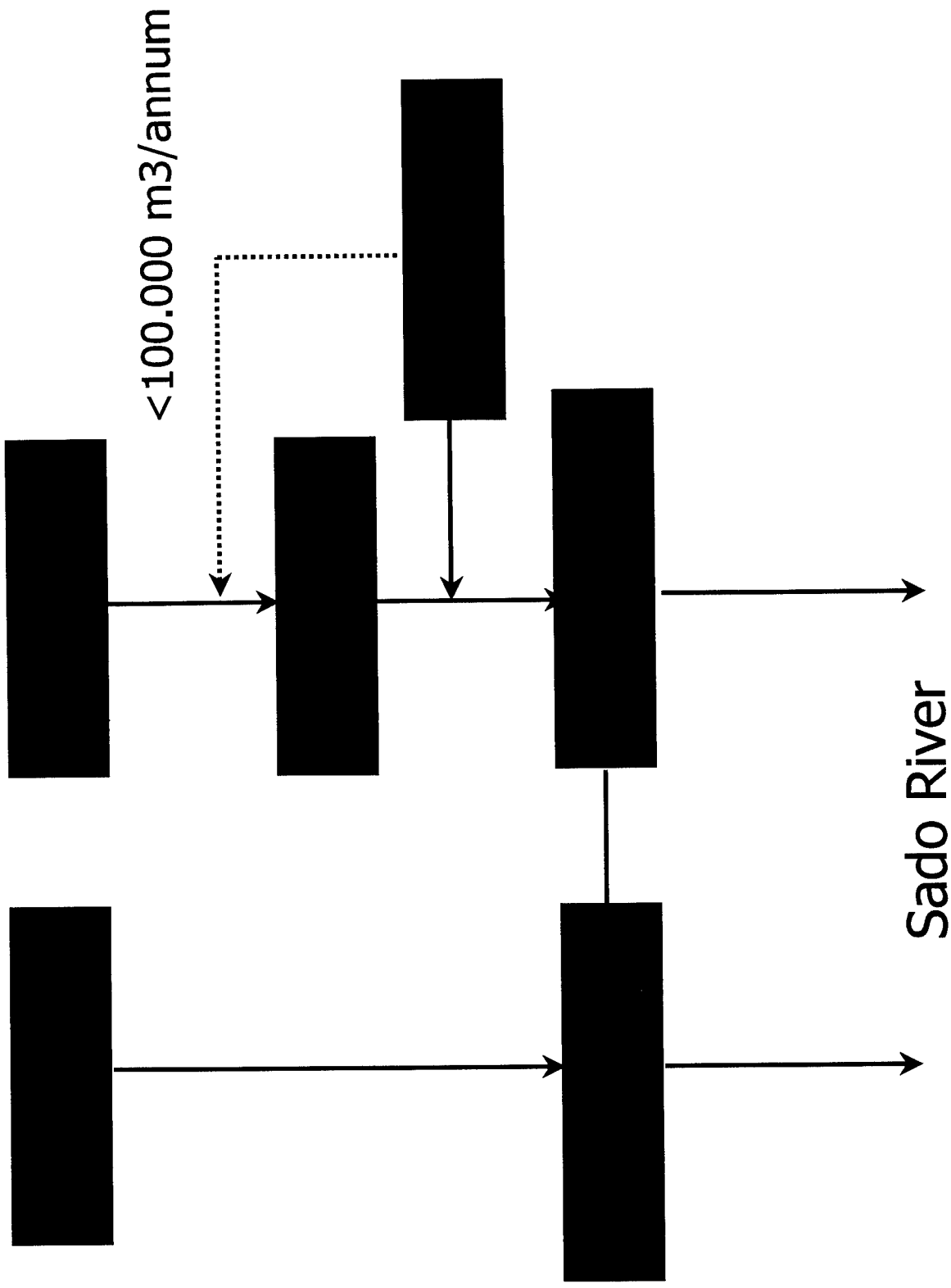




# *Hydrolift*

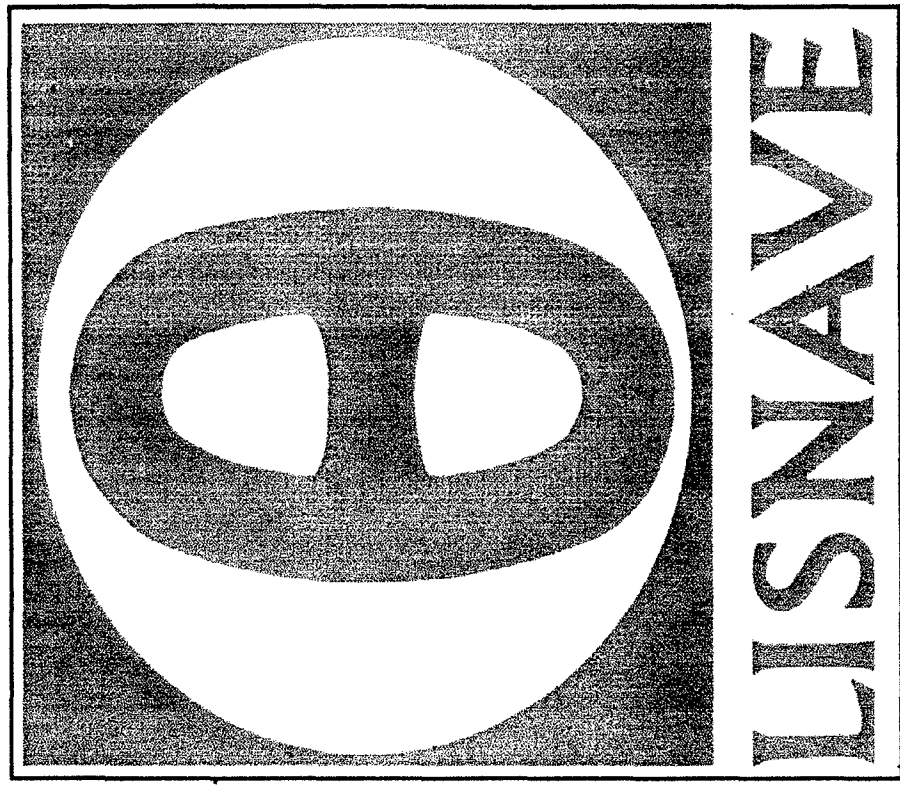


# Environmental Protection



# *Emission Limit Values for discharges of waste water*

| Parameters                   | Results              | VLE                | Parameters       | Results                                  | VLE  |
|------------------------------|----------------------|--------------------|------------------|------------------------------------------|------|
| pH (O)                       | Sorensen Scale       | 6.0-9.0            | Phenols          | mg/l of C <sub>6</sub> H <sub>5</sub> OH | 0.5  |
| Temperature (O)              | °C                   | Increase 3°C       | Oils and greases | mg/l                                     | 15   |
| BDO, 20°C (20) (O)           | mg/l O <sub>2</sub>  | 40                 | Sulfurs          | mg/l S                                   | 1.0  |
| COD (O)                      | mg/l O <sub>2</sub>  | 150                | Sulfides         | mg/l SO <sub>3</sub>                     | 1.0  |
| TSS (O)                      | mg/l                 | 60                 | Sulfates         | mg/l SO <sub>4</sub>                     | 2000 |
| Aluminium                    | mg/l Al              | 10                 | Total Phosphorus | mg/l P                                   | 10   |
| Total Iron                   | mg/l Fe              | 2.0                | Amonia Nitrogen  | mg/l NH <sub>4</sub>                     | 10   |
| Total Manganese              | mg/l Mn              | 2.0                | Total Nitrogen   | mg/l N                                   | 15   |
| Smell                        | -                    | Non visible        | Nitrates         | mg/l NO <sub>3</sub>                     | 50   |
|                              |                      | on a 1:20 dilution | Aldehydes        | mg/l                                     | 1.0  |
| Colour (O)                   | -                    | Non visible        | Total Arsenic    | mg/l As                                  | 1.0  |
|                              |                      | on a 1:20 dilution | Total Lead       | mg/l Pb                                  | 1.0  |
|                              |                      | Non visible        | Total Cadmium    | mg/ Cd                                   | 0.2  |
|                              |                      | on a 1:20 dilution | Total Chromium   | mg/l Cr                                  | 2.0  |
| Available Residual Chlorine: |                      |                    | Chromium (VI)    | mg/l Cr (VI)                             | 0.1  |
| Free                         | mg/l Cl <sub>2</sub> | 0.5                | Total Copper     | mg/l Cu                                  | 1.0  |
| Total                        | mg/l Cl <sub>2</sub> | 1.0                | Total Nickel     | mg/l Ni                                  | 2.0  |
|                              |                      |                    | Total Mercury    | mg/l Hg                                  | 0.05 |
|                              |                      |                    | Total cyanides   | mg/l CN                                  | 0.5  |
|                              |                      |                    | Mineral oils     | mg/l                                     | 15   |
|                              |                      |                    | Detergents       | mg/l                                     | 2.0  |





# Computational Fluid Dynamics Modeling of Compensated Fuel/Ballast Systems to Minimize Overboard Discharge of Fuel

Peter A. Chang, III\* and Ivan Caplan\*\*

Carderock Division

Naval Surface Warfare Center

9500 MacArthur Blvd.

West Bethesda, Maryland 20817-5700, USA

\*Hydromechanics Directorate

\*\*Environmental Quality Department

## ABSTRACT

Compensated fuel/ballast tanks (CFBTs) are used by the US Navy in four of its combatant classes of ships to maintain trim and draft. In such ships, when fuel is consumed, it is replaced by seawater in order to maintain approximately the same ship displacement and center of gravity. However, the compensating water discharged overboard during refueling often contains concentrations of (fuel) oil in excess of local environmental regulations. The US Navy has undertaken an extensive research and development (R&D) effort to assess the current performance of CFBTs during refueling operations and to develop and propose improvements to their design which could be implemented in ship classes currently under construction or in the design stage. This paper describes the computational fluid dynamics (CFD) analysis efforts performed by Carderock Division, Naval Surface Warfare Center (CDNSWC) to assess the complex flows in the CFBTs of the Arleigh Burke (DDG 51) class of US Navy guided missile destroyers. As currently designed, DDG 51 CFBTs have a large amount of internal structure that promotes fuel/water mixing and, thus, entrainment of fuel in the seawater. CFD analyses, however, have shown that with relatively minor modifications to the structure, the mixing can be minimized and even eliminated. Further analyses and experiments designed to validate and refine models for fuel entrainment also will be described. With the right analysis tools, there is a high probability that compensated fuel/ballast tanks can be designed in future ship classes to reliably meet stringent world-wide oily waste discharge regulations.



**COMPUTATIONAL FLUID DYNAMICS MODELING OF  
COMPENSATED FUEL/BALLAST SYSTEMS TO MINIMIZE THE  
OVERBOARD DISCHARGE OF FUEL OIL**

Peter A. Chang III\* and Ivan L. Caplan\*\*

Carderock Division  
Naval Surface Warfare Center  
9500 MacArthur Blvd.  
West Bethesda, MD 20817 – USA  
\* Hydromechanics Directorate  
\*\* Environmental Quality Department

**ABSTRACT**

Compensated fuel/ballast tanks (CFBTs) are used by the US Navy in many of its combatant classes of ships to maintain trim and draft. In such ships, when fuel is consumed, it is replaced by seawater in order to maintain approximately the same ship displacement and center of gravity. However, the compensating water discharged overboard during refueling often contains concentrations of (fuel) oil in excess of local environmental regulations. The US Navy has undertaken an extensive research and development effort to assess the current performance of CFBTs during refueling operations and to develop and propose improvements to their design which could be implemented in ship classes currently under construction or in the design stage. This paper describes the computational fluid dynamics (CFD) analysis efforts performed by Carderock Division, Naval Surface Warfare Center (CDNSWC) to assess the complex flows in the CFBTs of the Arleigh Burke (DDG-51) class of US Navy guided missile destroyers. As currently designed, DDG-51 CFBTs have a large amount of internal structure that promotes fuel/water mixing and, thus, entrainment of fuel in the seawater. CFD analyses, however, have shown that with relatively minor modifications to the structure, the mixing can be minimized and even eliminated. Further analyses and experiments designed to validate and refine models for fuel entrainment also will be described. With the right analysis tools, there is a high probability that compensated fuel/ballast tanks can be designed in future ship classes to reliably meet stringent world-wide oily waste discharge regulations.

---

\*\* Presenter



## INTRODUCTION

The US Navy has four classes of compensated fuel/ballast ships: DD 963, DDG 993, CG 47, and DDG 51. At all times, the fuel/ballast tanks are completely full of fuel and/or water enabling the ship to maintain uniform trim and seakeeping characteristics. After refueling, the tanks are essentially full of fuel; as the fuel is used, quantities of seawater ("compensating water") from the ship's firemain enter the bottom of the tanks. During refueling, the compensating water is discharged overboard as it is displaced by fuel.

Figure 1 shows that the tanks are arranged in groups of three or more which include a receiving/storage tank, two or more fuel storage tanks, and an expansion tank. The entire tank group is filled from a single inlet upstream of the receiving tank, thus simplifying refueling operations. The fuel is pumped into the top of the receiving tank, the pressure forcing the water out the bottom, through a sluice pipe into the next tank, and so on; the tanks filling in a sequential fashion. Typical at-sea refueling rates are 50–100 ℓ/sec, while in-port rates are 10-30 ℓ/sec.

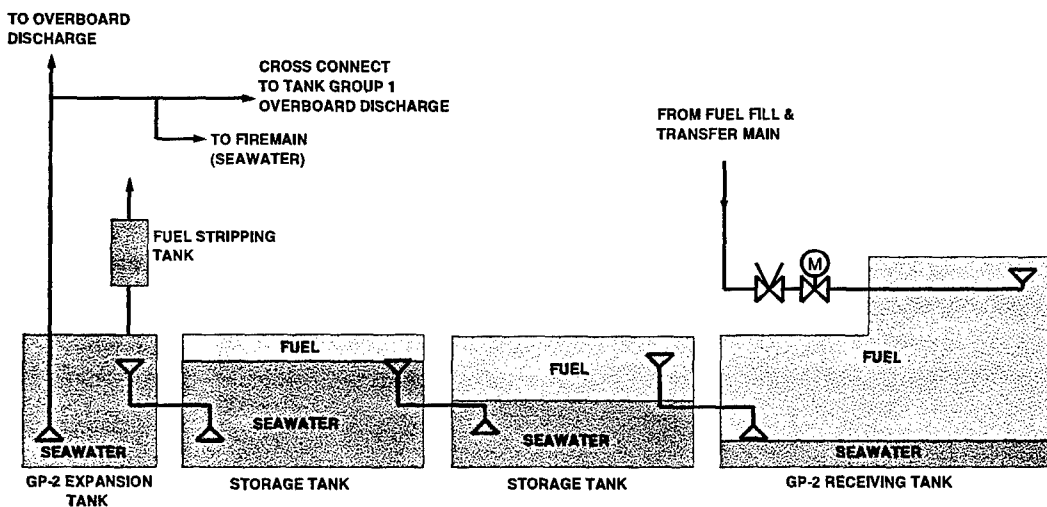


Figure 1: Schematic of a typical tank group in a compensated fuel/ballast ship.

There are advantages and disadvantages in employing a compensated fuel/ballast system. The advantages of such a system are smaller ship size, greater draft, improved survivability and reduced manning requirements. Sharing ballast and fuel tanks allows a significantly smaller ship since the center of gravity, and thus, the stability characteristics, are essentially the same at all times; for the DDG 51, a 1.4 m smaller beam (out of a maximum beam of approximately 18 m) meets the US Navy stability requirements. The draft of such a compensated ship is about 0.5 m greater, allowing for improved sonar operations, a larger, quieter, more efficient propeller, and reduced probabilities of slamming. Compensated ships provide better survivability. Since the fuel tanks are always full of liquid, there is no chance of setting off an explosion in an empty tank. Also, the tanks provide liquid layers to absorb torpedo or missile damage. Since the off-center tanks are

always full, below-the-waterline damage will not cause off-center flooding.

The major disadvantage of using a compensated fuel/ballast system is that without proper precautions, fuel/water mixing during refueling will result in fuel oil being discharged overboard with the compensating water. This can range from trace amounts to slugs of fuel. Strict environmental regulations, outlined below, prohibit such discharges and potentially restrict the operating envelope of such compensated ships. Also, sounding the tanks is difficult since tank level indicators (TLIs) must monitor the level of the fuel/water interface. Monitoring the fuel levels within the tanks is critical for preventing overboard discharge of fuel. However, as shown in this work, structural encumbrances often prohibit the TLIs from properly assessing the location and amount of fuel within a tank especially during refueling. The complex internal tank structure also results in large amounts of seawater remaining in the tanks after fueling. This problem is exacerbated by the necessity to terminate refueling prior to maximizing water discharge because of risk of discharging concentrations of fuel in excess of existing requirements. This "water hideout" problem is caused by the combination of the water being trapped by the internal structure and the short-circuiting of fuel from inlet to exit. Depending on the criteria for termination of refueling, up to 90 percent of the water can be left in the last fuel storage tank at the end of refueling.

## Current CFBT Design

Despite these problems, the US Navy has about 85 active compensated ships with approximately 25 more becoming active in the next few years. Figure 2 shows DDG 51 tank 5-300-2-F. A photograph taken inside one of the tanks is shown in Figure 3. Each DDG 51 class ship has six tank groups — two forward, two amidships and two aft. The tanks are in the bottom of the ship, and comprise the ship's structural backbone. The full depth structural elements inside the tank are the longitudinal and transverse "floors." In addition, there are 30 cm deep longitudinal stiffeners. To allow access throughout the tanks, there are 38 cm × 58 cm "manholes" in the floors; also, there are 15 cm diameter "limber" holes. In Figure 2, the tank inlet is a "bellmouth" at the forward end of the tank, while the tank exit is another bellmouth at the aft end of the tank. This inlet/outlet configuration will be referred to as the "point-to-point" configuration.

## Environmental Regulations and Constraints

The concentration of fuel oil in the compensating water is of the utmost concern to the US Navy. Department of Defense (DoD) Directive 6050.15 directs that the overboard discharge of oily waste from US Navy ships shall not contain more than 20 ppm oil in-port and 100 ppm at-sea. International regulations promulgated recently by MARPOL require an oil-in-water discharge concentration equal to, or less than, 15 ppm regardless of the ship's location. It is anticipated that this requirement will be further reduced to a maximum of 5 ppm in the near future. In addition, the coastal states of the United States have

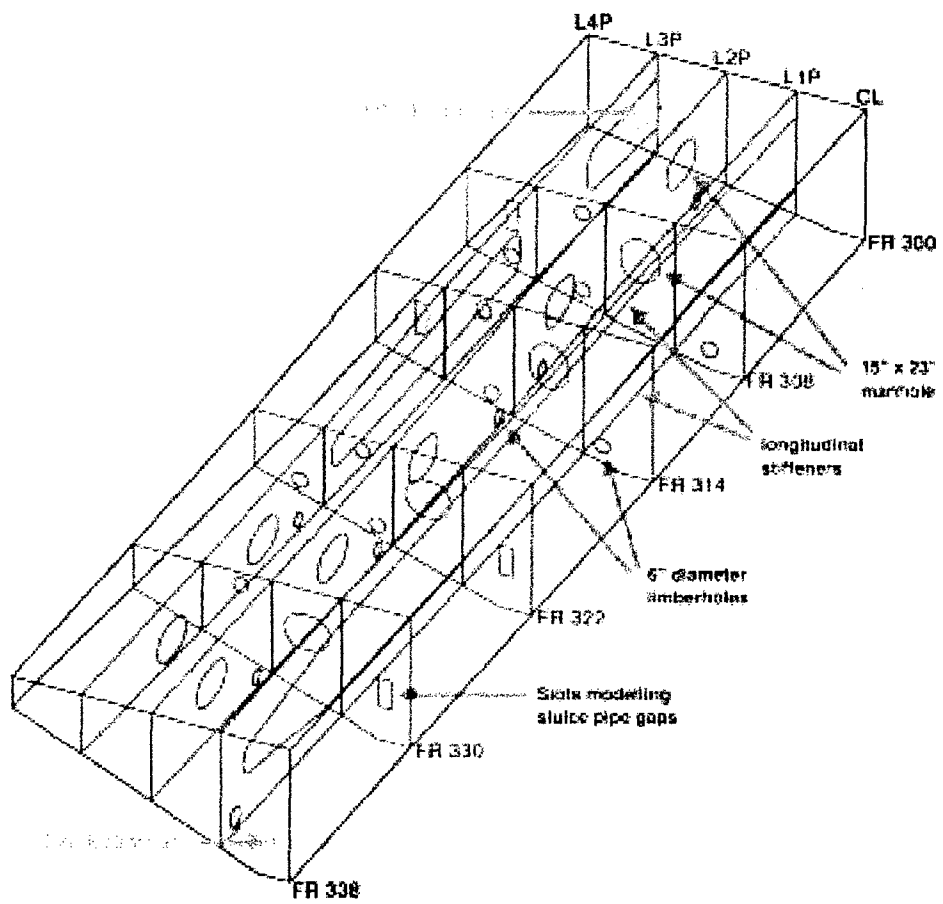


Figure 2: Isometric view drawing of DDG 51 tank 5-300-2-F.

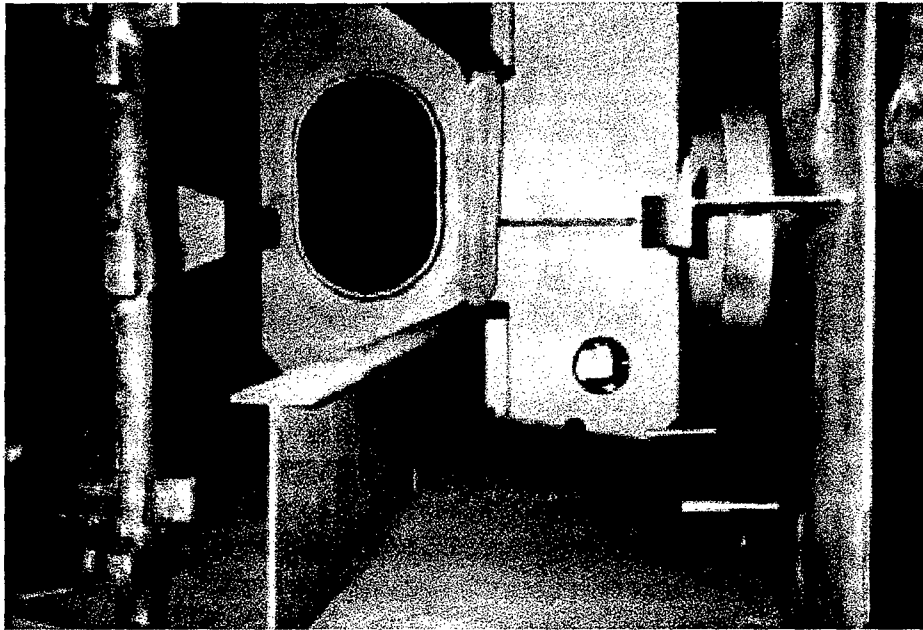


Figure 3: Photograph taken inside compensated fuel/ballast tank.

varying requirements on the overboard discharge of oily waste. It may be necessary to modify refueling procedures and/or fuel tank structures or develop methods to treat the compensating water prior to discharge overboard in order to ensure that the operations of these ships are unencumbered.

## US Navy Research and Development Efforts

The objective of US Navy R&D effort is: to assess the present performance and problems of compensated fuel/ballast tanks and, if necessary, to modify existing tank designs such that the compensating water discharged overboard during refueling meets present and future environmental regulations. For these purposes a multi-year computational and experimental validation program has been undertaken in which CFD is used as the primary assessment tool. Experiments will provide vitally important data for verification and validation of the CFD codes; by providing a quantitative understanding of two-fluid physics state-of-the-art CFD predictive capabilities will be developed. For example, information about droplet formation, fuel entrainment, droplet advection and agglomeration is necessary for formulating CFD models so that they may accurately predict the fuel content in the compensating water.

This paper will describe results of the CFD assessment of refueling of one of the DDG 51 mid-group tanks, the various flow problems within the tank, and the analysis of proposed tank modifications. In these simulations our first generation computational fluid dynamics models[3, 4] have been used. To date, the fuel/water interface physics have not been incorporated in these models. However, it is believed that the current sim-

ulations can successfully assess the bulk flow through the tanks and predict, qualitatively, where fuel entrainment is most likely to occur. Also, it has been possible to determine the locations and amounts of water hideout within the internal tank structure.

## COMPUTATIONAL APPROACH

The three dimensional viscous flow solver CFX-F3D Version 4.2 by AEA Technologies, was used to perform the simulations. The fuel and water flows were modeled as incompressible, and the two fluids were assumed to obey a Newtonian stress-strain relationship. The homogenous multiphase (HMP) model was used which solves a single set of momentum and mass conservation equations for both fluids and separate volume fraction equations for each fluid. With the HMP it is assumed that in each computational subvolume both fluids move with the same velocity. This is accurate if one fluid is displacing another, e.g., when the velocity is normal to the fuel/water interface. In the case where the velocity is tangent to the fuel/water interface, discontinuities across the interface cannot be accounted for since each subvolume has only a single or "averaged" velocity. The HMP then, assumes that the velocity discontinuity has been instantaneously eliminated by shear between the two fluids. Shear would tend to mix both fluids and their velocities, in effect diffusing all flow quantities across the interface. Modeling the real behavior of two fluids would require using a multi-fluid model which is presently being developed[2]. The homogenous model is considered to have sufficient accuracy for studying both the bulk flow of fuel through the tank and water hideout. While it cannot directly address the issues of mixing or settling, the flow information from homogenous simulations can give indications of where and when mixing will occur, based simply on regions where there are high rates of velocity shear at the fuel/water interface. For that reason, it is believed that the information from these simulations will give guidance as to the relative amount of mixing that will occur throughout the various geometries. For display purposes, it is assumed that above the 0.5 volume fraction surface the liquid is pure fuel; and, below the surface, the liquid is pure water. This assumption is used in all the results shown in this paper.

The densities of water and fuel were assumed to be  $1000 \text{ kg/m}^3$  and  $841 \text{ kg/m}^3$ , respectively. The dynamic viscosities were  $1.0 \times 10^{-3} \text{ kg/(m} \cdot \text{sec)}$  and  $5.8 \times 10^{-3} \text{ kg/(m} \cdot \text{sec)}$ , respectively. All simulations start with the tank full of water with fuel entering the tank at the nominal at-sea refueling rate of  $63 \text{ l/sec}$  ( $1000 \text{ gpm}$ ). Figure 4 shows a typical grid for a transverse floor. Even with such a coarse grid, a computational mesh of approximately 160,000 cells is required to discretize the tank. The typical cell sizes are about 7.6 cm cubes which are small enough to resolve the displacement flows throughout the tank, but not necessarily all the complex flow details. The refueling evolution takes approximately 500 seconds. A computational time step size of 2.5 seconds was used which can account for most of the important transient flow phenomena, such as the buoyant flow events, which take about 30-40 seconds. On a Silicon Graphics Origin 200 workstation the refueling simulations take on the order of two weeks.

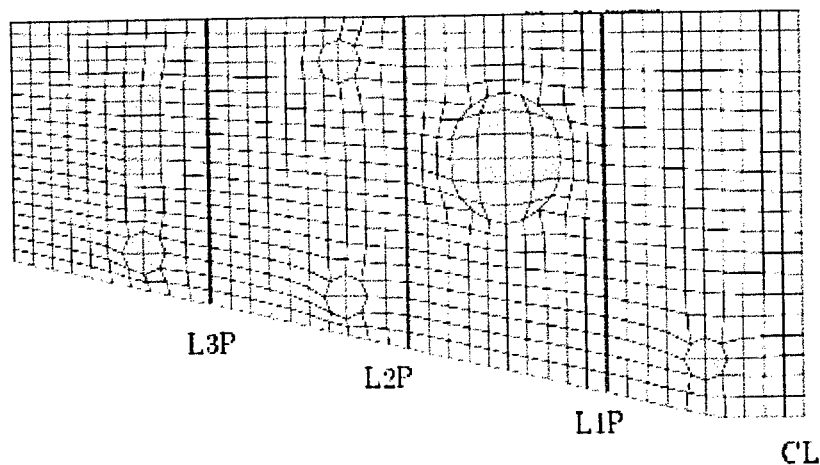


Figure 4: Typical grid showing manholes and limber holes; gray areas indicate openings; locations of longitudinal floors are demarcated as L1P-L3P.

## COMPUTATIONAL RESULTS

In this section we will discuss some of the results that have been obtained from CFD simulations of DDG 51 Tank 5-300-2-F. This is the last fuel storage tank in the mid-port group and, therefore, is a critical tank to assess. The overboard discharge from this tank group is highly dependent upon the amount of mixing that occurs during refueling. Also, being long and shallow, it is probably one of the worst tanks from an overboard discharge perspective in that it has a relatively short vertical height which could promote settling of mixed fuel/water regions. We will show the flow characteristics and water hideout for the point-to-point configuration, discuss the principles for structural design modifications, and then show results for a modified version of the point-to-point configuration. Then we will show results for the diffuser-to-diffuser configuration and the diffuser-to-diffuser configuration which has been modified. The piping and geometry configurations which will be discussed are summarized in Table 1.

### Point-to-Point Configuration

From a piping layout perspective, point-to-point is perhaps the simplest configuration, as the inlet and outlet are simple bellmouths through which fuel/water can enter/exit the tank at a single point. Figure 5 is a plan view schematic of tank 5-300-2-F with compartment numbers and longitudinal and transverse cuts where results will be shown. The fuel enters the tank by a jet in Compartment 3, spreads transversely and then longitudinally, primarily through the series of manholes into Compartments 6, 10, 14 and 18. Figure 6 shows the fuel/water configuration at  $t=160$  seconds. Here we see that the upstream part of the tank has filled and the fuel is flowing longitudinally. The fuel does not flow straight through the manholes, but enters each compartment in so-called "buoyant flow

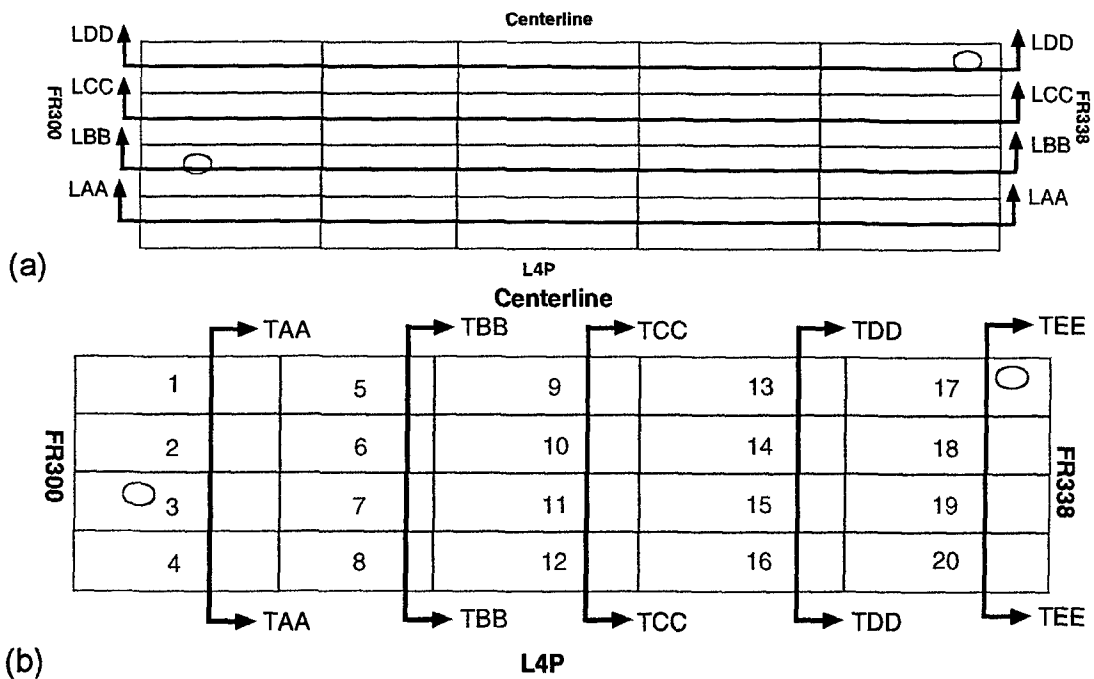


Figure 5: Location of two dimensional sectional planes for model flow simulations. (a) Longitudinal planes, (b) transverse planes.

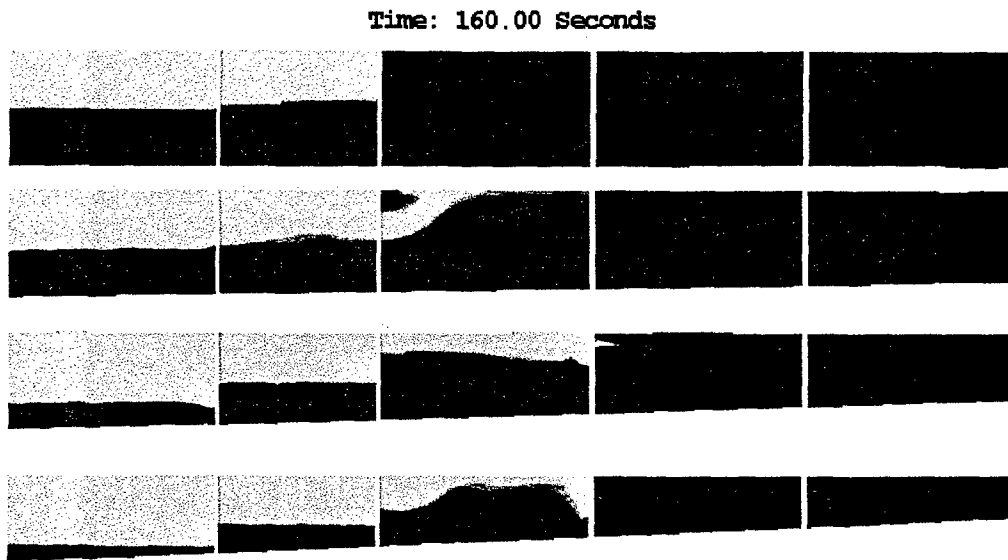


Figure 6: Fuel/water configuration for Tank C at t=160 seconds. Longitudinal slices, showing fuel (light) and water (dark), are defined in Figure 5; they are, from top to bottom, LAA, LBB, LCC and LDD respectively i.e., centerline → outboard. The forward end of the tank is to the left, the aft end to the right.

Table 1: Tank designations and their descriptions.

| Designation | Description                                                       |
|-------------|-------------------------------------------------------------------|
| Tank C      | Baseline point-to-point                                           |
| Tank E      | Point-to-point modified with 15 cm radius semi-circular openings  |
| Tank F      | Point-to-point modified with 11 cm radius semi-circular openings  |
| Tank G      | Baseline diffuser-to-diffuser                                     |
| Tank I      | Diffuser-to-diffuser modified with 15 cm radius circular openings |

events." The chronology of such an event, shown in Figure 7 is as follows: 1) The fuel fills the upper part of a compartment upstream of an opening in a tank floor. 2) When the fuel/water interface reaches the upper edge of the opening, fuel is advected through the opening. 3) The fuel, now downstream of the opening, enters into a compartment filled primarily with water and buoyancy forces drive the fuel upward. 4) The fuel forms a jet-like flow which impinges on the tank top and causes a recirculation zone directly downstream of the opening. The jet, which turns sharply upward, and the recirculation zone are regions where the fuel/water interface will break down causing fuel to become entrained in the compensating water. 6) The water, now contaminated with fuel, is advected downstream where it eventually goes out the exit sluice and is discharged through the expansion tank and overboard. The current computational fluid dynamics program cannot predict the amount of fuel that will become entrained in the compensating water. However, the volume fraction distributions and velocity vector plots indicate the relative amount of entrainment for various configurations.

Buoyant flow events occur through all the manholes; they also occur beneath all the 30 cm deep longitudinal stiffeners. The buoyant flow events beneath the stiffeners have much smaller velocities than through the manholes, but because of the long horizontal extent of the stiffeners, the buoyant flow events have a much greater surface area for entrainment to occur.

A more quantitative measure of the magnitude of the buoyant flow events is obtained from the maximum fuel flow rates into each of the compartments. These data indicate that each of the compartments fills with fuel in a step-like manner. Figure 8, shows that the volume of fuel in Compartment 6 is nil for the first 80 seconds. A buoyant flow event starts at about 90 seconds; the flow rate (slope of the fuel volume curve) quickly increases, reaching a maximum flow rate of 31  $\ell/\text{sec}$  at about  $t=105$  seconds. For the point-to-point configuration, the maximum flow rates are slightly smaller toward the middle compartments, but then increase dramatically near the exit. In fact, the maximum flow rate into Compartment 17, which contains the exit sluice, is 91  $\ell/\text{sec}$  — almost 50 percent greater than the 63  $\ell/\text{sec}$  flow rate into and out of the tank. It is hypothesized that a large



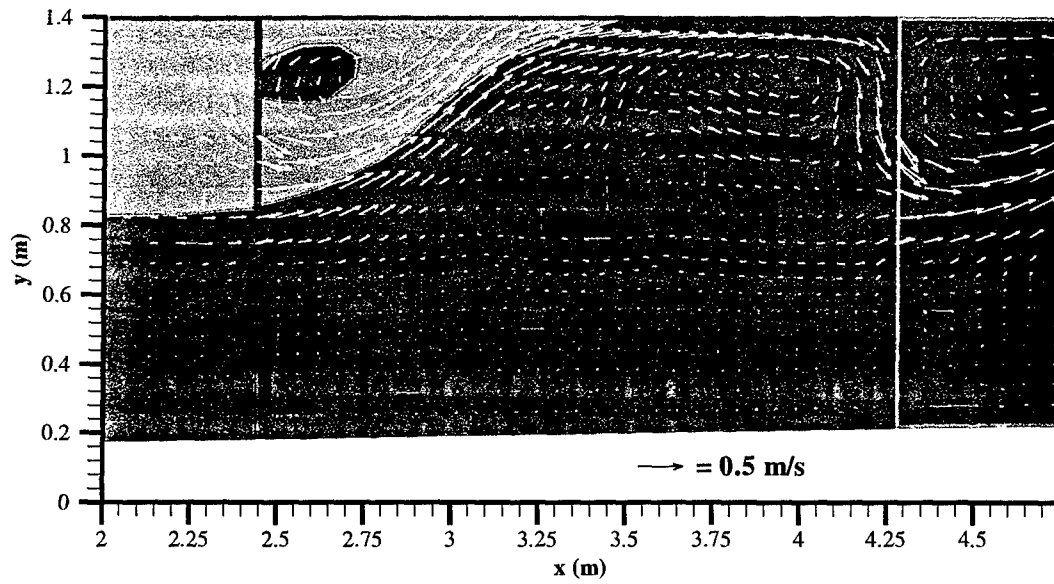


Figure 7: Buoyant flow event through manhole into Compartment 6 for Tank C at longitudinal cut LCC at t=100 seconds. Fuel (light) and water (dark).

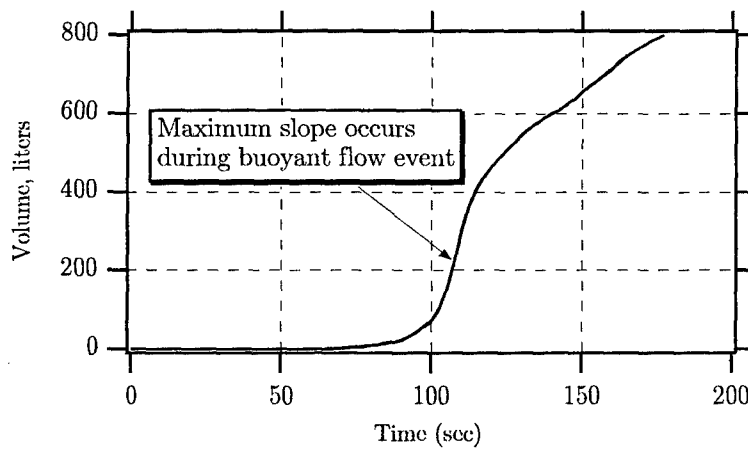


Figure 8: Fuel flow rates into compartment 6 for Tank C.

Time: 375.00 Seconds

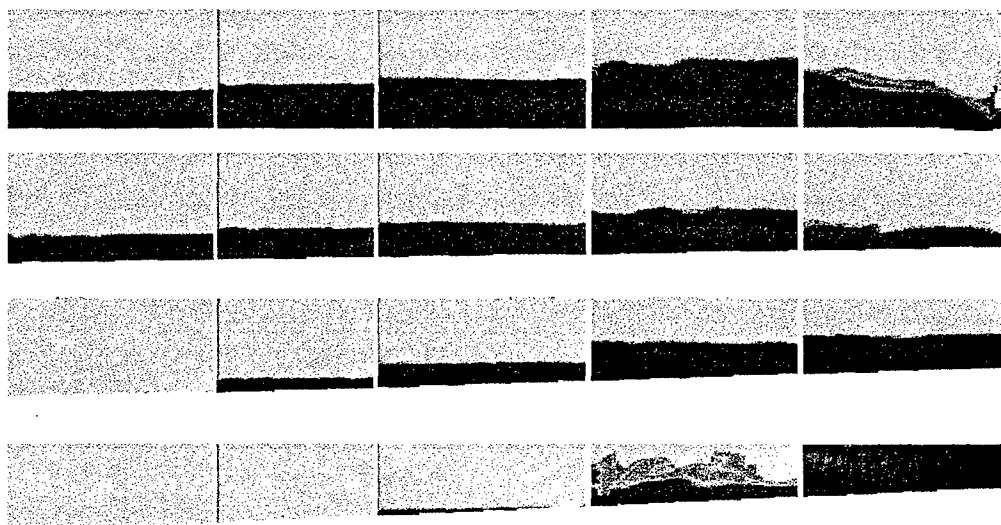


Figure 9: Fuel/water configuration for Tank C at  $t=375$  seconds — approximately when mass fuel starts to exit the tank. The exit compartment is in the upper right hand corner. See Figure 6 for explanation of data planes.

amount of mixing will occur in the same compartment as the exit bellmouth, and that a large amount of entrained fuel will be carried directly to the exit sluice, into the expansion tank, and then overboard.

Another significant problem observed is that the fuel flows directly through the row of manholes to the exit, short-circuiting many compartments. The compartments outside the main flow path are called "dead bays." The fuel enters the dead bay through a single manhole, with the water that is being displaced, flowing in the opposite direction through the same manhole. This counterflow has high velocity gradients at the fuel/water interface and high potential for fuel entrainment.

The short-circuiting of the fuel also affects the tank filling efficiency. Figure 9 shows the fuel/water configuration at a time when the mass fuel is just about reaching the exit sluice. At this time, 40 percent of the tank is filled with water. Large amounts of water are trapped in some of the dead bays, e.g., Compartments 16 and 20, and behind the L1P stiffener (Compartments 1, 5, 9 and 13).

### Modified Point-to-Point Configuration

It is hypothesized that fuel entrainment into the compensating water is due primarily to the impinging jet flow at the inlet bellmouth during the initial stages of refueling, buoyant flow events, and counterflows. The entrainment at the inlet jet occurs far from the exit, and entrained fuel may have the time and space to separate before reaching the exit bellmouth. The replacement of the inlet bellmouth by an inlet diffuser is one possible

solution to this problem and is discussed later. On the other hand, the buoyant flow events and counterflows occur throughout the tank, at times very close to the exit bellmouth. Another problem is that the efficiency of the tank filling is compromised by the fuel's short-circuiting to the exit, leaving significant quantities of water in the tank at the time when mass fuel is already exiting.

In order to minimize fuel/water mixing it was hypothesized that buoyant flow events and fuel/water counterflows must be either eliminated or minimized. A relatively simple solution to these problems is to "backfill" the downstream compartments so that when the fuel/water interface reaches the bottom of the longitudinal stiffeners or the upper edge of a manhole, the downstream compartment has a fuel/water interface at the same level. Then, when the fuel enters the downstream compartment, no buoyancy forces will act upon it and it will remain horizontally stratified. One method for backfilling the downstream compartments would be to provide flow areas at the top of the tank so that the fuel flows horizontally across the top of the tank.

The same types of openings can also be placed at the bottom of the tank floors, where they would allow water to flow toward the exit, reducing water hideout. With both top and bottom flow holes, the fuel and water flows are essentially segregated from one another. The majority of the fuel volume will flow along the tank top, whereas the water will flow along the tank bottom. The upper and lower openings will also eliminate the dead bays, since fuel can flow into these compartments from the top, while the water can exit through the manholes and lower openings.

Acting on the principles outlined above, tank 5-300-2-F was modified with the addition of semi-circular openings in all longitudinal and transverse structures at the top and bottom the tank. The semi-circular openings direct the bulk of the fuel/water flows where they are most needed: as high as possible for the upper openings and as low as possible for the lower openings. Also, the upper openings would allow the fuel to flow smoothly along the tank top, minimizing structural encumbrances. Two sizes of semi-circular openings were evaluated: the first, Tank E, shown in Figure 10, has 15.2 cm radius semi-circular openings. The second, Tank F, has 10.8 cm radius semi-circular openings which have half the flow area of the semi-circular openings in Tank E.

Results show that the addition of the 15.2 cm semi-circular openings significantly improves the flow throughout the tank. If we compare the fuel/water configuration in Figure 11 with that for the unmodified tank shown in Figure 6, we see that the buoyant flow events are mostly eliminated and the fuel spreads much more evenly throughout the tank, backfilling the compartments before it reaches the tops of the openings. For the most part, the fuel flow is almost completely horizontal throughout the tank, and the velocities near the interface decrease by about 50 percent. The buoyant flow events along the entire row of manholes are reduced in a similar manner. In particular, near the exit, where, for Tank C, the largest buoyant flow events occur, the maximum flow rates are reduced from 91  $\ell$ /sec to 16  $\ell$ /sec. Table 2 shows that all the flow rates through the manholes have been reduced significantly (30-80 percent).

The amount of water hideout for Tank E is shown in Figure 13. Comparing Figure 9 to

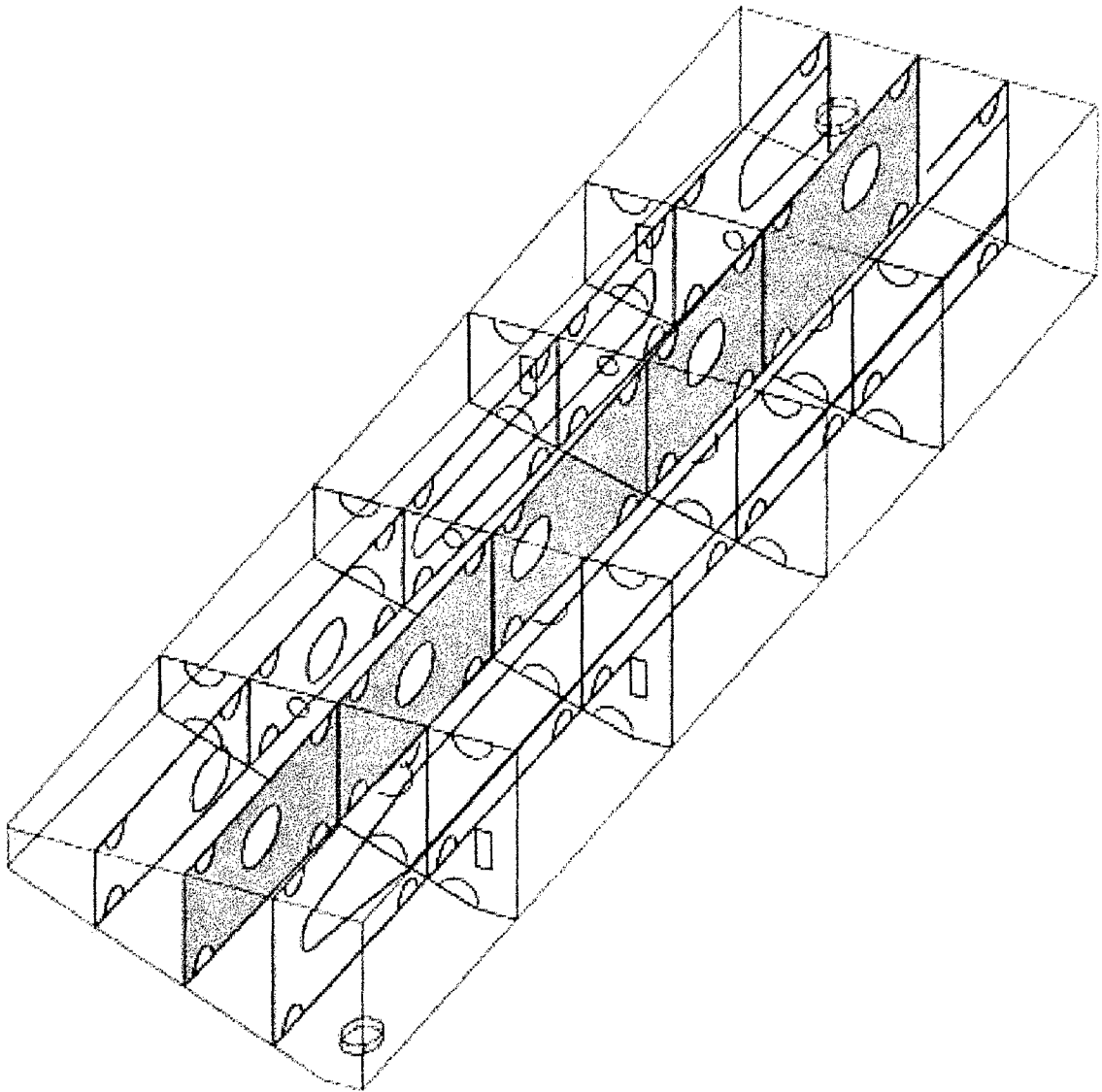


Figure 10: Isometric view of Tank E, highlighting one of the longitudinal floors. The modifications to the tank consist of 15.2 cm radius semi-circular openings in the tops and bottoms of the transverse and longitudinal floors.

Time: 160.00 Seconds

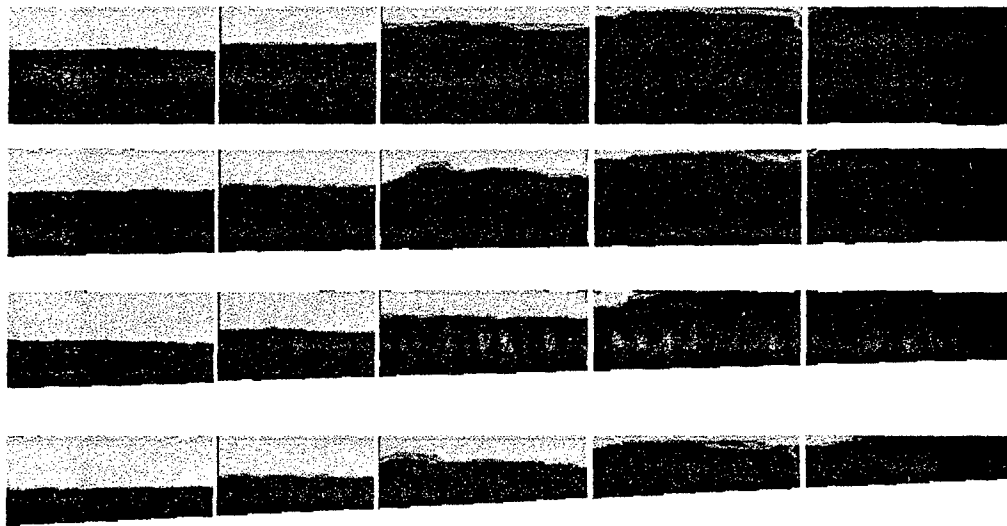


Figure 11: Fuel/water configuration for Tank E at t=160 seconds. Note that fuel advances along tank top, preceding the flow through the manholes, thus reducing the buoyant flow events. See Figure 6 for explanation of data planes.

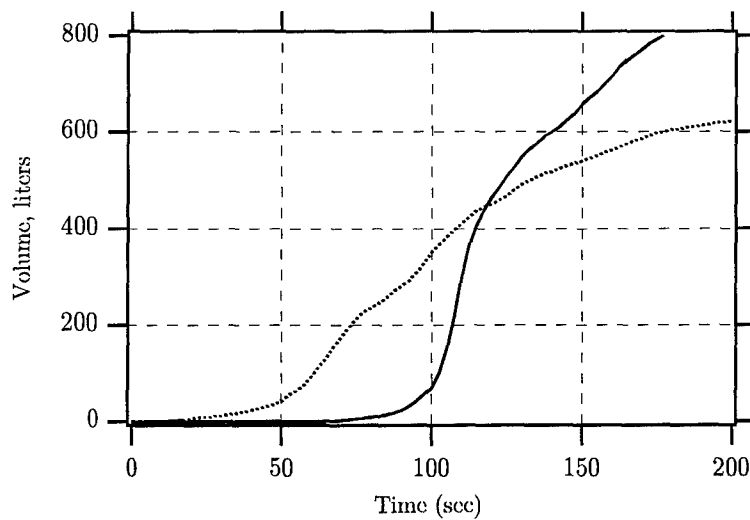


Figure 12: Fuel flow rates into compartment 6. — : Tank C; ..... : Tank E.

Table 2: Maximum fuel flow rates in  $\ell/\text{sec}$  into various compartments. Computed from the maximum slope of the fuel volume versus time curves. Lower flow rates are indicative of less potential for fuel/water mixing.

| Compartment | Flowrate $\ell/\text{sec}$ |        |        |
|-------------|----------------------------|--------|--------|
|             | Tank C                     | Tank E | Tank F |
| 6           | 31                         | 10     |        |
| 10          | 23                         | 15     |        |
| 14          | 20                         | 10     |        |
| 18          | 43                         | 18     |        |
| 17 (exit)   | 91                         | 16     | 41     |

Figure 13, it is possible to see that the compartments off the main flow path in Tank C (the dead bays) have been allowed to fill. At  $t=375$  seconds, the tank contains 39 percent water, just a one percent improvement over the unmodified point-to-point configuration. However, due to the lower velocities at the fuel/water interface it is hypothesized that there will be much less entrained fuel in the compensating water. Thus, even though the bulk amount of fuel at  $t=375$  seconds is the same, the refueling may be terminated at a later point in time with minimal risk of overboard discharge of entrained fuel. It is thought that with further refinement of the locations and sizes of the bottom semi-circular openings, it will be possible to decrease water hideout further, particularly between the centerline and L1P (the top slice in Figure 13).

Addition of the 10.8 cm radius semi-circular openings had less of a beneficial effect than the 15.2 cm radius semi-circular openings. Figure 14 shows that while some backfilling of the downstream compartments does occur, it is not enough to eliminate the buoyant flow events, e.g., the one into Compartment 10, shown in Figure 14. The maximum flow rates have been reduced somewhat, compared with Tank C, e.g., the maximum flow rate into the compartment containing the exit is 41  $\ell/\text{sec}$ . This sizing study shows that the flow area provided by the larger 15.2 cm radius semi-circular openings is necessary for eliminating most of the flow events that will cause fuel entrainment.

In order to assess the structural integrity of the modified point-to-point configuration, finite element (FE) structural analyses were performed on the baseline and modified tank 5-300-2-F under hogging and sagging conditions for the ship in static balance on a standard trochoidal wave. Results showed that the maximum stresses increased by about 50 percent with the addition of the 15.2 cm radius semi-circular openings. However, the addition of coamings and insert plates brought the stresses down to the baseline levels.

## Diffuser-to-Diffuser Configuration

Diffusers introduce fuel into the compartments along the entire outboard side of the

Time: 375.00 Seconds

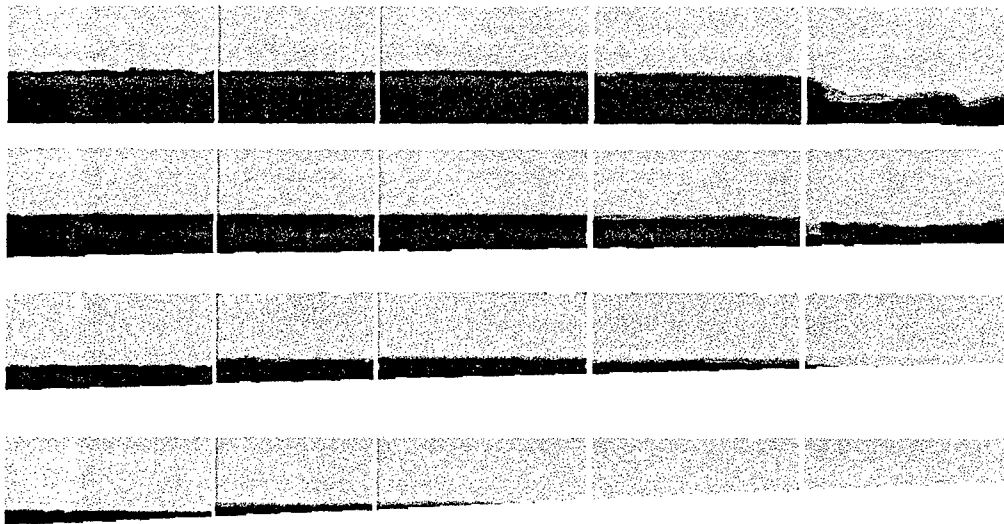


Figure 13: Fuel/water configuration for Tank E at  $t=375$  seconds. See Figure 6 for explanation of data planes.

Time: 160.00 Seconds

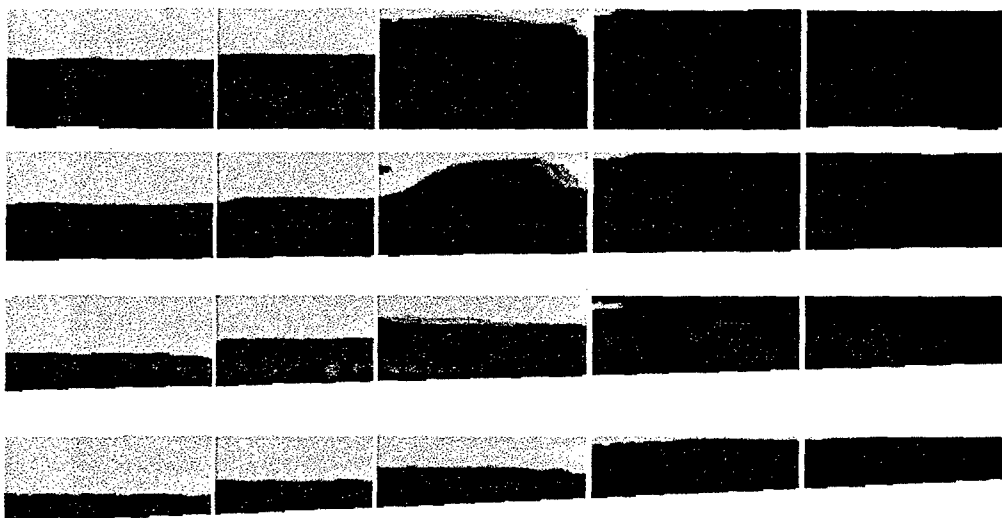


Figure 14: Fuel/water configuration for Tank F at  $t=160$  seconds. See Figure 6 for explanation of data planes.

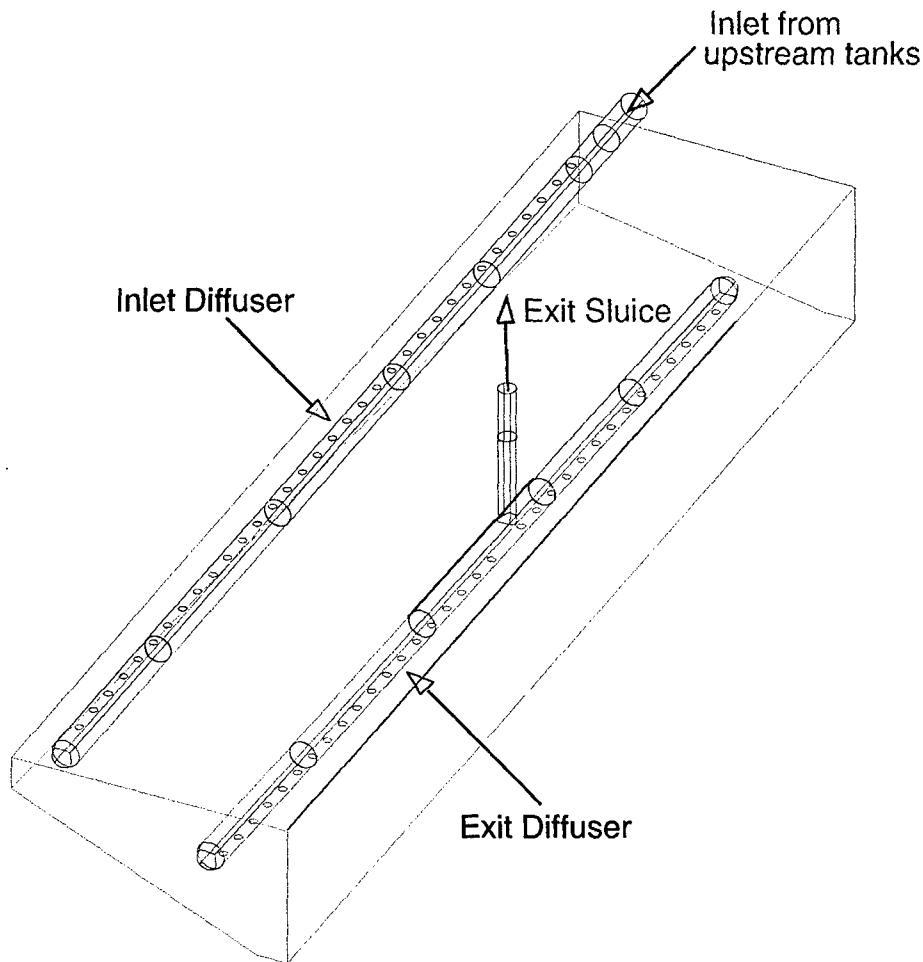


Figure 15: Diffuser-to-diffuser piping configuration in tank 5-300-2-F.

tank. Figure 15 shows the diffuser-to-diffuser piping configuration in tank 5-300-2-F where the internal tank structure has been removed for clarity. The general flow pattern is much different than with the point-to-point configuration as the fuel must flow transversely, rather than longitudinally through the tank. One of the design assumptions was that the maximum fuel flow rate out of the diffuser would be much smaller than for bellmouth in the point-to-point configuration. If the flow from the diffuser was close to uniform, then, at the 63  $l/sec$  at-sea refueling rate, it was expected that the mean velocities from the diffuser would be 0.4 m/s, or one-third that of the point-to-point configuration. In fact, results show that the flow out of the diffuser is not longitudinally uniform, but is weighted toward the aft end. Only about 7 percent of the total fuel flow enters into the upstream compartment (Compartment 4), while more than 33 percent enters into the last compartment (Compartment 20). It is hypothesized that this behavior is due to the relatively high pressure at the end of the diffuser, due to the stagnation point there. The inflow velocities at the aft end of the upper diffuser are approximately 0.8 m/s, two times



Time: 160.00 Seconds

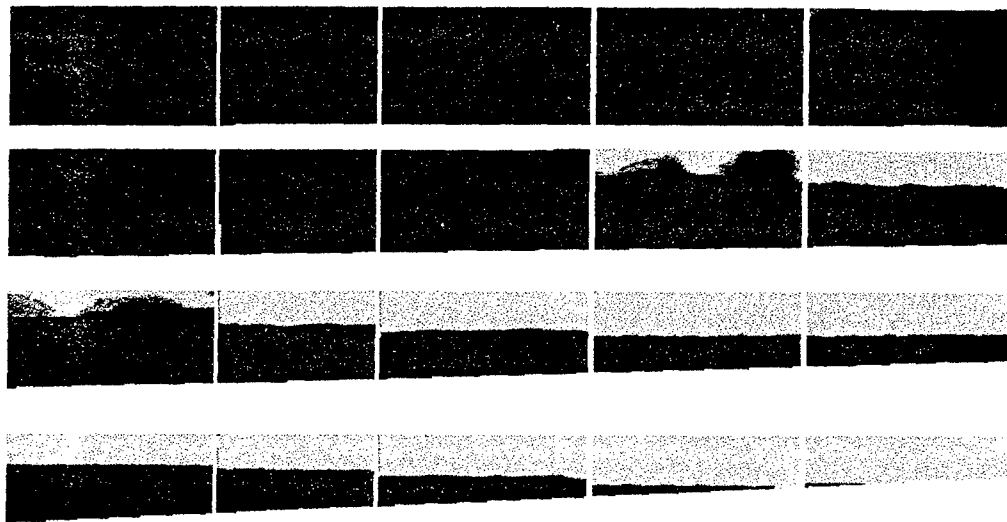


Figure 16: Fuel/water configuration for Tank G (baseline diffuser-to-diffuser) at t=160 seconds.

greater than if the flow was uniform. This compares with the 1.2 m/s inflow velocity for the point-to-point configuration. A consideration with the diffusers is that the separation between the upper diffuser and the lower diffuser is only about 1.7 m, whereas for the point-to-point the separation between the inlet and exit bellmouths is about 10 m. Therefore, the fuel content in the overboard discharge for the diffuser-to-diffuser configuration is much more sensitive to entrainment that occurs at the inlet than it is for the point-to-point configuration.

The effect of this uneven inlet diffuser flow distribution is demonstrated in Figure 16, which shows that most of the fuel enters the aft end of the tank then must flow forward. Despite the inlet distribution of fuel through 5 compartments by the diffuser rather than one by the point-to-point configuration, there are still buoyant flow events through all the manholes and beneath the stiffeners. The maximum flow rates due to the buoyant flow events are not that much different than for the point-to-point configuration: for Compartment 15 the maximum flow rate is 38  $\ell$ /sec and for Compartment 19, 34  $\ell$ /sec. Thus, the diffuser-to-diffuser configuration has some buoyant flow events which have the same potential for fuel entrainment as those found in the point-to-point configuration.

Figure 17 shows that the interface levels are fairly even across the tank after 375 seconds, with the forward end having a slightly greater proportion of its volume filled with fuel. At this time water comprises 36 percent of the tank volume which is a little smaller than the 40 percent for the point-to-point configuration at the same time.

Time: 375.00 Seconds

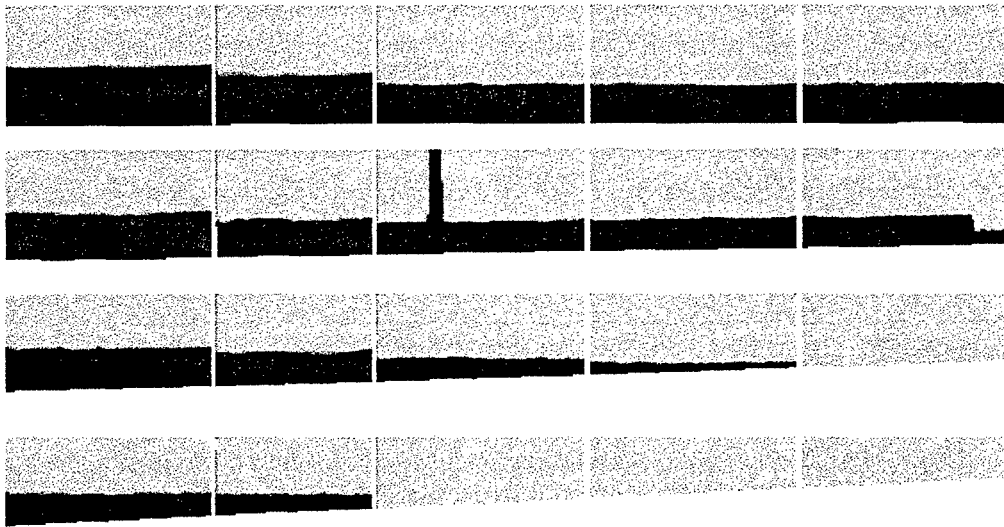


Figure 17: Fuel/water configuration for Tank G (baseline diffuser-to-diffuser) at t=375 seconds.

### Modified Diffuser-to-Diffuser Configuration

The objective of modifying the diffuser-to-diffuser configuration was to eliminate the buoyant flow events through manholes in the transverse and longitudinal floors while taking into greater account structural integrity considerations. In this case, 7.6 cm radius circular openings were selected, based on the premise that the circular openings would cause smaller stress concentrations due to global bending and localized overhead deck loads than would the semi-circular openings. The additional openings were placed only in the floors, 7.6 cm from the tank top or bottom. These openings were not placed in the stiffeners because the 30 cm deep stiffeners could not tolerate openings that are one-half of their depth and still provide sufficient structural strength. Some 7.6 cm radius circular openings already exist in the tanks, though not in the locations necessary to eliminate the buoyant flow events. The modified tank is shown in Figure 18.

The refueling simulation results show that the buoyant flow events through the manholes that existed in the baseline diffuser-to-diffuser configuration have been largely eliminated. The maximum flow rate into Compartment 15 has been reduced from 38 l/sec to 21 l/sec. For Compartment 19, the reduction is from 34 l/sec to 30 l/sec. The buoyant flow events beneath the stiffeners have not been reduced. Rather, the maximum flow rate into Compartment 1 increases from 38 l/sec to 41 l/sec. This is an important finding since it indicates that without the addition of some type of additional openings in the stiffeners, the buoyant flow events beneath them actually can be worsened by the addition of openings in the floors.

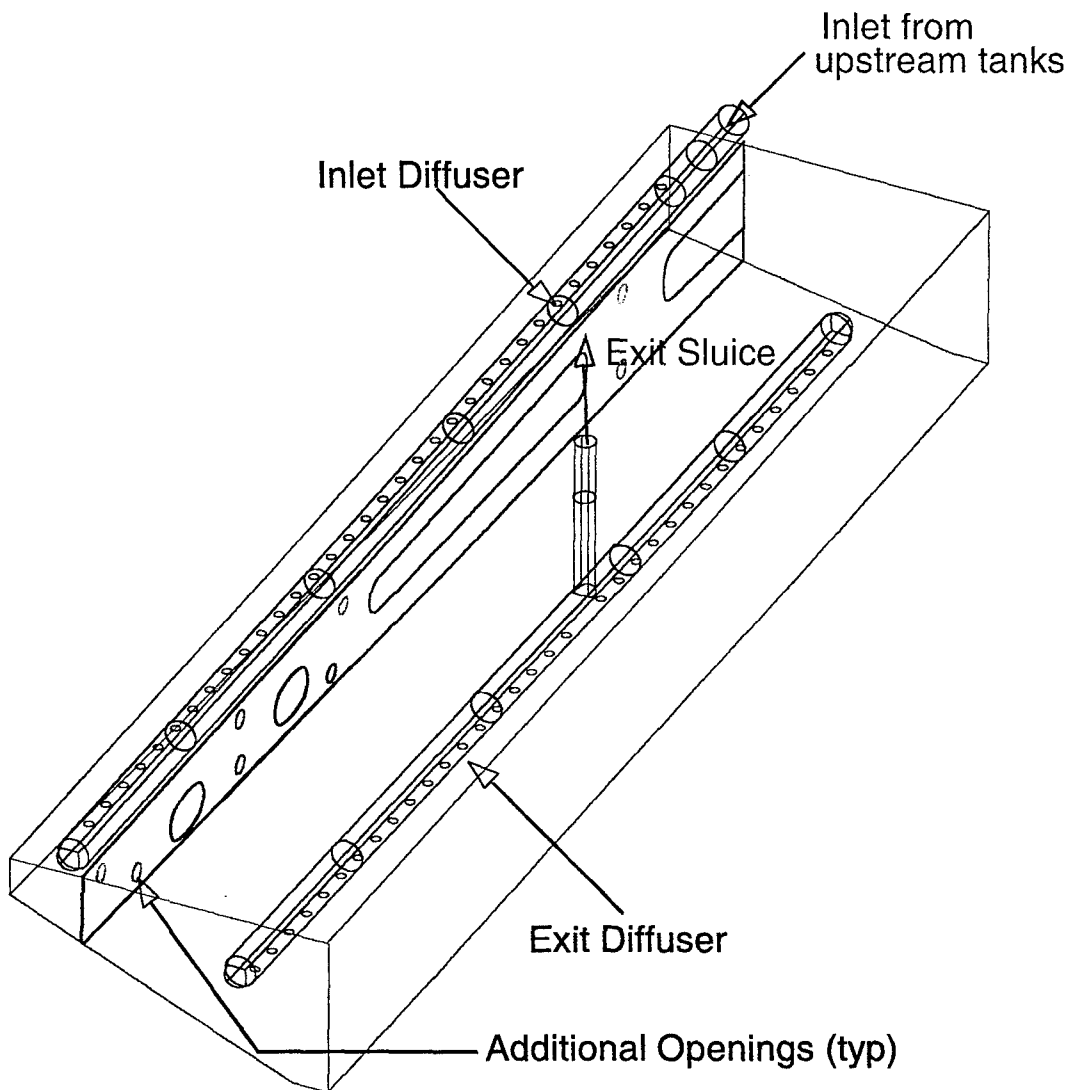


Figure 18: Diffuser-to-diffuser configuration modified by the addition of 7.6 cm radius circular openings in longitudinal and transverse floors. A single longitudinal floor is shown for clarity.

## FUTURE DEVELOPMENTS

As shown in this paper, the first generation CFD tool that has been developed has been used successfully to qualitatively assess existing tank designs and propose modifications for improving their flows. However, the first generation CFD tool cannot quantitatively predict the fuel content in the overboard discharge which is of utmost importance in determining whether the tanks can meet environmental regulations. To this end, a second generation CFD tool is presently being developed in conjunction with an extensive physical model test validation program.

The second generation CFD tool, the Single Fluid Scalar Transport (SFST) model, incorporates an entrainment model and slip velocity and drift flux algorithms[1, 2]. The entrainment model will predict the amount and droplet sizes of fuel entrained in the compensating water. The slip velocity models the relative motion between fuel and water; the drift flux model accounts for their momentum exchange. These models are necessary for predicting fuel entrainment at the inlet jet, due to buoyant flow events and counterflows, and for settling processes where gravity causes the fuel droplets to rise to the tank top. In order for these models to make accurate predictions, key experimental data are necessary from physical model tests. An extensive literature search yielded very little data which would help in our model development.

The physical model test program is focusing on two areas: (1) canonical flows which investigate the basic physics of two-fluid flows and (2) flows measured in realistic tank configurations at small- and full-scale. In the first area, experiments are being conducted on a shear flow (i.e., fuel and water layers flowing over each other in opposite directions), and a water jet impinging on a fuel layer. From these simple experiments, the very complex physics of fuel/water interfaces will be explored and quantified. In the second area, scale model experiments simulating refueling of tank sections and a 1/8 scale model of tank 5-300-2-F will be conducted. The data from these experiments will be used for validation of the CFD models and for development of full-scale testing techniques. Since scale effects are important, a true validation cannot be made unless full-scale physical model test data are obtained. To that end, full-scale tests of a model based DDG 51 tank 5-300-2-F as well as a portion of an entire tank group are planned.

## SUMMARY

This paper describes the computational fluid dynamics and experimental program that the US Navy is undertaking to ensure that their compensated fuel/ballast ships comply with present and future oily water discharge regulations. The computational fluid dynamics work performed to date has provided an understanding of the flow characteristics within the compensated fuel/ballast tanks during refueling and has allowed proposed tank modifications to be analyzed. In the near future, with the help of a major experimental program, the US Navy will have a computational tool which can be used to more quan-

titatively predict the levels of fuel entrainment in the overboard discharge from compensated fuel/ballast tanks and as a design tool for modifying and optimizing compensated fuel/ballast tanks in existing and new construction ships.

In the computational simulations, it was found that buoyant flow events occur when the fuel flows from one compartment to another. It is hypothesized that buoyant flow events are one of the primary mechanisms for fuel entrainment into the compensating water. However, modification of the internal tank structure with the addition of appropriately sized upper and lower flow holes was shown to eliminate buoyant flow events by creating a horizontally stratified flow with very small velocity gradients at the fuel/water interface. Another problem identified is water hideout, the entrapment of water behind the internal tank structure. Similarly, appropriately sized and located openings in the bottom of the structure coupled with the more benign flow enabled by the upper openings, have the potential for reducing water hideout.

It was found that inlet and exit piping configurations are also important in affecting fuel entrainment and water hideout. The point-point configuration is the simplest to implement, but produces the highest velocities at the inlet and, thus, encourages fuel/water mixing during the initial stages of refueling. Also, the point exit necessitates that the water have a clear flow path toward it, otherwise, a large amount of water hideout may result. In contrast, diffusers can significantly decrease velocities and fuel entrainment during the initial stages of refueling as well as decreasing water hideout. Nonetheless, even with diffusers, buoyant flow events are still a factor contributing to fuel entrainment.

Ships utilizing compensated fuel/ ballast tanks are often the choice of naval architects because of their favorable stability and trim characteristics and survivability advantages. In the case where such a ballast tank arrangement is chosen, the inherent environmental risks must be minimized. It has been shown through CFD analyses that current compensated fuel/ballast tank designs have a high probability of energetic fuel/water mixing and water hideout. However, CFD analyses also have shown that tank structures can be modified in such a way that mixing and hideout can be minimized. It is postulated that if the tanks have proportions which allow vertical settling of mixed fuel/water regions and proper care is taken in the design of the inlet/exit piping and tank structure, compensated fuel/ballast tanks can be utilized without adverse environmental impacts.

## ACKNOWLEDGEMENTS

This work was sponsored by the Naval Sea Systems Command (NAVSEA) under the Shipboard Waste Management Project, Mr. Carl Adema, Program Manager (SEA 03R16). The work was performed at the Carderock Division, Naval Surface Warfare Center under the cognizance of Mr. Ray Schmitt, the Environmental Quality Department Project Leader.

The authors wish to thank Mr. Brian Hill for generating the computational grids and assisting in all manner of tasks: running the simulations, reducing data and generating the graphics. Thanks to Dr. Dane Hendrix for assisting with the implementation of the

Arial font into L<sup>A</sup>T<sub>E</sub>X 2<sub>ε</sub>, and to Mr. Ray Schmitt for his editorial and technical advice. The guidance of Prof. Ismail Celik of West Virginia University is duly acknowledged, as well as the hard work and perseverance of his graduate students Messrs. Matthew Umbel and Wesley Wilson.

## References

- [1] Ismail Celik and Matthew Umbel. "CFD Simulation of Transport of a Scalar at a Sheared Density Interface." In The Fourth CFX International Users Conference, Chicago, IL, 1997.
- [2] Ismail Celik, Matthew Umbel, W. Wilson, Peter A. Chang, and Brian Hill. "Simulation of Transient Flow Inside an Experimental Compensated Fuel/Ballast Tank Model using Modified Two-Fluid Model." In Engineering Solutions '98, Wilmington, DE, Oct 1998.
- [3] Peter Chang, Scott Percival, and Brian Hill. "Transient, Two-Fluid Flow through two Compartments of a Compensated Fuel-Ballast Tank." In The Third CFX International Users Conference, Chesham, Buckinghamshire, England, UK, Oct 1996.
- [4] Peter A. Chang and Brian Hill. "Fuel/Water Mixing in Ship's Compensated Fuel/Ballast Tanks." CFX Update, No. 15, Spring, 1998.



Eule & Partners

International Consulting S.P.A.

Maritime Conferences

• **The Maritime Environment** •  
„Waste Water Treatment Technologies for Ships“

**Session 2**

**Mechanical Waste Water Treatment**

**Session Chairman: Professor Alfredo Riva, University of Bologna, Italy**





## **2SPEAKERS.DOC**

### **Session 2– Mechanical Waste Water Treatment**

***Session Chairman Prof. Alfredo Riva, University of Bologna, IT***

Alfredo Riva is Associate Professor of Industrial Chemistry at the University of Bologna, IT.

He has done research in photo chemistry and heterogeneous catalysis applied to industrial processes, he has worked in the fields of safety in chemical plants and laboratories and of problems of urban and industrial waste. In his projects he uses LCA techniques (life cycle assessment), adhering to the sequence of reduction – re-use – disposal of waste.

These ideas have been subject of experimental degree theses, post-graduate courses, and research, of various publications, of scientific communications and of conferences and meetings.

Prof. Riva has taken part in various committees and has collaborated with national and regional Environmental Protection Agencies, as well as with the US Environmental Protection Agency.

Thus Prof. Riva is well suited to tackle problems of solid, liquid and gaseous waste, both from the technical-scientific point of view and from the viewpoint of those who apply National and European Environmental Norms and Regulations.

Prof. Riva will act as Session Chairman for session 2. He will now introduce Paper 1 on

#### **Total Waste Water Management**

***Mr. Massimo Visibelli, ATHANÒR, IT***

Mr. Massimo Visibelli is graduated Engineer. He was educated at the Military Naval Academy in Leghorn and has a degree as Naval Architect and Mechanical Engineer from Genova University. Subsequently he worked with special masters from the Italian Navy and FIAT to build up the know-how to become a naval consultant for passenger vessels and yachts.

During his involvement with the shipyards SEC SpA and Picchiotti SpA and the employment at the shipping line Costa Crociere SpA he tried to tackle the problems concerning waste water treatment technologies for ships and started to collaborate with me (Prof. Riva) in order to create a new system for the storage and recycling of grey water.

Mr. Visibelli will now present paper 2 of this session

#### **Economical and Ecological Treatment of Grey Water – Recovery, Discharge in Protected Areas**

***Mrs. Rachel Jacobs, Carderock Div., Naval Surface Warfare Center, US***

Mrs. Rachel Jacobs received her BS degrees in Chemical Engineering and in Marine Biology from the University of Maryland (College Park, Ma.).

After working for the Naval Research Laboratory in Washington, DC. And the Center for Marine Biotechnology in Baltimore, Ma., she joined the Staff of Carderock Division, Naval Surface Warfare Center's (NSWC) Environmental Quality Department in 1997.

Since then she has worked in non-oily waste water treatment area. Her principal responsibility has been to technically supervise the evaluation, operation and modification of the laboratory tubular membrane ultra-filtration system for grey water treatment.

Mrs. Jacobs will now present paper 3 on

**Development of a 75-Person Prototype Tubular Membrane  
Grey Water Treatment System**

***Mr. Anders Pallmar, Alfa Laval Marine & Power AB, SW***

Mr. Anders Pallmar works as Engineer at Alfa Laval Marine & Power AB, Sweden.

He will present paper 4 on

**Conceptual Studies on Treatment of Oily Water and Sludge aboard Ships**

***Mr. Andy H.H. Hein., FACET FCE, NL***

Mr. Andy Hein is Sales Manager Marine Equipment for FACET Industrial BV, Almere, NL since 3 years. He is responsible for the areas BENELUX, Scandinavia, Baltic, Germany (Marine), Iceland, and Poland.

Formerly he worked for Philips Components, Nijmegen, NL, as Clean Room Engineer for Sub Micron Integrated Circuit Manufacturing. Then he worked for 6 years for Endress & Hauser, Naarden, NL as Sales Engineer for Flow Measurement Equipment before he joined FACET.

Mr. Hein will present paper 5 on

**Mechanical Bilge Water Treatment - Conventional and Membrane Separators**

**Mr. Rolf Ebus, FACET Deutschland GmbH, GE**

Mr. Rolf Ebus studied Engineering with a specialisation on construction techniques. He is employee of FACET Germany since 1989 and has served his company as a CAD constructor, as deputy director constructions, and as sales engineer aviation and general industry.

Since 1996 he is Sales Manager. He will now present paper 6 on

**Mechanical Bilge Water Treatment System Developed for the German Navy**

**Mr. Andreas Fleischer. Goodtech Betex A/S, NO**

Mr. Andreas Fleischer is Sales Manager for Goodtech Betex AS, NO, with special emphasis on the marine market.

He has been involved in the sale of bilge water separators since IMO Resolution 393, some 25 years ago.

Mr. Fleischer will present paper 7 on

**Membrane Technology – The Optimal Technology for Splitting Bilge Water Emulsions**

**Mr. Valentijne Korteling, Promac BV, NL**

Mr. Valentijn Korteling after Grammar School got an education as Naval Architect and Mechanical Engineer.

He worked for Van Voorden in a Propeller Hydrodynamics Design Team and on a Controllable Pitch Propeller and Marine Division.

For PROMAC, the company he is presently working for, he was involved in the General Management for 7 years, as a Business Unit Manager for Water Treatment for another 7 years and since 1993 he work on Special Accounts and Business Development again in the field of Water Treatment.

Mr. Korteling will present paper 8 on

**Membrane Technology – The Optimal Technology for Splitting  
Bilge Water Emulsion**



PROF. ALFREDO RIVA - UNIVERSITY OF BOLOGNA

“TOTAL WASTE WATER MANAGEMENT”

The problem of the total management of water is tackled following a scale of priorities which has now been accepted by the industrial and scientific communities:

1. Rational use of raw materials, improving the processes where they are used;
2. Treating the waste produced, in order to re-use it as a resource;
3. Final and definite disposal only of materials which have reached the end of their life cycle.

Every study carried out in this field should take into account the three forms of sustainability: economic, environmental and social, evaluating the issue from the points of view of the matter, energy and finance involved in the system under examination.

A powerful technique of study which was formulated at the beginning of the nineteen-nineties is Life Cycle assessment (LCA) which has four cyclical phases:

1. **Initiation**: the aims of the study, the dimensions of system to be examined, the quality of the data at our disposal are all defined;
2. **Life Cycle Inventory (LCI or Eco-balance)**: the balances between matter and energy are carried out, without judging the merits;
3. **Impact Assessment**: the LCI data are used to make decisions concerning the environmental and economic capabilities of the system which is being examined, also vis-à-vis the possible Eco-indicators;
4. **Improvement**: the possible improvements to the system are evaluated, repeating the study from initiation.

Following these criteria, the cycle of water can be tackled from its "cradle" as a raw material to its "grave" as waste.

National and local laws regulate the use of water as a resource for civil and industrial use, prescribing a rational use and ensuring the maximum degree of recycling.

This can be done comparatively easily in fixed sites that can be easily identified and checked, and there are several examples of improvements which have been carried out with the passing of time. On the other hand, it is more difficult to think of integral management of water on a mobile unit such a ship, which is made up of various plants for human and industrial use.

In the attempt to rationalise this sector, very strict international laws and agreements have been made; however, what is actually done in practice today is not in the best interests of the environment.

The taking on of mains water in port, to be used for all the necessities on board (cabins, laundry, galley, washing, decks, cooling engines etc.), the collection of waste water and its discharge directly into deep seas can be seen as the destruction of a raw material (the raw material being water from a well or other resource, which can only be regenerated with difficulty).

This is not a closed cycle inasmuch as the raw material, accumulated over geological time, is consumed in the very short period of human history.

So, even on ships, we need to study to application of waste water treatment systems that allow for the re-use of water in the same cycle that produced it, or for the recycling of this water into of low quality before its final discharge.

The final aim of this work must be to change the model of present ship management. By respecting increasingly restrictive National and International norms, we can progress to the concept of a "green ship".

## **LCA AND LCI FOR THE MANAGEMENT OF PROCESSES, PRODUCTS AND WASTES.**

Alfredo RIVA

Dipartimento di Chimica Industriale e dei Materiali, Università degli Studi di Bologna  
Viale Risorgimento 4, 40136 Bologna (Italia)

### **INTRODUCTION**

The problem of water as a primary resource is dramatic: since 1968 the Council of Europe pointed out this problem.

Any effective programme for the integrated management of a general material "from the cradle to the grave" – water included - requires a thorough assessment of the material flows, environmental impact and costs associated with the entire life-cycle of those products under review. Only in this way comparisons can be carried out between the different technologies available and decisions made which optimise the cost/benefit ratio in terms of the environmental performance of the various systems examined and the costs necessary to achieve the best results<sup>1,2</sup>.

A portion of recycled waste, in its turn, may be re-utilised in work processes to obtain new products and then enter once more, in changed form, into the waste management sector.

In the light of the above-indicated objectives, each study and assessment of the life-cycle of materials, conducted with one of the assessment and analysis techniques available, even if all are a means to improvement, cannot leave a careful analysis of the costs out of consideration.

### **LIFE-CYCLE ASSESSMENT (LCA): CHARACTERISTICS AND TECHNICAL FRAMEWORK**

In order to carry out the life-cycle assessment of a material one needs to identify the linking strands of all the management operations of the material itself, from the extraction of the necessary raw materials up to the point where the product emerges as such from its own Life-Cycle and becomes waste, through the various stages of transformation and utilisation/re-utilisation<sup>3-8</sup>.

Throughout the processing stages, whose transformation yield can never be 100%, one can identify flows that pass from the material management area to the waste management area; with the introduction of recycling operations currents are generated which reverse this route, bearing materials back from the waste management sector to the resource management area, with improvements in the environmental performance of



the activity as well as economic advantages. In Fig. 1 the entire life-cycle of a material is shown, from the resource stage to the point it becomes waste.

Once both the material management route and the burden of associated waste have been clearly identified, the impact on the environment relating to the entire sequence of operations may be assessed by means of the LCA, or Life-Cycle Assessment, procedure.

This new methodology, complex, articulated and still not fully refined, enables one to assess the environmental effects linked to any type of activity. Two main types of LCA may be discerned, comparative and decision-making, whose procedure is pronounced in a similar way but with results that assume different valences and meanings.

Comparative LCA starts from the selection of carrying out a comparison between several options; all are suitable for achieving the same objective; the results are expressed in relative, comparative terms and only the performances of the different systems are taken into consideration, wherever they are located.

The second type of assessment, the one of decision-making, extends the previous results and enables one to make decisions by evaluating the environmental performance and any critical points of the different strands of production, use, re-utilisation, recycling and disposal, with regard to the actual needs of the individual local situations.

The technical structure of Life-Cycle Assessment is developed in three principal stages, possibly repeatable in a fourth stage according to a cyclical procedure of assessment refinement and improvement:

1. Initiation: this is the preliminary stage of study which therefore assumes a key importance for all the successive stages. First of all one is dealing with defining, in the clearest possible way, the aims of the work, the intended use of the results (popular, for use within a company, as an instrument of selection for a public body, ...) and to decide the degree of research in relation also to the cost and time for achieving the results. In this first stage fundamental choices are assumed: after specifying if one plans a LCA of the decision-making or comparative type, one chooses if to implement the life-cycle analysis in its more complete meaning or if one intends to limit the field of work to greater or smaller portions by carrying out a partial analysis which may yet provide interesting results for the solution of a particular problem. The limits of the system to be analysed and the functional unit to which the results will be referred are then identified: in general one is dealing with functional units of a "weight" or "product piece" type, but in each case the choice should settle upon the unit which is common to the whole cycle (particularly in the comparative LCA case), easily measurable and able to provide significant results. The need of utilising the same functional unit is then evident in developing a comparative study. Still in this first stage the quantity and quality of necessary data is identified, clearly specifying the sources depicted and the type of data: primary (obtained from direct surveys), secondary (originating from published sources, books, magazines ...) or tertiary (obtained from statistical processing, extrapolations ...). In the end it is necessary to both specify and justify any approximations adopted.
2. Inventory: known also as Eco-balance this is the most studied and thoroughly examined stage of the LCA today; it should be without any intention of judgement and allows an assessment to be expressed with respect to the environmental performance of the system being studied. The balances of mass and energy relating to

the individual currents entering and leaving the system limits identified in the preceding stage are calculated. In the currents leaving the system the factors of water, air and ground emission are determined, relating to some key substances particularly representative of the main environmental impacts (eco-indicators); on the basis of these values the impact on the environment associated with the activity will then be identified and quantified. Next to the principal system any surrounding systems must also be considered (transport, electricity manufacture and supply, waste disposal, et c.). The result of the LCI (Life-Cycle Inventory) procedure is the so-called "impact table" which collects all the processed data available, in many cases it can provide useful indications about the system, inasmuch as many studies do not proceed further (Life-Cycle Analysis).

3. Impact Assessment: this is the most delicate stage of the whole procedure and, for this reason, a methodology at international level does not yet exist; the principal differences concern the selection of criteria on which to base the assessment itself, even if those based on the use of eco-indicators, also in the indecision on their selection and reduction at normalised conventional levels, have some characteristic passages in common. On the basis of the data gathered and processed at the LCI stage, the impact is classified and aggregated in homogeneous categories according to the effects produced on the environment (greenhouse effect, ozone layer depletion, ecobiototoxicity, photochemical smog, acid depositions, eutrofisation ....); it then follows a stage of weighting the impacts identified and aggregated, normally through the use of carefully-considered factors of various types of damage and a step of normalisation to reduce the values of emission factors relating to the eco-indicators at conventional values, to arrive at the true and proper assessment of environmental impact.
4. Improvement Analysis: this constitutes the final stage of the assessment in which improvement hypotheses are forwarded so as to restart a new assessment cycle.

The technical structure of LCA is schematised in detail in Fig. 2.

## **LCA APPLIED TO THE INTEGRATED MANAGEMENT OF WASTE**

Aside individual national regulations, waste can be defined as any material that, owing to the decision of the owner or because it is no longer, has reached the end of its life-cycle. Therefore, the life-cycle of waste commences from its production and its subsequent collection by the bodies or companies responsible for this service.

Consequently the use of LCA in the integrated management of waste involves a study "from the production to the grave", assuming as its starting-point the moment when the material loses its value and becomes waste or, when recycled, it acquires a new value; or because, on being disposed of, it gives off emissions into the air, water and ground. Waste collection, in this context, constitutes a peripheral or surrounding system.

Waste management passes through various processes, each one not always simultaneously present (mechanical selection, recycling, compounding (in compost),

biogasification, pyrolysis, gasification, incineration, delivery to a controlled dumping of the appropriate classification).

In the main, environmental sustainability demands a reduction in waste production, energy consumption, resource depletion and all the emissions in the various environmental sectors. When it comes to considering economic sustainability, there is no single method of treatment that, on its own, can satisfy all the needs of the requirements illustrated. Therefore, integrated interventions must be arranged which would include the reclamation of materials, biological and heat treatments and others, limiting the delivery to controlled landfill to the final product only, being without possibility of reuse.

The "hierarchisation" of interventions is a fundamental and exact criterion, on the condition that it is no longer limited to expressing a classification of preferences relative to individual treatment options, but provides an assessment for the whole integrated management system of interventions. On its own, however, it is too limiting a criterion and must be integrated with the study of waste and its life-cycle. It is to be applied to the entire process, both at its production, in order to minimise its quantity and at its end, to ensure an effective management.

## CONCLUSIONS

Life-Cycle Assessment, as mentioned, is a new instrument of fundamental importance for the choice of technology with the least impact on the environment, both by means of a comparison between the several possible alternatives and as a decision-making support for the local authorities.

It is all to be developed with a new method of approach, which therefore needs to be improved and finely-tuned before being completely workable; at present LCA is very often used for Life-Cycle Analysis, or eco-balance, while the prospect of reaching a true Assessment are still far away.

Some problems have not yet been discussed.

In the currently available management methodologies for a LCA the instrument for a careful cost analysis is still lacking; to calculate the costs associated with all processes connected with the life-cycle of a material is a fundamental passage to be able to reach a correct appraisal of the cost/benefit ratio. This parameter is essential if one intends to conduct a comparative LCA study to be able to estimate the relating management costs next to the incidence on the environment of the various choices available.

It is necessary, therefore, to extend the concept of life-cycle assessment into an "eco-eco" (ecological-economical) analysis to place environmental sustainability alongside economic sustainability: if, as the case may be, the environmental sustainability demands that the impact associated with the system should be reduced to a minimum, from the consumption of materials and energy to the emissions into air, water and earth, the economic sustainability envisages that the choices are acceptable for all the social forces involved. Then it is necessary to consider the third type of sustainability as well, the social, which must be taken into consideration to give an adequate response to the needs of the community involved, respecting both its values and priorities.

Neglecting these aspects would be restrictive and render the Life-Cycle Assessment technique even more "theoretical".

A second lack or deficiency concerns the assessment techniques on environmental impact, particularly in relation to the data normalisation stage; in general once an eco-indicator is identified and the relating emission factors in the various currents leaving the confines of one system, the normalisation of data is carried out on the basis of total emission factors on a wide scale, as a minimum on a European level.

This manner of proceeding frees the environmental assessment of the activity under review from its geographical setting, foreseeing similar impacts independent of the place where the system has been set up or is intended to be set up and it can only be valid for comparative ends. It is necessary to draw up a more articulated assessment which permits one to decide on the basis of the productive, social, economic and ecological context of the local situation.

#### REFERENCES

- 1) MUSMECI L., RIVA A., *Flusso dei rifiuti ed impatto ambientale. Procedure di controllo e linee di ecobilancio*, in "I rifiuti in uno sviluppo sostenibile", Perugia (1997)
- 2) REGIONE EMILIA-ROMAGNA, *L'Incenerimento dei Rifiuti. Ricognizione sulla Realtà Regionale*, L. Morselli ed., Bologna (1997)
- 3) SOCIETY OF ENVIRONMENTAL TOXICOLOGY AND CHEMISTRY, *A Technical Framework for Life-Cycle Assessment*, SETAC and the SETAC Foundation for Environmental Education Inc., Washington (1991)
- 4) SOCIETY OF ENVIRONMENTAL TOXICOLOGY AND CHEMISTRY, *Integrating Impact Assessment into LCA*, Fourth SETAC-Europe Congress, Brussel (1994)
- 5) SINGHOFEN A., *Introduction into a Common Format for Life-Cycle Inventory Data*, SPOLD Status Report, Brussel (1996)
- 6) SIGNANI S., *Ecobilancio Comparativo di una Industria Metalmeccanica. Life Cycle Assessment*, Tesi di laurea, Bologna (1996)
- 7) WHITE P.R., et al., *Integrated Solid Waste Management: a Life-cycle Inventory*, Glasgow, Blackie Academic & Professional (1995)
- 8) WEITZ K., et al., *Using Life-Cycle Management to Evaluate Integrated Municipal Solid Waste Management Strategies*, in "R'97, Recovery, Recycling, Re-integration", Ginevra (1996)



**WATER IS ESSENTIAL TO LIFE.**

**WATER IS A PRECIOUS RESOURCE,  
INDISPENSABLE FOR ALL HUMAN  
ACTIVITIES;**

humans need increasing quantities of water to drink and for nourishment, for use in cleaning and as a source of energy, as a raw material in production, for transportation, and in recreational activities.

**ALTERING THE QUALITY OF WATER  
HARMS HUMAN LIVES AND THOSE OF  
ALL THE LIVING CREATURES TO WHOM  
IT IS VITAL.**

**European Water Chart  
Council of Europe  
May 1968**

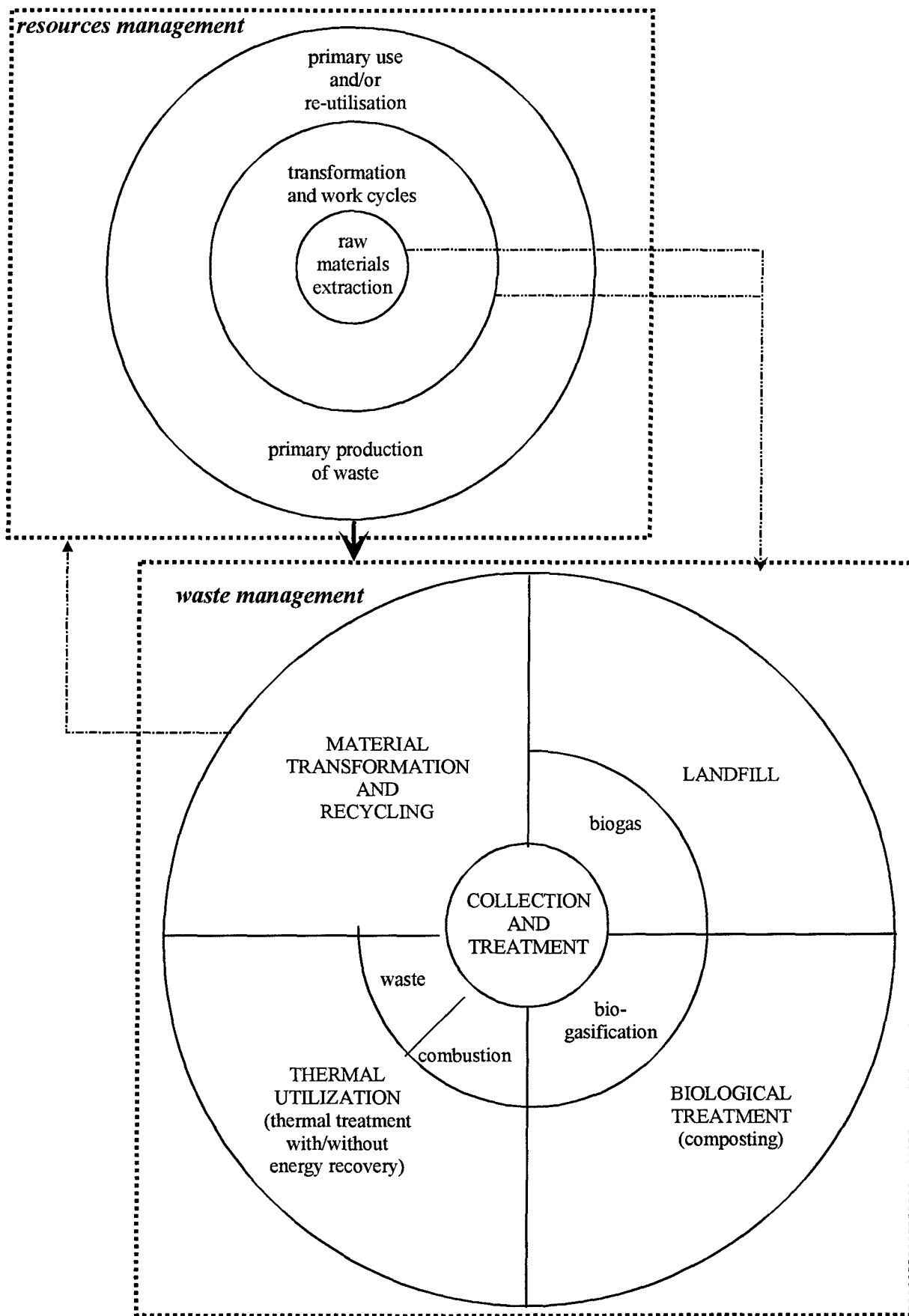
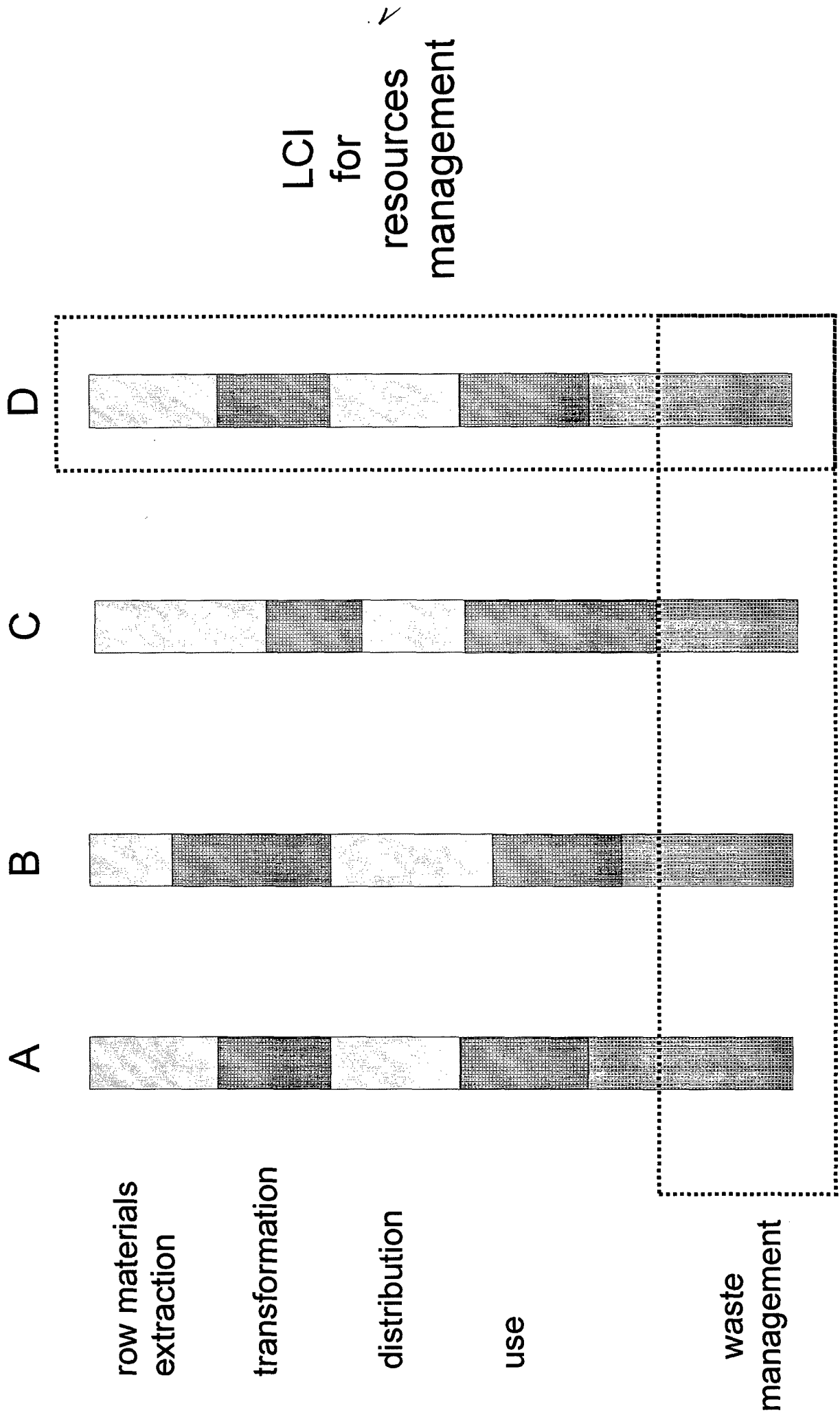


Figure 1. Integrated cycle for resource and waste management



LCI  
for  
resources  
management

LCI for waste management



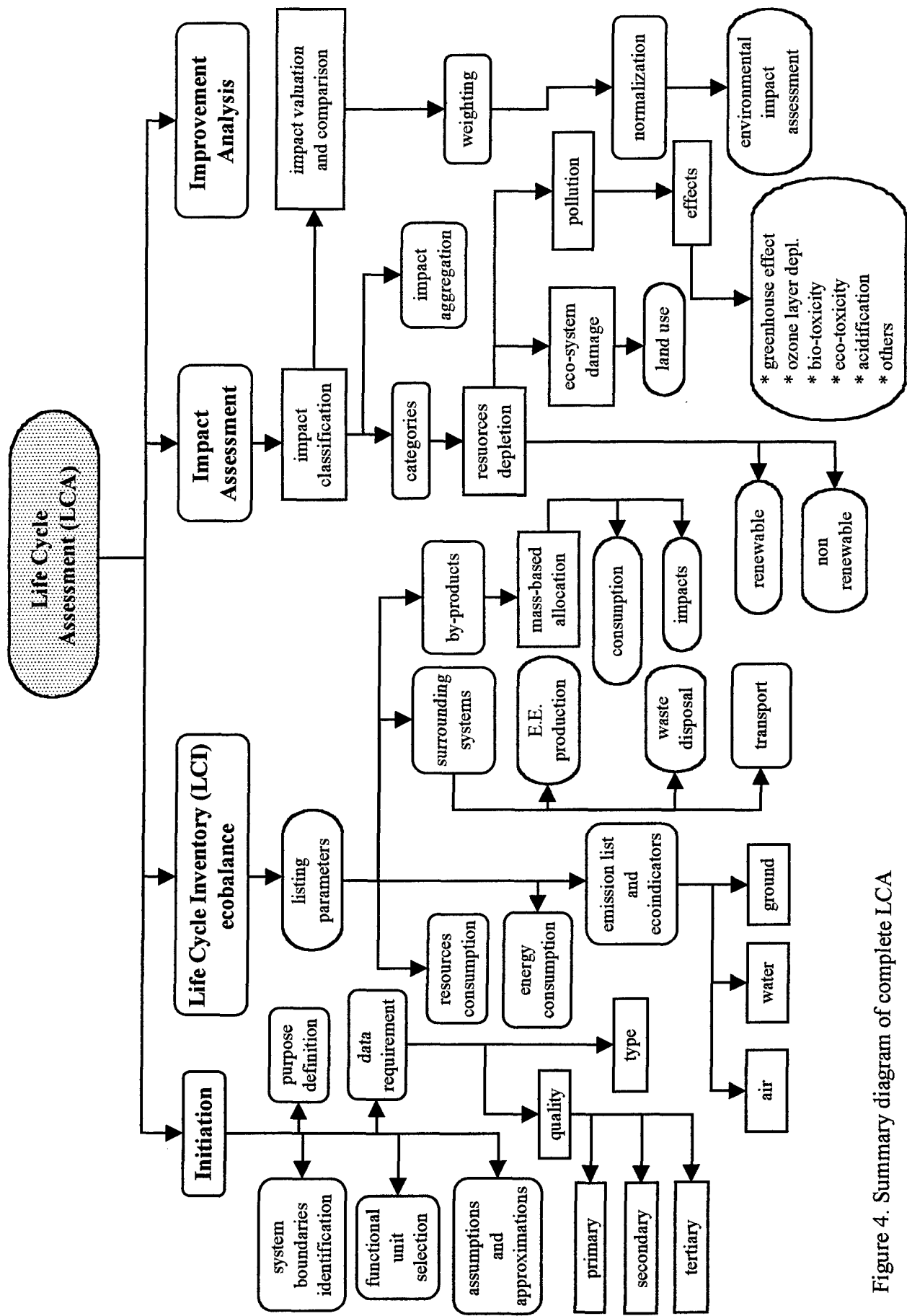


Figure 4. Summary diagram of complete LCA

**“ECONOMICAL AND ECOLOGICAL TREATMENT OF GREY WATER – RECOVERY,  
DISCHARGE I.A.W. MARPOL RULES “**

ENG. MASSIMO VISIBELLI  
ATHAÒR  
Italy

Grey waters represents more than half of the water consumption on board.

One of the most important problem to solve in the field of the water treatment on board is the storage and recycling of the grey waters.

Existing laws and rules are very restrictive for the discharge of waters off board.

Normally grey waters are stored in special tanks and discharged off shore during the navigation. The necessary water is restored while the ship halts in a port. When grey waters are treated, this treatment includes black waters.

We propose a plant for the specific treatment of grey waters on board. The treated water is pure and can be even discharged without any risk, or recycled for the technical use.

The plant is based on chemical and physical reactions; the main steps are:

- . first filtering
- . Ph control
- . solidification of mud
- . separation between solid and liquid with final clarification
- . turbidity control
- . chlorination
- . discharge or recycle

The plant is autocleaning and completely automatic to minimize management problems and workforce.

The plant requires a minimum space comparing to the space for water storage. It can be installed anywhere in the ship: without any restriction on a ship to be built, in an appropriate area on an operating ship.

Installation and operating costs are economically profitables comparing to the current solutions; the ship owner has no more restrictions for the discharge; the environment is preserved.



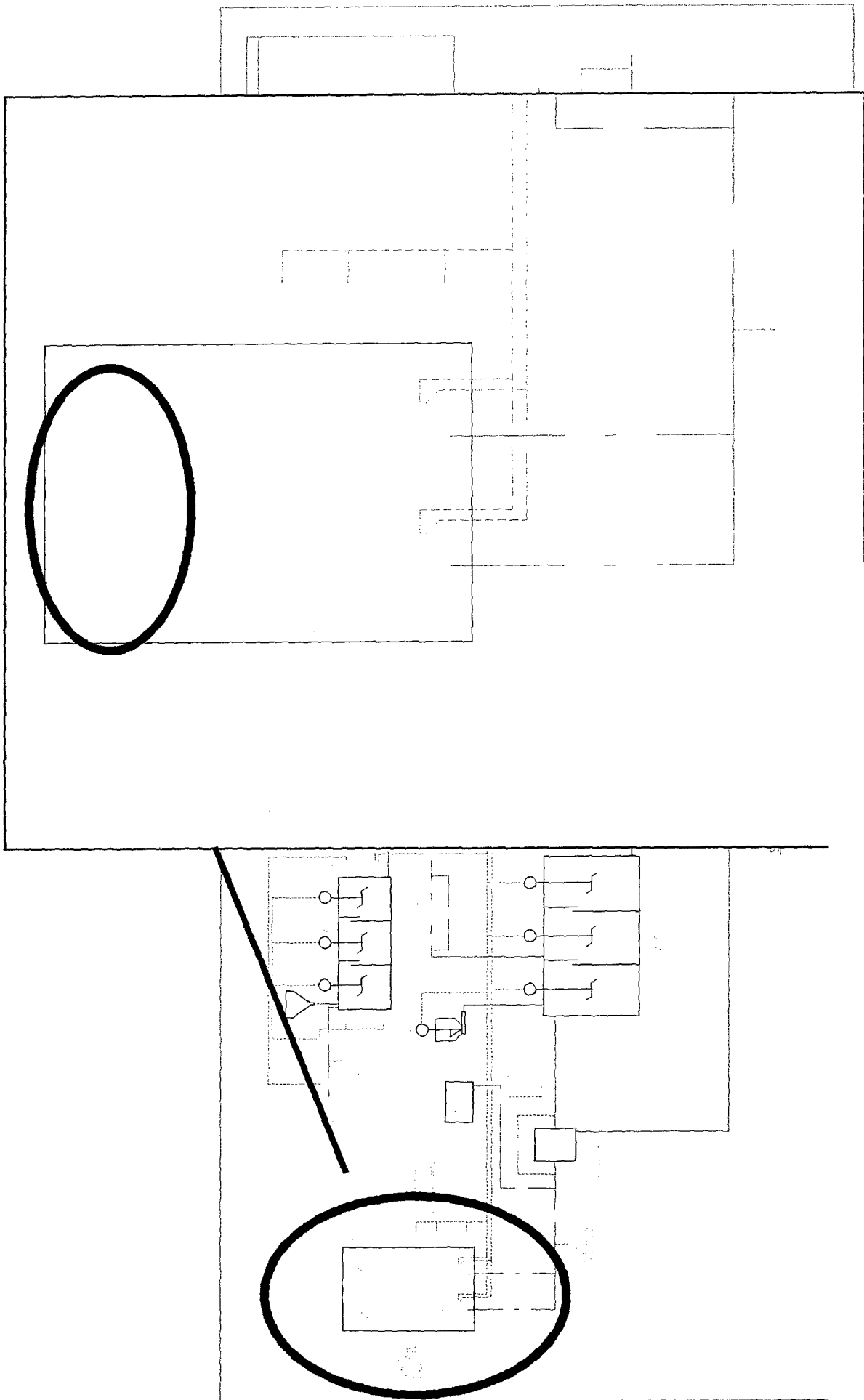
# ATHANÒR

IMPIANTO DI TRATTAMENTO DELLE ACQUE GRIGIE PER NAVI  
*GREY WATER TREATMENT PLANT FOR SHIPS*



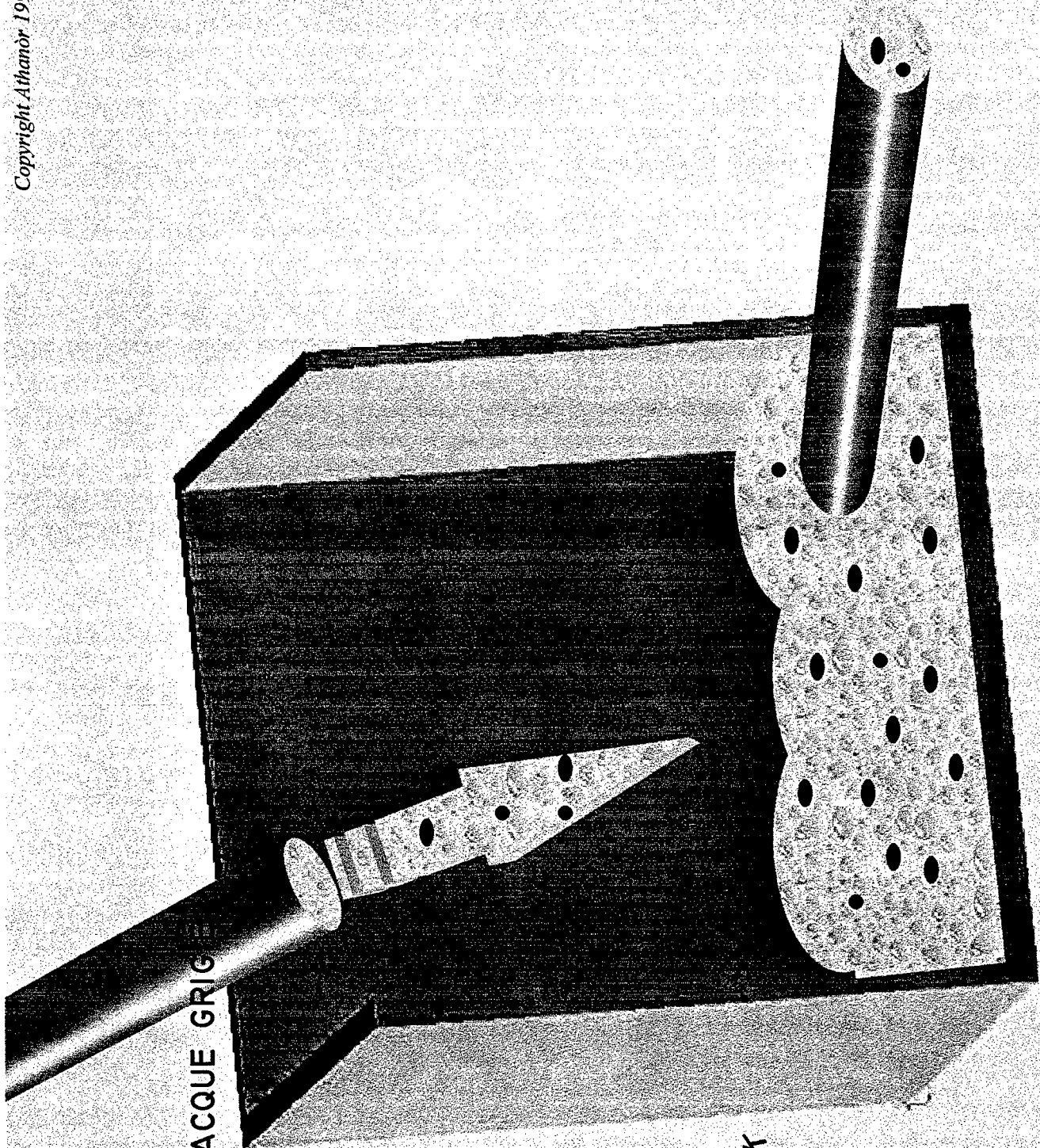
Athanòr s.r.l. - Via Ciabattini 61/B - 55049 Viareggio - Italy  
Tel.: +39 0584.96.38.56 Fax: +39 0584.96.38.58 E-mail: [main@athanor.it](mailto:main@athanor.it)

Copyright Athanòr 1998



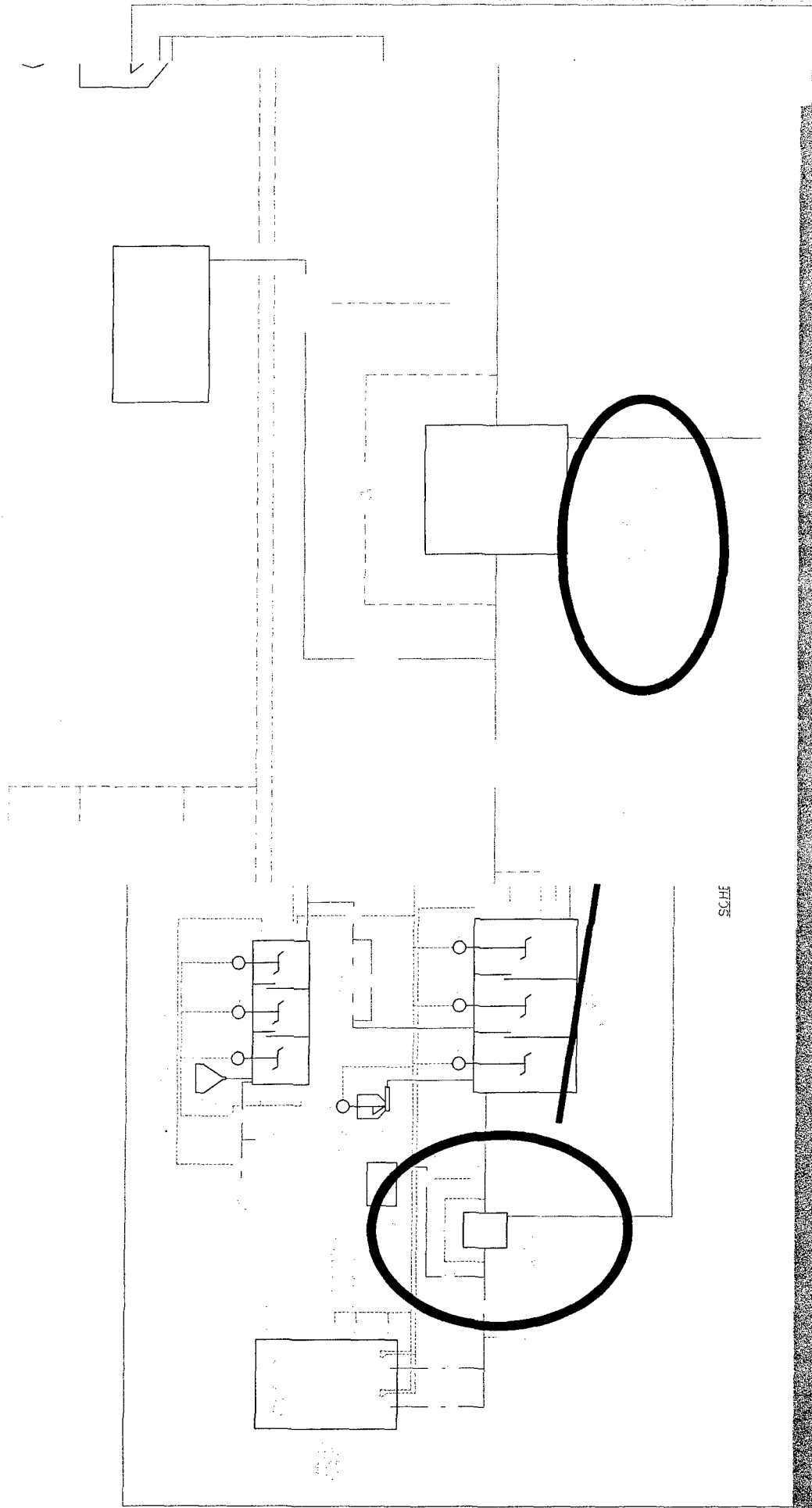
**FASE I:  
CASSA RACCOLTA ACQUE GRIGIE**

Le acque grigie provenienti dalla lavanderia vengono raccolte in un serbatoio.



**STAGE I:  
GREY WATER TANK**

*Grey water coming from laundry is collected in a tank.*



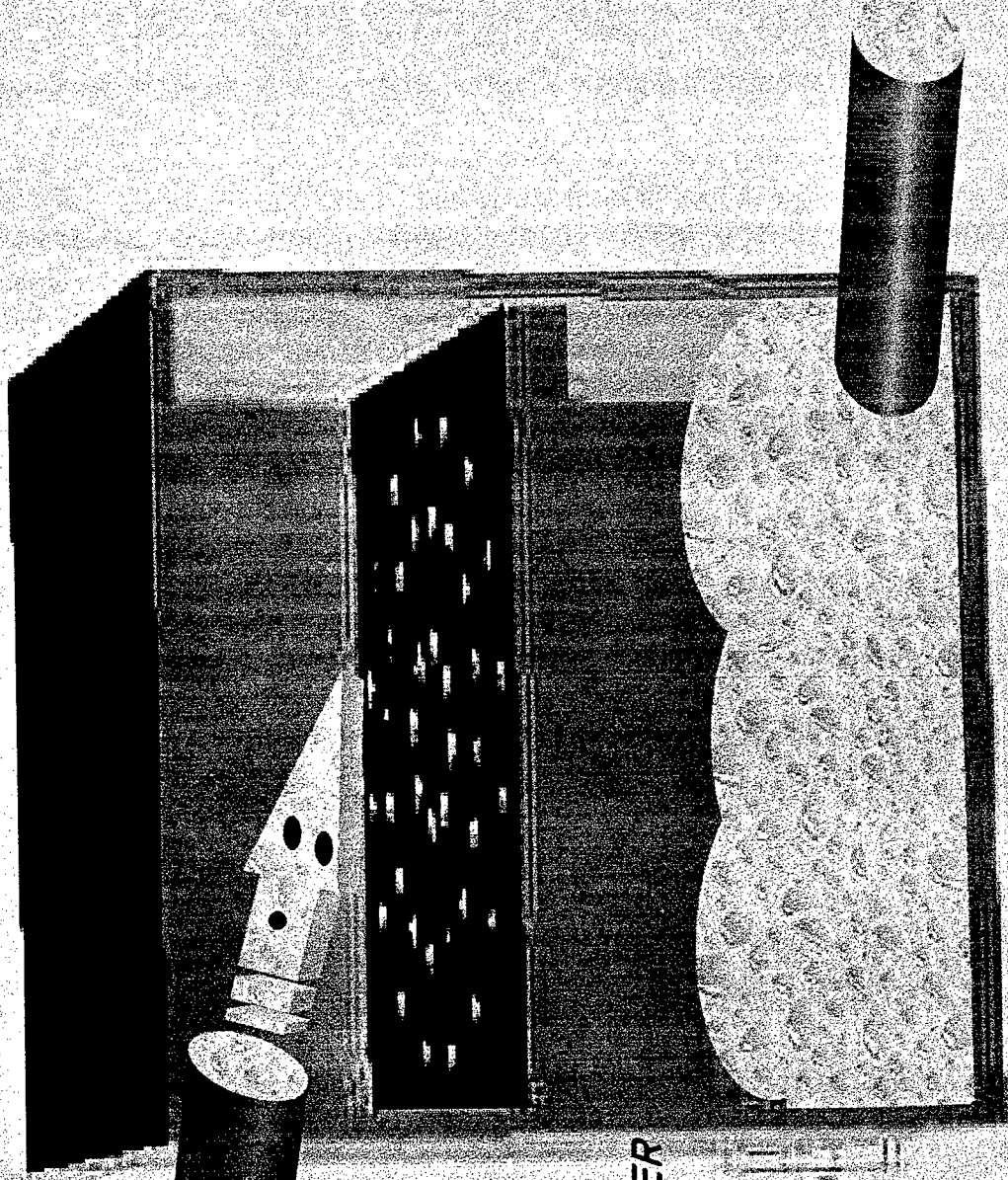
FASE 2. FILTRO AUTOPULENTE. SEPARAZIONE DEI SOLIDI SOSPESI.  
STAGE 2. AUTO-CLEANING FILTER

**FASE 2:  
FILTRO AUTOPULENTE: SEPARAZIONE DEI SOLIDI SOSPESI**

Il liquido prelevato dal serbatoio è

iniettato in un'unità

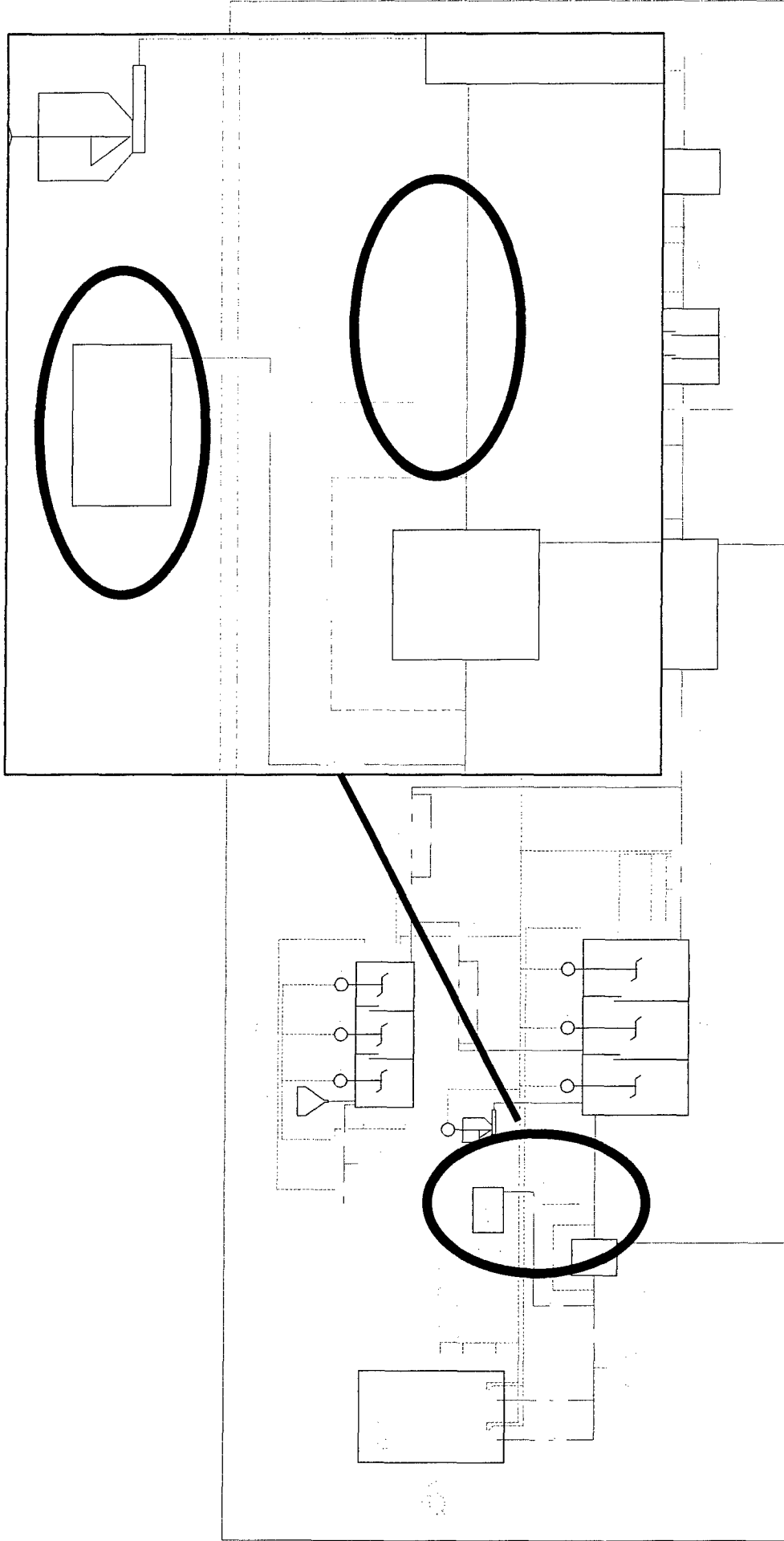
efficiente di separazione solido/liquido.



**STAGE 2:  
AUTO-CLEANING FILTER**

*The effluent from the tank passes to this filtering unit which efficiently divides solids from liquids.*

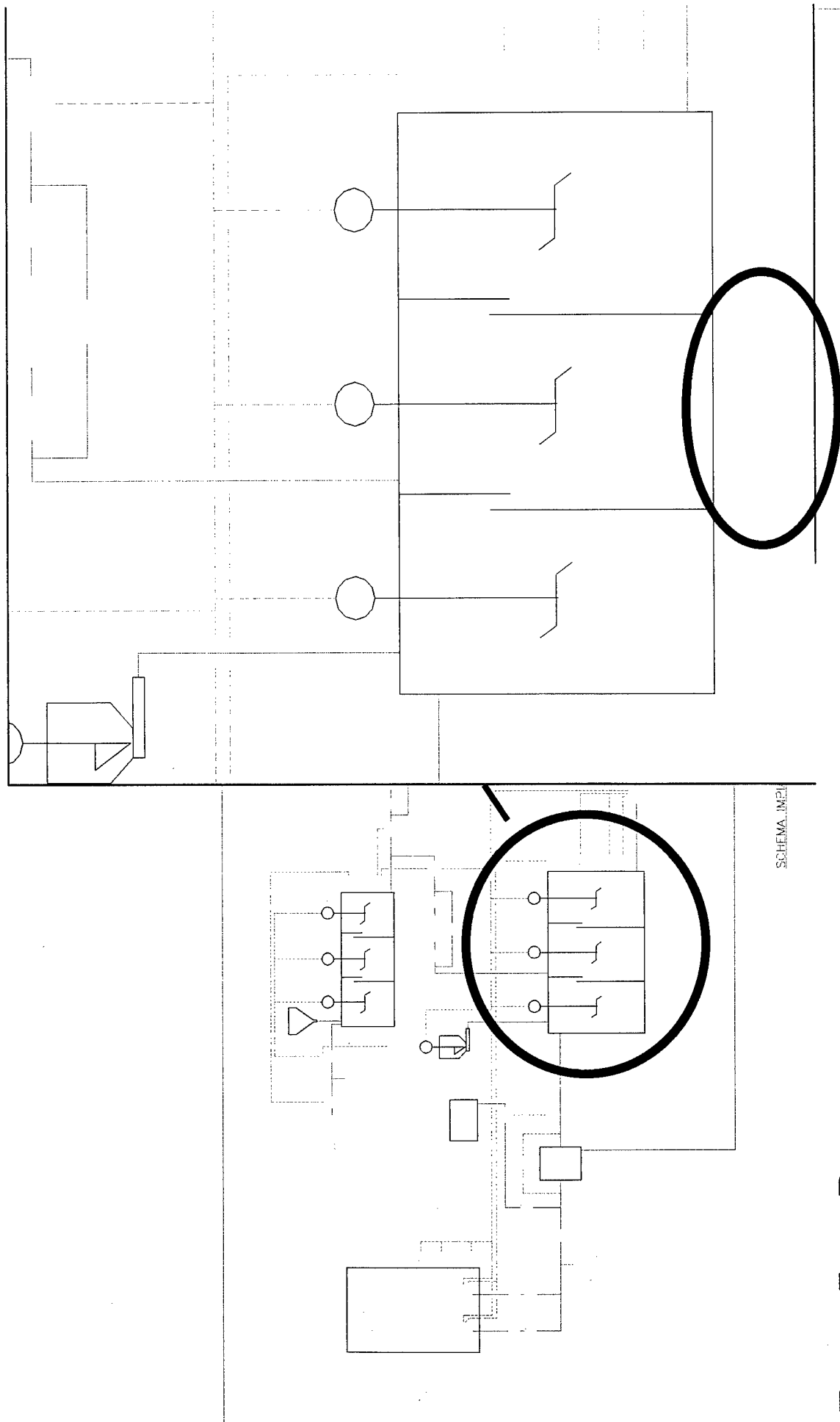




SCHEMA IMPIANTO TRATTAMENTO ACQUA

CONTROLLO I STAZIONE DI CORREZIONE DEL PH  
CHECK I. PH CORRECTING STATION

IMPIANTO DI TRATTAMENTO DELLE ACQUE GRIGIE PER NAVI  
GREY WATER TREATMENT PLANT FOR SHIPS

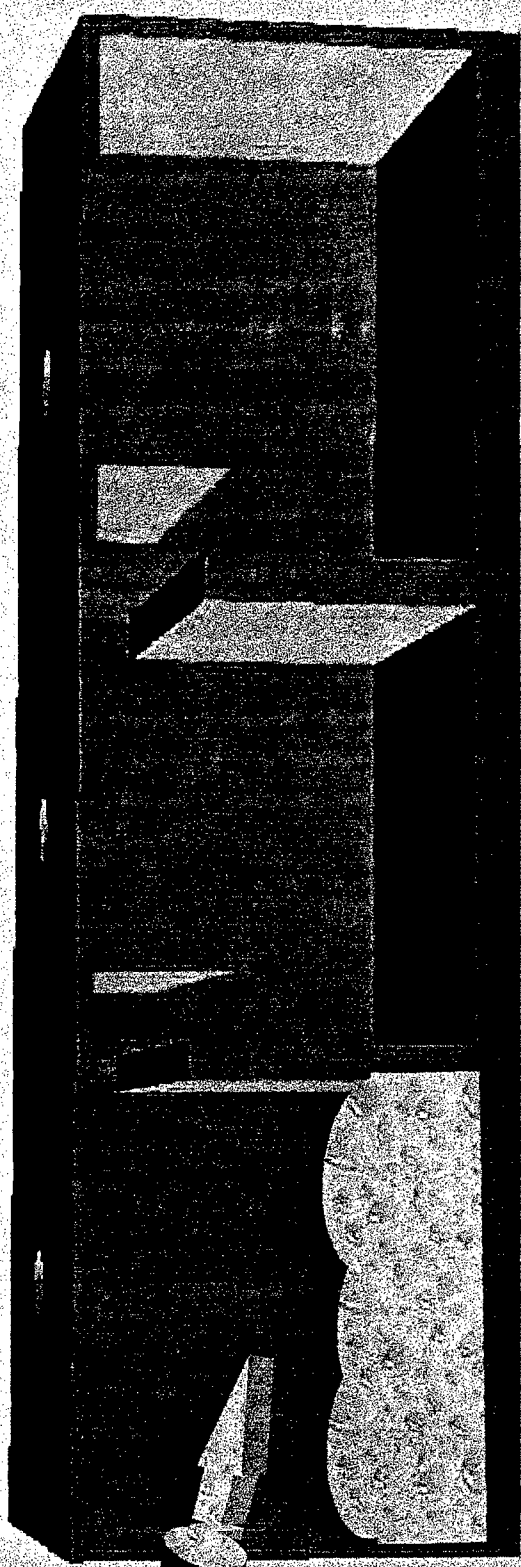


FASE 3: REATTORI TRATTAMENTO ACQUE  
STAGE 3: WATER TREATMENT REACTOR



**FASE 3:  
CHIARIFLOCCULAZIONE**

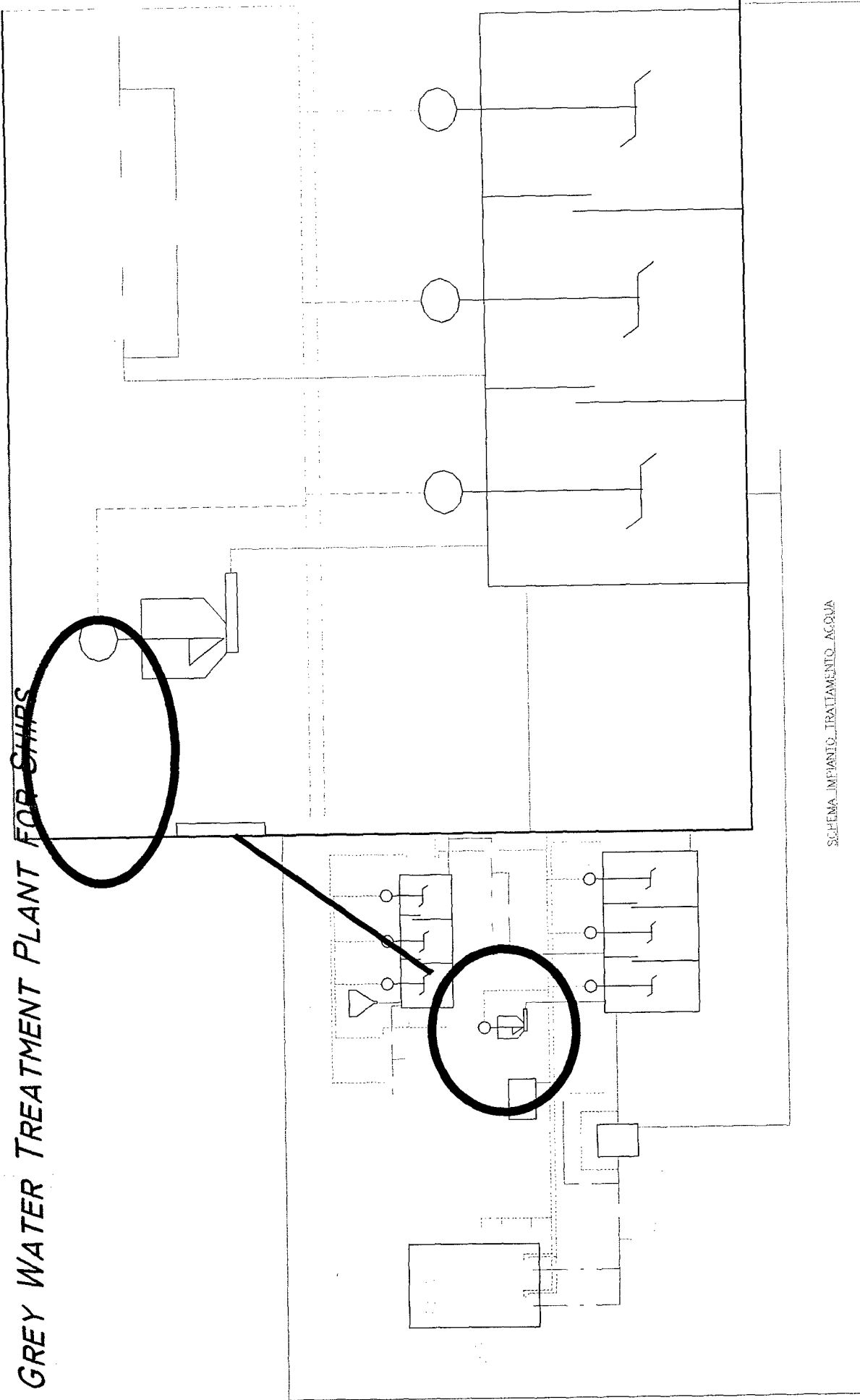
Il refluo è introdotto nel reattore vero e proprio a 3 stadi, nel quale, attraverso reazioni chimico-fisiche, le molecole di sporco si addensano, precipitano e coagulano formando una miscela torbida.



**STAGE 3:  
SIEVING FLOCCULATION**

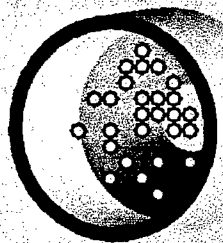
*The remaining fluid enters the reactor proper, a 3-step reactor where the molecules of waste substances undergo chemical and physical reactions to form dense coagulated precipitates.*

IMPIANTO DI TRATTAMENTO DELLE ACQUE GRIGIE PER NAVI  
GREY WATER TREATMENT PLANT FOR SHIPS



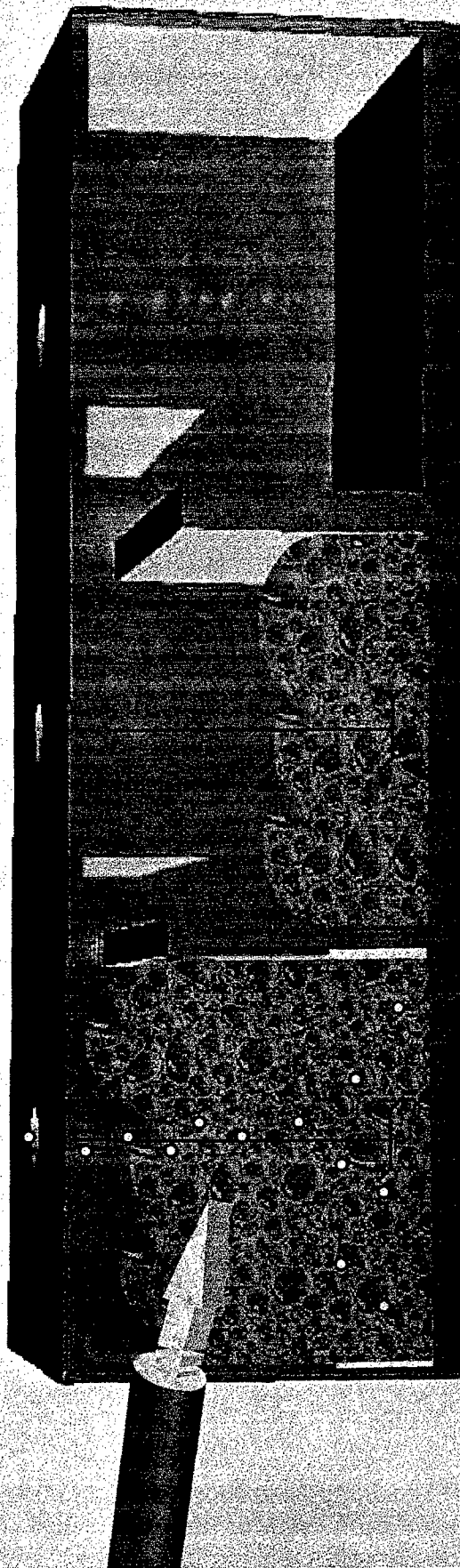
SCHEMA IMPIANTO TRATTAMENTO ACQUA

FASE 3: REATTORI TRATTAMENTO ACQUE STADIO 1: 1° REAGENTE  
STAGE 3: WATER TREATMENT REACTOR. STEP 1: 1ST REAGENT



**FASE 3:  
CHIARIFLOCCULAZIONE - 1° STADIO**

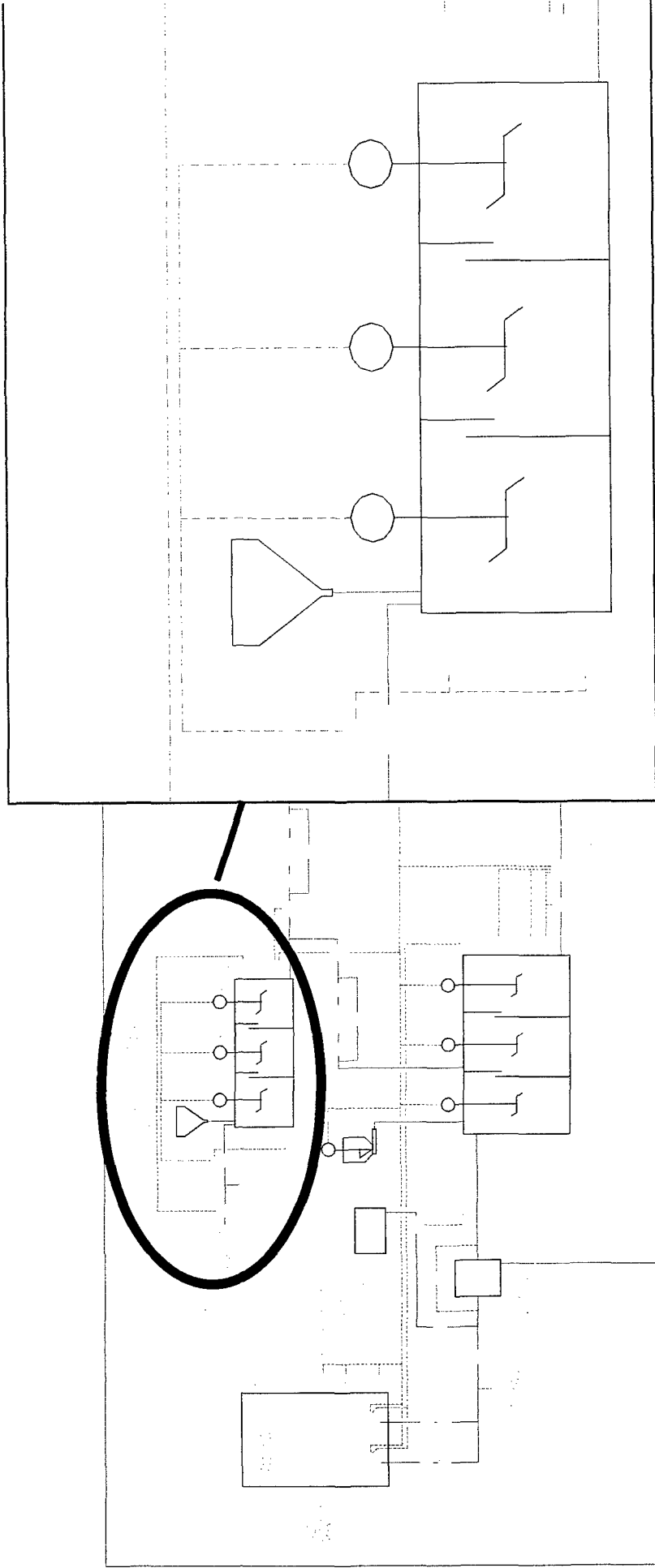
Lo sporco interagisce con il primo reagente grazie anche alle dimensioni della vasca e all'agitatore. Quindi la torbida passa per stramazzo nel secondo stadio di reazione.



**STAGE 3:  
SIEVING FLOCCULATION - 1st STEP**

*The waste substances interact with the first reagent because of the dimensions of the tank and the mixer. Then the precipitate passes down a water-fall to the second stage of the reaction.*

IMPIANTO DI TRATTAMENTO DELLE ACQUE GRIGIE PER NAVI  
GREY WATER TREATMENT PLANT FOR SHIPS



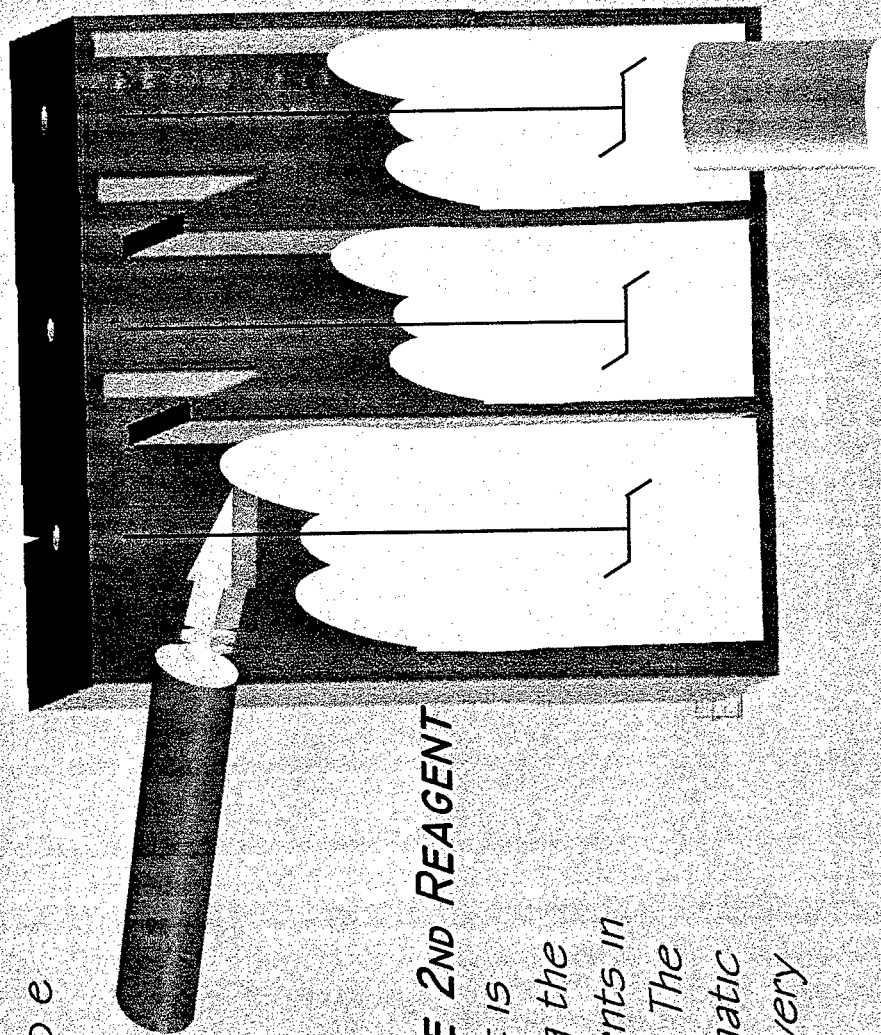
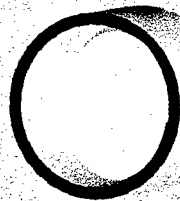
SCHEMA IMPIANTO TRATTAMENTO ACQUA

FASE 3: REATTORI TRATTAMENTO ACQUE STADIO 2: 2° REAGENTE  
STAGE 3: WATER TREATMENT REACTOR, STEP 2: 2ND REAGENT



## PREPARAZIONE 2° REAGENTE

Il 2° reagente è preparato diluendo i reagenti concentrati in un reattore separato per un dosaggio automatico e molto accurato.



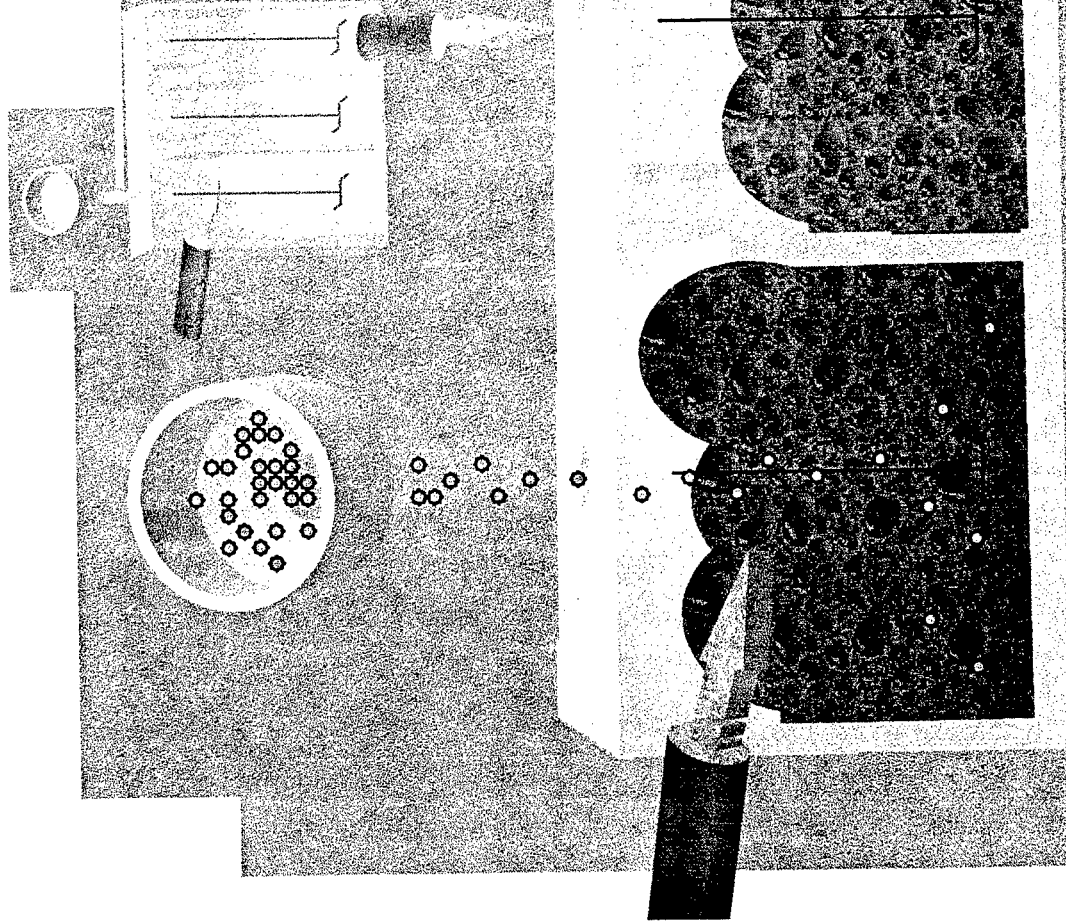
## PREPARATION OF THE 2ND REAGENT

*The second reagent is prepared by diluting the concentrated reagents in a separate reactor. The dosages are automatically controlled and very precise.*

### FASE 3:

### CHIARIFLOCCULAZIONE - 2° STADIO

L'aggiunta del 2° reagente permette la  
finitura di quanto iniziato nel primo stadio.



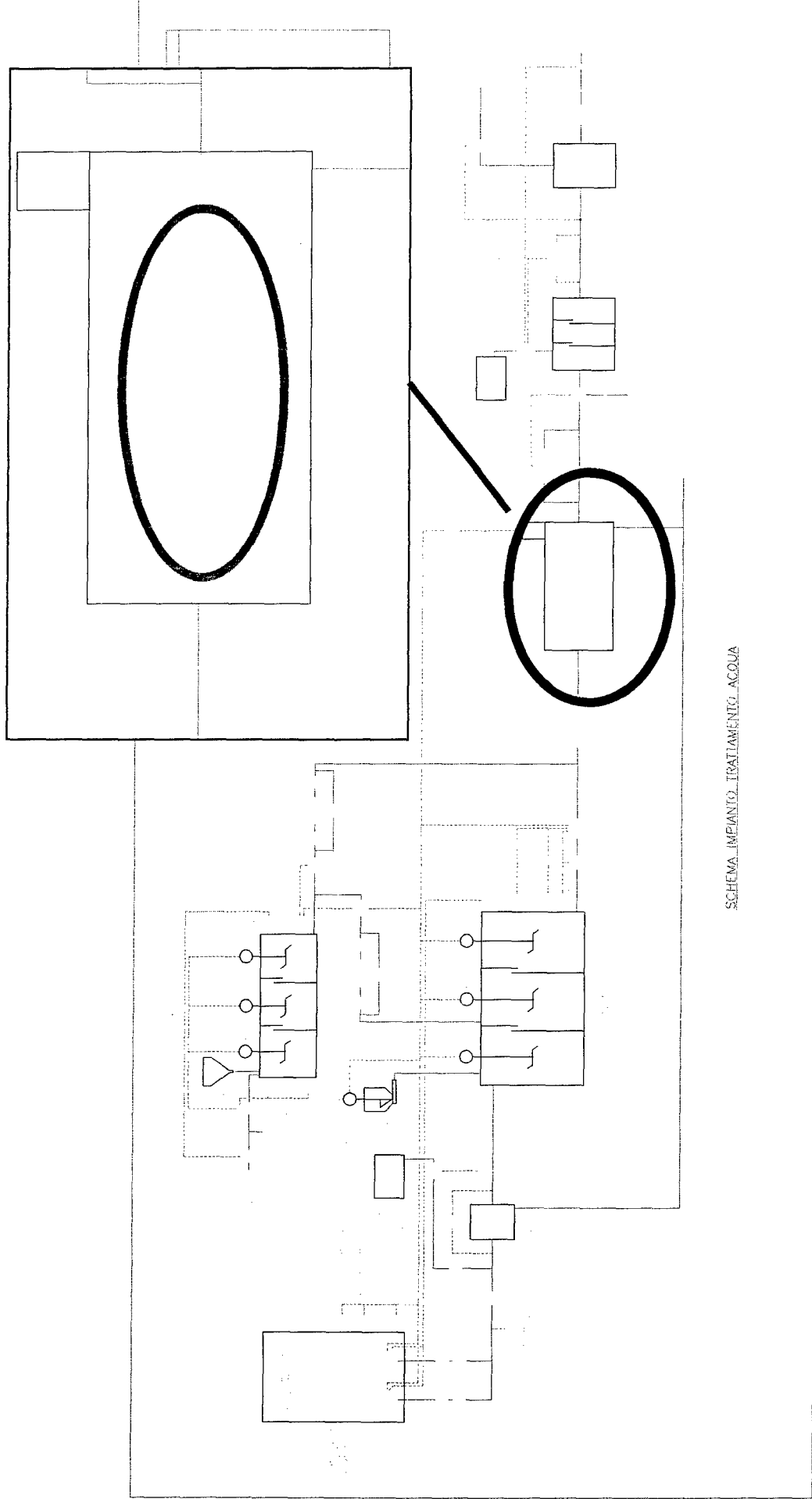
### STAGE 3:

### SIEVING FLOCCULATION - 2ND STEP

*The addition of the second reagent permits  
the reaction mixture to complete the  
process initiated at the first step.*



IMPIANTO DI TRATTAMENTO DELLE ACQUE GRIGIE PER NAVI  
GREY WATER TREATMENT PLANT FOR SHIPS



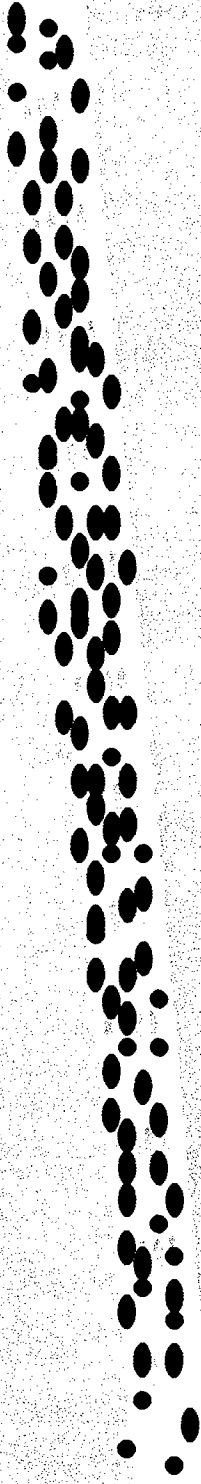
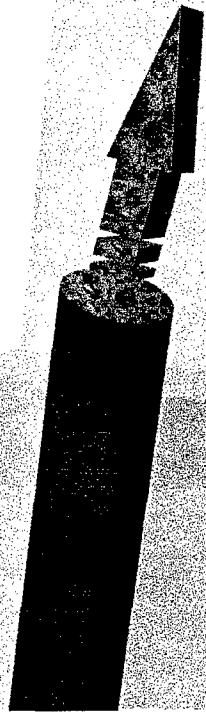
SCHEMA IMPIANTO TRATTAMENTO ACQUA

FASE 4: SEPARAZIONE SOLIDO/LIQUIDO E CHIARIFICAZIONE FINALE  
STAGE 4: SEPARATION SOLID/LIQUID AND FINAL CLARIFICATION

### FASE 6

#### SEPARAZIONE SOLIDO/LIQUIDO E SEPARAZIONE FASE

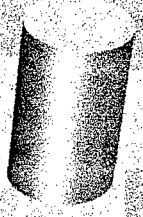
In questa ultima fase il liquido è separato dal solido e la fase liquida è trattata con un processo di separazione solido/liquido e la fase solida è trattata con un processo di separazione solido/solido.



### STAGE 6

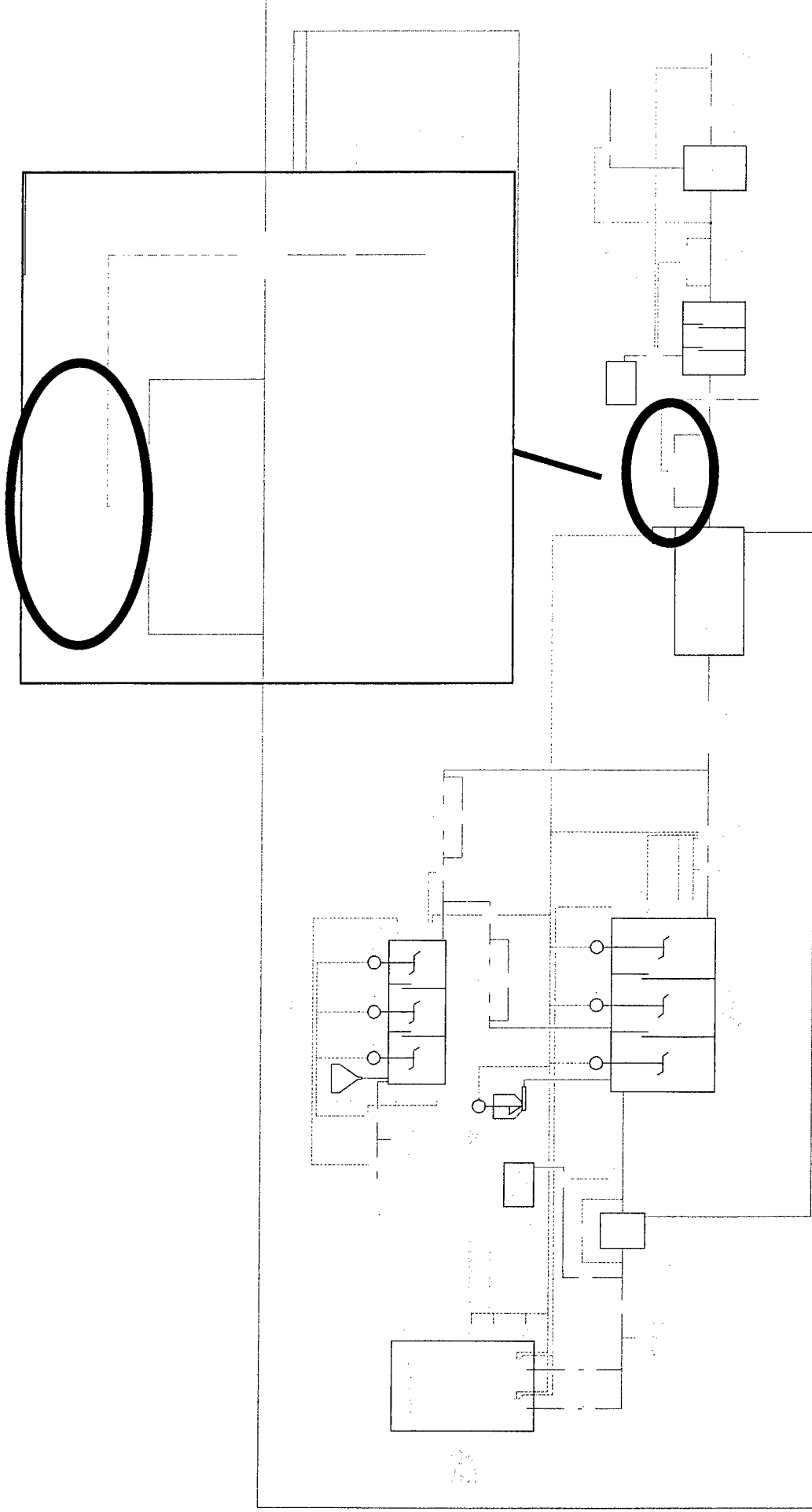
#### SEPARATION SOLID/LIQUID AND FINAL CLARIFICATION

In this unit the liquid is separated from the solid and the liquid phase is treated with a solid/liquid separation process and the solid phase is treated with a solid/solid separation process.



IMPIANTO DI TRATTAMENTO DELLE ACQUE GRIGIE PER NAVI  
GREY WATER TREATMENT PLANT FOR SHIPS

Copyright Athanòr 1998

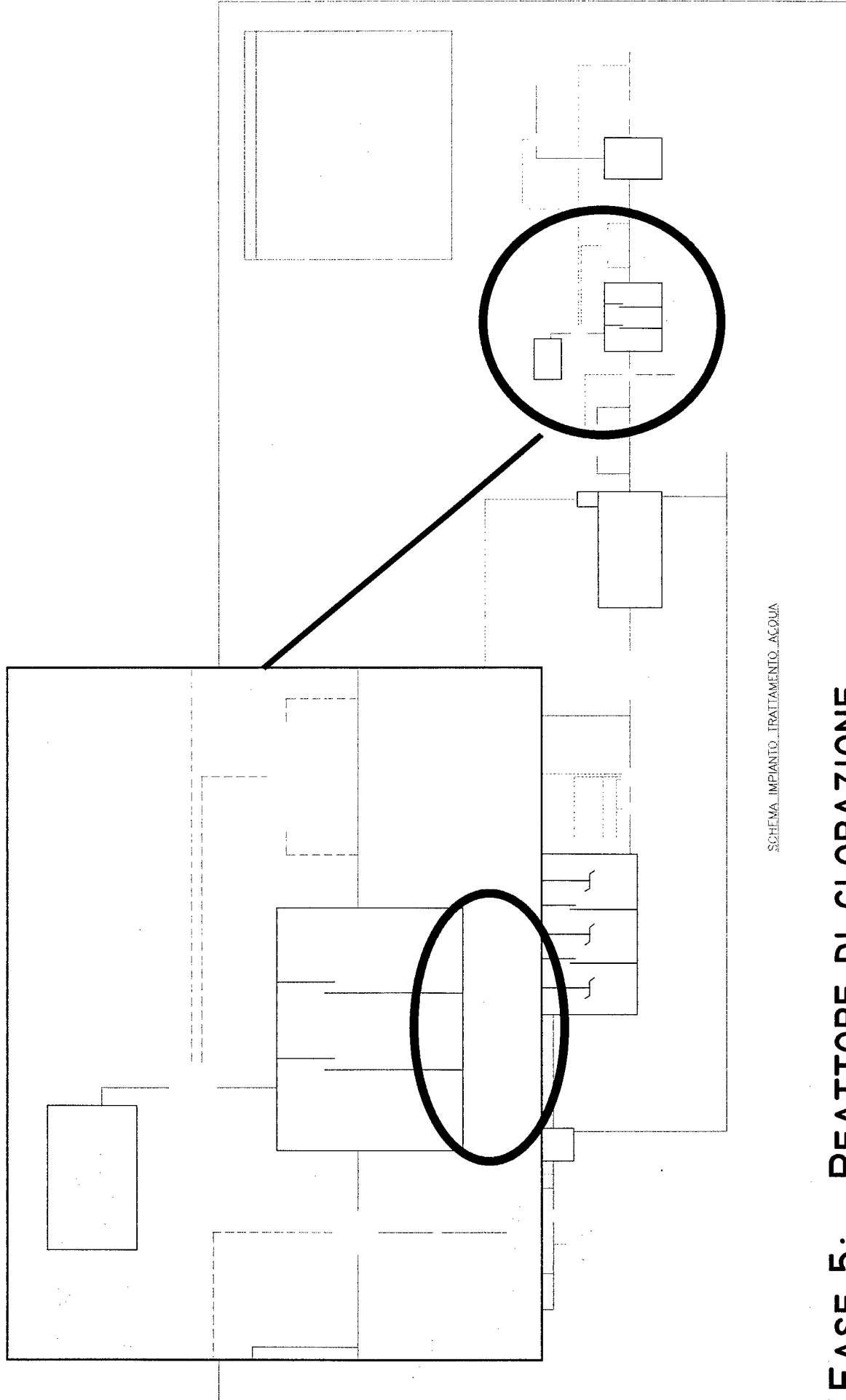


SCHEMA IMPIANTO TRATTAMENTO ACQUA

CONTROLLO 2: CONTROLLO DELLA TORBIDITÀ  
CHECK 2: TURBIDITY CHECK



IMPIANTO DI TRATTAMENTO DELLE ACQUE GRIGIE PER NAVI  
GREY WATER TREATMENT PLANT FOR SHIPS



SCHEMA IMPIANTO TRATTAMENTO ACQUA

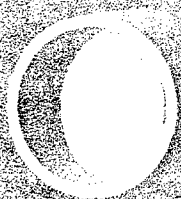
FASE 5: REATTORE DI CLORAZIONE  
STAGE 5: CHLORINATION REACTOR



### FASE 5:

### REATTORE DI CLORAZIONE

L'acqua limpida pronta per il riutilizzo viene trattata con reagenti chimici che la rendono batteriologicamente pura. Segue una misura della conducibilità per verificare la salinità dell'acqua prima del suo utilizzo.

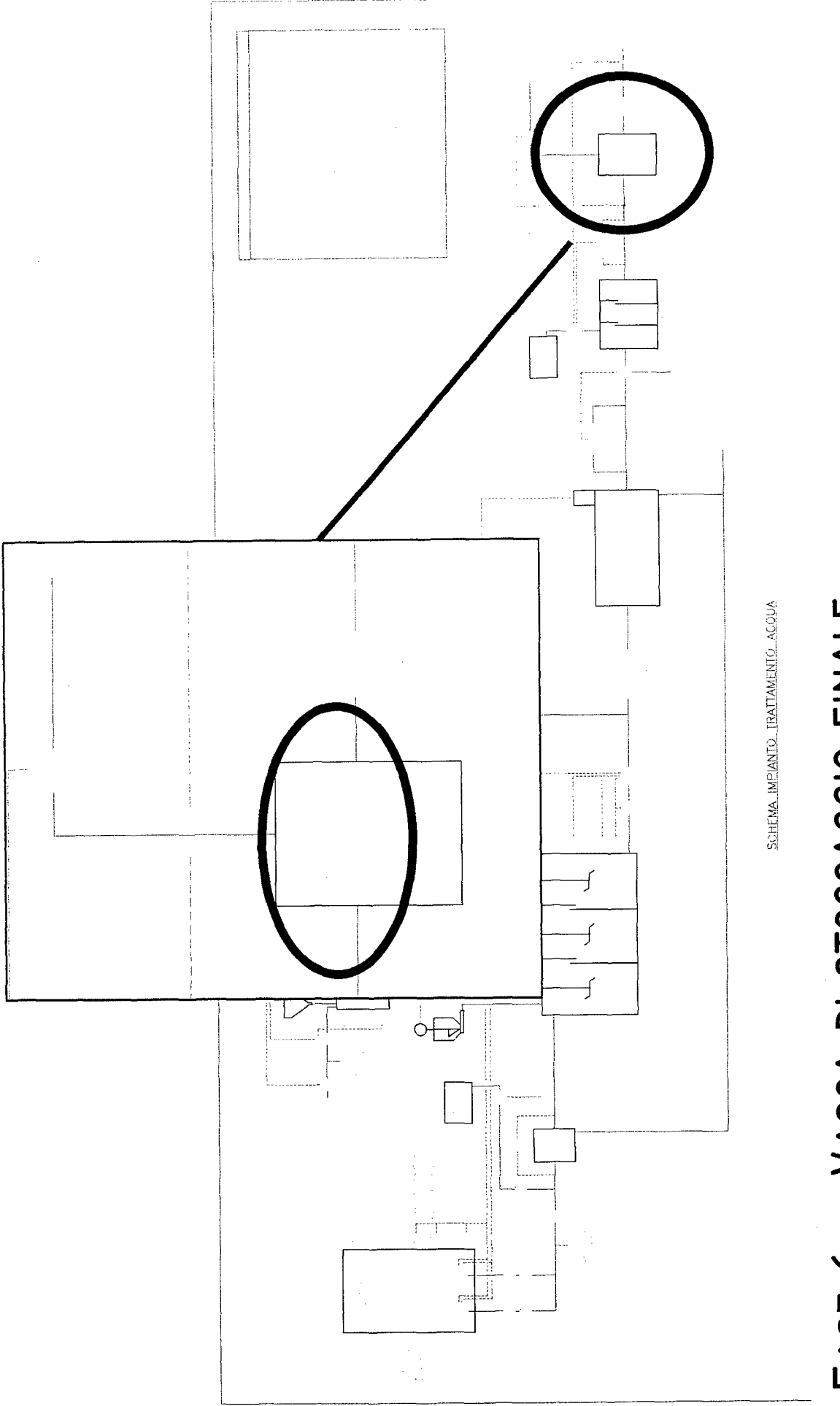


### STAGE 5:

### REACTOR OF CHLORINATION

The clean water ready for re-use is treated with chemical reagents that guarantee sanitary standards. The treatment is followed by a test of electrical conductivity to measure the salinity of the water before re-use.

IMPIANTO DI TRATTAMENTO DELLE ACQUE GRIGIE PER NAVI  
GREY WATER TREATMENT PLANT FOR SHIPS



SCHEMA IMPIANTO TRATTAMENTO ACQUA

FASE 6: VASCA DI STOCCAGGIO FINALE  
STAGE 6: FINAL STORAGE TANK

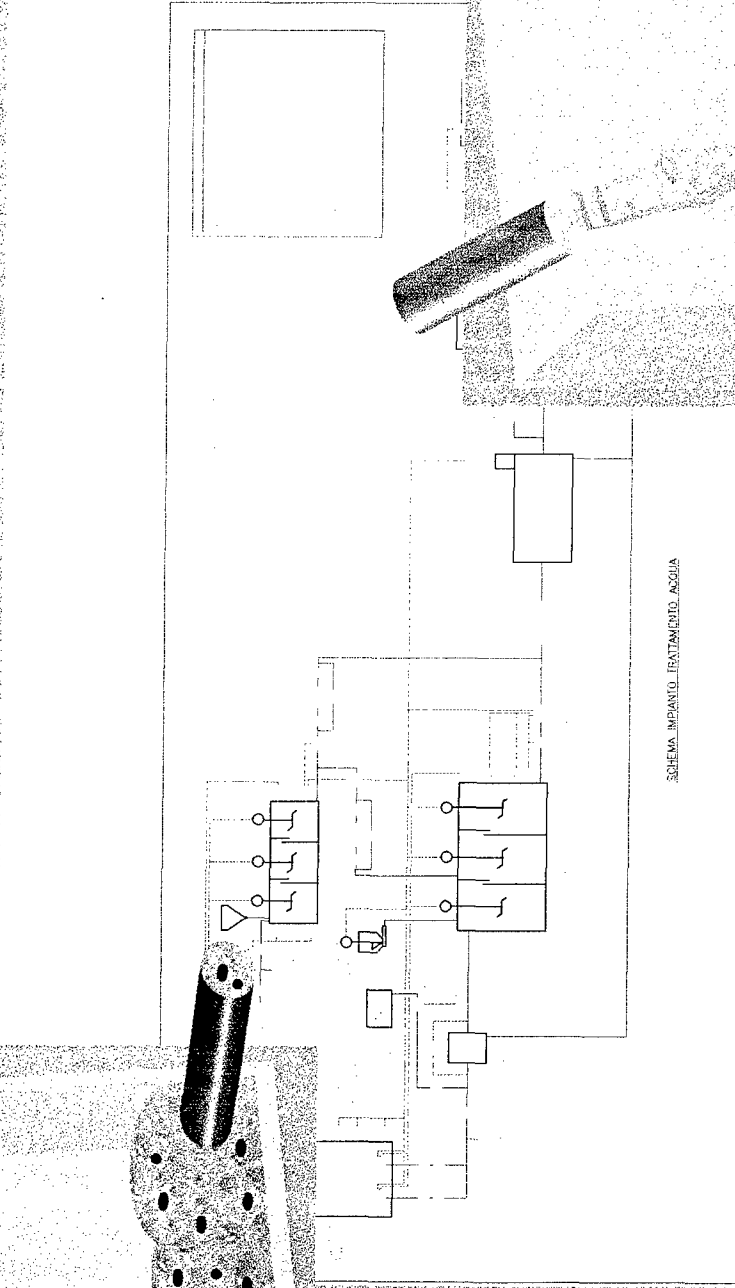




## FASE 6:

### VASCA DI STOCCAGGIO FINALE

L'acqua trattata e disinfettata viene di nuovo inviata ad una cassa, a disposizione per il riutilizzo nell'utenza finale.

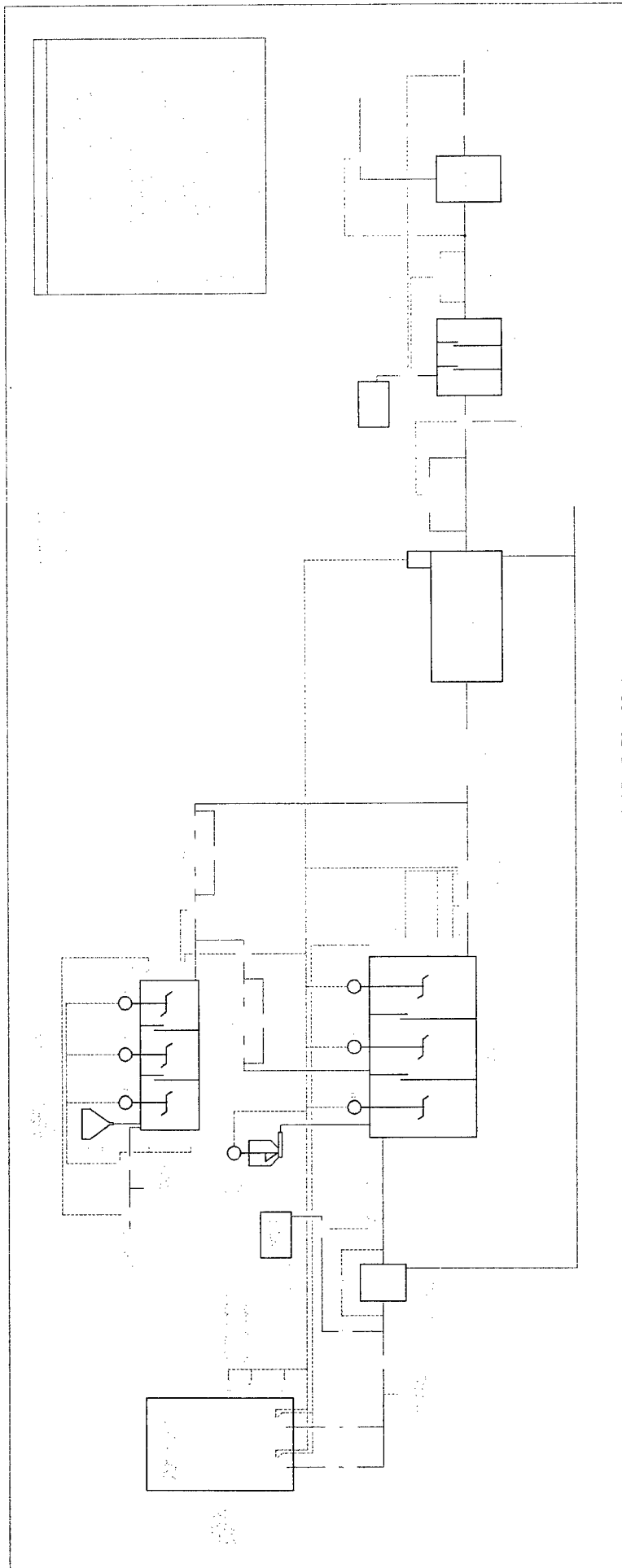


## STAGE 6:

### TANK FOR THE FINAL STORAGE

The disinfected treated passes into another tank where it is available for re-use.

# IMPIANTO DI TRATTAMENTO DELLE ACQUE GRIGIE PER NAVI GREY WATER TREATMENT PLANT FOR SHIPS



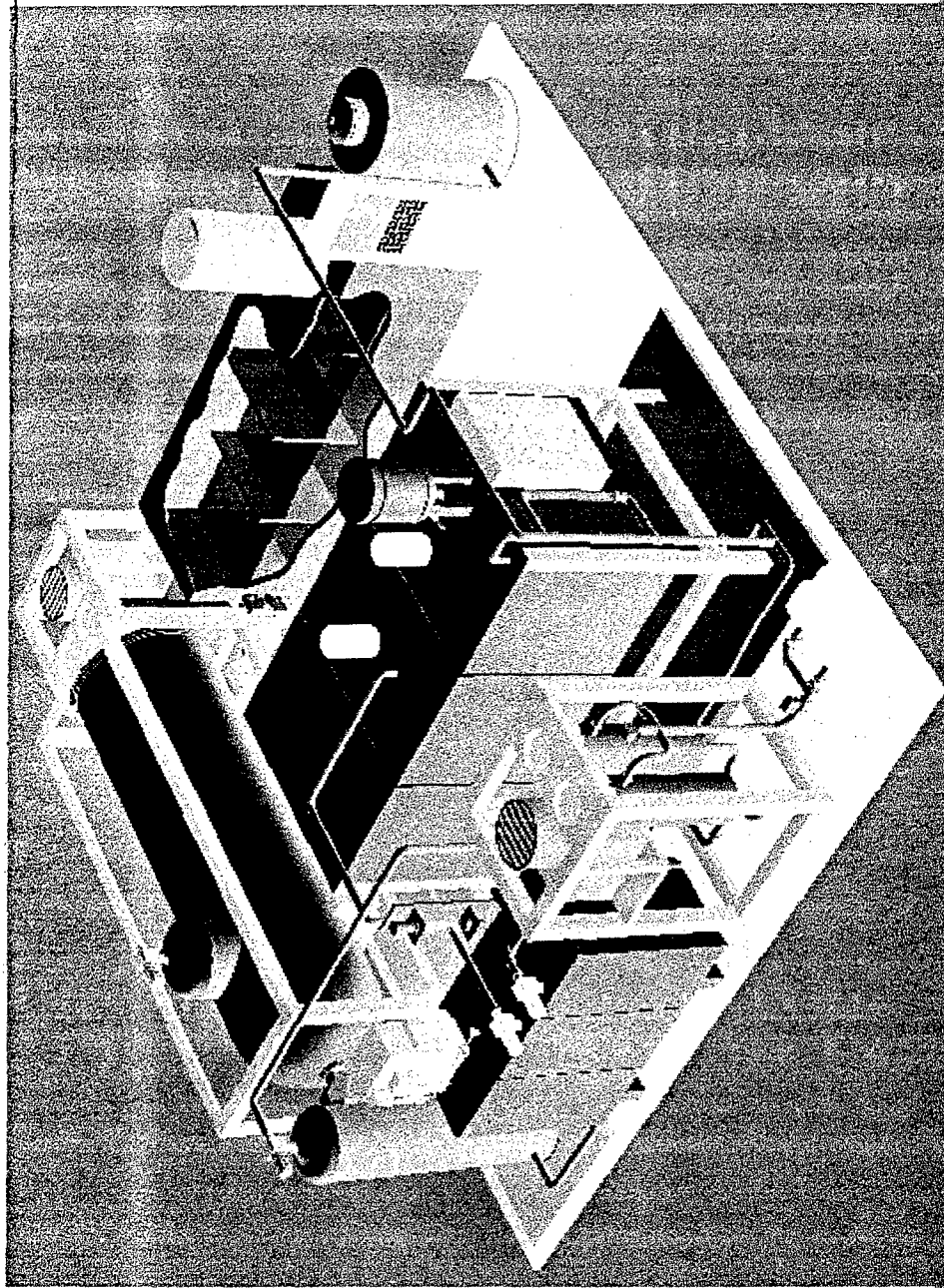
**ALLARMI E CONTROLLI:** L'impianto è interamente automatizzato, tale da permettere gestione e manutenzione semplicissime. Numerosi allarmi e controlli consentono di convogliare correttamente i flussi ed evitare disturbi.

**ALARMS AND CONTROLS:** The plant is completely automatic, allowing a very simple management and maintenance. Many alarms and controls drive the flows and avoid malfunctionings.



IMPIANTO DI TRATTAMENTO DELLE ACQUE GRIGIE PER NAVI  
GREY WATER TREATMENT PLANT FOR SHIPS

Copyright Athanor 1998



**ASSEMBLAGGIO DELL'IMPIANTO.** L'impianto è compatto e componibile in kit come nel disegno sopra raffigurato. In mancanza di spazio, i vari componenti possono essere disposti perimetralmente o anche in locali diversi.

**PLANT ASSEMBLY.** The plant can be reduced in a compact kit as shown in the image. In case of lack of space, the parts can be installed with a perimeteric arrangement or even in different areas.

**ATHANOR**

# ATHANÒR

Athanòr s.r.l. - Via Ciabattini 61/B - 55049 Viareggio - Italy  
Tel.: +39 0584.96.38.56 Fax: +39 0584.96.38.58 E-mail: [main@athanor.it](mailto:main@athanor.it)



**DEVELOPMENT OF A 75 PERSON PROTOTYPE TUBULAR MEMBRANE  
GRAYWATER TREATMENT SYSTEM**

Rachel Jacobs

Environmental Quality Department  
Carderock Division  
Naval Surface Warfare Center  
9500 MacArthur Blvd.  
West Bethesda, MD 20817 – USA

**ABSTRACT**

This paper presents the results of a baseline laboratory evaluation of a tubular membrane graywater treatment system. This system, designated Engineering Development Model No. 1 (EDM-1), has been developed to treat graywater produced on US Navy ships by a 75-man crew. The EDM-1 has been designed with aeration pre-treatment to reduce soluble BOD<sub>5</sub> levels in the feed stream, large bore tubular ultrafiltration polymeric membranes to reject solids and most of the Fecal Coliform bacteria, and an ultraviolet post-treatment unit to ensure adequate disinfection of the effluent. In addition, the system has been designed with a fully automatic control system to minimize manning. This paper will describe the key components of the system, overall system operation, and membrane performance. A two hundred (200) hour laboratory evaluation (LABEVAL) was conducted with graywater (combined laundry and galley water) to establish membrane system performance in terms of membrane flow rate and effluent quality. The system effluent met the MARPOL Annex IV effluent quality goals for total suspended solids (TSS) and fecal coliform (FC), and was only slightly above the goal for biochemical oxygen demand (BOD<sub>5</sub>). The system also maintained the desired flow rate of 2.5 gallons/minute for the duration of the membrane performance test. With the satisfactory performance of this baseline test, a long-term (600 hour) comprehensive laboratory test has been initiated to verify effluent water quality and to determine the extent of membrane fouling.



**Initial Performance Evaluation of a Laboratory  
Graywater Tubular Membrane Treatment  
Engineering Developmental Model No. 1  
(EDM-1)**

**Rachel N. Jacobs**

**Environmental Quality Department, Carderock Division  
Naval Surface Warfare Center, West Bethesda, MD**

**ABSTRACT**

This paper presents the results of a baseline laboratory evaluation for a tubular membrane graywater treatment system. This system, designated Engineering Development Model No. 1 (EDM-1), has been developed to treat graywater produced on US Navy ships by a 75-man crew. The EDM-1 has been designed with aeration pre-treatment to reduce soluble BOD<sub>5</sub> levels in the feed stream, large bore tubular ultrafiltration polymeric membranes to reject solids and most of the fecal coliform bacteria, and an ultraviolet post-treatment unit to ensure adequate disinfection of the effluent. In addition, the system has been designed with a fully automatic control system to minimize manning. This paper will describe the key components of the system, overall system operation, and membrane performance. A two hundred (200) hour laboratory evaluation (LABEVAL) was conducted with graywater (combined laundry and galley water) to establish membrane system performance in terms of membrane flow rate and effluent quality. The system effluent met the MARPOL Annex IV effluent quality goals for total suspended solids (TSS) and fecal coliform (FC), and was only slightly above the goal for biochemical oxygen demand (BOD<sub>5</sub>). The system also maintained the desired flow rate of 2.5 gallons/minute for the duration of the membrane performance test. With the satisfactory performance of this laboratory test, a long-term (600 hour) comprehensive laboratory test has been initiated to verify effluent water quality and to determine the extent of membrane fouling.

## INTRODUCTION

U.S. Navy ships generate significant quantities of non-oily wastewater that cannot be held for extended time periods due to the limited tankage installed. Shipboard "Non-oily Waste-water" is a combination of ship's sewage and graywater. "Graywater" is the product of hotel and commissary-type activities aboard ships. Common sources of graywater are showers, sinks, laundry and galley and scullery equipment.

The U.S. EPA Clean Water Act of 1977<sup>a</sup> prohibited the discharge of untreated sewage in restricted navigable waters. The U.S. Navy response to this legislation was to install collection, holding, and transfer (CHT) systems for most of the fleet. The systems were designed to: (1) collect and hold sewage for 12 hours while in transit through a 3-mile contiguous zone, and (2) collect sewage and graywater, then transfer these wastes ashore while a ship is pierside. No segregated graywater holding capacity was required for U.S. Navy ships with the exception of operations within the Great Lakes. However, several foreign countries and U.S. states including California, Washington, Virginia, Florida and Hawaii have begun to enforce more stringent water quality discharge standards that prohibits the discharge of graywater into navigable waters under their jurisdiction. In order to consolidate numerous and often varying local requirements, the Uniform National Discharge Standards (UNDS)<sup>b</sup> process is setting national standards for discharges from Vessels of the Armed Forces. In anticipation of UNDS and the tightened global wastewater discharge regulations outlined by MARPOL (International Maritime Convention for the Prevention of Pollution from Ships)<sup>c</sup>, the Chief of Naval Operations and Naval Sea Systems Command have identified the need to develop technologies that are appropriate for the control and treatment of combined shipboard graywater and sewage (non-oily wastewater) as one of their environmental priorities<sup>1,2,3</sup>.

In response, engineers and scientists at the Carderock Division Naval Surface Warfare Center under sponsorship of Naval Sea Systems Command (SEA 03R16), are developing a membrane-based, graywater treatment system as a first step in this endeavor. Membrane filtration has been selected as the most viable treatment option to meet the anticipated effluent discharge standards because it is: affordable (capital, logistics, manpower), compact (space and weight), reliable (deployment cycle), and safe. Commercial manufacturers, industrial membrane users, membrane experts, and academic researchers are assisting in the development of this treatment system. Current developmental efforts have resulted in the design and manufacture of a laboratory graywater treatment engineering development model (EDM).

---

<sup>a</sup> "Federal Water Pollution Control Act," As Amended (33 U.S.C. 1251 et seq.)

<sup>b</sup> UNDS is a joint rule-making effort outlined in Section 325 of the Fiscal Year 1996 National Defense Authorization Act. The UNDS legislation requires a collaborative effort between DOD and EPA to set national standards for incidental discharges from Vessels of the Armed Forces.

<sup>c</sup> Which gives the graywater guidelines of BOD  $\leq$  50 mg/L, TSS  $\leq$  100 mg/L and FC  $\leq$  200 cfu/100 mL.

This first graywater treatment engineering development model, EDM-1, principally consists of an aerated feed tank (bioreactor), polymeric tubular ultrafiltration (UF) membranes, and an ultraviolet (UV) light post treatment disinfection system. The membranes are arranged in a bundled configuration in which the tubes are connected in series within a pressure vessel. The wastewater passes through the tubes, and permeate collects in the shell of the pressure vessel. The permeate is passed through the UV unit prior to discharge. During shipboard operation of the system, the permeate will be discharged overboard and the retentate (concentrate) will be retained onboard. The design of EDM-1 was based on the comprehensive laboratory evaluation of a semi-automatic pilot-scale baseline graywater treatment system during 1997. EDM-1 is a fully automatic system and has a nominal flow rate of 2.5 gal/min; a capacity adequate to treat the graywater generated by 75-persons onboard a Naval combatant.

The EDM was designed jointly by CDNSWC and Geo-Centers, West Mifflin, PA. After system fabrication and factory acceptance testing by Geo-Centers, the EDM was delivered to CDNSWC on 8 January 1998. The system consists of two skids; one skid contains the membrane treatment system with related pumps and valves and the second contains the control panel, power panel, and ultraviolet light disinfection unit.

## TEST OBJECTIVES

The objective of this effort was to thoroughly evaluate both the EDM-1's operation and its resultant effluent quality during graywater processing. In order to assess membrane performance, a 200-hour membrane performance test was conducted while processing graywater with aeration of the graywater feed.

## EDM Installation

CDNSWC provided PVC piping and completed the installation to connect the aerated feed tank (bioreactor), discharge lines, macerator pumps and control panel skid to the treatment skid. The system was provided with 440 VAC and 75 amp electrical service. The lab installation was completed on 20 January 1998. An isometric view of the EDM is shown in Figure 1.

## Equipment Description

The EDM-1 is a graywater treatment system which consists of 3 major parts: an aerated bioreactor for bacterial breakdown of graywater organics, ultrafiltration membranes for physical separation of graywater solids, and an ultraviolet light reactor to sterilize the post-membrane effluent (see Figure 2). This EDM system is an automated version of an earlier, pilot-scale, "baseline" graywater system and requires an operator to simply turn the main switch to "AUTO" to begin graywater processing.



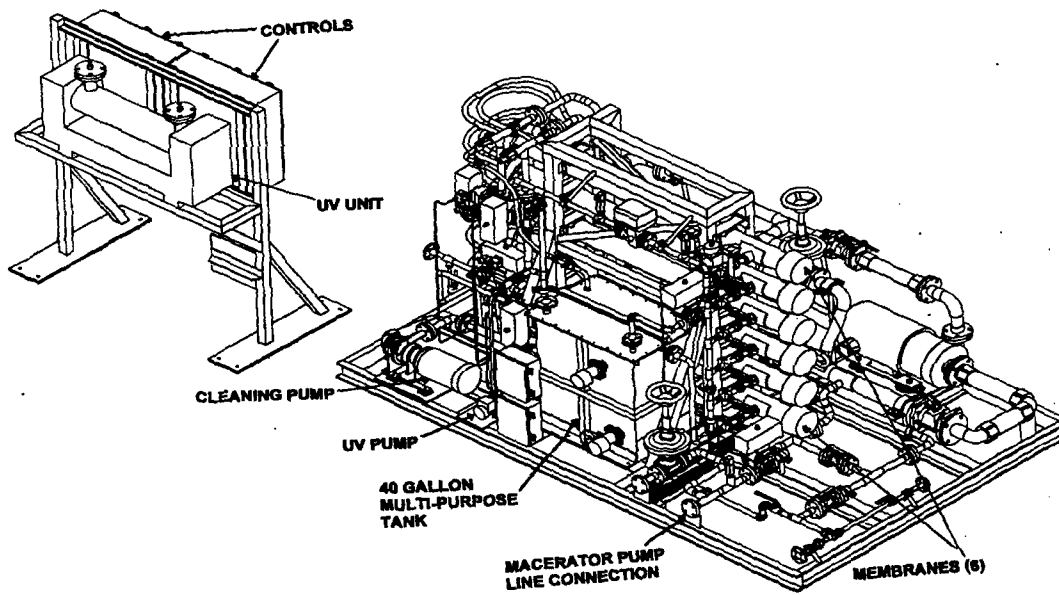


Figure 1. Laboratory Graywater EDM - Isometric Drawing : Rear View

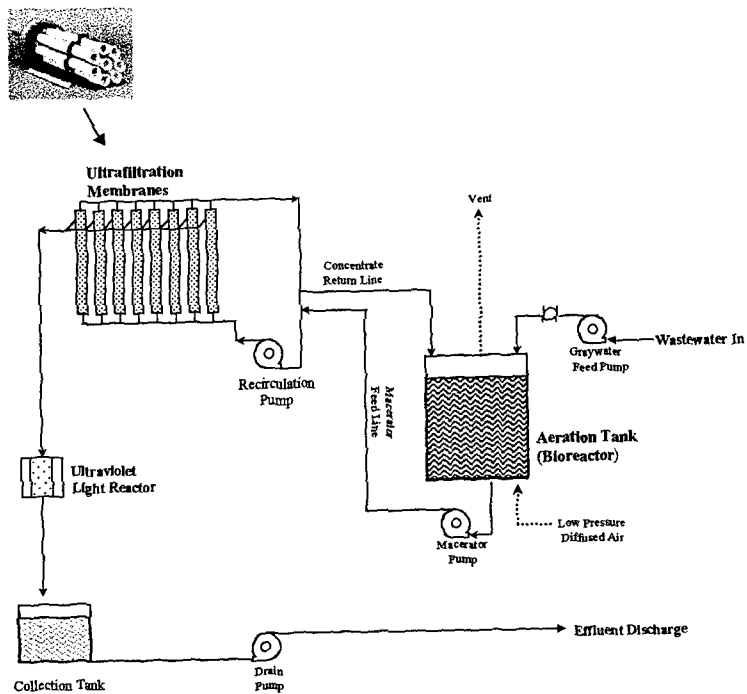


Figure 2. Laboratory Graywater EDM Process and Instrument Diagram

### Piping Materials

All piping, valves and fittings not installed on the treatment skid provided by Geo-Centers are schedule 80 PVC and are defined as "auxiliary" piping. Most of the auxiliary piping chosen for EDM-1 did not meet shipboard fire-resistance/corrosion standards since these materials were determined not to be cost-effective for a laboratory installation. Piping and valves smaller than 1-inch provided on the treatment skid are stainless-steel.

The treatment skid-mounted components are composed of materials suitable for shipboard use. Thus, the membrane housings, piping and valves 1-inch and larger, provided by Geo-Centers, are glass reinforced plastic (GRP) with a fire resistant coating.

### Feed System

Raw graywater is pumped from an outside 10,000 gallon underground tank into an aerated, 1500 gallon polypropylene bioreactor. Once in the bioreactor, naturally present bacteria break down the graywater's organic material. The bioreactor graywater is macerated by a 40 gal/min, 3 hp Barnes<sup>d</sup> dry pit grinder pump [Model NDGV-304] and circulates through the macerator pump and back to the feed tank. At the same time, an isolation diaphragm valve bleeds off bioreactor graywater as feed to the ultrafiltration membrane loop (shown on Figure 2 as the "Macerator Feed Line"). Ball valves for control, sampling, and eductor drainage are installed on the feed line between the macerator pump and the recirculation pump.

### Ultrafiltration Membrane Loop

The UF membrane modules produce high quality effluent, while retaining solids and impurities in the retentate. The membrane loop consists of a "macerator feed line" that brings aerated graywater into the loop, a recirculation pump, a bank of ultrafiltration membrane modules, a concentrate line to return graywater to the bioreactor, and a permeate line to direct cleaned water to the UV unit.

The recirculation pump has isolation ball valves to allow for maintenance, and this 200 gal/min, 15 hp Waukesha<sup>e</sup> centrifugal pump [Model 2065] provides up to 65 psi at the membrane inlet. The recirculation pump is not only capable of withstanding the high solids impurity level in the concentrate loop, but has a relatively flat operating curve in the operating pressure band, and has a small required net positive suction head.

The membrane bank initially consisted of six Zenon<sup>f</sup> 6' long ZPF-8, 4" diameter housings with eight MF-100, 3/4 - inch diameter tubular ultrafiltration membranes arranged in parallel (Figure 3). After several graywater processing trials, the number of modules

<sup>d</sup>Barnes Pump Company, Piqua Ohio

<sup>e</sup>Waukesha, Delevan, Wisconsin

<sup>f</sup>Zenon Environmental Systems, Inc. Burlington, Ont.

was increased in order to meet the system throughput design goals. The membranes have a nominal pore size of 0.1 micron or approximately 100,000 Dalton molecular weight cut-off. Each membrane module contains 10.2 square feet of membrane surface area.

Flushing water and concentrate return connections are incorporated into the membrane loop for membrane cleaning and return of the gray-water concentrate to the aerated feed tank. After exiting the membrane loop, membrane permeate flow is directed through an ultraviolet light disinfection post treatment unit (Figure 4) and fed to the multipurpose tank to be pumped down the main sewage drain in the laboratory.

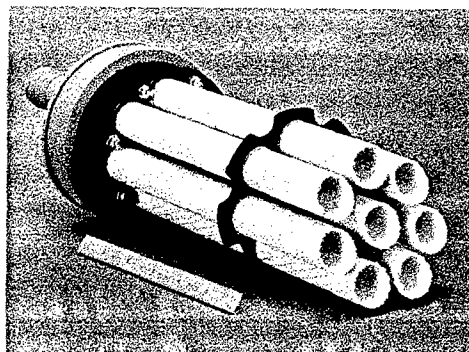


Figure 3: ZPF-8 Membrane Module with 0.83-inch diameter tubular membranes

Pressure transducers are installed on the membrane inlet, membrane outlet and permeate line to monitor system performance. Sample valves are installed at the permeate discharge of each membrane housing and an additional sample valve is installed after the disinfection unit to determine UV effectiveness.

### Multipurpose Tank

A 40 gallon epoxy-coated steel tank (multipurpose tank) is used to hold permeate prior to discharge, water for daily system flushing, and membrane cleaning solution as required.

A 20 gal/min, 1 hp Pulsafeeder<sup>g</sup> centrifugal pump [Model ECH1/SST] is connected to the tank. This "cleaning/flushing" pump discharges permeate (post-UV called "effluent") to the laboratory sewer, and is used once daily to recirculate heated (50°C) clean water through the membrane bank / UV unit as a "flush" before daily shutdown of the system. The same pump is also used to circulate cleaning solutions through the membranes when necessary.

### Ultraviolet Disinfection Unit

An Aquafine<sup>h</sup> four bulb, UV disinfection unit [Model CSL-4R] is installed in the permeate line to ensure that fecal coliform (FC) bacteria (used as an "indicator" organism) are always less than the design goal of 200 cfu per 100 mL. The unit, shown in Figure 4, consists of a completely enclosed single treatment chamber with internal baffles to increase mixing time and create

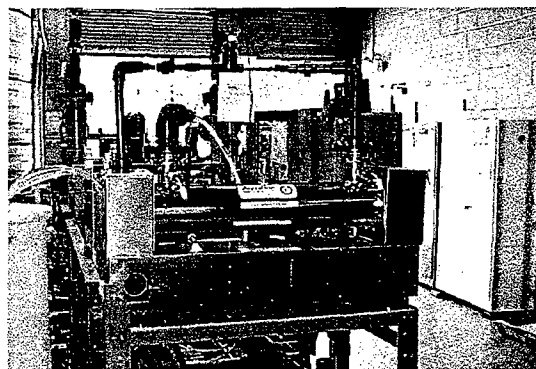


Figure 4. Aquafine CSL-4R, four bulb, UV disinfection unit (Model CSL-4R)

<sup>g</sup> Pulsafeeder Inc., Rochester, New York  
<sup>h</sup> Aquafine Corporation, Valencia, California

turbulence. To help prevent fouling and build-up of undesirable material in the unit (when unit not in operation), a 2 gal/min, 8 psig recirculation pump [March: Model AC-3D-MD<sup>i</sup>] provides flushing during down-time. Fresh water from the multi-purpose tank is continuously circulated through the unit after daily operations to decrease the frequency of manual cleanings of the UV bulb protective sleeve. A recent innovation involved retrofitting the UV unit with a clear, fluorinated ethylene propylene (FEP) sleeve (replacing the quartz sleeve initially provided with the unit) to improve system durability and facilitate cleaning.

### Control System

The control system provides the EDM-1 with fully automatic operation (minimal manning) and monitoring of tank levels, system flows, temperatures and pressures in order to prevent overflows and protect critical components from damage. A programmable logic controller (PLC) allows communication between the instrumentation and the operator interface (message display). The instrumentation for the EDM includes a permeate flow meter (magnetic type [Krohne: Model CE]), pressure transducers [Sensotec: Model 317-B], a variable area air flow meter [Cole-Parmer: Model E-32470-06], two temperature sensors (resistance thermal device [Pyromation]) and level sensors (magnetic switch [TriMod Besta]). Two sensors monitor dissolved oxygen in the laboratory EDM-1; one in the aerated feed tank and the second in the macerator return line to the aerated feed tank [Analytical Technology: Model B15/60]). Neither sensor is incorporated into the control logic at this time. Both of these two sensors were installed to compare performance in the chosen locations.

A message display screen provides the operator with system status and operating condition information. This "Graphical User Interface" (GUI) compliments the conventional warning lights, push buttons and instrument displays on the control panel. The GUI allows control during manual modes and provides specific instrumentation monitoring during automatic operation, manual operation, and troubleshooting. In addition, the unit is equipped with a data logger that uses a personal computer memory card [international association PCMCIA] for data storage and retrieval.

### **LABORATORY EVALUATION**

Upon completion of the laboratory installation and mechanical testing in early 1998, the EDM-1's operation and treatment system performance was evaluated via a 200 hour Membrane Performance Laboratory Evaluation [LABEVAL]. Table 1 below lists the parameters evaluated during the LABEVAL.

---

<sup>i</sup> upgraded from an earlier 2 gal/min: 3 psig recirculation pump incapable of overcoming head pressure



**Table 1. EDM-1 LABEVAL Performance Parameters**

|                       | Parameter        | Evaluation                     |
|-----------------------|------------------|--------------------------------|
| Operation Performance | Flow rate        | goal: over 2.5 gallons/minute  |
|                       | Permeability     | observe trends                 |
|                       | TMP              | observe trends                 |
| Treatment Performance | BOD              | goal: less than 50 mg/L        |
|                       | TSS              | goal: less than 100 mg/L       |
|                       | FC               | goal: less than 200 cfu/100 mL |
|                       | Oils and Greases | observe trends                 |

Description of Operation Parameters:

**Flow rate** = the volume of graywater processed over time. Assuming that a ship creates on average 30 gallons graywater per sailor per day, and that graywater is being generated for 17 hours of those hours, a graywater treatment system serving 75 sailors needs to process 2.5 gallons graywater/ minute. If the graywater treatment system cannot maintain this rate the system would overflow.

**Permeability** = the flow rate normalized to a common temperature and pressure (20°C, 1 bar). The permeability shows the relative ease with which permeate passes through the membranes (while the system maintains a constant programmed permeate flow rate). A slow decrease in permeability over time is usually indicative of membrane fouling (either particulate or biological which can build on the surface and/or in the pores). A sudden decrease in membrane permeability may indicate a blockage.

**TMP** = "Transmembrane Pressure", as determined by the average pressure across the membrane surface (tube to shell)<sup>j</sup>. Not only does the TMP demonstrate the pressure drop through the membranes, but is also provides a safety parameter for the fairly fragile membranes. The polymer membranes used in the EDM-1 system should not have a TMP higher than 45 psi<sup>k</sup> as a higher pressure can cause rupture.

<sup>j</sup> Note: in some tests the TMP is referred to as the THP (transheader pressure) because the pressure transducers were mounted on the membrane headers, not on the membranes themselves.

<sup>k</sup> Based upon an assumed maximum safety inlet pressure of 65 psi and the system's piping configuration.



### Description of Treatment Parameters:

**BOD** = "Biological Oxygen Demand". The BOD is a measure of how much organic matter is available as food in the graywater. A low BOD (< 50 mg/L) is desirable in overboard effluent since algae blooms and other prokaryote outbreaks occur when high nutrient levels are available. In most wastewater testing, the BOD is analyzed over a five day period and is reported as BOD<sub>5</sub>. A bioreactor is critical in reducing BOD in the EDM system as the bacterial population digests the organics initially present in the graywater.

**TSS** = "Total Suspended Solids". The TSS is a measure of the amount of suspended solids, both organic and inorganic, found in wastewater. Suspended solids levels below 100 mg/L is desirable in overboard effluent.

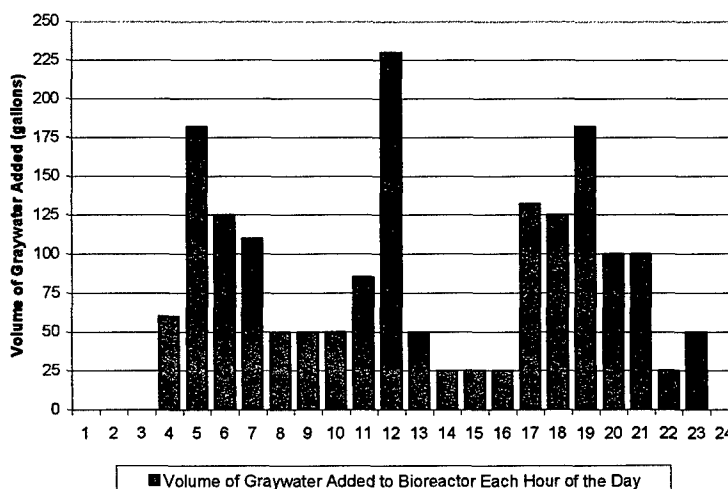
**FC** = "Fecal Coliform". Fecal Coliform (FC) is a common bacterium found in wastewater that can cause gastric disease in humans. Levels of fecal coliform are measured in "colony forming units", cfu (essentially a bacterium capable of reproducing), per milliliter of wastewater. Overboard effluent should have fewer than 200 cfu/mL.

**Oils and Greases (O/G)** = the amount of oils and greases found in graywater. There are no regulatory limits on the amount of oils and greases present in the effluent, but it has been surmised in the laboratory that high O/G levels in the bioreactor prevent the bacterial from effectively reducing BOD.

### **Experimental Procedure**

To establish overall system and membrane performance, the graywater system was operated for 264 hours in a "Laboratory Evaluation" or LABEVAL (processing time = 200 hours)<sup>1</sup>. During this LABEVAL, EDM-1 ran completely automatically for 24 hours/day during which time graywater processed approximately 17 hours/day @ 2.5 gallons/minute.

Roughly 3,000 gallons of raw graywater was processed daily. While processing, aerated graywater was pulled from the bioreactor and concentrated in the membrane loop as permeate was continuously removed. Raw graywater was supplied to



**Figure 5: Daily Feed Schedule**

<sup>1</sup> **Note:** "Operational Run Time" is the time the system is powered and available to process graywater (clock time). "Processing Time" is the time the system actually processes graywater. EDM processed graywater whenever the bioreactor reached a certain volume - as would be the case aboard ship.



the bioreactor in a ratio of 1 part galley to 10 parts laundry wastewater. This ratio resulted in a graywater mixture with characteristics similar to shipboard graywater. This raw graywater was added to the bioreactor in a schedule representative of a U.S. Navy vessel's anticipated graywater generation rate (Figure 5).

Based on the graywater transfer and resulting treatment schedule, one tap water flush was expected a day, at approximately 2300 hours (11:00 PM) with an average flush temperature of 50°C. A summary of the operating conditions follows in Table 2.

**Table 2. Operating and Daily Run Conditions**

|                              |                            |
|------------------------------|----------------------------|
| Membrane Type:               | Eight Zenon MF-100 Modules |
| Water Type:                  | Graywater                  |
| Throughput:                  | 2.5 gal/min                |
| Daily Flush:                 | Tap water @ 50°C           |
| Cross flow Velocity:         | 15 ft/s (+/- 3 ft/s)       |
| Average TMP:                 | 40 psi (+/- 3 psi)         |
| Bioreactor diffused air flow | 20 cubic feet/minute (CFM) |
| Hydraulic Retention Time:    | 8 hours                    |
| Operational Run Time         | 24 hours/day               |
| Processing Run Time:         | 17 hours/day               |

### EDM Operational Modes

Whenever the EDM is powered and set to "AUTO", several different operational modes occur:

- **Processing:** The system is processing graywater because the bioreactor has a volume of 1050 gallons or greater. System automatically adjusts pressure to maintain permeate flow rate at approximately 2.5 gal/min. Permeate is collected in the multipurpose tank, which is automatically drained when full.
- **Wait Mode:** The system has temporarily stopped processing because bioreactor volume has dropped below 1050 gallons. If more water is added to bioreactor, bringing the bioreactor volume above 1050 gallons before an hour has elapsed, the system will resume processing. During this waiting period the bioreactor is recirculated/aerated for 10 minutes every half hour.
- **Flush Mode:** System begins flushing with hot tap water after an hour has passed in Wait Mode (still less than 1050 gallons in bioreactor). The 8-membrane system flushes with approximately 150 gallons hot water.

- **Standby Mode:** System has finished flush, but waits until a high bioreactor level occurs (1250 gallons) before resuming processing. During this waiting period the bioreactor is recirculated/aerated for 10 minutes every half-hour.

### Sample and Data Collection

Data was recorded from the EDM control panel every half-hour to evaluate the performance of the membranes. From this data, membrane permeate flow, permeability, and transmembrane pressure (TMP) were generated. (The data logger operation was tested but not relied upon during the LABEVAL).

One hundred (100) samples from the feed, aerated tank contents (bioreactor), UF permeate, and UV effluent were collected during the 200 hour membrane performance test. Composite samples<sup>m</sup> were gathered four times a day, while grabs were collected once a day. The analytical methods used for sample analysis are listed in Table 3.

**Table 3. Analytical Methods**

| TEST                                                   | SAMPLE TYPE | STANDARD METHOD #                                 |
|--------------------------------------------------------|-------------|---------------------------------------------------|
| Five Day Biochemical Oxygen Demand (BOD <sub>5</sub> ) | composite   | 5210B, 19 <sup>th</sup> Edition                   |
| Total Suspended Solids (TSS)                           | composite   | 2540D, 19 <sup>th</sup> Edition                   |
| Fecal Coliform (FC)                                    | grab        | 9221E (MPN), 19 <sup>th</sup> Edition             |
| Total Organic Carbon                                   | composite   | 5310, 19 <sup>th</sup> Edition                    |
| Total Kjeldahl Nitrogen                                | composite   | 4500—N <sub>org</sub> C, 19 <sup>th</sup> Edition |
| Phosphorous                                            | composite   | 4500-P, 19 <sup>th</sup> Edition                  |
| Oil and Grease (O/G)                                   | composite   | 5520D, 19 <sup>th</sup> Edition                   |
| Chemical Oxygen Demand (COD)                           | composite   | 508, 19 <sup>th</sup> Edition                     |

<sup>m</sup> A "composite sample" is a series of samples taken from the same port over the course of a day and placed into a single container. This composite then provides an "average" sample for the day.

## Raw Graywater Characteristics

The raw graywater mix used in the laboratory evaluation was tested for the nutrient levels required for proper growth of the bioreactor's bacterial population - specifically total organic nitrogen (TKN), total phosphorus (P), and total organic carbon (TOC). According to "typical" compositions of untreated domestic waste-water<sup>n</sup>, nitrogen levels of approximately 15 mg/L constitute a "medium" concentration of wastewater while phosphorus levels above 5 mg/L and carbon levels above 290 mg/L are considered of "extremely strong" wastewater strength. Therefore, the bioreactor during this laboratory evaluation should not have been nutrient limited.

**Table 4: Raw Graywater Nutrients**

|                                                                   | TKN    | P      | TOC    |
|-------------------------------------------------------------------|--------|--------|--------|
| Ave. laboratory mass concentration (mg/L)                         | 14.3   | 10.36  | 398    |
| Compared to typical concentration of untreated domestic graywater | Medium | Strong | Strong |

## System Performance Criteria

### Membrane Throughput: Operational Performance

The EDM-1 system must produce 2.5 gal/min of permeate throughout the 200 hour test. Separate from this requirement, certain other trends are expected in the permeability, and TMP. Expectations are that the permeability decreases over time (indicative of membrane fouling), and that the TMP increases [as programmed] to maintain the required flow rate.

### Effluent Water Quality: Treatment Performance

The effluent water quality goals for BOD, TSS, and FC are listed in Table 5. In order to meet the system performance criteria, the geometric mean of the collected effluent samples during the membrane performance test must meet these water quality goals.

**Table 5. Effluent Quality Goals**

| TEST                                                   | QUALITY GOAL            |
|--------------------------------------------------------|-------------------------|
| Five Day Biochemical Oxygen Demand (BOD <sub>5</sub> ) | Less Than 50 mg/L       |
| Total Suspended Solids (TSS)                           | Less Than 100 mg/L      |
| Fecal Coliform (FC)                                    | Less Than 200 cfu/100mL |

<sup>n</sup> Metcalf and Eddy, Inc. "Wastewater Engineering: Treatment, Disposal, and Resuse". 3rd. Ed. McGraw-Hill, Inc.: New York, 1991. pg 109.

## Membrane Performance Test Results

### Throughput Results and Trends

The graywater test ran for 264 hours, of which 200 hours were process time. This system processed approximately 3000 gallons of graywater daily. While processing, the membranes needed to produce 2.5 gal/min of permeate. Table 6 shows average flow, permeability, TMP, flux and temperature.

**Table 6. EDM Membrane Performance Results**

|                 | Process Hours (hr.) | Ave Flow (gal/min) | Ave Perm. (LMH/bar) | Ave TMP (psi) | Ave Temp (°C) |
|-----------------|---------------------|--------------------|---------------------|---------------|---------------|
| LABEVAL Results | 200                 | 2.75               | 20.8                | 36.8          | 40.2          |
| Goal            | 150                 | 2.5                | NA                  | NA*           | NA            |

- UF Permeate Flow vs Time:** Figure 6 shows the UF Membrane Permeate Flow compared to clock time. This graph shows that the UF permeate flow continuously exceeded the processing goal of 2.5 gallons per minute. The periods of time where the flow line decreased to zero either indicates system "Wait" or "Standby" modes (periods where there isn't enough water in the bioreactor to warrant processing). The occasional rapid rise in permeate flow to over 3 gallons per minute [at 39.0, 110.5, and 264.0 hours] indicates flushing periods<sup>o</sup>. The extended standby period between 110 and 142 hours resulted from a delay in repairing a broken seal in the main recirculation pump.
- UF Membrane Permeability vs Time:** Figure 7 shows the UF Membrane Permeability compared to clock time. This graph shows that the membrane permeability did decrease slightly over time, indicating that a certain degree of fouling (either particulate or biological) occurred over the course of the experiment. Comparison of the permeability and the permeate flow graphs show that the EDM system needed to increase membrane pressure over time in order to maintain the same overall flow rate - thus confirming the proper functioning of the control logic.
- UF Membrane Flux and Differential Header Pressure vs Time:** Figure 8 compares the membrane flux to system pressure over time. This graph confirms that the EDM system did indeed increase pressure in the system in order to maintain a constant permeate flow.

<sup>o</sup> Since membranes are flushed with tap water, the flow rate through the membranes is far higher than is possible with graywater.



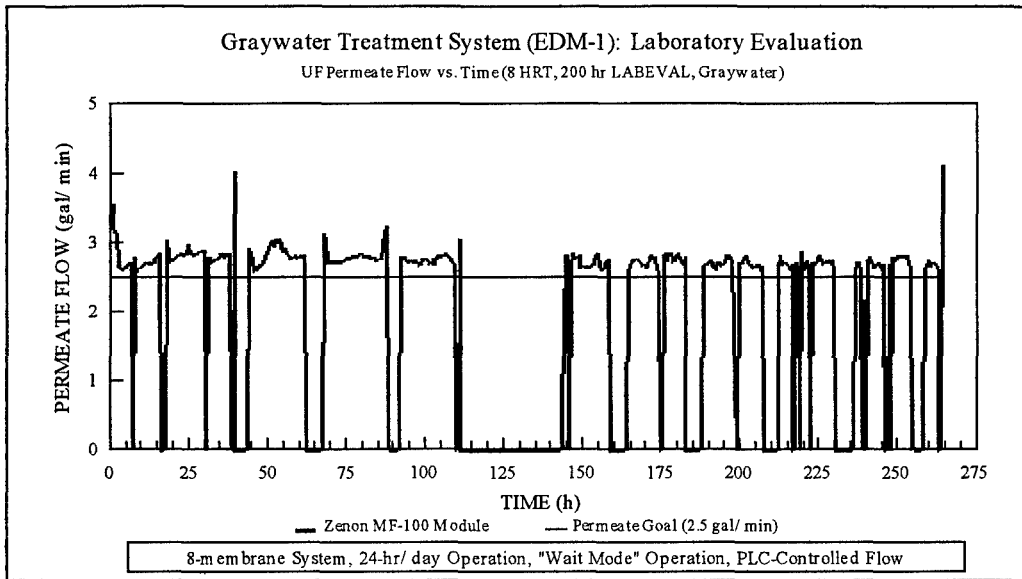


Figure 6. UF Permeate Flow vs Time

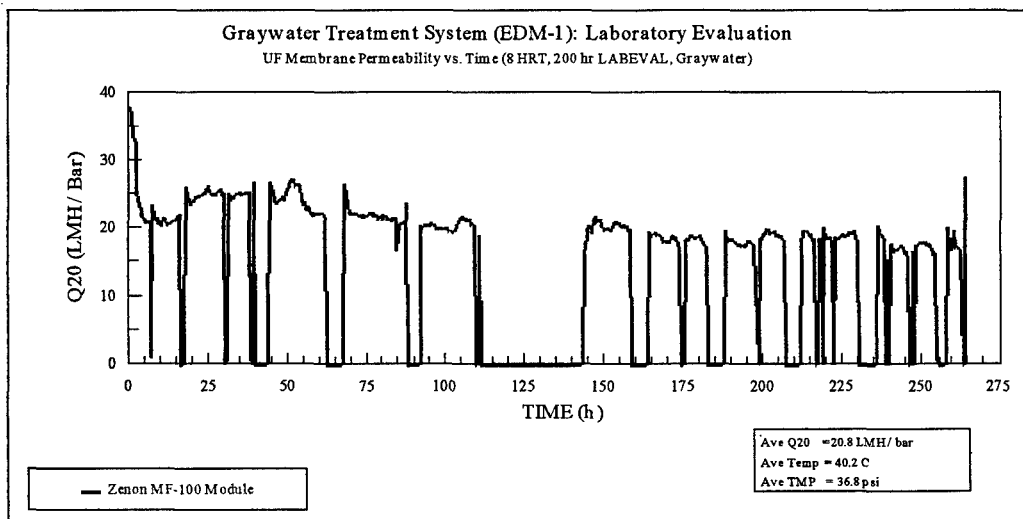


Figure 7. UF Membrane Permeability vs Time

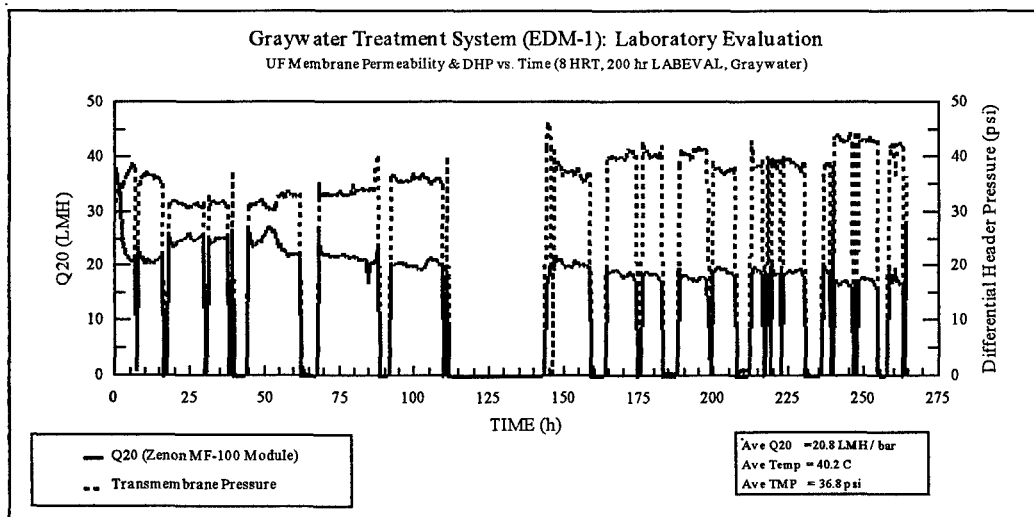


Figure 8. UF Membrane Permeability and Differential Header Pressure vs Time

Effluent Quality: Analytical Results

Samples of the feed, tank, UF permeate, and UV effluent were taken every day. Averages, geometric means and percent reduction of the contaminants were calculated from BOD, TSS, and FC from the various streams (see Table 7).

- **Five Day Biochemical Oxygen Demand (BOD<sub>5</sub>):** The average BOD<sub>5</sub> concentration in the feed was 1165 mg/L as compared to the pierside average of 958 mg/L. The average BOD<sub>5</sub> concentration in the UF permeate was 64 mg/L. The geometric mean for the feed was 1190 mg/L and for the UF permeate was 58 mg/L. The system was able to achieve the BOD effluent quality goal of less than 50 mg/L for only 3 out of the 9 samples collected, but did reduce the amount of BOD in the feed by 89%.
- **Total Suspended Solids (TSS):** The average TSS concentration in the feed was 312 mg/L as compared to the perside average of 451 mg/L. The average TSS concentration in the feed was 3 mg/L. The geometric mean for the feed was 305 mg/L and for the UF permeate was 2 mg/L. The calculated average percent reduction for TSS was 99%. None of the permeate samples had a TSS value that exceeded the 100 mg/L goal.
- **Fecal Coliform (FC):** The FC concentration in the feed ranged from 3,000 cfu/100 mL to 24,000,000 cfu/100 mL. The average FC concentration in the feed was 3,200,000 cfu/100 mL and in the UV effluent 3 cfu/100 mL. The geometric mean for the feed was 42,000 cfu/100 mL and in the UV effluent 3 cfu/100 mL. None of the effluent samples had a FC value that exceeded the 200 cfu/100 mL goal. In this particular trial, the membranes by themselves were capable of limiting fecal levels below the desired goal, although early 1998 trials have shown that the post-membrane ultraviolet unit was necessary to maintain low bacterial populations.

Table 7. EDM Effluent Quality Results

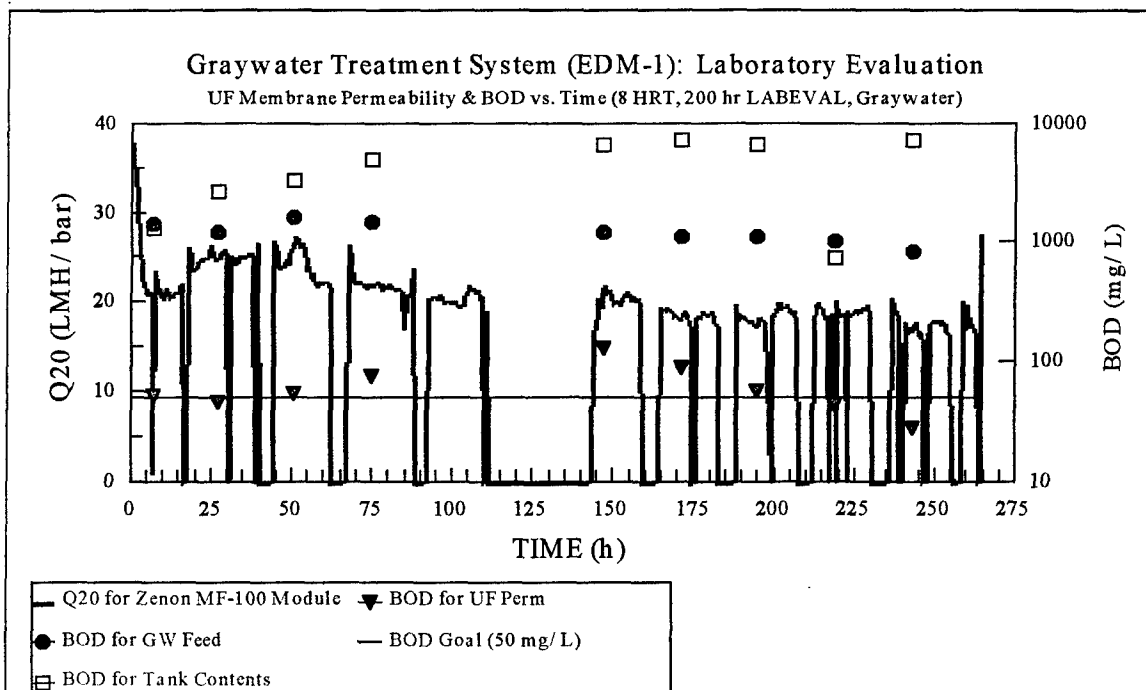
|           | BOD  | TSS  | FC           |
|-----------|------|------|--------------|
|           | PERM | PERM | UV EFFLUENT* |
|           | mg/L | mg/L | cfu/100mL    |
| 7/07/98   | 52   | 3    | < 3          |
| 7/08/98   | 46   | 1    | < 3          |
| 7/09/98   | 54   | 5    | < 3          |
| 7/10/98   | 76   | 4    | < 3          |
| 7/11/98   |      | 1    |              |
| 7/13/98   | 127  | 2    | < 3          |
| 7/14/98   | 90   | 2    | < 3          |
| 7/15/98   | 56   | 3    | < 3          |
| 7/16/98   | 44   | 3    | < 3          |
| 7/17/98   | 28   | 1    | < 3          |
| Geo. Mean | 58   | 2    | < 3          |
| Goal      | 50   | 100  | 200          |

\*Post-UV treatment values representative of overboard discharge for Fecal Coliform.

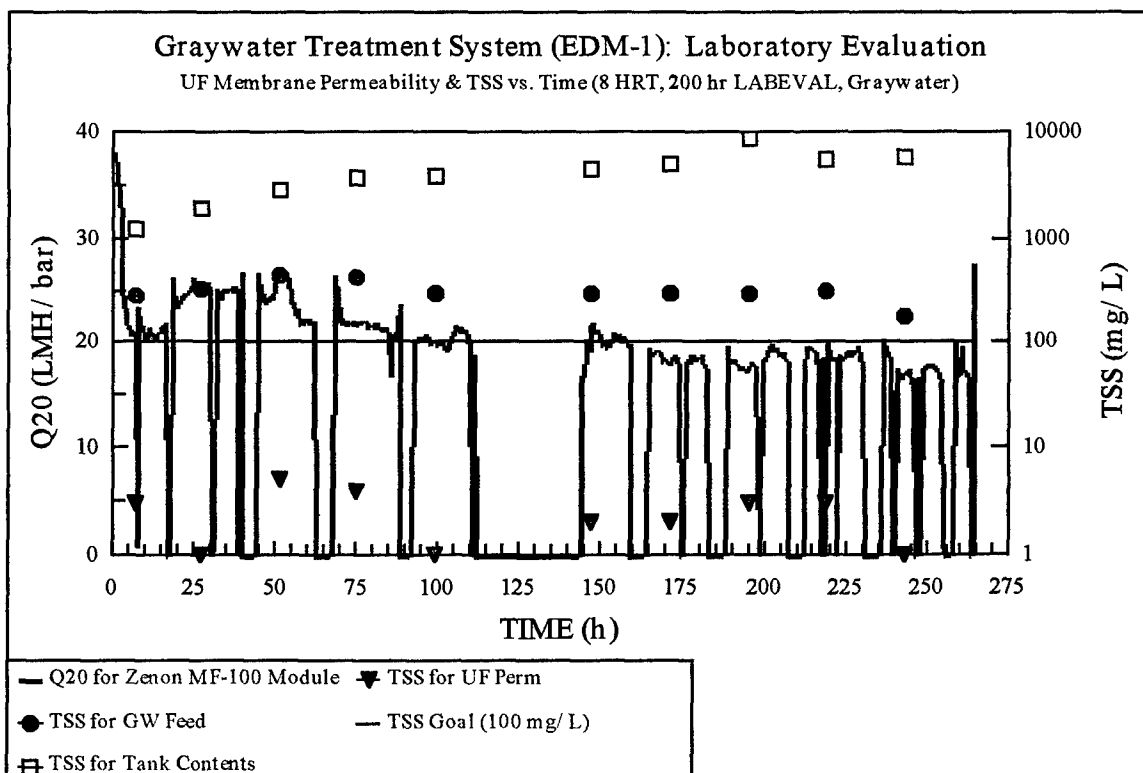
### Effluent Quality: Analytical Trends

- **UF Membrane Permeability & BOD vs Time:** Figure 9 compares the membrane permeability to biological oxygen demand (BOD) over time. This graph shows that the BOD concentration in both the feed and permeate slowly increased until approximately midtest, at which point the BOD decreased. Earlier trials have demonstrated that bacterial populations typically require a few days to establish themselves before they efficiently break down BOD, thus creating a fairly consistent downward trend. The "bell curve" shape of this LABEVAL, however, may be due to both the increasing BOD concentrations in the feed as well as abnormally high feed O/G levels (thought to have a deleterious effect on the bacteria's ability to break down BOD). The O/G levels during the LABEVAL averaged 376 mg/L while the pierside levels averaged 36.8 mg/L - an order of magnitude difference.
- **UF Membrane Permeability & TSS vs Time:** Figure 10 compares the membrane permeability to Total Suspended Solids (TSS) over time. This graph shows that even though the total solids concentration increased in the bioreactor tank as the system continually removed permeate, retained solids, and allowed the bacterial populations to grow - the ultrafiltration membranes kept the permeate suspended solids concentrations well below the goal of 100 mg/L.
- **UF Membrane Permeability & FC vs Time:** Figure 11 compares the membrane permeability to Fecal Coliform (FC) concentrations over time. This graph shows that even though fecal levels varied by orders of magnitude in the feed, the effluent fecal populations remained far below the desired level of 200 cfu/100mL.
- **UF Membrane Permeability & Oils and Greases (O/G) vs Time:** Figure 12 compares the membrane permeability to Oils and Grease (O/G) concentrations over time. O/G concentrations are not required to be at a certain level, but are thought to be a factor in membrane performance. In this LABEVAL, the oil and grease level appeared to mimic the same pattern as found in the BOD graph.

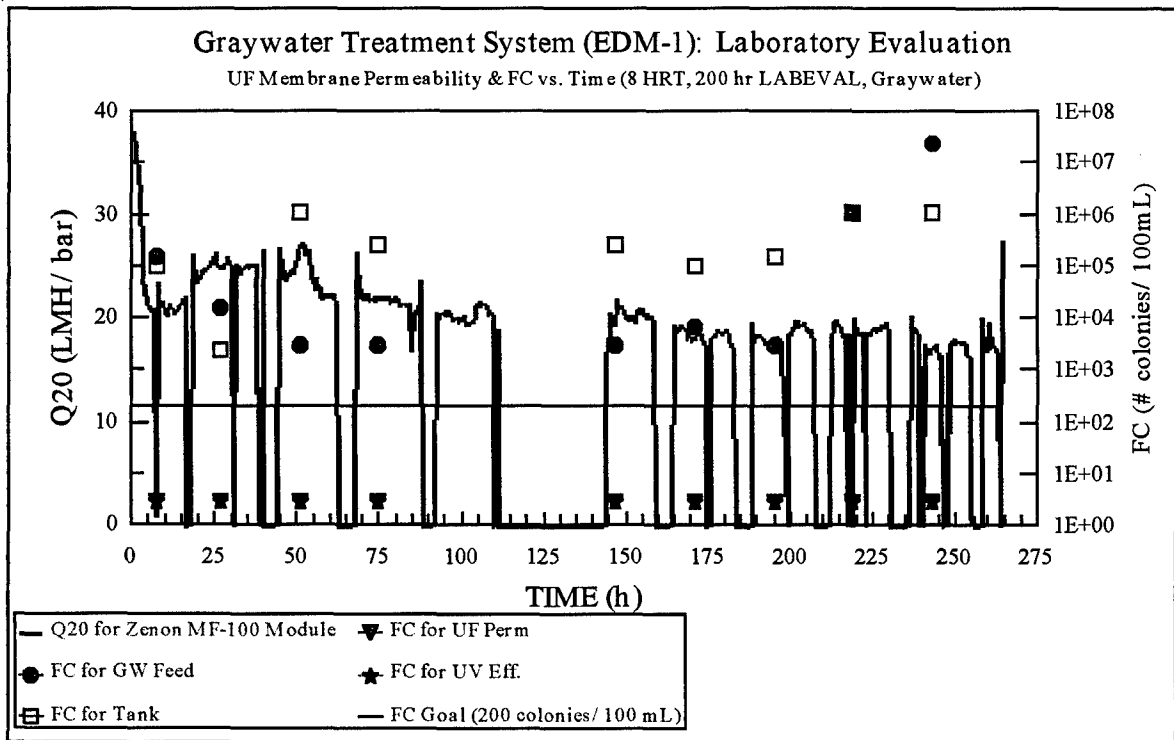




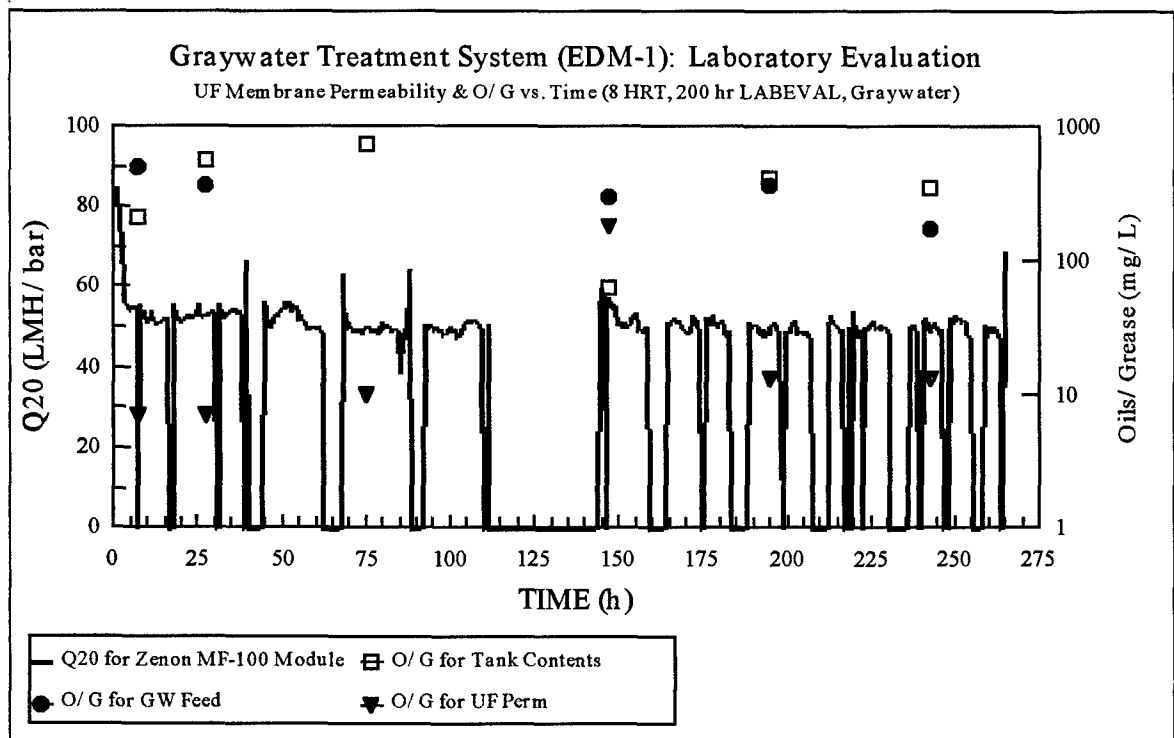
**Figure 9. UF Membrane Permeability & BOD vs Time**



**Figure 10. UF Membrane Permeability & TSS vs Time**



**Figure 11. UF Membrane Permeability & FC vs Time**



**Figure 12. UF Membrane Permeability & O/G vs Time**

## CONCLUSION

The initial performance evaluation of the laboratory graywater tubular membrane treatment model No 1 (EDM-1) was designed to determine if the automated EDM-1 could treat simulated shipboard graywater at a sufficient rate to accommodate a 75-man crew while meeting to effluent quality goals. In 200 hours of processing time, the EDM-1 demonstrated that it not only met all throughput goals, but also met the goals for total suspended solids (TSS) and fecal coliform (FC) concentrations. Biological Oxygen Demand (BOD) concentrations were only slightly higher than the 50 mg/L goal. This bypass was likely due to both higher oil and greases (O/G) concentrations and higher BOD concentrations found in the simulated feed than found in average shipboard graywater. The EDM also proved that it could reliably function in a completely automatic mode, thus providing the "reduced manning" required by the Navy of the 21<sup>st</sup> century.

## ACKNOWLEDGMENTS

I would like to acknowledge Mr. John Benson for his invaluable assistance in mentoring me in both the experimentation phase and report phase of this EDM-1 project; Mr. Jack McCrea and Mr. John Dentler [GeoCenters] for their technical assistance; and all the members of the EDM team (Dave Woods, John Foltz, Bill Ferrando, Rocco Gabriele, Sheila Riggs, Carrie Mero, Stephanie Johnson, Gil Lee, Marianne Walch, and especially the nocturnal Roy Smith) whose 24-hour vigilance made this laboratory evaluation possible.

## REFERENCES

1. Department of Navy, "Environmental Quality Research, Development, Test & Evaluation Strategic Plan," CNO (N4B), October 1994.
2. Department of Navy, "Afloat Environmental Quality Programs Baseline Assessment," CNO (N45), February 1996.
3. Department of Navy, "Strategic Technology Research Guidance (STRG)," CNO, June 1997.
4. Geo-Centers, Inc., "Failure Modes, Effects, and Criticality Analysis (FMECA) for the Graywater Tubular Membrane Treatment Unit," 8 January 1998.

## DEFINITIONS

Concentrate: The portion of the feed solution that does not pass through the membrane, but is retained within the processing loop of the EDM system (retentate).

Daily Clean Water Flush: The systems are flushed at the end of each test day with 50°C tap water to clean all concentrate off the surface of the membranes.

Hydraulic Retention Time: The average amount of time a theoretical graywater molecule is retained in the system before exiting [overboard] as effluent.

Membrane Flux: Liters of permeate produced per square meter of membrane per hour, normalized to 20°C.

Operational Run Time: The cumulative time the EDM system is powered and available to process graywater (clock time).

Permeability: Liters of permeate produced per square meter of membrane per hour, normalized to specific temperature and pressure (20°C, 1 bar). This parameter, designated  $Q_{20}$ , is an indicator of membrane fouling.

Permeate: The portion of the feed solution that passes through the membrane.

Processing Time: The time EDM is actually processing graywater.

Transheader Pressure: Transmembrane pressure as measured off the membrane headers vs. the membranes themselves.

Transmembrane Pressure: The effective pressure at the membrane surface as calculated by:

$$\left( \begin{array}{c} \text{Trans. Mem.} \\ \text{Pressure} \end{array} \right) = \frac{\text{Inlet Pressure} + \text{Outlet Pressure}}{2} - \left( \begin{array}{c} \text{Permeate} \\ \text{Pressure} \end{array} \right)$$

Volume Reduction: 20:1 volume reduction means that of 20 gallons of feed water processed, one gallon of concentrate remains.

## ABBREVIATIONS

|                  |                                                                                 |
|------------------|---------------------------------------------------------------------------------|
| '                | Feet                                                                            |
| "                | Inches                                                                          |
| °                | Degrees                                                                         |
| Ave              | Average                                                                         |
| BOD <sub>5</sub> | Five Day Biochemical Oxygen Demand                                              |
| CDNSWC           | Carderock Division, Naval Surface Warfare Center                                |
| CHT              | Collection Holding and Transfer System                                          |
| cfm              | cubic feet per minute                                                           |
| cfu              | Colony Forming Units                                                            |
| EDM              | Engineering Developmental Model                                                 |
| FC               | Fecal Coliform                                                                  |
| ft <sup>2</sup>  | Square feet                                                                     |
| ft/s             | Feet per second                                                                 |
| gal/min          | Gallon per minute                                                               |
| GUI              | Graphical User Interface                                                        |
| GRP              | Glass Reinforced Plastic                                                        |
| GW               | Graywater                                                                       |
| hp               | Horse power                                                                     |
| HRT              | Hydraulic retention time                                                        |
| LMH              | Liters per square meter per hour                                                |
| mg/L             | Milligrams per liter                                                            |
| MPN              | "Most Probable Number":<br>an analytical method for counting bacterial colonies |
| MWCO             | Molecular Weight Cut-off                                                        |
| n/a              | Not applicable                                                                  |
| NAVSEA           | Naval Sea Systems Command                                                       |
| Perm             | Permeate                                                                        |
| PLC              | Programmable Logic Controller                                                   |
| PVC              | Polyvinyl Chloride                                                              |
| psi              | Pounds per square inch                                                          |
| PTFE             | Polytetrafluoroethylene                                                         |
| Q <sub>20</sub>  | Permeability [normalized to 1 bar and 20°C]                                     |
| Temp             | Temperature                                                                     |
| THP              | Transheader Pressure                                                            |
| TMP              | Transmembrane Pressure                                                          |
| TSS              | Total Suspended Solids                                                          |
| UF               | Ultrafiltration                                                                 |
| UNDS             | Uniform National Discharge Standards                                            |
| US EPA           | United States Environmental Protection Agency                                   |
| UV               | Ultraviolet                                                                     |
| VAC              | Volts Alternating Current                                                       |

This page intentionally left blank



# Initial Performance Evaluation of a 75-Person Laboratory Prototype Graywater Tubular Membrane Treatment System

*Engineering Developmental Model No. 1 (EDM-1)*



**Rachel N. Jacobs**

**Environmental Quality Department  
Naval Surface Warfare Center, Carderock Division  
West Bethesda, MD  
USA**





# Presentation Outline



---

## *Graywater Engineering Developmental Model (EDM-1)*

---

- Introduction
- General Requirements for Graywater Treatment System
- NSWC Approach
- Prototype Description
- Evaluation Objectives
- Evaluation Procedures
- Evaluation Results
- Summary



# Introduction



---

## *Graywater Engineering Developmental Model (EDM-1)*

---

- U.S. Navy Need: The ability to operate anywhere, anytime, unencumbered by environmental constraints
- Problems:
  - High Cost of Waste Handling/Disposal in Foreign Ports
  - More Restrictive Wastewater Discharge Standards (Uniform National Discharge Stds./ MARPOL Annex IV)
  - Extension of Regulated Coastal Area (3  $\Rightarrow$  12 nm)
  - US Navy Ships Have Minimum or No Holding Capacity for Graywater



# General Requirements for Graywater Treatment System

## *Operational Goals*



---

*Graywater Engineering Developmental Model (EDM-1)*

---

- 75-man capacity  
(assumes 2 systems per 21<sup>st</sup> Century Destroyer)
- 15-hr daily processing cycle
- Fully automatic operation (manual override, built-in troubleshooting capability)



# General Requirements for Graywater Treatment System *Performance Goals*



---

*Graywater Engineering Developmental Model (EDM-1)*

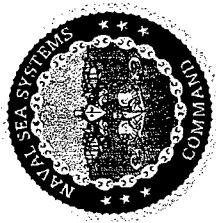
---

## Processing Rate

- Average effluent flow rate of 2.5 gallons/minute (9.5 liters/minute)

## Effluent Quality

- Biochemical Oxygen Demand (BOD<sub>5</sub>)  
\* < 50 mg/L
- Total Suspended Solids (TSS)  
\* < 100 mg/L
- Fecal Coliform Bacteria (FC)  
\* < 200 colony forming units (cfu)/100 mL



# Description of Performance Goals



---

## *Graywater Engineering Developmental Model (EDM-1)*

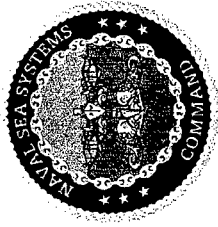
---

### Processing Rate

- **Flow rate** - The volume of graywater processed over time.

### Effluent Quality

- **Biological Oxygen Demand (BOD<sub>5</sub>)** - a measure of how much organic matter is available as nutrients in the graywater
- **Total Suspended Solids (TSS)** - a measure of the amount of suspended solids, both organic and inorganic, found in the graywater
- **Fecal Coliform Bacteria (FC)** - a common bacteria found in graywater that is used as an indicator organism for total harmful bacteria present.



# NSWC Approach



---

## *Graywater Engineering Developmental Model (EDM-1)*

---

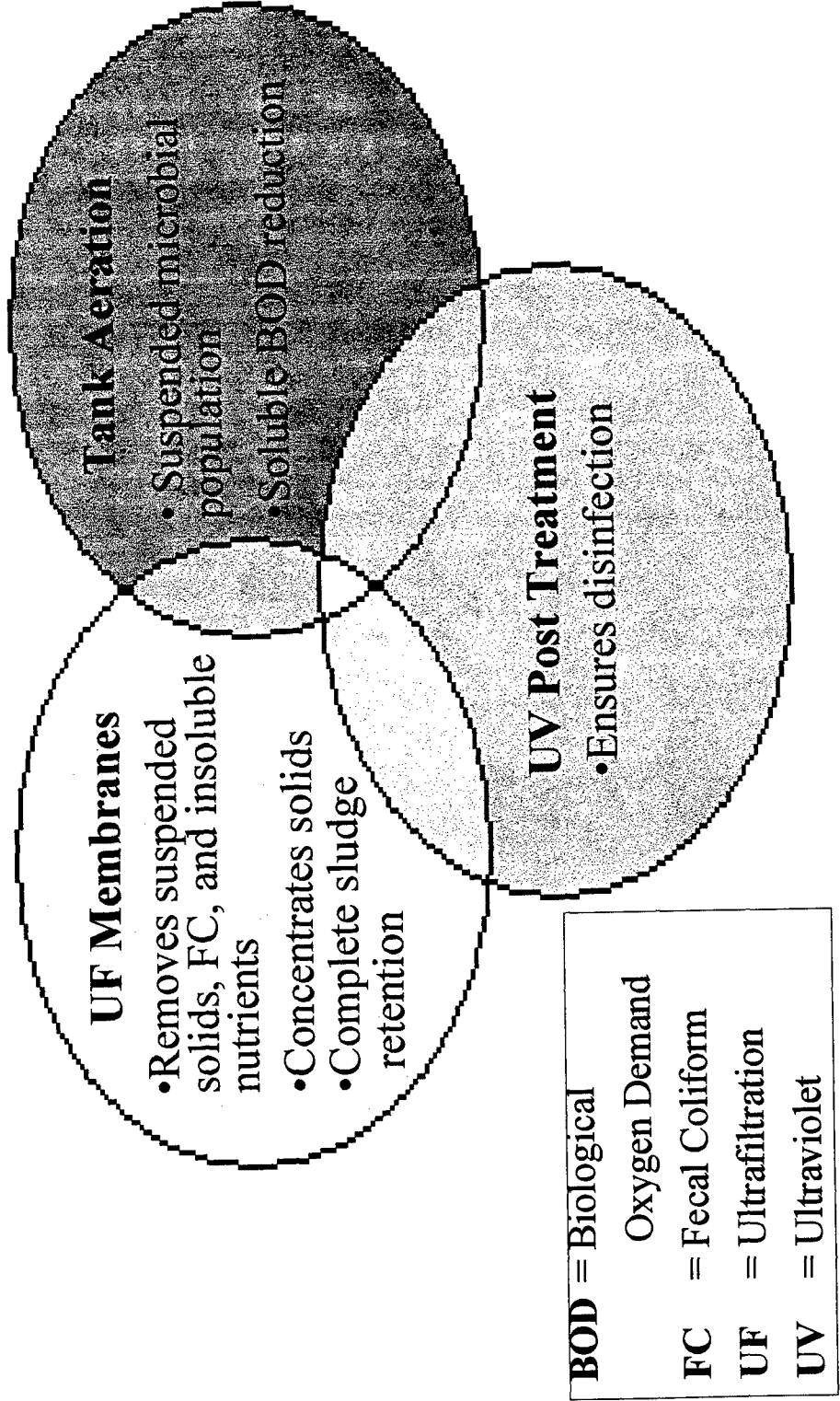
To develop a graywater treatment system prototype (EDM-1) that meets all operational and performance goals by combining membrane filtration with biological treatment and ultraviolet disinfection.

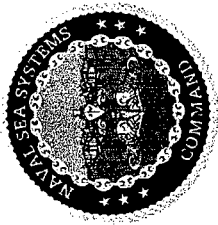


# Prototype Description Elements of Treatment System



*Greywater Engineering Developmental Model (EDM-1)*





# Prototype Description

## Components



---

*Graywater Engineering Developmental Model (EDM-1)*

---

Graywater System Combines both a Bioreactor and

Membrane Bank:

- Eight Bundled Tubular Polymeric Membranes
- 1400 gallon Aerated Bioreactor (w/ coarse bubble diffusers)
- Ultraviolet Disinfection Post-Treatment Unit
- PLC-based automatic control

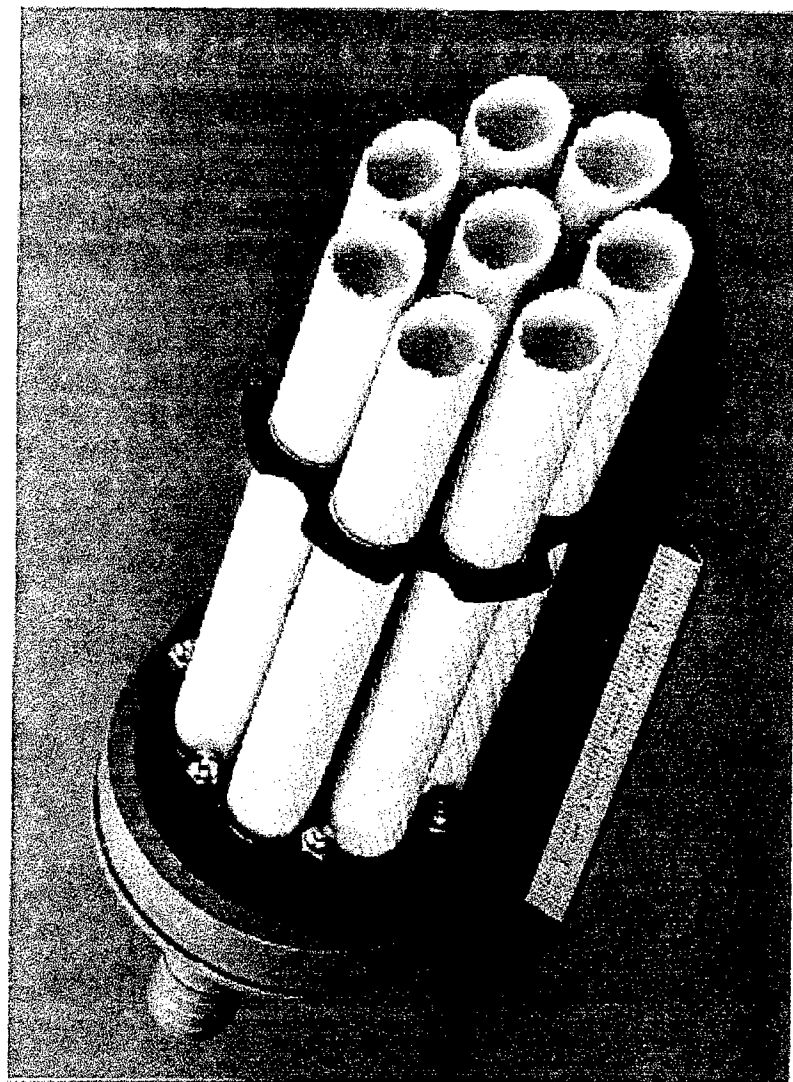




# *Bundled Tubular Ultrafiltration Membranes*



*Graywater Engineering Developmental Model (EDM-1)*



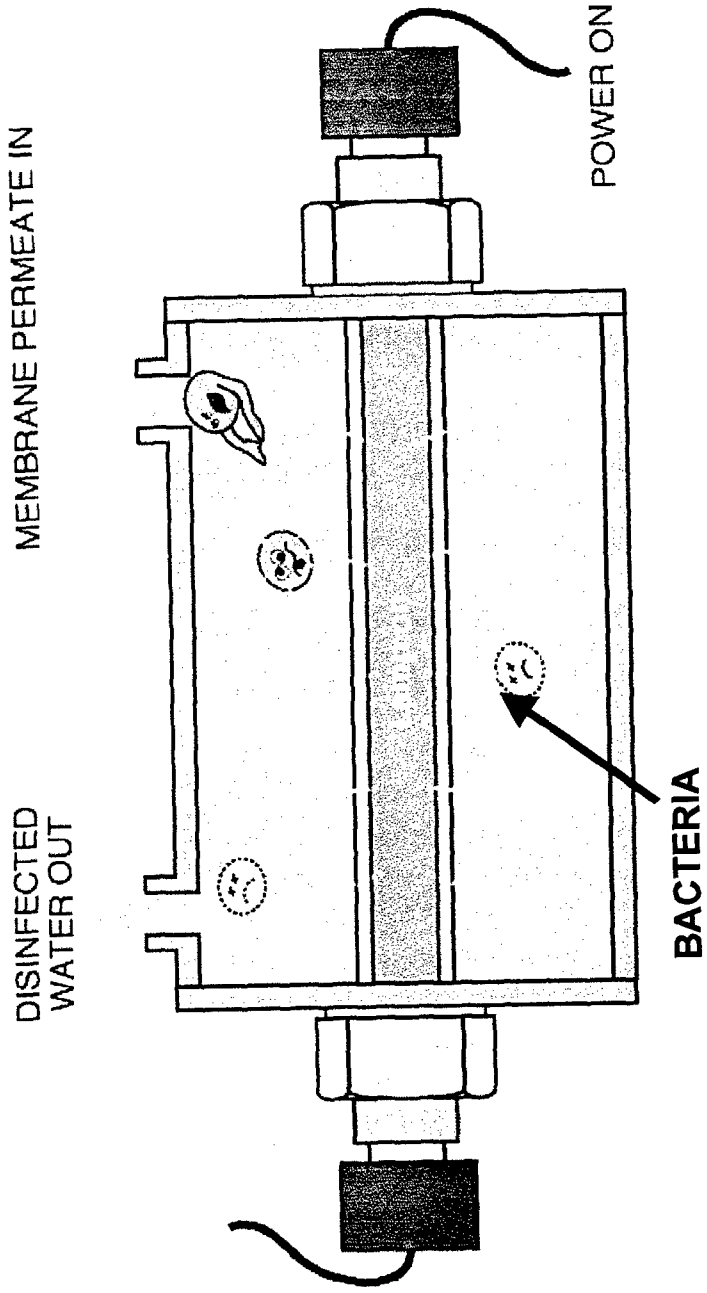


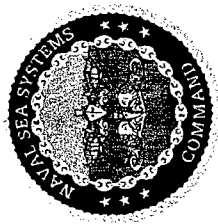
# Ultraviolet Light Disinfection Process



*Graywater Engineering Developmental Model (EDM-1)*

## CROSS-SECTION OF OPERATING ULTRA-VIOLET DISINFECTION SYSTEM

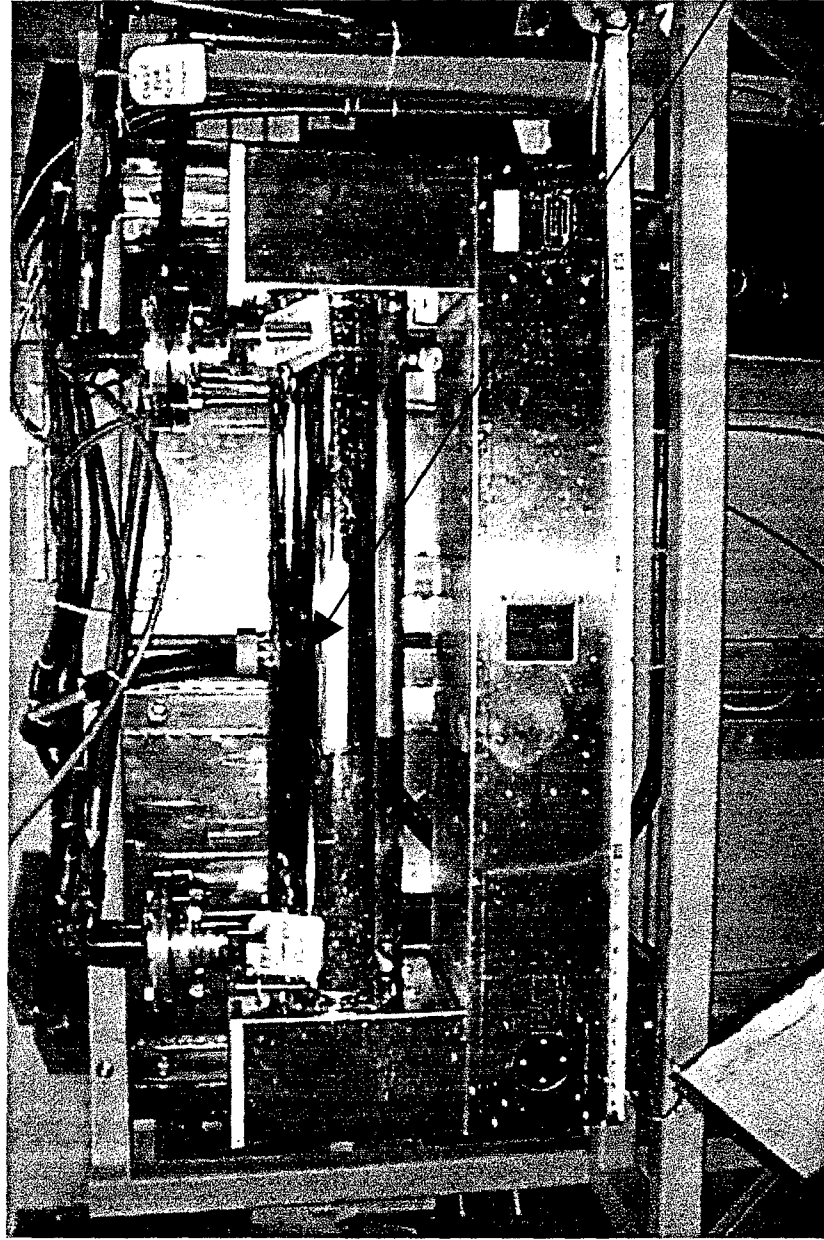




# Ultraviolet Disinfection Unit

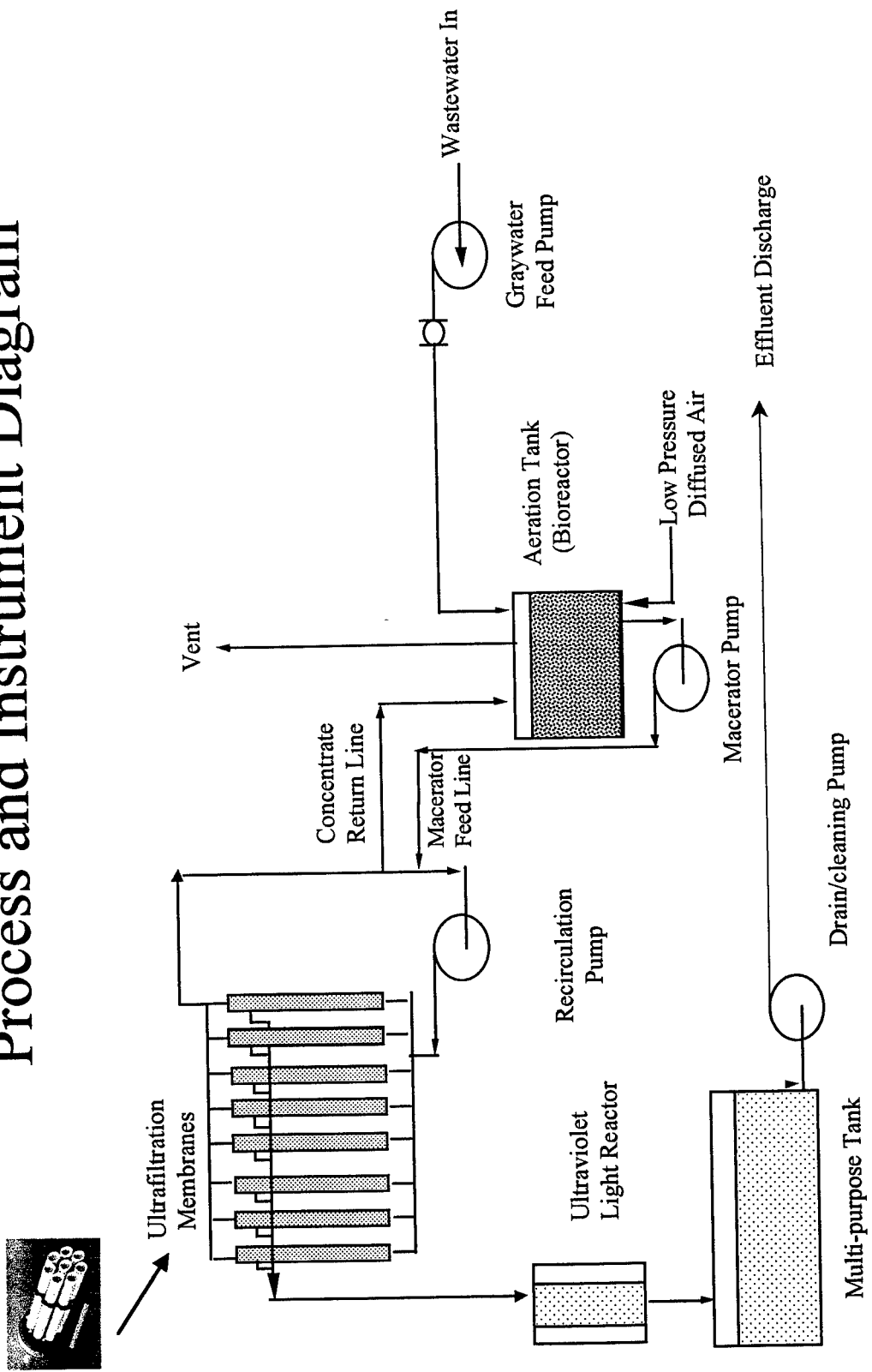


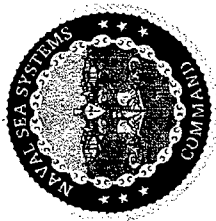
*Graywater Engineering Developmental Model (EDM-1)*



**Disinfection  
Chamber**

# Simplified Graywater Treatment Process and Instrument Diagram

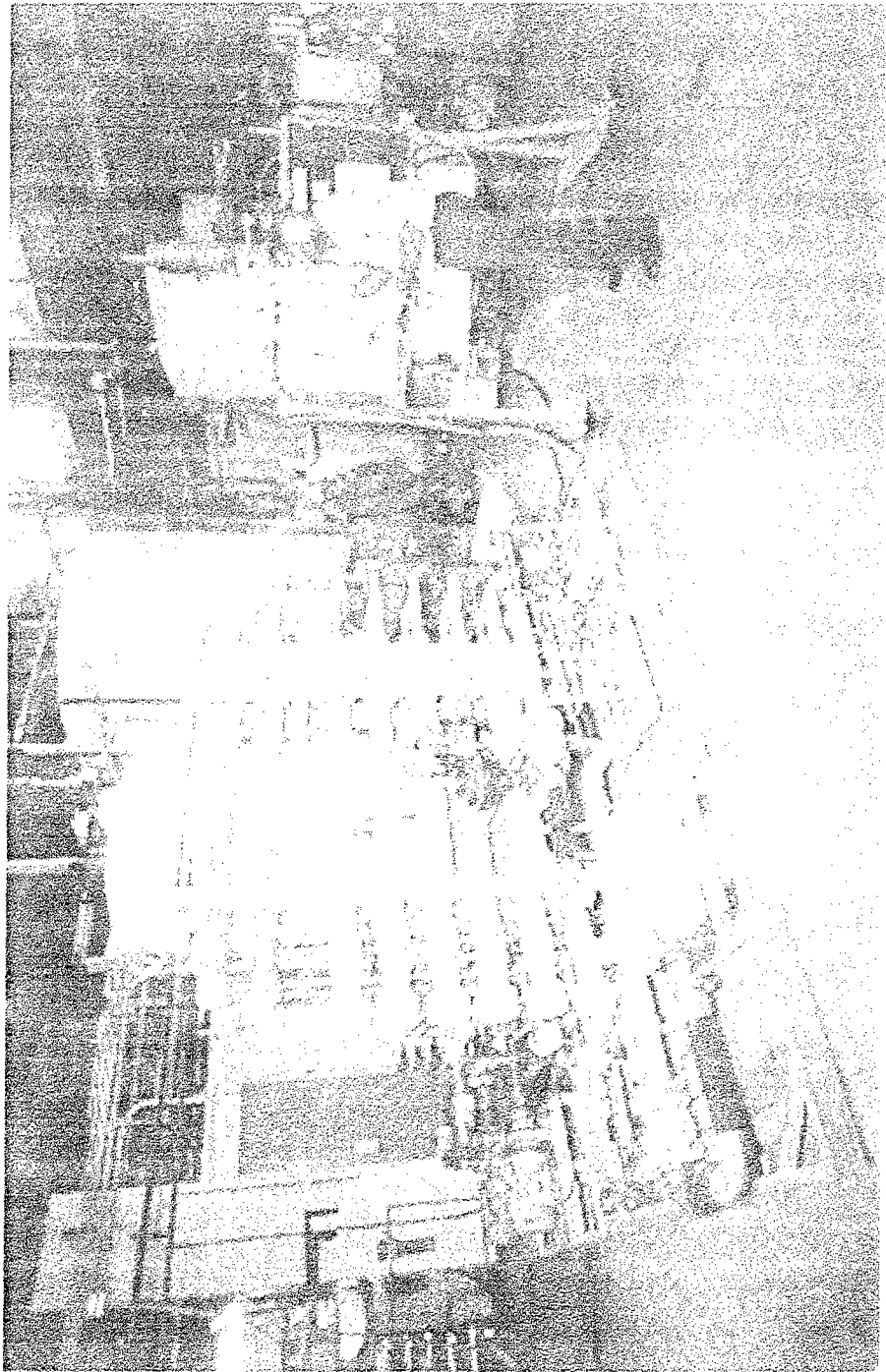


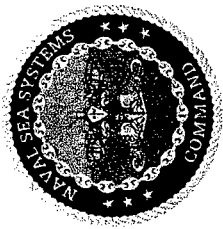


# Graywater EDM-1 Front View



*Graywater Engineering Developmental Model (EDM-1)*





# Evaluation Objectives



---

## *Graywater Engineering Developmental Model (EDM-1)*

---

Evaluate the EDM-1 prototype in a fully automatic, 150-hour processing test to ensure that it meets all operational and performance goals.

- Operational Goals:
  - \* Fully automatic operation
  - \* 15 processing hours per day
- Performance Goals:
  - \* Membrane performance: Flow rate
  - \* Treatment performance: BOD, TSS, FC

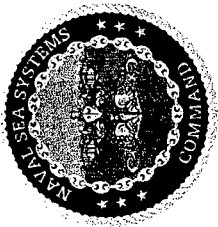


# Evaluation Goals



## Graywater Engineering Developmental Model (EDM-1)

|                      | Parameter             | Evaluation Goal                                         |
|----------------------|-----------------------|---------------------------------------------------------|
| Membrane Performance | Flow Rate             | $\geq 2.5$ gallons/minute<br>$(\geq 9.5$ liters/minute) |
|                      | Treatment Performance |                                                         |
|                      | BOD                   | $\leq 50$ mg/L                                          |
|                      | TSS                   | $\leq 100$ mg/L                                         |
|                      | FC                    | $\leq 200$ cfu/100 mL                                   |



# Evaluation Procedures



---

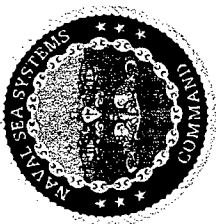
## *Graywater Engineering Developmental Model (EDM-1)*

---

Operate the laboratory prototype system for 24 hours per day, 7 days a week

- process graywater for 15 hours/day
- feed raw graywater (90% laundry: 10% galley) to EDM using a simulated shipboard generation rate
- allow 1 freshwater flush of membranes and UV system per day

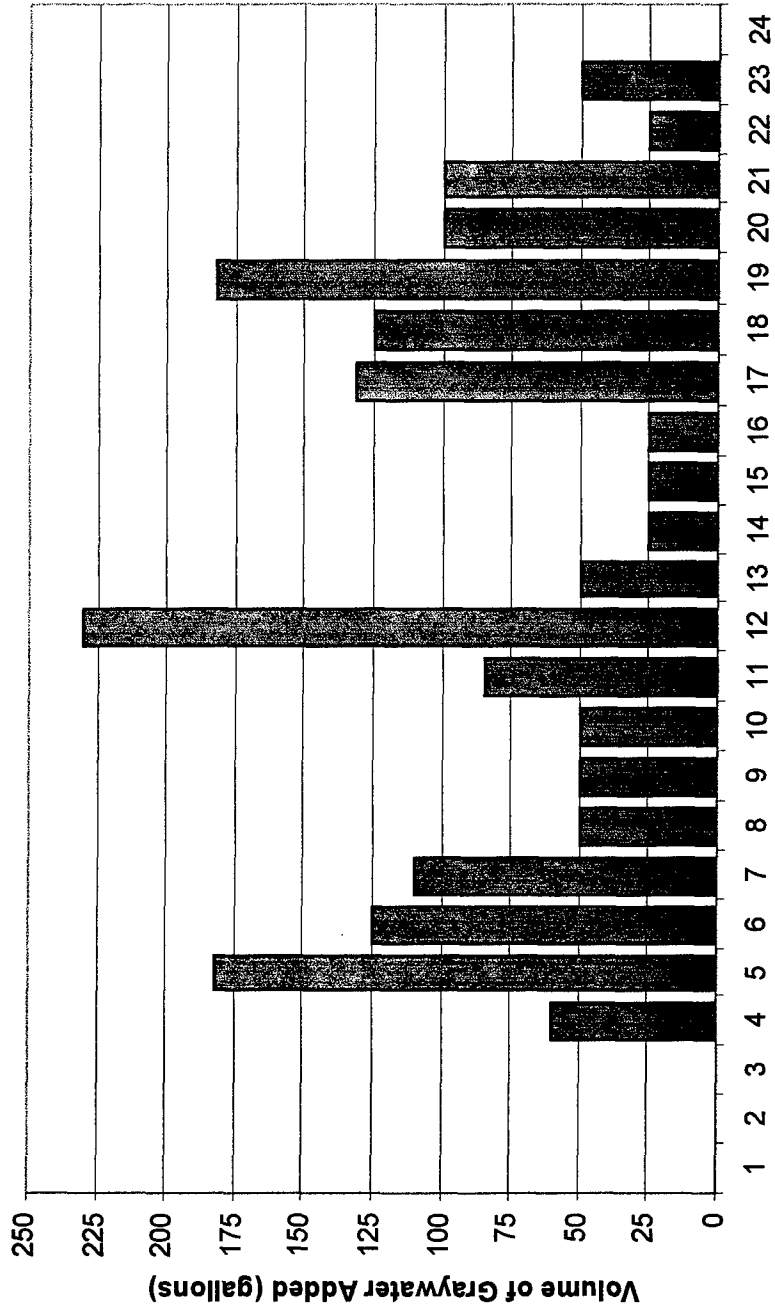




# Graywater Feed Profile



*Graywater Engineering Developmental Model (EDM-1)*



■ Volume of Graywater Added to Aerated Bioreactor Each Hour of the Day

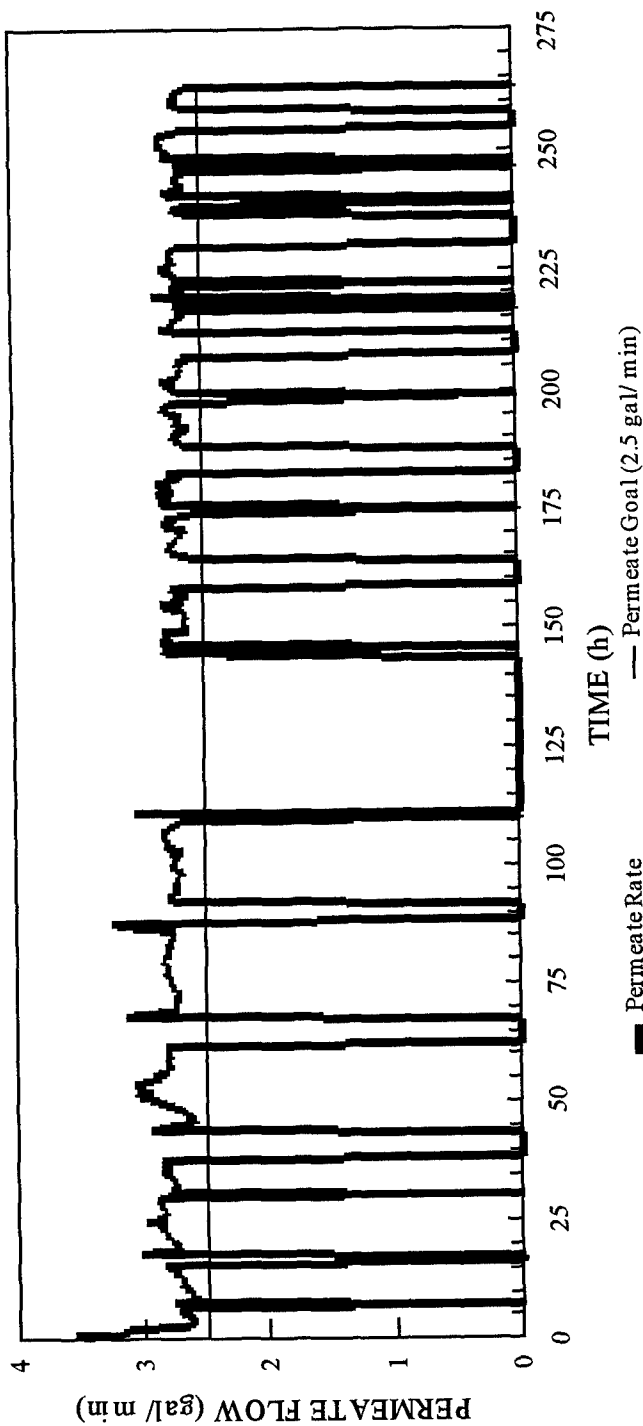


# Evaluation Test Results

## Flow Rate



Graywater Engineering Developmental Model (EDM-1)

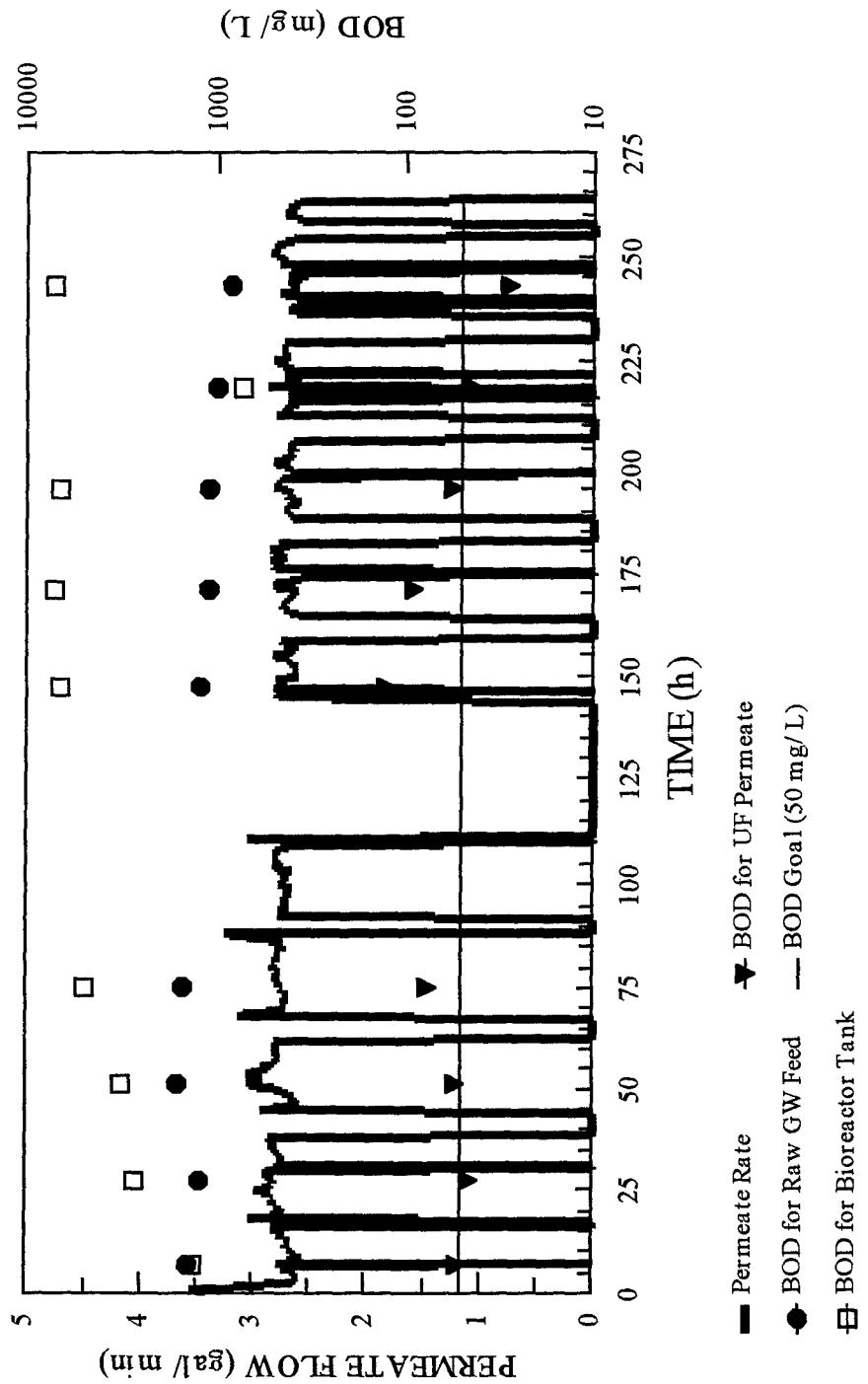




# Evaluation Test Results Biochemical Oxygen Demand (BOD)



Graywater Engineering Developmental Model (EDM-1)



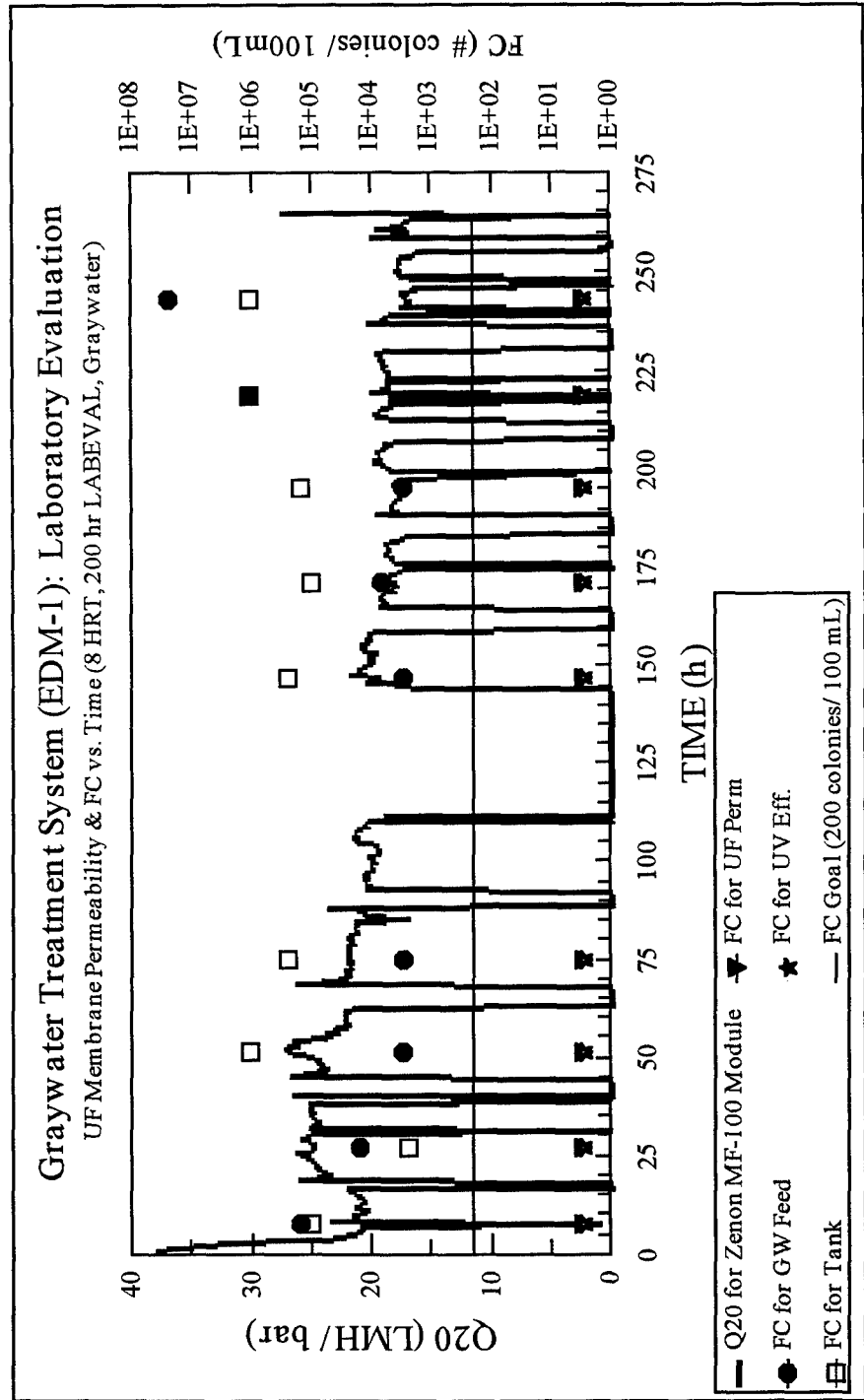


# Graywater EDM-1 Evaluation Test Results



## Fecal Coliform Bacteria (FC)

Graywater Engineering Developmental Model (EDM-1)





P4-PALABSTR.DOC

## **Conceptual Studies on Treatment of Oily Water and Sludge Aboard Ships**

Anders Pallmar

Alfa Laval Marine & Power AB  
Sweden

### **ABSTRACT**

#### **Abstract**

#### **Conceptual studies of the treatment of oily water and sludge onboard ships**

Problems with high oil contents in bilge water led to investigations into the use of conditioning chemicals as a possible solution to this problem. Onboard trials with a chemical conditioning/high speed separation module confirmed that conditioning chemicals were able to solve this problem.

As a result of these trials, a concept for the total solution of the problems of oily sludge and water onboard vessels was proposed. This concept, known as the OSWAL concept, has been evaluated in a number of ship board installations over extended time periods.

The evaluations show that the OSWAL concept is able to convert the combined streams of oily sludge and oily water produced onboard ships into three streams:

- bilge water with a maximum oil content of 10ppm
- oil with a maximum water content of 2%
- a reduced volume of concentrated, yet pumpable, sludge

The concept is described and data from the various installations are given.

The authors are: Anders Pallmar, Frederik Ajnefors – Alfa Laval Marine & Power AB, Sweden, and Gunnar Ström – Alfa Laval Separation AB, Sweden.

The paper will be presented by Anders Pallmar.



## Conceptual studies of the treatment of oily water and sludge onboard ships.

Authors:      A. Pallmar      Alfa Laval Marine & Power AB  
                  F. Ajnefors      Alfa Laval Marine & Power AB  
                  G. Ström      Alfa Laval Separation AB

### Introduction

Traditionally bilge water has been treated prior to discharge to the open sea by passing it through so-called bilge water separators. Whilst these separators, which are simple coalescers/lamella separators, have been adequate in the past, modern experience shows that they are no longer able to meet the requirements placed upon them, and this is due to changes that have taken place over the years.

The first change is to the composition of the oily material present in bilge water (Figure 1). Many years ago the bulk was present as free mineral oil but now, due to more sophisticated additives in lube and fuel oils and to more specialised cleaning fluids, this is no longer the case. The oil present in today's bilge water is mainly present in the form of either surfactant stabilised emulsions or particle stabilised emulsions, as well as some dissolved oil and some free mineral oil. That traditional bilge water separators are unable to separate these emulsions is clearly shown by analysis for mineral oil content of bilge water both before and after the bilge water separator of a modern vessel made earlier this year (Table 1).

The second change is the increasing control over what may be discharged to the open sea. Until recently, international regulations have stipulated that a maximum of 50 - 100 mg/l of mineral oil may be present in the discharge depending upon the age of the vessel, but in some inland seas, including the Baltic Sea, the maximum level has been set to 15 mg/l. A general trend that can be seen is that lower levels (such as the present level for inland seas) tend to soon become accepted as general levels especially if advances in technology make it possible to reach such lower levels. Therefore a general maximum level of 15 mg/l for discharge to all open seas must be accepted as a strong possibility in the not too distant future.

### New conditions require new approach

Accepting the facts of increasing amounts of stable emulsions in bilge water and a maximum discharge level of 15 mg/l then new methods of treating bilge water have to be considered.

Our ambition has been to design and test a concept that can produce less than 15 mg/l when in operation under practical shipboard conditions. Our experience has been that many of the systems that pass the formal approval test fail when put into practical operation most probably due to the wide spectra of contaminants and stabilised emulsions mentioned above.

High speed separators (HSS) can reduce the level of free mineral oil to below 15 mg/l but they are unable to separate emulsions. What therefore is needed is a method of treating emulsions so that they can be separated.

Ultra filtration is a possibility but the level of reject from the filters is quite high (10%) and therefore the problem is not fully solved. Equally, present ultra filtration technology results in an expensive and complex installation where fouling of the filters requires special attention and therefore this approach is not thought to be suitable.



An alternative approach is to use special conditioning chemicals such as those recently developed in-house by Alfa Laval under the trade name of ALPACON. These chemicals are designed to destabilise emulsions by deactivating (capturing) the emulsifying agents, and then to agglomerate the oil droplets so that they are separable. Patents applications have been made for this technology.

In order to determine the suitability of this approach, a test rig/pilot plant was built and was tested on a large quantity of bilge water that we had collected from ships. The bilge water contained about 1200 mg/l of mineral oil.

The test rig (Figure 2) had provision for the injection of conditioning chemicals at two separate points, a heat pack for temperature control and a static mixer. These were followed by three separation units, a paper filtration unit, a centrifugal separator and an activated carbon filter for removal of dissolved material by adsorption. The paper filtration unit could be by-passed if desired.

The results obtained with this rig were extremely positive and showed that almost 0 ppm total extractable hydrocarbons could be achieved by combining chemical treatment with the various separation stages. From a practical point of view however, this type of system was not considered suitable for ship-board operations.

### **Conceptual study of direct treatment of bilge water**

In order to further test the concept, a module consisting of chemical conditioning combined with a high speed separator (HSS) was designed and tested in three seagoing installations.

In the module (Figure 3) untreated bilge water is first treated with two different conditioning chemicals. ALPACON MP 300 destabilises the emulsions and ALPACON MP 302 reduces the repulsive forces between the oil droplets so that they coalesce into droplets of a sufficient size for centrifugal separation. The temperature of the mixture is raised in the steam heater before separation in the MSPX 303 self-cleaning separator.

The separated bilge water passes through an oil content detector and should the oil content be greater than the permitted 15 mg/l then the water is recycled through the centrifugal separator or can be returned back to the untreated bilge water tank for further chemical treatment.

Already from the start, these systems showed that they were able to produce treated bilge water with an oil content well below 15 mg/l but occasional high concentrations of free oil and sludge disturbed the system.

Changing the system so that it can operate either in a de-oiling mode, where the water phase is recycled, or in a normal cleaning mode solved this problem. This however creates a system with more complex control aspects since recycling must take place before the 15 mg/l oil content detector in order to prevent clogging.

Despite this problem, the modules showed that bilge water with an oil content less than 15 mg/l (Figure 4) can be produced by combining chemical treatment with separation in a high speed separator. Proof of this is given by one of the ships owners who has insisted in keeping the test module in operation on board his vessel.

At this point in our studies, we had shown by both laboratory and ship-board testing that the problem of high oil levels in bilge water could be solved by combining chemical treatment with centrifugal separation. This being the case, we could now look at possible solutions to the total problems of oily sludge and water in the engine room.

### **Conceptual Study of the Total Oily Sludge and Water Problem in Engine Rooms**

Apart from oily bilge water, a major problem onboard ships is the handling and storage of large volumes of sludge from separators, tank drains and filter rejects for later treatment or

disposal. Alfa Laval has, for some years, offered their Sludge Treatment System as a part solution to this problem (Figure 5).

The experience gained in the experiments described above gave us reason to believe that a total solution to the problems of oily sludge and water in engine rooms could be possible. The concept was to combine chemical treatment of oily material with the existing Sludge Treatment System to create a system that could convert oily sludge and water into three products;

- Water with maximum oil content of 10 mg/l
- Oil with maximum 2% water
- Concentrated sludge that can be pumped ashore

With these objectives we set ourselves a very tough target since the specifications were far better than the products available with the then current state of the art.

Further requirements were that the system should only use well proven components, should be self healing, should include a minimum of extra equipment for reasons of reliability, ease of operation and costs and should be easy to adapt to existing installation. Furthermore the system must not create restrictions on the cleaning fluids normally used onboard ships. The concept was given the code name OSWAL (Oily Sludge and Water – Alfa Laval).

### **The OSWAL concept**

The basic approach of the OSWAL concept is to split the process into two stages.

Stage 1: Deoiling and desludging of the oily sludge and oily water from engine room sources such as the fuel and lube oil separators and the bilge water tanks using chemical treatment and separation in an MSPX separator (see Figure 6).

Stage 2: Separation of oily material from the water from Stage 1 by treatment with conditioning chemicals and gravity settling (see Figure 7).

Systems based upon the above concept have been installed in a number of vessels for evaluation. The data given below is from one of these installations.

### **OSWAL Stage 1**

In the first stage of the OSWAL concept, the oily sludge from the fuel and lube oil separators together with oily bilge water is treated with a separation conditioning chemical (ALPACON MP 205) before being fed to the MSPX separator.

The sludge from the separator is collected and excess oil and water is allowed to flow over into the PX sludge tank ( the tank for sludge from the fuel and lube oil separators).

The dry oil from the separator (water content < 2.00%) can either be used as boiler fuel or incinerated.

The water phase is transferred to the bilge water treatment tank in stage 2.

Table 2 shows the level of water in oil from the separator in samples taken during a typical run. The high level of water (120 ppm and 1,6% oil) in the first two inlet samples is caused by oil having collected at the top of the tank prior to the run. As water is removed from the system, the water content of the inlet becomes more typical. The control sample is of special interest since it was taken at a time when addition of the separation conditioning chemical (ALPACON MP 205) had been turned off. The extremely high water content of the separated oil (30%) indicates the efficiency of the conditioning additive.

## **OSWAL Stage 2**

In the second stage of the OSWAL concept, the water from the first stage is collected in a heated tank. Bilge water recycling is started and the water is dosed with two conditioning chemicals, MP 300, which is an emulsion destabiliser and MP 302 which helps the oil droplets to coalesce. After dosing and recycling, the pumps are turned off and the contents of the tank are allowed to settle by gravity for a suitable period. Table 3 shows the decreasing oil content in the water during settling.

Some oil will collect on the surface of the water and this is skimmed off using a floating skimmer and is recycled to the sludge treatment tank. During the tests, the existing bilge water separator was used for pumping the cleaned water overboard. Samples taken from this installation showed that there was essentially no difference in the oil content of the water before and after the bilge water separator. This implies that the total water cleaning process takes place within the OSWAL system (see Table 4).

At regular intervals, the water and settled particles present in the tank below the clean water take off point should be pumped back to the sludge tank in stage 1.

## **OSWAL concept – key parameters**

- All oil, sludge and water should be separated in the MSPX system. In this way, most of the free mineral oil and solid particles can be removed from the bilge water to be treated.
- The feed temperature to the MSPX should be maintained at about 90°C in order to obtain good separation.
- The water in the bilge water treatment tank should be heated to at least 50°C during dosing, mixing and settling.

## **OSWAL concept – consumption of chemicals**

On board the vessel in question, about 2 m<sup>3</sup> of oily sludge and water are produced per day. In calculating the data presented in Table 5 we have assumed that the ship is in operation 350 days of the year. The vessel has an engine installation totalling 10,800 kW and operates on IF 380 fuel.

The installation described above is still in operation one year after start up. A further four installations will soon be in operation in order to fully evaluate the concept under practical shipboard operating conditions.

## **General comments**

In our discussions with the industry it would seem that high treatment capacities (in the region of 5m<sup>3</sup>/h) are required. This requirement does not match the actual production of bilge water but more reflects a need for rapid discharge whenever and wherever this is acceptable.

What does seem to be important for the industry is highly efficient oil removal in a system that is capable of continuous operation and which can operate under the conditions that apply in most sea going vessels.

Because bilge water with an oil content less than 15 mg/l can be produced, consideration must be given to storage of bilge water as a "clean" product rather than a "dirty" product so that dumping to sea can take place as soon as the vessel is in suitable waters.

## **General conclusions**

Current technologies are either not able to, or have difficulties in fulfilling the requirement of maximum 15 mg/l in actual sea going installation.

Over the last four years, our research and conceptual studies have shown that it is possible to achieve oil contents lower than 10 mg/l using chemical conditioning and high speed separation.

Using a total oily sludge and water concept (OSWAL) sludge volumes are reduced, oil with a maximum water content of 2% is produced and the bilge water contains less than 10 mg/l mineral oil.

Bilge water storage capacity should be moved from the dirty side to the clean side.

#### List of Tables and Figures

|          |                                                                                                                                       |
|----------|---------------------------------------------------------------------------------------------------------------------------------------|
| Table 1  | Mineral oil content in mg/l before and after conventional bilge water separator                                                       |
| Table 2  | Samples taken from OSWAL Stage 1                                                                                                      |
| Table 3  | Decrease in oil content with increased settling time                                                                                  |
| Table 4  | Analysis for mineral oil of samples taken before and after the conventional bilge water separator after treatment in an OSWAL system. |
| Table 5  | Consumption of ALPACON chemicals                                                                                                      |
| Figure 1 | Oily water sources in bilge water                                                                                                     |
| Figure 2 | Bilge water purification test rig                                                                                                     |
| Figure 3 | Bilge water treatment module                                                                                                          |
| Figure 4 | Oil content in cleaned bilge water after chemical conditioning and high speed separation.                                             |
| Figure 5 | Alfa Laval Sludge Treatment System (Existing AL dwg )                                                                                 |
| Figure 6 | OSWAL system, stage 1, desludging – deoiling.                                                                                         |
| Figure 7 | OSWAL system, stage 2, bilge water treatment.                                                                                         |



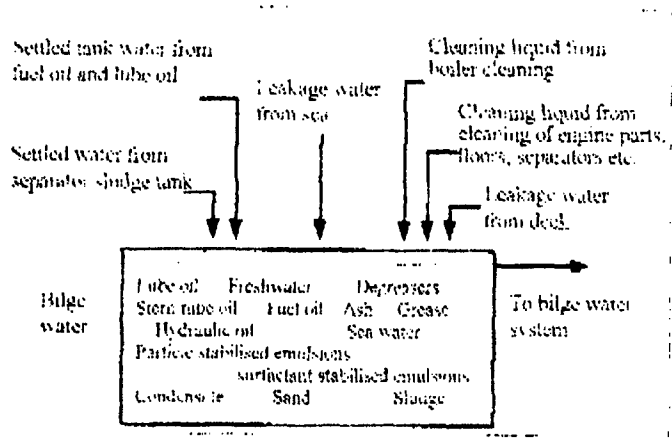


Figure 1. Oily water sources in bilge water.

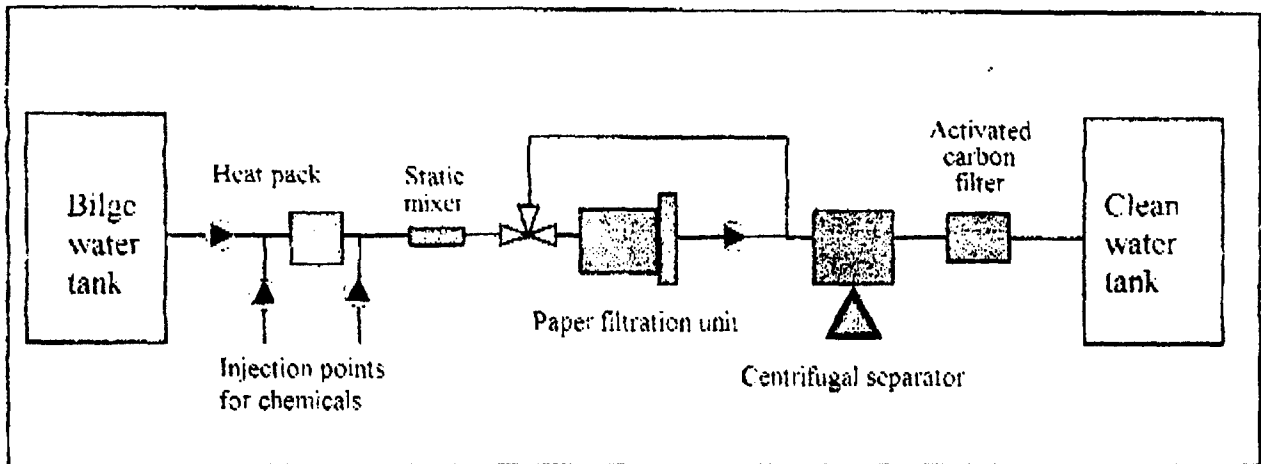


Figure 2. Bilge water purification test rig.

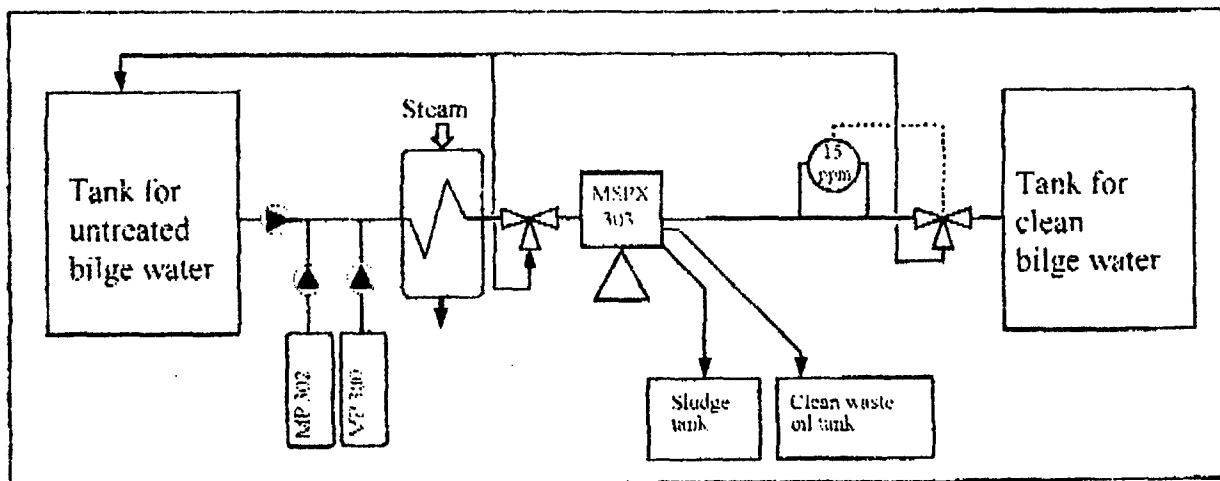


Figure 3. Bilge water treatment module

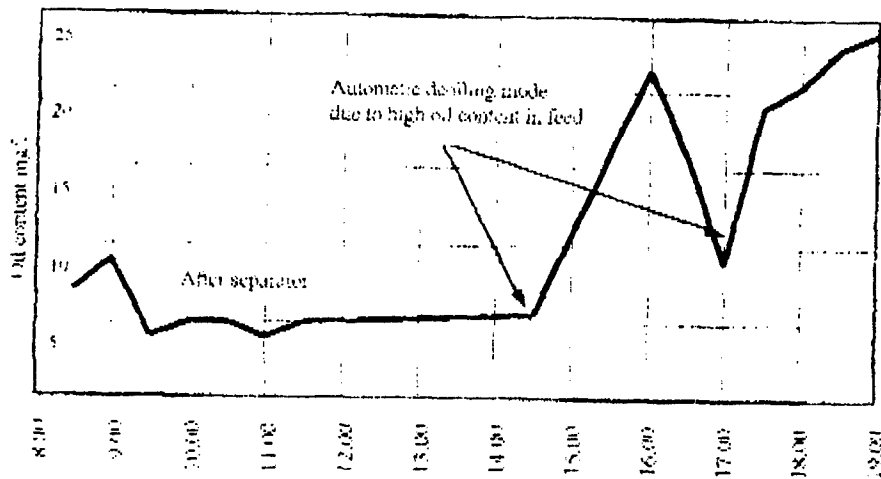


Figure 4. Oil content in cleaned bilge water after chemical conditioning and high speed separation.

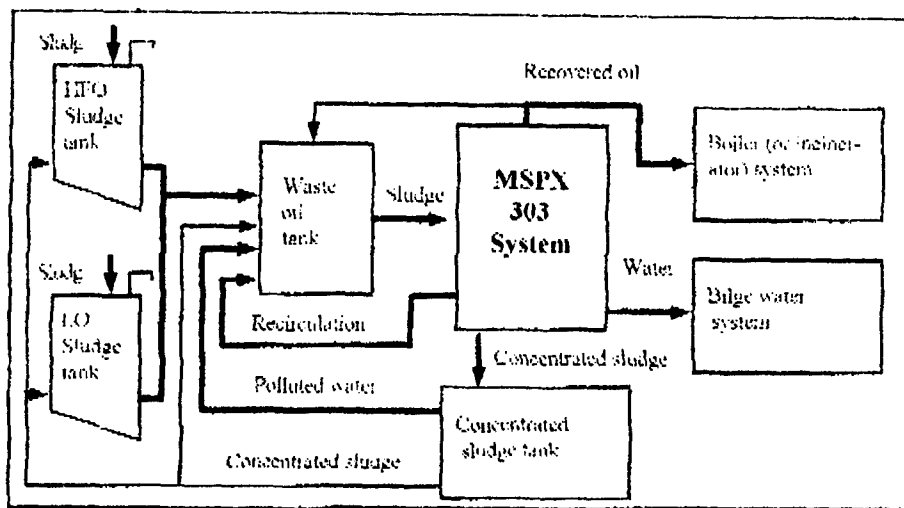


Figure 5. Alfa Laval Sludge Treatment System

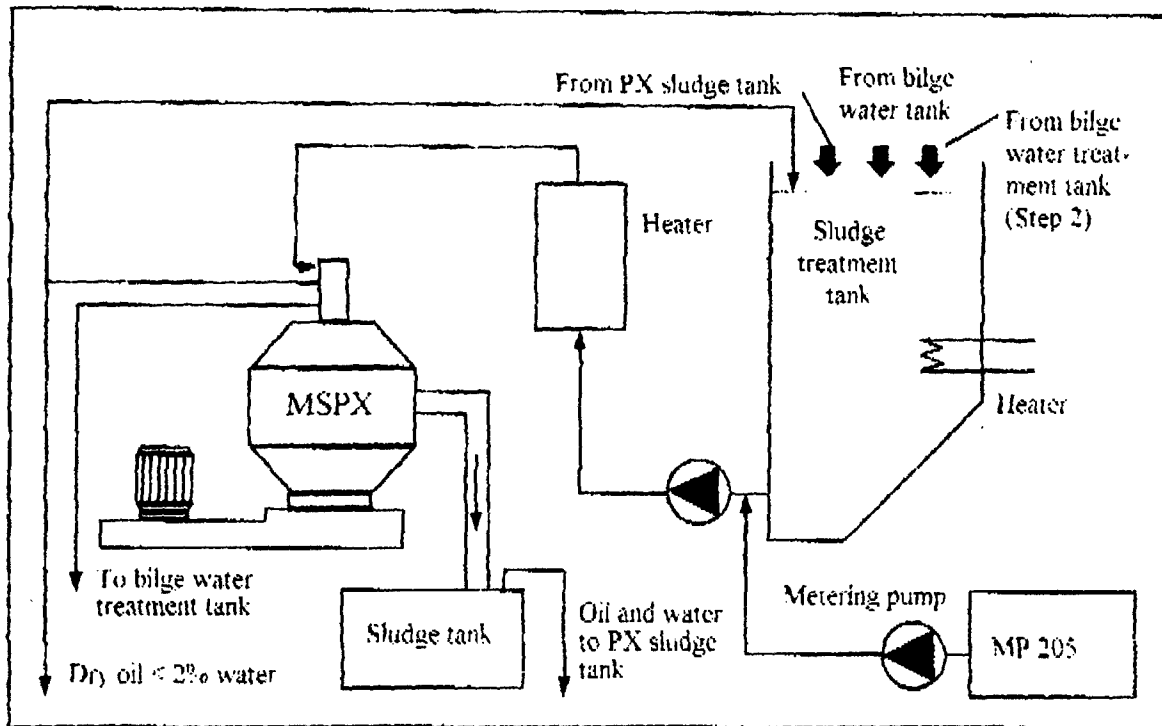


Figure 6 OSWAL system, stage 1, desludging - deoiling

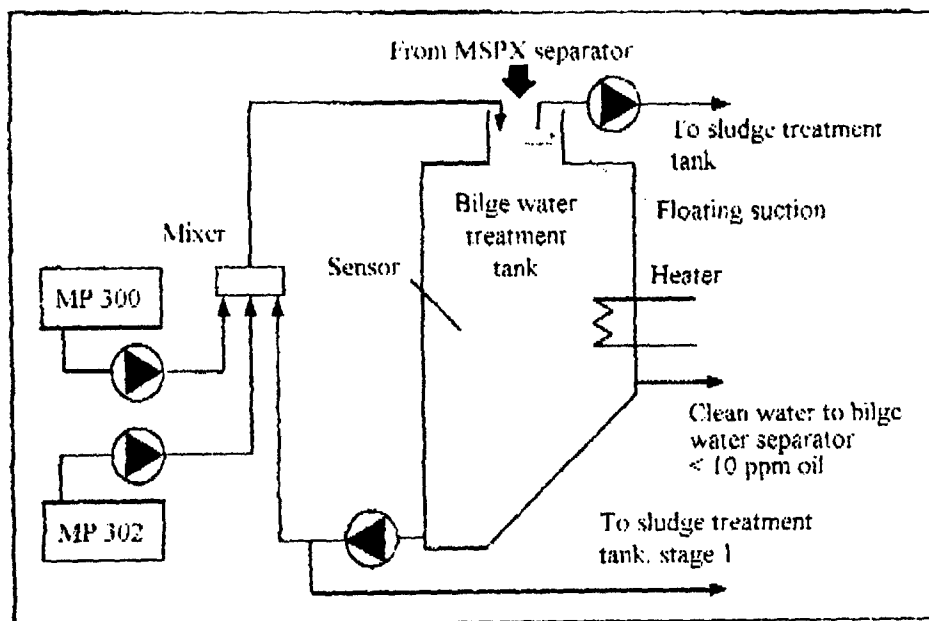


Figure 7 OSWAL system, stage 2, bilge water treatment.



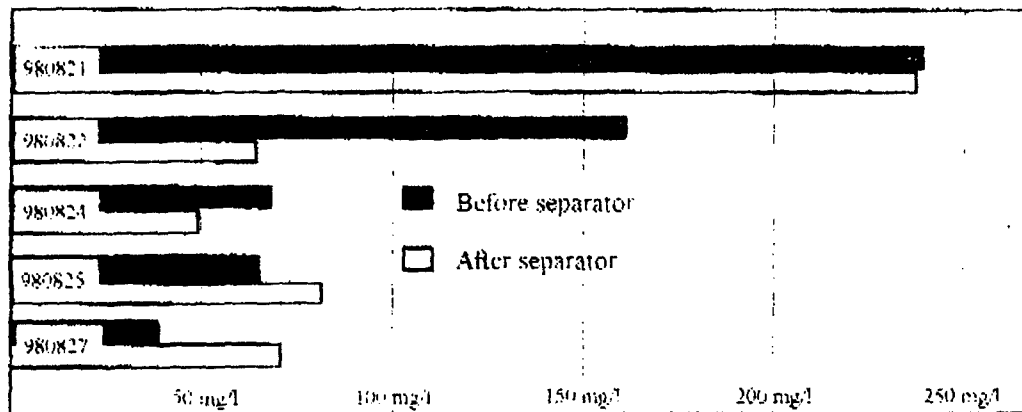


Table 1. Mineral oil content in mg/l before and after conventional bilge water separa-

| Number  | Inlet         | Oil outlet   | Water outlet |
|---------|---------------|--------------|--------------|
| 1       | 120 ppm (oil) | -            | 19 ppm       |
| 2       | 1,6% (oil)    | 1,8% (water) | 67 ppm (oil) |
| 3       | 27% (water)   | 1,3% (water) | -            |
| 4       | 4,8% (water)  | 1,2% (water) | -            |
| Control | 43% (water)   | 30% (water)  | -            |

Table 2. Samples taken from OSWAL Stage I

| Number | Settling time | Mineral oil content (ppm) |
|--------|---------------|---------------------------|
| 1      | 0 hours       | 141                       |
| 2      | 1 hour        | 15,4                      |
| 3      | 1,5 hours     | 10                        |
| 4      | 2 hours       | 10                        |
| 5      | 3 hours       | 7,5                       |

Table 3. Decrease in oil content with increased settling

| Number | Date     | Inlet mg/l | Outlet mg/l |
|--------|----------|------------|-------------|
| 1      | 97-11-03 | 7,4        | 7,9         |
| 2      | 97-11-03 | 8,0        | 8,2         |
| 3      | 97-11-03 | 8,2        | 6,8         |
| 4      | 97-11-04 | 7,5        | 7,3         |
| 5      | 97-11-04 | 7,2        | 8,0         |
| 6      | 97.11.04 | 6,7        | 5,7         |

Table 4. Analysis for mineral oil of samples taken before and after the conventional bilge water separator after treatment in an OSWAL system.

| ALPACON      | litre/m3   | litre/day  | litre/year   |
|--------------|------------|------------|--------------|
| MP 205       | 0,5        | 1,0        | 350          |
| MP 300       | 0,5        | 1,0        | 350          |
| MP 302       | 0,5        | 1,0        | 350          |
| <b>TOTAL</b> | <b>1,5</b> | <b>3,0</b> | <b>1,050</b> |

Table 5. Consumption of ALPACON chemicals

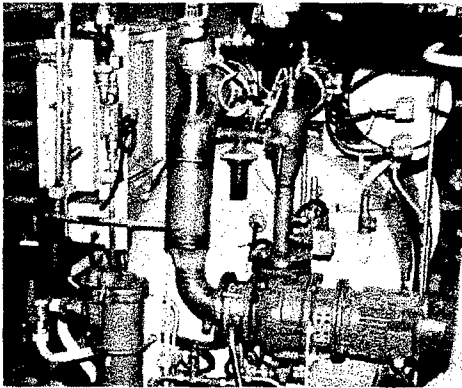




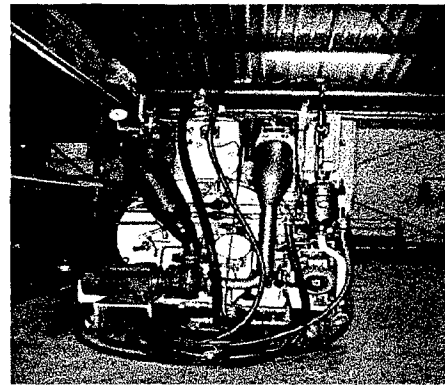
**B+V INDUSTRIETECHNIK GMBH**  
formerly Blohm+Voss Industrie GmbH

**Informations about bilgewater processing with membrane filtration**  
On the occasion of Waste Treatment Technologie for Ships, 18.-20.11.98, in Oldenburg

TURBULO<sup>R</sup> Separators were introduced over five decades ago into the market of Bilgewater cleaning. Because the requirements of bilgewater separators are changing, we are working to investigate, among other things, suitable processes for the cleaning of bilgewater. Because bilgewater is very difficult to chemically analyse, e.g. detergents and particle size and distribution, the experimental verification of a suitable process onboard is an important step to evaluation.



Prototype of the Membrane Separator on board



Workshop Separator

In 1992, a membrane separator was designed to investigate the basic process, also to answer membrane - specific questions. Among other things the selection of the membrane type and material, tool life, the possibilities of cleaning, the irregular start up and shut down, the reduction of the oil content and the COD<sup>\*</sup>, should be checked. At the beginning of the tests, the analysis of the COD was included in view of maritime environmental pollution questions. Up to this time we did not have any information about the oxygen demand of bilgewaters. Owing to the critical assessment of the BOD<sub>5</sub><sup>\*</sup> value even today, we did without an analysis.

Although significant problems existed at the beginning of the project, we have up to now several thousand documented operating hours. These hours give us important information regarding the onboard process. We have come to the conclusion that, by suitable selection of the membrane, i.e. of material and cut off, the reduction of the oil content in the effluent water is reliable, over a wide range of oil contents and different kinds of oils in the feed. It is necessary to take the total membrane process into consideration for an onboard application. The amount of the COD in the feed was more than we had assumed. A check on the mass and thermal flow conditions by using a calculation is recommended. Modification of the international test regulation which allow the testing of stable emulsions, would enable new technologies to be established on board.

\*BOD, COD Biochemical, Chemical Oxygen Demand



**Mechanical Bilge Water Treatment  
Conventional and Membrane Separators**

Andy H.H. Hein

Facet International BV  
Netherlands

**ABSTRACT**

Mr. Hein will briefly address

- Introduction of Facet International
- Facet International program for environmental products
- Launch of new, small and light weight bilge-water/oil separator



**Mechanical Bilge Water Treatment System  
Developed for the German Navy**

Rolf Ebus

Facet Deutschland GmbH  
Germany

**ABSTRACT**

Facet International has recently developed and manufactured yet another type of bilge-water separator to add to its already wide range of marine products. The **CPS 3.2E – 1EB12** was specifically designed to separate bilge water on all classes of sailing vessels and amphibian vehicles used by the German Navy.

The resulting CPS 3.2E – 1EB12 is a four-stage separation unit, comprising the patented Facet Mpak® coalescer and Facet coalescing filter pad, together with Facet coalescer and separator cartridges.

The ready-to-operate, compact, portable, pressurised oil/water separator was originally designed to remove free hydrocarbons from water.

However, the innovative design of the unit allows emulsified oils (mainly fuels, engine oils, hydraulic oils and lubricants), to be separated to a significant degree, thanks to the well-known Facet coalescing plate pack and a special new Facet coalescer cartridge.

Under normal conditions, the oil content in the effluent amounts to < 10mg/l of hydrocarbon.





## **P6\_EBUS.DOC**

Good morning Ladies and Gentlemen!

My name is Rolf Ebus. I am the General Sales Manager of Facet Deutschland GmbH.

My subject today is the new Facet oily water separator CPS 3.2E-1EB12.

I have divided my presentation into the following topics:

### **Table of contents of my presentation**

- Introduction/Situation before the launch of Facet CPS 3.2E-1EB12
- Task/Purpose  
BWB requirements/Technical specification  
Inland navigation legislation
- Facet solution: CPS 3.2E-1EB12
- Approvals and Certificates  
Expert's Report on an oily water separator by Germanischer Lloyd
- Conclusion
- Facet's relevant literature

### **Introduction/Situation before the launch of Facet CPS 3.2E-1EB12**

In 1994 we were invited by the BWB, which is the procurement department of the German Armed Forces, to develop a new oily water separator for their special needs. It was obvious that a lot of IMO-approved bilgewater separators were on the market, but there was no equipment which fulfilled the very special requirements of the German Army.

### **Task/Purpose BWB requirements/Technical specification Inland navigation legislation**

It took about a period of two years and a great deal of commitment from Facet International's R & D-department to design and manufacture this type of bilgewater separator.

Portable Oil/Water Separator CPS 3.2E-1EB12  
Presentation held at the International Marine Conference in Oldenburg  
on the 18th and 19th of November 1998

I would like to point out the special requirements of the German Forces:

The BWB was looking for equipment which is capable to separate the bilgewater on amphibious vehicles. These boats', for instance the bridge erection boat M3, main feature is the outstanding manoeuvrability, which is possible because a special pump jet propulsion system is used. The difficulty which comes along with this separation is that due to the strong movements of the boats a lot of energy is put in the mixture of oil and water. The result is a very tight mechanical emulsion. On top of that there are different kinds of hydrocarbons to deal with:

F54 Fuel

F58 Fuel

O-236 Engine oil

H540 Hydraulic oil

32-S Lubricant oil

Some of these oils do even have an emulsifying feature which is an advantage considering the lubricating characteristics but which is definitely a disadvantage considering the separation characteristics.

Another reason for our new development was the change of the inland navigation legislation which stipulates that each vessel must either have the possibility to retain the bilgewater or to treat it with a static oil separator.

**Facet solution: CPS 3.2E-1EB12**

- Facet International represented by Facet Deutschland GmbH together with the Dutch branch Facet Industrial b.v. has therefore recently developed and manufactured a new type of bilgewater separator.

- The CPS 3.2E-1EB12 was specifically designed to separate bilgewater on all classes of sailing vessels and amphibious vehicles used by the German military marine

The Facet solution to this problem is described in our leaflet 'Portable Oil/Water Separator: CPS 3.2E-1EB12'

## **Approvals and Certificates**

### **Expert's Report on an oily water separator by Germanischer Lloyd**

- Prior to the approval of this bilgewater separator as certified military marine equipment, Facet International had already conducted a fully comprehensive series of tests on the unit, not only under static laboratory test conditions but also comprising extensive field trials aboard M-Boats.
- Once the unit had been installed the vessels were then put through their paces with some real life manoeuvres.
- Even though this rigorous level of testing is not specified by the IMO it was essential that Facet carried out these additional tests in order to evaluate the unit's performance against the tighter emulsions to which this oily water separator is exposed, and also to compare the degree of purity of the effluent in authentic conditions with that obtained in static laboratory trials.
- This particular Facet CPS-unit was also subjected to handling operational and climatic tests, in order to ensure that it would give optimum performance even under the most severe conditions.
- The results of all these tests were outstanding.

I would like to show you some of the test results analysed by an independent test laboratory.

One test for example was carried out with a mixture of fuel F54 and engine oil O-236. Even after 65 minutes of testing the effluent remains below 5 ppm oil in the outlet.

Another test with F54 fuel shows a maximum oil content of only 1,5 ppm.

These were both static tests.

Now what happened under dynamic test conditions?

A first test was carried out with a maximum of 3,7 ppm after 1 hour and another test with a maximum oil content of 3.2 ppm after more than 1 hour.

And even the very difficult mixture of Fuel F54 and Engine oil O-236 shows only a maximum of 6,5 ppm after 1 hour of testing.

Portable Oil/Water Separator CPS 3.2E-1EB12  
Presentation held at the International Marine Conference in Oldenburg  
on the 18th and 19th of November 1998

Now let's have a look at the Expert's Report on our oily water separator issued by the Germanischer Lloyd in Hamburg.

Chapter 2.3 stipulates the test conditions and media of the IMO Resolution MEPC.60.(33).

See sheet.

Chapter 3.2 stipulates the standard programme for testing of oily water separators for water craft and amphibian military craft.

On top of that static trial condition a dynamic running trial where the oily water separator was installed on a M-boat was carried out.

Again the different kinds of oil and their mixtures have been used.

Chapter 4.21 describes the necessity of modification of the test programme.

1st reason : test media

2nd reason : concentration of media under the given operating and environmental conditions.

Finally in chapter 4.22 the equivalence of tests carried out compared with test programme as per IMO-Resolution is described. We would like to emphasise the fact that these tests were carried out 'under actual operating and ambient conditions'.

Due to these results and of course due to the right pricing of the unit Facet International had been awarded with the purchase order.

Following the initial procurement of 60 units the German Military is planning a further order. Many other military and civilian bodies, port authorities etc. have also expressed their interest in this unit attracted by the considerable cost cutting and environmental benefits it provides.

### **Conclusion**

As you can see and as discussed today and also yesterday, the manufacturer can provide the marine industry with equipment which is superior to the currently approved IMO equipment.

In my opinion it is therefore necessary to adjust and to upgrade the resolution in order to provide the final user with filtration and separation equipment capable of handling the most stringent conditions found in today's applications and at the same time to help the operators to fulfil the environmental program.

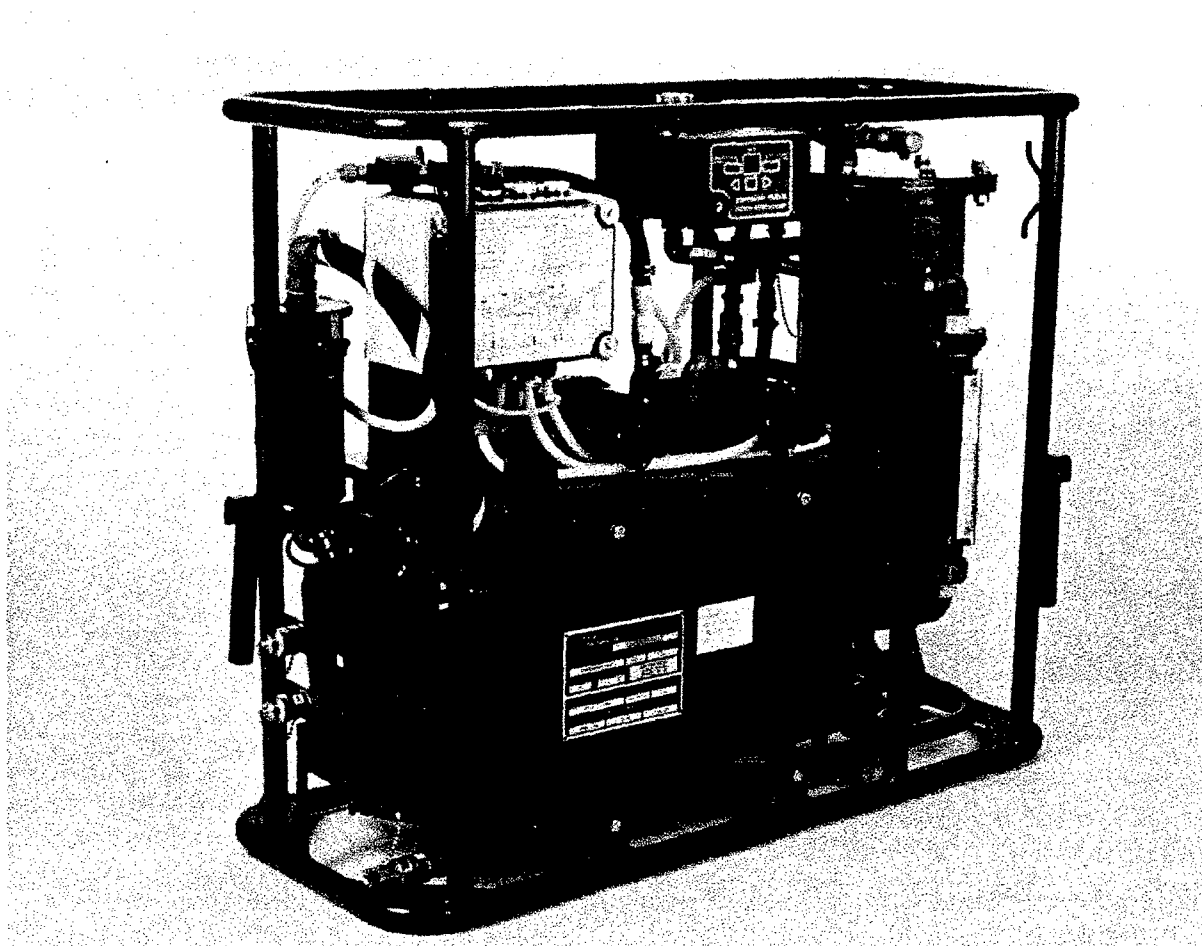
### **Facet International's relevant literature:**

for this oily water you may refer to the following brochures:

Portable Oil/Water Separator CPS 3.2E-1EB12  
Presentation held at the International Marine Conference in Oldenburg  
on the 18th and 19th of November 1998

- 'Engineering Clear Solutions for Environmental Clean-up
- Portable Oil/Water Separators: CPS 3.2E-1EB12'
- Facet International Newsletter No. 5

Thank you very much for your attention.





**Presentation at the International Maritime Conference in  
Oldenburg  
Thursday 19<sup>th</sup> November 1998**

**Membrane technology –The optimal technology for splitting bilge  
water emulsion**

The treating of bilge water has been governed by international laws for more than 25 years. Over the years the bilge water has changed dramatically from being water with suspended oil droplets and in worst case a mechanical emulsion to today's bilge water which consist to a great extend of chemical emulsion. This means that the equipment that was designed according to the IMO Res 393(X) and the newer MEPC 60(33) is not functioning for this bilge water.

The IMO committee issued the abovementioned resolutions, which was then again approved by the maritime authorities in the various leading shipping countries.

These resolutions led to the development of equipment that can only handle bilge water that contains free face of oil and water and to some extend mechanical emulsion. The same equipment, however, does not treat today's bilge water.

By still implementing the same IMO resolution the ship operators are not given the right equipment they believe they are getting.

The fact that bilge water contain chemical emulsion of oil and water is unfortunately still neglected by IMO.

But this is the real life onboard most of today's vessels.

In worst case the result is that even though the ship owners install equipment with IMO certificate, they still spill oil overboard.

IMO can easily change the situation by changing their way of influencing an important environmental challenge.

They can either state that in order to receive an approval of equipment, the test water must also contain detergents and other relevant emulsifying agents. Or they can state that the water overboard shall not contain more than 15 ppm total oil in water. The water shall be tested by an approved test method. (The level of rest oil can vary, depending on the waterway. Limits can be set as low as 2 ppm or even 0 ppm)

We in GOODTECH have developed a unit that can handle chemical emulsion without adding chemicals or other polluting components.

Our unit, which we call LenSep, is utilising the technology of modern membrane constructions.



By implementing the right membrane type and cleaning processes we achieve results that not only meets today's requirements. Future requirements will also be met. This means that by investing in LenSep today will give the ship operators equipment that will last for the next 20 and more years.

In addition to reducing the oil level to near to 0 the LenSep has also further advantages:

- Easy to operate. PLC operated
- A minimum of maintenance. Automatic CIP
- Represent an absolute barrier to oils as well as to micro-organism
- No chemicals. No extra waste.

The fact is that both the US and the Dutch navies are suggesting to the IMO committee to use membrane based bilge water treatment units in future installations.

The present IMO approved gravimetric separators can, however, still play an important part in the treatment of bilge water. There will always be some free oil in the bilge water and there is no doubt that this equipment handles this problem satisfactory.

In order to treat the bilge water completely, it is also necessary to treat the chemical emulsion as well. We therefore use the gravimetric separator as stage 1 and LenSep as stage 2.



# DET NORSKE VERITAS

## TYPE APPROVAL CERTIFICATE

CERTIFICATE NO. P-10096  
This Certificate consists of 2 pages

*This is to certify that the*  
**BILGE WATER SEPARATOR**

*with type designations*  
**LENSEP SP 1000A, SP2500A and SP5000A**

*Manufactured by*  
**BETEX A/S**  
**STRÅUMØ, NORWAY**

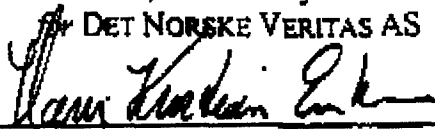
*is found to comply with*  
**IMO RESOLUTION MEPC 60 (33) 30 OCTOBER 1992**

### Application

This Type Approval covers system design principle and installation on board with regard to  
oil content in bilge water to be below 15ppm  
Capacity: 1, 2.5, 5 m<sup>3</sup>/hr

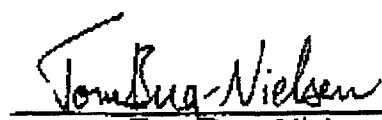
*Place and date*  
Høvik, 09. January 1998

DET NORSKE VERITAS AS

  
Jon Rysst  
Head of Section



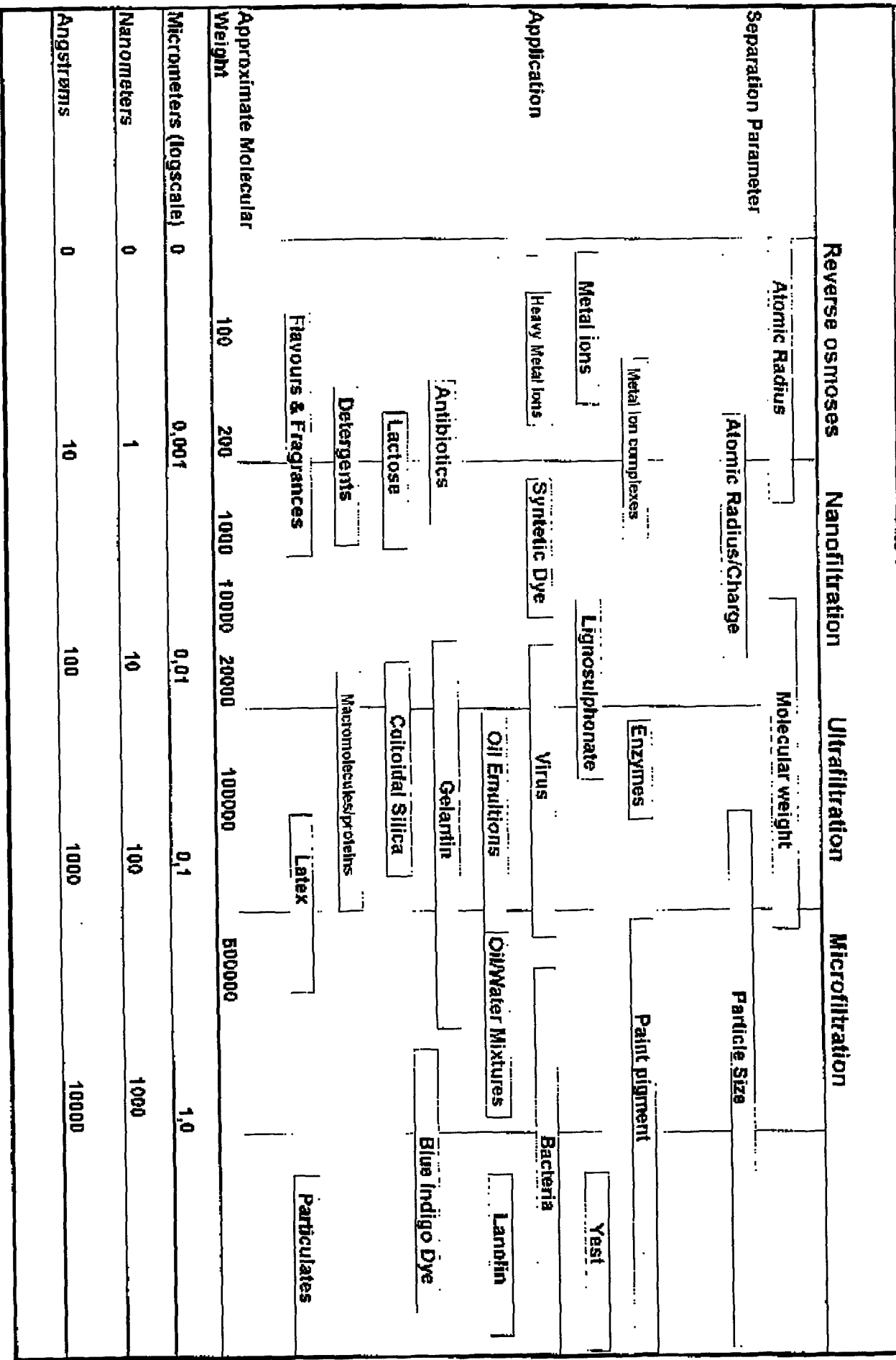
*This Certificate is valid until*  
31. December 2001

  
Tom Berg-Nielsen  
Surveyor

Notice: This Certificate is subject to terms and conditions overleaf. Any significant change in design or construction may render this Certificate invalid.

It is agreed that neither Det Norske Veritas, its subsidiaries, agents, officers, directors, employees and agents shall have any liability for any loss, damage or expense directly or indirectly by their actions or omissions (including gross negligence or willful misconduct) by any third parties and the assumption of gross negligence or willful misconduct by the governing bodies or bodies executive officers of Det Norske Veritas. This applies regardless of whether the loss, damage or expense has resulted from any contract or a third party who has acted or relied on documents issued or issued on behalf of Det Norske Veritas. However, if any person uses the services of Det Norske Veritas or its subsidiaries or relies on any document made or submitted given by or on behalf of them and in consequence is liable, completely or partially, to be held liable by any court, tribunal or other authority, then Det Norske Veritas will pay by way of compensation to such person a sum representing his proved loss. In the event Det Norske Veritas or its subsidiaries or employees or agents are held liable for any loss, damage or expense, then Det Norske Veritas will pay by way of compensation to such person a sum representing his proved loss. In the event that any person is held liable for any loss, damage or expense, then Det Norske Veritas will pay by way of compensation to such person a sum representing his proved loss. In the event that any person is held liable for any loss, damage or expense, then Det Norske Veritas will pay by way of compensation to such person a sum representing his proved loss.

# APPLICATION AREA - MEMBRANE SEPARATION TECHNOLOGY



## TECHNICAL DATA SHEET

### **Betex LenSep® Emulsion Breaker**

**Type: SP 1000-A, SP 2500-A and Sp 5000-A**

*For separation of emulsified oily water from bilge.*

#### **Technical data:**

Capacity: 1 m<sup>3</sup>/h, 2,5 and 5 m<sup>3</sup>/h

Cleanliness level: < 5 ppm total of oil hydrocarbons

Automatic operation with semi-automatic cleaning of membrane

#### **BETEX LenSep® Emulsion Breaker consists of:**

Feed and circulation pumps

Polymer based membranes

CIP (Cleaning in Place) of membranes

Back-pulse

Control Box, including PLC

Electric supply: 440 Volt, 60 Hz

Power consumption: 8,5, 11,5 and 14,5 kW)

Skid mounted, ready for operation.

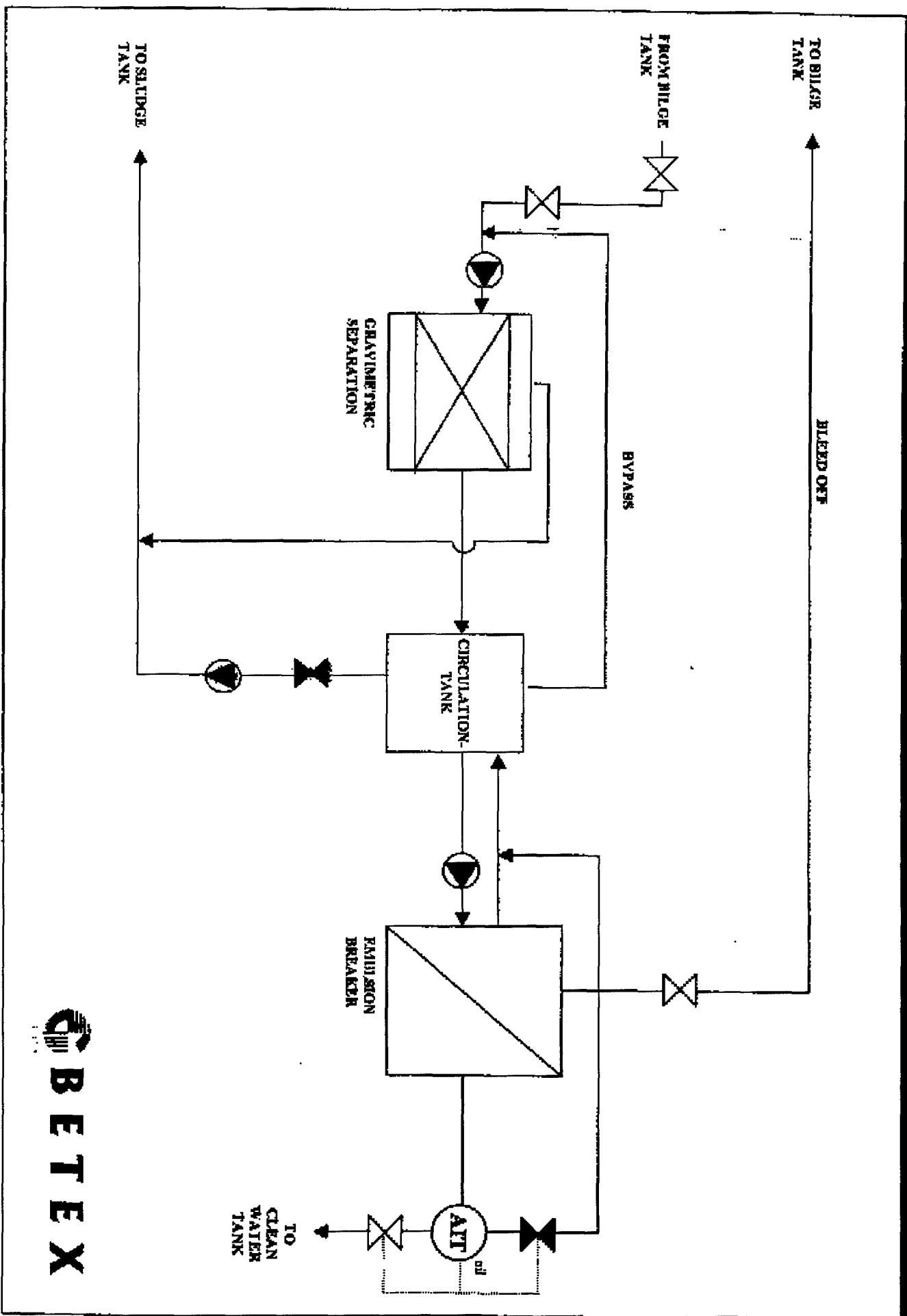
#### **Dimensions:**

Height: 1850 mm

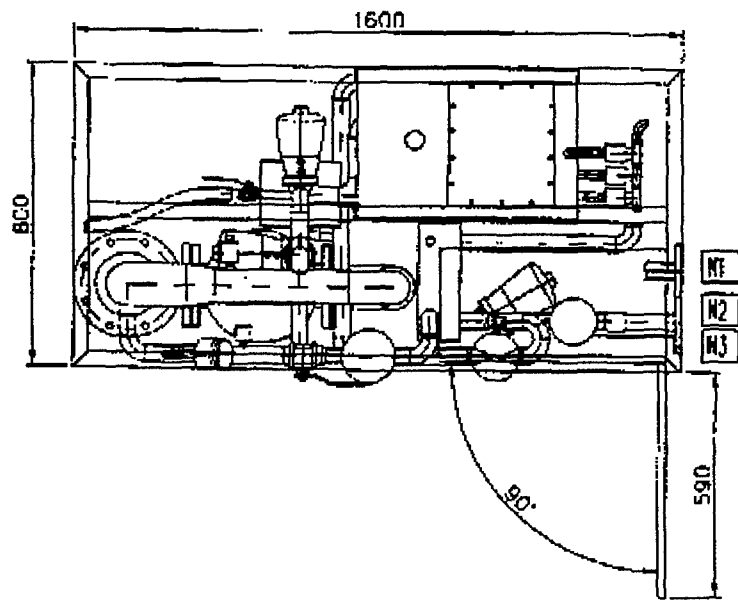
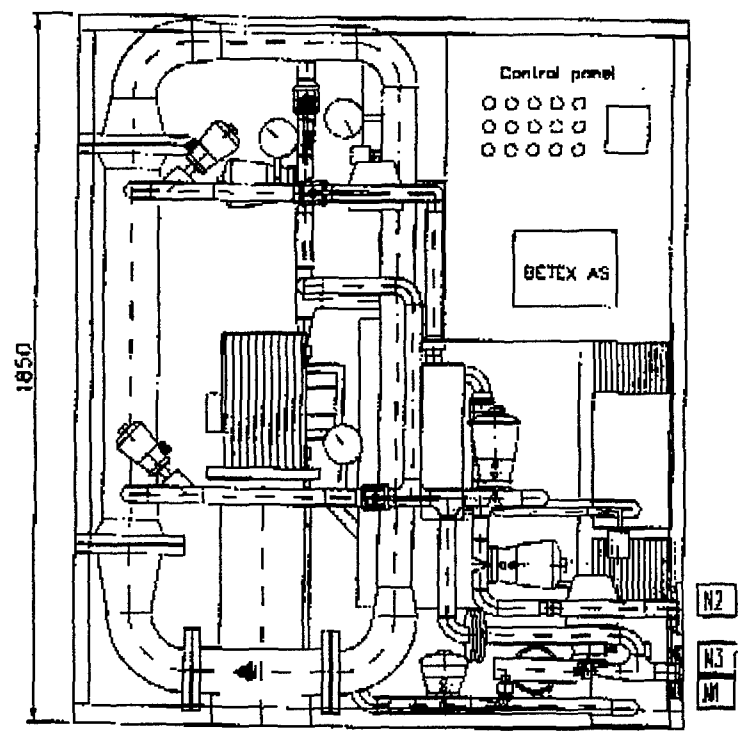
Length: 1600 , 2400 and 3200 mm

Depth: 800, 1000 and 1100 mm

Weight in kg, empty: 650, 900 and 1250 kg



DESIGNED BY BETEX A/S '81.1-4-13.ENG



## NOZZLE SCHEDULE

| REF. NO                  | SIZE | SERVICE                |
|--------------------------|------|------------------------|
| N1                       | DN32 | BILGE WATER INLET      |
| N2                       | DN32 | CLEAN WATER OUTLET     |
| N3                       | DN32 | DRAIN PIPE/FEED RETURN |
| POWER CONSUMPTION (est.) |      | 8,5kW                  |
| FREQUENCY                |      | 60Hz                   |
| VOLTAGE                  |      | 440V                   |
| WEIGHT (Est. Empty)      |      | 510 Kg                 |

FORMAT AS

|                                |      |                |        |
|--------------------------------|------|----------------|--------|
| Scale:                         | 1:20 | Project:       | HAR    |
| Author:                        |      | Date:          | 110697 |
| Checked:                       |      | Approved:      |        |
| Title:                         |      | Project no.:   |        |
| GA-DRAWING<br>EMULSION BREAKER |      | Equipment no.: |        |
| Project:                       |      | Drawing no.:   |        |
| LenSep SP 1000-A               |      | Date:          |        |
| <b>BETEX AS</b>                |      |                |        |

## FACTS AND FIGURES

**Relation between oil in water before and after treatment:**

**Results taken from test and real field measuring.**

|                          | <u>Oil content in ppm</u> |                   |                 |
|--------------------------|---------------------------|-------------------|-----------------|
|                          | <u>DnV</u>                | <u>"Rhapsody"</u> | <u>"Vision"</u> |
| <b>Before LenSep 965</b> |                           | <b>&gt;25</b>     | <b>&gt;15</b>   |
| <b>After LenSep</b>      | <b>2,75</b>               | <b>&lt;15</b>     | <b>2</b>        |

LenSep can handle emulsions with more than 1% of oil. However, the capacity will be reduced.

**1 m<sup>3</sup>/h of produced water will result in 50 l/h or less of sludge. This will require 3 l of diesel to evaporate.**

**The sludge can either be burned in an incinerator or taken ashore.  
In any case the amount of water has been reduced with minimum 95%**

### **Type & Size**

**LenSep SP1000, SP2500 and SP5000 - capacities of 1, 2.5 and 5 m<sup>3</sup> of clean treated water per hour.**

## BETEX Marine Technology

### Reference List: LenSep Bilge Water Separators

| <b>Installed</b>              | <b>Type</b>        | <b>Year</b> |
|-------------------------------|--------------------|-------------|
| <b>Norwegian Navy:</b>        |                    |             |
| <b>KNM „HORTEN“</b>           | <b>Supply Ship</b> | <b>1996</b> |
| <b>KNM „BERGEN“</b>           | <b>Frigate</b>     | <b>1997</b> |
| <b>KNM „TRONDHEIM“</b>        | <b>Frigate</b>     | <b>1998</b> |
| <b>KNM „NARVIK“</b>           | <b>Frigate</b>     | <b>1997</b> |
| <b>KNM „STAVANGER“</b>        | <b>Frigate</b>     | <b>1997</b> |
| <b>Cruise Ships:</b>          |                    |             |
| <b>„Rhapsody of the Seas„</b> | <b>RCCL</b>        | <b>1997</b> |
| <b>„Vision of the Seas“</b>   | <b>RCCL</b>        | <b>1998</b> |



## Betex Marine Technology

We would like to inform you that our

***LenSep***<sup>®</sup> - a membrane based bilge water separator  
for separation of emulsified water and oil

has been tested and approved by DnV according to IMO MEPC 60(33). The results were very good, the laboratory analyses showed a restoil in the separated water of less than 3 ppm.

It is well recognised that a traditional IMO approved gravity bilge water separator only solves part of the problem. Free oil is easily removed. The emulsified oil and water, however, is the real problem.

*Emulsified bilge water can not be discharged overboard.*

Hence the polluted water must be stored onboard and be pumped ashore as special waste.

The BETEX engineers had an ambition to design a unit that can separate emulsified oil and water *without the use of chemicals.*

*LenSep* turned out to be the solution

We hope that this is of interest to you and would appreciate your enquiries.

**FOR THE PROTECTION OF OUR ENVIRONMENT**

LENSEPIMO 1998/1

**Proven Technologies for Advanced Bilge-Water Treatment  
PROMAC AQUACLEANER-C-BW**

Valentijn Korteling

PROMAC BV  
Netherlands

**ABSTRACT**

PROMAC has its roots in the shipbuilding and shipping business in the early 60-ties and expended with the watertreatment/separation activity in 1978.

PROMAC AQUACLEANER-C-BW for separating oily-water/emulsion mixtures like bilge water, is a development of PROMAC Watertreatment Division since 1992 and was sponsored by CMO Maritime Research Coordination Agency and DGSM Netherlands Shipping Authority.

The Netherlands Navy was very much interested and has supported with practical facilities and the NATO Working Group on Environmental Issues has been informed from the beginning.

The proprietary AQUACLEANER technology is based on a special integration of crossflow micro filtration and gravity separation. Prior to pilot tests practically all available membranes have been evaluated including experience from the oil and gas industry.

During '94 – '96 many lab tests and shipboard practical performances have been realised. To day, Autumn 1998, AQUACLEANER units are in operation on board of NATO Navy ships in the Netherlands, Norway, Germany and UK with altogether about 70.000 operating hours.

In the NIAG SG 50 study on "NATO Environmentally Sound Ship of the 21<sup>st</sup> Century" the AQUACLEANER technology was identified as shipboard proven and commercially available (sheet L-O tech 3A FQI integrated MFGS).

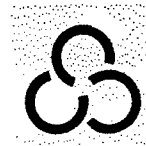
Verified by many independent tests the discharged water usually contains not more than 2 – 4 ppm residual oil. A dramatic volume reduction saves cost for storage and final harbor discharge of the residual dirty oil.

To day with accumulating all the 5 years experience the second generation design standard series has been completed and IMO MEPC 60/33 certified and contracts have been signed for deliveries 1998 – 2002, including among others all major new buildings for the Netherlands and German Navy and several retrofit programs.

Many fleet operators are planning to improve their environmental profile and to reduce the associated risks and costs.

For the important emulsion oil/water issue now an adequate and thoroughly shipboard proven solution is available with the high performance PROMAC AQUACLEANER-C-BW in standard and customer adapted versions.

PROMAC is an ISO 9001 and AQAP 110 certified company and a separations systems supplier since 1978 including government watertreatment systems since 1982.



# PROMAC BV

## PROVEN TECHNOLOGY FOR ADVANCED BILGEWATER TREATMENT

### PROMAC AQUACLEANER-C-BW

#### INTRODUCTION

Promac has its roots in the shipbuilding and shipping business since the early 60-ties and expanded with the watertreatment/separation activity in 1978 as an independent OEM-er specialised in membrane separation for AQUASET RO-freshwater generators and AQUACLEANER waste water treatment systems.

PROMAC is an ISO 9001 and AQAP 110 certified company and a separations systems supplier since 1978 including government watertreatment systems since 1982.

PROMAC AQUACLEANER-C-BW for separating oily-water/emulsion mixtures like bilgewater, is a development of PROMAC Watertreatment Division since 1992 and was sponsored by CMO Maritime research coordination agency and DGSM Netherlands Shipping Authority.

The Netherlands Navy was very much interested and has supported with practical facilities. The NATO working group on environmental issues has been informed from the beginning.

The proprietary AQUACLEANER technology is based on a special integration of crossflow micro filtration and gravity separation and has proven to be very efficient and cost effective.

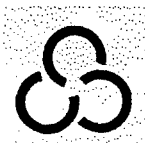
#### DEVELOPMENT RESULTS

During '94 - '96 many lab. tests and shipboard practical performances have been realised. To day, Autumn 1998, AQUACLEANER units are in operation on board of NATO Navy Ships in the Netherlands, Norway, Germany and UK with altogether about 70.000 operating hours.

In the NIAG SG 50 study on "NATO Environmentally Sound Ship of the 21st Century" the AQUACLEANER technology was identified as shipboard proven and commercially available (sheet L-O tech 3A EQI integrated MFGS).

Verified by many independent tests, performed by several customers themselves, the discharged water usually contains not more than 2 - 5 ppm residual oil. A **dramatic volume reduction saves considerable costs** for storage and final harbour off load or incineration discharge of the residual dirty oil.

# PROMAC BV



## PRINCIPLE OF SEPARATION PROCESS

To solve the serious problems in shipboard practice with separation of emulsified oily-water mixtures (both mechanical and chemical emulsions) **an entirely new approach** was necessary compared to the conventional systems because effective and reliable treatment of such mixtures goes beyond the limits of all processes where the specific density is determining for the separation results (stokes law).

A barrier separation on particle size is necessary in order to guarantee a reliable continuous process **without using chemical consumables**.

The entirely newly developed proprietary PROMAC AQUACLEANER technology fulfils these preset requirements. It combines a special integration of cross flow micro filtration and gravitational separation in a closed loop process with automatic PLC control.

*Fig. 5 shows the principle of operation and fig. 9 ships integration.*

In the first section is a special process tank where most of the free oil is separated and collected in the top of the container. In the heart of the AQUACLEANER the circulation loop for cross flow micro filtration most of the water is separated from the remaining mixture and its composition.

The retained concentrate is recirculated automatically to the process tank to join the free oil layer in the top.

When a certain level of oil is collected the discharge to the dirty oil tank is performed automatically or manual

In this unique way **two fundamentally different separation technologies have been integrated** in a very effective automatic continuous closed loop process.

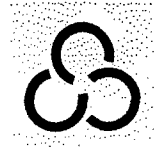
*Fig. 10 shows the specific characteristics and associated practical advantages.*

The natural fouling of the membrane surface is counteracted efficiently with the cross flow velocity effect and a unique automatic pneumatic hydraulic back pulse regime to ensure continuous undisturbed operation (see illustrations fig. 6, 7, 8).

Further periodical cleaning is limited to a minimum routine operation with normal biodegradable cleaners (one every 2 - 3 weeks).

Prior to the pilot tests of complete units practically all available membranes have been evaluated including our experience from the oil and gas industry applications. For the time being we use in AQUACLEANER tubular ceramic membranes because of the chemical and temperature resistance, the very effective back pulse and long membrane life time.

# PROMAC BV



## OPERATIONAL RESULTS

To day with accumulating all the 5 years experience the second generation design standard series has been completed and IMO MEPC 60/33 certified and contracts have been signed for deliveries 1998 - 2002, **including** a.o. **all major new buildings** for the Netherlands and German Navy and several retrofit programs.

Many fleet operators are planning to improve their environmental profile and to reduce the associated risks and costs.

For the important emulsion oil/water issue now an adequate and thoroughly shipboard proven solution is available with the high performance PROMAC AQUACLEANER-C-BW in standard and customer adapted versions.

Several shipowners have realised practical results in operational efficiency that **pay back** the investment **within 3 - 4 years** acc. to their own computations.

The table of characteristics and associated advantages (fig. 10) demonstrates the contributions:

- \* **increased freedom of operation**
- \* **better environmental compliance**
- \* **risk minimization**
- \* **cost saving operations**

AQUACLEANER is a good example where **environmental protection, operational efficiency and cost saving go hand in hand.**





MARITIEME TECHNIEK

KOUDE TECHNIEK

WATERBEHANDELING

SERVICE & REPARATIE

PROMAC



# **PROMAC BV**

## **PROMAC AQUASET MLT MK 1 "MINIMODU"**

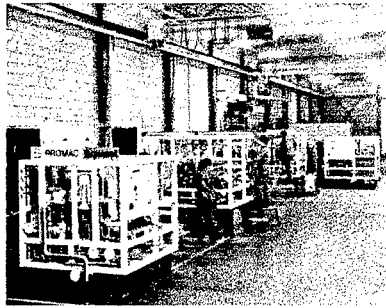


**THE ADVANCED LIGHTWEIGHT WATER PURIFICATION UNIT SINCE 1992 IN OPERATION BY THE NETHERLANDS UN MISSIONS IN CAMBODIA AND SINCE EARLY 1994 ALSO IN FORMER YUGOSLAVIA.**

# PROMAC BV

## PROMAC AQUASET<sup>®</sup> NAV 24 SSP

SPECIAL UNIT  
FRIGATES.  
FULL  
PLC  
WITH UF



FOR THE M-  
  
AUTOMATIC  
CONTROLLED

### PREFILTRATION.

CAPACITY            24 M<sup>3</sup>/24 HRS  
                          (TDS < 500 PPM)

DIMENSIONS        2000 X 1800 X 1600 MM

WEIGHT             3500 KG

POWER              440 V - 3 PH - 60 HZ, 22 KW

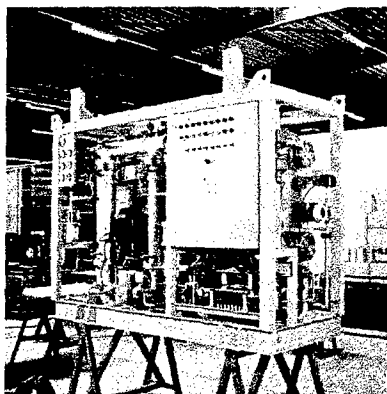
NOTE                SHOCKPROOF TESTED AT 20 G 50 MSEC  
                          EMC APPROVED

# PROMAC BV

# PROMAC AQUACLEANER-MAR-C-BW

THE ADVANCED MEMBRANE BILGEWATER SEPARATOR

TYPE 2-S-48 UNDER CONSTRUCTION FOR THE NETHERLANDS LCF AND GERMAN F124 PROGRAMM.



AQUACLEANER-C-B IS THE WELL PROVEN HIGH PERFORMANCE SEPARATOR FOR ALL TYPES OF BILGEWATERS INCLUDING EMULSIFIED MIXTURES.

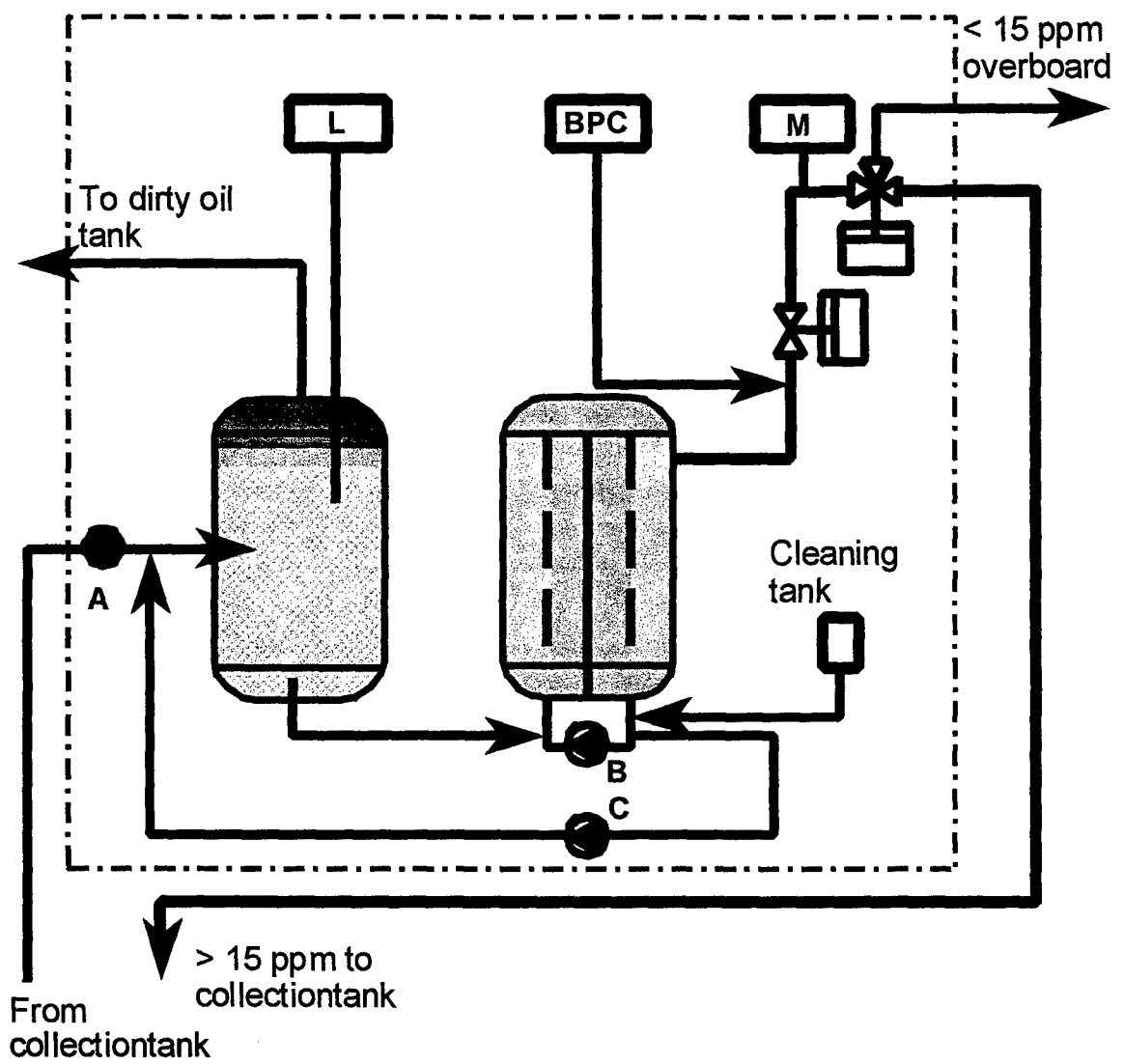
IMO TYPE APPROVAL CERTIFICATE FOR THE FULL RANGE SI/60-64/98

# PROMAC BV



## AQUACLEANER-C-BW

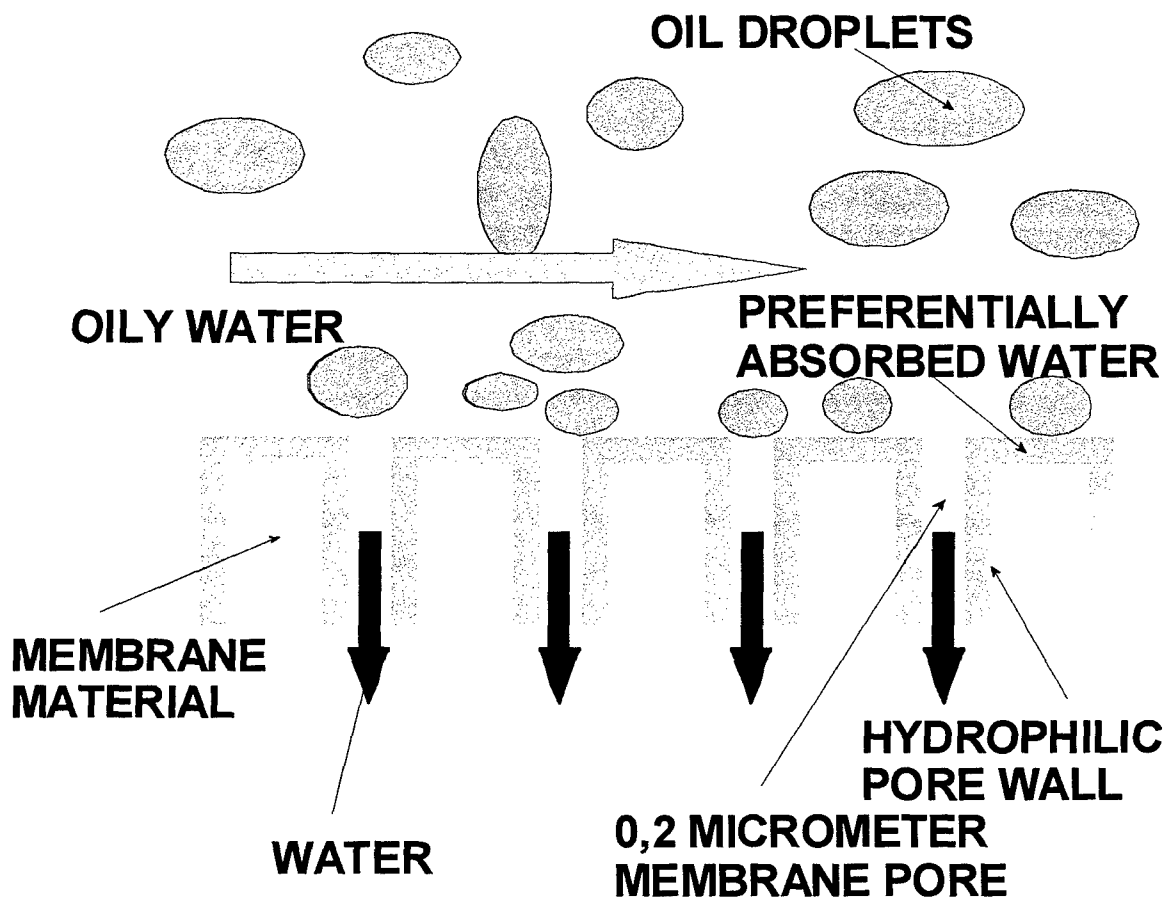
### PRINCIPLE OF OPERATION



# PROMAC BV



## THE PRINCIPLE OF A HYDROPHILIC MF MEMBRANE

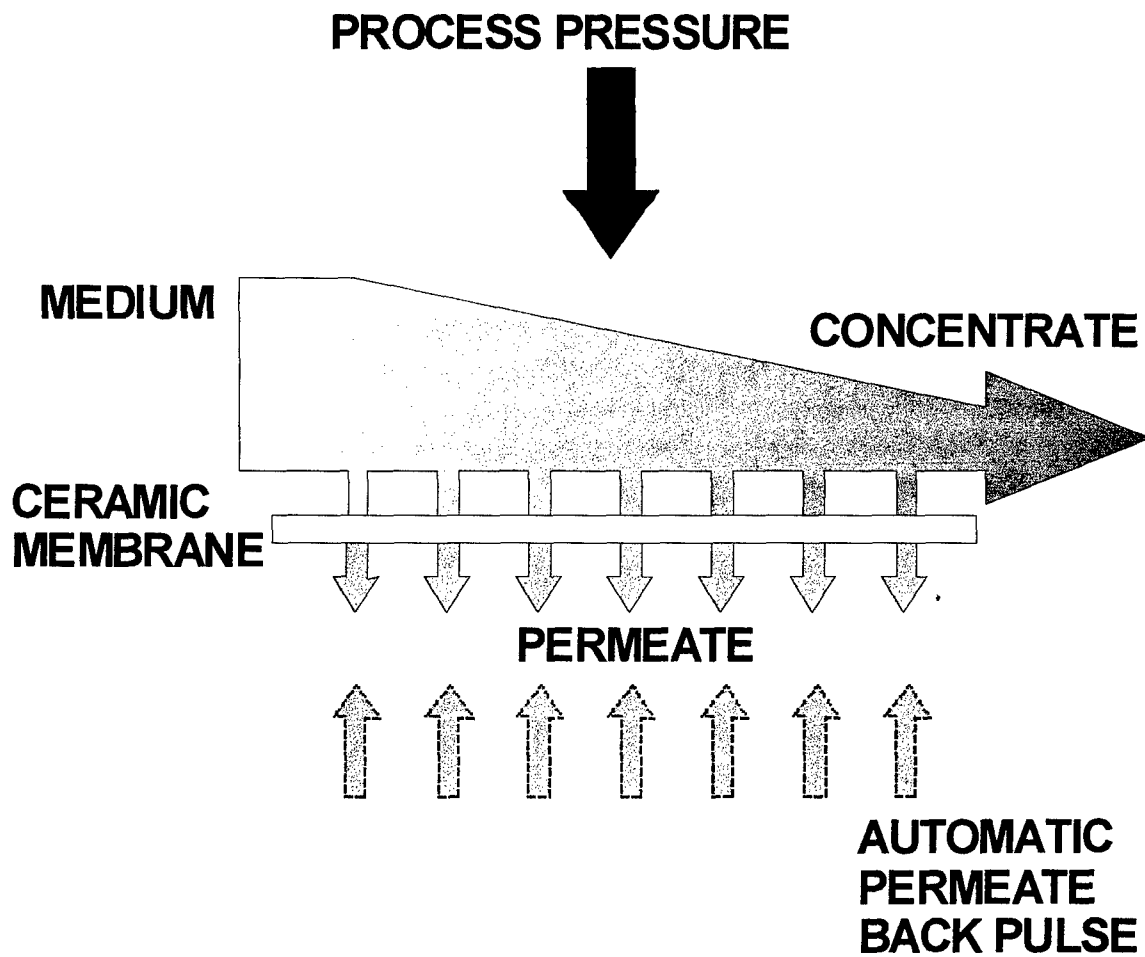


**THE WATER ABSORPTION ON THE HYDROPHILIC PORE WALLS INFLUENCES THE RETENTION OF OIL DROPLETS**

# PROMAC BV



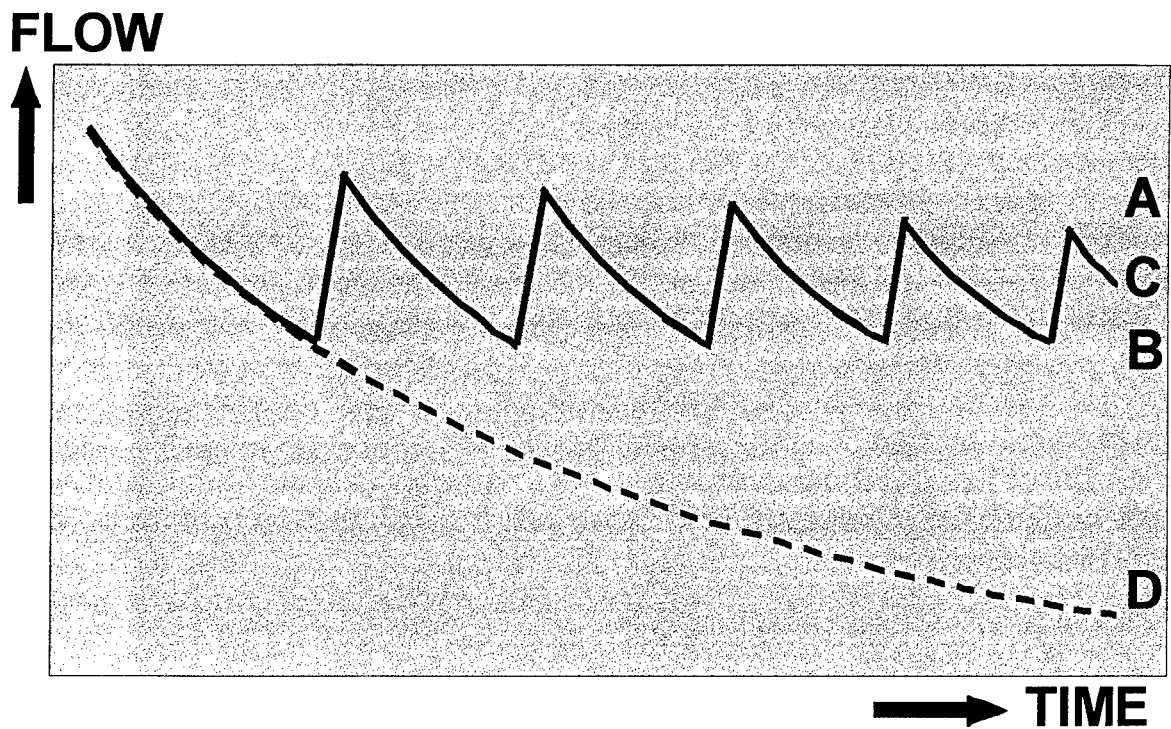
## THE PRINCIPLE OF CERAMIC MF MEMBRANE WITH BACKPULSE



### PRINCIPLE OF THE SEPARATION PROCESS



## THE PRINCIPLE OF CERAMIC MF MEMBRANE WITH BACKPULSE



- A = AFTER BACKPULSE**
- B = BEFORE BACKPULSE**
- C = WEIGHTED AVERAGE**
- D = NO BACK PULSE**

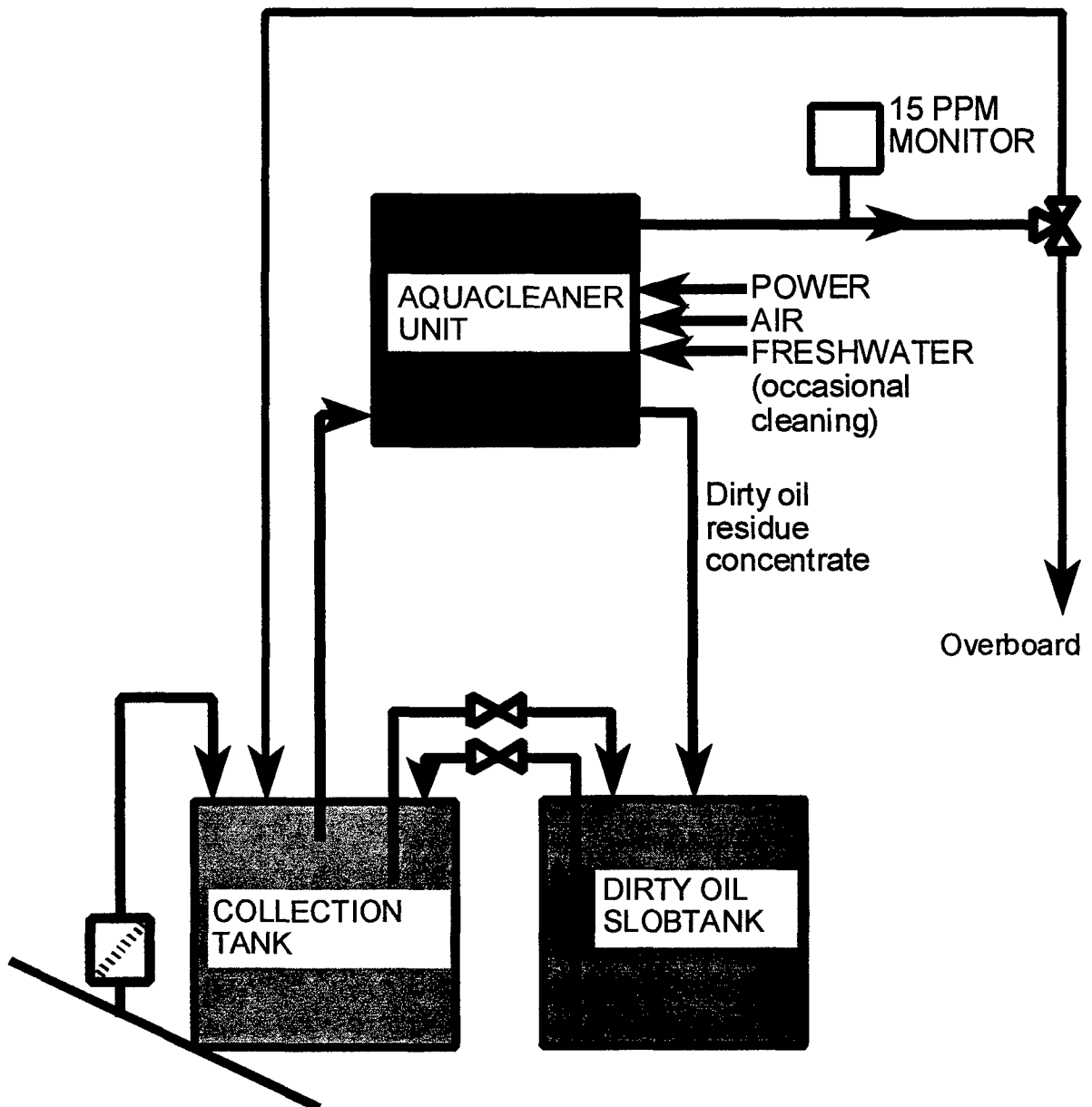
**PERMEATE FLOW AS A FUNCTION OF TIME**

# PROMAC BV



## AQUACLEANER-C-BW

### SHIPS INTEGRATION PRINCIPLE





# PROMAC BV

## AQUACLEANER-C-BW

### MAIN CHARACTERISTICS & ADVANTAGES

- \* Insensitive for emulsified oily-water mixtures and variation in bilgewater composition and oil content
  - > ***Continuous automatic operation***
  
- \* Insensitive for seagoing movements
  - > ***Continuous automatic unattended operation***
  
- \* Safe discharge of treated water < 15 ppm oil (< 5 ppm)
  - > ***No limitations in operational freedom and no risk for spoils and associated calamities***
  
- \* Maximum volume reduction - minimum volume of contaminated oil
  - > ***Lower costs for storage and harbour discharge or easy to incinerate.***
  
- \* No process consumables - additives
  - > ***Low operational costs***
  
- \* Compact small foot print stand alone unit
  - > ***Easy to install for new building and retrofit applications***
  
- \* Simple and reliable
  - > ***No extra labour constraints***

# PROMAC BV

## AQUACLEANER-C-BW

### TYPE RANGE SPECIFICATION AND CAPACITIES

| TYPE SPEC | NOMINAL CAP. M3/24 HR | IMO MEPC 60/33 CERTIFICATION | IMO TEST CAP. M3/HR | NSI SUBDIVISION INSTALLED POWER TOTAL IN KW | NSI CAP. M3/HR |
|-----------|-----------------------|------------------------------|---------------------|---------------------------------------------|----------------|
| 2-S-6     | 0,5                   | SI/60/98-5111-1              | 0,03                | I < 1000                                    | 0,025          |
| 1-S-24    | 1                     | SI/61/98-5111-1              | 0,06                | II 1000-5000                                | 0,05           |
| 2-S-24    | 2                     | SI/62/98-5111-1              | 0,12                | III 5000-10.000                             | 0,1            |
| 2-S-48    | 4                     | SI/63/98-5111-1              | 0,24                | IV > 10.000                                 | 0,2            |
| 4-S-48    | 8                     | SI/64/98-5111-1              | 0,48                |                                             |                |

NSI = NETHERLANDS SHIPPING INSPECTION

# PROMAC BV

## AQUACLEANER-C-BW

### DIMENSIONS AND WEIGHTS

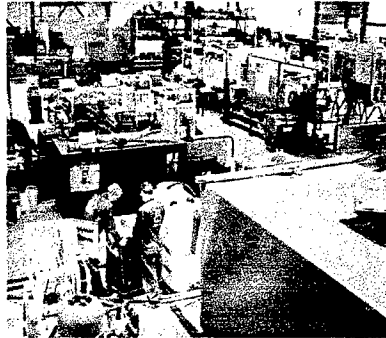
| TYPE SPEC | AQUACLEANER SKID |                     | FEEDPUMP + E- MOTOR SKID |           | POWER    |
|-----------|------------------|---------------------|--------------------------|-----------|----------|
|           | dim L x B x H    | weight kg dry / op. | dim L x B x H            | weight kg | total kW |
| 2-S-6     | 850x850x1800     | 350 / 430           | 900x280x340              | 40        | 1,25     |
| 1-S-24    | 1050x1000x1800   | 450 / 700           | 800x300x430              | 40        | 6,40     |
| 2-S-24    | 1050x1000x1900   | 450 / 700           | 800x300x430              | 60        | 6,60     |
| 2-S-48    | 2500x1100x1800   | 1000 / 1500         | 1000x300x400             | 60        | 8,25     |
| 4-S-48    | 2800x1500x2000   | 2000 / 3000         | 1200x400x500             | 80        | 8,65     |

CONTROL BOX AND OIL CONTENT MONITOR (1000x800x300 80 kg)  
ARE EXTERNAL ARRANGED FOR TYPES 2-S-6, 1-S-24 AND 2-S-24

# PROMAC BV

## PROMAC AQUASET AND AQUACLEANER

DESALINATION  
PURIFICATION  
FOR SHIPING =  
NAVY  
AND INDUSTRY



AND  
SYSTEMS  
OFFSHORE =  
= DEFENCE

WORKSHOP  
JUNE 1998

IMPRESSION

LEFT DOWN:  
MIDDLE:  
RIGHT TOP:

TESTING OF MOBILE DEFENCE SYSTEMS AND AQUASET "ECONOMIC"  
TWO UNITS AQUASET-EC-SP FOR FAST COASTGUARD CUTTERS

TWO UNITS AQUACLEANER-C-BW FOR NATO NAVY  
FRIGATES



Eule & Partners

International Consulting S.P.A.

Maritime Conferences

• **The Maritime Environment** •

"Waste Water Treatment Technologies for Ships"

**Session 3**

**Biological and Chemical Waste Water  
Treatment**

**Session Chairman: Mrs. Denise Oakley, AEA Technology, United Kingdom**



### 3SESSION.DOC

## **Session 3– Biological and Chemical Waste Water Treatment**

### ***Session Chairwoman, Mrs. Denise Oakley, AEA Technology, UK***

Mrs. Denise Oakley was trained in micro-biology at Warwick University and in environmental engineering at Birmingham University.

She has been with AEA Technology since 1987, gradually moving from technical and engineering work into project management and business development.

Denise has been active in waste management studies for the European Space Agency and the UK Navy.

AEA Technology provided key technical and management in to NATO NIAG Prefeasibility Study on Environmentally Sound Ship. Denise is currently Project Manager of the UK Feasibility Study in to Future Waste Stream Solutions for the UK Navy.

She will chair Session 2 on Mechanical Waste Water Treatment an present paper 1 on

#### **Potential Future Strategies for the Management of Liquid Waste Streams**

### ***Mrs. Bettina Schürmann, TH Aachen, GE***

Mrs. Bettina Schürmann studied at the Universities of Münster and Bonn before she graduated as biologist from the University of Aachen in 1980.

She worked as scientific collaborator at the Institute of Biology and the Department of Environmental Engineering , she worked as adviser of waste water treatment plants operators, trainer of students, laboratory technicians and civil engineers in chemical and biological water analysis, as an examiner of different diploma works on micro-biology and environmental engineering.

She worked as an Instructor of Indonesian biologists and in a Water Quality Management Project in Indonesia.

After 4 years of part-time lecture (faculty of chemical engineering) at the Aachen Advanced Technical College she became part-time lecture faculty of civil engineering including practical training in water chemistry and examination of diploma works.

Mrs. Schürmann will present paper 2 on

#### **Testing of Biological Waste Water Treatment Plants for Ships and Other Applications – Test Conditions and Results**



**Mr. Ulrich Brüß, Dr. Weßling-Gruppe, GE**

Mr. Ulrich Brüß is a graduated biologist.

He worked for Technik Labor GmbH as an Expert on the Project Gauging/Waste Water Techniques. He then became Project Manager Gauging/Waste Water Techniques at META Meßtechnische Systeme GmbH.

Presently he is Branch Chief in the field Water/Waste Water Techniques at Dr. Weßling beratende Ingenieure GmbH.

Mr. Brüß is presenting paper 3 on

**Optimised Sewage Treatment Plants for Ships -Combination of Activated Sludge Process and Membrane Technology**

**Dr. Fausto Strozzi, TAN, IT**

Dr. Fausto Strozzi was graduated in Chemical Engineering from the University of Genoa, IT, in 1974 and as MS in Environmental Engineering at the Manhattan College of New York, US.

He worked as Administrator of AZGA Nord SpA and of AZGA SpA – both operating in the public service sector integral water cycle and solid waste. As a Sale Administrator of MICRO S.R.L. he worked in the environmental, clinical and industrial analysis field before he became President and Technical Director of the Pollution Control Engineering S.R.L. of La Spezia, a company which designs, realises and manages civil and industrial waste water treatment plants.

During his carrier he worked as a designer and technical director/works director in various project. As such he signed responsible for inter alia more than 10 oily waste treatment plants, more than 20 biological waste treatment plants on board Italian and foreign ships, and more than 200 civil and industrial waste water treatment plants realised in Italy and abroad.

He worked on 4 experimental thesis disputed in the faculty of Chemical Engineering at the University of Genoa. He is member of NATO NIAG-SG/50. He is the originator of some scientific publications of importance in the field of Waste Water Treatment and holds three patents in this very field.

Dr. Strozzi is now presenting paper 4 on

**Biological Sewage Waste Water Treatment on Ships**

***Dr. Volker Schulz-Berendt, Umweltschutz Nord, GE***

Dr. Volker Schulz-Berendt graduated as a biologist from the University of Bremen and stayed there as a Scientific Collaborator. He was graduated Dr. rer. nat. in the special branch of Micro-Biology.

Since 1987 he is a leading employee at Umweltschutz Nord, presently as Manager of the business branch Water- and Air-Purification.

Dr. Schulz-Berendt will present paper 5 of this session on

**Cleaning of Bilge Waters from Ship Discharges by Planted-Soil Filters**



## Potential Future Strategies for the Management of Liquid Waste Streams

Denise L. Oakley  
AEA Technology Environment  
E4, Culham  
Abingdon  
Oxfordshire  
OX14 3DB  
United Kingdom

### Abstract

Liquid waste stream management on board ships is becoming increasingly difficult due to the implementation of more stringent regulations which limit or ban overboard discharges, particularly in port areas. Management systems for black and oily water are already installed on many vessels. These systems may include treatment, producing a discharge which complies with today's environmental regulations, but many are simply collect and hold systems to contain the waste streams until the vessel is outside areas where discharge is prohibited.

As environmental regulations worldwide are tightened, the areas where overboard discharges are acceptable will be greatly reduced. In particular, the trend is towards a greater number of 'Special Areas', where the discharge of most, if not all, liquid waste streams will be banned completely.

There will be an increasingly need for vessels to treat liquid waste streams on board. The resulting treated stream will need to be a benign discharge (with no adverse impact on the receiving environment), a stream suitable for recycle and continued use on board, destroyed completely on board to create benign gaseous and solid fractions or safely stored on board for shore based disposal.

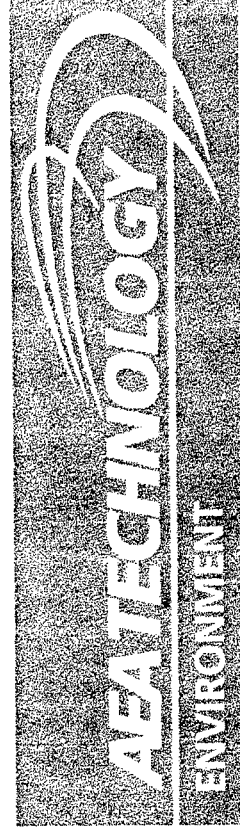
This paper will examine a variety of potential strategies for the management of liquid waste streams on board ships. The system concepts will be drawn from major recent studies in which AEA Technology has played key technical and project management roles: NATO NIAG Prefeasibility Study into an Environmentally Sound Ship for the 21st Century (completed in February 1996), UK MoD (Navy) Feasibility Study for Integrated Waste Streams Solutions for Environmentally Sound Future Warships Design (current) and Marine Engineering Improvement Programmes (UK MoD Navy) for the treatment of black, grey, oily and solid wastes.



# **Potential Future Strategies for the Management of Liquid Waste Streams**

**Denise L. Oakley**

**Principal Consultant**



# Contents of presentation

- Background
- The Problems
- The Potential Solutions
- Potential Management Strategies
- Technology Options
- Future Strategies for Management of Liquid Streams
- Future Development Requirements
- Concluding Remarks

## Background

- NATO NIAG Prefeasibility Study into an Environmentally Sound Ship for 21st Century (Feb. 95 - Feb. 96)
- Feasibility Studies for UK and US Navies (July 98 - Feb. 99)
- R&D work on technology options (e.g. UK, USA, Netherlands, Germany)
- Increasing interest in 'green' issues from cruise line / ferry companies and shipbuilders



**UK Feasibility Study (1)**  
**'Integrated Waste Stream Solutions for**  
**Environmentally Sound Warships Design'**

**Aim**

*Develop, technically appraise and select a number of feasible Integrated Environmental Systems for the destruction / treatment of all wastes generated onboard Navy ships (frigate size)*

**Key elements**

*Waste minimisation, available technology, ship integration, installation, operation & maintenance, refit / retrofit*

## UK Feasibility Study (2)

### Detailed System Designs

- *Waste segregation / mixing*
- *Pretreatment of individual or multiple streams*
- *Single or multi-stage treatment process(es) of individual or mixed waste streams*
- *Final effluent post-treatment*
- *Solids / sludge / waste oil storage*
- *Off-gas treatment*
- *Shore-based processing of solids, sludges and waste oil*

## UK Feasibility Study (3)

### Solids / sludge / waste oil

- Hold & discharge to shore-based destruction facility
- Hold & discharge to shore-based facility for recycle / reuse

### Final liquid effluents

- Overboard discharge (within acceptable limits)
- Recycle onboard (within agreed quality standards)
- Hold & discharge to shore-based treatment / disposal facility

### Gaseous emissions

- Discharge to atmosphere (within acceptable limits)

# The Problems

- No overboard discharge of liquids in many areas
- Stricter limits being set for allowable discharges
- Increasing cost of shore-based discharge
- Large volumes of liquid wastes requiring onboard treatment
- Widely differing compositions of the liquid streams

## For naval ships

- Severe restrictions imposed on volume, weight, power, utilities, manning (operation / maintenance), consumables of the total waste treatment system

# Overall Objective

## *The Environmentally Sound Ship*

- **Waste minimisation through supply chain management and crew awareness training**
- **Capable of destroying all wastes onboard or treating to produce emissions (solids, liquids and gases) that are environmentally benign (i.e. no adverse impact)**
- **Any residues are held safely onboard for environmentally sound shore based treatment / disposal / recycle / reuse**
- **Capable of worldwide operation with no constraint imposed by International, National or local regulations**

## Weight and Space Constraints for UK Future Escort

- 53 m<sup>2</sup> of deck area for waste disposal
- 17.22 tonnes for waste disposal
- 30.75 m<sup>3</sup> for sanitary tanks

## Liquid waste streams

- Black water (10 litres / man / day)
- Greywater (120 litres / man / day)
  - Bathroom (66)
  - Laundry (36)
  - Galley (18)
- Bilge water (peak production 2m<sup>3</sup> / day)
- Waste oil

[Ballast water]

# Potential solutions (1)

## Waste minimisation

- Vacuum collection (B)
- Water less urinals (B)
- Minimise volume per flush / infra red sensors (B)
- Smaller showerheads (G)
- Sensor and timer controls on taps (G)
- Water efficient washing machines & dishwashers (G)
- Run washing & dish washing machines only when full (G)
- Water recycling within laundry / machines (G)
- Preventative maintenance to minimise leaks (O)
- Improved seals and leak detection - fix immediately (O)
- Use rags to mop up oil (rather than water), wash and reuse (O/W)



## Potential management strategies (1)

- Treat all black and grey waters in the same process
- Pre treat greywater (either individually or together) prior to treatment in blackwater process
- Treat black and grey waters separately prior to polishing in single unit operation (for discharge)
- Treat black, grey & bilge in the same process
- Pre treat grey & oily water separately prior to treatment in black water process
- Option of storage or destruction of materials separated in pre treatment of grey & oily waters and treatment of blackwater

## Potential management strategies (2)

- Treatment with the intention of discharging compliant final effluents
- Treatment to enable recycle of some or all treated greywater (only some sources may be appropriate)
- Destruction on board with the intention of eliminating the need for onboard storage of residues and the discharge of liquid or gaseous streams
- Partial or complete integration of the treatment / destruction processes for liquid and solid wastes

# Technology options (1)

## Pretreatment

- Solid-liquid separation
- Liquid-liquid separation
- Grease traps / coarse filters

## Main destruction / treatment

- Biological
- Thermal
- Novel (plasma, supercritical water oxidation)

## Technology options (2)

### Post treatment

- Liquid-solid separation (L)
- Sterilisation (L)
- Gas cleaning (particles / residual organics / metals) (G)

### Residues

- Storage (prior to discharge to shore)
- Thermal treatment (debris solids, sludges, oil)
- Discharge (where allowable)

## **Future strategies for management of liquid waste streams**

**Examples of several schemes selected for further detailed evaluation within the UK Feasibility Study**

**(not included as these were presented in draft only at the Conference and are undergoing further development as part of the UK Feasibility Study)**

## Future development requirements (1)

### Biological treatment unit

- Continuous treatment of vacuum collected blackwater
- Continuous treatment of black & grey water
- Continuous treatment of black & pretreated grey & bilge waters
- Compact and automated
- Minimises generation of secondary residues (sludge / gas)

## Future development requirements (2)

### Thermal / novel destruction unit

- Batch or continuous destruction of pretreatment residues from grey & bilge waste streams TOGETHER with solid wastes (e.g. garbage, dewatered food solids) and sludges from biological treatment (B1 & pretreated grey + bilge)
- Compact and automated
- Energy efficient & minimises secondary fuel requirements
- Minimises production of secondary residues
- Clean gaseous emissions (either direct or integral cleaning)

## Future development requirements (3)

### Other unit operations

- No or low maintenance grease traps
- Compact and efficient oily water separator capable of producing discharges that are compliant (< 5ppm oil)
- Pretreatment units for individual greywater streams or total mixed greywater (generating low water content residues)
- Sludge-liquid separation unit for inclusion with bioprocess (alternative to current gravity separation)
- Non-chlorine sterilisation
- Storage (liquids / solids / dewatered debris & sludge)



## Future development requirements (4)

Control systems for integrated unit operations

Process monitoring systems

Water quality monitoring systems

'Black box' approach for fully integrated system

## Concluding remarks

- Onboard treatment of liquid streams will be required to ensure legislation compliance and maintain operational freedom
- Significant developments in treatment technology will be needed for use on small naval vessels
- Development of a *fully integrated* shipboard treatment system handling all liquids and solids will require extensive technical and engineering R&D / testing
- Additional control & monitoring systems will be required for inclusion in automated / integrated processes

**[UK Feasibility Study reports at end of Feb. 99]**



## **Testing of biological waste water treatment plants for ships and other applications - test conditions and results**

Dipl.-Biol. Bettina Schürmann  
Department of Environmental Engineering, ISA, RWTH Aachen, Germany

### **Abstract**

The IMO's recommendations on effluent standards and the guidelines for the test performance for waste water treatment plants for ships result from 1977. The modern plants for ships may also be used on land for research stations in sensible regions or as normal small waste water treatment plants for houses without sewer.

Test conditions for ships and the effluent standards are quite different for the varying applications. Test conditions and results are compared and recommendations given for the future with regard to the standardization process for waste water treatment plants in Europe.



P2\_SCHUERMANN.DOC

## Testing of biological waste water treatment plants for ships and other applications - test conditions and results

Dipl.-Biol. Bettina Schürmann

Department of Environmental Engineering, ISA, RWTH Aachen, Germany

Garbage and sewage from ships have traditionally been dumped into the sea. In relation to the amount of similar wastes poured into the sea each year from the land the quantities from ships were not considered excessive in the past. As long as biologically degradable carbon containing material form most of the garbage it will become CO<sub>2</sub> and water by degradation process. The also inherent chemical elements nitrogen and phosphorus will serve as nutrients for algae which lead to further problems.

Today ships and even very small ships can be provided with waste water treatment plants to avoid further water pollution. This fact does not only concern the marine environment but also rivers and lakes which often serve for drinking water purposes. It is much easier to make drinking water from clean water than from polluted river or ground water.

Any waste water treatment plant being in use to clean sewage anywhere in the world has to compile with certain degradation standards. Table 1 shows the german concentration limits of different plants in comparison to waste water treatment plants for ships

Table 1: Effluent standards for different waste water treatment plants

| Population equivalents | COD  | BOD <sub>5</sub> | NH <sub>4</sub> -N | N <sub>total</sub> | P <sub>total</sub> | SS   | faecal coliform |
|------------------------|------|------------------|--------------------|--------------------|--------------------|------|-----------------|
|                        | mg/l | mg/l             | mg/l               | mg/l               | mg/l               | mg/l | n/100 ml        |
| ≤ 50                   | 150  | 40               | -                  | -                  | -                  | -    | -               |
| ≤ 1.000                | 150  | 40               | -                  | -                  | -                  | -    | -               |
| ≤ 5.000                | 110  | 25               | -                  | -                  | -                  | -    | -               |
| ≤ 10.000               | 90   | 20               | 10                 | -                  | -                  | -    | -               |
| ≤ 100.000              | 90   | 20               | 10                 | 18                 | 2                  | -    | -               |
| > 100.000              | 75   | 15               | 10                 | 18                 | 1                  | -    | -               |
| ship                   | -    | 50               | -                  | -                  | -                  | ≤50  | ≤250            |

While the last improvements for effluent standards for normal waste water treatment plants result from the last two to three years the limits for ship plants stay the same since 1976. Thinking about 13 million people cruising in the Caribbean sea in only one year in 2000 everybody can imagine the necessity of further improvements in waste water treatment on ships.

In accordance with the Guidelines for Performance Tests for Sewage Treatment Plants with Respect to Effluent Standards there exist guidelines for performance tests of plants for less than 50 PE in Germany and other european countries as well as in the US. Table 2 compares two different kinds of test performance. As both systems are prefabricated before their installation and as plants in a container are as well used ashore it is quite legal to do this.

Table 2 Test performance

|                                | Treatment plant for ships, tested ashore                                                                    | Small prefabricated treatment plants for < 50 PE                                          |
|--------------------------------|-------------------------------------------------------------------------------------------------------------|-------------------------------------------------------------------------------------------|
| <b>Test location</b>           | ashore or aboard                                                                                            | on-site                                                                                   |
| <b>Raw sewage quality</b>      | fresh sewage (faecal manure, urine, toilet paper and flush water)                                           | domestic waste water incl. kitchen, washing mashine, bath and shower                      |
| <b>Concentration</b>           | 500 mg/l SS                                                                                                 | 600 mg/l BOD                                                                              |
| <b>Duration of test</b>        | 10 days having reached steady state conditions                                                              | 1 year having reached steady state conditions                                             |
| <b>Loading factors</b>         | average, minimum and maximum volumetric loadings                                                            | minimum 75% of the nominal loading (75% PE)                                               |
| <b>Sampling methods</b>        | "Sampling should be carried out in a manner and at a frequency which is representative of effluent quality" | 2 h composite samples or qualified grab samples and 24 h composite samples                |
| <b>Sampling frequency</b>      | 40 effluent samples and an adequate number of influent samples                                              | 15 grab samples and 6 24 h composite samples                                              |
| <b>Analytical testing</b>      | ASM                                                                                                         | EN, ISO or DIN                                                                            |
| <b>regular</b>                 | BOD, SS, faec. coliform                                                                                     | COD, BOD, settlable solids                                                                |
| <b>additiv</b>                 | COD, turbidity, P <sub>total</sub> , pH, TOC and others                                                     | COD <sub>f</sub> , N <sub>total</sub> , NH <sub>4</sub> , NO <sub>3</sub> , P, pH, oxygen |
| <b>Desinfectant residual</b>   | recommendation to use other disinfection media than chlorine                                                | no disinfection allowed                                                                   |
| <b>Scale-up considerations</b> | full-scale and certification of a range of equipment                                                        | full-scale and certification of a range of equipment sizes                                |

|  |       |  |
|--|-------|--|
|  | sizes |  |
|--|-------|--|

Comparing the test results of waste water treatment plants for ships and small plants being installed to treat the sewage of normal houses it is obvious that they are able to reach the same effluent concentrations. Table 3 shows results of a conventional activated sludge ship plant and a small plant for 8 population equivalents.

Table 3 Test results

|                                   | Ship plant             | Small plant                  |
|-----------------------------------|------------------------|------------------------------|
| <b>Designed organic loading</b>   | 1,125 kg/d BOD         | 0,480 kg/d BOD               |
| <b>Designed hydraulic loading</b> | 2,62 m <sup>3</sup> /d | 1,2 m <sup>3</sup> /d        |
| <b>Concentration of influent</b>  |                        |                              |
| <b>BOD (calculated)</b>           | 430 mg/l               | 400 mg/l                     |
| <b>BOD (analyzed)</b>             | 338 mg/l               | 168mg/l (after sedim. tank)  |
| <b>Suspended Solids</b>           | 655 mg/l               | 145 mg/l (after sedim. tank) |
| <b>COD</b>                        | not tested             | 384 mg/l (after sedim. tank) |
| <b>N<sub>total</sub></b>          | not tested             | 48 mg/l (after sedim. tank)  |
| <b>P<sub>total</sub></b>          | not tested             | 11,15 mg/l (after sedim.)    |
| <b>Effluent</b>                   |                        |                              |
| <b>BOD</b>                        | 7,3 mg/l               | 5 mg/l                       |
| <b>COD</b>                        | 40 mg/l                | 66 mg/l                      |
| <b>SS</b>                         | 17 mg/l                | 3,8 mg/l                     |
| <b>N<sub>total</sub></b>          | not tested             | 18 mg/l                      |
| <b>P<sub>tota</sub></b>           | not tested             | 5,46 mg/l                    |
| <b>Feecal coliform</b>            | 56 /100 ml             | not tested                   |



Though the results of the different tests look rather equal there are some crucial differences between these two tests. The ship plant has had sewage of equally good quality during the whole time. The waste water of a big waste water treatment plant - where these plants normally are installed - does not change very much neither in quantity nor in quality during a dry weather period. The testing time is very short and there are always some people looking for the plant during the test. A small treatment plant installed at a house with 8 inhabitants is tested over a period of one year. It is submitted to the changings of temperature, to the influence of different chemicals used in the house, varying hydraulic loads ( 30 to 200 l/(PE\*d)) and the untiring effort of people to use their toilet as garbage can. Normaly there is nobody to look for the plant and samples are taken just once per month. So it must be said that this kind of test is much nearer to reality than the normal test for a ship plant being performed ashore. It does never replace a test aboard with every days problems. So there are two alternatives:

1. Performance of a test programm with less samples over a longer period under the influence of changing hydraulic and organic loads on a test field or
2. performance of a test programm aboard a ship including comprehensive instruction of the ships stuff concerning the plants technology .

Though conventionell biological waste water treatment plants are able to reach today's effluent standards it is necessary to look forward to new technologies like membranfiltration technology for biological waste water treatment. This technology is able to clean the sewage much better than the conventional plants and takes less place in the ship. Technology is ready to provide any ship with a biological waste water treatment plant. And as soon as the first plants are available the Department of Environmental Engineering ISA RWTH Aachen is able to do the rquirement tests for these plants too.

**Optimised Sewage Treatment Plants for Ships –  
Combination of Activated Sludge Process and Membrane Technology**

Ulrich Brüß

Dr. Weßling Beratende Ingenieure GmbH  
Germany

**ABSTRACT**

Ships and boats of the German Navy operate often in coastal shallow water areas as well as in the special water areas North Sea and Baltic. For the protection of these ecological sensitive systems sanitary treatment systems have been installed on board. Analyses have shown that these installations very often are not capable to meet the requirements for the discharge of waste water.

Dr. Weßling Beratende Ingenieure (consulting engineers) GmbH was awarded a contract by the Bundesamt für Wehrtechnik und Beschaffung for the development of an improved technology for the treatment of ships waste waters. Following the development a test and evaluation of the employed technique was carried out on a test site in Altenberge which was simulating typical conditions for shipboard operation.

The results show that the developed techniques provide capabilities for substantial improvements of the cleaning effects reducing at the same time the space requirements and thereby building cost.

Due the positive results it is aspired also to make use of this technology in the area of passenger and cruise-line shipping.

The presented paper will introduce and discuss the developed and tested system technology.



Dr. Weßling Beratende Ingenieure GmbH



P3\_BRUESS.DOC

**Optimized Sewage Treatment Plants for Ships**  
**-Combination of Activated Sludge Process and**  
**Membran Technology-**



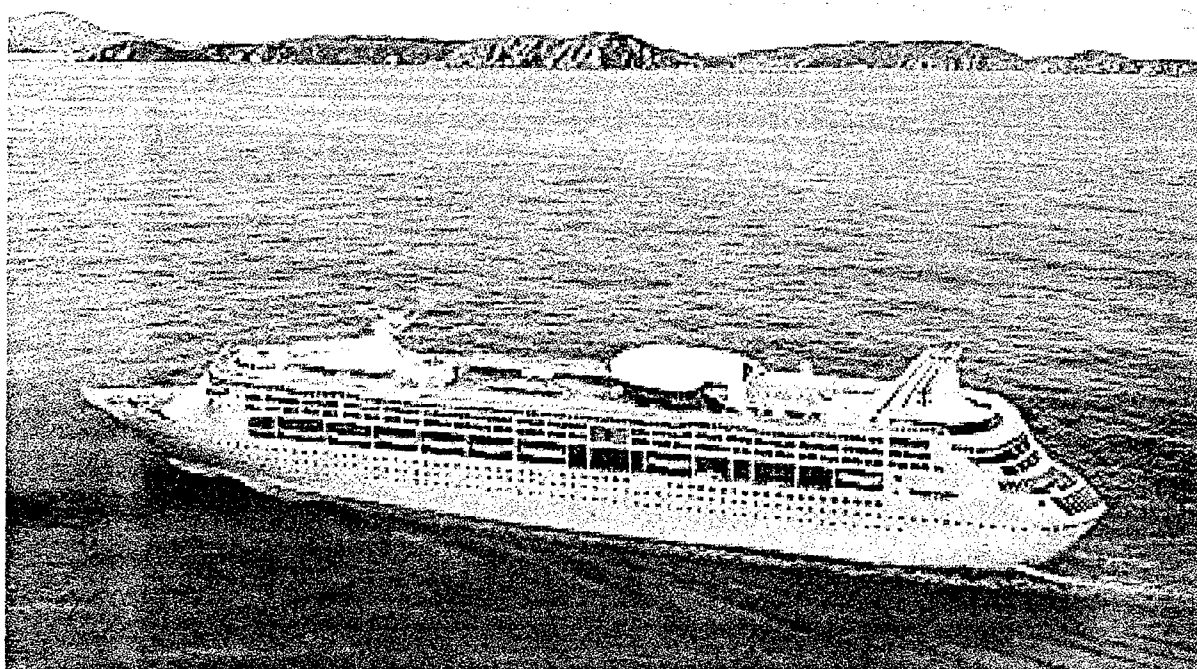
## Contents of Presentation:

- Introduction
- Legal status
- Current status
- Project objective
- Specific conditions on ships
- Schematics of pilot installation
- Experimental results
- Influences on the size of sewage treatment systems for ships



## **Introduction**

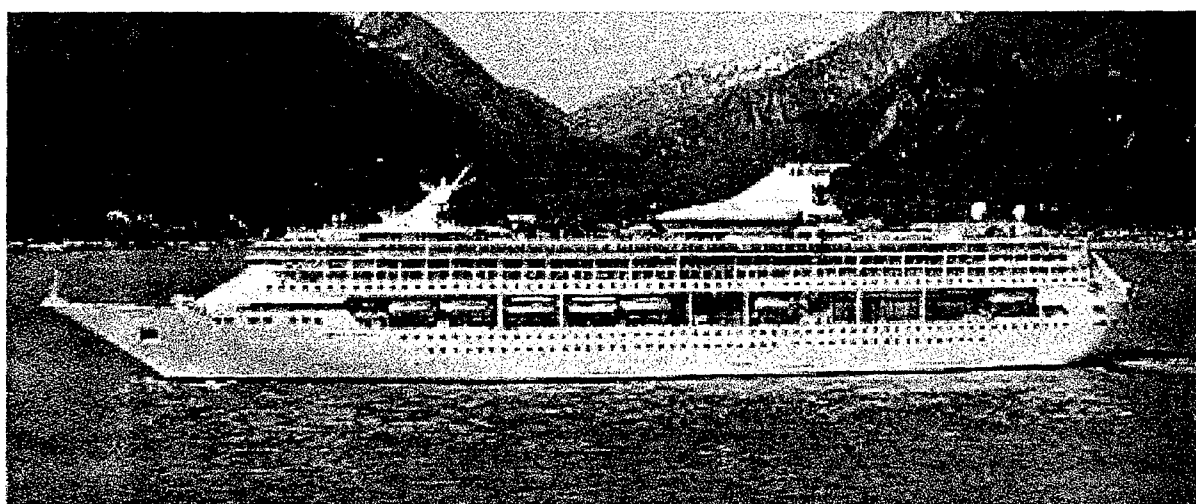
- Ship sewage is produced on all journeys lasting several days
- Amount of sewage:
  - Worldwide about 60,000 people work on 27,000 freighters
  - Currently about 1,300 passenger ships, with a capacity of 1,800 people or more, are travelling on the seas
  - In the year 2000 it is expected that 13 million passengers will travel through the Carribean Sea alone
- Both freighters and passenger ships especially travel through regions in need of protection, e.g., the polar region, tropical seas, flat coastal waters and inland waters



**M/S Rhapsody of the Seas**

Crew: 765

Passengers: 2.435



**M/S Splendour of the Seas**

Crew: 720

Passengers: 1,804



## Legal Status for Discharging Ship Sewage

### **International:**

- Annex IV of the MARPOL-Agreement for the Prevention of Sea Pollution by Ships
- IMO- Resolution MEPC.2 (VI) from 03.12.1976

### **National: (Germany)**

- Decree of the Sea Law

According to this decree:

“...it is not allowed to discharge untreated sewage into the sea” except when the ship is equipped with a sewage treatment system guaranteeing the mandatory water quality concentration levels.

### **Effluent quality:**

|                                              |                 |
|----------------------------------------------|-----------------|
| Biological oxygen demand (BOD <sub>5</sub> ) | max. 50 mg/L    |
| Raw water quality (Suspended solids)         | max. 50 mg/L    |
| Coliform germs                               | max. 250/100 mL |

During travel at sea BOD and raw water quality values are allowed to exceed the given values above by a factor of 2.





## Current Status

- Toilet water is treated biologically
- Shower water, kitchen water and washing water are not treated at all
- Single stage aeration tanks and static sedimentation tanks
- Irregular loading of systems with sewage
- No screening at inflow
- No controlled sludge removal
- The word "surplus sludge" is virtually unknown
- Sewage disinfection using chlorine
- The legal concentration levels of the effluent is often exceeded
- The systems need intensive maintenance
- The volume of the systems is often too large



## Project Objective

### **Development and Testing System Concepts for the Aerobic Cleaning of Ship Sewage**

**with the following objectives:**

- Development of small and compact systems to minimize the space needed on board
- Improving the effluent values of the systems
- Minimizing disturbances during operation
- Meeting the goal of maintenance-free operation

### **System concepts already tested:**

- Membrane biology with external microfiltration tube module (Martin Systems AG)
- Membrane biology with external microfiltration capillary module (Martin Systems AG)
- Membrane biology with internal microfiltration plate module (WABAG ESMIL GmbH)



Specific conditions on ships

| Parameter                    | Limitations                                                 |
|------------------------------|-------------------------------------------------------------|
| Height:                      | deck height 2.30 m                                          |
| Volume:                      | as small as possible since space on ship is expensive       |
| Energy consumption:          | of secondary importance                                     |
| Sewage hydraulics:           | strongly varying loads during day                           |
| Organic loading:             | about 90 g BOD <sub>5</sub> /E*d                            |
| Sewage system                | no degradation in vacuum toilet sytem                       |
| Modes of operation of ships: | harbour operation, low load operation, sea operation        |
| Ship dynamics:               | rolling movement of ship body ( $\pm 24^\circ$ in 13. sec.) |
| Vibrations:                  | Continuous low frequency vibrations on ship                 |
| Availability of system:      | quick repairs or modifications are not possible             |
| Maintenance:                 | through unschooled personnel                                |



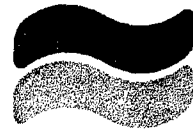
**Amount and composition of sewage**

| <b>Ship:</b>                                             | <b>Test system:</b>                                            |
|----------------------------------------------------------|----------------------------------------------------------------|
| Toilet water<br>Washing water<br>Kitchen water           | Communal sewage<br>Kitchen water                               |
| BOD <sub>5</sub> -concentration at inflow point 500 mg/L | BOD <sub>5</sub> -concentration at inflow point 500 mg/L       |
| Daily amount of sewage<br>180 L/E*d                      | Daily amount of sewage<br>180 L/E*d                            |
| Continuous loading via mix and buffer tank               | Continuous loading via mix and buffer tank                     |
| Rolling of ship                                          | Rolling angle: up to $\pm 24^\circ$<br>Rolling period: 13 sec. |



Cleaning power of tested systems

|                     | <b>Mean Values<br/>System Inflow<br/>Point</b> | <b>Internat.<br/>Concentr.<br/>Limits</b> | <b>Mean Value<br/>Discharge<br/>Point</b> |
|---------------------|------------------------------------------------|-------------------------------------------|-------------------------------------------|
| BOD <sub>5</sub>    | ca. 500 mg/ L                                  | 50 mg/L                                   | 3 mg/L                                    |
| COD                 | ca. 1000 mg/L                                  | ---                                       | 30 mg/L                                   |
| NH <sub>4</sub> -N  | ca. 36 mg/L                                    | ---                                       | 0.3 mg/L                                  |
| P <sub>total</sub>  | ca. 13 mg/L                                    | ---                                       | 3.8 mg/L                                  |
| Suspended<br>solids | 500 mg/L                                       | 50 mg/ L                                  | 0 mg/L                                    |
| Coliform<br>germs   | 10,000,000/<br>100 mL                          | 250/ 100 mL                               | 0/ 100 mL                                 |



**Operation Results:**

**Cleaning Power:**

Concentration levels were below allowed levels, additionally nitrification and partial denitrification occurred, and phosphorus was eliminated.

**Ship dynamics:**

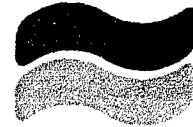
Rolling movements did not disturb system

**Vibrations:**

Vibrations did not disturb system

**System operation:**

System operation was automatic, only surplus sludge removal was done by hand.



**Operation results:**

**System availability:**

- **System with external microfiltration tube module**  
after extensive optimisation, work operation was stable;  
desired filtration power was not achieved.  
Module showed no wear and tear.
  
- **System with external microfiltration capillary module**  
stable operation could not be achieved.  
showed clogging tendencies.  
after extensive optimisation, work tests were discontinued.
  
- **System with internal microfiltration plate module:**  
was stable from the onset of the tests.  
showed no decrease of filtration power.  
Module showed no wear and tear.



**Influences on the Dimensions of Sewage Treatment Systems For Ships**

|                                  | Conventional                   | Membrane Biology               |
|----------------------------------|--------------------------------|--------------------------------|
| Nr. of persons                   | 100                            | 100                            |
| $Q_d$                            | 16.5 m <sup>3</sup> /d         | 16.5 m <sup>3</sup> /d         |
| $Q_h$                            | 0.7 m <sup>3</sup> /h          | 0.7 m <sup>3</sup> /h          |
| spec. BOD <sub>5</sub> -loading  | 90 gBSB <sub>5</sub> /E*d      | 90 gBSB <sub>5</sub> /E*d      |
| $B_d$                            | 9 kgBOD <sub>5</sub> /d        | 9 kgBOD <sub>5</sub> /d        |
| $B_{TS}$                         | 0.1 kgBSB <sub>5</sub> /kgTS*d | 0.1 kgBSB <sub>5</sub> /kgTS*d |
| $TS_{AT}$                        | 4 g/L                          | 20 g/L                         |
| $V_{AT}$                         | 22.5 m <sup>3</sup>            | 4.5 m <sup>3</sup>             |
| $V_{ST}$ bzw.<br>Memb.anteil BB: | about 10 m <sup>3</sup>        | about 0.75 m <sup>3</sup>      |
| Disinfection cell:               | 1 m <sup>3</sup>               | ---                            |
| Volume:                          | 33.5 m <sup>3</sup>            | 5.25 m <sup>3</sup>            |
| Dimensions:<br>LxWxH             | 2.0 m x 8.5 m x 2.0 m          | 1.6 m x 1.8 m x 2.0 m          |



344

## Biological Sewage Waste Water Treatment on Ships

Dr. Fausto Strozzi  
TAN  
Italy

### ABSTRACT

TAN founded in 1998 has acquired the consolidated know-how of **PCE** relevant to the realisation of the **Biodisk FVN** for sewage waste water treatment on board ships.

The **Biodisk FVN plant**, realised in 7 modules (from 2,5 m<sup>3</sup>/g and 45 m<sup>3</sup>/g), is formed by three phases:

- biological oxidation
- final settling
- chlorination

The peculiarity is constituted by the biological oxidation process achieved by an adhesive film aerobic biomass on special rotating discs with corrugated surface. This oxidative process (**RBC**) offers objective and doubtless advantages compared with the traditional biological process which consists of suspended growth biomass in the oxidation tank.

For an identical application, these advantages are synthetically the following:

- Greater purification efficiency
- Better treatment capability of temporary hydraulic and organic overloads
- Greater compactness of the module, small sized and easy to install
- Easy to manage: does not require specialised personnel
- Possibility of modular units
- Possibility of dismantling the module into sub-modules each on consisting of a treatment phase for special adaptation to the available spaces

As optimisation of the **Biodisk FVN**, we have the integration of two new phases: Rotofiltration (**Rofil**) and UVC Bacteria Sterilisation (**URBS**).

### Solids Separation

The purpose of the **Rofil** is to eliminate the suspended solids in the sewage waste waters by means of particular rotofiltration process in order to use to advantage the next phase by increasing the efficiency of the purification.

The continuously separated solids are automatically loaded by gravity into an adjacent infra-red incinerator (IRRF) where the solids are disposed of in an easy, safe and hygienic way.

### UVC bacteria sterilisation

The next improvement phase, used for the bacteriological sterilisation, adopts a UVC system (URBS) which sends its rays through special lamp, thus replacing the use of chlorine.

This new solution with great bactericide power, besides favouring the receiver body for the elimination of chlorine residue, also offers better management of the treatment plant since it eliminates the use of sodium hypochlorite solution and there is also no need to store this liquid on board as sterilising agent or have to handle its difficult dosage.

P4\_STROZZI.DOC

**LIQUID WASTE TREATMENT PLANTS**  
**ON BOARD SHIPS**

Dr. Fausto Strozzi  
TAN – Tecnologia Ambiente Navale  
Italy

## **INTRODUCTION**

TAN Srl - Tecnologia Ambiente Navale, (*Naval Environmental Technology*) was established in April 1998 with the equal participation of:

- Termomeccanica
- Guarco
- Clemna
- PCE

and has taken over the company branch of the last company relevant to naval pollution waste treatment.

In this regard the above Companies, which have been operating with success for many years in the environmental and naval sectors, have combined their common experience and competence.

These Companies operate on the La Spezia territory. The aim of their activity is to confront, in an integrative and innovative way, the problems of the new technologies to be applied on board military and cargo ships concerning marine environment safeguard through the treatment and control of liquid, solid and gaseous wastes.

This opportunity follows the currently adopted technical solutions, which are scarcely efficient and inadequate to meet with the new IMO quality rules relevant to the kind of wastes produced on board.

In particular, the field of activity will be the one relevant to the military sector owing to urgent present needs.

### **LIQUID WASTES**

Our present technology successfully applied on various cargo ships (chemical and gas carriers, platforms, passenger ships, ferries, etc.) and military ships (S. Giorgio, S. Marco, off-shore towboat, basins, etc.) will be optimised in order to be able to satisfy the new on board applications (vacuum plants, sea water in the sanitary services, etc.) for example by segregating and not triturating the solids in the liquid wastes.

Generally in this sector, our aim is to design new integrated plants suitable to simultaneously treat different type of liquid waste thus replacing the first generation plants currently installed.

## **SOLID WASTES**

For this particular issue, a program is to be developed on board ship with the purpose of reducing and selecting the solid matter, which will favour our proposal for adequate solutions for plastic material, small containers and for all the solid material in general.

The final solution for most of the solids is either by compacting or incinerating them on board the ship.

We will consequently design and build in a short time, compacting machines and small incinerators suitable to meet the requirements and problems on board.

## **GASEOUS WASTES**

According to the urgent need of reducing the NO<sub>x</sub>, SO<sub>x</sub> and unburned gas, adequate continuous control systems will have to be installed, in condition to give real time information to enable the propulsion systems to be corrected in a short time.

We are already actively engaged in the development of an adequate control system both highly efficient and easy to use.

In short TAN operates as follows:

### **LIQUID WASTES**

1. Optimisation of our biological treating plants "Biodisk FVN", certified by RINA and USCG
2. Optimisation of our rotofiltrating plant "ROFIL" for the continuous removal of the solids present in the liquid wastes.
3. Development, execution and integration of additional phases for the simultaneous treatment of different liquid wastes (grey waters, black waters, bilge waters)
4. Optimal interface of the sewage vacuum collecting plant with the biological plant

### **SOLID WASTES**

1. Development and execution of shredders for plastic material
2. Development and construction of compacting machines for small metallic containers
3. Development and constructions of compacting machines for various solids (kitchen, canteen, stores, etc.)
4. Development and execution of adequate incinerators to be installed on board

### **GASEOUS WASTES**



1. Development and execution of control system of the main gaseous polluted produced from the combustion in the propulsion systems.

## **MAIN CHARACTERISTICS OF THE BIODISK FVN**

- Highly efficient waste treatment
- Treatment capacity of temporary hydraulic and organic overloads
- Compact, small sized and easy to install
- Total automatic control of the plant from control panel
- Easy running conditions: does not require specialised personnel
- Easy inspection of each single plant component
- Great reliability owing to the choice of high quality material
- Unaffected by the movement of the ship
- Possibility of modular units

## **DESCRIPTION OF THE WASTE TREATMENT PLANT**

The BIODISK FVN uses, as main treatment phase, a simple oxidation process with supported biological growth, which has shown a great treatment efficiency in the application of waste generated on board.

### **COLLECTION OF LIQUID WASTES**

The liquid waste is collected under gravity into a special conveying chamber, ROFIL, where a dynamic self-cleaning bar screen system is located with 1 mm holes, from where it is then pumped to the treatment phase. While, in case of vacuum system waste collection, the liquid waste is conveyed by ejector into the chamber upstream the biological oxidation used for retaining the solids.

### **TREATMENT PROCESS PHASE**

The liquid waste produced on board is collected either under gravity or vacuum and conveyed to the phase for removing the solid parts from the slurry. This phase is constituted by the ROFIL, a dynamic self-cleaning bar screen system which continuously removes the solids and automatically conveys them along to a special container to be periodically treated in an infra-red chamber.

The solid-free slurry is then sent to the actual treatment phase consisting of a series of OXIDATION, SECONDARY CLARIFICATION AND BACTERIA STERILISATION PHASES.

The latter phase is carried out by a bacteriological action of UVA rays, produced by a specific lamp. After the biological phase, where the oxidation occurs through the dynamic action of the BIOWAWA rotor, the aerated slurry goes along to the SECONDARY CLARIFICATION where the suspended biological sludge is sedimented. Finally, the clarified and filtered liquid, under the chemical-physical profile, is sterilised by the

sending of UVC rays at specific wave lengths for obtaining the bacteriological standard foreseen by the regulations in force (MARPOL). In case of sudden breakdown or failure of the ultraviolet system, in standby, a sodium hypochlorite metering pump is provided, commanded by an electrolevel which, placed in the chlorine water basin, also commands the discharge pump which pumps the treated water off board the ship.

### **SECONDARY SLUDGE DISCHARGE**

The sludge removal pump which responds to a set timer periodically removes the sludge which has sedimented in the clarification phase. The extracted secondary sludge is either discharged over board or collected into a special tank to be then discharged into special containers on land and then either disposed of or treated. In case of emergency this pump can also act as a standby to the purified water discharge pump in case of breakdown or sudden hydraulic peak loads.





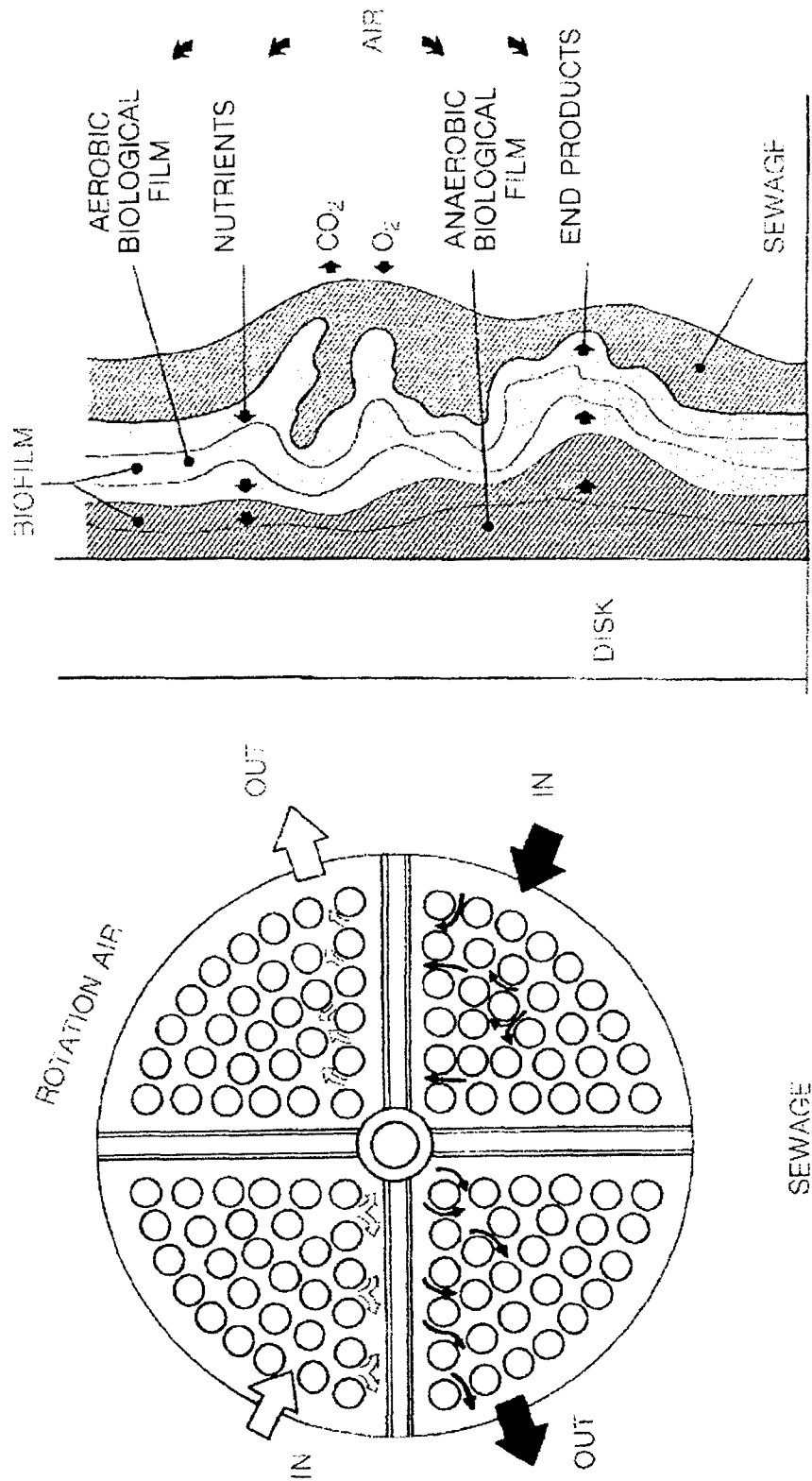
LIQUID WASTE TREATMENT PLANT  
ON BOARD SHIPS

TAN

TECNOLOGIA AMBIENTE NAVALE



# ROTATING BIOLOGIC CONTACTOR



# BIOLOGIC OXIDATION PHASE

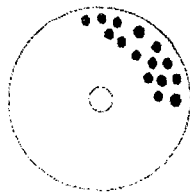
## COMPARISON TABLE

- ◆ SAME HYDRAULIC LOADING
- ◆ SAME ORGANIC LOADING



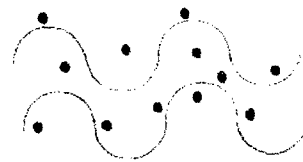
### BIOLOGIC GROWTH

#### FIXED FILM GROWTH



Fixed

#### SUSPENDED GROWTH



Suspended

#### OXI-RETENTION TIME

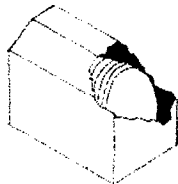


t = 2h

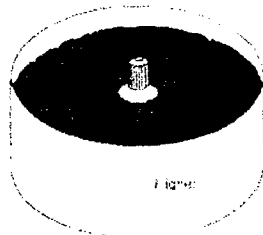


t = 6h

#### OXIDATION ZONE DIMENSIONS



Smaller

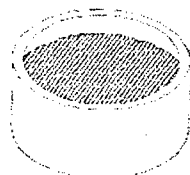


Higher

#### SECONDARY CLARIFICATION DIMENSIONS



Smaller

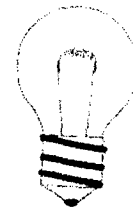


Higher

#### POWER COSTS



Smaller



Higher

#### MAINTENANCE COSTS



Smaller

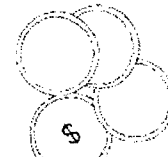


Higher

#### OPERATING COSTS



Smaller



Higher

#### WEIGHT



Smaller

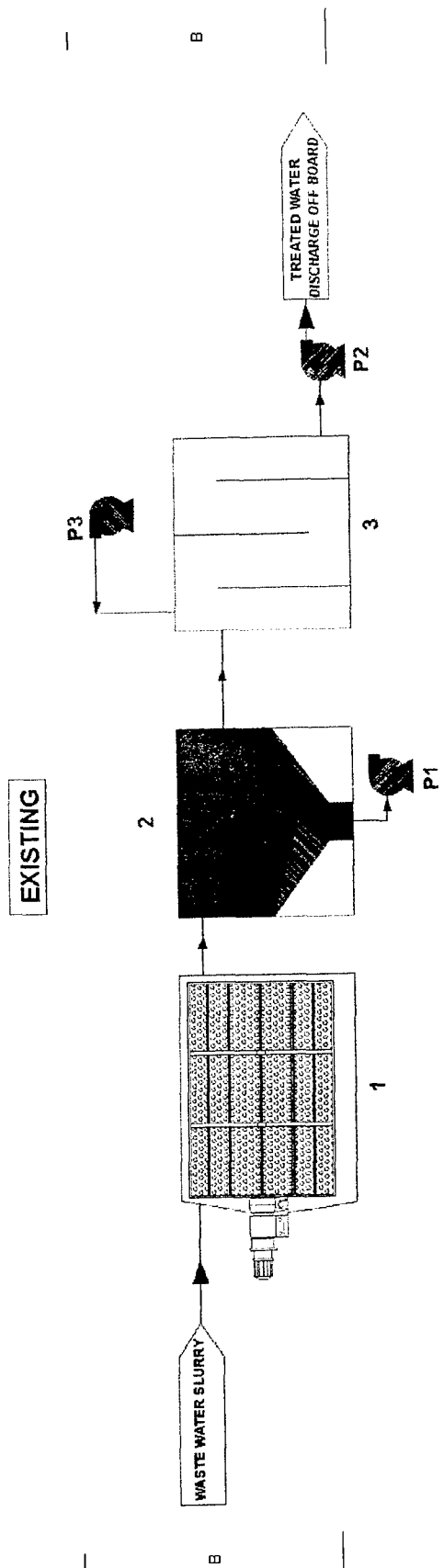


Higher



1 2 3 4 5 6 7 8

LAYOUT OF GRAVITY PLANT PROCESS



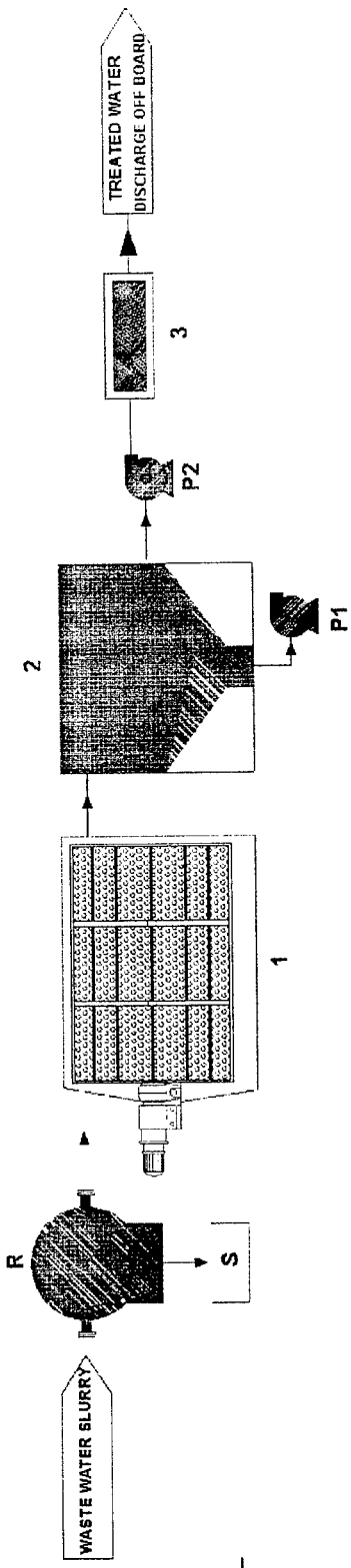
- 1 = BIOLOGICAL OXIDATION PHASE PACKAGE
- 2 = SECONDARY SETTLING PHASE BIODISK
- 3 = CHLORINATION PHASE FVN
- P1 = SECONDARY SLUDGE EXTRACTION PUMP
- P2 = PUMP FOR OFF BOARD DISCHARGE OF TREATED WATER
- P3 = CHLORINE DOSAGE PUMP

|                            |       |                            |             |                            |       |
|----------------------------|-------|----------------------------|-------------|----------------------------|-------|
| 00                         | ISSUE | DESIGNED BY / PROJECT NO.  | DATE / REV. | APPROVED / APPROVED DATE   | SCALE |
| 01                         | ISSUE | DESIGNED BY / PROJECT NO.  | DATE / REV. | APPROVED / APPROVED DATE   | SCALE |
| CLIENT / COMPANY           |       | DESIGNED BY / PROJECT NO.  |             | SCALE                      |       |
| TAN                        |       | A4                         |             | 01/98                      |       |
| PROJECT NO. / PROJECT NAME |       | PROJECT NO. / PROJECT NAME |             | PROJECT NO. / PROJECT NAME |       |
| PROJECT NO. / PROJECT NAME |       | PROJECT NO. / PROJECT NAME |             | PROJECT NO. / PROJECT NAME |       |

1 2 3 4 5 6 7 8

LAYOUT OF GRAVITY PLANT PROCESS

OPTIMIZATION



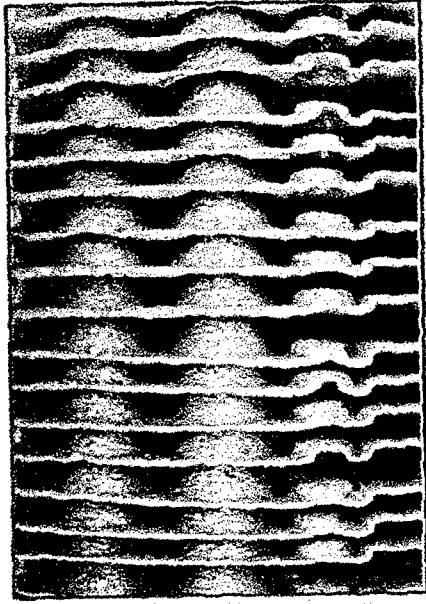
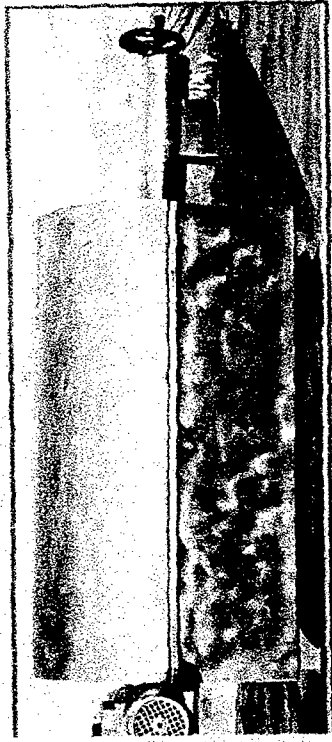
PACKAGE  
BIODISK  
FVN

- 1 = BIOLOGICAL OXIDATION PHASE
- 2 = SECONDARY SETTLING PHASE
- 3 = URBS - ULTRAVIOLET RAYS BACTERIA STERILIZATION PHASE
- P1 = PUMP FOR OFF BOARD DISCHARGE OF TREATED WATER
- R = ROFIL - REMOVAL OF SUSPENDED SOLIDS FROM THE WASTE WATERS
- S = IRRF - INCINERATION OF SEPARATED SUSPENDED SOLIDS

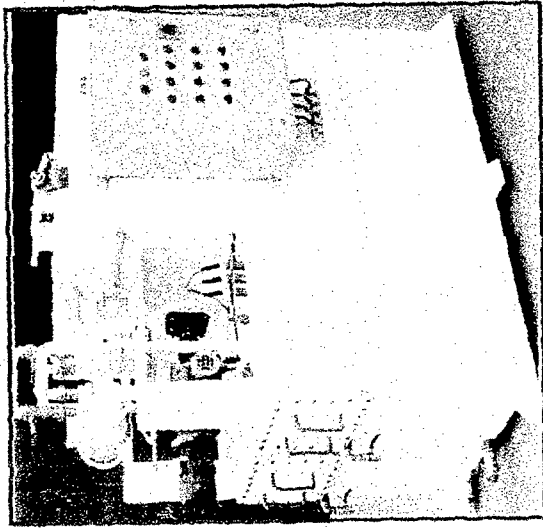
|                                            |                        |                     |             |
|--------------------------------------------|------------------------|---------------------|-------------|
| 00 ISSUE                                   | COMPLIANCE / STANDARDS | DESIGNED / APPROVED | DATE / DATE |
| 1                                          | 1                      | 1                   | LUG. 98     |
| WASTE WATER TREATMENT PLANT ON BOARD SHIPS |                        | SCALE / SCALE       |             |
| TAN                                        |                        | NO. 02 / 98         |             |
| A4                                         |                        | NO. 02 / 98         |             |

301

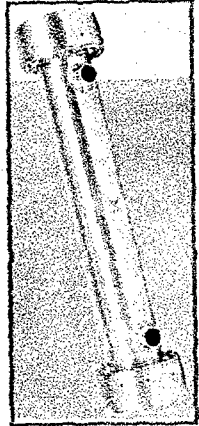
ROFIL = ROTOFILTRATION  
+  
IRRF = INFRARED RAYS  
FURNACE



ROTATING BIOLOGIC  
CONTACTORS



BIODISK FVN  
MODULE



URBS  
ULTRAVIOLET RAYS  
BACTERIC  
STERILIZATION

## **Cleaning of Bilge Waters from Ship Discharges by Planted-Soil-Filters**

Dr. Volker Schulz-Berendt  
Umweltschutz Nord  
Germany

### **ABSTRACT**

During the operation of ships, water from different sources is collected in the bilge. This so called "bilge water" is contaminated by hydrocarbons in high concentrations.

In former times bilge waters were often discharged to the sea where they caused a permanent pollution of sea water, sediment and coastal regions. To avoid this input of contaminants to the partly very sensitive ecosystem of the oceans the harbour-authorities installed services for a controlled discharge of bilge waters during the stay in the harbour. The contaminated waters are collected and transported to treatment facilities. In the coastal region of Germany different treatment plants with different treatment technologies are in operation for more than 10 years. UMWELTSCHUTZ NORD is operating a plant for the treatment of bilge waters and all other contaminated liquids in Ganderkese, which is located about 30 km west of Oldenburg.

Because of the good bio-degradability of hydrocarbons the main treatment technology is an aerobic biological degradation with a so called planted-soil-filter constructed according to the AQUAPLANT-System which was developed by UMWELTSCHUTZ NORD for the treatment of especially industrial waste water, seepage waters from dump sites and contaminated ground-waters. After pretreatment with physical-chemical methods the water with the dissolved oil components is pumped to basins containing a special soil mixture and adapted plants. In the root zone of these plants oil-degrading micro-organisms mineralise the hydrocarbons. Plants and sediment are responsible for optimised conditions, especially a suitable surface for the micro-organisms and a sufficient supply with nutrients and oxygen. By this technology high degradation rates are observed with up to more than 99% for hydrocarbons, COD, BOD, Cyanides and other organic compounds. Also heavy metals are reduced by absorption and plant uptake to a certain degree.

The presentation will demonstrate the efficiency of planted-soil-filters for the cleaning of bilge waters and discuss the advantages and limits of the AQUAPLANT technology.



## **The Maritime Environment**

**"Waste Water Treatment Technologies for Ships"**

**18<sup>th</sup> - 20<sup>th</sup> November 1998 in Oldenburg**

**Cleaning of Bilgewaters from Ship Discharges**

**by Planted-Soil-Filters**

Volker Schulz-Berendt  
UMWELTSCHUTZ NORD, Ganderkesee

- The Company UMWELTSCHUTZ NORD
- Principles of Planted-Soil-Filters
- The AQUAPLANT<sup>®</sup>-Technology
- Results of Bilgewater-Treatment
- Efficiency and limits of the AQUAPLANT<sup>®</sup>-Technology

**INTERNATIONAL ACTIVITIES OF  
UMWELTSCHUTZ NORD**

AUSTRIA

SWITZERLAND

GREAT BRITAIN

NORWAY

DENMARK

ITALY

GREECE

SPAIN

ARABIC EMIRATES

KUWAIT

USA

ECUADOR

BRAZIL

ARGENTINA

# BILGEWATER TREATMENT WITH THE AQUAPLANT<sup>®</sup>-TECHNOLOGY

Place: Ganderkesee

Year: 1985

Operation: since 1985

Capacity: max. 50 m<sup>3</sup>/d

Specific Area: 5 m<sup>2</sup>/m<sup>3</sup> x d

Efficiency:  
(Average) TPH

Inlet: 30 ppm

Outlet: < 0,5 ppm

Efficiency: > 98 %

COC

Inlet: 6,500 ppm

Outlet: < 500 ppm

Efficiency: > 90 %



## **FUNCTIONS OF PLANTS**

- Creation of a suitable Environment
- Oxygen supply
- Stabilization of water flow
- Reducing of odour emissions
- CO<sub>2</sub> uptake
- Carbon source for denitrification
- uptake of compounds

# **FUNCTIONS OF MICROORGANISMS**

- Degradation of pollutants
- Degradation of exceepting biomass

# **FUNCTIONS OF SEDIMENT**

- Surface for microorganisms
- Adsorption of pollutants
- Substrate for plants and microorganisms

# CHARACTERIZATION OF MACROPHYT PLANTS

- Kind of filter materials
- Hydraulic
- Vegetation

## **Dimensions of AQUAPLANT®**

- Capacity: 0,5 m<sup>3</sup>/h to > 70 m<sup>3</sup>/h
- Planted area: 40 m<sup>2</sup> to > 2000 m<sup>2</sup>
- Basin geometry: in cascade, one or two independent lines
- Number of basins: two to ten

## **Percents of degradation:**

- COD 70 to 90 %
- BOD<sub>5</sub> 80 to 95 %
- Hydrocarbons above 95 %
- Ammonia above 70 %
- Nitrate above 70 %

Table 1: Average percentage removal of PAH's, BTX and other environmental parameters over six months in the macrophyte-based biological treatment plant

|                       | Mean Influent | Mean Plant 1 | Mean Plant 2 | % Removal Plant 1 | % |
|-----------------------|---------------|--------------|--------------|-------------------|---|
| TOTAL BTEX            | 0,95          | 0,28         | 0,30         | 70,48 %           |   |
| TOTAL PAH             | 5,89          | 0,48         | 0,63         | 91,87 %           |   |
| Phenol index mg/l     | 2,72          | 0,16         | 0,57         | 94,06 %           |   |
| BOD <sub>5</sub> mg/l | 42            | 18           | 18           | 57,31 %           |   |
| COD mg/l              | 252           | 88           | 105          | 65,10 %           |   |

|           | Influent | Effluent 1 | Effluent 2 |
|-----------|----------|------------|------------|
| Total BTX | 3.45     | 0.37       | 0.36       |
| Total PAH | 14.75    | 0.14       | 0.09       |
| Phenols   | 3.125    | 0.059      | 0.058      |

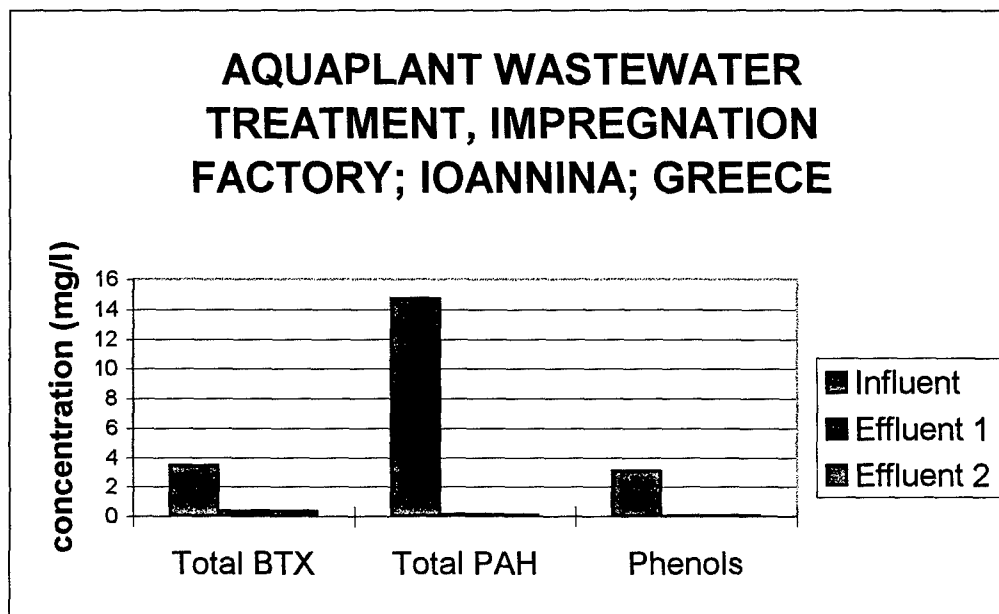
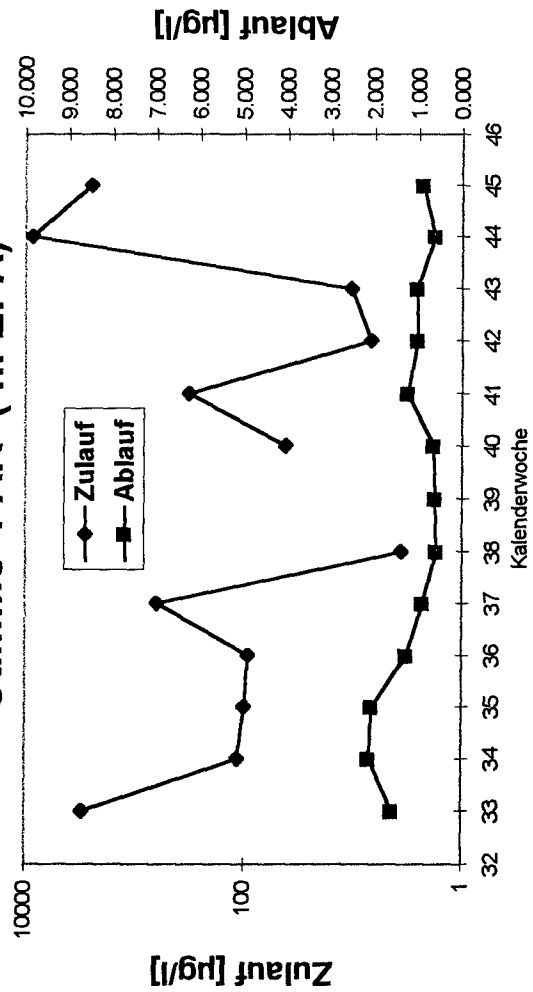


Tabelle1 (2)

|           | KW | EPA    |        | TVO zu | TVO ab  | EPA<br>/Ablauf | Total zu | Total ab |
|-----------|----|--------|--------|--------|---------|----------------|----------|----------|
|           |    | Zulauf | Ablauf |        |         |                |          |          |
| 1. Tankco | 0  | 33     | 2995   | 924    | 4658    | 1.6            | 4658     | 2.92     |
|           | 1  | 34     | 113    | 65     | 125.3   | 2.12           | 125.3    | 3.72     |
|           | 2  | 35     | 99.4   | 54.04  | 99.4    | 2.06           | 99.4     | 3.46     |
|           | 3  | 36     | 92.16  | 68.74  | 97.27   | 1.27           | 97.27    | 2.09     |
|           | 4  | 37     | 632.2  | 41.13  | 1417.7  | 0.91           | 1417.7   | 1.47     |
| 2. Tankco | 5  | 38     | 3.67   | 1.16   | 3.93    | 0.602          | 3.93     | 1.052    |
|           | 6  | 39     |        |        |         | 0.631          |          | 1.006    |
|           | 7  | 40     | 42.05  | 18.71  | 42.05   | 0.66           | 42.05    | 1.11     |
|           | 8  | 41     | 321.76 | 14.89  | 485.36  | 1.256          | 485.36   | 2.04     |
|           | 9  | 42     | 6.92   | 3.36   | 8.91    | 1.02           | 8.91     | 1.67     |
| 3. Tankco | 10 | 43     | 10.4   | 2.9    | 10.4    | 1.04           | 10.4     | 1.63     |
|           | 11 | 44     | 8764   | 775.3  | 14961.4 | 0.631          | 14961.4  | 1.005    |
|           | 12 | 45     | 2520   | 914    | 3917    | 0.902          | 3917     | 1.233    |
|           |    |        |        |        |         |                |          |          |
|           |    |        |        |        |         |                |          |          |
| 4. Tankco |    |        |        |        |         |                |          |          |
|           |    |        |        |        |         |                |          |          |
|           |    |        |        |        |         |                |          |          |
|           |    |        |        |        |         |                |          |          |
|           |    |        |        |        |         |                |          |          |

Summe PAK ( n. EPA)



374

Tabelle1 (2)

|                  | KW | BTEX   |        | Benzol |        |
|------------------|----|--------|--------|--------|--------|
|                  |    | Zulauf | Ablauf | Zulauf | Ablauf |
| <b>1. Tankco</b> | 33 | 249    | n.b.   | 54     | n.b.   |
| 8.               | 34 | 0.685  | 0.547  | 0.012  | < 0,01 |
| 8.               | 35 | 0.095  | 0.396  | < 0,01 | < 0,01 |
| 9.               | 36 | 0.325  | 0.052  | 0.214  | < 0,01 |
| <b>2. Tankco</b> | 37 | 337    | n.b.   | 98     | n.b.   |
| 9.               | 38 | 0.061  | 0.249  | -      | < 0,01 |
| 9.               | 39 | n.b.   | n.b.   | n.b.   | n.b.   |
| <b>3. Tankco</b> | 40 | 457    | 0.13   | 113.6  | < 0,01 |
| 10.              | 41 | 98     | 0.222  | 50     | < 0,01 |
| 10.              | 42 | 0.562  | 0.296  | -      | < 0,01 |
| <b>4. Tankco</b> | 43 | 301.4  | 0.129  | 295    | 0.018  |
| 11.              | 44 | 14.32  | 0.295  | 0.22   | 0.082  |
| 11.              | 45 | 4.343  | 0.144  | 2.28   | 0.014  |

Summe BTEX

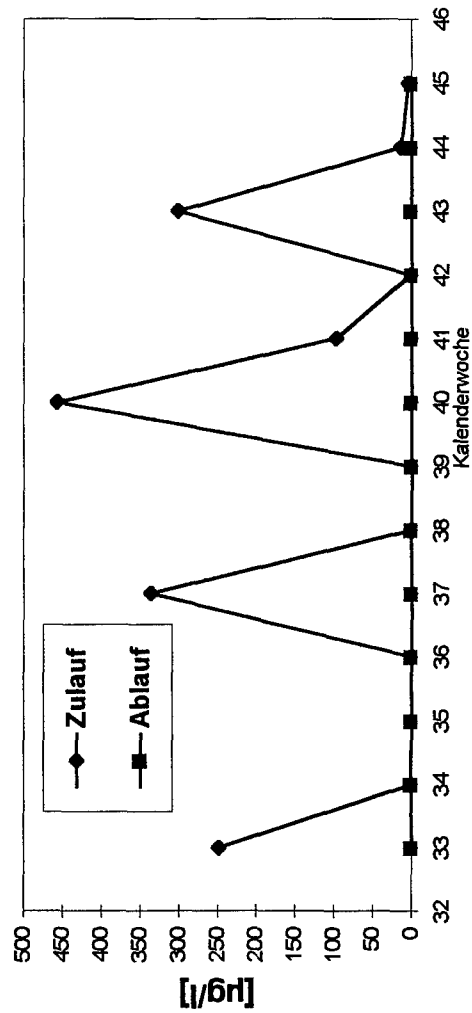




Tabelle1 (2)

|           |     |       | Nitrat    |        |        | Nitrit |        |  |
|-----------|-----|-------|-----------|--------|--------|--------|--------|--|
|           |     |       | KW Zulauf | Ablauf |        | Zulauf | Ablauf |  |
| 1. Tankco | 8.  | 33    | 25.2      | 2.4    | n.b.   | n.b.   | n.b.   |  |
|           | 8.  | 34    | 22.5      | 3.1    | n.b.   | n.b.   | n.b.   |  |
|           | 8.  | 35    | 24.3      | 3      | n.b.   | n.b.   | n.b.   |  |
|           | 9.  | 36    | 24        | <2     | n.b.   | n.b.   | n.b.   |  |
|           | 9.  | 37    |           | n.b.   | n.b.   | n.b.   | n.b.   |  |
| 2. Tankco | 9.  | KW    | 23.4      | 4.4    | Zulauf | Ablauf |        |  |
|           | 9.  | 39    | 26.2      | 6.2    | 2.43   | 0.1    |        |  |
|           | 10. | 40    | 63.6      | 3.9    | 7.99   | < 0,2  |        |  |
|           | 10. | 41    | 63.3      | 3.6    | 8.3    | < 0,2  |        |  |
|           | 10. | 42    | 63.2      | 5.4    | 7.75   | < 0,2  |        |  |
| 4. Tankco | 10. | 43    |           | n.b.   |        |        |        |  |
|           | 11. | 44    | 57        | 7      | 7.23   | < 0,2  |        |  |
|           | 11. | 45    | 52.5      | 15     | 7.13   | 0.26   |        |  |
|           |     |       |           |        |        |        |        |  |
|           |     |       |           |        |        |        |        |  |
| 1. Tankco |     |       | CSB       |        |        |        |        |  |
|           |     | KW Zu |           | Ab     |        |        |        |  |
|           | 8.  | 33    | 75        | < 10   |        |        |        |  |
|           | 8.  | 34    | < 10      | < 10   |        |        |        |  |
|           | 8.  | 35    | < 10      | < 10   |        |        |        |  |
| 2. Tankco | 9.  | 36    | < 10      | < 10   |        |        |        |  |
|           | 9.  | 37    |           |        |        |        |        |  |
|           | 9.  | 38    | n.b.      | n.b.   |        |        |        |  |
|           | 9.  | 39    | n.b.      | n.b.   |        |        |        |  |
|           | 10. | 40    | 22        | < 10   |        |        |        |  |
| 3. Tankco | 10. | 41    | 28        | < 10   |        |        |        |  |
|           | 10. | 42    | < 10      | < 10   |        |        |        |  |
|           | 10. | 43    | n.b.      | n.b.   |        |        |        |  |
|           | 11. | 44    | 17        | < 10   |        |        |        |  |
|           | 11. | 45    | 11        | < 10   |        |        |        |  |

376

Tabelle1 (2)

| Nitrat | Zulauf | Ablauf |
|--------|--------|--------|
| 33     | 25.2   | 2.4    |
| 34     | 22.5   | 3.1    |
| 35     | 24.3   | 3      |
| 36     | 24     | <2     |
| 37     | 24.5   | 2.8    |
| 38     | 23.4   | 4.4    |
| 39     | 26.2   | 6.2    |
| 40     | 63.6   | 3.9    |
| 41     | 63.3   | 3.6    |
| 42     | 63.2   | 5.4    |
| 43     | 62     | 6      |
| 44     | 57     | 7      |
| 45     | 52.5   | 15     |

| Nitrit | Zulauf | Ablauf |
|--------|--------|--------|
| 39     | 2.43   | 0.1    |
| 40     | 7.99   | 0.1    |
| 41     | 8.3    | 0.1    |
| 42     | 7.75   | 0.1    |
| 43     | 7.5    | 0.1    |
| 44     | 7.23   | 0.1    |
| 45     | 7.13   | 0.26   |

### AQUAPLANT-Verfahren Nitrat-Abbau

(mg/l)

Kalenderwoche

### AQUAPLANT-Verfahren Nitrit-Abbau

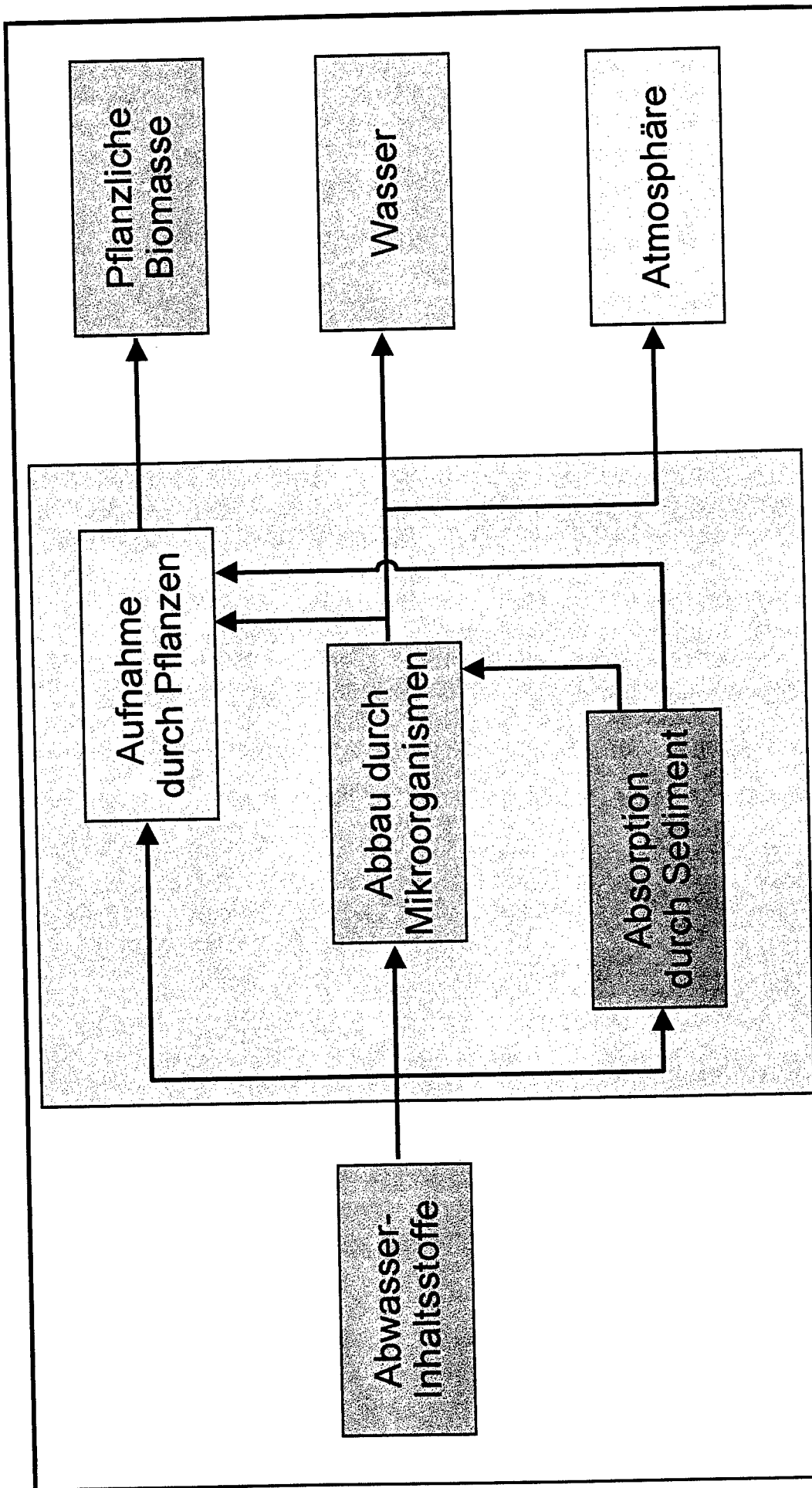
(mg/l)

Kalenderwoche

Tabelle1 (2)

| CSB | Zulauf | Ablauf |     |  |  |  |  |  |  |  |  |  |  |  |  |  |  |  |  |  |
|-----|--------|--------|-----|--|--|--|--|--|--|--|--|--|--|--|--|--|--|--|--|--|
|     | 33     | 75     | <10 |  |  |  |  |  |  |  |  |  |  |  |  |  |  |  |  |  |
|     | 34     | <10    | <10 |  |  |  |  |  |  |  |  |  |  |  |  |  |  |  |  |  |
|     | 35     | <10    | <10 |  |  |  |  |  |  |  |  |  |  |  |  |  |  |  |  |  |
|     | 36     | <10    | <10 |  |  |  |  |  |  |  |  |  |  |  |  |  |  |  |  |  |
|     | 37     | <10    | <10 |  |  |  |  |  |  |  |  |  |  |  |  |  |  |  |  |  |
|     | 38     | <10    | <10 |  |  |  |  |  |  |  |  |  |  |  |  |  |  |  |  |  |
|     | 39     | <10    | <10 |  |  |  |  |  |  |  |  |  |  |  |  |  |  |  |  |  |
|     | 40     | 22     | <10 |  |  |  |  |  |  |  |  |  |  |  |  |  |  |  |  |  |
|     | 41     | 28     | <10 |  |  |  |  |  |  |  |  |  |  |  |  |  |  |  |  |  |
|     | 42     | <10    | <10 |  |  |  |  |  |  |  |  |  |  |  |  |  |  |  |  |  |
|     | 43     | <10    | <10 |  |  |  |  |  |  |  |  |  |  |  |  |  |  |  |  |  |
|     | 44     | 17     | <10 |  |  |  |  |  |  |  |  |  |  |  |  |  |  |  |  |  |
|     | 45     | 11     | <10 |  |  |  |  |  |  |  |  |  |  |  |  |  |  |  |  |  |

378



**UMWELTSCHUTZ  
NORD**

**Reinigungsprinzip von  
AQUAPLANT® - Pflanzenkläranlagen**

P5\_SCHUPICT03.PPT



Eule & Partners

International Consulting S.P.A.

Maritime Conferences

• **The Maritime Environment** •

"Waste Water Treatment Technologies for Ships"

**Session 4**

**System Engineering for Waste Water  
Treatment on Ships**

**Session Chairman: Mr. Jochen Deerberg, DEERBERG-SYSTEMS, Germany**



**Session 4 – System Engineering for Waste Water Treatment on Ships**

***Session Chairman Mr. Jochen Deerberg, DEERBERG-SYSTEMS, GE***

Mr. Jochen Deerberg worked as an assistant to the owner of Martin Merkel Hamburg and was responsible for Organisation and the EDP Department, for Public Relation, Special Customer Service and Trouble Shooting.

In 1974 he became Manger for Controlling, Organisation, EDP and Centralisation of AEG Oldenburg.

In 1979 he founded DEERBERG-SYSTEMS Consultancy, in 1983 he founded DEERBERG-SYSTEMS Waste Management and in 1985 he founded DEERBERG-TRADING a general trading company.

Mr. Jochen Deerberg will now take the chair for Session 4 and present paper 1 on

**Waste Management Aboard Ships Including Liquid Waste**

***Mr. Greg Wilbur, AQUA-CHEM, US***

Mr. Greg Wilbur graduated in Chemical Engineering from the University of South Florida.

After some years in the chemical process industry in boiler operation, brine evaporation and freshwater treatment.

He works for Aqua-chem, Inc. since 1997 where he has been designing equipment for brine solution evaporation, freshwater generation and waste water evaporation.

Mr. Wilbur will present paper 2 on

**State of the Art Fresh Water Evaporators**

***Mr. Ari Nylund, EVAC OY, FIN***

Mr. Ari Nylund graduated as BS in Naval Architecture and Marine Engineering from the Swedish Institute of Technology, Helsinki in 1979.



He worked as a Research Engineer in two Arctic research centres for 7 years. Thereafter he was Project Manager for corrosion protection and Project Engineer for new Technology in Arctic Sea transportation for 3 years.

Before he became Sales Director of EVAC OY he was employed as Manager Marine Technology by Savcor Consulting OY and by Savcor Marine/Synton OY in the key marketing areas Scandinavia, Europe and Japan. In these positions he was responsible for Impressed Current Cathodic Protection and Current Antifouling systems

Mr. Ari Nylund is the author of various publications of importance in these areas. He will now present paper 3 on

#### **EVAC – Control of Total Waste Water Chain**

***Mr. Klaus Mascow, Triton-Format, GE***

Mr. Klaus Mascow is a graduated Engineer and is General Manager of Triton-Format GmbH.

He will present paper 4 of this session on

#### **Vacuum and Sewage Treatment System**

***Mr. Michael Fröhlich, Norddeutsche Filter, GE***

Mr. Michael Fröhlich is a graduated Engineer and works for Norddeutsche Filter since 1988 as Project Engineer and expert in the area of phase separation with emphasis on Oil-Water Separation.

He will now present paper 5 on

#### **Oily Water Separators**

***Mr. Roland Damann, ENVIPLAN, GE***

Mr. Roland Damann studied Marketing Management, Business Information Technology, and Business English at the University of Paderborn, GE.

He has worked as Product Manager of industrial and municipal Waste Water Purification Systems, as Executive Secretary of the companies ENVIPLAN and F.-J. Damann, and is now Managing Director of the companies ENVIPLAN and F.-J. Damann.

He has a tremendous experience in various areas of waste water treatment techniques, has published numerous papers and has applied for a patent on Method of Operation, Control and Optimisation of Waste Water Purification Process by a Neuronal Network (1995).

Mr. Damann is presenting paper 6 on

**AQUATECTOR Microfloat – An Innovative Conception to  
Upgrade and Improve Marine Sewage Treatment Systems  
Dr. Angelika Kraft, WABAG Esmil GmbH, GE**

Dr. Angelika Kraft graduated in Civil Engineering from the University of Hannover, GE .

She worked as scientific engineer at the Institute of Environment Science, Technology and Waste Management at the University of Hannover. She was graduated Dr. ing. in 1989.

She began her industrial career at WABAG Kulmbach and became Technical Director in 1994.

Dr. Kraft is presently Managing Director of WABAG ESMIL GmbH, Rathingen. She will present paper 7 on

**Innovative Waste Water Treatment on Ships with the WABAG Membrane  
Bio-Reactor System**

**Mr. John Glen Wright, LISNAVE, PO**

Mr. John Glen Wright was trained as Naval Architect at Yarrows Shipyard in Glasgow, UK.

He worked as consultant to several German shipyards and to Hellenic Shipyard in Greece. He managed a team of multi-disciplined engineers designing and supervising the implementation and function of a series of novel engineering and computer systems.

He developed the data and technology transfer systems between engineering pilot offices and the shipyards in Germany, England, Greece, Ireland and USA.

He was involved in major offshore, merchant and naval projects with customers and shipyards.

Before he was appointed as Executive Board Member at LISNAVE in April 98, Mr. Wright was Managing Director of an Engineering Company in Germany and Technical Director of an Engineering Company in England.

He will now present paper 8 on

**Requirements for Waste Management for Ships in Shipyards (Part 2)**



## Waste Management onboard Ships including Liquid Waste

Jochen Deerberg  
Owner & CEO DEERBERG-SYSTEMS  
Germany

### ABSTRACT

A consultancy order by Professor Zahn, at that time President of Mercedes, was the reason for Jochen Deerberg to start his own business with **DEERBERG CONSULTANCY** in 1979, analysing the suitability of land-based sewage treatment plants for a ship installation. He realised that environmental protection in general and thus waste management would be of major importance for the shipping industry, but especially for the cruise industry.

In 1984/85 he presented the world-wide first **TOTAL INTEGRATED WASTE MANAGEMENT SYSTEM** to the shipping industry.

Perfect co-operation partners and customers were the basis for the world-wide first and until now only privately organised **ENVIRONMENTAL WORKSHOP** at Fontainebleau Hilton, Miami, November 10, 1992.

On this occasion the new Deerberg Philosophy was presented in the sense of a **MULTI PURPOSE WASTE MANAGEMENT SYSTEM** where the operator has the option to decide between *sorting* and *non-sorting* operation.

With this workshop Deerberg became the world-wide leading supplier for Waste Management Systems and set standards for the Cruise Industry.

In total, Deerberg has been supplying 98 systems to large passenger vessels. Overall, Deerberg products can be found on 780 ships.





**DEERBERG  
SYSTEMS**

# **DEERBERG MULTI PURPOSE WASTE MANAGEMENT CONCEPT**

## **WASTE MANAGEMENT ONBOARD SHIPS INCLUDING LIQUID WASTE**



**PRESENTATION**

**JOCHEN DEERBERG**

**OWNER & CEO**

**AT MARITIME CONFERENCE - THE MARITIME ENVIRONMENT**

**OLDENBURG, NOVEMBER 20, 1998**



# GENERAL TARGET



**The general target of environmental protection is nothing else than trying to guarantee, that even our children`s children can still enjoy beaches like this ...**





# TABLE OF CONTENT

|                                            |       |
|--------------------------------------------|-------|
| GENERAL TARGET                             | 3     |
| DEERBERG HISTORY                           | 5     |
| DEERBERG ACTIVITIES                        | 6     |
| DEERBERG WASTE MANAGEMENT MILESTONES       | 7     |
| DEERBERG REFERENCES                        | 8     |
| WASTE MANAGEMENT DEVELOPMENT               | 9     |
| WASTE MANAGEMENT SYSTEM 1986               | 10    |
| MULTI PURPOSE WASTE MANAGEMENT SYSTEM 1998 | 11    |
| PREMISES                                   | 12    |
| RULES & REGULATIONS I                      | 13    |
| RULES & REGULATIONS II                     | 14    |
| STANDARDS                                  | 15    |
| CERTIFICATE FOR ONSHORE LANDING            | 16    |
| ONSHORE DISPOSAL OF ASH AND RESIDUALS      | 17-19 |
| ADVANTAGES MOVABLE GRATE TECHNOLOGY        | 20-21 |
| GREEN SHIP PHILOSOPHY - NON SORTING        | 22    |
| GREEN SHIP PHILOSOPHY - SORTING            | 23    |
| QUINTESSENCE                               | 25    |

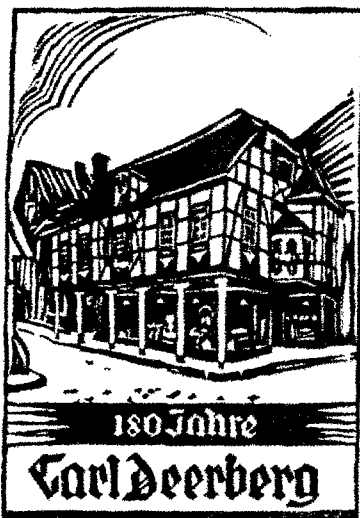






# DEERBERG HISTORY

## DEERBERG LÜBBECKE



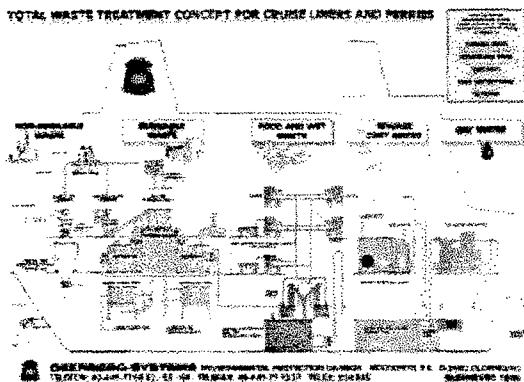
DEERBERG BROCHURE  
FROM 1936

- 1756      Founded as  
Blacksmith's shop
- 19. Century      Locksmith's shop
- 1930-97      Extension to a leading middle  
sized department store  
company. 6 Family-Stores.
- 1935      Oil- and Fuel-Trading
- 1948      Deerberg-Electronics
- 1949      Deerberg-Hotel
- until 1951      Deerberg production and  
sales of machinery for  
agriculture

### Activities Jochen Deerberg

Basis for the whole Deerberg development was quality in tradition and customer service. This background was always the main guideline for Jochen Deerberg - activities.

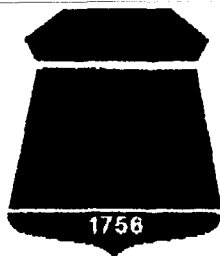
- 1979      Deerberg-Consultancy
- 1983      Deerberg-Systems  
Waste-Management  
onboard ships
- 1985      DEERBERG-TRADING  
Interior Outfitting Equipment  
for Cruise Vessels  
& General Trading  
Dealer & Agent for HOBART
- 1998      DEERBERG-SYSTEMS  
Leading Supplier  
for Waste Management  
Systems onboard  
89 Cruise Vessels and  
700 other ships.



**QUALITY IN TRADITION SINCE 240 YEARS**

**GROUP TURNOVER DM 750 MIO.**





## DEERBERG ACTIVITIES

The Deerberg family has been in business since 1756 in Lübbecke/Westfalen and has provided quality in tradition in various branches, such as Blacksmith, Agricultural Machinery and Services, Auto-Electric, Oil Tradings, Hotel, Real Estate and Department Stores.

## JOCHEN DEERBERG ACTIVITIES

**DEERBERG-SYSTEMS**  **DEERBERG SYSTEMS**, ESTABLISHED 1983

TECHNICAL ANALYSIS, DESIGN, SUPPLY OF PARTIAL AND COMPLETE CONCEPTS AND EQUIPMENT FOR WASTE MANAGEMENT ONBOARD SHIPS.

### Multi Purpose Incineration Systems

Waste Silos  
Waste Shredders  
Sludge Oil Units  
Container- & Vacuum Deashing Systems  
Ash bagging Systems  
Bag Carousels  
Chute Systems  
Snail Compactors  
Recycling Equipment of all kinds

Food Waste Pulper  
Waterpresses  
Food Waste Processing Units  
Compact Units Pulper/Waterpress  
Heavy Duty Pulper

Flue Gas Cleaning Systems  
Marine Sewage Treatment Plants  
Freshwater Evaporators  
Oily Water Separators

**DEERBERG-TRADING**  , ESTABLISHED 1985

Interior Outfitting Equipment for Cruise Vessels and General Trading

### Galley Equipment

Dishwashing Equipment  
Preparation Equipment  
Bakery Equipment  
Cooking Equipment  
Cooling Equipment

### State-of-the-art Guest Safes

- Magnet card & Keypad
- Combined or single systems
- Individual sizes
- Individual colours
- Individual operation

### Textiles & Outfitting Equipment

- ☛ Towels, bathrobes, mats
- ☛ Blankets, pillow / day covers
- ☛ Bed sheets, mattresses
- ☛ Corporate clothing, Uniforms
- ☛ Table linen, tableware, china
- ☛ Caps, T-shirts jackets, etc
- ☛ Curtains & Carpets
- ☛ Textile Import

### Sound & Light Systems

### Ship Signs

### Marine Cranes

### Fish Waste Processing





# DEERBERG WASTE MANAGEMENT MILESTONES

- 1986 **FIRST INTEGRATED FOOD + WET WASTE SYSTEM WORLDWIDE FOR:**  
**Princess Cruises, Fincantieri and Chantiers de l'Atlantique**  
*onboard Star-, Crown- and Regal Princess*
- 5 Pulper, 2 Waterpresses, Butcher Shop Pulper
- 1988 **BASED ON 1987 FIRST LARGEST INSTALLATION WORLDWIDE FOR:**  
**RCCL and Chantiers de l'Atlantique**  
*onboard Nordic Empress*
- 2 Incinerators each 750 kw, 9 Pulper, 2 Waterpresses
- 1988-93 **FIRST COMPANY INFLUENCING THE INDUSTRY IN**
- *Using of stainless steel or non corroding materials which work in PH 4 for Food Waste Systems*
- 1990 **FIRST INCINERATOR WORLDWIDE WORKING WITH**
- **MOVABLE GRATE TECHNOLOGY**
- 1992 **FIRST AND ONLY PRIVATELY ORGANIZED ENVIRONMENTAL WORKSHOP**  
**NOVEMBER 10, 1992, MIAMI**  
Participation of 40 international Delegates from Shipping & Shipbuilding
- Result:*  
**FUNDAMENTAL NEW PHILOSOPHY FOR  
WASTE MANAGEMENT ONBOARD SHIPS**
- 1993
- *Full PLC control for Food Waste System*
  - *New state-of-the-art Waterpress for parallel operation of 8-10 Pulpers*
  - *New Easy Service Pulper*
- 1993-95 **EMISSIONS + TECHNOLOGICAL STATEMENTS FROM THIRD PARTIES**
- *University of Bremerhaven, Germany*
  - *VTT Chemical Technology, Finland*
  - *South Florida Environmental Services, USA*
  - *Naval Air Warfare Center, US Navy, USA*
- 1987-98 **37 LECTURES GIVEN WORLDWIDE BY JOCHEN DEERBERG**  
**LAST LECTURE WAS:**  
*Seatrade Cruise Shipping, Miami Beach Convention Center, March 3-6, 1998*  
**"1983-1998 15 YEARS EXPERIENCE IN WASTE MANAGEMENT"**



DEERBERG-SYSTEMS has supplied Waste Management Systems and Components to more than 780 Vessels.

Thereof

Cargo: 650

Navies: 22

Research: 6

## PASSENGER VESSEL REFERENCES

| Order                       | Vessel's Name       | Pers. Onboard |
|-----------------------------|---------------------|---------------|
| <b>FERRY REFERENCES</b>     |                     |               |
| 1. TT-Line                  | Peter Pan           | 2.000         |
| 2. TT-Line                  | Nils Holgerason     | 2.000         |
| 3. TT-Line                  | Nils Dacke          | 950           |
| 4. TT-Line                  | Hobm Hood           | 350           |
| 5. Olau-Line                | Olau Hollandia II   | 2.100         |
| 6. Olau-Line                | Olau Britannia II   | 1.100         |
| 7. Birka-Line               | Birka Princess      | 2.000         |
| 8. Prince of Fundy Cruise   | Scotia Princg.      | 2.000         |
| 9. Color Line               | Venus               | 2.000         |
| 10. Sea Escape              | Scandinavian Dawn   | 2.000         |
| 11. Silja Line              | Silja Europa        | 2.000         |
| 12. TR-Line                 | Kahleberg           | 2.000         |
| 13. Swedish Ferry Line      | Aurora of Holmabron | 2.000         |
| 14. Swedish Ferry Line      | Tycho Brahe         | 1.500         |
| 15. DSR                     | Gyda                | 200           |
| 16. Irish Ferries           | Spa S. Innesfree    | 1.000         |
| 17. Atika Enterprises       | Superfast I         | 1.200         |
| 18. Atika Enterprises       | Superfast II        | 1.200         |
| 19. Shanghai Shipping Group | Zi Yu Lan           | 400           |
| 20. Shanghai Shipping Group | Xiang Xue Lan       | 400           |
| 21. Unity Line              | Belonia             | 1.000         |
| 22. Unity Line              | Belonia             | 1.000         |
| 23. Unity Line              | Yerpoimom           | 400           |
| 24. Unity Line              | Superfast III       | 1.500         |
| 25. Superfast Ferries       | Superfast IV        | 1.500         |
| 26. Colunav                 | N.N.                |               |

| Order                            | Vessel's Name      | Pers. Onboard |
|----------------------------------|--------------------|---------------|
| <b>CRUISE VESSELS REFERENCES</b> |                    |               |
| 27. RCI                          | Crown Ooyssoc      | 1.600         |
| 28. Hapag Lloyd                  | Europa             | 1.100         |
| 29. Discoverer Reederei          | Lindblatt Explorer | 150           |
| 30. Aloha Pacific Cruises        | Monterey           | 860           |
| 31. Star Cruises                 | Megastar Aries     | 120           |
| 32. Star Cruises                 | Megastar Taurus    | 120           |
| 33. NCL                          | Westward           | 1.200         |
| 34. Yacht Ship Italy             | Renaissance I      | 170           |
| 35. Yacht Ship Italy             | Renaissance II     | 170           |
| 36. Yacht Ship Italy             | Renaissance III    | 170           |
| 37. Yacht Ship Italy             | Renaissance IV     | 170           |
| 38. Yacht Ship Italy             | Renaissance V      | 170           |
| 39. Yacht Ship Italy             | Renaissance VI     | 170           |
| 40. Yacht Ship Italy             | Renaissance VII    | 170           |
| 41. Yacht Ship Italy             | Renaissance VIII   | 170           |
| 42. Chandris Cruises             | Horizon            | 2.000         |
| 43. Chandris Cruises             | Meridian           | 2.100         |
| 44. NYK                          | Asuka              | 850           |
| 45. Chandris Cruises             | Zenith             | 2.000         |

| Order                     | Vessel's Name        | Pers. Onboard |
|---------------------------|----------------------|---------------|
| 46. White Star            | Star Fire            | 2.300         |
| 47. White Star            | Star Fire            | 2.300         |
| 48. Star Cruises          | Star Fire            | 2.300         |
| 49. Cunard Crown          | Star Fire            | 2.300         |
| 50. Cunard Crown          | Star Fire            | 2.300         |
| 51. Cunard Crown          | Star Fire            | 2.300         |
| 52. Cunard Crown          | Star Fire            | 2.300         |
| 53. Cunard Crown          | Star Fire            | 2.300         |
| 54. Cunard Crown          | Star Fire            | 2.300         |
| 55. Cunard Crown          | Star Fire            | 2.300         |
| 56. Cunard Crown          | Star Fire            | 2.300         |
| 57. Cunard Crown          | Star Fire            | 2.300         |
| 58. Cunard Crown          | Star Fire            | 2.300         |
| 59. Cunard Crown          | Star Fire            | 2.300         |
| 60. Cunard Crown          | Star Fire            | 2.300         |
| 61. P&O/Princess          | Crown Princess       | 2.300         |
| 62. P&O/Princess          | Regal Princess       | 2.300         |
| 63. P&O/Princess          | Oriana               | 2.900         |
| 64. P&O/Princess          | Sun Princess         | 3.100         |
| 65. P&O/Princess          | Dawn Princess        | 3.100         |
| 66. P&O/Princess          | Grand Princess       | 4.400         |
| 67. P&O/Princess          | Sea Princess         | 3.100         |
| 68. P&O/Princess          | Ocean Princess       | 3.100         |
| 69. P&O/Princess          | "Capricorn"          | 3.100         |
| 70. Hanseatic Reederei    | Hanseatic            | 2.300         |
| 71. KCL                   | Royal Viking Queen   | 2.300         |
| 72. Majesty Cruise Line   | Royal Majesty        | 2.300         |
| 73. Deilmann              | Lily Marleen         | 2.300         |
| 74. Silversea Cruises     | Silver Wind          | 2.300         |
| 75. Silversea Cruises     | Silver Cloud         | 2.300         |
| 76. Black Sea Shipping    | Kazakhstan II        | 2.300         |
| 77. Black Sea Shipping    | Gruziya              | 2.300         |
| 78. RCCL                  | Legend of the Sea    | 2.800         |
| 79. RCCL                  | Splendour of the Sea | 2.800         |
| 80. Star Cruises          | Star Aquarius        | 2.700         |
| 81. Star Cruises          | Star Pisces          | 2.700         |
| 82. CCL                   | Fascination          | 3.500         |
| 83. CCL                   | Imagination          | 3.500         |
| 84. CCL                   | Inspiration          | 3.500         |
| 85. Costa Crociere        | Costa Victoria       | 3.000         |
| 86. NCI                   | Norwegian Sky        | 3.000         |
| 87. Hapag Lloyd           | Bremen               | 280           |
| 88. Deilmann              | Deutschland          | 650           |
| 89. Hapag Lloyd           | Columbus             | 600           |
| 90. DSR                   | Aida                 | 1.500         |
| 91. DSR                   | Arkona               | 800           |
| 92. Star Cruises          | Superstar Leo        | 2.000         |
| 93. Star Cruises          | Superstar Virgo      | 2.000         |
| 94. Royal Olympic         | N.N.                 | 1.400         |
| 95. Royal Olympic         | N.N.                 | 1.400         |
| 96. Hapag Lloyd           | Europa II            | 200           |
| 97. Carnival Corporation  | N.N.                 | 3.600         |
| 98. Carnival Corporation  | N.N.                 | 3.600         |
| 99. Carnival Corporation  | Option               | 3.600         |
| 100. Carnival Corporation | Option               | 3.600         |

November 1998

Equipped with the MPWMS (MULTI PURPOSE WASTE MANAGEMENT SYSTEM) means, the owner can decide from day to day to operate in a SORTING or NON-SORTING mode to fulfill his own GREEN SHIP PHILOSOPHY

From 98 large applications 26 are equipped with the DEERBERG MPWMS.



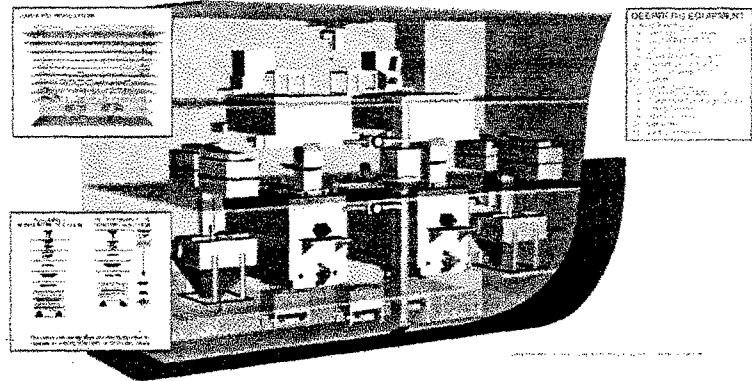
# WASTE MANAGEMENT DEVELOPMENT 1900 UNTIL 2020





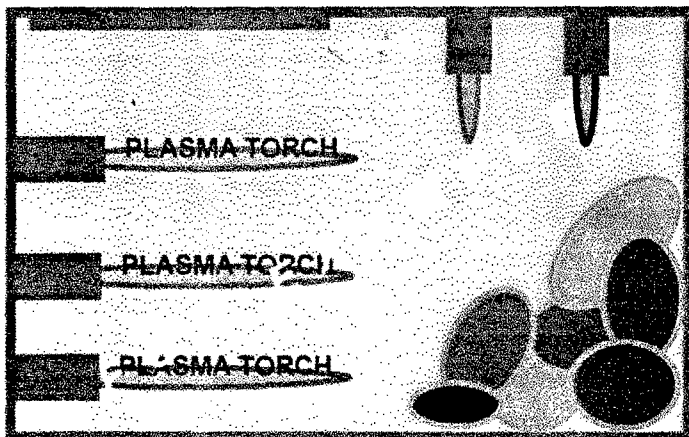
Not long ago Waste Management Philosophy was „Out of sight out of mind“  
But, the fast growing market demanded for rules and regulations and companies to develop the first Waste Management Systems.

In 1986 Deerberg presented the world-wide first **Total Integrated Waste Management System** to the **Cruise Industry**. Today in 1998 Deerberg has been starting up the world-wide largest Multi Purpose Waste Management System for Princess Cruises onboard Grand Princess. The equipment is able to handle the accumulating waste of 4.400 Persons onboard with a **GREEN SHIP PHILOSOPHY**.

 **DEERBERG MULTI PURPOSE WASTE MANAGEMENT SYSTEM**  
WORLDWIDE LARGEST WASTE MANAGEMENT SYSTEM FOR OPTIMAL ENVIRONMENTAL PROTECTION



 YOUR WORLDWIDE No. 1 PARTNER FOR WASTE MANAGEMENT SYSTEMS   
FORERUNNER IN PHILOSOPHY • FORERUNNER IN TECHNOLOGY • RELIABLE PARTNER



In the near future we will have advanced waste treatment possibilities.

**A straight environmental philosophy, new materials and new technologies will ensure best environmental protection for the Cruise Industry.**

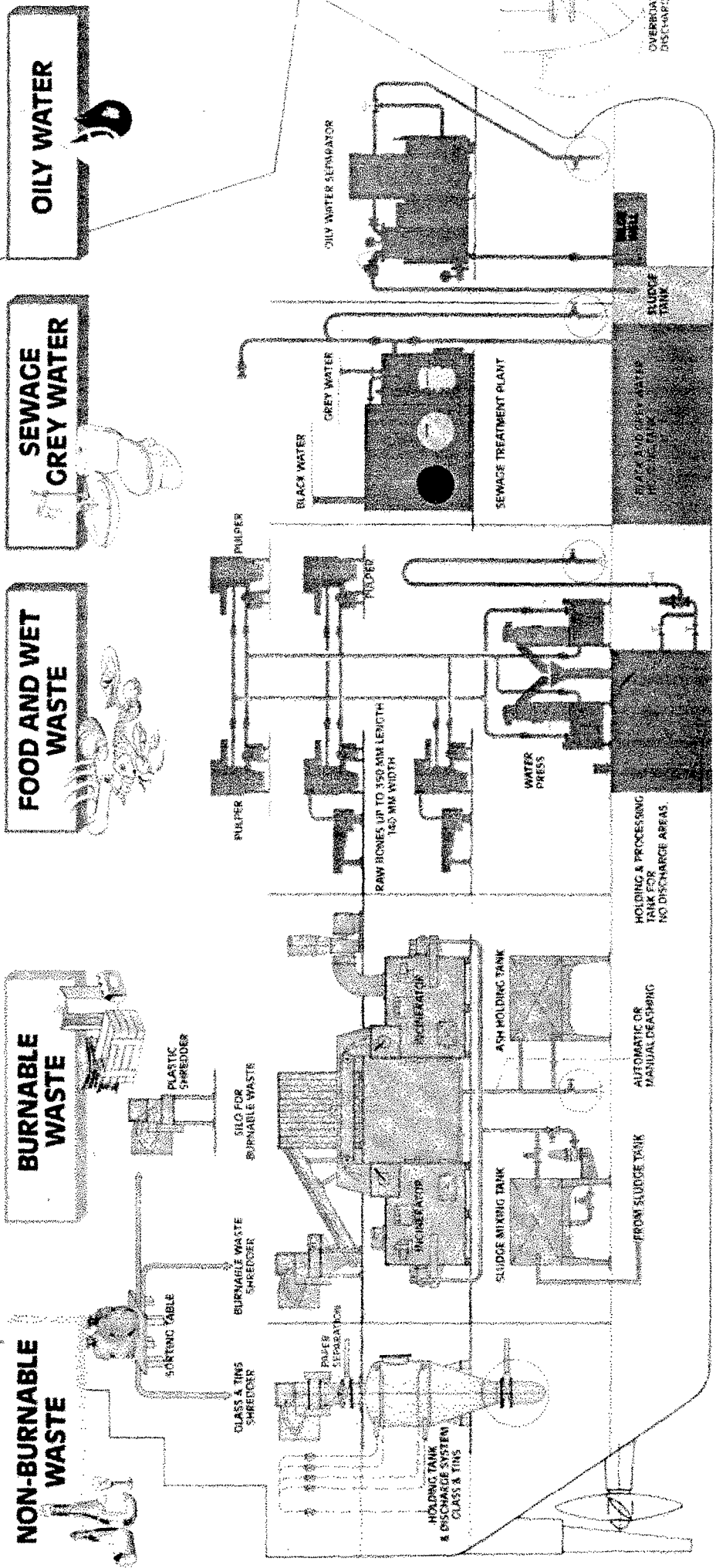


# TOTAL WASTE TREATMENT CONCEPT FOR CRUISE LINERS AND FERRIES

1986

Technical Analysis  
Feasibility Study, Design  
Supply of Material or Certificate  
Contracts for Problems-solving  
in respect of

- BURNABLE WASTE**  
HOUSEHOLD WASTE, OFFICE WASTE, INDUSTRIAL WASTE
- NON-BURNABLE WASTE**  
METALS, GLASS, CERAMICS, RUBBER, PLASTIC
- FOOD WASTE**  
RESTAURANT WASTE, KITCHEN WASTE, BUTCHERY WASTE
- BLACK AND GREY WATER**  
TOILET WASTE, SINK WASTE, SHOWER WASTE, BATH WASTE
- OILY WATER**  
KITCHEN WASTE, ENGINE OIL, HYDRAULIC OIL

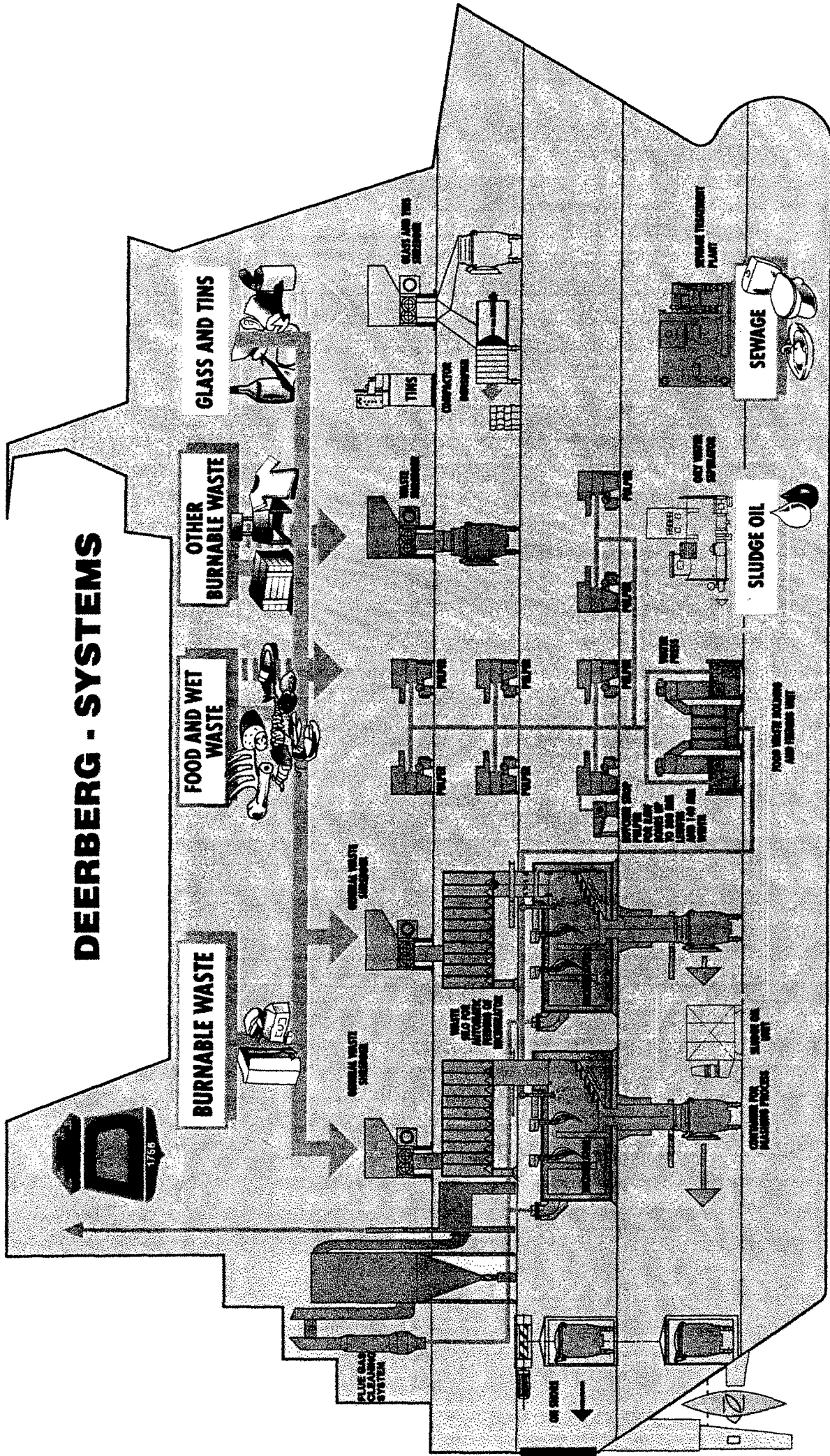


**DEERBERG-SYSTEMS ENVIRONMENTAL PROTECTION DIVISION · MOLTKESTR. 6 A · D-2900 OLDENBURG**  
**TELEFON: 49-41-77 6062 / 63 / 64 · TELEFAX: 49-41-77 73 37 · TELEX: 2 54 945**  
**OLDENBURG 1986**

Copyright Deerberg Systems



# DEERBERG - SYSTEMS



**State-of-the-Art Multi Purpose Waste Management System**  
*The optimal solution for economical operation and environmental protection*



# PREMISES

The regulations for environmental protection will become stricter than the new IMO 2000 regulations. It has to be assumed, that already shortly after your ships delivery stronger regulations will become valid.

## THE MOST IMPORTANT REGULATIONS WILL BE:

- **Strict controlling of zero discharge conditions by international and local public authorities**
- **The cause of environmental pollutions will be punished = POLLUTER PAYS PRINCIPLE.**

Out of these reasons, the **Waste Treatment Systems** for Newbuildings have to be designed to fulfill the up-coming assumable future regulations for world wide operation.

The conditions for these requirements:

- **100% ZERO DISCHARGE TO SEA**
- **100% FLEXIBILITY OF WASTE MANAGEMENT SYSTEM**
- **Onshore landing of ash in containers or on palets under the assumption that not everywhere garbage receivers and recycling possibilities are available e.g. Mediterranean and Baltic.**

Out of these reasons, the following has to be guaranteed for onshore landing:

- **NO BACTERIA IMPORT / EXPORT**
- **FULLFILMENT OF EPA**
- **NOT SMELLING**

On top of this, future Waste Treatment Systems have to be sailorproofed, robust and automatically operatable . The Systems have to be designed for a Multi Purpose Waste Management and disposal of waste within the framework of specified rules, regulations and standards. In general the system is to be designed for handling the garbage residuals in a **non-sorted** and **sorted** way.







# RULES AND REGULATIONS

- **IMO** International Maritime Organisation  
known
- **EPA** Environmental Protection Agency  
see next page
- **USDA** United States Department for Agriculture  
see next page
- **DERM** Department of Environment  
Resources Management  
see next page
- **USCG** United States Coast Guard  
see next page
- **USPHS** United States Public Health Services  
known
- **Local rules**  
ALASKA - LOS ANGELES - MIAMI - HELSINKI - ATHENS -  
ISTANBUL - FUNCHAL - HONG KONG - HAWAII
- **Future rules for emissions**
- **ON TOP: OWNERS' OWN STANDARDS,  
ABOVE THE MENTIONED**





# RULES AND REGULATIONS

IN 5-7 YEARS A MUCH HIGHER AMOUNT OF WASTE WILL BE LANDED ON-SHORE THAN TODAY. CONSEQUENTLY THE AUTHORITIES WILL SET UP STRICTER REGULATIONS FOR ONSHORE DISPOSAL.

- **EPA**      SETS UP RULES FOR WASTE MANAGEMENT IN USA,  
DEFINES TOXITY CHARACTERISTICS
- **DERM**      RESOURCES MANAGEMENT, LANDFILL MANAGEMENT  
STATEMENT LORI CUNNIFF (DERM) AT THE ENVIRONMENTAL  
WORKSHOP ,1992, MIAMI:
  - 1) ONE GENERAL CHECK IF THE SYSTEM IS ABLE TO  
FULFILL REGULATIONS.
  - 2) SPOT CHECKS ( SPREADING GARBAGE ON THE FLOOR )  
TO CONTROL 100% BURNING OF ASH RESIDUALS  
(ESP. FOOD WASTE) TO AVOID A BACTERIA AND  
EPIDEMIC IMPORT TO U.S.
- **USDA**      CHECKS WHETHER RESIDUALS ARE REALLY DISINFECTED  
AND BACTERIA FREE OR WHETHER RESIDUALS ARE  
CONTAMINATED BY UNBURNED PARTS (FOOD WASTE).  
**STRICT CONTROL**
- **USCG**      RULES FOR WASTE-RECORD KEEPING, WASTE PLANS AND  
INFORMATIONAL REQUIREMENTS. IMPLEMENTATION OF  
RULES TO FOREIGN VESSELS OPERATING IN US WATERS.
- **LOCAL**      DIFFERENT REQUIREMENTS FOR ONSHORE LANDING OF  
GARBAGE/ASH RESIDUALS AT LOCAL / PROFESSIONAL  
RECEIVING STATIONS.  
THE STRICTEST REQUIREMENTS ACC. TO ITINERARIES AND  
WORLD-WIDE CRUISING AREAS HAVE TO BE FULFILLED.





# STANDARDS

## FOR DESIGNING A STATE-OF-THE-ART MULTI PURPOSE WASTE MANAGEMENT SYSTEM

- Zero discharge everywhere
- Multi Purpose Incineration System with possibilities for non-sorting and sorting operation
- 10 days operation without any disposal to sea or to shore
- Fulfilling international rules and regulations today and in the year 2010
- Flexible, Troublefree and sailorproofed operation ( easy maintenance and operation )
- Human factor
  - Functioning of equipment
  - Operation with less labour
  - Building up unions
  - Less low-job mentality
- Central monitoring and control system
- Vertical waste-flow in garbage area
- Zero bacteria import / export to foreign countries

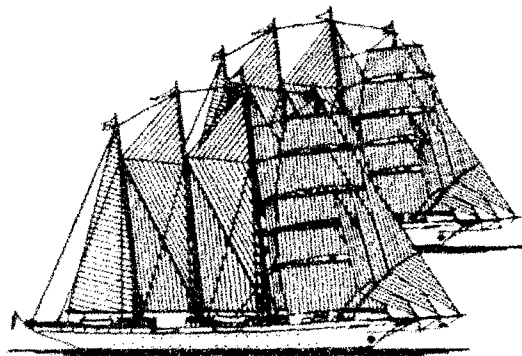


# Star Clippers

MV Royal Clipper

## CERTIFICATE

for  
the quality of disposed  
Ash Residuals and Garbage



Herewith Star Clippers certifies,  
that the Ash (incl. all Residuals) which is landed  
onshore has passed the onboard Incineration System and  
is therewith classified **acc. to EPA, USDA, Derm** as

**BACTERIA FREE**  
**NON HAZARDOUS**  
**NOT SMELLING**

(we specially guarantee a 100% burnout of Food + Wet Waste)

---

Captain

---

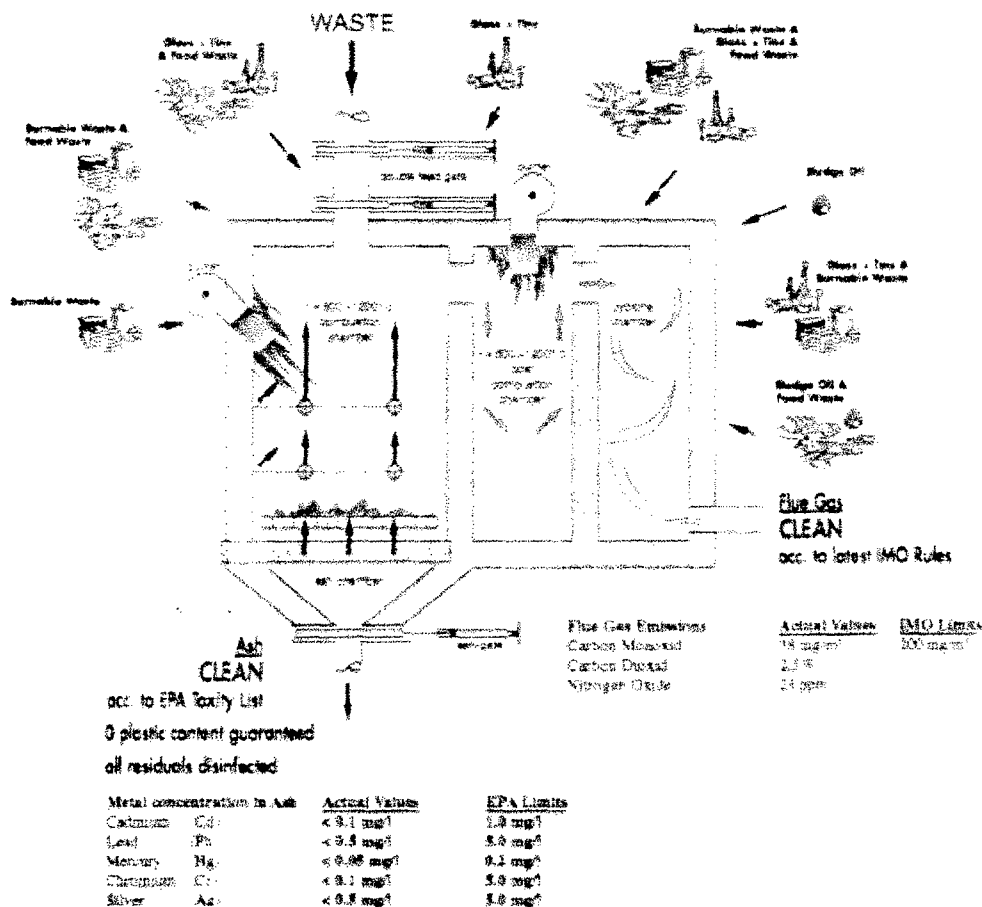
Chief Engineer



# THE ANSWER TO PREMISES AND STANDARDS

## DEERBERG INCINERATOR WITH MOVABLE GRATE TECHNOLOGY

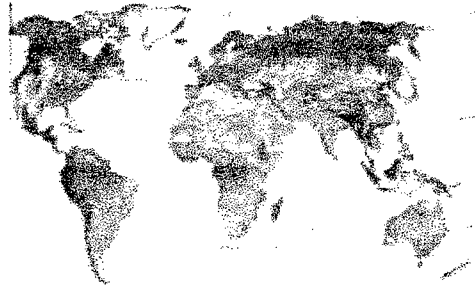
A State of the Art  
Incineration System is suitable for:





# ADVANTAGES OF THE DEERBERG MOVABLE GRATE TECHNOLOGY

A world-wide operating Cruise Vessel should be in the position to **dispose the onboard accumulated garbage in every port of call.** The amounts of ash and recyclables stored onboard take away precious space without any revenue. The space required should be kept as small as possible.



It is therefore necessary to treat the garbage to the full satisfaction of all onshore receivers.

The Waste Management has to be **FLEXIBLE** enough to fulfill the following needs from day to day:

### **NON-SORTING OPERATION**

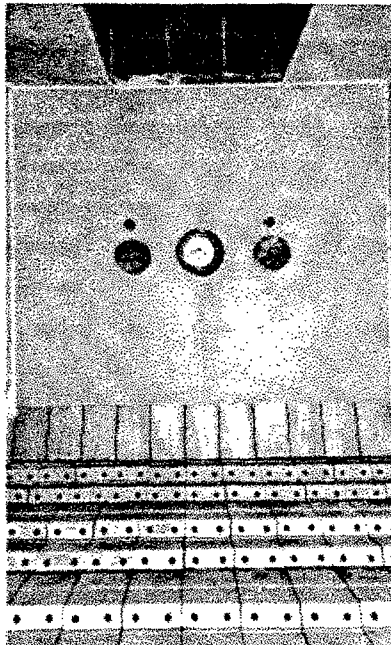
where no recycling possibilities are available

### **SORTING OPERATION AND RECYCLING**

where recycling possibilities are available

**IN ANY CASE** the residuals have to be

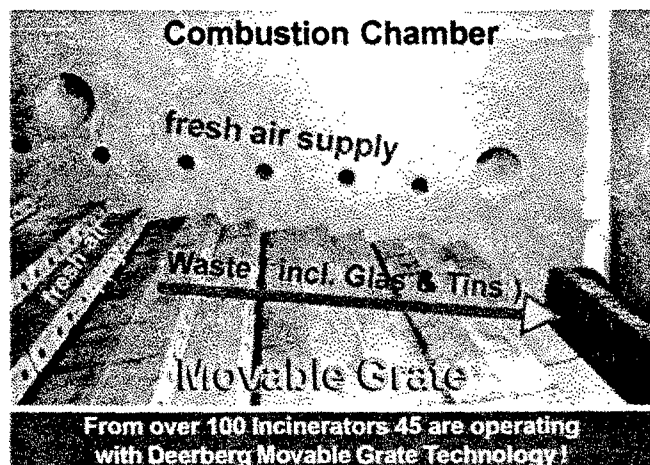
**100% BACTERIA FREE, NON HAZARDOUS** to avoid any illness import to foreign countries.



The operator should not be restricted in landing the residuals because of the onboard Waste Management System.

**Out of a.m. reasons the Deerberg Incinerator is equipped with the Movable Grate Technology.**

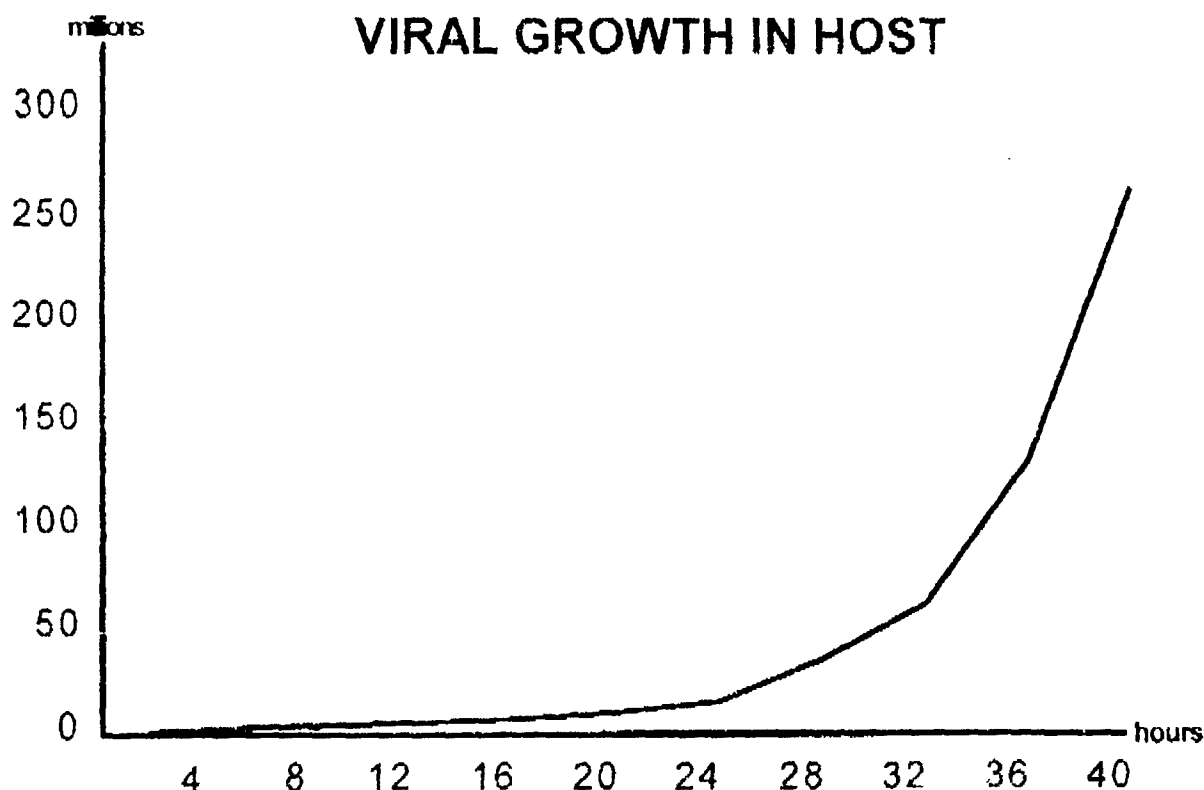
The grate allows to pass Glass & Tins through the Incinerator to disinfect them 100%. In addition the grate ensures a perfect burning out result because of its fresh air supply from underneath and above the grate.





## ONSHORE DISPOSAL OF ASH AND RESIDUALS

Virus's and bacteria that cause these diseases can reside in food waste. Either direct contact with these food waste or transmission from waste to persons by flies or other insect vectors can spread disease.



### 2) PLANT PEST

Food contaminated waste can carry both adult and larva of plant pestsuch as Mexican or Mediterranean fruit fly For areas with a commercial citrus crop introduction of these pests can cause billions of dollars of loss to commerce. Similar problems exist with timber and grain pests.

Once an area is considered to have an infestation of a plant pest that product is often banned from international trade.





## ONSHORE DISPOSAL OF ASH AND RESIDUALS

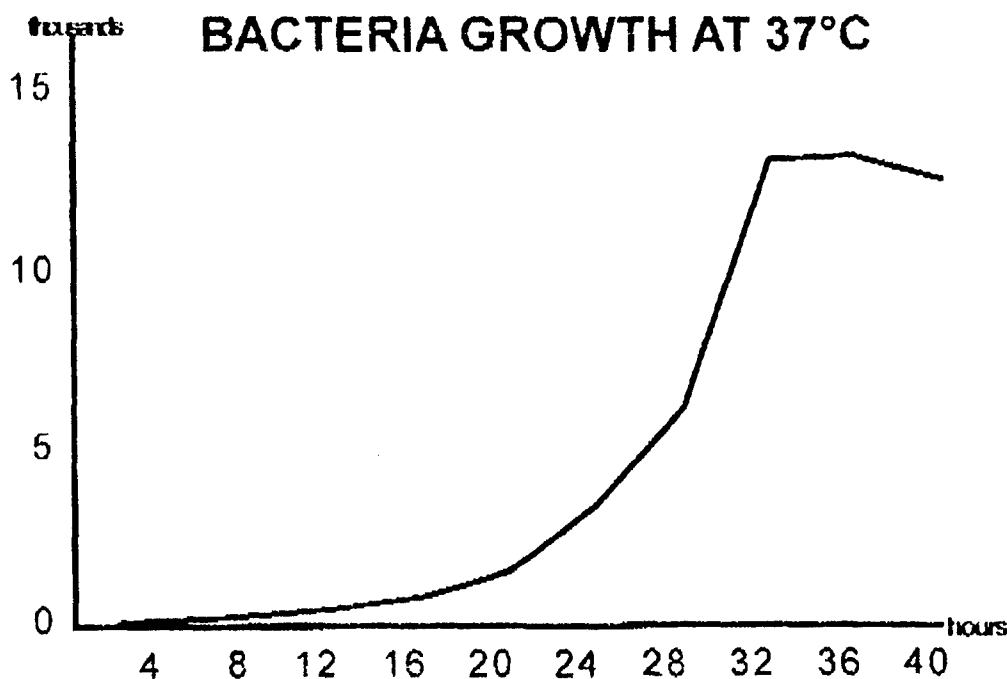
### 3) PROTECTION OF WASTE LANDFILL

Most areas of the world have diminishing space to safely dispose of waste. Poorly designed and maintained landfills of the past are being closed. Most new landfills restrict the disposal of food waste. Food waste decompose producing methane gas that becomes a significant management problem for the landfills.

Most island and tropical tourist areas of the world simply do not have adequate land area to develop now properly designed landfills.

This leaves the ship owner more responsible for the on board management of solid waste.

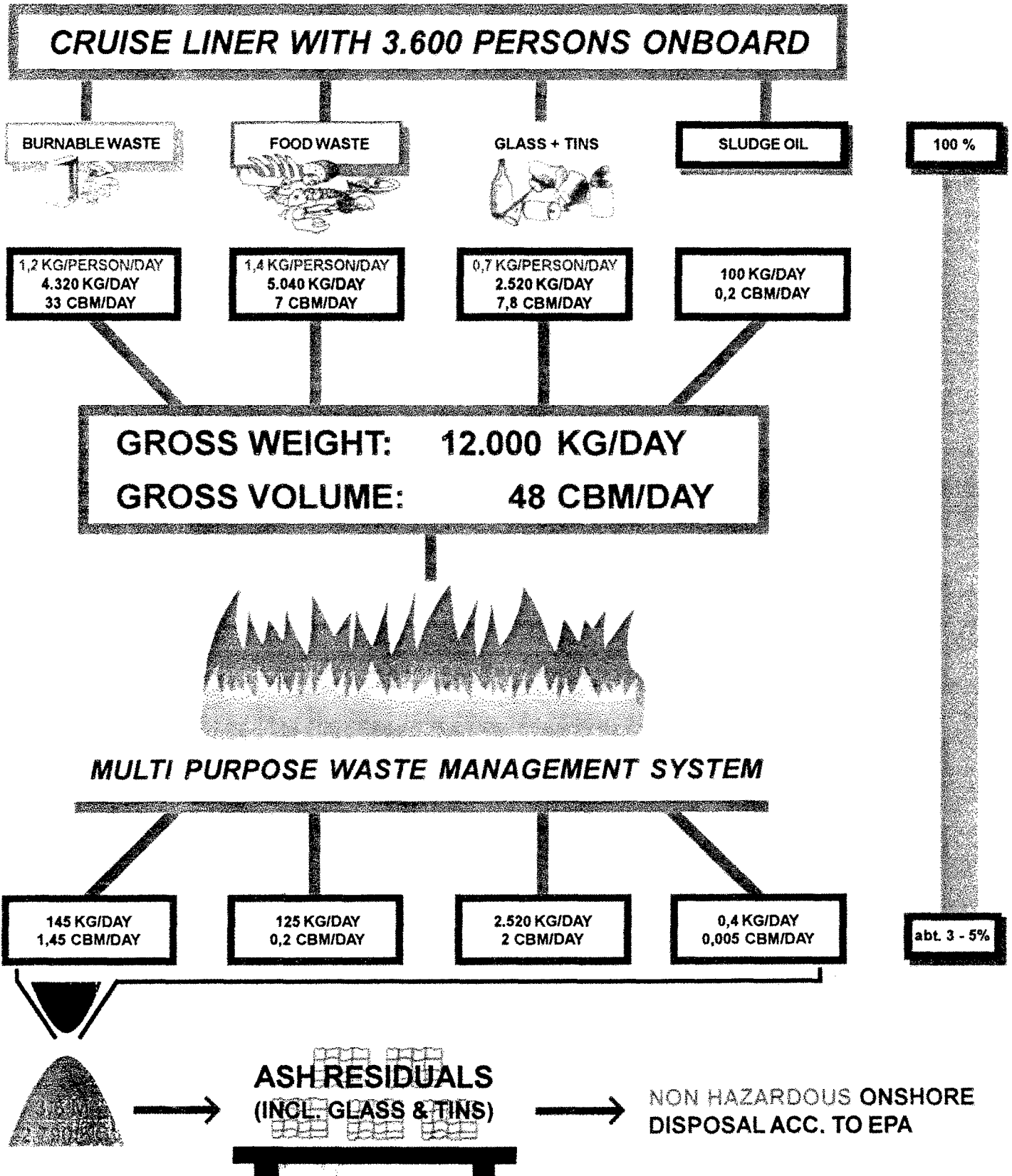
Thus, integrated waste management programs that utilize the best available technologies in food waste management (pulper & waterpress), incinerators, ash management and recycling are both ecologically sound and save the operator money.







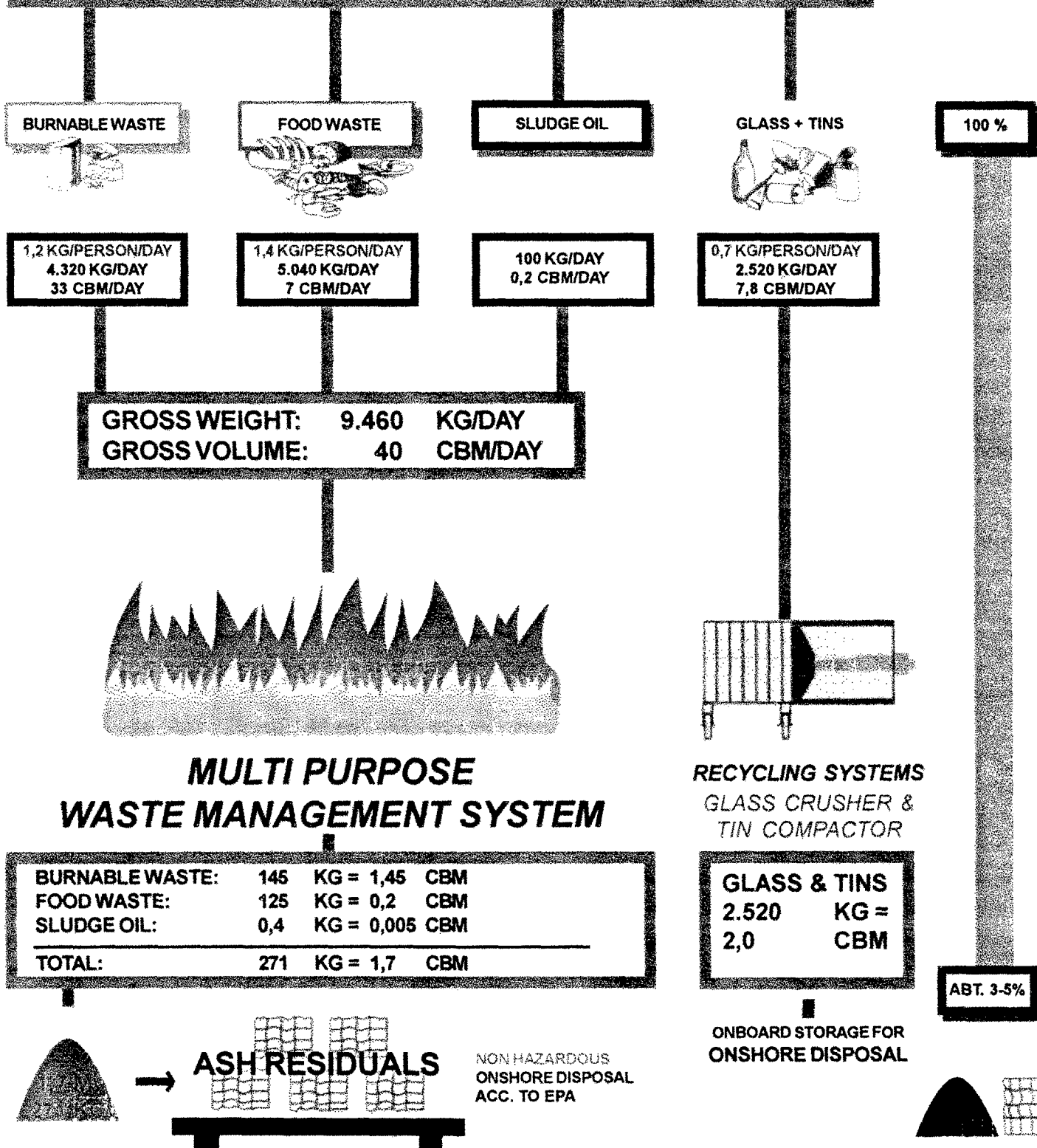
## GREEN SHIP PHILOSOPHY - CALCULATION OF WASTE AMOUNT NON-SORTING SOLUTION





## GREEN SHIP PHILOSOPHY - CALCULATION OF WASTE AMOUNT SORTING SOLUTION

### CRUISE LINER WITH 3.600 PERSONS ONBOARD





# QUINTESSENCE

FUTURE DEVELOPMENT OF WASTE MANAGEMENT SYSTEMS

- ZERO DISCHARGE TO SEA
- STRICT CONTROL BY AUTHORITIES  
„POLLUTER PAYS PRINCIPLE“
- ONSHORE LANDING OF RESIDUALS ONLY
  - DISINFECTED
  - BACTERIA FREE
  - = NO ILLNESS IMPORT  
TO FOREIGN COUNTRIES
- THE INCINERATOR WILL BE MORE &  
MORE „THE HEART“ OF THE WHOLE  
SYSTEM FOR BURNING + DISINFECTING
  - BURNABLE WASTE
  - FOOD WASTE
  - MEDICAL WASTE
  - GREYWATER RESIDUALS
  - PLASTIC
  - SLUDGE OIL
  - GLASS & TINS
- SHIPS MUST HANDLE THE ONBOARD  
WASTE SELF-SUFFICIENT AND CAN NOT  
RELY ONLY ON ONSHORE FACILITIES
- RECYCLING WILL BE POSSIBLE AS  
BEFORE ONLY IN OTHER WAYS



**State of the Art Fresh Water Evaporatorsof the Art Fresh  
Water Evaporators**

**Abstract**

Greg Wilbur  
Aqua-Chem  
USA

Aqua-Chem designs, manufactures and services Water treatment equipment.

Aqua-Chem is known for freshwater generators om the marine industry, water purification systems for the bottled water and pharmaceutical industries and zero liquid discharge systems for the chemical process and power generation industries.

We have been serving the needs of the marine industry for almost fifty years. With an installed base of over 2,000 systems ranging from waste heat, flash and vapor compression freshwater generators to custom designed zero liquid discharge systems we have the experience to meet the challenge of the worlds and the marine industries water needs.

We are now and always looking for better ways to serve our customers iln the marine, offshore and process industries.



## State of the Art Fresh Water Evaporators

By Greg Wilbur  
Aqua-Chem  
USA

### **Aqua-Chem**

Aqua-Chem has 50+ years of experience in the evaporation and crystallization of aqueous solutions. This began in the 1940's when Cleaver-Brooks (manufacturer of world-class boilers and pioneer in packaged boilers) was approached by the US government to develop portable water stills. The company Developed the Special Products Group (which later became Aqua-Chem) to explore the evaporation and Crystallization technology. Today Aqua-Chem has experience in aspects of evaporation ranging from 7.5 Tpd vapor compression watermakers aboard USCG vessels, flash evaporators for Cruise Ships and Aircraft Carriers and 7000Tpd Multiple Stage Flash Desalination Plants. We have made brine crystallizers for India, Paper Pulp evaporators in China and Zero Liquid Discharge wastewater systems for chemical and power plants in The United States. Most Bottled Water companies and pharmaceutical companies have an Aqua-Chem evaporator for producing pure water for drinking or injection.

Since the early 50's Aqua-Chem has been building vapor compression, flash and multiple effect evaporators for marine and offshore service. We have also built reverse osmosis and plate to plate type fresh water generators for the industry.

### **Products**

#### **Spray-Film™**

Aqua-Chem's Spray-Film™ Vapor Compression evaporators have performed freshwater generation service with flying colors in the offshore oil, bottled water and pharmaceutical industries since 1963. Spray-Film™ technology is also applied to wastewater treatment with poor scaling and fouling properties in the Chemical Processing Industry.

The Spray-Film™ technology guarantees equal and consistent water distribution to all tubes in the evaporator. This even wetting reduces scaling and increases heat transfer even for very viscous materials such as corn syrup and glycerin, Careful design of spray systems prevents plugging in services with high fiber content such as paper pulp liquor and corn stillage.

In many applications for Bottled water pharmaceutical the narrow evaporation and condensation range of the Aqua-Chem Spray-Film Evaporator and a distillate deareator remove dissolved gases and volatiles from the pure water produced.

By spraying the liquor on the outside of the tubes Aqua-Chems system can be easily monitored for cleanliness of the tubes by looking in a sightglass. The heat transfer surfaces aren't hidden inside tubes or plates. Since the outside of the tubes are the scaling surfaces cleaning solutions are easily distributed to all tubes. Other technologies can completely plug sections of the heat exchange area requiring reaming or equipment disassembly to ensure thorough cleaning. These properties are very important when dealing with materials that scale and foul easily. PLC controls monitor the unit operation and can communicate with your control systems. Unsuitable distillate is automatically diverted to a waste stream to prevent contamination.

## **Reverse Osmosis**

Reverse Osmosis and ultrafiltration is being examined by Aqua-Chem for re-entry into the market place for freshwater generation and water treatment. Aqua-Chems experience with Reverse Osmosis extends to the high performance requirements for variable feedwater chemistry and ambient conditions demanded by military organizations.

## **Flash Evaporators**

Aqua-Chems flash evaporators have been used since the 50's aboard ship for freshwater generation. With over one thousand installations performing in Naval, offshore and commercial service Aqua-Chem has the history and experience to continue serving these markets for the next fifty years.

Aqua-Chems flash evaporators can be operated using low pressure steam, electric heat and/or engine waste heat.

In flash evaporation the separation of steam from the seawater is performed in a separate vessel from the heating of the seawater. This reduces the formation of scale on the heat transfer surfaces extending the life of plates and tubes and reducing maintenance requirements.

In many applications the brine is heated to a temperature hot enough to pasteurize the brine. This effectively sterilizes the produced water for consumption.

In waste heat applications Aqua-Chem flash plants have operated for up to three years without requiring cleaning. Even when needed cleaning involves minimal work. Adding a small amount of Aqua-Chems AC-2 cleaning powder to freshwater in the unit and circulating. The addition of the cleaning solution involves the removal of a 4" diameter sightglass and no additional equipment or equipment disassembly.

Life cycle costs for Aqua-Chems flash plants are lower than other technologies because there are no consumable membranes, submerged heat transfer surfaces limit scaling, easy cleaning and ready access to heat transfer surfaces. The brine heater is as easy to maintain as any other heat exchanger aboard. External mounting of the heater means that the unit does not have to be disassembled to access the heat exchanger.

## **New Technologies**

Aqua-Chem is also exploring new technologies to meet the requirements of the future water treatment needs of the Marine Industry.

We are currently applying our expertise in evaporation to the development of enhanced and agitated surface designs. For wastewater treatment these technologies promise the ability to handle waters with very poor scaling or fouling properties. Similar designs are used throughout the Chemical Process Industry for evaporation of very viscous and fouling solutions.

## **Complete Systems**

With years of experience we have often provided complete wastewater treatment plants for customers. Zero Liquid Discharge plants often include centrifuges and dryers provided by Aqua-Chem.

Plants are designed around your specific needs. Whether you need a watermaker to utilize wasteheat from a Wartsila 12V200 or a freshwater system designed for brackish or coastal water. Aqua-Chem can tell you just what is needed to meet your needs.

## **Manufacturing**

Aqua-Chem has been building its own equipment for the life of the company. We have developed expertise needed to manufacture in most materials used in the marine industry including Copper Nickel, Stainless Steel, Titanium and others.

To guarantee the quality and long life of our equipment we manufacture our own design compressors. Many of which continue to operate 10, 15 even 20 years without rebuilding.

Aqua-Chem has experienced and fully trained service personnel to assist in start-up and train the crew to operate the Aqua-Chem equipment.

## **Aqua-Chem**

Aqua-Chem promises the ability to combine wastewater treatment expertise with marine experience to meet the water treatment needs of the marine industry for the coming new century.





## **P2\_WILPICT.DOC**

### **Aqua-Chem Advantages**

- 50 years experience designing and manufacturing desalination equipment
- ISO 9001 Certified United States manufacturing facility
- Experience designing flash plants between 20-7000 m<sup>3</sup>/day
- Experience designing vapor compression plants for freshwater generation and wastewater treatment for over 40 years
- Experience constructing plants in CuNi, titanium, high alloy stainless steels, lined and clad materials
- Extensive marine, offshore and landbased references
- Worldwide service
- Guaranteed equipment performance and customer satisfaction
- Focused on the customers' needs
- Leader in quality and dependability
- Visit us at [www.aqua-chem.com](http://www.aqua-chem.com)

- **Spray-Film  $\nabla$  Advantages**

- Proven design for freshwater generation, fouling and scaling liquid evaporation
- Heat transfer surfaces easily monitored
- Even distribution of water over tubes
- Can remove some volatiles from produced water
- Low energy consumption
- Easy maintenance
- Proven compressor designs
- PLC controls for automatic operation and communications
- Seawater resistant materials of construction

## **Flash Evaporation Advantages**

- Minimal scale formation due to no boiling on heat transfer surfaces
- Minimal scale formation due to low concentration factor
- Reliable, proven technology
- Low capital cost
- Minimal spare parts due to welded construction, minimal gaskets
- Low operating cost
- Low maintenance cost
- Easy maintenance
- Seawater resistant materials

## **New Technologies**

- Designed to handle viscous materials
- Designed to limit scaling
- Uses vapor compression for low energy costs
- High heat transfer coefficients
- Uses Aqua-Chems expertise in evaporation and wastewater treatment to optimize effectiveness

## **Manufacturing and Engineering**

- Extensive experience in designing wastewater and freshwater generation systems
- Experience includes Zero Liquid Discharge systems
- Plants are designed around your needs
- Experience in all seawater materials including CuNi, Titanium and clad steels
- Fully trained and qualified service personnel to help setup, start and train your operators

## **The Maritime Environment**

**International Conference and Exhibition  
"Waste Water Treatment Technologies for Ships"**

Paper:

### **Control of the total waste water chain.(Evac Oy) Ari Nylund**

#### **Abstract**

This paper mainly concentrates on the management and control of the waste water process onboard Passenger Vessels. The range and size of the waste water systems is wide starting from a 12 people system to a system for nearly 5000 people onboard.

The biggest vessels are like floating cities visiting extremely vulnerable environment like Caribbean Islands, coastal areas of Alaska, Baltic sea, Mediterranean Sea, South East Asian Islands and coastal waters of Australia.

On some of these areas even a small amount of unpurified waste water can cause fatal unrecoverable damages. Therefore, it is essential to be able to control the whole waste water chain onboard a vessel. Onboard the latest passenger vessels this means actually remote process control because of the physical size of the systems and relatively long distances to different process units.

To be able to control this kind of system a remote computer controlling system is a necessity. Operators must sometimes interfere the process in short notice in case of some process disturbances like blackout or some other malfunction in the systems. Even these are carried out automatically and if not there is always a fast local and remote manual control possibility.

This paper presents shortly the systems onboard the latest newbuildings under construction in Finland.





VACUUM SYSTEMS

# Control of the total waste water chain.

## Introduction:

- ◆ To be able to protect the environment 100% there should be zero discharges from the Vessels. The infrastructure in many places especially on "Paradise" islands is not capable to handle shipboard waste. To manage this there should be a huge fleet of tanker barges or tankers for waste water discharge. At present this kind of arrangement does not exist so therefore we will concentrate to the present systems onboard the Vessels. It seems that holding capacity has increased on the latest newbuildings.
- ◆ The most vital thing is to control the whole process so that we do not overload the units so that collecting & treatment processes run continuously and we also restrict the discharges to take place only on areas where it is accepted. The control of the system is similar to "traffic lights" and there is easy access to different operation modes.
- ◆ Also a vital thing is to create a network of the systems so that all units are connected together with a pipe network. This makes it possible to divide the loading of sewage & waste water. When we have peaks the sewage is divided to units automatically. Another thing is maintenance work. The unit to be maintained is just disconnected from the network and other units will take the loading.





VACUUM SYSTEMS

## Different system layouts

### Different system approaches from small ships to huge Cruise Vessels:

---

- ◆ **Simple systems with one/two ejector(s) in collecting unit.**
  - electrical cabinet with relays/timers/indication lamps.
- ◆ **Standard systems with two or more ejectors in collecting unit.**
  - PLC(programmable logic's)
- ◆ **For more advanced systems with two or more ejectors in collecting unit.**
  - PLC-PC-MAS (progr.logic-PC-ship's main automation system)
- ◆ **Extremely advanced systems with interfaces to ship's whole waste water system even with capabilities to control the whole waste water system.**
  - PLC-PC-MMI(progr.logic-PC-man machine interface)This system is based on GUI (graphical user interface) control by using mimics on the controller PC.



VACUUM SYSTEMS

# New Building n:o 1.

## ◆ Ship data

- ⇒  $L_{pp} = 330$  m
- ⇒  $B = 48$  m
- ⇒  $D = 8$  m

## ◆ Evac data

- ⇒ number of collecting units 5 pieces of 25 m<sup>3</sup>
- ⇒ number of VT's = 2500 pieces
- ⇒ Collecting units ( 5 pieces)
- ⇒ digital inputs 32 pieces
- ⇒ digital outputs 32 pieces
- ⇒ analogue inputs 4 pieces
- ⇒ plc type telemecanique TSX 5710m =>programming device PC-486/10 inch colour display/durapoint mouse

### Evac master unit (2 pieces)

- ⇒ digital inputs 192 pieces
- ⇒ digital outputs 120 pieces
- ⇒ analogue inputs 32 pieces
- ⇒ plc type telemecanique TSX 5710 M



VACUUM SYSTEMS

◆ **PC-GUI-controller**

- ⇒ PC Compaq DP2000/Pentium 133 MHz/16 MB Ram/1.6 HD/WIN95/CITECT software.
- ⇒ laptop PC/P-150MHz/WIN95/CITECT software.
- ⇒ LIS station (2 pieces) to link data between CITECT<=>Damatic XD

**Logic I/O consisting of following controls:**

- ⇒ black water holding tanks(4)
- ⇒ vacuum cross connection valves (5)
- ⇒ inlet valves for blackwater holding tanks (4)
- ⇒ grey water collecting tanks (7)
- ⇒ BW inlet valves for mixing tanks (2)
- ⇒ GW inlet for mixing tanks (2)
- ⇒ sea water inlet valves for mixing tanks (2)
- ⇒ sewage treatment plants (2)
- ⇒ overboard discharge valves indication (control through MAS).



VACUUM SYSTEMS

## EMU (Evac master unit) functions:

- ◆ SYSTEM CONSISTS OF TWO EMU UNITS BECAUSE OF REDUNDANCY & HALF SHIP REQUIREMENT:

EMU units acts as linking devices to LIS terminals.

LIS terminals are the last links in this case to Damatic main automation system(MAS-system).EMU units transfer information tables to LIS terminals where the information is transferred to MAS terminal in the control room.

Following data is transferred

- ⇒ discharge modes(holding/treatment/sea/emptying)
- ⇒ cross-connection valves/Evac collecting units(status,alarms)
- ⇒ status of Evac units (vacuum level,vac.generation,sewage level,discharging,alarms)
- ⇒ inlet valves to black water holding tanks(status,alarms)
- ⇒ condition of BW holding tank(sewage level,discharging,alarms)
- ⇒ condition of grey water collecting tanks(water level,discharging,alarms)
- ⇒ BW inlet valves to mixing tanks(status,alarms)
- ⇒ GW inlet valves to mixing tanks(status,alarms)
- ⇒ sea water inlet valves to mixing tanks(status,alarms)
- ⇒ laundry tanks (status,alarms)
- ⇒ overboard discharge valves (status,alarms)
- ⇒ process of the mixing tanks

Discharge control from bunker stations directly after receiving permission from MAS to EMU.

In normal condition EMU unit transmits a check signal once in every 60 seconds to MAS.If MAS does not receive any signal from EMU an alarm will be generated in MAS.

Current supply to EMU units is secured by UPS units.



VACUUM SYSTEMS

# Operation modes

## Discharge modes

The discharge modes are selected from MAS(main automation system)are transmitted to Evac Master Units(EMU).

Depending of the selected mode the EMU units will distribute the discharging turns to Evac collecting units,sewage water holding tanks,greys water collecting tanks and mixing tank.Discharge is then carried out according following modes.

### ◆ **Holding mode=>**

In the holding mode the sewage will be collected to the vessels black and grey water holding tanks.Evac collecting units 5 pieces will ask the permission from EMU to discharge to the black water holding tanks as soon as ASK-level is reached.

The discharge to holding tanks start after receiving the command from EMU.The discharging will stop when the low level condition has been reached.

In holding mode all sewage treatment plant pumps are stopped.

### ◆ **Treatment mode=>**

In treatment mode Evac collecting units will discharge pre-set portions of 300 litres to the mixing tanks of the sewage treatment units.After receiving the black water from Evac collecting units there will follow a transfer of grey water and/or sea water to the mixing tanks.Transfer is controlled by EMU. The treatment mode is divided to three sub modes.

a)black water is diluted with sea water and grey water is collected to the grey water tanks.

b)black water is diluted with sea water and grey water discharged to sea

c)black water is diluted with grey water and sludge pumps can not be used ("harbour mode")

## Modes=>

The transfer is regulated from the EMU and starts after Evac collecting units have sent a signal to the EMU. The EMU(s) will open the black water inlet valves and grey water inlet valves. The discharge from Evac collecting units will be followed by a discharge from grey water collecting tanks (or from sea water line).

The sewage treatment units have three different working modes. aa) Harbour mode=>The EMU will transmit the "harbour" signal to the control panel of the STP (sewage treatment panel).

Based on the sewage level in the tank the frame units (minimizer, mixing /draining pump and dosing pump) will start based on their running hours.

Sludge pumps can not be operated in this mode.

bb) Sea mode=>The EMU unit informs the STP(s) of the Sea-mode. Based on the sewage level in the tank the frame units (minimizer, mixing /draining pump and dosing pump) will start based on their running hours.

Sludge pumps can be operated in this mode locally from the starter if a permission has been given from the MAS via EMU.

cc) Working off mode=>The control panel of the STP is linked to the EMU and further to MAS, but the pumps are not in operation.

## Sea mode=>

The Sea mode is divided to two sub modes. These must be separately selected from MAS. The modes will be active when the selected remote operated overboard discharge valve has been opened.

◆ **Sea-mode for black water=>**

The operation is selected from MAS. When the corresponding overboard discharge valve either port or starboard side is opened and the EMU's got the "open" indication from the limit switches of the selected valves the overboard discharge will start.

When any of the Evac collecting units or sewage water holding tanks has reached the preset ASK level condition they will send a request signal to EMU. When the respective unit has received the signal to discharge it will discharge until the "low level" condition is reached. While one unit is discharging the other units are prevented awaiting their turn to discharge based on level situation.

◆ **Sea-mode for grey water=>**

The operation is selected from MAS. When the corresponding overboard discharge valve either port or starboard side is opened and the EMU's got the "open" indication from the limit switches of the selected valves the overboard discharge will start.

When any of the grey water tanks has reached the preset ASK level condition they will send a request signal to EMU. When the respective unit has received the signal to discharge it will discharge until the "low level" condition is reached. While one unit is discharging the other units are prevented awaiting their turn to discharge based on level situation.



VACUUM SYSTEMS

## Emptying mode =>

The selection of Emptying mode must always be followed by the selection of the remote operated overboard discharge valve. The mode will become active when the selected overboard discharge valve has been opened.

- ◆ When all the necessary valves has been opened and the indication has reached EMU unit the discharge will take place in following order.

In black water system the first discharge turn will be given to one of the Evac collecting units which has the highest sewage level condition. After this each collecting unit will discharge to the low level condition.

The same procedure is carried out with the sewage water holding tanks also in similar sequence.

In grey water system the first discharge turn will be given to one of the grey water tanks which has the highest level condition. After this each grey water tank will discharge to the low level condition.

Enclosed is general layout regarding automation system. Notice the Half Ship requirement. This means that all units are operating in the network but the units are also independent capable to operate in local mode.

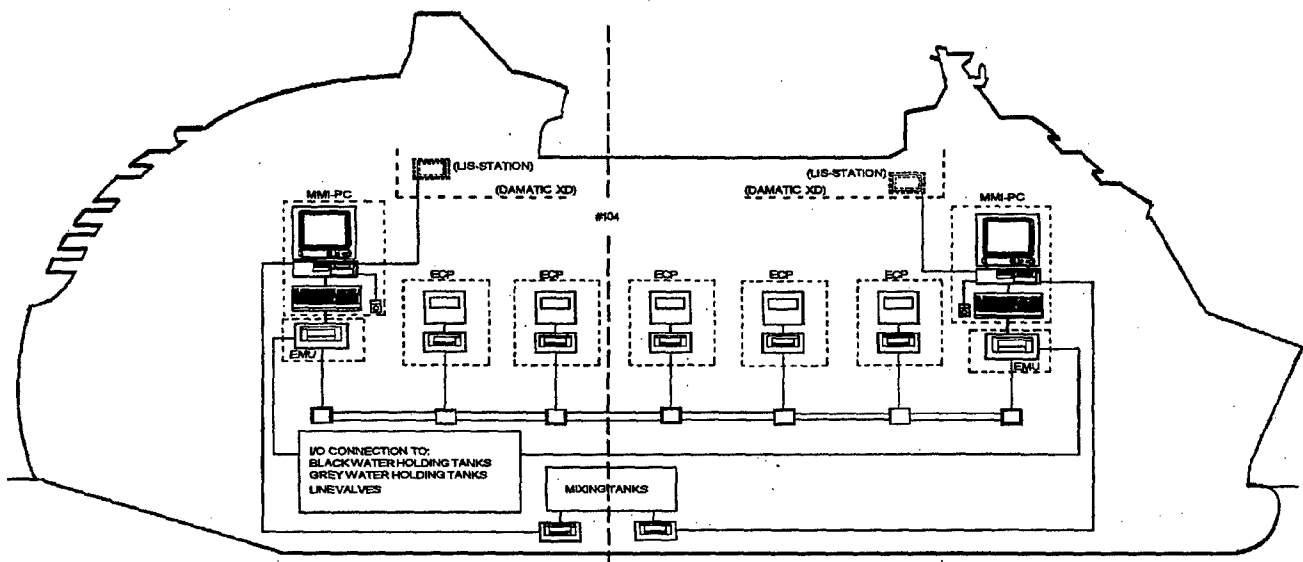
One EMU can control the whole system. Current supplies to create vacuum are connected to emergency generators so that the toilet system will function in case of black out or some other problems onboard.





VACUUM SYSTEMS

# General layout /controlling system



24-Feb-99

Ari Nylund

10

432



VACUUM SYSTEMS

## New Building n:o 2.

### Evac control system

- ◆ Evac control system controls Evac collecting units and biological treatment plants. The control is based on Evac master PLC and three slave PLC's.

As an interface for the whole chain is used a PC based computer system. The system is linked to main system via Ethernet DDE-link.

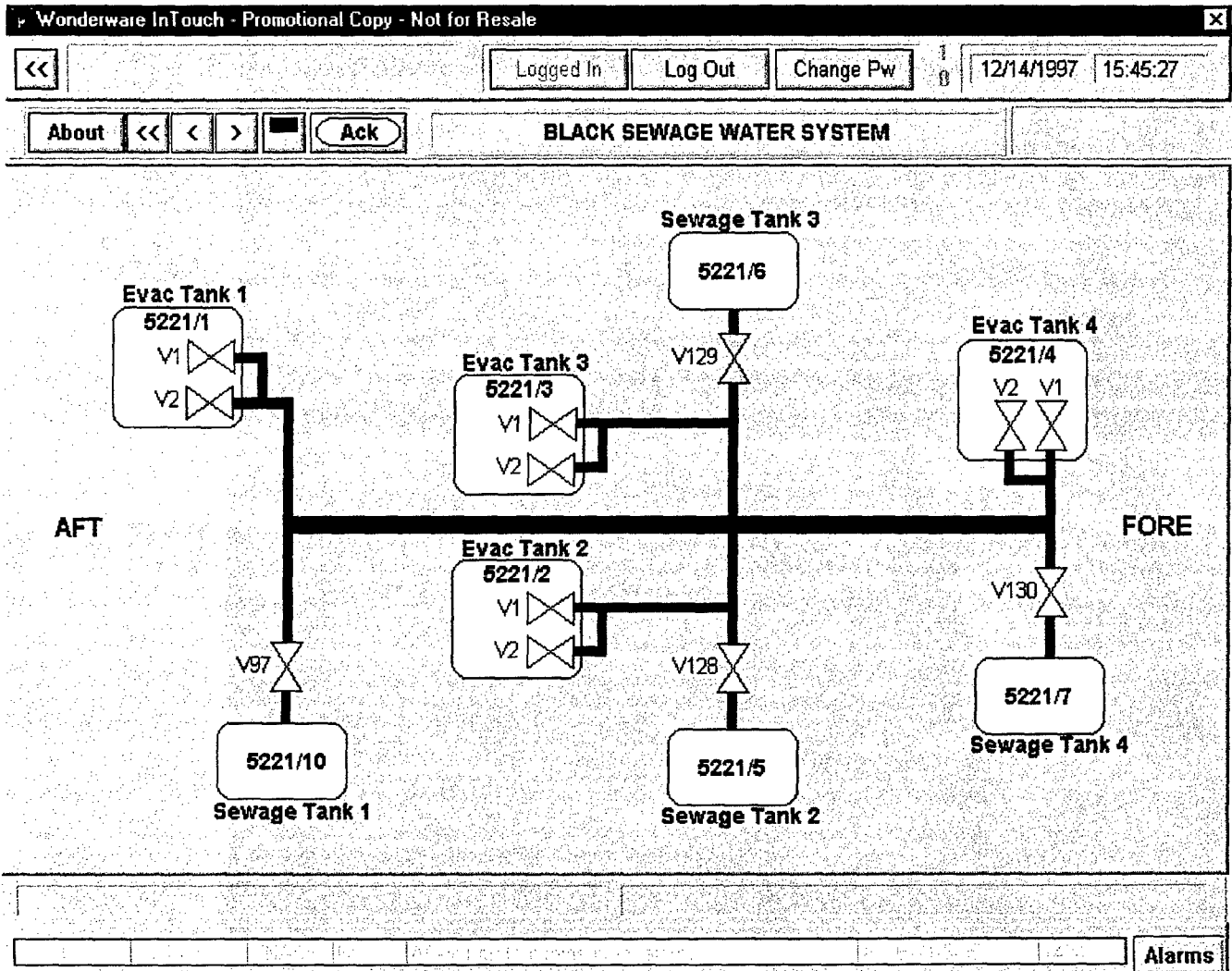
GUI (graphical user interface) with "traffic light" functions is the operator interface to the system.

General layouts of the system is include on the next pages.



VACUUM SYSTEMS

# General layout network:



24-Feb-99

Ari Nylund

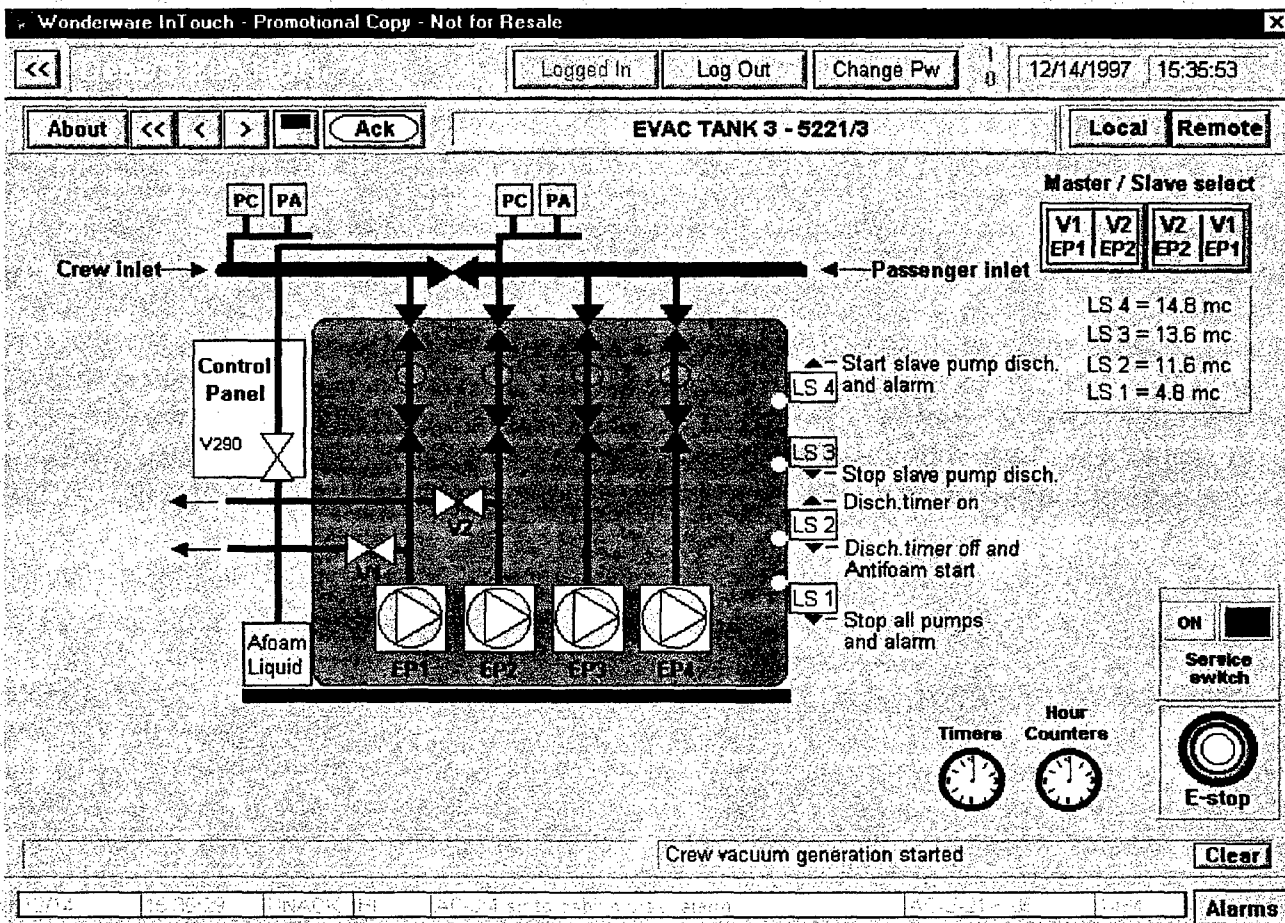
12

434



VACUUM SYSTEMS

# Evac collecting units





# Evac counters :

Wonderware InTouch - Promotional Copy - Not for Resale

Logged In | Log Out | Change Pw | 12/14/1997 15:39:07

About << < > >> Ack EVAC TANK 3 - 5221/3 COUNTERS Local Remote

### EVAC TANK 3 - 5221/3

|              | Total | Run 24h | Previous 24h |
|--------------|-------|---------|--------------|
| EP1 run hrs  | 8     | 1       | 0            |
| EP2 run hrs  | 8     | 1       | 1            |
| EP3 run hrs  | 5     | 1       | 0            |
| EP4 run hrs  | 5     | 1       | 0            |
| V1op/24hrs   |       | 2       | 10           |
| V2op/24hrs   |       | 10      | 23           |
| V290op/24hrs |       | 70      | 72           |
| LS2up/24hrs  |       | 98      | 130          |
| LS4up/24hrs  |       | 0       | 2            |

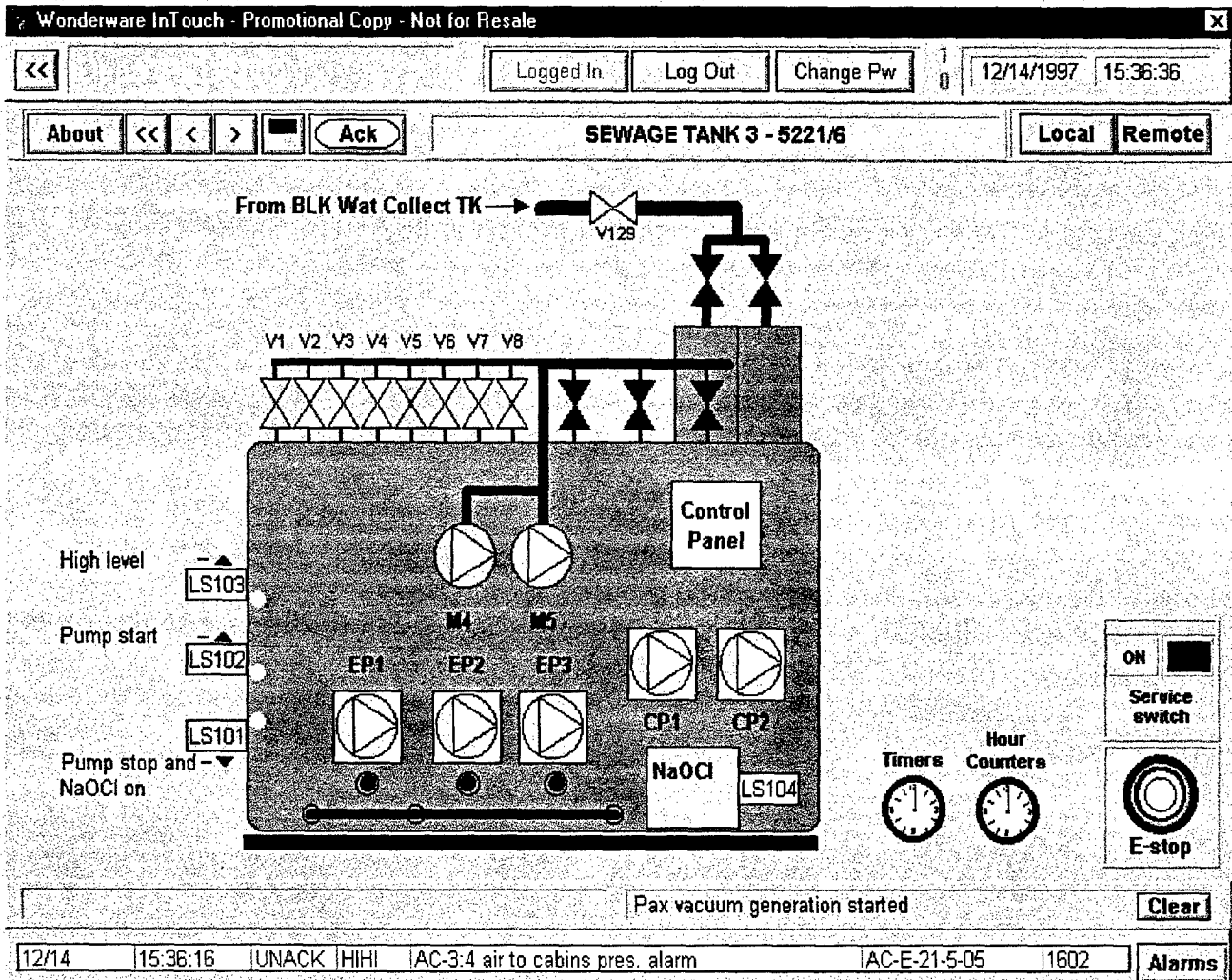
Pax vacuum generation started Clear

12/14 15:39:05 UNACK ILOLO EVAP BUNK FLOW Controller7 0.883 Alarms



VACUUM SYSTEMS

# Sewage treatment plant:



24-Feb-99

Ari Nylund

15

## New Building n:o 3.

### CRUISE VESSEL

- ◆ 4 off collecting tanks 18 m<sup>3</sup> each
  - ◆ 1 off holding tank 20 m<sup>3</sup>
  - ◆ 4 off treatment plants MSTP-9 std.
  - ◆ 5 off greywater collecting tanks 5 m<sup>3</sup> each
  - ◆ 2 off grease/greywater tanks 5 m<sup>3</sup> each
  - ◆ 1510 off vacuum toilets
  - ◆ totally 16 pieces of AISI-316 tanks/vessel
- 
- ◆ **Evac is controlling the whole chain from toilets to discharge.**

#### **Conclusion:**

Why network of different units and why computer controlling. The sewage handling onboard is actually a big process especially onboard the huge Cruise Vessels.

It has been problematic to connect single different units together to form a process. Therefore it is essential that control software binds together the different processes.

A clear graphical "traffic light" operation interface makes it easy for the crew to control the total waste water chain.

## **Vacuum and Sewage Treatment**

Klaus Mascow  
TRITON-FORMAT  
Germany

### **ABSTRACT**

The paper consists of a presentation of TRITON-FORMAT.

It will present the Vacuum-System, prescribe its requirements and its components.

It will then present Biological Sewage Treatment Systems, prescribe the IMO/MARPOL requirements and the components of the Sewage Treatment Plant.

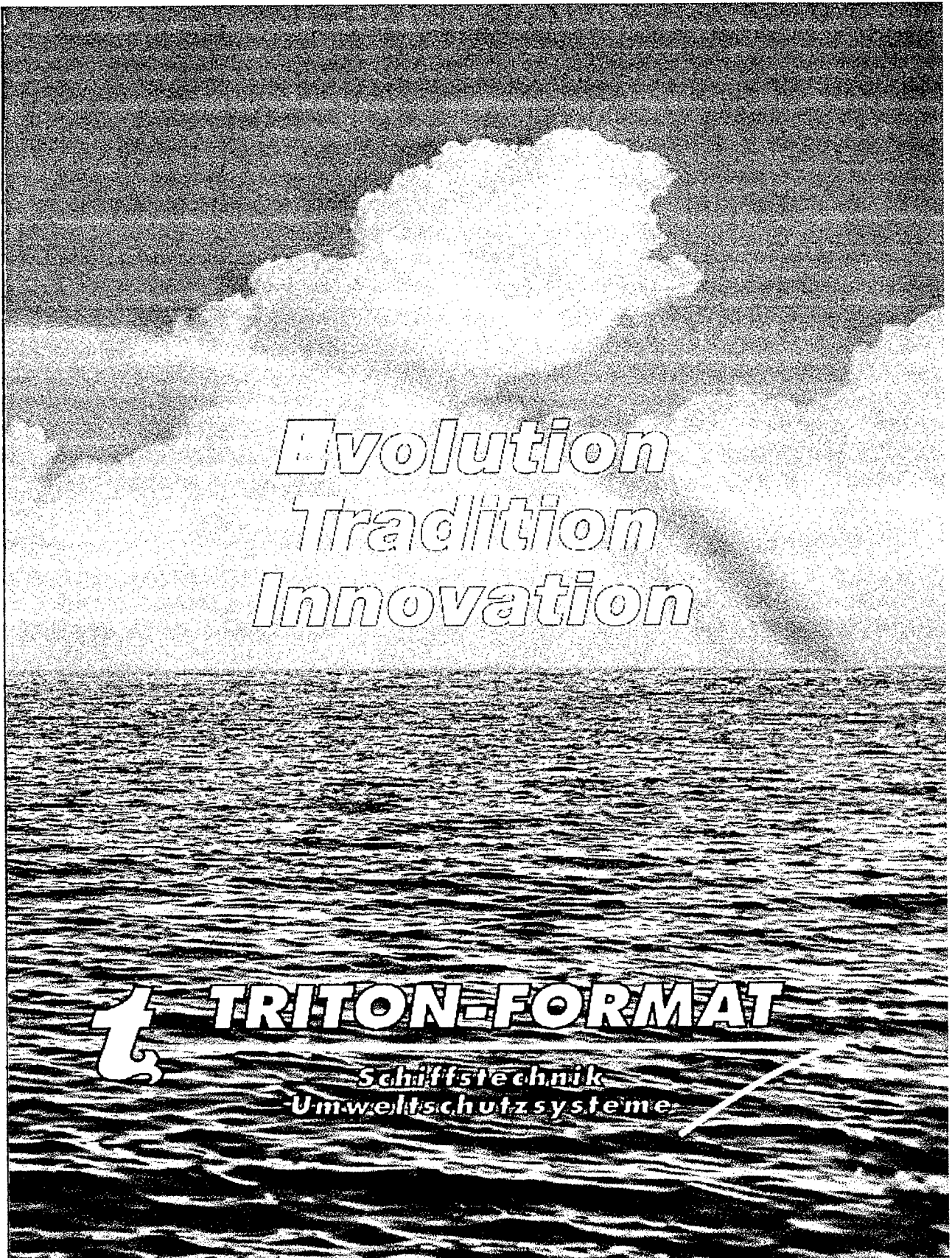
The harmonisation of Sewage/Vacuum is discussed, the PLC-PC-MMI-System Vacuum Sewage is described and test results obtained from the German Frigate-Programme are introduced.

The paper will finally discuss miscellaneous aspects of the Vacuum and Sewage Treatment System.





P4\_MASCOW.DOC



**Evolution  
Tradition  
Innovation**



**TRITON-FORMAT**

Schiffstechnik  
-Umweltschutzsysteme



The Fountain of Triton

By the famous Roman sculptor and architect,  
Gian Lorenzo Bernini (1592-1680).

This baroque masterpiece representing the figure of Triton,  
who gave the company its name,  
can still be admired.

The fountain with its crystal clear water  
is in the Villa Borghese, Rome's famous park.

---

**TRITON-FORMAT Schiffstechnik · Umweltschutzsysteme GmbH**

**Werner-von-Siemens-Straße 2 · 25479 Ellerau**

**Telefon: (04106) 77 10 – 0**

**Telefax: (04106) 77 10 - 60**

**TABLE OF CONTENTS**

*TRITON-FORMAT the company*

*TRITON-FORMAT for shipping*

*MARPOL Edition 1997*

*Base of Measurements*

*Design of Sewage Treatment Plants*

*Design Requirement for Sewage Treatment Plants*

*International Effluent Standards for Sewage Treatment Plants*

*TRITON-FORMAT Sewage Treatment Plant MSTP4-9 Standard*

*Representation of Biological Sewage Treatment Plant*

*Description of Function*

*Piping Diagramm of Sewage Treatment Plant MSTP4-9 Standard*

*Black Water Transfer Sewage Treatment Plant "Carnival Cruise Lines"*

*Results of Sewage Tests*

*Validity of Certificates*

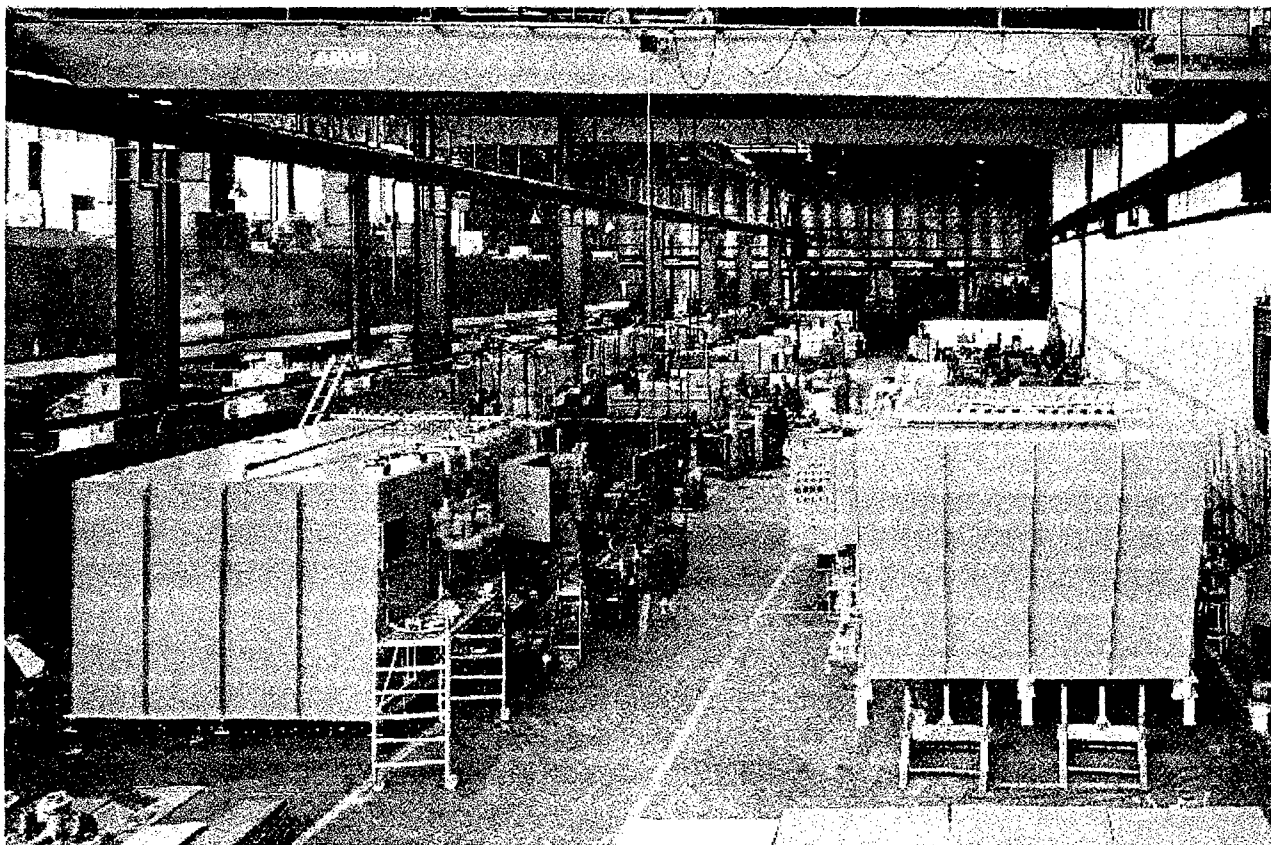
*New TRITON-FORMAT Sewage Treatment Plant MSTP1 AV with  
Ultrafiltration*

*Prospects*

*Since its establishment 150 years ago, everything at TRITON has revolved around water. The founder, Ferdinand Müller, followed the principle of nature: survival through adaptation. This evolutionary principle, an essential element of our company's philosophy right from the beginning, ensures that we continually develop and improve the quality of products we offer to the people we do business with.*

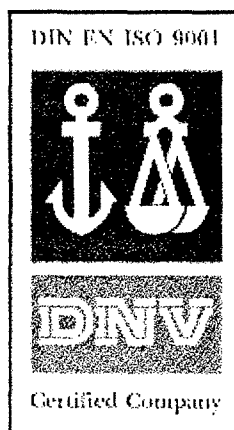
*The ocean is the largest and oldest habitat on earth. We are duty-bound to ensure its conservation for coming generations. Therefore we have to concentrate on manufacturing environmentally safe equipment for the treatment of waste water and water conservation systems with future-oriented technology.*

*In other words, TRITON-FORMAT develops and builds equipment that protects the environment.*

*Our factory*

*As a shipping-oriented company, it is not surprising that we have located our production plant in the neighbourhood of Hamburg harbour, a port with quick transhipment throughput, which means short delivery times and distances.*

*Our products and systems are manufactured in our 5.000 m<sup>2</sup> plant situated in the industrial park of Ellerau, only 25 km from Hamburg harbour.*

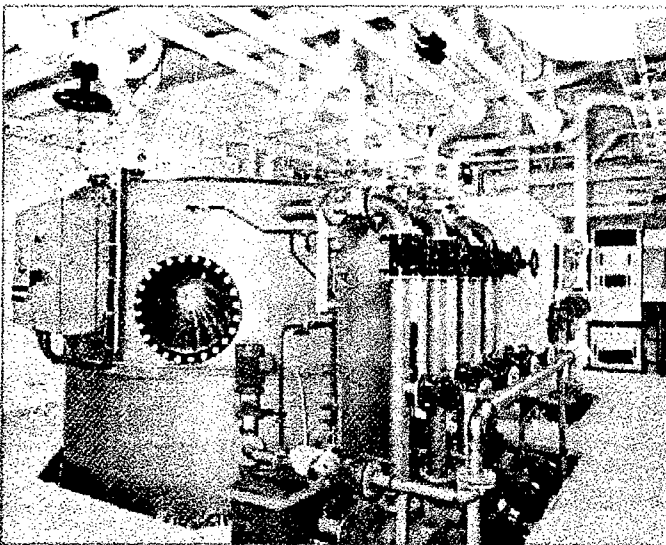


*TRITON-FORMAT production conforms to the ISO9001 Certificate of "DET Norske Veritas" and often exceeds these quality standards of manufacture.*

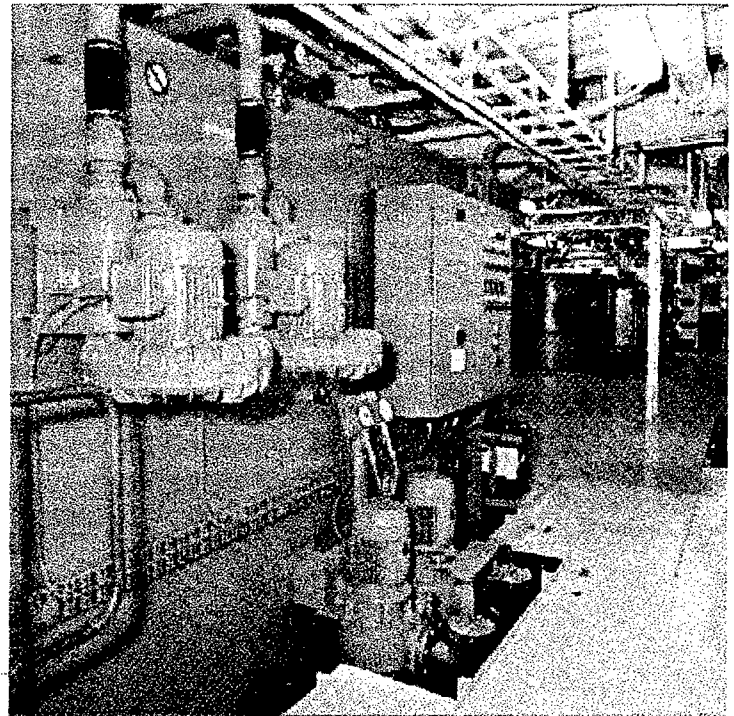
## For shipping

*Absolute safety and smooth functioning of all equipment operating absolutely compatibly is of fundamental importance of oceangoing vessels. TRITON-FORMAT has geared itself to meeting this requirement as regards both the building of large systems and machinery as well as the manufacture of single components and ship's fittings.*

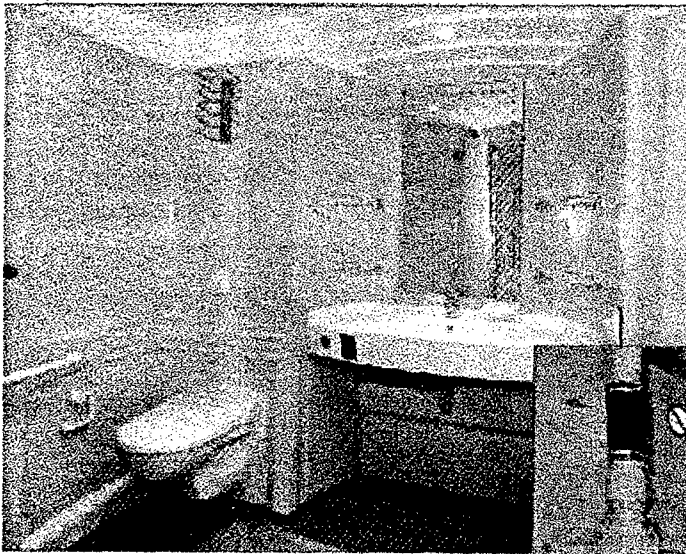
*TRITON-FORMAT also provides optimal, state-of-the-art solutions for numerous cleaning tasks, a particularly good example being its well-known automatic ship window washing system.*



Four fully automatic vacuum units based on the ejector principle create the necessary low pressure for the vacuum toilets.

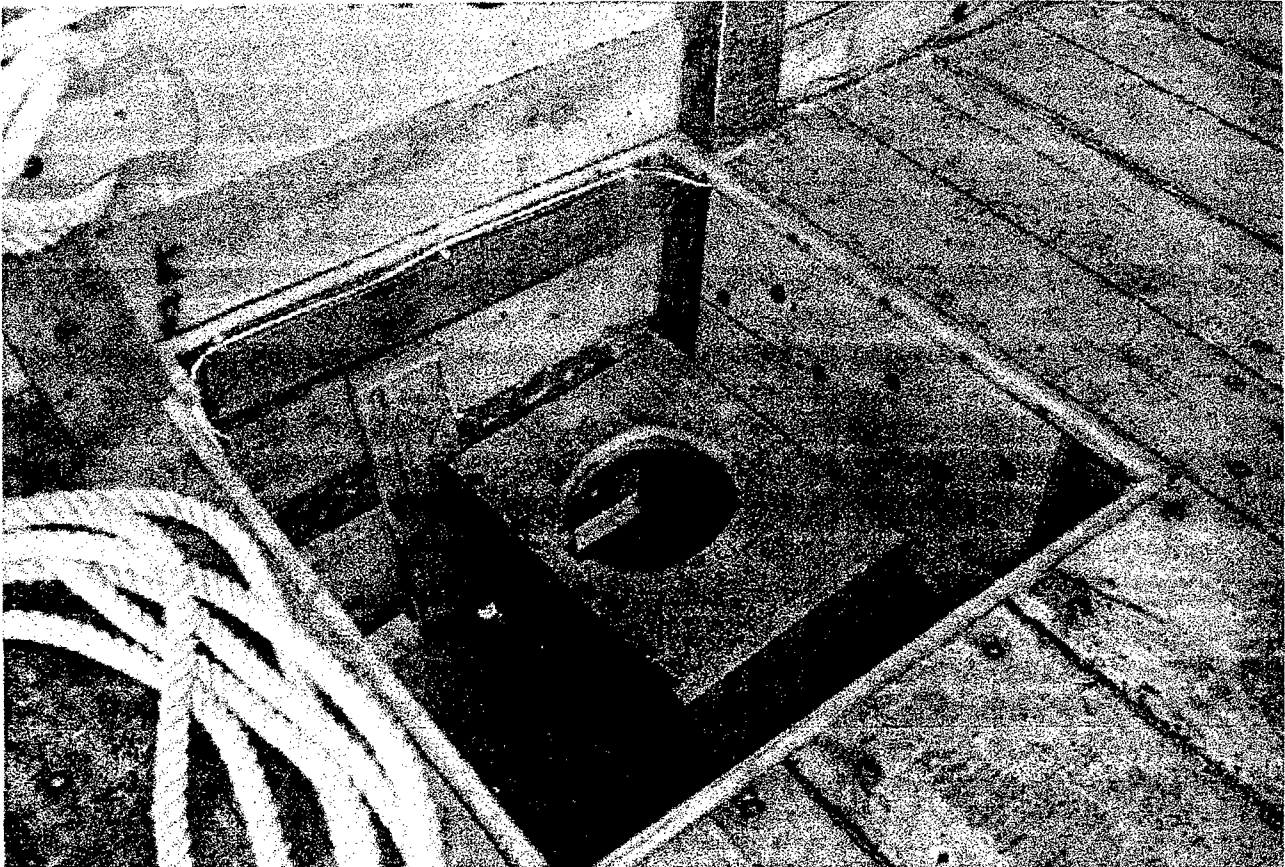


One of the 1,501 TRITON FORMAT vacuum toilets installed on the SuperStar Leo.



Four waste water treatment plants were installed on the SuperStar Leo. They return to the sea only fully biologically purified, germ-free waste water in drinking water quality.





*The old Hanseatic plump toilet, more hygienic than many of the yachting toilets.*

*Sunked into the bottom planks of the ship you had best view on horizon, deck and sails.*



MARPOL 73/78  
Consolidated Edition, 1997

# MARPOL 73/78

## Consolidated Edition, 1997



International Maritime Organization



## **1. Base of Measurements**

*The technical calculation of the Compact Sewage Treatment Plant for Seaships is basing on requirements made by IMCO MEPC.2 (IV) dd. December 3, 1976, basing on the Convention for the Protection of the Baltic Sea (Helsinki Convention) dd. March 1974, modified for the last time in November 30, 1979, basing as well on the 8<sup>th</sup> Baltic Convention of Alteration of the Environment Protection dd. October 25, 1990; leaning as well on the following prescriptions, DIN-Norms and ATV-(German Rules) working papers:*

- 1. Requirements for "Construction Measures on Seaships" of the Sea convention - Ship's Security Department - dd. February 1<sup>st</sup>, 1989, latest modified on October 10, 1991.*
- 2. DIN 4261, part 2 - "small treatment plants - plants with sewage aeration" - Edition of June 1984.*
- 3. ATV (German Rules) working sheet A126 - "Base for Measuring, Layout and Operation of small sewage treatment plants with aerobic biological clearing step for connecting values between 50 and 500 persons" - Edition of April 1992.*
- 4. ATV (German Rules) - working sheet A126 "Principles for the sewage treatment in small treatment plants according to an activating system with common stabilisation of sludge with connecting values in a range between 500 and 5.000 persons" - Draft of April 1992.*
- 5. ATV (German Rules) - working sheet A129 - "Elimination of Sewage coming from Recreation - and Tourist Installations" - Edition of February 1992.*
- 6. ATV (German Rules) - working sheet A131 - "Evaluation of one-step Activating Plants starting from 5.000 persons" - Edition of February 1992.*
- 7. 1<sup>st</sup> Annex to General Scope of Administration Instructions for Minimal Requirements for Inlet of Sewage into Water - Scope of Administration Instructions dd. March 4, 1992.*

***Design of sewage treatment plants******Volume of sewage in litres per person per day***

|                                                    | without vacuum plant |                      | with vacuum plant |                      |
|----------------------------------------------------|----------------------|----------------------|-------------------|----------------------|
|                                                    | black water          | grey and black water | black water       | grey and black water |
| <b>Passenger ships</b>                             | 70                   | 230                  | 25                | 185                  |
| <b>Seagoing vessels except for passenger ships</b> | 70                   | 180                  | 25                | 135                  |

**Design Requirement for Sewage Treatment Plant****Preliminary Remarks:**

*Layout is based on actual valid guidelines of ATV and German Bundesmarine.*

*Measurement parameters and suppositions of load at inlet.*

**Sewage**

|                    |       |   |             |
|--------------------|-------|---|-------------|
| <i>Black water</i> | $Q_s$ | = | $10l/(E*d)$ |
|--------------------|-------|---|-------------|

---

|                        |          |   |               |
|------------------------|----------|---|---------------|
| <i>Sanitary sewage</i> | $Q_{sa}$ | = | $100 l/(E*d)$ |
|------------------------|----------|---|---------------|

|                        |          |   |              |
|------------------------|----------|---|--------------|
| <i>Hospital sewage</i> | $Q_{ho}$ | = | $10 l/(E*d)$ |
|------------------------|----------|---|--------------|

|                                               |          |   |              |
|-----------------------------------------------|----------|---|--------------|
| <i>Laundry sewage<br/>(at 1 kg laundry/d)</i> | $Q_{la}$ | = | $20 l/(E*d)$ |
|-----------------------------------------------|----------|---|--------------|

|                       |          |   |              |
|-----------------------|----------|---|--------------|
| <i>Kitchen sewage</i> | $Q_{ki}$ | = | $10 l/(E*d)$ |
|-----------------------|----------|---|--------------|

---

|                                                                       |       |   |               |
|-----------------------------------------------------------------------|-------|---|---------------|
| <i>Total Greywater<br/>(<math>Q_{sa}+Q_{ho}+Q_{la}+Q_{ki}</math>)</i> | $Q_t$ | = | $140 l/(E*d)$ |
|-----------------------------------------------------------------------|-------|---|---------------|

|                     |       |   |              |
|---------------------|-------|---|--------------|
| <i>Total Sewage</i> | $Q_o$ | = | $150l/(E*d)$ |
|---------------------|-------|---|--------------|

---

*E = unit, person*

*d = day*

*ATV = union of sewage technics*

**Sewage load**

|                    |                  |   |       |
|--------------------|------------------|---|-------|
| <i>Black water</i> | $BSB_{5s}/(E*d)$ | = | 50g/d |
|--------------------|------------------|---|-------|

---

|                        |                   |   |       |
|------------------------|-------------------|---|-------|
| <i>Sanitary sewage</i> | $BSB_{5sa}/(E*d)$ | = | 15g/d |
|------------------------|-------------------|---|-------|

|                        |                   |   |      |
|------------------------|-------------------|---|------|
| <i>Hospital sewage</i> | $BSB_{5ho}/(E*d)$ | = | 2g/d |
|------------------------|-------------------|---|------|

|                       |                   |   |      |
|-----------------------|-------------------|---|------|
| <i>Laundry sewage</i> | $BSB_{5la}/(E*d)$ | = | 4g/d |
|-----------------------|-------------------|---|------|

|                       |                   |   |       |
|-----------------------|-------------------|---|-------|
| <i>Kitchen sewage</i> | $BSB_{5ki}/(E*d)$ | = | 20g/d |
|-----------------------|-------------------|---|-------|

---

*Sewage load*

|                                                                               |                  |   |       |
|-------------------------------------------------------------------------------|------------------|---|-------|
| <i>Grey water</i><br>( $BSB_{5sa} + BSB_{5ho}$<br>$+ BSB_{5la} + BSB_{5ki}$ ) | $BSB_{5g}/(E*d)$ | = | 41g/d |
|-------------------------------------------------------------------------------|------------------|---|-------|

*Sewage load*

|                     |                  |   |       |
|---------------------|------------------|---|-------|
| <i>Total Sewage</i> | $BSB_{5o}/(E*d)$ | = | 91g/d |
|---------------------|------------------|---|-------|

=====

*E* = *unit, person*

*d* = *day*

*ATV* = *union of sewage technics*

## **International Effluent Standards for Sewage Treatment Plants**

### **1. Faecal Coliform Standard:**

*The geometric mean of the faecal coliform count of the samples of effluent taken during the test period should not exceed 250 faecal coliform/100 ml M.P.N. (most probable number).*

### **2. Suspended Solids Standard**

- a. *Where the equipment is tested on shore, the geometric mean of the total suspended solids content of the samples of effluent taken during the test period shall not exceed 50 mg/l above the suspended solids content of ambient water used for flushing purposes. Analysis for suspended solids should be conducted in accordance with gravimetric methods approved by the Administration.*
- b. *Where the equipment is tested aboard ship, the geometric mean of the total suspended solids content of the samples of effluent taken during the test period shall be not more than 100 mg/l.*

*3. In addition to the above conditions, the plant should be so designed that the geometric mean of 5-day Biochemical Oxygen Demand (BOD5) of the samples of effluent taken during the test period does not exceed 50 mg/l.*

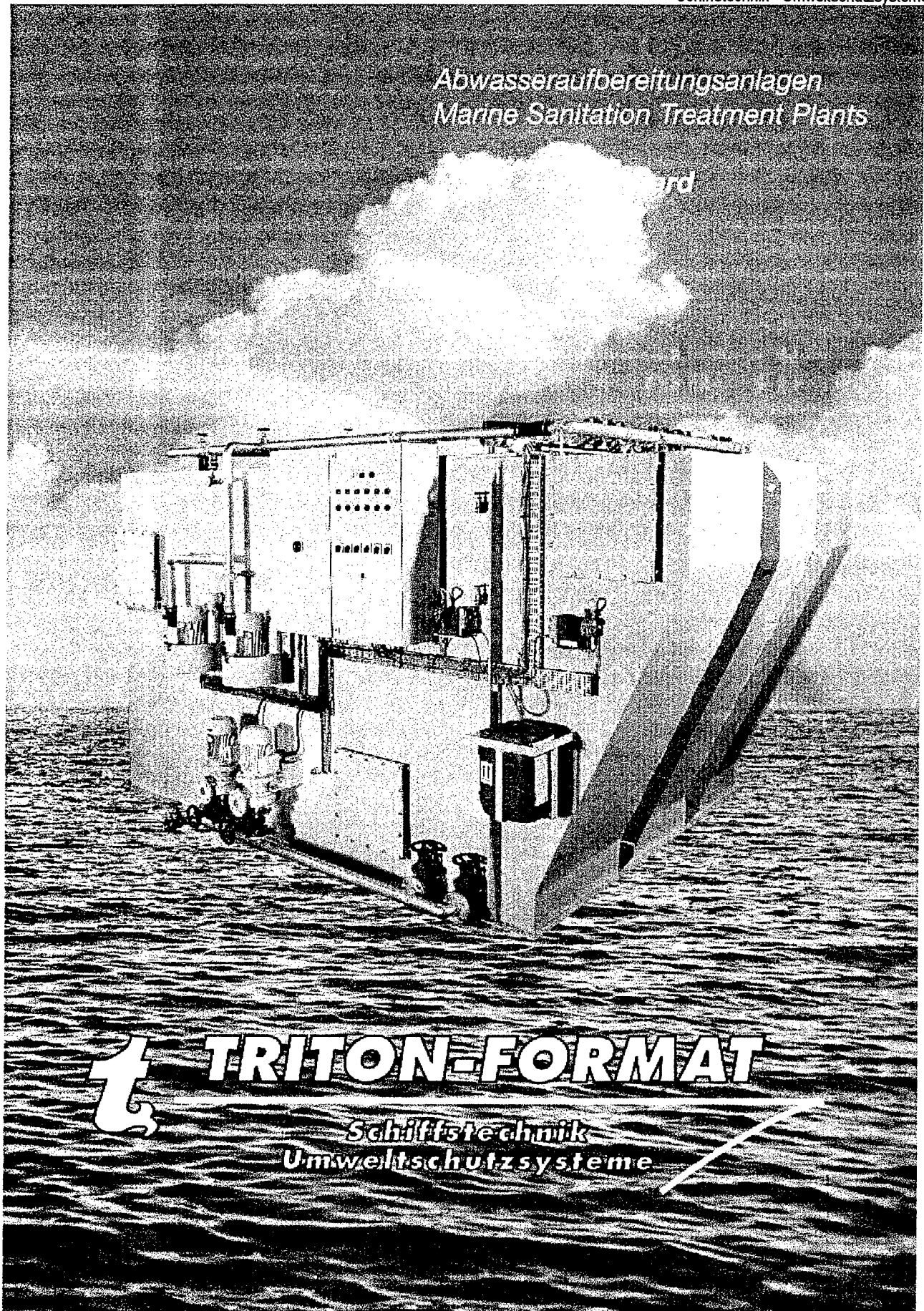
### **4. Raw Sewage Quality**

*For equipment tested ashore, the influent should be fresh sewage consisting of faecal matter, urine, toilet paper and flush water to which, for testing purposes, primary sewage sludge has been added as necessary to attain a minimum concentration of 500 mg/l of suspended solids. For equipment tested aboard ship the influent may consist of the sewage generated aboard the vessel under normal operational conditions.*

*The performance of sewage treatment plants may vary considerably when the system is tested on-shore under shipboard simulated conditions or on-board ship under actual operating conditions. The actual test data showed this difference could be as high as a factor two.*



*Abwasseraufbereitungsanlagen  
Marine Sanitation Treatment Plants*

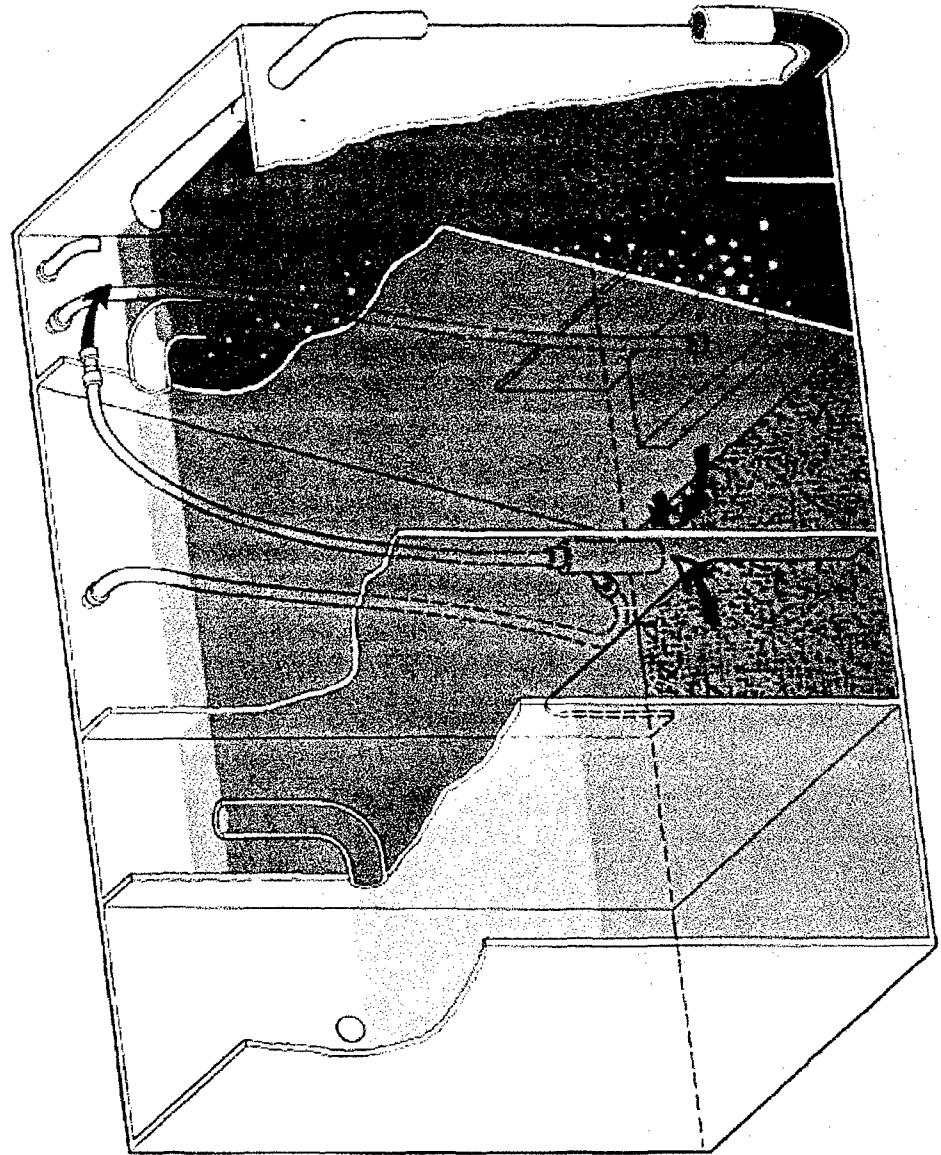


**TRITON-FORMAT**

*Schiffstechnik  
Umweltschutzsysteme*

**Representation of Biological  
Sewage Treatment Plant**

**Darstellung der biologischen  
Abwasseraufbereitung**





## **Description of Function**

### **A. Aeration Section**

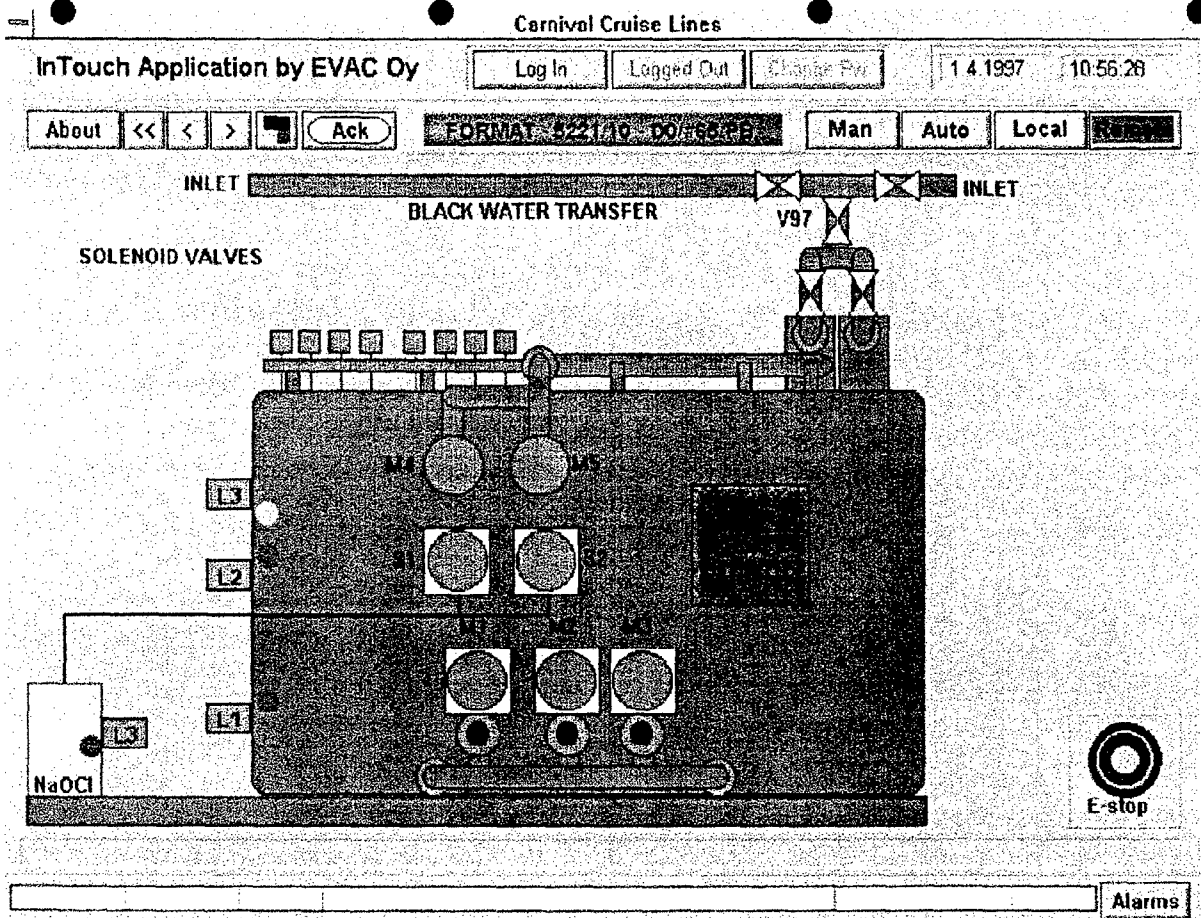
*The black water will be discharged by the vacuum creation unit to the aeration section of the Sewage Treatment Plant, whilst the grey water is collected in the disinfectant section. To optimise a circulation in the aeration section and to prevent unaerated areas pipe membrane aerators are installed on the side to get a roller effect.*

### **B. Settling Section**

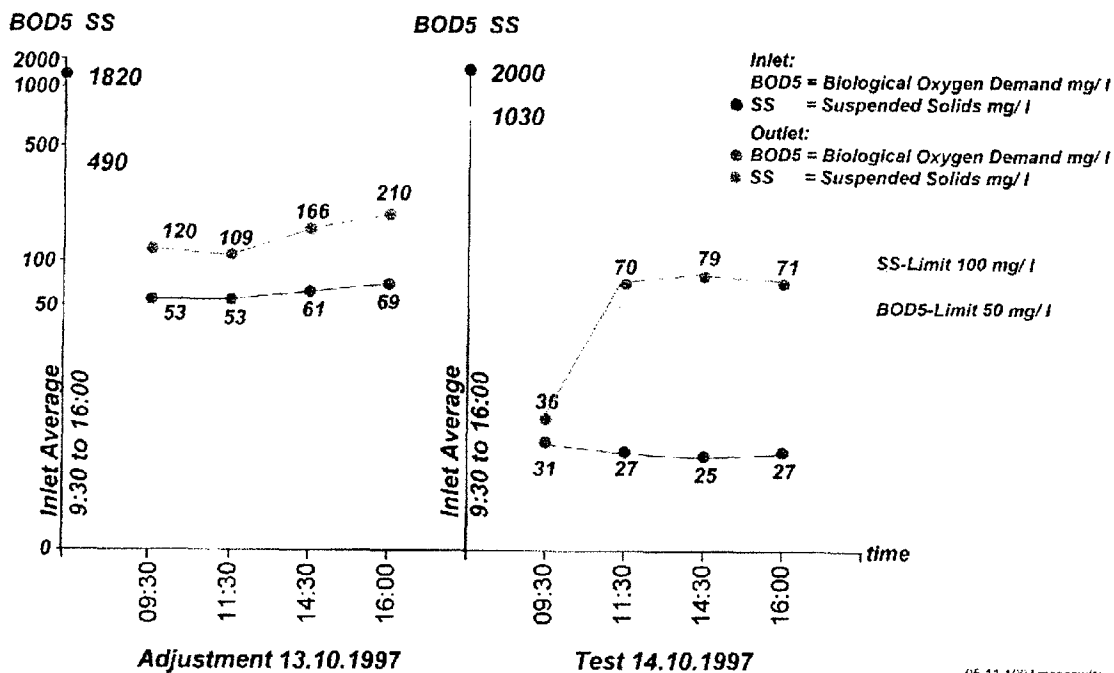
*For re-aeration of the sludge, lifters are installed at the bottom of the settling section for return to the aeration section. To obtain a controlled sludge return, solenoid valves are fitted in the air sully line to the lifters. The solenoid valves are controlled from the switch boards and the activation time is adjustable. To prevent the skimmer sludge from entering the disinfecting section, the overflow to this section is below the water level. Simmer sludge is returned to the aeration section in the same way as the sludge.*

### **C. Disinfecting Section**

*The disinfecting is injected after the overboard discharge pump has stopped. The pump is controlled by two level switches inside the disinfecting section. Aerators are installed to create circulation which ensures optimum mixing of the disinfecting.*



**Test-Results MSTP 2**  
Hydraulic-Load 2,5m<sup>3</sup>/day Black Water



05.11.1997/mascow/sj

**Gültigkeit der Zertifikate/ Validity of Certificates**

|                                                |                                                    |                                       |
|------------------------------------------------|----------------------------------------------------|---------------------------------------|
| SBG                                            | MSTP1A-9                                           | 30.11.2003                            |
| USCG                                           | <i>nicht mehr erforderlich/ no longer required</i> |                                       |
| CCG<br>Canadian Coast Guard                    | MSTP1A-9                                           | <i>keine Begrenzung<br/>no limits</i> |
| Soefartsstyrelsen<br>Dänemark/ Denmark         | MSTP5                                              | 31.01.99                              |
| RINA<br>Italien/ Italy                         | MSTP1-9                                            | <i>keine Begrenzung<br/>no limits</i> |
| USSR Register<br>Rußland/ Russia               | MSTP1-9                                            | <i>keine Begrenzung<br/>no limits</i> |
| Shipping and<br>Navigation<br>Schweden/ Sweden | MSTP1-9                                            | <i>keine Begrenzung<br/>no limits</i> |
| DOT<br>England/ GBR                            | MSTP1-9                                            | <i>keine Begrenzung<br/>no limits</i> |
| Board of Navigation<br>Finland/ Finland        | MSTP1-9                                            | <i>keine Begrenzung<br/>no limits</i> |
| Croatia                                        | MSTP2                                              | <i>keine Begrenzung<br/>no limits</i> |
| Griechenland/ Greece                           | MSTP1-9                                            | <i>keine Begrenzung<br/>no limits</i> |
| ZC/ Register of<br>Shipping China              | MSTP1A/ 1-9                                        | <i>keine Begrenzung<br/>no limits</i> |

## ***A look into the future***

*Ship owners are more and more interested in sewage treatment plants showing best function, small volume and weight, thus requiring a minimum of maintenance.*

*All existing sewage treatment plants have technically arrived at their end so that new ways will have to be found.*

*An optimum plant collecting all new requirements is a combination of the biological aeration process with an ultra-filterstation installed behind it.*

*Using membran biology most of the volume necessary for the traditional elements is economized.*

*This is reached by concentrating the dry substance from 5g/l onto 20g/l in standard plants.*

*Furthermore the whole procedure of membrane biology is simplified as there is no need any more for settling and disinfection tanks.*

*Good function of the new plants does not depend anymore on the position of the vessel.*

*This new system assures an optimum of good operation and shows an important improvement of the rest water quality.*

*No more coliforms in the outlet, BSB5-values less than 10mg/l and all floating elements completely eliminated.*

*The first of these plants is already being produced and tested, showing water values which will corresponds to the highest values required by public institutions.*

## **Oily Water Separators**

Michael Fröhlich  
NORDDEUTSCHE-FILTER Vertriebs GmbH  
Germany

### **ABSTRACT**

The paper consists of the following major points:

- Present IMO-Regulations and changes/tightening to be expected in the future.
- Advantages and disadvantages of different de-oiling systems in life ship operations.
- Concept of NFV for the bilge water de-oiling of the future.



**AQUATECTOR® Microfloat®**  
**An Innovative Conception to Upgrade and Improve Marine Sewage  
Treatment Systems**

Roland Damann  
ENVI-PLAN INGENIEUR GmbH  
Germany

**ABSTRACT**

In the last decade, ENVI-PLAN Wassertechnische Anlagen GmbH has carried out interesting large-scale projects in the field of water technology. Within the scope of these projects excellent results could be achieved.

The essential conceptions of a modular DAF Unit, the patented **AQUATECTOR® Microfloat®** for use in ships to treat different waste water streams are to be outlined and summarised herinafter.

The following subjects are concerned:

**Physical pre-treatment and grease and oil separation by  
AQUATECTOR® Microfloat®**

**Final clarification by AQUATECTOR® Microfloat®**

Outlet rate of **AQUATECTOR® Microfloat®**: filterable substances < 2mg/L

**Activated sludge thickening by AQUATECTOR® Microfloat®**

Result: TS-Content by **AQUATECTOR® Microfloat®** sludge thickening > 7% without the addition of flocculants.

All these excellent results and experiences made have been carefully evaluated and adapted to meet the requirements of marine applications.



In all applications **AQUATECTOR® Microfloat®** Systems are operating chemical-free at a low pressure of approx. 2.7 bar and show a reliable function even at strong moving roll-rated of ships.

A new conception of modernising existing maritime sewage treatment systems with compact modules will be introduced and presented in this paper.

Performance results of **AQUATECTOR® Microfloat®** tell that this worldwide patented technique as physical or physical-chemical processes is robust, easy to stop and restart, the operational problems are none, small particles, like bacteria are removed effectively resulting in small coagulant residuals.

Cold water and summer operation conditions do not create problems.

The good tolerance of both hydraulic and solid load variations is characteristic for the **AQUATECTOR® Microfloat®** units.

P6\_DAMANN.DOC

**Evaluation of a dissolved air flotation unit  
for post purification purpose in a  
marine waste water treatment plant**

**Kurzfassung  
short version**

**Verfasser**  
enviplan Ingenieurgesellschaft mbH  
Dammstraße 21  
33165 Lichtenau-Henglar



| <b>Inhaltsverzeichnis</b>                                                      | <b>Seite</b> |
|--------------------------------------------------------------------------------|--------------|
| <b>1 Aufgabenstellung und Ziel der Studie</b>                                  | <b>4</b>     |
| <b>2 Technische Auslegungsdaten</b>                                            | <b>4</b>     |
| <b>3 Vorhandene Abwasseraufbereitungsanlage Typ "MSTP 1"</b>                   | <b>6</b>     |
| <b>4 Betriebsprobleme bei vorhandener Anlage, Typ "MSTP 1"</b>                 | <b>7</b>     |
| <b>5 Lösung der Betriebsprobleme</b>                                           | <b>7</b>     |
| <b>5.1 Ausführliche Darlegung der Mikroflotation</b>                           | <b>8</b>     |
| <b>6 Technische Anwendung der Druckentspannungsflotation</b>                   | <b>12</b>    |
| <b>6.1 Systembedingte Vorteile der Mikroflotation</b>                          | <b>12</b>    |
| <b>6.2 Vorteile der AQUATECTOR® - Flotationstechnik für Schiffskläranlagen</b> | <b>15</b>    |
| <b>7 Integration der AQUATECTOR® - Flotationstechnik</b>                       | <b>17</b>    |
| <b>7.1 Funktionsweise</b>                                                      | <b>18</b>    |
| <b>8 Zusammenfassung</b>                                                       | <b>20</b>    |
| <b>9 Literaturverzeichnis</b>                                                  | <b>21</b>    |

## 1 Aufgabenstellung und Ziel der Studie

Die Aufgabenstellung der vorliegenden Realisierbarkeitsstudie umfaßte die Modifikation der bereits bestehenden Abwasseraufbereitungsanlage (AWA) auf einem Mehrzweckboot mit Hilfe der **AQUATECTOR**<sup>®</sup> - Druckentspannungsflotation zur Verbesserung der Ablaufqualität. Dabei sollten vor allem die geforderten Einlauf- und Ablaufwerte berücksichtigt bzw. eingehalten werden.

Gemäß ihrem derzeitigen Stand der Technik sollte die Anlage dazu überarbeitet und die Einbaugröße der zur Zeit installierten AWA angepaßt werden.

Als zu erreichendes Ziel lag ein besonderes Augenmerk auf einem von Feststoffen und Schwebstoffen befreiten Ablauf der Nachklärung, um eine optimale Desinfektion und damit Keimfreiheit des Abwassers zu gewährleisten, welches ins Fahrwasser gelangt.

## 2 Technische Auslegungsdaten

Folgende technische Auslegungsdaten wurden für die Planung, als Ziel und für den zukünftigen Einsatz einer überarbeiteten Abwasserbehandlungsanlage vom Auftraggeber vorgegeben:

- **Zulauf**

Die Flotationsanlage ist für ein Schiff mit der Besatzungsstärke von 7 E auszulegen. Als Abwasservolumenstrom sind 160 l/E x d (150 l/E x d Grauwasser, 10 l/E x d Vakuumschwarzwasser) zugrunde zu legen.

Einheits - BSB<sub>5</sub> = 90 g/E x d

- **Ablauf**

Als Ablaufwerte sind einzuhalten:

- BSB<sub>5</sub> = 50 mg/l (im dynamischen Betrieb = 100 mg/l)
- abfiltrierbare Stoffe = 50 mg/l (im dynamischen Betrieb = 100 mg/l)
- Fäkalkolikeimzahl = 250 pro 100 ml.

- **Seegangswerte für den dynamischen Betrieb**

Die vorhergehenden Werte sind bis zu nachfolgend genannten Grenzseegang sicherzustellen.

Rollwinkel =  $\pm 24^\circ$

Rollperiode = 7 sec

- **Gewicht**

Ein Betriebsgewicht von 6000 kg soll nicht überschritten werden.

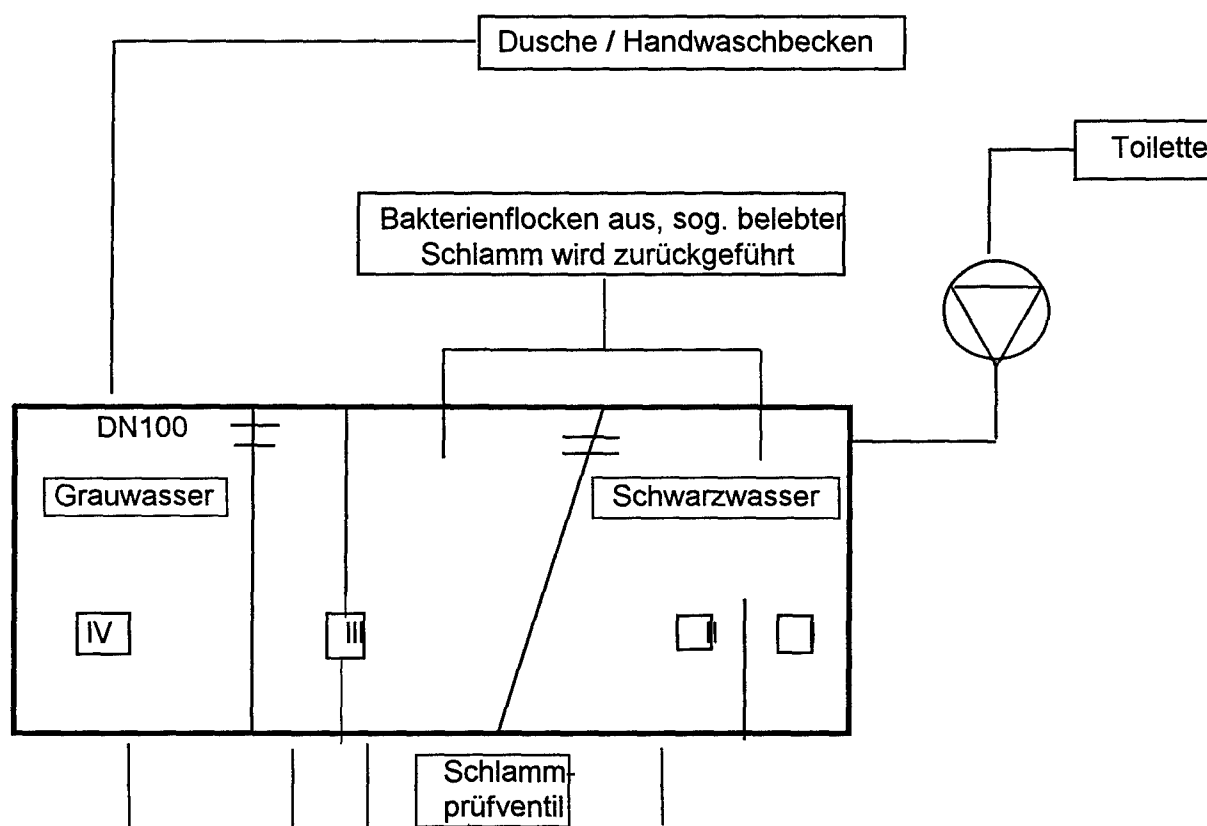
- **Ausführung/Komponenten**

- Zur Vermeidung von Schäden und Verstopfungen in der Anlage, ist vor dem Einlauf ein Feinsiebrechen zu installieren.
- Die Schlammrückführung sowie die Zuführung des Abwassers in das Belebungsbecken sollte möglichst mit Exzentrerschneckenpumpen erfolgen.
- Anstatt Schwimmerschalter sind Drucktransmitter vorzusehen.
- Wenn das Verfahren es ermöglicht, ist zur Entkeimung eine UV - Entkeimungsanlage vorzusehen (Klarwasserablauf nach der Druckentspannungsflotation).

### 3 Vorhandene Abwasseraufbereitungsanlage Typ "MSTP 1"

Die nachstehend beschriebene Abwasseraufbereitungsanlage sollte optimiert und modifiziert werden.

Abb. 1 zeigt eine vereinfachte Darstellung der im Mehrzweckboot vorhandenen Abwasseraufbereitungsanlage.



- I : Sammel - Tank - Sektion
- II : Belüftungs - Mischtank - Sektion
- III : Setz - Tank - Sektion
- IV: Desinfektion - Tank - Sektion

Abb. 1: Vereinfachte Darstellung der im Mehrzweckboot "Klein" vorhandenen Abwasseraufbereitungsanlage.

Die Verweildauer in den Zellen I bis III beträgt insgesamt ca. 18 - 24 h. In Zelle IV wird automatisch mit Hilfe einer Dosierpumpe 165 g/m<sup>3</sup> Desinfektionsmittel Format – Aktivator zugegeben, wodurch keine Kolibakterien mehr ins Fahrwasser gelangen.

Die Abwasseraufbereitungsanlage Typ MSTP 1 ist für eine Abwassermenge von max 6600 Liter pro Tag ausgelegt. Sie ist durch die US-Coast Guard zum Betrieb auf unkontrollierten Wasserfahrzeugen abgenommen und entspricht der Kategorie II der US-Coast Guard – Vorschrift 33 CFR 159.

#### **4 Betriebsprobleme bei vorhandener Anlage, Typ "MSTP 1"**

Eine durchgeführte Systemanalyse der vorhandenen Abwasseraufbereitungsanlage (AWA) vom Typ "MSTP 1" zeigte, daß diese trotz intensiver Wartung nicht im vorhergesehenen Rahmen arbeitet und die erwünschten Ergebnisse bringt.

So kann sich durch eine mangelhafte Schlammrückführung keine einwandfrei arbeitende Biologie mit eigenem Belebtschlamm bilden. Außerdem werden die gewünschten Absetzvorgänge im Bereich der Sedimentationsstufe durch die vorhandenen Schiffsbewegungen be- oder sogar ganz verhindert.

#### **5 Lösung der Betriebsprobleme**

In immer größerem Umfang wird heute bei Kläranlagen die konventionelle Sedimentation durch eine Flotation ersetzt.

Die Gründe liegen nicht nur in der Platzersparnis einer Flotationsanlage gegenüber einem Sedimentationsbecken.

Um den Einsatz einer **AQUATECTOR**<sup>®</sup> – Druckentspannungsflotation darzustellen wird hier zuerst eine ausführliche Darlegung der Mikroflotation gegeben.



## 5.1 Ausführliche Darlegung der Mikroflotation

Die Löslichkeit eines Gases in einer Flüssigkeit ist temperaturabhängig und proportional zum Partialdruck des Gases über der Flüssigkeit, Henry Dalton'sches Gesetz. Bei einer Entspannung wird die zu dem Druckabfall zugehörige Differenz an Gasmenge in Form von Blasen frei, sofern jeweils der zum Druck zugehörige Sättigungszustand erreicht wurde. Der Aufsättigungsvorgang ist jedoch ein kinetischer Prozeß, welcher von der Phasengrenzfläche, Turbulenz, Strömungsführung und Verweilzeit im Sättiger abhängig ist.

Für den Grenzwert der Sättigung werden bei den üblicherweise eingesetzten Druckkesseln ca. 50 bis 90 % der maximalen Sättigungskonzentration angegeben. In verfahrenstechnisch günstiger ausgelegten Anlagen durch Kombination von Düsensystemen und Mischrohren (z.B. **AQUATECTOR**<sup>®</sup>) können Sättigungsgrade von größer 95% bis nahezu 100% erreicht werden. Diesem Faktum wird leider zu wenig Aufmerksamkeit geschenkt. Geht man davon aus, daß der größte Teil der Energiekosten, die bei der Flotation anfallen, durch die Erzeugung der Gasblasen verursacht werden, wird die Bedeutung des Sättigungsgrades deutlich. Darüber hinaus erlaubt eine hohe Sättigung des Recyclevolumenstromes, die hydraulische Belastung des Flotationsbeckens zu verringern. Außerdem ist der Vergleich verschiedener Anlagen beispielsweise im Recyclestromverhältnis, dem Recyclevolumenstrom bezogen auf den Durchsatz problematisch, wenn der Sättigungsgrad unberücksichtigt bleibt.

Abgesehen von dem eingetragenen Gasstrom bezogen auf die Feststoffmenge, spielt die bei der Entspannung entstehende Blasengröße eine für das Flotationsergebnis bestimmende Rolle. Die Anlagerung von Luftbläschen an Feststoffe findet um so leichter statt bzw. ist intensiver, je kleiner die Bläschen sind. Wegen der besseren Anlagerungsfähigkeit kleiner Blasen führt die Verringerung der Blasengröße einerseits zu einer verbesserten Ausnutzung der eingetragenen Luft und andererseits zu einer vollständigeren Austreibung des Feststoffs, wodurch sowohl die Feststoffkonzentration im Klarlauf sinkt, als der Feststoffgehalt im Flotat und die Stabilität der Flotatdecke zunimmt.

Aus der gesamten Blasentheorie, die die Grundlage für die Flotation mathematisch beschreibt, ist der Einfluß der Blasengröße im Zusammenhang mit der Auftriebsge-

schwindigkeit nicht berechenbar d.h., die Effektivität des Massenverhältnisses, Luft zu Feststoff, in Bezug auf den Wirkungsgrad, ist durch eine Vielzahl von experimentellen Versuchen nachgewiesen. Die Ausbildung der Entspannungsorgane liegt im besonderen Know How der Enviplan Ingenieurgesellschaft mbH. Nach empirischen Untersuchungen nimmt bei einer Druckerhöhung von 2 auf 4 bar der mittlere Blasendurchmesser von ca. 140  $\mu\text{m}$  auf 50  $\mu\text{m}$  ab.

Diese Untersuchungen sind am Druckkesselbegaser durchgeführt worden, in dem ein Sättigungsgrad von lediglich 50% bis 90 % erreicht werden kann. Durch die Erhöhung des Sättigungsgrades auf 99 % verschiebt sich die Summenhäufigkeitskurve des Blasendurchmessers. Auch hier wird deutlich, daß bei gleichem Energieeintrag jedoch besserem Wirkungsgrad bzw. Sättigungsgrad des Begasers, die Feststoffabtrennung durch Flotation effektiver wird.

Steiggeschwindigkeit und Gasblasenzahl sind wesentliche Kenngrößen der Entspannungsflotation.

In den beiden folgenden Abbildungen ist die Steiggeschwindigkeit von Luftblasen über 1 mm Durchmesser dargestellt. Die Steiggeschwindigkeit steigt bis etwa 2 mm steil an, und fällt bei 5 mm wieder leicht ab und steigt dann wieder kontinuierlich an.

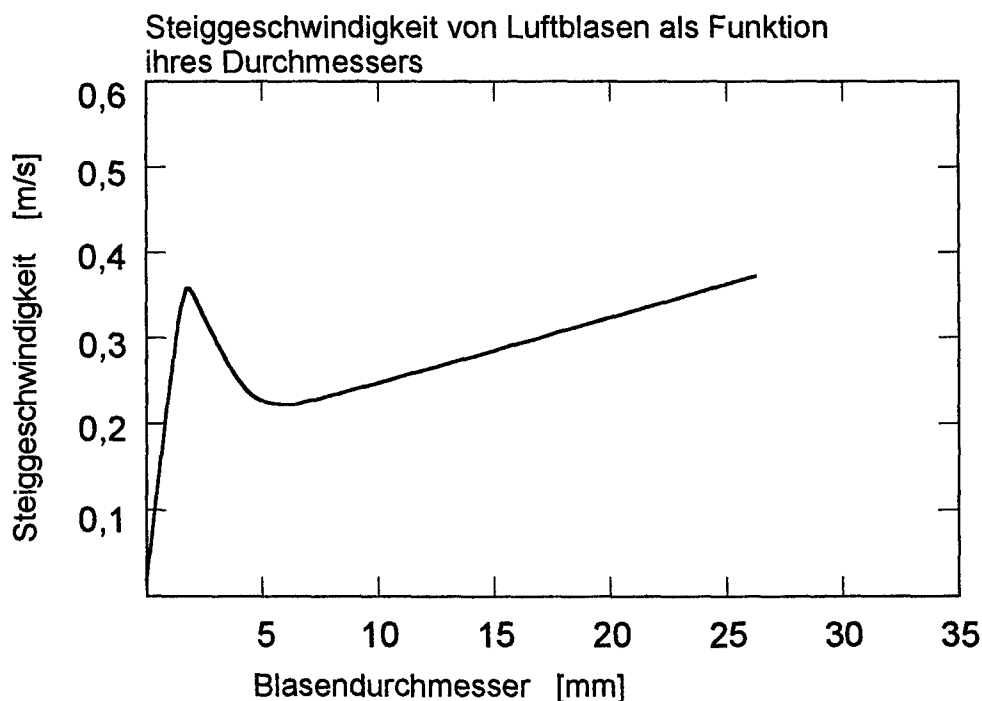


Abb. 2: Steiggeschwindigkeit von Luftblasen als Funktion ihres Durchmessers.

In der nächsten Abbildung wird noch einmal die Abhängigkeit der Steiggeschwindigkeit von Luftblasen mit einem Blasendurchmesser  $d < 1\text{ mm}$  verdeutlicht.

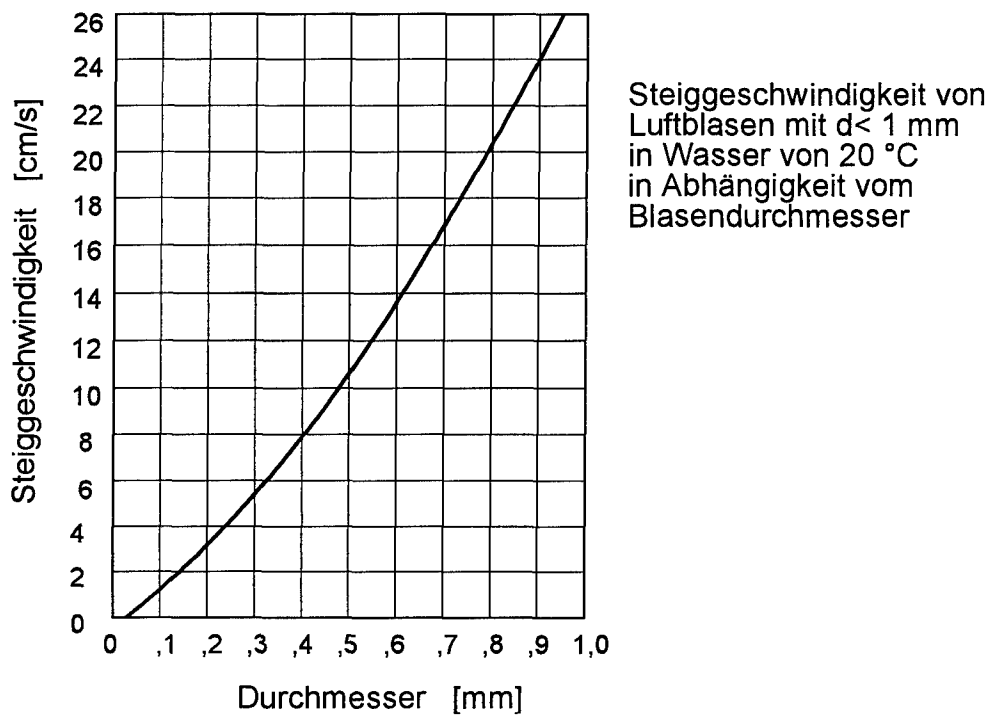


Abb. 3: Abhängigkeit der Steiggeschwindigkeit von Luftblasen mit einem Blasendurchmesser  $d < 1\text{ mm}$

Der Einfluß verschiedener Parameter auf die Blasengröße wird in der nachfolgenden Tabelle aufgezeigt.

| Einfluß verschiedener Parameter auf die Bildung   |                                                                                    |
|---------------------------------------------------|------------------------------------------------------------------------------------|
| großer Blasen                                     | kleiner Blasen                                                                     |
| niedriger Sättigungsdruck                         | hoher Sättigungsdruck                                                              |
| hohe Oberflächenspannung                          | niedrige Oberflächenspannung                                                       |
| pH - Wert < 7 saurer Bereich                      | pH - Wert > 7 alkalischer Bereich                                                  |
| niedrige Viskosität $\eta$                        | hohe Viskosität $\eta$                                                             |
| hohe Überströmgeschwindigkeit $w$<br>$w > 40$ m/s | niedrige Überströmgeschwindigkeit $w$<br>dabei jedoch turbulent $w \sim 15-40$ m/s |

Abb. 4: Einfluß verschiedener Parameter auf die Blasengröße

Da es ein universales Mischsystem für alle zu behandelnden Abwässer nicht gibt, werden spezielle Ausbildungen notwendig, die den Einmischbereich der Flotationsanlage dem jeweilig zu behandelndem Abwasser anpassen.

Für die Gestaltung sind folgende Parameter ausschlaggebend:

- Art der zu flotierenden Partikel

Stabile Flocken oder Fasern überstehen eine hoch turbulente Mischung eher, als eine wenig scherstabile Flocke. Der erhöhte Einsatz von FM und FHM erzeugt zwar bei vielen Wässern eine gute Stabilität der Flocke, beeinflusst jedoch die Kosten der Wasserbehandlung .

Auf den ersten Blick bedeutet eine kräftige Durchmischung einen Vorteil. Abwasser und Entspannungsblasenstrom ergeben ein optimales Gemenge. Durch die auftretenden Scherkräfte werden aber nicht nur die Flocken beansprucht. Die Mikroblasen können leicht größere Blasen, besonders an den Wänden des Mischsystems (Rohr oder Kammer) bilden.

- **Stabilität der Flotatdecke**

Bei einem stark turbulenten Mischraum -(stark turbulent deshalb, weil ein Mischraum mit einer laminaren Strömung sowieso nicht zu realisieren ist und auch kaum noch den Namen Mischraum verdienen würde)- setzt sich die Bewegung bis an die Beckenoberfläche fort. Im vorderen Teil des Flotationsbeckens kann sich keine gute Flotatdecke aufbauen.

Im ungünstigsten Fall besteht die Gefahr des zu schnellen Entgasens, d.h., neben den obersten Schwebeteilchen geben auch untere ihre Transporteure ab.

Zusammenballungen können durch den "Flotatteppich" nicht mehr gehalten werden und sinken besonders im hinteren Bereich des Becken auf den Boden.

## **6 Technische Anwendung der Druckentspannungsflotation**

Die Druckentspannungsflotation läßt sich in der Abwassertechnik in vielen Bereichen für die Abtrennung von Textil- und Papierfasern, Belebtschlamm, mineralische, pflanzliche und tierische Öle und Fette, Flocken, Staub, pflanzliche und tierische Zellverbände, kolloidale Stoffe, Tenside und weiteres einsetzen.

Die Flotationsverfahren sind somit für Feststoffe unterschiedlichster Art und Struktur geeignet, deren Abtrennung beispielsweise auf Grund der Dichte, der Größe oder der Konsistenz durch Sedimentation, Zentrifugation oder Filtration nicht, schwierig oder nur mit hohem technischen Aufwand möglich ist.

Dabei kann das Ziel der Flotation in der Abwasserreinigung sowohl im Sinne einer Schmutzlastverminderung, als auch in dem Gewinn von rezirkuliertem Prozeßwasser oder verwertbarem suspendierten Inhaltstoffen liegen.

### **6.1 Systembedingte Vorteile der Mikroflotation**

Die **AQUATECTOR®**-Druckentspannungsflotation in der Nachklärung ist auch in groß-technischen Anlagen für z.B. 1000 m<sup>3</sup>/h nachgewiesen.

Die wesentlichen und systembedingten Vorteile liegen in nachfolgend beschriebenen Punkten:

- Die **AQUATECTOR**<sup>®</sup>-Druckentspannungsflotation ist in einem vergleichsweise großen Bereich unempfindlich gegenüber Schwankungen des Feststoffgehaltes im Zulaufwasser.
- Recyclestrom und/oder Dispersionsdruck bzw. Luftblasenmenge können an den jeweiligen Belastungsfall angepaßt werden.
- Es entstehen keine zusätzlichen eigengenerierten Abwasser- bzw. Feststoffströme (z.B. in Form von Rückspülwasser), die ihrerseits eine zusätzliche Belastung der bestehenden Klärvorrichtungen bedeuten.
- Der Feststoffaustrag im Flotat mit TS-Gehalten von in aller Regel 4 bis 7% bedeutet eine drastische Verringerung des Schlammvolumens. Dies trifft auch für Fälle zu, bei denen bedingt durch Chemikaliengabe (z.B. Phosphatfällung) zwangsläufig zusätzliche Feststoffmengen anfallen.
- Durch die verfahrensbedingte Zufuhr von Luft in feinstverteilter Mikroblasenform kommt es quasi als Nebeneffekt zu einer Sauerstoffanreicherung im Abwasser. Bildet die **AQUATECTOR**<sup>®</sup>-Druckentspannungsflotation den letzten Verfahrensschritt, so bedeutet diese Sauerstoffanreicherung im Kläranlagenauslauf eine weitere Entlastung des Sauerstoffhaushaltes des Vorfluters.

In der industriellen Verfahrenstechnik hat das **AQUATECTOR**<sup>®</sup>-Flotationsverfahren wegen seiner vielfältigen verfahrenstechnischen und betrieblichen Vorzüge bereits seit vielen Jahren seinen festen Platz; aber auch die kommunale Abwasserreinigung bedient sich in zunehmendem Maße dieser erprobten und effektiven Technologie.

Auf kommunalen Kläranlagen bestehen verschiedene Möglichkeiten für den Einsatz der **AQUATECTOR®**-Flotation:

Die Sanierung von hydraulisch und/oder mit organischen Schmutzstoffen überlasteten mechanisch-biologischen Anlagen, wobei die **AQUATECTOR®**-Druckentspannungsflotation als Entlastung der bestehenden Vorklärung dienen kann. Wie die Ergebnisse aus der Praxis zeigen, werden ohne Zugabe von Fällungs/Flockungschemikalien auf diesem Wege CSB-Eliminationen im Bereich von 30 bis 50% erreicht; durch Zugabe von solchen Chemikalien und polymeren Flockungshilfsmitteln kann die CSB-Eliminationsrate bis deutlich über 70% gesteigert werden.

Weitergehende Feststoffabscheidung aus dem Kläranlagenablauf. Bei dieser Aufgabenstellung bestehen unterschiedliche betriebliche Varianten:

- Entlastung der bestehenden Nachklärung durch Parallelbetrieb einer **AQUATECTOR®**-Flotationanlage (= Teilstrombetrieb).
- Flotative Nachbehandlung des gesamten Ablaufs der bestehenden Nachklärung (= Vollstrombetrieb).

Ersatz der bisherigen Nachklärung bei überalterten und damit funktionsuntüchtigen Sedimentationsbecken.

## 6.2 Vorteile der **AQUATECTOR®** - Flotationstechnik für Schiffskläranlagen

Vor allem die folgenden Vorteile geben der **AQUATECTOR®** - Flotationstechnik eine gute Zukunft für die Modifikation bereits bestehender bzw. als unersetzliche Komponente für neu konzipierte Schiffskläranlagen:

- Hoher TS-Gehalt im Flotat

Der Flotatschlamm wird höher komprimiert als der Sedimentschlamm. Dadurch wird eine stabilere Masse erzeugt.

- Entfernung von "richtigen" Schwebstoffen ohne Chemikalienzufuhr

Je feiner und leichter ein partikulärer Wasserinhaltsstoff ist, desto schlechter ist sein Absetzverhalten. Viele richtige Schwebstoffe mit einer Dichte in der Nähe von Wasser setzen sich nur nach sehr langer Zeit ab (Gärungsprozesse nach Tagen z.B., wobei sie auch durch Gasentwicklung teilweise aufsteigen können) oder müssen mit Hilfe von Flockungsmitteln (z.B. Fe Cl<sub>3</sub>) zu sedimentierenden Verbänden zusammengefaßt werden.

Bei der Flotation wirkt der Mikroblasennebel wie ein Transportmittel. Somit werden auch Partikel mit der Dichte von Wasser mit an die Oberfläche flotiert.

Vor allem die vollständige Entfernung der Schwebstoffe aus dem Ablauf der Biologie bewirkt zum Einen eine stark reduzierte Schmutzfracht, die somit das Schiff erst gar nicht verläßt und zum Anderen wesentlich bessere Voraussetzungen für die optimale Zugabe des Desinfektionsmittels und die damit verbundene Keimfreiheit des Kläranlagenablaufes.

- Aerober Betrieb

Bei der Flotation wird eine anaerobe Umgebung durch die stetige Luftsauerstoffzufuhr vermieden.

Der Rücklaufschlamm wird somit aktiv in die Biologie zurückgefördert.



- Schiffsbewegungen

Das Sediment ist aufgrund seiner geringen Komprimierung empfindlich gegen Bewegungen. Die flotative Behandlung kann man gegenüber der Sedimentation als Zwangsentfernung von Wasserinhaltsstoffen ansehen.

Während bei der Sedimentation nur die Erdanziehung für den Absetzvorgang sorgt, wird bei der Flotation die Entfernung durch eine Trägermasse aus Mikroblasen, ähnlich einer Filterdecke, durchgeführt.

Der ständig nachwachsende Mikroblasenteppich hält den entstehenden Flotatschlamm auch bei Bewegungen bis zu einer bestimmten Stärke in Schwebe und bewirkt eine kontinuierliche Komprimierung der abgetrennten Biomasse.

Nach den bisherigen Betrachtungen erscheint der Einsatz einer Flotationsanlage im Bereich der Nachklärung am sinnvollsten.

## 7 Integration der **AQUATECTOR®** - Flotationstechnik

Im Bereich der derzeitigen Nachklärung läßt sich vom vorhandenen Platz her eine Flotationsanlage unterbringen. Die folgende Abbildung zeigt das **AQUATECTOR®** - Flotationsmodul.

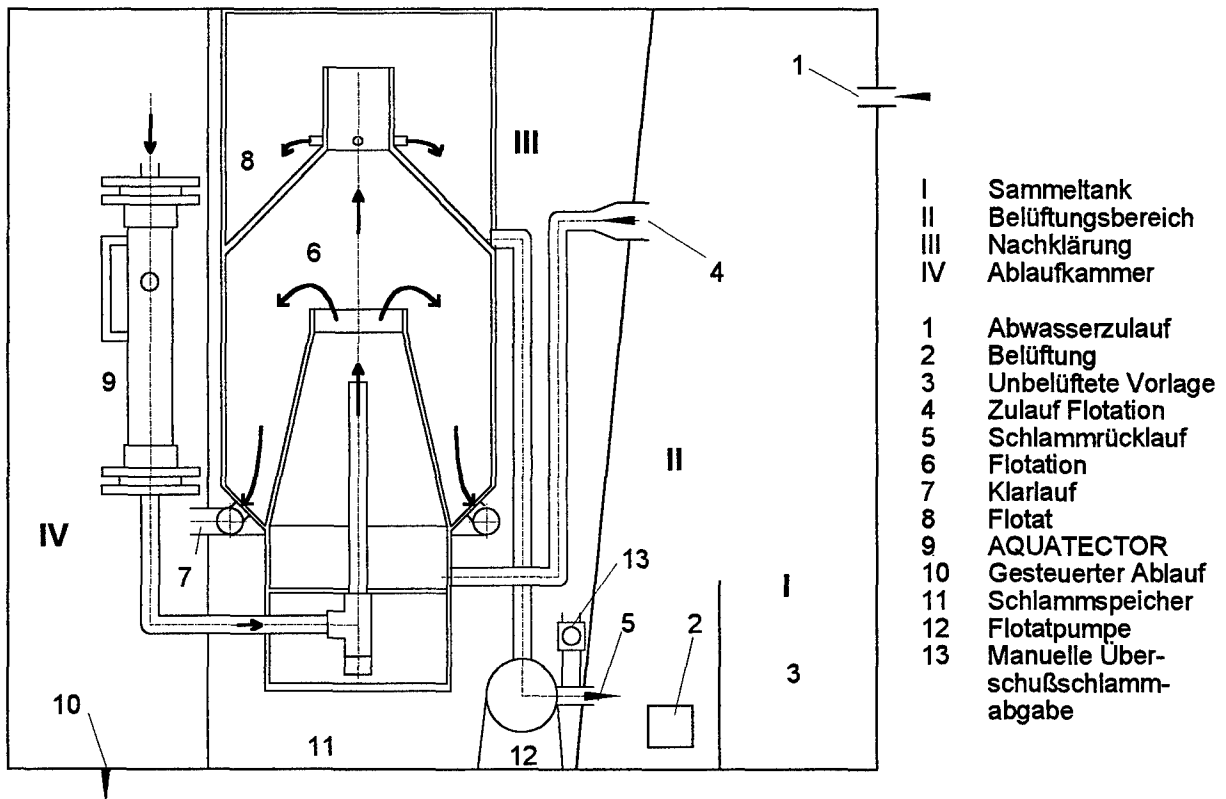


Abb. 5: Das **AQUATECTOR®** - Flotationsmodul.

Das **AQUATECTOR®** - Flotationsmodul läßt sich im Bereich der ehemaligen Absetzkammer einsetzen. Der verbleibende Platz um die Flotationsanlage läßt sich als Speicher für den Überschußschlamm nutzen.

Die **AQUATECTOR®**-Dispergierstation sollte zugänglich (mitsamt der benötigten Recyclepumpe) außen an der Anlage installiert werden.

Die Flotationsanlage ist durch eine vorhandene Luke in das Schiff einzubringen. Probleme können beim Einbau in die vorhandene Anlage auftreten, da die Vorderwand wahrscheinlich aufgetrennt werden muß.

## 7.1 Funktionsweise

Die Führung des Wassers sollte von dem vorhandenen Verfahren übernommen werden (Grauwasser getrennt von Küche und Toilette).

Das zu behandelnde Wasser wird der Biologie zugeführt und dort wie bisher belüftet. Hier sollte auf jeden Fall die Möglichkeit einer Sauerstoffmessung und Regelung des Gebläses in Betracht gezogen werden.

Der Ablauf aus der Biologie erfolgt im freien Fall in den Mischraum des **AQUATECTOR®** - Flotationsmoduls.

In diesem Mischraum werden der Belebtschlamm und der Entspannungsstrom des **AQUATECTOR®** 's miteinander vermischt.

Die nächste Abbildung zeigt das den **AQUATECTOR®** , die Entspannungseinheit und die Flotationskammer.

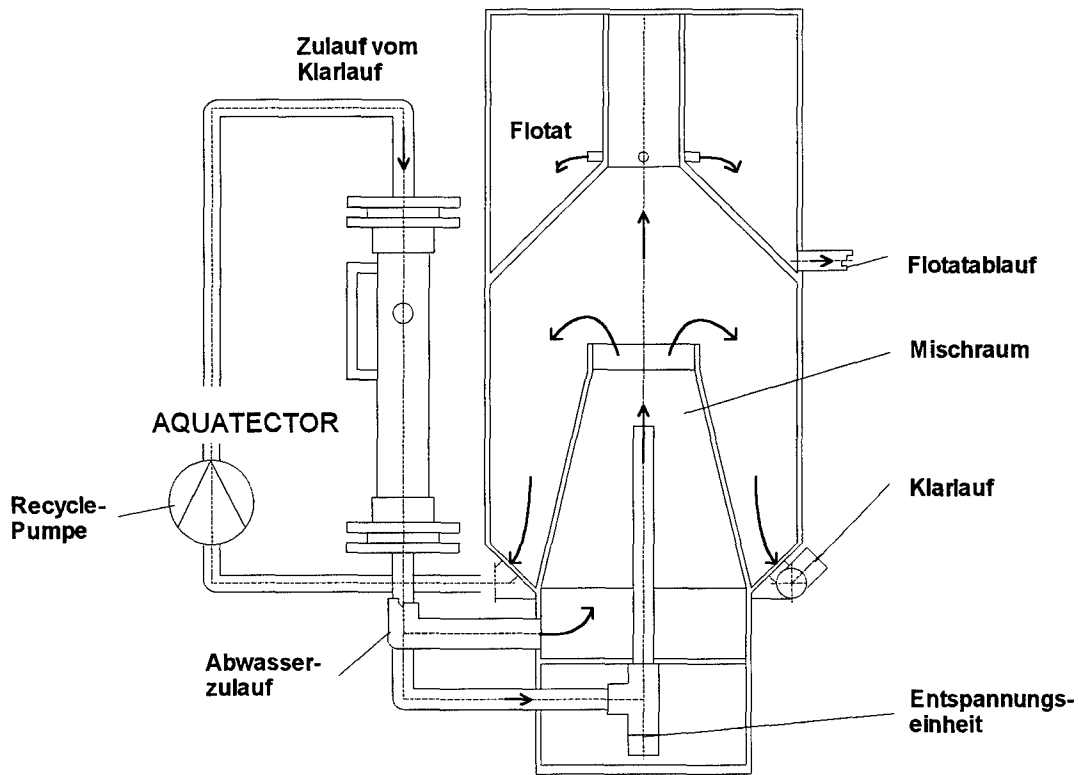


Abb. 6: **AQUATECTOR®**, Entspannungseinheit und Flotationskammer.

Die Mikroluftblasen heften sich an die partikulären Wasserinhaltsstoffe (oder auch umgekehrt) und transportieren sie an die Oberfläche des Mischraumes.

Der Mischraum verjüngt sich nach oben. Die Flotatdecke wird somit komprimiert und zum Überlaufrohr gedrückt.

Das Überlaufrohr ist so ausgebildet, daß ein sicherer Flotatablauf auch bei schwankendem Schiff gewährleistet ist.

Das Flotat - Rücklaufschlamm - wird über eine Druckluftpumpe zurück zur Biologie gefördert. Überschußschlamm muß über einen manuellen Schieber zeitweise kontrolliert abgegeben werden. Dazu ist eine Kontrolle des Belebtschlammes in der Biologie notwendig.

Das gereinigte Wasser wird über einen Ringkanal am Boden des Reaktions-(Trenn - ) Raums zur Sektion IV abgeleitet.

Der **AQUATECTOR®** entnimmt über eine Pumpe seinen Teilstrom ebenfalls diesem Kanal. Aus dem Ablaufbereich wird das Wasser weiterhin über die niveaugesteuerte Pumpe entfernt.

Der anfallende Überschußschlamm wird im freibleibenden Raum der ehemaligen Nachklärung gesammelt und muß wie der Inhalt des Fettfanges entsorgt werden.

## 8 Zusammenfassung

Das dargestellte **AQUATECTOR®** Flotationsverfahren stellt eine sehr gute neue Verfahrensalternative zur herkömmlichen Abwasseraufbereitung auf Schiffen dar.

Das **AQUATECTOR®** Flotationsverfahren, das sich zur Zeit in der dynamischen Erprobungsphase befindet, zeigt auch bei hoher Belastung (Abwasserkonzentration, dynamische Betriebsweise) seine positiven Eigenschaften.

Neben der hier aufgeführten Anwendung eignet sich das Verfahren auch für die Abwasserreinigung einer großen Anzahl von Personen (Schiffsbesatzung und/oder Passagiere). Auch dabei würden sich die positiven Eigenschaften des **AQUATECTOR®** - Flotationsverfahren zeigen. Neben einer stetig guten Abwasserreinigung könnte auch hier die notwendige Einbaugröße den gegebenen, meistens beschränkten Bedingungen angepaßt werden.

Zusätzlich befindet sich die Anwendung der **AQUATECTOR®** - Flotationstechnik zur Reinigung des Belastwassers von Schiffen in einer Vorversuchsphase und läßt auch hier wieder positive Ergebnisse erwarten.

## 9 Literaturverzeichnis

Die zur Bearbeitung der Realisierbarkeitsstudie in Anspruch genommene Literatur:

- Lehr- und Handbuch der Abwassertechnik  
Band 3 :  
Grundlagen für Planung und Bau von Abwasserkläranlagen und mechanische Klärverfahren  
Dritte, überarbeitete Auflage  
Ernst & Sohn; Verlag für Architektur und technische Wissenschaften, Berlin
- Lehr- und Handbuch der Abwassertechnik  
Band 4 :  
Biologisch-chemische und weitergehende Abwasserreinigung  
Dritte, überarbeitete Auflage  
Ernst & Sohn; Verlag für Architektur und technische Wissenschaften, Berlin 1985
- Lehr- und Handbuch der Abwassertechnik,  
Band 5.  
Hrsg. Abwassertechnische Vereinigung,  
Ernst & Sohn; Verlag für Architektur und technische Wissenschaften, Berlin  
1985.
- Kleinert, P.:  
Münchener Beiträge zur Abwasser-, Fischerei- und Flußbiologie,  
Band.38. R. Oldenburg Verlag,  
München 1984.
- Technologie und Anwendung der Entspannungsflotation in der  
Abwasserreinigung. Wasser, Luft und Betrieb, 19,  
1975

- Patente:  
DE 3501 175 C2,  
EP 208696, US 4 735 750,  
N 51760-SS - 863684,  
CAN 571 069-3.  
enviplan-Ingenieur GmbH, Lichtenau-Henglarn, Westfalen.
- Abwassertechnik in der Produktion  
Hempel, Dietmar, Band 2
- Konstruktion und Untersuchung einer Mischraumdüse für die Verbesserung des Lufteintrags einer Druckbegasungsanlage  
Studienarbeit Finkeldei, Uni / GH Paderborn, Matr.-Nr. 3448874,
- Berechnungsgrundlagen für Preßluft-Ölsperren, Dissertation  
Stehr, E.: Fakultät für Bauwesen der TH Hannover.
- Die wirtschaftliche Anwendung der Flotation mit sehr kleinen Luftblasen zur Reinigung von Abwasser,  
Hanisch, B.  
Kommissionsverlag Oldenburg, München 1960.
- Anwendung der Entspannungsflotation bei der Abwasserreinigung in der chemischen Industrie.  
Bennoit, H.
- Verfahrenstechnik der Abwasserreinigung. Preprints GVC-Diskussionstagung,  
Baden-Baden 1988.
- Reaktionstechnische Untersuchungen zur Flotation mit gleichzeitiger Entkeimung  
Becker, Ralf-Jürgen  
Uni - GH Paderborn, Tech. Chemie und Chemische Verfahrenstechnik

- Vergleichende Untersuchungen zur Druckentspannungs- und Begasungsflotation von Emulsionen und Suspensionen in einem pH - Bereich von 6,8 - 7,3  
Walter, Jürgen  
TU Berlin, Energie- und Verfahrenstechnik
- Untersuchung über Möglichkeiten der Einflußnahme auf das Entspannungsverhalten von Ventilen bei der Flotation  
Breidenbach, Markus  
Uni - GH Paderborn, Tech. Chemie und Chemische Verfahrenstechnik
- Airlifreaktoren mit inversem inneren Umlauf - Design und Scale up -  
Dipl.-Chem. Birgit Kochbeck, Paderborn  
Fortschrittberichte VDI  
Reihe 3: Verfahrenstechnik Nr.409
- Flotationsversuche auf der KA Grundsteinheim  
Zeitraum : 30.11 - 14.12.1989  
Uni - GH Paderborn, enviplan Ing. GmbH, Saarberg Interplan GmbH
- Flotationsversuche auf der KA Grundsteinheim (Versuchsprogramm)  
Uni - GH Paderborn, enviplan Ing. GmbH, Saarberg Interplan GmbH
- Flotationsversuche der Saarberg Interplan GmbH auf der Kläranlage St.Wendel  
Zeitraum: Juni/Juli 1989, Saarberg Interplan GmbH
- Klärschlammabtrennung durch Entspannungsflotation  
Versuchsbericht über den Einsatz einer Anlage auf der Kläranlage Lebach  
Uni-GH Paderborn, enviplan Ingenieur GmbH, Saarberg Interplan GmbH
- **AQUATECTOR®** Flotationsanlage im Einsatz der Kläranlage Lebach des  
Abwasserverbandes Saar  
enviplan Ingenieur GmbH



- **AQUATECTOR**<sup>®</sup> -Technologie in der modernen Abwasserbehandlung  
Grundlagen und Anwendungsgebiete  
Firmenschrift enviplan Ingenieur GmbH
- Einsatz des **AQUATECTOR**<sup>®</sup> 's für Flotationsprozesse  
Firmenschrift enviplan Ingenieur GmbH
- ATV (Abwassertechnische Vereinigung e.V.)  
Desinfektion von Abwasser  
Hinweis H 205  
DK 628.322 Regelwerk Abwasser Abfall, Oktober 1993
- Ultraviolet disinfection of wastewaters from secondary effluent and combined sewer overflows  
O.Karl Scheible  
Maureen C. Casey  
Angelika Forndran  
Port Richmond Studie
- Abwasserfiltration  
Grundlagen, Betriebserfahrungen, Entwicklungstendenzen  
ATV Dokumentation und Schriftenreihe aus Wissenschaft und Praxis  
St. Augustin 1992
- ATV Regelwerk Abwasser Abfall  
Arbeitsblatt ATV - A203  
Abwasserfiltration durch Raumfilter nach biologischer Reinigung  
April 1995

**Innovative Waste Water Treatment on Ships With the WABAG  
Membrane Bio-Reactor System**

Dr. Angelika Kraft  
Dr. Martin Brockmann  
WABAG ESMIL GmbH  
Germany

**ABSTRACT**

The WABAG Membrane Bio-Reactor System is based upon submerging a membrane filtration process within the activated sludge sewage treatment tank. By this arrangement, the energy required for aeration of the biological process also generates an upward cross flow over the membrane surfaces keeping the membrane surfaces clean. The absence of primary and secondary settlement stage allows the use of high activated sludge strength in a very low volume tank, and directly provides excess sludge of > 2% thickness.

A pilot plant was tested more than 9 months under aboard ship conditions. The aim of the trial was to determine operational and system performance in terms of effluent quality excess sludge production, membrane efficiency and reliability.

Effective treatment was achieved during the whole test phase with a very high reliability. The effluent quality from the system remained consistently high during the trial period. Suspended solids, BOD, COD and faecal coliforms in the final effluent were at or close to the detection limit of the analytical tests employed. No membrane failures or significant operational problems even under "aboard ship" conditions have been encountered to date.



## **Innovative Schiffsabwasserbehandlung mit dem WABAG Membrane Bioreaktor System**

Dr.-Ing. Angelika Kraft and Dr. Martin Brockmann, WABAG ESMIL GMBH, Ratingen

### **Abstract**

The WABAG Membrane Bioreaktor System is based upon submerging a membrane filtration process within an activated sludge sewage treatment tank. By this arrangement, the energy required for aeration of the biological process also generates an upward cross-flow over the membrane surfaces keeping the membrane surfaces clean. The absence of a primary and secondary settlement stage allows the use of high activated sludge strength in a very low volume tank, and directly provides excess sludge of > 2 % thickness.

A pilot plant was tested more than 9 month under aboard ship conditions. The aim of the trial was to determine operational and system performance in terms of effluent quality excess sludge production, membrane efficiency and reliability.

Effective treatment was achieved during the whole test phase with a very high reliability. The effluent quality from the system remained consistently high during the trial period. Suspended solids, BOD, COD and faecal coliforms in the final effluent were at or close to the detection limit of the analytical tests employed. No membrane failures or significant operational problems even under "aboard ship" conditions have been encountered to date.

### **→ Einführung**

Membranen werden heute in einer ständig breiter werdenden Palette verschiedenster Anwendungen großtechnisch eingesetzt.

Hohe Reinigungsleistung bei niedrigen Betriebskosten, geringe Schlammproduktion mit hoher Anpassungsfähigkeit auch an große Schwankungen in der Abwasserbeschaffenheit und möglichst geringer Platzbedarf sind heute Anforderungen an ein modernes Abwasserreinigungssystem, die durch den Einsatz optimierter Membranverfahren problemlos erfüllt werden können.

-2-

Bei der Abwasseraufbereitung werden insbesondere im Zuge strenger werdender Anforderungen an die Ablaufqualität fallweise Nachklärbecken und Sandfilter durch Niedrig-Energie-Mikrofiltrationsanlagen ersetzt.

In diesem Bereich wurden und werden in Europa Pilotstudien durchgeführt, so daß mittlerweile zu den verschiedensten Anwendungen fundierte Erfahrungen vorliegen. In England und Japan sind derartige Anlagen (> 140) schon seit einigen Jahren erfolgreich in Betrieb (Tabelle 1).

|                     | Kapazität                                                  | erste Installation | Anzahl der gebau-ten Anlagen |
|---------------------|------------------------------------------------------------|--------------------|------------------------------|
| Kommunales Abwasser | bis 6000 m <sup>3</sup> /d<br>max 12.700 m <sup>3</sup> /d | 1989               | 71                           |
| Schlammbehandlung   | bis 300 m <sup>3</sup> /d                                  | 1991               | 23                           |
| Industrieabwasser   | bis 1000 m <sup>3</sup> /d                                 | 1994               | 50                           |

**Tabelle 1: Derzeitige Referenzen von SMS-Anlagen**

Auch die derzeitige Schiffsklärtechnik arbeitet in der Regel mit einer möglichst klein-räumigen hochbelasteten biologischen Reinigungsstufe und einer nachgeschalteten, zumeist chemischen, Desinfektion. Schiffbauliche Gegebenheiten und Funktionalitäten lassen Bau und Betrieb einer betriebssicheren Belebungsanlage nicht zu. Die Sedimentation in der Nachklärung wird durch die Vibration der Antriebsaggregate und durch die Bewegungen des gesamten Schiffes nachhaltig gestört.

Die Verfahrenstechnik einer Membranbelegung bietet an dieser Stelle einen leistungsfähigen Ansatz, da durch den Einsatz einer Mikrofiltration der belebte Schlamm sicher in der belüfteten Stufe zurückgehalten wird. Dadurch werden hohe Feststoffgehalte sicher-gestellt und gleichzeitig ein hygienisch unbedenklicher Ablauf gewährleistet. Eine opti-

male Verfahrenstechnik für diesen Einsatzfall ist die WSMS - Verfahrenstechnik, welche getauchte Plattenmembranen im Niederdruckbetrieb einsetzt. Versuche mit einer Test-anlage über mehr als 12 Monate konnten erfolgreich durchgeführt werden und bestä-

tigen die Leistungsfähigkeit des Systems. Aufbauend auf den Erfahrungen aus den Pilotversuchen wurde eine Schiffskläranlage konzipiert.

### → Funktionsweise des WABAG SMS-Verfahrens

Die Kombination eines Belebungsbeckens mit einer Partikel abfiltrierenden Membran zur Schlammrückhaltung wird als Membranbiologie bezeichnet. Die Schlammrückhaltung und die Abtrennung des gereinigten Abwassers erfolgt beim WSMS- (WABAG submergend membrane system) Verfahren durch den Einsatz von Mikrofiltrationsmembranen, die direkt in das Belebungsbecken eingetaucht sind. Neben der Platzersparnis durch den Wegfall des Nachklärbeckens kann mit Hilfe der Membranen die biologische Stufe mit einer Schlamm Trockensubstanz von ca. 20 g/l betrieben werden, was einerseits die Größe des Belebungsbeckens deutlich vermindert und andererseits durch den Filtrationseffekt eine äußerst hohe Reinwasserqualität in bezug auf Bakterien, Keime und abfiltrierbare Stoffe erzeugt.

Im Gegensatz zu den bisher eingesetzten Verfahren, wird bei dem WABAG SMS-Verfahren keine zusätzliche Energie zur Umwälzung bzw. für den Cross flow ein-gebracht. Mit diesem "Niedrig-Energie-Membranverfahren" ist ein entscheidender Durchbruch gelungen bezüglich der Kopplung der maximal möglichen Entlastung der Gewässer bei einer minimalen Reststoffproduktion und einem angemessenen Energie-verbrauch.

Der Filtrations-Energiebedarf des WABAG SMS-Verfahrens liegt aufgrund der o. g. Merkmale bei nur ca. **0,05 bis 0,15 kWh/m<sup>3</sup>** Filtrat. Im Vergleich dazu benötigen konventionelle Mikro- und Ultrafiltrationsverfahren ca. 4,5 - 9 kWh/m<sup>3</sup> Filtrat.

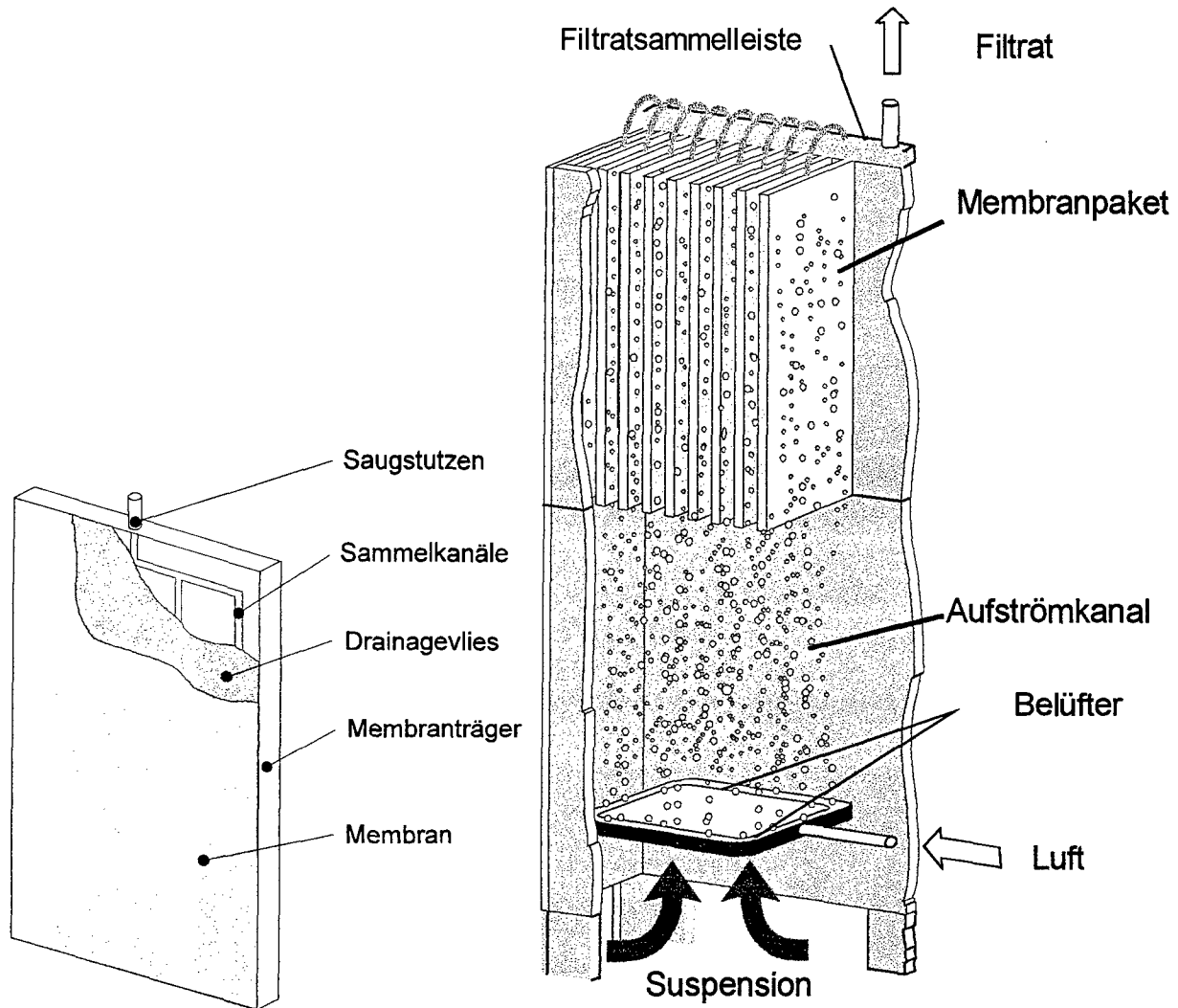


Bild 1: schematische Darstellung des Membranplattenaufbaus

Bild 2: schematische Darstellung des Modulaufbaus

Die gelegentlich durchzuführende Reinigung der Module erfolgt in situ, indem eine Reinigungslösung über eine Dosiereinheit permeatseitig in die Membrane gefördert wird. Die Menge an Reinigungslösung, die durch die Membrane in den Reaktor gelangt, ist so gering, daß eine Beeinträchtigung der biologischen Reinigungsleistung nicht eintritt. Ist die Einwirkzeit von 0,5 - 2 h verstrichen, wird die restliche Reinigungslösung aus den

Membranen abgezogen und anschließend die Filtration wieder in Betrieb genommen. Während der Zeit der Reinigung übernehmen die verbleibenden Module vollständig die Filtration. Sollte darüber hinaus eine weitergehende Reinigung oder Wartung notwendig werden, so können die Membranmodule bzw. Membranplatten durch die konzipierte Einschubtechnik aus dem Membranbehälter entnommen und einfach überprüft, gereinigt und einzelne Platten ggf. ausgetauscht werden. Diese Wartung kann während der Liegezeit im Hafen erfolgen und ist in wenigen Stunden durchführbar.

### → Anwendungsfall - Schiffskläranlage

Die Anforderungen an die Konstruktion von Schiffskläranlagen sind vielfältig und unterscheiden sich deutlich von denen landgestützter Kläranlagen. Besondere Erfordernisse resultieren aus den räumlichen Gegebenheiten auf Schiffen, den Schiffsbewegungen und der Charakteristik des Schiffsabwassers.

Um die Eignung eines Membranbioreaktorsystems als Schiffskläranlage zu untersuchen, wurden vor dem Einsatz auf einem Schiff halbtechnische Versuche unter schiffstypischen Bedingungen (wie z. B. Schiffsbewegung) durchgeführt.

Die wesentlichen Untersuchungspunkte waren dabei:

- Betriebssicherheit
- Reinigungsleistung
- Filtrationsleistung
- Membranstandzeit
- Reinigungsintervalle.

Die Ergebnisse wurden während der Versuchsphasen von April 1997 bis Januar 1998 erzielt. Die Betreuung erfolgte durch ein unabhängiges Ingenieurbüro (Dr. Weßling, Beratende Ingenieure GmbH, Altenberge, im Auftrag des Bundesamtes für Wehrtechnik und Beschaffung).



Die Anlage bestand im wesentlichen aus den Teilkomponenten (Bild 3):

- Feinsieb
- Vorlagebehälter
- Membranbioreaktor
- Mikrofiltrationsplattenmodul
- Sauerstoffversorgung (Gebläse, Belüfter)
- Filtratpumpen

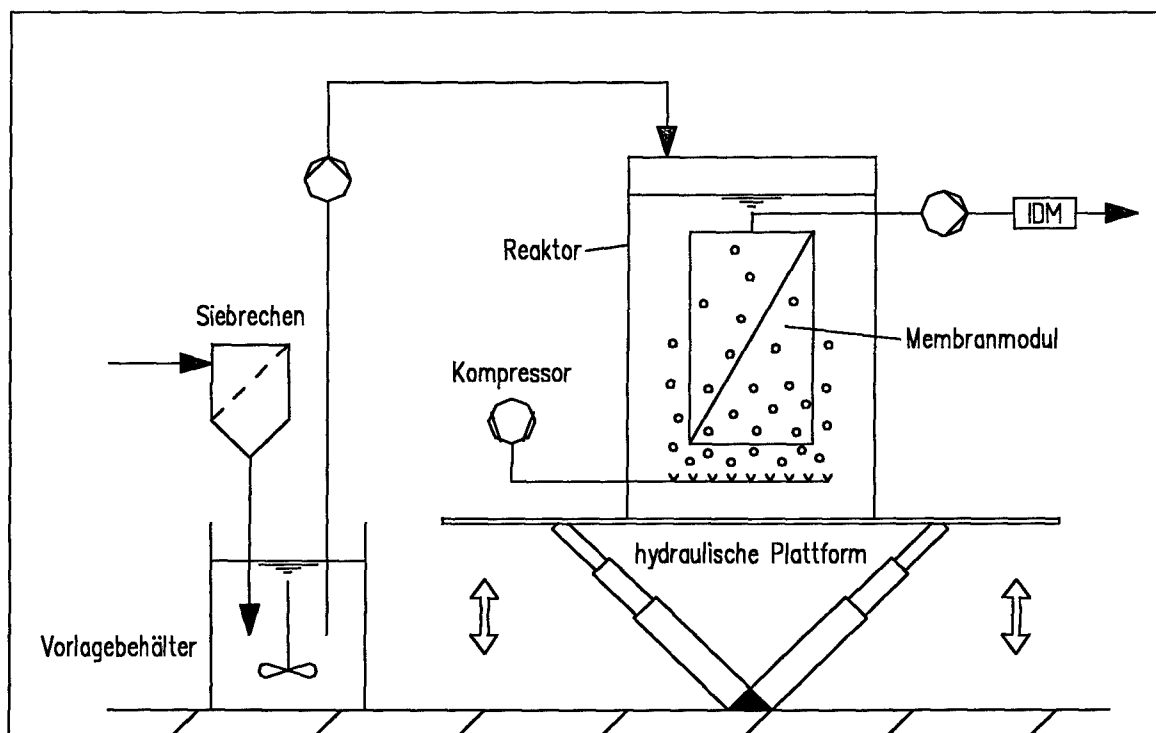


Bild 3: Aufbau der halbtechnischen Membranbioreaktoranlage  
-7-

Die Anlage bewies im Versuchsbetrieb eine hohe Betriebssicherheit. Sie war in jedem Versuchsabschnitt in der Lage, die geforderten Leistungen zu erbringen. Der Reaktor wurde bei Trockensubstanzgehalten zwischen 15 g/l und 30 g/l betrieben, ohne daß Auswirkungen auf die Filtrationsleistung zu beobachten waren. Die Anlage zeichnete sich durch eine einfache, robuste Bau- und Betriebsweise aus. Die Wartung der Anlage beschränkte sich auf die Kontrolle der zugeführten Luftmenge und des Sauerstoffgehaltes im Reaktor sowie die Kontrolle des Filtratvolumenstromes. (Brüß, 1998)

Die Reinigungsleistung übertraf bei weitem die Anforderungen des MARPOL-Abkommens. Während des gesamten Versuchsbetriebes wurden die geforderten Ablauf-grenzwerte sicher eingehalten bzw. unterschritten. Bei einer mittleren Schlammbelastung von  $B_{TS} = 0,05 \text{ kg/kg} \cdot \text{d}$  lag der  $BSB_5$  bei 3 - 5 mg/l und somit an der Nachweisgrenze und der CSB lag zwischen 15 - 50 mg/l. Die Nitrifikation war vollständig, respektive die Ablaufwerte  $< 1 \text{ mg/l}$ . Des weiteren waren im Ablauf keine coliformen Keime nachweisbar. Die Ergebnisse sind in Tabelle 2 zusammengefaßt.

| Parameter               | Zulauf | Ablauf | Grenzwert<br>See-BG |
|-------------------------|--------|--------|---------------------|
| CSB mg/l                | 1028   | 25     | ---                 |
| $BSB_5$ mg/l            | 424    | 3      | 50                  |
| TKN mg/l                | 67     | ---    | ---                 |
| $NH_4\text{-N}$ mg/l    | 36     | 0,1    | ---                 |
| AFS mg/l                | 650    | n.n    | 50                  |
| Coliforme Keime /100 ml | ---    | n.n    | 250                 |

**Tabelle 2: Zusammenfassung der Versuchsergebnisse (Mittelwerte)**

8

→ Ausblick

## → Ausblick

Die Kopplung biologischer Prozesse mit der Membrantechnik (Mikrofiltration) zum Biomasserückhalt erlaubt eine maximal mögliche Entlastung der Gewässer auf kleinstem Raum bei einer minimalen Reststoffproduktion. Die bereits vorliegenden großtechnischen Erfahrungen sowie die umfangreich durchgeführten Pilotversuche zu den verschiedensten industriellen und kommunalen Anwendungsfällen bestätigen die Leistungsfähigkeit des Verfahrens, selbst unter schwierigsten Bedingungen, wie es der Schiffsbetrieb zeigte.

Die besonderen Vorteile des WABAG Membranbioreaktorsystems sind:

- geringer Platzbedarf aufgrund hoher Belebtschlamm-dichte und dadurch hohen Raumabbauleistungen,
- sehr hohe Ablaufqualität aufgrund der Filterfeinheit der eingesetzten Membranen von 0,2 - 0,4 µm, als Folge dessen:
  - stark reduzierte Keimzahlen,
  - keine abfiltrierbaren Stoffe nachweisbar,
  - Schwimmschlamm-bildung kann toleriert werden,
- weitestgehende C-Elimination, da durch hohe Schlammalter speziell adaptierte Organismen vermehrt vorhanden sind,
- unempfindlich gegenüber Frachtspitzen, da der Belebtschlamm einen Teil der Last vorübergehend adsorptiv aufnimmt,
- niedrige Überschussschlammproduktion aufgrund des hohen Schlammalters und der geringen Schlammbelastung im Normalfall,
- einfache Technik mit geringem Fehlerpotential, da kaum regelungs- und maschinentechnische Aufwand notwendig ist.

## → Literatur

- A. Kraft: Membrantechniken für kommunale Kläranlagen  
- Anwendungen und Betriebserfahrungen -  
VDI Seminar 435312 - Neue Technologien zur kommunalen Abwasserreinigung, 19.-20. Okt. 1998, Düsseldorf
- A. Kraft  
M. Brockmann: Biologie mit getauchten Membranen  
- Ausführungsbeispiele und Betriebserfahrungen  
2. Aachener Tagung - Membrantechnik  
15.-16. Sept. 1998, Klenkes
- U. Brüß: Optimierte Schiffsabwasserreinigung  
- Kombinationsverfahren Belebung/Mikrofiltration  
2. Aachener Tagung - Membrantechnik  
15.-16. Sept. 1998, Klenkes
- A. Neumann: Entwicklung einer Schiffskläranlage  
unter Verwendung getauchter Niederdruckverfahren  
Dipolmarbeit WABAG ESMIL GMBH, 1998

Anschrift der Verfasserin:  
**WABAG ESMIL GMBH**  
Lise-Meitner-Str. 4a  
D-40878 Ratingen  
Tel. 02102 - 45 27 -0  
Fax 02102 - 45 27 99

Fav:AK-Rede Oldenburg



**Requirements for Waste Management for Ships in Ship Yards  
Part II**

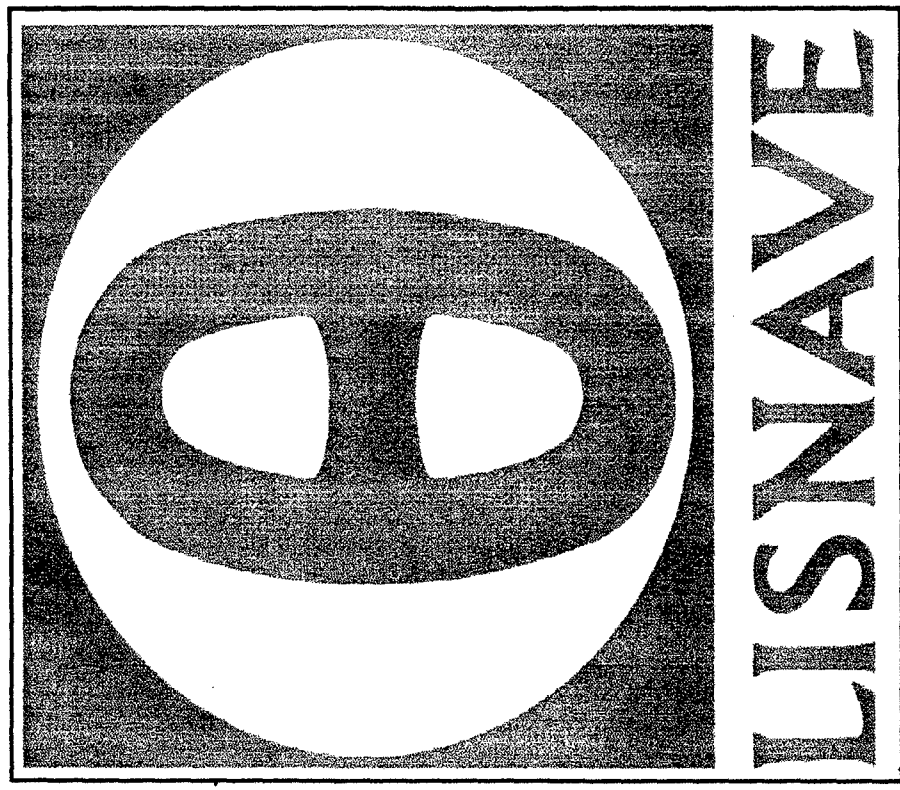
John Glen Wright  
LISNAVE  
Portugal

**ABSTRACT**

The paper will describe the difficulties observed when ships enter ship yards and when ships are being repaired or converted in ship yards.

The paper will also describe some of the equipments that LISNAVE is going to acquire in their attempt to achieve an environmental friendly activity.







# **Requirements for Waste Treatment Equipment for Ships in Shipyards**

**by John Glen Wright**

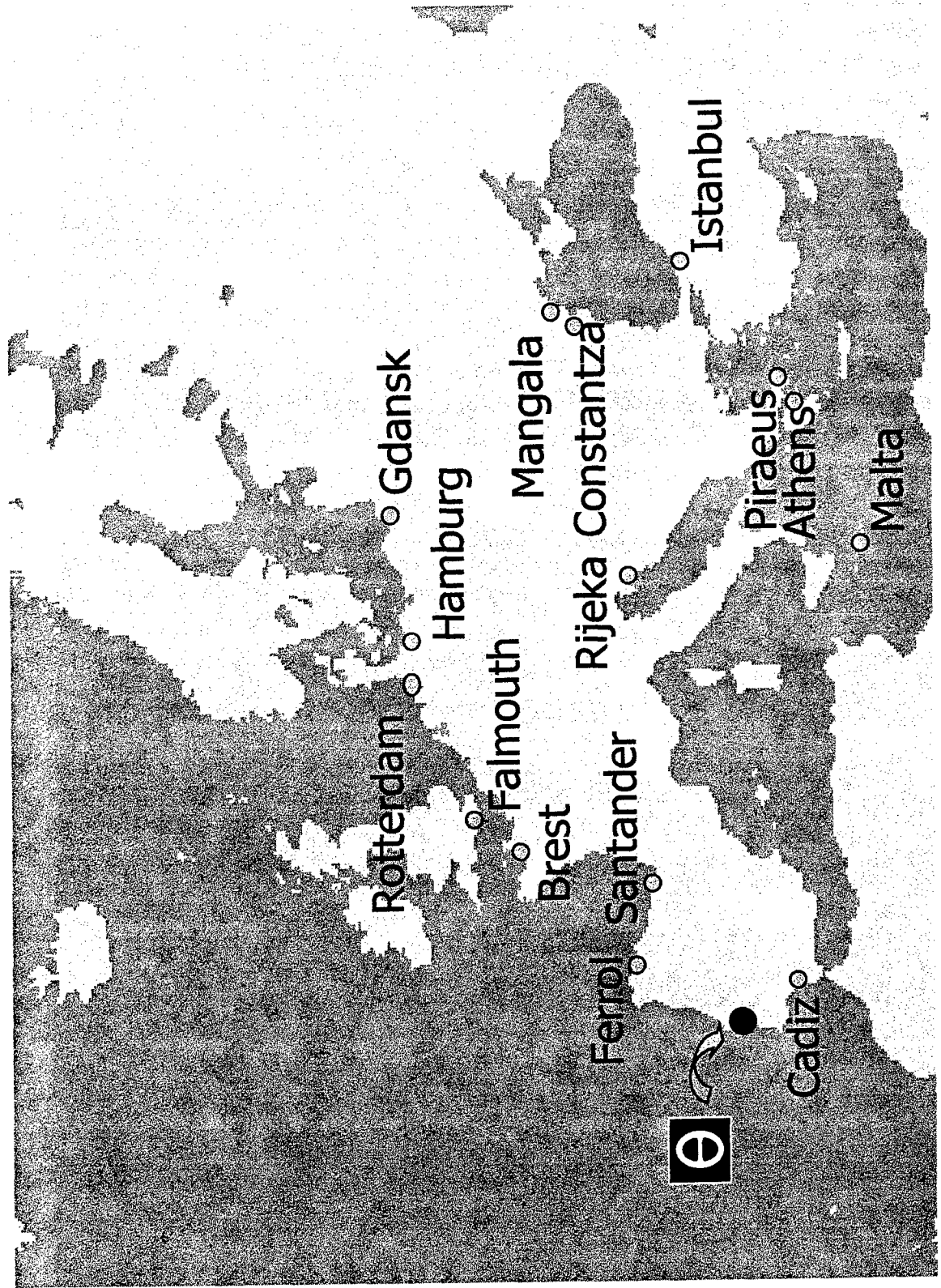
**LISNAVE - ESTALEIROS NAVAIS, SA**

# LISNAVE - No. 2 Worldwide

Ships repaired between February and April 1998 (> 30 000 DWT )

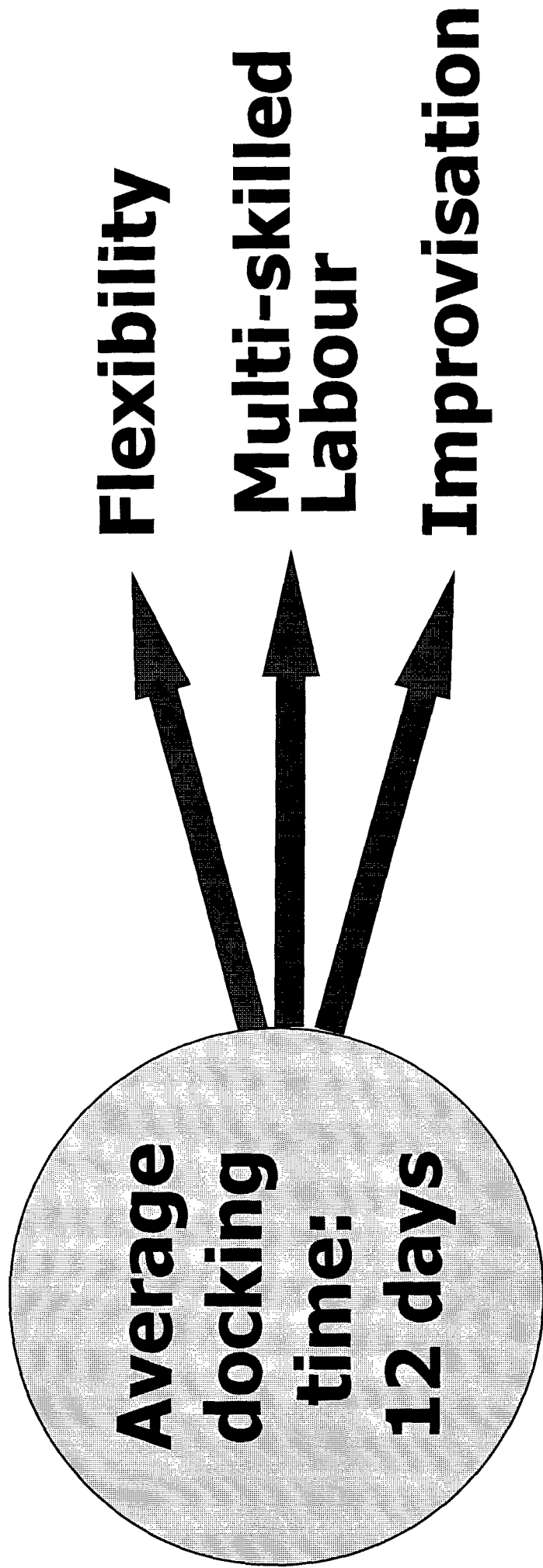


# *Location of main competitors in Europe*

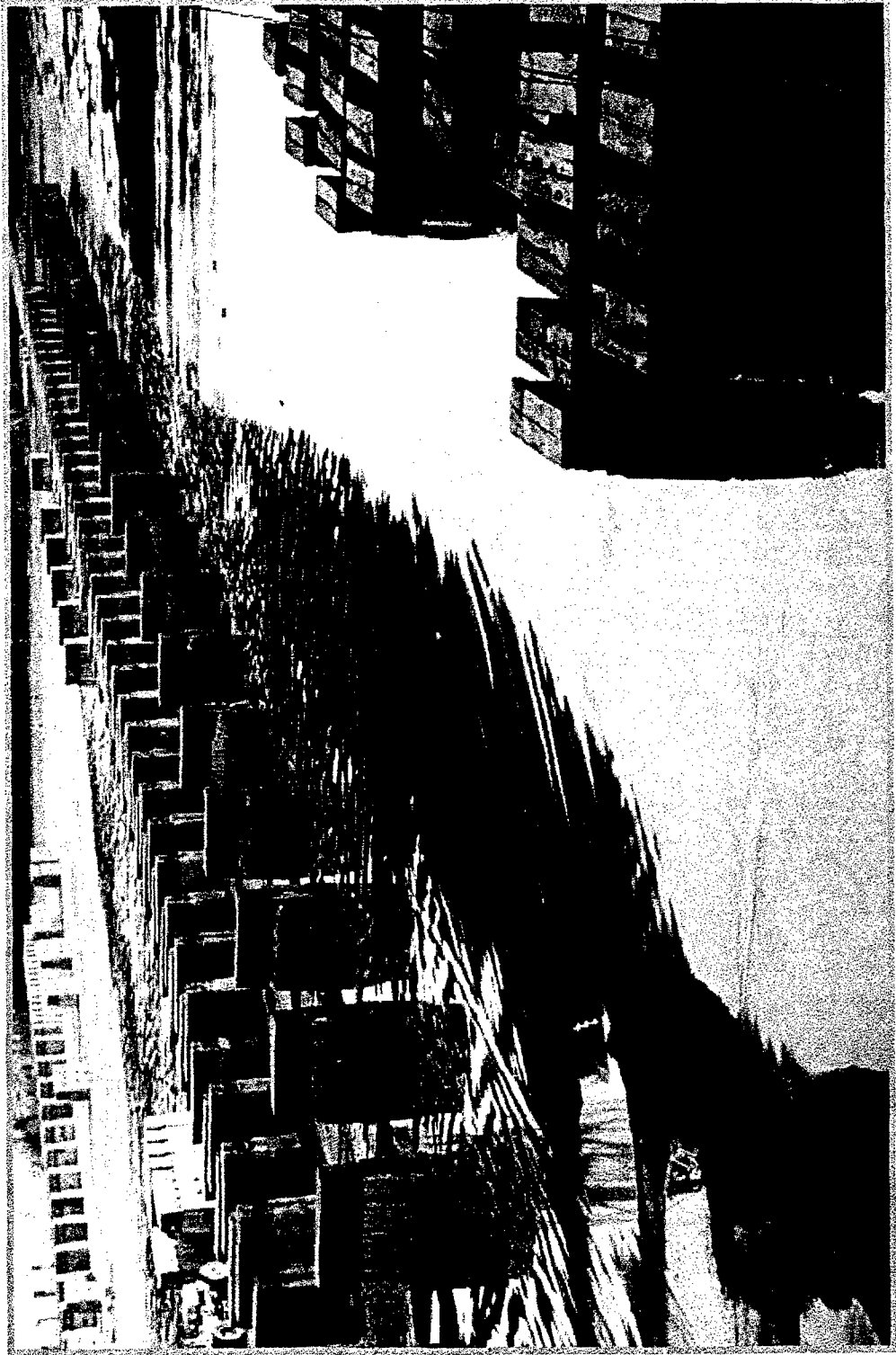




# *The key to success in the sector*



# *The vulnerability of the sector*

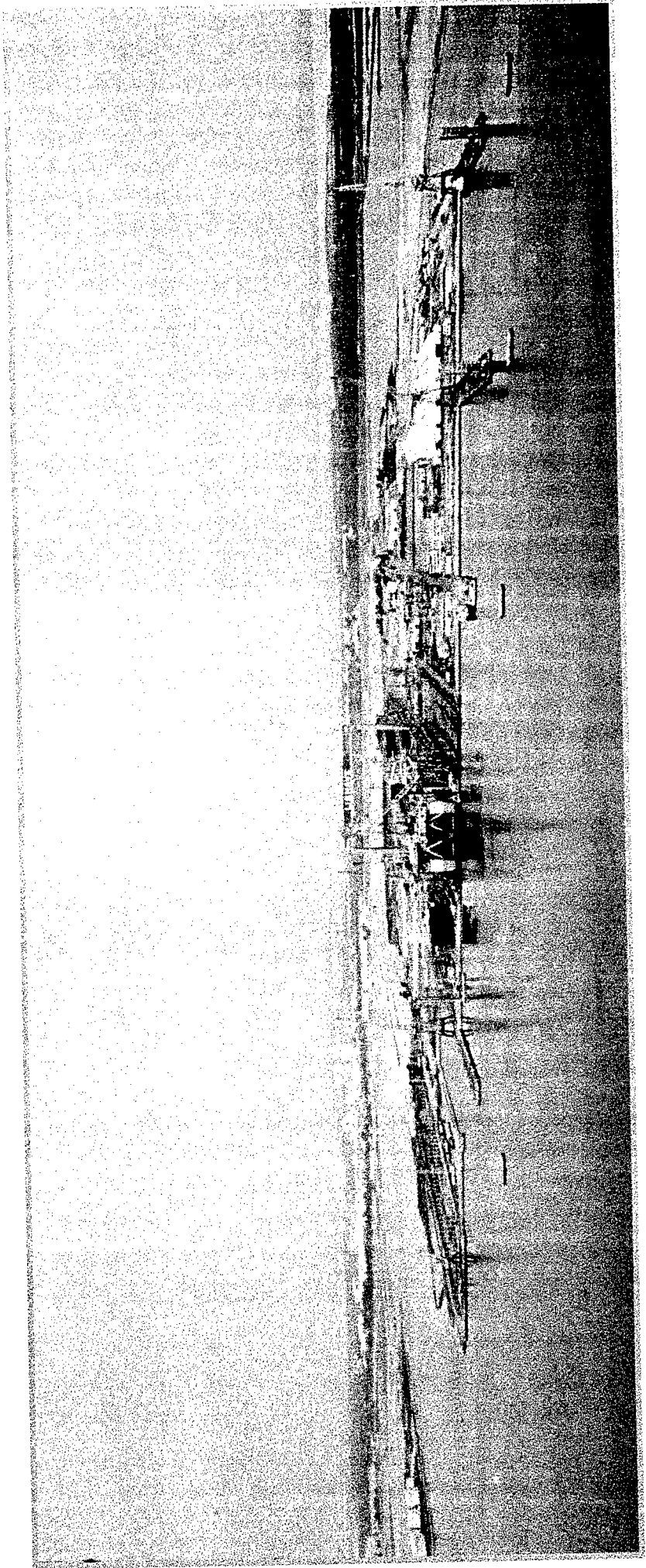


# ***Mitrena shipyard***



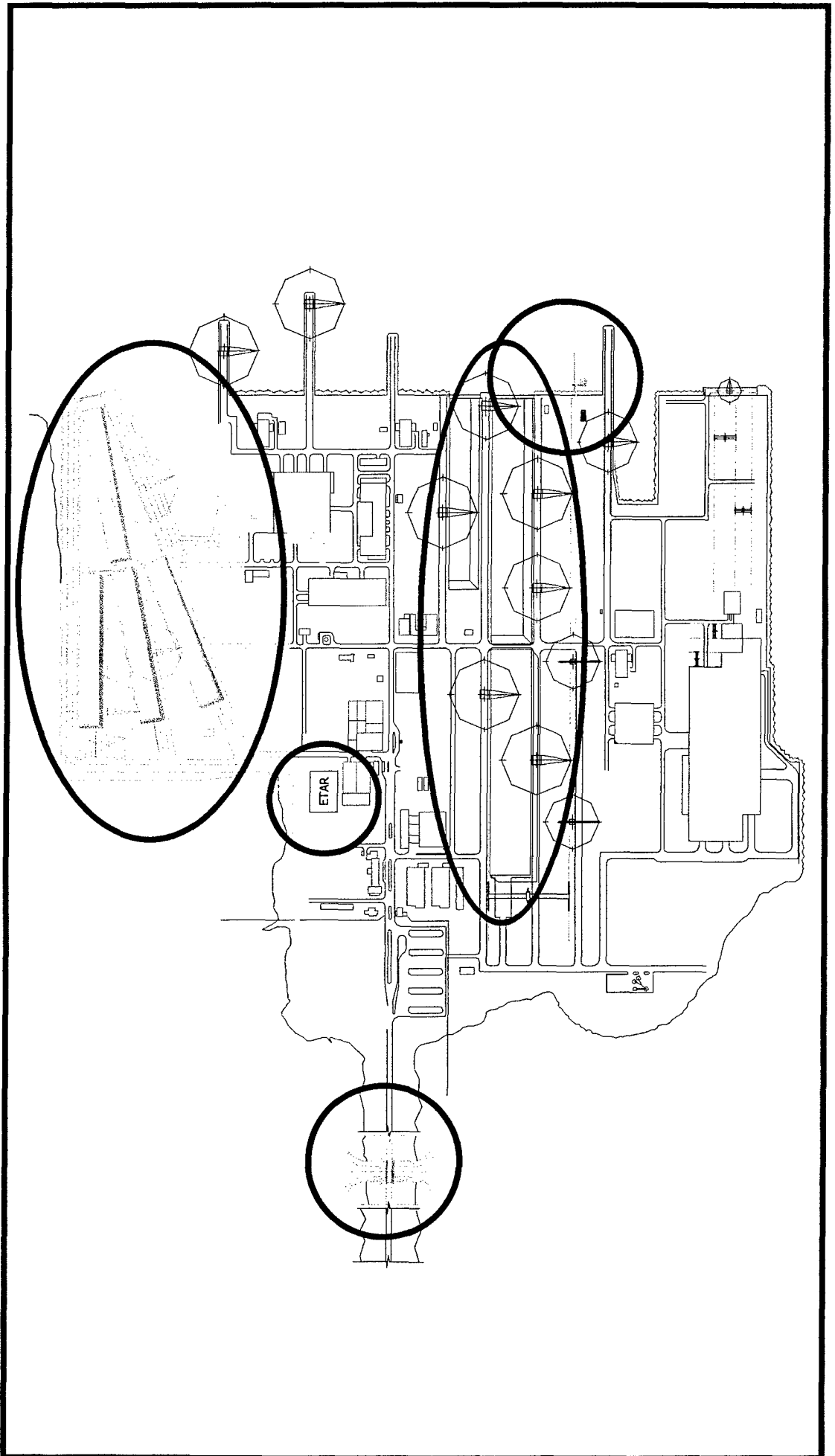


# *Shipyard and Surrounding Area*

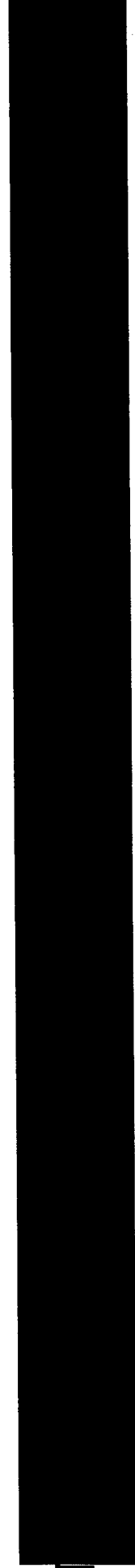




# *Master plan*



# **LISNAVE - MITRENA 2000 INVESTMENT PLAN**



TOTAL

Hydrolift

44

Modernization and adaptation of infrastructures,  
auxiliary installations

21.7

Purchase of equipment

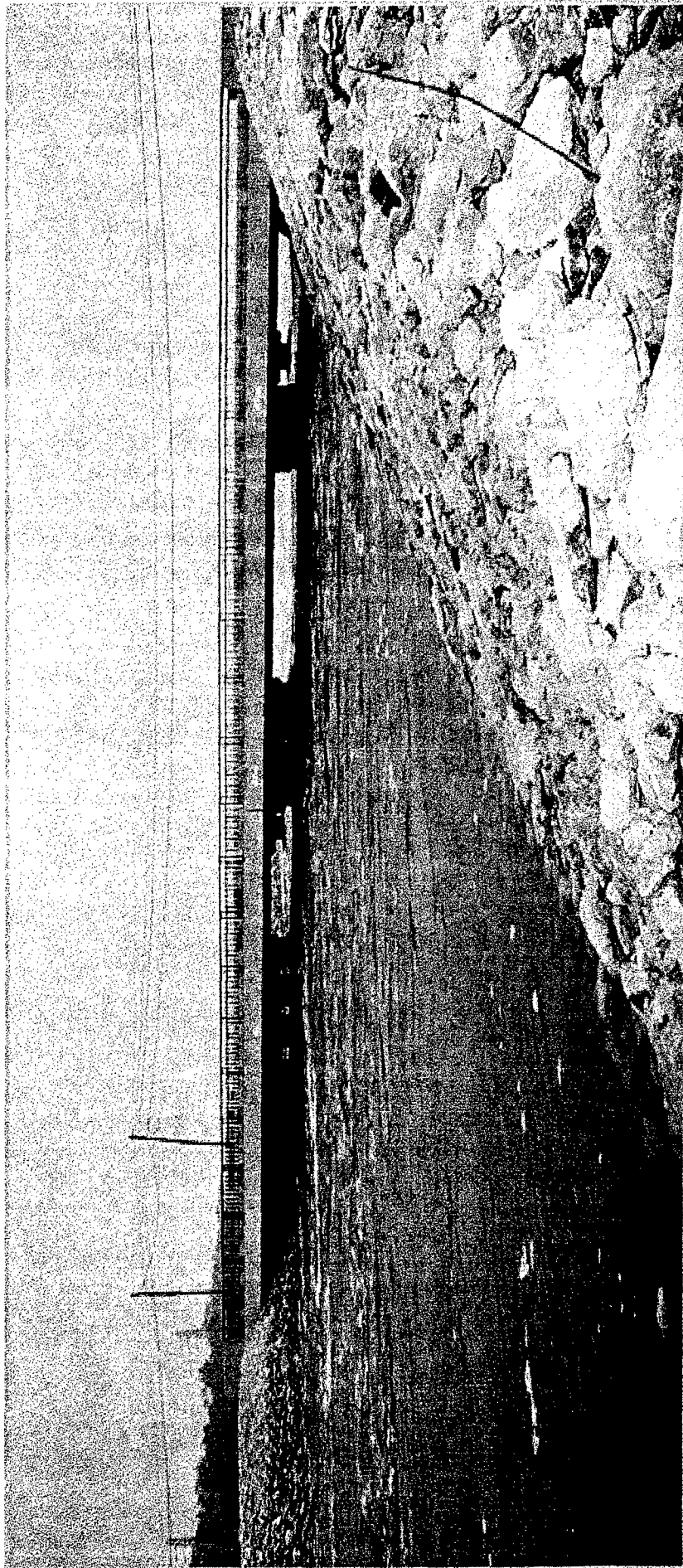
10.7

Studies, projects, supervision and consultancy

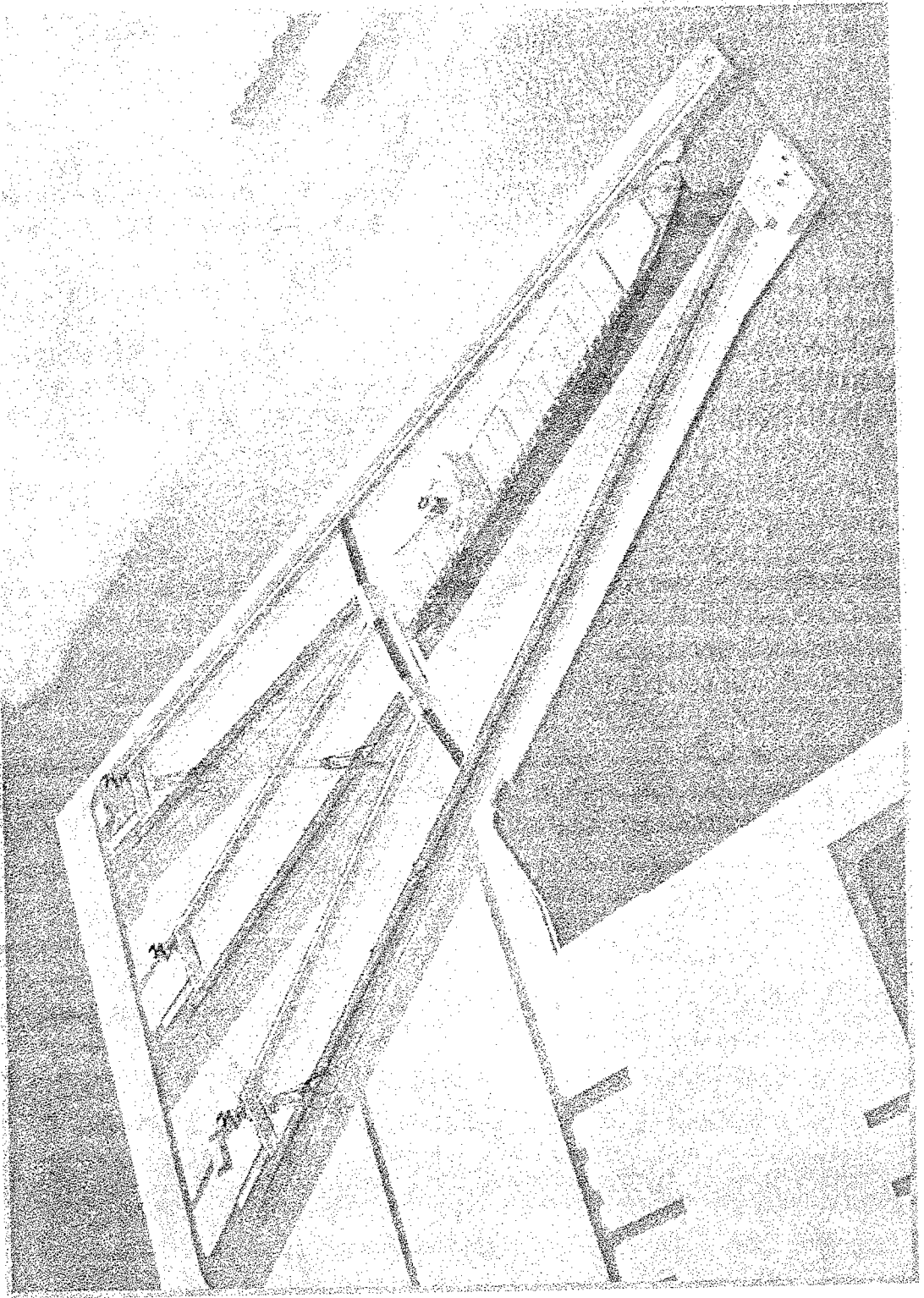
6.3

Amounts in millions of USD at 1996 values

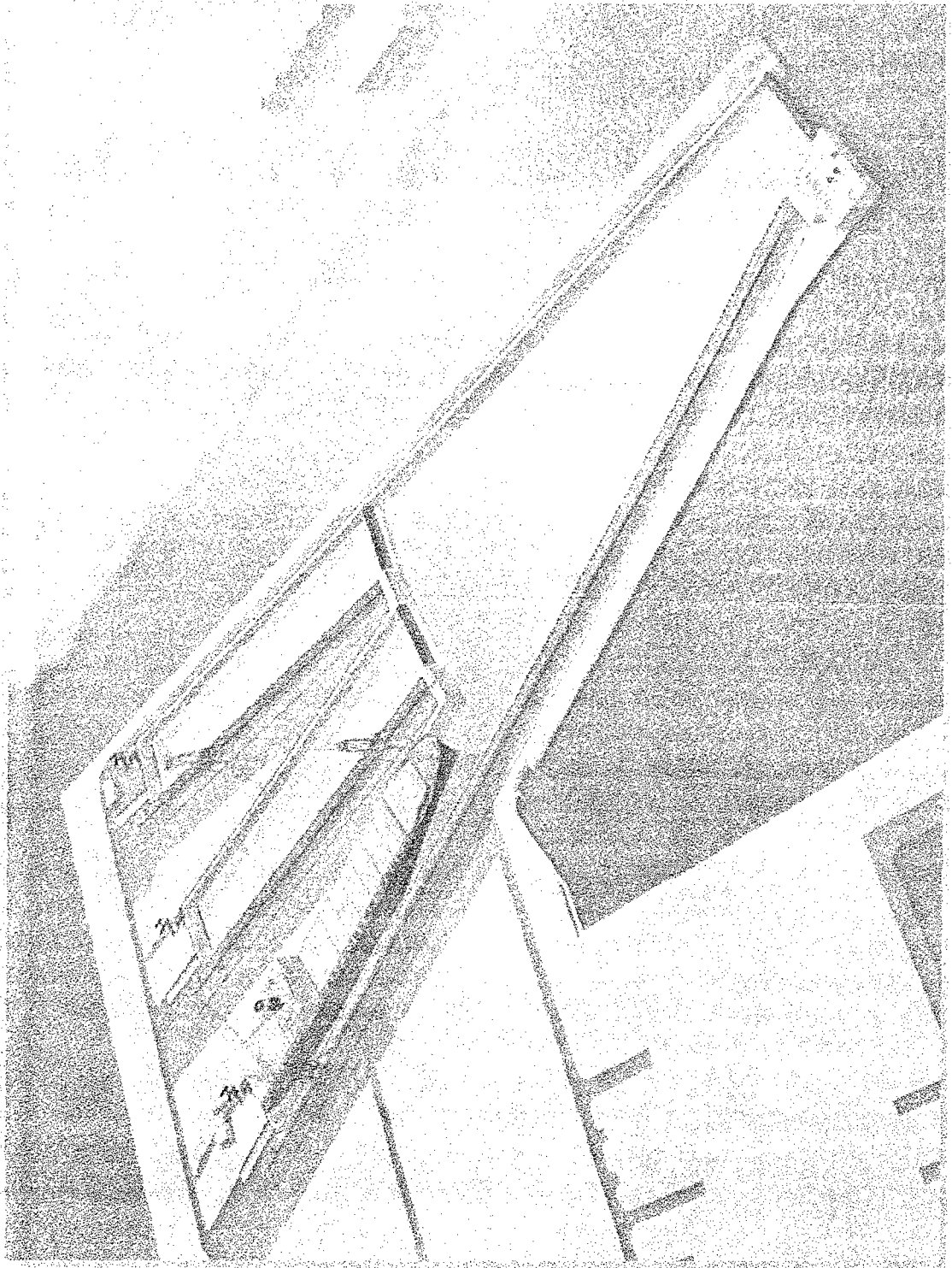
# *New Viaduct*



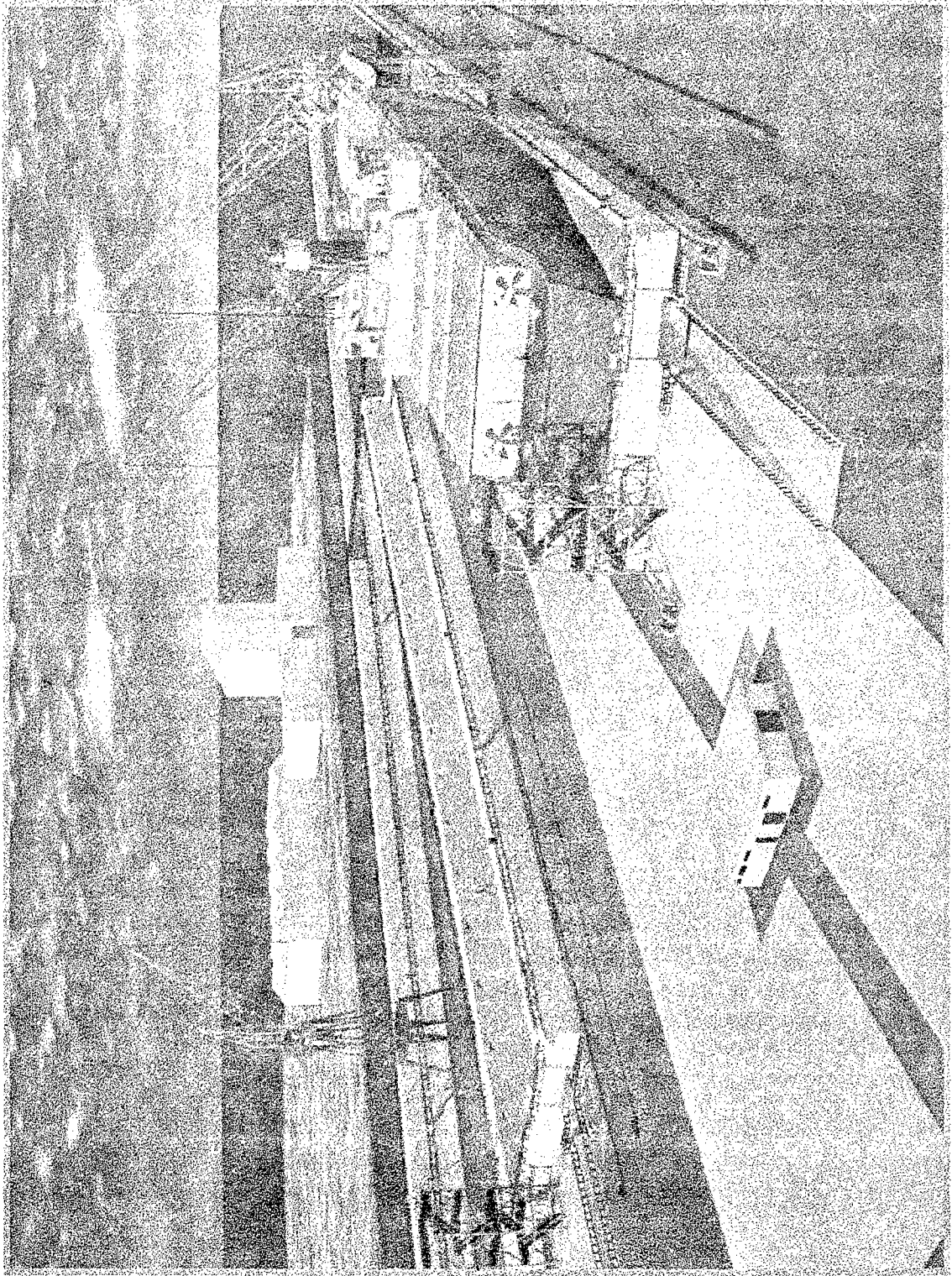
# *Hydrolift*



# *Hydrolift*



# *Hydrolift*





# ***Aerial View of Hydrolift Area***



| dock | bottom area in m <sup>2</sup> | ships/year | average docking period (days) |
|------|-------------------------------|------------|-------------------------------|
| 20   | 31.000                        | 1          | 120 - 180                     |
| 21   | 34.000                        | 40         | 12                            |
| 22   | 19.000                        | 30         | 12                            |
| 31   | 10.500                        | 30         | 12                            |
| 32   | 10.500                        | 30         | 12                            |
| 33   | 10.500                        | 30         | 12                            |

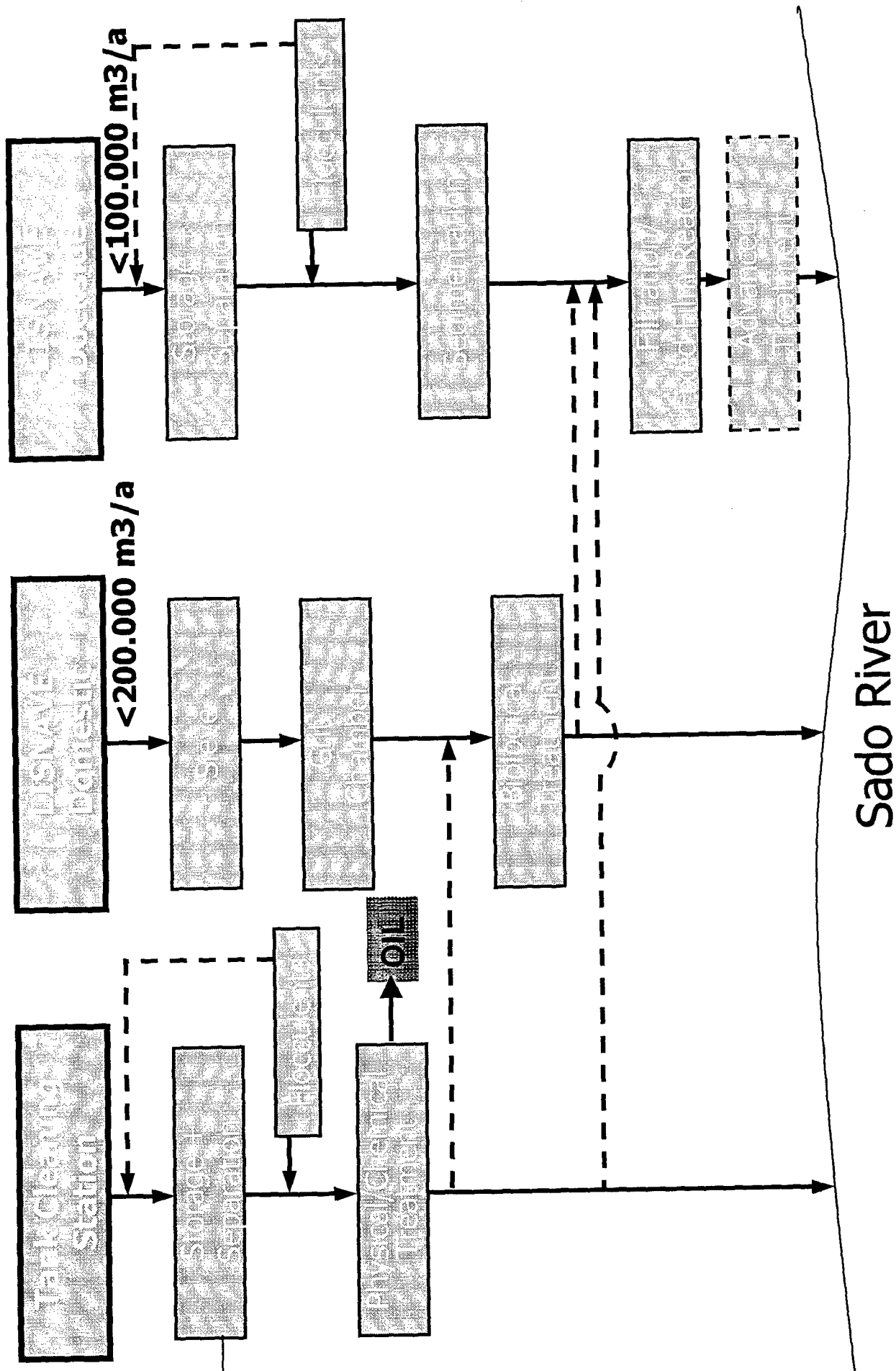
## *Assumed Precipitation*

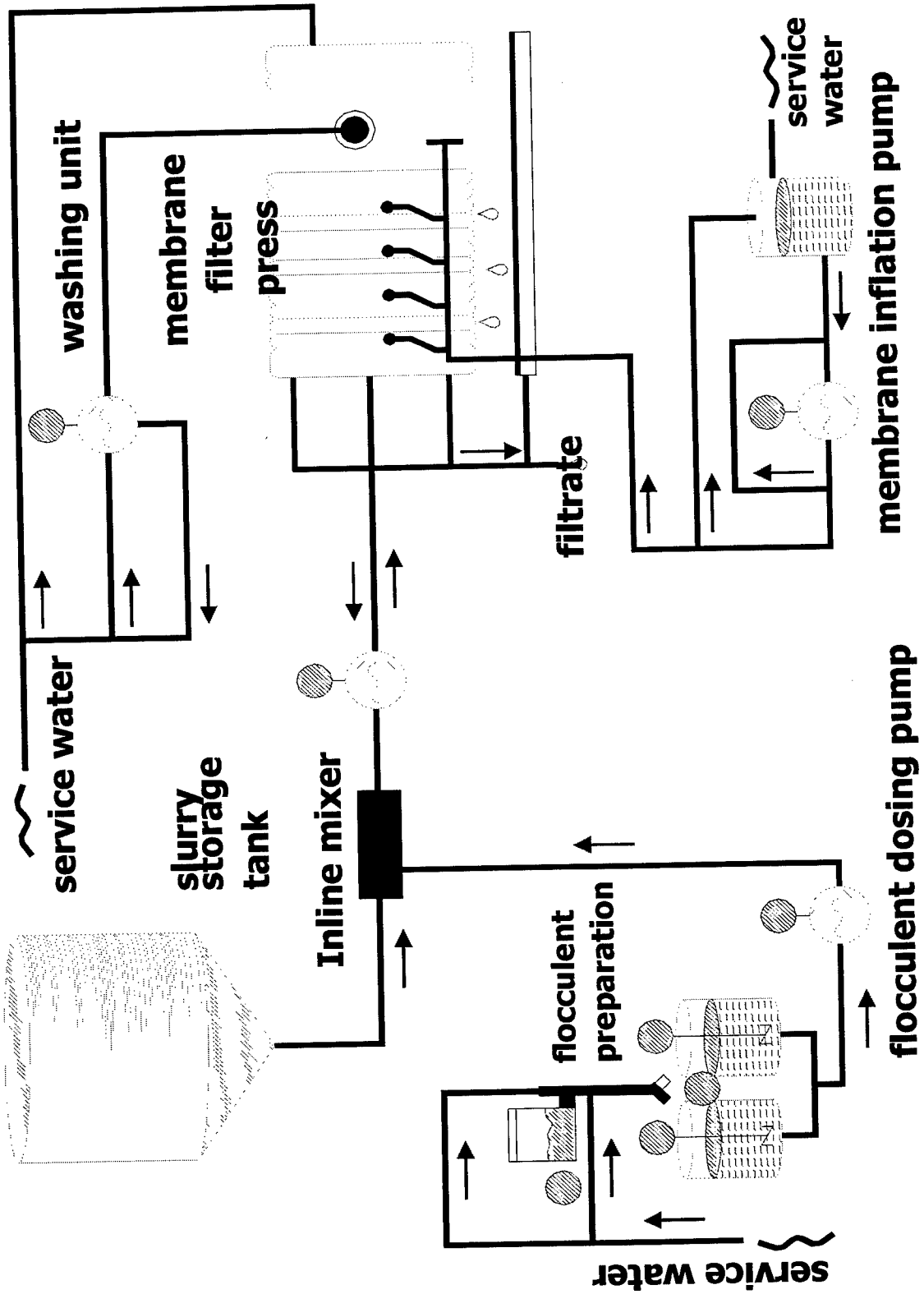
| <u>period</u> | <u>quantity</u> | <u>frequency</u> |
|---------------|-----------------|------------------|
| 10 minutes    | 218 L/ha*s      | once within 5 a  |
| 1 hour        | 20mm            | once within 1 a  |
| 1 day         | 50mm            | once within 1 a  |
| 5 days        | 70mm            | once within 1 a  |
| 1 year        | 700mm           | average          |

***Lisnave Dockwater ≤ 100.000m<sup>3</sup>/a***

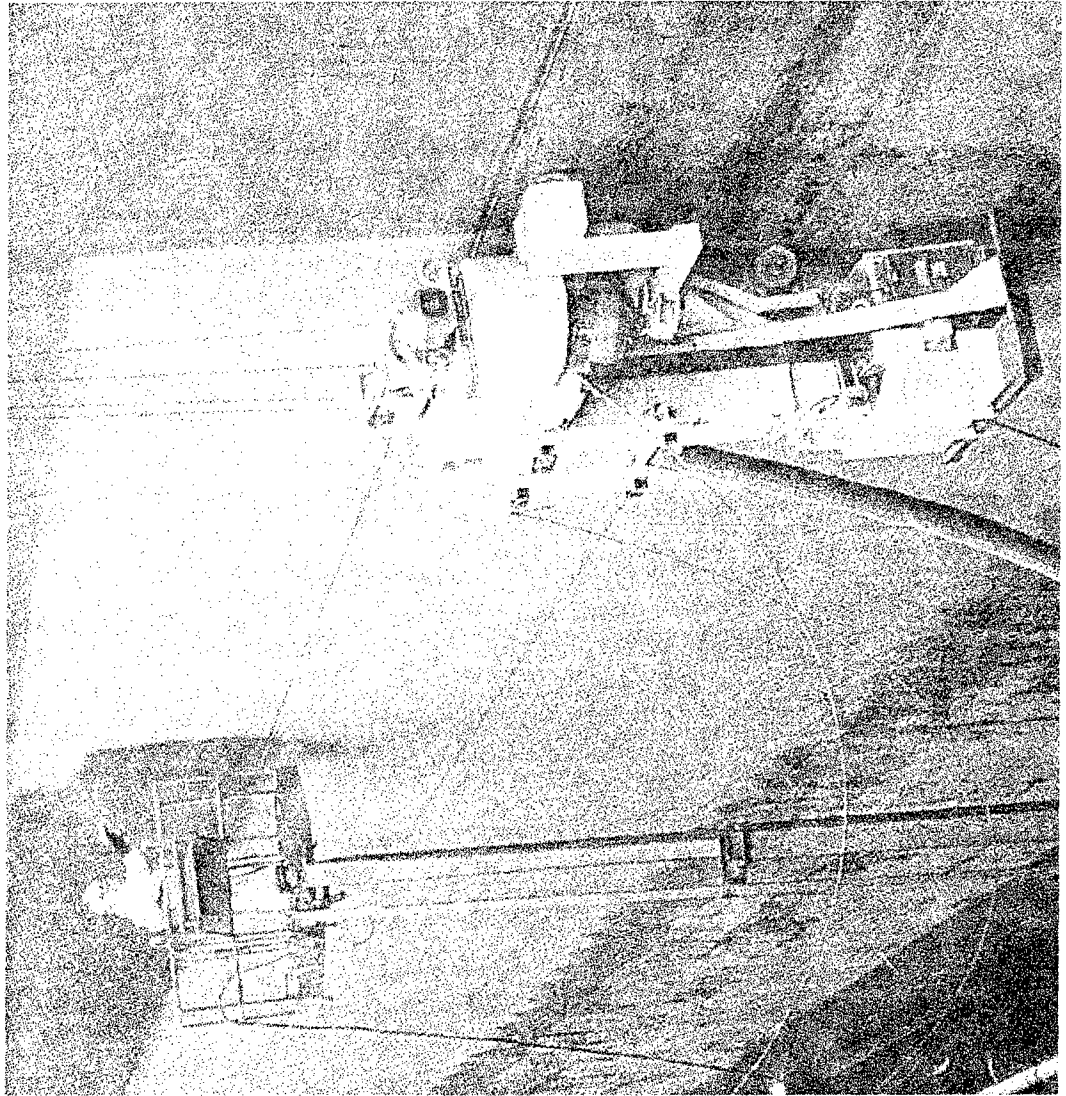


# Combined Waste Water Treatment

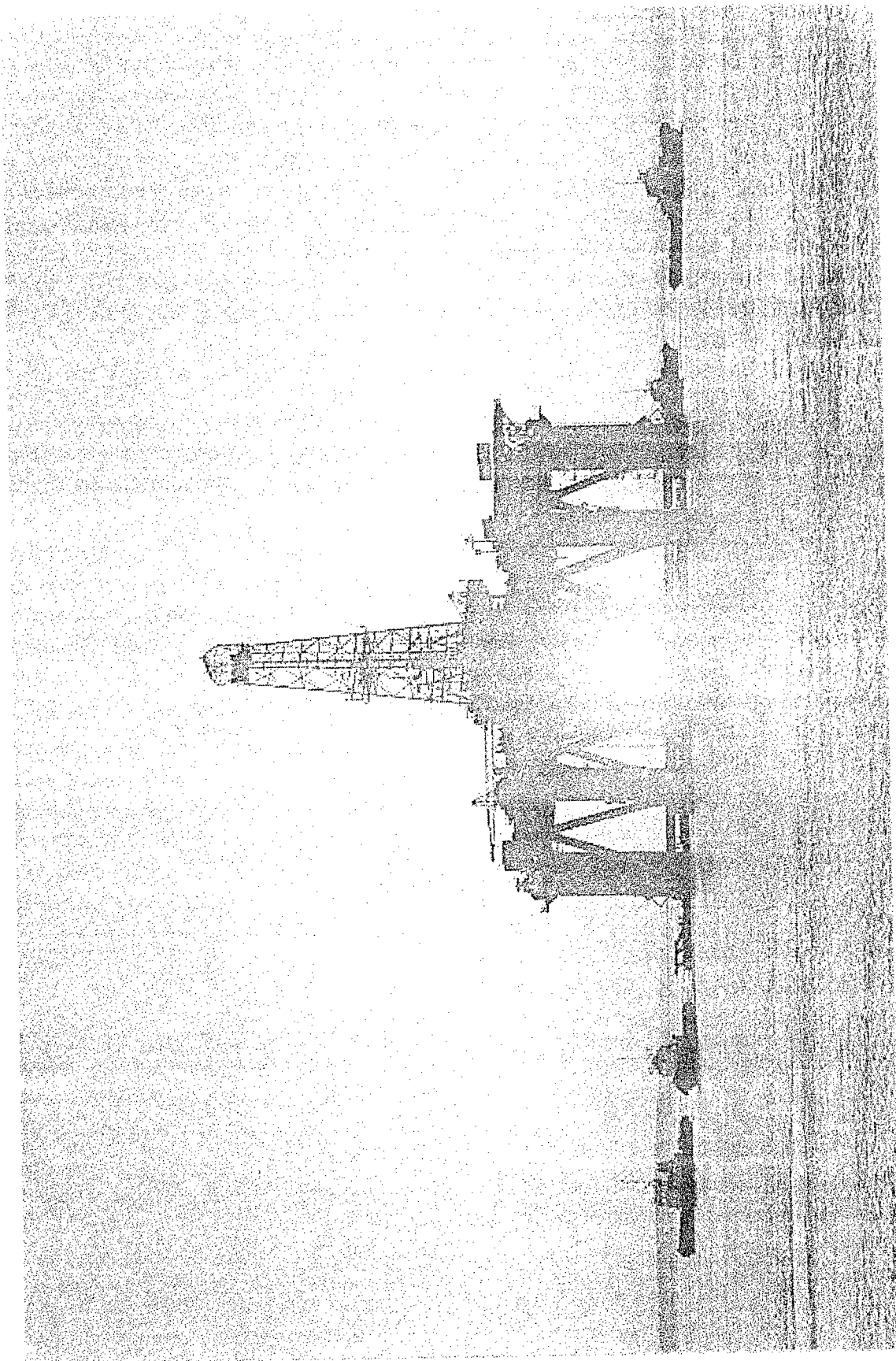


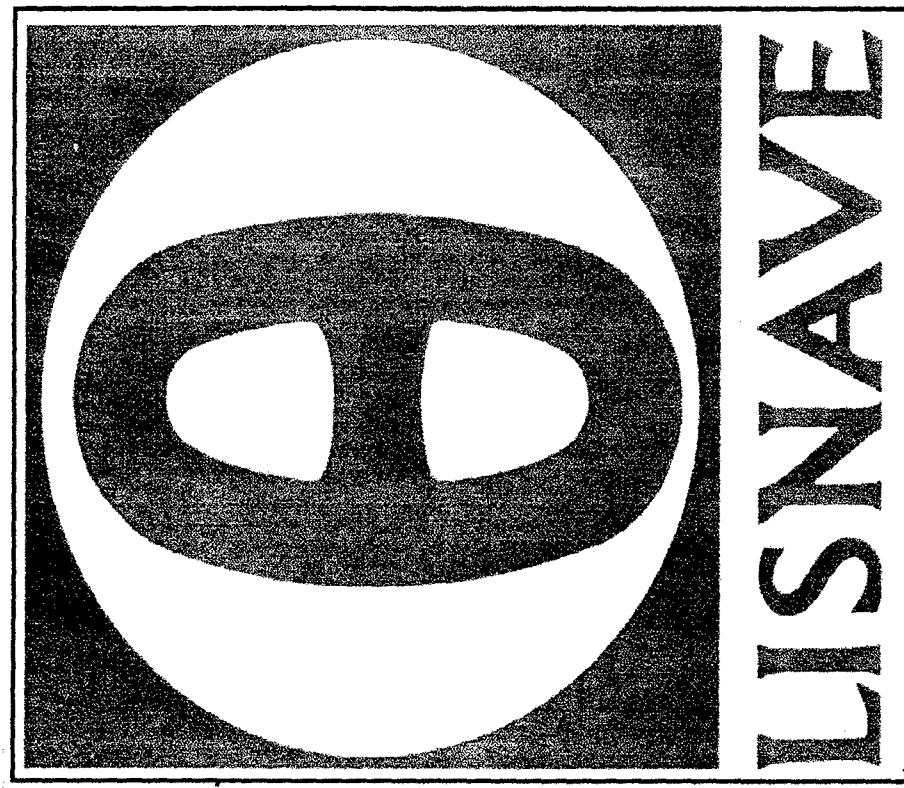


# ***New Blasting Concept***



# ***The conversion market***





# Participants in the Conference "Waste Water Treatment Technologies for Ships"

November 18th - 20th, 1998 in Oldenburg/Germany

| Company                               | Name        | Titel        | First Name | Address                          | Nation: DK                   | Telephone         | Telefax           |
|---------------------------------------|-------------|--------------|------------|----------------------------------|------------------------------|-------------------|-------------------|
| NavMatCom Denmark                     | Søgaard     |              | Jens       | Dannelskjold-Samsøes Allé 1      | 1434 Copenhagen              | +45 32663398      | +45 32663299      |
| Chantiers de L'Atlantique             | Ludovic     | Ing          | Perio      | Avenue Antoine Bourdelle         | 44608 Saint Nazaire Cedex    | +33 2 51109470    | +33 2 51109856    |
| CNIM                                  | Schmidt     |              | Klaus      | Z.I. de Brégaillon - B.P. No 208 | 83507 La Seyne-sur-Mer Cedex | +33 4 94103285    | +33 4 94111591    |
| DCN Brest                             | Bathany     |              | Daniel     | SDEEMACH Brest Naval             | 29240 Brest                  | +33 2 98 22 51 20 | +33 2 98 22 69 99 |
| DGAD/AS/SPN/ST                        | Matez       |              | Richard    | 8 Boulevard Victor               | Paris 00303 Armées           | +33 1 40 59 10 58 | +33 1 40 59 23 91 |
| Evac Oy                               | Nylund      |              | Ari        | Purotie 1                        | 00380 Helsinki               | +358 9 50676202   | +358 9 50676333   |
| Evac Oy                               | Peltola     |              | Markus     | Purotie 1                        | 00380 Helsinki               | +358 9 50676260   | +358 9 50676333   |
| Alfa Laval                            | Möller      |              | Petra      | Siebuschstieg 10                 | 20537 Hamburg                | +49 40 215 352    |                   |
| Alfa Laval                            | Habert      | Dipl.Ing     | Martin     | Wilhelm-Berghner-Str. 1          | 21509 Glinde                 | +49 40 7274 2792  | +49 40 7274 2726  |
| Aquamar GmbH                          | Schlapmann  | Dipl.Ing     | Wolfhard   |                                  | 21509 Glinde                 | +49 40 7274 2771  | +49 40 7274 2726  |
| B & V Industrietechnik GmbH           | Bittner     | Dr.rer.nat.  | Michael    | Zum alten Wasserwerk 6           | 51491 Overath                | +49 2204 72987    | +49 2204 72966    |
| B & V Industrietechnik GmbH           | Fischer     |              | Frank      | Hermann - Blohm - Straße 5       | 20457 Hamburg                | +49 40 30110      | 040 3011 1900     |
| B & V Industrietechnik GmbH           | Williams    |              | Sam        | Hermann - Blohm - Straße 5       | 20457 Hamburg                | +49 40 30110      |                   |
| B W B - SG 15                         | Neubold     |              | Michael    | Ferdinand-Sauerbruch Straße 1    | 56057 Koblenz                | +49 261 400 4155  | 0261 400 4339     |
| Bundesministerium für Verkehr - S 14- | Kehden      | MinRat       | Max        | Robert-Schumann-Platz 1          | 53175 Bonn                   | +49 226 3004640   | 0228 300 3428     |
| Deerberg - Systems                    | Deerberg    |              | Jochen     | Molkkestraße 6A                  | 26122 Oldenburg              | +49 441 973 570   | +49 441 75301     |
| Deerberg - Systems                    | Effertz     |              | Dietmar    | Molkkestraße 6A                  | 26122 Oldenburg              | +49 441 973 570   | +49 441 75301     |
| Deerberg - Systems                    | Ehbrecht    |              | Ingo       | Molkkestraße 6A                  | 26122 Oldenburg              | +49 441 973 570   | +49 441 75301     |
| Deerberg - Systems                    | Wenmakers   |              | Anja       | Molkkestraße 6A                  | 26122 Oldenburg              | +49 441 973 570   | +49 441 75301     |
| Degussa AG                            | Fuchs       | Dr.          | Rainer     | PO Box 1345                      | 63403 Hanau                  | +49 6181 59 3892  | +49 6181 59 4099  |
| Dr. Weßling Beratende Ingenieure      | Brüß        | Dipl.Bio.    | Ulrich     | Oststraße 7                      | 48341 Altenberge             | +49 2505 89 805   | +49 2505 89 279   |
| ENVI-Plan Ingenieurgesellschaft mbH   | Damann      |              | Roland     | Dammstraße 21                    | 33165 Lichtenau - Hengjlam   | +49 5292 986912   | +49 5292 986910   |
| Enviro - Chemie                       | Oles        | Dr.          | Volker     | In den Leppsteinswiesen 9        | 64380 Rossdorf               | +49 6154 6998-0   | +49 6154 696460   |
| Environmental Consulting              | Volgt       | Dr.          | Mathias    | Kampstr. 7                       | 24601 Stolpe                 | +49 4326 98737    | +49 4326 98738    |
| FACET Deutschland                     | Ebus        |              | Rolf       | St. Huberter Str.21              | 47906 Kempen                 | +49 2152 519925   | +49 2152 519920   |
| Freizeit GmbH                         | Beckershaus |              | Rainer     | Südstrand 108                    | 26382 Wilhelmshaven          | +49 4421 98200-13 | +49 4421 98200-20 |
| G W B                                 | Scheffzok   |              | Peter      | Ovelgönne 4c                     | 22605 Hamburg                | +49 40 8811145    | +49 40 8810585    |
| Howaldtwerke Deutsche Werft AG        | von Berg    | Dipl.Ing.    | Herbert    | Werftstraße 112-114              | 24143 Kiel                   | +49 431 700 2904  | +49 431 700 3393  |
| Meyer Werft                           | Poelmann    | Dipl.Ing     | Gerd       | P.O.Box 1555                     | 26855 Papenburg              | +49 4961 81-283   | +49 4961 81279    |
| MUKdo GeA 5                           | Lüders      | Capt. (GENA) | Werner     | Bordum                           | 26483 Wilhelmshaven          | +49 4421 470      |                   |
| Norddeutsche Filter NFV               | Fröhlich    |              | Michael    | Tarpenring 33                    | 22419 Hamburg                | +49 405273011     | +49 405278089     |
| Norddeutsche Filter NFV               | Runge       |              | Eberhard   | Tarpenring 33                    | 22419 Hamburg                | +49 405273011     | +49 405278089     |
| Noske Kaeser GmbH                     | Behrens     | Dipl.Ing     | Volker     | Schmackenburgallee 47-51         | 22525 Hamburg                | +49 40 8544 2391  | +49 40 8544 2639  |
| R W O Water Technology                | Werle       | Dipl.Ing     | Helmuth    | Leerkämpfe 3                     | 28259 Bremen                 | +49 421 53705-16  | +49 421 53705-40  |
| RWTH Aachen                           | Schürmann   | Dipl.Biol.   | Bettina    | Templergraben 55                 | 52056 Aachen                 | +49 241 805874    | +49 241 870924    |

525

| <i>Company</i>                       | <i>Name</i>      | <i>Titel</i> | <i>First Name</i> | <i>Address</i>              |         | <i>Telephone</i> | <i>Telefax</i>      |
|--------------------------------------|------------------|--------------|-------------------|-----------------------------|---------|------------------|---------------------|
| Senator für Häfen                    | Lampe            | Dr.          | Carola            | Kirchenstraße 4-5a          | 28195   | Bremen           | +49 421 361 6602    |
| Triton - Format                      | Mascow           | Dipl.Ing     | Klaus             | Werner-von-Siemens-Straße 2 | 25479   | Ellerau          | +494106 771026      |
| Umweltschutz Nord                    | Schulz - Berendt | Dr.          | Volker            | Industriepark 6             | 27777   | Ganderkesee      | +49 4222 47 205     |
| WABAG Esmil GmbH                     | Kraft            | Dr.Ing.      | Angelika          | Lise-Meitner-Str. 4a        | 40878   | Ratingsen        | +49 2102 45 270     |
| Wehrle Werke                         | Roth             | Dipl.Ing     | Peter             | Bismarck Straße 1-11        | 79312   | Emmendingen      | +49 6155 65180      |
| Westitalia Separator Mineraloil      | Mackel           | Dr. Ing.     | Jürgen            | Werner - Habig - Straße 1   | 59302   | Oelde            | +49 2522 772707     |
| Westitalia Separator Mineraloil      | Witte            | Dr. Ing.     | Klaus-Rainer      | Werner - Habig - Straße 1   | 59302   | Oelde            | +49 2522 772979     |
| <b>Nation: GR</b>                    |                  |              |                   |                             |         |                  |                     |
| Environmental Protection Engineering | Karantzis        |              | Kyriakos          | 24 Dervenaktion Str.        | 18545   | Piraeus          | +301 4080190        |
| Environmental Protection Engineering | Polychronopoulos |              | Helen             | 24, Dervenaktion Str.       | 18545   | Piraeus          | +301 4080190        |
| Superfast Ferries SA                 | Kardasis         |              | Michael           | 157 Alkyonidon Avenue       | 16673   | Voula, ATHENS    | +30 1 969 1390      |
| University of Ioannina               | Pilidis          | Prof. Dr.    | George            |                             | 45110   | Ioannina         | +301 651 98381      |
| <b>Nation: IT</b>                    |                  |              |                   |                             |         |                  |                     |
| ATHANOR s.r.l.                       | Borgioli         |              | Simone            | Via Ciabattini, 61/b        | 55049   | Viareggio (LU)   | +39 584 963856      |
| ATHANOR s.r.l.                       | Visibelli        |              | Massimo           | Via Ciabattini, 61/b        | 55049   | Viareggio (LU)   | +39 584 963856      |
| Engineering Field Activity           | Fortunato        |              | Francesco         | PSC 817, Box 51             | 09622   | FPO AE           | +39 81 586 4720x381 |
| Engineering Field Activity           | Stigile          |              | Kevin             | PSC 817, Box 51             | 09622   | FPO AE           | +39 81 586 4720x380 |
| Fincantieri C.N.I. S.p.A.            | Pozzali          | Dr. Ing.     | Gianfranco        | Via Cipro, 11               | 16129   | Genova           | +39-010-599651      |
| Fincantieri Divisione Costruzioni    | Cossi            |              | Fabio             | Paseggio S. Andrea 6        | 34100   | Trieste          | +39 40 3193682      |
| I.S.I.R. S.p.A                       | Antonelli        |              | Enrico            | Via Luigi Canepa, 16R       | 16165   | Genoa            | +39 10 803307       |
| TAN                                  | Strozzi          | Ing.         | Fausto            | V. del Molo, 3              | 19126   | La Spezia        | +39-187-552436      |
| Università degli Studi di Bologna    | Riva             | Prof.        | Alfredo           | Viale del Risorgimento 4    | 40136   | Bologna          | +39 51 6443681      |
| <b>Nation: NL</b>                    |                  |              |                   |                             |         |                  |                     |
| Directorate Material RNLNAVY         | Rijpma           |              | Hendrik J.        | Bunschotenstr. 2            | 1324 PD | Almere           | +31 36 5303739      |
| Directorate Material RNLNAVY         | Kerklaan         | Ing          | P.J.F.M.          | Van der Burchlaan 31        | 2597 PC | The Hague        | +31 70 32 00 544    |
| FACET Industrial bv                  | van der Klugt    |              | Peter             | Van der Burchlaan 31        | 2597 PC | The Hague        | +31 70 32 00 544    |
| Min. Transport & Public Works        | Hein             |              | Andy              | Draaibrugweg 10             | 1332 AD | Almere           | +31 36 5320004      |
| Promac BV                            | Bolt             |              | Klaas Jan         | P.O. Box 20940              | 2500 EX | The Hague        | +31 70 351 1560     |
| QUA-VAC BV                           | Korteling        | Ing.         | Valentijn         | P.O.Box 22                  | 5300 AA | Zaltbommel       | +31-418-683333      |
| Sterling Berkefeld                   | De Waal          |              | Hans              | Televisieweg 157            | 1322 BH | Almere           | +31 36 5461991      |
|                                      | de Jongk         |              | Joop              | Cairostraat 55              | 3047 BB | Rotterdam        | +31 10 262 2525     |
| <b>Nation: NO</b>                    |                  |              |                   |                             |         |                  |                     |
| Goodtech Betex A/S                   | Fleischer        |              | Andreas           | Po Box 429                  | 1301    | Sandvika         | +47 67551942        |
| Hydo Agri Porsgrunn                  | Portillo         |              | Heidi             | Industriepark               | 3901    | Porsgrunn        | +47 35 50 20 00     |
| Hydro Chemicals Norge AS             | Brekke           |              | Britt             | Postboks 6405               | 0604    | Oslo             | +47 22 43 25 65     |
| Norsk Hydro ASA,                     | Johannessen      |              | Liv Kari          | Postbox 2560                | 3901    | Porsgrunn        | +47 35 924549       |
| Norsk Inova AS                       | Akkerhaugen      |              | Johannes          | Postbox 44                  | 3671    | Notodden         | +47 3501 7100       |
| Royal Caribbean Cruise Line          | Dimmen           |              | Gunnar            | PO Box 114                  | 0216    | Oslo             | +47 2251 3700       |
| Royal Caribbean Cruise Line          | Larsen           |              | Erik              | PO Box 114                  | 0216    | Oslo             | +47 2251 3740       |

| <i>Company</i>                  | <i>Name</i>           | <i>Titel</i> | <i>First Name</i> | <i>Address</i>                       |                                         | <i>Telephone</i>  | <i>Telefax</i>   |
|---------------------------------|-----------------------|--------------|-------------------|--------------------------------------|-----------------------------------------|-------------------|------------------|
| Scanship Engineering AS         | Holbu                 |              | Jan Willie        | Kanalveien 4                         | 3101                                    | +47 33 31 0044    | +47 33 31 82 57  |
| Scanship Engineering AS         | Løtken                |              | Reidar            | Kanalveien 4                         | 3101                                    | +47 33 31 0044    | +47 33 31 82 57  |
|                                 | <b>Cáceres Alves</b>  |              | Victor Manuel     | Po Box 135                           | <u>Nation: PO</u><br>2902               | +351 65 709 1174  | +351 65 71 9407  |
| LISNAVE                         | <b>Espirito Santo</b> |              | Graca             | Po Box 25                            | 2801                                    | +351 1 2754121    | +351 1 2764670   |
| LISNAVE                         | <b>Spranger</b>       | Ing.         | Claudia           | Po Box 25                            | 2801                                    | +351 1 2764121    | +351 1 2763973   |
| LISNAVE                         | <b>Wright</b>         |              | John              | Apartado 335                         | 2910                                    | +351 65 709 1234  | +351 65 709 1475 |
|                                 | <b>Pallmar</b>        | Dipl.Ing     | Anders            | Tumba                                | <u>Nation: SE</u><br>14780              | +46 8530 65600    | +46 8530 34555   |
|                                 | <b>Oakley</b>         |              | Denise            | Culham, Abingdon                     | <u>Nation: UK</u>                       | +44 1235 463105   | +44 1235 463001  |
| A E A Technology                | <b>Vodyanoy</b>       |              | Igor              | 223 Old Marylebone Road              | London NW1 5TH                          | +44 171 514 4539  | +44 171 723 6359 |
| Office of Naval Research Europe | <b>Aldridge</b>       |              | Philip            | Richmond House , Terminus Terrace    | Southampton SO14 3PN                    | +44 1703 534251   | +44 1703 534393  |
| P&O Cruises                     | <b>Jepson</b>         |              | Michael           | Richmond House , Terminus Terrace    | Southampton SO14 3PN                    | +44 1703 534251   | +44 1703 534393  |
| P&O Cruises                     | <b>Sauer</b>          |              | Anthony           | Richmond House , Terminus Terrace    | Southampton SO14 3PN                    | +44 1703 534415   | +44 1703 335293  |
| P&O Cruises                     | <b>Yeo</b>            |              | Simon             | Richmond House , Terminus Terrace    | Southampton SO14 3PN                    | +44 1703 534251   | +44 1703 334393  |
| Pall Rochem Wassertechnik GmbH  | <b>Palmer</b>         |              | Gerard            | Stenzelring 14 A                     |                                         | +44 1 158 409 079 |                  |
|                                 | <b>Wilbur</b>         |              | Gregory           | 7800 North 113th Street              | <u>Nation: US</u><br>Milwaukee/WI 53224 | +1 414 359-0600   | +1 414 577-2723  |
| aqua - chem, Inc.               | <b>Garcia</b>         |              | Albert            | 3655 NW 87 Avenue                    | Miami, FL 33178                         | +1 305 599 2600   | +1 305 406 4670  |
| Carnival Cruise Lines           | <b>Szewczyk</b>       |              | Simon             | 3655 NW 87 Avenue                    | Miami, FL 33178                         | +1 305 599 2600   | +1 305 406 4670  |
| Carnival Cruise Lines           | <b>Dorris</b>         |              | Mike              | 1430 Mitscher Ave                    | Norfolk, VA 23551 - 2494                | +1 757 836 3144   | +1 757 7836 3281 |
| CNSL                            | <b>Bailey</b>         |              | William           | 1755 Jefferson Davis Hwy - Suite 910 | Arlington, VA. 22202                    | +1-703- 416-1023  | +1-703- 416-1178 |
| GEO-CENTERS, INC.               | <b>Bryce</b>          |              | Dexter            | 1755 Jefferson Davis Hwy - Suite 910 | Arlington, VA. 22202                    | +1-703- 769-1891  | +1-703- 769-1895 |
| GEO-CENTERS, INC.               | <b>Kopack</b>         | Cdr          | David             | 2531 Jefferson Davis Hwy             | Arlington VA 22242 -5160                | +1 703 602 3594   | +1 703 602 7213  |
| Naval Sea Systems Command       | <b>Krinsky</b>        |              | Joel              | 2531 Jefferson Davis Hwy             | Arlington VA 22242 -5160                | +1 703 602 0547   | +1 703 602 8010  |
| Naval Sea Systems Command       | <b>Neff</b>           |              | Kurt              | 2531 Jefferson Davis Hwy             | Arlington VA 22242 -5160                | +1 703 602 8144   | +1 703 602 5010  |
| Naval Sea Systems Command       | <b>Caplan</b>         |              | Ivan              | 9500 Mac Arthur Blvd                 | West Bethesda MD 20817-5700             | +1 301 227 5522   | +1 301 227 5557  |
| Naval Surface Warfare Center    | <b>Jacobs</b>         |              | Rachel            | 9500 MacArthur Blvd                  | West Bethesda MD 20817-5700             | +1 301 227 5233   | +1 301 227 5557  |
| Naval Surface Warfare Center    | <b>Cole</b>           |              | Linda             | 1510 Gilbert Street                  | Norfolk, VA 23511-2699                  | +1 301 227 5233   | +1 301 227 5557  |
| NavFacEngCom                    |                       |              |                   |                                      |                                         | +1 757 322 4734   | +1 757 322 4178  |





## Future Conferences

### 1999

|                                          |                                                     |               |
|------------------------------------------|-----------------------------------------------------|---------------|
| 21 <sup>st</sup> –23 <sup>rd</sup> April | <b>Solid Waste Treatment Technologies</b>           | Antwerp       |
| 23 <sup>rd</sup> –25 <sup>th</sup> June  | <b>Measures against Oil- and Chemical Accidents</b> | Wilhelmshaven |
| 22 <sup>nd</sup> –24 <sup>th</sup> Sept  | <b>Gaseous Waste Treatment Technologies</b>         | Athens        |
| 03 <sup>rd</sup> – 05 <sup>th</sup> Nov  | <b>Water Production, Purification, Recycling</b>    | Tenerife      |

### 2000

|           |                                                                                                                                    |               |
|-----------|------------------------------------------------------------------------------------------------------------------------------------|---------------|
| Mid April | <b>Liquid Waste Treatment Technologies</b>                                                                                         | Genoa         |
| September | <b>Major Symposium on Maritime Environmental Technologies during "EXPO 2000 by the Sea"</b><br>Conferences, Workshops, Exhibitions | Wilhelmshaven |