

PB99-910401
NTSB/AAR-99/01
DCA94MA076

NATIONAL TRANSPORTATION SAFETY BOARD

DISTRIBUTION STATEMENT A
Approved for Public Release
Distribution Unlimited

WASHINGTON, DC 20594

AIRCRAFT ACCIDENT REPORT

UNCONTROLLED DESCENT AND COLLISION WITH TERRAIN
USAIR FLIGHT 427
BOEING 737-300, N513AU
NEAR ALIQUIPPA, PENNSYLVANIA
SEPTEMBER 8, 1994

19991105 095

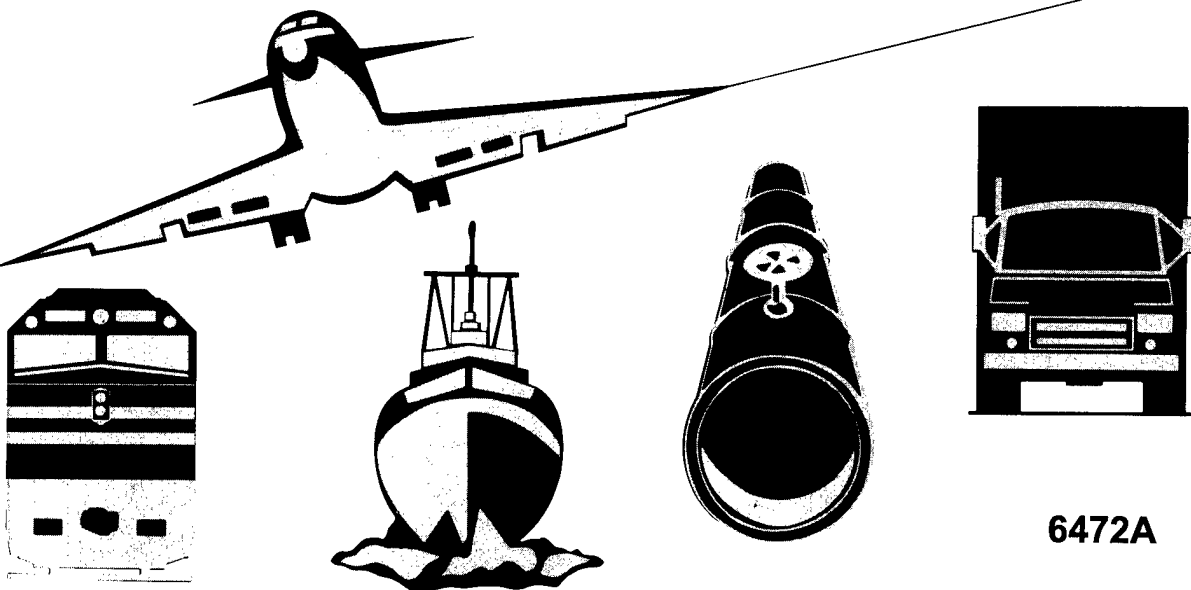

6472A

Abstract: This report explains the accident involving USAir flight 427, a Boeing 737-300, which entered an uncontrolled descent and impacted terrain near Aliquippa, Pennsylvania, on September 8, 1994. Safety issues in the report focused on Boeing 737 rudder malfunctions, including rudder reversals; the adequacy of the 737 rudder system design; unusual attitude training for air carrier pilots; and flight data recorder parameters. Safety recommendations concerning these issues were addressed to the Federal Aviation Administration.

The National Transportation Safety Board is an independent Federal Agency dedicated to promoting aviation, railroad, highway, marine, pipeline, and hazardous materials safety. Established in 1967, the agency is mandated by Congress through the Independent Safety Board Act of 1974 to investigate transportation accidents, study transportation safety issues, and evaluate the safety effectiveness of government agencies involved in transportation. The Safety Board makes public its actions and decisions through accident reports, safety studies, special investigation reports, safety recommendations, and statistical reviews.

Recent publications are available in their entirety at <http://www.nts.gov/>. Other information about available publications may also be obtained from the Web site or by contacting:

**National Transportation Safety Board
Public Inquiries Section, RE-51
490 L'Enfant Plaza, East, S.W.
Washington, D.C. 20594**

Safety Board publications may be purchased, by individual copy or by subscription, from the National Technical Information Service. To purchase this publication, order report number **PB99-910401** from:

**National Technical Information Service
5285 Port Royal Road
Springfield, Virginia 22161
(800) 553-6847 or (703) 605-6000**

Aircraft Accident Report

Uncontrolled Descent and Collision With Terrain

USAir Flight 427

Boeing 737-300, N513AU

Near Aliquippa, Pennsylvania

September 8, 1994

**NTSB/AAR-99/01
PB99-910401
Notation 6472A
Adopted March 24, 1999**



**National Transportation Safety Board
490 L'Enfant Plaza, S.W.
Washington, D.C. 20594**

DTIC QUALITY INSPECTED 4

Contents

Executive Summary	ix
Abbreviations	xi
Glossary of Terms	xv
1. Factual Information	1
1.1 History of Flight	1
1.2 Injuries to Persons	7
1.3 Damage to Aircraft	7
1.4 Other Damage	7
1.5 Personnel Information	7
1.5.1 The Captain	8
1.5.2 The First Officer	10
1.5.3 Flight Attendant Information	11
1.6 Airplane Information	11
1.6.1 Accident Airplane Maintenance Information	12
1.6.1.1 Inspections	12
1.6.1.2 Events on Earlier Flights	14
1.6.2 Boeing 737 Hydraulic System Information	15
1.6.2.1 Hydraulic System Maintenance	18
1.6.3 Boeing 737 Flight Control Systems	19
1.6.3.1 Auto-Flight System	19
1.6.3.2 Rudder Control System	23
1.6.3.2.1 Main Rudder PCU and Servo Valve	29
1.7 Meteorological Information	33
1.8 Aids to Navigation	34
1.9 Communications	34
1.10 Airport Information	35
1.11 Flight Recorders	35
1.11.1 Cockpit Voice Recorder	35
1.11.2 Flight Data Recorder	35
1.12 Wreckage and Impact Information	36
1.12.1 On-Site Examination	36
1.12.2 Reconstruction Examination	39
1.12.2.1 Flight Control System Components	40
1.12.2.2 Examination/Reconstruction of Cargo Compartments	41

1.12.2.3 Examination/Reconstruction of the Auxiliary Fuel Tank	41
1.12.3 Examination of Wreckage for Indications of Possible Bird Strike.....	42
1.13 Medical and Pathological Information	43
1.14 Fire.....	43
1.15 Survival Aspects.....	44
1.16 Tests and Research	44
1.16.1 Background Information—Other Significant Yaw/Roll Events.....	44
1.16.1.1 United Airlines Flight 585 Accident	44
1.16.1.2 Eastwind Airlines Flight 517 Incident.....	51
1.16.2 Wake Vortex Tests and Studies Resulting From the USAir Flight 427 Accident.....	54
1.16.3 Flight and Simulator Tests of Effects of Various Flight Control and System Failures.....	59
1.16.3.1 Eastwind Flight 517 Flight Tests.....	61
1.16.4 Flight Control Characteristics Flight Tests (Blowdown and Crossover Airspeed)	63
1.16.5 Examination and Testing of Flight Control Systems/Components	65
1.16.5.1 Rudder Pedal Assemblies	65
1.16.5.2 Tests to Determine the Effects of Rudder Cable External Forces, Breaks, and Blocked Input Linkage	66
1.16.5.3 Examination and Testing of Standby Rudder.....	68
1.16.5.3.1 Metallurgical Examination of Standby Rudder Components	68
1.16.5.3.2 Standby System Actuator Binding/Jam Tests	69
1.16.5.4 Detailed Examinations and Tests of Main Rudder PCUs	71
1.16.5.4.1 Detailed Examinations of Main Rudder PCU Servo Valves.....	71
1.16.5.4.1.1 Examination of Exemplar Servo Valves for White Layer.....	73
1.16.5.4.2 PCU Dynamic Testing	73
1.16.5.4.3 Tests of Hydraulic Fluid.....	74
1.16.5.4.4 Tests to Determine the Effects of Silting	75
1.16.5.4.5 PCU Servo Valve Chip Shear Tests.....	76
1.16.5.4.6 PCU Tests Conducted to Determine the Effects of Air in the Hydraulic Fluid.....	76
1.16.5.4.7 PCU Thermal Testing.....	77
1.16.5.4.7.1 Baseline Test Condition	78
1.16.5.4.7.2 Simulated Hydraulic System Failure Condition.....	78
1.16.5.4.7.3 Extreme Temperature Differential Test Condition.....	79
1.16.5.4.7.4 Additional Testing	80
1.16.5.4.8 Rudder Actuator Reversals During Servo Valve Secondary Slide Jams.....	81

1.16.5.4.9 Ground Demonstration of Rudder PCU Servo Valve Jam.....	85
1.16.6 Flight Performance Simulation Studies	87
1.16.6.1 USAir Flight 427 Simulation Studies.....	90
1.16.6.2 United Flight 585 Simulation Studies	100
1.16.6.3 Eastwind Flight 517 Simulation Studies	116
1.16.7 Identification of CVR Sounds/Sound Spectrum Analysis.....	129
1.16.7.1 Sounds Similar to Thumps (Three Initial Thumps Within 1 Second and Two Subsequent Thumps About 1 Second Apart)	130
1.16.7.2 Sound of Electrical Impulse Recorded on the Captain's Radio Channel	131
1.16.7.3 Sound Similar to Airplane Engines Increasing in Loudness.....	132
1.16.7.3.1 Comparison of Engine Sound Signatures From the United Flight 585 CVR and a CVR From 737-200 Flight Tests.....	134
1.16.7.4 Sounds of "Clickety Click"	134
1.16.7.5 Sound of Wailing Horn	135
1.16.8 Study of Pilots' (USAir Flight 427 and United Flight 585) Speech, Breathing, and Other CVR-recorded Sounds	135
1.16.8.1 Independent Specialists' Review of Pilots' Speech, Breathing, and Other Sounds—USAir Flight 427	140
1.16.8.1.1 Summary of Observations of Interstate Aviation Committee Specialist.....	141
1.16.8.1.1.1 Interstate Aviation Committee Specialist's Guidelines Applied to United Flight 585 CVR Information	143
1.16.8.1.2 Summary of Observations of U.S. Naval Aerospace Medical Research Laboratory Specialist.....	144
1.16.8.1.3 Summary of Observations of NASA's Ames Research Center Specialist.....	145
1.17 Operational and Management Information	145
1.17.1 USAir.....	145
1.17.2 USAir Flight Training	146
1.18 Additional Information.....	147
1.18.1 Overall Accident Record and History of the 737	147
1.18.1.1 History of 737 Potential Rudder System and/or PCU-Related Anomalies/Events.....	148
1.18.1.1.1 QAR Data Findings.....	159
1.18.1.2 Recent Rudder-Related Events on 737s Equipped With the 1998 Redesigned Servo Valve.....	159
1.18.2 Independent Technical Advisory Panel.....	162
1.18.3 Boeing 737 Certification Requirements and Information	163

1.18.3.1	Initial Certification of the 737-100 and -200 Series	163
1.18.3.2	Regulatory Changes Made After Certification of the 737-100 and -200 Series (Sections 25.671 and 25.1309)	165
1.18.3.3	Certification of the Boeing 737-300, -400, and -500 Series (Derivative Certification)	167
1.18.3.4	Certification of the 737-600, -700, and -800 Series	169
1.18.4	Critical Design Review Team 737 Certification Information and Recommendations	175
1.18.5	Boeing 737 Rudder System Design Improvements.....	178
1.18.5.1	Fractures in 1998 Redesigned Servo Valve Secondary Slides.....	181
1.18.6	Human Performance Considerations	183
1.18.6.1	Pilot Incapacitation.....	183
1.18.6.2	Spatial Disorientation	184
1.18.7	Wake Turbulence/Upset Event Information.....	185
1.18.7.1	Previous Wake Turbulence Accidents.....	185
1.18.7.2	Aviation Safety Reporting System Reports of Uncommanded Upsets/Wake Turbulence Encounters.....	186
1.18.8	Ergonomics—Study of Maximum Pilot Rudder Pedal Force	189
1.18.9	Unusual Attitude Information and Training	194
1.18.9.1	Preaccident Activity	194
1.18.9.2	Postaccident Activity.....	197
1.18.10	Procedural Information Available to Boeing 737 Flight Crews.....	198
1.18.10.1	Preaccident Information Available to 737 Pilots Regarding Abnormal Procedures (Flight Controls Malfunctions).....	198
1.18.10.2	Postaccident Changes/Information Available to 737 Pilots Regarding Abnormal Procedures (Flight Controls Malfunctions)	200
1.18.10.2.1	1994 Through 1995—Information and Changes Disseminated by Boeing.....	200
1.18.10.2.2	1996 Through 1997—FAA Issuance of Airworthiness Directive 96-26-07	200
1.18.10.2.3	1997 Through 1998—Information and Changes Disseminated by Boeing.....	202
1.18.10.2.3.1	Implementation of AD 96-26-07 and Boeing 737 Operations Manual Revision by U.S. 737 Air Carrier Operators	206
1.18.10.2.4	Safety Board Recommendations Relating to Unusual Attitude Training.....	207
1.18.11	History of Safety Recommendations Resulting From the United Flight 585 and USAir Flight 427 Accidents and the Eastwind Flight 517 Incident.....	207

1.18.11.1	Galling of Standby Rudder Actuator Bearings—United Flight 585 Accident (Safety Recommendation A-91-77).....	207
1.18.11.2	Weather-Related Recommendations—United Flight 585 Accident (Safety Recommendations A-92-57 and -58).....	209
1.18.11.3	Recommendations Resulting From the July 1992 United Airlines Ground Check PCU Anomaly (Safety Recommendations A-92-118 Through -121).....	211
1.18.11.4	Flight Data Recorder Recommendations (Safety Recommendations A-95-25 Through -27).....	213
1.18.11.5	October 1996 Recommendations Issued as a Result of United Flight 585, USAir Flight 427, and Eastwind Flight 517 (Safety Recommendations A-96-107 Through -120).....	219
1.18.11.6	February 1997 Recommendations Issued as a Result of United Flight 585, USAir Flight 427, and Eastwind Flight 517 (Safety Recommendations A-97-16 Through -18).....	230
1.18.12	Party Submissions.....	232
1.19	New Investigative Techniques.....	237
2. Analysis	240
2.1	General.....	240
2.2	USAir Flight 427 Upset.....	241
2.2.1	USAir Flight 427 Computer Simulation Analysis.....	246
2.2.2	USAir Flight 427 Human Performance Analysis.....	247
2.2.2.1	Rudder Jam/Reversal Scenario.....	249
2.2.2.2	Pilot Input Scenario.....	252
2.2.2.3	USAir Flight 427 Scenario Summary.....	255
2.2.2.4	Likelihood of Recovery From a Rudder Reversal.....	256
2.3	United Flight 585 Upset.....	258
2.3.1	United Flight 585 Computer Simulation Analysis.....	258
2.3.2	United Flight 585 Human Performance Analysis.....	260
2.4	Eastwind Flight 517 Upset.....	263
2.4.1	Eastwind Flight 517 Computer Simulation Analysis.....	265
2.4.2	Eastwind Flight 517 Human Performance Analysis.....	267
2.5	Rudder System Jam Scenarios.....	271
2.6	Adequacy of the Boeing 737 Rudder System Design.....	273
2.6.1	FAA Certification System.....	281
2.7	Flight Crew Procedures and Training.....	283
2.7.1	Unusual Attitude Training for Air Carrier Pilots.....	283
2.7.2	Unusual Attitude Training for Boeing 737 Pilots.....	284
2.8	Flight Data Recorder Capabilities.....	288

3. Conclusions	292
3.1 Findings.....	292
3.2 Probable Cause.....	295
4. Recommendations	296
5. Appendixes	299
Appendix A: Investigation and Hearing.....	299
Appendix B: Cockpit Voice Recorder Transcript.....	300
Appendix C: History of Federal Aviation Administration Airworthiness Directives Related to the Boeing 737 Rudder System.....	328
Appendix D: Critical Design Review Recommendations and Federal Aviation Administration Responses.....	333
Appendix E: List of Documented Boeing 737 Events.....	339
Appendix F: Boeing's "Blue Water" Assessment Team.....	345

Executive Summary

On September 8, 1994, about 1903:23 eastern daylight time, USAir (now US Airways) flight 427, a Boeing 737-3B7 (737-300), N513AU, crashed while maneuvering to land at Pittsburgh International Airport, Pittsburgh, Pennsylvania. Flight 427 was operating under the provisions of 14 Code of Federal Regulations Part 121 as a scheduled domestic passenger flight from Chicago-O'Hare International Airport, Chicago, Illinois, to Pittsburgh. The flight departed about 1810, with 2 pilots, 3 flight attendants, and 127 passengers on board. The airplane entered an uncontrolled descent and impacted terrain near Aliquippa, Pennsylvania, about 6 miles northwest of the destination airport. All 132 people on board were killed, and the airplane was destroyed by impact forces and fire. Visual meteorological conditions prevailed for the flight, which operated on an instrument flight rules flight plan.

The National Transportation Safety Board determines that the probable cause of the USAir flight 427 accident was a loss of control of the airplane resulting from the movement of the rudder surface to its blowdown limit. The rudder surface most likely deflected in a direction opposite to that commanded by the pilots as a result of a jam of the main rudder power control unit servo valve secondary slide to the servo valve housing offset from its neutral position and overtravel of the primary slide.

The safety issues in this report focused on Boeing 737 rudder malfunctions, including rudder reversals; the adequacy of the 737 rudder system design; unusual attitude training for air carrier pilots; and flight data recorder (FDR) parameters.

Safety recommendations concerning these issues were addressed to the Federal Aviation Administration (FAA). Also, as a result of this accident, the Safety Board issued a total of 22 safety recommendations to the FAA on October 18, 1996, and February 20, 1997, regarding operation of the 737 rudder system and unusual attitude recovery procedures. In addition, as a result of this accident and the United Airlines flight 585 accident (involving a 737-291) on March 3, 1991, the Safety Board issued three recommendations (one of which was designated "urgent") to the FAA on February 22, 1995, regarding the need to increase the number of FDR parameters.

Abbreviations

AAIB	Air Accidents Investigation Branch
AC	advisory circular
ACO	Aircraft Certification Office
AD	airworthiness directive
AFIP	Armed Forces Institute of Pathology
AFA	Air Force Academy
AFM	airplane flight manual
AFS	auto-flight system
agl	above ground level
ALPA	Air Line Pilots Association
APU	auxiliary power unit
ARAC	Aviation Rulemaking Advisory Committee
ASB	Alert Service Bulletin
ASRS	Aviation Safety Reporting System
ATC	air traffic control
ATP	airline transport pilot
ATR	Avions de Transport Regional
BAC	British Aerospace Corporation
BWI	Baltimore-Washington International Airport
CAM	cockpit area microphone
CAMI	Civil Aeromedical Institute
CDR	critical design review
CFR	Code of Federal Regulations
CMD	command (autopilot mode)
CRM	crew resource management
CVR	cockpit voice recorder
CWS	control wheel steering (autopilot mode)
DER	Designated Engineering Representative
DNA	deoxyribonucleic acid
DOT	Department of Transportation

EDP	engine-driven hydraulic pump
EDS	energy dispersive x-ray spectrum
E/E bay	electrical/electronic compartment
EGT	exhaust gas temperature
EMI	electromagnetic interference
EPR	engine pressure ratio
F	Fahrenheit
FAA	Federal Aviation Administration
FAR	Federal Aviation Regulations
FBI	Federal Bureau of Investigation
FD	flight director
FDAU	flight data acquisition unit
FDR	flight data recorder
FL	flight level
FSIB	Flight Standards Information Bulletin
GPR	ground penetration radar
GPWS	ground proximity warning system
HBAT	Handbook Bulletin for Air Transportation
HIRF	High-intensity radiated fields
Hg	mercury
HRC	Hardness Rockwell C (scale)
Hz	Hertz
IFR	instrument flight rules
IOE	initial operating experience
IRS	inertial reference system
KCAS	knots calibrated airspeed
KIAS	knots indicated airspeed
LIDAR	Light Distancing and Ranging
LOFT	line-oriented flight training
LVDT	linear variable displacement transducer
LWD	left wing down

M-CAB	multipurpose cab (simulator)
MCP	mode control panel
MM	Maintenance Manual
MPD	Maintenance Planning Document
MRB	Maintenance Review Board
MSG-3	Maintenance Steering Group 3
msl	mean sea level
N1	engine fan speed
N2	engine compressor speed
NAS	National Aerospace Standard
NASA	National Aeronautics and Space Administration
NCAR	National Center for Atmospheric Research
NG	next generation
nm	nautical mile
NOAA	National Oceanic and Atmospheric Administration
NPRM	notice of proposed rulemaking
NTSB	National Transportation Safety Board
OEM	original equipment manufacturer
ORD	Chicago-O'Hare International Airport
OSHA	Occupational Safety and Health Administration
OTS	Officer Training School
PA	public address
PADDS	portable airborne digital data system
PC	production certificate
PCU	power control unit
PF	pilot flying
PIT	Pittsburgh International Airport
PIT TRACON	Pittsburgh terminal radar approach control
PMA	parts manufacturing approval
P/N	part number
PNF	pilot not flying
POI	principal operations inspector
PPE	personal protective equipment
PSA	Pacific Southwest Airlines
psi	pounds per square inch

QAR	quick access recorder
RA	radio altitude
RWD	right wing down
SAE	Society of Automotive Engineers
SB	service bulletin
SEM	scanning electron microscope
SET	special events training
SFAR	Special Federal Aviation Regulation
SL	service letter
S/N	serial number
TOGA	takeoff/go-around
T/R	thrust reverser
UCP	Unified Command Post
USAF	U.S. Air Force
VFR	visual flight rules
VMS	vertical motion simulator
WSFO	Weather Service Forecast Office
WSR-88D	Weather Surveillance Radar

Glossary of Terms

Acceptance Test Procedure (for the Boeing 737 main rudder power control unit): A series of post-production functional tests used by Parker Hannifin Corporation to measure the performance of the main rudder power control unit (PCU).

Actuator: A device that transforms fluid pressure into mechanical force.

Adverse tolerance buildup: A description for a condition in which the assembling (stacking) of a series of parts, all of which are individually built within tolerances (that is, within an allowable deviation from a standard), has an adverse result.

Aileron: An aerodynamic control surface that is attached to the rear, or trailing, edges of each wing. When commanded, the ailerons rotate up or down in opposite directions.

Auto-flight system: A system, consisting of the autopilot flight director system and the autothrottle, that provides control commands to the airplane's ailerons, flight spoilers, pitch trim, and elevators to reduce pilot workload and provide for smoother flight. The auto-flight system does not provide control commands to the 737 airplane's rudder system.

Bank: The attitude of an airplane when its wings are not laterally level.

Block maneuvering speed: The recommended maneuvering speeds for each flap configuration that provide, for all airplane weights, adequate airspeed for maneuvering in at least a 40° bank without activation of the stickshaker. The "block" term simplified the concept so that a single airspeed was specified for all airplane weights less than 117,000 pounds; thus, airplanes operating at weights lighter than 117,000 pounds (such as the USAir flight 427 accident airplane) had a greater maneuvering margin.

Blowdown limit: The maximum amount of rudder travel available for an airplane at a given flight condition/configuration. Rudder blowdown occurs when the aerodynamic forces acting on the rudder become equal to the hydraulic force available to move the rudder.

Blue water: Lavatory fluid. Boeing's Blue Water Assessment Team reviewed fluid contamination in the electrical/electronic compartment (E/E bay) from various potential sources, including lavatories, galleys, rainwater, and condensation.

Catastrophic failure condition: A failure condition that will prevent continued safe flight and landing. (Source: Federal Aviation Administration Advisory Circular 25.1309-1A.)

Command mode: A position on the two autopilot flight control computers that, when engaged, allows the autopilot to control the airplane according to the mode selected via the Mode Selector Switches, which include Altitude Hold, Vertical Speed, Level Change, Vertical Navigation, VOR Localizer, Lateral Navigation, and Heading Select.

Compliance (when referring to PCU linkages): The elastic deformation of PCU internal input linkages that does not damage the linkages but allows additional motion.

Computer simulation: A term in this accident report that refers to models of the USAir flight 427, United flight 585, and Eastwind flight 517 upsets that were used to develop potential accident scenarios. The Safety Board's computer workstation-based flight simulation software used flight controls, aerodynamic characteristics, and engine models (developed by Boeing) to derive force and moment time histories of the airplanes. The Board developed its own equations to convert these forces and moments into airplane motion. Boeing performed similar flight simulations on its own computer workstations.

Control wheel steering mode: A position on the two autopilot flight control computers that, when engaged, allows the autopilot to maneuver the airplane through the autoflight system in response to control pressure, similar to that required for manual flight, applied by either pilot. The use of control wheel steering does not disengage the autopilot.

Cross-coupled: The ability of the aerodynamic motion about an airplane's control axes to constantly interact and affect each other in flight.

Crossover airspeed: The speed below which the maximum roll control (full roll authority provided by control wheel input) can no longer counter the yaw/roll effects of a rudder deflected to its blowdown limit.

Directional control: The function that is normally performed by the rudder by pilot input or yaw damper input. (Also known as yaw control.)

Dual jam (as used in this accident report): The simultaneous jams of the main rudder PCU primary to secondary slides and the secondary slide to the servo valve housing.

Dutch roll: A combination yawing and rolling oscillations that is an inherent characteristic of all swept-wing airplanes.

E/E bay: An airplane compartment that contains electrical and electronic components.

Elevator: An aerodynamic control surface to the back of the horizontal stabilizer that moves the airplane's nose up and down to cause the airplane to climb or descend.

Empennage: The tail section of an airplane, including stabilizing and flight control surfaces.

Extremely improbable failure condition: A condition that is so unlikely that it is not anticipated to occur during the entire operational life of all airplanes of one type and that has a probability on the order of 1×10^{-9} or less each flight hour based on a flight of mean duration for the airplane type. (Source: Federal Aviation Administration Advisory Circular 25.1309-1A.)

Flap: An extendable aerodynamic surface usually located at the trailing edge of an airplane wing. The 737 also has an extendable aerodynamic surface located at the wing's leading edge, which is called a Krueger flap.

- G:** A unit of measurement. One G is equivalent to the acceleration caused by the earth's gravity (32.174 feet/sec²).
- Galling:** A condition in which microscopic projections or asperities bond at the sliding interface under very high local pressure. Subsequently, the sliding forces fracture the bonds, tearing metal from one surface and transferring it to the other.
- Heading:** The direction (expressed in degrees between 001 and 360°) in which the longitudinal axis of an airplane is pointing, in relation to north.
- Hinge moment:** The tendency of a force to produce movement about a hinge; specifically, the tendency of the aerodynamic forces acting on a control surface to produce motion about the hinge axis of the surface.
- Hydraulic fluid:** Liquid used to transmit and distribute forces to various airplane components that are being actuated.
- Hydraulic pressure limiter:** A device incorporated in the design of the main rudder PCU on all 737 next-generation (NG) series airplanes to reduce the amount of rudder deflection when active. It is commanded to limit hydraulic system A pressure (using a bypass valve) as the airspeed is increased to greater than 137 knots, and it is reset as the airspeed is decreased to less than 139 knots.
- Hydraulic pressure reducer:** A modification on 737-100 through -500 series airplanes to reduce the amount of rudder authority available during those phases of flight when large rudder deflections are not required. The pressure reducer, added to hydraulic system A near the rudder PCU, will lower the hydraulic pressure from 3,000 to 1,000 pounds per square inch (psi) on 737-300, -400, and -500 series airplanes or to 1,400 psi on 737-100, and -200 series airplanes.
- Hydraulic system A (for 737-300, -400, and -500 series airplanes):** A system that includes an engine-driven hydraulic pump and an electrically powered pump that provides power for the ailerons, rudder, elevators, landing gear, normal nosewheel steering, alternate brakes, inboard flight spoilers, left engine thrust reverser, ground spoilers, the system A autopilot, and the autoslats through the power transfer unit.
- Hydraulic system B (for 737-300, -400, and -500 series airplanes):** A system that includes an engine-driven hydraulic pump and an electrically powered pump that provides power for the ailerons, rudder, elevators, trailing edge flaps, leading edge flaps and slats, autoslats, normal brakes, outboard flight spoilers, right thrust reverse, yaw damper, the system B autopilot, autobrakes, landing gear transfer unit, and alternate nose-wheel steering (if installed).
- Input shaft (of the 737 main rudder PCU):** When rudder motion is commanded, this device moves the primary and secondary dual-concentric servo valve slides by way of the primary and secondary internal summing levers to connect hydraulic pressure and return circuits from hydraulic systems A and B so that hydraulic pressure is ported to the appropriate sides of the dual tandem actuator piston to extend or retract the main rudder PCU piston rod.
- Interpolation:** The determination, or approximation, of unknown values based on known values.

Iteration: A process used by the Safety Board that includes repeating Board computer simulations to compare the flights of USAir flight 427, United Airlines flight 585, and Eastwind Airlines flight 517 with available flight data recorder (FDR) data from those flights. The simulation process includes inputting assumed flight control surface (aileron, rudder, and elevator) positions, running the flight simulations, and comparing the output of the simulations (for example, altitude, airspeed, and heading) with FDR data.

Kinematics: A process used by Boeing and the Safety Board that involves fitting curves through available FDR data (such as heading, pitch, and roll), obtaining flight control time history rates from these curves, and obtaining accelerations from these rates. Forces, moments, and aerodynamic coefficients are then obtained from these accelerations using Newton's Laws.

Knot: A velocity of 1 nautical mile per hour.

Linear variable displacement transducer: An electromechanical device that measures linear movement and converts the measurement into an electrical signal (output voltage) that relates position to signal. In the 737 main rudder PCU, it is used to sense the yaw damper position. (Also referred to as a linear variable displacement transformer.)

M-CAB: A Boeing multipurpose cab flight simulator that can be modified to simulate a variety of aircraft models and scenarios. It is an engineering simulator that is capable of simulating events that are outside of normal flight regimes, but it is not used for flight training.

Metering edges: The sides of grooves that are cut into the land surface of the primary or secondary slides of the main rudder PCU servo valve. Flow of hydraulic fluid is controlled by positioning a metering edge relative to a metering port (that is, a rectangular hole in the valve housing and secondary slide through which hydraulic fluid flows). Metering occurs when the metering edge opens and closes the metering port.

Minimum tolerance servo valve: A servo valve used by Boeing during thermal shock testing (for this accident investigation) because it had the tightest diametric clearances (between the primary and secondary slides and the secondary slide and valve housing) that would pass the PCU acceptance test procedure friction requirements.

NG: Boeing's next-generation 737 series, designated as the 737-600, -700, -800, and -900 models.

Overtravel: The ability of a device to move beyond its normal operating position or range. Within the main rudder PCU servo valve, overtravel of the primary or secondary slides would be the result of elastic deformation of the mechanical input mechanism.

Pitch control: The function that is performed by the elevator by moving the control column forward or aft, which raises or lowers the nose of the airplane.

Portable airborne digital data system: A self-contained flight test data recording system developed by Boeing that was installed on a flight test airplane to record parameters

needed to evaluate airplane performance. For USAir 427 and Eastwind 517 flight testing, the system recorded all data at a sampling rate of 20 times per second.

Power control unit (PCU): A hydraulically powered device that moves a control surface, such as a rudder, elevator, and aileron.

Roll: Rotation of an airplane about its longitudinal axis.

Roll control: The function that is performed by the ailerons and flight spoilers by moving the control wheel to the right or the left.

Rotor (when referring to weather): An atmospheric disturbance produced by high winds, often in combination with mountainous terrain, and expressed by a rotation rate (in radians per second), a core radius (in feet), and a tangential speed (in feet per second). Rotation can occur around a horizontal or vertical axis.

Rudder: An aerodynamic vertical control surface that is used to make the airplane yaw, or rotate, about its vertical axis.

Rudder control quadrant: A device in the rudder system that connects rudder cables to control rods to transmit rudder system inputs.

Reverse rudder response: A rudder surface movement that is opposite to the one commanded.

Rudder hardover: The sustained deflection of a rudder at its full (blowdown) travel position.

Rudder trim: A system that allows the pilots to command a steady rudder input without maintaining foot pressure on the rudder pedals. It can be used to compensate for the large yawing moments generated by asymmetric thrust in an engine-out situation.

Servo valve (in the 737 main rudder PCU): A valve used to control rudder direction and rate of movement. The valve comprises a primary slide that moves within a secondary slide that, in turn, moves within the servo valve housing. These slides direct hydraulic fluid through passages to cause rudder movement.

Servo valve housing (in the 737 main rudder PCU): A cylinder-shaped assembly that contains hydraulic fluid passages and interacts with the servo valve secondary slide.

Servo valve primary slide (in the 737 main rudder PCU): A cylindrical piston that moves within the servo valve secondary slide. It is moved by an internal primary summing lever, which translates inputs from the yaw damper and/or the external input crank (which moves when a pilot applies pressure to a rudder pedal) into axial movement of the primary slide.

Servo valve secondary slide (in the 737 main rudder PCU): A cylindrical "sleeve" that encloses the servo valve primary slide. It is moved by the internal secondary summing lever, which translates inputs from the yaw damper and/or the external input crank (which moves when a pilot applies pressure to a rudder pedal) into axial movement of the secondary slide.

Sideload: The effect of lateral acceleration, typically the result of sideslip or yaw acceleration.

Sideslip: The lateral angle between the longitudinal axis of the airplane and the direction of motion (flightpath or relative wind). It is normally produced by rudder forces, yawing motion resulting from asymmetrical thrust, or lateral gusts.

Silting: The accumulation of particles of contaminants in hydraulic fluid in a hydraulic component. The particles are smaller than the filter on the inlet side of the component and tend to settle at various edges and corners of valves and stay there unless washed away by higher flow rates.

Slat: An aerodynamic surface located on an airplane wing's leading edge that may be extended to provide additional lift.

Spoiler: A device located on an airplane wing's upper surface that may be activated to provide increased drag and decreased lift.

Standby hydraulic system: An independent hydraulic system that contains its own electric pump that, when activated, powers the standby rudder system. It also provides an alternate source of power for both thrust reversers and extends the leading edge flaps and slats in the "ALTERNATE FLAPS" mode.

Standby rudder system: A system that provides backup control of the rudder when activated or in the event of a hydraulic system failure. It is powered by the standby hydraulic system and is unpressurized during normal operations.

Summing lever (in the 737 main rudder PCU): One of two internal levers (primary or secondary) within the main rudder PCU that applies force to move the servo valve's primary or secondary slides, respectively. Also, an external lever that transmits rudder pedal and trim input to the PCU's external input crank.

Vertical motion simulator: A simulator at the National Aeronautics and Space Administration's Ames Research Center that is the world's largest motion simulator (with 60 feet of vertical travel). It can be adapted to represent a large number of airplanes, helicopters, and spacecraft. The large motion of this simulator provides a more accurate representation of flight dynamics and accelerations than can be experienced in the Boeing M-CAB or a normal pilot training simulator.

Wake vortex: A counterrotating airmass trailing from an airplane's wing tips. The strength of the vortex is governed by the weight, speed, and shape of the wing of the generating aircraft; the greatest strength occurs when the wings of the generating aircraft are producing the most lift, that is, when the aircraft is heavy, in a clean configuration, and at a slow airspeed. (Also known as wake turbulence.)

Yaw: Rotation of an airplane about its vertical axis.

Yaw control: The function that is normally performed by the rudder by pilot input or yaw damper input. (Also known as directional control.)

Yaw damper (in the 737 main rudder PCU): A system, composed of the yaw damper control switch and a yaw damper coupler, that automatically corrects for yaw motion. The 737 yaw damper coupler includes a rate gyro that senses aircraft motion about the yaw axis and converts the motion to an electrical signal that is sent to the main rudder PCU, which applies the rudder to stop the yaw.

1. Factual Information

1.1 History of Flight

On September 8, 1994, about 1903:23 eastern daylight time,¹ USAir (now US Airways)² flight 427, a Boeing 737-3B7 (737-300), N513AU, crashed while maneuvering to land at Pittsburgh International Airport (PIT), Pittsburgh, Pennsylvania. Flight 427 was operating under the provisions of 14 Code of Federal Regulations (CFR) Part 121 as a scheduled domestic passenger flight from Chicago-O'Hare International Airport (ORD), Chicago, Illinois, to Pittsburgh. The flight departed ORD about 1810, with 2 pilots, 3 flight attendants, and 127 passengers on board. (Table 1, in section 1.2, shows an injury chart.) The airplane entered an uncontrolled descent and impacted terrain near Aliquippa, Pennsylvania. All 132 people on board were killed, and the airplane was destroyed by impact forces and fire. Visual meteorological conditions prevailed for the flight, which operated on an instrument flight rules (IFR) flight plan.

The accident occurred on the third day of a 3-day trip sequence for the flight crew. The pilots reported for duty on the day of the accident about 1215 in Jacksonville, Florida, and departed Jacksonville International Airport in the accident airplane, designated as USAir flight 1181, to Charlotte, North Carolina, about 1310. Flight 1181 arrived at Charlotte-Douglas International Airport about 1421. The next trip segment, also designated as flight 1181, departed Charlotte for ORD about 1521. The airplane arrived at the destination airport about 1707.

At ORD, the accident airplane was designated as USAir flight 427 with an intended destination of Pittsburgh and the same flight crew performing flight duties. Flight 427 departed the gate at ORD about 1802, and became airborne about 1810. The flight plan filed for flight 427 indicated an estimated en route time of 55 minutes. Review of air traffic control (ATC) and cockpit voice recorder (CVR) information³ indicated that the captain was performing the radio communications and other pilot-not-flying (PNF) duties and that the first officer was performing the pilot-flying (PF) duties with the auto-flight system (AFS) engaged.⁴

The CVR indicated that, about 1845:31, ATC personnel at Cleveland Air Route Traffic Control Center cleared USAir flight 427 to descend from its en route cruise altitude of flight level (FL) 290 to FL 240.⁵ The captain responded, "out of two nine oh for

¹ Unless otherwise indicated, all times are eastern daylight time, based on a 24-hour clock.

² For consistency, US Airways is referred to as USAir.

³ A complete transcript of the CVR is included in appendix B of this report.

⁴ For additional information regarding the AFS, see section 1.6.3.1.

⁵ FL 290 is 29,000 feet mean sea level (msl), based on an altimeter setting of 29.92 inches of mercury (Hg). Likewise, FL 240 is 24,000 feet msl.

two four oh....” As the airplane neared its destination (about 1850:56), Cleveland Center controllers advised the pilots of USAir flight 427 to “cross CUTTA [intersection]⁶ at and maintain one zero thousand....” The flight crew acknowledged the descent clearance, and the CVR recorded PIT automatic terminal information service information Yankee beginning about 1851:22.

About 1853:15, the CVR recorded the cockpit door being opened and closed. About 1853:26, a flight attendant inquired about connecting flight and gate information and asked if the pilots wanted anything to drink. About 1854:02, the flight attendant exited the cockpit. About 1854:27, Cleveland Center reiterated the instructions to cross CUTTA intersection at 10,000 feet mean sea level (msl) and instructed the pilots to reduce the airspeed to 250 knots. According to ATC and radar information, at that time, Delta Air Lines flight 1083, a Boeing 727 that had been sequenced to precede USAir flight 427 on the approach to PIT from the northwest, was in level flight at 10,000 feet msl with an assigned airspeed of 210 knots and an assigned heading of 160°. Delta flight 1083 was in communication with Pittsburgh terminal radar approach control (PIT TRACON) personnel.⁷

About 1856:16, Cleveland Center stated, “USAir [427] reduce speed to two one zero [210 knots] that’s at the request of [PIT] approach....” About 11 seconds later, the Cleveland Center controller told the pilots of USAir flight 427 that they did not have to make the previously issued crossing restriction (cross CUTTA at 10,000 feet msl), “just uh, speed first...pd [pilot’s discretion] to ten....” About 1856:32, Cleveland Center told the pilots to “contact PIT approach (on frequency 121.25 Hertz [Hz]).” The captain acknowledged the instructions about 1856:36 and advised PIT TRACON about 1856:52 that he was “descending to ten [thousand feet msl].”

About 1857:07, the CVR recorded the flight attendant returning to the cockpit and delivering juice drinks to the pilots. About 1857:23, PIT TRACON responded to the initial contact from the pilots of USAir flight 427. The controllers instructed the pilots to turn right to a heading of 160°, advised them that they would receive radar vectors to the final approach course for runway 28 right (28R) at PIT, and instructed them to reduce airspeed to 210 knots. About 1858:03, PIT TRACON instructed the pilots of Delta flight 1083 to descend to and maintain an altitude of 6,000 feet msl. About 1858:24, the accident airplane’s CVR recorded the sound of an aural tone similar to an altitude alert and the flight attendant stated, “OK, back to work.” Flight data recorder (FDR) information⁸ indicated that the airplane was at 10,818 feet msl at that time. About 1858:29, the CVR recorded the sound of the cockpit door opening and closing.

⁶ CUTTA intersection is located about 30 nautical miles (nm) northwest of PIT and is a northwest arrival fix for traffic landing at PIT.

⁷ Radar data show that, at their closest point (about 1902:39), Delta flight 1083 and USAir flight 427 were 4.1 nm apart at 6,000 feet msl. For additional information regarding radar data for airplanes in the vicinity of the accident site, see section 1.16.2.

⁸ For more information about the data recorded by the FDR, see sections 1.11.2 and 1.16.6.1.

About 1858:33, PIT TRACON controllers instructed USAir flight 427 to descend and maintain an altitude of 6,000 feet msl. The pilots acknowledged the descent instructions and, about 1859:04, started to accomplish the Preliminary Landing checklist (altimeters/flight instruments, landing data, shoulder harnesses, and approach briefing). The pilots conducted an approach briefing about 1859:28.

According to ATC transcripts, about 1900:06, PIT TRACON instructed Delta flight 1083 to turn left to a heading of 130° and reduce airspeed to 190 knots. About 1900:14, the approach controllers assigned USAir flight 427 a heading of 140° and an airspeed of 190 knots, and the flight crew acknowledged the instructions. About 1900:24, the CVR recorded a sound similar to the flap handle being moved.⁹ About 1900:43, the first officer began a routine public address (PA) announcement,¹⁰ thanking the passengers for traveling with USAir and asking the flight attendants to prepare the cabin for arrival. At 1901:06, the CVR recorded a chime similar to the seatbelt chime.

The CVR indicated that, while the first officer was making the PA announcement (about 1900:44), PIT TRACON instructed Delta flight 1083 to turn left to a heading of 100°. Also during the first officer's PA announcement (about 1901:02), the captain of USAir flight 427 asked the controllers "did you say two eight left for USAir four twenty seven?" About 1901:06, the PIT TRACON controller responded "...USAir [427] it will be two eight right." About 1901:16, the approach controller advised Delta flight 1083 to contact approach control on a different frequency.¹¹

According to the CVR and ATC transcripts, about 1902:22 PIT TRACON stated "USAir 427, turn left [to] heading one zero zero. Traffic will be [at your] one to two o'clock [position, and] six miles, northbound, [a] Jetstream climbing out of thirty-three [hundred feet msl] for five thousand [feet msl]."¹² The pilots of USAir flight 427 acknowledged the approach controller's transmission at 1902:32 and stated, "We're looking for the traffic [and] turning to one zero zero, USAir 427."

⁹ According to USAir personnel, the standard configuration for a 737-300 airplane operating at an airspeed of 190 knots during an approach to land would be flaps 1, which provides for partial extension of the wing leading edge slats and full extension of the Krueger (leading edge) flaps and 1° of extension of the wing trailing edge flaps. During postaccident examination, the accident airplane's flaps were found in the flaps 1 position (see section 1.12).

¹⁰ FDR data indicated that, when the first officer started the PA announcement, the airplane was descending through 7,800 feet msl.

¹¹ Review of the ATC transcripts indicated that USAir flight 427 and Delta flight 1083 were using a common Pittsburgh approach control frequency for approximately 4 minutes 40 seconds. When he was interviewed after the accident, the captain of Delta flight 1083 stated that he did not recall hearing USAir flight 427 on the frequency. He described the flight conditions as "good weather, with no turbulence or bird activity." He further stated that the horizon was clearly visible and that visibility was not restricted.

¹² This traffic was an Atlantic Coast Airlines Jetstream 31, operating as flight 6425 and departing the Pittsburgh area on a 360° heading. Although ATC issued a traffic advisory to Atlantic Coast flight 6425 regarding "traffic at 11 o'clock" (USAir flight 427), the captain and first officer of the Jetstream stated that they did not see flight 427. The captain of Atlantic Coast flight 6425 recalled seeing traffic at his 12:30 to 1 o'clock position, which he believed to be a 727. This position and type of airplane was consistent with that of Delta flight 1083.

FDR data indicated that, about 1902:53, USAir flight 427 was rolling out of the left bank (moving through 7° of left bank toward a wings-level attitude) as it approached the ATC-assigned heading of 100° and was maintaining the ATC-assigned airspeed (190 knots) and altitude (6,000 feet msl). According to the CVR transcript, about 1902:54 the first officer stated, "oh, ya, I see zuh Jetstream."¹³ As the first officer finished this statement (about 1902:57), the CVR recorded a sound similar to three thumps in 1 second,¹⁴ the captain stating "sheez" (at 1902:57.5), and the first officer stating "zuh" (at 1902:57.6).¹⁵ Between about 1902:57 and about 1902:58, FDR data indicated that USAir flight 427's airspeed fluctuated from about 190 knots to about 193 knots and then decreased to about 191 knots for the next 4 seconds. Between about 1902:57 and about 1902:59, FDR data indicated that the airplane's left bank steepened from slightly less than 8° to slightly more than 20°. Figure 1 shows a plot of the FDR data during the last 30 seconds of the flight, along with CVR comments and sounds.¹⁶ About 1902:58, the CVR recorded an additional thump, two "clickety click" sounds, the sound of the engine's noise getting louder,¹⁷ and the sound of the captain inhaling and exhaling quickly one time. Also about 1902:58, the FDR recorded a brief forward movement of the control column.

About 1902:59, the left roll was arrested, and the airplane began to briefly roll right toward a wings-level attitude; FDR data show that, between about 1902:59 and about 1903, the airplane's left bank had decreased to about 15°. Also about 1902:59, the airplane's heading data, which had been moving left steadily toward the ATC-assigned heading of 100°, began to move left at a more rapid rate, passing through the 100° heading. At 1902:59.4, the CVR recorded the captain stating "whoa" and, at 1902:59.7, the sound of the first officer grunting softly. By just after 1903:00, the airplane had begun to roll rapidly back to the left again; its airspeed remained about 191 knots. FDR heading data indicated that, by 1903:01, the airplane's heading had moved left through about 089° and continued to move left at a rate of at least 5° per second until the stickshaker activated about 1903:08. Between about 1903:01 and about 1903:04, the CVR recorded the sound of the first officer grunting loudly and making brief exclamatory remarks¹⁸ while the airplane continued to roll left, with several fluctuations in the roll rate.

¹³ The 737 has three windows on each side of the cockpit. These windows consisted of a forward-facing windscreen, a window located at the pilot's side, and a middle window (located between the forward and side windows). Postaccident examination of radar data and simulations revealed that the Jetstream traffic would have been visible at that time through the lower part of the middle window on the first officer's side of the airplane.

¹⁴ These sounds (and other sounds that occurred during the upset sequence) are discussed in detail in section 1.16.7.

¹⁵ In this report, CVR comments and noises, which are recorded continuously and can be accurately transcribed to the nearest one-tenth of a second, are depicted to the nearest one-tenth of a second during descriptions of the upset sequence portion of the flight for detail and clarity. FDR data are sampled at specific times and intervals, which vary depending on the parameter; therefore, FDR times in this report are referenced to the nearest full second.

¹⁶ The CVR time equals the FDR time in seconds plus 1900:43 (local time).

¹⁷ The sound of the engine noise getting louder was determined from a spectrum analysis of sounds recorded on the CVR (see section 1.16.7.3). This sound cannot be discerned simply by listening to the CVR and is therefore not described on the CVR transcript.

¹⁸ The pilots' speech, breathing, and other sounds are discussed in greater detail in section 1.16.8.

FDR Data and CVR Excerpts
September 8, 1994

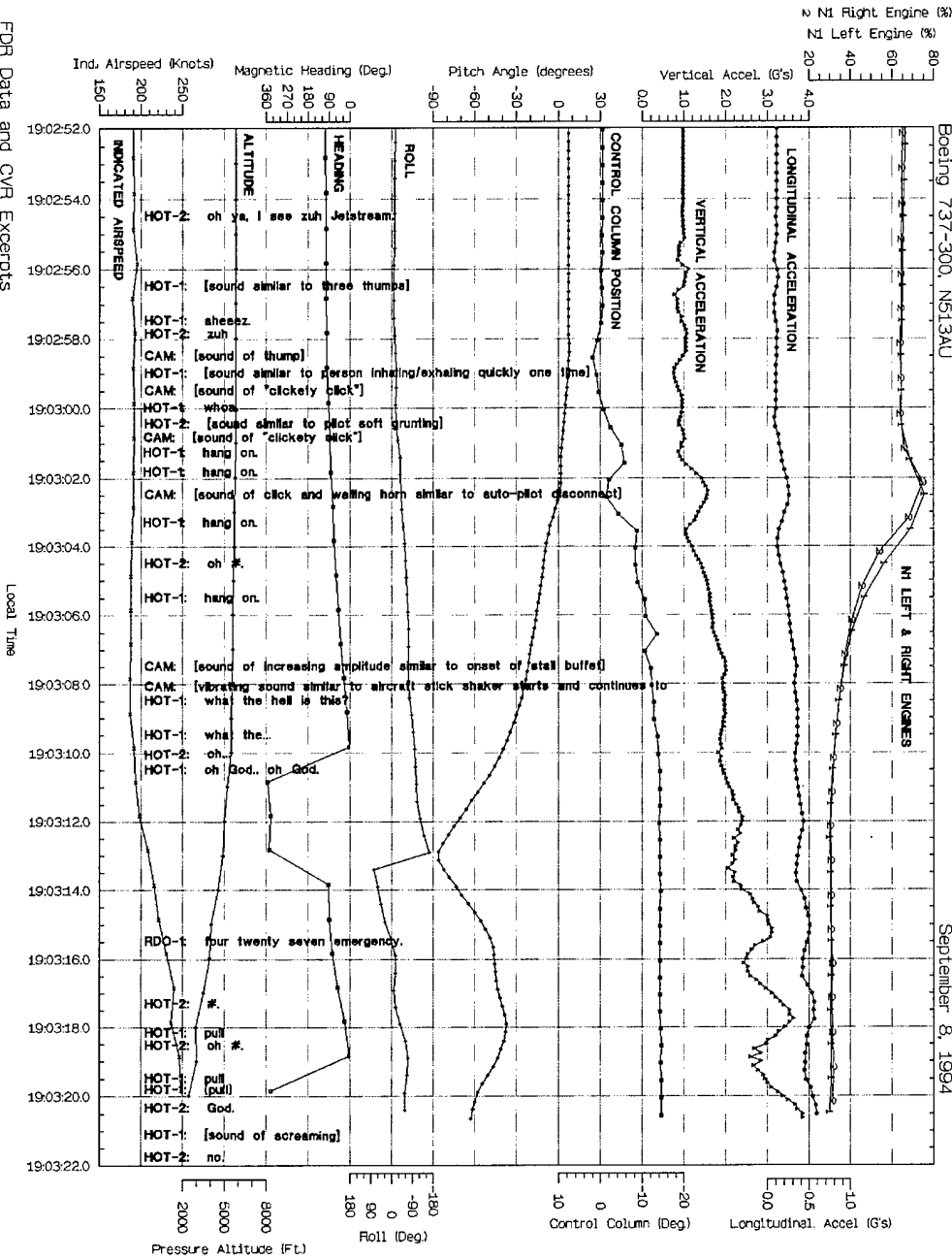

National Transportation Safety Board

Figure 1. FDR data during the final 30 seconds of USAir flight 427.

FDR information revealed that, just before 1903:03, the airplane's left bank angle had increased to about 43°, the airplane had begun to descend from its assigned altitude of 6,000 feet msl, the control column had started to move aft, and the airspeed started to decrease below 190 knots. Less than 1 second later, the CVR recorded the sound of the autopilot disconnect horn. During the next 5 seconds, the FDR recorded increasing left roll, aft control column, decreasing altitude, and a decreasing airspeed to about 186 knots.

Also between 1903:02.7 and 1903:07.7, the CVR recorded several brief remarks on the flight crew channels. At 1903:07.5, the CVR recorded a sound of increasing amplitude similar to onset of stall buffet and the captain stating "what the hell is this?" The CVR transcript indicated that, at 1903:08.1, a vibrating sound similar to aircraft stickshaker started and continued until the end of the recording. At 1903:08.3, an aural tone similar to an altitude alert sounded, and 1 second later, the traffic alert and collision avoidance system sounded "traffic traffic."¹⁹

According to the ATC transcript, a radio transmission from USAir flight 427 about 1903:10 stated, "Oh (unintelligible) Oh [expletive]."²⁰ The approach controller reported that, at that time, flight 427's altitude readout on the radar screen indicated 5,300 feet. About 1903:14, the controller stated "USAir 427 maintain 6,000, over." About 1903:15, the CVR transcript indicated that the captain made a radio transmission, stating "four twenty seven emergency." Between 1903:18.1 and 1903:19.7, the CVR recorded the captain stating "pull...pull...pull." From about 1903:09 to about 1903:22, the first officer's radio microphone was activated and deactivated repeatedly, so the ATC tapes recorded exclamations and other sounds from the accident airplane. During postaccident interviews, air traffic controllers who were in the tower cab when the accident occurred reported that they observed dense smoke rising to the northwest of the airport shortly after USAir flight 427's final transmission. The CVR stopped recording at 1903:22.8.

About 1903:23, the airplane impacted hilly, wooded terrain near Aliquippa, Pennsylvania, approximately 6 miles northwest of PIT. The location of the accident was 40° 36 minutes, 14.14 seconds north latitude, 80° 18 minutes, 36.95 seconds west longitude at an elevation of about 930 feet msl. The accident occurred during daylight hours.

¹⁹ The traffic alert and collision avoidance system is an airborne system based on radar beacon signals that operate independent of ground-based equipment. Although it was not possible to positively determine what triggered the system's alert, radar information indicated that, during the accident sequence, USAir flight 427 was within about 3 miles of Atlantic Coast flight 6425 when the accident airplane descended through the Atlantic Coast flight's altitude.

²⁰ The CVR transcript also indicated that the pilots of USAir flight 427 made a radio transmission to ATC about 1903:10 and that the captain's cockpit microphone recorded the statement, "Oh God...Oh God."

1.2 Injuries to Persons

Table 1. Injury chart.

Injuries	Crew	Passengers	Others	Total
Fatal	5	127	0	132
Serious	0	0	0	0
Minor/None	0	0	0	0
Total	5	127	0	132

1.3 Damage to Aircraft

The airplane was destroyed by ground impact and postcrash fire. According to insurance company records, the airplane was valued at \$30 million.

1.4 Other Damage

No structures on the ground were damaged. Trees and vegetation near the accident site were destroyed or damaged by the impact, fuel blight, and postcrash fire and during wreckage removal.

1.5 Personnel Information

The flight crew consisted of the captain and the first officer. Three flight attendants were also on duty aboard the airplane. The 3-day trip sequence during which the accident occurred was the first time the captain and the first officer had flown together.

Both pilots were off duty on Monday, September 5, 1994 (Labor Day holiday). According to their wives, both pilots spent their off-duty time relaxing with family and friends and received a normal amount of sleep²¹ before they reported for flight duty.

The pilots reported for duty in Philadelphia, Pennsylvania, on Tuesday, September 6, about 1615 for the 3-day trip sequence. On the first day, the pilots flew to Indianapolis, Indiana, returned to Philadelphia, and then continued to Toronto, Ontario, Canada. They arrived in Toronto about 2310, completed their flight-related duties about 2327, and remained in Toronto overnight. According to the flight logs, the pilots' duty time for the first day of their trip sequence was about 7 hours 12 minutes, including about 4 hours 56 minutes of flight time. At Toronto, the pilots had a scheduled layover of about 14 hours 30 minutes.

²¹ The captain's wife reported that he normally slept about 7½ hours each night when he was not working. She indicated that, on September 4 and 5, the captain went to bed between 2300 and 2400 and awoke between 0700 and 0800 the following mornings. The first officer's wife reported that he normally slept about 8 hours each night when he was not working. She indicated that, on September 4, the first officer went to bed about 2200 and awoke about 0630 the next morning; on September 5, he went to bed about 2200 and awoke earlier than usual (about 0500) the next morning to begin the commute from his home near Houston, Texas, to Philadelphia, Pennsylvania, to report for duty later that day.

On the second day of the trip sequence (Wednesday, September 7), the pilots' duty period began about 1400 at Toronto. They flew to Philadelphia, then Cleveland, Ohio; then Charlotte, North Carolina; and then Jacksonville, Florida. They arrived in Jacksonville about 2254, completed their flight-related duties about 2321, and remained in Jacksonville overnight. According to the flight logs, the pilots' duty time for the second day of their trip sequence was about 9 hours 21 minutes, including about 5 hours 16 minutes of flight time. At Jacksonville, the pilots had a scheduled layover of nearly 13 hours before reporting for duty about 1215 on Thursday, September 8.

1.5.1 The Captain

The captain, age 45, was hired by USAir on February 4, 1981, while on furlough from Braniff Airways. He held airline transport pilot (ATP) certificate No. 1954135 with a multiengine land airplane rating and a type rating in the 737. Additionally, he held a flight engineer certificate and a commercial pilot certificate with single-engine land, multiengine land, and instrument ratings. The captain's most recent first-class Federal Aviation Administration (FAA) airman medical certificate was issued on July 9, 1994, with no restrictions or limitations.

The captain's initial flight experience was in general aviation, and he obtained a private pilot certificate in August 1969. He subsequently entered the U.S. Air National Guard and successfully completed the U.S. Air Force (USAF) pilot training program²² in December 1973. The Safety Board was unable to review the captain's USAF training and flight records from before September 3, 1975, because, according to a USAF representative, flight records dated before then (including the captain's initial training records) had been destroyed. The captain's available military flight records indicated that, between September 3, 1975, and March 15, 1979, he accumulated about 894 hours of military flight time, including 227 hours of training and 667 hours in the Cessna O-2 observation airplane.²³

The captain obtained a commercial pilot certificate in June 1974, a flight engineer certificate on July 28, 1976, and an ATP certificate with a type rating in the 737 on August 25, 1988. He was hired by Braniff Airways on October 17, 1977. His initial assignment with Braniff was as second officer on a Douglas Aircraft Company DC-8. On December 1, 1980, the captain was furloughed by Braniff. Two months later, the captain was hired by USAir. As he neared the end of the required 1-year probation period at USAir, the captain submitted a letter of resignation to Braniff on January 25, 1982, with an effective date of February 4, 1982. Braniff personnel records indicated that the captain would be considered for rehire.

The captain's first assignment with USAir was as a flight engineer on the 727. He was upgraded to first officer on the British Aerospace Corporation (BAC) 111 in

²² The USAF provides pilot training for Air National Guard personnel.

²³ The Cessna O-2 is the military version of the Cessna 337, an in-line thrust, twin reciprocating engine-powered airplane. The Cessna O-2 is used in forward air control observations and is not approved for aerobatic maneuvers.

November 1982. He transitioned to the 737 in September 1987 as a first officer and was upgraded to captain on the 737 on August 25, 1988. According to USAir records, at the time of the accident, the captain had flown approximately 12,000 flight hours, including 3,269 hours as a 737 captain. He also had 795 flight hours as a 737 first officer.

USAir records indicated that the captain was on extended sick leave from January 25 to April 28, 1994, because of back surgery.²⁴ When he returned to flight duty, the captain underwent 737 requalification and crew resource management (CRM) training, which he completed on April 29, 1994. The captain's most recent line check was completed on May 6, 1994, and his most recent line-oriented flight training (LOFT) was completed on July 19, 1994.

A review of USAir's training records indicated that the captain performed satisfactorily in initial, recurrent, CRM, and LOFT training and line and proficiency checks in all airplanes and all positions.²⁵ Additionally, a review of the captain's USAir personnel records, FAA airman certification records, and FAA accident/incident and violation histories revealed nothing noteworthy. During postaccident interviews, several check airmen, instructors, and first officers who were acquainted with the captain and his piloting abilities indicated that the captain was meticulous, very proficient, very professional, and attentive to detail and that he flew "by the book." They also reported that the captain was well liked and exhibited excellent CRM skills.

According to his wife, the captain did not complain of back pain after he returned to flight duty. She stated that he took no medication, other than allergy injections,²⁶ and drank alcohol rarely. She considered his overall health to be "very good." A review of the USAir-sponsored insurance company medical records revealed that, during the 5 years before the accident, the medical claims submitted by the captain indicated no significant illnesses or hospitalizations except for the back surgery shown in company records.

The Safety Board's review of the captain's available flight records (civilian and post-1975 military records) revealed no documentation of aerobatic flight experience.²⁷

²⁴ The captain underwent back surgery in March 1994 to remove a ruptured disk.

²⁵ Although the captain's training records indicated that he satisfactorily completed all training and line and proficiency checks in all airplanes and all positions, the training record from his September 1987 transition from BAC-111 first officer to 737 first officer contained the instructor's remark, "I would place at end of training, [the captain] in [the] lower 10 percent." During postaccident interviews, the instructor stated that he did not recall the circumstances that prompted him to make this remark. He further stated that, if the captain had not satisfied all the requirements, he would have graded the captain's performance unsatisfactory.

²⁶ During postaccident interviews, the captain's allergist stated that the captain exhibited mild allergy symptoms, such as sneezing, runny nose, and postnasal drip, which responded well to allergy injections. The allergist reported that the captain was current with his allergy injections, having received the most recent one in August 1994.

²⁷ The Safety Board is aware that the USAF's initial pilot training program included aerobatic training in the T-37 and T-38 jet trainers. (No records were available of the captain's initial training in the Air Force.)

1.5.2 The First Officer

The first officer, age 38, was hired by Piedmont Airlines in February 1987 and became a USAir employee after USAir acquired Piedmont Airlines in June 1989. He held ATP certificate No. 2238867 with single-engine and multiengine land airplane ratings. Additionally, he held a commercial pilot certificate with single-engine land, multiengine land, and instrument ratings. The first officer's most recent FAA first-class airman medical certificate was issued on July 7, 1994, with no restrictions or limitations.

The first officer's initial flight experience was in general aviation. He was issued a private pilot certificate in May 1973, multiengine and instrument ratings in December 1980, a commercial pilot certificate in January 1981, and the ATP certificate in October 1982.

The first officer's initial position with Piedmont Airlines was as a first officer on the Fokker F.28. He transitioned to first officer on the 737 on May 1, 1989, and remained in that position after he became a USAir employee in June 1989. At the time of the accident, the first officer had a total of 9,119 flight hours, including 3,644 flight hours as a 737 first officer. His most recent proficiency check, which included CRM refresher training, was satisfactorily completed on May 12, 1994.

A review of the first officer's USAir personnel records, FAA airman certification records, and FAA accident/incident and violation histories revealed nothing noteworthy. According to his training records, the first officer performed satisfactorily in initial and LOFT training and line and proficiency checks in all airplanes and all positions. During postaccident interviews, check airmen, instructors, and captains who were acquainted with the first officer and his piloting abilities indicated that the first officer was friendly, very well qualified, and an outstanding first officer who exhibited exceptional piloting skills. USAir's Philadelphia-based chief pilot stated that the first officer was a "very dedicated, professional, dependable person." One captain who had flown with the first officer described an in-flight hydraulic system emergency that occurred during one of their flights. He stated that the first officer remained very calm during the emergency situation.

According to the first officer's wife, he did not take medication and was a moderate, occasional drinker. She characterized the first officer's overall health as "excellent." A review of the USAir-sponsored insurance company medical records revealed that the first officer had not made any medical claims during the 5 years before the accident.

Examination of the first officer's personal logbooks and records did not indicate any aerobatic flight training or experience. However, his flight logbooks indicated that he had performed spin recoveries on three occasions in 1973 in a Piper J-3 "Cub" airplane when he had total flight times between 77 and 93 hours.

1.5.3 Flight Attendant Information

The lead, or "A" position flight attendant was hired by Piedmont Airlines in May 1989. He completed the USAir Merger Module Training that was required when USAir acquired Piedmont Airlines in June 1989. His most recent recurrent training was satisfactorily completed on June 14, 1994, and he was qualified on the 737-300. The "B" position flight attendant was hired by Piedmont Airlines in March 1989. She also completed the USAir Merger Module Training in June 1989. Her most recent recurrent training was satisfactorily completed on February 2, 1994, and she was qualified on the 737-300. The "C" position flight attendant was hired by USAir in October 1988. Her most recent recurrent training was satisfactorily completed on October 14, 1993, and she was qualified on the 737-300.

1.6 Airplane Information

N513AU, a 737-300 series airplane (model 737-3B7),²⁸ serial number (S/N) 23699, was a pressurized, low-wing, narrow-body transport-category airplane, equipped with two CFM International²⁹ CFM56-3B-2 engines (operated at the CFM56-3-B1 thrust rating). The No. 1 (left) engine, S/N 725150, had been operated about 13,880 flight hours since new, including 3,462 flight hours and 2,160 flight cycles since it was overhauled and installed on N513AU in August 1993. The No. 2 (right) engine, S/N 720830, had been operated about 16,810 flight hours since new, including 3,789 flight hours and 2,340 flight cycles since it was overhauled and installed on N513AU in July 1993. At the time of the accident, the airplane had been operated about 23,846 total hours of flight time and 14,489 cycles. When the accident airplane was manufactured and delivered to USAir in October 1987, it was registered as N382AU; USAir re-registered the airplane as N513AU in December 1987 after the airline acquired Pacific Southwest Airlines (PSA).

The airplane was equipped with an auxiliary fuel tank, which had been deactivated and held no fuel at the time of the accident.³⁰ The presence of the auxiliary fuel tank limited the cargo capacity of the aft cargo compartment.

Dispatch records indicate that the airplane held a total of 15,400 pounds of fuel when it left the gate at ORD and that the estimated fuel consumption for the flight to Pittsburgh was about 6,400 pounds. According to the USAir dispatch papers for USAir

²⁸ The 737-300 series airplane is one of several 737 models. Other 737 models include the -100, -200, -400, -500, -600, -700, -800, and -900. The 737-600 through -900 series airplanes are referred to as the 737 next-generation (NG) airplanes.

²⁹ CFM International is a joint venture engine-manufacturing company formed in 1974 by General Electric (now General Electric Aircraft Engines) of the United States and Society National d'Etude et de Construction de Moteurs d'Aviation of France.

³⁰ The accident airplane was equipped with a Patrick Aircraft Tank System auxiliary fuel tank system. This 425-gallon-capacity auxiliary fuel tank system was located in the forward end of the aft cargo bay. According to USAir maintenance records, the auxiliary fuel tank was installed in the accident airplane on October 17, 1987, and was deactivated in accordance with the manufacturer's procedures on January 10, 1994.

flight 427, 8 passengers were seated in the first-class cabin, and 119 passengers were seated in the coach cabin. According to USAir's dispatch papers, flight 427's documented cargo consisted of 10 boxes of magazines weighing 1,939 pounds. The boxes were loaded in the forward compartment with about 425 pounds of passenger baggage; the aft cargo compartment was loaded with 1,275 pounds of passenger baggage. USAir's dispatch papers also indicated that the airplane's gross takeoff weight when it departed ORD was 114,969 pounds. The airplane had a certificated maximum gross weight of 135,500 pounds and a maximum takeoff weight for the departure runway (32L) at ORD of 118,700 pounds. On the basis of Safety Board calculations, flight 427, at the time of the accident, had an estimated operating weight of 108,600 pounds and a center of gravity of 19 percent mean aerodynamic chord, which was within the allowable weight and balance envelope for the approach and landing phase of flight.

1.6.1 Accident Airplane Maintenance Information

1.6.1.1 Inspections

USAir's FAA-accepted continuous airworthiness maintenance program for its 737s included six specific checks to be accomplished at various calendar or operating time intervals. The maintenance inspection intervals and the times and dates that those inspections were last accomplished on the accident airplane were as follows:

- Wheel/Oil Check—Accomplished once every operating day. Accomplished on the accident airplane during transit check on September 8, 1994, about 5¾ flight hours before the accident.
- Transit Check—Accomplished every 35 flight hours or 7 calendar days, whichever comes first. Accomplished on the accident airplane on September 8, 1994, about 5¾ flight hours before the accident.
- "A" Check—Not to exceed 200 flight hours. Accomplished on the accident airplane on August 25, 1994, about 133 flight hours before the accident.
- "B" Check—Not to exceed 1,150 flight hours. Accomplished on the accident airplane on May 19, 1994, about 1,008 flight hours before the accident.
- "C" Check—Not to exceed 4,600 flight hours. The C check is broken down into four segments at 1,150-hour intervals. A quarter C check was completed on the accident airplane on July 20, 1994, about 433 flight hours before the accident.
- "Q" Check—Not to exceed 11,000 hours or 42 months, whichever comes first. The initial Q check is not required until 20,000 hours or 80 months, whichever comes first. The Q check is an approved alternative to the structural inspection ("D" check). Maintenance endorsements for work completed during the accident airplane's last Q check were dated February 3 through 5, 1993, about 19 months before the accident.

A review of the accident airplane's maintenance records from June 2, 1994, to the accident date revealed the following five maintenance carryover items:

- the left aft inboard flap assembly was dented,
- an interim repair to correct a soft and spongy aisle floor section adjacent to seat row number 5 (about fuselage station 360) was needed,
- the attach mount bushing on the thrust reverser "C" duct for the right engine was worn,
- the lower left and right C duct sliders on the right engine were worn 30 to 49 percent, and
- the lower left and right C duct sliders on the left engine were worn 30 to 49 percent.

Examination of the maintenance work cards from the most recent C and Q checks noted several reports of lavatory fluid, known as "blue water," leaking under the sink and toilet of the forward lavatory.³¹ Additionally, the work cards noted corrosion in the forward galley floor structure.

Maintenance records for the most recent Q check indicated that a thrust reverser synchronizer lock (sync-lock) system³² was installed in accordance with Boeing Service Bulletin (SB) 737-78-1053, dated December 17, 1992, and USAir engineering authorization 18190. However, on February 11, 1993, Boeing issued Service Letter (SL) 737-SL-78-26, which advised all 737 operators to deactivate the sync-lock system (if installed) because of "the possibility of an intermittent condition which results in the inability to attain reverse thrust when commanded." A USAir work card, dated February 5, 1993, stated "accomplish...de-activation of T/R [thrust reverser] sync lock system...[according to] 737-SL-78-26"³³ and referenced USAir engineering authorization 18477, "De-activation of Thrust Reverser Sync Lock System," dated February 4, 1993. The system's wiring harness remained installed with its electrical connectors capped and secured and the electric synchronizer locks removed. The sync-lock system on the accident airplane remained deactivated on the date of the accident.³⁴

³¹ The last report of blue water leakage on the accident airplane was in May 1994, when blue fluid was found aft of the main entry door. The area was inspected and cleaned, and no additional leakage was noted.

³² The thrust reverser sync-lock system was designed to minimize the possibility of in-flight thrust reverser deployment.

³³ Boeing's 737-SL-78-26 was dated February 11, 1993, 6 days after USAir's maintenance personnel indicated that they accomplished the deactivation of the thrust reverser sync-lock system (according to work card No. 3-72-93853, dated February 5, 1993). According to USAir personnel, they deactivated the thrust reverser sync-lock system in response to an advance copy of 737-SL-78-26, which they received in early February 1993. The installation and subsequent deactivation were completed during the same maintenance visit.

³⁴ After the accident, the FAA issued Airworthiness Directive (AD) 94-21-05 R1, which became effective November 25, 1994. The AD required the installation of the sync-lock feature on all 737-300, -400, and -500 series airplanes.

Maintenance records also indicated that the main rudder power control unit (PCU) was replaced during the last Q check (February 1993) after leakage was observed at the rear seal. Three of the Q check work cards described the work pertaining to the main rudder PCU as follows:

Work card No. J3-64-55501-2 indicated that the PCU "reference rod [had] been scraped against [the] vertical fin liner structure" and that the damaged area was cleaned up, inspected, and "found to be within limits."

Work card No. J3-65-27500-2 indicated that the "main bolt which attaches power control unit to rudder attach point has slight step worn in it." The worn bolt was replaced.

Work card No. J3-65-27500-3 indicated that the "rod bearing on [the] PCU at [the] PCU to rudder attach point has rough feel during operation" and that the PCU was replaced "due to leakage."

The replacement main rudder PCU, S/N 1596A, was examined and tested thoroughly during the accident investigation. (For additional information regarding the main rudder PCU, see sections 1.6.3.2 and 1.16.5.)

USAir's maintenance records showed that the periodic rudder functional checks required by Airworthiness Directive (AD) 94-01-07 (explained in more detail in sections 1.6.3.2.1 and 1.18.5) were successfully performed on the accident airplane three times in 1994. The initial check was performed on March 21, 1994, at 22,368 flight hours and 13,511 flight cycles. Repetitive inspections were performed on June 14, 1994, at 23,100 hours and 13,994 cycles and on August 8, 1994, at 23,572 hours and 14,298 cycles. The maintenance records also indicated that the accident airplane was in compliance with all other applicable ADs at that time.

1.6.1.2 Events on Earlier Flights

The accident airplane departed Windsor Locks, Connecticut,³⁵ about 0620 on the morning of September 8, 1994, and was flown to Syracuse and Rochester, New York; Charlotte; and Jacksonville (where the accident flight crew boarded). The pilots of the earlier flights reported no difficulties with the airplane. However, a passenger who was on the accident airplane when it arrived in Jacksonville reported an "abrupt maneuver" during the approach to Jacksonville. Subsequent examination of the FDR information for this approach indicated a roll of 9° to the left followed by a roll of 12° to the right. The FDR indicated the event, from the beginning of the left roll to the return to wings-level attitude, occurred over 20 seconds. The pilots of that flight stated that they did not notice any unusually abrupt maneuvers. They suggested that a slight roll might have occurred as they changed to different modes of the autopilot, but they had no recollection of an unusual roll event. The pilots stated that the airplane's systems and controls functioned normally during the flight.

³⁵ The accident airplane remained in Windsor Locks on the night of September 7, 1994, where a maintenance transit check was accomplished. Records indicated that only routine service was performed and that no discrepancies were noted during this inspection.

The Safety Board also received postaccident passenger reports of an unusual sound that occurred during the flight immediately preceding the accident flight, from Charlotte to ORD. An off-duty/commuting USAir captain who traveled on flight 1181 from Jacksonville to Charlotte and then to ORD occupied a seat in the passenger cabin during the flight from Jacksonville to Charlotte; however, he occupied the observer's jumpseat³⁶ in the cockpit during the flight from Charlotte to ORD because of a full passenger load. According to the off-duty captain, during the flight from Charlotte to ORD, a passenger in the forward cabin told the flight attendant that he heard an unusual noise, and the flight attendant informed the flight crew of the passenger's comment. While the flight crew attempted to determine the origin of the noise, the off-duty captain noted that the cabin address microphone had come out of its holder. The microphone was returned to its holder, and there were no further reports of unusual noises.

During the Safety Board's January 1995 public hearing regarding this accident,³⁷ the off-duty USAir captain indicated that airplane operations during the two flights appeared to be "normal." He stated that the flight and cabin crew interaction appeared to be routine and professional and that both pilots seemed to be friendly and in good spirits. He observed no problems with the airplane and reported that the captain was performing the PF duties for the leg from Charlotte to Chicago.

1.6.2 Boeing 737 Hydraulic System Information

Hydraulic power on the 737-300 is provided by three independent hydraulic systems, each of which is capable of operating pressures of about 2,950 pounds per square inch (psi). The systems are designated as hydraulic system A, hydraulic system B, and the standby hydraulic system. Hydraulic systems A and B have independent hydraulic reservoirs and two hydraulic pumps each. Although hydraulic systems A and B normally operate together to provide dual hydraulic power for primary flight controls (ailerons, elevators, and rudder), either system is capable of powering the flight controls alone if the other system fails. Further, if one of the hydraulic pumps in either the A or B systems were to fail, the remaining pump has sufficient capacity to provide full flight control authority for its respective system operation.

The 737-300 hydraulic system A is powered by one engine-driven hydraulic pump (EDP) and one electrical-powered hydraulic pump. Hydraulic system A provides power for the ailerons, rudder, elevators, landing gear, normal nosewheel steering, alternate brakes, inboard flight spoilers, left engine thrust reverser, ground spoilers, the A system autopilot, and the autoslats through the power-transfer unit. The 737-300 hydraulic

³⁶ The cockpit was configured with two crew seats (captain on the left and first officer on the right) with the throttle/communication/navigation console located between them. The observer seat is located behind the flight crew seats and console and in front of the cockpit-to-cabin access door.

³⁷ The Safety Board conducted two sessions of its public hearing regarding this accident. The first session was held in Pittsburgh in January 1995, and the second session was held in Springfield, Virginia, in November 1995. Although it is unusual for the Safety Board to hold two sessions of a public hearing, the Board believed that a second session was warranted, given the scope and technical depth of the accident investigation.

system B is also powered by one EDP and one electrical-powered hydraulic pump. Hydraulic system B provides power for the ailerons, rudder, elevators, trailing edge flaps, leading edge flaps and slats, autoslats, normal brakes, outboard flight spoilers, right engine thrust reverser, yaw damper, the system B autopilot, autobrakes, landing gear transfer unit, and alternate nose wheel steering (if installed).

The 737-300 standby hydraulic system is unpressurized during normal operations. This system is powered by an electric pump and can be activated manually by the pilots by arming "ALTERNATE FLAPS" or selecting the hydraulic system A or B flight control switch to "STBY RUD" (standby rudder) on the overhead panel in the cockpit.³⁸ The 737-300 standby hydraulic system will activate automatically in the event of a loss of hydraulic system A or B pressure during takeoff or landing. (For automatic operation, speed must be greater than 60 knots, or the airplane must be airborne with wing flaps extended.) The standby hydraulic system powers the standby rudder system, provides an alternate source of power for both thrust reversers, and extends the leading edge flaps and slats in the ALTERNATE FLAPS mode. In the event of a failure of both hydraulic systems A and B, the ailerons and elevators can be operated manually without hydraulic power (referred to as manual reversion).³⁹ The rudder has no manual reversion capability but can be operated with the standby hydraulic system.⁴⁰

Controls and indicators for hydraulic systems A and B are located on the first officer's overhead panel in the cockpit;⁴¹ they include on/off switches for each pump and amber lights that indicate hydraulic system low pressure or overheat conditions for the electrically driven pumps. Figure 2 illustrates the hydraulic system panel.

³⁸ During normal operation, the hydraulic system A and B flight control switches would be in the ON position, and the ALTERNATE FLAPS switch would be in the OFF position.

³⁹ According to Boeing, manual reversion requires approximately 40 pounds of force at the control wheel to initiate a roll and approximately 60 pounds of force at the control column to initiate a pitch change.

⁴⁰ Although the 737 rudder technically has no manual reversion capability, it is possible for a pilot (with sufficient rudder pedal force) to command some rudder movement with no hydraulic system power.

⁴¹ Although located on the first officer's overhead panel, the hydraulic system control panel is accessible to both pilots.

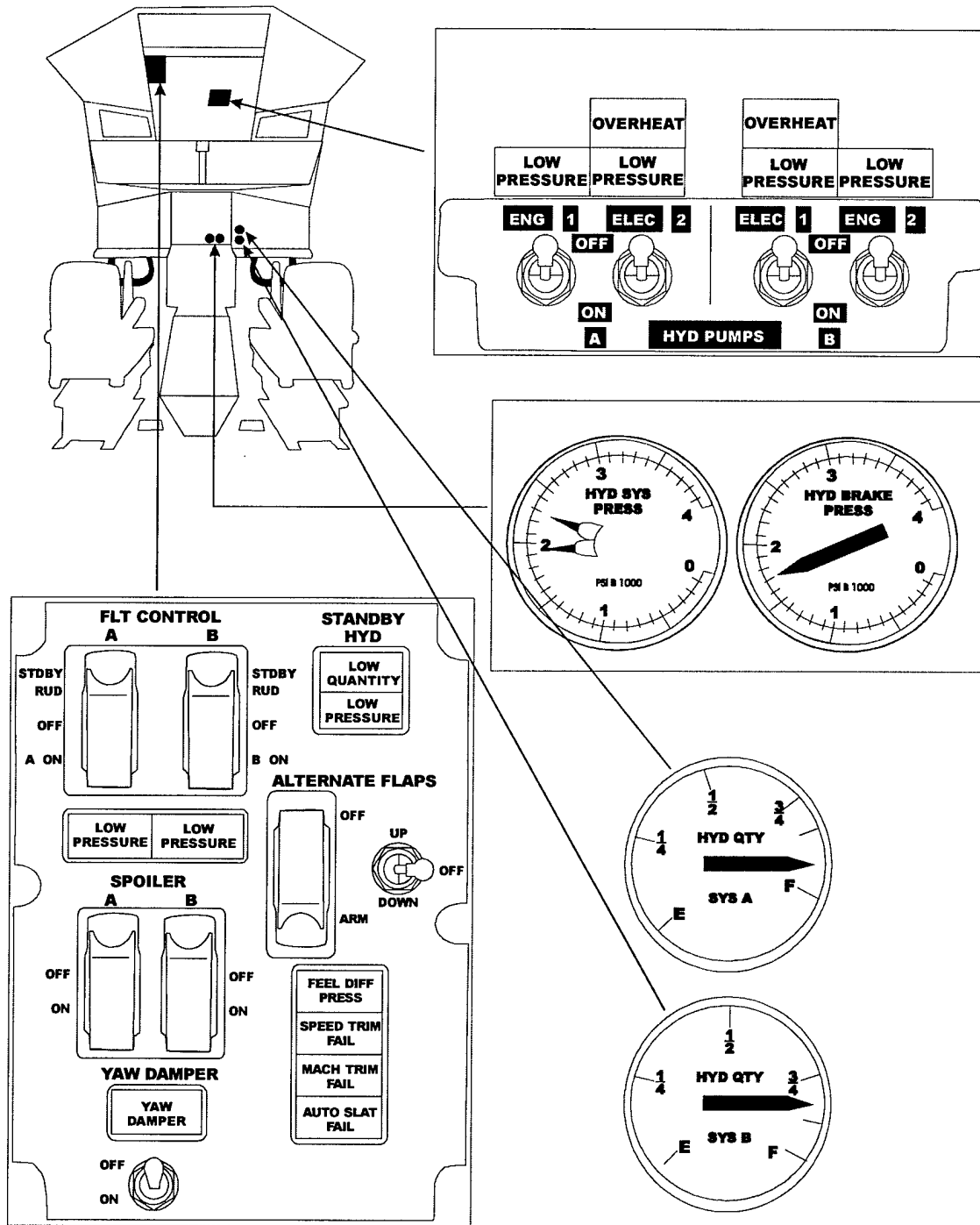

Figure 2. Boeing 737 hydraulic system panel.

1.6.2.1 Hydraulic System Maintenance

USAir's maintenance records indicated that the accident airplane had been serviced at the time of manufacture with Skydrol LD4 hydraulic fluid manufactured by Monsanto.⁴² According to Boeing, it ensures that the particulate count in the hydraulic systems of newly delivered airplanes meets the cleanliness requirement of National Aerospace Standard (NAS) 1638 Class 9. According to NAS 1638, "Cleanliness Requirements of Fluid Used in Hydraulic Systems," the "cleanliness limit of the representative fluid sample from parts, assemblies, lines and fittings shall not exceed the permissible maximum contamination limits of the specified class...in Table I...." NAS 1638 Table I lists hydraulic fluid cleanliness limits by particle count and size, ranging from Class 00 to Class 12. Table 2 shows excerpts from the NAS table.⁴³

Table 2. Hydraulic fluid cleanliness limits from NAS 1638 Table I.

	5-15 μ	15-25 μ	25-50 μ	50-100 μ	>100 μ
Class 00	125	22	4	1	0
Class 1	500	89	16	3	1
Class 9	128,000	22,800	4,050	720	128
Class 12	1,024,000	182,400	32,400	5,760	1,024

Boeing's Maintenance Planning Document recommends the replacement of the hydraulic system A and B filters at C check intervals and the replacement of filters located at the flight control system PCUs "on condition"⁴⁴ during maintenance of the filters' respective components. USAir's maintenance program incorporated these recommended replacement intervals.

Boeing's 737 Maintenance Manual (MM) did not recommend any specific interval for the sampling or replacement of the hydraulic fluid during the life cycle of the airplane. However, section 29-15-00 in the MM (pages 601-606), which describes Boeing's recommended "Hydraulic Systems A, B, and Standby—Inspection Check" procedures and limits, states the following on page 601 (dated November 15, 1993):

The operational environment of the airplane hydraulic system can affect the service life of the hydraulic fluid. You make a decision to take a sample of the hydraulic fluid for analysis if you find that it is necessary from your service experience.... If the fluid properties are greater than the limits...replace some quantity of fluid with new fluid until the fluid properties agree with the limits shown.

⁴² Skydrol LD4 is a phosphate ester hydraulic fluid. It is part of the Skydrol family of fire-resistant hydraulic fluids and meets the airframe manufacturer's specifications for viscosity, flashpoint, and moisture content as a Type IV fluid. It has been used commercially since 1978.

⁴³ The symbol μ in table 2 represents the unit of measurement termed a micron, which is 1/1,000 of a millimeter. For a point of reference, a 0.5-millimeter mechanical pencil is 500 microns in diameter.

⁴⁴ Replacement "on-condition" means that the component or part is removed/replaced only after a defect or anomaly is noted during an inspection. The replacement is not based on a time or cycle limit.

During postaccident discussions, Boeing personnel stated that fluid sampling (or replacement/replenishment) intervals were to be established by the operator (along with the operator's hydraulic fluid supplier) based on service experience and the operational environment. USAir's maintenance program did not include a requirement to sample or replace the hydraulic fluid in the systems, and such sampling or replacement of hydraulic fluid were not required by the FAA. The Safety Board examined hydraulic fluid samples from the accident airplane during the investigation (see section 1.16.5.4.3 for details).⁴⁵

1.6.3 Boeing 737 Flight Control Systems

The flight controls on the 737 are the ailerons, flight spoilers, elevators, horizontal stabilizer, rudder, flaps, and slats. Flight control about the longitudinal (roll) axis of the airplane is provided by an aileron on each wing assisted by two flight spoilers. Flight control about the lateral (pitch) axis is provided by the horizontal stabilizer and two elevators. Flight control about the vertical or directional (yaw) axis is provided by the single-panel rudder.⁴⁶ The ailerons and flight spoilers (roll control) are operated by moving the control wheel clockwise or counterclockwise,⁴⁷ the elevator (pitch control) is operated by moving the control column forward or aft, and the rudder (directional/yaw control) is operated by moving either the right or left rudder pedal forward or aft. Figure 3 depicts the three axes of motion, and figure 4 shows the flight control surface locations.

Boeing stated that the 737 roll and yaw control systems were designed to be capable of countering the effects of failures (such as loss of power on one engine, flap and/or slat asymmetries, and hydraulic system failure) and achieve the desired crosswind control capability. According to Boeing, the 737 is aerodynamically cross-coupled (as are most airplanes); that is, motions about the roll and the yaw axes constantly interact and affect each other in flight. Thus, any yawing motion (sideslip) would cause the airplane to roll unless countered by the control wheel. The 737 rudder system is discussed in greater detail in section 1.6.3.2.

1.6.3.1 Auto-Flight System

When engaged, the 737-300 AFS provides control commands to the airplane's ailerons, flight spoilers, horizontal stabilizer, and elevators to reduce pilot workload and provide for smoother flight. The AFS does not provide control commands to the airplane's rudder system. A yaw damper system automatically stabilizes the airplane about its yaw axis by limiting yaw motions caused by atmospheric disturbance or the airplane (an

⁴⁵ On October 18, 1996, the Safety Board issued Safety Recommendation A-96-116, asking the FAA to "define and implement standards for in-service hydraulic fluid cleanliness and sampling intervals for all transport-category aircraft." See section 1.18.11.5 for a full discussion of the FAA's response to this recommendation.

⁴⁶ For more information about the 737 rudder design, see section 1.6.3.2.

⁴⁷ A clockwise control wheel input commands roll in a right-wing-down (RWD) direction, whereas a counter-clockwise control wheel input commands roll in a left-wing-down (LWD) direction. In this report, clockwise and counter-clockwise control wheel inputs will be described as right and left control wheel inputs, respectively.

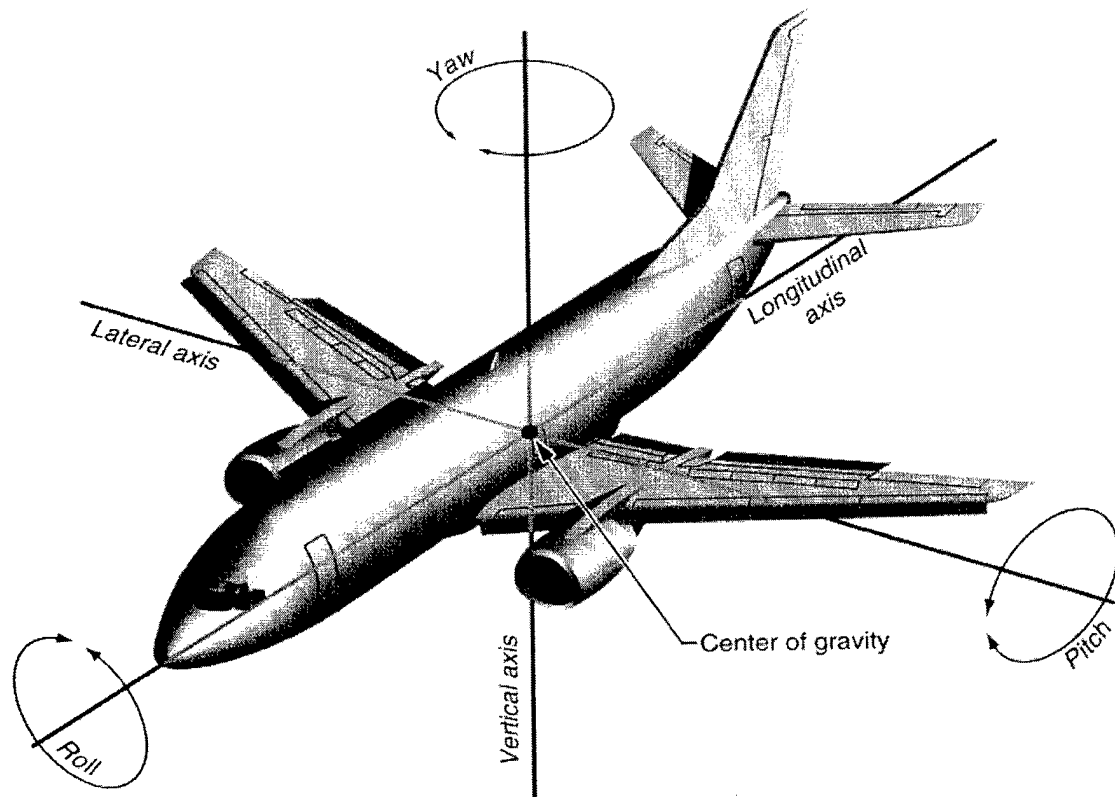

Figure 3. Three axes of motion.

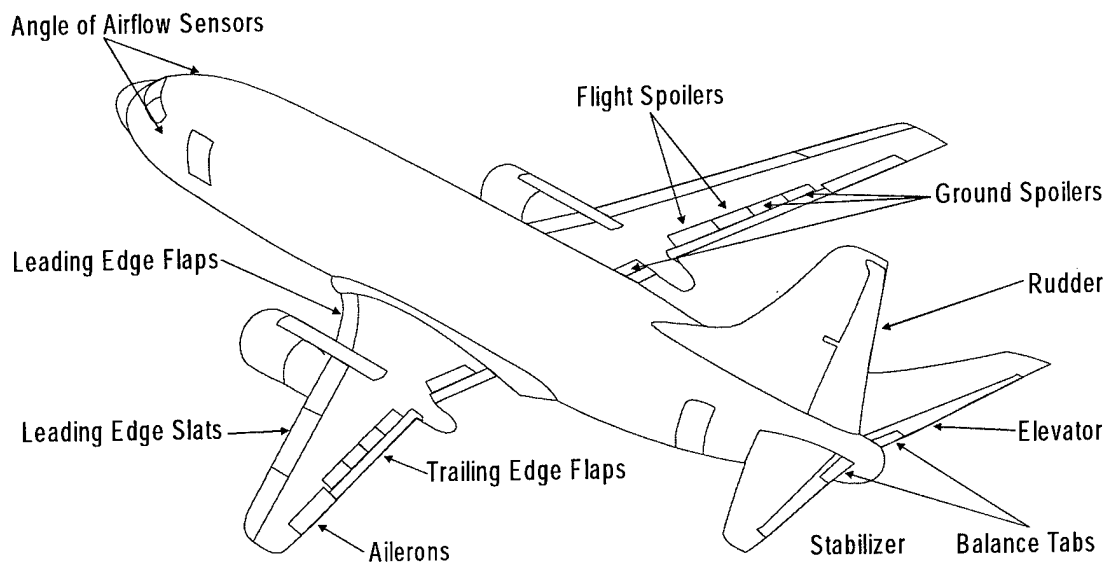
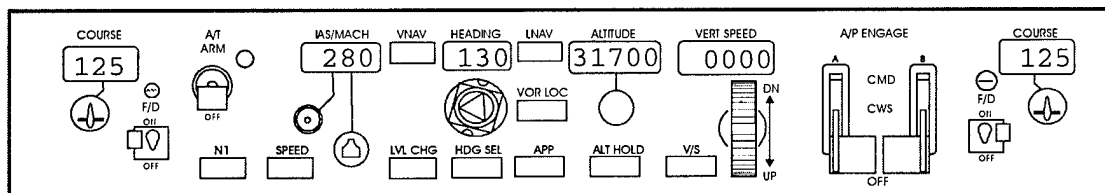

Figure 4. Boeing 737 flight control surface locations.

inherent characteristic of all swept-wing airplanes). Section 1.6.3.2 contains additional details about the yaw damper system. Rudder trim control during flight is maintained by the pilots with automatic assistance from the yaw damper.

The AFS consists of the autopilot flight director system and the autothrottle. Within the autopilot flight director system, commands from two flight control computers move the related flight controls (elevators, stabilizer trim, ailerons, and flight spoilers) through the hydraulic systems. The autopilot flight director system mode control panel (MCP) is located on the glareshield between the pilot positions and provides coordinated control of the autopilot and flight director (FD).⁴⁸ The MCP contains power switches; indicator lights; flight mode selectors; and airspeed, altitude, vertical speed, heading, and bank angle selectors/displays. Figure 5 shows a 737 MCP display. The autothrottle moves thrust levers to maintain airspeeds and/or thrust settings selected by the pilots and/or calculated by the flight management computer. The autothrottle is armed by a switch on the MCP and is activated by the takeoff/go-around (TOGA) switches on the throttles.



Note: Autothrottle is depicted as A/T, and autopilot is depicted as A/P.

Figure 5. Boeing 737 MCP display.

Page 14-15-1 of USAir's 737-300 and -400 Pilot's Handbook, under the heading "Autopilot Engagement Criteria," states that the two autopilot flight control computers are engaged with separate switches, each of which can be in one of three positions: mechanically latched in the OFF position, magnetically held in the control wheel steering (CWS) or in the command (CMD) position,⁴⁹ or magnetically released from the CWS or the CMD position. According to Boeing's 737 Pilot's Handbook, manually overriding autopilot commands with the control wheel or control column does not disengage the autopilot but shifts autopilot control from CMD to CWS mode.⁵⁰ Manual override can shift the autopilot from CMD to CWS in the pitch and roll axes separately or together, depending on the inputs made by the pilot. When the airplane is operating in the CWS mode and the pilot is not exerting force on the control column or control wheel, the

⁴⁸ The FD provides command bar "pointers" on the attitude indicator display to guide pilots when hand flying the airplane.

⁴⁹ With CWS engaged, the autopilot maneuvers the airplane in response to control pressure applied by either pilot. The control pressure is similar to that required for manual flight, and the use of CWS does not disengage the autopilot. With CMD engaged, the autopilot will control the airplane according to the mode selected via the Mode Selector Switches, which include Altitude Hold, Vertical Speed, Level Change, Vertical Navigation, VOR Localizer, Lateral Navigation, and Heading Select.

⁵⁰ If both autopilots are engaged (that is, for a dual-channel autoland operation), the autopilots will not shift from CMD mode to CWS mode.

autopilot will attempt to maintain constant pitch and bank attitude or, under certain circumstances, to roll level and maintain the previously selected altitude.

A magazine article published in Boeing's October through December 1995 issue of *Airliner*, entitled "737 Directional Control System," stated that when a "force of 10 pounds is applied to the yoke, the control wheel moves and the autopilot reverts into CWS [mode]." The article indicated that the autopilot would continue to function in the CWS mode until the CMD mode was reselected or the autopilot was disengaged. The article also stated the following:⁵¹

Normally in CWS, pilots use wheel input rates of 5 to 10 degrees per second. If the wheel is turned at a high rate (40 degrees per second, or more), then the force required to turn the wheel approximately triples. This happens because the autopilot actuators can not respond fast enough and are being forced by the pilot's input. So, for a very quick wheel motion, the lateral control forces can noticeably increase, but the corresponding roll rate doesn't.

According to USAir's 737-300/400 Pilot's Handbook, the autopilot disengages under the following circumstances:

- Pressing either [autopilot] disengage switch.
- Pressing either TOGA switch with a single [autopilot] engaged in CWS or CMD below 2,000 feet RA [radio altitude].
- Pressing either TOGA switch after touchdown with both [autopilots] engaged in CMD.
- Moving the [autopilot] engage switch to OFF.
- Activating either pilot's control wheel trim switch.
- Moving the stabilizer trim autopilot cutout switch to CUTOUT.
- Loss of respective hydraulic system pressure.
- Either left or right IRS [inertial reference system] failure or FAULT light illuminated.
- Loss of electrical power or a sensor input which prevents proper operation of the engaged [autopilot] and mode.

Page 14-55-1 of USAir's 737-300/400 Pilot's Handbook describes the autopilot disengage switches, which are located on the outer grips of each control wheel. The handbook states that, if a pilot presses the autopilot disengage switch on either control wheel, the switch "disengages both [autopilots]. [Autopilot] disengage lights flash and [autopilot] disengage warning tone sounds for a minimum of 2 seconds. Second push extinguishes [autopilot] disengage lights and silences disengage warning tone."

⁵¹ This description of control wheel forces was supported in a September 26, 1995, letter from Boeing's Director of Air Safety Investigation to the Safety Board.

1.6.3.2 Rudder Control System

The 737-300 has a single rudder panel actuated by a single hydraulic rudder PCU. A standby rudder actuator is available to move the rudder if hydraulic systems A and/or B fail. According to a Safety Board review of large transport-category airplanes (including Boeing, McDonnell Douglas, Airbus, and Lockheed models), the 737 is the only twin wing-mounted engine, large transport-category airplane designed with a single rudder panel and single rudder actuator. All other large transport-category airplanes with twin wing-mounted engines were designed with a split rudder panel, multiple hydraulic actuators, or a mechanical/manual/trim tab rudder actuation system.

Pilot control of the 737-300 rudder is transmitted in a closed-loop system from the pilots' rudder pedals in the cockpit through a single cable system to the airplane's tail section and then through linkages to the main rudder PCU and a standby rudder PCU in the aft portion of the vertical stabilizer. The rudder pedals at each pilot position are located on either side of the control column stem, which is protected within a housing (commonly termed the "doghouse" by 737 flight crews) that is located between each pilots' lower legs at the pilot positions. Figures 6 and 6a show the 737 rudder system.

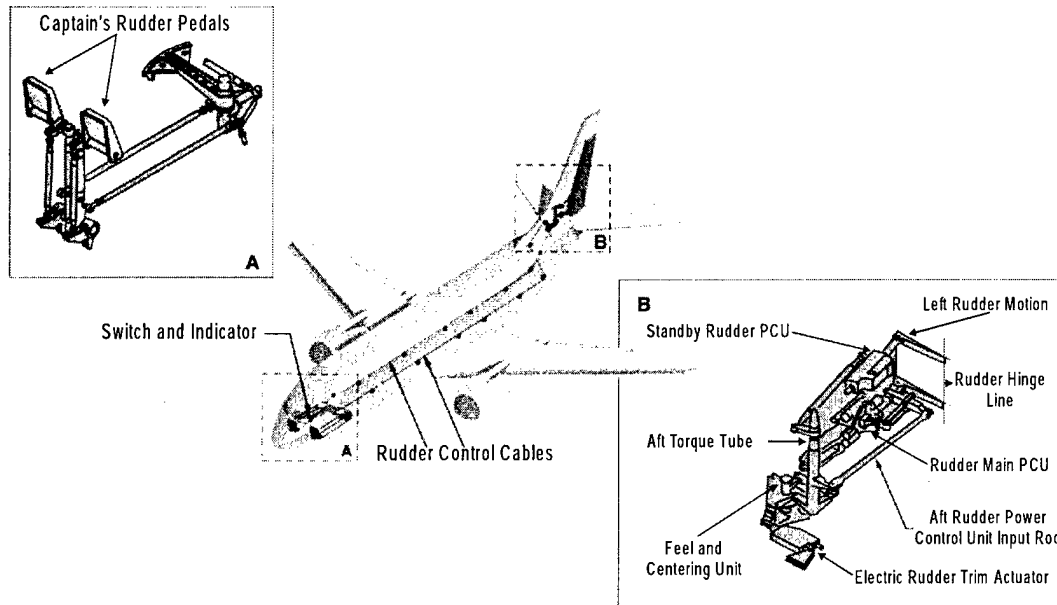

Figure 6. Boeing 737 rudder system.

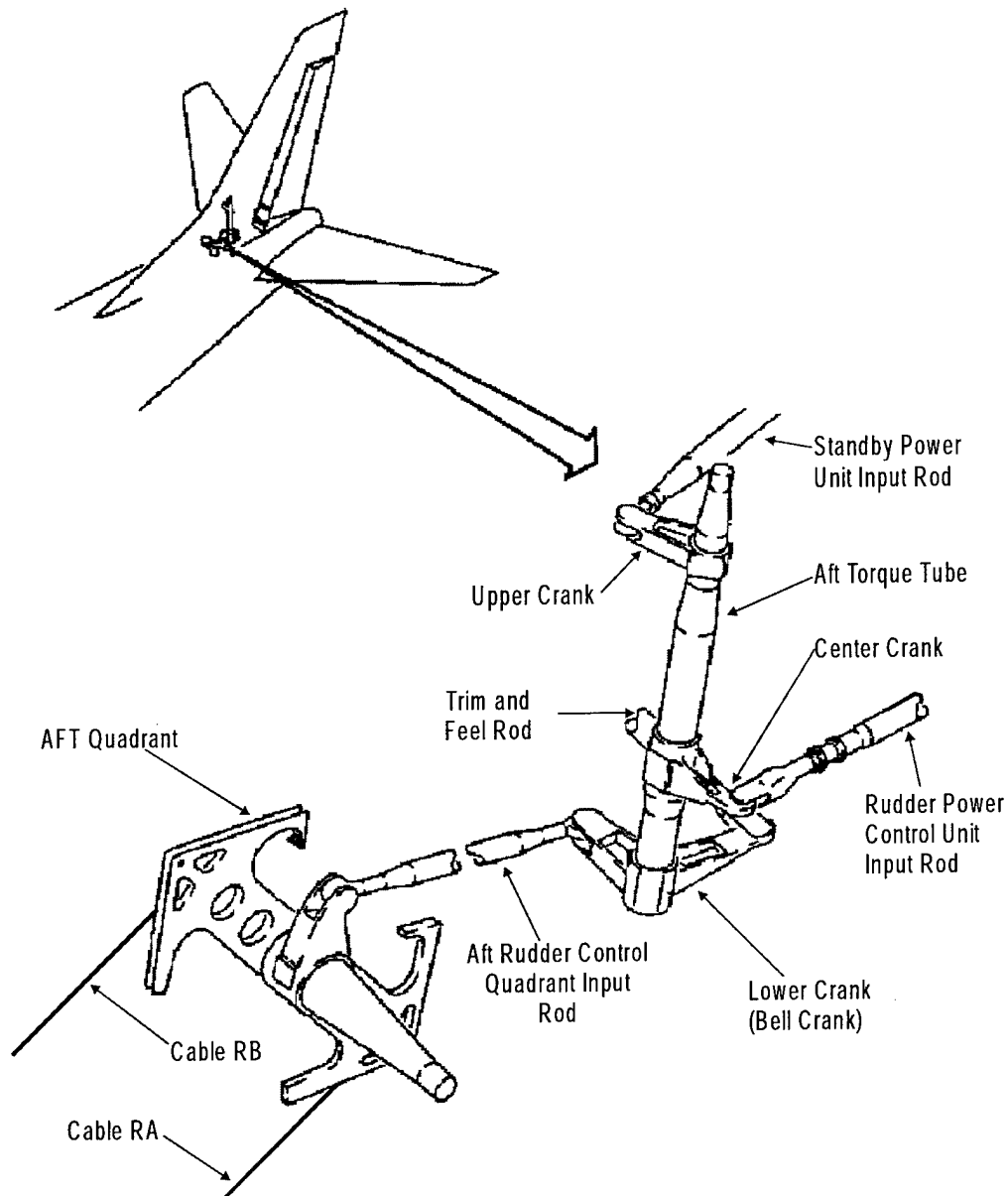

Figure 6a. Detailed view of 737 aft rudder system controls and linkages.

According to Boeing personnel, because of the engine placements on the wings, the 737 rudder has to be sufficiently powerful to effectively counter the effects of a loss of engine power on one side during a maximum gross weight takeoff at low airspeeds, especially in crosswind conditions. A loss of engine power on one side of the airplane would result in a large yawing moment, in the direction of the inoperative engine, produced by thrust from the operating engine. The loss of engine power can be countered

by a rudder input in the opposite direction (for example, left pedal input to counter loss of power on the right engine).⁵²

When properly installed and rigged, the 737-300 main rudder PCU can command a maximum deflection of 26° to the right and the left of the rudder's neutral position (under no aerodynamic load conditions); the rudder can travel to those limits at a maximum rate of 66° per second. (The 737 main rudder PCU is capable of producing about 5,900 pounds of output force to move the rudder when both hydraulic systems are operating at their normal operating pressure—2,950 psi each.) The rudder pedals move about 1 inch (from their neutral position) for every 6.5° of rudder surface travel (under no aerodynamic load conditions) until the rudder pedals reach their maximum travel of about 4 inches (backward and forward) from the neutral position. The rudder pedal stops at the pilots' forward rudder control quadrant are set to provide a mechanical stop at 28° of rudder travel (exceeding the rudder's travel authority) because compliance in the cable system (cable stretch) may require rudder pedal travel beyond the 4-inch limit to achieve the full travel rudder movement of 26°. With the aerodynamic loads encountered in flight, the available amount of rudder surface travel is reduced. The maximum amount of rudder travel available for an airplane at a given flight condition/configuration is referred to as the rudder's "blowdown" limit.⁵³

The rudder feel and centering unit is attached to the aft rudder torque tube in the vertical fin, forward of the main rudder PCU (see figure 6). This unit holds the rudder at the neutral (or trimmed) position when no rudder pedal force is applied. It also provides a feedback force to the rudder pedals that increases as the rudder pedals are depressed. The pilot rudder pedal force required for full rudder deflection is about 70 pounds; however, the rudder trim system allows the pilots to maintain a rudder deflection without having to maintain a rudder pedal force.

During normal and abnormal operations, the rudder can be moved beyond the movement commanded by the hydraulic actuator through a pilot's application of force on the rudder pedals. (Normal operation of the rudder refers to the rudder's motion, or lack thereof, resulting from normal PCU servo valve operation. Abnormal operation refers to the rudder's motion that results from a PCU servo valve that is functioning abnormally, for example, because of a rudder jam and/or reversal.⁵⁴ Both types of operation can include rudder movement within the range of the rudder authority on the ground and/or to the rudder's in-flight blowdown limit.)

⁵² The rudders on airplanes with fuselage-mounted engines are typically less powerful than the rudders on airplanes with wing-mounted engines. The rudders for fuselage-mounted engine airplanes do not have to be designed to counter as significant an asymmetrical thrust effect in the event of a loss of power on one engine. Because the rudder on airplanes with fuselage-mounted engines is less powerful, the consequences of a rudder hardover are less serious; thus, the Safety Board's investigation did not consider this type of airplane.

⁵³ Rudder blowdown is the maximum rudder angle resulting from a pilot-commanded full rudder input under the existing flight conditions. It represents a balance between the aerodynamic forces acting on the rudder and the mechanical forces produced by the PCU. The maximum rudder angle can be increased beyond that produced by the hydraulic force if the pilot exerts sufficient force on the rudder pedals.

⁵⁴ Rudder reversals are discussed in section 1.16.5.4.7.

During normal rudder operation, if a pilot applies a sufficiently rapid rudder pedal input (the rudder pedal must move faster than the PCU's ability to respond to the input), the PCU input crank would contact the PCU external body stop (manifold stop), transmitting force from the rudder pedal input to the rudder surface through the main rudder PCU and the rudder system's linkages. Also, the additional force applied by the pilot would increase the rudder PCU output force, moving the rudder farther in the intended direction of travel. The rudder feel and centering unit would oppose the rudder pedal force (decrease the force applied by the pilot's foot)⁵⁵ with about 9 to 70 pounds of force, depending on how far the rudder is away from its centered position.

During normal operation of the rudder in flight, if a pilot applied between 9 and 70 pounds of force to a rudder pedal, the rudder would move in response until it reached its blowdown limit (when the aerodynamic forces acting on the rudder surface equal the hydraulic actuator force). According to Boeing engineers, if the pilot were to then apply additional force to the rudder pedal, the pedal would move about 1 inch farther, with no corresponding movement of the rudder, as the slack in the rudder linkage system is removed and the external input crank contacts the external stop. Any additional pilot application of force to the rudder pedal would result in rudder pedal movement of about 1 inch for each 300 pounds of rudder pedal force, which in turn would move the rudder surface slightly beyond the maximum deflection possible from the hydraulic actuator force.

During a servo valve jam/rudder reversal, the rudder pedal force from a pilot resisting the jam would cause the rudder to move in the direction opposite the jam (toward the rudder's neutral position). The feel and centering unit would add to the rudder pedal force. As a pilot applied force to a rudder pedal in opposition to the jam/reversal, the first inch of movement of the pedal would cause the PCU input crank to move to the PCU manifold body stop. After the PCU input crank contacts the manifold body stop, approximately 300 additional pounds of pilot rudder pedal force would be required to move the rudder pedal each additional 1 inch of travel until the rudder pedal contacts the forward quadrant stops. Pilot rudder pedal force in opposition to a jammed/reversing rudder malfunction would reduce the deflection of the rudder.

The 737 rudder trim system allows the pilots to command a steady rudder input without maintaining foot pressure on the rudder pedals. The primary purpose for rudder trim is to compensate for the sustained large yawing moments generated by asymmetric thrust in an engine-out situation. Pilots also sometimes use a small amount of rudder trim during normal flight to compensate for slight yawing moment asymmetries, such as those caused by flight control and engine rigging imperfections. To trim the rudder on the 737-300, -400, and -500, the pilot uses an electrical trim motor activated by the trim switch located on the flight deck center pedestal. The rudder trim switch activates an electric rudder trim actuator (located near the aft control torque tube in the vertical fin) that rotates the feel and centering unit, thus changing the neutral, or zero, position of the rudder.⁵⁶ The 737-300 electric rudder trim moves the rudder at a rate of about 0.5° per

⁵⁵ USAF ergonomic studies indicate that the maximum rudder pedal force pilots can exert on the rudder pedals is about 500 pounds. For additional information regarding pilot rudder pedal force, see sections 1.16.6 and 1.18.8.

second to the desired rudder trim deflection; maximum rudder trim authority is $\pm 16^\circ$. According to USAir's 737-300 Pilot's Handbook, when the rudder trim is used, the rudder pedals are displaced proportionately.

The 737 yaw damper system improves ride comfort by sensing turbulence- or airplane-generated yaw motion and countering the yaw with rudder surface movement. The system is initially activated by the yaw damper switch on the overhead panel in the cockpit and is continuously engaged during normal operations; all inputs are automatic and require no pilot action. The yaw damper system comprises the yaw damper control switch and a yaw damper coupler, which includes a rate gyro that senses airplane motion about the yaw axis and converts the motion to an electrical signal that is sent to the main rudder PCU. An electrohydraulic servo valve (or transfer valve) converts the electrical signal from the yaw damper coupler to PCU motion by directing hydraulic fluid from hydraulic system B to move the rudder left or right. The yaw damper system also includes a cockpit indicator of yaw damper activity.

In the 737-300 series, the yaw damper can command up to 3° of rudder surface deflection in either direction at a rate of 50° per second (when correctly assembled/rigged).⁵⁷ Rudder movements that result from yaw damper system inputs do not move the rudder pedals.

Figure 7 shows the main rudder PCU. Figure 8 shows the main rudder PCU schematic and installation. Figure 9 depicts the rudder, rudder trim, and yaw damper authority limits.

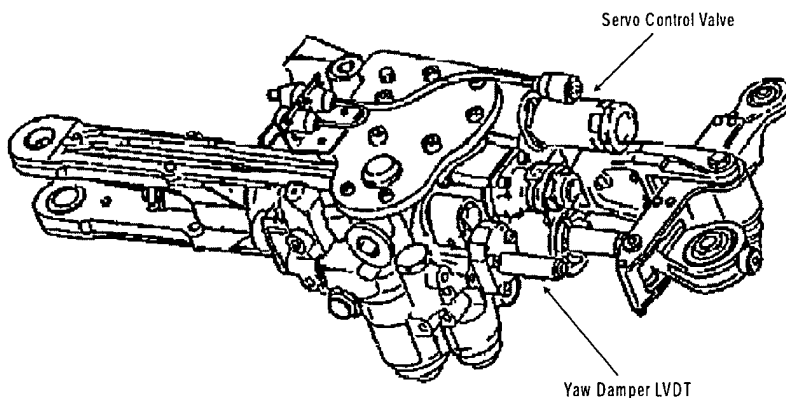

Figure 7. Boeing 737 main rudder PCU.

⁵⁶ To trim the rudder on the 737-100 and -200, the flight crew turns a knob on the flight deck center pedestal that is mechanically connected to the rudder trim actuator.

⁵⁷ The 737-300 yaw damper was initially designed with $\pm 30^\circ$ of rudder authority. The -100 and -200 series airplanes' yaw dampers were designed to command either ± 2 or $\pm 4^\circ$ of rudder authority. Boeing indicated that units permitting ± 2 , 3, or 4° of rudder deflection may be used interchangeably on 737-100 and -200 series airplanes, and units permitting ± 2 or $\pm 3^\circ$ of rudder deflection may be used interchangeably on 737s in the -300, -400, and -500 series. For information regarding rigging of the yaw damper linear variable displacement transducer (LVDT), see section 1.16.1.2.

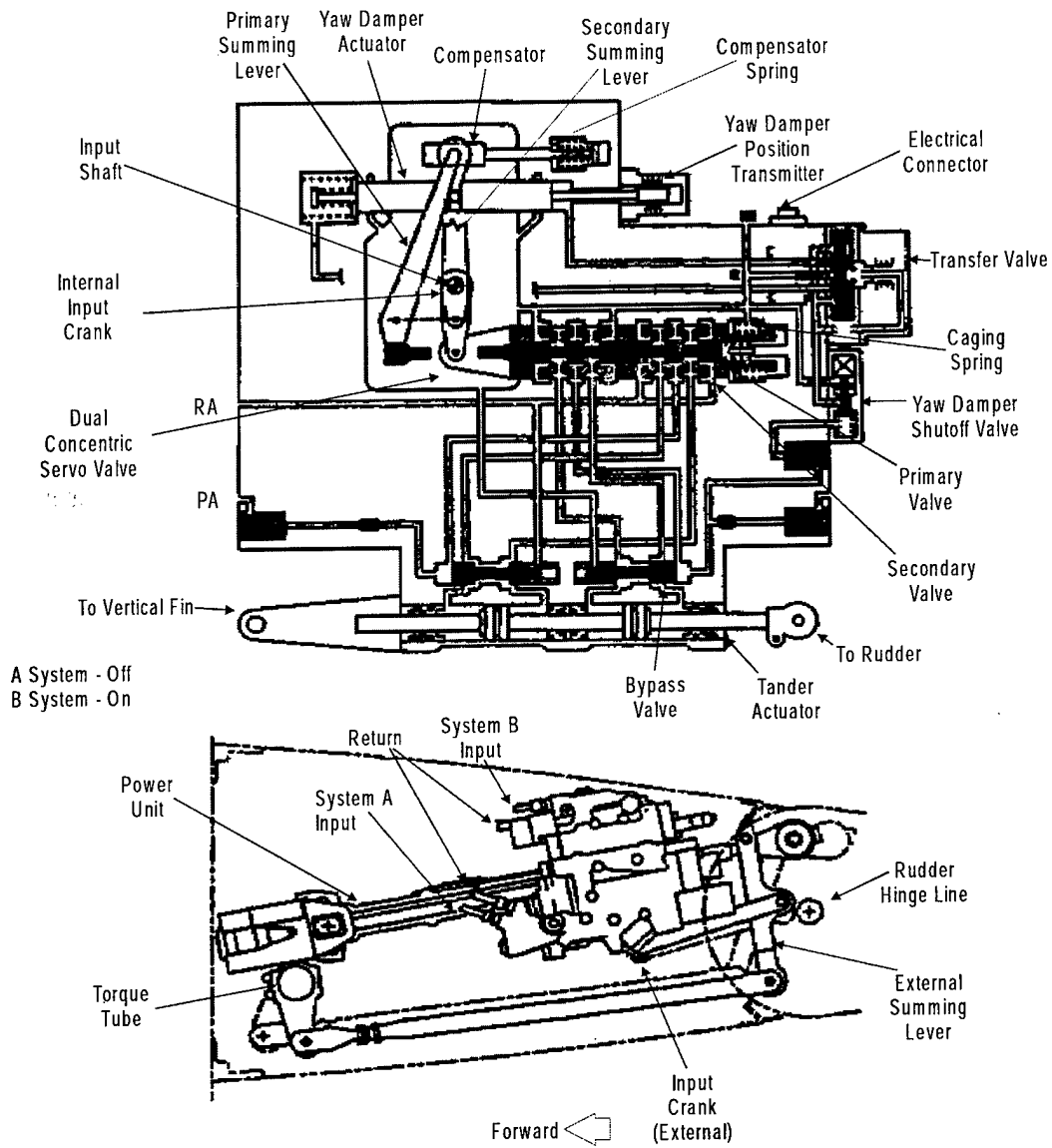

Figure 8. Boeing 737 main rudder PCU schematic and installation.

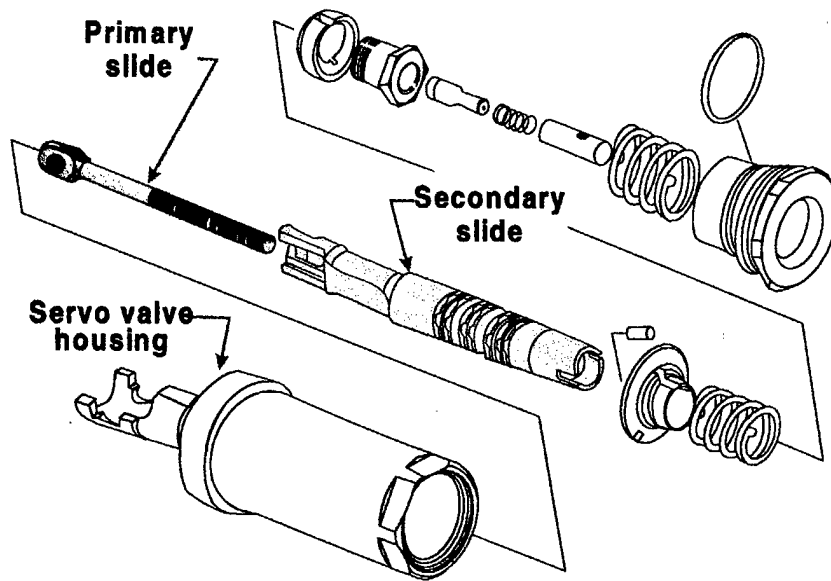

Figure 9. Boeing 737-300, -400 and -500 rudder, rudder trim, and yaw damper authority limits.

1.6.3.2.1 Main Rudder PCU and Servo Valve

The main rudder PCU is powered by hydraulic systems A and B, each of which provides about 3,000 pounds of output force to move the rudder, for a total output force of about 6,000 pounds. The main rudder PCU operates by converting either a mechanical input from the rudder pedals or an electrical signal from the yaw damper system into motion of the rudder by means of mechanical linkages (summing levers, input cranks, and shafts) and a servo valve that directs hydraulic fluid either to extend or retract the PCU actuator rod that moves the hinged rudder surface.

The body of the main rudder PCU is attached to the airplane vertical fin structure, and the actuating rod is attached to the rudder. The PCU moves the rudder right or left when actuated by rudder pedal or trim input or signals from the yaw damper. Rudder pedal and trim input are transmitted to the PCU's external input crank through an external summing lever and linkage. The external input crank is also moved by feedback from motion of the rudder, which comes from a mechanical system linkage (see figure 8). The input shaft rotates, actuating the internal summing levers and moving the primary and secondary slides of the servo valve.

The 737 main PCU servo valve was designed by Boeing and is manufactured to Boeing specifications by Parker Hannifin Corporation. It is a dual-concentric tandem valve composed of a primary slide that moves within a secondary slide that, in turn, moves within the servo valve housing. The primary and secondary concentric slides are moved by primary and secondary internal summing levers, which translate inputs from the yaw

damper⁵⁸ and/or the external input crank (which moves when a pilot steps on the rudder pedals) into axial movement of the slides. Figure 10 shows an expanded view of the servo valve.

When rudder motion is commanded (by the yaw damper, rudder pedal input, and/or rudder trim), the internal input shaft moves the servo valve slides through the internal summing levers to connect hydraulic pressure and return circuits from hydraulic systems A and B so that hydraulic pressure is ported to the appropriate sides of the dual-tandem actuator piston to extend or retract⁵⁹ the main rudder PCU piston rod. At the same time, fluid is directed from the other side of the piston to the hydraulic return system. As the rudder reaches the commanded deflection, external linkages reposition the servo valve's internal summing levers to nullify the initial command signal and arrest further motion.

During normal operation, the primary summing lever applies force to move the primary slide, and the secondary summing lever applies force to move the secondary slide as needed. The primary slide is normally displaced first, and the secondary slide is displaced only when the primary slide does not provide enough hydraulic flow to keep up with the input commanded by the pilots or the yaw damper (that is, when the movement of only the primary slide is not sufficient to move the rudder at the commanded rate). The normal maximum axial movement from the neutral positions to the extreme travel positions in either the extend or retract directions is about 0.045 inch for both the primary and secondary slides, for a combined distance of about 0.090 inch. Both the primary and secondary slides are designed so that they can move about 0.018 inch axially beyond their normal operating range (overtravel capability).

The two slides are designed to provide approximately equal flow. Thus, the primary slide alone can provide a rudder rate of about 33° per second, and the primary and secondary slides together can provide a rudder rate of about 66° per second (under zero aerodynamic load conditions).

The outside diameter surfaces of the primary and secondary slides are composed of Nitralloy 135 that, in its prefinished form (slightly larger in diameter than its finished form), is nitrided⁶⁰ to a depth from 0.005 to 0.008 inch to a surface hardness of 55 to 58 on

⁵⁸ When the yaw damper solenoid control valve is energized, 3,000 psi of hydraulic pressure is applied to the transfer valve, which proportionally converts electrical signals from the yaw damper coupler into hydraulic flow and control pressure. The control pressure moves the yaw damper actuator assembly piston (mod piston), which moves the pivot point of the internal summing levers. The internal summing levers move the primary and secondary slides of the servo valve from neutral, which causes movement of the pistons in the actuator assembly. Movement of the yaw damper actuator piston generates a balancing signal by the LVDT, which assists in returning the transfer valve to the neutral position. Feedback, provided through the external summing lever and linkage, returns the slides of the servo valve to near neutral, which maintains hydraulic pressure to hold the actuator position against the air load while not commanding further motion.

⁵⁹ When the actuator moves in the extend direction, it commands left rudder; when it moves in the retract direction, it commands right rudder.

⁶⁰ Nitriding is a process in which the surface of the part is impregnated with nitrogen to increase hardness.

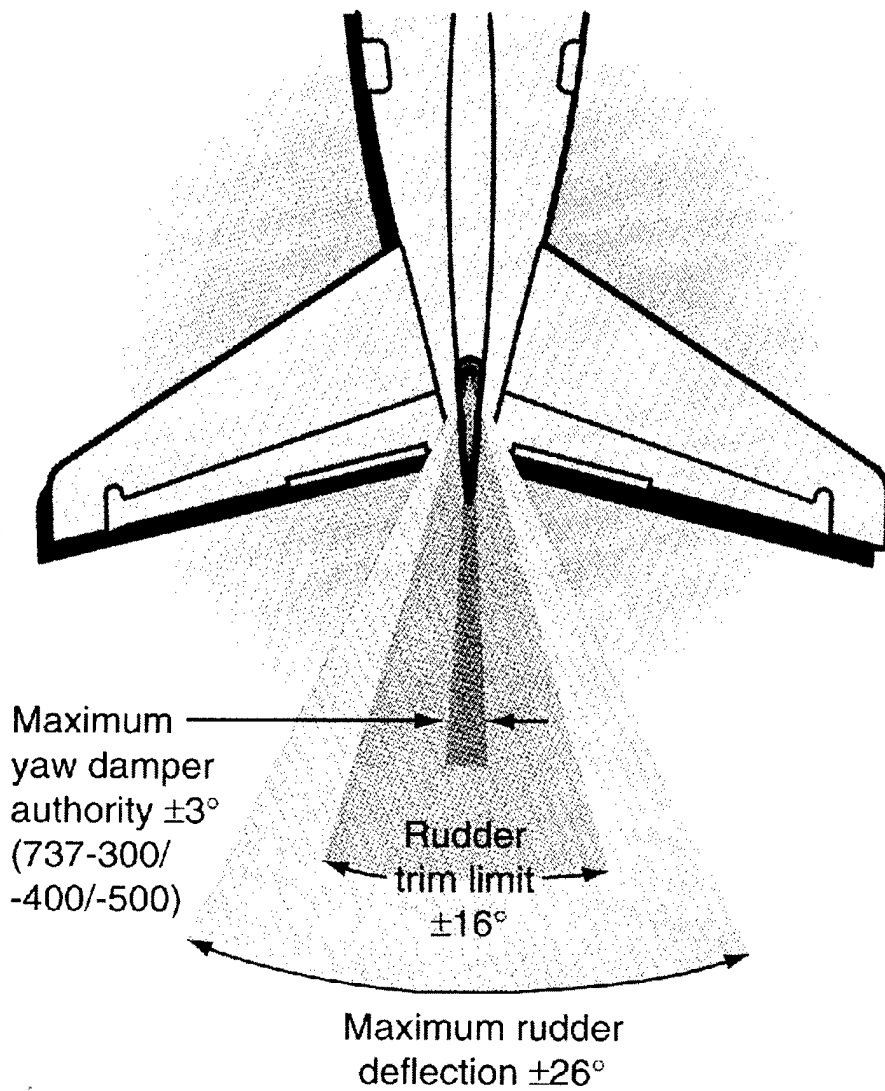

Note: The maximum 737 rudder deflection that the yaw damper can command is only a small portion of the total rudder travel. Yaw damper limits of the 737-100 and -200 can be 2, 3, or 4°, depending upon the installation.

Figure 10. Boeing 737 main rudder PCU servo valve.

the Hardness Rockwell C (HRC) scale. The inside surfaces of the secondary slide and the servo valve housing are made of 52100 hardened steel (surface hardness 57 to 62 on the HRC scale). The outside diameter surfaces of the primary slide are very close to the inside diameter surfaces of the secondary slide, and the outside diameter surfaces of the secondary slide are very close to the inside diameter surfaces of the servo valve housing.

In a March 18, 1999, letter, Parker advised the Safety Board that two engineering documents from 1966,⁶¹ which were produced during prototype testing of the servo valve, revealed that dimensional changes were made to the prototype because of conditions and performance results observed during the initial testing. According to the letter, a March 11, 1966, Parker engineering order modified certain dimensions in the servo valve slightly to “insure accumulated tolerances will not cause reverse flow.” Additionally, the letter stated that a December 9, 1966, Parker engineering order indicated that other modifications were made “to preclude bottoming of [the] secondary slide at the detent at the max[imum] tolerance stackup.” According to the letter, after the dimensional changes were incorporated into the prototype servo valve’s design, it passed the acceptance test procedure, and no further flow problems were noted. Parker personnel stated that no servo valves with the original prototype dimensions were provided to customers. The letter further stated, “as we can best determine, ‘reverse flow’ was used to refer to cross-flow or higher internal leakage in the servo valve than is desirable...but had nothing to do with reversal in the dual concentric servo valve” and indicated that “the reversal phenomenon in the servo valve...was first seen in the 1992 examination of the...United Airlines Boeing 737 rudder power control unit [which resulted from a July 16, 1992, anomaly found during a ground check, as discussed later in this section and in more detail in sections 1.16.1.1 and 1.18.1.1]—rudder or servo valve reversal was not an issue recognized at the time of the 1966 Engineering Orders.”

Before 1989, the servo valve assembly engineering drawings did not specify diametrical clearances between the primary and secondary slides or between the secondary slide and servo valve housing. However, “shop travelers” (manufacturing documents that include instructions for specific tasks) used before 1989 indicated that the minimum and maximum clearances were 0.00010 and 0.00015 inch, respectively. On March 14, 1989, Parker released an engineering order that amended the servo valve assembly drawings to specify minimum and maximum diametrical clearances of 0.00015 and 0.00020 inch, respectively, between the outside diameter of the secondary slide and the inside diameter of the servo valve housing assembly and between the outside diameter of the primary slide and the inner diameter of the secondary slide assembly.

According to Parker, the engineering drawing clearances normally allow the servo valve assembly to pass the functional testing that is part of the acceptance test procedure, and the servo valve components may then be individually polished based on functional test results to obtain the proper ease of movement. Because of the variability in dimensions of individual servo valve primary and secondary slides and the tight

⁶¹ These documents were located by Parker in response to requests made in the context of litigation resulting from the USAir flight 427 accident.

clearances required by the design, the servo valve components are assembled, installed, and maintained as matched sets.

Before 1992, the acceptance test procedure for the servo valve assembly was based on compliance with performance standards. (According to Parker, each valve was to be "trimmed"⁶² until the desired functional performance was obtained.) Actual travel (or overtravel) capability of the primary and secondary slides had not been measured. In 1992, as a result of findings from the main rudder PCU anomaly found during a July 1992 United Airlines ground check, Boeing established maximum axial distances between metering edges for both the primary and secondary slides, and Parker instituted a functional test. In addition, the FAA issued AD 94-01-07, effective March 3, 1994, which required operators to test 737 main rudder PCUs at 750-hour intervals for internal hydraulic fluid leakage until they are replaced with new PCUs containing servo valves designed to prevent secondary slide overtravel. (For additional information regarding this part of AD 94-01-07, see section 1.18.5 and appendix C.)

In addition to the functional testing performed on each individual main rudder PCU servo valve, one valve was subjected to qualification testing at the time of the 737's initial certification.⁶³ The purpose of this qualification testing was to ensure that the servo valve would be able to withstand the operational and environmental stresses expected during its life.

1.7 Meteorological Information

The official PIT hourly weather observation taken at 1852 stated:

sky condition—clear, visibility—5 miles, temperature—73° Fahrenheit (F), dew point—1° F, wind—250° at 7 knots, altimeter setting—30.10 inches Hg [mercury], remarks—few cumulus cirrus.

A PIT special weather observation taken at 1932 stated:

sky condition—clear, visibility—15 miles, wind—240° at 6 knots, altimeter setting—30.10 inches Hg; remarks—few cumulus cirrus.

The PIT hourly weather observation taken at 1952 stated:

sky condition—clear, visibility—15 miles, temperature—69° F, dew point—54° F, wind—240° at 5 knots, altimeter setting—30.10 inches Hg.

⁶² Trimming is the machine grinding of the outside diameter/groove interface that forms the metering edges for the primary and secondary slides. Trimming moves the metering edges to new longitudinal positions to better align the metering edges with the metering ports to meet functional test requirements.

⁶³ The qualification testing involved functional and environmental testing (including pressure, vibration, and thermal testing) under conditions that replicated assumed operating conditions (based on Boeing's analyses). The redesigned servo valve being retrofitted on earlier 737 series airplanes and installed on the 737-NG series airplanes (see section 1.18.5) also underwent qualification testing, and those tests included conditions that exceeded the assumed operating conditions (including thermal conditions that simulated an overheated hydraulic system) to evaluate the component's functional limits.

The PIT Weather Service Forecast Office (WSFO) is located about 2 miles north-northwest of PIT and about 6 miles southeast of the accident site. A Weather Surveillance Radar-88 Doppler (WSR-88D) is installed at that location. (At the time of the accident, the WSR-88D was operational but had not been officially commissioned.) The WSR-88D base reflectivity products⁶⁴ provided to the WSFO for the times of 1859 and 1905 indicated random radar returns in the PIT area. According to PIT WSFO personnel, those returns were consistent with the local ground clutter pattern around the radar. No primary radar returns were noted in the vicinity of the accident airplane. Some witnesses reported that they observed large flocks of migrating birds and geese in the area the afternoon and evening before the accident. However, radar data revealed no evidence of such activity in the vicinity of the accident site at the time of the accident.

According to measurements transmitted by a radiosonde balloon⁶⁵ launched by the PIT WSFO at 1914, the winds near 6,000 feet msl were from 274° at 15 knots, and the temperature at that altitude was about 47° F. The wind gust recorder at PIT indicated that wind speeds at the surface varied from 6 to 8 knots between 1840 to 1940. (Wind directions were not recorded by the wind gust recorder.)

According to sunrise and sunset tables, on September 8, 1994, at 1903 at the accident location, the altitude of the sun above the horizon was approximately 7.9°. The magnetic bearing from the accident location to the sun was about 278.7°. Sunset at 6,000 feet occurred about 1949.

During postaccident interviews, witnesses on the ground reported that the weather was clear and sunny at the time of the accident, and the winds were calm near the accident site. Pilots of other airplanes that were operating in the vicinity of PIT about the time of the accident were also interviewed. They reported that the sky was clear with unlimited visibility and that the air was smooth with light winds and no turbulence. The captain of Delta flight 1083, which was sequenced ahead of the accident flight on the approach, stated that the horizon was clearly defined and that visibility was not restricted.

1.8 Aids to Navigation

No difficulties with the navigational aids were known or reported.

1.9 Communications

No difficulties with communications were known or reported.

⁶⁴ Base reflectivity products display weather echo intensity and are used to detect precipitation.

⁶⁵ A radiosonde balloon is an instrument used for the simultaneous measurement and transmission of meteorological data. The PIT WSFO launches two radiosonde balloons about 0700 and 1900 every day.

1.10 Airport Information

PIT is located 15 miles northwest of the city of Pittsburgh. The airport elevation is 1,203 feet. The airport has four runways. Flight 427 was scheduled to land on runway 28R, which is 10,502 feet long and 150 feet wide. No significant Notices to Airmen were in effect for PIT during the time period in which USAir flight 427 was estimated to arrive.

1.11 Flight Recorders

The two flight recorders installed on the accident airplane were removed from the wreckage and sent to the Safety Board's laboratory in Washington, D.C., for readout.

1.11.1 Cockpit Voice Recorder

The CVR installed on the accident airplane was a Fairchild model A-100A.⁶⁶ The CVR recording consisted of four channels of audio information: the cockpit area microphone (CAM), the captain position, the first officer position, and the jumpseat/observer position.⁶⁷ Although the CVR unit showed evidence of external and internal structural damage, the recording medium (magnetic tape) was in good condition, and the quality of the recording was excellent.⁶⁸ A transcript was prepared of the entire 30-minute 56-second recording. A copy of the CVR transcript appears in appendix B.

1.11.2 Flight Data Recorder

The FDR was a Loral/Fairchild Data Systems model F1000 (S/N 442), which recorded 13 parameters⁶⁹ of airplane flight information using solid-state nonvolatile flash memory as the recording medium. Although the FDR exhibited external and internal impact damage, the crash-protected memory module unit and recording medium were

⁶⁶ The CVR identification plate and S/N were missing; however, USAir maintenance records indicate that the CVR on the accident airplane was S/N 5061.

⁶⁷ The audio obtained from the jumpseat/observer channel was of a lower intensity and sounded more "hollow" than that obtained from the CAM. Further investigation revealed that similar audio information was obtained in a 737 airplane in which the microphone selector switch at the jumpseat/observer position was left in the oxygen mask position and the oxygen mask was stowed correctly in its formed plastic sleeve.

⁶⁸ The Safety Board uses the following categories to classify the levels of CVR recording quality: excellent, good, fair, poor, and unusable. An excellent recording is one in which virtually all of the crew conversations can be accurately and easily understood. The transcript that is developed from the recording may indicate only one or two words that were not intelligible, usually because of simultaneous cockpit/radio transmissions that obscured each other.

⁶⁹ Title 14 CFR Section 121.343 required that, by May 26, 1995, large airplanes type certificated before October 1, 1969 (which included the accident airplane), be equipped with FDRs that record 11 parameters. The regulations also required that airplanes type certificated after October 1, 1969, and airplanes manufactured after May 26, 1989, be equipped with FDRs that record 17 parameters. Additionally, the regulations required that airplanes manufactured after October 11, 1991, be equipped with FDRs that record 31 parameters. Even though the accident airplane's FDR recorded 13 parameters, it has often been referred to as an 11-parameter recorder because it was not required by 14 CFR Section 121.343 to record the engine EGT and fuel flow parameters.

intact and yielded good data. Recorded parameters that were sampled at once-per-second intervals were altitude, indicated airspeed, heading, microphone keying, exhaust gas temperature (EGT, both engines), fuel flow (both engines), compressor speed (N2, measured as a percentage, for both engines), and fan speed (N1, measured as a percentage, for both engines). Recorded parameters that were sampled at more frequent rates were roll attitude and control column position (two times per second), pitch attitude and longitudinal acceleration (four times per second), and vertical acceleration (eight times per second). The FDR did not record data regarding the flight control surface positions, and Federal regulations (14 CFR Section 121.343) did not include a requirement to record such data. (See section 1.18.11.4 for information about Safety Board recommendations regarding FDRs.)

1.12 Wreckage and Impact Information

1.12.1 On-Site Examination

The on-site phase of the investigation, including examination, documentation, decontamination, and recovery of the wreckage, occurred between September 9 and September 20, 1994.

The accident airplane's primary impact point was in a densely wooded area on an up-sloping hillside on the south side of a dirt road that was oriented southwest/northeast and accessed three houses. The airplane wreckage was severely fragmented, crushed, and burned, and some sections had been destroyed or nearly destroyed by fire. Because some portions of the wreckage were not visible above the ground, investigative personnel used ground-penetrating radar (GPR) to locate and recover additional pieces of the wreckage. (See section 1.19 for details about the use of GPR.) Some pieces of wreckage were excavated from the hillside at depths of up to 8 feet. Most of the airplane wreckage, including all flight controls and major components, was located within a 350-foot radius of the main impact crater.

The left wing and the No. 1 engine, which were located south of the access road and east of the main impact crater, exhibited severe impact and postimpact fire damage. The No. 1 engine was separated from the left wing and partially covered by burned left wing skin and spar materials. A ground scar, about 25 feet in length, extended in an easterly direction from the No. 1 engine and left wing wreckage on an up-sloping hill. The outboard end of the ground scar contained several small pieces of red glass, and portions of the left wing tip were located nearby. Trees located near the ground scar and the left wing had broken limbs and branches.

The right wing, which was located along the northern edge of the access road about 40 feet west of the main impact crater, also exhibited severe impact damage. The No. 2 engine was separated from the right wing and located along the northern edge of the access road about 30 feet west of the main impact crater. Sections of the right wing were found on the north side of the access road and the adjacent hillside, and the inboard section

of the wing was facing in the northeast direction. The remaining leading edges of both wings were crushed in an aft and up direction.

Examination of the spoiler control surfaces and actuators revealed that the four wing spoilers were located in the retracted position at impact with no evidence of preimpact failure. Examination of the Krueger (leading edge) flaps and leading edge slats indicated that they were extended symmetrically at impact with no evidence of preimpact failure of the flaps; slats; and their attachments, rollers, or tracks.⁷⁰ The trailing edge flaps were in a partially extended symmetrical position. Jackscrew and hydraulic actuator measurements indicated that the leading and trailing edge devices were positioned consistent with a flaps 1 setting. The trailing edge flaps exhibited compression damage and postimpact fire damage. No evidence was found of structural fatigue or preimpact fire on the trailing edge flaps or flap tracks. The wing spoilers were fractured and exhibited fire damage. The landing gear were found in the retracted position.

Both engines were found fragmented, burned, and separated from their respective pylons. The pylons, nacelles, and thrust reverser components from both engines were fragmented and scattered around the impact crater. Examination of the engines, nacelles, and pylons revealed damage that was consistent with engine low- and high- pressure rotors rotating at impact.⁷¹

Fragments of engine thrust reverser components (including the cascades, hinges, latches, cowls, and bulkhead) and the 12 thrust reverser actuators⁷² were located, identified, and examined. All thrust reverser components exhibited damage consistent with ground impact and exposure to heat. Examination of the thrust reverser actuators indicated that the left engine thrust reverser locking actuators were in the stowed position at impact; however, the right engine thrust reverser locking actuators were discovered in the extended position. (Three of the four left engine nonlocking thrust reverser actuators and all four right engine nonlocking thrust reverser actuators were in the stowed position.) The four locking thrust reverser actuators were removed from the main wreckage for further inspection and disassembly. Subsequent x-ray inspection and disassembly of the four thrust reverser locking actuators indicated that all four locking actuator pistons were in the stowed position, with locking keys engaged, at impact.

The airplane's tail section was located in an inverted position near the north edge of the access road, about 20 feet west of the left wing. The horizontal stabilizers and elevators remained attached to the tail section. The outboard trailing edge of the right

⁷⁰ Because of unusual damage observed on the inboard hinge of the No. 1 slat, the Safety Board conducted ultraviolet light and metallurgical inspections of components of the slat track. For additional information regarding these inspections, see section 1.12.3.

⁷¹ FDR data indicated that the engines were operating normally and symmetrically until ground impact. However, the CVR and physical evidence indicated that the auxiliary power unit (APU) was not operating up to ground impact.

⁷² Six thrust reverser actuators, two locking and four nonlocking, were located on each of the two engines. The locking actuators are designed to prevent thrust reverser deployment without the application of hydraulic pressure.

horizontal stabilizer and the right elevator exhibited heat, smoke, and soot damage patterns consistent with postimpact fire. The outboard 5 feet of the leading edge of the left horizontal stabilizer was destroyed. The inboard 7 feet of the left horizontal stabilizer, adjacent to the auxiliary power unit (APU) access door, was crushed 5 feet in the aft direction, exposing the internal spars and ribs. Both elevators were attached at their respective horizontal stabilizers, and flight control continuity was established within the tail section. The elevator tab rods were connected and operated properly (that is, elevator "up"/tab "down," and vice versa). Both elevator balance weights were attached, and the elevator neutral shift rods were attached to the stabilizer and the elevator centering unit. The elevators were positioned about 14° trailing edge up, and the horizontal stabilizer was in an intermediate position.

The vertical stabilizer and rudder were located adjacent to the tail section. The vertical stabilizer was resting on its left side with the lower portion of the vertical fin adjacent to the horizontal stabilizer. The leading edge of the vertical stabilizer skin was destroyed, and the exposed vertical webs were crushed in the upward and aft direction. The vertical stabilizer aft of the rear spar sustained fire damage, and an 11- by 4-foot area, about 6½ feet from the base of the vertical stabilizer, was consumed by fire. The rudder had a 10-foot, 3-inch area, about 6½ feet from the base of the rudder hinge, of burned and missing structure. A bend in the PCU actuator rod was consistent with a rudder position of about 2° to the right (airplane nose right).

The cockpit, which was found approximately 45 feet south of the main impact crater, was severely fragmented. The identified sections of the cockpit and the forward portion of the fuselage exhibited compression damage, deformation along the airplane's longitudinal axis, and some postimpact fire damage. Although sections of the seat tracks for both pilots were identified, it was not possible to determine either seat position at impact.⁷³ The left rudder pedal shafts were sheared at both pilot positions; both right rudder pedals exhibited bending but were not sheared.⁷⁴ Cockpit instrumentation and switches that were identified included a radio magnetic indicator, two airspeed indicator digital displays, the autopilot MCP, ground proximity warning system (GPWS) switch, and an FD switch. The radio magnetic indicator showed 212°, the airspeed displays indicated 264 knots, and the GPWS and FD switches were in the "on" position; damage to the autopilot MCP precluded a determination of the preimpact mode selections.

A ground and helicopter search for additional airplane components was conducted during the on-site phase of the investigation, but no additional components were found. Several light-weight items (for example, pieces of interior insulation and a passenger business card) were discovered as far as 2½ miles east-northeast of the main wreckage; these items exhibited soot and smoke damage. One witness stated that he heard the sound of the crash while he was playing golf about 2 miles east-northeast of the accident site; about 2 minutes later, he observed blackened insulation falling onto the golf course. The insulation, business card, and sections of the airplane's cargo liner were sent to

⁷³ Pilot seat position is discussed further in section 1.18.8.

⁷⁴ The rudder pedal assemblies were retained for further examination, as described in section 1.16.5.1.

Safety Board and Federal Bureau of Investigation (FBI) laboratories for examination, which revealed no evidence of explosive residue.

Before removal from the accident site, the wreckage was thoroughly examined, components were identified and photographed, and critical measurements were recorded. Also, fire and explosives experts examined pieces of the wreckage for evidence of preimpact fire and/or explosion, and no such evidence was found. After the airplane wreckage was documented and decontaminated, it was relocated from the accident site to a hangar facility at PIT for further examination and a two-dimensional reconstruction. Except for certain components and control cables that were retained for further examination,⁷⁵ the airplane wreckage was released to USAir on April 3, 1995.

1.12.2 Reconstruction Examination

Between October 30 and November 11, 1994, the Safety Board conducted a two-dimensional reconstruction of the wings and the fuselage, including the forward pressure bulkhead, floor beams, wheels and tires, wheel wells, auxiliary fuel tank, and roll control cables. The reconstruction was accomplished to determine whether a control cable failure, bird (or other airborne object) strike, floor beam failure, or in-flight explosion were involved in the accident.

Because of its experience in reconstructing the Boeing 747 airplane involved in the Pan American World Airways flight 103 in-flight explosion and crash that occurred near Lockerbie, Scotland,⁷⁶ the Air Accidents Investigation Branch (AAIB) of Farnborough, England, was asked to and did participate in the effort to reconstruct the USAir flight 427 accident airplane. The AAIB representatives stated that the destruction and fire damage (which they considered "extreme for that associated with civil aircraft accidents") complicated efforts to identify components and reconstruct the airplane. Despite the complications, the AAIB found no evidence of any preimpact explosion. The wreckage was further examined by explosion experts from the FAA and the FBI, and they also found no evidence of any preimpact explosion.

With the use of Boeing drawings, Safety Board investigators identified pieces of the fuselage and wings, and the pieces were positioned on the hangar floor according to their structural station locations. Numerous pieces of the lower forward fuselage and sections of the wing were too small, fragmented, or severely damaged by postimpact fire to be identified. The lateral and longitudinal floor beam structures were severely fragmented. The amount of identifiable lateral floor beam structure varied at each fuselage station, with a minimum of 5 percent identified forward of the center wing section and a maximum of about 95 percent identified at the rear galley/lavatory. Overall, about 50 percent of the floor beams (lateral and longitudinal, forward and aft) were recovered and identified for use in the reconstruction.

⁷⁵ For additional information on the retained items, see section 1.12.2.1.

⁷⁶ See Air Accidents Investigation Branch. 1990. "Report on the accident to Boeing 747-121, N739PA, at Lockerbie, Dumfriesshire, Scotland on 21 December 1988." Aircraft Accident Report 2/90.

No sections of the forward galley or the forward lavatory floor structure were identified. The aft galley floor panel was charred, and the attached seat tracks exhibited fire and heat damage; however, the floor beams that supported the aft galley exhibited no signs of fire or heat damage. The floor of the lavatory in the aft cabin was charred, and the attached forward and aft floor beams displayed evidence of peeled paint and sooting.

The identifiable sections of passenger cabin and cockpit structure exhibited no evidence of streaking or burns that would be consistent with preimpact fire or explosion. No evidence of streaking or burned/sooted structure was found on the interior or exterior surfaces of cabin and cockpit materials.

Portions of all of the doors and their respective frames were identified and documented. These doors included the forward entry, forward service, aft entry, aft galley service, forward cargo, rear cargo, lower nose compartment access, electrical/electronic compartment (E/E bay), overwing emergency exit, and APU service doors. The majority of structure identified in the forward fuselage was located near the fuselage doorways. The doors forward of the wing were the most severely fragmented. The examination of the remains of the doors, door frames, and locking mechanisms revealed witness marks and other evidence that was consistent with all of the doors being in the closed position at impact.

The wing center section and the main landing gear wheel wells were severely fragmented and exhibited minimal fire damage. Approximately 60 percent of the center section wing structure was positively identified. Examination of the reconstruction confirmed that the landing gear were in the retracted position at impact. No evidence of preimpact failures or fire in the wheel wells before impact was found. The examination of the tires and wheels revealed no evidence of a tire explosion or fire damage before impact.

1.12.2.1 Flight Control System Components

During the wreckage reconstruction, flight control system components were examined and separated by location and system function. The following flight control system items were removed from the wreckage for further examination: the main rudder PCU, standby rudder PCU, rudder trim actuator, rudder feel and centering unit, aileron PCUs, spoiler mixer and ratio changer, flight and ground spoiler actuators, slat control valve, autopilot servos, various autopilot electrical relays, both pilots' rudder pedal and control yoke systems, and most of the control cables. In addition, hydraulic fluid samples were obtained from various locations in the accident airplane's hydraulic systems for laboratory evaluation and analysis. (See section 1.16.5.4.3 for further information.)

The aft rudder control quadrant was found attached to its mounting bracket and separated from the vertical stabilizer. The aft rudder control quadrant input rod, the main rudder PCU input rod, and the lower end of the rudder torque tube (see figures 6 and 6a) were fractured, and the cable attach points were separated from the quadrant on each end. The upper portion of the tower shaft was located at the vertical fin with the main and standby rudder PCUs attached. The input rod for the standby PCU remained attached with no signs of damage or binding.

The broken ends of all identified flight control cables, and several unidentified cable sections, were inspected at 10-power magnification to determine their mode of failure. The examination revealed no evidence of preimpact cable failure. Measurements of the broken aileron cable sections and pulley positions indicated a right control wheel input at impact.

Safety Board investigators identified about 60 percent of the rudder control cable length for the right-side cable and about 20 percent of the rudder control cable length for the left-side cable. Both right- and left-side cables were kinked about every 20 inches (the approximate distance between floor beam locations), and both cables exhibited multiple breaks at the turnbuckle locations. Some recovered and identified cables were sent to the Safety Board materials laboratory for metallurgical examination, which revealed that the cable breaks resulted from tensile overload. No evidence of preimpact failure of the rudder cables was found.

1.12.2.2 Examination/Reconstruction of Cargo Compartments

Identified sections of the forward and aft cargo compartments were examined for evidence of preimpact fire or explosion. One section of aluminum flooring from the forward cargo compartment exhibited sooting on the lower side, but no evidence of fire, heat, or soot damage was found on the upper (inner) floor surface. Neither of the two cargo compartment pressure relief/emergency access panels (which form a section of the cargo compartment ceiling liner in the forward and aft compartments) displayed fire damage on either side. No evidence of fire damage or soot was found on either the aft cargo door or the recovered pieces of the forward cargo door. In addition, the forward outflow valve showed no evidence of soot deposits. Pieces of cargo compartment liner exhibited evidence of smoke and fire damage that was consistent with a postimpact fire.

1.12.2.3 Examination/Reconstruction of the Auxiliary Fuel Tank

Safety Board investigators examined the recovered pieces of the auxiliary fuel tank system for evidence of preimpact fire, explosion, corrosion, or structural failure. Investigators identified about 85 percent of the auxiliary tank fuel control valve box components and fuel transfer/vent hoses and fittings, about 50 percent of the electrical control box components, and about 40 percent of the auxiliary fuel tank structure. The identified sections of the auxiliary fuel tank included portions of the upper panel (including a 5-inch portion of the forward upper seam), the center and lower portions of the forward panel, center and lower portions of the aft panel, side angle panels, and sump drain doubler from the lower panel. The compression beams located at the aft pressure bulkhead were the only pieces of auxiliary fuel tank support structure that were identified. Although a small section of the forward tank panel displayed fire damage, identified mating sections of the tank structure contained no evidence of heat or fire damage. Further examination of the auxiliary fuel tank panels and support structure revealed no additional evidence of heat or fire damage.

The auxiliary fuel tank components (valves, screens, filters, and motors) did not exhibit any abnormal characteristics, and the auxiliary fuel tank valve positions were

consistent with a deactivated fuel tank.⁷⁷ The auxiliary fuel tank pressure relief valve was found intact. Postaccident pressure and leak tests revealed that the relief valve opened at 9 psi; the valve is designed to open at 10 ± 1 psi. The bleed air filter exhibited no evidence of internal or external contamination and no odor of fuel.

Examination of the identified fuel lines and hoses revealed varying amounts of heat and fire damage. For example, the portion of steel braid-covered fuel hose that extended forward from the auxiliary fuel tank to the bulkhead at body station 727 showed no evidence of heat or fire damage. However, the steel braid-covered fuel hose that extended forward from the body station 727 bulkhead to the wing center section exhibited severe heat and fire damage; only the end fittings and steel braid remained intact. One portion of the wing center section structure, installed 4 feet away from the charred portion, exhibited severe charring; however, the center section structure exhibited no evidence of heat or fire damage. The fuel hose assembly contained in the airplane's center fuel tank exhibited heat exposure and burned hose rubber; however, the crossfeed line (external to the center fuel tank) was not charred.

1.12.3 Examination of Wreckage for Indications of Possible Bird Strike

Because of witness reports that large flocks of migratory birds were observed in the Pittsburgh area throughout the afternoon and evening of the accident,⁷⁸ the Safety Board examined the wreckage for indications of a possible bird strike. Ultraviolet light, a method commonly used for detecting blood,⁷⁹ was used to examine several pieces of the radome, portions of the forward pressure bulkhead, left wing slats, cockpit flight control components, and leading edges of the vertical and horizontal stabilizers for bird remains.

Although no evidence of bird stains, remains, or other organic matter was found on most of the examined areas, investigators noted a small (10- by 5-inch chordwise) stain on the outer surface of the outboard No. 1 slat. A 3- by 5-inch section of the stain, located in the upper external portion aft of the leading edge of the slat and oriented in a spanwise direction, exhibited a more intense white fluorescence when illuminated by ultraviolet light. The stained area was adjacent to fractured segments of the No. 1 outboard slat track. Two small samples of the fluorescent debris were removed from the slat surface and the adjacent interior slat cavity. The samples were examined by an ornithologist at the

⁷⁷ According to USAir's maintenance procedures, after auxiliary fuel tank deactivation, the fuel transfer valve and the fuel fill valve should be in the closed position, with the fuel fill valve circuit breaker in the cockpit pulled and collared to ensure that the valve remains closed (unless intentionally reactivated). The auxiliary fuel tank bleed air circuit breaker (which controls the bleed air solenoid valve) is also pulled during the deactivation process. The fuel fill valve and auxiliary fuel tank bleed air circuit breakers were not located in the wreckage.

⁷⁸ No such observations were reported in official weather observations, by pilots of other airplanes in the area, or in WSR-88D data.

⁷⁹ According to an Armed Forces Institute of Pathology (AFIP) laboratory report on its examination of a portion of the accident airplane's left wing, biological material can fluoresce when viewed under an ultraviolet light of the appropriate wavelength.

Smithsonian Institution's Associate Division of Birds, who determined that the debris exhibited no characteristics that resembled those of a bird.

The outboard No. 1 slat was also examined by specialists from the Armed Forces Institute of Pathology (AFIP). According to the AFIP laboratory report, the pieces of debris were inspected using an Omnichrome Alternate Light Source unit (all wavelength spectrums and all optical filters), a Luminol solution, and Leucomalachite Green solution. The AFIP report stated that none of the inspection techniques revealed any luminescence that would indicate the presence of blood or blood-like material on the debris pieces but that "several type of fibers, minerals and other fuel and petroleum products were present in the samples collected [on scene]." The report concluded that the samples examined contained "no blood or blood-like products."

The fractured segments of the No. 1 outboard slat track that were adjacent to the stained area of the No. 1 slat were removed from the wreckage and transported to the Safety Board's materials laboratory for metallurgical examination. The metallurgist's report of the examination stated that the aileron hinge bracket "was grossly distorted and separated approximately at a roller position. Visual examination of the separated arm revealed features typical of an overstress separation. No evidence of preexisting fracture areas was noted."

1.13 Medical and Pathological Information

Toxicological samples (muscle tissue) from both pilots were sent to the FAA's Civil Aeromedical Institute (CAMI) in Oklahoma City, Oklahoma, for examination. Although ethanol was detected in muscle tissue samples from both the captain (34 mg/dl, or 0.034 percent weight/volume—also known as blood alcohol content) and first officer (54 mg/dl, or 0.054 percent blood alcohol content), the toxicological reports stated that "the delay in the collection and the analysis of specimens may have resulted in postmortem ethanol production." The pilots' toxicological results were negative for all drugs of abuse and prescription as well as over-the-counter medications.

1.14 Fire

An intense postimpact fire melted localized sections of the airplane structure and scorched nearby trees and the ground surrounding the crash site. Fire-fighting personnel and equipment from Hopewell Township and Beaver and Allegheny Counties, Pennsylvania, arrived at the accident site within minutes of the crash, and firefighters began efforts to extinguish the fire immediately after arriving on the scene. The fire burned for approximately 5 hours before it was extinguished but continued to smolder for several days.

1.15 Survival Aspects

Because the airplane was destroyed and no occupiable space remained intact, the accident was not survivable. The Beaver County Coroner's Office investigative report stated that all airplane occupants were killed as a result of "blunt force impact trauma."

The emergency response by Hopewell Township, Beaver County, and Allegheny County authorities was initiated after they received telephone calls informing them of the accident. The authorities began to arrive at the accident site within minutes after the crash.

1.16 Tests and Research

1.16.1 Background Information—Other Significant Yaw/Roll Events

Because of early indications that the initial upset of USAir flight 427 might have been caused by an unintended or uncommanded rudder movement, which was considered (but not established as a cause or factor) in connection with the 1991 crash of a 737 at Colorado Springs, Colorado (United Airlines flight 585),⁸⁰ the Safety Board reviewed all of the information collected for the investigation of that accident during the investigation of the USAir flight 427 accident.⁸¹ In addition, the Safety Board investigated a 1996 yaw/roll incident involving a 737 near Richmond, Virginia (Eastwind flight 517), to determine if the upset event may have been related to an anomalous rudder movement. Because much of the testing and research that was done in connection with the USAir flight 427 investigation also incorporated information or examined components from the United accident and Eastwind incident,⁸² factual information from these two events is presented in the next two subsections.

1.16.1.1 United Airlines Flight 585 Accident

On March 3, 1991, United Airlines flight 585, a 737-291, N999UA, was rolling out of a right turn to the north on the final approach for runway 35 at Colorado Springs Municipal Airport in Colorado Springs, Colorado, when it suddenly yawed and then rolled to the right, pitched nose down, and crashed short of the runway. The airplane impacted

⁸⁰ See National Transportation Safety Board. 1992. *United Airlines Flight 585, Boeing 737-291, N999UA, Uncontrolled Collision With Terrain for Undetermined Reasons, 4 Miles South of Colorado Springs Municipal Airport, Colorado Springs, Colorado, March 3, 1991*. Aircraft Accident Report NTSB/AAR-92/06. Washington, DC.

⁸¹ In addition, one of the recommendations in the FAA's 1995 Critical Design Review (CDR) report was that the Safety Board begin a combined investigation of the United flight 585 and USAir flight 427 accidents. (See section 1.18.4 for more information on the CDR team and its report.)

⁸² For more information, see, for example, section 1.16.3.1 (Eastwind Flight 517 Flight Tests), section 1.16.6 (Flight Performance Simulation Studies), section 1.16.5.4 (Detailed Examinations and Tests of Main Rudder PCUs), and section 1.16.7.4.1 (Comparison of Engine Sound Signatures From United Flight 585 CVR and CVR from 737-200 Flight Tests).

the ground about 0943:42.⁸³ All 25 people aboard the airplane were killed, and the airplane was destroyed by impact forces and postcrash fire.

When the accident sequence began (CVR and FDR evidence indicated that the upset began about 0943:32), the airplane was operating at 160 knots with flaps extended to 30° and the landing gear extended. CVR and meteorological information indicated that the pilots of United flight 585 were conducting a visual approach to the runway in moderate-to-severe turbulence and gusty wind conditions; low-level windshear was reported.

The United flight 585 CVR indicated that, as the pilots prepared for the approach to the destination airport, they discussed the strong gusty winds and windshear conditions they expected to encounter during the approach, airspeed adjustments to compensate for those conditions, and missed approach procedures. The captain was performing the PF duties, and the first officer was performing PNF duties. About 0938:14, the first officer requested information from ATC regarding pilot reports concerning loss or gain of airspeed. About 0939:26, when the airplane was on a southerly heading and had just passed abeam (and to the east) of the end of runway 35, the CVR recorded the captain saying "...we're not gonna be in a rush...we want to stabilize it out here..." The first officer responded, "yeah, I feel the same way." About 0940:44, while the first officer was busy completing a checklist, the captain requested additional information from ATC regarding traffic. The pilots began a series of right turns toward the (northbound) final approach. They incrementally extended flaps, extended the landing gear, and accomplished the final descent checklist. Figure 11 shows a plot of United flight 585's ground track based on FDR and radar data.

As the pilots began to align the airplane with the final approach course, the airplane was experiencing airspeed changes (± 10 knots) and rapid heading changes.⁸⁴ About 0942:29, 0942:31, and 0943:01, the CVR recorded the flight crew stating information related to uncommanded airspeed changes. According to the CVR, the first officer said "wow about 0943:08" and "we're at a thousand feet" at 0943:28.2. At 0943:32.6, the CVR recorded the first officer exclaiming "oh god;" less than 1 second later (at 0943:33.5), the captain stated "fifteen flaps," and the first officer responded "fifteen." The CVR sound spectrum study indicated that the sounds before impact were consistent with both engines accelerating.⁸⁵

FDR data indicated that United flight 585 began a sharp heading change to the right and a sudden descent about the time the captain called for "fifteen flaps." The CVR recorded the first officer stating "oh" at 0943:34.4 and the captain exclaiming "oh" loudly at 0943:34.7. One second later, the first officer and the captain each stated "[expletive]"

⁸³ All times in this subsection are mountain standard time, based on a 24-hour clock. The CVR time equals FDR time in seconds plus 0941:55 (local mountain standard time).

⁸⁴ The FDR installed on United flight 585, a Fairchild Digital Flight Recorder Model F800 (S/N 4016), directly recorded five parameters. Altitude, indicated airspeed, magnetic heading, and microphone keying versus time were recorded at once per second, and vertical acceleration was recorded eight times per second. The Safety Board conducted simulation studies to derive additional flight-related information from the FDR and radar data (see section 1.16.6).

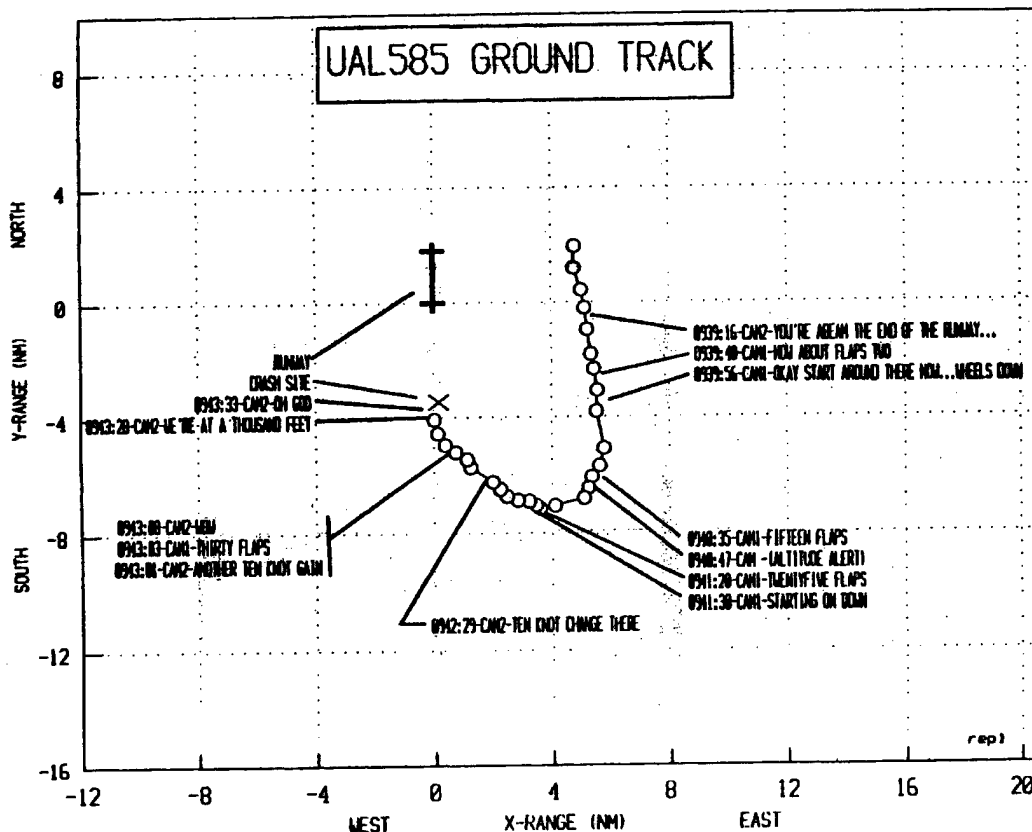

Figure 11. Ground track of United flight 585.

(at 0943:35.4 and 0943:35.7, respectively). At 0943:36.5, the CVR recorded the captain stating “no” very loudly and, about 1 second later, the first officer and the captain stating “oh, [expletive]” (at 0943:37.5 and 0943:38.2, respectively). The CVR recorded the first officer stating “oh, my god...oh, my god...” beginning at 0943:38.4, the captain stating “oh, no, [expletive]” beginning at 0943:40.5, and the sound of impact just before the CVR recording ended at 0943:41.5.

The accident airplane’s maintenance history included two rudder-related pilot writeups during the week before the accident. On February 25, 1991, a pilot wrote that “on departure got an abnormal input to rudder that went away. Pulled yaw damper circuit breaker.” The noted corrective action was “replaced yaw damper coupler and tested per maintenance manual.” On February 27, 1991, a pilot wrote that “yaw damper abruptly

⁸⁵ According to United Airlines personnel, the command “fifteen flaps” is part of the company’s go-around procedure. Although United’s standard procedure for a go-around at the time of the accident included the statement “go-around thrust” before reducing the flap setting, no such statement was recorded by the accident airplane’s CVR. Company personnel advised the Safety Board that the “fifteen flaps” command would have no function, other than a go-around, at the United flight 585 airplane’s altitude and configuration. Further, the Safety Board’s report regarding the United flight 585 accident stated, “four or five seconds prior to impact, two signatures were noted that are consistent with two engines accelerating.” These indications of increasing engine power are consistent with an attempted go-around.

moves rudder occasionally for no apparent reason on 'B' actuators. Problem most likely in yaw damper coupler...unintended rudder input on climbout at FL250. [Autopilot] not in use, turned yaw damper switch OFF and pulled circuit breaker. Two inputs, one rather large deflection." The main rudder PCU yaw damper transfer valve (see figure 8) was removed and replaced, and the airplane was returned to service.

The main rudder PCU from United flight 585 was severely damaged by ground impact and postcrash fire. Operational testing of the complete PCU was not possible because of fire damage. However, visual examination of the servo valve indicated that the secondary slide of the PCU servo valve was at its neutral position during the postcrash fire.

The Safety Board's investigation of the rudder anomaly discovered during a July 1992 United Airlines ground check (discussed earlier in section 1.6.3.2.1 and further in section 1.18.1.1) revealed that the 737 rudder had the potential to operate in a direction opposite to that commanded by the flight crew if the main rudder PCU primary slide became jammed to the secondary slide and pushed the secondary slide to its internal stop. Adverse tolerance buildup⁸⁶ in some secondary slides and servo valve housings could allow a rudder reversal if the secondary slide was forced to its internal stop. Examination of the United flight 585 servo valve indicated that the buildup of tolerances of the secondary slide and servo valve components were such that the maximum travel of the secondary slide (regardless of the relative position of the primary slide) would not result in a reversal of the rudder surface motion.

Examination of the standby rudder actuator input bearing revealed evidence of metal transfer (also referred to as galling)⁸⁷ between the input shaft and the bearing. However, the examination determined that the galling did not have sufficient contact area to result in binding that could not be overcome by pilot input on the rudder pedals. (Galling of the input bearing of the standby rudder actuator is discussed in more detail in section 1.16.5.3.2.)

During its investigation of the United flight 585 accident, the Safety Board also reviewed the performance of the flight crew. First officers who had flown recently with the captain of United flight 585 described his strict adherence to standard operating procedures and conservative approach to flying. They indicated that the captain briefed all approaches even in visual conditions, always reported equipment malfunctions, and discussed deferred maintenance items with the first officer. The first officers also reported that, if the captain had not previously flown with a first officer, he would observe that first officer perform PF duties during the first leg of a trip sequence. Further, a first officer who had previously flown with the captain in gusty, turbulent weather reported during a

⁸⁶ Adverse tolerance buildup occurs when the assembling (stacking) of a series of parts, all of which are individually built within tolerances (that is, within an allowable deviation from a standard), has an adverse result.

⁸⁷ Galling is a condition in which microscopic projections or asperities bond at the sliding interface under very high local pressure. The sliding forces subsequently fracture the bonds, tearing metal from one surface and transferring it to the other.

postaccident interview that the captain had advised him to conduct a go-around if windshear was encountered. The first officer stated that the captain had indicated that he had no problem with an early go-around and had encouraged the first officer to conduct a go-around if he thought the approach was unsafe. Regarding the first officer's performance, the captain of United flight 585 had flown a 3-day trip sequence with the United flight 585 first officer a few weeks before the accident and had described her to a friend as "very competent." According to the Safety Board's final report on this accident, "comments on the CVR indicate that the pilots were alert and aggressive throughout the final 9 seconds [of the accident sequence]."

The Safety Board also examined the available information regarding the weather conditions present in the Colorado Springs area at the time of the accident (strong gusty winds with the potential for mountain rotors⁸⁸ and windshear). Additional expertise in this area was provided by the National Oceanic and Atmospheric Administration (NOAA), National Center for Atmospheric Research (NCAR), and National Aeronautics and Space Administration (NASA). The Safety Board's final report on the United flight 585 accident stated the following:

Normally, intense rotors produce a distinctive "roaring" sound. A person 12 miles north of COS [Colorado Springs airport] reported a rotor hitting the ground about noon. He was inside a building and went outside to observe the rotor after hearing what he described as a roaring sound. However, there were no reports from witnesses to this accident hearing such sounds.

Most of the weather investigation focused on the possibility of a rotor as a cause or a factor in this accident....

While approaching [Colorado Springs], flight 585 probably encountered orographically induced atmospheric phenomena, such as updrafts and downdrafts, gusts, and vertical and horizontal axis vortices. The most likely phenomenon that would cause the airplane to roll was a horizontal axis vortex.... It is possible that flight 585 encountered a strong horizontal axis vortex that induced a rolling moment which exceeded the airplane's control capabilities, but the FDR data is not consistent with such an encounter. [The Safety Board's review of FDR data from airplanes that had penetrated horizontal axis vortices⁸⁹ revealed that the FDRs recorded a transient altitude increase (pressure decrease) and anomalous airspeed indications. These were not observed in the FDR data from United flight 585.]

NOAA originally estimated, and NOAA research work has confirmed, that a typical rotor on the day of the accident could have a rotational velocity of 0.06 radians/second (3.4 degrees per second) with a radius of 1,640 feet. The tangential velocity at the core radius would have been 100 feet per second. Simulations showed that such a rotor had little effect on airplane control except that performance problems could develop if the airplane

⁸⁸ A rotor is an atmospheric disturbance produced by high winds, often in combination with mountainous terrain, and expressed by a rotation rate (in radians per second), a core radius (in feet), and a tangential speed (in feet per second). Rotation can occur around a horizontal or vertical axis. One radian equals approximately 57°.

remained in the downflow field of the rotor. In a sustained downflow, the airplane would either have to lose altitude or airspeed, similar to the outcome of entering the downflow field of a microburst.... The airplane did lose altitude at a higher than normal rate, but the airspeed remained constant....

...It was determined that rotors with rotation rates of 0.6 radians/second (34 degrees per second) with a 250 feet core radius (150 feet/second tangential velocity) generated extreme control difficulties....

Wind shears or gust fronts severe enough to produce control difficulties also produced flight responses that were clearly different than those recorded on the accident airplane.... Large changes in heading into the wind, large increases in airspeed, and rapid rolling away from the wind if not controlled by the pilot.... Wind-induced side slip...with marked increases in normal acceleration (G-load).

On December 8, 1992, the Safety Board adopted the following probable cause statement for the United flight 585 accident:

The National Transportation Safety Board...could not identify conclusive evidence to explain the loss of United Airlines flight 585.

The two most likely events that could have resulted in a sudden uncontrollable lateral [roll] upset are a malfunction of the airplane's lateral [roll] or directional control system or an encounter with an unusually severe atmospheric disturbance. Although anomalies were identified in the airplane's rudder control system, none would have produced a rudder movement that could not have been easily countered by the airplane's lateral [roll] controls. The most likely atmospheric disturbance to produce an uncontrollable rolling moment was a rotor (a horizontal axis vortex) produced by a combination of high winds aloft and the mountainous terrain. Conditions were conducive to the formation of a rotor, and some witness observations support the existence of a rotor at or near the time and place of the accident. However, too little is known about the characteristics of such rotors to conclude decisively whether they were a factor in this accident.

As a result of the United flight 585 accident investigation, the Safety Board made seven safety recommendations, including Safety Recommendations A-92-57 and -58, which were issued on July 20, 1992.⁹⁰ These recommendations asked the FAA to

⁸⁹ The Safety Board's review of its accident/incident database revealed that, although several high-altitude horizontal axis vortex encounters resulted in serious injuries (from turbulence), only one instance of such a vortex resulted in a catastrophic air carrier accident. (See National Transportation Safety Board. 1967. *Braniff Airways, Inc., BAC-111, N1553, August 6, 1966, near Falls City, Nebraska*. Washington, DC.) During the Safety Board's investigation of the USAir flight 427 accident (and subsequent reexamination of United flight 585 data), Air Line Pilots Association (ALPA) personnel advised the Safety Board of a documented mountain rotor encounter that occurred on January 29, 1993. A 737-200 operating as Alaska Airlines flight 66 encountered a mountain rotor while climbing through 900 feet above ground level (agl) after takeoff from Juneau, Alaska. (For additional information, see Human Performance Segment Factual Report, Addendum, November 20, 1998.)

Develop and implement a meteorological program to observe, document, and analyze potential meteorological aircraft hazards in the area of Colorado Springs, Colorado, with a focus on the approach and departure paths.... This program should be made operational by the winter of 1992. (A-92-57)

Develop a broader meteorological aircraft hazard program to include other airports in or near mountainous terrain, based on the results obtained in the Colorado Springs, Colorado, area. (A-92-58)

In response to Safety Recommendation A-92-57, NOAA and NCAR collected weather and wind data in the Colorado Springs area between February and April 1997. The June 1998 NOAA/NCAR interim report⁹¹ indicated that numerous mountain-induced weather phenomena were observed, including low-altitude windflow reversals, windshears, and horizontal axis vortices (rotors). The Safety Board's review of the NOAA/NCAR data revealed that, in several cases, the upper wind directions were similar to, but weaker than, those that existed in the Colorado Springs area when the United flight 585 accident occurred.⁹² The data from these cases showed that mountain rotors were present. Some of the weaker rotors measured by NOAA/NCAR were located between the surface and about 3,000 feet above ground level (agl), whereas other (stronger) rotors were observed at altitudes exceeding 4,000 feet agl.

The rotors observed during the NOAA/NCAR data gathering program had a maximum rotational rate of 0.05 radians per second, which is less than the rotational rate of 0.6 radians per second that was demonstrated during the investigation of the United flight 585 accident to be necessary to produce extreme control difficulties in a 737 airplane. According to NOAA scientists, stronger upper windspeeds produce proportionally stronger rotors. Therefore, if the upper windspeeds encountered by United flight 585 were three times stronger than those measured by NOAA/NCAR, the rotor rotational rate could be three times stronger. (For example, a rotor three times stronger than the maximum observed by NOAA/NCAR would have a maximum rotational rate of 0.15 radians per second.)

In its January 20, 1999, letter to the FAA, the Safety Board indicated that, pending the issuance of the NOAA/NCAR final report, Safety Recommendation A-92-57 was classified "Open—Acceptable Response." The Safety Board's letter also indicated that, pending further information about a meteorological program to observe, document, analyze, and report meteorological hazards at other airports in mountainous areas, Safety Recommendation A-92-58 was classified "Open—Unacceptable Response."

⁹⁰ For additional information regarding the seven recommendations, see sections 1.18.11.1, 1.18.11.2, and 1.18.11.3.

⁹¹ *A Pilot Experiment to Define Mountain-Induced Aeronautical Hazards in the Colorado Springs Area: Project MCAT97 (Mountain-Induced Clear Air Turbulence 1997)*, NOAA/NCAR, June 1998. As of March 1999, a final report had not been issued.

⁹² The Safety Board's review of the data indicated that the upper winds present at the time of the United flight 585 accident were about two to three times stronger than those observed in the NOAA/NCAR data.

Further, in connection with its investigation of the USAir flight 427 accident, the Safety Board reexamined the CVR, FDR, meteorological data, airplane performance data, and physical evidence from the United flight 585 accident investigation. As part of its reexamination of airplane performance data, the Safety Board conducted additional airplane performance simulation studies using the FDR and radar data (see section 1.16.6.2). The Safety Board also conducted additional human performance studies based on the FDR and CVR data from the United flight 585 accident (see sections 1.16.8 and 1.18.8).

1.16.1.2 Eastwind Airlines Flight 517 Incident

On June 9, 1996, Eastwind Airlines flight 517, a 737-200, N221US, experienced a yaw/roll upset about 2200 near Richmond, Virginia. The airplane was operating at an airspeed of about 250 knots and an altitude of about 4,000 feet msl in visual flight rules (VFR) conditions when the yaw/roll event occurred. The pilots were able to regain control of the airplane and land at the destination airport without further incident. None of the 53 airplane occupants were injured, and no damage to the airplane resulted from the incident.

During postincident interviews, the captain reported that he was flying the airplane with the autopilot disengaged⁹³ and his feet resting lightly on the rudder pedals during the descent to land at Richmond. Both the captain and first officer reported that they had not encountered any turbulence or unusual weather during the flight, which originated from Trenton, New Jersey, or the approach to land. However, the captain said that, as the airplane descended through about 5,000 feet msl, he felt a brief rudder "kick" or "bump" on the right rudder pedal but that the pedal did not move. The captain stated that he glanced at the first officer's feet to see if he had contacted the rudder pedals but that the first officer had his feet flat on the floor.

FDR information⁹⁴ and flight crew and flight attendant interviews indicated that, as the airplane descended through about 4,000 feet msl, the airplane yawed abruptly to the right and then rolled to the right. The captain stated that he immediately applied "opposite rudder and stood pretty hard on the pedal." The captain stated that, almost simultaneously with these rudder inputs, he applied left aileron.⁹⁵ Further, the captain consistently reported that the rudder pedal control felt stiffer than normal and did not seem to respond normally throughout the upset event. The first officer stated that he saw the captain

⁹³ The captain reported that it was his practice to disconnect the autopilot when descending through 10,000 feet msl and manually fly the airplane to landing.

⁹⁴ The FDR installed on the Eastwind flight 517 airplane, a Loral/Fairchild Data Systems model F1000 (S/N 00948), recorded 11 parameters. Altitude, airspeed, magnetic heading, engine pressure ratio (EPR) engine No. 1, EPR engine No. 2, and microphone keying were recorded at once-per-second sampling intervals. Parameters that were sampled more frequently than once per second were roll attitude and control column position versus time (two times per second), pitch and longitudinal acceleration (four times per second), and vertical acceleration (eight times per second). The CVR installed on the incident airplane, which was designed to preserve about 30 minutes of data, continued to record after the upset event and recorded over the data pertinent to the incident. Because no pertinent CVR data was available, the Safety Board referenced the incident times as follows: radar time equals FDR time in seconds minus 11,000 plus 2205:47 (local eastern standard time).

“fighting, trying to regain control” and “standing on the left rudder.” According to the captain, these flight control inputs slowed the yaw/roll event; however, the airplane “was still trying to roll,” so he advanced the right throttle to compensate for the rolling tendency with differential power.⁹⁶ The captain stated that, after he made these inputs, the airplane appeared to move back toward neutral “for one or two seconds” and “might have momentarily banked left because of all the correction present” before returning abruptly to a right bank.

The flight crew performed the emergency checklist, which included disengaging the yaw damper. Subsequently, the upset event stopped, and the airplane flew normally for the remainder of the flight. The pilots reported a delay of several seconds between the disengagement of the yaw damper and the end of the upset event.

During postincident interviews, the lead flight attendant of Eastwind flight 517 stated that she was standing in the aisle near the rear of the airplane cabin before the upset began. At that time, she heard a distinct thump from below but not directly underneath her feet. (The rear flight attendant also reported hearing a thump sound while the airplane yawed to the right) She reported that, immediately after the thump occurred, the airplane began “rocking with a violent back and forth motion.... The motions...lasted no more than fifteen seconds, were violent from start to finish, and appeared to come in cycles.”

The FDR data revealed that the airplane rolled rapidly to the right about 10° with a simultaneous heading change to the right of about 5° per second. The FDR data also revealed that the airplane rolled back to the left, to a maximum left bank angle of approximately 15°, while the right engine thrust increased.⁹⁷ (The airplane was in a 15° left bank for approximately 3 seconds and remained in a left bank for an additional 9 seconds while the engine thrust increased; however, the FDR recorded little heading change.) While the right engine pressure ratio (EPR) increased, the airspeed increased from about 250 to about 254 knots. The airplane’s heading changed to the left; hesitated at about

⁹⁵ During an interview 5 days after the incident, the captain estimated that he input about 40 to 45° of control wheel displacement and stated that “the airplane seemed to hold in a 25 to 30° bank.” A statement obtained from the first officer at the same time was consistent with the captain’s estimates of control wheel input and bank angle. However, during an interview 10 days later, the captain indicated that a flight test in which the airplane rolled about 15° “provided a better recreation of the motions of the airplane during the incident.” (FDR data indicated that the incident airplane rolled between 10 and 15° during the upset event.) Although both pilots estimated the captain’s control wheel input during the incident to be about 40 to 45°, Safety Board and Boeing kinematic studies indicated that the initial control wheel input was closer to 60°. Additionally, during the interview 5 days after the incident, the captain estimated that he input about 3 to 4 inches of left rudder pedal displacement; however, in an interview 2 years later, the captain stated that the rudder pedals moved no more than 1 or 2 inches. The captain stated that he immediately put “a lot” of pressure on the rudder pedals but that they “did not go down to the floor.”

⁹⁶ During postincident interviews, the captain told Safety Board investigators that his automatic decision to use differential power to counter the yaw/roll event reflected his experience in turbopropeller-driven airplanes.

⁹⁷ About 5 seconds after the beginning of the upset, the EPR values for the right (No. 2) engine began to increase. The right engine EPR values increased to a maximum of 1.32; remained constant at 1.26 for 5 seconds; increased to 1.30 for 1 second; and then decreased to about 1.01, which was consistent with EPR values of the left (No. 1) engine for the entire incident.

242°; and began a series of heading oscillations of decreasing magnitude, including a left heading excursion of 4.1° and a right heading excursion of 5.6° (both in 1 second). During the heading oscillations, the airplane's roll attitude also oscillated between an approximate wings-level attitude and 10° left wing down (LWD). The heading and roll oscillations decreased while the airplane maintained an approximate constant heading of about 240°.

Postincident examination of the airplane's maintenance records revealed three flight crew-reported rudder-related events during the month preceding the incident. The first event occurred on May 14, 1996, when the captain of the June 9 Eastwind incident flight experienced a series of uncommanded "taps" on the right rudder pedal just after takeoff, which he stated felt "like someone hitting their foot on the right rudder." The captain returned to the departure airport and landed without further incident. As a result of the uncommanded rudder movements reported to have occurred on May 14, the main rudder PCU was replaced that same day,⁹⁸ and the airplane was returned to service.⁹⁹ During a May 21 overnight inspection, rudder sweep and PCU leak examinations were conducted.

The captain reported that the rudder pedal bumps he experienced on May 14 felt identical to the rudder pedal bump he felt at the onset of the yaw/roll event on June 9. Additionally, the Eastwind flight 517 lead flight attendant was a cabin crewmember on the May 14 flight, during which the captain experienced the uncommanded rudder "taps." The flight attendant stated that she did not hear any sounds during the May 14 event and reported that the event was much less intense than the June 9 incident. She was in the front of the cabin during the May 14 event but was near the rear of the cabin during the June 9 incident.

The other two uncommanded yaw/roll events were reported to have occurred on June 1 and June 8, 1996.¹⁰⁰ As a result of these reports, the yaw damper transfer valve and the yaw damper linear variable displacement transducer (LVDT) were removed and replaced on June 8. The incident pilots performed a postmaintenance test flight on the morning of June 9 and reported that the airplane performed normally, with no rudder system anomalies noted during the test flight. Because the airplane performed satisfactorily during the test flight, it was returned to service.

When Safety Board investigators examined the rudder system and the main rudder PCU after the June 9 incident, they observed that the rudder's yaw damper system had been adjusted such that the rudder neutral (at rest) position was 1.5° to the left when the

⁹⁸ The Eastwind flight 517 main rudder PCU servo valve was assembled and tested at Parker on April 15, 1996.

⁹⁹ As a result of the uncommanded rudder movements reported to have occurred on May 14 (and another undocumented rudder event that occurred on or about May 31), on June 2, 1996, Eastwind issued Flight Crew Briefing Bulletin 96-03, which advised company pilots of the circumstances of the events and requested that pilots notify maintenance immediately if an unexplained yaw movement occurred.

¹⁰⁰ The airplane's June 1, 1996, logbook entry stated, "...[airplane] may have exp[er]ienced] 2 each [slight] rudder yaws [to] the left...approx[imately] 30 sec[onds] apart.... No rudder pedal movement...." The June 8, 1996, logbook entry stated, "with yaw damper off in level flight aircraft rolls to the right and the yaw damper test indicator also goes to the right."

yaw damper system was engaged and the rudder trim was set at zero. The active yaw damper could move the rudder 1.5° farther to the left of this neutral position and 4.5° to the right of this neutral position with no aerodynamic loads.¹⁰¹ Postincident PCU testing at Parker's facility indicated that the yaw damper LVDT neutral position was incorrectly set. (The normal limit of yaw damper authority on the rudder, if properly set, would have been 3° to the left and 3° to the right of the rudder's neutral position.)

Additional examination and testing conducted by the Safety Board, Eastwind, and Boeing revealed that the wiring from the yaw damper coupler to the main rudder PCU was chafed and could have resulted in a short circuit, causing a full yaw damper command left or right. Additionally, examination of the yaw damper system revealed damage from infiltration of fluid that was consistent with, but not conclusive evidence of, an electrical fault. The main rudder PCU and yaw damper coupler were removed and replaced, new wiring was installed between the PCU and the yaw damper coupler, and the airplane was returned to service. To date, no further pilot complaints or maintenance writeups regarding rudder "bumps" or other anomalous rudder motions have been reported on the incident airplane.

1.16.2 Wake Vortex Tests and Studies Resulting From the USAir Flight 427 Accident

The PIT Automated Radar Terminal System III radar tracking data indicated that the only airplanes operating in the vicinity of USAir flight 427 when the upset occurred were Atlantic Coast flight 6425, a Jetstream 31 that had just departed PIT and was climbing and heading north, and Delta flight 1083, a 727-200 that was preceding USAir flight 427 to PIT. The Safety Board plotted radar tracking data for these three airplanes to determine whether the wake vortices¹⁰² from either the Atlantic Coast or Delta airplanes might have played a role in the USAir airplane's accident sequence.

The radar data indicated that, at the time of the upset, USAir flight 427 and Atlantic Coast flight 6425 were separated by 1,500 feet vertically (flight 427 was at the higher altitude) and 3.5 nautical miles (nm) horizontally (with flight 427 northwest of flight 6425). About 8 seconds later (about 1903:11), radar data showed that USAir flight 427 was at 5,300 feet msl (600 feet above Atlantic Coast flight 6425) and that the airplanes were 3.1 nm apart. About 1903:20, the radar data indicated that USAir flight 427 was at 2,300 feet msl (2,600 feet below Atlantic Coast flight 6425) and that the airplanes were 2.8 nm apart.¹⁰³ The radar tracks of the two airplanes did not cross at any time.

¹⁰¹ With the rudder trim set at zero, the yaw damper travel limits were $\pm 3^\circ$ about the 0° rudder position (not the rudder's neutral position).

¹⁰² According to the FAA's Aeronautical Information Manual, all airplanes generate wake vortices (a pair of counterrotating airmasses trailing from the wing tips) while in flight. The strength of these vortices depends on the weight, speed, and shape of the wing of the generating aircraft. The greatest vortex strength occurs when the generating aircraft is heavy, in a clean configuration, and at a slow airspeed.

¹⁰³ The recorded radar data plots and separation tables are included in the Performance Group Chairman's Report of Investigation, dated January 14, 1995.

The radar data showed that Delta flight 1083 was descending through 6,300 feet msl on an easterly heading when it passed the approximate location where the initial upset of USAir flight 427 subsequently occurred. The accident airplane reached that location about 69 seconds after Delta flight 1083. According to information provided by Delta Air Lines and ATC records, Delta flight 1083 would have been operating at an estimated weight of 126,400 pounds, in the flaps 1 configuration, and at an ATC-assigned airspeed of 190 knots when it passed the location where the initial upset occurred. USAir flight 427, also on an easterly heading, was at 6,000 feet msl when the initial upset occurred. The closest Delta flight 1083 and USAir flight 427 were to each other was 4.1 nm apart (both airplanes were at 6,000 feet msl) about 24 seconds before the upset occurred. About the time of the upset (1902:50), the distance between the two airplanes had increased to 4.5 nm.

NASA and Safety Board aerodynamics experts performed a study of the most likely movement of the wake vortices produced by Delta flight 1083 (at its estimated weight and configuration). The study indicated that the wake vortices would have drifted with the wind¹⁰⁴ and descended at a rate of 300 to 500 feet per minute. On the basis of these rates, the wake vortices would have likely descended to between 5,800 and 6,000 feet msl during the 69 seconds after Delta flight 1083 descended through 6,300 feet msl near the location of the initial upset. The study indicated that USAir flight 427 most likely encountered the wake vortices produced by Delta flight 1083 about the time of the initial upset.

In September and October 1995, the Safety Board conducted a series of flight tests near Atlantic City, New Jersey, to examine the aerodynamic effects of 727-generated wake vortices on a 737. These tests were conducted with participation and support from parties to the USAir flight 427 investigation, including the FAA, Boeing, USAir, and the Air Line Pilots Association (ALPA), as well as other interested parties, including NASA. The tests used a highly instrumented 737-300 provided by USAir¹⁰⁵ and a 727-100 owned by the FAA and equipped with wing-tip smoke generators to assist in the visual identification of the wake vortex core.¹⁰⁶ To accurately simulate the wake turbulence conditions encountered by the accident airplane, the test airplanes were loaded to the approximate weights of USAir flight 427 and Delta flight 1083 at the time of the wake vortex encounter. Most of the flight tests were conducted in early morning hours when calmer

¹⁰⁴ As previously indicated, a radiosonde balloon that was launched approximately 6 miles southeast of the accident site about 11 minutes after the accident measured winds at 6,000 feet msl from 274° at 15 knots.

¹⁰⁵ The 737 used for the wake turbulence flight tests (which was flown by FAA, Boeing, USAir, and ALPA pilots during the flight tests) was equipped (by Boeing) with an FDR that had enhanced recording capabilities. More parameters, such as control input and control surface position, were included, and parameters were sampled and recorded more frequently than those parameters recorded by the FDR on the accident airplane. The flight test airplane also had a digital audiotape recorder and a video recording system with seven cameras (two in the cockpit facing forward out the windshield, one in the cockpit facing the flight crew and the instruments, one under each wing tip facing forward, one on the vertical fin facing forward, and two in the midcabin facing out windows toward the wing tips). A T-33 observation airplane (provided by Boeing) also used video recording equipment to document the flight tests.

¹⁰⁶ The 727-100 provided by the FAA (and flown by FAA flight test pilots) for the wake turbulence flight tests is shorter than the 727-200, but both airplanes' wing lengths and shape are identical.

atmospheric conditions would be most likely to permit strong, stable, long-lasting wake vortices.

During the tests, the 737 penetrated the 727's smoke-indicated wake vortex cores about 150 times¹⁰⁷ from various intercept angles; in turns, climbs, descents, and level flight at various altitudes;¹⁰⁸ and at separation distances of between 2 and 4.2 nm (USAir flight 427 and Delta flight 1083 were 4.5 nm apart at the time of the upset). For other flight test conditions, the flight test pilots positioned the 737 so that specific airplane surfaces (for example, left wing, right wing, vertical fin, engine, and fuselage) passed through the wake vortex cores. The pilots performed intercepts under the following conditions: autopilot on without pilot input, autopilot on with pilot input (in CWS mode), autopilot off without pilot input (hands off), and autopilot off with pilot input.

Information was obtained from the videotapes, enhanced FDR, Boeing's portable airborne digital data system (PADDS),¹⁰⁹ the 2-hour CVR installed on the 737, and test pilot statements. These data revealed that the 727 wake vortices remained intact as much as 6 to 8 miles behind the wake-generating airplane, and wake strength values ranged from 800 to 1,500 feet/sec². The videotapes revealed numerous examples of wake vortices breaking apart; linking up; and moving up, down, and sideways. The 737 encounters with the wake vortices occasionally resulted in rapid airspeed fluctuations of ± 5 knots, although some fluctuations resulted from the wake vortices' interaction with the pitot-static system and low-level (± 0.1 G) turbulence.

Further, the data showed that the wake vortices did not move in a straight or uniform path (as previously assumed by wake turbulence models that had been developed before the accident). Rather, flight test participants noted large fluctuations in the vertical position of the wake vortex cores over short distances. The wake movement was especially unpredictable when the wake was generated during a descent. During public hearing testimony related to the USAir flight 427 accident, Boeing's flight test pilot described the 727 wake vortices as follows:

...the wakes...stay at this three, four, five foot diameter core all the way back until they burst.... They flow left, right, up and down, inside maybe a 15 foot diameter tube on a stable day. It is possible to quickly hit the same wake twice, because the wake is not fixed in space. You could possibly get a left roll and...[if] the wake vortex is actually on your left side at that point...if you cross over, it means that you roll right back into the wake....

¹⁰⁷ Data from the 150 wake encounters were examined to identify 737 flight characteristics during wake vortex encounters; CVR sound signatures from 50 of the 150 wake encounters were selected and compared with the sounds recorded by the accident airplane's CVR.

¹⁰⁸ According to the FAA test pilot involved in the wake turbulence flight tests, part of the flight test safety plan "required that we do this at a high altitude...15,000 feet [msl] or greater, in case there was some type of an upset that would take some time to recover from.... We were above a deck of clouds at about [18,000] or 19,000 feet [msl] for the first encounter...."

¹⁰⁹ PADDS is a high-rate, self-contained flight test data recording system developed by Boeing that was installed on the flight test airplane to allow investigators to record and evaluate parameters that were not recorded by the accident airplane's FDR system. The PADDS system recorded all data at higher sampling rates (20 times per second) than the FDR system that was installed on the incident airplane.

According to the flight test pilot statements, although the wake encounters had varying effects on the 737 flight handling characteristics, the effects usually lasted only a few seconds and did not result in a loss of control or require extreme or aggressive flight control inputs to counteract. The flight test pilots with experience flying in air carrier operations stated that the wake encounters experienced during the flight tests were similar to those that they had experienced during normal flight line operations. The pilots described the wake encounters as "routine" and not startling.

The flight test data also indicated that even "routine" wake vortices could result in strong rolling¹¹⁰ and yawing moments,¹¹¹ depending on the wake vortex intercept angle. During public hearing testimony, the FAA flight test pilot reported that, at wake vortex intercept angles of less than 10° (particularly at intercept angles of between 2 and 5°), the airplane experienced strong rolling tendencies. However, the pilot stated that, at intercept angles of 10° or more, the encounter did not result in a significant rolling moment, although the airplane experienced a couple of sharp bumps as it crossed the wake vortex. The FAA flight test pilot reported that, when the airplane encountered the wake vortex with no autopilot or manual control (hands-off condition), he observed uncommanded roll angles between 15 and 30°. When the airplane encountered the wake vortex under manual control (hands-on condition) and with the autopilot on (with and without pilot input), the FAA pilot observed roll angles between 10 and 20°.

According to the flight test pilots, the rolling moment tended to self-correct as the airplane passed through the wake vortex. The FAA flight test pilot said that "the airplane would start to roll as you [entered the wake]...then as you hit the right vortex, it would roll you back up to level again..." Several of the flight test pilots reported that the wake vortex encounters were generally short in duration (unless the pilots intentionally maneuvered the airplane to stay in the wake effect) because the wake vortex tended to force the airplane out of its effects. The FAA test pilot stated that it was very difficult to keep the airplane in the vortex. During test conditions in which the vortex was positioned on the top of the airplane and hit the vertical fin (in the flaps 1 configuration at 190 knots), the pilot reported that full aileron deflection was required to counter the vortices' tendency to push the airplane out of the vortex.

During the public hearing testimony, Boeing's flight test pilot stated that he did not use much rudder during the wake turbulence flight tests; rather, he used mostly aileron. The pilot stated that "the only time you use the rudder pedal is when you have a definitive yawing moment... or you have a very...high rolling moment..." Boeing's flight test pilot also reported that "every now and then, I started to use the rudder, but then you would translate left or right out of the full effect of the [wake vortex] core and then I would be left with either putting... the [control] wheel back in or leaving the rudder there and just playing with the [control] wheel." The pilot stated he did not experience anything during

¹¹⁰ Boeing's flight test pilot stated that the effect of the wake turbulence was "a bit stronger than I would have expected...[resulting in] probably 25 to 30 [degrees of roll]."

¹¹¹ Wake turbulence-related yawing moments were transient in nature and did not result in large sustained heading changes.

the wake vortex encounters that he believed would prompt a pilot to apply and hold full rudder.

In the public hearing testimony, the flight test pilots indicated that the wake encounters they experienced during the flight tests were not disorienting or violent enough to have caused a sustained loss of control. However, the flight test pilots said that a strong wake vortex encounter would likely be startling and surprising to pilots when encountered unexpectedly during otherwise smooth, routine flight operations.

The wake turbulence encounter flight test data were compared with the results of computer flight simulations¹¹² performed at Boeing using its previously developed mathematical model. The comparison indicated that the simulation model adequately predicted wake-induced lift, roll, and pitch characteristics; however, the mathematical model did not accurately predict the wake-induced yawing moment characteristics of the airplane during certain wake encounters. The videotape taken during the flight tests revealed that, when the airplane passed over or directly through the wake vortex cores, the wake (as shown by the smoke) was disrupted by the 737's wings, fuselage, and horizontal tail surfaces; under these circumstances, the yawing moments predicted by the simulation were not evident in the flight test data. However, when the airplane was slightly underneath the wake so that its vertical tail surface passed through the wake vortex core generated by the 727, the wake that contacted the vertical tail surface had not been previously disrupted. The flight test data revealed that this situation resulted in a transient yaw response that exceeded the yaw predicted by the simulation wake turbulence model.

Boeing's mathematical wake vortex model was refined based on the wake turbulence encounter flight test data, and additional flight simulations were performed by investigators to further evaluate the interaction of USAir flight 427 with Delta flight 1083's wake vortices. The simulations employed various wake vortex characteristics, wake vorticities, positions, and core sizes; the accident airplane's closure rates and intercept angles with the wake; and the use or operation of the airplane's autopilot, yaw damper, and autothrottle. Encounters with wake vortices in these simulations did not result in significant problems controlling the airplane.

¹¹² Flight simulations were conducted at Boeing using its computer workstation-based flight simulation software and its multipurpose cab (M-CAB) engineering simulator. The M-CAB utilizes a standard, 6 degree-of-freedom motion base to provide some acceleration cues to the occupants of the cab. The motion base can replicate some short-term accelerations or some smaller magnitude, long-term accelerations. It can rotate the cab through roll, pitch, and yaw angles of about $\pm 30^\circ$ and can translate the cab in the forward/aft, side, and vertical directions about up to about ± 2 feet. Long-term vertical accelerations, such as those from sustained normal flight loads, cannot be duplicated. Some side loads, such as those from sustained sideslips, can be duplicated by rolling the cab to a steady angle, similar to tilting a chair sideways. Forward accelerations, such as those felt during a normal takeoff roll acceleration, can be somewhat replicated by rotating the cab upward to a steady pitch attitude.

1.16.3 Flight and Simulator Tests of Effects of Various Flight Control and System Failures

The Safety Board used Boeing's multipurpose cab (M-CAB) engineering simulator, "flown" by FAA flight test pilots, to document and test several possible 737 failure or malfunction scenarios. The following possible flight control/system failure scenarios were examined:

- loss of engine power, with various flight control inputs and rates;
- asymmetric thrust reverser extension;
- yaw damper hardover;
- leading edge asymmetry, with or without autoslats;
- asymmetric autoslat deployment at stickshaker;
- flap malfunction;
- loss of roll control spoilers;
- elevator malfunction;
- outer slat damaged and extended over wing; and
- rudder hardover, at various rates of input, with AFS on and off.

Of all the simulations conducted, only the rudder hardover simulation produced results that were generally consistent with the data from USAir flight 427's FDR.¹¹³ Specifically, some of the results of the M-CAB simulation of the rudder hardover scenario were similar to FDR heading data that were recorded several seconds after the initial upset. This similarity prompted additional investigation of rudder hardover scenarios.

Because the pilots who flew the M-CAB simulator responded differently (either in the magnitude or the timing of their responses), the simulator results were not consistent among the pilots, and precise matches of the FDR data were thus not possible. As a result, the Safety Board and Boeing conducted flight simulations on computer workstations to remove the individual variances introduced by the pilots who participated in the M-CAB study. The workstation simulations enabled engineers to make small parametric changes to the input data and then determine the effects of various rudder hardware scenarios and resultant wheel and elevator responses. These simulation studies are discussed in section 1.16.6.

¹¹³ For example, for an asymmetric thrust reverser extension to result in the left yawing moment recorded by the accident airplane's FDR during the first several seconds of the upset, the right engine would have had to have been in forward thrust and the left engine in reverse. Boeing's calculations revealed that the net thrust differential required to sustain the left yaw recorded by the FDR during the first few seconds of the upset would be 37,890 pounds, affecting the airplane's yaw to the left. However, the FDR's recorded engine power settings (66 percent N1 at 190 knots), indicated that the accident airplane's engines could have only been producing a net thrust differential of 13,269 pounds (4,500 pounds forward thrust on the right engine and 8,769 pounds reverse thrust on the left engine), affecting the airplane's yaw to the left.

Boeing's M-CAB simulator was also used to conduct postaccident simulator flights using the accident airplane's FDR data, with a rudder hardover induced either manually or electronically to represent the USAir flight 427 upset condition. During the simulator exercise, the participants¹¹⁴ were briefed by Boeing personnel regarding the circumstances of the USAir flight 427 accident, prepared for and expecting the upset event when it occurred, and coached through a specific recovery technique (full right control wheel maintained throughout the duration of the event, and forward control column pressure sufficient to reduce the normal load factor and maintain airspeed above the crossover point).¹¹⁵ The pilots were able to recover from the upset (or at least stabilize the roll to the point at which a continued loss of control would not have likely occurred) when they applied the recovery technique promptly at the beginning of the event. If the pilots varied their responses from the specific techniques that they were told to apply (for example, when they modified the control wheel input in anticipation of the simulator's responses to the inputs or applied aft control column pressure to maintain 6,000 feet), it became much less likely that the pilots would successfully recover from the upset event.)

Additionally, Safety Board investigators, with representatives from parties to the investigation and a research scientist from NASA's Ames Research Center, documented possible pilot responses to the upset using the vertical motion simulator (VMS) at the Ames Research Center.¹¹⁶ The VMS had a larger range of motion than the Boeing M-CAB and could therefore more accurately replicate the airplane motion recorded by the accident airplane's FDR. The time histories of the airplane motion, as documented by the FDR and the initially derived positions of the flight control surfaces (based on computer workstation modeling), were input into the VMS. In addition, a portion of the accident airplane's CVR was synchronized to the FDR data and replayed during the VMS runs. The VMS cab did not resemble a 737 cockpit; however, the cab included a view of a computer-simulated horizon, which was adjusted to the accident airplane's attitude. The VMS allowed participants to feel the motion of the airplane, listen to the CVR excerpts, and view the horizon and control inputs to assess possible flight crew responses (such as whether the flight crew might have responded to the upset with left rudder pedal input). In addition, a NASA specialist on human spatial orientation rode in the simulator to provide observations on the possibility that pilot disorientation contributed to the accident. (See section 1.18.6.2 for additional discussion regarding the NASA specialist's observations.)

¹¹⁴ Participants in these postaccident simulator flights included pilots and nonpilots from the Safety Board and parties to the investigation.

¹¹⁵ See section 1.16.4 for more information on the crossover airspeed.

¹¹⁶ A research scientist from NASA's Ames Research Center described the VMS as "...a full 6 degree-of-freedom simulator that has a vertical thrust of plus and minus 30 feet, lateral thrust of plus and minus 20 feet, and a fore and aft thrust of 2.5 feet.... there are full visual simulations on the VMS...." The motion base of the VMS simulator permits an improved replication of the feel of the airplane motion over that of Boeing's M-CAB (or most other motion-based simulators.) Although the acceleration cues are better represented by the VMS, its range of motion limits the range of lateral and vertical acceleration cues available to the occupants of the VMS cab.

1.16.3.1 Eastwind Flight 517 Flight Tests

On June 22 through 24, 1996, the Safety Board conducted flight tests in the Eastwind flight 517 incident airplane, with Boeing, FAA, and Eastwind Airlines participation. The flight tests were to document the operation and limits of the airplane's yaw damper system, test and record the airplane's responses to various rudder inputs, and expose the captain of Eastwind flight 517 to various rudder inputs and document his reactions to and insights on the inputs. For the flight tests, the airplane's yaw damper system bias remained misadjusted so that it could command 1.5° to the left and 4.5° to the right of the rudder's trimmed position (as it was at the time of the incident). As with the wake vortex tests, additional test equipment and instrumentation were installed on the incident airplane to record and document the flights.¹¹⁷

During the ground and flight tests,¹¹⁸ the incident airplane was operated with a Boeing flight test pilot in the left seat and an FAA flight test pilot in the right seat; the captain of Eastwind flight 517 and additional Boeing and FAA personnel were seated in the cabin. The first flight test was conducted at altitudes between 8,000 and 13,000 feet msl, at an airspeed of 250 knots, and with the yaw damper engaged and the flaps and landing gear retracted. Attempts were made to induce an in-flight yaw damper failure and subsequent hardover command through a series of rapid and abrupt rudder pedal and control wheel inputs; however, the flight test pilots were unsuccessful in inducing a yaw damper hardover. Before the second test flight, the incident yaw damper coupler was removed, and a different yaw damper coupler, a yaw damper fault insertion box, and associated wiring were installed to allow the flight test pilots to command a yaw damper hardover condition using an electrical signal.

The second flight test was also conducted at altitudes between 8,000 and 13,000 feet msl; at an airspeed of 250 knots; and with the yaw damper engaged, autopilot disengaged, and flaps and landing gear retracted. Yaw damper hardovers to the left and right were electronically commanded by the flight crew via the cockpit switchbox, and the maximum rudder and control wheel positions needed to stabilize the airplane were noted. Additionally, rudder pedal release tests were conducted using the following procedures:

¹¹⁷ During the Eastwind flight tests, the PADDs system recorded 28 parameters, including 5 yaw damper-related parameters and 3 rudder system parameters, which provided valuable data for investigators. (The Eastwind flight 517 FDR recorded 11 parameters, none of which provided yaw damper or rudder position information.) The PADDs system recorded all data at higher sampling rates (20 times per second) than the FDR system that was installed on the airplane at the time of the incident. Additionally, a digital audiotape was installed to record CVR data beyond the normal 30-minute duration, and a Boeing noise recording system was installed to record noises emanating from the aft cabin and galley area during the flight tests (to determine the source of the thump noise described by the flight attendants from flight 517).

¹¹⁸ Ground taxi tests were conducted before each of the two test flights to test the rudder and yaw damper system for anomalies that would preclude safe test flights and perform operational tests of the additional test equipment and instrumentation installed on the airplane.

- While maintaining straight and level flight using control wheel and rudder pedal inputs, right rudder trim was added in 1° increments, from 0 to 6° trailing edge right rudder position.
- Rudder pedal inputs were released.
- Rudder position and control wheel input needed to control bank angle were noted.

During portions of the second flight test, the captain of Eastwind flight 517 occupied the right pilot seat previously occupied by the FAA flight test pilot¹¹⁹ and controlled the airplane during a series of yaw damper hardover insertions and rudder pedal release conditions (including four yaw damper hardovers of 4.5° right rudder, three rudder pedal releases from the 6° right rudder trim position, and three rudder pedal releases from the 4° right rudder trim position).

Recorded FDR and PADDs data indicated that the captain responded to the first yaw damper hardover 0.6 seconds after its initiation by stepping on the left rudder pedal. The flight test FDR data indicated that the airplane's bank angle increased to a maximum of about 4.5° right wing down (RWD) and that its heading changed about 2° (both in 1 second) before the airplane responded to the Eastwind flight 517 captain's recovery efforts. During the three subsequent yaw damper hardovers, the Eastwind flight 517 captain, at the direction of the Boeing flight test pilot, allowed the airplane to respond to the hardover condition for a few seconds before the captain responded with rudder pedal input.

When the Eastwind flight 517 captain was exposed to the 6° right rudder pedal release test condition (during which FDR and PADDs equipment recorded a 4° right heading excursion and a bank angle increase to 8° RWD, both within 2 seconds), he stated "that was more like it." (The incident FDR data indicated a 4.1° right heading change within 1 second and a maximum bank angle increase to 10° RWD within 2 seconds.)

The Eastwind flight 517 captain indicated that the motion of the airplane during the portion of the second test flight, for which he was seated in the right pilot seat in the cockpit, was similar to the airplane motion he recalled experiencing during the incident and that the yoke pressure felt the same. However, the captain indicated that the rudder response during the first and second tests seemed different from what he experienced during the incident. He stated that the rudder felt stiffer and less effective during the actual incident.

¹¹⁹ The FAA test pilot moved to the cockpit observer jumpseat and continued to control the yaw damper hardover switchbox.

1.16.4 Flight Control Characteristics Flight Tests (Blowdown and Crossover Airspeed)

In September 1995, a series of flight tests were conducted from Boeing Field in Seattle, Washington, to validate existing and acquire additional aerodynamic data for the 737-300 flight simulator data tables, study the airplane's performance during high sideslip conditions, and measure the airplane's response to various roll and yaw inputs. The flight tests were conducted with the USAir 737-300 that was used for the wake vortex tests conducted in September and October 1995 (see section 1.16.2). The flight tests included operating the 737-300 (instrumented with the Boeing PADDs system) at a flaps 1 setting and at airspeeds from 150 to 225 knots calibrated airspeed (KCAS). The flight test conditions included steady heading sideslips; airplane roll response to control wheel input, rudder pedal input, cross controls of control wheel and opposite rudder pedal input, and combined controls of control wheel and rudder pedals; autopilot turns; and slowdown turns to aerodynamic stall.

Several flight test conditions required the test pilots to maintain control of the airplane and, if possible, a constant (or steady) heading by using the control wheel to oppose full rudder surface deflections. These tests revealed that, in the flaps 1 configuration and at certain airspeeds, the roll authority (using spoilers and ailerons) was not sufficient to completely counter the roll effects of a rudder deflected to its blowdown limit. The airspeed at which the maximum roll control (full roll authority provided by control wheel input) could no longer counter the yaw/roll effects of a rudder deflected to its blowdown limit was referred to by the test group participants as the "crossover airspeed."

The flight tests revealed that, in the flaps 1 configuration and at an estimated aircraft weight of 110,000 pounds,¹²⁰ the 737-300 crossover airspeed was 187 KCAS at one G.¹²¹ At airspeeds above 187 KCAS, the roll induced by a full rudder deflection could be corrected by control wheel input; however, in the same configuration at airspeeds of 187 KCAS and below, the roll induced by a full rudder deflection could not be completely eliminated by full control wheel input in the opposite direction, and the airplane continued to roll into the direction of the rudder deflection. The flight test data also confirmed that an increase in vertical load factor, or angle-of-attack, resulted in an increase in the crossover airspeed.

The flight tests also revealed that the test airplane's rudder traveled slightly farther than originally indicated by Boeing's 737-300 computer models before reaching its aerodynamic blowdown limit. Data from the flight test were incorporated into Boeing's M-CAB engineering software, and flight simulations were performed. The M-CAB flight simulations indicated that, with a rudder deflected to its aerodynamic blowdown limit and in the configuration and conditions of the USAir flight 427 accident airplane, the roll

¹²⁰ At the time of the initial upset, USAir flight 427 had an estimated operating weight of 108,600 pounds and was operating at an airspeed of about 190 knots.

¹²¹ One G is equivalent to the acceleration caused by the earth's gravity (32.174 feet/sec²).

could not be completely eliminated (and control of the airplane could not be regained) by using full control wheel inputs if the airspeed remained below 187 KCAS. The pilots who were involved in the flight and simulator tests indicated that successful recovery required immediate flight crew recognition of the upset event and subsequent prompt control wheel inputs to the full authority of the airplane's roll control limits and pitch flight control inputs to maintain a speed above the crossover airspeed.¹²² To return the airplane to a wings-level attitude, the pilots had to avoid excessive maneuvering that would increase the vertical load factor, or angle-of-attack, and thus increase the crossover airspeed.

In June 1997, additional flight tests were conducted by FAA and Boeing test pilots¹²³ using a newly manufactured 737-500¹²⁴ to obtain additional information regarding crossover airspeeds and quantify 737-300 controllability, handling characteristics, techniques, and altitude required for recovery from rudder deflections to aerodynamic blowdown limits. (Earlier flight tests had been limited to 75 percent of the available rudder rate deflection because of concern that, at higher deflection rates, the vertical fin would be overstressed during a dynamic maneuver.) The flight test conditions included full-rate rudder deflections and/or maximum rate aileron roll maneuvers that were initiated at various airspeeds, configurations, and aircraft weights and with variable pilot responses (delayed and immediate response, aggressive flight control input, and autopilot on and off). During the tests, strain gauges attached to the vertical fin revealed that the full-rate rudder deflections did not exceed the design loads for the vertical fin structure. Because the flight test airplane was to be subsequently delivered to a customer, all maneuvers were conducted within the airspeed, G, and roll angle limitations specified in the 737 airplane flight manual (AFM).

The Boeing test pilots described the handling of the airplane when they applied full left rudder with the test airplane configured similar to the USAir flight 427 accident airplane (190 knots and flaps 1). One pilot described how the airplane would initially respond to aileron inputs and begin to roll out of the rudder-induced bank attitude and how, by pulling back on the control column and adding some vertical load factor, the recovery could be stopped and the airplane could hang in a sideslip bank. The test pilot said that he did not apply additional aft column inputs at these moments but that these inputs would have caused the airplane to "roll into the rudder." The pilot concluded that "you can control roll rate with the control column." The other Boeing test pilot said that, in referring to the control inputs required to perform a recovery from full rudder input, "there is some technique required between the G [normal load factor] and the roll."

¹²² Pilots who participated in these M-CAB simulations reported that, for a full rudder hardover condition with an airspeed greater than 187 KCAS, they initially applied full opposite control wheel and then slightly reduced the wheel deflection in response to the recovery rate. The pilots then found it necessary to apply more wheel to counter the roll being produced by the rudder. The pilots reported that three such cycles of the wheel were normally required to find the control wheel position that would neutralize the roll.

¹²³ Safety Board staff were not on board the airplane during the flight tests. However, Safety Board investigators helped design the test procedures, attended postflight debrief sessions and discussions, and reviewed all the data gathered during the flight tests.

¹²⁴ The 737-500 series airplane is approximately 8 feet shorter than the 737-300 series and requires less roll authority (ailerons and spoilers) to counter the effects of a rudder deflection. After the flight tests, Boeing adjusted the data in the 737 simulator model to account for this difference.

The flight test pilots affirmed that the Boeing M-CAB and computer simulation models incorporated the tradeoff between normal load factor and roll control but that the tradeoff occurred at a greater load factor in the simulator than in the airplane. (Thus, the airplane was somewhat more prone to a loss of roll control from an aft control column input than was the simulator.) The flight test pilots said that the Boeing simulation would need to be modified according to the flight test results.

Boeing's flight test pilots stated that, when they allowed the airspeed to increase to about 220 to 225 KCAS (sacrificing altitude as necessary to maintain airspeed),¹²⁵ the airplane recovered easily. The pilots reported that, when they initiated the event at higher airspeeds, the airplane was easier to control and that recovery was accomplished with less roll. The Boeing flight test pilots also indicated that, when the airplane was configured at higher flap settings at the initiation of the event, recovery was easier but that the airframe experienced considerable vibration.

1.16.5 Examination and Testing of Flight Control Systems/Components

The 737 flight control systems from the USAir flight 427 airplane were examined and tested to determine if they were a factor in the upset event and the accident. Examination of the airplane's flight control system components revealed no physical evidence of preimpact malfunction. The Safety Board also examined and tested the accident airplane's rudder system components, including rudder pedal assemblies; rudder cables; and standby and main rudder PCUs, yaw damper, linkages, and input arms.

1.16.5.1 Rudder Pedal Assemblies

The accident airplane's rudder pedal assemblies from both flight crew positions were removed from the wreckage. Both rudder pedal assemblies were fragmented and heavily distorted. The rudder pedal assembly from the first officer's position exhibited postimpact fire damage. The left rudder pedal pivot lugs on both rudder pedal assemblies were fractured near their respective support tubes.¹²⁶ Figure 12 shows a diagram of the rudder pedal assemblies as installed on the accident airplane.

The rudder pedal assemblies were visually and microscopically examined by a Safety Board metallurgist and others on December 8, 1994, at Boeing's Equipment Quality Analysis Laboratory in Renton, Washington. According to the Safety Board metallurgist, microscopic examination of the fracture faces revealed features typical of bending overstress fractures on both pivot lugs. With the support tubes positioned vertically, both left rudder pedal pivot lugs failed in the forward (and slightly downward)

¹²⁵ The test pilots indicated that the amount of altitude lost during the recoveries varied but that, with a prompt response and good technique, control could be regained with a loss of less than 500 feet. The pilots also indicated that, if they did not have to comply with the vertical load factor restrictions imposed for the tests, they would have been able to recover with less lost altitude.

¹²⁶ During normal operation, the rudder pedal pivot lugs are held stationary in the upper ends of the support tubes and allow the pedals to pivot and articulate as they are activated and as the brake is applied.

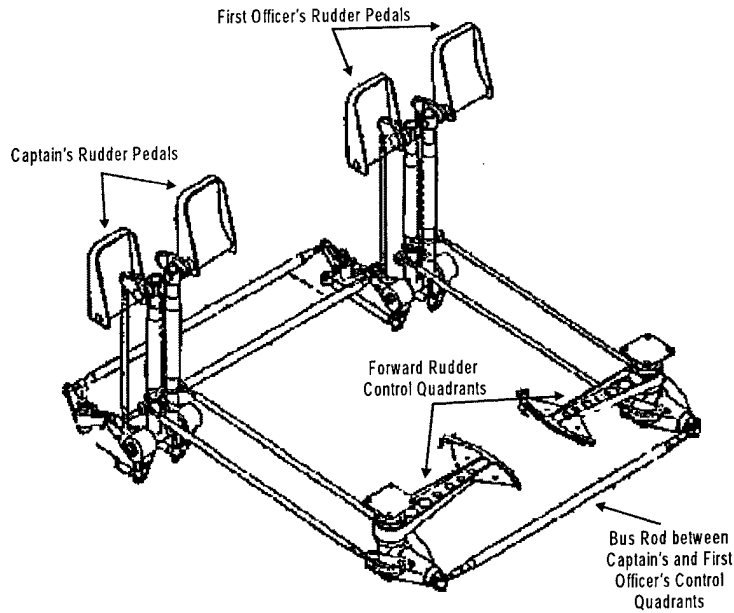

Figure 12. Rudder pedal assemblies as installed on the USAir flight 427 airplane.

direction. The right rudder pedal pivot lugs on both assemblies were bent but remained attached to their support tubes. With the support tubes positioned vertically, the right rudder pedal pivot lug at the captain's position was bent forward and downward, but the right rudder pedal pivot lug at the first officer's position was bent forward and upward.

1.16.5.2 Tests to Determine the Effects of Rudder Cable External Forces, Breaks, and Blocked Input Linkage

The Safety Board used an out-of-service 737-200 for a series of flight control system tests that examined the effects that external (nonsystem) inputs to the rudder cables from within the airplane's cargo compartment and rudder cable separations¹²⁷ would have on the rudder. All tests were conducted on the ground (with no aerodynamic loads). CVR equipment similar to that on the USAir flight 427 airplane was installed on the test airplane.

To examine the effects of pressure applied to the rudder cable from within the cargo compartment (possibly from a passenger stepping through a soft spot in the cabin floor), incremental loads of between 50 and 250 pounds were applied vertically to the rudder cables within the forward cargo compartment, and the rudder deflection was measured. The testing showed that a maximum rudder deflection of 3.2° was measured when a 250-pound force was applied to the left rudder cable; all other test conditions (lesser loads and the right rudder cable) resulted in rudder deflections of no more than 2.3°.

¹²⁷ The maintenance records for the USAir flight 427 airplane indicated that a temporary patch had been made to the floor above an area of the rudder cable. Thus, the testing attempted to simulate an outside force from above the patched area that could have deflected the rudder cable.

To examine the effects on the rudder system of rudder cable separations, the rudder cables in the test airplane were cut, and the rudder system responses (sounds and rudder pedal and rudder surface movement) were recorded. A cable was cut during two tests (under light and no load conditions at two different locations within the fuselage), and the rudder cable was replaced between test conditions. The first cable cut was performed at fuselage station 360¹²⁸ with no pressure on the rudder pedals. A loud "bang" was recorded by the CVR when the cable was cut, but no rudder pedal or rudder surface movement resulted. The second cable cut was performed at fuselage station 259.5¹²⁹ with the pilot's feet resting lightly on the rudder pedals. Another "bang" was recorded by the CVR when the cable was cut, and no rudder surface movement resulted. However, the left rudder pedal, which corresponded to the cut cable, moved to the -5° position. In both cable separation conditions, normal leg force applied to the rudder pedals after the cable cut resulted in the rudder pedal connected to the cut cable moving to the floor, but the rudder pedal attached to the uncut cable maintained the ability to move the rudder surface in the direction of the intact cable.

The Safety Board's review of the sounds recorded by the CVR during the rudder cable separation tests revealed that the sounds generated by cutting the rudder cables were impulsive and had energy that was distributed throughout the frequency spectrum. Another characteristic of the sounds recorded during the tests was the multiple secondary signals that appeared to be the result of mechanical "ringing" of the rudder cable system. The unknown thump sounds recorded by the CVR during the upset of flight 427 (see section 1.16.7.1) were in the low-frequency (below 500 Hz) range only and exhibited no "ringing" or secondary signals.

Other tests were conducted to determine the effects on the rudder system of the presence of a foreign object or blockage between the main rudder PCU external input crank and one of the PCU external manifold stops. Figure 13 shows the locations of the 737's external manifold stops. Safety Board investigators inserted a business card (folded three times) between the manifold body stop and the input crank arm and observed the effect of this blockage on yaw damper and rudder pedal inputs.

The tests indicated that, when the input crank arm's movement was blocked at the aft stop, a sustained left yaw damper command caused the rudder to travel to its full left deflection. The test also showed that, when the blockage was positioned at the forward side of the external input crank, a sustained right yaw damper command caused the rudder to travel to a full right rudder deflection. When the yaw damper command was sustained, the movement in either direction could not be stopped until the blocking material was removed from its position between the manifold stop and the external input crank; yaw damper (or rudder pedal) input opposite the direction of rudder movement tended to keep the blockage in place. When the yaw damper input command was stopped, the rudder

¹²⁸ Fuselage station 360 is located near seat row 5 in the cabin; maintenance records for the accident airplane indicated that a soft interim floor panel repair was accomplished in this location.

¹²⁹ Fuselage station 259.5 was selected for the cable cut test because that location allowed easy control cable access.

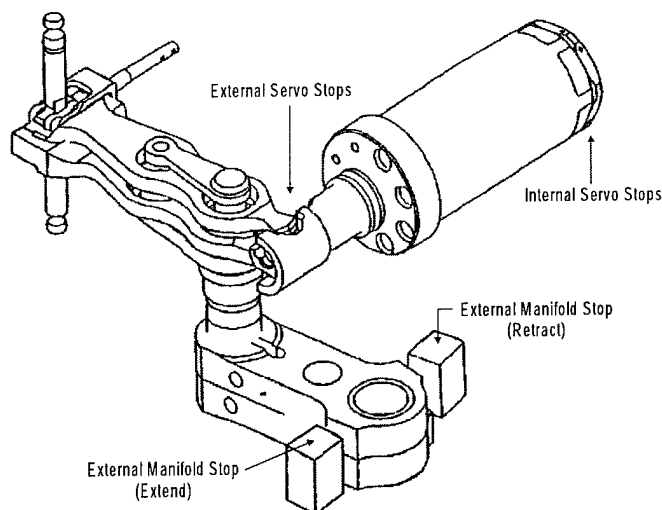

Figure 13. Locations of Boeing 737 main rudder PCU external manifold stops.

surface returned to neutral. In some tests, yaw damper or rudder pedal input in the direction of the rudder movement dislodged the blockage, and normal rudder control was regained.

Examination of the main rudder PCU, as installed in an in-service 737 airplane, revealed that the PCU linkage was positioned so that it prevented a foreign object from dropping into the space between the aft stop and the crank arm. The PCU's orientation would also make it difficult for a foreign object to lodge between the forward stop and input link. The external summing lever effectively covers the gap in the PCU retract direction (left rudder command).

1.16.5.3 Examination and Testing of Standby Rudder

1.16.5.3.1 Metallurgical Examination of Standby Rudder Components

The Safety Board conducted a metallurgical examination of USAir flight 427's standby rudder actuator input shaft, bearing, and thrust bearing race in its materials laboratory in Washington, D.C. Initial examination of the components revealed the effects of galling. The input shaft exhibited two areas of material buildup on the lubricated land surface on the inboard side of the shaft's Teflon seal. The bore of the bearing in which the shaft turns contained two shallow cavity areas corresponding in orientation, size, and shape to the two areas on the shaft that contained the material buildup, and the thrust bearing race exhibited a non-uniform roller contact pattern.

Energy dispersive x-ray spectrum (EDS) analyses were performed on the input shaft and the bearing. According to a Safety Board metallurgist, EDS performed on the surface of the input shaft in an area not affected by the galling produced a spectrum consistent with the type 440C stainless steel specified for the input shaft. However, the

metallurgist stated that EDS performed on the bearing bore and the galled areas of the shaft generated spectra that were consistent with the type 416 stainless steel specified for the bearing. Measurements of the accident airplane's standby rudder actuator components were within the engineering drawing specifications.

1.16.5.3.2 Standby System Actuator Binding/Jam Tests

Safety Board investigators conducted tests on the rudder system of a 737 to examine the effects of variable input shaft binding forces and input shaft binding at different positions, with and without yaw damper input and various hydraulic system failures. Before testing, the investigators verified that the airplane's rudder system rigging and main and standby rudder PCU installations met in-service standards; the investigators also cycled the rudder systems to verify instrumentation and operational limits and establish a baseline. The standby rudder actuator was removed from the test airplane and replaced with a standby rudder actuator that was selected for the testing because it exhibited input shaft and bearing galling similar to the unit that was installed on the USAir flight 427 accident airplane.

The following rudder commands were input with the main and standby rudder PCUs pressurized:¹³⁰ full rudder pedal inputs in both directions with the yaw damper disengaged, full rudder pedal inputs in both directions with the yaw damper engaged, and full yaw damper commands in both directions. In all of these tests, the rudder system functioned normally, and higher-than-normal pilot rudder pedal forces were not required.¹³¹

After these tests, the standby rudder actuator was replaced with one that had an input shaft that could be adjusted to various levels of binding (intended to simulate galling). The replacement actuator was used to determine the effects of binding of the standby rudder input shaft and bearing and the various levels of force that would be required to overcome such binding. Tests were conducted with the actuator adjusted so that 60 to 70 and 100 pounds of force were required to move the actuator input arm. The tests also measured the effects of left, right, and no yaw damper commands.

The tests showed that, with 60 to 70 pounds of standby rudder binding force, the rudder could travel 7° to the left with a full left yaw damper command and 8° to the right with a full right yaw damper command. With 100 pounds of standby rudder binding force, the rudder could travel 8° to the left and right with full left and right yaw damper commands, respectively.¹³² Test conditions that simulated hydraulic system failures, along with binding of the standby actuator, did not significantly affect the rudder system's

¹³⁰ The standby and main rudder PCU input rods move together regardless of which PCU is pressurized.

¹³¹ According to Boeing, normal input force is about 0.5 pounds.

¹³² The 737-300 yaw damper still commanded $\pm 3^\circ$ of motion. Therefore, if the standby actuator jammed when the rudder was positioned 3° left of its neutral position, the yaw damper could command rudder movement 3° in either direction, resulting in left rudder movement to 6° of left, or right deflection back to neutral. If the rudder was at 6° left when the standby actuator binding occurred, the yaw damper could command rudder movement that would result in between 3 and 9° of left rudder deflection.

operation. Ergonomic research indicates that pilots should have no difficulty applying 80 to 100 pounds of leg-pushing force against the rudder pedal, thus overriding the effect of such standby rudder actuator binding. (For additional information regarding ergonomic research on pilot rudder pedal forces, see section 1.18.8.)

Tests were also conducted to determine the effects of a hard jam (not just binding) of the standby rudder actuator input shaft and bearing at the neutral, 3° (simulating left and right yaw damper inputs), and maximum standby rudder actuator positions (limited by the main rudder PCU external manifold stop). The tests showed that, with the standby rudder actuator input shaft jammed at the neutral position, the rudder could travel 6° to the left and 4° to the right with respective full yaw damper commands. A force of 45 pounds on the left rudder pedal or 55 pounds on the right rudder pedal would return the rudder to the neutral position; when the yaw damper command was turned off, the rudder remained at neutral.

When the standby rudder actuator input shaft was jammed at the 3° left position, the rudder could travel 10° to the left with a full left yaw damper command and 3° to the right with a full right yaw damper command. With the yaw damper at its full deflection, a force of 95 pounds or 25 pounds on the appropriate rudder pedal, respectively, would return the rudder to the neutral position. When the yaw damper was turned off, the rudder was positioned 2° left of the neutral position.

When the standby rudder actuator input shaft was jammed at the 3° right position, the rudder could travel 2° to the left with a full left yaw damper command and 13° to the right with a full right yaw damper command. With the yaw damper at its full deflection, a force of 30 or 110 pounds on the appropriate rudder pedal, respectively, would restore the rudder to the neutral position. When the yaw damper was turned off, the rudder was positioned 4° to the right of the neutral position.

With the standby rudder actuator input shaft jammed at a position required for a full maximum rate left rudder input (limited by the main rudder PCU external manifold stop), the rudder traveled 19° to the left of the neutral position. Under this test condition, 65 pounds of force applied to the right rudder pedal returned the rudder to the neutral position. The 65-pound force to the right rudder pedal would create a 140-pound force on the standby PCU input arm.

Regardless of whether the standby rudder actuator input shaft was jammed at 3° left or 3° right of the neutral position or at the main rudder PCU body stop in either direction, the rudder moved to an off-neutral position when the hydraulic system was powered. With the standby rudder actuator input shaft and bearing jammed at the neutral position, no initial offset to the rudder occurred. In every case, the rudder could be centered by applying rudder pedal force to oppose the offset.

The replacement standby actuator contained an input shaft and bearing that displayed galling similar to the unit that was installed in the United flight 585 airplane. Subsequent testing indicated that a full 3° yaw damper command would result in a 5° rudder movement to the left and a 6° rudder movement to the right. Another galled

input shaft and bearing were installed in the standby rudder actuator, and subsequent tests indicated that full 3° yaw damper commands to the left and right resulted in 6° of rudder movement in the respective directions.

1.16.5.4 Detailed Examinations and Tests of Main Rudder PCUs

1.16.5.4.1 Detailed Examinations of Main Rudder PCU Servo Valves

Several times during this investigation, the Safety Board subjected the USAir flight 427 PCU¹³³ to Parker's postproduction acceptance test procedure (which is a performance-based test only and does not require the measurement of diametrical clearances). The acceptance tests did not reveal any disqualifying anomalies. To determine the diametrical clearances that existed within the USAir flight 427 PCU servo control valve slides and clarify the variability of clearances that passed the acceptance tests, the Safety Board measured the clearances between the primary and secondary slides and between the secondary slide and the servo valve housing on three PCU servo valves—a new-production PCU servo valve and the PCU servo valves from the USAir flight 427 and Eastwind flight 517 airplanes.¹³⁴ The primary and secondary slides and the servo valve housing of each PCU were measured in three places—at the input lever end, midpoint, and spring end (see figure 10). Table 3 lists the minimum diametrical clearances (in inches) measured for each PCU at each position.

Table 3. Diametrical clearance measurements (in inches) for three PCUs.

Measurement position	427 PCU slide to housing	427 PCU slide to slide	517 PCU slide to housing	517 PCU slide to slide	New PCU slide to housing	New PCU slide to slide
Input lever end	0.000130	0.000170	0.000190	0.000200	0.000195	0.000190
Midpoint	0.000140	0.000140	0.000170	0.000180	0.000215	0.000200
Spring end	0.000170	0.000150	0.000180	0.000190	0.000190	0.000210

As part of its investigation, the Safety Board conducted further detailed examination and testing of the main rudder PCU servo valves from USAir flight 427, Eastwind flight 517, and United flight 585. The Safety Board also examined a "minimum tolerance" servo valve that was used by Boeing during thermal shock testing (see section 1.16.5.4.7);¹³⁵ new-production servo valves; the servo valve from the Silk Air flight 185 accident in Palembang, Indonesia;¹³⁶ and five servo valves supplied by Parker that had been removed from service and had varying hours of operation (referred to as exemplar valves). The Safety Board's materials laboratory examined the primary and secondary

¹³³ Postaccident tests and examinations were performed on the USAir flight 427 main rudder PCU servo valve and the primary and secondary slides in their condition as recovered. The PCU actuator rod and external input linkage, however, exhibited impact damage that precluded normal operation; thus, these components (and their associated hardware) were replaced to facilitate testing.

¹³⁴ It was not possible to measure the clearances that existed within the PCU servo valve from United flight 585 because the valve was damaged by the postaccident fire and attempts to remove the PCU from the wreckage.

slides and housing from each of these main rudder PCU servo valves¹³⁷ using a specially designed borescope and video recording system. Each segment of the primary and secondary slides' outside diameter surfaces, the metering ports,¹³⁸ and the inside diameters of the secondary slide and the servo valve housing were examined with a 90° borescope at magnifications up to 130 times. The outside diameter surfaces of the primary and secondary slides were also examined with a binocular microscope.

A few small chipped areas were noted on the metering edges of the primary slide of each of the units examined; the locations of the chipped areas did not correspond circumferentially to the metering port areas. Examination with a scanning electron microscope (SEM) revealed that the dimensions of the largest chipped area on the USAir flight 427 primary slide was 0.006 inch in circumference by 0.002 inch in length. The other primary slides examined (including the new-production servo valve primary slide) had chipped areas of similar or larger size yet still met specifications.

The metering ports for the secondary slide and the servo valve housing inside diameter surfaces were also examined using a 15° borescope so that the metering port edges could be better viewed. No evidence of deformation or distress was noted on any of the metering ports on any of the secondary slides and servo valve housings.

In addition, small deposits of material that appeared to have the same composition as the secondary slide were observed on the slide's outside diameter surface adjacent to the metering edge. To identify the origin of these material smears, the Safety Board reviewed Parker's manufacturing procedures. This review found that, during manufacture, the servo valve slides are trimmed (or cut) at the metering edges, burr-wiped (or polished), and functionally tested in matched assemblies. The Safety Board obtained from Parker

¹³⁵ This servo valve was specifically selected from existing stock because it had the tightest tolerances between the primary and secondary slides and the secondary slide and the servo valve housing that would pass the PCU acceptance test friction requirements. According to Boeing, the diametric clearance between the secondary slide and the servo valve housing was 0.000070 inch. (The same clearance in the USAir flight 427 valve was 0.000130 inch.)

¹³⁶ The December 19, 1997, accident involving Silk Air flight 185, a 737-300, 9V-TRF, had not, as of March 1999, revealed any evidence that the accident was related to a rudder anomaly. The airplane was en route from Jakarta, Indonesia, to Singapore when it disappeared from the ATC radar screen at 35,000 feet msl and crashed at the mouth of a river about 33 miles northeast of Palembang. The Safety Board is participating in the Indonesian government's ongoing accident investigation under the provisions of Annex 13 to the Convention on International Civil Aviation. The airplane's CVR and FDR were evaluated by the Safety Board's laboratory in Washington, D.C. That evaluation revealed that both had stopped recording before the airplane disappeared from the radar screen. (The CVR stopped recording first and the FDR stopped recording about 6 minutes later, 1 minute 14 seconds before the airplane's last radar return was recorded.) The recorded data indicated no problems with the airplane or unusual comments by the flight crew.

¹³⁷ The main rudder PCU from the Silk Air accident airplane was examined by Safety Board investigators under the supervision of a representative from the Indonesian government. The examination did not reveal any evidence of a preimpact jam or failure.

¹³⁸ Metering ports are rectangular holes in the servo valve housing and secondary slide through which hydraulic fluid flows to cause actuation of the unit. Metering edges are the sides of grooves that are cut into the outside diameter surface of the primary and secondary slides. Flow of hydraulic fluid is controlled by positioning the metering edges relative to the metering ports.

two primary slides in an intermediate manufacturing condition to microscopically observe the trimmed and trimmed/burr-wiped conditions. SEM examination of the trimmed-only primary slide revealed numerous pieces of folded-over metal curled over the metering edge at the trimmed edge of the slide. SEM examination of the trimmed and burr-wiped primary slide showed areas on the slide's outside diameter adjacent to the trimmed edge that appeared to be flattened down and smoothed over, similar to that observed on the USAir flight 427 primary slide.

1.16.5.4.1.1 Examination of Exemplar Servo Valves for White Layer

As discussed in section 1.16.5.4.1, the five servo valves supplied by Parker that had been removed from service were referred to as exemplar servo valves. During manufacture, the outside diameter surfaces of the primary and secondary slides in the servo valve were nitrided (impregnated with nitrogen to increase hardness). The nitriding process can produce a brittle surface layer, referred to as a "white layer." The Safety Board considered whether such a layer, if it remained after the manufacturing process, could have provided chips that could cause jamming of the unit. Parker reported that the thickness of the white layer created during nitriding is monitored by cutting into samples and that the manufacturing process removes an amount of material from the outside diameter surface that is far greater than the typical thickness of the white layer. Also, the grooves in the primary and secondary slides are cut after the parts are nitrided, preventing the accumulation of the white layer at the corner between the grooves and outside diameter surfaces. The Safety Board's materials laboratory cross-sectioned the five exemplar slides and found no white layer on the slides' outside diameter surfaces or within the grooves.

1.16.5.4.2 PCU Dynamic Testing

On September 16 through 20, 1996, the Safety Board conducted a series of tests to examine the effects of dynamic external loads (such as those that the USAir flight 427 airplane might have experienced during the wake turbulence encounter) applied axially to the main rudder PCU actuator rod. These tests, conducted on a new-production PCU and the flight 427 PCU,¹³⁹ included the following test conditions: (1) wake encounter simulation tests (600- and 1,200-pound¹⁴⁰ load inputs to the PCU in the left and right rudder directions while the yaw damper was cycling), (2) yaw damper hardover tests (hardover commands input coincident with 600- and 1,200-pound loads applied to the PCU in the left and right rudder directions), (3) manual rudder input with no yaw damper input (600- and 1,200-pound loads applied to the PCU actuator rod in the left and right rudder directions coincident with manual left and right rudder input commands), (4) manual rudder input with no yaw damper input but with hydraulic system pressurization failures, and (5) a 3,500-pound input test (performed on the production PCU only). Both PCUs responded normally throughout all tests without any abnormal motions.¹⁴¹

¹³⁹ The PCU from United flight 585 was too badly damaged to test.

¹⁴⁰ The main rudder PCU output rod on the accident airplane might have been subjected to a load as high as 600 pounds as a result of its encounter with wake turbulence from Delta flight 1083; the Safety Board doubled that load to 1,200 pounds for the dynamic tests to establish a margin of confidence.

1.16.5.4.3 Tests of Hydraulic Fluid

During on-site and reconstruction activities for USAir flight 427, the Safety Board obtained hydraulic fluid samples from the accident airplane's main rudder PCU and other portions of hydraulic systems A and B for further examination.¹⁴² After visual inspection for color and clarity, a small portion of each fluid sample was analyzed using gas chromatography/mass spectrometry¹⁴³ and tested for moisture content; the remaining fluid was filtered for contaminant particle counting and tested for acidity.

The tests revealed that the system A hydraulic fluid was 94 percent Skydrol LD4 fluid and that the system B hydraulic fluid was 77 percent Skydrol LD4 fluid; the remaining percentage in both systems was identified as Chevron HyJet fluid. The average system moisture content, color of the fluid, and average system acid numbers for the fluids in both systems A and B met the specifications for in-service fluid limits in Boeing Material Specification 3-11J, dated December 22, 1993.¹⁴⁴ Table 4 shows those specifications.

Table 4. Boeing Material Specification 3-11J specifications for in-service fluid limits.

Fluid properties	In-service fluid limits
Visual	Must be transparent. No phase separation or precipitation. All colors are satisfactory.
Percent of water by weight	0.1 to 0.8.
Neutralization (acid No.—in mg KOH/gm)	1.5 mg KOH/gm maximum.

Table 5 shows the results of the contaminant particle counting tests of the hydraulic fluid in one sample from the accident airplane's PCU. The results correspond to NAS 1638 fluid standards for Class 11.¹⁴⁵

¹⁴¹ Because the tests showed that dynamic loads had no effect on PCU operation, the tests were not repeated on the Eastwind PCU.

¹⁴² Tests performed using hydraulic fluid samples from the USAir flight 427 airplane could not be conducted in accordance with standard industry practices because of the limited volume of fluid in the samples available. According to NAS, the "fluid sample size shall be proportional of the total volume of fluid contained in the device being checked.... The sampling procedure shall provide a method of applying motion to the item being checked which will result in fluid agitation within, so that a reasonable assumption shall be made that the fluid [sample] will be representative of particle dispersion in the total fluid volume." The hydraulic fluid samples from the accident airplane were obtained from damaged and broken components under uncontrolled circumstances, and it is possible that the fluid samples did not represent the true contamination level of the hydraulic fluid in the system before the accident.

¹⁴³ In this analysis method, a mixture of compounds is separated by gas chromatography, and the molecular composition of each is determined by mass spectrometry.

¹⁴⁴ According to this document's Qualified Products List for hydraulic fluid, both identified fluids were classified by Boeing as Class 1, Grade A hydraulic fluids and were approved for use in 737 hydraulic systems.

¹⁴⁵ As previously mentioned, Boeing ensures that the hydraulic fluid particulate count of newly delivered airplanes meet the NAS 1638 fluid standards for Class 9. Tests conducted on hydraulic fluid samples from the Eastwind flight 517 airplane indicated that the level of contaminants in that fluid was roughly equivalent to the NAS 1638 fluid standards for Class 10, which permits a lower number and smaller size of particles than Class 11 but a higher number and larger size of particles than Class 9.

Table 5. Results of contaminant particle counting tests.

Particle size	5-15 μ	15-25 μ	25-50 μ	50-100 μ	>100 μ
Hydraulic system A	482,116	8,897	1,328	70	6
Hydraulic system B	489,510	7,631	733	5	0

1.16.5.4.4 Tests to Determine the Effects of Silting

The primary slide metering edges are “underlapped” relative to the secondary slide metering ports, which allows a certain amount of hydraulic fluid circulation.¹⁴⁶ In contrast, the secondary slide metering edges are “overlapped” relative to the servo valve housing metering ports, which minimizes hydraulic fluid flow.¹⁴⁷ Because of the possibility that the fine, subfiltration-size particles that normally circulate through the hydraulic system suspended in hydraulic fluid could build up in the servo valve and restrict the movement of the secondary slide, the Safety Board conducted tests, using hydraulic fluid from an in-service 737,¹⁴⁸ to determine if such a buildup (or silting)¹⁴⁹ within the PCU could result in a jam of the PCU servo valve primary or secondary slides or an increase in sliding force to cause an anomalous rudder command. The USAir flight 427 PCU external input crank was rigidly fixed (pinned in position), which prevented the PCU servo valve from moving off its neutral position. Hydraulic pressure was applied to the PCU in its neutral position for about 1.2 hours to allow silting to occur. The pin was then removed.

The external input crank did not move after it was released. (According to Boeing representatives, a servo valve bias spring normally allows the external input crank to move toward the retract direction when the external input crank is not fixed.) A force of

¹⁴⁶ When the primary slide is in its neutral position relative to the secondary slide, the axial position of the metering edges on the primary slide falls short (typically by 0.001 to 0.002 inch) of closing off the secondary slide metering ports. This shortfall allows for some hydraulic fluid to continually circulate throughout the area. The amount of hydraulic system A fluid flowing through the servo valve when it is not in motion varies from 300 cc/min in a new servo valve up to 3,000 cc/min in an old servo valve. The hydraulic system B (including yaw damper) fluid flows through the servo valve at 1,370 cc/min.

¹⁴⁷ When the secondary slide is in its neutral position relative to the servo valve housing, the metering edges of the secondary slide extend axially beyond (typically by 0.001 to 0.002 inch) the edges of the servo valve housing metering ports, completely covering the metering ports and restricting hydraulic fluid flow. However, a small amount of hydraulic fluid leakage occurs around the metering ports through the diametrical clearance between the secondary slide and the servo valve housing.

¹⁴⁸ At the beginning of the testing, the hydraulic fluid used met the hydraulic fluid cleanliness limits in NAS 1638 standard for class 10 fluid. At the end of the testing, the fluid met the limits for class 12. (See table 2 for permissible contaminant ranges for selected fluid classes.)

¹⁴⁹ The term “silting” refers to the accumulation of particles of contaminants in hydraulic fluid in a hydraulic component. The particles are smaller than the filter on the inlet side of the component and tend to settle at various edges and corners of valves and stay there unless washed away by higher flow rates. In other words, when the servo valve is in the hydraulically neutral position, the flow of hydraulic fluid is restricted, and the servo valve can function as a filter by catching some of the particles. These particles tend to accumulate at the upstream side of edges and corners of narrow orifices (such as the servo valve ports); however, movement of the servo valve from the hydraulically neutral position results in increased hydraulic fluid flow, which tends to flush any accumulated particles through the servo valve.

4 pounds was required to move the external input crank. Normal input crank operation requires about 1.5 pounds of force.

1.16.5.4.5 PCU Servo Valve Chip Shear Tests

The Safety Board conducted two series of tests to determine if a chip of material could lodge between the PCU servo valve primary and secondary slides or between the secondary slide and the valve housing and result in a jammed servo valve. The first series of tests were conducted at Boeing's Equipment Quality Analysis Laboratory in January 1995 with chips of various materials that could be found in an airplane system. These materials included rubber, Teflon, steel wire, aluminum alloys, hardened and stainless steels, lockwire, aluminum-nickel-bronze, and chrome plating. The chip sizes were manufactured so they would be large enough to fill as much as possible of the 0.015- by 0.045-inch primary metering ports. Chips were inserted into these metering ports at the interface of the primary and secondary slides of a servo valve slide assembly. The primary slide was then moved to close off the metering port.

The tests demonstrated that, when forces of up to 44 pounds were applied¹⁵⁰ to move the primary slide to close off the secondary slide metering ports, all but one type of chip sheared. The chip that did not shear was a hardened-steel chip that jammed the primary slide to the secondary slide and did not shear with the maximum force of 44 pounds applied.¹⁵¹ When investigators examined the servo valve after the primary slide jammed on the hardened-steel chip, they noted a physical mark on the surface of the primary slide where the chip was inserted. The physical mark had the approximate size and shape of the hardened-steel chip.

A second series of chip shear tests was conducted at Boeing's facility in Everett, Washington, in February 1997. These chip shear tests were similar to the January 1995 tests except that (1) the February 1997 test chips were inserted in the secondary metering ports at the interface of the secondary slide to the servo valve housing, (2) different sizes of hardened-steel chips were used and (3) forces of up to 140 pounds were applied. In the February 1997 tests, all of the chips were successfully sheared, and each shearing event created a mark on the secondary slide that was approximately the shape of the chip. The maximum shear force needed was 140 pounds for a 0.042-inch wide by 0.014-inch thick chip. The minimum shear force for the same material was 23 pounds for a 0.011-inch wide by 0.013-inch thick chip.

1.16.5.4.6 PCU Tests Conducted to Determine the Effects of Air in the Hydraulic Fluid

To determine the effects that air in the hydraulic fluid would have on the main rudder PCU operation, the Safety Board conducted operational tests in August 1996 of the USAir flight 427 PCU. During these tests, nitrogen was introduced into the system A

¹⁵⁰ According to Boeing, the PCU design allows a maximum input force of about 50 pounds to the primary slide and 200 pounds to the secondary slide.

¹⁵¹ This chip was 0.032 to 0.058 inch wide by 0.012 to 0.016 inch thick.

hydraulic fluid, upstream of the PCU. (Gaseous nitrogen was used to simulate air for these tests.) Tests were conducted with manual inputs at the external input crank with a cyclic yaw damper input (hydraulic system A pressure off with a sustained 0.3-Hz¹⁵² cyclic damper input, hydraulic system B pressure off with a sustained 0.3-Hz cyclic yaw damper input, and a $\pm 3^\circ$ stepped yaw damper command in each direction). The PCU responded normally (the output command matched the input command) during these tests.

1.16.5.4.7 PCU Thermal Testing

A hydraulic system thermal analysis by Boeing engineers indicated that the failure of one of the 737 airplane's EDPs could result in the overheating of the fluid in one of the hydraulic systems. Further, in response to recommendations made by an independent technical advisory panel,¹⁵³ the Safety Board conducted two series of thermal tests (in August and October 1996)¹⁵⁴ to identify the effects of thermal variations on the operation of the main rudder PCU. The hydraulic fluid used in the Safety Board's silting tests was used for both series of thermal tests.¹⁵⁵

During the August 1996 thermal tests, a total of 12 tests were conducted: 4 on a new-production PCU and 8 on the USAir flight 427 PCU. During the October 1996 thermal tests, a total of 19 tests were conducted: 8 on the new-production PCU and 11 on the USAir flight 427 PCU. The tests for both series were conducted first on the new-production PCU (to verify setup and methodology) and then on the USAir flight 427 PCU. Testing under all of the thermal test conditions was accomplished by pushing or pulling the external PCU input crank with a rod (simulating a left or right input command) and using sufficient force to move the secondary slide. (In the absence of jamming or binding, the secondary slide moves when about 12 pounds of force is applied at the input crank.)

The results of three thermal test conditions (performed on both PCUs during both the August and October 1996 test series) are discussed in this report section. Two of these test conditions were included in this section because the tests and their results were representative of all other thermal tests that were conducted under conditions believed at the time to approximate those that a 737 airplane might encounter during normal operation (baseline and with a hydraulic system failure). The third test condition, which used hot hydraulic fluid injected directly into a cold PCU to explore the effects of extreme temperature differentials on the main rudder PCU's operation, was selected for inclusion

¹⁵² 0.3 Hz—about 1 cycle every 3+ seconds—approximates the airplane's nominal dutch roll frequency and corresponding yaw damper output to dampen dutch roll.

¹⁵³ The independent technical advisory panel was created by the Safety Board in January 1996 to review the work of the Safety Board's Systems Group. See section 1.18.2 for more information about the panel.

¹⁵⁴ The October 1996 tests used improved temperature control and data recording capabilities. For additional information regarding thermal tests, see "Systems Group Chairman's Factual Report of Investigation Addendum—Main Rudder PCU Thermal Testing and Dimensional Examinations," dated April 18, 1997.

¹⁵⁵ As previously discussed, the hydraulic fluid used in the silting tests was collected from in-service 737 aircraft and met the NAS 1638 hydraulic fluid cleanliness limits for Class 10 and Class 12 fluids.

in this section because the USAir flight 427 PCU exhibited anomalous behavior during this test condition.

For these three thermal test conditions, the exterior temperature of the PCU servo valve housing was allowed to reach and stabilize at a temperature believed, at the time the tests were conducted, to be representative of the vertical stabilizer cavity (where the rudder PCU is located) of the accident airplane just before the upset (-27 to -40° F).¹⁵⁶ These temperatures were achieved before each test without hydraulic fluid circulating through the PCU. Also, the PCU servo valve housing continued to be cooled by the cold ambient air inside the test chamber and was warmed to varying degrees and at varying rates by the introduction of hydraulic fluid into the servo valve.

1.16.5.4.7.1 Baseline Test Condition

This test condition approximated the system operating temperatures that investigators initially hypothesized for the USAir 427 accident airplane if both hydraulic systems A and B were operating normally (PCU temperatures of about 10 to 20° F and hydraulic fluid temperatures of about 70° F at the PCU inlet). Test results for this condition indicated that the difference in the servo valve exterior surface temperature and the hydraulic fluid temperature at the PCU was approximately 50 to 60° F. Both the new-production PCU and the accident airplane's PCU responded normally during all tests under this condition.

1.16.5.4.7.2 Simulated Hydraulic System Failure Condition

In this test condition, the temperature of the hydraulic fluid entering the PCU was raised to simulate a malfunction of one of the EDPs. Boeing could not provide flight test data for the temperature of the hydraulic fluid at the PCU. Therefore, at the Safety Board's request, Boeing performed a thermal analysis, which indicated that a failed EDP could raise the temperature of the hydraulic system reservoir associated with the pump failure to 180 to 207° F. (The 737 incorporates a hydraulic fluid temperature sensor near the EDPs that provide a cockpit indication of an overheat condition when the hydraulic fluid reaches or exceeds 220° F. The accident airplane's CVR recorded no flight crew comment regarding hydraulic system overheating.) Boeing's thermal analysis also indicated that, if the hydraulic fluid were to overheat to a point just below the threshold of the overheat detector, the hydraulic fluid would cool to about 170° F as it passed from the hydraulic pumps to the end of the pressurized section of the fuselage. The fluid would then pass through about 15 feet of 3/8-inch diameter steel tube before it would reach the hydraulic fluid inlet point on the main rudder PCU.

¹⁵⁶ The temperatures used during these tests (-27 to -40°F) were based on the results of Boeing's thermal analyses. In October and December 1996, Boeing conducted flight tests to measure the operating temperatures of the 737 hydraulic system and main rudder PCU in a normal operating environment. The December 1996 tests indicated that the PCU servo valve housing operating temperature was greater than -27°F, as discussed at the end of this section.

The tests for this condition were conducted with the hydraulic fluid temperature raised to about 170° F at the point that the fluid entered the thermal test chamber. The fluid was then cooled by the ambient conditions in the chamber (temperatures in the chamber were between -27 and -40° F) as the fluid passed through the steel tubing into the main rudder PCU. Testing was conducted with both hydraulic systems A and B overheated and with only system A overheated (system B was at about 60° F). Test results for these conditions indicated that the difference in the servo valve exterior surface temperature and the hydraulic fluid temperature at the PCU inlet was approximately 100° F. Both the new-production PCU and the accident airplane's PCU responded normally during all tests under this condition.

1.16.5.4.7.3 Extreme Temperature Differential Test Condition

This test condition examined the effects of subjecting the PCU to a relatively extreme differential between the hydraulic fluid temperature at the PCU inlet and the servo valve exterior surface temperature. The extreme temperature differential produced during this test condition would not be expected during normal flight operations. For this test condition, the PCU was cooled to about -40° F while both hydraulic systems were depressurized (no hydraulic fluid passing through the PCU). At the beginning of these tests, heated hydraulic fluid only from system A (at a temperature of 170° F) was inserted directly into the PCU. The maximum temperature differential between the inlet hydraulic fluid and the servo valve housing of 180° F was attained 25 seconds after insertion of the heated hydraulic fluid.

The new-production PCU responded normally under the extreme temperature differential test condition. However, the USAir flight 427 PCU exhibited anomalous behavior during these tests. During the August 1996 extreme temperature differential tests, the accident airplane's PCU responded normally for the initial three external input crank commands, but the external input crank stuck in the full left rudder position for about 5 seconds at the end of the fourth input command. Afterward, the movement of the external input crank was normal, except for a hesitation in motion as the crank was pushed and pulled on each input command in both the rudder left and rudder right directions.

The anomalous operation of the USAir flight 427 PCU was verified by a repeat test. During this repeat test, the PCU responded normally for one input command. However, during the next two input command cycles, the external input crank moved slower than normal for the left rudder command. At the end of the fourth left rudder command cycle, the external input crank stuck in the full left rudder position for about 1 second, after which the movement of the external input crank returned to normal.

To further examine the extreme temperature differential test condition, the PCU temperature was once again lowered to about -40° F and stabilized, and the test was repeated again. During this repeat test, the PCU responded normally for the first three input commands. During the next 3 input commands, however, the external input crank moved slower than normal during the left rudder command. At the end of each of these left rudder command inputs, the force required to return the input crank to neutral

increased to about 124 pounds for about 1 second. Afterward, the external input crank returned to its neutral position with the application of less than 5 pounds of force.

The October 1996 tests under the extreme temperature differential test condition, which utilized improved temperature control and data collection systems, yielded similar results for the USAir flight 427 PCU. Examination of the hydraulic fluid flow data revealed that momentary, anomalous increases in hydraulic system fluid return flow occurred during the jamming/binding. Further examination of the data indicated that the servo valve secondary slide momentarily jammed to the servo valve housing and that the subsequent overtravel of the primary slide resulted in an increase in system return flow that could cause a rudder actuator reversal (travel in the direction opposite to that commanded). Although reversal of the PCU actuator was not noted by any of the participants or observers during the tests, the periods of anomalous hydraulic system fluid flow observed in the data were consistent with the misporting of the hydraulic fluid from the effects of the jammed secondary slide and overtravel of the primary slide, resulting in a momentary output command opposite to the input command.

1.16.5.4.7.4 Additional Testing

The USAir flight 427 PCU was disassembled and examined at Parker after both of the August and October 1996 test series were completed. The primary slide, secondary slide, and interior of the servo valve housing showed no evidence of damage or physical marks from jamming or binding during the thermal testing. The PCU also passed the functional acceptance test procedure used by Parker for validating PCU performance.

On October 4, 1996, at the Safety Board's request, Boeing conducted a flight test to measure the operating temperatures of the 737 hydraulic system and main rudder PCU in a normal operating environment. A test airplane was flown for about 2 hours at an altitude of up to 30,000 feet. Measurements included static air temperature outside the airplane (-40° F), temperature on PCU body (20° F), and temperature of the hydraulic fluid exiting the EDP (100° F).

Additional temperature data was obtained during a flight test on December 6, 1996, that was conducted by Boeing (at the request of the Safety Board) with additional instrumentation. During this flight test, a test airplane was flown for about 2 hours at an altitude of up to 35,000 feet, and then the airplane descended to 20,000 feet for 1 hour. Data from this flight test indicated the following temperatures at 35,000 feet: static air outside the airplane, -58° F; hydraulic system A fluid at the outlet of the EDP, 58° F; hydraulic system A fluid at the PCU inlet, 22° F; hydraulic system B fluid at the PCU inlet, 34° F; PCU servo valve housing, 35° F; and ambient air around the PCU (inside the vertical stabilizer), -15° F.

Data from this flight test indicated the following temperatures at 20,000 feet; static air outside the airplane, -36° F; hydraulic system A fluid at the outlet of the EDP, 65° F; hydraulic system A fluid at the PCU inlet, 35° F; hydraulic system B fluid at the PCU inlet, 35° F; PCU servo valve housing, 38° F; and ambient air around the PCU (inside the vertical stabilizer), 0° F.

In February 1997, Boeing independently conducted a third series of thermal tests.¹⁵⁷ These tests were conducted on a main rudder PCU that was specifically selected by Boeing because it had the tightest diametrical clearances (between the primary and secondary slides and between the secondary slide and servo valve housing) that would pass the Parker functional acceptance test procedure frictional requirements.¹⁵⁸

Boeing reported that this minimum tolerance PCU servo valve operated normally for each test condition designed to simulate a hydraulic system overheat, with one or both hydraulic systems circulating fluid through the servo valve before insertion of the heated fluid and at Boeing's estimated normal operating temperatures within the vertical fin (conditions similar to those used in the Safety Board's simulated hydraulic system failure tests). Boeing conducted additional tests in which hot hydraulic fluid was injected directly into the minimum tolerance servo valve. Hydraulic fluid was not circulated through the servo valve before insertion of the heated hydraulic fluid (conditions similar to those used in the Board's extreme temperature differential tests). In some tests under these two conditions, the minimum tolerance servo valve's secondary slide jammed to the servo valve housing (and remained jammed as long as the force on the input crank was maintained). The smallest temperature differential between the inlet hydraulic fluid and the servo valve housing at which the minimum tolerance PCU jammed was 145° F.

1.16.5.4.8 Rudder Actuator Reversals During Servo Valve Secondary Slide Jams

After the Safety Board's October 1996 thermal tests, Boeing engineers began an independent detailed examination of the test data. Their review of the data indicated that the PCU servo valve responded slowly and erratically to the input commands when the secondary slide was jammed to the housing by the thermal shock and an input was applied to the external input arm. Boeing subsequently conducted tests using a new-production PCU that had been modified to simulate a jam of the secondary slide to the servo valve housing at various positions and then to simulate the application of a full rudder input to the PCU. These tests revealed that, when the secondary slide was jammed to the servo valve housing at certain positions, the primary slide could travel beyond its intended stop position because of bending or twisting of the PCU's internal input linkages (compliance). This deflection allowed the primary slide to move to a position at which the PCU commanded the rudder in the direction opposite of the intended command (reversal). Specifically, the tests revealed that, when the secondary slide was jammed at positions greater than 50 percent off neutral toward the extend or retract position and a full-rate command was applied to the PCU, the rudder would move opposite to the commanded position.¹⁵⁹

¹⁵⁷ See Boeing's Test and Analysis of 737 Rudder Power Control Unit (PCU) Valve Thermal Jam Potential, Boeing correspondence B-B600-16147-ASI, May 29, 1997.

¹⁵⁸ As noted in section 1.16.5.4.1, the diametrical clearance of the minimum tolerance servo valve (secondary slide to servo valve housing) was 0.000070 inch. (The same clearance in the USAir flight 427 main rudder PCU servo valve was 0.000130 inch.)

Figures 14 and 15 show normal operation of the servo valve. Figure 16 shows the servo valve with a secondary slide jam (normal operation). Figure 17 shows the servo valve with a secondary slide jam and primary slide in the overtravel condition.

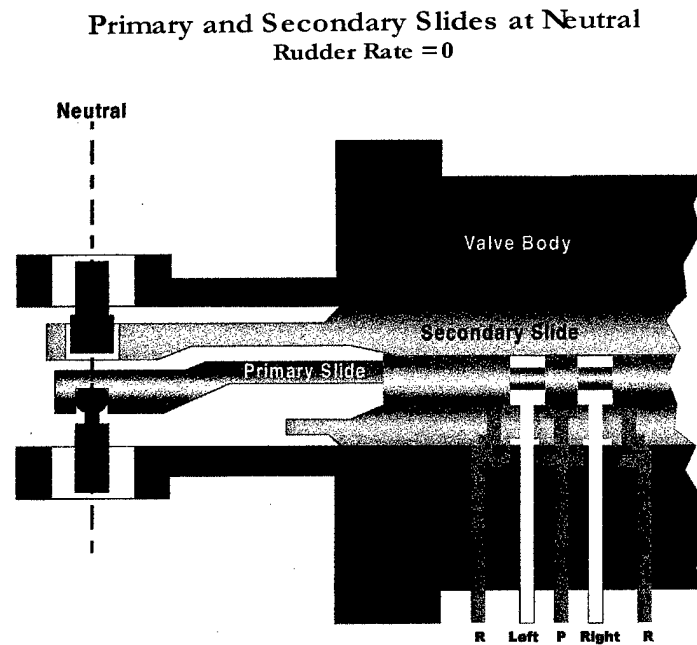

Figure 14. Normal operation of the 737 PCU servo valve with slides in the neutral position (no jam).

¹⁵⁹ The Safety Board has investigated several fatal aviation accidents that have involved flight control reversals. In some cases, improper maintenance resulted in an airplane's aileron controls being connected backward so that a pilot control wheel input intended to command a right turn resulted in a left turn. See the following National Transportation Safety Board accident reports: ANC94LA101 (August 3, 1994), FTW92FA218 (August 25, 1992), ATL88LA149 (June 4, 1990), ANC88FA062 (May 20, 1988), LAX85LA104 (January 10, 1985), MIA84FA040 (December 4, 1983), and MKC83FA090 (April 15, 1983). Also, see National Transportation Safety Board Briefs of Accident 1469 (August 20, 1982) and 3-1496 (June 9, 1976).

**Normal Full Rate Command-
Primary & Secondary Slides Full Open
Rudder Rate TEL**

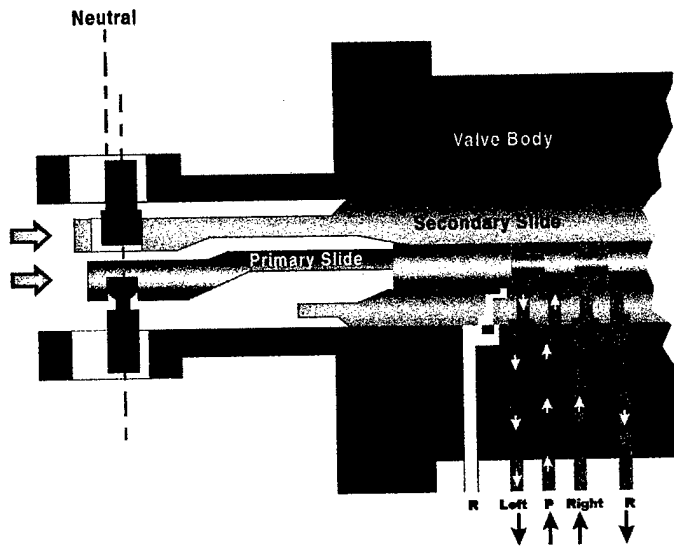

Figure 15. Normal operation of the 737 PCU servo valve with slides in the extend command position (no jam).

**Intended Operation:
Secondary Slide Jammed Full Open, Primary Slide Opposing
(Full Cross Flow)
Rudder Rate = 0**

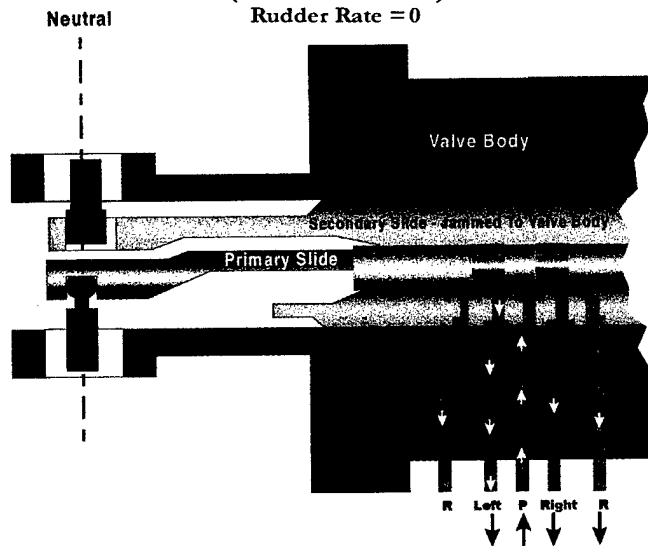

Figure 16. PCU servo valve intended operation with the secondary slide jammed to the servo valve housing and primary slide opposing.

**Newly Discovered Failure Effect:
Secondary Slide Jammed Full Open, Primary Slide Over-Stroke
In Opposing Direction
Rudder Rate TEL**

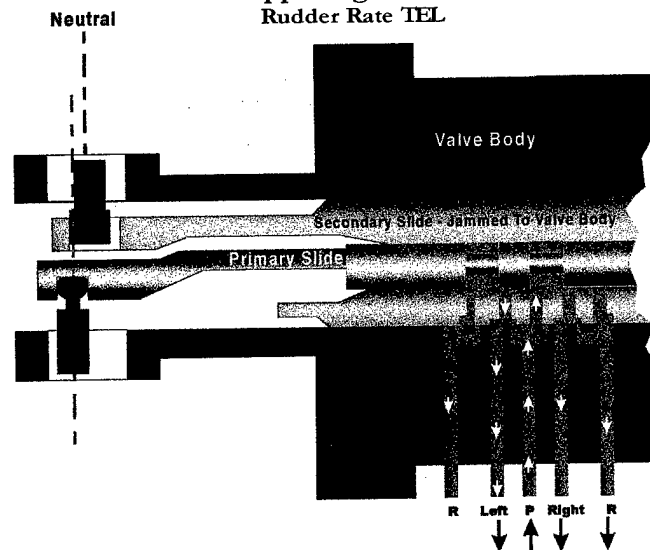

Figure 17. PCU servo valve with the secondary slide jammed to the servo valve housing and the primary slide in the overtravel condition.

After studying the thermal test conditions in which the USAir flight 427 main rudder PCU jammed, the Safety Board attempted to determine the combined effects of PCU servo valve secondary slide jamming and input linkage deflections (compliance) to determine if the USAir flight 427 PCU was more susceptible to reversal than other servo valves. These tests were conducted in November 1996 on three PCUs: a new-production PCU, the USAir flight 427 PCU, and the Eastwind flight 517 PCU. For this series of tests, a tool was used to mechanically jam the secondary slides of all three PCUs to their respective servo valve housings. Manual inputs were then applied to the PCUs with the yaw damper energized and deenergized (no yaw damper command was applied in both cases). When inputs at a less-than-maximum rate were made to the PCU, all three PCUs operated normally. However, if the external input crank rate exceeded the capability of the PCU to respond at its maximum rate, the input caused deflection of the internal linkages (that is, caused them to bend or twist), resulting in overtravel of the primary slide and a reverse rudder response (that is, a response opposite to that commanded).

To identify the threshold for reversal, the Safety Board conducted tests on the three PCUs to determine the distance that the secondary slides had to be placed away from the neutral ("no rudder command") position to result in rudder actuator reversal when an input force was applied to the PCU. The tests indicated that each of the three PCUs would stall (stop movement) or reverse when the secondary slide was jammed at or beyond the following positions (expressed as a percentage of full secondary slide travel from the neutral position):

- New-production PCU: 38 percent in the extend direction, 54 percent in the retract direction.
- USAir flight 427 PCU: 12 percent in the extend direction, 41 percent in the retract direction.
- Eastwind flight 517 PCU: 17 percent in the extend direction, 30 percent in the retract direction.

On August 20, 1997, the Safety Board conducted additional tests on the USAir flight 427 and Eastwind flight 517 PCUs to determine the effects of a jammed secondary slide on the force and rate of rudder movement. For these tests, each PCU was installed in a test fixture at Parker that simulated the airplane installation, and the servo valve secondary slide was jammed with the jamming tool. Table 6 shows the test results, which indicated that the position of the secondary slide jam affected the rudder's output (force and rate).

Table 6. Test results on the effects of a jammed secondary slide on the force and rate of rudder movement.

PCU	Position (percent off neutral)	Force (percent of full PCU output capability) ^a	Rate (degrees per second)
USAir 427	0	100	31.7
USAir 427	12	50	3.9 ^b
USAir 427	22	76	9.5 ^b
USAir 427	50	88	17.8 ^b
USAir 427	71	93	26.6 ^b
USAir 427	100 ^c	~ 100	~ 33
Eastwind 517	0	100	31.7
Eastwind 517	22	34	4.8 ^b
Eastwind 517	50	79	14.3 ^b
Eastwind 517	71	89	25.4 ^b
Eastwind 517	100 ^c	~ 100	~ 33

^a Full PCU output capability is 5,800 pounds.

^b Rudder motion was in the opposite direction from that commanded.

^c The 100-percent secondary slide jam position was not tested for either PCU because of test equipment limitations. Force and rate values for both 100-percent positions are estimated by Boeing.

1.16.5.4.9 Ground Demonstration of Rudder PCU Servo Valve Jam

In June 1997, the Safety Board participated in a ground demonstration conducted by Boeing at its facility in Seattle, Washington.¹⁶⁰ The demonstration was intended to identify and document the cockpit characteristics of a rudder PCU servo valve secondary slide jam. The demonstration was accomplished in a newly manufactured 737-300 airplane that was fitted with a special tool to simulate a rudder PCU servo valve secondary

slide jam at three different positions (about 0 percent, about 25 percent, and about 50 percent of travel from the neutral position). The demonstration was conducted while the airplane was parked on the ground with both engines off and with hydraulic systems powered by an external source of power.

Before the demonstration began, the participants sat in the pilot seats of another newly manufactured 737-300 and manipulated the rudder pedals to become familiar with the feel of a normally functioning 737 rudder system on the ground. The participants then moved to the airplane that was fitted with the special jamming tool, and each participant manipulated the rudder pedals under the three simulated rudder jam conditions. As recorded in the Human Performance Group Chairman's addendum report, one Safety Board participant described the demonstration as follows:

All demonstrations were conducted in the cockpit, with Boeing test pilot...sitting in one of the pilot seats to coordinate the procedure.... When I was the active participant, I sat in the right seat wearing the seat belt.

The first demonstration in the test airplane represented a jam of the secondary slide about 25 percent off [its] neutral position. I pushed the respective rudder pedals slowly to their full down positions as though I were performing a slow rudder system check. The right rudder pedal seemed easier to push down than the left pedal, although the difference seemed subtle. I then performed about 7 tests in which I [applied] hard left rudder. With one or two exceptions, this input triggered a rudder reversal on the pedals. Immediately after my input, the left rudder pedal began moving outwards until it reached the upper stop. The motion was slightly slower than an input I would expect from a human. The motion was steady and continued without pause no matter how hard I pushed to counter it ("unrelenting" was a description that, at the time, seemed to capture my impression).... [When] I... "stopped fighting" the motion, [the] action of the rudder system ended almost immediately and the rudder pedals returned to the neutral position. On subsequent trials, I "stopped fighting" the rudder motion earlier, before the left pedal had reached the upper stop. Again, the rudder motion stopped almost immediately as soon as I stopped applying pressure, no matter where the pedal was located, and the pedals returned to neutral.

The second demonstration represented a jam of the secondary slide about 0 percent off [its] neutral position. I pushed each respective rudder pedal slowly to the lower stop as though performing a rudder system check. The right pedal again seemed easier to push than the left pedal, although the difference was small. I also pushed the rudder pedals aggressively and abruptly, but this did not produce a rudder reversal situation.

The third demonstration represented a jam of the secondary slide about 50 percent off [its] neutral position. I performed about 9 trials. When

¹⁶⁰ Representatives of the interested parties who were members of the Human Performance Group were notified of the demonstration but declined to participate. However, party members of the Systems Group and a representative from the expert technical panel were present during the testing and participated informally in the tests.

I moved the pedals slowly and steadily [as though performing a rudder system check], I was generally able to move the pedals to their stops without starting a reversal. Sometimes, however, even a slow input initiated a rudder reversal situation (this time with the right pedal moving to the upper stop). Any abrupt motion on the pedals initiated an immediate rudder reversal situation. The rudder reversal motion was faster than was the case with a jam in [the] 25 percent position, perhaps similar to a relaxed or slow input speed by a human operator. Again, it was impossible to stop the motion by physically pushing against the rudder pedal. On several trials, I tried relaxing my input momentarily before the rudder pedal reached the upper stop. I found that the rudder reversal motion continued. This [was not true in the jam at the approximate 25 percent position], when the relaxation of pressure seemed to automatically stop the reversal motion. This motion was faster, easier to initiate, and more difficult to stop.

Other participants reported similar experiences during the demonstrations. They described the rudder back pressure during the reversal as “machine-like,” “startling,” and “relentless.”

Another Safety Board employee who participated in the demonstrations stated that he switched the hydraulic system B flight control switch to “standby rudder” during the simulation of a secondary slide jam near the 50-percent position, which eliminated the rudder reversal and allowed the rudder to be centered by rudder pedal inputs in the normal direction. He reported that the centering was slow and required more rudder pedal pressure than in the absence of a jam but that there was no need to release the rudder pedal pressure and reapply it to eliminate the reversal. During subsequent rudder sweeps with the standby rudder system engaged, the rudder did not reverse. This Safety Board employee (who is 5 feet 8 inches tall) further stated that he was able to reach the hydraulic system A and B flight control switches in the overhead panel without difficulty from either the left or right pilot seats.

1.16.6 Flight Performance Simulation Studies

During the investigation of the USAir flight 427 accident, Boeing applied a “kinematics analysis,” that is, a technique developed from prior flight test activities to derive from available FDR data the position of the flight control surfaces that were not among the parameters recorded by the FDR.¹⁶¹ The Safety Board reviewed Boeing’s kinematics process early in the investigation and then developed its own kinematics programs that ran on the Board’s computer workstation. The Safety Board developed the programs to validate the kinematics solutions being developed by Boeing for the USAir flight 427 investigation and now has the technique available for use in future aviation investigations.

¹⁶¹ Boeing’s kinematics process involves fitting curves through available FDR data (such as heading, pitch, and roll), obtaining time histories of rates from these curves, and obtaining accelerations from these rates. Forces, moments, and aerodynamic coefficients are then obtained from these accelerations using Newton’s laws of physics. Boeing uses its aerodynamic models to derive flight control time histories from the aerodynamic coefficients.

The Safety Board's kinematic results were compared with Boeing's kinematic results for the same inputs. Because the review of the kinematic results indicated that more frequent heading samples were needed to effectively perform the kinematic calculations, the Safety Board and Boeing used interpolation techniques to curve fit the FDR's magnetic heading data and thereby provide data between the FDR data points. (As indicated in section 1.11.2, the accident airplane's FDR recorded magnetic heading data at a once-per-second rate.) The FDR's once-per-second magnetic heading data could be matched by different interpolation techniques, each resulting in different rudder surface time histories. Further, kinematics techniques magnified the noise¹⁶² that was inherent in the accident airplane's FDR data, so smoothing techniques were needed to reduce this noise and minimize the potential for erratic signatures in the extracted control surface time histories.

Safety Board investigators used the Safety Board's workstation-based flight simulation computer program¹⁶³ for the 737-200 and -300 to perform simulations of the flights of USAir flight 427, United flight 585, and Eastwind flight 517.¹⁶⁴ The flight simulation process was used by the Safety Board, rather than the kinematics process, because it eliminated the uncertainties introduced into the kinematics process through the data interpolation and smoothing techniques (required because of the limited number of FDR parameters recorded and the limited sampling of the data). The Safety Board initially used assumed flight control (control wheel [aileron and spoilers], rudder, and control column [elevator]) positions (based on earlier Boeing and Safety Board kinematic solutions and FDR-recorded column position when available) as inputs into its computer simulations and then compared the output of the simulations—such as altitude, airspeed, and heading—with the available FDR data. Safety Board investigators then modified the control input, reran the simulations, and continued this process (known as iteration) until a good match with the FDR data was obtained.¹⁶⁵

Various factors affect the extent to which the derived control surface positions reflect the actual control surface positions. For example, the accuracy of the USAir flight 427 simulations is affected by the fidelity of the aerodynamic modeling of the airplane in the flight conditions at the time of the upsets. The aerodynamic models used in the simulations are validated by flight tests, but this validation process is limited by safety

¹⁶² According to page 60 of Boeing's "Submission to the National Transportation Safety Board for the USAir 427 Investigation," dated September 30, 1997, "when the heading data is sampled at less than twice a second, the rudder position derived using kinematics becomes contaminated with an overlying 'noise' signal that shows up as an oscillation in derived rudder.... Proper interpolation can reduce the 'noise' providing more reliable information on rudder movement."

¹⁶³ The Safety Board's flight simulation computer program is a WindowsTM-based executive program that uses Boeing-developed flight control, aerodynamics, and engine models to derive force and moment time histories of the airplane. Safety Board-developed equations of motion convert these forces and moments into airplane motion.

¹⁶⁴ The Safety Board's workstation-based flight simulations used computer software that describes the physics of the motion of an airplane in flight and various computer subroutines, including those that use data and equations from Boeing, to describe the 737's aerodynamic characteristics and engine thrust.

¹⁶⁵ Boeing also performed similar flight simulations on its own computer workstations.

factors, such as the structural load limits for which flight tests can be safely conducted, and the number of flight tests to be conducted.

In addition, the computer simulations generally assumed calm air conditions. Although most of the flight from ORD to PIT occurred in smooth air, studies of FDR, CVR, and radar data indicate that, during the initial upset, USAir flight 427 encountered wake vortices from the 727 that preceded it on the approach to PIT (Delta flight 1083). Therefore, the effect of the wake was taken into account at the times when the FDR and CVR data indicated that the accident airplane was being affected by the wake vortices. The effects of the wake vortices on the airplane's motion were based on a theoretical model that was modified to account for the effects on the yawing moment that were developed from the wake vortex flight tests and improve the match with vertical acceleration and pitch angle FDR data.¹⁶⁶

Further, the United flight 585 airplane most likely encountered significant winds and turbulence; thus, the computer simulations were adjusted to account for such winds. However, because the actual wake vortex and turbulence conditions were not known, the respective contributions of the flight control surfaces and wake turbulence/winds to the motion of the airplane are uncertain. For example, if a large rolling moment resulting from a wind gust was quickly countered by the flight crew through a large control wheel movement, the resulting roll recorded by the FDR would be relatively small. If the wake turbulence/wind gust effect introduced into the simulation was less than the actual wake turbulence/wind gust experienced by the flight crew, the control wheel movements derived through the simulations would be less than the movements that actually occurred.

Other factors affecting the accuracy of the simulation studies include instrumentation calibration errors and time lags in data recording. In addition, the directional gyroscopes that provided heading information to the FDRs in the Eastwind flight 517 and United flight 585 airplanes could have introduced errors in the recording of the heading data when the airplanes were operating in certain flight attitudes. The Safety Board accounted for part of the potential heading gyro gimbal errors by using a computer program especially developed for that purpose.¹⁶⁷

¹⁶⁶ The effects of the wake vortices were introduced into the simulations by slight modifications to the coefficients from the 737 aerodynamic model. Initially, the wake was modeled at Boeing using a Rankine vortex model and aerodynamic strip theory for all aerodynamic coefficient wake deltas except yaw. The Rankine wake vortex model assumes that the rotational velocity increases linearly with distance from the center of the vortex to the core radius. The velocity then decreases as the square of the distance beyond the core radius. The effect of the wake on the yawing moment coefficient was obtained using empirical data from the wake vortex flight tests. The wake was positioned relative to the airplane by Boeing to match the peaks and valleys in the FDR-recorded vertical acceleration data. The Safety Board modified Boeing's lift and pitching moment coefficient wake deltas (preserving the locations of the peaks and valleys) to better match FDR vertical acceleration and pitch angle data. The original wake resulted in a full control wheel input at 1902:58.5, when the bank angle was about 15°. This result was judged to be an excessive response from a human performance standpoint. A wheel response range of 40 to 60° at that time was considered more realistic, so the wake rolling moment was modified to match a 60° wheel input. The yawing moment from the wake resulted from the encounters of the vertical stabilizer with the wake. The vertical stabilizer wake encounter at 1902:58.5 was extended by 0.10 second to facilitate a match with the FDR heading data. Similarly, the vertical stabilizer wake encounter at 1903:01.5 was extended by about 0.35 second.

Because a pilot exerting considerable force on the rudder pedals could alter the rudder blowdown limit that would result from the hydraulic actuator alone,¹⁶⁸ the simulations also had to account for the estimated pilot rudder pedal force time history. This estimation was accomplished for the USAir flight 427 and United flight 585 accidents and the Eastwind flight 517 incident based on the physical characteristics of the flying pilot, available human performance research data, and CVR information. (See section 1.18.8 for further information.)

The Safety Board used its computer simulation studies to evaluate a significant number of potential scenarios for the USAir flight 427 and United flight 585 accidents and the Eastwind flight 517 incident. The Safety Board also used Boeing's kinematic results (flight control surface time histories) for USAir flight 427 in performing computer simulations to assess how well the Boeing heading (and pitch and roll) results matched the FDR data.¹⁶⁹ Boeing used its kinematic results in performing its own computer simulations for Eastwind flight 517 and comparing the heading results with FDR data.

All parties to the investigation had the opportunity to submit proposed accident scenarios. However, only Boeing submitted detailed simulations or studies. The Safety Board notes that Boeing may be one of the few entities in the world with the technological ability and knowledge of the 737 airplane to conduct the complex and sophisticated simulations that were used during this investigation to evaluate potential accident scenarios. Accordingly, the Safety Board assumed that the alternative scenarios provided by Boeing were the best alternatives that could be developed. The Safety Board therefore gave serious consideration to the scenarios submitted by Boeing for the USAir flight 427, United flight 585, and Eastwind flight 517 upset events. The results of the Safety Board's best-match solutions¹⁷⁰ from simulation studies and Boeing's kinematic solutions are discussed in sections 1.16.6.1, 1.16.6.2, and 1.16.6.3 for the USAir flight 427 and the United flight 585 accidents and the Eastwind flight 517 incident, respectively.¹⁷¹

1.16.6.1 USAir Flight 427 Simulation Studies

USAir flight 427 was flying in calm air while making a left turn to a heading of 100°. About 1902:57, as the airplane was rolling toward wings level, it was experiencing

¹⁶⁷ A heading gyro consists of a rotating gyro mounted inside two gimbals, and heading data is subject to gyro gimbal error. Heading is determined by the angle of the outer gimbal to the airplane body. Combinations of pitch, roll, and gyro rotor alignment introduce angle errors into the outer gimbal and produce predictable heading errors that can be quantified and corrected. For a further description of gimbal error, refer to the Safety Board's "Addendum to Eastwind Rudder Jam Study," November 11, 1998.

¹⁶⁸ During normal rudder operation, a considerable pilot force on the rudder pedals can result in the rudder moving beyond its blowdown limit based on hydraulic actuator force alone. However, in a rudder reversal situation, a considerable pilot force on the rudder pedals can reduce the blowdown limit.

¹⁶⁹ The USAir flight 427 FDR recorded roll attitude twice per second and pitch attitude four times per second.

¹⁷⁰ The Safety Board's best-match solutions are the derived flight control surface position time histories that best match the recorded FDR data, radar data, and human performance information.

¹⁷¹ For additional information regarding the Safety Board's simulation studies, see the Board's "Rudder Jam Simulation Study," dated January 27, 1998.

airspeed deviations and accelerations consistent with wake turbulence produced by the wake vortex of a Boeing 727.¹⁷² Within the next few seconds, USAir flight 427 rolled to about 20° of left bank, back to 15° left bank, and then farther to the left. The airplane entered an aerodynamic stall about 1903:08 and rolled more rapidly to the left. The Safety Board's workstation-based flight simulator computer program for a 737-300 airplane was used to simulate the event. Input to the simulation for engine thrust was based on N1 (fan speed) data recorded on the FDR.

As previously mentioned, the flight control surface position time histories needed for the computer simulations were not available from the FDR and had to be estimated or derived. The Board derived the elevator position time history from the control column position recorded by the FDR. The initial control wheel (aileron and spoilers) position inputs were based on kinematic solutions and were then derived by iteration. The Safety Board's best-match simulation showed that, just after 1902:58, the wake vortex produced a nose left heading change. This simulation assumed that the flight crew responded to the nose left yawing motion with a right rudder pedal input about 1903:00. This scenario further assumed that the secondary slide was jammed to the servo valve housing and that the flight crew's rudder pedal input resulted in a rudder motion reversal, with the rudder reaching its blowdown limit (about 12.5°) about 1903:00. Thus, the best-match simulation indicates that the initial wake vortex-related left yaw (and left heading change) was followed about 1 second later by movement of the rudder to its left blowdown limit, which resulted in a continuing left yaw/heading change.

On the basis of these assumptions, rudder position time histories were developed for jams of the secondary slide to the servo valve housing at 100, 71, 50, and 22 percent from the neutral position.¹⁷³ The rudder position, once reversed,¹⁷⁴ was assumed to remain at the blowdown limit¹⁷⁵ corresponding to a main rudder PCU servo valve jam at the 100-percent position (blowdown limit is partly dependent on jam position, airspeed, and

¹⁷² Evidence of the turbulence is reflected in the vertical acceleration and airspeed data recorded on the FDR.

¹⁷³ For more information on the Safety Board's USAir flight 427 rudder jam studies, see "Rudder Jam Simulation Study," dated January 27, 1998, and "Addendum to Rudder Jam Simulation Study," dated February 26, 1999. In addition, the "Kinematics Validation Study," dated August 4, 1997, contains information regarding basic kinematics validation, curve fits, and simulation closure.

¹⁷⁴ In a reversal scenario, the primary and secondary slides are misaligned to produce reverse flow and internal leakage, which creates a restricted flow and loss of pressure. Because of the reduced hydraulic pressure ported to (moving) the actuator in the overtravel situation, the 100-percent jam resulted in the rudder moving at a reduced rate of about 32° per second.

¹⁷⁵ Rudder blowdown is the maximum rudder angle resulting from a pilot-commanded full rudder input under the existing flight conditions. It represents a balance between the aerodynamic forces acting on the rudder and the mechanical forces produced by the PCU. The maximum rudder angle can be increased (or decreased if the rudder reverses) beyond that produced by the hydraulic force if the pilot exerts sufficient force on the rudder pedals. Rudder blowdown was modeled in the simulation using Boeing data and equations that rigorously model the PCU from the valve input to rudder deflection. For the blowdown simulation, the valve input was set to full open (full commanded rudder), and provisions for pilot rudder pedal forces were added, which lower the blowdown angle in a reversal. The blowdown simulation was verified by comparing its output with Boeing's blowdown rudder plots for several conditions based on a normally operating actuator and available flight test data.

sideslip angle) until 1903:08, about the time the airplane stalled. The timing of the rudder inputs was modified by iteration until the simulation produced heading time histories consistent with the FDR data.

The heading data that resulted from the simulation with the secondary slide jammed to the servo valve housing at the 100-percent position matched the FDR heading data better than simulations with the secondary slide jammed at the other three positions. Control surface position data are presented for the 100-percent jam. The pilot rudder pedal force time history is shown in figure 18a.¹⁷⁶ The rudder surface and control wheel positions are shown in figures 18b and 18c, and the resultant heading, bank angle, pitch angle, and vertical acceleration data, compared with the FDR data, are shown in figures 18d through 18g, respectively.

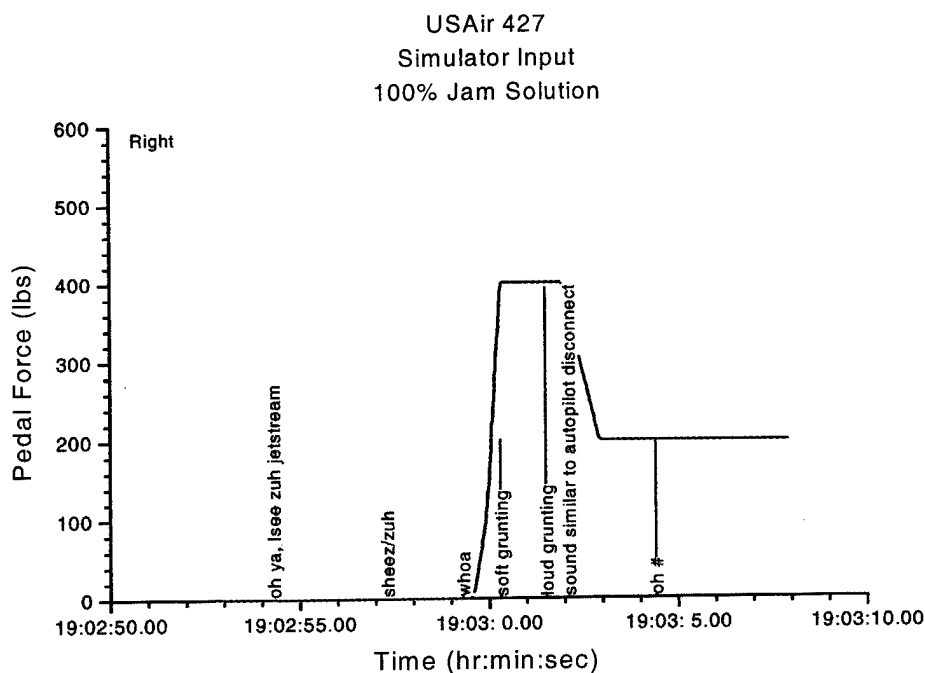

Figure 18a. Pilot rudder pedal force for USAir flight 427.

¹⁷⁶ The Safety Board's best-match simulation used 400 pounds of rudder pedal force reducing to 200 pounds, based on ergonomic and other research data (see section 1.18.8). However, the Safety Board was also able to match the USAir flight 427 FDR data using only the minimum pedal force necessary to sustain full rudder authority (about 70 pounds).

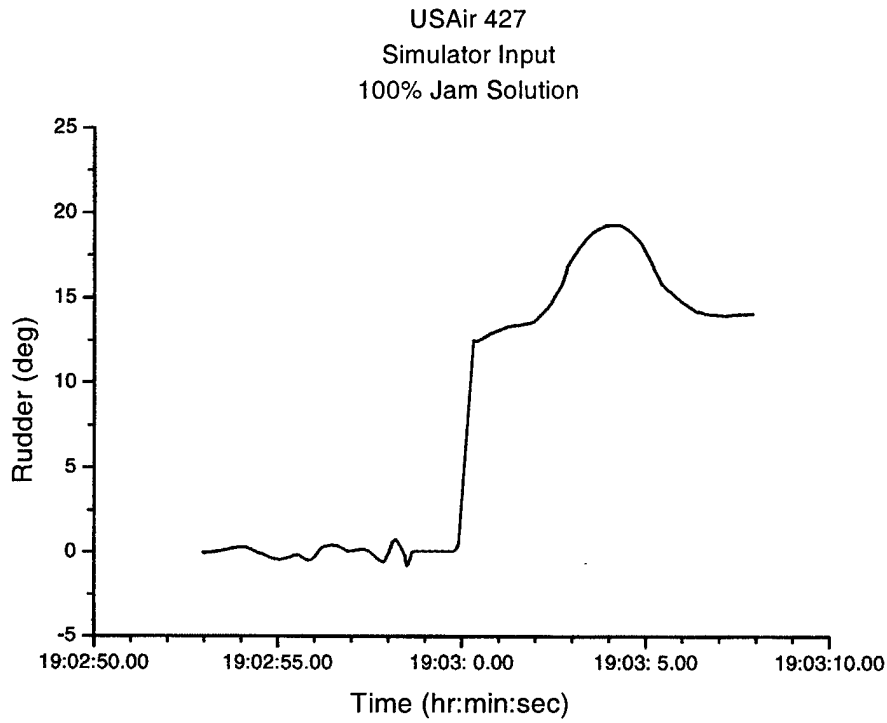

Figure 18b. Rudder surface positions for USAir flight 427.

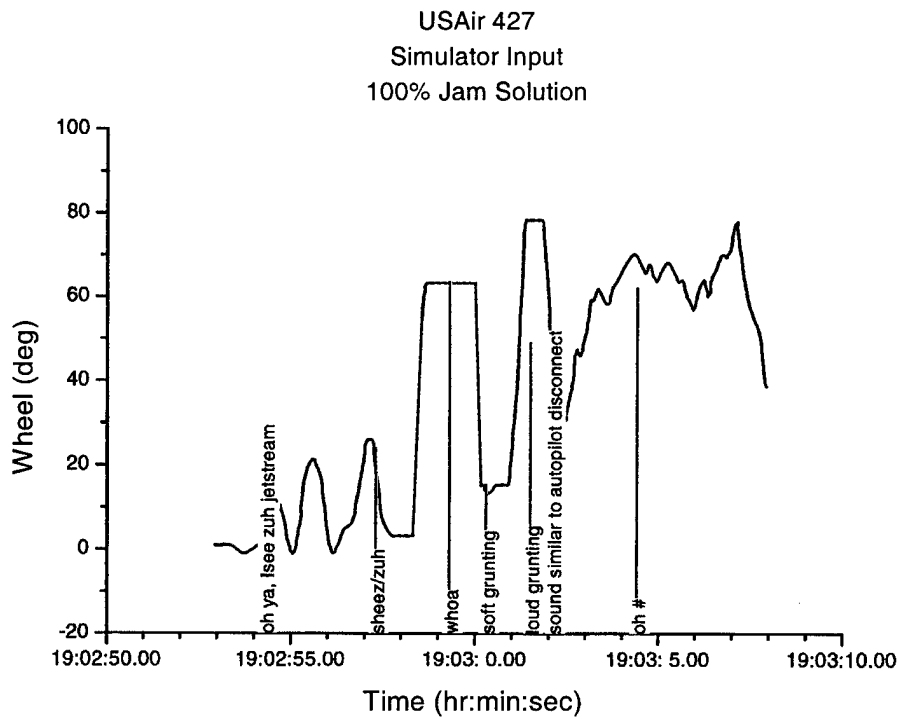

Figure 18c. Control wheel positions for USAir flight 427.

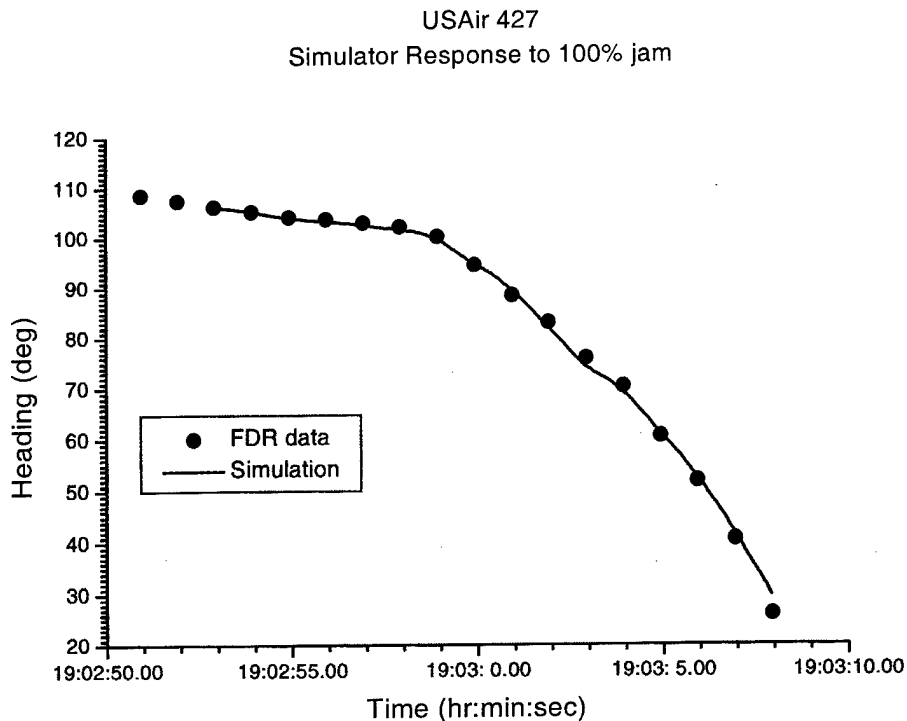

Figure 18d. Heading data for USAir flight 427.

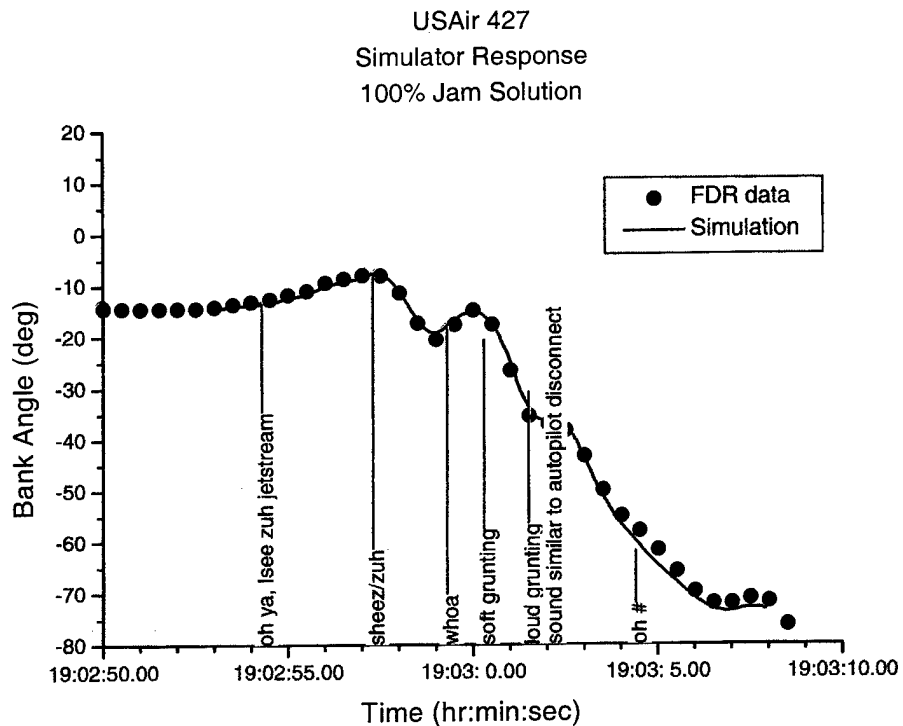

Figure 18e. Bank angle data for USAir flight 427.

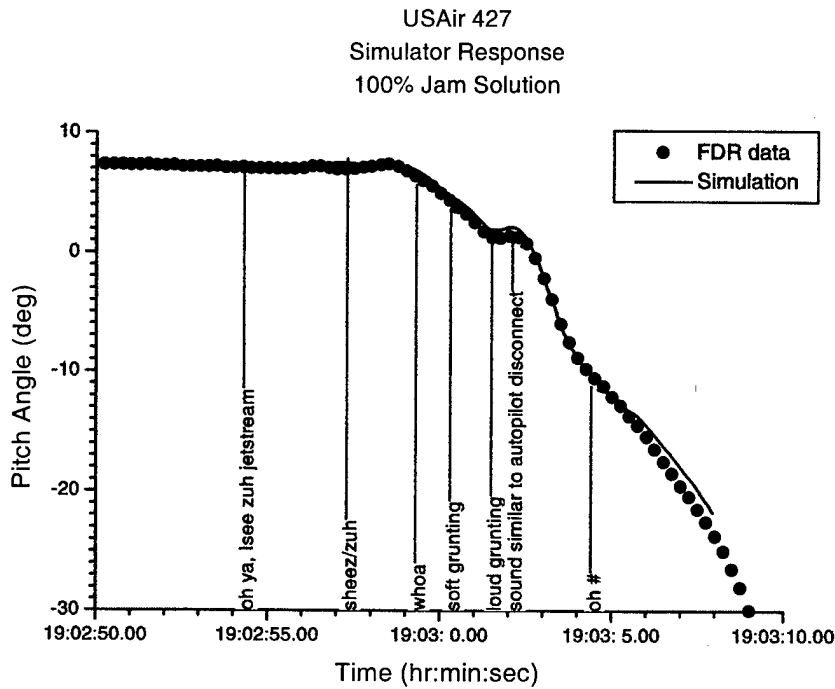

Figure 18f. Pitch angle data for USAir flight 427.

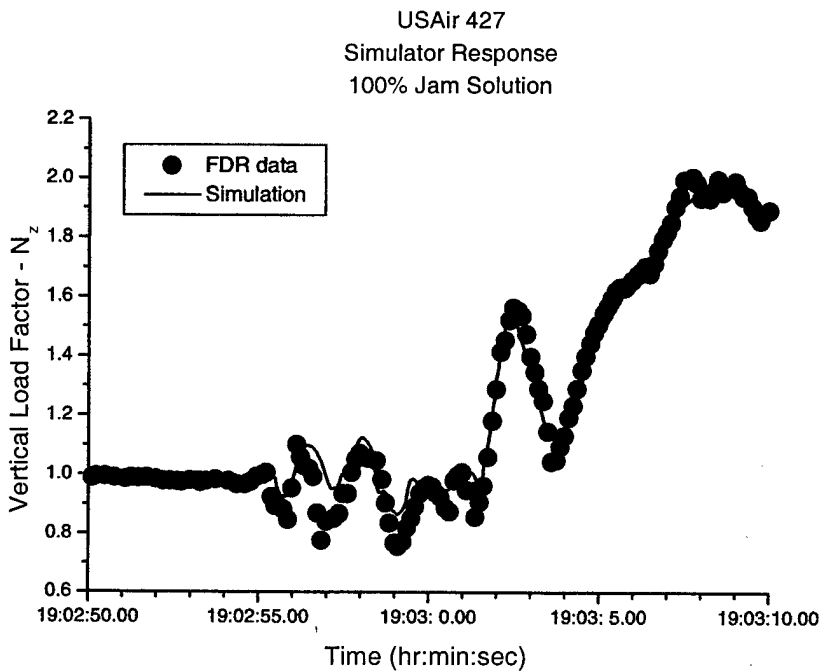

Figure 18g. Vertical acceleration data for USAir flight 427.

According to Boeing's September 30, 1997, submission to the Safety Board,¹⁷⁷ Boeing first improved its wake vortex model using the results of the wake vortex flight tests. Boeing then used its kinematics process to determine the flight control position time histories during the upset sequence of USAir flight 427. Boeing's kinematic analysis required that the FDR heading data be curve fit using interpolation techniques¹⁷⁸ and then run through data smoothing techniques. These various techniques resulted in numerous curves that could fit the USAir flight 427 FDR heading data.¹⁷⁹

Boeing's scenario assumed that, about 1902:58, the first officer input right control wheel (overriding the autopilot, which had been commanding some right control wheel) because of the continuing left acceleration that the wake vortex encounter produced. The first officer applied considerable right control wheel, which arrested the left roll and increased the right roll acceleration. Boeing's scenario then assumed that a left rudder input occurred just after 1902:59, resulting in a left rudder movement of about 12° just before 1903:00. About 1903:00, the full right control wheel and the left rudder inputs were being returned to neutral (the left rudder deflection was reduced to about 3°), but the airplane was still in the effect of the wake, which was rolling the airplane to the left. To counter the left roll, the first officer again applied considerable right control wheel; however, the airplane continued to accelerate in a left roll. Boeing's scenario also assumed that, between 1903:00 and 1903:01, the first officer again applied left rudder pedal pressure, driving the rudder hard to the left, and maintained the left rudder pedal input until ground contact.¹⁸⁰

The rudder surface and control wheel position time histories resulting from Boeing's kinematic analysis for this scenario are presented in figures 19 and 20, respectively. Further, the Safety Board used Boeing's kinematically derived flight control position time histories as inputs in the Board's computer simulation to derive heading, bank angle, pitch angle, and vertical acceleration data and compared these results with the FDR data. These results are presented in figures 21a through 21d, respectively.

¹⁷⁷ Boeing first presented its kinematic analysis of the USAir flight 427 upset event in its "Submission to the National Transportation Safety Board for the USAir 427 Investigation," dated September, 30, 1997. On October 31, 1997, Boeing presented the Safety Board with a refined version of its USAir flight 427 kinematic analysis. The Board used Boeing's data from its later presentation for this report.

¹⁷⁸ A variety of methods exist for curve-fitting data, including mathematical models such as the cubic spline, least squared polynomial, and fast Fourier transform techniques. Boeing used a technique that involved fitting the data manually. (This manual technique involved reviewing the data and providing a nonlinear fit between the FDR data points.)

¹⁷⁹ See page 17 of Boeing's "Submission Supplement USAir 737-300 accident near Pittsburgh," dated September 30, 1997.

¹⁸⁰ Page 49 of Boeing's September 30, 1997, submission states that "from [just after stickshaker activation] until ground impact, the controls remained at full right wheel, full left rudder, and full aft column."

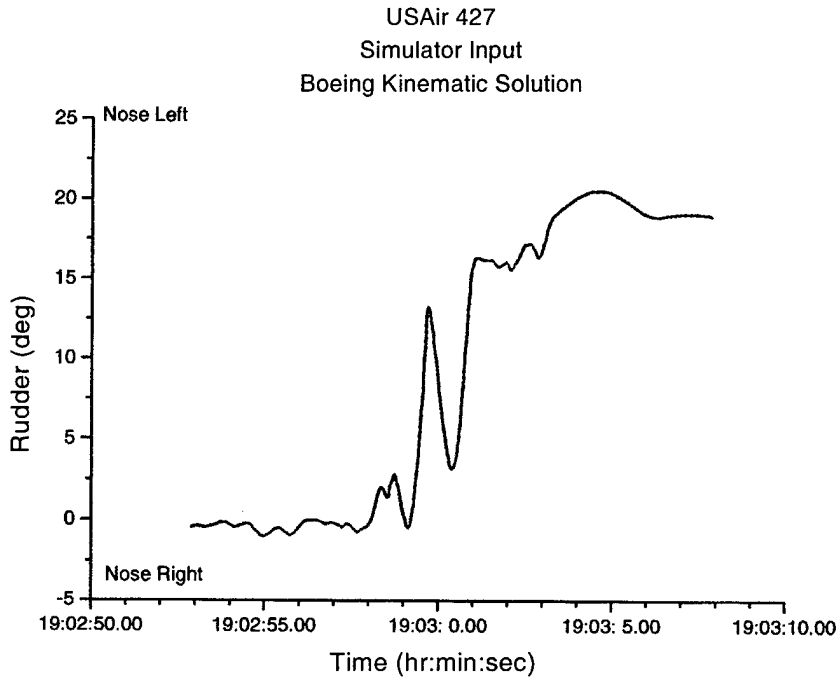

Figure 19. USAir flight 427 rudder surface positions resulting from Boeing's kinematic analysis.

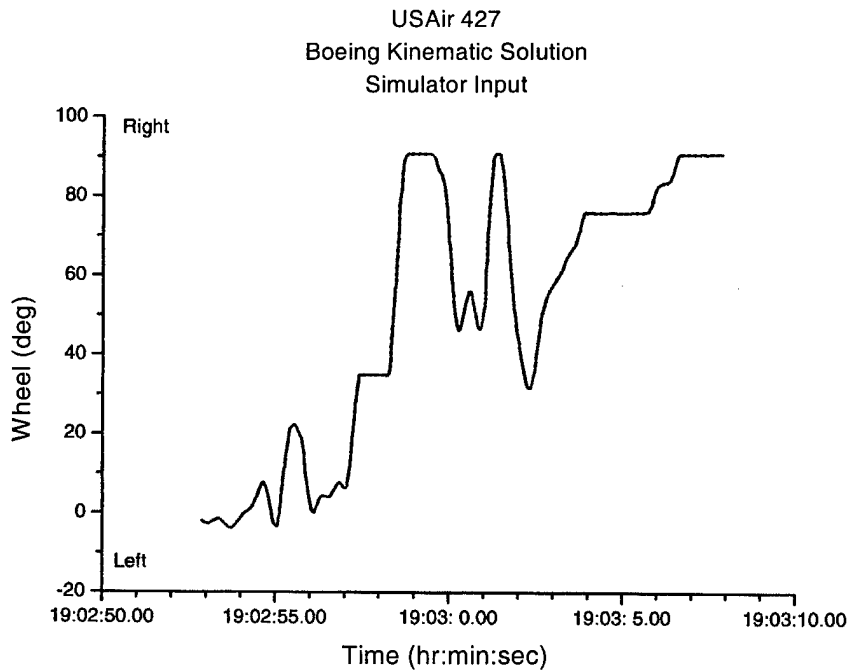

Figure 20. USAir flight 427 control wheel positions resulting from Boeing's kinematic analysis.

USAir 427
Simulator Response to Boeing Solution

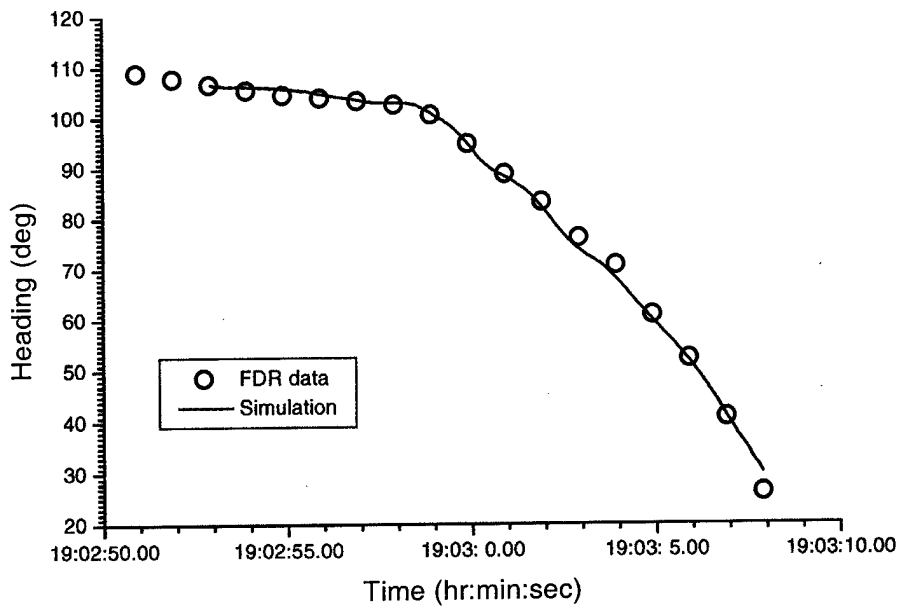

Figure 21a. Derived heading data for USAir flight 427 using Boeing's kinematic analysis.

USAir 427
Simulator Response to Boeing Solution

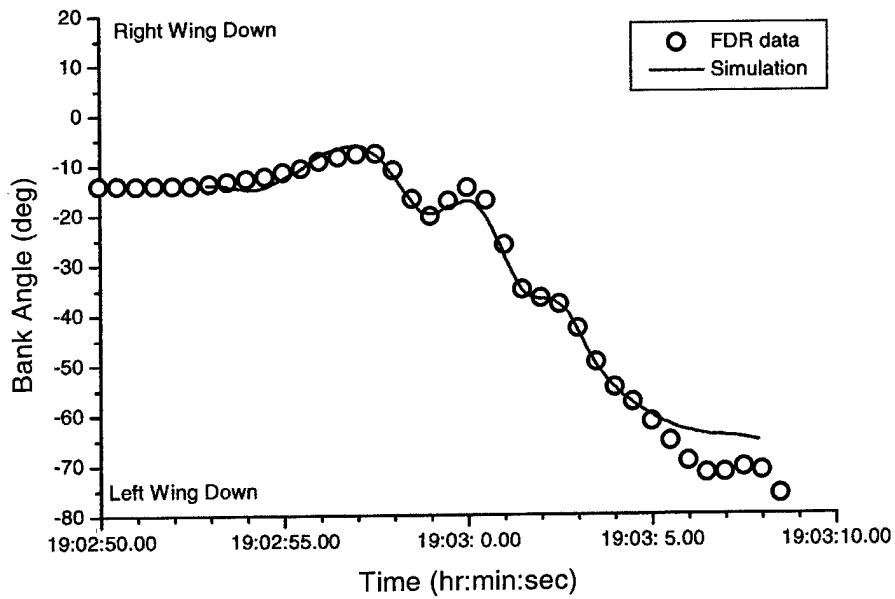

Figure 21b. Derived bank angle for USAir flight 427 using Boeing's kinematic analysis.

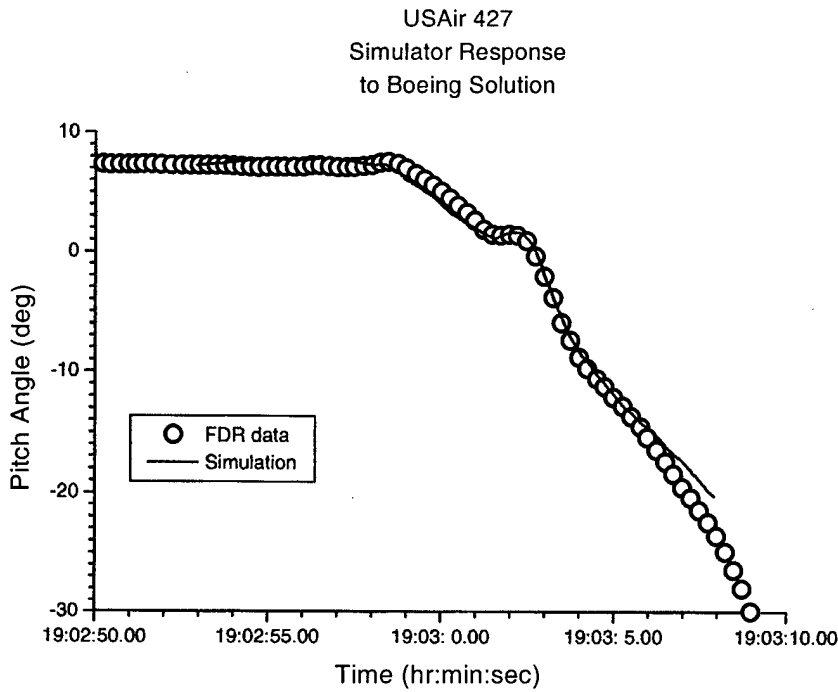

Figure 21c. Derived pitch angle for USAir flight 427 using Boeing's kinematic analysis.

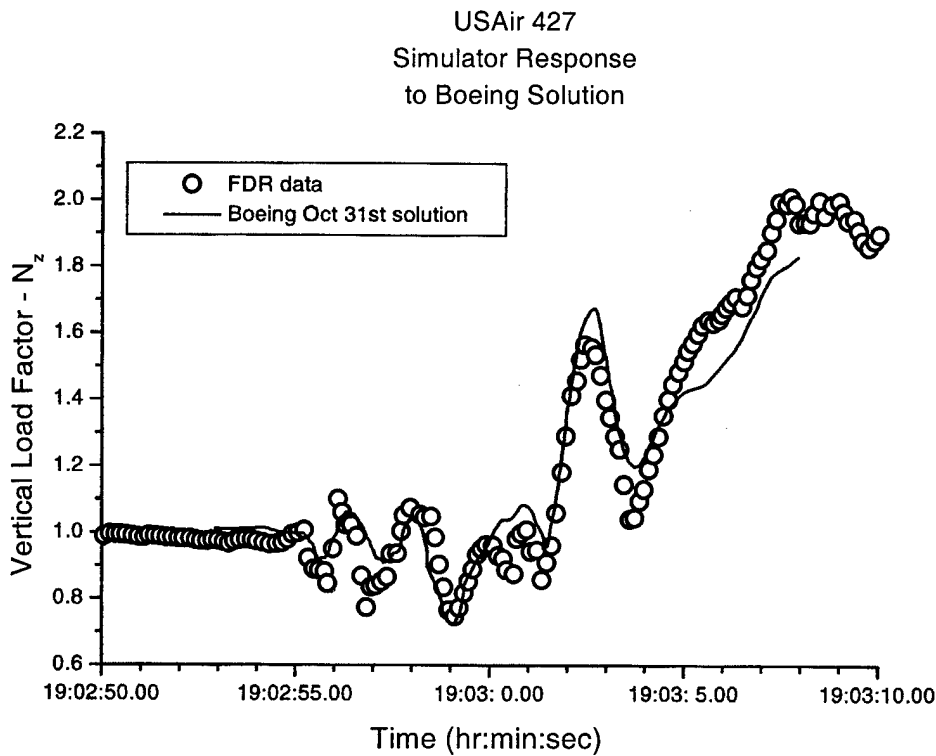

Figure 21d. Derived vertical acceleration data for USAir flight 427 using Boeing's kinematic analysis.

According to Boeing's September 30, 1997, submission, three of the hypothetical system-related scenarios (a dual slide jam, a secondary slide jam with primary slide overtravel, and an input linkage jam) and one hypothetical flight crew input scenario evaluated during the investigation all "potentially fit a kinematic analysis." However, with regard to the three hypothetical system-related scenarios, Boeing's submission commented that "evidence does not support finding as probable cause." Boeing's submission further stated that "there is no evidence to support a conclusion that an uncommanded full rudder deflection occurred. While there is no evidence of a crew-commanded, sustained left-rudder input, such a possibility is plausible and must be seriously considered, especially given the lack of evidence of an airplane-induced rudder deflection."

1.16.6.2 United Flight 585 Simulation Studies

United flight 585 was flying in turbulent air while making a right turn to the final approach to Colorado Springs Municipal Airport. Strong winds aloft created complex airflow patterns that moved from west to east across the mountains located west of the airplane's flightpath; these airflow patterns likely included strong turbulence, eddies, rotational flow fields, and crosswind shear. The FDR data showed that, as the airplane was descending through an altitude of about 1,000 feet agl and was about on track to approach the airport from the south (about 0943:32)¹⁸¹, its heading changed to the right. The airplane impacted the ground about 9 seconds later. The airplane's orientation and flightpath angle at impact were near vertical. The airplane was aligned approximately 205° magnetic heading, and the ground track (as defined by the debris field) was about 020° magnetic heading.¹⁸²

The Safety Board's workstation-based simulator for a 737-200 airplane was used to simulate the event. The simulation process used available FDR data, radar data, and information on the accident location and airplane orientation at impact. Input to the simulation for engine thrust was based on engine sounds recorded on the CVR. The flight control surface position time histories needed for the simulation were not among the parameters recorded by the FDR and thus had to be estimated or derived. The control wheel (aileron and spoilers), rudder surface, and elevator position time histories used in each simulation were derived by iteration.

The simulations assumed that the airplane encountered turbulence with a crosswind gust (perhaps associated with a mountain rotor).¹⁸³ In the Safety Board's best-match simulation that involved a rudder movement for this event, these winds produced a heading change and yaw rate to which the pilot was assumed to have responded (about 0943:32) with left rudder pedal input.¹⁸⁴ This scenario further assumed that this input

¹⁸¹ All times in this subsection are mountain standard time, based on a 24-hour clock.

¹⁸² The heading and ground track were about 180° opposed because of the near-vertical flightpath angle.

¹⁸³ The Safety Board considered several rotor scenarios in its studies, including moving rotors above, below and at the airplane's altitude; standing rotors located left, right, and directly along the airplane's flightpath; and horizontal rotors that transitioned to vertical rotors along the airplane's flightpath.

occurred while the main rudder PCU servo valve secondary slide was jammed to the servo valve housing, resulting in a rudder reversal to the right.

The general wind field was derived by comparing the ground track from the radar data with the airspeed and heading data from the FDR. An approximation of a vertical gust profile was developed from the vertical load factor data. Crosswind gust components were also used in this best-match simulation.

In this simulation, at 0943:21, when the airplane was nearly aligned with the landing runway, the airplane began to experience a significant heading change to the right. The simulation indicated that a right bank angle of about 30° was required to produce this heading change. The Safety Board determined that the heading change and the rolling moment that occurred after 0943:21 were likely the result of turbulence, and these data became the baseline for the turbulence models used in some of the Board's simulations.¹⁸⁵

Rudder position time histories were developed for jams of the secondary slide to the servo valve housing at 100, 71, 50, 40, and 30 percent from the neutral position. The rudder position, once reversed, was assumed to remain at the blowdown limit¹⁸⁶ corresponding to a servo valve jam at the 100-percent position (blowdown limit is partly dependent on jam position, airspeed, and sideslip angle) for the duration of the reversal. The timing of the rudder inputs was modified by iteration until the simulation produced heading time histories consistent with the FDR data.

The heading data that resulted from the simulation with the secondary slide jammed to the housing at 100 percent produced the Safety Board's best-match with the FDR heading data.¹⁸⁷ The pilot rudder pedal force, rudder surface, and control wheel time histories for the 100-percent jam are presented in figures 22a through 22c, respectively.¹⁸⁸ The resultant heading, normal load factor, pitch angle, and bank angle data for the Safety Board's 100-percent jam solution compared with the FDR data are presented in figures 22d through 22g, respectively. Roll and yaw rate, two parameters pertinent to human

¹⁸⁴ The complete data sets for this and other scenarios can be found in the Safety Board's "United flight 585 Simulation Study," dated October 19, 1998, and the Board's "Addendum to Simulation Study," dated February 23, 1999.

¹⁸⁵ The 100-percent jam scenario does not include the rotational eddy from the turbulence model; the 30-percent jam (which is not presented in this report) does include the eddy.

¹⁸⁶ Because of fire damage to the United flight 585 PCU, the Safety Board was unable to perform laboratory tests to determine the rudder deflection rate and the hinge moment capability of the PCU with the secondary slide jammed at various positions from neutral. Therefore, data from the USAir flight 427 PCU servo valve tests in which the secondary slide was jammed at 71, 50, and 22 percent from neutral were used. Data from the Eastwind flight 517 PCU servo valve tests were not used because that servo valve had a leaky bypass valve.

¹⁸⁷ Because of the reduced hydraulic pressure ported to the actuator in the overtravel situation, this 100-percent jam would result in the rudder moving at a reduced rate of about 32° per second to the reduced blowdown limit.

¹⁸⁸ The Safety Board's best-match simulation used 300 pounds of force reducing to 200 pounds, based on ergonomic and other research data (see section 1.18.8). The Safety Board was also able to match the United flight 585 FDR data using only the minimum pedal force necessary to sustain full rudder authority (about 70 pounds).

performance, are presented in the figures 22h and 22i, respectively, for the 100-percent jam case (figures 22i and 22j). CVR data are presented on figures 22f, 22g, and 22i to correlate verbal responses of the pilots to simulated pitch angle, bank angle, and yaw rate, respectively. Wind direction and horizontal and vertical windspeeds used in the Safety Board's best-match scenario are presented in figures 22j through 22l, respectively.

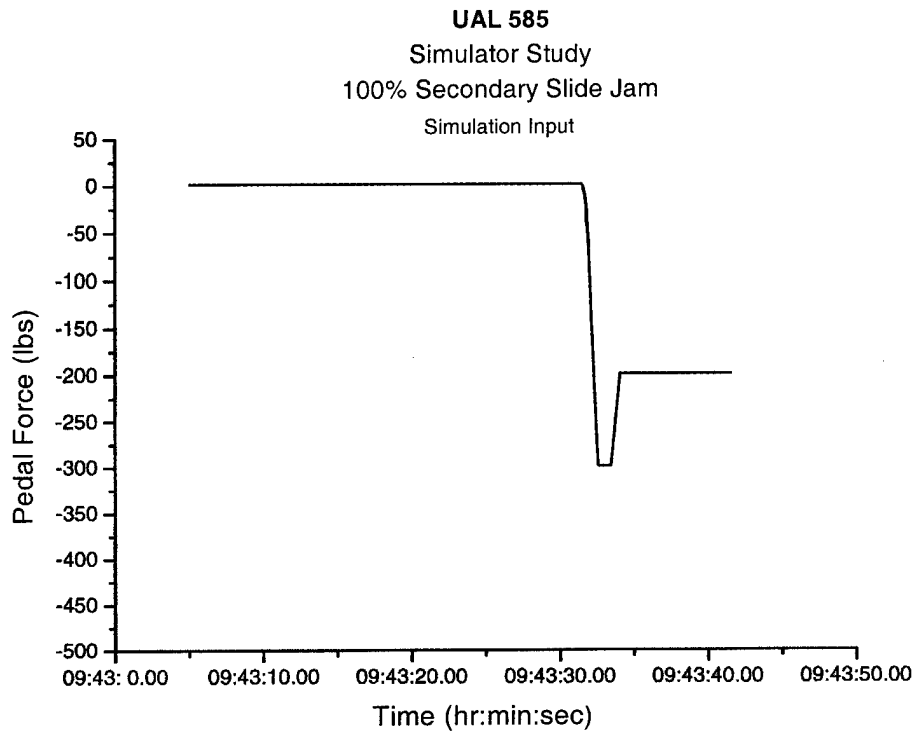

Figure 22a. Pilot rudder pedal force positions for United flight 585.

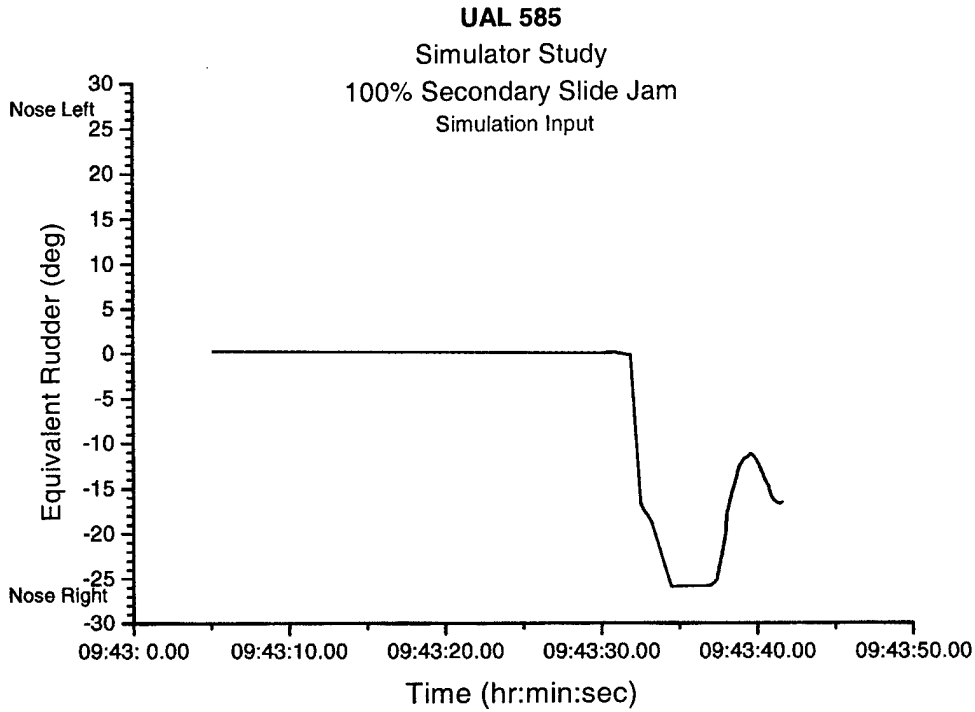

Figure 22b. Rudder surface positions for United flight 585.

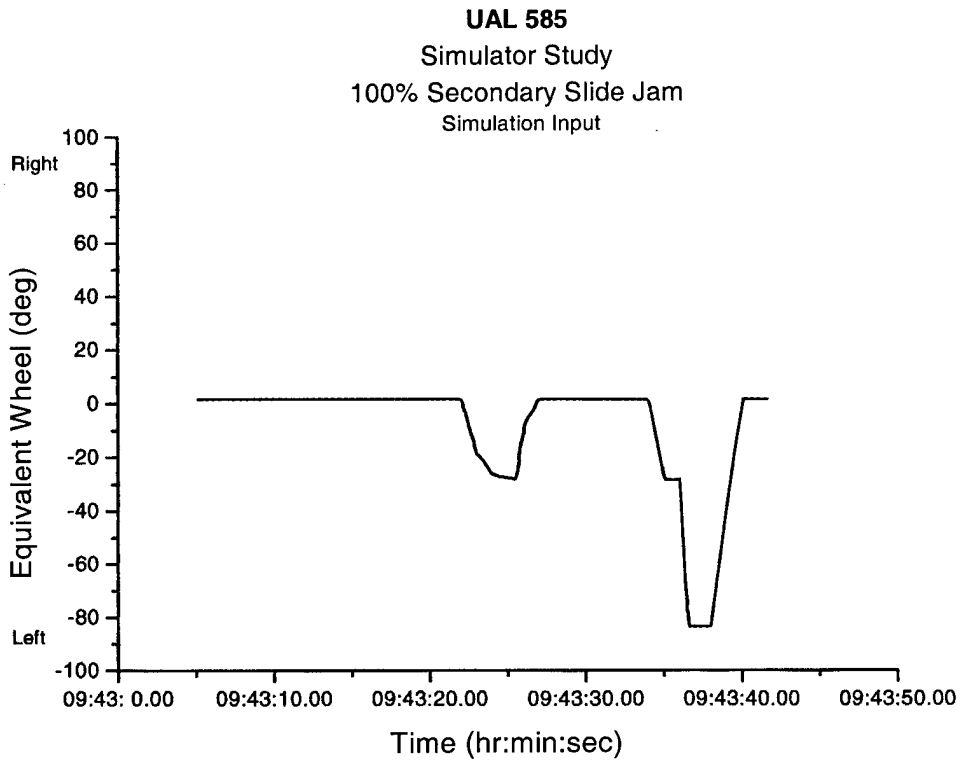

Figure 22c. Control wheel positions for United flight 585.

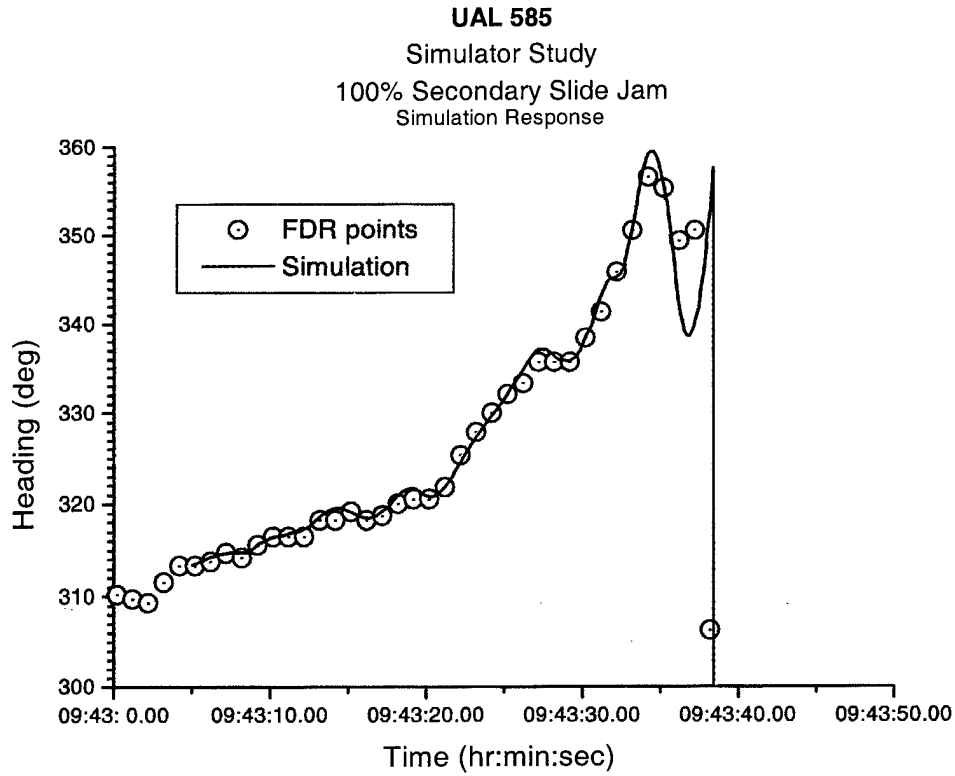

Figure 22d. Heading data for United flight 585.

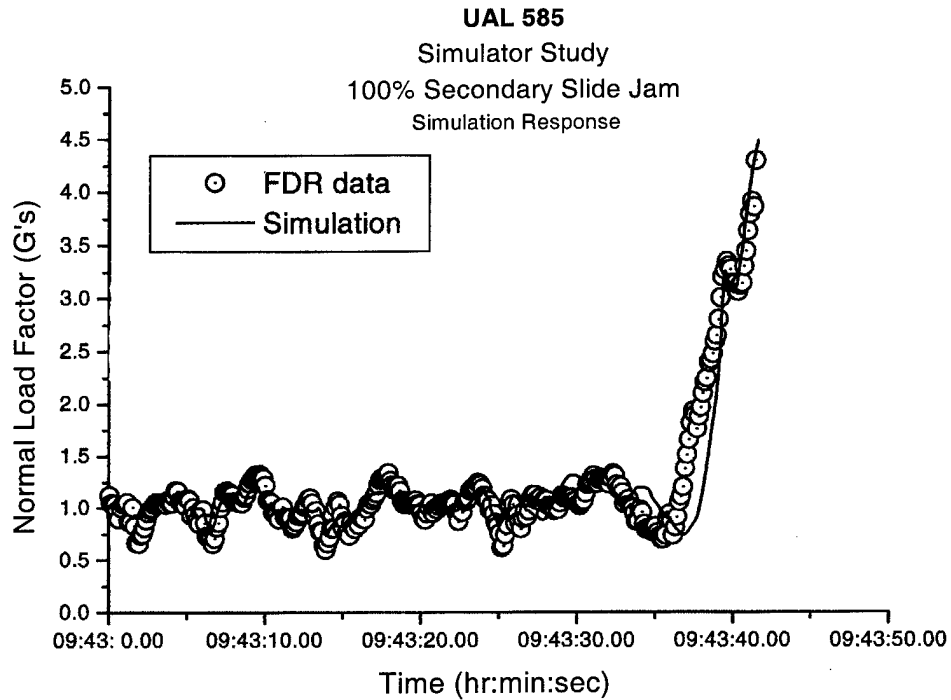

Figure 22e. Normal load factor data for United flight 585.

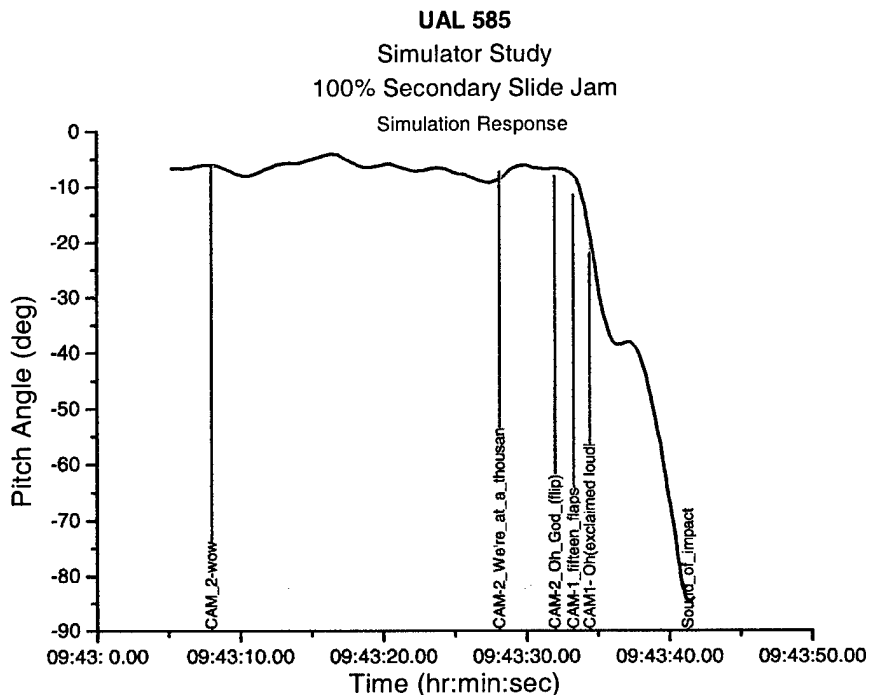

Figure 22f. Pitch angle data for United flight 585.

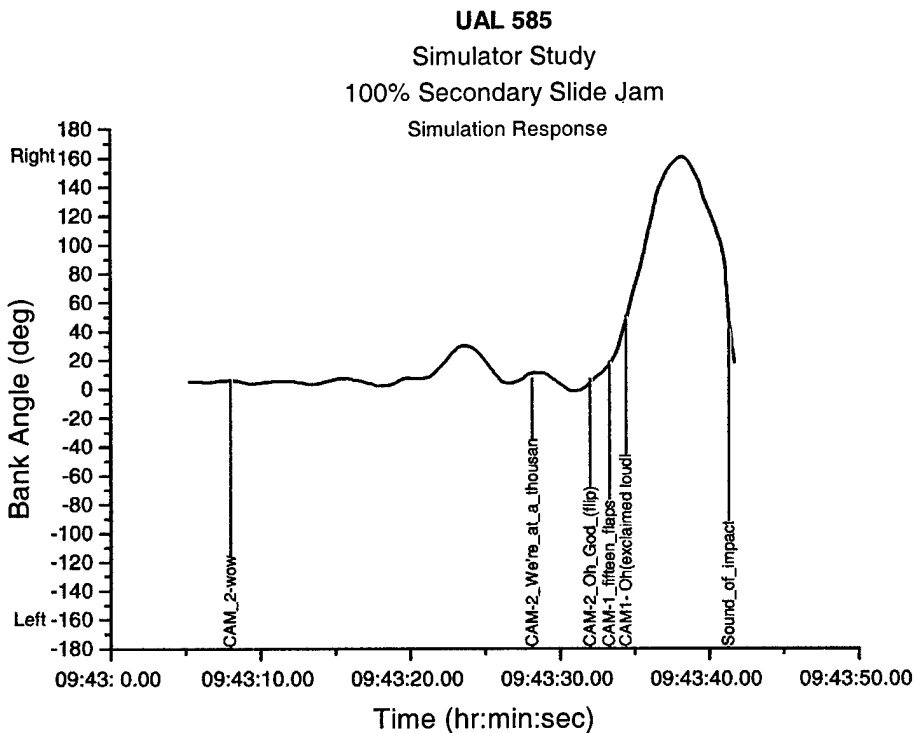

Figure 22g. Bank angle data for United flight 585.

UAL 585
 Simulator Study
 100% Secondary Slide Jam
 Simulation Response

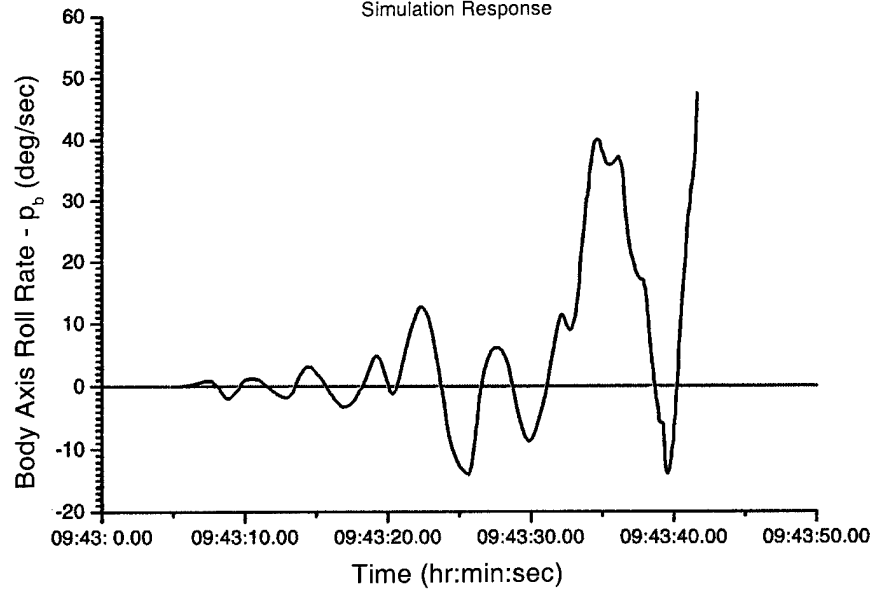

Figure 22h. Roll rate for United flight 585.

UAL 585
 Simulator Study
 100% Secondary Slide Jam
 Simulation Response

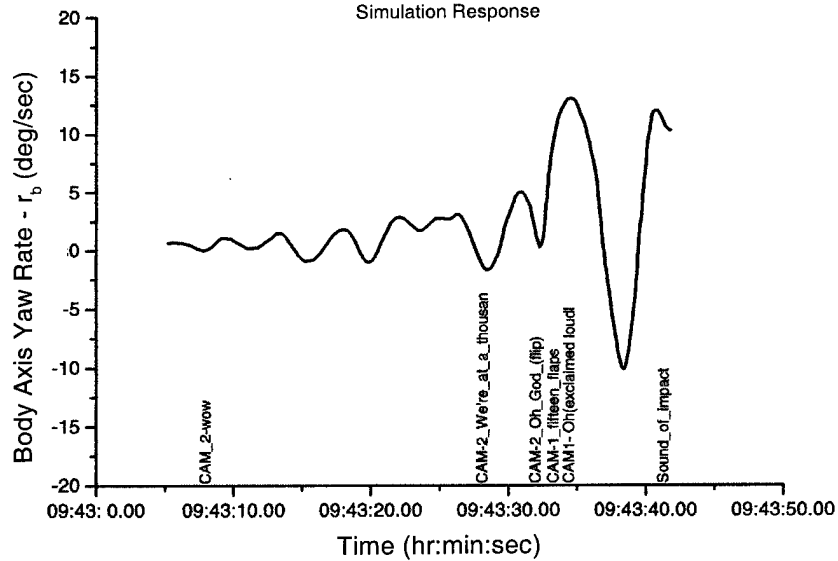

Figure 22i. Yaw rate for United flight 585.

UAL 585
Simulator Study
100% Secondary Slide Jam

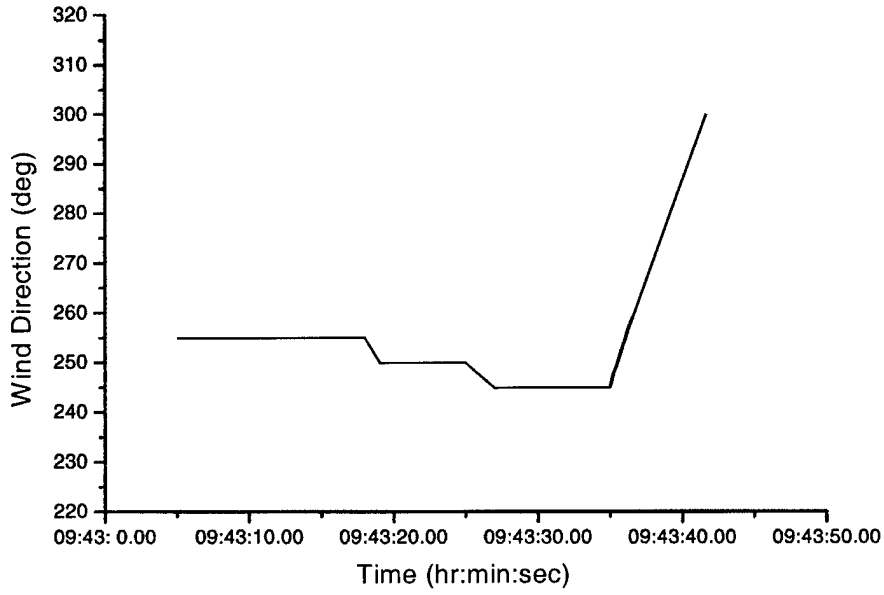

Figure 22j. Wind direction for United flight 585.

UAL 585
Simulator Study
100% Secondary Slide Jam

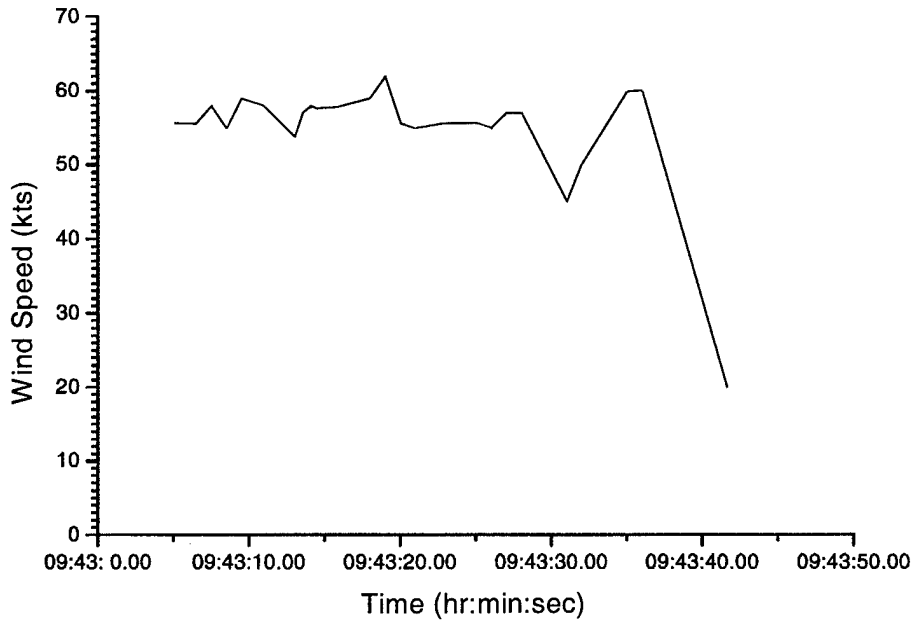

Figure 22k. Horizontal windspeeds for United flight 585.

UAL 585
Simulator Study
100% Secondary Slide Jam

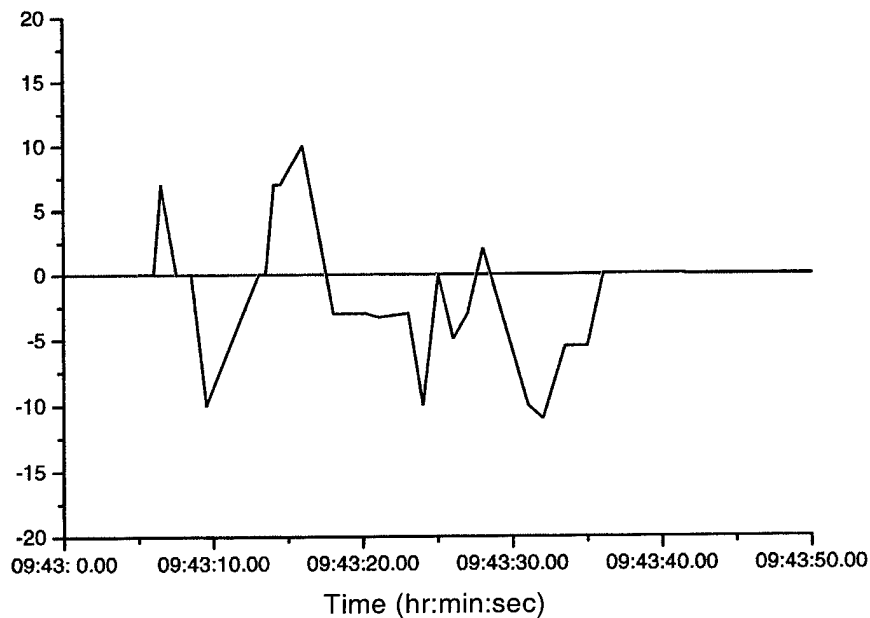

Figure 22l. Vertical windspeeds for United flight 585.

One of the Safety Board simulation scenarios that produced a good match with the FDR data and other physical evidence assumed a sustained equivalent control wheel input to the right with no rudder input. The equivalent control wheel input could represent a pilot command, a rotational wind, or a combination of the two. Figures 23a through 23g show the resultant data for rudder surface and control wheel positions and heading, normal load factor, calibrated airspeed, pitch angle, and bank angle data, respectively. Figures 23f and 23g also show CVR data.

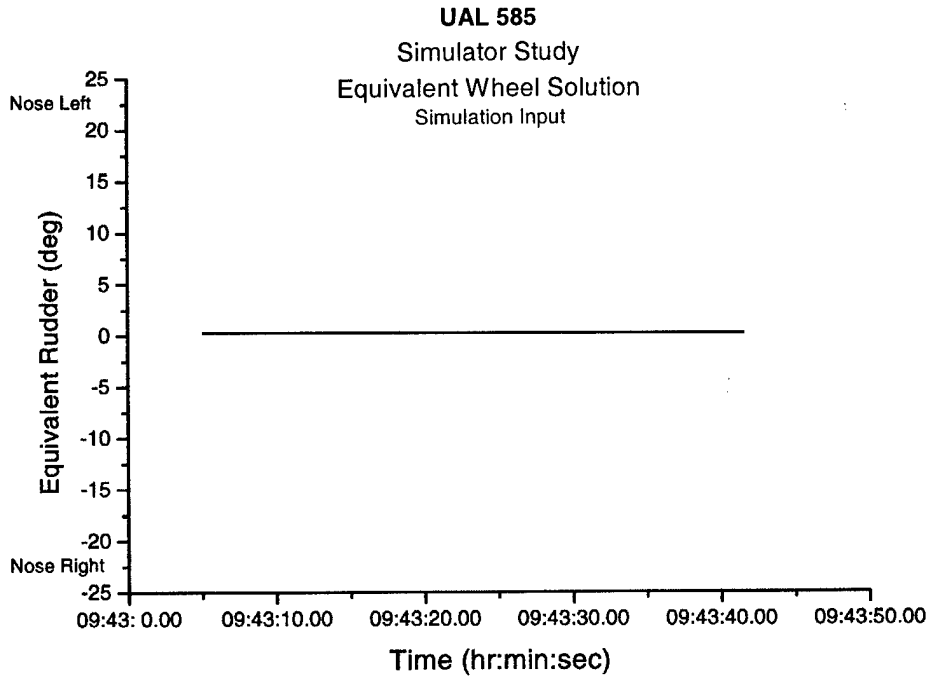

Figure 23a. Rudder surface positions for United flight 585 assuming a sustained equivalent control wheel input.

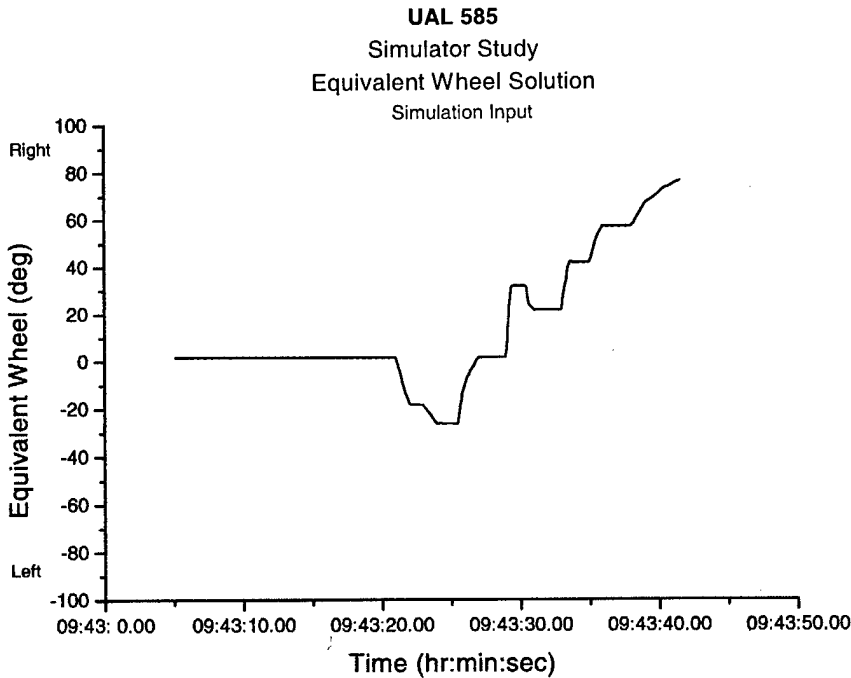

Figure 23b. Control wheel surface positions for United flight 585 assuming a sustained equivalent control wheel input.

UAL 585
Simulator Study
100% Secondary Slide Jam

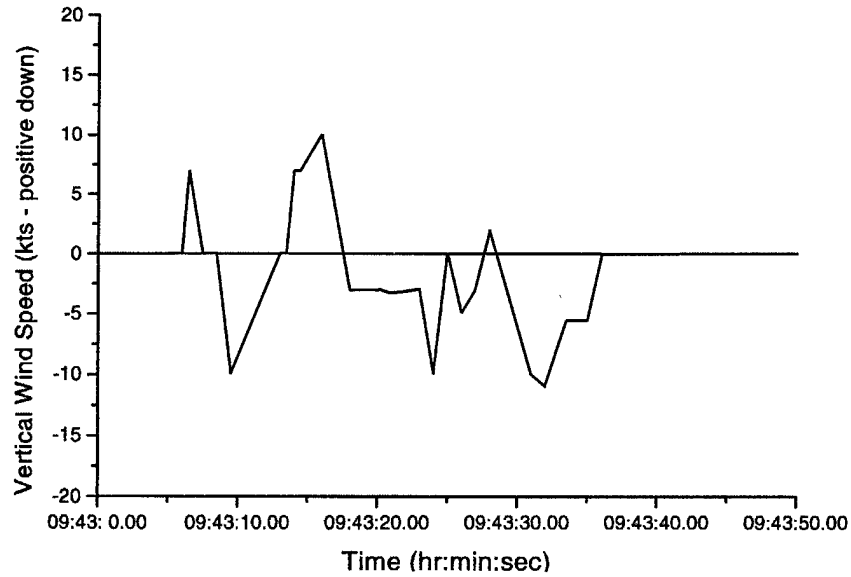

Figure 23c. Heading data for United flight 585 assuming a sustained equivalent control wheel input.

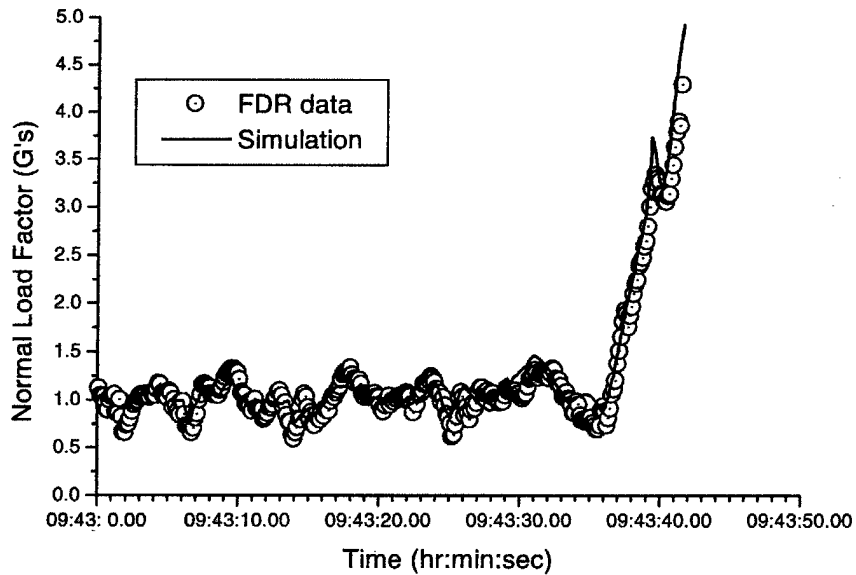

Figure 23d. Normal load factor for United flight 585 assuming a sustained equivalent control wheel input.

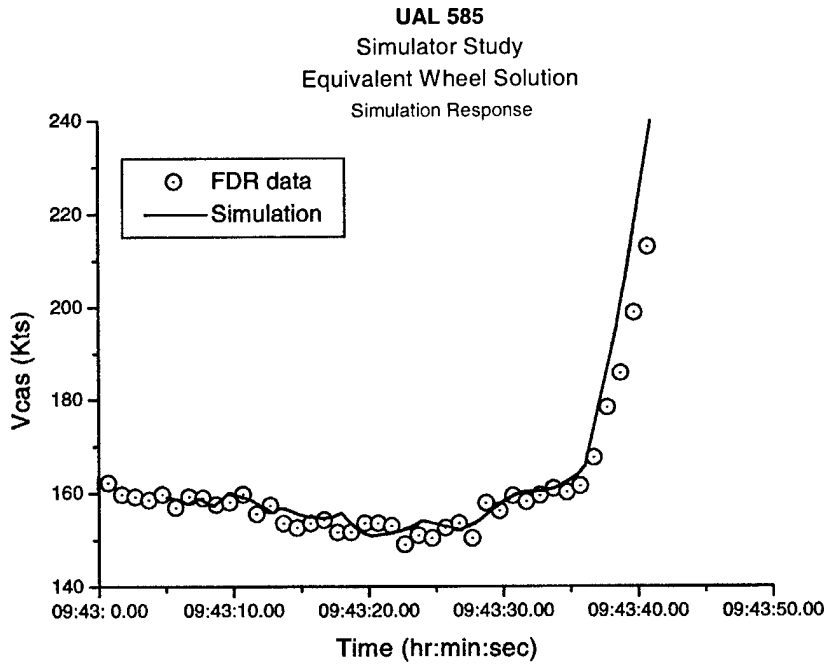

Figure 23e. Calibrated airspeed for United flight 585 assuming a sustained equivalent control wheel input.

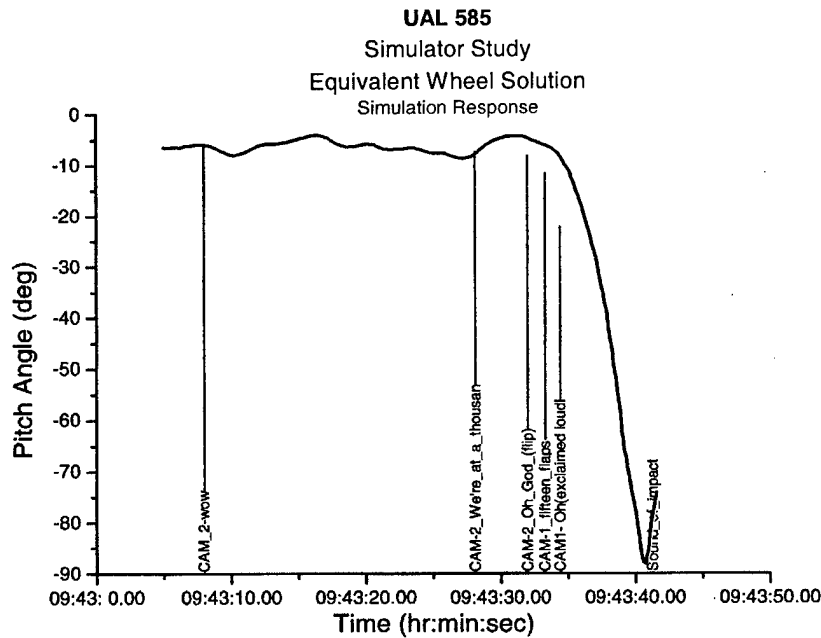

Figure 23f. Pitch angle data for United flight 585 assuming a sustained equivalent control wheel input.

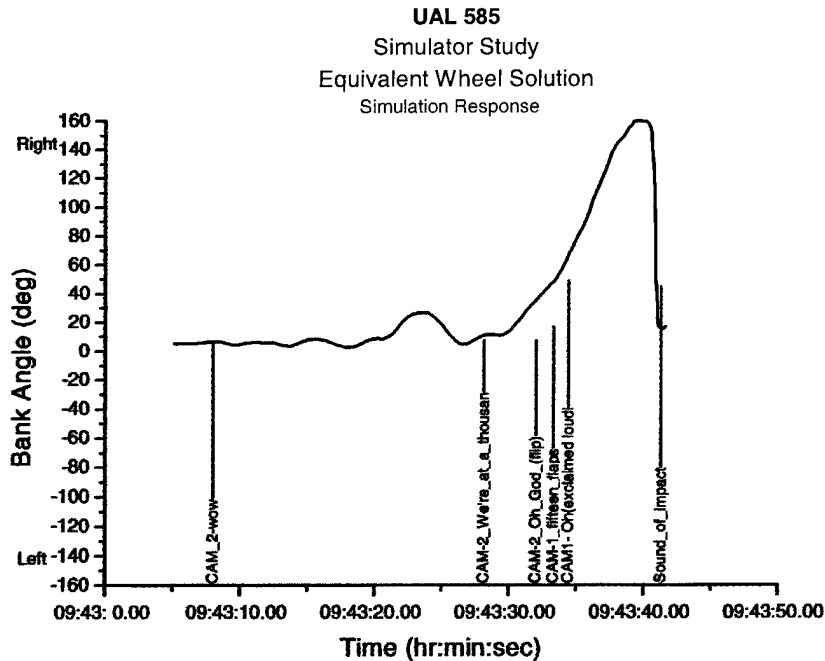

Figure 23g. Bank angle data for United flight 585 assuming a sustained equivalent control wheel input.

In a June 23, 1997, letter to the Safety Board, Boeing provided its analysis of the United flight 585 accident.¹⁸⁹ Boeing's analysis concluded that a rudder hardover scenario did not fit the FDR data and that a "new rotor model" did match the data.¹⁹⁰ Further, Boeing derived this new rotor model to match the available data and introduced a rotational effect of near zero just before 0943:28, which increased linearly to about 0.4 radians per second just before 0943:29 and then increased linearly to about 1.8 radians per second about the time the airplane impacted the ground (just before 0943:42).

Boeing's simulation using its new rotor model produced the data shown in figures 24a through 24g for rudder surface positions, windshear, control wheel positions, heading, bank angle, normal load factor, and pitch angle, respectively. As shown in figure 24c, Boeing's simulation assumed a left control wheel input by the flight crew just after 0943:30.

¹⁸⁹ Boeing's analysis was resubmitted to the Safety Board in a September 14, 1998, letter.

¹⁹⁰ According to Boeing, "the new rotor model is significantly different from that evaluated during the original [United flight] 585 investigation. The original [rotor] model was a solid rotating core of air with a distinct boundary. This meant that the air at the outside edge of the core was at a very high velocity for large cores with high rotational velocity. [Boeing's new rotor] model is not a solid rotating body, but has a velocity profile which varies significantly as the distance from the center core increases. The model was developed based on a simulation of the weather conditions that existed in the Colorado Springs area on the day of the accident."

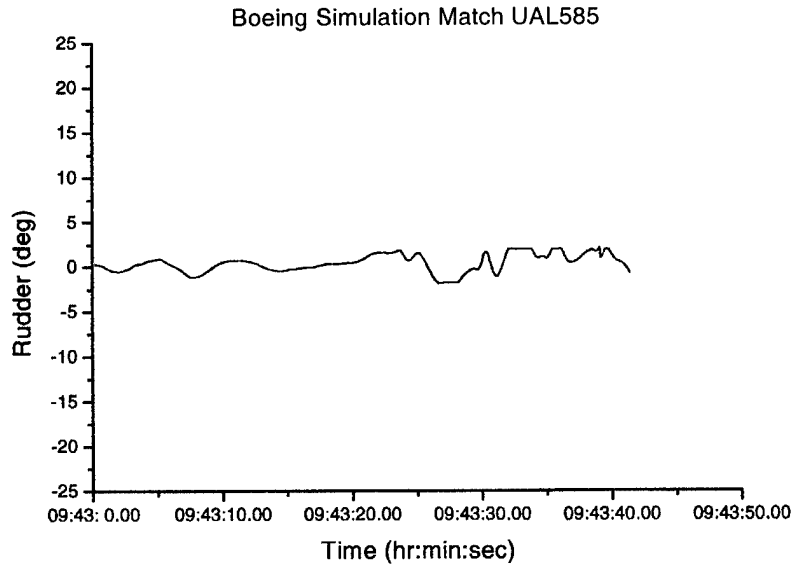

Figure 24a. United flight 585 rudder surface positions according to Boeing's new rotor model.

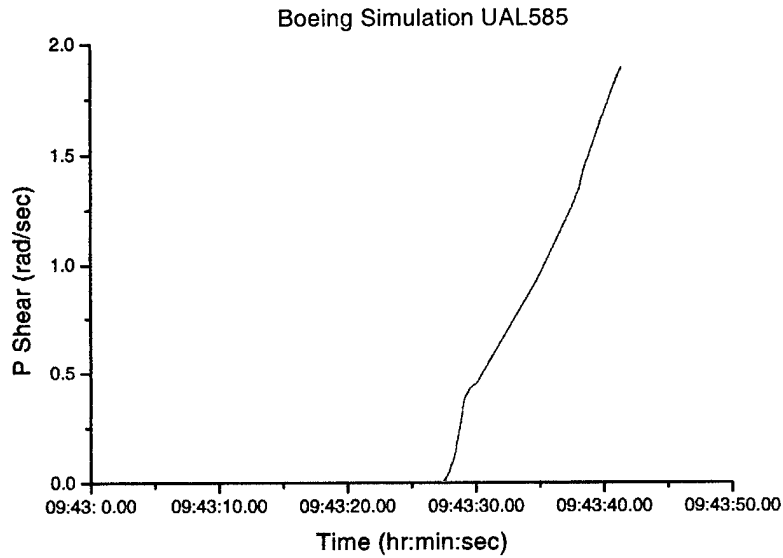

Figure 24b. Rotational windshear encountered by United flight 585 according to Boeing's new rotor model.

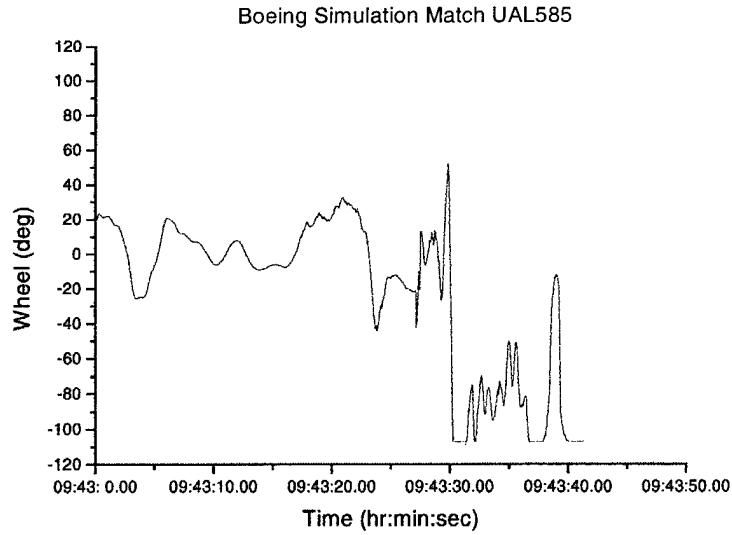

Figure 24c. United flight 585 control wheel positions according to Boeing's new rotor model.

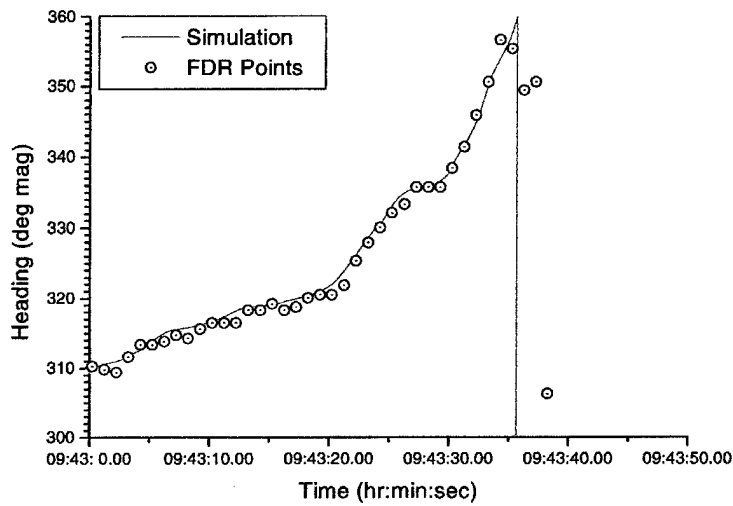

Figure 24d. United flight 585 heading data according to Boeing's new rotor model.

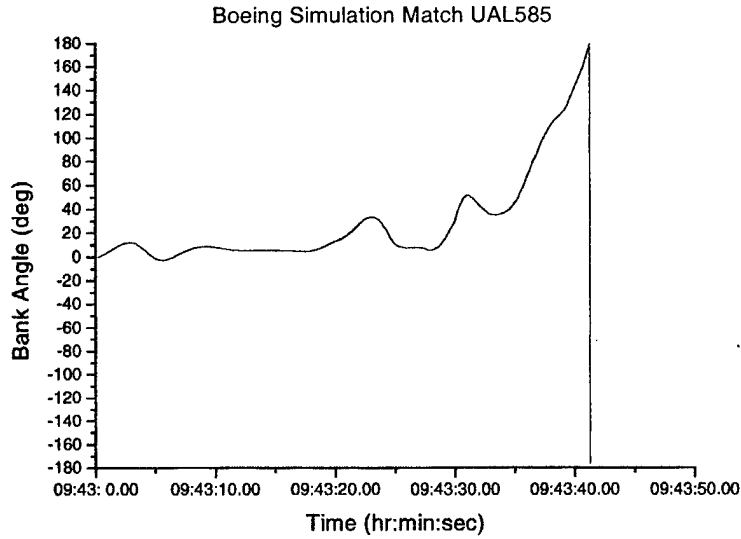

Figure 24e. United flight 585 bank angle data according to Boeing's new rotor model.

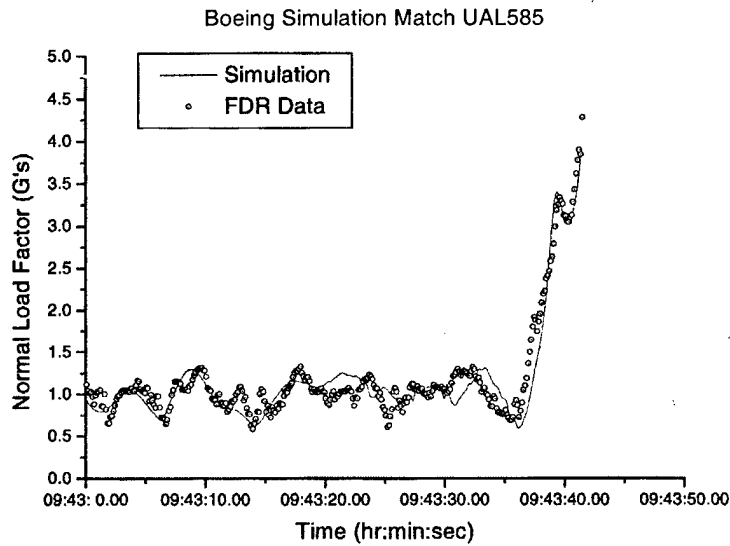

Figure 24f. United flight 585 normal load factor data according to Boeing's new rotor model.

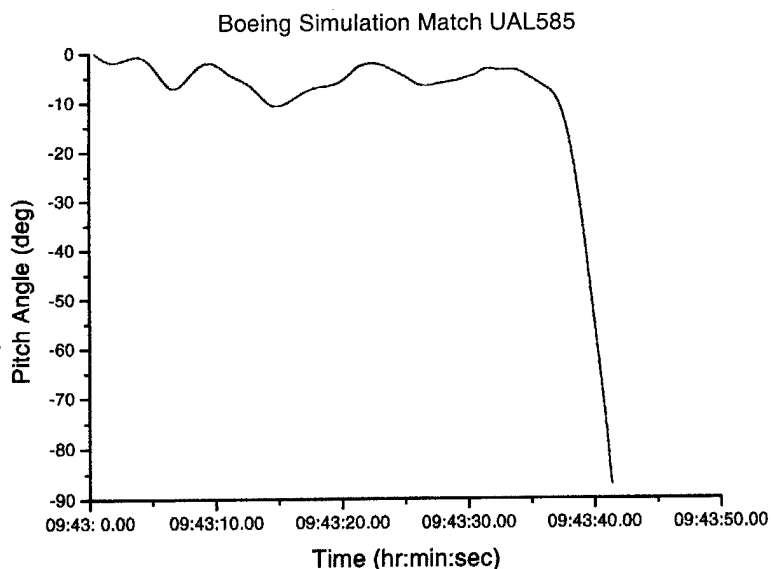

Figure 24g. United flight 585 pitch angle according to Boeing's new rotor model.

1.16.6.3 Eastwind Flight 517 Simulation Studies

Pilot statements and data from Eastwind flight 517 indicated that the airplane was flying in relatively calm air¹⁹¹ when it rolled and yawed to the right. The event lasted about 13 seconds. Postincident investigation revealed that the airplane's yaw damper had been rigged incorrectly so that the neutral point of the rudder would be 1.5° to the left if the rudder trim knob were set to zero. Ground tests and measurements indicated that, in this incorrectly rigged condition, a yaw damper hardover would move the rudder an additional 1.5° to the left or 4.5° toward the right. Flight tests conducted in the Eastwind flight 517 airplane indicated that compliance within the rudder system would reduce the right yaw damper authority from 4.5 to 3.7° ($\pm 0.25^\circ$ error band) right during the flight conditions at the time of the upset.

The Safety Board's workstation-based simulator for a 737-200 airplane was used to simulate the events. Input to the simulation for engine thrust was based on data recorded on the FDR. The flight control surface position time histories needed for the simulations were not among the parameters recorded by the FDR and thus had to be estimated or derived. With the use of a detailed Boeing elevator model, the elevator input was derived from the control column position recorded by the FDR. The control wheel (aileron and spoilers) position input time histories were initially estimated from a kinematic analysis; the final control wheel position time histories were derived by iteration.

¹⁹¹ Although the Eastwind flight 517 FDR data showed that the flight was mostly smooth, there were two positive spikes in the vertical load factor of about 1.2 Gs about 45 and 5 seconds before the event. There were coincident signatures in the longitudinal load factor data.

For the rudder position time history input in the Safety Board's best-match simulation, the rudder was assumed to have been trimmed to its zero position at some time before the roll and yaw event to compensate for the yaw damper offset. (This action would result in the trim knob being positioned about 1.5° to the right, which is the position where the trim knob was discovered during postincident cockpit documentation.) The Safety Board's best-match simulation also assumed a rudder input similar to a yaw damper hardover to the right followed by a left rudder pedal input by the pilots to counter the yaw from this rudder input. The Board's simulation scenario then assumed that a rudder reversal occurred as a result of the left rudder pedal input while the PCU servo valve secondary slide was jammed to the servo valve housing.

Rudder position time histories were developed for a number of different conditions, including jams of the secondary slide to the servo valve housing at 100, 71, 55, 43, and 30 percent from the neutral position. The rudder position, once reversed, was assumed to remain at the jam-reduced blowdown limit (which is partly dependent on jam position within the servo valve, airspeed, and sideslip angle) for about 13 seconds, consistent with the period of heading shift recorded by the Eastwind flight 517 FDR during the incident. The timing of the rudder inputs was modified by iteration until the simulation produced heading time histories consistent with the FDR data.

The simulation assumed that, consistent with flight crew reports, the rudder PCU servo valve became unjammed at some point, enabling the captain to regain control of the airplane. Because there was no evidence of the rudder position after the captain regained control of the airplane, the Safety Board considers its simulation to be meaningful only until 2210:42. This time is also when Boeing terminated the data in its simulations that were presented in its August 14, 1998, submission supplement.¹⁹²

The heading data that resulted from the simulation with the secondary slide jammed to the servo valve housing at the 55-percent position provided the best-match with the FDR heading data.¹⁹³ This scenario assumed that the rudder pedal input resulted in a rudder reversal and rudder movement¹⁹⁴ to the (reduced) blowdown limit (6.5°) corresponding to the 55 percent jam.¹⁹⁵ Figure 25a shows the right and left EPR settings recorded by the FDR and those used in the Safety Board's simulations. The control wheel, pilot rudder pedal force, and rudder surface time histories for a 55-percent jam are shown in figures 25b through 25d, respectively. The resultant roll angle, vertical acceleration, and

¹⁹² See Boeing's "Submission Supplement USAir 737-300 Accident Near Pittsburgh," dated August 14, 1998.

¹⁹³ The Safety Board's best-match simulation used 500 pounds of force reducing to 250 pounds, then gradually reducing to 0 pounds, based on ergonomic and other research data (see section 1.18.8). The Safety Board was also able to match the Eastwind flight 517 FDR data using only the minimum pedal force necessary to sustain full rudder authority (about 70 pounds).

¹⁹⁴ Because of the reduced hydraulic pressure ported to the actuator in the overtravel situation, this 55-percent jam would result in the rudder moving at a reduced rate of about 15° per second.

¹⁹⁵ For data related to other jam scenarios, refer to the Safety Board's "Eastwind Rudder Jam Study," dated June 5, 1998; its "Addendum to Eastwind Rudder Jam Study," dated November 11, 1998; and its "Addendum 2 to Eastwind Rudder Jam Simulation Study," dated February 18, 1999.

heading data, compared with the FDR data, are shown in figure 25e through 25g, respectively. Figure 25h shows the simulator heading, corrected for gimbal error, compared with the FDR-recorded heading data for a family of gyro gimbal spool-up angles for the 55-percent jam case. Yaw and roll rates (parameters pertinent to human performance) are presented in figures 25i and 25j, respectively, for the 55-percent jam case.

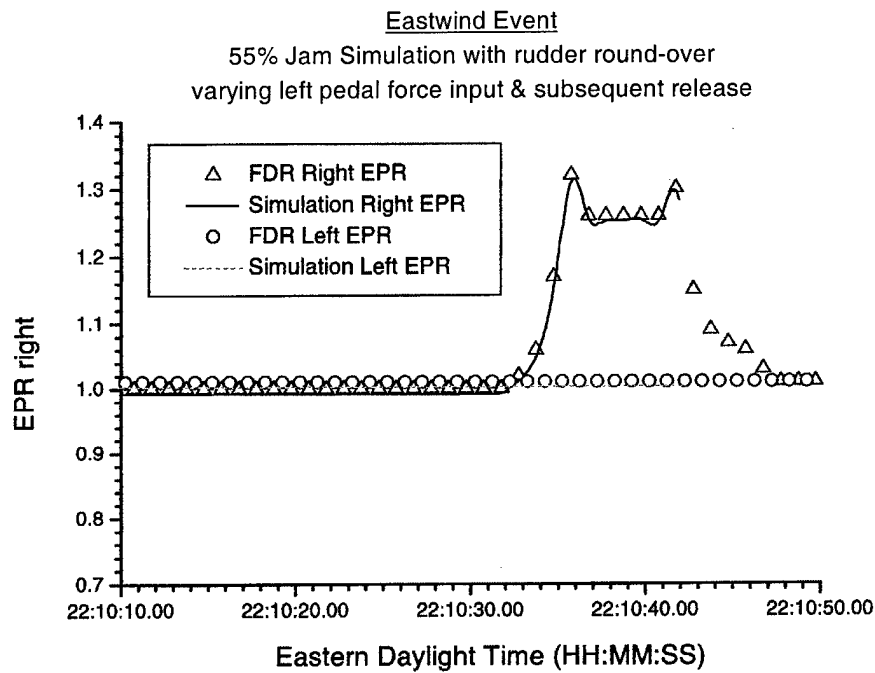

Figure 25a. Right and left EPR settings for Eastwind flight 517.

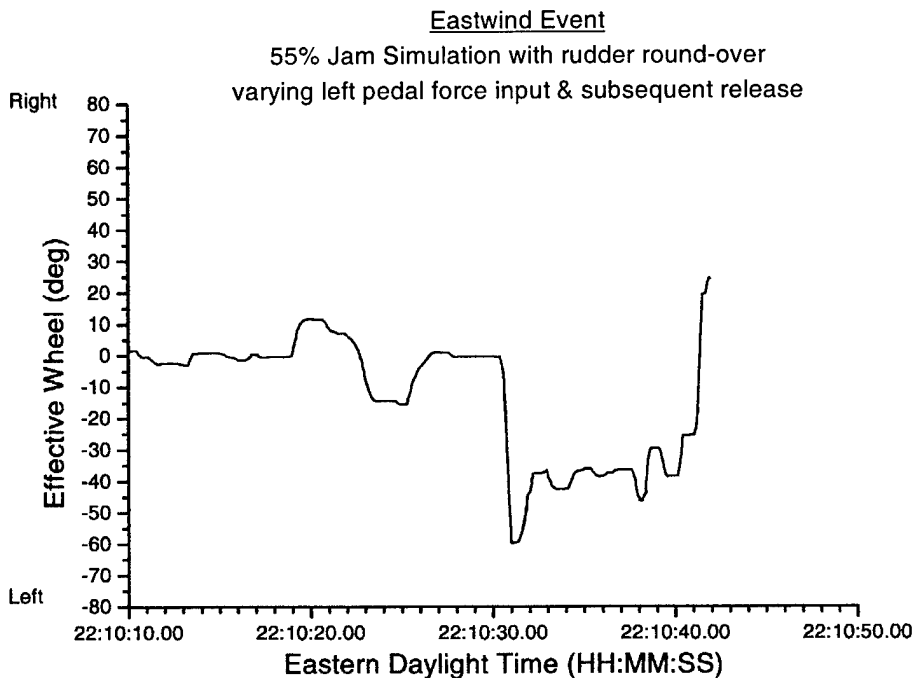

Figure 25b. Control wheel positions for Eastwind flight 517.

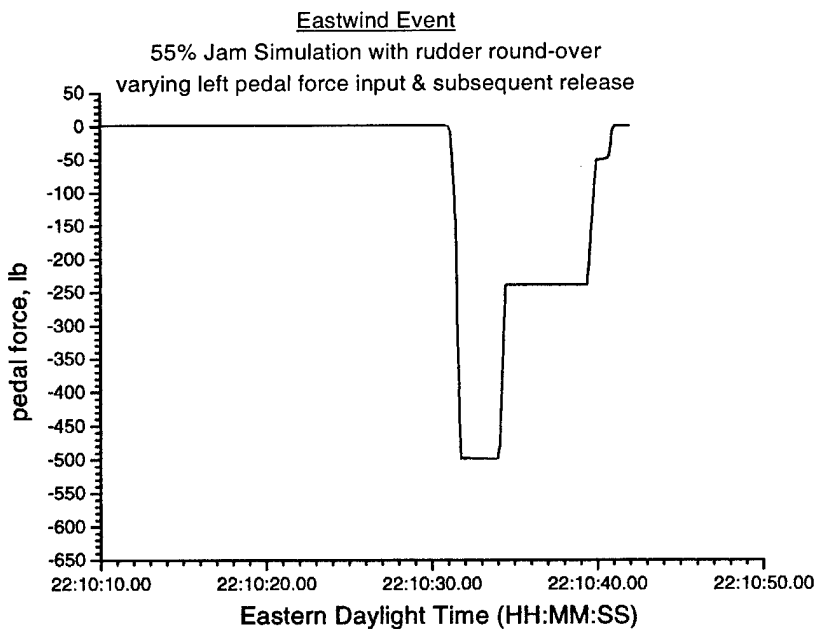

Figure 25c. Pilot rudder pedal force for Eastwind flight 517.

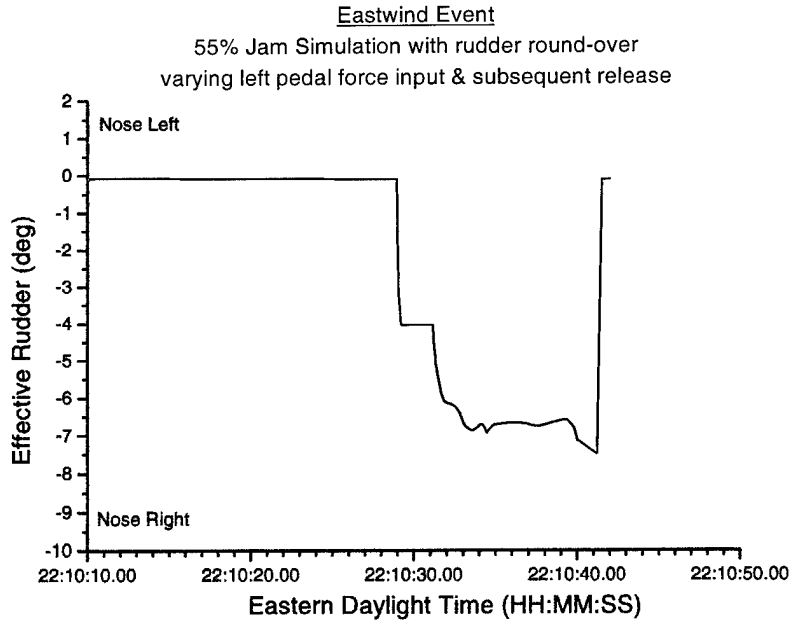

Figure 25d. Rudder surface positions for Eastwind flight 517.

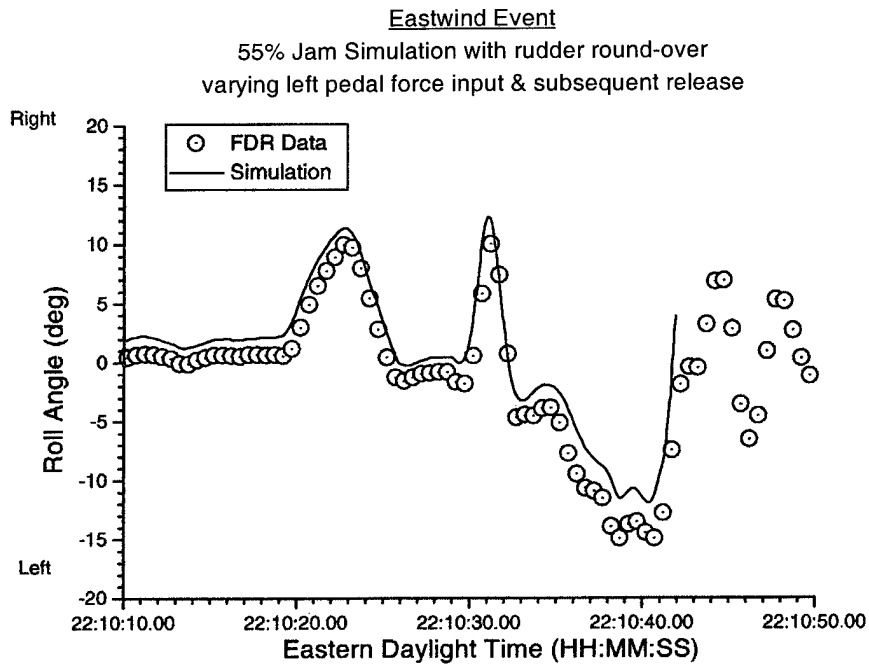

Figure 25e. Roll angle data for Eastwind flight 517.

Eastwind Event

55% Jam Simulation with rudder round-over
varying left pedal force input & subsequent release

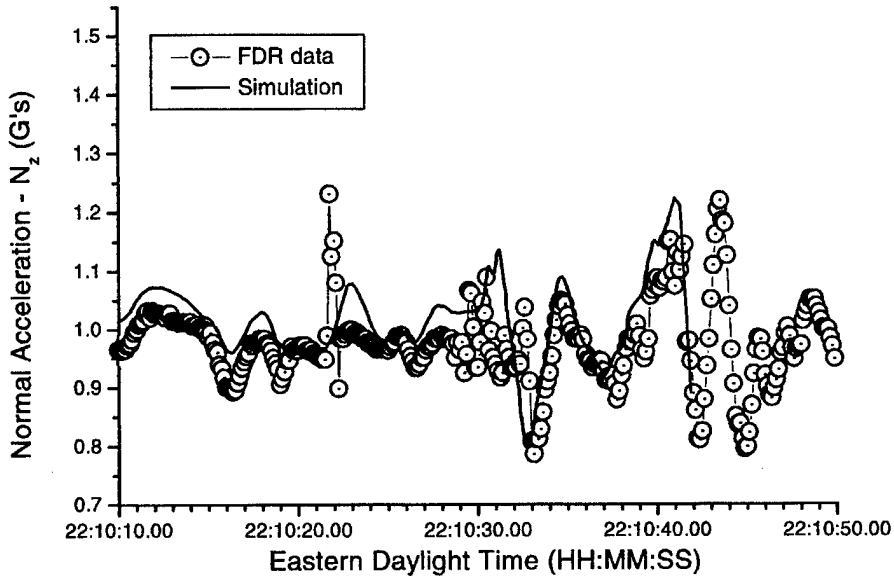

Figure 25f. Normal acceleration data for Eastwind flight 517.

Eastwind Event

55% Jam Simulation with rudder round-over
varying left pedal force input & subsequent release

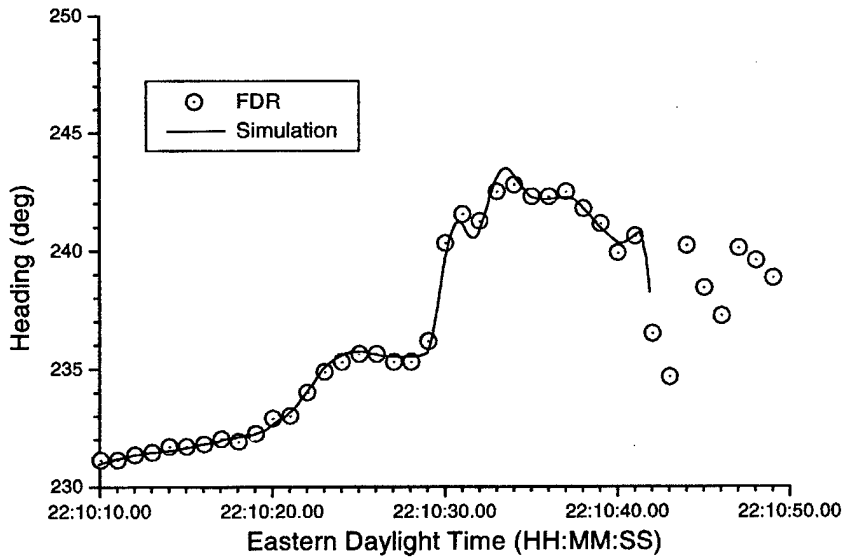

Figure 25g. Heading data for Eastwind flight 517.

Eastwind Event

55% Jam Simulation with rudder round-over
 varying left pedal force input & subsequent release
 Gimbal Error Corrected Indicated Heading

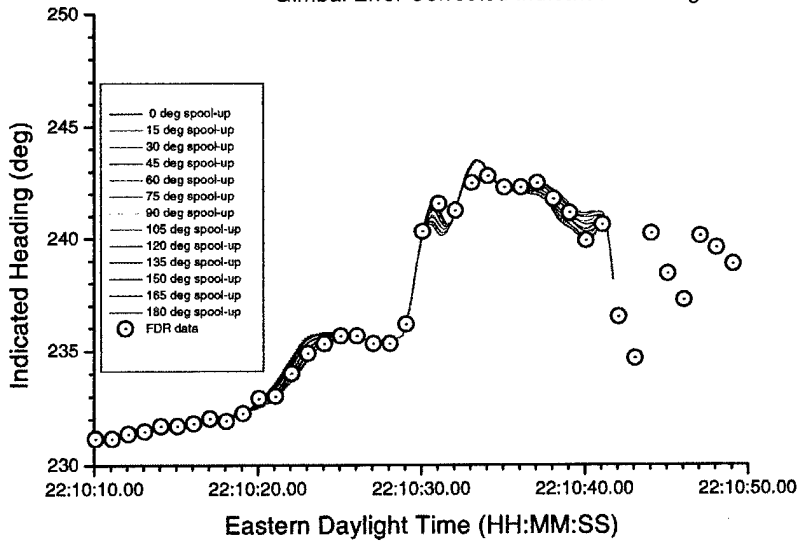

Figure 25h. Heading data corrected for gimbal error for Eastwind flight 517.

Eastwind Event

55% Jam Simulation with rudder round-over
 varying left pedal force input & subsequent release

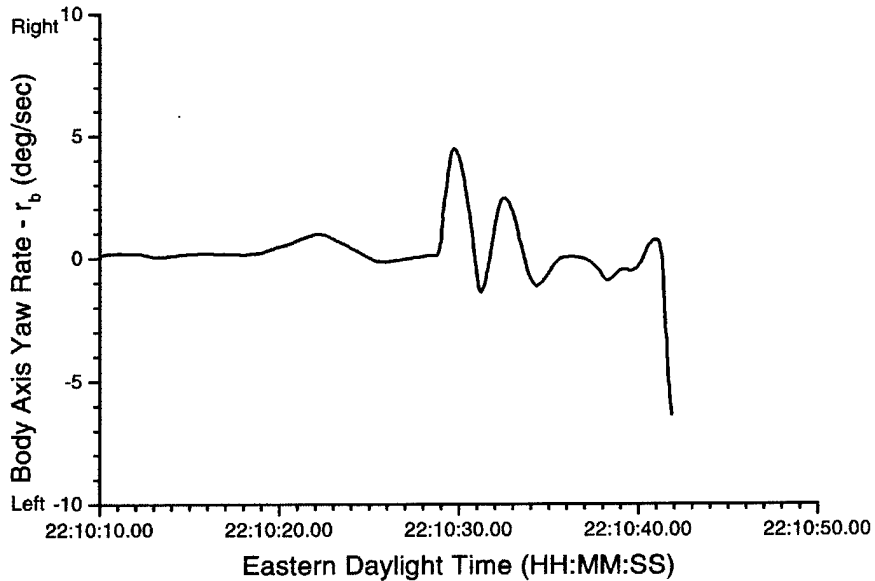

Figure 25i. Yaw rate for Eastwind flight 517.

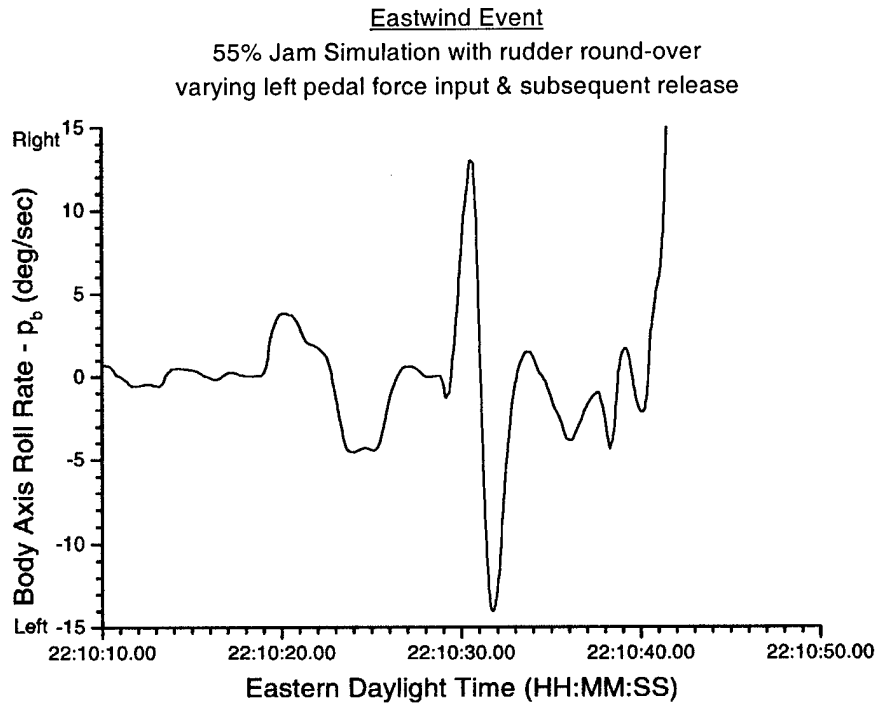

Figure 25j. Roll rate for Eastwind flight 517.

Boeing's August 14, 1998, submission supplement presented four scenarios for the Eastwind incident that were evaluated using Boeing's kinematic analysis and computer simulations.¹⁹⁶ In its submission supplement, Boeing suggested that one of its scenarios (number 4) was most consistent with the physical evidence, pilot reports, and kinematic analysis. Scenario 4 involves a preexisting yaw damper hardover condition that resulted in a rudder surface movement to 3° to the right, which the pilots compensated for with 3° of left rudder trim. According to this scenario, the yaw damper hardover condition cleared itself at the beginning of the upset event (about 2210:28), resulting in a sudden rudder movement to 3.7° to the left¹⁹⁷ and prompting a right rudder input (just after 2210:28) by the pilot(s), which resulted in the rudder moving to 6° to the right. In a February 19, 1999, letter to the Safety Board, Boeing provided "the results and analysis of a flight test...in support of conclusions made in [scenario 4 of Boeing's submission supplement]." Boeing's letter included a rudder plot that demonstrated a pilot rudder pedal response within ¼ second after the yaw damper hardover condition cleared (see figures 26a through 26c).

¹⁹⁶ According to Boeing's submission supplement, scenario 1 involved a preexisting left yaw damper hardover with a subsequent right yaw damper hardover, followed by a small nose-right rudder pedal input; scenario 2 involved a right yaw damper hardover with a servo valve secondary slide jam and reversal; scenario 3 involved a preexisting left yaw damper hardover with a subsequent right yaw damper hardover, plus a secondary slide jam and reversal; and scenario 4 involved a preexisting right yaw damper hardover that subsequently cleared, and the resultant yaw damper movement prompted a right rudder pedal input.

¹⁹⁷ The 3.7° left rudder position occurred because of the previous left rudder trim, the misrigged LVDT (see section 1.16.1.2), and compliance within the airplane's rudder system.

Eastwind Event
Boeing Solution
from fig 4 of February 24, 1999 letter

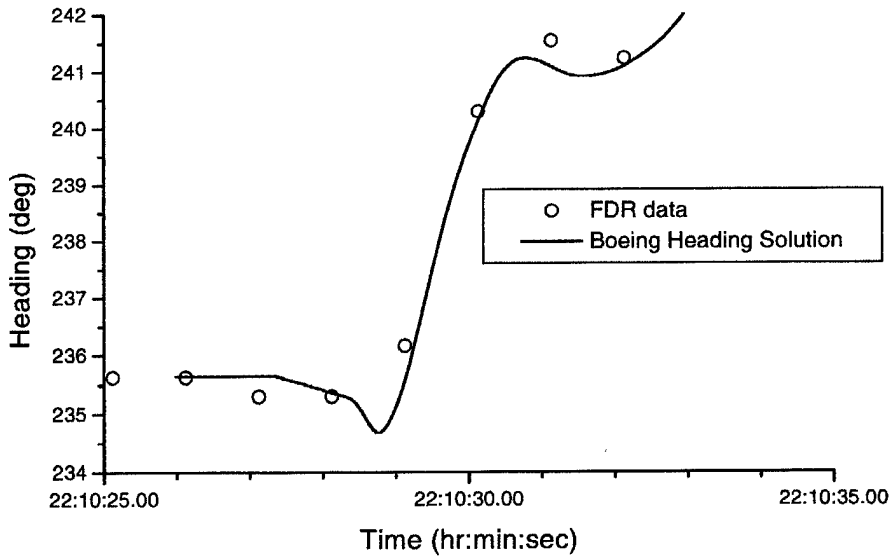

Figure 26a. Eastwind flight 517 heading data according to Boeing's scenario.

Eastwind Event
Boeing Solution
from fig 4 of February 24, 1999 letter

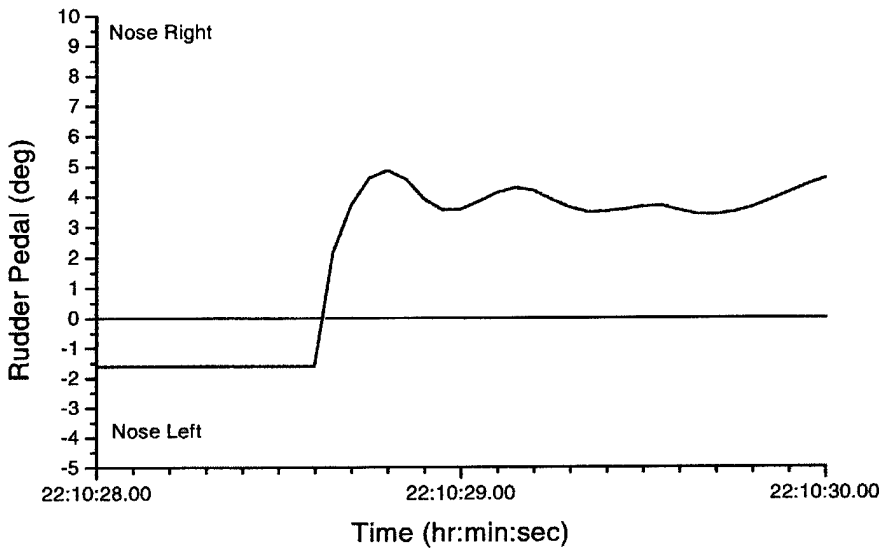

Figure 26b. Eastwind flight 517 pilot rudder pedal force according to Boeing's scenario.

Eastwind Event
Boeing Solution
from fig 4 of February 24, 1999 letter

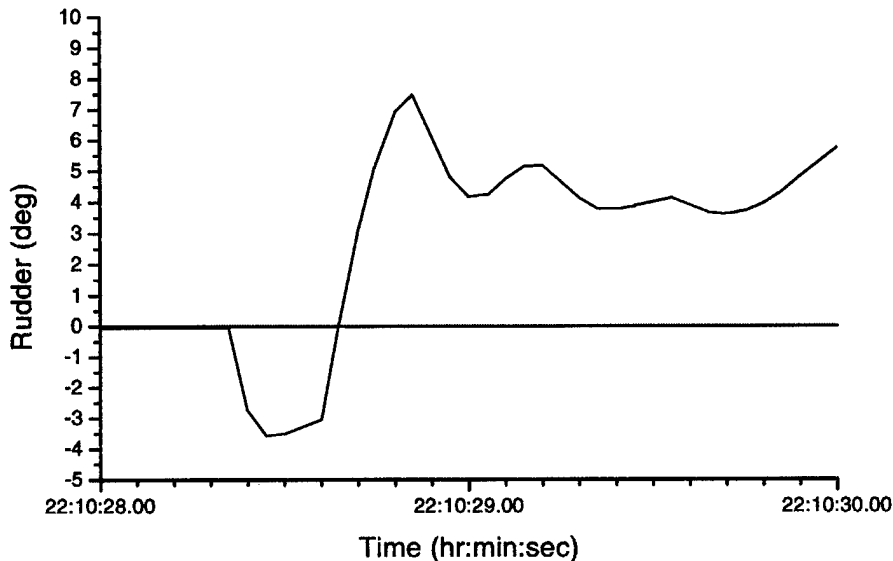

Figure 26c. Eastwind flight 517 rudder positions according to Boeing's scenario.

In Boeing's scenario, the pilots subsequently maintained the pressure on the right rudder pedal and used left control wheel and differential engine power to maintain directional control until the roll and yaw event ended. Boeing's August 1998 submission supplement stated the following regarding scenario 4:

The airplane rolls to the left during the initiation of the event and matches the heading very closely.... This scenario correlates with the reported nearly simultaneous input of rudder and wheel during the recovery.... [The captain's] usage of significant rudder input...is consistent with the manner in which [he] used rudder...during flight testing. The [captain's] stiff rudder comment may have been caused by the lack of expected airplane response to the significant rudder pedal input made by the pilot. The only significant discrepancy with the pilot report is the direction of his pedal command and his report that there was no yaw to the left.

Boeing's submission supplement also stated that "the yaw damper hardover and recovery proposed in scenario 4 does match the flight data recorder information." According to Boeing's scenario 4, the yaw damper would have been active after the yaw damper hardover cleared at the beginning of the upset event. Boeing's estimated rudder, yaw damper response, and rudder command is shown in figures 27a, and Boeing's estimated rudder with pilot command and no yaw damper activity is shown in figure 27b.

Eastwind
Boeing Kinematic Analysis
Fig 11, May 12, 1998 presentation

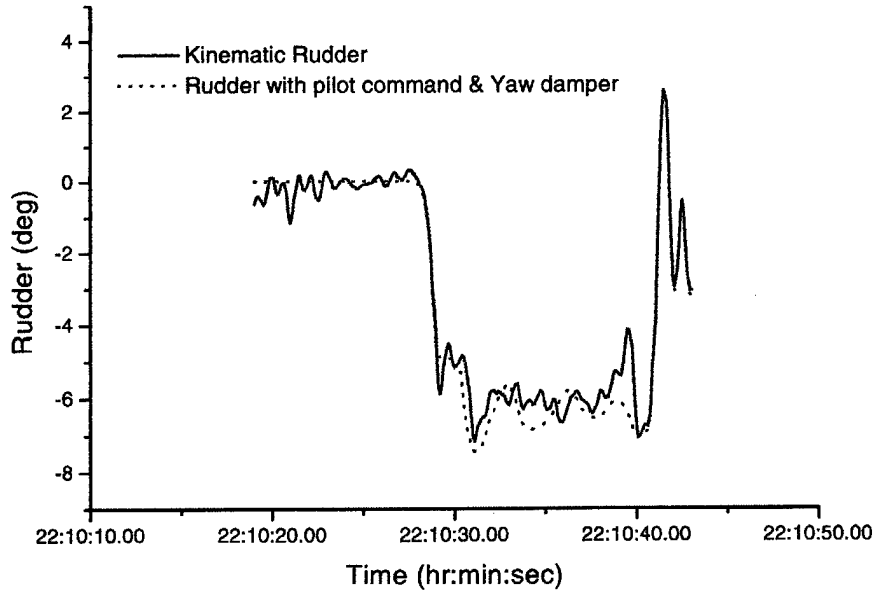

Figure 27a. Boeing's kinematic rudder for Eastwind flight 517 and rudder with pilot command and yaw damper activity.

Eastwind
Boeing Kinematic Analysis
Fig 11, May 12, 1998 presentation

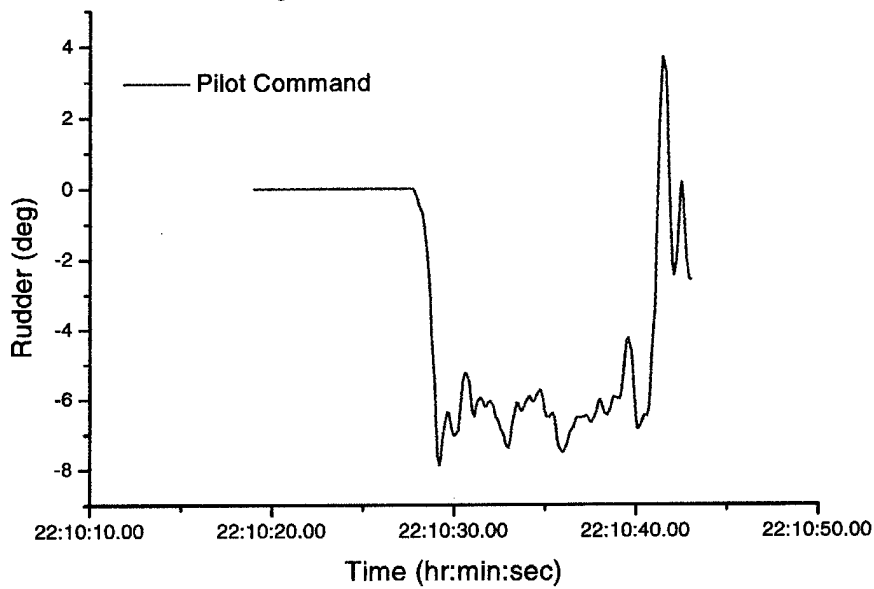

Figure 27b. Boeing's kinematic rudder for Eastwind flight 517 with pilot command and no yaw damper activity.

Figure 28a presents the rudder time history that resulted from Boeing's kinematic analysis of scenario 4. The heading time history that Boeing derived from its kinematically developed rudder (uncorrected for what Boeing has determined to be a simulator heading error) and used in its computer simulations is shown in figure 28b. Figure 28c shows the average flight test heading error, and 28d presents the "error corrected" heading time history compared with the FDR heading data.

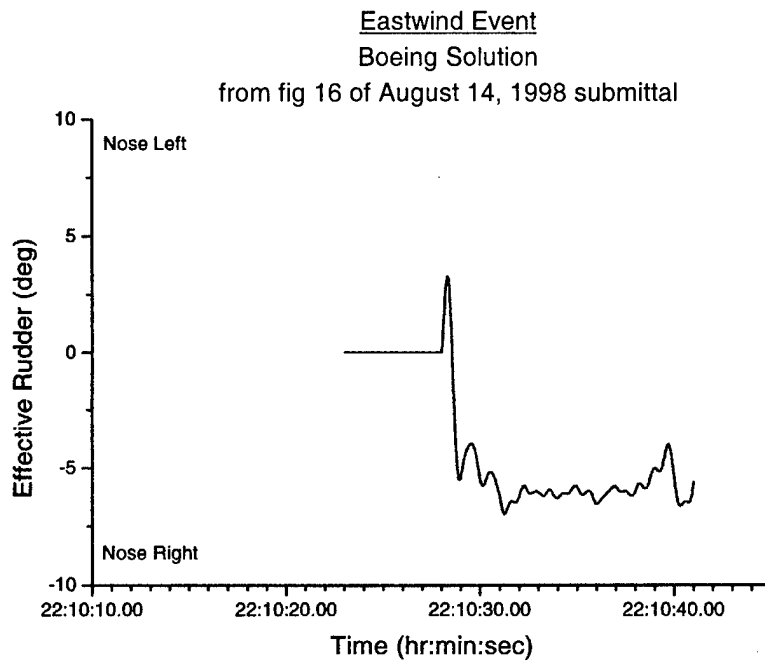

Figure 28a. Eastwind flight 517 rudder positions according to Boeing's scenario.

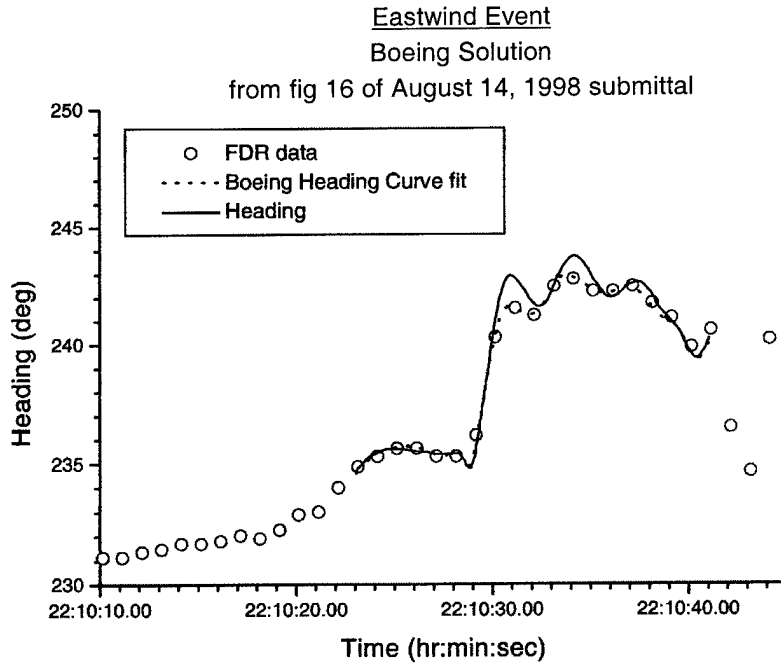

Figure 28b. Eastwind flight 517 heading data according to Boeing's scenario.

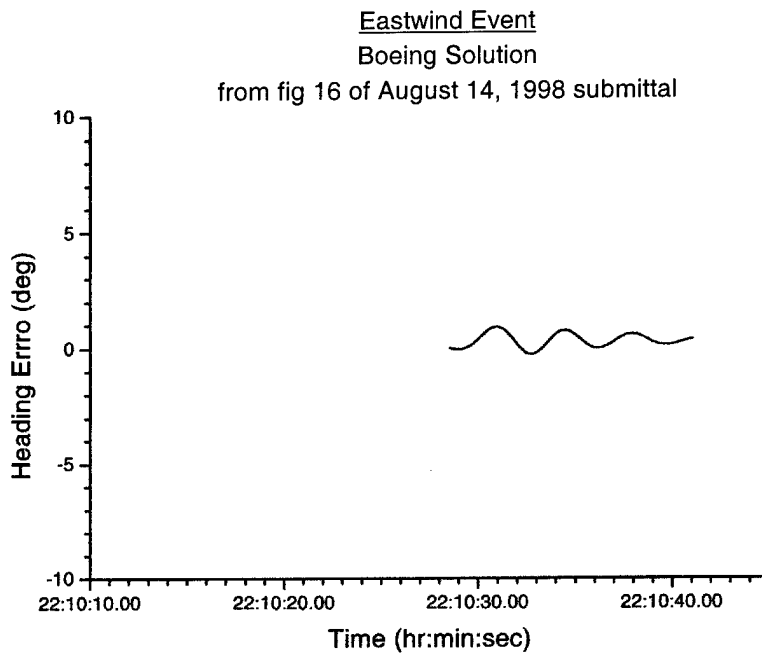

Figure 28c. Eastwind flight 517 average flight test heading error according to Boeing's scenario.

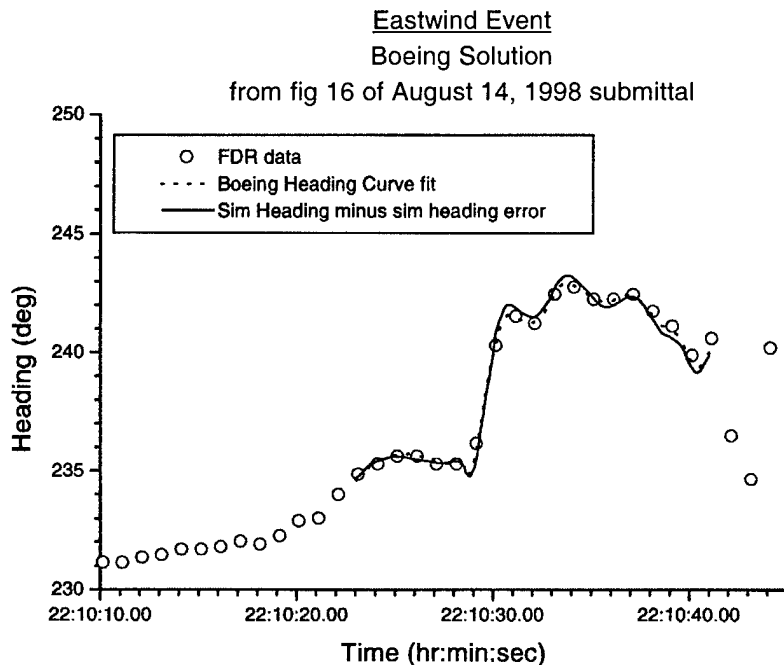

Figure 28d. Eastwind flight 517 corrected heading according to Boeing's scenario.

Boeing's submission supplement concluded that "multiple scenarios have been identified that match at least some of the data and crew reports from the Eastwind 517 event. None of the scenarios fully match all the data, kinematic analysis, and crew reports." The submission supplement also included Boeing's belief that, "...under the NTSB standard for identifying 'probable cause,' there is insufficient data to find a 'probable cause' for this event."

1.16.7 Identification of CVR Sounds/Sound Spectrum Analysis

During the examination of the CVR recording from the USAir flight 427 airplane, the CVR Group members noted several sounds that occurred during the initial upset and descent into terrain that they were initially unable to identify or explain. These sounds were as follows:

- sound similar to three thumps (at 1902:56.547, 1902:56.72, and 1902:56.855);
- sound of electrical impulse recorded on the captain's radio channel (at 1902:56.9);
- sound of two thumps (at 1902:58.2 and 1902:59.2);
- sound similar to airplane engines increasing in loudness (at 1902:58.27);
- sound of "clickety click" (at 1902:58.6 and 1902:59.5); and
- sound of wailing horn (at 1903:02.1).

To identify the sources of the sounds, the Safety Board examined the recording on a spectrum analyzer, which gives a visual presentation of the frequency content of the signals, and a computer signal analyzer, which allows detailed analyses of the analog waveform, frequency content, and detailed timing information. (Additionally, at Boeing's request, the Safety Board's Sound Spectrum Group conducted an additional review of the CVR sounds with Boeing flight test and system design engineers participating; no additional information was gained as a result of this review.)

When Safety Board investigators compared the CVR sounds from USAir flight 427 with CVR sounds obtained from known in-flight explosions, no similarities were noted. The Safety Board also provided the original CVR recording to the FBI's forensic audio laboratory in Quantico, Virginia, which examined the recording to identify any unusual sounds or signatures that might be associated with criminal or terrorist activity. The laboratory discovered no sounds that appeared to result from explosions, gun shots, or any other identifiable acts of violence.

1.16.7.1 Sounds Similar to Thumps (Three Initial Thumps Within 1 Second and Two Subsequent Thumps About 1 Second Apart)

Beginning at 1902:56.5, the accident airplane's CVR recorded a sound on the CAM channel, which investigators characterized as similar to three thumps within 1 second. Simultaneously, the CVR recorded an electrical impulse (when plotted, this impulse showed itself as a voltage spike) on the captain's channel (see section 1.16.7.2). These sounds were followed by two additional thump sounds, about 1902:58.2 and 1902:59.2. Examination of the entire 31-minute CVR recording revealed that the CVR had not recorded anything similar to the thump sounds during the previous 30½ minutes. Examination of each of the thump sounds using the spectrum analyzer and computer signal analyzer revealed that the sounds exhibited frequency signatures with most of their energy in the low-frequency (below 500 Hz) range. The "impulse" type of sound that is usually formed when two hard surfaces strike each other contains energy distributed equally through a large range of frequencies.

Because investigators were initially unable to identify the source of these thump sounds, and because of the circumstances of the accident, the Safety Board devised a test to document the effects (and sounds) of rudder cable(s) breaking. As previously discussed, the sounds recorded by the CVR during these tests were impulsive in nature, with energy distributed throughout the frequency spectrum. (See section 1.16.5.2 for details of the rudder cable break tests.)

Because the sounds were recorded by both the CAM and the jumpseat/observer channels of the CVR, indicating that the sounds could have been transmitted to those microphones through the air and/or through the airplane's metal structure, the Safety Board conducted tests to derive the source and relationship of the thump sounds. A test 737-300 was configured to represent the accident airplane's condition at the time the thump sounds were recorded: the cabin and cockpit doors were closed, the jumpseat/observer position oxygen mask was stowed properly,¹⁹⁸ the CAM was positioned in the same location as in the accident airplane, and two crew microphones were used.¹⁹⁹

Investigators then struck the airplane structure at various locations (inside and outside) with a rubber mallet and moved/bumped service equipment within the cabin, with the CVR recording the resultant sounds.

Examination of the CVR recording from the tests revealed that the rubber mallet impact sounds were recorded by each microphone as two distinct events; in both cases, the first recorded event was the sound transmitted through the airplane structure, and the second was the sound that was transmitted through the air. The time difference between the recorded sounds for any given mallet strike corresponded directly to the distance between the microphone and the location of that mallet strike. Further, investigators noted that the sound signals would arrive first at the microphone closest to the mallet strike. Thus, it was possible to calculate the approximate distance and direction to the source of the sounds. Reexamination of the thump sounds recorded by the accident CVR, in relation to the sounds recorded by the CVR recording from the tests, revealed that the accident CVR recorded sounds consistent with a sound from a source approximately 12 to 16 feet back from the CAM (corresponding to the fuselage area about the location of passenger seat row 1 or 2). Although the rubber mallet strike tests could duplicate the timing of the thump sounds, the sound signatures produced during the tests (whether from mallet strikes, jumping in the cabin, or movement of cabin service equipment) were distinctly different from those recorded by the accident CVR.

The pilots who participated in the wake turbulence encounter test flights reported that, under some flight test conditions, they heard sounds in the cockpit that they associated with the wake turbulence encounters. The pilots described the sounds as "whooshing" sounds and stated that they were usually heard during the test conditions in which the main fuselage passed through the center of the wake core. The Sound Spectrum Group compared the CVR sounds from USAir flight 427 with the CVR sounds recorded during the wake turbulence flight tests and noted that the sounds recorded during some of the wake encounters were very similar in frequency, energy, and timing to the thumps recorded by the accident CVR.

1.16.7.2 Sound of Electrical Impulse Recorded on the Captain's Radio Channel

At 1902:56.9, an electrical impulse (a voltage spike) of unknown origin was recorded on the captain's radio channel. The duration of the voltage spike was measured to be 0.0068 seconds. Further examination of the voltage spike revealed that it was composed primarily of two frequencies (2818 and 400 Hz) superimposed on one another. Safety Board investigators subjected a representative CVR installation to a test series of

¹⁹⁸ For additional information regarding the jumpseat/observer position oxygen mask, see section 1.11.1.

¹⁹⁹ The thump sounds on the accident airplane's CVR were not recorded on either pilots' channel. Investigation revealed that both pilots wore headsets with boom microphones that were wired "hot" to the CVR. According to the manufacturer, the microphones were designed to pick up voice frequencies and suppress most background noises. Further, the microphones would not be sensitive to sounds transmitted through the airplane structure because they were isolated from the structure by the human body.

disturbances, including electrical field, magnetic field, induced voltage spike, radio frequency susceptibility, over- and undervoltage transients, power interruptions, and high voltage induced transients (simulating lightning strikes). The CVR recording from the test revealed that, although some of the test conditions induced voltage spikes and noise on the CVR recording, none of the spikes resembled the voltage spike recorded by the accident CVR. However, during the testing, investigators noted that activation of a radio/intercom selector switch in the intercom position produced a voltage spike nearly identical to the spike recorded by the accident CVR. The spring-loaded radio/intercom selector switch on the radio selector panel is located outboard of the pilots' knees in the cockpit.

1.16.7.3 Sound Similar to Airplane Engines Increasing in Loudness

A review of the sound signatures associated with the rotating engines recorded by USAir flight 427's CVR revealed that, throughout the 31-minute CVR recording, the engine's sound signatures changed in frequency as the engine speed increased or decreased²⁰⁰ but remained constant in intensity (volume). During the upset sequence, the CAM channel of the accident CVR also recorded variations in the volume of the sound signatures associated with the engines. The sound spectrum study indicated that, at 1902:58.27 and 1903:02.3, the sounds on the CVR recording that were associated with both engines simultaneously increased in volume by about 30 percent; at the same time, the frequency of the engine sound signatures, and the volume of all other background noises, remained constant. The first increase signature occurred about 0.17 seconds after the first thump in the second set of thump sounds; the second increase occurred about 1 second later, just before the captain exclaimed "hang on." Although FDR data indicated that the engine power settings changed during the accident sequence,²⁰¹ the engine sounds (when identifiable) remained at the increased volume throughout the remainder of the CVR recording.

The Safety Board attempted to determine why the volume of the engine sound signatures increased in a manner that did not correspond to FDR-recorded changes in engine power setting during the upset sequence. The Board considered the following possibilities: the ability of the CVR recording system to pick up these sounds had increased; the sound transmission path between the engines and the CVR area microphone had changed; and the amount of engine inlet fan noise had increased. The Safety Board could not identify any physical or electrical phenomena that would account for an increase in the ability of the CVR recording system to record the volume of the engine sound signatures, while sound signatures at all other frequencies remained unchanged, as they did in the accident airplane's CVR recording. The engine noise volume increase affected

²⁰⁰ Examination of these sound signatures revealed two distinct traces, one being slightly higher in frequency than the other. Review of the FDR data revealed that the right engine fan speed (N1) was operating at 1 to 3 percent higher revolutions per minute than the left engine fan speed. This difference coincided with the difference in engine fan speeds calculated from the CVR engine sound signatures.

²⁰¹ The FDR data indicated that, after a brief increase in engine power setting at 1903:02, the engine power settings began to decrease from the peak power setting recorded during the accident sequence (about 80 percent N1); by 1903:09, the engine power settings had decreased to about 30 percent N1, at which point they remained until ground impact.

both engines equally and symmetrically, and the accident CVR did not record an increase in background wind noise. In other accident investigations,²⁰² the Safety Board observed that a change in the engines' sound transmission path because of a change in the airplane's structure (loss of a fuselage panel or a cabin door opening in flight) was accompanied by a dramatic increase in background wind noise. No such increase in background wind noise was recorded by the USAir flight 427 CVR. The Safety Board's review of CVR information from previous investigations yielded several occurrences (such as a bird strike or a loss of engine cowling structure) that affected the amount of inlet fan noise that one of the engines produced. However, these occurrences on previous accidents did not affect both engines equally and simultaneously.

Safety Board investigators also examined a representative sample of the CVR recordings from the wake vortex flight tests²⁰³ (discussed in section 1.16.2) in an attempt to identify any potential relationship between crossing a wake vortex and the engine sound signature recorded by the CVR. None of the sampled CVR recordings showed any significant change in the engine sound signatures as a result of the wake encounters.

During a series of flight tests on the 737-300 conducted by the Safety Board in September 1995 to evaluate flight control characteristics and validate and expand Boeing's 737 mathematical simulator model, the instrumented airplane was subjected to several full rudder deflection and maximum rate aileron roll maneuvers. During postflight examination of the audio recordings from these flights, Safety Board investigators observed that, during some of the maneuvers, the engine sound signatures increased in volume, similar to the volume increases that were observed on the accident CVR recording. The airplane maneuvers that resulted in such changes to the engine sound signatures included large rudder displacements (both right and left) at various angles and rates in which flight test pilots utilized opposite aileron to limit rudder-induced bank angle (steady heading sideslip) and rudder-only flight control input (both right and left) at various rudder displacement angles and rates. The test maneuvers in which large and rapid rudder displacements were applied resulted in the greatest change in engine sound signature intensity. When the CVR recordings from the flight tests were compared with the CVR recording from the USAir flight 427 airplane, the best match was with the flight test condition involving rapid rudder input from 0 to 14° rudder.

²⁰² See National Transportation Safety Board. 1990. *Aloha Airlines Flight 243, In-flight Structural Failure, near Maui, Hawaii, April 28, 1988*. Aircraft Accident Report NTSB/AAR-89/03. Washington, DC. Also see National Transportation Safety Board. 1990. *United Airlines Flight 811, In-Flight Cargo Door Separation, near Honolulu, Hawaii, February 24, 1989*. Aircraft Accident Report NTSB/AAR-90/01. Washington, DC.

²⁰³ Fourteen encounters were selected for this examination; these selections were considered representative of wake vortex penetrations from all the various entry angles and trailing distances behind the wake-producing airplane.

1.16.7.3.1 Comparison of Engine Sound Signatures From the United Flight 585 CVR and a CVR From 737-200 Flight Tests

Because of the Safety Board's findings (discussed in section 1.16.7.3) that certain sideslip and yaw maneuvers in a 737-300 could result in changes in engine sound signatures, investigators next attempted to determine whether such maneuvers in a 737-200 would result in similar changes in engine sound signatures and, if so, whether any such changes could be discerned on the United flight 585 CVR.²⁰⁴ According to Boeing, the overall geometry and proportions of the 737-200 and -300 series fuselages are very similar; however, the airplanes are equipped with significantly different engines. The 737-200's engines are equipped with inlet vanes or diffusers that intentionally make the inlet airflow turbulent.²⁰⁵ Therefore, investigators recognized the possibility that maneuvers causing the inlet airflow to be slightly more turbulent might not produce significant change in the engine's noise-producing characteristics.

On June 3, 1996, the Safety Board conducted an engine perturbation flight test using a United Airlines 737-200 at the United Airlines Maintenance Operations facility in Indianapolis, Indiana. The flight test consisted of airplane maneuvers similar to those conducted during 737-300 flight control characteristics testing in September 1995. (See section 1.16.4.) The CVR recordings of the 737-200 flight test during sideslip and yaw conditions revealed engine sound signature changes similar to those heard in the 737-300 flight test CVR recordings for the same conditions.

The CVR recording from United flight 585 was compared with the CVR recording from the 737-200 flight test. However, analysis of the engine sounds on the United flight 585 CVR was hampered by two factors: the recording was of poor quality with obscuring background noise and the pilots of United flight 585 were changing the engine power settings—and therefore, varying the revolutions per minute frequency—almost constantly during the approach to land. Investigators attempted to compensate for these factors when possible and then extracted and plotted the resulting engine sounds. Further, investigators plotted the FDR data (heading, altitude, vertical Gs, and indicated airspeed) along with the CVR data. No changes in engine sound volume were detected on the United flight 585 CVR.

1.16.7.4 Sounds of “Clickety Click”

During public hearing testimony, Boeing's flight test pilot speculated that the clickety click sounds might have been caused by the windshield wipers “chattering” or “slapping” on the windshield as the wake vortex impacted the airplane's fuselage. He

²⁰⁴ The Safety Board would have attempted to apply the same techniques to the CVR recording from the Eastwind flight 517 incident, which also involved a 737-200; however, the 30-minute CVR tape continued to run after the airplane landed, and the relevant portion of the flight was recorded over.

²⁰⁵ According to the engine manufacturer, the engines installed on the 737-200 series airplane were designed when controlling/reducing inlet noise was not a critical issue for manufacturers. Because of the differences in engine inlet design, the engines installed on the 737-200 series airplanes produced more noise than the engines installed on the 737-300 series airplanes.

stated that when the wake core hit the fuselage, "it actually lifted the windshield wiper perpendicular off the wind screen and then it popped back with a rather subtle clicking noise." The Safety Board was unable to find a sound on the wake turbulence flight test CVR recordings that matched the clickety-click sounds recorded by the accident CVR at 1902:58.6 and 1902:59.5.

1.16.7.5 Sound of Wailing Horn

Although the wailing horn sound that was recorded by the USAir flight 427 CVR was originally identified as being "similar to autopilot disconnect," further investigation revealed that the wailing horn recorded by the accident CVR did not sound the way the autopilot disconnect aural warning was designed to sound. According to Boeing engineers, the autopilot aural warning is generated by sweeping electronic sound oscillators from low to high frequency, resulting in a sound that is described in Boeing literature as a "fast wailer." The aural warning is designed to continue to cycle every second for as long as the horn is activated. On the accident CVR recording, the wailing horn started as a fast wailer but, after one cycle, lapsed into a fast-cycle warbling tone, which continued to the end of the recording.

Investigation revealed that the unit that generated the autopilot disconnect aural warning on the accident airplane also generated most of the cockpit aural warnings. The unit was equipped with multiple sound oscillators and bells and generated aural warnings, in addition to autopilot disconnect, for engine fire, loss of pressurization, aircraft overspeed, and takeoff/landing conditions. The unit was designed with a warning priority schedule—when a warning is being sounded and a warning with a higher priority is sensed, the unit will stop the lower priority warning and sound the higher priority warning.

The Safety Board conducted tests on a USAir 737-300 that was equipped similarly to the accident airplane. These tests revealed that, when the autopilot disconnect and landing gear warnings²⁰⁶ were sounded simultaneously, the test airplane unit produced a cockpit aural warning that appeared to mix the steady landing gear warning tone with the wailing autopilot disconnect horn, producing a warbling tone centered around the landing gear warning tone—similar to the aural warning recorded by the accident airplane's CVR. However, when the test airplane unit was examined on a test bench, all warnings were within specification, and the warning priority specifications functioned in a manner consistent with their design. Further examination revealed that unintended mixing of aural warnings can result from incomplete-electrical grounding of the warning system.

1.16.8 Study of Pilots' (USAir Flight 427 and United Flight 585) Speech, Breathing, and Other CVR-recorded Sounds

As part of its investigation of the USAir flight 427 accident, the Safety Board examined the pilots' speech (voice fundamental frequency, or pitch; amplitude, or

²⁰⁶ According to Boeing representatives, the landing gear warning can be activated when one or both throttles are retarded to idle and the landing gear is not extended.

loudness; speaking rate; and content) and breathing (inhaling, exhaling and grunting) patterns recorded by the CVR during the routine portions of the flight, the initial upset, and the uncontrolled descent. Investigators extracted several acoustical measures of speech (fundamental frequency, amplitude, and speaking rate) from pilot statements on the CVR recording to understand the actions and emotional states of the pilots during the accident sequence.²⁰⁷ Similar speech analysis techniques have been used previously by Russian, Japanese, and Australian investigative and research authorities²⁰⁸ and by Safety Board investigators on three occasions before this investigation.²⁰⁹

The Safety Board reviewed the USAir flight 427 CVR for pilot speech samples appropriate for computer speech analysis. The Safety Board observed that the captain spoke the airplane's call sign, "four twenty seven," during routine and emergency radio transmissions, providing a basis for direct comparison using the same words. When the captain spoke the phrase "four twenty seven" during routine flight operations, the average fundamental frequency value was 144.6 Hz. However, when the captain stated four twenty seven about 1903:15 during the emergency descent, the speech fundamental frequency increased 47 percent, to 214 Hz. Figure 29 graphs the fundamental frequency measures obtained for the captain's statements before and during the upset period, showing changes in the fundamental frequency of his speech as the emergency situation developed.²¹⁰ Figure 30 graphs the amplitude measures obtained for the same statements. According to scientific literature,²¹¹ fundamental frequency, amplitude, and speaking rate tend to increase in response to increased psychological stress.

The captain's speech fundamental frequency during the 3 minutes before the initial upset event generally ranged between 127 and 148 Hz and then increased to 210 Hz when he stated "sheez." Additionally, the captain's amplitude during the 3 minutes before the upset event ranged between 237 and 520 volts²¹² and then increased to 904 volts when he

²⁰⁷ See "Speech Examination Factual Report, May 5, 1997" for details on the extraction procedures, which employed computer analysis.

²⁰⁸ For additional information, see Brenner, Malcolm, Mayer, David, and Cash, James [NTSB]. "Speech Analysis in Russia." In *Methods and Metrics of Voice Communications*. 1996. Ed. B.G. Kanki and O.V. Prinzo. Washington, DC: Department of Transportation, Federal Aviation Administration, Office of Aviation Medicine, DOT/FAA/AM-96/10. Also see Mayer, David L., Brenner, Malcolm, and Cash, James R. [NTSB]. "Development of a Speech Analysis Protocol for Accident Investigation." In *Methods and Metrics of Voice Communications*. 1996. In addition, see Aircraft Accident Investigation Report [Japan], *Japan Air Lines Co., Ltd., Boeing 747 SR-100, JA8119, Gunman Prefecture, Japan, August 12, 1985* and Bureau of Air Safety Investigation Accident Investigation Report, *Mid-Air Collision Between Cessna 172-N VH-HIZ and Piper PA38-112 VH-MHQ, near Tweed Heads, New South Wales, 20 May 1988* (BASI Report 881/1042).

²⁰⁹ For additional information, see NTSB Aircraft Accident Reports FTW91FA144 and SEA95FA175. Also see National Transportation Safety Board. 1990. *Grounding of the U.S. Tankship EXXON VALDEZ on Bligh Reef, Prince William Sound near Valdez, Alaska, March 24, 1989*. Marine Accident Report NTSB/MAR-90/04. Washington, DC. In addition, see Brenner, M., and Cash, J. 1991. "Speech Analysis as an Index of Alcohol Intoxication—The Exxon Valdez Accident." *Aviation, Space, and Environmental Medicine*, 62, 893-98.

²¹⁰ Only those statements that were free of artifacts caused by background conversation or other sounds appear on this graph and the one in figure 30. Of the three measured aspects of the captain's speech, fundamental frequency provided the most measurable data. Missing data precluded similar measurements of the captain's speech rate or amplitude.

stated "sheeez." (The captain's speech amplitude reached its maximum measured value of 2,865 volts at 1903:18.1 during the emergency descent.) Review of the first officer's speech during the accident flight revealed that he did not speak enough during the emergency period to provide a basis for meaningful analysis.

The Safety Board conducted a similar laboratory speech analysis examination of the speech and other sounds recorded by the United flight 585 CVR. The only measurable data obtained during this examination was for speech fundamental frequency.²¹³ The captain's speech fundamental frequency when he spoke the word "flaps" during routine and emergency radio transmissions provided a basis for direct comparison. When the captain said "flaps" during routine flight operations, his speech exhibited an average fundamental frequency of 131 Hz. However, when the captain stated "flaps" at 0943:33.5 during the upset event, the fundamental frequency of his speech had increased 77 percent, to 233 Hz.

²¹¹ See Ruiz, R., Legros, C., and Guell, A. 1990. "Voice analysis to predict the psychological or physical state of a speaker." *Aviation, Space, and Environmental Medicine*, 61, 266-71. Also, see Brenner, M., Doherty, E.T., and Shipp, T. 1994. "Speech measures indicating workload demand." *Aviation, Space, and Environmental Medicine*, 65:21-26.

²¹² Amplitude is often measured in decibels, a logarithmic scale determined relative to an internationally accepted calibration standard. Because no calibration standard was available in the CVR recording, amplitude was measured in volts (the direct measure of physical intensity) and plotted on a logarithmic scale for convenience.

²¹³ Amplitude could not be measured because of the automatic gain control feature on the microphone. Speech rate could not be measured because of the limited amount of speaking by either crewmember during the emergency period.

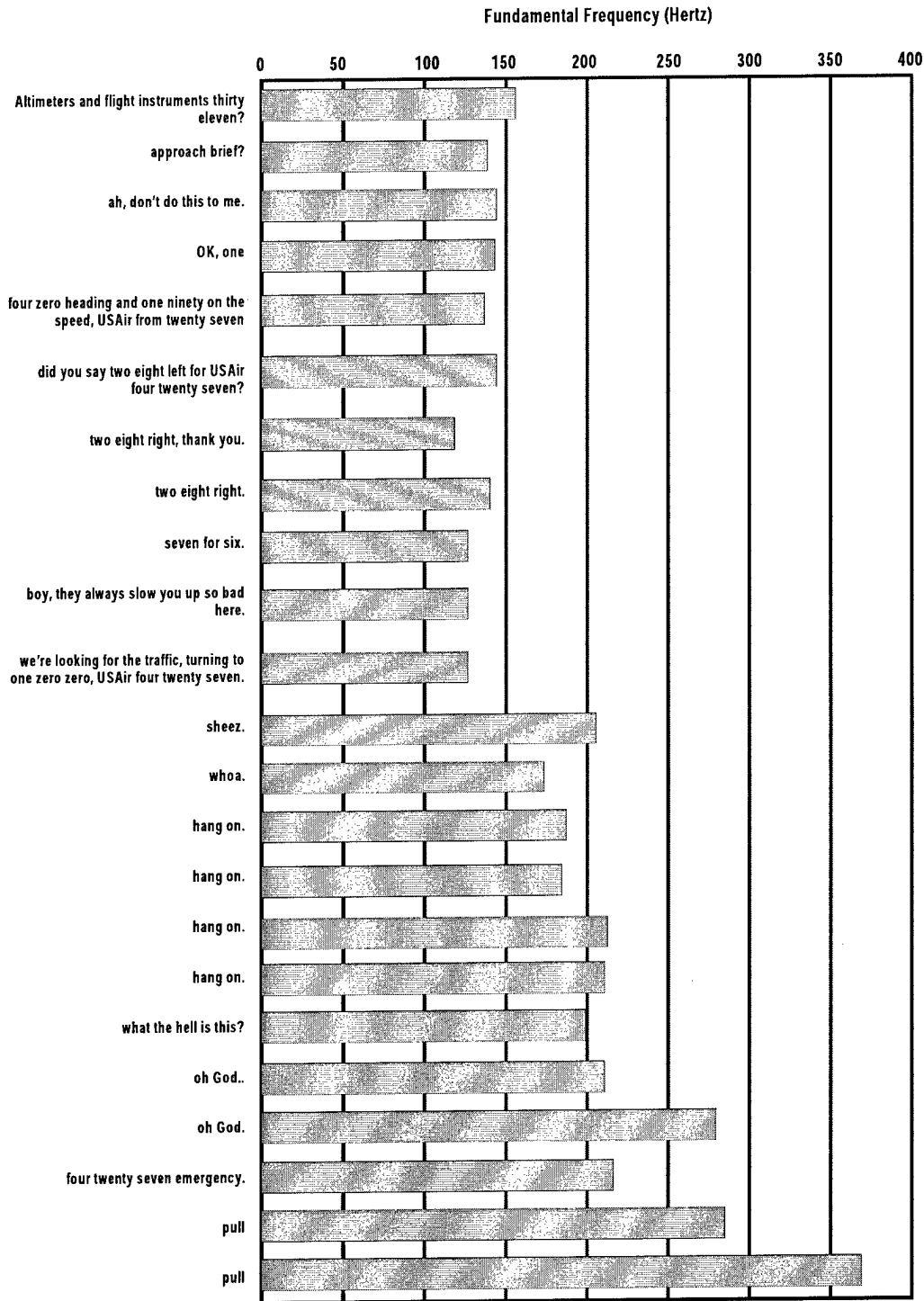

Figure 29. Fundamental frequency measures of the USAir flight 427 captain's speech.

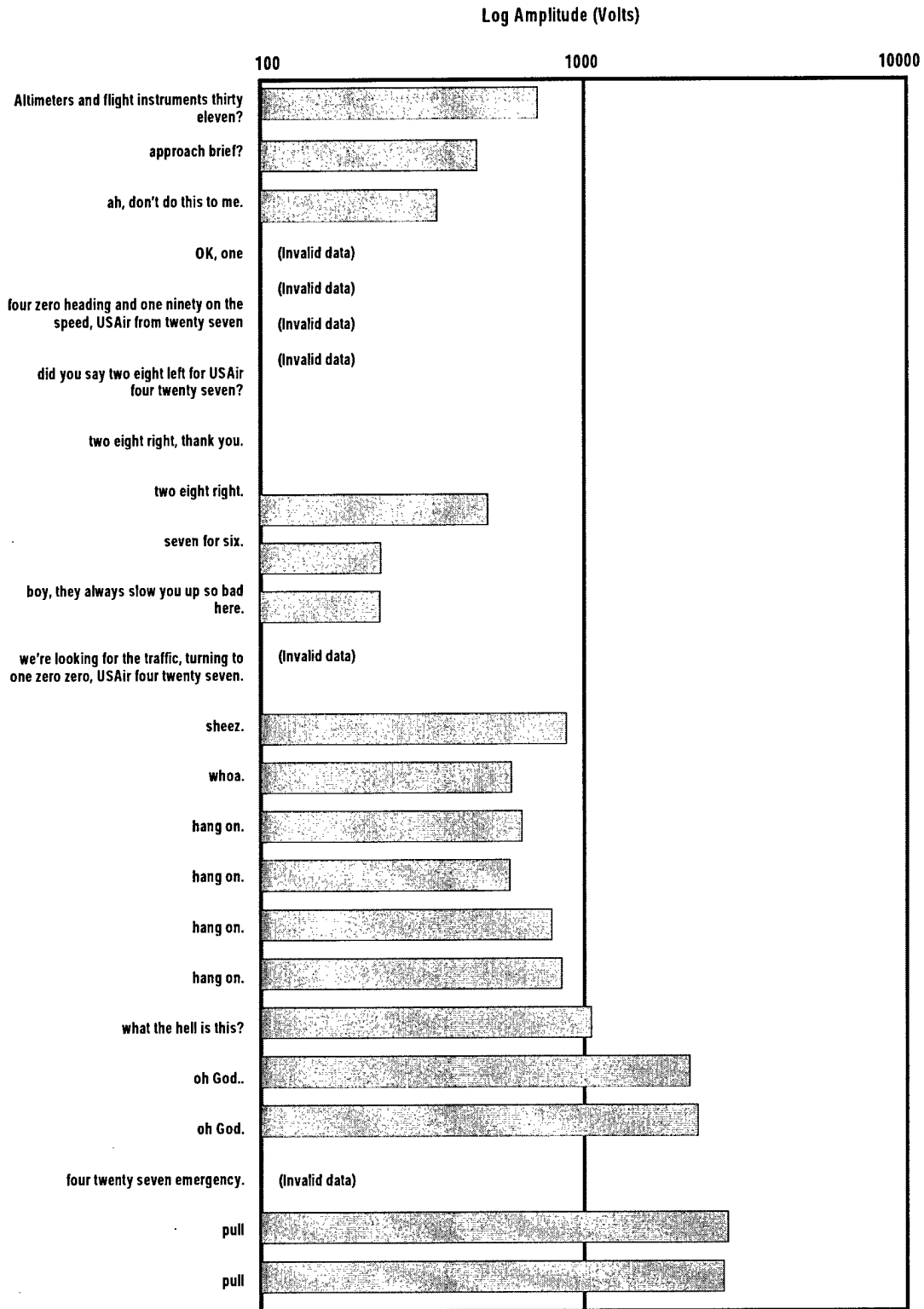

Figure 30. Amplitude measures for the USAir flight 427 captain's speech.

1.16.8.1 Independent Specialists' Review of Pilots' Speech, Breathing, and Other Sounds—USAir Flight 427

The laboratory speech analysis results and CVR tape and transcript from USAir flight 427 were provided to three independent specialists from the Interstate Aviation Committee, Moscow, Russia;²¹⁴ the U.S. Naval Aerospace Medical Research Laboratory, Pensacola, Florida;²¹⁵ and NASA's Ames Research Center, Moffett Field, California.²¹⁶ Their areas of specialization were general speech analysis (focusing on issues of psychological stress and physical effort), breathing physiology,²¹⁷ and communication information, respectively.

The specialists agreed that the USAir flight 427 CVR recorded no speech patterns by the pilots or other sounds to indicate that either pilot was physiologically impaired or incapacitated; rather, the specialists stated that both pilots sounded alert and responsive throughout the flight, including the upset and accident sequence. The specialists agreed that the first indication of the upset event on the CVR recording occurred about 1902:57, just as the first officer finished stating, "oh, ya, I see zuh Jetstream." Within 1 second, the CVR recorded a sound similar to three thumps (see section 1.16.7.1), "sheeez" from the captain, and "zuh" from the first officer. The specialists stated that the speech patterns of the pilots indicated that they were surprised by the initial upset, but the specialists agreed that the pilots responded promptly to the situation and were attempting to control the airplane and identify the problem. None of the specialists were able to determine if the pilots were operating the control wheel, the rudder, or both in their efforts to control the airplane.

To ensure that all the straining, grunting, and other sounds recorded by the CVR were thoroughly and accurately documented,²¹⁸ the Safety Board and the independent speech experts from Moscow's Interstate Aviation Committee and the U.S. Naval

²¹⁴ This specialist is the Chief of the Acoustical Laboratory at the Interstate Aviation Committee. He has a medical degree and graduate level training in psychology. He has participated in more than 250 aviation accident investigations and specializes in medical and psychological aspects, especially the psychological analysis of speech.

²¹⁵ This specialist is a Research Physiologist in the Aviation and Operational Medicine Department of the U.S. Naval Aerospace Medical Research Laboratory. He has a doctorate degree in exercise physiology, and his research includes work on the effects of physical fitness on normal load factor tolerance and the development of anthropometric standards for naval aviators.

²¹⁶ This specialist is a Research Psychologist at the NASA's Ames Research Center. She has a doctorate degree in behavioral sciences, and her research addresses aerospace human factors, focusing on crew communication, coordination, and performance issues.

²¹⁷ Breathing sounds are normally not audible on the CAM channel, which is recorded by a microphone in the overhead panel above the pilots (and used for most CVR transcripts). However, breathing sounds are often audible on the "hot microphone" channels recorded from boom microphones attached to the headset of each pilot and positioned directly in front of each pilot's mouth. The breathing information in this investigation was recorded on these hot microphone channels.

²¹⁸ The CVR transcript indicates that the captain inhaled and exhaled quickly at 1902:58.7 and that the first officer was grunting at 1903.01.6. Several other instances of such sounds on the CVR are not noted in the transcript. The Safety Board does not generally document every such sound when preparing official transcripts of CVR recordings.

Aerospace Medical Research Laboratory reexamined the sounds recorded by the CVR between 1902:57.6 and 1903:23. Both experts noted additional sounds recorded on the first officer's hot microphone channel that could indicate high physical loads. These sounds and their duration were documented by Safety Board investigators as follows:²¹⁹

- “zuh” from 1902:57.6 to 1902:57.8,
- a rapid inhale from 1902:59.7 to 1902:59.9,
- a soft grunt from 1903:00.3 to 1903:00.5,
- a louder grunt from 1903:01.5 to 1903:01.6,
- a loud exhale from 1903:01.8 to 1903:02.1, and
- “oh [expletive]” from 1903:04.6 to 1903:05.1.

No other inhaling, exhaling, or vocalizing sounds were detected during this time period.

1.16.8.1.1 Summary of Observations of Interstate Aviation Committee Specialist

The specialist from Moscow's Interstate Aviation Committee reviewed the pilots' speech communication and other noise evidence recorded by the CVR to evaluate the pilots' responses, actions, and psychological state during the emergency. He stated that, at 1902:57.5, both pilots exhibited symptoms of sudden surprise that were “characteristic of a human response to sudden motion or to a physical disturbance.”

The specialist observed that both pilots showed symptoms of psychological stress (increased amplitude and fundamental frequency of speech, increased frequency of breathing, and reduced information within a statement) beginning almost immediately after the initial upset and that these symptoms increased throughout the accident sequence. However, the specialist believed that the increased psychological stress did not necessarily interfere with the pilots' ability to respond to the emergency situation. The specialist's report stated that stress can be viewed as having the following three increasing stages,²²⁰ which reflect typical changes in performance:

Psychological stress, at low levels, can improve a person's performance by providing a constructive mobilization of attention and resources (first stage). As the person's stress increases, the performance often displays

²¹⁹ One participant in this examination thought that the louder grunting and loud exhale (the fourth and fifth sounds on the list) were part of the same straining effort but agreed with the other participants to provide separate timings for both sounds.

²²⁰ As a guideline, the specialist from the Interstate Aviation Committee indicated that stage 1 speech is characterized by an intra-individual increase in fundamental frequency of about 30 percent compared with that individual's speech in a relaxed condition, stage 2 speech is characterized by an increase in fundamental frequency of 50 to 150 percent, and stage 3 speech is characterized by an increase of 100 to 200 percent. These guidelines are advisory and considered with other speech factors in characterizing the speaker's level of stress.

hasty or premature actions [such as the omission of words or checklist items]. However, they can still accomplish their task (second stage). It is only at the highest levels of stress (third stage, or "panic"), that the person can not think or perform clearly.

The specialist further observed that, although the captain's level of psychological or emotional stress was increasing during the emergency, he was still capable of adequate responses; the captain's attempts to evaluate the situation were reflected in his statements "hang on" and "what the hell is this?" (about 1903:05 and 1903:08, respectively). According to the specialist, although the captain's response to an ATC transmission at 1903:15 was "incomplete and it is obvious that the situation was unclear for him," the attempt to respond demonstrated that the captain was capable of appropriate responses.

The specialist's review of the USAir flight 427 captain's fundamental frequencies indicated that when he spoke the phrase "four twenty seven" during the emergency (about 1903:15), the fundamental frequency was 47 percent higher than the average fundamental frequency when that phrase was spoken during routine flight operations. Additionally, although this communication was incomplete ("four twenty seven emergency"), it was appropriate for the situation. The specialist believed that the captain was operating at the second stage of psychological stress at that time because his speech displayed characteristics of a significant level of stress but did not indicate that he had reached a level of panic (the third stage).

The specialist stated that neither of the USAir flight 427 pilots exhibited the third stage of psychological stress until 1903:17.4 (about 5 seconds before ground impact). The specialist reported that the captain then appeared to enter the highest stage of emotional stress because he issued inadequate commands between 1903:18.1 and 1903:19.7 ("pull...pull...pull") and was unable to "act and react in accordance to the situation." The specialist also noted that the first officer "demonstrated high levels of psychological stress before the impact, reflected by the speech degrading into short exclamations and expletives."

In his analysis of the pilots' physical responses, the specialist reported that the first officer exhibited signs of high physical effort (coinciding with signs of increased psychological stress). According to the specialist, the first officer exhibited speech disruptions, such as grunts and forced exhalations beginning at 1902:59.7 (when he was likely to have been actively controlling the airplane) and continuing for several seconds. The specialist stated that:

...a person making a great physical effort develops a musculo-skeletal "fixation" (of the chest), which leads to deterioration of the normal expansion and ventilation of the lungs (inhaling and exhaling). These changes are manifested during speech. Sounds such as grunting and strain appear in speech as the person tries to minimize the outflow of air. Inhaling and exhaling become forced and rapid."

The specialist further stated that normal use of the cockpit controls should not produce these types of sounds. He said that the sounds emitted by the first officer during

the upset sequence indicated that “[he] was struggling unusually hard...[as] if he was experiencing unusual resistance in the use of a control.”

The specialist noted that, although the first officer displayed signs of significant physical effort almost immediately after the upset event, he did not display those signs throughout the entire accident sequence. At 1903:04.6, when the first officer stated “oh [expletive],” no evidence of grunting, straining, or forced exhalation was recorded. However, at 1903:18.5, the first officer’s statement of “oh [expletive]” was accompanied by forced exhalation, exhibiting evidence of high physical exertion. The specialist stated that the first officer’s “unconscious pressing of ATC/intercom switch suggests that he could be trying to position his hands on the control wheel during the high pulling forces.”²²¹

According to the specialist, during the last 5 seconds of the flight, the captain began to exhibit symptoms of increased physical effort, as evidenced by short, forced inhalations after each “pull” command. On the basis of his observations, the specialist from the Interstate Aviation Committee developed the following conclusions:

- The accident sequence was completely unexpected by the crew. It caused their orientation response of the “What is that?!” type.
- The accident sequence was completely unclear for the crew.
- From the beginning of the accident sequence until 1903:18.1 the captain did not apply high physical loads to the controls and, most likely, did not participate in the control.
- The first officer applied physical loads and controlled the airplane. The loads were high, probably maximum, but varied during the upset period.
- Both crew members experienced high psychological stress. At the last moments (beginning at 1903:17.4), stress increased and became a panic (stage 3).

1.16.8.1.1 Interstate Aviation Committee Specialist’s Guidelines Applied to United Flight 585 CVR Information

The Safety Board applied the specialist’s guidelines and criteria to the speech and other sounds recorded by the United flight 585 CVR. In this case, when the captain spoke the word “flaps” during the accident sequence (at 0943:33.5),²²² his speech fundamental frequency was 77 percent higher than when he spoke the same word during routine flight operations. In addition, the captain’s statement “fifteen flaps” (at 0943:33.5) signified a

²²¹ Evidence from the ATC transcript and the CVR indicated that the first officer’s ATC/intercom switch was intermittently activated from 1903:09:4 (shortly after CVR began to record a vibrating sound similar to an airplane stickshaker at 1903:08.01) to the end of the CVR recording at 1903:22.8. In addition to the intercom switches located on the radio selector panels outboard of each pilot’s knees in the cockpit (discussed in section 1.16.7.2), an intercom switch is also located on the forward side of the control wheel (away from the pilots).

²²² All times in this section are mountain standard time, based on a 24-hour clock.

go-around decision but occurred without the captain first stating "go-around thrust," as specified in the procedures section of the company flight manual at the time of the accident. According to the specialist's guidelines, the captain's responses (high fundamental frequency value and omission of a standard procedure item while communicating and responding appropriately to the situation) indicated that he was likely operating at the second stage of stress at 0943:33.5. He had not reached panic but was displaying characteristics of a high level of stress within about 1½ seconds of the onset of the emergency period. The Safety Board's examination of the remaining 8 seconds of CVR information indicated that the pilots likely reached the third stage of stress—panic—before the airplane crashed.

1.16.8.1.2 Summary of Observations of U.S. Naval Aerospace Medical Research Laboratory Specialist

The specialist from the U.S. Naval Aerospace Medical Research Laboratory reviewed the USAir flight 427 CVR to provide observations on pilot breathing and muscular exertion. The specialist stated that both pilots appeared "conscious and fully aware of the emergency nature of the situation" and that "neither seemed impaired or incapacitated [according to] the sounds heard on the tape."

With regard to the captain, the specialist noted that "after the onset of the emergency period, the rate of breathing of the [captain] increased...there was an initial, large exhalation with the utterance 'sheez' in response to the first sudden, unusual movement of the aircraft at the start of the emergency sequence. That was followed shortly by a deep, rapid inhalation²²³ before the word 'whoa' was heard from the captain, almost as if he was startled by the continued departure of the aircraft from normal flight. The breathing response of the captain after the onset of the emergency appears to have been a normal sympathetic nervous system response that would include increased heart rate, breathing rate, body temperature, and blood pressure, all commonly observed in emergency situations."

The specialist stated that, almost immediately after the initial upset, the CVR recorded two rapid grunting exhalations on the first officer's channel, which the specialist attributed to the first officer's muscular exertion to control the airplane during the accident sequence. The specialist also stated that the first grunting sound was soft, whereas the second was louder and more forceful, representing the use of increased muscular force. Other than the first officer's deep rapid breathing, no additional audible (nonverbal) noises were recorded on the first officer's channel during the remainder of the recording. The specialist stated that, although the CVR did not record similar indications of muscular exertion/strain on the captain's channel, "that is not to say that the [captain] was not on the controls, but only that he did not appear to be exerting increased muscular force...."²²⁴

²²³ The USAir flight 427 captain's breathing response is noted in the CVR transcript at 1902:59.1 as a "sound similar to person inhaling/exhaling quickly one time."

²²⁴ This specialist stated that the captain (who had recently returned to flying duties after back surgery) may have been reluctant to exert excessive muscular force with his upper body because of the surgical repair.

The specialist stated that "the physical act of manipulating the controls of modern aircraft under normal conditions does not usually require excessive muscular force...during emergency situations, increased muscular force may be needed...."

1.16.8.1.3 Summary of Observations of NASA's Ames Research Center Specialist

The specialist from NASA's Ames Research Center reviewed the USAir flight 427 CVR, focusing on the flight crew's task-related (routine and emergency), procedural (ATC communications, checklists, and PA announcements), and nontask-related (interpersonal interactions) speech communications. She stated that the pilots' speech communications during the routine portion of the flight appeared to be complete, cooperative, and responsive and that the interactions between crewmembers were casual and friendly. She reported that crew coordination was thorough and that neither pilot appeared reluctant to seek or incorporate information from each other or ATC. The specialist noted that all coordination issues and questions had been resolved and that all appropriate procedural communications appeared to have been accomplished (checklists and PA announcements) before the initial upset occurred.

The specialist indicated that an evaluation of the speech communications recorded during the emergency portion of the flight was made difficult because flight crew speech in the final 25 seconds of the CVR recording was minimal and often fragmented. The specialist stated that the comments made by the first officer throughout the accident sequence did not contain much information. She reported that the best source of verbal information during the accident sequence was contained in the captain's statements between about 1902:57 and about 1903:10. The specialist stated that, although the captain's language was ambiguous during this period, it indicated that he recognized that a problem existed but that he had not yet identified the source or nature of the problem.

1.17 Operational and Management Information

1.17.1 USAir

At the time of the accident, USAir employed approximately 46,000 people and operated a fleet of 443 aircraft, including 234 Boeing 737s.²²⁵ USAir maintained major hub operations in Pittsburgh and Charlotte and smaller hub operations in Philadelphia; Indianapolis; and Baltimore, Maryland. USAir's heavy maintenance, structural repairs, and overhauls were accomplished in Pittsburgh; Charlotte; and Winston-Salem, North Carolina.

In the 6 years preceding the accident, USAir had grown as the result of several mergers. The largest mergers occurred in 1988, when USAir acquired PSA, and in 1989, when USAir merged with Piedmont Airlines. According to USAir personnel,

²²⁵ Records indicate that the 234 Boeing 737 airplanes operated by USAir included 79 737-200 series models, 101 737-300 series models, and 54 737-400 series models.

standardization of the different pilot groups that resulted from the mergers was accomplished through a process described as "mirror-imaging." Specifically, USAir developed a team of check airmen from USAir, PSA, and Piedmont Airlines to establish standardized procedures for the merged aircraft fleet based on the procedures used by USAir at the time. Checklists, flight operations manuals, and pilot handbooks were rewritten, and flight and simulator training sessions were revised to implement the standardized procedures. A review of USAir staffing assignments revealed that management and training positions were staffed by personnel with backgrounds from USAir, PSA, and Piedmont. USAir management and training personnel reported that they believed that the merged airlines' procedures, personnel, and aircraft had been successfully integrated.

At the time of the accident, USAir had a full-time Quality Assurance/Flight Safety Department that was responsible for identifying, communicating, and resolving flight safety-related issues. The Director of Flight Safety reported to the Vice President of Flight Operations. The Quality Assurance/Flight Safety Department interacted with the FAA, ALPA, USAir management, USAir training personnel, and line pilots to develop and disseminate safety-related information to flight crews. Safety information was communicated to employees via electronic mail; bulletin boards; attachments to flight paperwork; printed notices distributed to company mailboxes; periodic "Flight Crew View" publications; and USAir's Flight Training and Standards Department during simulator, line check, CRM, and LOFT training sessions.

Because USAir was a military contract carrier, the Department of Defense completed a survey in June 1994 that rated the airline's capabilities. USAir received "excellent" to "above average" ratings in all areas of flight crew operations, training, and safety.

1.17.2 USAir Flight Training

USAir's Flight Training and Standards Department was responsible for ensuring the continuing competency of the pilots, check pilots, and instructors in each of the aircraft operated by the company. At the time of the accident, six flight training managers were responsible for training in the following aircraft:

- Boeing 727, 757, and 767;
- Boeing 737-300 and -400;
- Boeing 737-200;
- Douglas DC-9 and McDonnell Douglas MD-80;
- Fokker F.100; and
- Fokker F.28.

The training staff for the 737-300 and -400 airplanes consisted of two senior check airmen, 6 check pilot designees, and 47 full-time check pilots. According to the Director

of Flight Training and Standards, USAir flight training staff performed all training and flight check functions, including initial simulator training, initial operating experience (IOE), proficiency checks, requalifications, line checks, CRM, LOFT, and special airport qualification training. Additionally, the Director of Flight Training and Standards stated that the FAA, ALPA, and USAir flight training personnel met regularly to discuss standardization matters, such as syllabi, procedures, training techniques, grading criteria, and trend analyses.

1.18 Additional Information

1.18.1 Overall Accident Record and History of the 737

According to Boeing, 737 series airplanes have flown more than 92 million hours since entering service in December 1967. During its investigation of the USAir flight 427 accident, the Safety Board reviewed the overall accident history record of the Boeing 737 airplane and compared this record with other generally comparable airplane types. The Safety Board examined worldwide aviation accident and departure data provided by Airclaims Limited of London, England.²²⁶ These data indicated that 737 series airplanes were involved in 43 total loss accidents²²⁷ between January 1988 and December 1997, which corresponds to 0.99 total loss accidents per 1 million departures.²²⁸ Table 7 shows total loss accident data for several airplane types arranged in order of least to most number of total loss accidents per 1 million departures.

Table 7. Number of worldwide total loss accidents and total loss accidents per 1 million departures for selected aircraft types, 1988-97.

Airplane type	Total number of loss accidents	Total loss accidents per 1 million departures
Boeing 757	4	0.62
Douglas DC-9/McDonnell Douglas MD-80	27	0.86
Airbus A319, A320, and A321	5	0.95
Boeing 737	43	0.99
Boeing 727	23	1.19
Fokker F.28, F.70, and F.100	15	2.23

²²⁶ Airclaims Limited is an aviation consulting firm that collects data, in part, for the aviation insurance industry. The Airclaims Limited database is recognized by the aviation industry as a definitive source for worldwide aviation accident information.

²²⁷ Airclaims Limited defines a total loss as an aircraft that has been destroyed or for which the estimated repair costs rendered the aircraft a total loss under the terms of the insurance contract. (Airclaims Limited notes that some aircraft that became total losses have been repaired and returned to service.) Any total losses that Airclaims listed as the result of a deliberate violent act were eliminated from these data.

²²⁸ Airclaims Limited. 1998. *Airliner Loss Rates*. Heathrow Airport, England.

1.18.1.1 History of 737 Potential Rudder System and/or PCU-Related Anomalies/Events

The following list of selected 737 yaw/roll events describes identified rudder-related anomalies that were reported before the USAir flight 427 accident. (Yaw/roll events reported after the USAir flight 427 accident are discussed later in this section and are listed in appendix E.) Some of the anomalies summarized in this section were previously discussed in the Safety Board's final report on the 737 accident at Colorado Springs, and others were reported to Boeing through various means (such as reports from AAIB and the civil airworthiness authority of New Zealand). As a result, the extent to which these events were documented and the amount of available data regarding these events varied widely.

- On July 24, 1974, the flight crew of a 737 reported that a rudder moved "full right" upon touchdown. The investigation revealed that the primary and secondary slides were stuck together by a shotpeen ball lodged in the servo valve.
- On October 30, 1975, during a main rudder PCU inspection, shotpeen balls were found in a servo valve that had undergone chrome plating.
- On August 26, 1977, the flight crew of a 737 reported that, during taxi, the right rudder pedals moved in "half way" and then jammed. This event happened three times and was corrected each time by cycling the rudder with the standby rudder system. Further examination indicated that the main rudder system was contaminated by metal particles.
- On August 31, 1982, a 737 reported that the rudder "locked up" on approach and that the flight crew initiated a go-around and activated the standby rudder system. The subsequent landing was uneventful. The examination of the PCU revealed internal contamination and worn seals, which resulted in the PCU having a limited capability to generate enough force to move the rudder.
- On November 8, 1990, during an overhaul, a main rudder PCU was found to have internal corrosion. The primary slide was stuck to the secondary slide at the neutral position as a result of the corrosion. No malfunctions were reported before disassembly.
- On January 4, 1993, the flight crew of a United Airlines 737-300, N309UA, reported a "hydraulic block/binding" during the flight control check. The main rudder PCU was removed from the airplane and shipped to Parker for examination. When tested in its "as received" condition, the PCU exhibited reduced rates, complete stalls, and reversals while being commanded in the retract direction (right rudder). Further examination at the Parker facility revealed that the servo valve retaining nut was loose; when the retaining nut was tightened properly (to 170 inch-pounds), investigators were unable to duplicate the anomalies that were observed during the previous testing. As a result of this investigation, Boeing and Parker modified the spring guide (which locks the retaining nut in place) to provide better engagement with and

retention of the nut. The companies also devised an additional test procedure to stroke the secondary slide within the internal limits of the servo valve. This test procedure was added to Parker's acceptance test procedure and Boeing's Overhaul Manual.

- On April 16, 1993, the flight crewmembers of an Air New Zealand 737-200 reported that they were descending from FL 350 to FL 330 (because of turbulence encountered at the higher altitude) when they experienced a series of uncommanded rudder inputs (with rudder pedal feedback) that continued (randomly right and left) throughout the remainder of the flight. The pilots reported that, during landing, a "large" left rudder offset was experienced. Both pilots stated that the rudder was stiffer than normal throughout the incident flight. Postincident testing revealed that the yaw damper coupler was capable of normal operation (although the rate gyro tested "out of limits") and that the standby and main rudder PCUs operated normally except when the standby PCU was tested at cooler temperatures²²⁹ with 3,000 psi hydraulic pressure. Under those test conditions, the input arm required up to 4.5 pounds of force before it moved; the input arm normally moves with about 0.5 pounds of force. Evidence of corrosion was found on the outer diameter of the bypass valve sleeve, and slight galling was noted on the input shaft and bearing.
- On August 31, 1994, a British Airways 737-200, G-BGJI, experienced a full left rudder deflection and subsequent rudder jam when the standby rudder system was selected during ground operations. According to the United Kingdom civil airworthiness authority, when the standby rudder system was selected, no rudder movement was possible through the rudder pedals. However, when the standby rudder system was deactivated and rudder system operation was transferred to hydraulic systems A and/or B, the rudder jam was eliminated, and the rudder returned to neutral. The standby rudder actuator was removed and replaced, and the rudder subsequently functioned normally on hydraulic systems A and B and the standby hydraulic system. A partial teardown of the standby rudder actuator revealed that the servo valve had seized; examination revealed corrosion and water in the unit and corrosion in the bypass valve, input shaft, and input shaft bearing.

In January 1999, Parker notified the Safety Board that a recent search of its files produced three additional reports of anomalous Boeing 737 main rudder PCU operation. Two reports were from 1982, and one was from 1984.

The first report, dated October 4, 1982, indicated that Parker had examined a main rudder PCU at Boeing's request "to determine the cause for rudder lockup during flight."²³⁰ No date for the rudder lockup event was specified in the report. Fluid samples removed from the unit were found to be contaminated, but the nature of the contamination

²²⁹ Since the time that it was notified of this event, the Safety Board has made several requests (first in May 1993 and most recently in October 1998) for additional information regarding the temperatures used during these tests. To date, officials at Air New Zealand, the New Zealand civil airworthiness authority, and Boeing have been unable to provide the requested information.

was not described in the report. The PCU passed Parker's acceptance test procedure at room temperature; however, when it was cooled to -65° F, the PCU failed the linkage breakout friction test (which measures the amount of force needed to move the input arm) in the extend direction and the yaw damper system test (which measures consistency of yaw damper response). According to the report, a new-production PCU also failed these tests at -65° F. The incident PCU was disassembled after the testing, and no discrepancies were noted.

Parker summarized the results of its examination as follows:

...no determination could be made as to the cause for the rudder lockup. Both units, during the subtemperature tests, exhibited high friction and reduced reactions to electrical input signals. These high frictions and reactions exceeded the allowable specifications [sic]; however, it is Parker[]'s opinion that this would be expected at the low temperatures. This friction would be the result of changes in the materials, which would affect the close tolerance fit of mating parts, ie: linkages, bearings, lap fits of valve assemblies, etc.....

The second report, dated October 8, 1982, also stated that a main rudder PCU was examined "to determine the cause for rudder lockup during flight." The report did not specify a date of the rudder lockup event. The PCU passed all of Parker's acceptance tests with the exception of the yaw damper system test and the yaw damper engage test (which tests the yaw damper's response when it is switched on). Disassembly of the PCU indicated excessive wear on the yaw damper's walking beam assembly. When the servo valve was removed from the PCU and the primary slide was fully retracted into the secondary slide, the primary slide jammed against the secondary slide. However, when the servo valve was reinstalled on the PCU, the primary slide could not travel as far in the secondary slide as it had when it was removed from the PCU; thus, the primary slide did not jam in the secondary slide. The report indicated that the servo valve was removed and tested again but that "no evidence of binding, jamming, or lockup could be verified."

Parker summarized the results of its examination as follows:

...no determination could be made as to the cause for a rudder lockup. The test findings for the phase Lag and Yaw Damper Engage tests were determined to have been caused from the Transfer Valve being off null position. It was determined that the Servo Slide does not have enough travel by design to allow the Primary Slide to bottom into the Secondary Slide and jam. Parker[]'s conclusion to the investigation is that none of the noted findings could have caused the rudder lockup.

The third report, dated May 11, 1984, describes a January 25, 1984, examination of a main rudder PCU that experienced an "intermittent kick and hardover condition." According to the report, Boeing notified Parker that an operator had experienced an intermittent rudder kick and hardover condition during flights at high altitude and that the

²³⁰ According to the report, a Parker facility had previously examined the unit, found no fault with it, and returned it to the customer.

PCU had been removed and overhauled at a repair station. According to the report, after the PCU was reinstalled on another airplane in the operator's fleet, that airplane also experienced a "rudder kick and hardover condition." Boeing requested that the operator remove the PCU and send it to Parker for detailed analysis. When tested at room temperature, the PCU passed all of Parker's acceptance tests except the linkage breakout friction test in both the extend and retract directions. When tested at -65° F, the PCU failed the yaw damper system test. The report stated that, after the examinations, the unit was reassembled, recertified, and returned to the operator.

Parker summarized the results of its examination as follows:

...a determination as to the cause of the rudder kick and hardover condition could not be made from the discrepancies found during testing and disassembly."

As a result of the USAir flight 427 accident and other accidents and incidents involving apparent 737 directional control anomalies, the Safety Board reviewed available information regarding more than 100 other 737 yaw/roll upset events and anomalies that were reported since the 737 was initially certificated.²³¹ Further, the Safety Board examined more thoroughly available data from many of these events for evidence that servo valve jamming or other main rudder PCU anomalies were involved (including the events described individually in this report).²³² When available, FDR and/or quick access recorder (QAR)²³³ data from these 737 events were obtained by the Safety Board for examination, comparison, and evaluation. The Safety Board's review indicated that 71 of the reported yaw/roll events involved anomalous operation of the rudder system. In many cases, the identified causes were yaw damper anomalies; others were attributed to rudder PCU anomalies.

The Safety Board determined that several of the anomalous yaw damper events were the result of a failure within the yaw damper rate gyro, which is located in the yaw damper coupler in the E/E bay beneath the cabin directly behind the cockpit. In many airplanes, the forward lavatory or galley is located directly above the E/E bay, and several

²³¹ Information from Boeing indicates that, between 1990 and 1994 (before the USAir flight 427 accident) there were 187 reported yaw/roll events involving the 737. (Yaw/roll event reporting is mostly voluntary. The number of such reports increased considerably after the USAir flight 427 accident.) In comparison, information from Boeing's Douglas Products Division indicates that, over about 75 million flight hours, there had been only 3 reported yaw/roll events involving the DC-9/MD-80 series airplanes. Information from Airbus indicates that, over about 4 million flight hours as of November 1995, there had been only one reported yaw event involving the A-320, and that event was caused by a rudder mistrim.

²³² See appendix E for a complete list of the 112 documented 737 rudder events that were examined by the Safety Board. This list is not necessarily intended to suggest that the events are similar to those involved in the USAir flight 427 accident; it is simply a documentation of 737 yaw/roll events that have been reported to and followed by the Safety Board. Additionally, the list is not necessarily a complete list of all yaw/roll events because air carriers often do not report events in which the yaw/roll anomaly ceased when the yaw damper or autopilot system was disengaged. Thus, although several air carriers have been aggressive about reporting yaw/roll events (especially during the months after the USAir flight 427 accident), many such events may not have been reported.

²³³ QARs have greater data storage capabilities than FDRs but are primarily intended for air carrier maintenance fault analysis. QARs are not protected/hardened to survive crash impact or fire conditions.

737 yaw damper system-related anomalies were found to be the result of fluid contamination (resulting from leakage of lavatory fluid, or "blue water") of the yaw damper coupler, associated wires, and/or connectors. (The 737 series airplanes have a documented history of blue water contamination and erosion;²³⁴ see appendix F for more information.) Another possible source of yaw damper anomalies that was considered is electromagnetic interference (EMI) or high-intensity radiated fields (HIRF).²³⁵

Several events that appear to involve PCU servo valve and/or rudder-related anomalies and may have potential relevance to the flight control issues investigated in connection with the USAir flight 427 accident are discussed in the following text. Two additional events that also appear to have potential relevance to the USAir flight 427 accident—the United flight 585 accident and the Eastwind flight 517 incident—were discussed previously (in section 1.16.1) and are not discussed further in this section.

July 1992 United Airlines Ground Check PCU Anomaly (737-300)

On July 16, 1992, during a preflight rudder control ground check at ORD, the captain of a United Airlines 737-300 noted that the left rudder pedal stopped and jammed near 25-percent pedal travel. The captain reported that he was moving the rudder pedals more rapidly than usual when the jam occurred. He further stated that the rudder pedals returned to their neutral position after he removed foot pressure from the left rudder pedal. The airplane returned to the gate, and the main rudder PCU was removed for further examination.

The main rudder PCU was tested and examined at United Airlines' facility in San Francisco, California, and Parker's facility in Irvine, California. The testing revealed that the PCU exhibited anomalous behavior, ranging from sluggish movement of the actuator piston to a full reversal in the direction of piston travel opposite to the direction being commanded, when the input crank was fixed against the PCU body stops (to move the primary and secondary slides throughout their full travel) and the yaw damper piston was in the extend position. The testing also revealed high internal fluid leakage. When investigators tapped on the dual servo valve housing or the summing levers or released the force on the input crank, the PCU returned to normal operation.

²³⁴ According to Boeing, the 737 is not designed to port excess blue water overboard; instead, the airplane is equipped with a shallow drip pan at each lavatory, which is intended to catch spills and overflows and prevent blue water contamination/erosion. However, 737 operators report that the drip pan cannot catch large spills, such as those that result from overfilling the lavatory system. See section 1.6.1.1 for information regarding blue water contamination from the accident airplane's maintenance records.

²³⁵ EMI or HIRF can induce an electrical potential in electrical wiring and circuits or be received by an airplane's navigational systems. Numerous navigational anomalies and sudden flight control movements on 737s and other airplanes have been attributed to EMI (generated by on-board portable devices, such as laptop computers, electronic games, or cellular telephones) or HIRF (generated from outside sources, such as radio towers, radar sites, and power stations). Technical literature indicates that it is possible for EMI or HIRF to affect an airplane's autopilot or yaw damper system up to the limits of the system. See Shooman, M.L. "A Study of Occurrence Rates of Electromagnetic Interference to Aircraft with a Focus on HIRF..." National Aeronautics and Space Administration, Langley Research Center, Hampton, Virginia, April 1994, pp. 2, 7, and 20. Also see Flight Standards Information Bulletin for Airworthiness 97-16A, "Lightning/High Intensity Radio Frequency Protection Maintenance," Federal Aviation Administration, August 4, 1997.

Further examination of the servo valve components showed that the secondary slide could move axially beyond its designed operating position (overtravel), resulting in abnormal porting of hydraulic fluid. When the secondary slide overtraveled to its mechanical stop (internal stop) in the servo valve housing, the abnormal flow could produce full pressure opposite to that intended at the actuator piston. Thus, the rudder would move in a direction opposite to the commanded direction; for example, rudder input intended to command left rudder could result in the rudder moving right.

The Safety Board's examination of this servo valve revealed that overtravel of the secondary slide occurred when the rudder pedals were moved rapidly to command a maximum rate of rudder travel or when a pedal was fully depressed to command full deflection of the rudder. During subsequent tests, the overtravel of the secondary slide was determined to be the result of the failure of the secondary summing lever to maintain contact with its respective external stop. Examination of the summing levers revealed that the secondary summing lever did not meet design specifications in that the chamfer²³⁶ on the summing lever was 50°, rather than the specified 45°, at the point where it contacted the external stop. This anomaly allowed the secondary summing lever to move beyond its external stop; thus, the secondary slide and summing lever could continue to move beyond the normal range of travel until the secondary slide bottomed out at its internal stop in the servo valve housing.²³⁷

As a result of its investigation of this incident, the Safety Board became concerned about the potential for rudder reversal in all 737 main rudder PCUs, specifically, that the internal stops of the dual-concentric servo valve could allow sufficient movement to route hydraulic fluid through a flow passage located outside the normal valve operating range, resulting in movement in the direction opposite to the control input. On November 10, 1992, the Safety Board issued Safety Recommendations A-92-120 and -121.

Safety Recommendation A-92-120 asked the FAA to

Issue an airworthiness directive mandating design changes for main rudder PCU servo valves that would preclude the possibility of rudder reversal attributed to the overtravel of the secondary slide.

On March 3, 1994, AD 94-01-07 became effective (see sections 1.6.3.2.1 and 1.18.5). Because the Safety Board determined that the AD satisfied the intent of Safety Recommendation A-92-120, it was classified "Closed—Acceptable Action" on August 11, 1994.

²³⁶ A chamfer is an oblique face located at a corner (a beveled edge).

²³⁷ The servo valve was designed to prevent abnormal flow if the secondary slide bottomed out at its internal stop; however, during the investigation of this incident, it was discovered that parts built within tolerances could be assembled with a resulting tolerance buildup that would allow the abnormal flow to occur if the secondary slide moved to its internal stop. Thus, in addition to the potential for overtravel because of the incorrect chamfer, it became evident that the secondary slide could also be forced into the overtravel range if it became jammed to the primary slide. Normal movement of the primary slide could produce a rudder reversal if a primary to secondary slide jam existed.

Safety Recommendation A-92-121 asked the FAA to

Conduct a design review of servo valves manufactured by Parker Hannifin that have a design similar to the 737 rudder power control unit servo valve that control essential flight control hydraulic power control units on transport-category airplanes certificated by the Federal Aviation Administration to determine that the design is not susceptible to inducing flight control malfunctions or reversals due to overtravel of the servo slides.

On January 19, 1993, the FAA stated that it had completed a design review of the servo valves manufactured by Parker on all transport-category airplanes. The FAA stated that its review indicated that the problem identified in this incident investigation existed only in the main rudder PCU on the 737 airplane. Because this design review met the intent of Safety Recommendation A-92-121, it was classified "Closed—Acceptable Action" on June 10, 1993. (See section 1.18.11.3 for additional information regarding these recommendations and two others related to this incident.)

British Airways Incident (747-436, G-BNLY)

On October 7, 1993, a British Airways 747-436, G-BNLY, experienced an in-flight upset as the airplane climbed through 100 feet agl during its departure from London's Heathrow Airport. The airplane suddenly pitched down from 14 to 8° nose up because of uncommanded downward travel of the elevators on the right side of the airplane. The flight crew maintained control of the airplane and landed uneventfully at Bangkok, Thailand, the flight's intended destination. The incident was investigated by the AAIB.

The elevators on the 747-400 are not interconnected. Postincident examination of the airplane's QAR²³⁸ indicated that the elevators on the right side of the airplane moved to near their maximum downward deflection limit. The elevators on the left side of the airplane moved upward to counter the right-side downward deflection, which allowed recovery of the airplane. The AAIB's investigation revealed that failure of the inboard elevator PCU occurred because the servo valve secondary slide overtraveled to the internal retract stop and that the primary slide had moved to the limit of the extend linkage stop. (The 747 elevator PCU, as with the 737 main rudder PCU, contains dual-concentric servo control valves and is manufactured by Parker.)

The AAIB issued its final report on this accident on December 14, 1994.²³⁹ The report identified the following causal factors:

The secondary slide of the servo valve of the inboard elevator Power Control Unit (PCU) was capable of overtravelling to the internal retract stop; with the primary slide moved to the limit imposed by the extend

²³⁸ In testimony at the Safety Board's January 1995 public hearing session regarding USAir flight 427, the AAIB investigator stated that, without the information available on the QAR, the event would have probably been attributed to a wake vortex encounter rather than an elevator-related anomaly.

²³⁹ See Air Accidents Investigation Branch. 1994. *Report on the incident to Boeing 747-436, G-BNLY, at London Heathrow Airport on 7 October 1993*. Aircraft Accident Report 1/95.

linkage stop, the four chambers of the actuator were all connected to both hydraulic supply and return, the servo valve was in full cross-flow resulting in uncommanded full down travel of the right elevators.

A change to the hydraulic pipework associated with the right inboard elevator Power Control Unit was implemented on the Boeing 747-400 series aircraft without appreciation of the impact that this could have on the performance of the unit and consequently on the performance of the aircraft elevator system, in that it could exploit the vulnerability of the servo valve identified in (i) above.

As a result of its investigation, the AAIB recommended that the Safety Board "consider re-issuing safety recommendation A-92-121 [asking the FAA to determine whether servo valves in other than those in the 737 PCU could induce flight control malfunctions or reversals] to verify that its full intent has been met." Page 22 of the AAIB final report stated that Boeing was queried about what consideration it gave to the 747 inboard elevator PCU based on the Safety Board's Safety Recommendation A-92-121 and that Boeing replied:

Parker did an analysis to support the NTSB recommendation. Parker looked at all possible jam positions with pilot limiting linkage stops, specifically with the primary slide jammed at null and determining possible reversals. There were no discrepancies uncovered and therefore no actions taken. The extreme stop condition was not envisioned at the time.

In connection with its investigation of the USAir flight 427 accident and because of its continuing concern about the potential for failure of the PCU servo valves in other designs and applications, the Safety Board issued Safety Recommendation A-96-117 on October 18, 1996. Safety Recommendation A-96-117 requested the FAA to

Conduct a detailed design review of all dual-concentric servo control valves that control essential flight control system actuators on transport-category airplanes certificated by the FAA to determine if the design is susceptible to inducing flight control malfunctions and/or reversals as a result of unexpected improper positioning of the servo slides. If the design is determined to be susceptible, mandate appropriate design changes.

On May 13, 1998, the FAA stated that its detailed design review of dual-concentric servo valves would address the intent of this safety recommendation. However, on February 2, 1999, the Safety Board indicated that airplanes produced by Airbus were not included in the FAA's review. Pending the Safety Board's review of the FAA's detailed design review, including information on Airbus airplanes, Safety Recommendation A-96-117 was classified "Open—Acceptable Response." (See section 1.18.11.5 for additional information regarding this recommendation.)

Sahara India Airlines Training Flight Accident (737-200, VT-SIA)

On March 8, 1994, a Sahara India Airlines 737-200, VT-SIA, was on a training flight when it experienced a loss of control during initial climbout after takeoff at the Palam Airport in New Delhi, India. The airplane crashed on an airport ramp area, caught

fire, and collided with a parked Aeroflot IL-86 near the international terminal. The four pilots on board the 737 (three pilots-in-training and one instructor pilot) and five individuals on the ground were killed, and four individuals on the ground received serious injuries. The final accident investigation report, issued in November 1996,²⁴⁰ stated that the cause of the accident was "the application of wrong rudder by [the] trainee pilot...during [an] engine failure exercise."

On November 14, 1994, the main rudder PCU from the Sahara Airlines 737 was examined at Parker's facility in Irvine, California, under the supervision of Safety Board investigators. Examination of the PCU revealed that the unit had apparently been serviced at a facility other than the manufacturer and that a different serial number had been applied to the PCU. A servo valve test was performed to simulate a jammed primary slide and subsequent overtravel of the secondary slide. The test indicated that the PCU could reverse if the primary slide was jammed to the secondary slide and the rudder was moved rapidly or to its limits. According to Parker personnel, the PCU spring guide appeared to have been modified to a different configuration (one which would have fit a Boeing 707). Parker personnel attributed the PCU's reversal potential to the use of this modified spring guide, which permitted more overtravel than a properly configured spring guide would have. It was not possible to determine where the spring guide had been reworked or when it had been installed.

On December 5, 1994, the U.S. Accredited Representative to the Sahara accident (under the provisions of Annex 13 to the Convention on International Civil Aviation) advised the Indian Court of Inquiry of the incorrect spring guide installation and the resultant potential for reverse rudder operation. In a June 6, 1995, letter, the U.S. Accredited Representative advised the Indian Court of Inquiry that the final report regarding the Sahara accident did not mention the PCU-related findings. The Safety Board did not receive a response to either of these letters.

Continental Airlines Flight 1057 (737-300, N17344)

On April 11, 1994, Continental Airlines flight 1057, a 737-300, N17344, experienced flight control anomalies during a flight between Houston, Texas, and Tegucigalpa, Honduras. The flight crew diverted to San Pedro Sula, Honduras, and made a successful emergency landing. During postincident interviews, the pilots reported that they were in cruise flight at FL 370 when they heard a muffled boom and felt an uncommanded yaw and roll to the right. The pilots applied full opposite aileron to counteract the roll and disengaged the autopilot; however, they reported that control wheel forces were high for the remainder of the flight. The pilots reported that they maintained higher-than-normal airspeeds for improved controllability during the approach and landing.

Review of the FDR information revealed that the yaw/roll event was consistent with a 2.5° sustained rudder input, which was consistent with the yaw damper authority

²⁴⁰ Report on Accident to Sahara India Airlines 737 Aircraft VT-SIA During Training Flight at IGI Airport, Delhi, on March 8, 1994. Indian Director General—Civil Aviation, November 1996.

for the given flight conditions (241 knots at 37,000 feet msl). Postincident examination of the airplane's yaw damper revealed a higher-than-normal output voltage on the rate gyro of the yaw damper coupler. Further examination of the yaw damper revealed an intermittent open resistance condition in the yaw damper engage solenoid valve; this condition could allow the voltage from the PCU to build up over time within the yaw damper coupler and result in a maximum yaw damper command. The cause of the intermittent yaw damper engage solenoid operation was determined to be hydraulic fluid contamination of the solenoid's coil assembly. On June 9, 1997, the FAA issued AD 97-09-15, which requires replacing the yaw damper engage solenoid with a solenoid that has encapsulated electrical coils to prevent the intrusion of hydraulic fluid. The solenoid was to be replaced the next time the PCU is repaired or within 5 years or 15,000 flight hours from the AD's date of issuance.

British Airways Maintenance Test Flight Incident (737-236, G-CBJI)

On October 22, 1995, a British Airways 737-236, G-CBJI, experienced several yaw/roll oscillations during a postmaintenance test flight. The pilots were preparing to test the passenger oxygen mask automatic deployment system at an altitude of about 20,000 feet msl and an airspeed of 290 knots when the oscillations began. The pilots disconnected the autopilot and autothrottle system, and the captain reported that he believed he turned off the yaw damper system; however, the oscillations continued. The oscillations exceeded 10° of bank with a period between peaks of about 2 seconds. The flight crew declared an emergency and started a descent back to the departure airport (London's Gatwick Airport). At an altitude of about 7,000 feet msl and an airspeed of 250 knots, the oscillations began to decrease in severity and subsequently stopped completely. The pilots landed the airplane at Gatwick Airport without further incident.

The incident was investigated by the AAIB, which determined that the cause of the yaw/roll oscillations was corrosion of a multipin electrical connector inside the yaw damper coupler. The failure resulted in the yaw damper moving the rudder back and forth within the yaw damper limits ($\pm 2^\circ$ on this airplane). The combination of rudder oscillations, air density, and airspeed allowed for excitation of the airplane's natural frequency in the dutch roll mode. Once the airplane descended to denser air and reduced airspeed, the excitation was damped and the oscillations stopped.

The AAIB's investigation found that the corrosion in the electrical connector was most likely the result of leakage from the forward lavatory or galley. Additionally, the investigation revealed that it might be possible to "generate stray current paths capable of sustaining engagement of the yaw-damper system when selected to OFF, but only in the presence of a high resistance in the engage-switch earth [ground] path."

As a result of this incident and others involving fluid contamination of the 737 E/E bay components, Boeing created an assessment team to investigate the problem and recommend solutions. Appendix F provides information about the assessment team's activities, composition, and recommendations.

Delta Air Lines Incident (737-200, N377DL)

On August 13, 1998, a Delta Air Lines 737-200, N377DL, experienced a yaw/roll event while en route from Houston to Cincinnati, Ohio. The event occurred while the airplane was in cruise flight at FL 330 in the vicinity of Memphis, Tennessee. The airplane was operating on the autopilot and in the "heading select" and "altitude hold" modes with the autothrottles engaged. The pilot stated that the first irregularity he noted was that the airplane did not turn when the heading bug was moved a few degrees. He noted that the control wheel was not centered so he added rudder trim and disengaged the autopilot. He then reengaged the autopilot, but rudder trim was required again. About 5 minutes after reengaging the autopilot, the airplane made an abrupt uncommanded right turn. The pilot said that he then took the controls, disengaged the autopilot, and applied left rudder and "a little left aileron." He did not turn off the yaw damper. The pilot stated that he thought the airplane had lost an engine. After the event, the flight continued uneventfully and landed in Cincinnati. The pilot made a maintenance entry regarding the autopilot, and the airplane was decommissioned by Delta maintenance for the subsequent flight.

The FDR on the airplane recorded 11 parameters, but rudder surface or rudder pedal position were not among those parameters. Examination of the FDR and radar data revealed that on the flight from Houston to Cincinnati, while at an altitude of 34,000 feet and an airspeed of 320 knots on a northerly heading, the airplane experienced a right heading excursion of 4.2° within 1 second. The airplane's bank angle changed from about 1° RWD to about 13° RWD within 2 seconds of the initial heading change. After the 4.2° heading change, the airplane's heading increased in an oscillatory manner until the airplane was steadied after a total heading change of 7°. The heading was stabilized within 20 seconds of the initial heading excursion.

On the subsequent flight, the same airplane experienced a yaw/roll event while en route from Cincinnati to Greensboro, North Carolina. The flight crew reported that the airplane abruptly yawed left and then started to roll left. The captain reported that, during this left yaw event, he had to apply considerable right control wheel input to maintain wings-level flight. The flight crew reported that the yaw stopped but that the airplane then yawed to the right just past neutral. The flight crew then disengaged the yaw damper. Both crewmembers reported that the rudder pedals "pulsed" for the remainder of the flight.

Further examination of the FDR data indicated that, while at a cruise altitude of 23,000 feet and an airspeed of 325 knots, the airplane first experienced a left heading change of 1.6° within 1 second, followed approximately 20 seconds later by a right heading change of 2° within 1 second. During the same time, the airplane's roll angle was between 3° LWD and 5° RWD. Further calculations by the Safety Board determined that the rudder position changes necessary to produce the abrupt yaws were consistent with a yaw damper system input to the rudder and would not have exceeded the yaw damper system authority. Delta subsequently examined the main rudder PCU and yaw damper coupler and reported that no anomalies were found.

1.18.1.1.1 QAR Data Findings

Although the origins of many 737 yaw/roll events were identified, some were not as easily explained, including the anomalous yawing motions reported by the pilots who flew the United flight 585 airplane during the month before the accident; the accidents involving United flight 585, Sahara India Airlines, and USAir flight 427; the preincident Eastwind Airlines rudder “bumps;” the Eastwind flight 517 uncommanded yaw/roll incident; and the SilkAir accident (for more information regarding the SilkAir accident, see section 1.16.5.4.1).

During its investigation of the USAir flight 427 accident, the Safety Board contracted with Flight Data Limited, in the United Kingdom to examine QAR data from 737s operating in Europe for evidence of unusual rudder activity and rudder movements opposite to the control wheel movements. Review of the resultant QAR data (about 57,000 hours of operational data from 27 airplanes, including rudder position and control wheel position) indicated the following:

- 737 rudder position remained within the yaw damper range of operation during 97 to 98 percent of the samples (including departure, cruise, and approach-to-landing phases of flight).
- 737 control wheel position data showed that pilots were not likely to exceed 20° of control wheel input during cruise flight (99.9 percent of cruise flight control wheel position samples were within 20° of neutral).
- 737 control wheel position data indicated that the control wheel remained within 20° of neutral in 94.4 percent of the samples during the departure phase of flight (between 50 and 5,000 feet agl) and in 95.9 percent of the samples during the approach-to-landing phase of flight (between 5,000 and 50 feet agl).

1.18.1.2 Recent Rudder-Related Events on 737s Equipped With the 1998 Redesigned Servo Valve

Parker redesigned the main rudder PCU servo valve twice—once in response to Safety Recommendation A-92-120 and AD 94-01-07 and again after Safety Board testing in 1996 revealed the potential for the servo valve primary slide to overtravel if the secondary slide jammed to the housing. (See section 1.18.5 for additional information.) The second redesigned servo valve was completed in 1998. The following two rudder-related events involved 737s that were equipped with the newly redesigned servo valve:

United Airlines Ground Check Rudder Anomaly (737-300, N388UA)

On February 19, 1999, the flight crew of a 737-300, N388UA, operated by United Airlines reported a stiff or sluggish rudder response during a pre-takeoff flight control check at Seattle, Washington. The flight crew stated that, when left rudder pedal was applied, the required pedal pressure felt somewhat greater than normal and that the right pedal would only move with an unusually large amount of force. After the pilots repeated the check several times with similar results, they returned to the terminal gate.

Maintenance personnel tested the rudder pedals and also found that an unusual amount of force was required to move the right rudder pedal. The maintenance personnel further found that the force required to move the right rudder pedal increased with the rate of input and that the left rudder pedal required slightly more force than that normally experienced.

The rudder system was examined, and no discrepancies were noted in the cables, linkages, and push rods. The main rudder PCU was removed from the airplane. After a replacement PCU was installed, the forces required to move the rudder pedals returned to normal. The airplane was then returned to service, and no further problems with the rudder system have been reported.

The main rudder PCU (which was equipped with the modified servo valve per AD 97-14-04 and had been tested to check for cracking of the secondary slide 71 flight hours [61 flights] before the anomalous ground check in Seattle)²⁴¹ was examined under the Safety Board's direction at United's maintenance facility in San Francisco. Before disassembly, the PCU input crank was noted to be visibly offset. Further, the PCU did not pass Parker's standard acceptance test procedure. After disassembly of the PCU servo valve, the valve spring guide was found to be mispositioned, thereby pushing the secondary slide off center and resulting in high leakage and an unequal amount of force necessary to achieve a right or left rudder input. After the guide was properly positioned, the servo valve passed the acceptance test procedure.

The mechanic who had previously performed the test to detect secondary slide cracking on the incident servo valve indicated to Safety Board investigators that the servo valve was the first one at United to be tested for such cracks. The mechanic stated that, after he tested the servo valve for a cracked secondary slide, the PCU passed the acceptance test procedure. However, the mechanic reported that he then demonstrated the test to detect secondary slide cracking to another United employee using the same PCU but that he did not repeat the acceptance test procedure after completing the second (demonstration) test.

Parker representatives indicated that implementation of the secondary servo valve slide test procedures to detect cracking could have displaced and rotated the spring guide. They also stated that a mispositioned spring guide should have been noted during an acceptance test procedure or after testing of the rudder system when the PCU was installed on the airplane. Additionally, Parker representatives indicated that improper rudder response caused by the mispositioned spring guide should have been noticed either during flight control checks or in flight. The Safety Board's investigation of this incident is continuing.

USAirways Metrojet In-flight Rudder Movement (737-200, N282AU)

On February 23, 1999, a 737-200 operated by USAirways as Metrojet flight 2710, N282AU, made an emergency landing at Baltimore-Washington International Airport

²⁴¹ For additional information regarding AD 97-14-04, see section 1.18.5.

(BWI) after the flight crew reported to ATC that it was experiencing control problems with the airplane's rudder. The flight crew consisted of a training captain and a captain who was receiving initial operating experience (IOE). The training captain reported that, while in cruise flight with the autopilot engaged, he noticed that the control wheel was rotating to the left but that the airplane was not turning. The training captain stated that, after he disconnected the autopilot and took control of the airplane, he noticed that the right rudder pedal was displaced at what appeared to be full forward travel. The training captain stated that he had to apply left aileron input and asymmetric engine power to prevent the airplane from rolling to the right. Further, that captain reported that he pushed on the left rudder pedal but that it would not move. The captain receiving IOE stated that he also pushed on the left rudder pedal and found that it would not move. According to the pilots, they turned off the yaw damper, but the right rudder pedal remained displaced. The pilots reported that, after they moved the hydraulic system B switch to the standby rudder position²⁴² the rudder pedals returned to their neutral position. The flight crew reported that the rudder pedals moved, or "kicked," several times during the approach to landing.

The airplane was examined at BWI by Safety Board investigators with participation from Boeing, FAA, USAirways, ALPA, and International Association of Machinists and Aerospace Workers representatives. Investigators inspected the operation of the rudder system from the rudder pedals to the main rudder PCU and standby rudder PCU for any evidence of jamming or other malfunction that could have caused the event but found no evidence of any jam. Investigators also tested the landing gear (by retracting them while the airplane was raised on jacks) but found no evidence of binding or jamming in the nosewheel steering mechanism. The main rudder PCU and a standby rudder PCU were removed from the incident airplane at the Safety Board's request. After replacement PCUs were installed, the airplane was returned to service. No problems with the rudder system have been reported since the airplane reentered service.

The main rudder PCU (which was equipped with the modified servo valve per AD 97-14-04) was removed from the airplane and examined by investigators at Parker's facility in Irvine, California. The PCU passed all functional examinations, and the subsequent teardown examination found no evidence of a jam or binding in the servo valve. Examination of the standby rudder PCU revealed no discrepancies and no galling of the input rod bearing.

The FDR from the incident airplane was examined at the Safety Board's laboratory. The FDR recorded 11 parameters, and rudder surface and rudder pedal position were not among the parameters. Simulation and kinematic studies of the data are being conducted by the Safety Board and Boeing. Preliminary results of these studies indicate that, during the upset, the rudder moved slowly to the blowdown limit. The Safety Board's investigation of this incident is continuing.

²⁴² Moving the B hydraulic system switch to the standby rudder position removes B hydraulic system pressure from the main rudder PCU and energizes the standby hydraulic pump, thus pressurizing the standby rudder PCU.

1.18.2 Independent Technical Advisory Panel

In January 1996, the Safety Board formed an independent advisory panel to review the work accomplished by the Systems Group in the USAir flight 427 investigation, ensure that all systems issues had been fully addressed, and provide guidance and suggestions to the Systems Group as appropriate. The six-member advisory panel consisted of five technical experts and engineers specializing in aircraft systems and hydraulic components from NASA, the FAA, the USAF, and two hydraulic component manufacturing companies and one independent system safety and reliability consultant. The advisory panel members' areas of specialization included

- failure analysis,
- hydraulic systems and components,
- contamination/filtration,
- FAA Critical Design Review (CDR) team/hydraulics, and
- powered flight controls.

The advisory panel's initial meeting was held in Washington, D.C., on February 8, 1996. At the meeting, the panel members were presented with all completed factual reports, test data, transcripts of public hearing testimony, and an outline of further planned engineering tests and actions for the USAir flight 427 accident as well as pertinent information regarding the United flight 585 accident. During the first meeting, one of the panel members stated that he had worked on a military fighter project that had used a control system PCU similar in design to the 737 main rudder PCU. He stated that an accident caused by a jammed PCU occurred very early in the initial production test flights. According to the panel member, the investigation of that accident determined that the PCU jammed when a sudden full-rate input caused hot hydraulic fluid to enter the cold PCU. The panel member reported that the thermal expansion of the inner parts of the PCU into the cold PCU body resulted in the jammed condition.

The Systems Group developed thermal shock test plans and, with the panel's participation, conducted these tests on a new-production main rudder PCU and the USAir flight 427 airplane's main rudder PCU. (The results of those tests are discussed in section 1.16.5.4.7.)

In comments dated October 31, 1996, another panel member stated that the accident airplane's PCU servo valve had characteristics that might have made it more susceptible to binding than other main rudder PCU servo valves. That panel member stated that the characteristics that may have made the accident PCU servo valve more susceptible to binding resulted from a combination of factors, such as dirty hydraulic fluid, thermal shock, rapid input, and normal load factors. The panel member further noted that, although the accident PCU servo valve diametrical clearances met the specifications that existed at the time it was manufactured, those specifications had been refined since that time. Other panel members did not provide formal comments on the thermal test results.

In addition, the independent technical advisory panel was also involved in the following investigative activities:

- Tests to determine the effects of silting from fluid contamination on the main rudder PCU.
- Cable break tests.
- Review of wake turbulence encounter flight test data. The advisory panel concluded that the forces involved in wake encounters were not sufficient to produce a yaw of the magnitude observed (after the initial upset) in flight dynamics simulations of USAir flight 427.
- Examination and hardness tests of the bent PCU actuator rod. The advisory panel concluded that the actuator rod exhibited impact-related damage and that the rod hardness was found to be within specifications.
- Review of other scenarios, including (1) separation of rudder skin, leading edge slat failure over the wing, and asymmetric spoilers—the advisory panel considered these were unlikely to have resulted in the accident because of the low yaw moments produced; (2) yaw damper anomalies—the advisory panel concluded that most yaw damper anomalies involve minor flight control interruptions, which would not result in a loss of aircraft control; and (3) foreign object jam at the external stop or external link that would prevent return of the input lever—the advisory panel concluded that the external protection of the stop gap made this scenario unlikely.
- Review of available information regarding 737 yaw incidents.
- Review of 1990 revision to the servo valve tolerances.
- Review of maintenance records for the accident airplane.
- Examination of the mechanical linkage and cables for rudder jam/reversal mechanism.

In April 1997, the independent technical advisory panel briefed the Safety Board on its work. The panel recommended several areas for further study, including the thermal shock phenomenon, the servo valve's tight diametrical slide clearances, possible causes of linkage binding, and the effects of silting. The Safety Board conducted further study in some of these areas. In September 1997, the advisory panel's formal efforts ended, but individual members of the panel continued to be contacted for consultation as needed by the Safety Board.

1.18.3 Boeing 737 Certification Requirements and Information

1.18.3.1 Initial Certification of the 737-100 and -200 Series

The Boeing 737 design was conceived in the early 1960s, and the original type certificate (which included the 737-100 and -200 series airplanes) was issued in December 1967. According to original type certification documentation, Boeing performed analysis

and testing and demonstrated compliance with the type certification requirements that were contained in 14 CFR Part 25 at that time.

When the 737-100 and -200 series airplanes were certificated, 14 CFR Section 25.695, entitled "Power-boost and power-operated control system," stated the following:

(c) The failure of mechanical parts (cables, pulleys, piston rods and linkages) and the jamming of power cylinders must be considered unless they are extremely remote.²⁴³

According to transcripts of meetings attended by FAA and Boeing personnel on May 4 and 5, 1965, FAA certification personnel raised questions during the 737-100 and -200 certification process about the airplane's single-panel, power-actuated rudder design. At that time, Boeing personnel stated that redundancy was provided by the dual-concentric PCU servo valve and dual load path design²⁴⁴ of the rudder actuator system. The Boeing officials indicated that the servo valve assembly was designed to accommodate a single jam (primary slide to secondary slide or secondary slide to housing) without resulting in a loss of control of the PCU because, if either the primary or secondary slides were to jam, the other slide should still move to counteract the jam and connect the proper flow paths to command rudder movement in the intended direction. Boeing officials also acknowledged that such a single jam could remain undetected until the valve assembly was removed and examined and that a single jam might not be perceptible to the pilot during normal operations, although it would result in a slower rudder movement and a reduced hinge moment.

During the 737 initial certification process, Boeing provided the FAA with a failure analysis of possible malfunctions of the rudder control system (Boeing document D6-14072, dated March 1967). In addressing several possible rudder control system failures, this analysis stated repeatedly that a jammed rudder or rudder control system could be "countered by the use of the lateral [roll] control system." The Boeing analysis also stated that the 737's "lateral [roll] control authority exceeds the rudder control authority at any rudder angle it would be reasonable to expect the pilot to command under all flight conditions" and that lateral control authority could therefore be used "to overcome the effect of a jammed rudder control system or loss of rudder control."²⁴⁵ Further, in specifically addressing the requirements of 14 CFR Section 25.695(c), Boeing stated in the March 1967 failure analysis report that "...in the event of a jamming failure

²⁴³ "Extremely remote" was not specifically defined, and a mathematical probability was not officially provided. However, during postaccident discussions, several FAA aircraft certification representatives stated their belief that extremely remote was essentially a probability of 1×10^{-6} or less for each flight hour.

²⁴⁴ The dual load path design provides two structurally redundant paths for inputting pilot commands to the main rudder PCU, including separate and independent linkages, levers, and cranks, so that a failure or malfunction in one load path will not affect the proper operation of the PCU. The redundant paths are created by the use of redundant designs (such as a push rod within a push rod or a fastener within a fastener) or mirror-image designs (for levers, linkages, and cranks).

²⁴⁵ This statement was made in the context of addressing the effects of a failure of the manual control system between the rudder pedals and the forward rudder quadrants at the pilots' stations.

that immobilizes the rudder system[,] yaw control can be maintained through the use of lateral [roll] control.”

1.18.3.2 Regulatory Changes Made After Certification of the 737-100 and -200 Series (Sections 25.671 and 25.1309)

In April 1970, the FAA issued amendment 25-23 to 14 CFR Part 25. According to the FAA, the amendment was intended “to improve the airworthiness requirements applicable to the type certification of transport category airplanes.” (35 Federal Register 5665, April 8, 1970.) Among the new requirements promulgated in the amendments were those in Section 25.671 (which appears in Subpart D of Part 25, “Design and Construction,” and supersedes the requirements of 25.695). Section 25.671, entitled “General,” states in part:

(c) The airplane must be shown by analysis, tests, or both, to be capable of continued safe flight and landing after any of the following failures or jamming in the flight control system and surfaces (including trim, lift, drag, and feel systems), within the normal flight envelope, without requiring exceptional piloting skill or strength.^[246] Probable^[247] malfunctions must have only minor effects on control system operation and must be capable of being readily counteracted by the pilot.

- (1) Any single failure, excluding jamming (for example, disconnection or failure of mechanical components, such as actuators, control spool housing, and valves).
- (2) Any combination of failures not shown to be extremely improbable,^[248] excluding jamming (for example, dual electrical or hydraulic system failures, or any single failure in combination with any probable hydraulic or electrical failure).
- (3) Any jam in a control position normally encountered^[249] during takeoff, climb, cruise, normal turns, descent, and landing unless the jam is shown to be extremely improbable, or can be alleviated. A runaway of a flight control to an adverse position and jam must be accounted for if such runaway and subsequent jamming is not extremely improbable.

²⁴⁶ The terms “normal flight envelope” and “exceptional piloting skill” are not defined in the Federal Aviation Regulations (FAR). However, the 737 AFM contains flight limitations, such as allowable load limits and airspeeds in the “Limitations” section.

²⁴⁷ Probable was (and is) defined in FAA Advisory Circular (AC) 25.1309-1A, “System Design and Analysis,” June 21, 1988, as a probability of failure on the order of greater than 1×10^{-5} for each flight hour.

²⁴⁸ “Extremely improbable” failure conditions are described in FAA AC 25.1309-1A as “those so unlikely that they are not anticipated to occur during the entire operational life of all airplanes of one type” and “having a probability on the order of 1×10^{-9} or less each flight hour, based on a flight of mean duration for the airplane type.”

²⁴⁹ The term “normally encountered” was not defined in the FARs. However, as further discussed in section 1.18.3.4, the FAA defined a “normally encountered” rudder position for the 737-NG certification as 2.5° or less.

FAA Amendment 25-23 also included new requirements in Section 25.1309, entitled "Equipment, Systems, and Installations" (which appears under Subpart F of Part 25, "Equipment"). That section states in part:

- (a) The equipment, systems, and installations, whose functioning is required by this subchapter, must be designed to ensure that they perform their intended functions under any foreseeable operating condition.
- (b) The airplane systems and associated components, considered separately and in relation to other systems, must be designed so that –
 - (1) The occurrence of any failure condition which would prevent the continued safe flight and landing of the airplane^[250] is extremely improbable, and
 - (2) The occurrence of any other failure conditions which would reduce the capability of the airplane or the ability of the crew to cope with adverse operating conditions is improbable.^[251]
- (c) Warning information must be provided to alert the crew to unsafe system operating conditions, and to enable them to take appropriate corrective action. Systems, controls, and associated monitoring and warning means must be designed to minimize crew errors, which could create additional hazards.
- (d) Compliance with the requirements of paragraph (b) of this section must be shown by analysis, and where necessary, by appropriate ground, flight, or simulator tests. The analysis must consider –
 - (1) Possible modes of failure, including malfunctions and damage from external sources;
 - (2) The probability of multiple failures and undetected failures;
 - (3) The resulting effects on the airplane and occupants, considering the stage of flight and operating conditions, and
 - (4) The crew warning cues, corrective action required, and the capability of detecting faults.

The FAA's Advisory Circular (AC) 25.1309-1A describes various acceptable means for showing compliance with the requirements of Section 25.1309(b), (c), and (d). According to the AC, Section 25.1309 requires that there be "a logical and acceptable inverse relationship between the probability and the severity of each failure condition, such that 'minor' failure conditions may be probable, 'major' failure conditions must be

²⁵⁰ Such a failure is referred to as a "catastrophic" failure condition in FAA AC 25.1309-1A.

²⁵¹ "Improbable" failure conditions are described in the FAA's AC 25.1309-1A as "those not anticipated to occur during the entire operational life of a single random airplane. However, they may occur occasionally during the entire operational life of all airplanes of one type." These conditions are further defined as "those having a probability on the order of 1×10^{-5} or less, but greater than on the order of 1×10^{-9} each flight hour, based on a flight of mean duration for the airplane type]."

improbable, and 'catastrophic' failure conditions must be extremely improbable."²⁵² The AC provides the following definitions of those failure conditions:

- Minor: those that would not significantly reduce airplane safety, and which involve crew actions that are well within their capabilities. Minor failure conditions may include, for example, a slight reduction in safety margins or functional capabilities, a slight increase in crew workload, such as routine flight plan changes, or some inconvenience to occupants;
- Major: those that would reduce the capability of the airplane or the a crew to cope with adverse operating conditions to the extent that there would be, for example, a significant reduction in safety margins or functional capabilities, a significant increase in crew workload or in conditions impairing crew efficiency, or some discomfort to occupants; or, in more severe cases, a large reduction in safety margins or functional capabilities, higher workload or physical distress such that the crew could not be relied on to perform its tasks accurately or completely, or adverse effects on occupants; and
- Catastrophic: those that would prevent continued safe flight and landing.

In a May 13, 1998, letter, the FAA Administrator offered the following additional explanation of the term "catastrophic failure condition:"

A catastrophic failure is one that will always result in an accident. In the case of a dual slide jam in the rudder PCU, this condition will not always result in an accident. The airplane is fully controllable in that configuration throughout much of its flight envelope. Thus, it is not a catastrophic event as defined by FAA regulations and policy. Not being catastrophic, the regulations do not require that the dual slide jam be extremely improbable. Nevertheless, with the service history and the number of hours of operation on the 737, the FAA believes a dual slide valve jam has been shown to be extremely improbable and in compliance with the regulations.

1.18.3.3 Certification of the Boeing 737-300, -400, and -500 Series (Derivative Certification)

According to 14 CFR Section 21.17, an applicant for a type certificate must show that the aircraft meets the applicable regulatory requirements "that are effective on the date of application for that certificate." However, according to Section 21.19, when a manufacturer proposes a change to an aircraft that has already been certified, a new application for a new type certificate is required only if

- (a) The Administrator finds that the proposed change in design, configuration, power, power limitations (engines), speed limitations

²⁵² The AC further states that "the failure of any single element, component, or connection during any one flight...should be assumed, regardless of its probability" and that "subsequent failures during the same flight, whether detected or latent, and combinations thereof, should also be assumed, unless their joint probability with the first failure is shown to be extremely improbable."

(engines), or weight is so extensive that a substantially complete investigation of compliance with the applicable regulations is required [or];

(b) ...the proposed change is...in the number of engines or rotors; or...[t]o engines or rotors using different principles of propulsion or to rotors using different principles of operation.

Further, 14 CFR Section 21.101 states that

(a) ...an applicant for a change to a type certificate must comply with either—

(1) The regulations incorporated by reference in the type certificate; or

(2) The applicable regulations in effect on the date of the application, plus any other amendments the Administrator finds to be directly related.

(b) If the Administrator finds that a proposed change consists of a new design or a substantially complete redesign of a component, equipment installation, or system installation, and that the regulations incorporated by reference in the type certificate for the product do not provide adequate standards with respect to the proposed change, the applicant must comply with—

(1) The applicable [regulatory] provisions . . . in effect on the date of the application for the change, that the Administrator finds necessary to provide a level of safety equal to that established by the regulations incorporated by reference in the type certificate for the product; and

(2) Any special conditions, and amendments to those special conditions, prescribed by the Administrator to provide a level of safety equal to that established by the regulations incorporated by reference in the type certificate for the product.

When the 737-300 series airplane was added to the 737 type certificate in November 1984 (followed by the 737-400 series in 1988 and the -500 series in 1990), some updated regulations were added to the type certification basis for those models. However, the certification basis for those airplanes consisted primarily of the same certification requirements and design criteria that existed for the original -100 and -200 series airplanes (certificated 17 years earlier). The -100 through -500 series airplanes were certificated with the original rudder system design.

According to Boeing and FAA personnel, the newer series 737 airplanes (737-300, -400, -500) were derived from the existing certificated models (737-100 and -200) and the flight control system designs for the newer series airplanes were similar to the existing models (and not unique to the newer series airplane). The officials stated that the FAA therefore did not require Boeing to meet the certification requirements of 14 CFR Sections 25.671 or 25.1309. In a November 24, 1998, letter to the Safety Board, the FAA stated that "it is by no means certain that if [Section] 25.671 amendment 23 had been applied to the original 737 certification, that the system would have been significantly different."

According to an appendix to Boeing's 1967 analysis report that was added in 1984 to address the certification of the 737-300, "the 737-300 rudder control system is essentially unchanged from the 737-200 design. Modifications to the 737-200 design have been made due to differences in 737-300 requirements, aerodynamic characteristics, and to provide improved uncontained engine failure protection. All of the modifications have no effect on the basic method of system operation, failure modes, redundancy, or interaction with other systems." In addressing the requirements of Section 25.695(c), the 1984 appendix stated that, in the event of a jamming failure that immobilized the rudder system, yaw control can be maintained through the use of the lateral (roll) system.

In a separate failure analysis report pertaining to the 737-300, -400, and -500 series airplanes that addressed potential rudder system failures (prepared by Boeing in February 1995 at the FAA's request), Boeing indicated that lateral control authority would be adequate to control a rudder offset for a jam at a normally encountered flight position. In discussing a jam of the manual input linkage to the hydraulic control valve in the main rudder PCU, the analysis report stated that roll control authority "exceeds the rudder control authority for most but not all flight conditions." In discussing the effects of a jam of the main rudder PCU servo valve's primary or secondary slides, the analysis report stated that "for most valve jams the rudder would remain operable and no pilot action would be required" but that "for a worst case jam [seizure of either the primary or the secondary slide at its fully deflected position, resulting in the loss of actuator force capability in one direction] the pilot could maintain flight path control using the lateral control system."

The Safety Board notes that the Boeing 757, which was certificated in 1982, was designed with three rudder actuators. Boeing indicated that the use of three actuators on that airplane allowed autopilot control over the rudder during autolandings and removed the need to mass balance the rudder.

1.18.3.4 Certification of the 737-600, -700, and -800 Series

According to the FAA type certification data sheets, Boeing showed compliance with most of the current requirements of 14 CFR Part 25, including Section 25.671, during certification of the 737-600, -700, and -800 series airplanes (737-next-generation [NG] series airplanes).²⁵³ In a November 24, 1998, letter to the Safety Board, the FAA indicated that it had encouraged Boeing to comply with the newer regulations in certifying the 737-NG series airplanes and that Boeing had elected to do so.

During meetings in January and February 1996, Boeing, the FAA, and Joint Airworthiness Authority representatives developed an agreement for an acceptable means

²⁵³ According to Boeing, 737-NG series airplanes fly for longer ranges, at higher altitudes, and at faster speeds; use less fuel; and produce less noise than the earlier series 737s. The 737-NG series airplanes also have a longer/wider wing with improved aerodynamics, advanced cockpit displays, and more powerful engines. Because of the enhanced engine power, the 737-NG series airplanes have a larger rudder so that airplane control can be maintained in the event of an engine failure. The main rudder PCU of the 737-NG series airplanes is more powerful than that used on earlier series airplanes, and the PCUs are therefore not interchangeable.

of showing 737-NG compliance with Section 25.671(c)(3). The representatives agreed that service history and exposure time could be used to show compliance.²⁵⁴

In a February 1996 document entitled "Primary Flight Controls, Ground Spoilers, and High Lift System Certification Plan," Boeing indicated that it intended to show compliance with Section 25.671(c)(3) by design review, safety assessment, flight tests and simulations, and service experience. This document also contained a description of the intended means of compliance, which stated in part:

A system safety analysis will be conducted to show that failure conditions that could prevent continued safe flight and landing are extremely improbable. Design changes have been made to ensure that uncommanded rudder motion is controllable with wheel in the vast majority of the flight envelope. Means are available on the flight deck which will allow the rudder to return to the faired position. Jams causing uncommanded motion that could be uncontrollable will be shown to be extremely improbable due to the very short exposure time and the very low failure rate demonstrated in service.

In an April 23, 1996, letter, the FAA informed Boeing that its proposed certification plan for the 737-NG was acceptable (with some exceptions that were not relevant to Section 25.671). On September 29, 1997, the FAA closed issue paper F-2, which addressed flight control jams for the 737-NG series airplanes. The issue paper defined the normally encountered flight control positions for the 737-NG, noting that "applicants have generally been unable to demonstrate that it would be extremely improbable for a flight control jam to occur in a control position normally encountered, or that a jam could be alleviated" and that "therefore, it must be shown that the airplane retains structural integrity, has sufficient remaining control authority, and is controllable following such a jam, without requiring exceptional piloting skill or strength." The FAA stated that a jam in a flight control is expected to occur approximately once every 10 million flight hours. Boeing indicated its belief that a jam in a flight control is expected to occur approximately every 9 million flight hours.

The FAA indicated in issue paper F-2 that, during takeoff, normally encountered roll/yaw control positions were those necessary to counteract a steady 15-knot crosswind and that it would also be necessary to consider approach and landing configurations to address jams during the final flight phase. The issue paper further defined normally encountered roll/yaw control positions after takeoff as the more critical of one-third of the total travel of the control surface, the authority limit of the yaw damper, or those positions required to counter a 25-foot-per-second discrete gust. In its November 24, 1998, letter to the Safety Board, the FAA indicated that it considered the normally encountered control position for the 737-NG series airplanes to be 2.5° of rudder, which is approximately the maximum yaw damper authority.

²⁵⁴ The information in this paragraph and in several of the paragraphs that follow is contained in briefing materials prepared by Boeing for presentations it made to the FAA during October 1997. Boeing provided those briefing materials to the Safety Board in response to its requests for information pertaining to certification of the 737-NG series airplanes.

Issue paper F-2 also described Boeing's position, as indicated in a June 26, 1997, document, that a 2° rudder displacement should be accepted as the maximum normally encountered position. Boeing stated that the "service history of these systems on previous models provides evidence to validate the qualitative evaluations of these areas. Additionally, further jam protection features have been added to the flight control system for the 737-600/-700/-800."

Boeing also stated that

...for areas of the flight control system where rigid jams cannot be shown to be extremely improbable, Boeing plans to conduct analysis and/or testing to demonstrate that continued safe flight and landing is possible, without requiring exceptional piloting skill or strength, after a jam in a normally encountered position. Based on a review of in-service jam incidents, there is no evidence which would indicate that a jam failure becomes more likely [at] greater...deflection[s]. From Boeing service history, the probability of a jam is less than 10^{-7} /flt hr. ...therefore, evaluation of jams will be accomplished at the maximum control position which addresses 99% of system operational exposure time. Jams outside the 99% boundary are extremely improbable based on the 10^{-7} /flt hr failure rate. This maximum control position will be determined from a survey of in-service and flight test recorded data.

According to Boeing's October 1997 briefing materials, the FAA informed Boeing on October 15, 1997, that the 737-NG elevator and rudder control systems did not comply with Section 25.671(c)(3). The FAA indicated that the definition of extremely improbable in Section 25.671(c)(3) did not allow the use of exposure time and that the possibility of the jam itself must be less than 10^{-9} . In its November 24, 1998, letter to the Safety Board, the FAA indicated that it initially concluded that the use of a small exposure time (as proposed by Boeing) was not appropriate to show a jam to be extremely improbable. The FAA stated that its conclusion was based on the belief that this type of probability analysis had never been used to show compliance with Section 25.671(c)(3) and that no existing policy provided direction on the use of this type of analysis.

The briefing materials stated that Boeing appealed the FAA's finding of noncompliance and presented its position on October 22 and 27, 1997, to local FAA certification officials in Seattle and on October 28 and 29, 1997, to FAA upper management in Washington, D.C. Boeing's position was that a showing of jam avoidance was permitted by Section 25.671(c)(3). Boeing stated that its interpretation of Section 25.671(c)(3) was that a new airplane without a service history must be designed for jam tolerance but that derivative airplanes with a proven service history could be designed for jam tolerance where possible and jam avoidance in other areas. Boeing stated that the FAA's interpretation of Section 25.671(c)(3) was inconsistent with the language of the rule. Boeing cited AC 25.1309-1A, paragraphs 10a and 10b, in its argument that existing FAA policy allowed an event to be shown to be extremely improbable by multiplying the failure rate of the jam by the exposure time of the flight phase(s) when the jam would be catastrophic.

Boeing further asserted that the FAA's interpretation of Section 25.671(c)(3) would not have allowed a finding that the Boeing 747, 757, 767, and 777 complied with that rule, even though the FAA had already made such findings. Boeing indicated that its proposed exposure time-based analysis had been used in past certifications of these airplanes for failures that are only catastrophic during short segments of flight, such as rudder control on takeoff with an engine out, spoiler surface hardover at low altitude, autolands, 777 rejected takeoffs, and 777 thrust asymmetry compensation failures on takeoff. Boeing stated that both the 737-NG and 747 were exposed to rate jams, which could result in rudder hardovers that would be controllable except at a low altitude, and that a jam avoidance design philosophy had been used in the certification of the 747. Boeing argued that, because the 747 and the 737-NG have the same certification basis, the rule has not been changed, and no advisory material has been issued, the 747 precedent established policy and an acceptable means of showing compliance with the rule.

Boeing indicated that the FAA's change in position regarding the acceptability of Boeing's originally proposed means of showing 737-NG compliance came "late in the game" with no practical opportunity for a design fix. Boeing argued that the change in the FAA's past interpretation of the rule was not justified, given the number of flight hours accumulated by the existing 737 series and the design improvements incorporated to enhance the system, and that the new interpretation had not achieved consensus across the aviation industry.

Boeing indicated during its October 1997 presentations to the FAA that it did not believe a "position jam" (defined by Boeing as one that would occur in a normally encountered position and fix the rudder in a steady-state position) was an issue because the failure would be controllable. Boeing indicated that rate jams (defined by Boeing as those that would cause a hardover position outside of that normally encountered) could be caused either by a dual slide jam or an input arm jam. (Boeing's presentation did not address the single jam/reversal failure mode.) According to Boeing, concerns about a dual slide jam could be eliminated because of the servo valve's dual concentric design.²⁵⁵ Further, Boeing indicated that no input arm rate jams had been identified in the 737 fleet's service history and that, as a result of this finding, a design review, and tests, no input arm rate jam scenario was foreseeable. As further protective measures, Boeing cited the addition of a hydraulic pressure limiter, which would reduce the exposure time of a catastrophic rudder hardover to a 60- to 90-second window on takeoff and landing, and a rudder hardover shutdown procedure.

Boeing's qualitative assessment indicated that a catastrophic rate jam (that is, one that would occur during the 60- to 90-second exposure window at takeoff or landing) was extremely improbable based on service experience, design, and limited exposure.

²⁵⁵ Boeing indicated that the probability of a jam of the primary slide was 2.36×10^{-3} and that the probability of a secondary slide jam was 2.10×10^{-8} . These calculations were based on Boeing's awareness of 7 possible occurrences of a jam of the primary slide in 74 million flight hours and the recognition that the jam could be latent over the entire mean time between unscheduled removal of the PCU (estimated by Boeing to be 25,000 hours). Boeing indicated that there have been no known occurrences of a jam of the secondary slide and that one failure was assumed for the calculation.

Additionally, Boeing's calculations of failure rate and exposure time indicated that the quantitative probability of such a catastrophic rate jam was 7.02×10^{-10} .

The certification fault tree analysis provided by Boeing to the FAA indicated that the possibility of an engine out during takeoff and a jammed servo valve were considered. However, Boeing indicated that the exposure time for this potential scenario was 7 seconds "during takeoff from V_1 through liftoff where the lateral controls can be used to help control the engine out." The fault tree analysis assumed that "there is always adequate lateral control to overpower a rudder hardover when the rudder pressure limiter is operational." The analysis also assumed that "under normal circumstances flight crew members, ground crew members and maintenance personnel will perform their routine tasks without errors or omission. Additionally, under anticipated normal circumstances, flight crew members will perform their non-normal procedures and basic airmanship per their training."

In its November 24, 1998, letter to the Safety Board, the FAA stated that, in response to Boeing's October 1997 presentations, it agreed that Section 25.671 allowed the type of qualitative analysis proposed by Boeing and that, based on the Boeing 747 precedent, the use of such analysis was appropriate to demonstrate compliance with the rule. However, the FAA requested that Boeing show that it had evaluated the design of the 737-NG flight control system with regard to critical jam conditions, considered postulated jams, and determined that they were extremely improbable.

On November 1, 1997, a group of Boeing engineers, including four Designated Engineering Representatives (DER) performed an inspection of the 737-NG elevator control system for position jams and the rudder system for rate jams. Boeing provided the FAA with the documentation of these inspections and FAA Form 8110-3, Statement of Compliance with the Federal Aviation Regulations (FAR), in which the DERs requested a finding of compliance with Section 25.671 (c)(3). The form indicated that the DERs performed an inspection of the elevator, rudder, main rudder PCU and associated input and feedback linkages, and the standby rudder PCU and associated input and feedback linkages. The form stated that "the inspections identified eight areas of interest with regard to jam potential [one of which pertained to the rudder]. Each jam area was analyzed or tested by the DERs and design specialists. For each jam case, it was concluded that either the jam could not occur or sufficient control movement would be available for continued safe flight and landing."

In supplemental data provided to the FAA to support the requested finding of compliance with Section 25.671(c)(3), Boeing indicated that the DERs concluded that the "rudder PCUs are not susceptible to jams that cause uncommanded motion" and that the "service history shows that there have been NO events or PCU rate jams in flight on Boeing models." Boeing concluded that "(1) rudder position jams are controllable when the jam occurs within a normally encountered position and (2) Rudder PCU rate jams are extremely improbable as supported by analysis, test, and service history."

Boeing listed rudder system design features of the 737-NG series that preclude jamming, including the following:

- Dual concentric control valves allow continued control if either valve jams (rate jam)—designed for jam tolerance.
- Internal summing levers are bussed together to increase stiffness (for chip shearing capability)—designed for jam tolerance.
- The input stops are oriented to prevent exposure to jams—designed for jam avoidance.

In its November 24, 1998, letter to the Safety Board, the FAA stated that Boeing provided data that showed the ability of the 737-NG to land safely with the rudder jammed at 2.5° of deflection (defined by the FAA's issue paper F-2 as the maximum normally encountered control position). The FAA further stated that with the incorporation of the hydraulic pressure limiter, rate jams (rudder hardovers) were found to be controllable throughout the flight envelope except for a short period of time during takeoff and landing, which the FAA identified as being about 2 minutes. According to the FAA, Boeing showed that a rate jam during this exposure time is extremely improbable. In addition, the FAA stated that some detailed design features of the rudder control system aid in jam protection, including the following:

- controlled clearances between bearing races and interfacing surfaces so that a bearing jam does not seize a rotating joint or shaft,
- a controlled clearance between internal summing linkages and the PCU manifold that is much larger than possible debris particles,
- increased servo valve chip shear capability,
- PCUs installed in a sealed compartment that is rarely accessed and only for maintenance,
- before each takeoff, a system functional check or operational check by a maintenance crew to ensure no anomalies after rudder system maintenance, and
- a rudder system freedom-of-control check by the flight crew before each takeoff to ensure that no anomalies are present.

The FAA stated in its November 24, 1998, letter that, after reviewing the data provided by Boeing and all known jams on 727, 737, and 747 airplanes, it determined that the design changes made for the 737-600, -700, and -800 rudder system would prevent similar jams from occurring or would allow alleviation of such jams. The FAA also indicated that it was able to find compliance with Section 25.671 for the 737-NG series airplanes based on the certification of the 747, the DER evaluation, flight tests, and simulator tests that showed that jam overrides are acceptable to overcome jams and that the override system operates correctly when installed.

1.18.4 Critical Design Review Team 737 Certification Information and Recommendations

Because the USAir flight 427 accident and other 737 accidents raised questions regarding the 737's flight control systems, the FAA stated that, on October 20, 1994, its Transport Airplane Directorate began a Critical Design Review (CDR) of the 737 flight control systems with emphasis on the roll control and directional flight control systems. The CDR was conducted by a team of seven flight control systems specialists from the FAA, Transport Canada (the Canadian airworthiness authority), and the USAF.²⁵⁶ According to the CDR team's report,²⁵⁷ the team's specific objectives were to

- identify those failure events, both single and multiple, within certain flight control systems that result in an uncommanded deflection or jam of a flight control surface;
- identify latent failures in each axis of flight control;
- review the service history of the failed or malfunctioning component or subsystem through a review of ADs, SBs, SLs, Service Difficulty Reports, Safety Board recommendations, NASA Aviation Safety Reporting System (ASRS) reports, and other reports;
- identify and review the maintenance or inspection requirements (task and inspection interval), as provided by the manufacturer's Maintenance Planning Document, Maintenance Review Board report, or MM for each identified component or subsystem with critical failure potential.

The CDR reviewed the certification basis and compliance of the 737-100 and -200 and 737-300, -400, and -500 series airplanes. The CDR team noted that the results of the analyses and tests conducted by Boeing during certification of the 737-100 and -200 and 737-300, -400, and -500 series airplanes showed compliance with the applicable certification regulations. However, the CDR noted the ambiguity of some of the terminology used in 14 CFR Section 25.671 (although that section was not part of the certification basis of the -100 through -500 series 737s); specifically, the CDR questioned the usage of the terms "normal flight envelope" and "normally encountered." The CDR team's report indicated that it did

"not agree with the rationale that only control positions associated with 'normally encountered' should be considered. There are too many

²⁵⁶ The CDR team also involved one Safety Board observer. Five of the seven flight control specialists were employed by the FAA in the following capacities: aviation safety inspector, aircraft certification engineer, flight test pilot, aerospace mechanical systems engineer, and project engineer. Another specialist was employed by Transport Canada as an Airworthiness Inspector, and the other specialist was a Chief Master Sergeant in the Colorado Air National Guard. Each of the seven specialists had expertise in 737 certification, 737 operations, systems and/or maintenance, flight control and hydraulic systems design/specifications, or latent failures.

²⁵⁷ The CDR team's report, entitled "B-737 Flight Control System Critical Design Review," was issued May 3, 1995.

variables (atmospheric conditions, pilot technique, airplane condition [trim requirement], air traffic, etc.) to define 'normally encountered' other than that it may be less than full deflection. The Team's position is that if a control position is possible, it is there for a purpose, and the pilot can use that control authority."

The CDR team's report further stated that it believed "the interpretations that have been applied in the past, regarding amount of flight control input to be considered in showing compliance with the referenced regulations, may not be sufficient." Therefore, the CDR team reviewed failures, combinations of failures, and malfunctions without regard to their probability of occurrence.

The CDR team's report also cited an FAA issue paper developed during the certification of the 737-300 that addressed maintenance items resulting from certification activities. According to the report, the FAA determined that it was not necessary to establish a maintenance interval to show compliance with certification requirements. However, the report stated that the CDR team had "identified a number of latent failures that require some maintenance/flightcrew action to ensure that a latent failure, combined with any subsequent failure, is not hazardous.... The Team believes that inspection tasks and intervals should be established for vital components whose latent failure could have hazardous consequences, even though a failure analysis has shown a numerical probability of failure that allows the component to go uninspected for the life of the airplane or until an 'on-condition' overhaul."

According to the CDR report, the team also had general concerns regarding the design of the 737 aileron and rudder PCUs and specifically cited the use of the dual concentric servo valves and the potential for jamming as a latent condition of the PCU. According to the CDR team's report, "...when considering some undetected (latent) failures...in the directional control system, in combination with some of the single failures...the potential for a sustained jam of the rudder at full deflection, as limited by blowdown, is increased. Since full rudder hardovers and/or jams are possible, the alternate means for control, the lateral control system, must be fully available and powerful enough to rapidly counter the rudder and prevent entrance into a hazardous flight condition."

The CDR team's report included the results of a series of simulator exercises in Boeing's M-CAB simulator (configured as a 737-300) that the team conducted on November 17, 1994. The purpose of these exercises was to determine the degree of hazard associated with certain control system malfunctions, including a rudder hardover. The rudder hardover was simulated by the PNF applying full rudder pressure to one pedal as rapidly as possible and holding the rudder pedal to the floor. This pressure resulted in rudder deflection rates of about 40° per second (the rudder system is capable of deflecting the rudder at a rate of 66° per second under no aerodynamic load). According to the CDR team's report, tests evaluating "lateral [roll] versus directional control power" during a rudder hardover

...basically confirmed Boeing's contention that lateral [roll] control has more roll authority than does the dihedral effect from full rudder inputs for flight conditions tested except the flaps 1, 190 KIAS [knots indicated

airspeed] condition. For this condition lateral [roll] control also predominated, but recovery from a rudder "hardover" was slow and required precise pilot control of resulting pitch/airspeed. Prompt pilot response was required to prevent entering the inverted flight regime at high altitude/speed.

The team's report stated, "as qualified by Boeing, the rudder PCU dual concentric valve...was intended to prevent unacceptable rudder deflection after a single slide jam....The dual concentric arrangement does play a vital part in maintaining flight safety....the crew should be assured that they have a properly operating valve assembly." The CDR team's report further stated the following:

There is no adequate means for testing the dual spool servo valve for proper operation on the airplane.

The dual spool servo valve is a complex assembly and is a critical component of the rudder and aileron power control units and, therefore, critical to flight safety. Any facility authorized by the FAA to perform repair and maintenance or manufacture this component must assure the FAA of having the necessary equipment, personnel and data (design, manufacture, qualification and acceptance test procedures), including access to the latest revisions to the data provided by the [original equipment manufacturer].

The CDR team's report made 27 recommendations to the FAA regarding 737 certification issues, including the following:

Develop national policy and or rule making as necessary and applicable to transport category airplanes that define "normal," with respect to jams. This definition should include consideration of a jam of a control surface at any position up to its full deflection as limited by design

Develop national policy requiring that, when alternate means for flying an airplane are employed, those means shall not require exceptional pilot skill and strength and that the pilot can endure the forces for a sufficient period of time to ensure a safe landing

Develop national policy for transport category airplanes requiring the determination of critical hydraulic flight control system and component sensitivity (jam potential and actuator performance) to contamination, requirements for sampling hydraulic fluid, and requirements for actuator components to eliminate or pass (shear) particulate contamination,

Require failure analysis of the B-737 yaw damper identified components and any relevant tests be conducted to identify all failure modes, malfunctions and potential jam conditions of these vital elements.

Require corrective action(s) for those failure modes or malfunctions not shown to be extremely improbable.

Require appropriate action be taken to reduce the number of B-737 yaw damper failure occurrences to an acceptable level.

Require appropriate action be taken to correct the referenced galling condition of the standby rudder on the B-737.

Revise B-737 flightcrew training programs to ensure the use of the proper procedures for recovery from flight path upsets and flightcrew awareness regarding the loss of airplane performance due to a flight control system malfunction. Consideration should be given to flightcrew action items as a consequence of the failure analysis developed for the relevant flight control system and the failure conditions/malfunctions examined....

Request the NTSB form a special accident investigation team to begin a new combined investigation of both the B-737 Colorado Springs and the Pittsburgh accidents.

In an August 27, 1998, letter to the Safety Board, the FAA described its actions in response to the CDR team's recommendations. The FAA, among other things, referred several of the regulatory and policy issues raised by the CDR team's recommendations (including the definition of normally encountered) to an Aviation Rulemaking Advisory Committee; referred the issue of hydraulic fluid contamination to the Society of Automotive Engineers (SAE) A-6 Committee—Aerospace Fluid Power, Actuation, and Control Technologies—which made recommendations on contamination limits; and issued several ADs to address operational and maintenance issues. (A complete list of the recommendations made by the CDR team and the FAA's follow-up actions in response to those recommendations are contained in appendix D.)

Also in response to the CDR team's recommendations, the Safety Board convened an independent technical panel of consultants (see section 1.18.2) and combined the investigation of USAir flight 427 with the investigation of United flight 585 (see section 1.16.1.1).

1.18.5 Boeing 737 Rudder System Design Improvements

As a result of the rudder reversal mechanism that became apparent during the investigation of the July 16, 1992, United Airlines ground check incident (see section 1.18.1.1), the Safety Board issued Safety Recommendation A-92-120, asking the FAA to issue an AD to require 737 operators to incorporate design changes for the main rudder PCU servo valves that would preclude the possibility of rudder reversals attributed to overtravel of the secondary slide.²⁵⁸ In response to this recommendation, the FAA issued AD 94-01-07, effective March 3, 1994. The AD required a leak test of the 737 main rudder PCU in accordance with Boeing SL 737-SL-27-82-B. The leak test involved inputting full rapid rate rudder commands and monitoring the hydraulic system flow demand to detect signs of internal leakage, which would indicate that the secondary slide was extending beyond its design limits. The AD required the leak test to be repeated at 750-flight hour intervals until the main rudder PCU was replaced with a unit designed to preclude overtravel of the secondary slide and included improved control of dimensional

²⁵⁸ As previously discussed, overtravel is the axial movement of the servo valve slides beyond the intended design limit.

tolerances and part matching. The AD required replacement of the main rudder PCUs within 5 years of the AD's effective date. The redesign of the servo valve was approved by the FAA by the time that AD 94-01-07 became effective.

The FAA also issued AD 96-23-51, effective November 27, 1996. The AD required that all 737 airplanes be inspected within 10 days and tested in accordance with Boeing SB 737-27A1202 every 250 flight hours thereafter until the main rudder PCU was replaced with one that incorporated the redesigned servo valve. Boeing's SB and the FAA's AD required that the rudder pedals be exercised to determine if a secondary slide jam to the servo valve housing had previously occurred but had not been detected.

Further, the FAA issued AD 97-14-04, which became effective on August 4, 1997, and superseded the servo valve replacement requirement of AD 94-01-07. The new AD required, within 2 years of its effective date, that the main rudder PCUs on all 737-100 through -500 series airplanes be replaced with units containing a redesigned servo valve.²⁵⁹ AD 97-14-04 also required the replacement of outer bolts on 737 main rudder PCU input rods. This requirement was mandated because fractured outer bolts had been discovered on two occasions during normal maintenance activities. In each case, the fracture was found to have initiated when the nut was sufficiently tightened to cause the nut threads to contact the shank of the bolt. The bolts are used in a dual load path design with inner and outer elements, either of which is sufficient to retain the input rod. However, if the redundant load path is compromised and fails, a fully deflected rudder is possible; therefore, a new bolt was designed to prevent the shank from contacting the nut threads. These bolts are to be replaced when the main rudder PCUs are removed to incorporate the redesigned servo valve.

After Safety Board testing in 1996 showed that the servo valve primary slide could overtravel (move past its intended position) if the secondary slide jammed to the housing, Parker redesigned the servo valve again. The redesign, which was completed in 1998, lengthened the primary and secondary slides about 0.5 inch, modified the servo valve end cap, and moved the flow port pathways and metering edges farther apart so that, if the secondary slide were to jam to the servo valve housing, overtravel of the primary slide would not connect ports that could cause reverse operation. All 737-NG series airplanes (the -600, through -900 series) are being produced with the newly redesigned servo valve.

The original servo valve design incorporated small washer-like "inserts" that had fluid passages cut into them. These inserts (made of 52100 steel) were installed in the inner diameter of the housing and secondary slide (made of surface-hardened Nitralloy) and formed the passages for hydraulic fluid flow through the valve. In the 1998 redesigned servo valve, the inserts were replaced with a one-piece design (made of 52100 steel) that provides the same function and reduces the number of parts required. The redesign of the inserts to the single-piece configuration was made possible by advances in manufacturing technology that allows the small fluid passages to be Electro Discharge Machined into the

²⁵⁹ According to Boeing, as of September 1998 there were 2,776 in-service 737s in the -100 through -500 series and 3,187 in-service PCUs (accounting for serviceable spares not installed on in-service airplanes).

single piece rather than built up by a group of smaller parts. Figure 31 shows the 1998 redesigned servo valve for both the earlier 737 series airplanes and the 737-NG airplanes.

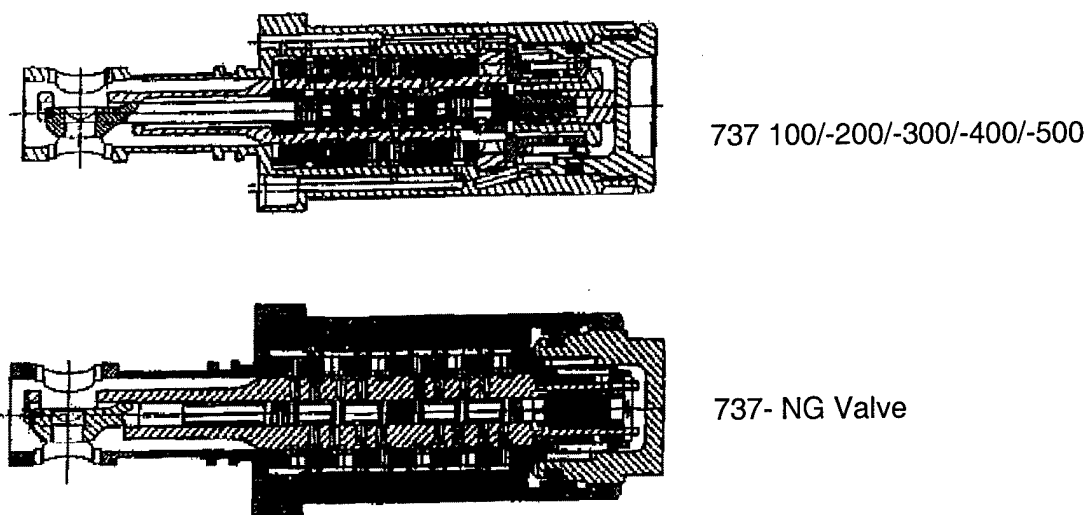

Figure 31. Parker's 1998 redesigned servo valve for 737 airplanes.

In addition, the FAA issued AD 97-14-03, which requires a redesigned yaw damper system on all 737-100 through -500 series airplanes by August 1, 2000. The redesigned system is to replace the current yaw damper coupler with a single electromechanical rate gyro that includes an improved coupler with a dual solid-state rate sensor. The system is also to provide improved system monitoring and fault analysis through improvements in built-in test equipment. The yaw damper system wire shielding and isolation are to eliminate potential electrical interference. All 737-NG series airplanes incorporate the redesigned yaw damper system.

AD 97-14-03 also requires that all 737-100 through -500 series airplanes be modified by adding a hydraulic pressure reducer to hydraulic system A near the rudder PCU to reduce the amount of rudder available to the flight crew during those phases of flight when large rudder deflections are not required. The reduced rudder authority is to be accomplished by lowering the hydraulic pressure from 3,000 to 1,000 psi (737-300, -400, and -500) or 1,400 psi (737-100, and -200 series airplanes). The yaw damper system is not affected by the hydraulic pressure reducer because that system operates off hydraulic system B. The hydraulic pressure reducer system is inactive in the two situations in which full rudder authority may be required: below 1,000 feet agl during takeoff climb and below 700 feet agl during landing approach. The hydraulic pressure reducer to be installed on the 737-300, -400, and -500 series airplanes also restores full rudder authority regardless of altitude when the rotation speed of the two engines differs by more than 45 percent. According to Boeing personnel, because the hydraulic pressure reducer control and indication logic are incorporated into the redesigned yaw damper coupler, the pressure reducer will be added at the same time as the yaw damper system changes.

All 737-NG series airplanes incorporate a hydraulic pressure limiter into the main rudder PCU. The limiter is controlled by airspeed and limits pressure to hydraulic system A inputs of the PCU by a bypass valve. The limiter is commanded to limit hydraulic pressure as the airspeed is increased to greater than 137 knots and resets as the airspeed is decreased to less than 139 knots.

1.18.5.1 Fractures in 1998 Redesigned Servo Valve Secondary Slides

In August 1998, Parker staff became aware that, during production slide testing, fractures had been discovered in several of the newly redesigned servo valve secondary slide legs. Subsequent examination of 502 servo valves in Parker's stock revealed a total of 9 fractured secondary slides; 1 fractured secondary slide and 1 chipped secondary slide²⁶⁰ were subsequently discovered in stock by Olympic Airways personnel. (Another cracked secondary slide was also discovered in a Maersk 737 main rudder PCU that was removed from service on February 3, 1999, because of a malfunctioning yaw damper and leakage. The crack was discovered as a result of a test performed at Parker on February 9, 1999, to detect cracking of the secondary slide.) According to Parker and Boeing personnel, of the 1,686 redesigned servo valves that had been shipped (to Boeing or the airlines), about 969 had been installed on airplanes before the fractured secondary slides were discovered. Boeing and Parker personnel stated that all of the fractured secondary slides had been magnetic particle inspected in their preassembled form with no fractures detected.²⁶¹

Safety Board personnel became aware in late September 1998 of the fractures in the redesigned servo valve secondary slides. The Safety Board's (visual and microscopic) examination of the fractured secondary slides revealed that the fractures consistently occurred on only one of the two legs at the input side of the secondary slide. The fracture appeared to initiate at the relatively sharp radius where the secondary slide reduces in cross section to accommodate the input mechanism for the primary and secondary slides, and the fracture progressed all the way through the leg, deviating on an angle, in all but one secondary slide. (The location of the crack on the remaining slide was farther along the leg.)

According to Boeing and Parker personnel, they examined several known and suspected cracking scenarios to determine the source of the cracks. These scenarios included delayed quench cracking, delayed cracking resulting from transformation of retained austenite to martensite, residual tensile stresses (from grit or bead blasting after machining), slow overstress, improper rig pin installation, and external impact loads. (External impact loads were generated by dropping the secondary slide from a height of about 3 feet onto a steel plate floor.) According to Boeing and Parker personnel, the fractures that resulted during tests involving external impact loads produced a fracture

²⁶⁰ According to Boeing personnel, the chipped secondary slide leg was not fractured completely through: both sides of the leg exhibited what appeared to be marks from a rigging tool, and Boeing indicated that the chip likely resulted from abusive handling of that rigging tool.

²⁶¹ After the servo valve components undergo inspection, the servo valves are assembled, rigged, and tested at Parker.

surface with characteristics similar to those exhibited by the 10 fractured secondary slides. Boeing personnel stated that, although the cause of the fractured secondary slides has not yet been identified, improper handling would be the most likely mechanism.

During a December 3, 1998, briefing at Safety Board headquarters in Washington, D.C., Boeing personnel stated that review of the potential fractured secondary slide leg scenarios indicated the following:

- if only one leg of the secondary slide failed, rudder performance would be normal;
- if the second leg of the secondary slide also failed, but the end piece remained in place, rudder performance would be normal except that trailing edge left movements would occur at half rate; and
- if the second leg failed and the separated end piece moved within the PCU cavity, an input link jam off neutral might occur, resulting in a rudder hardover.

Boeing and Parker personnel have developed and are instituting a modified servo valve production plan, which includes new (postassembly) servo valve dye penetrant inspection and PCU servo valve secondary slide displacement tests. Boeing drafted two alert service bulletins (ASB)²⁶² that describe procedures for the PCU servo valve secondary slide displacement test, criteria for passing the test, and procedures for replacement of any discrepant servo valve assembly with one having a secondary slide that passed the displacement test.

During the December 1998 briefing, Boeing personnel also prioritized the fractured secondary slide problem, asking "what's more important: crack fix or reversal fix?" Boeing's proposal indicated that its analysis showed that continued use of the current servo valve would be preferred over the 1998 redesigned servo valve. The proposal further stated that "as a precaution, Boeing believes correction of crack issue should have priority over correction of reversal scenario." Because of this proposed shift in priorities, Boeing recommended that the deadline for the installation of redesigned servo valves (required by AD 97-14-04, which addressed the potential of a rudder reversal condition) be extended to August 2000 or later (instead of August 1999, as currently required).

On January 13, 1999, the FAA issued a Notice of Proposed Rulemaking (NPRM, Docket No. 98-NM-383-AD), proposing an AD that would require operators to perform PCU servo valve secondary slide displacement tests (as described in Boeing's draft ASBs) at regular intervals and replace the servo valve assembly if necessary. The NPRM stated that because the proposed AD is an "interim action and a final action has not yet been identified to adequately address the identified unsafe condition, it will be necessary to repeat the displacement test on all [737] series airplanes, including airplanes that are produced subsequent to those with line numbers specified in the draft alert service bulletins."

²⁶² When finalized, ASBs 737-27A1221 and 737-27A1222 will apply to 737-100 through -500 series airplanes and 737-NG series airplanes, respectively.

1.18.6 Human Performance Considerations

1.18.6.1 Pilot Incapacitation

The Safety Board is aware of two instances of pilot incapacitation involving unintentional rudder inputs during flight.²⁶³ The first instance occurred on June 11, 1980, and involved a Frontier Airlines 737 on a visual approach to its destination airport in Cheyenne, Wyoming. The captain of this flight reported that the first officer was manually flying the airplane and that he decided to fly the approach 10 knots faster than the normal approach airspeed because of a possible windshear encounter during the approach. The captain indicated that, as the airplane descended through about 800 feet agl, he observed the airspeed increasing and commented "we are too...fast" but that the first officer did not respond. The captain reported that, when he called for a go-around and reached for the throttles, the airplane's nose yawed to the left. According to the captain's postincident written report, "I...glanced at the First Officer and realized that he was incapacitated and apparently unconscious. I added full power and began a climb and missed approach. The aircraft was still wallowing around and I was having a problem getting the controls into a coordinated flight situation. The airplane flew best in a climbing left turn."

The captain stated that he instructed a flight attendant to put an oxygen mask on the first officer. The flight attendant advised the captain that the first officer's left leg was rigid and was pushing against the left rudder pedal. The flight attendant moved the first officer's leg off the rudder, and the captain regained normal control of the airplane. The captain stated that he returned to land without further incident, and the first officer began to revive as the airplane taxied to the terminal. (The article in *Flying* magazine indicated that the first officer's incapacitation/seizure was the result of a chemical imbalance, which was subsequently treated successfully.)

During postincident interviews with Safety Board personnel, the captain reported that he was "startled" at the beginning of the incident; he stated that he flew reflexively and that his motor responses were sharp and unaffected by the sudden change of events. However, the captain stated that, until the flight attendant observed that the first officer was depressing the left rudder pedal, he did not know what was causing the airplane to yaw to the left. The captain reported that he was surprised that he was not aware that the left rudder pedal was pushed forward.

The second instance of pilot incapacitation involving unintentional rudder inputs occurred on March 29, 1994, and involved a Southwest Airlines 737 on approach to its destination airport in Oakland, California. During postincident interviews with Safety Board personnel, the captain of the Southwest Airlines flight stated that the first officer

²⁶³ The Safety Board became aware of the first incident when a staff member read an account of the event in the January 1996 issue of *Flying* magazine. The captain of the Frontier Airlines flight told Safety Board investigators that he decided to write the article after the United Airlines flight 585 accident in March 1991 and that the article was accepted for publication in July 1994. After learning about this incident, Safety Board staff asked the FAA's CAMI to search the Pilot Incapacitation Database for similar incidents. This search revealed a second incident, involving a Southwest Airlines 737.

was performing PF duties during the approach with the autopilot engaged in CWS mode. The captain stated that the airplane was in clouds and fog, about 1,500 feet agl, when the first officer “let out a blood curdling scream.” The captain reported that the first officer was staring out the forward cockpit window, his eyes were extremely large, and his back was arched. (These observations led the captain to wonder at first whether the first officer might have been shocked by the circuit breakers located behind his seat).

The captain reported that, seconds later, the first officer screamed another time, his back went rigid, and he clutched at the control column. The captain noticed that the airplane began to roll right and felt the left rudder pedal hit his ankle. The captain stated that, when he placed his feet on the rudder pedals, he noted the left rudder pedal was displaced aft about 5 to 6 inches. The captain reported that he disconnected the autopilot, applied aileron in the direction opposite the roll, and physically struggled (against the rudder pressure applied by the first officer) to neutralize the rudder pedal position. The captain stated that he also tried to use differential engine thrust to counter the effects of the rudder pressure. When a flight attendant unlatched the first officer’s lap belt and shoulder harness, the pressure on the rudder pedals was released, and the captain landed the airplane without further incident. The captain stated that he was startled at the beginning of the incident, which delayed his action by no more than 2 to 3 seconds. The captain also stated that he later learned that the first officer had suffered a seizure and had no recollection of the incident.

1.18.6.2 Spatial Disorientation

According to a book on flightdeck performance,²⁶⁴ spatial disorientation (a loss of correct perception of one’s orientation with respect to the ground—typically from a conflict between vestibular cues and those of visual and kinesthetic cues) can contribute to incorrect pilot control inputs. The book states that a pilot uses information from vestibular (inner ear) and visual (internal—flight instrumentation, external—horizon) cues to determine the airplane’s position in space, making disorientation more likely when fewer cues exist. The book further states that spatial disorientation is unlikely when strong external visual cues exist; however, abrupt, rapid aircraft movements and accelerations can lead to spatial disorientation if combined with a loss of external visual references (or the presence of misleading external visual references).

At the request of the Safety Board, a research scientist from NASA’s Ames Research Center, who is an experimental psychologist specializing in human spatial orientation, reviewed the FDR information, the CVR transcript, and a description of the USAir flight 427 accident circumstances. The research scientist was also involved in the Safety Board’s wake encounter simulations in NASA-Ames’ VMS simulator (see section 1.16.3), which attempted to represent the conditions and forces experienced by the pilots of flight 427.

²⁶⁴ Roscoe, S., and O’Hare, D. 1990. *Flightdeck Performance; The Human Factor*. Ames, Iowa: Iowa State University Press, chapter 2.

During the series of wake encounter simulations, the NASA research scientist occupied either the right or left seat of the simulator, with a Safety Board, ALPA, USAir, or Boeing official occupying the other seat.²⁶⁵ The research scientist stated that the simulator was programmed so that he received motion cues alone (without any visual display) during several of the simulations and motion cues combined with simulated, but representative, external visual cues during other simulations. At one of the public hearing sessions related to the USAir flight 427 investigation, the research scientist described his impressions of the wake turbulence encounter (the initial portion of flight 427's upset event) as follows:

...I was surprised at how gentle it all was. I had thought that the upset would be more severe. It was a surprise, it did get my attention. But it was not a violent kind of an upset that would...have me fail to know where I was and what my orientation was....

The research scientist strongly believed that the simulator pilots were not spatially disoriented during the initial upset event because clear external visual cues (the sky, ground, and horizon cues provided by the VMS visual simulation) were available throughout the simulation and the motions of the simulator were gradual and not excessively violent. The scientist further stated that, during postsimulator ride interviews, the simulation pilots reported that they always knew the location and orientation of the airplane in relation to the ground and that they could have flown out of the wake turbulence portion of the upset event.²⁶⁶

With regard to the accident flight, the research scientist stated:

I believe that the pilots probably would have experienced little difficulty in maintaining an accurate perception of their orientation, even during any brief periods when they may have lost sight of the visual horizon due to the pitch down attitude of the airplane. In addition, perturbations of the flight path generally appear to have been followed by verbal comments from the pilots, indicating that they were fully aware of their trajectory, and that they were not able to change it...it does not appear at all likely that pilot disorientation due to abnormal vestibular stimulation provided a major contribution to this accident.

1.18.7 Wake Turbulence/Upset Event Information

1.18.7.1 Previous Wake Turbulence Accidents

The Safety Board's Aviation Accident Database (which contains information regarding aviation accidents that occurred in the United States since 1962) revealed three air carrier accidents in which wake turbulence encounters were determined to be causal

²⁶⁵ The individuals who participated in these simulator sessions were passengers in the simulator and did not manipulate the simulator's flight controls.

²⁶⁶ As previously discussed, although the VMS is better able to represent airplane motions than most simulators, even VMS motions do not realistically represent some airplane motions and accelerations (lateral and vertical).

factors in the accident. All three accidents occurred when the airplanes were at a low altitude in the vicinity of airports.

- On March 8, 1964, a Douglas DC-3 crashed while landing at Chicago, Illinois. According to the accident report, the airplane was following a Boeing 707 jet aircraft. The probable cause of the accident was “the failure of the crew to utilize available de-icing equipment and engine power to maintain positive control of the aircraft under conditions of rapid airframe ice accretion and vortex induced turbulence.”²⁶⁷
- On July 15, 1969, a deHavilland DHC-6 crashed while taking off at Jamaica, New York, behind a “recently departed jet.”²⁶⁸ All other material regarding this accident was destroyed in 1984 (15 years after the accident).
- On May 30, 1972, a Douglas DC-9 crashed while landing at Fort Worth, Texas, behind a DC-10. The DC-9 was being operated in the airport traffic pattern under VFR, which places the responsibility for ensuring adequate air traffic separation on the pilots. The DC-9 was following 53 to 54 seconds behind the preceding DC-10. Although this accident involved VFR traffic separation, the FAA increased ATC IFR separation standards 2 months after the accident; since this change, there have been no documented air carrier accidents in which wake turbulence encounters were determined to be causal factors. Review of FDR data from this accident airplane revealed that, during the wake vortex encounter, the airspeed decreased from about 130 to about 60 knots and then increased to about 300 knots. Further, the FDR-recorded altitude (which had been descending consistent with approach to landing) changed from about 600 to 6,300 feet. These variations are consistent in direction and scale with FDR data from other rotor encounters.²⁶⁹

1.18.7.2 Aviation Safety Reporting System Reports of Uncommanded Upsets/Wake Turbulence Encounters

To support the Safety Board’s investigation of the USAir flight 427 accident, NASA personnel reviewed the agency’s ASRS pilot report database²⁷⁰ and produced reports in several subject areas, including 737-type reports, 737-type rudder trim/control reports, Pittsburgh terminal area conflicts, and wake turbulence encounter/uncommanded upset/loss of control events in multiengine turbojet aircraft. These reports assisted the Safety Board in conducting a thorough review of previous yaw/roll events (as discussed in section 1.18.1.1.) ASRS personnel also accomplished “structured callback” studies in

²⁶⁷ See Civil Aeronautics Board. 1965. *Hansen Air Activities, Douglas DC-3A, N410D, near Chicago-O’Hare International Airport, Chicago, Illinois, March 8, 1964*. CAB File 2-0002. Washington, DC.

²⁶⁸ See National Transportation Safety Board. Brief of Accident. *New York Airways, Inc., deHavilland DHC-6, N558MA, at JFK International Airport, Jamaica, New York, July 15, 1969*. NTSB File 1-0020. Washington, DC.

²⁶⁹ See National Transportation Safety Board. 1973. *Delta Air Lines, Inc., McDonnell Douglas DC-9-14, N3305L, Greater Southwest International Airport, Fort Worth, Texas, May 30, 1972*. Aircraft Accident Report NTSB/AAR-73/03. Washington, DC.

which they interviewed the pilots who provided the original reports. (After preliminary processing, ASRS personnel typically deidentify all incoming ASRS reports to protect the identity of the reporting individuals; however, the pilots who were interviewed on a voluntary basis as part of the structured callback studies waived that anonymity.)

Data from the "Multi-Engine Turbojet Uncommanded Upsets Structured Callback Summary" (a project conducted to support the USAir flight 427 investigation) revealed that wake turbulence was the most common cause of the upset/loss of control events reported by pilots between January 1987 and May 1995, cited in 96 of 297 cases. Pilots reported using rudder during recovery efforts in one-third (11 events) of the 33 upset events reported by airline pilots to ASRS between May 1 and October 31, 1995 (and examined in depth through structured callback efforts).²⁷¹

Data from the ASRS "Wake Turbulence Structured Callback Project" (a project conducted by the FAA in response to a Safety Board recommendation)²⁷² revealed that 166 wake turbulence events were reported between April 1995 and August 1997, of which 101 were from pilots of multiengine turbojet airplanes (including 33 from 737 pilots).²⁷³ Review of the ASRS reports and comments obtained from the pilots during followup interviews revealed that flight crews were frequently surprised by the suddenness and severity of the wake turbulence encounters.²⁷⁴ The pilots' comments included the following:

"The severity of this encounter surprised me.... I could have very easily ended up on my back, and this was from another 737!"

"[The pilots] encountered a violent roll [to the left] 25 [degrees] and then a violent roll back to [the right] into a 25 [degree] bank."

"It took almost full aileron input to keep from rolling past 45 degrees.... The wake I encountered was considerably more than normal."

"During that time we experienced very rapid roll rates...rolling 45 degrees left and right, and full aileron often required to keep...right side up."

"[An uncommanded upset that produced aircraft roll of] at least 45 [degrees]," and that the "[aircraft] felt out of control, very mushy...didn't think...could control the [aircraft]."

"We were rolled into an approx[imately] 45-50 [degree] bank from wake turbulence.... Such encounters...are highly distracting and require immediate attention."

²⁷⁰ ASRS is a national repository for reports regarding aviation safety-related issues and events. ASRS reports are voluntarily submitted by pilots, air traffic controllers, air carrier personnel, and other aviation professionals when they want to make known a potentially unsafe condition or event. The Director of NASA's ASRS program cautions that the existence of reports pertaining to any subject area should not be considered a statistically valid indication of the prevalence of that problem within the aviation system; however, the ASRS database may provide some indication of the number of aviation safety-related events that occur in any given subject area, and the reports are a useful source of narrative descriptions of in-flight events.

The Safety Board's review also revealed that, among pilots of multiengine turbojet airplanes, 30 percent reported that the wake turbulence encounter occurred at night, and 7 percent reported that the encounter occurred in IFR conditions.²⁷⁵ Of the reported encounters, 55 percent occurred at altitudes at or below 6,000 feet msl (the altitude of USAir flight 427 at the time of the initial upset); 18 percent occurred at altitudes at or below 500 feet. In addition, 25 percent of the pilots reported that the autopilot remained engaged during the turbulence encounter. In all the cases examined through the ASRS reports, the pilot(s) maintained or regained control of the airplane and landed without further incident.

²⁷¹ To obtain additional data regarding rudder use during air carrier operations, the Safety Board reviewed more than 100 references to accidents and incidents that were provided by Boeing (in its "Human Factors Supplement, Submission to the National Transportation Safety Board for the USAir 427 Investigation," September 30, 1997), the Board's own records of 737 accidents and incidents, and additional 737 incident data and QAR information obtained from accident investigation authorities worldwide. Examination of the available data revealed that cross-control conditions (rudder pedal input opposing control wheel input) occurred occasionally in response to an unexpected anomaly or wake turbulence. One such event occurred on October 27, 1986, and involved a Trans Australia Airlines 737 during its approach to land at Canberra, Australia. The airplane's FDR data indicated that a cross-control condition existed for about 21 seconds during the airplane's right turn to align with the runway. FDR data indicated that the extent of the cross-control varied during the event; at its most severe, the cross-control consisted of about 60° of left control wheel input and 12° of right rudder pedal input. The pilots stated that they perceived an airframe vibration and performed a go-around, during which coordinated control was maintained. Throughout the cross-control event, the airplane's right bank remained stable at 20° to 25°. FDR records indicate that a similar cross-control situation occurred during the airplane's second approach to the runway. That cross-control condition was less severe; the pilots resumed coordinated flight and an uneventful landing ensued.

Another cross-control condition occurred on April 23, 1993, and involved a United Airlines 737 that encountered wake turbulence at 6,500 feet msl during its approach to its destination airport. FDR data indicated that the incident involved about 9 seconds of rudder activity, during which moments of cross-control occurred. Maximum rudder input during this event was less than 7°. On July 25, 1995, a USAir 737 was approaching to land at Richmond, Virginia. Pilot statements and incident airplane FDR data indicated that the pilots responded to an uncommanded roll event appropriately with coordinated left aileron and rudder. However, after the uncommanded roll event subsided, moments of cross-control occurred when several degrees of left rudder input remained while the aileron position varied, providing mostly right aileron input until the airplane landed. The pilots' statements indicated that they made rudder and aileron inputs "as necessary throughout the approach and landing to maintain directional control of the aircraft." Maximum rudder input during this event was about 7°. In June 1997, a 737 encountered wake turbulence at 10,000 feet msl behind a 747. FDR data from the incident airplane indicated that the pilots had commanded right aileron and right rudder as the airplane began to roll left at the beginning of the wake encounter; the right rudder input remained (although reducing gradually) for about 14 seconds, but moments of cross-control occurred when the aileron input varied during the recovery. Maximum rudder input was less than 7°.

Although not a wake turbulence event, an example of an accident resulting from improper rudder input occurred on September 6, 1985, and involved a Midwest Express Airlines DC-9 that crashed after experiencing a loss of engine power shortly after liftoff (see National Transportation Safety Board. 1987. *Accident Involving Midwest Express Airlines, Inc., Flight 105, Douglas DC-9-14, N100ME, Milwaukee, Wisconsin, September 6, 1985*. Aircraft Accident Report NTSB/AAR-87/01. Washington, DC.) The Safety Board's accident report indicated that, because of the airplane's nose-high pitch attitude, the pilots were operating with reduced external visual cues. Although the pilots initially applied correct rudder in response to the loss of engine power, incorrect rudder was applied about 4 to 5 seconds later.

1.18.8 Ergonomics—Study of Maximum Pilot Rudder Pedal Force

As previously discussed, one of the variables in the Safety Board's computer simulations was pilot rudder pedal force. Because pilot rudder pedal force was not recorded by the FDRs in the USAir flight 427, United flight 585, and Eastwind flight 517 airplanes, the Safety Board conducted a study, using ergonomic research and other data, to estimate the rudder pedal forces that the pilots might have applied during the upset events.

A researcher at the USAF's Armstrong Laboratory studied strength capability for operating aircraft controls in a study often used as a standard for aircraft design.²⁷⁶ The data reported in this study represent the maximum isometric strength demonstrated by USAF subjects operating the aircraft controls of a laboratory simulator. Subjects were healthy volunteers, either from the Air Force Academy (AFA) or Officer's Training School (OTS), who were instructed to push forward on the rudder pedal with as much force as they could exert and hold that force for 5 seconds.

Among 199 of the subjects (male AFA students between 19 and 25 years old), median strength output of the left leg against the left rudder pedal was 624 pounds, and median strength output of the right leg against the right rudder pedal was 623 pounds. Among 249 other subjects (male OTS students between 21 and 34 years old), median strength output of the right and left legs was 510 pounds each. These results were some of the highest leg force outputs obtained in a laboratory setting and cited in the available ergonomic literature,²⁷⁷ even when the results were compared with other studies using USAF subjects.²⁷⁸

The results from the USAF study involving OTS subjects were considered to be more representative of the airline pilot population for two reasons: the OTS subjects (although physically fit) were not subject to the rigorous physical selection and exercise

²⁷² See National Transportation Safety Board. 1994. *Safety Issues Related to Wake Vortex Encounters During Visual Approach to Landing*. Special Investigative Report NTSB/SIR-94/01. Washington, DC.

²⁷³ ASRS reports of wake turbulence encounters by general aviation and air carrier pilots increased after NASA began its Wake Turbulence Project in April 1995, which was publicized in the piloting community. Before 1995, ASRS received an average of 55 wake turbulence reports annually. In 1995, 109 reports of wake turbulence encounters were received. In 1996, 60 reports were filed, and 87 reports were filed in 1997.

²⁷⁴ In many cases, review of the FDR data revealed that the flight crews overestimated the degree of bank experienced as a result of the wake turbulence encounters. The flight crew of Eastwind flight 517 overestimated the degree of bank experienced during the incident.

²⁷⁵ The data reported here were extracted by ASRS staff at the request of the Safety Board to focus on reports from pilots of multi-engine turbojets.

²⁷⁶ McDaniel, J.W. 1995. "Strength capability for operating aircraft controls." *SAFE Journal*, 25, pp. 28-34.

²⁷⁷ Weimer, J. 1993. *Handbook of ergonomic and human factors tables*. Englewood Cliffs, New Jersey: Prentice Hall, pp. 90-91.

²⁷⁸ Hertzberg, H.T.E., and Burke, F.E. 1971. "Foot forces exerted at various aircraft brake-pedal angles." *Human Factors*, 13, pp. 445-56.

requirements that were applied to the AFA students, and the OTS students, on average, were older than the AFA subjects. Therefore, the Safety Board used the results of the USAF studies involving OTS subjects as a baseline for its ergonomic study; an output of 510 pounds, sustained for a short period of time, was deemed as a reasonable estimate for the maximum leg force output of an airline transport pilot.

In evaluating the leg force that could have been applied during the three upset events, the Safety Board also considered the effect that seat position and knee angle would have on that force. Ergonomic studies indicate that an individual's maximum potential leg thrust varies dramatically with knee angle, with an optimal knee angle range of between 140 and 160° (180° corresponds to a straight leg).²⁷⁹ (The knee angles of the subjects in the USAF studies were between 130 and 140° for a neutral pedal position, which provided for adequate leg extension to obtain a full rudder input with the most effective knee angles.)

The Safety Board also considered the effect that age might have on a pilot's ability to exert leg forces approaching those demonstrated in the USAF studies. Research indicates a loss of strength in leg extension forces among subjects older than those in the USAF studies (about a 6 percent reduction in strength per decade in individuals older than 30 years old).²⁸⁰ However, studies also indicate that general muscle loss can be prevented or reversed as a result of regular exercise.²⁸¹

Further, the Safety Board researched the correlation between physical size (such as height) and leg strength and found that the correlation between the two was low. In other words, the research showed that a shorter person may be extremely strong, whereas a taller person may be comparatively weak.

The Safety Board recognizes that a pilot's leg force output in a real cockpit emergency (such as those that occurred on USAir flight 427, United flight 585, and Eastwind flight 517) may also depend on the motivation and perception of the pilots about their situation. Thus, laboratory results may not necessarily replicate actual flight situations.

²⁷⁹ Woodson, W.E., Tillman, B., and Tillman, P. 1993. *Human Factors Design Handbook*. New York: McGraw Hill. Kroemer, K.H.E., Kroemer, H.B., and Kroemer-Elbert, K.E. 1994. *Ergonomics: how to design for ease and efficiency*. Englewood Cliffs, New Jersey: Prentice Hall, p. 379.

²⁸⁰ Hortob'agyi, T., Zheng, D., Weidner, M., Lambert, N.J.; Westbrook, S.; and Houmard, J.A. 1995. "The influence of aging on muscle strength and muscle fiber characteristics with special reference to eccentric strength." *Journal of Gerontology, Biological Sciences*, 50: B399-406. Bembem, M.G., Massey, B.H., Bembem, D.A., Misner, J.E., and Boileau, R.A. 1996. "Isometric intermittent endurance of four muscle groups in men aged 20-74 yr." *Medicine and Science in Sports and Exercise*, 28 (1), pp. 145-54. Borges, O. 1989. "Isometric and isokinetic knee extension and flexion torque in men and women aged 20-70." *Scandinavian Journal of Rehabilitation Medicine*, 21 (1), pp. 45-53. Sanders, M.S., and McCormick, E.J. 1993. *Human Factors in Engineering and Design*. New York: McGraw Hill, Inc., p. 251.

²⁸¹ Yukitoshi, A., and Shephard, R.J. 1992. "Aging and muscle function." *Sports Medicine*, 14 (6), pp. 376-396. Sanders and McCormick, p. 251.

Therefore, in estimating the maximum rudder pedal force applied by the flying pilots in the USAir flight 427 and United flight 585 accidents and the Eastwind flight 517 incident, the Safety Board used the available ergonomic and other data, including the leg strength results from the USAF OTS subject study and the pilot's knee angle, age, physical fitness, physical size, motivation, and perception of the situation. In the case of the Eastwind flight 517 incident, the Safety Board also used the flight crew's statements, the flying pilot's actual knee angle, and pilot rudder pedal force measurements.

USAir Flight 427

The Safety Board modeled the pedal forces exerted by the first officer of USAir flight 427 based on the pilot rudder pedal force norms identified in the USAF OTS study. The first officer, who was 6 feet 3 inches tall, was reported to be healthy and, at 38 years old, might have been subject to a small degradation in leg extension strength (perhaps 6 percent) compared with the younger USAF OTS subjects. The CVR indicated physical straining sounds over a period of less than 5 seconds at the beginning of the upset period, which was consistent with the period of maximum effort exerted by the subjects in the USAF study. Thus, on the basis of his age (and the assumption of an optimal knee angle), the first officer could be expected to have been able to exert about 480 pounds of force on a single rudder pedal (510 pounds minus 6 percent, or about 30 pounds).

To estimate the first officer's probable seat position and knee angle during the upset, postaccident ergonomic measurements were conducted in a 737 cockpit using a Safety Board employee who was similar to the first officer in height, weight, and inseam measurement.²⁸² The Safety Board employee found it necessary to place the right-hand cockpit seat in its farthest aft position and the rudder pedal adjustment in its farthest forward position for optimal flight control usability and leg room comfort. He adjusted the seat height to the correct eye reference position, according to guidance in the USAir Operations manual.²⁸³ In this position, the Safety Board employee's right knee angle was 133° when his foot was pushing on the right rudder pedal in its neutral position. When the right rudder pedal was displaced 1¼ inches aft (toward the Safety Board employee), his right knee angle was 122°.

Ergonomic research indicates that a pilot's maximum leg thrust with a 122° knee angle would be further degraded by about 28 percent (compared with the 130 to 140° range in the USAF study). The Safety Board used the blowdown limit for USAir flight 427 to calculate that the right rudder pedal would likely have moved about 1 inch aft of its neutral position, causing the first officer's knee angle to diverge from the optimum range. On the basis of this information and the results of measurements of the Safety Board

²⁸² Information about the first officer's height and weight was based on his most recent flight physical. The first officer's inseam measurement was provided by his wife.

²⁸³ According to US Airways personnel, no eye reference adjustment device was in the cockpit of the accident airplane. The company 737 Pilot's Handbook directed pilots to adjust the seat for the correct eye reference position, which is established when the top-most flight mode annunciators are just in view below the glareshield and, at the same time, a slight amount of the aircraft nose structure is visible above the forward lower window sill.

employee's seat position and knee angle, the Safety Board assumed that the USAir flight 427 first officer's right rudder pedal force was reduced about 15 to 20 percent as the right rudder pedal moved aft during the upset event.

Accordingly, on the basis of the available information, the Safety Board's computer simulation studies (discussed in section 1.16.6.1) assumed that the first officer of USAir flight 427 would have applied an initial maximum force of about 400 pounds on the right rudder pedal in response to a rudder reversal. Further, the simulation studies assumed that the first officer reduced his leg force on the right rudder pedal by about 50 percent (to about 200 pounds) later in the upset sequence when he would have been maintaining rudder pedal pressure but making less than a maximum effort so he could attend to other aspects of the emergency. (See section 2.2.2 for more discussion of this rudder pedal force reduction.)

United Flight 585

The captain of United flight 585 was 5 feet 7 inches tall, which permitted him to make seat adjustments that could have obtained an optimum knee angle for exerting force on the rudder pedals (unlike the first officer of USAir flight 427). The captain was assumed to have selected a seat and rudder pedal adjustment that resulted in the optimal (130 to 140°) knee angle with the rudder pedals in the neutral position and allowed for leg extension to command full rudder. (The CVR transcript indicates that the captain performed a rudder check before takeoff,²⁸⁴ which would have required the captain to adjust his seat position to allow for the full range of motion on the rudder pedals.) Although the captain's age (52 years) might have resulted in some degradation in maximum leg force,²⁸⁵ postaccident interviews indicated that the captain was in excellent health and followed a rigorous exercise regimen.

Because the captain's personal health characteristics might have countered the normal age-related loss of strength, the Safety Board did not reduce its estimate of the captain's leg force from the USAF norms based on his age. However, the United flight 585 circumstances indicated that, in a rudder reversal situation, the left rudder pedal could move as much as 3 inches aft (toward the captain) during the rudder's movement to its blowdown limit (and within about 1 additional second as sideslip allowed the rudder to deflect more). This rudder pedal movement would have forced the captain to use a less effective knee angle than that of the USAF OTS subjects, which would have reduced his rudder pedal input force.

Further, because of the suddenness of the United flight 585 upset and the airplane's rapid departure from controlled flight, it is possible that the captain never reached his personal maximum leg force effort. In the short time available to recover from the upset, the captain may have pushed hard on the left rudder pedal only long enough to realize that

²⁸⁴ The CVR transcript indicates that, at 0914:20, before taxiing for takeoff, the captain warned the first officer to "watch your feet here comes the rudder."

²⁸⁵ Research indicated that a loss of about 15 percent in pilot rudder pedal force might be expected in an individual the same age as the captain.

there was a serious problem in the flight control and then shifted his focus to attempt a go-around and stop the yaw/roll with control wheel inputs. Therefore, on the basis of the available information, the Safety Board's simulation studies assumed that the captain applied a force of about 300 pounds during the brief period between pedal input and the go-around decision/control wheel input and that he subsequently reduced his rudder pedal force to about 200 pounds (see section 2.3.2 for more discussion of the force reduction).²⁸⁶

Eastwind Flight 517

The captain of Eastwind flight 517 was 5 feet 10 inches tall. Postincident measurements in a cockpit identical to that of the incident airplane showed that, when the seat and rudder pedals were adjusted to the positions the captain normally used in landing, his left knee angle was 130° when his left foot was pushing the left rudder pedal in its neutral position. The captain estimated that, during the incident, the left rudder pedal moved 1½ inches forward of its neutral position in response to his efforts to depress it.²⁸⁷ With the left rudder pedal in this position, the captain's left knee angle was 140° when his left foot pushed the pedal. Further, when the captain demonstrated how he "stood on the pedal" during the incident to gain greater pushing force, he used a raised posture in which his body moved upward by 2 inches (as measured at the shoulder). In this posture, his left knee angle was 145° when he pushed on the left pedal, which was displaced 1½ inches forward of its neutral position. Ergonomic literature indicates that this posture may have increased the captain's maximum leg force by as much as 35 percent compared with the USAF OTS subject norm.

During postincident testing, the captain displayed a leg strength on a standard medical rehabilitation testing protocol that placed him below average compared with norms established by a sample of healthy, recreationally active adults. However, in allowing for the advantage that may have been provided by his effective knee angle, the Safety Board assumed that the captain could produce a maximum force in the 500-pound range when "standing" on the rudder pedal to oppose a rudder reversal.

On the Eastwind flight 517 airplane, a force of about 300 pounds would have been required to move the rudder pedal beyond its neutral position in a rudder reversal situation. Therefore, the captain's demonstration to investigators of the left rudder pedal position that he recalled obtaining during the incident (about 1½ inches forward of neutral) would correspond to an effort of about 450 pounds. This rudder pedal force is

²⁸⁶ This model of pilot rudder pedal force was considered the most appropriate, but a second model also provided a good fit of the data. In this second model, the captain was assumed to have initially input a rudder pedal force of about 500 pounds and then reduced this input force to 250 pounds.

²⁸⁷ During a June 14, 1996, interview, the captain stated that he stood hard on the rudder pedal and applied about 3 to 4 inches rudder displacement. During a June 17, 1998, interview, the captain stated that the rudder pedals moved no more than 1 or 2 inches. In a February 4, 1999, cockpit test, in which the captain moved actual rudder pedals, the left pedal moved downward by 1½ inches on his first demonstration and by 1-5/8 inches on his second demonstration (as measured by a Safety Board investigator seated in the opposite pilot seat). On the basis of all four estimates, and the simplicity of a pedal demonstration compared with a verbal description, the Safety Board employed a 1½-inch displacement as a representation of the captain's recall. (A 4-inch displacement would move the pedal down to its lower stop, which would contradict the captain's numerous reports that the pedal was stiff and would not go down to the floor.)

consistent with the Board's estimates based on the USAF data, adjusted for the captain's measured strength and knee angles.

Accordingly, on the basis of the available information, the Safety Board's simulation studies assumed that the captain's initial rudder pedal force was about 500 pounds. The simulation studies further assumed that this rudder pedal force was reduced later in the incident sequence (see section 2.4.2 for more discussion of the force reduction).

1.18.9 Unusual Attitude Information and Training

The FAA's AC 61-27C, "Instrument Flying Handbook," defines an unusual attitude as "...any airplane attitude not normally required for instrument flight." The AC states that an unusual attitude may result from "a number of conditions, such as turbulence, disorientation...or lack of proficiency in aircraft control."

The Airplane Upset Recovery Training Aid (developed in 1997 and 1998 by a working group, as described in section 1.18.9.2) states that "while specific values may vary among airplane models, the following unintentional conditions generally describe an airplane upset [unusual attitude]: Pitch attitude greater than 25° nose up; pitch attitude greater than 10° nose down; bank angle greater than 45°; and within the above parameters, but flying at airspeeds inappropriate for the conditions."

1.18.9.1 Preaccident Activity

Before the USAir flight 427 accident, the Safety Board had issued three safety recommendations that addressed training flight crews involved in 14 CFR Part 121 operations in the recognition of and recovery from unusual flight attitudes. Safety Recommendation A-70-21, issued on May 1, 1970, referenced an accident that occurred on November 16, 1968, in which a flight crew lost control of a 737 near Detroit, Michigan, in poor weather conditions.²⁸⁸ The Safety Board recommended additional flight crew training in which pilots would be required to periodically demonstrate proficiency in recovery from unusual attitudes. The Safety Board also suggested that a simulator be utilized to provide flight crew familiarization with (1) the various instrument displays associated with and resulting from encounters with unusual meteorological conditions, (2) the proper flight crew response to the various displays, and (3) demonstration of and recovery from possible ensuing unusual attitudes.

In its May 21, 1970, letter to the Safety Board, the FAA stated that airline training was now emphasizing the proper use of trim, attitude control, and thrust, which the FAA believed was far more effective than the practice of recovery from unusual attitude maneuvers. The FAA indicated that unusual attitude maneuvers had been deleted from the pilot proficiency check in 1965. The FAA also believed that it was inconceivable to require training maneuvers that would place a large jet airplane in a nose high, low airspeed, high angle-of-attack situation.

²⁸⁸ See National Transportation Safety Board. 1969. NTSB Log 69-0115, notation 413.

In a July 8, 1970, letter to the Safety Board, the FAA stated to the Safety Board that changes in airline training and operational procedures had resulted from this safety recommendation and cited a "marked decrease in upset events" as evidence that these actions had addressed the intent of the recommendation. The FAA further stated that it would discuss with industry representatives the feasibility of simulating large excursions from flightpath caused by abnormal meteorological conditions. Because no further action was taken by the FAA, the Safety Board classified Safety Recommendation A-70-21 "Closed—Unacceptable Action" on August 17, 1972.

On March 31, 1971, a Boeing 720B yawed and crashed while the flight crew was attempting a three-engine missed approach. The Safety Board attributed the probable cause of the accident to a failure of the airplane's rudder actuator and expressed concerns regarding the flight crew's ability to rapidly assess the situation and recover. As a result of this accident, the Safety Board issued Safety Recommendation A-72-152, which asked the FAA to require pilots to demonstrate their ability to recover from abnormal regimes of flight and unusual attitudes solely by reference to flight instruments. The Board recommended the use of simulators for this demonstration and noted that current simulators should be modified if they were not capable of being used for this purpose.

In its response, the FAA stated that it did not believe that simulators were capable of simulating certain regimes of flight that go beyond the normal flight envelope of the aircraft. Further, because an aircraft simulator is not required as part of an air carrier training program, the FAA stated that it could not require that a simulator be replaced or modified to simulate regimes of flight outside the flight envelope of the aircraft. On the basis of this response, Safety Recommendation A-72-152 was classified "Closed—Unacceptable Action" on January 16, 1973.

The Safety Board issued Safety Recommendation A-92-20 as a result of a July 10, 1991, Beech C99 accident at Birmingham, Alabama.²⁸⁹ The recommendation asked the FAA to require that recurrent training and proficiency programs for instrument-rated pilots include techniques for recognizing and recovering from unusual attitudes.

In its July 9, 1992, letter to the Safety Board, the FAA stated that pilots are already required to demonstrate recovery from unusual flight attitudes on their private pilot examination. In addition, the FAA noted that the instrument rating requires a pilot to be proficient in recovery from unusual attitudes. Therefore, the FAA believed that, by the time a pilot had the required experience to become part of a flight crew with a 14 CFR Part 121 or 135 air carrier, the pilot would have received extensive training and flight checks for procedures and techniques in recovery from unusual attitudes. The FAA further cited existing requirements for the ATP certificate and pilot training under Part 121, including recovery from "specific flight characteristics that are considered reasonably probable for the airplane (such as dutch roll recovery in the Boeing 727), steep turns, approaches to stalls, and the windshear escape maneuver."

²⁸⁹ For more information, see National Transportation Safety Board. 1992. *L'Express Airlines, Inc., Flight 508 Beech C99, N72171, Weather Encounter and Crash Near Birmingham, Alabama, July 10, 1991*. Aircraft Accident Report NTSB/AAR-92/01. Washington, DC.

In a January 26, 1993, letter to the FAA, the Safety Board stated that it continued to believe that instrument-rated pilots should receive recurrent training in techniques for recognizing and recovering from unusual attitudes and that proficiency programs should include this same training. The letter also stated the Board's belief that requiring such training annually would greatly enhance a pilot's ability to safely recover from an unusual attitude. Because the FAA planned no additional response, Safety Recommendation A-92-20 was classified "Closed—Unacceptable Action."

The Safety Board's accident report of a DC-8-63, near Swanton, Ohio, on February 15, 1992,²⁹⁰ addressed the subject of airline pilots' reluctance to aggressively apply flight controls. The report stated the following:

...basic control manipulations by the first officer during the recovery attempt were in general accordance with accepted procedures in that he attempted to roll the wings level and then began pulling the nose up. If he had been more aggressive with both sets of controls, he might have succeeded. A larger, more rapid aileron input would have leveled the wings faster[,] and a more aggressive pullout could have been within the operating envelope of the aircraft.... Obviously, this situation called for extremely quick and aggressive control inputs.

According to USAir flight training personnel, the flight training syllabus at the time of the USAir flight 427 accident included pilot training in the following maneuvers:

- recovery from approaches to stalls,
- recovery from a dutch roll,
- high-speed buffet,
- steep turns (45° bank), and
- windshear escape.

However, the Safety Board's review of the USAir training syllabus that was in effect before the accident for both the ground and simulator training programs revealed that the training being conducted did not include recovery from unusual attitudes or upsets, as defined in AC 61-27C or in the Airplane Upset Recovery Training Aid.

Additionally, the Safety Board surveyed the content of the flight training syllabi of six other major airlines at the time of the flight 427 accident. Of the six airlines surveyed, five had training syllabi similar to the USAir training syllabus. The sixth, United Airlines, had recently developed and implemented an Advanced Maneuvers Package²⁹¹ for its Boeing 757 and 767 flight crew simulator training program. According to United Airlines

²⁹⁰ See National Transportation Safety Board. 1992. *Air Transport International, Inc., Flight 805, DC-8-63, N794AL, Loss of Control and Crash, Swanton, Ohio, February 15, 1992*. Aircraft Accident Report NTSB/AAR-92/05. Washington, DC.

²⁹¹ United Airlines' training captains developed the Advanced Maneuvers Package over a 2-year period, and it was incorporated into the 757 and 767 training program in July 1994. The program involves recognition and recovery from unusual flight attitudes, including nose high, nose low, and inverted.

flight training personnel, the Advanced Maneuvers Package received an "overwhelmingly positive" response from flight crews and instructors, and the airline was incorporating the training throughout its fleet.

On July 13, 1993, Boeing published a *Flight Operations Review* article, which addressed the subject of unwanted roll tendencies, as follows:

If aileron control is affected, rudder inputs can assist in countering unwanted roll tendencies. The reverse is also true if rudder control is affected.

If both aileron and rudder control are affected, the use of asymmetrical engine thrust may aid roll and directional control.

When encountering an event of the type described above, the flightcrew's first consideration should be to maintain or regain full control of the airplane and establish an acceptable flight path. This may require the use of unusual techniques such as the application of full aileron or rudder.

1.18.9.2 Postaccident Activity

On August 16, 1995, the FAA disseminated Flight Standards Handbook Bulletin for Air Transportation (HBAT) 95-10, entitled "Selected Events Training" (SET), to its principal operations inspectors (POI). The HBAT contains "...guidance and information on the approval and implementation of 'Selected Events Training' for operators training under 14 CFR Part 121, who use flight simulation devices as part of their flight training programs."

The HBAT states that the SET is "voluntary flight training in hazardous inflight situations which are not specifically identified in FAA regulations or directives." Some of the examples of these selected events include false stall warning in rotation, excessive roll attitude (in excess of 90°), and high pitch attitude (in excess of 35°). The HBAT further states that the SET program was developed jointly by the FAA and the aviation industry in response to previously issued Safety Board recommendations addressing the need for unusual events and unusual attitude training for Part 121 and 135 air carrier pilots.

In 1996, USAir implemented SET as a required recurrent training element for all of its pilots. The training program at USAir included simulator training in recovering from nose high, nose low, and inverted airplane attitudes. Also, many air carriers began implementing SET/Advanced Maneuvers Package programs patterned after the guidelines of the FAA's HBAT 95-10 and United Airlines' program, respectively.

On October 18, 1996, the Safety Board issued Safety Recommendation A-96-120. This recommendation asked the FAA to require 14 CFR Part 121 and 135 operators to provide training to flight crews in the recognition of and recovery from unusual attitudes and upset maneuvers, including upsets that occur while the aircraft is being controlled by automatic flight control systems and unusual attitudes that result from flight control malfunctions and uncommanded flight control surface movements.

In a January 16, 1997, letter to the Safety Board, the FAA stated that it was considering an NPRM proposing to require that air carriers conduct training that will emphasize recognition, prevention, and recovery from aircraft attitudes that are normally not associated with air carrier flight operations. In its July 15, 1997, response, the Safety Board stated that it was not aware of any training programs that specifically addressed unusual attitudes that resulted from a control system failure or for which some flight controls would not be available, or would be counterproductive to, the recovery. (This recommendation is discussed more fully in section 1.18.11.5.)

In a November 2, 1998, letter to the FAA, the Safety Board listed those safety recommendations, including A-96-120, for which no recent action had been taken by the FAA. In a January 13, 1999, letter to the Safety Board's Director of the Office of Aviation Safety, the FAA's Associate Administrator for Regulation and Certification stated that "14 CFR part 121, subparts N and O (Training Program and Crewmember Qualifications, respectively), are being extensively rewritten. The rulemaking is expected to contain specific requirements addressing the NTSB's concerns." (See section 2.7 for the Safety Board's review and evaluation of the FAA's action in response to Safety Recommendation A-96-120 and the recommendation's current classification.)

During 1997 and 1998, a working group composed of representatives of aircraft manufacturers, air carriers, pilot associations, training organizations, and government agencies (including the FAA) developed the Airplane Upset Recovery Training Aid. This publication and video program provided background information for air carrier pilots and managers on jet aerodynamics, stability, control, and upset recovery. The training aid also provided a model curriculum for classroom and flight simulator training in recovering from unusual flight attitudes. As of late 1998, the Airplane Upset Recovery Training Aid publication and video program were being distributed by two major air transport manufacturers (Boeing and Airbus) to their customers. This training aid, however, does not include simulator training in unusual attitudes resulting from flight control malfunctions and uncommanded flight control surface movements.

1.18.10 Procedural Information Available to Boeing 737 Flight Crews

1.18.10.1 Preaccident Information Available to 737 Pilots Regarding Abnormal Procedures (Flight Controls Malfunctions)

The abnormal operations section of the USAir 737-300 Pilot's Handbook that was in effect at the time of the flight 427 accident contained procedural guidance for abnormal flight control and hydraulic system conditions. Page 1-307-3 of the Pilot's Handbook, dated May 8, 1992, listed abnormal checklist procedures for flight control low pressure and yaw damper anomalies. Page 1-307-6 of the Pilot's Handbook, dated June 17, 1994, listed abnormal checklist procedures for "Jammed or Restricted Flight Controls."

Under "Flight Control Low Pressure," the abnormal checklist procedures stated:

Flight Control Switch STBY RUD [bold original to text]

Placing a flight control switch to STBY RUD starts the standby hydraulic pump and arms the STANDBY LOW PRESSURE light. The FLT CONTROL LOW PRESSURE light extinguishes, indicating the standby rudder shutoff valve has opened.

CAUTION: If flight control malfunctions are indicated, do not deactivate systems until the cause is established. If any flight control caution lights illuminate during flight, check position of corresponding switches, and monitor hydraulic system indications.

CAUSE: The light indicates low hydraulic system pressure to ailerons, elevators, and rudder.

Under "Yaw Damper," the abnormal checklist procedures stated:

Yaw Damper Switch..... OFF, THEN ON [bold original to text]

If light remains illuminated: [bold original to text]

Yaw Damper Switch..... OFF [bold original to text]

NOTE: Flying in turbulence with the yaw damper inoperative can be difficult, and uncomfortable for the passengers. Before commencing a flight with yaw damper inoperative, insure that turbulence (especially continuous turbulence of moderate or greater intensity) can be avoided.

Under "Jammed or Restricted Flight Conditions," the abnormal checklist procedures stated:

This procedure is accomplished when jammed or restricted movement of flight controls in roll, pitch, or yaw control is experienced.

Jammed or Restricted System OVERPOWER
[bold original to text]

Use maximum force, including a combined effort of both pilots, if necessary.

Note: A maximum two-pilot effort on the control will not cause a cable or system failure.

Do NOT turn off any flight control switches unless the faulty control is positively identified. [bold original to text]

If the aileron or spoiler is jammed, force applied to the Captain's and the First Officer's control wheels identifies which lateral control system (aileron or spoiler) is usable, and which control wheel...provides roll control....

With a jammed elevator, manual or electric trim may be used to trim in either direction to offload control column forces....

Should the rudder control cable system fail, inputs to the rudder can be accomplished through the rudder trim control mechanism. If the rudder pedals are jammed, rudder control, rudder trim, and nose wheel pedal steering are inoperative.

If freezing water is the suspected cause, consider descent to warmer air if conditions persist and re-attempt to override the jammed or restricted controls.

If faulty system cannot be overpowered, use operative flight controls, trim and thrust, as required for airplane control.

1.18.10.2 Postaccident Changes/Information Available to 737 Pilots Regarding Abnormal Procedures (Flight Controls Malfunctions)

1.18.10.2.1 1994 Through 1995—Information and Changes Disseminated by Boeing

On July 22, 1994, (less than 2 months before the USAir flight 427 accident) Boeing issued an internal document entitled "Change Proposal" (Flight Operations Review Board control No. 2247). The document recommended that the 737 Operations Manual include a procedure directing the flight crew to turn off the yaw damper if uncommanded yaw or rudder oscillations occurred in flight. The document also noted that the 737 AFM stated that "if directional hunting or rudder oscillations occur, turn the yaw damper off" but that the Operations Manual did not include a similar procedure. In addition, the document indicated that Air France had questioned the discrepancy between the manuals in 1993.

On December 9, 1994, Boeing issued a revision to its 737 Operations Manual that established a procedure for uncommanded yaw. Page 03.10.08 of the manual stated:

UNCOMMANDED YAW

Accomplish this procedure if uncommanded yaw or rudder oscillations occur in flight:

YAW DAMPER SWITCH..... OFF

The YAW DAMPER light illuminates when the yaw damper is disengaged.

1.18.10.2.2 1996 Through 1997—FAA Issuance of Airworthiness Directive 96-26-07

On December 23, 1996, the FAA issued AD 96-26-07, effective January 17, 1997. The AD required revising the FAA-approved AFM for all 737 series airplanes to include procedures that would enable the flight crew to take "appropriate action to maintain control of the airplane during an uncommanded yaw or roll condition, and to correct a jammed or restricted flight control condition." The FAA stated that the AD had been

prompted by its determination that such procedures were not adequately defined in the existing version of the 737 AFM.

The AD established a "recall" procedure to be performed by flight crews immediately, from memory, in the event of an uncommanded yaw or roll. The recall procedure stated, "Maintain control of the airplane with all available flight controls. If roll is uncontrollable, immediately reduce angle of attack and increase airspeed. Do not attempt to maintain altitude until control is recovered. If engaged, disconnect autopilot and autothrottle."

The AD further required that the AFM section concerning procedures for jammed flight controls be modified to include in part the following:

If the rudder pedals will not move to the pilot-commanded position, or if the pedals are deflected in one direction and jammed, maintain control of the airplane with all available flight controls. Disengage the autopilot and autothrottle. Use maximum force (combined effort by both pilots) to overpower the rudder system.

After establishing control of the aircraft, check rudder pedal position. If the rudder pedals have centered, accomplish a normal descent, approach, and landing. If the rudder pedals remain jammed and are deflected to a degree that significantly affects the controllability of the airplane, select System B flight control switch to STBY RUD. If this action clears the jam/deflection, make a normal approach and landing, noting that rudder control may be limited. If moving the System B flight control switch to STBY RUD does not clear the jam, select System A flight control switch to OFF. If pedals do not center, select System B flight control switch to OFF....

The FAA specified that air carriers could comply with the AD by inserting a copy of it in the AFM. No flight crew training requirements were established by the FAA for the procedures that had been introduced or changed by the AD.

On March 3, 1997, the Safety Board provided comments to the FAA about AD 96-26-07. The Board expressed concern that selecting the hydraulic system B flight control switch to standby rudder was specified by the FAA as a followup procedure rather than as an immediate action procedure. The Safety Board noted that, under certain failure conditions, if rudder system malfunctions were to occur at a relatively low altitude and airspeed, or if the flight crew's recovery attempt were to be delayed by only a few seconds, the flight crew might not be able to regain control of the airplane from the resulting extreme aircraft attitude and roll rate without immediately moving the system B flight control switch to the standby rudder position.

The Safety Board recognized the potential for pilots to have difficulty identifying the hydraulic system B flight control switch among the several identically shaped and colored switches located nearby on the 737 overhead instrument panel. The Board noted the possibility of changing the shape and color of the system B flight control switch to provide greater conspicuity and distinctness.

1.18.10.2.3 1997 Through 1998—Information and Changes Disseminated by Boeing

On February 17, 1997, Boeing issued Operations Manual Bulletin for USAir, Inc., USA-17, "Uncommanded Yaw or Roll; Jammed or Restricted Rudder; Jammed or Restricted Elevator or Aileron." This bulletin provided Boeing's recommendations and suggestions on how to implement the FAA's AD 96-26-07.²⁹² With regard to uncommanded yaw or roll and jammed or restricted rudder, Boeing's Operations Manual Bulletin stated the following:

UNCOMMANDED YAW OR ROLL [bold original to text]

Accomplish this procedure if uncommanded yaw or roll occurs in flight.

Maintain control of the airplane with all available flight controls. If roll is uncontrollable, immediately reduce pitch/angle of attack and increase airspeed. Do not attempt to maintain altitude until control is recovered.

AUTOPILOT (if engaged).....DISENGAGE

AUTOTHROTTLE (if engaged)DISENGAGE

Verify thrust is symmetrical.

If yaw or roll continues:

YAW DAMPER SWITCH..... OFF

If it is confirmed that the autopilot or autothrottle is not the cause of the uncommanded yaw or roll, the autopilot and autothrottle may be re-engaged at the pilot's discretion.

JAMMED OR RESTRICTED RUDDER [bold original to text]

This procedure is accomplished only after establishing control of the airplane with all available flight controls and when the rudder pedals are jammed or deflected in one direction and will not move to the pilot's commanded position.

AUTOPILOT (if engaged).....DISENGAGE

AUTOTHROTTLE (if engaged)DISENGAGE

Verify thrust is symmetrical.

RUDDER PEDALSOVERPOWER

²⁹² According to Boeing, similar bulletins were issued to other operators of the 737.

Identify rudder pedal position and then use maximum rudder pedal force, including a combined effort of both pilots on the corresponding rudder pedal, to free and/or center the rudder.

If rudder pedals are centered:

Accomplish Normal DESCENT-APPROACH and LANDING checklists.

Note: Rudder authority may be limited. Crosswind capability may be reduced. Do not use auto brakes. Landing roll steering may require differential braking.

If rudder pedals do not center and are verified to be jammed:

SYSTEM B FLIGHT CONTROL SWITCH..... STBY RUD

Apply pedal force to center the rudder.

If rudder pedals can be centered:

Accomplish Normal DESCENT-APPROACH and LANDING Checklists.

Note: Rudder authority may be limited. Crosswind capability may be reduced. Do not use auto brakes. Landing roll steering may require differential braking.

If rudder pedals will not center:

SYSTEM A FLIGHT CONTROL SWITCH OFF

If rudder pedals can be centered:

ACCOMPLISH JAMMED OR RESTRICTED RUDDER DESCENT-APPROACH and LANDING Checklists.

If rudder pedals will not center:

SYSTEM B FLIGHT CONTROL SWITCH..... OFF

DESCENT-APPROACH [bold original to text]

Ailerons and elevator are controlled manually. Rudder is inoperative if all flight control switches are off.

- Land at the nearest suitable airport.
- Use longest runway with minimum crosswind.
- Plan a flaps 15 landing.
- Set V_{ref} 15 [reference airspeed for approach with flaps 15 setting].

ANTI-ICE AS REQUIRED

AIR CONDITIONING AND PRESSURIZATION SET
ALTIMETERS & INSTRUMENTSSET & CROSSCHECKED
N1 AND IAS [indicated airspeed] BUGSCHECKED
& SET, V_{ref} 15
GND PROX SWITCH (As installed) FLAP/GEAR INHIBIT
GO-AROUND PROCEDURE REVIEW

Accomplish normal go-around procedure. Advance thrust to go-around smoothly and slowly to avoid excessive pitch-up.

LANDING [bold original to text]

ENGINE START SWITCHESON
RECALL.....CHECKED
SPEEDBRAKE..... ARMED, GREEN LIGHT
LANDING GEARDOWN, 3 GREEN
FLAPS 15, GREEN LIGHT

Ground and flight spoilers, nose steering wheel, wheel brakes and reverse thrust are still operative. Landing roll steering may require differential braking. Do not use auto brakes.

Additionally, in July 1997, Boeing published a *Flight Operations Review* article, entitled "737 Directional Control." The article indicated that Boeing continued to receive questions from pilots about the likelihood of 737 rudder malfunctions, the effect of potential rudder malfunctions on flightpath control, the meaning of crossover airspeed, and the benefit of increased flap maneuvering speeds on the crossover airspeed. Boeing stated that it published the article "to address these issues, to assure pilots that the 737 is controllable during a yaw and roll event and provide a recovery technique in case an uncommanded yaw or roll results in an airplane upset."

The article addressed likely and unlikely causes of 737 yaw and roll events, procedural revisions contained in the FAA's AD 96-26-07, the FAA's flight and ground validation testing for the AD-related revisions, procedures for recovery from 737 yaw and/or roll events, and crossover airspeed. The article stated that:

...the vast majority [of yaw and/or roll events] were caused by external sources such as wake vortices, turbulence and wind shear, or internal airplane sources such as yaw damper, autopilot and autothrottle malfunctions, asymmetric flaps/slats, and pilot inputs. Additionally, analysis and testing have shown that it is hypothetically possible, although highly unlikely, that if one of the following rudder malfunctions occurs, yaw and then roll would result:

1. Rudder Power Control Unit (PCU) valve secondary slide jam off-neutral and a rudder pedal input causing full rudder reversal.
2. Jams of both primary and secondary slides in the rudder PCU valve.
3. Standby rudder actuator galling causing a rudder offset.
4. Linkage Jam causing blockage of the feedback loop of the main PCU, resulting in uncommanded rudder motion.
5. A foreign object (e.g., screwdriver, wrench, nut or bolt) located somewhere between the rudder pedals and the PCU causing a rudder system jam.

Note: The rudder pedals will always follow the direction of the rudder during these conditions.

Boeing's article defined crossover airspeed as the speed below which the rolling moment created by a full lateral control input will not overcome the roll effect from full rudder displacement. The article stated that "while the airspeed at which this occurs is variable, cross-over speeds exist on all commercial airplanes. ...the [737] 'cross-over speed' is at or above [Boeing's recommended] block maneuvering speeds²⁹³ at high gross weights and for flaps up through 10. For flaps 15, 25, 30, or 40, the 'cross-over speed' occurs significantly below recommended block maneuvering speeds and is near or below stick shaker speeds."

According to the article, some 737 operators had chosen to increase their maneuvering speeds for flaps up through flaps 10 configurations by adding 10 knots above the block maneuvering speeds. Boeing stated that it had no technical objection to such an increase and acknowledged that a block speed increase would provide a marginal increase in lateral (roll) control authority relative to directional control authority. However, the article cautioned operators that the crossover airspeeds "vary as a function of left and right sideslip, differences in thrust, and differences in trim." The article also stated that "relying on speed additives...is simply not as effective" as executing a recovery procedure in which the angle-of-attack is reduced, airspeed is increased, and full control inputs are made "expeditiously."

Boeing's article stressed prioritizing roll control during recovery from nose-down bank upsets unless the airplane was in a stall condition; if the airplane was stalled, Boeing

²⁹³ Boeing stated that it has published block maneuvering speeds for the 737 since the -100 model began service. The recommended maneuvering speeds for each flap configuration provided, for all airplane weights, adequate airspeed for maneuvering in at least a 40° bank without activation of the stickshaker. "Block" referred to the simplification of the airspeed schedule with regard to airplane's weight. A single airspeed was specified for all airplane weights less than 117,000 pounds; thus, airplanes operating at weights less than 117,000 pounds (including the USAir 427 accident airplane) had a greater maneuvering margin. Alternative minimum maneuvering speed schedules were used by some air carriers at their option. These specified a minimum airspeed for each flap configuration and weight (in 10,000-pound increments). For airplanes operating at weights less than 117,000 pounds, these airspeeds were slower than the block maneuvering speeds. According to Boeing, even though block maneuvering speeds were recommended, it calculated and provided alternative minimum maneuvering speed schedules at air carriers' request.

recommended recovering from the stall before recovering from the upset. The article described the nose-down upset recovery technique as follows:

- Reduce angle of attack. This unloads the wing, allows the airplane to accelerate, which reduces rudder deflection and improves lateral control ability.
- Roll wings level using all available flight controls. This significantly reduces the chance of accelerated stall.
- Apply up elevator to recover toward the desired pitch attitude and airspeed. Always respect the stick shaker, even in a nose low situation. We do not suggest using asymmetric thrust to recover from a large bank angle upset.

The article specifically stated that if roll was uncontrollable, the pilot should immediately reduce the airplane's pitch attitude/angle-of-attack and increase airspeed; pilots were cautioned not to attempt to maintain altitude until control was recovered. In addition, Boeing's article urged pilots to "use and hold" full lateral control input to counter the roll (with coordinated rudder for bank angles of 45° or greater). The article further stated that "under all situations, respect the stick shaker" [underscore original to text].

1.18.10.2.3.1 Implementation of AD 96-26-07 and Boeing 737 Operations Manual Revision by U.S. 737 Air Carrier Operators

During July 1998, the Safety Board assessed the implementation of AD 96-26-07 by U.S. 737 air carrier operators. Of the 13 air carriers contacted by the Safety Board, 12 provided the requested information. These 12 air carriers operated a total of 1,070 Boeing 737s.

The assessment results indicated that six of the responding air carriers (accounting for 88 percent of the airplanes) were providing 737 flight crews with a flight simulator demonstration of crossover airspeed (the overpowering of roll flight controls by rudder input.) Four of these six air carriers (accounting for 72 percent of the airplanes) were providing flight crews a specific demonstration of the crossover airspeed in the flaps 1 configuration. However, six air carriers (accounting for 12 percent of the airplanes) had no documented simulator training on crossover airspeed.

According to the assessment information, 8 of the 12 responding air carriers provided simulator training to flight crews on the jammed rudder procedure, but the remaining 4 (accounting for 20 percent of the airplanes) provided no simulator training on this procedure. Of the eight air carriers that trained crews on the jammed rudder procedure, five (accounting for 40 percent of the airplanes) required instructors to continue the procedure at least to the step of selecting the hydraulic system B flight control switch to the standby rudder position. The remaining three air carriers that trained crews on the jammed rudder procedure (accounting for 40 percent of the airplanes) did not specify the extent to which the procedure was to be performed or terminated the procedure to respond to a jammed rudder malfunction with disengagement of the yaw damper.

The assessment results also indicated that 10 of the 12 air carriers had implemented a minimum maneuvering airspeed for the flaps 1 configuration (110,000-pound airplane gross weight) of at least 190 knots. Four of these 10 air carriers (accounting for 66 percent of the airplanes) had increased Boeing's recommended block maneuvering speeds by 10 knots and were requiring pilots to use at least 200 knots as the minimum airspeed for flaps 1. The remaining two air carriers were using slower minimum maneuvering speeds specified for each 10,000-pound increment of airplane weight. For flaps 1 and a 110,000-pound airplane gross weight, these two carriers (accounting for a combined total of 16 of the airplanes) were using minimum block maneuvering speeds of 158 and 164 knots.

Further, the assessment indicated that all responding air carriers had modified the checklist for "Uncommanded Yaw and Roll" in accordance with AD 96-26-07 and the February 17, 1997, Boeing Operations Manual Bulletin. These modifications included the bulletin's requirement for pilots to recall from memory the procedure to disengage the yaw damper in the event of an uncommanded yaw or roll.

1.18.10.2.4 Safety Board Recommendations Relating to Unusual Attitude Training

During its investigation of the USAir flight 427 accident, the Safety Board issued Safety Recommendations A-96-118, A-96-120, and A-97-18 regarding unusual attitude procedures and training. In its February 2, 1999, letter to the FAA, the Safety Board indicated that Safety Recommendations A-96-118 and A-97-18 were classified "Open—Unacceptable Response" and that Safety Recommendation A-96-120 was classified "Open—Acceptable Response." The letter also stated that the Board would further discuss and analyze these recommendations in the USAir flight 427 accident report. The histories of Safety Recommendations A-96-118, A-96-120, and A-97-18 are discussed in sections 1.18.11.5 and 1.18.11.6 and analyzed in section 2.7.

1.18.11 History of Safety Recommendations Resulting From the United Flight 585 and USAir Flight 427 Accidents and the Eastwind Flight 517 Incident

The Safety Board made 27 safety recommendations as a result of its investigation of the United flight 585 and USAir flight 427 accidents, the Eastwind flight 517 incident, and other occurrences involving 737 series airplanes. A listing of these safety recommendations appears in sections 1.18.11.1 through 1.18.11.6.

1.18.11.1 Galling of Standby Rudder Actuator Bearings—United Flight 585 Accident (Safety Recommendation A-91-77)

During its investigation of the accident involving United flight 585, the Safety Board became concerned about galled standby rudder actuator bearings on 737s and 727s. As a result, the Safety Board issued Safety Recommendation A-91-77 on August 20, 1991.

Safety Recommendation A-91-77 asked the FAA to

Issue an airworthiness directive requiring a check on all Boeing 737 and 727 model airplanes with the part number (P/N) 1087-23 input shaft in the rudder auxiliary actuator unit for the force needed to rotate the input shaft lever relative to the P/N 1087-22 bearing of the auxiliary actuator unit. During this check, the bearing should be inspected to determine if it rotates relative to the housing. All shaft assemblies in which rotation of the bearing occurs, or in which excessive force is needed to move the input lever, should be removed from service on an expedited basis, and the assemblies should be replaced with a P/N 1087-21 shaft assembly that has a reduced diameter on the unlubricated portion of the shaft in accordance with revision G of the P/N 1087-23 engineering drawing. All assemblies meeting the force requirement should be rechecked at appropriate intervals until replaced with a P/N 1087-21 shaft assembly containing a P/N 1087-23 shaft that has a reduced diameter on the unlubricated portion of the shaft.

On January 3, 1992, the FAA issued an NPRM (Docket No. 91-NM-257-AD) in response to this recommendation. The NPRM proposed to adopt an AD that would require inspecting the input shaft in the auxiliary (standby) rudder PCU on all 727 series and certain 737 series airplanes and reporting to the FAA on those units that failed the inspection test procedure.

In a March 27, 1992, letter, the Safety Board expressed concern that an inspection of the standby rudder actuator bearings was not included in the NPRM. Because loose bearings can indicate a galling problem, the Safety Board believed that inspection of the bearings for rotation in the housing and for the integrity of the safety wire was essential. The Safety Board was also concerned that the proposed time for compliance for these inspections (4,000 flight hours) might be excessive. As the FAA indicated in the NPRM, the tests and inspections would only take about 6 hours. Because of the possibility that the components affected could cause an uncommanded rudder input, the Safety Board believed that these inspections should be performed as soon as possible or, at the very least, at the next available inspection of the airplane.

After the NPRM was issued, the FAA determined that the condition addressed in the NPRM was not unsafe and did not warrant the issuance of an AD. Consequently, on April 19, 1993, the FAA issued a notice in the Federal Register to withdraw the NPRM. In an August 5, 1993, letter to the Safety Board, the FAA indicated that it withdrew the NPRM based on its reevaluation of the design of the rudder control system on the 727 and 737 series airplanes. The reevaluation determined that a flight crew would be capable of detecting a galling condition by (1) increased force necessary to move the rudder pedal, (2) erratic nose gear steering with the yaw damper engaged, (3) rudder yaw damper kick back or yaw damper back drives on the rudder pedals during flight, and (4) erratic operation of the rudder yaw damper or erratic rudder oscillations with the yaw damper engaged. The FAA concluded that none of these indications of galling represented a safety hazard.

On November 15, 1993, the Safety Board acknowledged the results of the FAA's reevaluation of the design of the rudder control system on 727 and 737 airplanes. The

Safety Board did express concern, however, that the galling could result in erratic flight control, distract a flight crew, and be potentially hazardous in certain circumstances. Because the Board stated that it had no further evidence that galling could result in uncommanded rudder deflections of a significant magnitude, Safety Recommendation A-91-77 was classified "Closed—Acceptable Alternate Action."

1.18.11.2 Weather-Related Recommendations—United Flight 585 Accident (Safety Recommendations A-92-57 and -58)

As a result of information developed during the accident investigation of United Airlines flight 585, the Safety Board issued Safety Recommendations A-92-57 and -58 on July 20, 1992.

Safety Recommendation A-92-57 asked the FAA to

Develop and implement a meteorological program to observe, document, and analyze potential meteorological aircraft hazards in the area of Colorado Springs, Colorado, with a focus on the approach and departure paths of the Colorado Springs Municipal Airport. This program should be made operational by the winter of 1992.

Safety Recommendation A-92-58 asked the FAA to

Develop a broader meteorological aircraft hazard program, to include other airports in or near mountainous terrain, based on the results obtained in the Colorado Springs, Colorado, area.

On October 8, 1992, the FAA stated that its Research and Development Service was planning to start a program in fiscal year 1995 to address potential aircraft hazards resulting from mountain-induced meteorological phenomena. On March 26, 1993, the FAA indicated that the Research and Development Service was planning to accelerate program implementation to fiscal year 1994. On June 10, 1993, the Safety Board indicated that it was pleased with the FAA's accelerated program because the Board was investigating four accidents in which mountain-induced meteorological phenomena might have been a cause or factor. On September 14, 1993, the FAA indicated that it had tasked NOAA's Forecast Systems Laboratory to (1) formulate a plan to provide a definitive study of mountain-induced wind phenomena and their effect on aircraft in flight and (2) develop initiatives to define and implement a program to alert pilots of these hazards.

On December 14, 1995, the FAA indicated that, in September 1995, the FAA/NOAA program was redefined in scope because of reduced budget allocations and expected future funding constraints. As a result, the FAA planned to complete (1) a pilot training manual on the impact of mountain-induced aeronautical hazards on aircraft operations; (2) a Colorado Springs data collection and baseline experiment for a terminal area detection system for mountain-induced turbulence hazards; and (3) a final report with recommendations from this experiment on the viability of developing a prototype prediction, detection, and display system for these hazards in the terminal area. The FAA reported that it had drafted the training manual.

On March 20, 1996, the Safety Board indicated that the FAA's draft pilot training manual was very comprehensive and detailed. However, the Safety Board expressed concern that funding constraints had reduced the scope, duration, and rigor of the originally proposed data collection experiment. The Board urged the FAA to increase funding for the program.

On April 3, 1998, the FAA stated that it had completed several actions to improve the safety of flying in mountainous areas "by providing pilots, dispatchers, and others in aviation operations with a series of products that will detect, display, and forecast hazardous mountain winds." The letter stated that the FAA had accomplished the following:

- The FAA, NOAA, and NCAR published AC 00-57, "Hazardous Mountain Winds and Their Visual Indicators," to provide information on hazardous mountain winds and their effects on flight operations near mountainous regions. The primary purpose of the AC is to assist pilots involved in aviation operations in diagnosing the potential for severe wind events in the vicinity of mountainous areas and provide information on preflight planning techniques and in-flight evaluation strategies for avoiding destructive turbulence and loss of aircraft control.
- NOAA and NCAR personnel collected data on the intensity and direction of wind flows at the Colorado Springs Airport during January through March 1997, when mountain-induced activity was known to be prevalent. A data set was developed through the use of one Doppler Light Distancing and Ranging (LIDAR) unit, three wind profilers with radio acoustic sounding system, anemometers, an instrumented King Air airplane that traversed the landing and takeoff flightpaths, six surface meteorological stations, an infrasonic laboratory, and pilot reports. NOAA and NCAR were expected to complete a report by September 1998 on a limited analysis of the Colorado Springs data. The analysis was to assess the turbulence-detection capabilities of the LIDAR and ground anemometers and determine the strengths of LIDAR-detected wind turbulence as a function of other factors that were recorded during the experiment.

On January 20, 1999, the Safety Board stated that the data collected during the Colorado Springs meteorological program in early 1997 represented an important and somewhat unique data set that defined mountain-induced wind flows and the associated hazards. The Board urged the FAA to make every effort to ensure the complete and detailed analysis of these data and the timely publication of the results. Pending the issuance of a final report by NOAA and NCAR, Safety Recommendation A-92-57 was classified "Open—Acceptable Response." However, the Safety Board still believed that the FAA should develop a broader meteorological aircraft hazard program to include airports (other than Colorado Springs) in or near mountainous areas. Pending receipt of information on such a program, Safety Recommendation A-92-58 was classified "Open—Unacceptable Response."

1.18.11.3 Recommendations Resulting From the July 1992 United Airlines Ground Check PCU Anomaly (Safety Recommendations A-92-118 Through -121)

On July 16, 1992, during a preflight check of the flight controls in a United Airlines 737-300 that was taxiing to takeoff from ORD, the captain discovered that the airplane's rudder pedal stopped at around 25 percent left pedal travel. The airplane returned to the gate, and the main rudder PCU (S/N 2228A) was removed. Subsequent testing indicated that, when the input crank was fixed against the body stops (to simulate a jam of the primary slide to the secondary slide) and the yaw damper piston was in the extend position, the PCU servo valve exhibited anomalous actions, ranging from sluggish movement of the actuator piston to a full reversal in the direction of piston travel opposite to the direction being commanded.

As a result of this and other incidents involving anomalies in the 737 rudder system, the Safety Board issued Safety Recommendations A-92-118 through -121 on November 10, 1992.

Safety Recommendation A-92-118 asked the FAA to

Require that Boeing develop a repetitive maintenance test procedure to be used by 737 operators to verify the proper operation of the main rudder power control unit servo valve until a design change is implemented that would preclude the possibility of anomalies attributed to overtravel of the secondary slide.

On January 19, 1993, the FAA stated that Boeing would issue service information to inspect and retrofit all 737 series airplanes. The FAA also stated that it would issue an NPRM to mandate compliance with this information. On January 3, 1994, the FAA issued AD 94-01-07, which became effective on March 3, 1994. The AD required, within 750 flight hours after its effective date, (1) repetitive tests of the main rudder PCU of certain 737 series airplanes, in accordance with Boeing SL 737-SL-27-82-B, to detect excessive internal leakage of hydraulic fluid, stalling, or reversal and (2) the eventual replacement of the main rudder PCU with an improved model incorporating a redesigned servo valve.

In an August 11, 1994, letter to the FAA, the Safety Board stated that, in the interest of safety, all 737 main rudder PCUs should be modified at the earliest possible date and that the compliance period in AD 94-01-07 appeared to be founded on reasonable estimates of equipment availability. Because the AD met the intent of the Safety Recommendation A-92-118, it was classified "Closed—Acceptable Action."

Safety Recommendation A-92-119 asked the FAA to

Require that Boeing develop an approved preflight check of the rudder system to be used by operators to verify, to the extent possible, the proper operation of the main rudder power control unit servo valve until a design change is implemented that would preclude the possibility of rudder reversals attributed to the overtravel of the secondary slide.

On January 19, 1993, the FAA responded that it did not agree with this safety recommendation because it believed that the current preflight check procedures adequately ensured proper rudder operation. On June 10, 1993, the Safety Board indicated that rapid rudder pedal inputs were required to induce the lockup that occurred during the July 16, 1992, preflight check conducted by the captain of the United Airlines 737-300 and that a routine preflight check would not have uncovered the problem. In all test cases that resulted in the locked-up condition or reversal, the input control was moved at a rate faster than the rudder actuator could respond, thus forcing the secondary valve into the overtravel position. The Safety Board further stated that rapid movement of the rudder pedals on the ground could result in damage to the airplane.

In a July 14, 1994, letter, the FAA reiterated its position that current preflight check procedures adequately ensure proper rudder operation. The FAA agreed that rapid rudder inputs were a factor in uncovering rudder control anomalies and that a rapid rudder input during every preflight check increased the possibility of structural rudder damage. The FAA also stated that it would be impossible to conduct this check with any degree of consistency because of variances among pilots. Finally, the FAA stated that not all rudder control anomalies resulting from secondary slide overtravel can be detected during preflight checks.

Instead of incorporating rapid rudder movements in the preflight check, the FAA included specific requirements in AD 94-01-07 for a periodic (750 flight hours) inspection of the rudder system until the servo valve was redesigned. The AD required that the rudder pedals be cycled at the maximum rate and that special instrumentation and additional observers be available to properly detect any anomaly. According to the FAA, the requirements of the AD were intended to ensure the detection of high internal leakage within the main rudder PCU servo valve, which is a symptom of secondary slide overtravel. The inspection was expected to identify servo valves that performed marginally by measuring the internal leakage rate. The FAA stated that a servo valve with marginal performance would not be detected during a preflight check but would have a reduced hinge moment capability because of excessive internal leakage. This internal leakage rate cannot be measured during a preflight check.

On August 11, 1994, the Safety Board notified the FAA that the requirement for repetitive inspections of the main rudder PCU at 750-hour intervals was sufficient. Because the FAA's action addressed the intent of Safety Recommendation A-92-119, it was classified "Closed—Acceptable Alternate Action."

Safety Recommendation A-92-120 asked the FAA to

Require operators, by airworthiness directive, to incorporate design changes for the 737 main rudder power control unit servo valve when these changes are made available by Boeing. These changes should preclude the possibility of rudder reversals attributed to the overtravel of the secondary slide.

On January 3, 1994, the FAA issued AD 94-01-07 (see A-92-118). On August 11, 1994, the Safety Board stated that, because the AD satisfied the intent of Safety Recommendation A-92-120, it was classified "Closed—Acceptable Action."

Safety Recommendation A-92-121 asked the FAA to

Conduct a design review of servo valves manufactured by Parker Hannifin having a design similar to the 737 rudder power control unit servo valve that control essential flight control hydraulic power control units on transport-category airplanes certified by the Federal Aviation Administration to determine that the design is not susceptible to inducing flight control malfunctions or reversals due to overtravel of the servo slides.

On January 19, 1993, the FAA stated that a design review of the servo valves manufactured by Parker Hannifin on all transport-category airplanes was completed. The problem was found to exist in the main rudder PCU only on 737 airplanes. On June 10, 1993, the Safety Board responded that, because this information met the intent of Safety Recommendation A-92-121, it was classified "Closed—Acceptable Action."

1.18.11.4 Flight Data Recorder Recommendations (Safety Recommendations A-95-25 Through -27)

The FDRs on the airplanes involved in the United flight 585 and USAir flight 427 accidents recorded very limited amounts of data. The FDR installed on the United airplane recorded data for five parameters. (For more information, see section 1.16.1.1.) The FDR installed on the USAir airplane recorded data for 13 parameters.²⁹⁴ (For more information, see section 1.11.2.) However, neither FDR recorded other parameters that would have been useful in these accident investigations, including control wheel position, rudder pedal position, flight control surface (rudder, aileron, and spoiler) positions, or lateral acceleration. As a result of its concerns about limited-parameter FDRs, the Safety Board issued Safety Recommendations A-95-25 through -27 on February 22, 1995.

Safety Recommendation A-95-25, which was designated as urgent, asked the FAA to

Require that each Boeing 737 airplane operated under 14 CFR Parts 121 or 125 be equipped, by December 31, 1995, with a flight data recorder system that records, at a minimum, the parameters required by current regulations applicable to that airplane plus the following parameters (recorded at the sampling rates specified in "Proposed Minimum FDR Parameter Requirements for Airplanes in Service"): lateral acceleration; flight control inputs for pitch, roll, and yaw; and primary flight control surface positions for pitch, roll, and yaw.

²⁹⁴ The existing regulations at the time of the USAir flight 427 accident (14 CFR Section 121.343) required that airplanes operated under Part 121 have FDRs that record 11 parameters. Title 14 Sections 125.225 and 135.152 contained a similar requirement for airplanes operated under Parts 125 and 135, respectively.

Safety Recommendation A-95-26 asked the FAA to

Amend, by December 31 1995, 14 CFR Sections 121.343, 125.225, and 135.152 to require that Boeing 727 airplanes, Lockheed L-1011 airplanes, and all transport-category airplanes operated under 14 CFR Parts 121, 125, or 135, whose type certificate applies to airplanes still in production, be equipped to record on a flight data recorder system, at a minimum, the parameters listed in "Proposed Minimum FDR Parameter Requirements for Airplanes in Service" plus any other parameters required by current regulations applicable to each individual airplane. Specify that the airplanes be so equipped by January 1, 1998, or by the later date when they meet Stage 3 noise requirements but, regardless of Stage 3 compliance status, no later than December 31, 1999."

Safety Recommendation A-95-27 asked the FAA to

Amend, by December 31, 1995, 14 CFR Sections 121.343, 125.225, and 135.152 to require that all airplanes operated under 14 CFR Parts 121, 125, or 135 (10 seats or larger), for which an original airworthiness certificate is received after December 31, 1996, record the parameters listed in "Proposed FDR Enhancements for Newly Manufactured Airplanes" on a flight data recorder having at least a 25-hour recording capacity.

In issuing these safety recommendations, the Safety Board stated that information from FDRs with additional parameters substantially aided its investigations of two regional airline accidents. The first accident, on February 1, 1994, involved a dual-engine power loss in a Saab 340B at New Roads, Louisiana.²⁹⁵ The FDR installed on this airplane recorded 128 parameters. Because of the expanded FDR data, the Safety Board was able to rule out early in the investigation an airplane system anomaly as the initiating event and focus on operational and human performance issues. The second accident, on October 31, 1994, involved an uncommanded roll excursion of an Avions de Transport Regional Model 72-212 (ATR-72) near Roselawn, Indiana.²⁹⁶ The airplane's FDR was configured to record approximately 115 parameters. The volume of data recorded by this enhanced FDR enabled the Board to narrow the focus of its investigation early on to possible explanations for aileron control surface movements. As a result, the Safety Board issued, within days of the accident, urgent safety recommendations to minimize the likelihood of similar occurrences.

In a February 24, 1995, letter, the FAA stated that it would open a public docket and seek comments on these recommendations and that it planned to hold a public meeting to review the recommendations. On March 8, 1995, the Safety Board responded that these actions could create an unacceptable delay and urged the FAA to establish an accelerated schedule for adopting Safety Recommendation A-95-25.

²⁹⁵ For more information, see National Transportation Safety Board. 1994. *Overspeed and Loss of Power on Both Engines During Descent and Power-off Emergency Landing, Simmons Airlines, Inc., d.b.a. American Eagle Flight 3641, N349SB, False River Air Park, New Roads, Louisiana, February 1, 1994.* Aircraft Accident Report NTSB/AAR-94/06. Washington, DC.

²⁹⁶ For more information, see the discussion of Safety Recommendation A-96-120 in section 1.18.11.5.

On May 16, 1995, the FAA indicated that it agreed with the intent of the recommendations but that it could not meet the December 31, 1995, retrofit completion date in Safety Recommendation A-95-25. The FAA characterized the Safety Board's timetable as "an extremely aggressive schedule which, if it were physically possible, would result in substantial airplane groundings and very high associated costs." On July 17, 1995, the Safety Board indicated its disappointment that the recommended compliance date could not be met. The Board believed that the date of compliance for the recommendation must reflect the urgency associated with retrofitting 737s to record additional FDR parameters.

In an April 29, 1996, letter to the FAA, the Safety Board pointed out that more than 1 year had elapsed since it issued urgent Safety Recommendation A-95-25 and that it had been almost 1 year since the FAA formally responded to this issue. Also, the Board said that FDR recordings from several other 737s that reported in-flight disturbances similar to those associated with the United flight 585 and USAir flight 427 accidents did not provide sufficient data to isolate rudder and pedal movement primarily because the flight control inputs or control surface positions were not recorded. The Board believed that, if the FAA and industry had begun to implement Safety Recommendation A-95-25 after it was issued, most 737s would have been retrofitted with an acceptable, short-term improved recording capability. The Safety Board concluded that the lack of FAA action was unacceptable.

In addition, the Safety Board stated that, according to the FAA, the major impediment to the retrofit of 737s was cost. However, Board staff visited a maintenance facility to observe the installation of FDR sensors and associated wiring and found that industry cost estimates apparently did not seek innovative measures that might reduce cost. For example, in the installation observed, industry assumed that aft lavatories had to be removed to allow wires to be routed from the airplane's tail to the FDR. Consultations with installation experts demonstrated that wiring could be routed through existing access ports on a lower portion of the aft pressure bulkhead, which could eliminate the need to remove the aft lavatory and save 150 hours of labor. On the basis of these consultations, Safety Board staff believed that adding rudder pedal and rudder position sensors to existing 737s could be accomplished without interrupting normal revenue service. The Board suggested that the work be performed on approximately four to five overnight visits or during a C maintenance check without extending the visit.

In a July 1, 1996, letter to the FAA, the Safety Board addressed the Eastwind flight 517 incident that had occurred the previous month. The Board believed that, under slightly different circumstances, the Eastwind incident could have become the third fatal 737 upset accident for which there was inadequate FDR information to determine the cause. The Board also believed that, if the FAA had complied with the intent of Safety Recommendation A-95-25, the Eastwind airplane would have been fitted with an FDR that recorded the parameters necessary to better understand the events leading to the upset and develop corrective actions to prevent a future catastrophic 737 accident. In addition, the Board expressed its continued strong concern about the failure of the FAA to require the needed retrofit of the 737. The Board noted that more than 15 months had passed with

no action taken on this important safety issue. As a result, Safety Recommendation A-95-25 had been placed on the Safety Board's Most Wanted Safety Improvements List.²⁹⁷ The Board once again urged the FAA to take the necessary actions to meet the intent of this safety recommendation.

On July 9, 1996, the FAA issued an NPRM, "Revisions to Digital Flight Data Recorder Rules." The proposed rule would require a 4-year retrofit of FDR systems, with parameter upgrade requirements based on when the aircraft was manufactured and whether the aircraft was equipped with a flight data acquisition unit (FDAU).²⁹⁸ The proposed rule would also mandate increases in the number of required FDR parameters for newly manufactured aircraft, with the first parameter increase occurring 3 years from the date of the final rule and the second increase 5 years after the date of the final rule.

On August 15, 1996, the Safety Board commented on the NPRM. The Board recognized that the FAA's proposed revisions attempted to increase the minimum number of FDR parameters and impose the minimum financial, operational, manufacturing, and purchase contract burdens on industry. However, the Board strongly disagreed with the FAA's proposed compliance dates for newly manufactured and existing aircraft and with the minimum parameter requirements for existing aircraft. The Board also strongly disagreed with the FAA's decision not to require more expeditious flight control parameter upgrades for 737 airplanes. The Board strongly requested that the FAA act on the Board's comments to the NPRM and expedite issuance of a final rule.

On October 7, 1996, the FAA reiterated the position presented in its May 16, 1995, letter. On December 12, 1996, the Safety Board stated that, although it had been verbally informed that the FAA hoped to issue a final rule by the end of December 1996, the October 7 letter made no mention of an issue date for the final rule. The Board also stated that, even if a final rule were issued by the end of 1996, all aircraft would not be required to be upgraded until December 2000, almost 6 years after Safety Recommendations A-95-25 through -27 were issued. Because of the FAA's failure to take action to ensure timely upgrades of the 737 FDR parameters, Safety Recommendation A-95-25 was classified "Closed—Unacceptable Action."

On July 9, 1997, the FAA issued its final rule in response to the safety recommendations, which required in part that all existing transport-category airplanes operated under 14 CFR Parts 121, 125, and 135 be equipped with FDRs that record at least 18 parameters, instead of the previously required 11 parameters. Also in its final rule, the FAA indicated that the retrofit modification to existing airplane's FDRs should be accomplished at the earliest practicable time but no later than the airplane's first heavy maintenance check after August 18, 1999. In a July 22, 1997, letter, the FAA stated that

²⁹⁷ The Safety Board's Most Wanted Safety Improvements List contains the agency's 10 most urgent safety recommendation issues in the areas of aviation, highway, pipeline and hazardous materials, railroad, and marine safety.

²⁹⁸ A FDAU is external to the FDR and collects and digitizes data to be recorded by the FDR. The FDR on an airplane equipped with a FDAU can record additional parameters as modified.

the final rule requires all affected existing airplanes to "be equipped to record the parameters recommended by the Board" by August 19, 2001.²⁹⁹

Further, the FAA stated that the July 9, 1997, final rule also requires all airplanes operated under 14 CFR Parts 121, 125, or 135 (10 seats or more) for which an original airworthiness certification is received after December 31, 1996, to record the parameters listed in "Proposed Flight Data Recorder Enhancements for Newly Manufactured Airplanes" on an FDR having at least a 25-hour recording capacity. The new FDR rules call for parameters 1 through 57 to be recorded for airplanes manufactured after August 18, 2000, and parameters 1 through 88 to be recorded for airplanes manufactured after August 19, 2002. The FAA considered its action on the safety recommendations to be completed.

On August 4, 1998, the Safety Board indicated that it was generally pleased that the FAA issued revised FDR rules because the changes in the FDR parameter requirements offered a major improvement over the former requirements. For example, the Safety Board agreed with the FAA's decision to include flight control surface positions and flight control inputs as portions of the minimum number of parameters to be recorded by existing airplanes. However, the Board believed the final rulemaking fell short of the intent of Safety Recommendations A-95-26 and -27 in two critical areas:

²⁹⁹ The Safety Board is aware that some air carriers have not retrofitted their airplanes with the required FDR upgrades during scheduled heavy maintenance checks. For example, the Board's investigation of the February 23, 1999, Metrojet upset event revealed that, although the incident airplane was scheduled for a heavy maintenance check in March 1999, it was not scheduled to receive the required FDR upgrade until its next heavy maintenance check in March 2001. In contrast, the Safety Board is aware of one air carrier (Southwest Airlines) that is retrofitting the FDRs in its fleet. Southwest's fleet consisted of 248 Boeing 737s, 100 of which are already equipped with FDAUs and enhanced FDRs and thus do not require the upgrade. Southwest began to retrofit its remaining 148 Boeing 737s in July 1996 (about the same time that the FAA issued the NPRM regarding FDR upgrades and 1 year before the resultant final rule was issued). Although not required by the FAA's final rule, Southwest also elected to install FDAUs on the 148 airplanes that were not so equipped (at a cost of \$70,000 per airplane) to permit future expansion of FDR parameters. Southwest expected to have completed the retrofit all of its affected airplanes by December 1999.

- Although the new FDR rules would eventually mandate all of the Safety Board's recommended parameters for new airplanes, the parameter requirements for existing airplanes were less than those referenced in Safety Recommendation A-95-26.³⁰⁰ Therefore, the Board disagreed with the FAA's assertion that the rule required airplanes to "be equipped to record the parameters recommended by the Board."

The recommended minimum parameter requirements for existing airplanes were based on the Safety Board's investigative experience. The Board believed that all U.S.-registered airplanes should record these parameters. According to the Board, the FAA's reasoning for not including all the recommended parameters—that FDR requirements should be determined by the capabilities of the FDR system fitted to a specific airplane rather than by investigative requirements—placed far too much emphasis on cost. The Safety Board recognized that substantial costs would be associated with retrofitting all of the proposed minimum parameter requirements on existing airplanes not equipped with a FDAU or a digital data bus. However, all of the 88 parameters referenced in Safety Recommendation A-95-26 are potentially critical to future investigations. The Board maintained that the FAA's final rule should have included all the recommended parameters for existing airplanes.

- The compliance dates stated in the final rule for newly manufactured airplanes extended far beyond the recommended compliance dates, and the Board believed that the FAA's reasoning for the extended compliance dates was flawed. Although the final rule included all 88 recommended parameters for newly manufactured airplanes, the Board was disappointed that the recording of the 88 parameters would not be accomplished immediately. The new regulations will mandate an incremental increase in FDR capability, from 29 to 57 and then to 88 parameters. The Board did not believe that this incremental expansion was necessary and that there was not sufficient justification for airplanes manufactured between August 18, 2000, and August 19, 2002, to record only 57 parameters.

According to the Safety Board, the FAA cited the needed development of control force sensors and availability of 256-word-per-second FDRs as explanations for the incremental increase of parameters for newly manufactured airplanes. On the basis of its conversations with airplane manufacturers, the Board determined that the necessary technology was already available and that a 5-year development time for all 88 parameters was unnecessary. In fact, the Board was aware that some operators and manufacturers had elected to record, or at least to make provisions to record, all 88 parameters (including the control force parameters) on airplanes

³⁰⁰ For example, the Safety Board recommended that FDRs installed on affected existing airplanes be upgraded to record pitch trim; thrust reverser position; angle-of-attack; outside and total air temperatures; and flap, leading edge slat, and ground spoiler positions in addition to the 18 parameters required by the FAA's final rule. However, the FAA did not require these additional parameters.

manufactured after August 18, 2000, to provide commonality with airplanes manufactured after August 19, 2002. In addition, FDR manufacturers were already delivering FDRs that record at the higher data frame rate. Therefore, the Safety Board urged the FAA to change the 88-parameter compliance date for newly manufactured airplanes from August 19, 2002, to August 18, 2000.

In addition, the Safety Board was disappointed that the FAA, with the issuance of its final rule, considered its action on these safety recommendations to be completed. The Safety Board believed that the FAA did not make every effort to ensure that the maximum number of parameters would be recorded within an achievable time period. Because all of the recommended retrofit parameters and the recommended compliance dates were not included in the FAA's final rule, Safety Recommendations A-95-26 and -27 were classified "Closed—Unacceptable Action."

1.18.11.5 October 1996 Recommendations Issued as a Result of United Flight 585, USAir Flight 427, and Eastwind Flight 517 (Safety Recommendations A-96-107 Through -120)

After the accident involving United Airlines flight 585, the Safety Board was informed of numerous uncommanded roll and yaw events involving the 737 series. Most of these incidents did not result in any damage to the airplane or injuries to those on board. As a result of these occurrences, the accident involving USAir flight 427, and the incident involving Eastwind flight 517, the Safety Board issued Safety Recommendations A-96-107 through -120 on October 18, 1996.

Safety Recommendation A-96-107 asked the FAA to

Require the Boeing Commercial Airplane Group, working with other interested parties, to develop immediate operational measures and long-term design changes for the 737 series airplane to preclude the potential for loss of control from an inadvertent rudder hardover. Once the operational measures and design changes have been developed, issue airworthiness directives to implement these actions.

On January 16, 1997, the FAA stated that it intended to take final action on several proposed ADs, some of which would require the retrofit of four newly developed or redesigned components into the rudder system of existing 737 airplanes. The FAA further stated that the safety issues addressed in this recommendation would be resolved during the type certification of the new main rudder PCU servo valve and that it would propose a 2-year compliance timeframe for the retrofit of the servo valve.

On July 15, 1997, the Safety Board noted that the FAA's proposed design changes did not address (1) the development of operational measures and design changes to preclude the loss of control from an inadvertent rudder hardover, (2) the need to establish appropriate inspection intervals and a service life limit for the 737 main rudder PCU (addressed in Safety Recommendation A-96-112), or (3) a method to detect a jammed PCU servo valve slide (addressed in Safety Recommendation A-96-113). The Safety Board believed that operational measures, periodic inspections, and the detection and

annunciation of a jammed slide to the flight crew were needed to ensure flight safety. Because the proposed design did not address reliability or latent failure issues, Safety Recommendation A-96-107 was classified "Open—Unacceptable Response."

On May 13, 1998, the FAA stated that, along with Boeing, it had taken several measures to address the intent of this safety recommendation. These actions included the development and certification of modifications to the 737 main rudder PCU servo valve to prevent the potential for reverse rudder operation. The FAA cited its issuance of the following three ADs:

- AD 96-26-07 was issued on December 23, 1996, and became effective on January 17, 1997. The AD required revising the AFM for all 737 series airplanes within 30 days to include procedures that would enable the flight crew to take "appropriate action to maintain control of the airplane during an uncommanded yaw or roll condition" and "correct a jammed or restricted flight control condition." The FAA stated that the AD had been prompted because such procedures were not defined adequately in the existing 737 AFM. The AD established a "recall" procedure to be performed by flight crews immediately, from memory, in the event of an uncommanded yaw or roll and required that the AFM section concerning procedures for jammed flight controls be modified. The FAA specified that air carriers could comply with the AD by inserting a copy of it in the AFM. No flight crew training requirements were established by the FAA for the procedures that had been introduced or changed by the AD.
- AD 97-14-03 was issued on June 23, 1997, and became effective on August 1, 1997. The AD mandated design changes to all 737 airplanes by August 1, 2000. The AD required the installation of (1) a hydraulic pressure reducer to limit the amount of rudder available to the flight crew during certain portions of flight and (2) a redesigned yaw damper system to improve reliability and fault monitoring capability.
- AD 97-14-04, which superceded ADs-94-01-07 and 96-23-51, was also issued on June 23, 1997, and became effective on August 4, 1997. The AD mandated design changes to the main rudder PCU and servo valve on all 737 airplanes, within 2 years, to "prevent uncommanded movements of the rudder, and consequent reduced controllability of the airplane." In addition, this AD mandated a periodic inspection to test the main rudder PCU for internal leakage and ensure that it is producing an acceptable hinge moment. According to the FAA, the internal leakage test will detect certain servo valve slide jams and provide greater safety margins than a hard-time replacement of the main rudder PCU because the test will ensure that the PCU is functioning within acceptable limits at more frequent intervals than a hard-time interval. The FAA also said that any design change to monitor the servo valve slides would increase the complexity of the servo valve and most likely increase the probability of jamming of a slide.

The FAA also stated in its May 13, 1998, letter that the Safety Board had expressed concern that, although the redesigned servo valve eliminated all known rudder reversal modes, unknown failures might still exist in the system. The FAA concluded that no evidence, either from in-service experience or testing, indicated that a rudder reversal event had actually occurred. The FAA noted that the main rudder PCU had been tested to evaluate chip shear capacity, fluid contamination, thermal jam conditions, input linkage jams, and linkage compliance. According to the FAA, all of these tests failed to create a sustained servo valve jam or any other reasonable failure that could cause erroneous rudder movement.

In addition, the FAA's letter included the Safety Board's position that the detection and indication of a slide jam were necessary because, if a single slide jam was not recognized by the flight crew or mechanics, a second slide jam would cause an accident in some airplane configurations and flight conditions. The Board considered this event to be a catastrophic failure condition. However, the FAA stated that its regulations and policy define a catastrophic failure condition as one that will always result in an accident. According to the FAA, a dual slide jam in the rudder PCU will not always result in an accident and thus should not be considered a catastrophic condition. The FAA also stated that an airplane with a dual slide jam in the rudder PCU would be fully controllable in that configuration throughout much of its flight envelope. Furthermore, the FAA believed that, on the basis of 737 service history and number of hours of operation, a dual slide servo valve jam would be extremely improbable.

On February 2, 1999, the Safety Board stated that it would further analyze and discuss Safety Recommendation A-96-107 in the USAir flight 427 accident report. The Board indicated that, pending the analysis and discussion, Safety Recommendation A-96-107 remained classified "Open—Unacceptable Response." The Safety Board's evaluation of Safety Recommendation A-96-107 and the recommendation's current classification are discussed in section 2.6.

Safety Recommendation A-96-108 asked the FAA to

Revise 14 CFR Section 25.671 to account for the failure or jamming of any flight control surface at its design-limited deflection. Following this revision, reevaluate all transport-category aircraft and ensure compliance with the revised criteria.

On January 16, 1997, the FAA stated that its aircraft certification offices were reviewing data from airplane manufacturers to determine which airplanes certified under 14 CFR Part 25 utilize PCU servo valves that could encounter valve jamming problems resulting from unexpected improper positioning of the servo slides. The FAA stated that it would take appropriate action based on the results of the review. On July 15, 1997, the Safety Board responded that, because the FAA had not specified its planned actions, Safety Recommendation A-96-108 was classified "Open—Await Response."

On May 13, 1998, the FAA indicated that it decided not to revise 14 CFR Section 25.671. The FAA did not concur with the Safety Board's position that it is necessary to

account for a jam in any flight control surface at its design-limited deflection. According to the FAA, a control surface jam at its design-limited deflection during flight would require an active system failure to cause the control surface to move to the extreme position and remain there. The FAA indicated that the last sentence of 14 CFR Section 25.671(c)(3) required that such a jam be accounted for unless such a jam can be shown to be extremely improbable. The FAA stated that an applicant can show compliance with the regulation by demonstrating, based on a probability analysis, that the runaway and jam condition is an extremely improbable event or that the condition can be alleviated. Because a jam condition is more likely to occur in a control position normally encountered, the FAA's policy requires the applicant to demonstrate controllability for this condition.

On February 2, 1999, the Safety Board stated that it would further analyze and discuss Safety Recommendation A-96-108 in the USAir flight 427 accident report. The Board indicated that, pending the analysis and discussion, Safety Recommendation A-96-108 remained classified "Open—Await Response." The Safety Board's evaluation of Safety Recommendation A-96-108 and the recommendation's current classification are discussed in section 2.6.

Safety Recommendation A-96-109 asked the FAA to

Require the Boeing Commercial Airplane Group to develop and install on all new-production 737 airplanes a cockpit indicator system that indicates rudder surface position and movement. For existing 737 airplanes, when implementing the installation of an enhanced-parameter flight data recorder, require the installation of a cockpit indicator system that indicates rudder surface position and movement.

On January 16, 1997, the FAA stated that an additional indicator in the cockpit would add no practical information to the pilot because all rudder movements on the 737, except those caused by the yaw damper, are directly apparent to the flight crew through the movement of the rudder pedals. The FAA further stated that a rudder position indicator will have very little value during the immediacy of a roll/yaw departure from controlled flight because such an event would require prompt and aggressive pilot response depending on the attitude, rate, and acceleration experienced.

On July 15, 1997, the Safety Board responded that it agreed with the FAA's assertion that a rudder position indicator would be of little value in the initial moments of an upset during which immediate pilot reaction may be needed to prevent a loss of control. However, the Safety Board disagreed with the FAA's position that a rudder position indicator would provide no practical information to the pilot. The Safety Board's investigation of numerous yaw/roll upset events found that pilots, when trying to troubleshoot the problem, are often uncertain about the position of the rudder in the moments after regaining control. The Safety Board noted that recent testing had indicated the possibility for reverse rudder operation and that the installation of a rudder position indicator would provide a means for the pilot to understand that a rudder reversal had occurred. The Safety Board also noted that essentially all new-production 737s and other

transport-category airplanes are equipped with rudder position indicators. As a result, Safety Recommendation A-96-109 was classified "Open—Unacceptable Response."

On May 13, 1998, the FAA reiterated its position that it is not necessary to require the installation of a rudder indicator system in 737 airplanes. The FAA repeated that any rudder movement outside the small movement of the yaw damper system will back-drive the rudder pedals and be noted by the pilots if their feet are on the pedals. Further, the FAA believed that ADs 96-26-07, 97-14-03, and 97-14-04 preclude a rudder jam/reversal scenario and support the conclusion that a rudder surface position indicator should not be mandated.

On February 2, 1999, the Safety Board stated that it would further analyze and discuss Safety Recommendation A-96-109 in the USAir flight 427 accident report. The Board indicated that, pending the analysis and discussion, Safety Recommendation A-96-109 remained classified "Open—Unacceptable Response." The Safety Board's evaluation of Safety Recommendation A-96-109 and the recommendation's current classification are discussed in section 2.6.

Safety Recommendation A-96-110 asked the FAA to

Conduct a detailed engineering review of the 737 yaw damper system, and require the Boeing Commercial Airplane Group to redesign the yaw damper system, as necessary, to eliminate the potential for sustained uncommanded yaw damper control events. After the 737 yaw damper system is redesigned, issue an airworthiness directive to require the installation of the improved yaw damper system on all 737 series airplanes.

On June 23, 1997, the FAA issued AD 97-14-03. In its May 13, 1998, letter, the FAA explained that Boeing was developing design changes to the rudder limiter and yaw damper system to comply with the requirements of the AD. The FAA indicated that the Manager of the Seattle Aircraft Certification Office was expected to approve the design changes by July 31, 1998. On February 2, 1999, the Safety Board stated that, pending the FAA's certification of the proposed new yaw damper system, Safety Recommendation 96-110 was classified "Open—Acceptable Response."

Safety Recommendation A-96-111 asked the FAA to

Require the Boeing Commercial Airplane Group and the operating airlines to eliminate the procedure for removal and replacement of the main rudder power control unit rudder position transducer from their respective 737 maintenance manuals unless the manual provides for testing to verify that the replacement transducer performs its intended function.

According to the FAA's August 7, 1997, letter, Boeing issued a revision to its 737 MM on November 27, 1996, to eliminate the removal and installation sections for the main rudder PCU rudder position transducer. This revision was applicable to 737-100 through -500 series airplanes. On November 4, 1997, the Safety Board stated that, because this revision met the intent of Safety Recommendation A-96-111, it was classified "Closed—Acceptable Action."

Safety Recommendation A-96-112 asked the FAA to

Require the Boeing Commercial Airplane Group to establish appropriate inspection intervals and a service life limit for the 737 main rudder power control unit.

On January 16, 1997, the FAA stated that it intended to take final action on several proposed ADs, some of which would require the retrofit of four newly developed or redesigned components into the rudder system of existing 737 airplanes. The FAA stated that the safety issues addressed in this recommendation would be resolved during the type certification of the new main rudder PCU servo valve and that it would propose a 2-year compliance timeframe for the retrofit of the servo valve.

On July 15, 1997, the Safety Board noted that the FAA's proposed design changes did not address (1) the development of operational measures and design changes to preclude the loss of control from an inadvertent rudder hardover (addressed in Safety Recommendation A-96-107), (2) the need to establish appropriate inspection intervals and a service life limit for the 737 main rudder PCU, or (3) a method to detect a jammed PCU servo valve slide (addressed in Safety Recommendation A-96-113). The Safety Board believed that operational measures, periodic inspections, and the detection and annunciation of a jammed slide to the flight crew were needed to ensure flight safety. Because the proposed design did not address reliability or latent failure issues, Safety Recommendation A-96-112 was classified "Open—Unacceptable Response."

On May 13, 1998, the FAA stated that, along with Boeing, it had taken several measures to address the intent of this safety recommendation. These actions included the development and certification of modifications to the 737 main rudder PCU servo valve to prevent the potential for reverse rudder operation. Also, the FAA issued ADs 96-26-07, 97-14-03, and 97-14-04. In addition, the FAA's letter noted the Safety Board's concerns that unknown failures might still exist in the redesigned servo valve and that, if a single slide jam was not recognized by the flight crew or mechanics, a second slide jam would cause an accident in some airplane configurations and flight conditions. The FAA's response included its position on what constitutes a catastrophic failure condition and whether a dual slide jam would be considered a catastrophic condition.

On February 2, 1999, the Safety Board stated that it would further analyze and discuss Safety Recommendation A-96-112 in the USAir flight 427 accident report. The Board indicated that, pending the analysis and discussion, Safety Recommendation A-96-112 remained classified "Open—Unacceptable Response." The Safety Board's evaluation of Safety Recommendation A-96-112 and the recommendation's current classification are discussed in section 2.6.

Safety Recommendation A-96-113 asked the FAA to

Require the Boeing Commercial Airplane Group to devise a method to detect a primary or a secondary jammed slide in the 737 main rudder power control unit servo valve and ensure appropriate communication of the information to mechanics and pilots.

On January 16, 1997, the FAA stated that it intended to take final action on several proposed ADs, some of which would require the retrofit of four newly developed or redesigned components into the rudder system of existing 737 airplanes. The FAA stated that the safety issues addressed in this recommendation would be resolved during the type certification of the new main rudder PCU servo valve and that it would propose a 2-year compliance timeframe for the retrofit of the servo valve.

On July 15, 1997, the Safety Board noted that the FAA's proposed design changes did not address (1) the development of operational measures and design changes to preclude the loss of control from an inadvertent rudder hardover (addressed in Safety Recommendation A-96-107), (2) the need to establish appropriate inspection intervals and a service life limit for the 737 main rudder PCU (addressed in Safety Recommendation A-96-112), or (3) a method to detect a jammed PCU servo valve slide. The Safety Board believed that operational measures, periodic inspections, and the detection and annunciation of a jammed slide to the flight crew were needed to ensure flight safety. Because the proposed design did not address reliability or latent failure issues, Safety Recommendation A-96-113 was classified "Open—Unacceptable Response."

On May 13, 1998, the FAA stated that, along with Boeing, it had taken several measures to address the intent of this safety recommendation. These actions included the development and certification of modifications to the 737 main rudder PCU servo valve to prevent the potential for reverse rudder operation. Also, the FAA issued ADs 96-26-07, 97-14-03, and 97-14-04. In addition, the FAA's letter noted the Safety Board's concerns that unknown failures might still exist in the redesigned servo valve and that, if a single slide jam was not recognized by the flight crew or mechanics, a second slide jam would cause an accident in some airplane configurations and flight conditions. The FAA's response included its position on what constitutes a catastrophic failure condition and whether a dual slide jam would be considered a catastrophic condition. (For further information on the FAA's response, see A-96-107.)

On February 2, 1999, the Safety Board stated that it would further analyze and discuss Safety Recommendation A-96-113 in the USAir flight 427 accident report. The Board indicated that, pending the analysis and discussion, Safety Recommendation A-96-113 remained classified "Open—Unacceptable Response." The Safety Board's evaluation of Safety Recommendation A-96-113 and the recommendation's current classification are discussed in section 2.6.

Safety Recommendation A-96-114 asked the FAA to

Evaluate the adequacy of the chip shearing capacity for all sliding spool control valves used in transport-category aircraft flight control systems, and take appropriate action to correct any problems identified to preclude the potential for actuator jamming, binding, or failure.

On June 29, 1998, the FAA stated that its aircraft certification offices have evaluated the adequacy of the chip shearing capacity of sliding spool control valves for

certain airplanes. The criteria used in this evaluation were recommended by the SAE A-6 Committee and incorporated information from an August 12, 1997, letter by Boeing.

The FAA concluded that all sliding spool control valves used in the following transport-category airplanes' flight control systems met the evaluation criteria:

- Boeing 707 (except the rudder system), 727, 737, 747, 757, 767, and 777;
- McDonnell Douglas DC-9, DC-10, MD-11, MD-80, and MD-90;
- Lockheed L-1011 and L-382
- Gulfstream V;
- Saab 340 and 2000;
- Dornier DO-328;
- Fokker F.28 (all models);
- Embraer EMB-120 and EMB-145; and
- Cessna, Learjet, Raytheon, and Sabreliner (applicable models).

The FAA planned no further action for these airplanes. However, the FAA was waiting for data from European and Canadian manufacturers, additional data for the 707 rudder system, and data for the Douglas DC-8 airplanes. These data were expected to be received by July 1998.

On February 2, 1999, the Safety Board indicated that it would like to review the FAA's evaluation criteria for determining the adequacy of the chip shearing capacity of sliding spool control valves. Pending the Board's review of the criteria and the FAA's completion of the evaluation project, Safety Recommendation A-96-114 was classified "Open—Acceptable Response."

Safety Recommendation A-96-115 asked the FAA to

Require the modification of the input rod bearing on the 737 series standby rudder actuator, by August 1, 1997, to prevent galling and possible discrepant operation of the rudder system.

The FAA issued AD 97-26-01, which became effective January 20, 1998, to require repetitive inspections to detect galling on the input shaft and bearing of the standby rudder PCU and replacement of the standby rudder actuator with a serviceable actuator, if necessary. The AD also required the installation of a newly designed standby PCU input shaft bearing within 3 years of the effective date of the AD. On February 2, 1999, the Safety Board stated that, because the FAA's action complied with the intent of Safety Recommendation A-96-115, it was classified "Closed—Acceptable Action."

Safety Recommendation A-96-116 asked the FAA to

Define and implement standards for in-service hydraulic fluid cleanliness requirements and sampling intervals for all transport-category aircraft.

On June 29, 1998, the FAA stated that it had reviewed a study by the SAE A-6 Committee Hydraulic Fluid Contamination Task Force. On the basis of the study's findings, the FAA identified NAS 1638 as an industry standard that defines fluid cleanliness levels; defined NAS 1638 Class 9 as the in-service limit; and verified that manufacturers already included or are in the process of including this limit in their maintenance manuals, along with a sampling interval. The FAA added that it was participating in the development of an Aerospace Recommended Practice document for sampling and testing techniques. On February 2, 1999, the Safety Board stated that, because the FAA's actions met the intent of Safety Recommendation A-96-116, it was classified "Closed—Acceptable Action."

Safety Recommendation A-96-117 asked the FAA to

Conduct a detailed design review of all dual-concentric servo valves that control essential flight control system actuators on transport-category airplanes certificated by the Federal Aviation Administration to determine if the design is susceptible to inducing flight control malfunctions and/or reversals as a result of unexpected improper positioning of the servo slides. If the design is determined to be susceptible, mandate appropriate design changes.

In a July 15, 1997, letter to the FAA, the Safety Board stated that recent tests had found that the 737 main rudder PCU could possibly cause reverse rudder operation if the servo valve secondary slide were to jam. This finding had not been indicated by numerous prior tests and research and was unknown at the time that the Board issued this safety recommendation. Thus, the Board believed that extra efforts needed to be taken to determine if any other dual-concentric servo valves are susceptible to flight control malfunctions as a result of unexpected improper positioning of the servo slides.

On May 13, 1998, the FAA stated that its detailed design review of dual-concentric servo valves would address this recommendation. Also on May 13, 1998, and again on June 29, 1998, the FAA stated that its aircraft certification offices reviewed the data from airplane manufacturers under their geographic purview and determined that 12 dual-concentric servo valves, used on various transport-category airplane flight control systems, needed a detailed design review. Ten of these valves are used on Boeing 707, 727, 737, and 747 series airplanes; one is used on McDonnell Douglas DC-10 and MD-11 series airplanes; and one is used on the Lockheed L-1011 series airplane. The FAA further stated that the valve jam conditions, including those involving the secondary slide, and evaluation criteria had been identified.

Also on June 29, 1998, the FAA stated that it had reviewed additional study results submitted by Boeing, its Douglas Products Division, and Lockheed Martin; however, Boeing was still reviewing the 707 rudder PCU. The FAA indicated that it would review

the results of the 707 rudder PCU evaluation as soon as it was completed. In addition, the FAA stated that it issued ADs for two servo valves and found nine servo valves to be acceptable.

On February 2, 1999, the Safety Board noted that airplanes produced by Airbus were not mentioned as part of the FAA's evaluation. Pending the Board's review of the results of the FAA's detailed design review, including a review of Airbus flight control systems, Safety Recommendation A-96-117 was classified "Open—Acceptable Response."

Safety Recommendation A-96-118 asked the FAA to

Require the Boeing Commercial Airplane Group, working with other interested parties, to develop procedures that require 737 flight crews to disengage the yaw damper in the event of an uncommanded yaw upset as a memorized or learned action. Once the procedures are developed, require operators to implement these procedures.

On January 16, 1997, the FAA stated that Boeing had taken appropriate action to address this issue. Specifically, Boeing revised its 737 Operations Manual and published an Operations Manual Bulletin to amend the "Uncommanded Yaw" procedure to "Uncommanded Yaw and Roll Procedure." According to the FAA, the revised Operations Manual Bulletin addressed the three failure modes of the 737 yaw damper system and provided specific guidance to the flight crew on how to address each of the failure modes. The FAA stated that it planned no further action on this issue.

On July 15, 1997, the Safety Board responded that the revision to Boeing's Operations Manual does not advise flight crews to disengage the yaw damper as a memorized or learned item in the event of an uncommanded roll. Additionally, the Safety Board was aware that not all operators had adopted a procedure to disengage the yaw damper as a memorized or learned item. The Board requested that the FAA reconsider its position not to take further action on this issue. As a result, Safety Recommendation A-96-118 was classified "Open—Unacceptable Response."

On May 13, 1998, the FAA indicated that Boeing revised its 737 AFM to include procedures that enable the flight crew to take appropriate action to maintain control of the airplane during an uncommanded yaw or roll condition and correct a jammed or restricted flight control condition.

On February 2, 1999, the Safety Board stated that it would further analyze and discuss Safety Recommendation A-96-118 in the USAir flight 427 accident report. The Board indicated that, pending the analysis and discussion, Safety Recommendation A-96-118 remained classified "Open—Unacceptable Response." The Safety Board's evaluation of Safety Recommendation A-96-118 and the recommendation's current classification are discussed in section 2.7.2.

Safety Recommendation A-96-119 asked the FAA to

Require the Boeing Commercial Airplane Group to develop operational procedures for 737 flight crews that effectively deal with a sudden uncommanded movement of the rudder to the limit of its travel for any given flight condition in the airplane's operational envelope. Once the operational procedures have been developed, require 737 operators to provide this training to their pilots.

On January 16, 1997, the FAA stated that it directed the Seattle Aircraft Evaluation Group, along with Boeing and the Seattle Aircraft Certification Office, to develop a pilot operating procedure for recovery techniques of sudden uncommanded movement of the rudder to its maximum limit. This new procedure would be incorporated into the 737 AFM. The FAA also stated that, once the procedure is developed and the AFM is revised, it would issue a FSIB directing POIs, whose carriers operate 737 airplanes, to inform pilots of the new procedure and ensure that they are trained during their next scheduled recurrent training.

On July 15, 1997, the Safety Board responded that the potential for a rudder movement opposite from that commanded by pilot input on the rudder pedals was not included as part of this recommendation. Because Safety Recommendation A-97-18, which had been issued on February 20, 1997, superseded the earlier recommendation by addressing this rudder movement situation, Safety Recommendation A-96-119 was classified "Closed—Acceptable Action."

Safety Recommendation A-96-120 asked the FAA to

Require 14 CFR Part 121 and 135 operators to provide training to flight crews in the recognition of and recovery from unusual attitudes and upset maneuvers, including upsets that occur while the aircraft is being controlled by automatic flight control systems, and unusual attitudes that result from flight control malfunctions and uncommanded flight control surface movements.

This recommendation expanded on the intent of Safety Recommendation A-96-66, which was issued on August 15, 1996, as a result of the Safety Board's investigation into the accident involving American Eagle flight 4184, an ATR-72, near Roselawn, Indiana, on October 31, 1994.³⁰¹ The airplane, which was operated by Simmons Airlines, had been in a holding pattern and was descending to a newly assigned altitude of 8,000 feet when the initial uncommanded roll excursion occurred. The airplane entered a rapid descent and crashed. All 68 people on board were killed, and the airplane was destroyed by impact forces. Safety Recommendation A-96-66 asked the FAA to amend the FARs to require operators to provide standardized training that adequately addresses the recovery from unusual events, including extreme flight attitudes in large transport-category airplanes.

³⁰¹ See National Transportation Safety Board. 1996. *In-Flight Icing Encounter and Loss of Control, Simmons Airlines, d.b.a. American Eagle Flight 4184, Avions de Transport Regional (ATR) Model 72-212, N401AM, Roselawn, Indiana, October 31, 1994*. Aircraft Accident Report NTSB/AAR-96/01. Washington, DC.

In issuing Safety Recommendation A-96-120, the Safety Board recognized that pilots receive unusual attitude training when obtaining their private pilot and commercial pilot certificates as well as their instrument ratings. However, the Safety Board believed that the ability of pilots to recognize and recover from an unusual attitude could be severely diminished without additional or recurrent unusual attitude training. Therefore, Safety Recommendation A-96-66 was classified "Closed—No Longer Applicable/Superseded."

On January 16, 1997, the FAA responded to Safety Recommendation A-96-120. The FAA stated that it was considering an NPRM proposing to require that air carriers conduct training that will emphasize recognition, prevention, and recovery from aircraft attitudes that are not normally associated with air carrier flight operations.

On July 15, 1997, the Safety Board responded that it was not aware of any training in which the unusual attitude was the result of a control system failure or in which some flight controls would not be available for, or would be counterproductive to, the recovery. The Safety Board encouraged the FAA to address the full intent of this recommendation. Pending the Board's review of the FAA's final action, Safety Recommendation A-96-120 was classified "Open—Acceptable Response." The Safety Board's review and evaluation of the FAA's actions in response to Safety Recommendation A-96-120 and the recommendation's current classification are discussed in section 2.7.1.

1.18.11.6 February 1997 Recommendations Issued as a Result of United Flight 585, USAir Flight 427, and Eastwind Flight 517 (Safety Recommendations A-97-16 Through -18)

As a result of the numerous occurrences of uncommanded roll and yaw events involving 737 series airplanes, the accidents involving United flight 585 and USAir flight 427, and the incident involving Eastwind flight 517, the Safety Board issued Safety Recommendations A-97-16 through -18 on February 20, 1997.

Safety Recommendation A-97-16 asked the FAA to

Require the expeditious installation of a redesigned main rudder power control unit on Boeing 737 series airplanes to preclude reverse operation of the rudder and ensure that the airplanes comply with the intent of the certification requirements.

On June 23, 1997, the FAA issued AD 97-14-04, which requires, by August 1999, the installation of a newly redesigned main rudder PCU on all 737 series airplanes. Boeing indicated that the new PCU would preclude the rudder reversal scenarios that have been previously identified or hypothesized. On February 2, 1999, the Safety Board indicated that, because the FAA's action complied with the intent of Safety Recommendation A-97-16, it was classified "Closed—Acceptable Action."

Safety Recommendation A-97-17 asked the FAA to

Advise 737 pilots of the potential hazard for a jammed secondary servo control valve slide in the main rudder power control unit to cause a reverse rudder response when a full or high-rate input is applied to the rudder pedals.

On April 18, 1997, the FAA stated that AD 96-26-07, which was issued on December 23, 1996, and became effective on January 17, 1997, required Boeing to revise its AFM to include procedures that would enable a flight crew to take appropriate action to maintain control of the airplane during an uncommanded yaw or roll condition and correct a jammed or restricted flight control condition. The FAA also stated that it was developing an FSIB to meet the intent of this recommendation.

On January 29, 1998, the FAA issued FSIB 98-03, "Recognition of and Recovery From Unusual Attitudes and Upsets Caused by Reverse Rudder Response Involving Boeing 737s." The FSIB directs, among other things, that POIs advise their air carriers to inform pilots of (1) the potential for a jammed servo valve secondary slide in the main rudder PCU when a full or high-rate input is applied to the rudder and (2) the procedures training necessary to cope with the hazards.

On February 2, 1999, the Safety Board expressed concern about the amount of time that elapsed before the FAA issued FSIB 98-03; the FAA had anticipated issuing the bulletin in July 1997. Nonetheless, because the bulletin met the intent of Safety Recommendation A-97-17, it was classified "Closed—Acceptable Action."

Safety Recommendation A-97-18 asked the FAA to

Require the Boeing Commercial Airplane Group to develop operational procedures for 737 flight crews that effectively deal with a sudden uncommanded movement of the rudder to the limit of its travel for any given flight condition in the airplane's operational envelope, including specific initial and periodic training in the recognition of and recovery from unusual attitudes and upsets caused by reverse rudder response. Once the procedures are developed, require 737 operators to provide this training to their pilots.

On April 18, 1997, the FAA stated that AD 96-26-07, which was issued on December 23, 1996, and became effective on January 17, 1997, required Boeing to revise its AFM to include procedures that would enable a flight crew to take appropriate action to maintain control of the airplane during an uncommanded yaw or roll condition and correct a jammed or restricted flight control condition. The FAA also stated that it was developing an FSIB to meet the intent of this recommendation.

On July 15, 1997, the Safety Board stated that issuance of AD 96-26-07 partly responded to the intent of this recommendation but neglected a critical portion of the recommendation. Specifically, AD 96-26-07 did not address specific initial and periodic training in the recognition of and recovery from unusual attitudes and upsets caused by reverse rudder response or require 737 operators to provide this training to their pilots.

The Safety Board continued to believe that pilots must receive specific initial and periodic training if they are expected to recover the airplane if a reverse rudder response results in an unusual attitude. Therefore, pending further correspondence, Safety Recommendation was classified "Open—Unacceptable Response."

On January 29, 1998, the FAA issued FSIB 98-03, "Recognition of and Recovery From Unusual Attitudes and Upsets Caused by Reverse Rudder Response Involving Boeing 737s." The FSIB directs, among other things, that FAA inspectors require 737 operators to amend their training programs to provide initial and recurrent training in the recognition of and recovery from unusual attitudes and upsets caused by reverse rudder response.

On February 2, 1999, the Safety Board stated that it would further analyze and discuss Safety Recommendation A-97-18 in the USAir flight 427 accident report. The Board indicated that, pending the analysis and discussion, Safety Recommendation A-97-18 remained classified "Open—Unacceptable Response." The Safety Board's evaluation of Safety Recommendation A-97-18 and the recommendation's current classification are discussed in section 2.7.2.

1.18.12 Party Submissions

The Safety Board received party submissions that discussed possible scenarios and/or causes for the USAir flight 427 accident from the FAA, Boeing, Parker Hannifin, USAir, and ALPA.

FAA Submission

The FAA's September 1997 submission stated:

While the investigation has produced evidence which support the scenarios where the rudder moved to a full-left position after an encounter with wake turbulence, the cause of the movement is still at issue. The FAA upon review of the evidence, cannot conclude that a failure mode which resulted in an uncommanded rudder movement on Flight 427 has been identified. Any causal findings, to be legitimate, must have conclusive evidence to support findings of a hard over or reversal rudder. Such evidence has yet to be found. Consequently, a specific causal finding of this nature may not be appropriate.

The rudder system abnormalities that have been discovered during this investigation have not been shown to have occurred on USAir flight 427. There is no evidence of any of these abnormalities being present during the accident sequence. While the FAA acknowledges the fact that some failure modes of the main rudder power control unit servo valve have been discovered during this accident investigation, it has not been substantiated that any of these failures occurred on the accident aircraft. The FAA also acknowledges that a secondary slide jam to the housing of the servo valve or interference with the rudder input link could provide both full rudder rate and full hinge moment. However, once again there is no direct evidence that this occurred.

The Boeing Aircraft Company and the FAA have reacted to the discovered failure modes with modifications of the rudder system, including some recommended by the National Transportation Safety Board that are designed to prevent future events of this type. However, the FAA does not believe sufficient evidence exists to establish a rudder system failure as the cause of the accident.

Boeing Submissions

During the investigation of the USAir flight 427 accident, Boeing provided the Safety Board with a formal submission and a human factors supplement (dated September 30, 1997), a supplemental submission (dated August 14, 1998), and numerous letters containing what might be considered submittal information. Portions of these submittals relating to Boeing's proposed accident scenarios for the United flight 585 accident and the Eastwind flight 517 incident and Boeing's kinematic and simulation studies are discussed in sections 1.16.1 and 1.16.6, respectively.

Boeing's September 30, 1997, submission concluded that the flight crew was startled by the severity of an unexpected wake encounter, a full rudder deflection occurred, the pilots applied aft pressure on the control column, and the airplane subsequently entered a stall and remained stalled for approximately 14 seconds as it descended to the ground. However, the submission stated that the events that led to the full rudder deflection were not clear. Boeing's September 1997 submission stated, "there is no certain proof of airplane-caused full rudder deflection during the accident sequence. The previously unknown failure conditions that have been discovered in the 737 rudder PCU have been shown to not be applicable to Flight 427 or any other conditions experienced in commercial service."

Boeing's September 1997 submission stated the following probable cause of the USAir flight 427 accident:

...there is no evidence to support a conclusion that an uncommanded full rudder deflection occurred. While there is not conclusive evidence of a crew-commanded, sustained left-rudder input such a possibility is plausible and must be seriously considered, especially given the lack of evidence of an airplane-induced rudder deflection."

Boeing's September 1997 submission also stated the investigation and the 737 design review identified "areas where the 737 rudder system could be improved. In addition, extremely unlikely failure modes were identified that could hypothetically result in unwanted rudder deflections." The submission stated that, in accordance with the FAA's ADs 97-14-03 and 97-14-04, Boeing pursued several rudder system design changes, including redesigns of the main rudder PCU servo valve and the yaw damper system, new PCU input rod fasteners, and the design and installation of a hydraulic pressure reducer.

Boeing's September 1997 submission further stated that the most significant findings from the investigation included the following:

- Commercial transport flight crews need to be specifically trained to handle large upsets. Transport pilot training widely used in the 1994 time frame did not prepare flight crews for recovery from the highly unusual roll rates and roll and pitch attitudes encountered by the crew of Flight 427.
- 737 yaw damper reliability enhancements are needed to reduce potential airplane contribution to upsets.
- Highly unlikely potential 737 failure modes can be eliminated:
 - Potential 737 rudder PCU failure modes.
 - Potential 737 rudder PCU input rod fastener failure mode.
- We can reduce the impact of either airplane-related or crew-input-related rudder upsets by limiting 737 rudder control authority.
- Research is needed on better ways to detect and avoid wake vortices.
- Existing 737 flight control anomaly procedures could be improved.
- The flight data recorder information from this accident was inadequate to prove definitive events.

Additionally, Boeing's submission recommended that "the appropriate organizations within the industry take steps to improve industry understanding of possible flight crew responses to wake vortex encounters and other upset events. Boeing believes that such an effort would be valuable to training organizations worldwide."

In its August 14, 1998, supplemental submission, Boeing stated the following regarding its analysis of the Eastwind flight 517 event:

- Multiple scenarios have been identified that match at least some of the data and crew reports from the Eastwind 517 event. None of the scenarios fully match all the data, kinematic analysis, and crew reports.
- Boeing believes that under the NTSB's standard for identifying "probable cause," there is insufficient data to find a "probable cause" for this event.
- All parties generally agree that the initiation of the Eastwind event included some form of activity from the yaw damper system.
- The most likely explanation for the Eastwind event involves a preexisting yaw damper fault that subsequently cleared itself.
- There is no data to indicate that the Eastwind Flight 517 event, the United Flight 585 accident, and USAir Flight 427 accident were caused by a common airplane malfunction.

Parker Hannifin Submission

Parker Hannifin's September 1997 submission stated that the postaccident examination of the USAir flight 427 PCU revealed no physical evidence of a jam or other anomaly. Further, the submission stated that "the conclusion reached by Boeing was that

the accident PCU would not seize if subject to thermal shocks or temperature differential consistent with those which could be encountered in realistic flight conditions.”

Parker’s submission concluded

A significant indication of the reliability of the main rudder PCU from Flight 427 is a comparison of the performance of the unit at the time of its original manufacture in 1987 as measured by the acceptance test, its performance at the time of its testing during removal from service in September 1992, its performance when tested immediately following the accident the September 1994, and finally, its performance when tested in August 1997 after having been subject to numerous tests and conditions outside the normal flight environment of the unit. In each of these instances, the PCU consistently operated normally and within specifications. In sum, after years of one of the most critical examinations in aviation history, there is no evidence that the main rudder PCU from Flight 427 malfunctioned or was other than fully operational.

USAir Submissions

USAir provided the Safety Board with a submission (dated September 30, 1997) and a supplemental submission (dated August 12, 1998). In its September 30, 1997 submission, USAir stated that “data demonstrates, and all parties seem to agree, that USAir flight 427’s rudder moved to a full-left position shortly after the aircraft encountered wake vortices generated by a preceding aircraft. It is also clear that the wake vortex encounter did not directly cause the accident.” The USAir submission described the background and experience of the pilots and their actions during the emergency and concluded the following:

[The pilots] did not apply full-left rudder during the wake vortex encounter, oppose it with opposite aileron and spoiler, and hold these cross-controlled positions for 23 seconds as the aircraft spiraled into the ground. The investigation did, however, reveal several anomalies in the Boeing 737 rudder control system that may have caused the aircraft’s rudder to fully deflect without crew input or to move opposite to the crew’s input.

The USAir submission concluded that the probable cause of the accident was “an uncommanded, full rudder deflection or rudder reversal that placed the aircraft in a flight regime from which recovery was not possible using known recovery procedures. A contributing cause of this accident was the manufacturer’s failure to advise operators that there was a speed below which the aircraft’s lateral control authority was insufficient to counteract a full rudder deflection.”

In its August 12, 1998, supplemental submission, USAir supported the results of the Safety Board’s simulation studies. USAir’s supplemental submission indicated that “a mechanical malfunction of USAir flight 427 rudder PCU resulted in a rudder reversal or uncommanded deflection that caused USAir flight 427 to depart controlled flight and crash.” USAir also restated its previous conclusions.

ALPA Submissions

ALPA provided the Safety Board with a submission (dated September 1997) and a supplemental submission (dated August 7, 1998) in which it offered its conclusions and recommendations. ALPA's September 1997 submission stated that

...aircraft performance analysis revealed that the maneuver of USAir 427 is consistent with full nose left rudder travel.... There is no evidence to support the hypothesis that the flightcrew mishandled the flight control following the upset event, or that this control mishandling led to the accident.

As for the B737 rudder control system however, during the course of this investigation a number of failure modes have been identified which could result in an uncommanded full rudder input. It was also discovered that at least one failure mode, secondary valve jam resulting in primary valve overtravel, would not leave witness marks. In addition, this failure mode resulted in rudder movement that matched the rudder time history, in both magnitude and input rate, determined from the aircraft performance studies necessary to match the maneuver.

ALPA's submission concluded that

...the airplane experienced an uncommanded full rudder deflection. This deflection was a result of a main rudder power control unit (PCU) secondary valve jam which resulted in a primary valve overstroke. This secondary valve jam and primary valve overstroke caused USAir 427 to roll uncontrollably and dive into the ground. Once the full rudder hardover occurred, the flight crew was unable to counter the resulting roll with aileron because the B737 does not have sufficient lateral control authority to balance a full rudder input in certain areas of the flight envelope.

Additionally, ALPA's submission offered the following recommendations for the Safety Board's consideration:

- Boeing and Parker should work diligently to replace existing B737 rudder PCUs with improved units as quick as possible without sacrificing quality.
- The FAA should eliminate the current practice of derivative certification. Newly developed aircraft should be carefully evaluated against FAR criteria in place at the time of aircraft development.
- For aircraft which were certificated as "Derivative" models, the FAA should evaluate those aircraft against existing FAR requirements and those aircraft, to the extent feasible, should be modified in order to be in compliance with the current FAR regulations.
- The FAA should require all FAA certified repair stations to meet all standards of the original equipment manufacturer.

- In order to increase B737 lateral control margin to an acceptable level, the FAA should mandate the development of additional operational techniques such as increasing B737 minimum maneuvering speed to Boeing recommended "Block" speed plus 10 knots.
- The industry should continue with the development and implementation of "Advanced Maneuver" or "Selected Event" training and that the FAA should require the inclusion of this training in every airline's training program.

In the August 7, 1998, supplemental submission, ALPA noted that a comparison of Boeing's kinematic analysis and the Safety Board's computer simulation of the Eastwind flight 517 event indicated that

...both scenarios match the same recorded [FDR] data, demonstrating that it is possible to match the maneuver with different scenarios by varying the assumption and interpretation of the course data. However, ALPA believes that the Board is more accurate in their scenario since the rate of the rudder input required to match the maneuver is the same rate which would result from a PCU secondary valve jam.

NTSB staff, using [its] simulation, has also been able to match both the USAir [flight] 427, and [United flight] 585 accident upsets by assuming a PCU secondary valve jam. In all three cases the rudder input rate needed to match flight recorder data is consistent with the rudder rate which would result from a secondary valve jam. It is extremely unlikely that three different pilots in three different B737s, on three different days would use the same rudder rate. Yet if the secondary valve were jammed in each case, it would result in the same rudder input rate.

The supplemental submission concluded that "ALPA believes more strongly than ever that the cause of the accident was a rudder anomaly."

1.19 New Investigative Techniques

The extent of the destruction involved the USAir flight 427 accident and the complexity, depth, and duration of the accident investigation resulted in the use of some new techniques and practices. After its initial examination of the accident site, the Safety Board (in cooperation with local public safety officials) determined that the accident site and the airplane wreckage and components were a potential biological hazard. As a result, the Board required the use of personal protective equipment (PPE) and the implementation of safety procedures, as outlined in the Occupational Safety and Health Administration (OSHA) regulations contained in 29 CFR Part 1910. During the on-scene investigation, the Safety Board (with assistance from other emergency response authorities) established formal procedures for the large-scale provision, use, and disposition of PPE;³⁰² the distribution of Hepatitis B inoculations to all noninoculated

³⁰² The OSHA procedures for this type of environment required all investigative and emergency response personnel to wear PPE when they accessed those areas of the accident site containing biological hazards and undergo decontamination procedures after departing the biohazard area.

on-scene investigative/emergency response personnel; and the decontamination of every recovered piece of airplane wreckage.

The monitoring of and access control to the accident site was initially the responsibility of the Hopewell Township emergency response personnel, with support from neighboring jurisdictions, the Beaver County Sheriff's Office, and the Pennsylvania State Police. A Unified Command Post (UCP) was subsequently established, and the responsibility for control and coordination of site access, PPE, decontamination, and other site logistics came under the purview of UCP authorities. The UCP included representatives from the Safety Board, the U.S. Air National Guard, the USAF Reserve, Pennsylvania Emergency Management Agency, Pennsylvania Department of Environmental Resources, Pennsylvania State Police, Beaver County Sheriff's and Coroner's Offices, and Hopewell Township Fire and Police Departments. Other groups involved in the UCP were the American Red Cross, the Salvation Army, and a University of Pittsburgh Critical Incident Stress Debriefing team.

Because of the catastrophic destruction of the airplane and occupants, the Safety Board sought assistance from the AFIP in positively identifying the flight crews' remains. AFIP personnel used deoxyribonucleic acid (DNA) protocols to identify and differentiate the muscle tissue samples obtained from the cockpit area of the wreckage. With the use of DNA protocols and reference specimens from the first officer's family, AFIP personnel were able to positively identify one set of tissue samples as the first officer's remains. The Safety Board was unable to obtain reference specimens from the captain's family. However, the FBI identified footprints from tissue specimens recovered from the cockpit area, and these footprints matched those of the captain's USAF footprint records.³⁰³ With the use of the footprints and DNA tests, the captain's remains were positively identified.

Because the accident airplane impacted the ground at a high airspeed, the Safety Board became concerned that important airplane components might have penetrated the ground and might not be easily located and recovered. To locate any components under the surface, the U.S. Bureau of Mines provided Safety Board investigators with a GPR system, metal detectors, and researchers to operate the equipment. A GPR search of the area was conducted after most of the airplane wreckage had been removed from the accident site to the hangar at PIT. The GPR equipment detected pieces of wreckage that had penetrated up to 6 feet deep in the soil; these wreckage components were subsequently recovered and moved to the hangar. This accident was the first time that a GPR system was used during a Safety Board investigation; the system was subsequently used during the Safety Board's on-scene investigation of the aircraft accident involving ValuJet flight 592, which occurred in the Everglades, near Miami, Florida, on May 11, 1996.³⁰⁴

³⁰³ The USAF documented the captain's footprints when he was involved in its pilot training program.

³⁰⁴ National Transportation Safety Board. 1997. *In-Flight Fire and Impact with Terrain, ValuJet Airlines Flight 592, DC-9-32, N904VJ, Everglades, Near Miami, Florida, May 11, 1996*. Aircraft Accident Report NTSB/AAR-97/06. Washington, DC.

Another practice that the Safety Board used for the first time during an investigation was the establishment of an independent technical advisory panel (see section 1.18.2) to review the work performed by the Safety Board's investigative team and propose additional tests and scenarios for investigation. This collaborative effort helped the Safety Board test for and identify the main rudder PCU thermal jam rudder reversal scenario.

2. Analysis

2.1 General

The USAir flight 427 flight crew was properly certificated and qualified and had received the training and off-duty time prescribed by Federal regulations. No evidence indicated any preexisting medical or behavioral conditions that might have adversely affected the flight crew's performance during the accident flight.

The USAir flight 427 accident airplane was equipped, maintained, and operated in accordance with applicable Federal regulations. The airplane was dispatched in accordance with FAA- and industry-approved practices.

On the basis of postaccident examination of the wreckage and identification of all fuselage doors, door frames, and locking mechanisms, the Safety Board concludes that all of USAir flight 427's doors were closed and locked at impact.

The catastrophic impact with terrain, postimpact fire, and subsequent destruction of the airplane precluded a complete inventory of the airplane's structure and components. However, all recovered structural pieces were examined thoroughly by fire and explosion experts from the Safety Board, FAA, FBI, and the United Kingdom's Air Accidents Investigation Branch. Additionally, the Safety Board examined the CVR and FDR information from the accident airplane and compared it with FDR information obtained from the investigation into the accident involving Pan Am flight 103 over Lockerbie, Scotland, and other known in-flight fire, bomb, and explosion events. These examinations revealed no evidence of an in-flight fire, bomb, or explosion.

Also, more than 100 witnesses on the ground were interviewed, and all but 1 reported that the airplane appeared to be intact during the accident sequence. The Safety Board nonetheless conducted a series of postaccident ground and helicopter searches. Although the search did not reveal any significant airplane components located away from the main wreckage, light-weight pieces from the airplane (for example, insulation and paper) were located as far as 2.5 miles downwind from the accident site. On the basis of witness statements, physical evidence from the wreckage, and the prevailing winds at the time of the accident, the Safety Board considers it likely that those light-weight airplane pieces became airborne as a result of the postimpact explosion and fire and then drifted downwind from the accident site. The extremities of the airplane and all flight control surfaces were found at the main wreckage site. Further, no evidence indicated that material fatigue or corrosion contributed to the accident.

On the basis of the findings discussed in the previous two paragraphs, the Safety Board concludes that USAir flight 427 did not experience an in-flight fire, bomb, explosion, or structural failure.

A review of ATC procedures and radar information revealed that the air traffic controllers followed applicable air traffic and wake turbulence separation rules and that the required air traffic separation was maintained during flight 427's approach to the Pittsburgh International Airport (PIT). The accident airplane and the Boeing 727 airplane that preceded it inbound to PIT (Delta flight 1083) were separated by at least 4.1 miles when they were at the same altitude

The Safety Board considered the possibility that a midair collision with an airplane or birds was involved in the accident scenario. However, examination of the airplane wreckage; CVR, FDR, and radar data; and statements from ATC personnel and witnesses on the ground revealed no evidence that an impact with other air traffic or a bird strike were involved in the accident.

The Safety Board also considered the possible role of weather in the accident. However, weather and FDR information and statements from witnesses on the ground and the pilots of other airplanes operating in the area indicated that, at the time of the accident flight's upset/loss of control, the weather in the Pittsburgh area was clear with light winds. No evidence indicated that clear air turbulence or other atmospheric phenomena were involved in the accident. Accordingly, the Safety Board concludes that a midair collision with other air traffic, a bird strike, clear air turbulence, or other atmospheric phenomena were not involved in the USAir flight 427 accident.

2.2 USAir Flight 427 Upset

The accident flight was apparently routine until it neared PIT. FDR data indicated that, about 1902:54, the accident airplane was rolling out of a left bank to its assigned heading of 100°, after which it began to yaw and roll; about 1902:59, the airplane's heading moved left past 100° at an increasing rate. By 1903:01, the airplane's heading was moving left at a rate of at least 5° per second; the airplane's heading continued to move left at least at this rate until the stickshaker activated about 1903:08. The airplane's left roll angle was also increasing rapidly during this time; about 1903:01 the airplane's left roll angle was about 28°, and 5 seconds later (at 1903:06) the airplane's left roll angle exceeded 70°. The Safety Board therefore considered various scenarios that could have resulted in such a heading change, including the following: (1) asymmetric engine thrust reverser deployment, (2) asymmetrical spoiler/aileron activation, (3) transient electronic signals causing uncommanded flight control movements, (4) yaw damper malfunctions, and (5) a rudder cable break or pull. The Safety Board ruled out each of these scenarios as a possible factor or cause of the left yaw/roll and heading change for the following reasons:

- Postaccident examination of the engine thrust reversers, including disassembly of the thrust reverser actuators, indicated that the engine thrust reversers were in the stowed position at impact. Further, the investigation revealed that, at the engine power settings recorded by the FDR during the upset event, a thrust reverser deployment would not have produced a heading change that would match the FDR heading data and would have produced longitudinal acceleration signatures that were not reflected by the FDR longitudinal acceleration data.
- Simulator tests indicated that even the most adverse asymmetrical spoiler/aileron extension condition could not create a heading change rate of the magnitude that was recorded by the accident airplane's FDR.
- The Safety Board examined the possibility that transient electronic signals, possibly caused by blue water contamination of components in the electrical/electronic compartment (E/E bay),³⁰⁵ high-intensity radiated field (HIRF) interference, or electromagnetic interference (EMI) could result in an uncommanded flight control movement. Although the Boeing 737 flight controls are primarily hydromechanical (not electrical), there are electrical links to the flight control systems through the autopilot (which interfaces with the ailerons, spoilers, elevators, and stabilizer trim but not the rudder), the rudder trim, and the rudder system's yaw damper. Therefore, EMI and/or HIRF could theoretically affect the autopilot, rudder trim, and/or yaw damper systems within the limits of those systems. Further, the autopilot and yaw damper systems have components located in the E/E bay and therefore could have been affected by fluid contamination.
- The Safety Board's flight tests and review of event histories demonstrated, however, that pilots could easily override uncommanded movements of the ailerons, spoilers, or elevators resulting from electronic signals influencing those flight controls. If such an uncommanded flight control movement persisted, a pilot could easily disengage the autopilot (as the pilots of USAir flight 427 ultimately did), thus likely eliminating the electrical/electronic influence on the flight controls. In addition, postaccident examination of the rudder trim system components indicated that the rudder trim actuator was in the neutral position at impact. If the rudder trim actuator were disturbed by a transient electrical input, it would have remained in its trimmed position until it was trimmed again by specific pilot action—unlike the rudder PCU, which would revert to its neutral position when pilot or yaw damper input ceased and was found in a near-neutral position at the accident site. Further, because the rudder trim system moves the rudder at a much slower rate than the rudder system or the yaw damper (0.5° versus 66 and 50° per second, respectively),

³⁰⁵ Although postaccident examination of recovered portions of the forward lavatory/galley and E/E bay revealed no evidence of blue water contamination, such contamination may have existed on portions of those structures that were not recovered or identified.

it could not produce a rudder deflection rate that would result in the rapid yawing motion and heading change observed in the FDR and computer simulation data.

- A review of the yaw damper system indicated that it could not produce a rudder deflection that would result in the yawing motion observed in the FDR data because the yaw damper system authority is limited to $\pm 3^\circ$ (when properly rigged). Simulator tests confirmed that these limited rudder deflections could not result in the yawing motion observed in the accident airplane's FDR data. Further, pilot statements describing uncommanded yaw excursions within the yaw damper system's normal range ($\pm 3^\circ$) indicated that such excursions are typically considered to be merely nuisance events and are easily controlled by the flight crew. Additionally, as with the autopilot, the pilots could have easily disengaged the yaw damper system if necessary, thus eliminating the yaw damper's effect.
- The Safety Board considered the possibility of a yaw damper failure in combination with a jam of the standby rudder PCU input bearing. Tests showed that such a combination could result in a rudder deflection of about 9° . However, this rudder deflection could not have produced the heading change recorded by the accident airplane's FDR. Further, the Safety Board's tests also showed that a pilot input on the rudder pedals could override this combined failure/jam and neutralize the rudder.
- Testing examined the possibility that a rudder cable pull or break might have caused the heading change. However, the tests demonstrated that the effects of loads up to 250 pounds applied to the rudder cables could produce maximum rudder deflections of only 2.3° and that rudder cable separations could produce maximum rudder surface deflections of only 5° . Simulator tests indicated that such rudder deflections would not create a yawing motion or heading change of the magnitude that was recorded by the accident airplane's FDR. In addition, when the rudder cables were cut during postaccident tests, the CVR recorded "bang" sounds that had energy distributed throughout the frequency spectrum, with multiple secondary signals that appeared to be the result of mechanical "ringing" of the rudder cable system. These sounds and frequencies did not resemble any of the sounds or frequencies recorded by the CVR during the upset/loss of control of USAir flight 427.

Therefore, the Safety Board concludes that asymmetrical engine thrust reverser deployment, asymmetrical spoiler/aileron activation, transient electronic signals causing uncommanded flight control movements, yaw damper malfunctions, and a rudder cable pull or break were not factors in the USAir flight 427 accident.

The accident investigation revealed that, when the airplane began to yaw and roll left (as it penetrated the path of the descending wake of Delta flight 1083), the FDR began to record load factor fluctuations and an increase in airspeed. These airplane motions were consistent with the performance changes that were observed during the Safety Board's wake turbulence flight tests. Further, the "thump" sounds recorded by the

accident airplane's CVR during the following 6 seconds (while the airplane was still likely passing through the 727's wake vortices) were similar to the sounds recorded by the flight test airplane's CVR when the wake vortices passed across the test airplane's fuselage. (These sounds were described by flight test pilots as "whooshing" noise.)³⁰⁶

The Safety Board considered the possibility that the wake turbulence encounter alone resulted in the accident airplane's heading change and the subsequent upset event and accident. However, wake turbulence flight test data and flight test pilot statements indicated that it was not difficult to recover from the wake vortex encounters, although some encounters resulted in rolling moments that were surprisingly intense (especially those in which the intercept angle was small and the vortex impacted the airplane's fuselage, as most likely occurred with the accident airplane). Further review of the wake turbulence flight test data did not reveal any instances in which the wake vortex encounter resulted in a heading change resembling that recorded by the accident airplane's FDR. In most of the flight test encounters, the airplane rapidly exited the wake vortex, thus ending the encounter. In fact, the wake turbulence flight tests indicated that wake vortices naturally tended to push the airplane out of the wake's effects.

Additionally, the Safety Board's review of wake turbulence-related events in its accident and incident database³⁰⁷ and in NASA's Aviation Safety Reporting System revealed that, although air carrier pilots frequently reported being surprised by the severity of wake vortex encounters, these encounters typically resulted in upsets that pilots were easily able to counter. The Safety Board's database indicated that wake turbulence encounters were determined to be causal factors in three air carrier accidents. These three accidents, which occurred between 1964 and 1972, involved airplanes operating at low altitudes near airports (two airplanes were landing, and one was taking off). After the 1972 accident, ATC airplane separation standards were increased; since that time, no fatalities aboard air carrier airplanes have involved a wake turbulence encounter. Notably, no record exists of a catastrophic encounter with wake turbulence by an air carrier airplane when the airplane was operating at altitudes and/or airspeeds similar to those of USAir flight 427.

Evidence of wake vortex-related airplane motions were detected in the accident airplane's FDR data by about 1902:55. However, the results of the wake vortex flight tests and the Safety Board's computer simulations indicate that the airplane would not have remained in the wake long enough to have produced the heading change and bank angles that occurred after 1903:00. On the basis of the results of wake turbulence flight tests and flight simulator sessions and review of available wake turbulence event information, the

³⁰⁶ Boeing's flight test pilot reported that, during some of the wake vortex encounters, he heard a clicking sound that he attributed to the wake vortices causing the windshield wipers to slap against the windshield. At 1902:58.6, the USAir flight 427 CVR recorded a "clickety click" sound, the source of which could not be positively identified. Although the Safety Board reviewed the sounds recorded by the CVR on 50 of the 150 wake turbulence flight test conditions, it did not identify a case in which the CVR recorded such a clickety click sound. Therefore, no direct comparison was possible between the sounds heard on the flight test airplane and the accident airplane.

³⁰⁷ The Safety Board's database contains information regarding aviation accidents beginning in 1962.

Safety Board concludes that, although USAir flight 427 encountered turbulence from Delta flight 1083's wake vortices, the wake vortex encounter alone would not have caused the continued heading change that occurred after 1903:00.

Boeing and Safety Board flight and computer simulations (discussed in section 1.16.6.1) have demonstrated, however, that the heading change rates recorded by the FDR after 1903:00 were consistent with the rudder being deflected to its left aerodynamic blowdown limit. Accordingly, the Safety Board concludes that, about 1903:00, USAir flight 427's rudder deflected rapidly to the left and reached its left aerodynamic blowdown limit shortly thereafter. This movement of the airplane's rudder could only have been caused by a flight crew action or a mechanical rudder system anomaly.

The potential for such a mechanical rudder anomaly was demonstrated during postaccident tests in which the secondary slide was intentionally jammed (pinned) to the servo valve housing and a rapid input was applied in a direction that would oppose the jam. These tests showed that the primary slide could overtravel,³⁰⁸ resulting in hydraulic fluid porting in such a way that the rudder moves to its aerodynamic blowdown position in the direction opposite to the rudder input (rudder reversal).³⁰⁹

Further, during the most severe postaccident thermal tests (a temperature difference of about 180° between the heated hydraulic fluid and the servo valve housing of the USAir flight 427 main rudder PCU), the secondary slide jammed to the servo valve housing, and hydraulic fluid flow data indicated that a momentary reversal of the rudder occurred during this jam. Although the USAir flight 427 servo valve jammed repeatedly during these extreme thermal tests, the new-production servo valve also subjected to these tests never jammed. Examination of the internal measurements of both servo valves indicated that the USAir flight 427 servo valve had significantly tighter diametrical clearances between the secondary slide and the servo valve housing than the new-production servo valve. The Safety Board considers it likely that the USAir flight 427 servo valve was more susceptible to a jam because of its tighter clearances.

Although the USAir flight 427 main rudder PCU servo valve had been subjected to impact forces from the accident and extensive postaccident testing (including repeated thermal jams), internal examination of the servo valve revealed no evidence of physical marks that would indicate that a jam had existed. Further, the servo valve slides still moved freely, and the servo valve was still capable of successfully completing Parker Hannifin's acceptance test procedure functional tests.

The Safety Board recognizes that the temperature differential to which the accident PCU servo valve was exposed under the most severe thermal test conditions was greater than that expected in normal operation; the hydraulic fluid had not been circulating through the PCU before the tests began and was therefore not continuously warming the

³⁰⁸ This overtravel is the result of elastic deformation of the mechanical input mechanisms that allow the primary slide to move beyond its intended design limits.

³⁰⁹ Normally, if the secondary slide were to jam to the PCU servo valve housing, the primary slide would move to oppose the jam, neutralizing hydraulic flow.

PCU servo valve housing as it would be in flight if the yaw damper were energized.³¹⁰ Nonetheless, these thermal tests demonstrate that it is possible for the secondary slide of the servo valve to jam to the valve housing and leave no evidence of physical marks. These tests also demonstrate that, with the secondary slide thus jammed, it is possible for the primary slide to overtravel and cause a rudder hardover in the direction opposite to that commanded without leaving any physical evidence.

2.2.1 USAir Flight 427 Computer Simulation Analysis

Kinematic analysis and workstation-based computer simulations were performed to determine the control wheel (ailerons and flight spoilers) and rudder inputs that could produce the motion of the airplane between the time of the initial upset and ground impact. During its investigation of this accident, the Safety Board evaluated many solutions, including the kinematic analysis presented by Boeing in its September 30, 1997, submission to the Board.³¹¹

Because the data available from the USAir flight 427 FDR was limited (in both the number of parameters recorded and the frequency with which the parameters were recorded)³¹² and investigators could not positively identify the characteristics of the wake, multiple control wheel and rudder solutions provided a reasonable match with the pertinent FDR data: the airplane's vertical load factor (acceleration), pitch, roll, and (most importantly) heading.

The Safety Board obtained an excellent match of the USAir flight 427 FDR data with a computer simulation in which, after a right rudder pedal input about 1903:00, the rudder reversed as a result of a jam of the secondary slide to the servo valve housing (about 100 percent off neutral) and moved to its left blowdown limit. This simulation (subsequently referred to as the Safety Board's best-match simulation) included an estimation of the influence of the wake vortex during the upset event and resulted in a heading output that not only matched the FDR-recorded heading within less than 1° but also matched the character³¹³ of the FDR-recorded heading data until about 1903:08, at

³¹⁰ The amount of hydraulic fluid flow through the main rudder PCU directly affects the temperatures within the PCU (increased hydraulic fluid flow through the PCU results in increased temperatures within the PCU and vice versa). Although some hydraulic fluid continually flows through the PCU as a result of leakage around the primary slide permitted by the underlapped metering edge design, additional hydraulic fluid flow through the PCU occurs as a result of yaw damper activity or rudder pedal usage. Therefore, normal operations in smooth, calm air, with minimal yaw damper activity or pilot rudder pedal usage would result in minimal hydraulic fluid flow through the PCU, whereas operations in turbulent air with increased yaw damper/rudder activity would result in increased hydraulic fluid flow through the PCU. Conditions were quite calm before the USAir flight 427 upset, so there would have been little yaw damper activity or rudder usage and thus very little hydraulic fluid flowing through and warming the PCU. However, yaw damper activity upon encountering the wake vortex would have resulted in increased hydraulic fluid flow through the PCU.

³¹¹ During the Safety Board's first technical review for the USAir flight 427 accident, which was held on October 31, 1997, in Pittsburgh, Boeing presented a refined version of the information contained in its September 30, 1997, submission.

³¹² For more information, see section 1.11.2.

which time the stickshaker activated and the FDR data showed the beginning of an aerodynamic stall.³¹⁴

In its September 30, 1997, submission to the Safety Board, Boeing presented a kinematic solution for the USAir flight 427 accident. This solution postulated that the pilot applied full left rudder about 1902:59, relaxed that rudder pressure momentarily, applied full left rudder once again beginning about 1903:01, and then sustained this input until ground contact, about 1903:23.

A comparison of the heading, roll, and vertical acceleration results from the Safety Board's best-match simulation with Boeing's kinematic solution indicates that both solutions match the FDR data about equally well. The Safety Board then evaluated how well the rudder and control wheel time histories produced by the Safety Board computer simulations and Boeing's kinematic solution comported with the human performance data obtained during this investigation.

2.2.2 USAir Flight 427 Human Performance Analysis

A review of CVR, FDR, and ATC information indicated that the accident flight and flight crew performance were routine before the upset occurred. All required checklists were completed, communications with ATC and other crewmembers were appropriate, and the pilots were responsive and displayed no evidence of problems that would impede working together during an emergency. No evidence indicated any physiologic or ergonomic reason that either pilot would have been incapable of manipulating the airplane's controls throughout their range of motion during the accident sequence. Although the Safety Board was unable to positively determine which pilot was manipulating the airplane's flight controls during the initial upset and the early recovery attempts,³¹⁵ the following indications showed that the first officer likely provided flight control inputs throughout the accident sequence:

- The first officer was the flying pilot for the flight segment during which the accident occurred, and the CVR recorded no verbal transfer of command (as specified in USAir procedures) to indicate that the captain had assumed those responsibilities.
- The first officer emitted straining and grunting sounds early in the upset period, which speech and communication experts stated were consistent with applying substantial physical loads; the CVR did not record any such sounds on the captain's microphone channel until just before ground impact.

³¹³ The "character of the data" is used in this report to refer to the shape of the curve that would be formed by connecting the FDR data points smoothly.

³¹⁴ The Safety Board and Boeing were unable to analyze poststall/high sideslip events because the aerodynamic model of the airplane in that condition is unreliable and inaccurate.

³¹⁵ Because the FDR did not record aileron and rudder flight control inputs at either pilot position, it was not possible to determine what flight control inputs were applied by the flight crew or which pilot applied such controls. The FDR recorded control column position but did not identify which pilot(s) applied control column pressure.

- The first officer keyed the microphone (apparently inadvertently) on the air-to-ground radio channel repeatedly while the stickshaker activated between 1903:09.4 and the end of the recording, which would be consistent with gripping the control wheel and the vibrations of the stickshaker tripping his finger on and off the radio switch on the back of the yoke.

The captain might have joined the first officer in manipulating the flight controls during the upset sequence; however, according to speech and communication experts, the captain's breathing (rapid and shallow) and speech patterns (for example, "whoa," "hang on," and "what the hell is this") did not indicate that he was exerting substantial physical loads during the initial upset. Further, speech experts stated that the captain's "four twenty seven emergency" transmission, about 1903:15, was a reasonable attempt to communicate and an appropriate response for the situation, but the captain's speech during the transmission did not indicate that the captain was exerting substantial physical loads. After about 1903:18 (about 5 seconds before ground impact), that the captain's breathing and speech patterns recorded by the CVR indicated that he might have been exerting strong force on the controls (as he said "pull...pull...pull"). Therefore, the Safety Board concludes that analysis of the human performance data shows that it is likely that the first officer made the first pilot control response to the upset event and manipulated the flight controls during the early stages of the accident sequence; although it is likely that both pilots manipulated the flight controls later in the accident sequence, it is unlikely that the pilots simultaneously manipulated the controls (possibly opposing each other) during the critical period in which the airplane yawed and rolled to the left.

As previously discussed, the accident airplane was returning to level flight under autopilot control from a shallow left turn to an ATC-assigned heading of 100° when it penetrated the wake vortex of the preceding 727 airplane (Delta flight 1083). The first officer was announcing that he had visual contact with the Jetstream traffic (Atlantic Coast flight 6425), of which ATC had advised the flight crew, when the accident airplane's FDR began to record vertical loads consistent with a wake vortex encounter from the 727. The most severe perturbations resulting from the wake turbulence penetration occurred between about 1902:55 and about 1903:03. As the airplane's bank angle (which had been rolling out of a commanded left bank toward a wings-level position) began accelerating to the left away from level flight, the turbulence apparently caused the captain to inadvertently activate the intercom button on his side console³¹⁶ and caused both the captain and first officer to voice exclamations of surprise ("sheez" and "zuh" at 1902:57.5 and 1902:57.6, respectively).

The results of the Safety Board's computer simulation and Boeing's kinematics analysis showed a significant right control wheel input about 1902:58 in response to the left roll/yaw effects of the wake vortex. This input was likely the result of the first officer reacting to the wake turbulence, aggressively inputting right control wheel (initially about 65°, according to the Safety Board's simulation) to keep the airplane level.³¹⁷ The speed

³¹⁶ The captain was likely touching the radio/intercom transmit button on his side console because he was preparing to advise ATC that he and the first officer had visual contact with the Jetstream traffic.

of this pilot reaction, about 1 second after his first verbal reaction, suggested a reflexive action to counter the rolling motions of the wake. The timing of the first officer's early control wheel response to the wake turbulence encounter indicated that the first officer quickly recognized the strength of the wake-induced roll event and acted accordingly. The Safety Board's simulation (rudder jam/reversal scenario) and Boeing's simulation (pilot input scenario) differ markedly as to what happened after the right control wheel input.

2.2.2.1 Rudder Jam/Reversal Scenario

According to the Safety Board's computer simulations, at about 1902:59, as the airplane responded to the right control wheel input and began rolling back toward level flight, the control wheel position moved from about 65° right to about 15° right. This movement indicates that the first officer had relaxed his input force on the control wheel. However, according to the FDR, between about 1902:58 and about 1903:00, the airplane's heading moved quickly past the assigned 100° to about 94°. Both the Safety Board's computer simulation and Boeing's kinematic analysis indicated that this heading change was likely to have been associated with a significant yawing motion³¹⁸ that would have caused a lateral acceleration at the pilots' seats of more than 0.1 G to the left. The pilots would have likely felt this acceleration as a sustained, uncomfortable sideforce in the cockpit and would have observed the ground and sky moving sideways against the fixed reference of the airplane's windshield area.

Beginning with initial flight training and continuing throughout their careers, pilots are trained to minimize uncoordinated yawing motions and sideforces. At 1902:59.4, the captain stated "whoa" likely in response to the kinesthetic and visual sensations produced by the airplane's yawing motion.³¹⁹ It would have been reasonable for the first officer to respond to this yawing motion (and possibly to the captain's statement) by applying right rudder pedal pressure about 1903:00. This right rudder input, intended to relieve the sideforce and return the airplane to its assigned heading, was instead followed by a rapid rudder deflection to the left (rudder reversal) that increased the left yawing motion and accelerated the airplane's heading change to the left.

As the rudder deflected to its initial blowdown position, the rudder pedals would have moved in a direction opposite to that commanded by the first officer. The first officer would likely have sensed the right rudder pedal rising underneath his right foot despite attempts to depress the pedal. During that time (between about 1903:00 and about

³¹⁷ The control wheel and column inputs would have caused the autopilot to change to its control wheel steering mode for both the pitch and roll axes; as a result, the first officer's control inputs would have positioned the flight controls through the autopilot servos.

³¹⁸ According to the geometry of USAir flight 427's wake vortex encounter, this yawing motion likely resulted from the entry of the airplane's tail into the vortex field. The Safety Board's computer simulation of the event models the wake vortex encounter in this way.

³¹⁹ At the time of the captain's statement, the left yawing motion would have been the most significant of the sensations being experienced in the cockpit. The airplane's bank angle (19.5° left) and pitch angle (6.5° nose up) were within the parameters of normal flight. The vertical acceleration was relatively small. Although the airplane experienced a roll acceleration to the right, it remained in a left bank; thus, the roll acceleration would have been in the direction desired by the pilots.

1903:02), the CVR recorded the sounds of grunting on the first officer's hot microphone channel. Two speech experts who examined these sounds indicated that they were signs of significant physical effort, greater than the sounds produced by the normal use of flight or cockpit controls. One speech expert concluded that the sounds indicated that the first officer was "struggling unusually hard...for example [as] if he was...experiencing an unusual resistance in the use of a control." The Safety Board considers it likely that the soft grunting sound recorded on the CVR at 1903:00.3, shortly after the start of the rudder reversal, is a manifestation of an involuntary physical reaction by the first officer to the beginning of the reversing motion of the rudder pedal.

Without additional input pressure from the first officer, the right pedal would have tended to push his foot back from the neutral position. However, if the first officer resisted the reversal, the right rudder pedal would have yielded somewhat. Force on the right rudder pedal could have returned that pedal to about the neutral position. However, as the airplane entered a sideslip (resulting from the rudder deflection), the maximum rudder deflection at blowdown would have increased; thus, the rudder pedal would have tended to push the pilot's foot farther aft.

The CVR recorded louder grunting sounds by the first officer beginning at 1903:01.5, about 0.6 seconds after the rudder pedals would have reached their maximum uncommanded displacement. Few, if any, actions in the use of normally functioning 737 flight controls would cause a pilot to strain so hard as to grunt.³²⁰ The first officer could not have been grunting because of control column (pitch) inputs; the FDR shows that the column was moving freely and not against a stop. The possibility that the two pilots struggled against each other by making opposing inputs is unlikely because the CVR did not record any straining sounds or forced breathing from the captain or comments from the flight crew about conflicting inputs. If the autopilot is engaged in the control wheel steering (CWS) mode, a pilot might grunt while attempting aggressive control wheel inputs that exceeded the input rate of the autopilot.³²¹ However, no grunting sounds were recorded about 1902:58, when the autopilot would have been in CWS mode while the first officer made his first rapid wheel input to the right. Further, both the Safety Board computer simulations and the Boeing kinematic studies showed the control wheel moving back toward neutral during the latter portion of the time that the grunting sounds were made by the first officer. Movement of the control wheel toward neutral would be associated with relaxation of the pilot's input force on the wheel rather than the addition to or maintenance of input force that might have generated the grunting sound.

³²⁰ During the 30 minutes of pilot conversation previously recorded by the CVR, neither pilot had emitted grunting sounds before this time.

³²¹ Information provided by Boeing indicated that the forces necessary to move the control wheel under the CWS mode would increase quickly from about 15 to about 40 pounds or more as a pilot exceeded the input rate of the autopilot. According to ergonomic research, such control wheel forces would be significant for many pilots controlling the wheel with one hand, but would not be significant for pilots controlling the wheel with two hands. See McDaniel, J.W. 1995. "Strength Capabilities for Operating Aircraft Controls." *SAFE Journal* 25 (1), pages 28-34.

The Safety Board was unable to find an explanation for the first officer's louder grunting sounds other than his efforts to overcome a rudder system malfunction in which he was increasing the pressure on the rudder pedal with no apparent effect. Consequently, for the purposes of the computer simulation of the rudder jam/reversal scenario, the first officer's reaction to the rudder reversal was modeled as the application of increasing force (400 pounds of force within 1 second of the beginning of the reversal) to the right rudder pedal to oppose the direction of the airplane's yaw and roll.³²²

From a human performance standpoint, a rudder reversal malfunction can explain how a full rudder deflection could have continued despite efforts by the first officer to correct the situation. The unexpected rudder pedal reversal, combined with the rapid left roll and yaw of the airplane, would have undoubtedly confused and alarmed the first officer. Any pilot pushing on the rudder pedal in this situation would know that the pedal was not responding normally but would have difficulty comprehending, evaluating, and correcting the situation. A reversal malfunction runs counter to pilot experience, training, and knowledge. Depressing a rudder pedal during a reversal malfunction would have an effect contrary to a pilot's understanding of the function of the rudder system. Increased pressure on the rudder pedal would not correct the problem.³²³ As long as the airplane continues to depart from controlled flight, a pilot reacting to a rudder reversal would likely maintain at least some pedal pressure in a continued attempt to oppose the uncommanded yawing and rolling moments.

During the few seconds after the left rudder deflection that occurred about 1903:00, the accident airplane's control wheel position was adjusted several times, eventually reaching nearly full right control wheel, in response to the airplane's left rolling and yawing motions. Any pilot faced with an acceleration away from the desired flightpath could be expected to make an initial control input (about 65° right control wheel in this case) to assess the effects of the control input; remove some, or all, of the input when the airplane began to respond (so as not to overcontrol); and converge on the appropriate input (almost full right wheel in this case). Thus, the Safety Board considered that the flight crew's control wheel inputs in response to the initial wake turbulence encounter and rudder reversal were reasonable pilot reactions to the evolving situation. Therefore, the flight control inputs used in the Safety Board's best-match computer simulation of the USAir flight 427 upset are consistent with the pilot responses that might be expected during a rudder reversal. Further, the CVR information from the period of the initial upset is consistent with rudder reversal.

³²² Although the Safety Board's best-match simulation used 400 pounds of force reducing to 200 pounds, based on ergonomic and other research data (as discussed in section 1.18.8), the Safety Board was also able to obtain an excellent match using only the minimum pedal force necessary to sustain full rudder authority (about 70 pounds).

³²³ As previously indicated, the Safety Board has investigated aviation accidents that have been caused by flight control reversals (see section 1.16.5.4.8). The Board notes that such reversals are often fatal because few pilots (even test pilots) are able to absorb the information, analyze it, and apply inputs to correct the situation in the moments available before the airplane attains an unrecoverable attitude.

The grunting sounds ended at 1903:02.1, when the CVR also recorded the sound of the autopilot disengaging. According to the Safety Board's computer simulation, the wheel was briefly returned to near neutral at that time. The CVR did not record any more grunting or straining sounds until a few seconds before ground impact. This evidence is consistent with the first officer slightly relaxing his control wheel and rudder pedal inputs—perhaps because he thought that he was contending with a malfunctioning autopilot, in which case autopilot disengagement would restore normal control.

After disengaging the autopilot, the first officer likely focused his attention on modulating the control wheel inputs or attempting to raise the airplane's nose and, in the quickly changing situation, did not return his attention to overpowering the rudder pedal anomaly. On the basis of the cessation of grunting sounds and the control wheel inputs that followed, the Safety Board's computer simulation of the rudder jam/reversal scenario incorporated a reduction in the pilot's right rudder pedal pressure to 200 pounds at that time. Because the rudder feel and centering unit would combine with the pilot's foot pressure in applying force to the PCU during a rudder reversal, the rudder reversal could have continued with a minimum rudder pedal pressure by the pilot of only about 50 pounds.

2.2.2.2 Pilot Input Scenario

According to the Boeing kinematic solution, the pilots of USAir flight 427 applied full right control wheel about 1902:58 in response to the left roll and yaw from the airplane's encounter with the wake vortex. Boeing proposed that the pilots then applied left rudder input from about 1902:58 to about 1903:01 in response to a right roll acceleration (shown in Boeing's kinematic analysis from about 1902:58 to about 1902:59) from the control wheel input, which momentarily reversed the airplane's left rolling motion. However, such a right roll acceleration would have helped the pilots stop the left roll and regain a level bank attitude; thus there would be little reason for the pilots to have opposed the right roll acceleration. (In fact, Boeing's scenario indicated that, at the time of the proposed full left rudder pedal input, the right control wheel input had just stopped the airplane's left roll.) Although the right roll acceleration toward level flight might have prompted the flight crew to remove some, or all, of the existing right control wheel input, it is unlikely that the flight crew would have responded to this right roll acceleration by applying full left rudder before using the airplane's roll control authority to the left.

Moreover, both the Safety Board's computer simulation and Boeing's kinematic analysis of this period indicated that the pilots were experiencing the sideload from a yaw acceleration to the left (caused by the wake vortex). The sideload would logically have prompted the pilots to apply right, rather than left, rudder. Therefore, the Safety Board considers it highly unlikely that the flight crew of USAir flight 427 applied full left rudder, as specified in the pilot input scenario proposed by Boeing.

Further, Boeing's pilot input scenario requires the flight crew to have sustained the full left rudder input for at least 10 seconds. In its September 30, 1997, submission and Human Factors Supplement Submission, Boeing cited four 737 incidents (in October 1986, April 1993, July 1995, and June 1997) in which the FDR data indicated that flight

crew responses to unexpected upsets resulted in momentary cross-control situations. However, FDR information also showed that the flight crews maintained control of the airplane. The airplanes' flight attitudes never exceeded reasonable levels, and the airplanes never diverged from controlled flight. The control inputs, bank angles, and headings all converged on stable values, and all of the flights landed safely.

During the USAir flight 427 upset, the airplane's increasingly extreme left bank attitude would have provided the pilots with a consistent and powerful cue to remove any left control inputs they may have applied. Further, the Safety Board's review of available data from previous accidents and incidents obtained from Boeing, the Board's database, and accident investigation authorities worldwide indicated that momentary, incorrect rudder applications by air carrier pilots have occasionally occurred in response to an unexpected anomaly during a critical phase of flight. However, those events often occurred in conditions of reduced external visual cues or during abrupt, rapid aircraft movements and accelerations. Some pilots reported being startled by the in-flight upset, but no case was found in which a pilot responded to an in-flight upset involving a sustained yaw or roll by continuing to hold extreme rudder input in a direction opposite to that required to recover the airplane.

To further evaluate the possibility of a sustained, inappropriate rudder input, the Safety Board examined numerous possible explanations for the flight crew to have applied and sustained a full left rudder input until a loss of control occurred. These possibilities included pilot incapacitation, deliberate pilot action, disorientation, and unintended rudder pedal activation.

The Safety Board reviewed documentation from two incidents in which pilot (specifically, first officer) incapacitation adversely affected the controllability of a 737. In both cases, the incapacitation occurred suddenly; the first officers stiffened and applied pressure to a rudder pedal, resulting in a large rudder deflection as the airplanes descended during the approach to their destination airports. Although both captains reported that they were startled by the unexpected event, both responded appropriately and were capable of compensating for inputs made by the incapacitated first officers. Neither of these cases resulted in a significant loss of control. Further, a review of the available data from previous accidents and incidents revealed no evidence of pilot incapacitation that had resulted in a loss of control in other air carrier airplanes. In the case of USAir flight 427, no evidence indicated that pilot incapacitation was involved in the accident sequence because

- neither pilot had a medical history that indicated a risk of incapacitation,
- CVR evidence indicated that both pilots were alert and appropriately responsive during the accident sequence, and
- CVR evidence indicated that neither pilot was alarmed by the behavior of the pilot or that any medical emergency was occurring.

The Safety Board considered whether either pilot deliberately applied an incorrect rudder input. However, the remarks and sounds recorded by the CVR during the initial

upset and loss of control indicated that both pilots were surprised by the event and did not understand its nature or cause. Further, the Safety Board carefully examined aspects of the pilots' personal and professional lives and found both pilots to be stable. Moreover, analysis of the communications and sounds recorded by the CVR indicated that the pilots expended extraordinary effort in their attempts to recover from the upset throughout the accident sequence. Therefore, no evidence supports a deliberate action by either pilot to apply the rudder incorrectly.

The Safety Board also considered the possibility that one or both of the pilots became disoriented during the loss of control and was therefore unable to take actions to recover control of the airplane. The accident and incident records, expert opinions, and literature regarding spatial disorientation (a phenomenon that occurs when visual and kinesthetic/vestibular cues are in conflict) indicate that spatial disorientation resulting in a loss of airplane control is extremely improbable in air carrier operations when strong external visual cues exist, even if abrupt, rapid airplane movements and accelerations occur.

Witnesses on the ground and the pilots of other airplanes in the area reported that the sky was clear with a visible horizon when the USAir flight 427 accident occurred. The accident airplane was operating in a cruise flight attitude, and the pilots would have had no obstructions to visual cues. The horizon would have been visible to both pilots when, according to Boeing's proposed scenario, the first officer made and held a left rudder input. Thus, the pilots of USAir flight 427 had ample visual cues available to maintain an accurate awareness of the airplane's orientation.

To illustrate a vehicle operator's persistence in making an inappropriate control input, Boeing's September 30, 1997, Human Factors Supplement Submission suggested the phenomenon of "unintended acceleration" from automotive safety literature.³²⁴ This phenomenon refers to evidence from automobile accidents that drivers may inadvertently press the accelerator pedal when they believe that they are applying the brake pedal, which can lead to the driver pressing even harder on the accelerator pedal in the belief that this action will slow the motion of the automobile. However, unlike automobile drivers, pilots use a different foot to activate each rudder pedal. Further, the 737 cockpit layout locates the stem of the control column and a large rudder pedal adjustment mechanism between each pilot's legs, making it physically difficult or impossible to push a rudder pedal with the wrong leg. Therefore, the possibility that a pilot would activate the wrong rudder pedal on a 737 is much less than the possibility that an automobile driver would confuse the accelerator and brake pedals.

In addition, an important factor in an automobile driver's persistence in pressing down the accelerator pedal in such events is the driver's perception that the brake is being applied; hence, the driver believes that the more pedal pressure applied, the better chance

³²⁴ Schmidt, R.A. 1989. "Unintended acceleration: A review of human factors contributions." *Human Factors*, 31, pp. 345-64. Also, Reinhart, W. "The effect of countermeasures to reduce the incidence of unintended acceleration accidents." *Proceedings From the Fourteenth International Technical Conference on Enhanced Safety of Vehicles*, Munich, Germany, 1994.

there is for recovery. In this respect, the phenomenon of unintended acceleration in automobiles may be more instructive with regard to pilot actions and frame of mind in a rudder reversal scenario than in a pilot input scenario.

The Safety Board analyzed the CVR for possible indications of a left rudder input by the pilots. The grunting sounds recorded on the first officer's hot microphone channel were not well correlated in time with any of the pilot control actions proposed by Boeing's scenario that might have resulted in such sounds. According to Boeing, the grunting sounds occurred after the first officer made a full right control wheel input and the first of two postulated left rudder inputs. However, neither of the two postulated rudder inputs would have required more than 70 pounds of force on a normally operating left rudder pedal. This relatively mild force should not cause a pilot to grunt. Although a pilot could exert more than 70 pounds of force in holding a rudder at full deflection, there would be no reason to do so once full left rudder deflection was achieved.

Also, it is unreasonable that both pilots would have allowed a sustained incorrect rudder input to continue in the presence of salient cues without one of them recognizing the error and commenting and/or attempting to correct the rudder's position. The CVR did not record any evidence of one pilot being alarmed or struggling against the control inputs of the other pilot (as might be expected if a pilot made an abrupt and counterproductive flight control input). Rather, the CVR recorded sounds indicating that both pilots were surprised by and did not understand the event as it developed from a wake turbulence encounter into a more critical situation.

2.2.2.3 USAir Flight 427 Scenario Summary

No evidence indicates that an air carrier pilot has ever responded to an in-flight upset by applying and holding full rudder in the incorrect direction to the extent that control was lost. Also, the circumstances of this accident are inconsistent with the pilots applying and sustaining a left rudder input because of pilot incapacitation, deliberate pilot action, unintended rudder pedal activation, or spatial disorientation. Further, CVR information does not support pilot left rudder pedal input as the explanation for the left rudder deflection in this accident.³²⁵ Consequently, the Safety Board concludes that analysis of the human performance data (including operational factors), does not support a scenario in which the flight crew of USAir flight 427 applied and held a full left rudder input until ground impact more than 20 seconds later. The Safety Board further concludes that analysis of the CVR, Safety Board computer simulation, and human performance data (including operational factors) from the USAir flight 427 accident shows that they are consistent with a rudder reversal most likely caused by a jam of the main rudder PCU servo valve secondary slide to the servo valve housing offset from its neutral position and overtravel of the primary slide.

³²⁵ Although the rudder pedal pivot lugs on both the captain's and first officer's rudder pedal assemblies were damaged, (see section 1.16.5.1), this damage provided no useful evidence of pilot rudder pedal activation during the upset.

2.2.2.4 Likelihood of Recovery From a Rudder Reversal

FDR data and Safety Board computer simulations indicated that, about 1902:59, the airplane began to roll to the left and pitch slightly nose down, and the control column position began to move slightly aft. Although the airplane's left bank continued to increase by about 1903:02, the nose-down pitch rate had been temporarily arrested by the aft control column inputs. The airplane's motions and the aft control column pressure resulted in a slight increase in vertical load (to about 1.2 Gs). On the basis of the existing airspeed and the increase in vertical G load, by about 1903:02 the airplane would have been below the airspeed at which the roll controls (aileron and spoilers) could counter the effects of the fully deflected rudder (crossover airspeed). Thus, from that time onward, it would have been impossible for the flight crew to regain roll control without increasing airspeed and/or decreasing the airplane's vertical G load.

After the autopilot was disengaged about 1903:02, the airplane's left bank angle continued to increase and the control column position continued to move farther aft. As a result, by about 1903:03, the vertical load had increased to about 1.55 Gs. At that time, aft control column input would have been an instinctive pilot reaction to try to prevent the airplane from pitching nose down in a steep bank and maintain the ATC-assigned (and pilot-selected) altitude.

During the early seconds of the upset event, the pilots did not likely suspect that the event was anything other than a strong, but otherwise routine, wake turbulence encounter. They had no foreknowledge of a rudder reversal or rudder hardover or of the crossover airspeed phenomenon. Therefore, it is understandable that the pilots of USAir flight 427 would have, at least momentarily, attempted to maintain their assigned altitude by increasing control column back pressure. Further, it is extremely unlikely that the pilots would have been able to diagnose the relationship between airspeed, vertical G load, and the loss of control in the few seconds available to them after this back pressure brought the airplane below the crossover airspeed.³²⁶

The accident airplane's FDR data indicated that the control column position generally continued to move farther aft as the event continued; the airplane continued to roll left and pitch farther nose down, decelerated a few knots, and began to lose altitude. About 1903:08, as the airplane descended through about 5,700 feet msl, the stall warning stickshaker activated, indicating to the pilots that the aft column input was commanding an angle-of-attack near stall. However, by that time the airplane had attained an extreme attitude (about 70° left bank and more than 20° nose down), which would have been well beyond any attitude that the pilots would have experienced in air carrier operations. About 3 seconds later, when the control column reached its full aft position, the airplane's bank angle had gone beyond vertical (90°), and its pitch attitude had exceeded 50° below the horizon.

³²⁶ Boeing pilots who were evaluating the 737's handling characteristics during postaccident flight tests identified a stronger-than-expected relationship between vertical G load and the ability to overpower the roll induced by a full rudder deflection with full wheel input. The pilots reported that "there is some technique [required] between the G and the roll."

The Safety Board notes that pilots are trained to respond to the stickshaker warning by decreasing pitch (column forward). In some previous air carrier accidents involving stalls, the Board has cited the flight crew as a causal factor in the accident for failing to take the necessary actions to recover from the stall.³²⁷ However, in a rudder reversal scenario, the pilots of USAir flight 427 would have been struggling to cope with the rudder's anomalous movements (in addition to the airplane's extreme roll and pitch attitudes) when they also would have been surprised to discover that full left control wheel input was ineffective in countering the airplane's steepening left roll. These factors combined to produce a flight situation and control problems that the pilots of USAir flight 427 had never before encountered in flight or training, including during stickshaker/stall recovery training. With this series of problems in the course of a few seconds, it is understandable that the crew was no longer responding in a manner that might have allowed recovery.³²⁸

During postaccident simulator tests,³²⁹ test subjects were able to recover from the USAir flight 427 upset, or at least stabilize the roll to the point at which a continued loss of control would most likely not have occurred, when they applied a specific recovery technique (full right control wheel maintained throughout the duration of the event and forward control column pressure sufficient to reduce G load and maintain a speed above the crossover airspeed) promptly when the event began. However, unlike the pilots of USAir flight 427, the simulator test subjects were aware of the circumstances of the accident, prepared for and expecting the upset event as it occurred, and coached through the recovery procedure.

When the simulator test subjects varied their responses from the specific techniques that they were told to apply (for example, when they modified their control wheel input in anticipation of the simulator's responses to their inputs), a successful recovery from the upset event became much less likely. Further, when the simulator test subjects tried to maintain altitude at the outset of the event, the simulator's speed decreased below the crossover airspeed, and recovery became unlikely.

Therefore, although it was possible to recover from the upset event during its early stages, such a recovery would have required the pilots to immediately abandon their normal pitch control criterion (maintaining altitude) and hold full control wheel inputs against the roll. These actions may be successful with prior awareness of the effects of a

³²⁷ See, for example, National Transportation Safety Board. 1997. *Uncontrolled Flight Into Terrain, ABX Air Inc. (Airborne Express), Douglas DC-8-63, N827AX, Narrows, Virginia, December 22, 1996*. Aircraft Accident Report NTSB/AAR-97/05. Washington, DC.

³²⁸ No reliable aerodynamic model exists for the 737's flight characteristics in a stall; consequently, the Safety Board could not evaluate the possibility of recovery after activation of the stickshaker. The Safety Board notes, however, that if the pilots had reacted to the stickshaker by reducing aft control column pressure only enough to silence the stickshaker (as air carrier pilots are trained to do in a minimum altitude loss stall recovery), the airplane would have remained below the crossover airspeed for the existing vertical G load, and the pilots would not have regained control of the airplane.

³²⁹ These simulator tests were conducted in Boeing's M-CAB simulator using the accident airplane's FDR data and a rudder hardover (induced either manually or electronically) to represent the USAir flight 427 upset condition.

rudder reversal and the crossover airspeed, as shown by the simulator tests. The Safety Board concludes that the flight crew of USAir flight 427 recognized the initial upset in a timely manner and took immediate action to attempt a recovery but did not successfully regain control of the airplane. However, because the pilots did not have foreknowledge of the problem, immediate awareness of its onset, and prior training and experience with the crossover airspeed phenomenon, the Safety Board concludes that the flight crew of USAir flight 427 could not be expected to have assessed the flight control problem and then devised and executed the appropriate recovery procedure for a rudder reversal under the circumstances of the flight.

2.3 United Flight 585 Upset

2.3.1 United Flight 585 Computer Simulation Analysis

FDR³³⁰ and radar data, the accident location, and wreckage orientation were used as data points in the Safety Board's computer simulation studies of United flight 585. Because the FDR did not record roll or sideload information, it was not possible to positively determine whether the recorded heading changes were the result of a roll or a sideslip followed by a roll.³³¹ Other variables had to be factored into the simulation studies. The winds and turbulence encountered by United flight 585 during the approach undoubtedly acted on the airplane during the upset and descent. Because the exact winds encountered by the airplane were not known, the winds could be reasonably varied during the simulations, resulting in a number of possible scenarios that would be consistent with the radar data and the limited FDR data. Pilot pedal input force was another variable that was incorporated in the simulations.

The Safety Board employed several computer simulation scenarios in which the resulting heading data matched the available FDR data. These simulations used rudder position time histories that assumed jams of the secondary slide to the valve housing at various positions from the neutral position (100, 71, 50, 40, and 30 percent), and a concomitant rudder reversal. (Each of the rudder-related solutions required a control wheel response opposing the roll).

The Safety Board's best-match computer simulation was one in which the secondary slide jammed at 100 percent off its neutral position and, about 0943:32,³³² the rudder reversed in response to the pilot's attempt to make a left rudder input. In this simulation, the airplane's right yaw rate had reached 4.7° per second just before the rudder reversal because of the effects of a wind gust (a 17-knot decrease in the wind velocity for 3 seconds as the airplane descended on its approach). The Safety Board incorporated this

³³⁰ United flight 585 was equipped with a five-parameter FDR, which recorded microphone keying, airspeed, altitude, and heading at once-per-second intervals and vertical Gs at 8 times per second.

³³¹ Simulations using a control wheel input could produce a scenario involving only a roll, whereas simulations using a rudder movement could produce a scenario involving a sideslip followed by a roll, both of which could be consistent with the recorded data.

³³² All times in this section and section 2.3.2 are mountain standard time, based on a 24-hour clock.

wind velocity change with decreased altitude into its computer simulation to match the heading data recorded by the FDR from about 0943:28 to about 0943:31. The heading output from the Safety Board's best-match simulation matched the FDR heading data within 1° or less and matched the character of the data.

The Safety Board's computer simulations that used right control wheel input alone (and no rudder movement) also produced heading results that matched the available FDR data. However, that solution was not considered to be realistic because it required the pilots to fly the airplane into the ground when simple wheel corrections could prevent this occurrence. The Safety Board has no evidence that the pilots of United flight 585 would have deliberately flown the airplane into the ground.³³³

The Safety Board could also match the FDR data by assuming that the increasing roll was the result of a rotational external wind, such as a mountain rotor. The Safety Board considered the possibility that a mountain rotor forced the airplane along the accident flightpath.³³⁴ With the weather conditions present in the area on the day of the accident (strong westerly winds flowing over the mountains located west of the accident site), rotors could have been generated, rotating in a clockwise direction (from United flight 585's perspective on the approach). These rotors would have likely been moving to the east (pilots' left to right) with the wind at an unknown altitude; however, it is possible for a mountain wave to trap a rotor, resulting in a "standing" rotor, which would not move with the wind.

In a June 23, 1997, letter to the Safety Board, Boeing indicated that a "rudder hardover scenario" did not fit the United flight 585 FDR data but that a "new rotor model" it developed did fit the data. This Boeing model proposed an encounter with a rotor that followed the flightpath of the accident airplane and increased in strength to about 1.8 radians (103°) per second as the airplane descended to the ground. However, according to NOAA scientists, the strongest rotors ever documented in the Colorado Springs area had a strength of about 0.05 radians per second. Further, a NOAA/National Center for Atmospheric Research (NCAR) report³³⁵ indicated that researchers have not documented rotors that would descend to the ground in increasing strength, such as the one proposed by Boeing.

The Safety Board evaluated the accident airplane's FDR information for signatures that would be expected if the airplane encountered a rotor. In addition to changes in

³³³ Reports from other pilots who had flown with the captain (the flying pilot on United flight 585) indicate that he was a very conservative and conscientious pilot. These reports are consistent with the captain's conduct on the accident flight, as documented on the CVR.

³³⁴ The Safety Board considered several mountain rotor scenarios, including moving rotors above, below and at the airplane's altitude; standing rotors located left, right, and directly along the airplane's flightpath; and horizontal rotors that transition to vertical rotors along the airplane's flightpath.

³³⁵ The NOAA/NCAR interim report (prepared in response to Safety Recommendation A-92-57) was entitled *A Pilot Experiment to Define Mountain-Induced Aeronautical Hazards in the Colorado Springs Area: Project MCAT97 (Mountain-Induced Clear Air Turbulence 1997)*. The NOAA/NCAR final report has not been completed; however, the Safety Board has reviewed a draft of the final report and reflected its content in this analysis.

heading, the signatures would have included changes in indicated airspeed and altitude resulting from the effects of the low ambient pressure within the rotor. None of these expected pressure signatures were found. Although encounters with translating rotors at certain angles might not produce these pressure signatures, the masking of the FDR signatures would occur only while an airplane was entering such a rotor. United flight 585 could not have penetrated a rotor's low pressure core and remained there for 8 seconds (the time that the airplane would have had to remain in the rotor for the heading output and the flightpath to match the FDR data) without pressure changes from the rotor producing changes in airspeed and altitude. Further, none of the sounds that are normally characteristic of intense rotors were recorded by the accident airplane's CVR, and witnesses on the ground did not report such sounds at the time and location of the accident.

On the basis of the absence of the signatures of a rotor penetration on the FDR, the absence of recorded/reported characteristic rotor sounds, and the small likelihood that a rotor of the necessary strength and orientation would have matched the airplane's flightpath to the point of ground contact, the Safety Board concludes that it is very unlikely that the loss of control in the United flight 585 accident was the result of an encounter with a mountain rotor.

2.3.2 United Flight 585 Human Performance Analysis

On the day of the United flight 585 accident, pilots flying in the area of the Colorado Springs airport had reported moderate to severe turbulence, gusty winds, and windshear. Information recorded by the CVR and FDR indicated that, as the captain (who was the flying pilot) maneuvered the airplane in the traffic pattern, the airplane encountered wind gusts and windshear that resulted in 10-knot airspeed changes. Because of the turbulence and wind gusts, and because he was preparing for a crosswind landing, the Safety Board considers it likely that the captain had his feet on the rudder pedals as he aligned the airplane on its final approach.

According to the Safety Board's best-match computer simulation, about 0943:20, the airplane rolled rapidly (about 10° per second) to the right to a bank angle of about 27° and returned to approximately a level flight attitude. This bank was entered more rapidly and was steeper than the bank a pilot would likely have commanded for a heading adjustment to track the extended centerline of the runway. Consequently, the Safety Board assumed that the right roll was caused by an eddy or rotational wind component. (The recovery from this right roll, however, was presumed to have been a result of control wheel inputs made by the captain beginning about 1 second after the airplane's roll accelerated to the right.)

The Safety Board's review of the CVR, FDR and radar information revealed that, about 0943:28 (8 seconds after the 27° uncommanded right roll), the airplane was flying at 160 knots with 30° of flaps and the landing gear extended and was nearly aligned on the final approach for the runway. According to the CVR, at 0943:28.2, the first officer advised "we're at a thousand feet [above the ground]." The FDR indicated that, about

0943:30, another right heading change began and continued at a rate of 4.7° per second. In its computer simulation, the Safety Board matched this heading change by introducing a crosswind gust component, resulting in right yaw. The yaw rate was sustained for more than 3 seconds before a rapid right roll developed. This sustained yaw would have been apparent to the captain as motion of the ground and sky features relative to the fixed reference of the airplane's windshield area. This heading change would have been especially salient to the captain because the runway, with which he was trying to maintain alignment, would have been visible ahead.

The Safety Board's simulation scenario assumed that the captain responded to the sudden, rapid, and sustained heading change by applying left rudder pedal input about 0943:32. The timing of this input (about 3 seconds after the peak yaw rate was attained) would be consistent with the time required for the pilot to perceive the yaw, wait a moment for the effect of the turbulence to subside (to avoid overcontrolling), decide that a left rudder input was required, and then apply the left rudder pedal input. The Safety Board's simulation postulated that this left rudder input initiated a rudder reversal to the right. According to the Safety Board's simulation, at 0943:33.5 (about 1.5 seconds after the rudder reversal began), when the captain signaled his decision to abandon the approach by stating "fifteen flaps," the bank angle had not exceeded 20° , and the pitch angle was 8° nose down (approximately what it had been during the normal descent in the period leading up to the upset). However, speech analysis indicated that the captain's "fifteen flaps" statement displayed a heightened level of speech fundamental frequency that was consistent with a sense of urgency. This sense of urgency was also indicated by the captain's omission of a call-out item in the normal go-around procedure.³³⁶ Although many factors may have precipitated a go-around decision by the captain, a flight control difficulty, such as that produced by a rudder reversal, would have been consistent with the captain's speed and urgency in making this decision.

If the captain applied force to the left rudder pedal, he would have felt the pedal push strongly back against his foot pressure. Further, the Safety Board assumed that the captain would have acted to oppose a continuing uncommanded right yaw that was being sustained by a reversing rudder; thus, the Safety Board's computer simulation of the event increased the captain's force on the left rudder pedal to 300 pounds within 1 second.³³⁷

During postaccident simulator exercises, the Safety Board determined that an immediate full left control wheel response during a right rudder reversal in the airspeed and flap configuration of United flight 585 could have allowed the flight crew to maintain control of the airplane. However, during a rudder jam and reversal, the captain of United flight 585 would have been contending with the distraction of the malfunctioning rudder and thus would have been devoting his physical effort to overpowering the rudder pedals. Further, the airplane's yawing motion and heading changes (derived from the Board's

³³⁶ The captain did not state aloud "go-around thrust," as specified in United's go-around procedure.

³³⁷ Although the Safety Board's best-match simulation used 300 pounds of force reducing to 200 pounds, based on ergonomic and other research data (as discussed in section 1.18.8), the Safety Board was also able to obtain an excellent match with the FDR data using only the minimum pedal force necessary to sustain full rudder authority (about 70 pounds) and using 500 pounds of force.

computer simulations) would have produced stronger cues than those produced by the rolling motion during the first few seconds of the upset, so the captain was likely focusing his attention on the rapid yaw acceleration that he could not control with the rudder.

These circumstances would have been extremely confusing and distracting and would have been unknown to the flight crew based on previous experience. Thus, it would be understandable for the captain to have initially made a partial wheel input while contending with the powerful physical and mental demands of the problem with the rudder. The CVR evidence of increasing engine thrust indicated that the captain would have been using his right hand to advance the thrust levers for an attempted go-around. Thus, the captain would have had only his left hand available to rotate the wheel to the left, which would have made it difficult to achieve large left control wheel deflections. (This motion would have required the captain to pull his left arm down and across his body while twisting his left wrist.)

Further, at the time of the left rudder input in the Safety Board's simulation, the airplane was in about a 5° right bank. According to the Board's assumption that the captain applied moderate left wheel (about one-third of the available control wheel) about 2 seconds later, the airplane would have been in a right bank of about 30°. On the basis of the time required for the captain to perceive the need for and execute his control input (about ¾ second), the bank angle that the captain would have been responding to with this moderate control wheel input was about 15°. With this relatively shallow roll angle, it would be normal for a pilot (especially an air carrier pilot) to first apply a moderate control input and then gauge the airplane's response before making an extreme control input. (The Safety Board considers it likely that the first officer's statement "Oh God" at 0943:32.6 referred to her concerns about the abrupt, sustained yaw rate and heading change resulting from the rudder's reversal movement to its right blowdown limit and not about the airplane's roll attitude or rate of change because the roll attitude was not excessive at that time.) The Safety Board's computer simulation further indicated that the captain applied full control wheel to the left about 2 seconds later.

The computer simulation results also indicated that, within 2 seconds of rudder reversal, the pilots were experiencing as much as 0.44 G of sideforce from the right yaw acceleration. This sideforce would have made a left wheel input even more difficult for the captain because his body would have been pulled to the left and away from the control wheel, causing a tendency to level the wheel unless he quickly returned his right hand to the controls.

Therefore, because of the unknown nature of a rudder reversal, the initially shallow roll angle, and the physical limitations that would have hindered an immediate full left control wheel input, the Safety Board considers it understandable that the captain might not have immediately applied a full left control wheel input to counter a reversing rudder.

The Safety Board's computer simulation showed that, about 0943:34, the bank angle of the airplane transitioned suddenly; by about 0943:35, only 3 seconds after the reversal, the right bank angle had increased to more than 80°. The Safety Board's

simulation also showed that the captain, at that time, rapidly moved the control wheel fully to the left. The airplane's pitch angle had decreased to almost 30° nose down, and the pilots would have been able to see only the ground through the windshield. The Safety Board would expect that the captain would no longer be applying as much force to the left rudder pedal because he was likely focusing on holding a full left wheel input and attempting a go-around and the left rudder pedal would have forced him to a less efficient knee angle. Consequently, the Board's computer simulation of the event moderated the captain's force on the left rudder pedal to 200 pounds at that time.

Shortly thereafter (perhaps in response to the loss of attitude reference), the captain apparently removed some of his left wheel inputs, possibly because he was concentrating on aft control column pressure in an attempt to raise the airplane's nose. By about 0943:36, the airplane rolled into an inverted attitude and the captain said "no" very loudly. Ground impact occurred about 5 seconds later, only 9 seconds after the rudder reversal began.

The Safety Board concludes that analysis of the CVR, Safety Board computer simulation, and human performance data (including operational factors) from the United flight 585 accident shows that they are consistent with a rudder reversal most likely caused by a jam of the main rudder PCU servo valve secondary slide to the servo valve housing offset from its neutral position and overtravel of the primary slide. Also, because the United flight 585 upset occurred when the airplane was less than 1,000 feet above the ground, the pilots had very little time to react to or recover from the event. Thus, the Safety Board concludes that the flight crew of United flight 585 recognized the initial upset in a timely manner and took immediate action to attempt a recovery but did not successfully regain control of the airplane. The Safety Board further concludes that the flight crew of United flight 585 could not be expected to have assessed the flight control problem and then devised and executed the appropriate recovery procedure for a rudder reversal under the circumstances of the flight. The Safety Board also concludes that the training and pilot techniques developed as a result of the USAir flight 427 accident show that it is possible to counteract an uncommanded deflection of the rudder in most regions of the flight envelope; such training was not yet developed and available to the flight crews of USAir flight 427 and United flight 585.

2.4 Eastwind Flight 517 Upset

The logbook records for the Eastwind flight 517 airplane indicated that a series of flight crew-reported rudder-related anomalies (uncommanded rudder movements and rudder pedal "bumps") occurred during the month before the upset event. As a result of these anomalies, the main rudder PCU was removed and replaced on May 14, 1996, and the yaw damper transfer valve and yaw damper position transducer were removed and replaced on June 8, 1996.³³⁸ The captain of the incident flight, who had experienced some of the previous rudder pedal bumps, conducted the postmaintenance flight test on the

³³⁸ On June 2, 1996, Eastwind issued a bulletin to all flight crews advising them to report any "unexplained" yaw events.

morning of the incident flight. The captain noted no rudder system anomalies during the test flight or the incident flight until the upset event began.

The Safety Board's postincident examination of the incident airplane's rudder system components revealed several anomalous conditions, including a misadjusted yaw damper linear variable displacement transducer (LVDT) and chafed wiring between the yaw damper coupler and the main rudder PCU. Either of these conditions might have resulted in anomalous rudder behaviors. The misadjusted LVDT would have changed the yaw damper's authority over the rudder from the specified 3° left or right of neutral to 1.5° left of neutral to 4.5° right of neutral with no aerodynamic loads on the rudder. Chafed wiring could cause a short circuit, which could result in a yaw damper hardover command. Although the Safety Board was unable to positively identify the source of the rudder-related anomalies, a short circuit related to the chafed wiring may have caused a yaw damper hardover during the incident.³³⁹

Safety Board simulations and Boeing kinematics studies revealed that the heading change observed in the Eastwind airplane's FDR data required a right rudder deflection of about 6 to 6.5°. This rudder movement is larger than the yaw damper could command (even allowing for the misrigged LVDT and compliance in the system, the yaw damper could only command 3.95° of right rudder movement in flight).³⁴⁰ Further, although examination of the Eastwind flight 517 PCU components revealed a higher-than-normal hydraulic fluid leakage at the bypass valve (resulting in a reduced hinge moment, which would result in a reduced blowdown rudder deflection),³⁴¹ the aerodynamic blowdown limit for the Eastwind flight 517 incident airplane, assuming normal (unreversed) operation, far exceeded the 6 to 6.5° rudder deflection that was apparently involved in the incident.³⁴²

Examination of internal measurements of the Eastwind flight 517 PCU servo valve revealed that it had relatively tight clearances, similar to those measured in the USAir flight 427 PCU servo valve. Thus, the Eastwind servo valve (similar to the USAir servo

³³⁹ The postincident removal and replacement of all components and wiring associated with the incident airplane's yaw damper system apparently eliminated the source of the rudder bumps; since then, there have been no pilot complaints or maintenance writeups regarding rudder bumps or other anomalous rudder behavior.

³⁴⁰ Although the misadjusted LVDT allowed for 4.5° of movement to the left on the ground, the rudder movement with aerodynamic loads in flight would have been 3.7°. This estimate has an error band of $\pm 0.25^\circ$, yielding an estimated maximum right rudder deflection (caused by the yaw damper) of 3.95°.

³⁴¹ Although the bypass valve allowed higher-than-normal leakage, which affected the rudder's blowdown deflection, the leakage was not significant enough to prevent the Eastwind PCU from successfully completing Parker's acceptance test procedure functional tests at the full PCU level. However, when the bypass valve was removed from the PCU package and tested independently, it did not successfully complete the bypass valve functional tests.

³⁴² According to Boeing, the rudder blowdown limits for the Eastwind flight 517 incident airplane (including the reduced hinge moment from the PCU's excessive leakage at the bypass valve) would have been about 9° when operating at 250 knots under normal (unreversed) pilot command, with the variation depending on the sideslip value.

valve) would be more likely to jam than a servo valve with greater clearances (such as the new-production PCU servo valve also subjected to these tests).

2.4.1 Eastwind Flight 517 Computer Simulation Analysis

Eastwind flight 517 was equipped with an 11-parameter FDR that included vertical acceleration, pitch, roll, and heading. Because heading data were recorded only once per second, several computer simulations resulted in reasonable matches of the FDR heading data (and vertical acceleration, pitch, and roll data). (FDR heading data sampled at more frequent intervals would have likely resulted in fewer computer simulations that match the data reasonably well.) The Safety Board's best-match simulation assumes that the rudder surface was trimmed to neutral to compensate for the offset yaw damper. This scenario also assumes that, about 2210:31, the pilot stepped on the left rudder pedal to counter a yaw damper hardover of 3.95° to the right that had occurred about 2 seconds earlier; the yaw damper hardover created a yaw acceleration that peaked at more than $7^\circ/\text{sec}^2$ and a lateral acceleration in the cockpit above 0.1 G. This scenario further assumes that the secondary slide was jammed to the servo valve housing about 55 percent off neutral and that, when the pilot applied force to the left rudder pedal, the rudder moved in a direction opposite that commanded to about 6.5° right (the blowdown limit with the leaking bypass valve and the reduced rudder hinge moment from the secondary slide jam at 55 percent from neutral).

The Safety Board's simulation results matched each FDR heading and roll data point within about 1° . The results also matched well with the FDR recorded vertical acceleration data.

Boeing proposed a scenario in which a yaw damper hardover of 3° right (from 1.5° left because of the misrigged LVDT) occurred during the ground roll. Boeing further proposed that the pilots added 3° of left rudder trim to compensate for the yaw damper input.³⁴³ According to Boeing's scenario, the fault that initially moved the yaw damper to 3° right cleared just before 2210:28, and the rudder then moved rapidly 3.7° to the left, resulting in a left yaw about 2210:28. Boeing's scenario indicated that the pilot responded with right rudder pedal, commanding the rudder to about 6° right and causing the airplane to yaw right. In Boeing's scenario, the pilot maintained the right rudder pedal input, and the yaw damper remained active and responded appropriately.³⁴⁴

Boeing used its kinematic analysis to derive flight control surface position time histories (particularly the rudder position time history). This effort required Boeing to curve fit the once-per-second FDR heading data, which Boeing accomplished with a manual, nonlinear fit of the heading data, as shown in figure 32. To justify a right rudder

³⁴³ The Eastwind pilots' statements indicated that the yaw damper behaved normally during the maintenance test flight that occurred before the incident flight and was observed in the neutral position during the ground operations before takeoff of the incident flight.

³⁴⁴ The Boeing scenario was described in its August 14, 1998, Submissions Supplement to the USAir flight 427 accident investigation. In a document dated February 24, 1999, Boeing provided updated data in support of its scenario.

input by the pilot about 2210:29, Boeing introduced a left heading change between 2210:28 and 2210:29 (in response to the postulated left rudder movement from the release of the yaw damper hardover about 2210:28) through its manual nonlinear curve fit of the FDR heading data, even though the FDR data did not reflect a left heading change. (Further, both the flight crew and the lead flight attendant recalled a yaw to the right as the initiating event.). When this manual curve fit of the heading data was used in Boeing's kinematic analysis, the results indicated a left rudder movement about 2210:28 that was consistent with Boeing's scenario of the release of the yaw damper hardover at that time. Boeing then used this rudder surface time history (and other control surface time histories) as input data in its computer simulation to produce airplane motion parameters, including heading.

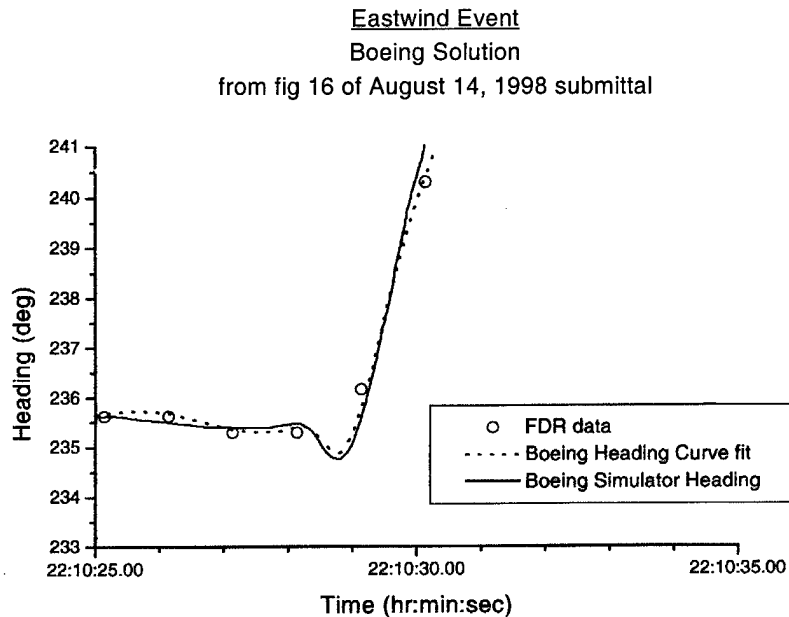

Figure 32. Boeing's curve fit of the FDR heading data from Eastwind flight 517.

Boeing asserted that its analysis demonstrated rudder activity during the event, which it considered evidence of the yaw damper activity during the event (and therefore evidence that the rudder was not jammed and did not reverse). However, the basis for this assertion that the yaw damper was active during the event is the rudder activity resulting from Boeing's kinematic analysis, which in turn resulted from Boeing's manual, nonlinear curve fit of the FDR heading data. Although the Safety Board cannot prove that the left heading change introduced into Boeing's curve fit about 2210:28 did not exist, no evidence indicates that it did. Further, the heading change does not match the character of the heading data between about 2210:27 and about 2210:30.

Further, Boeing used the rudder time history resulting from its kinematic analysis and the concomitant rudder activity to conclude that the yaw damper was active. However, because of the noise inherent in the curve-fitting process, these results do not prove that the yaw damper was active but only allow for this possibility. The Safety

Board's computer simulations, which assumed that the secondary slide jammed to the servo valve housing about 55 percent from its neutral position after the pilot input left rudder (about 2210:30) in response to a right yaw damper hardover (about 2210:28), did not require yaw damper activity to achieve its match.

Boeing's computer simulation results and the Safety Board's results matched the FDR data well, with the resulting heading data from both simulations matching the FDR heading data within 1°. Further, within the approximately 12 seconds of significance (about 2210:28 to about 2210:40), the character of the resulting heading data from both the Boeing and Safety Board simulations is generally consistent with the character of the FDR heading, except for the hump in the heading data between 2210:28 to 2210:29 introduced by Boeing's curve fit for its kinematic analysis.

Boeing's simulation, however, suffers from a timing deficiency: its simulation presumes a right pedal input by the pilot about ¼ second after the postulated clearing of the yaw damper hardover in reaction to a heading change of less than 0.5° and a peak heading change rate of only 1.4° per second. Further, Boeing's simulation results in a 6° right rudder deflection. However, the blowdown limit for Eastwind flight 517 at that time (without a reversal scenario)³⁴⁵ would have been about 9°, even with the higher bypass leakage rate. Thus, the Boeing scenario requires that the pilot only partially depress the right rudder pedal to move the rudder surface to match the simulation deflection.

2.4.2 Eastwind Flight 517 Human Performance Analysis

The captain of Eastwind flight 517 had adopted a personal technique of routinely disengaging the autopilot as his airplane descended through 10,000 feet mean sea level (msl). Consequently, when Eastwind flight 517 approached Richmond on the night of the incident, the captain was hand flying the airplane with his feet on the rudder pedals.

The weather on the night of the incident was reported to be clear with relatively calm winds. The airplane was descending through 4,300 feet msl when the captain felt a motion that he later described as a "bump" on the right rudder pedal. The captain reported that, almost immediately afterward, he felt a sharp yaw to the right followed by a right roll. The captain stated that the rudder pedals displayed little, if any, displacement. This report is consistent with the 3.95° nose right yaw damper hardover about 2210:29 in the Safety Board's computer simulation scenario.

In postincident interviews with Safety Board investigators, the captain stated that he immediately applied "opposite [left] rudder and stood pretty hard on the pedal." He said that the "rudder moved, but felt stiffer than normal." The first officer told investigators that he observed the captain "fighting, trying to regain control" and "standing on the left rudder [pedal]." The captain further stated that the rudder pedal moved but did not depress to the floor. He believed that these actions slowed the event but that the airplane was still trying to roll.

³⁴⁵ In a reversal scenario, the leaking bypass valve and the reduced hinge moment caused by a secondary slide jam would have reduced the blowdown limit to 6.5°.

These pilot statements are consistent with the Safety Board's computer simulation scenario in which the main rudder PCU servo valve's secondary slide jammed and the rudder moved in the direction opposite to that commanded by the pilot. The Safety Board's simulation studies indicated that, after the rudder initially deflected 3.95° to the right, it increased its deflection to about 6.5° to the right within the next 2 seconds. This 2-second period from yaw damper hardover to reversal of the rudder was adequate time for the captain to perceive the effects of the yaw damper hardover as a sideload upon his body and react with left rudder input. The Safety Board's computer simulation assumed that this left rudder input initiated a rudder reversal by causing the primary slide of the servo valve to overtravel.

Thus, as the captain added left rudder pedal input, under the Safety Board's rudder reversal scenario, the rudder would have moved the remainder of the distance to its right blowdown limit (to about 6.5° right) with little movement of the left rudder pedal back against the captain's foot. Under the assumption that the captain continued to apply an increasing amount of force to the left rudder pedal to counter the right yaw/roll (from the reversing rudder), the left rudder pedal would have moved slightly forward without removing the uncommanded right rudder deflection. The rudder pedal motion and force required to move the pedal are consistent with the captain's report of rudder pedals that moved but felt "stiffer than normal." Further, because both pilots reported that the captain exerted substantial force on the left rudder pedal (by "standing on" it), the Safety Board's computer simulation of the jam/reversal scenario modeled the captain's rudder pedal force as an increase to 500 pounds within 1 second.³⁴⁶

The captain stated that, as the event continued, his wheel inputs appeared to stop the roll but did not correct the condition. The captain increased the right engine's power, hoping that differential engine thrust would counter the airplane's right yaw/roll. According to the FDR, when the right engine's thrust increased, the captain's initial control inputs had recovered the airplane from its right rolling moment and rolled the airplane back through level flight to a stable left bank attitude of about 5 to 15° .

The Safety Board's computer simulation shows the captain relaxing both control wheel and rudder inputs about 2210:34 as differential engine thrust became effective and as the captain attempted to restore a level bank attitude. According to the Safety Board's scenario and the captain's recollection, the captain had achieved a stable, though uncoordinated (cross-controlled), flight condition with only moderate control wheel inputs required. Given the stability of the situation, particularly with the airplane already in a left bank, it would have been reasonable for the captain to have relaxed some of his rudder pedal and control wheel inputs. At this time, the Safety Board's computer simulation shows the captain relaxing his rudder pedal force to 250 pounds.

³⁴⁶ Although the Safety Board's best-match simulation used 500 pounds of force reducing to 250 pounds, based on ergonomic and other research data (as discussed in section 1.18.8), the Safety Board was also able to obtain excellent matches with the FDR data using only the minimum pedal force necessary to sustain full rudder authority (about 70 pounds) and using 300 pounds of force.

The captain stated that, when the uncommanded event continued, he reached for the yaw damper switch (located on the overhead panel above the captain's head) and disengaged the yaw damper. Seconds later, the yaw/roll event ended (about 12 seconds after it began, according to FDR data). The captain stated that he did not believe the end of the event was directly related to the yaw damper disengagement. However, the Safety Board considers it possible that the captain may have (unknowingly) eased his pressure on the left rudder pedal when he reached for the yaw damper switch or afterward as he assessed the effect that the yaw damper disengagement had on the yaw/roll event. (The Safety Board modeled this scenario in its computer simulation of the event with a further reduction in left rudder pedal pressure about 2210:40.) If the captain relaxed his force on the left rudder pedal to less than about 50 pounds, a rudder reversal resulting from a secondary slide jam to the servo valve housing might have ended (that is, the primary slide might have returned to neutral from its overtravel position).

Unlike United flight 585 and USAir flight 427, Eastwind flight 517 was moving throughout the event at a speed that remained well above the crossover airspeed. Thus, the flight crew of Eastwind flight 517 had sufficient roll control authority to overcome the effects of a full rudder deflection. This roll control authority was clearly a factor in the ability of the flight crew to recover from the event.

In addition to the human performance aspects of the Eastwind flight 517 reversal scenario, the Safety Board reviewed the human performance aspects of the pilot input scenario proposed by Boeing. As discussed in section 2.4.1, Boeing's scenario proposed that a yaw damper hardover, which had occurred while on the ground before departure, resulted in a constant 3.7° right rudder input at the beginning of the flight. The scenario further proposed that the pilots then applied an equal and opposite amount of left rudder trim so that the rudder surface was about neutral with respect to the vertical fin.

During interviews with investigators, the captain of Eastwind flight 517 did not recall having trimmed the rudder at any time before the beginning of the yaw/roll incident. Further, the captain indicated that he never used more than $\frac{1}{2}$ unit of rudder trim during routine flight operations. Therefore, the need to trim the rudder by more than 3 units (as indicated in Boeing's scenario) would most likely have been salient and memorable to the captain. Further, the pilots of Eastwind flight 517 had been aware of previous rudder anomalies with the incident airplane, and they had test flown the airplane immediately before the incident flight to verify the proper function of the rudder system. Therefore, the pilots would have been more likely to note and recall a requirement for 3 units of rudder trim if it had occurred.

Boeing's pilot input scenario also proposes that the yaw damper hardover released between 2210:28 and 2210:29 and that the pilots immediately responded to the resulting left yaw with right rudder input. This scenario postulates that the pilots reacted within less than $\frac{1}{4}$ second after the beginning of the rudder's leftward motion. (The scenario must include such a rapid pilot response to the postulated release of the yaw damper hardover because the entire initiating event—release of the yaw damper hardover and pilot right rudder input—must take place within the 1-second interval between the FDR heading data

points at 2210:28 and 2210:29, or the Boeing simulation heading time history would not match these FDR heading data.)

According to human factors literature on reaction time,³⁴⁷ it is unlikely that a pilot could detect an unusual situation, recognize what was happening, decide how to respond, and make a motor response in a time period as little as 1/4 second. At the beginning of the postulated yaw damper hardover release, no substantial cues would have signaled the Eastwind pilots to respond with an immediate rudder input. The motion of the rudder from the yaw damper hardover release would have provided no feedback to the rudder pedals. Although yaw acceleration (perceived by the pilots as sideload) would have begun almost immediately after the rudder movement started, it would not have reached 0.05 G until about 1/3 second after rudder movement began and its peak of approximately 0.1 G until about 1/2 second after rudder movement began.³⁴⁸ Airplane heading, which could have been apparent to the pilots during the night flight as motion of lights on the ground relative to the airplane, would have changed less than 1° during the 1/4-second period after the yaw damper hardover release. Consequently, the cues that might have alerted the flight crew to a yaw damper hardover release would not have developed until most, or all, of the 1/4-second period had elapsed. Finally, the pilot would have been required to make a foot response, which can be 20 percent slower than a hand response.³⁴⁹

When the captain of Eastwind flight 517 was subjected to a yaw damper hardover in the test flight conducted after the event, he took 3/5 second to initiate a rudder pedal input in response to the hardover. This reaction time is probably less than the captain's reaction time would have been during the incident flight because he knew the test flight would involve a sudden rudder event and he knew exactly how to respond. Therefore, on the basis of these human reaction time capabilities, the flight crew of Eastwind flight 517 would not have likely been able to react to the cues from an unexpected yaw damper hardover release in less than 1/4 second.

To match the FDR data from the Eastwind flight 517 incident, Boeing's pilot input scenario also required the pilots to have applied and held about 6° of right rudder for 10 seconds or more after the postulated yaw damper hardover release.³⁵⁰ However, the scenario's requirement for pilot right rudder input is inconsistent with the statements of the captain and first officer: both recalled that the captain applied left rudder. Further, both pilots recalled that the captain made a substantial rudder input (describing his actions

³⁴⁷ See Sens, M.J., Cheng, P.H., Wiechel, J.F., and Guenther, D.A. 1989. *Perception/reaction time values for accident reconstruction*. Warrendale, Pennsylvania: Society of Automotive Engineers, Paper 890732. Woodson, W.E., and Tillman, B. and P. 1992. *Human factors design handbook*. 2nd edition. New York: McGraw-Hill, Inc. Also, Boff, K.R., and Lincoln, J.E. 1988 *Engineering data compendium: Human perception and performance*. Wright-Patterson Air Force Base, Ohio: Armstrong Aerospace Medical Research Laboratory.

³⁴⁸ This finding was based on Safety Board simulations of a 3.7° rudder step input under the existing flight conditions.

³⁴⁹ Woodson and Tillman, p. 631.

³⁵⁰ Slight variations in the rudder's position during this time period were proposed by Boeing to indicate variations in pilot inputs and/or the operation of the yaw damper. See section 2.4.1 for more information.

as “standing on the left rudder [pedal]” and “push[ing] quite hard”). In contrast, if the pilots had made an inappropriate right rudder input to a properly functioning rudder system (as the Boeing scenario proposes) to achieve a 6° right rudder, the captain would have had to apply only 54 pounds of pressure to the right rudder pedal, depressing the pedal no more than 1 inch, or about one-quarter of the available pedal travel.

A forceful full right rudder input with a normally functioning rudder system (based on postincident testing of the Eastwind flight 517 main rudder PCU without a jam and reversal) would have resulted in the right rudder pedal depressing to its forward quadrant stops (about 4.2 inches) and the rudder surface moving to its normal blowdown limit of about 9° right. However, simulations of the Eastwind flight 517 incident performed by both the Safety Board and Boeing indicate that a 9° rudder deflection does not match the FDR data.

The Safety Board considers it highly unlikely that the pilots of Eastwind flight 517 would have forgotten about having trimmed the rudder by more than 3 units before the incident began, reported applying left rudder when they had actually applied right rudder, and (perhaps least likely) recalled “standing on the left rudder” when the captain had actually applied only a light touch on the pedal. The Safety Board also considers it very unlikely that the pilots could have reacted to the postulated yaw damper hardover release in less than ¼ second. Therefore, the Safety Board does not consider the scenario proposed by Boeing for the Eastwind flight 517 incident to be consistent with the available evidence from the FDR and the flight crew.

On the basis of the results of its computer simulation (including reduced hinge moment) and analysis of the human performance data (including postincident flight crew statements), the Safety Board concludes that, during the Eastwind flight 517 incident, the rudder reversed, moving to its right blowdown limit when the captain commanded left rudder, consistent with a jam of the main rudder PCU servo valve secondary slide to the servo valve housing offset from its neutral position and overtravel of the primary slide.

2.5 Rudder System Jam Scenarios

In its examinations of the rudder systems of the USAir flight 427, United flight 585, and Eastwind flight 517 airplanes, the Safety Board was unable to identify any obvious physical evidence that a jam occurred within the servo valve. Further, the investigation has not revealed how the secondary slide could jam to the servo valve housing under conditions that would normally be encountered by an airplane in air carrier operations and not leave any physical evidence that the jam occurred. However, the Safety Board demonstrated that, in servo valves with tight clearances,³⁵¹ the secondary slide could jam to the servo valve housing and leave no physical evidence of that jam (albeit under thermal conditions that would not normally be encountered by an airplane in

³⁵¹ The Safety Board’s dimensional examination of the main rudder PCU servo valves from the USAir flight 427 and United flight 585 accidents and the Eastwind flight 517 incident revealed that the USAir and Eastwind servo valves had relatively tight clearances. The United servo valve was damaged so severely that accurate internal measurements could not be obtained.

air carrier operations). Further, small particulate matter in the hydraulic fluid could reduce the already tight clearances in the servo valve, requiring less of a thermal differential for the valve to jam. In addition, it is possible for a large amount of small particles to provide the jamming potential of a larger stronger piece of metal without leaving a mark.³⁵²

Further, testing showed that, when the secondary slide was jammed to the servo valve housing and a sufficiently high-rate force was applied on the input crank, compliance within the rudder system could allow the primary slide to overtravel and result in a reverse rudder command. Therefore, the Safety Board concludes that it is possible that, in the main rudder PCUs from the USAir flight 427, United flight 585, and Eastwind flight 517 airplanes (as a result of some combination of tight clearances within the servo valve, thermal effects, particulate matter in the hydraulic fluid, or other unknown factors), the servo valve secondary slide could jam to the servo valve housing at a position offset from its neutral position without leaving any obvious physical evidence and that, combined with a rudder pedal input, could have caused the rudder to move opposite to the direction commanded by a rudder pedal input.

In one or more of the three upset events, the main rudder PCU system could have malfunctioned in some way other than the rudder reversal scenario previously described such that the rudder moved uncommanded by a pilot to its aerodynamic blowdown limit, without leaving any physical evidence, just before the pilot commanded opposite rudder. However, the Safety Board is unaware of any mechanism by which this possibility could have occurred. Such a malfunction scenario would need to include an explanation for the reduction in the rudder hinge moment on Eastwind flight 517 to be consistent with the rudder movement during that upset event.

To summarize, the Safety Board's analysis indicates that the USAir flight 427 and United flight 585 accidents and the Eastwind flight 517 incident involved rudder deflections that could have only been the result of inappropriate pilot input or a malfunction of the rudder system (or possibly a rotor in the case of United flight 585). The Board and Boeing were able to perform computer simulations and kinematic analyses involving these explanations that resulted in good matches of the available FDR data. Further, Safety Board testing showed that the main rudder PCU servo valve could jam, without leaving a physical mark, in a way that could lead to rudder reversal. Additionally, in all three upset events, the available human performance data comported well with a rudder system malfunction but were inconsistent with an inappropriate pilot input (or a rotor in the case of United flight 585).

The statements of the Eastwind flight 517 flight crew were fully consistent with an uncommanded rudder input. In addition, the Safety Board's and Boeing's computer simulation and kinematic studies both indicated that, in the Eastwind flight 517 incident, the rudder moved to a position consistent with rudder reversal but inconsistent with a normally operating rudder system (given the pilots' consistent recollections of the captain applying great force to the rudder pedals). Therefore, the Safety Board concludes that the

³⁵² Safety Board tests found that pieces of high-strength material could jam the servo valve but that they would leave a mark as a result of the jam.

upsets of USAir flight 427, United flight 585, and Eastwind flight 517 were most likely caused by the movement of the rudder surfaces to their blowdown limits in a direction opposite to that commanded by the pilots. The rudder surfaces most likely moved as a result of jams of the secondary slides to the servo valve housings offset from their neutral position and overtravel of the primary slides.

In addition to this reversal potential, the Safety Board's investigation revealed two other potential failure mechanisms³⁵³ within the 737 rudder control system that could result in a deflection to the rudder's blowdown limit. One of these potential failure mechanisms is a physical jam in the rudder system input linkage (between the PCU's input crank and body stop), preventing the main rudder PCU control valve from closing; the other is a jam of the primary to the secondary slide of the main rudder PCU servo valve combined with a jam of the secondary slide to the servo valve housing at positions other than neutral (known as a dual jam). These failure mechanisms probably did not play a role in the USAir flight 427, United flight 585, and Eastwind 517 upsets.³⁵⁴ Nonetheless, the failure mechanisms are cause for concern because they further illustrate the vulnerability of the 737 rudder system to jams that could produce rudder deflections and result in catastrophic consequences.

2.6 Adequacy of the Boeing 737 Rudder System Design

Boeing has recently made significant design changes in the 737 rudder system, especially on the 737-NG. (The design changes on the NG series airplanes include a redesigned main rudder PCU servo valve in which the hydraulic fluid ports are spread, thus eliminating the reversal mechanism identified in the thermal tests; a redesigned yaw damper system; a hydraulic pressure limiter; a rudder input force transducer; and a new standby rudder PCU input bearing.) The 737-100 through -500 series airplanes are being retrofitted with the redesigned servo valve and a hydraulic pressure reducer designed to limit the extent to which the airplanes would be vulnerable to the rudder overpowering the roll authority of the ailerons and spoilers.

As a result of ADs issued by the FAA, the redesigned main rudder PCU servo valve should eliminate the possibility of a rudder reversal from the specific circumstances

³⁵³ A third potential failure mechanism—a jam of the primary to the secondary slide with overtravel of the secondary slide—was identified as a result of testing after the July 1992 United Airlines rudder anomaly that occurred during a ground check. Although the testing determined that this mechanism could cause a rudder reversal, Boeing indicated that subsequent design changes in the servo valve eliminated this possibility.

³⁵⁴ The Safety Board's postaccident examination of the USAir flight 427 rudder components revealed that the rudder system feedback control loop was probably not jammed during the accident sequence because there was no evidence of foreign material to cause such a jam and there were no nicks or gouges on the input linkage to indicate that a jamming material might have been present at impact. Further, the main rudder PCU's external input linkage effectively covers (blocks) the opening between the input crank and the PCU body stop for the left rudder command direction, preventing jamming material from entering the area. The Safety Board considers that a dual slide jam is a less likely accident scenario than a jam of the secondary slide to the servo valve housing because the dual jam would require two extremely rare failures to exist in the servo valve at the same time.

of a secondary slide jam to the servo valve housing combined with overtravel of the primary slide. Other ADs issued by the FAA should result in improved operational procedures and pilot training programs for addressing the more general problem of uncommanded movement of the rudder, including rudder reversal. The Safety Board concludes that, when completed, the rudder design changes to the 737 should preclude the rudder reversal failure mode that most likely occurred in the USAir flight 427 and United flight 585 accidents and the Eastwind flight 517 incident.

However, even with these changes, the 737 series airplanes (including the NG) remain susceptible to rudder system malfunctions that could be catastrophic. In its October 1997 briefings to the FAA, Boeing acknowledged that a rudder hardover on the 737-NG during the most critical phases of flight—takeoff and/or landing (which Boeing estimated as 60 to 90 seconds per flight)—would be catastrophic. Although this period of vulnerability appears limited, the takeoff and landing phases are when the pilot is most likely to use the rudder, particularly to apply a high-rate rudder input. Pilots can apply rudder inputs during the takeoff or landing ground roll as they use the rudder pedals for nosewheel steering; these inputs can occur at low altitude with a loss of engine power or during a turbulence encounter. Any malfunction resulting in uncommanded rudder motion during an engine failure or in turbulence at low altitude may be catastrophic because of the limited time, altitude, and roll control authority to regain control of the airplane.

The Board is also concerned that the limited period of vulnerability to rudder malfunction is based on the assumption that a pilot will perform perfectly and that all airplane systems will perform normally. For example, according to Boeing's fault tree analysis for the 737-NG, the combination of a jammed servo valve with a loss of engine power during takeoff would be catastrophic only during a 7-second window from V_1 through liftoff, at which point roll controls could be used to help control the airplane in the event of a loss of engine power. However, Boeing's analyses apparently assumed that a pilot would always react immediately and correctly and that the hydraulic pressure limiter would not fail. Such assumptions may not be fully warranted.

The Safety Board recognizes that the potential for the specific rudder malfunction that was most likely involved in the accidents of USAir flight 427 and United flight 585 and the incident involving Eastwind flight 517 appears to have been eliminated by the redesigned servo valve. However, the Board remains concerned that other rudder system malfunctions might potentially lead to rudder reversal or hardover conditions in the 737.

The 737 has a history of rudder system-related anomalies, including numerous instances of jamming. Examples of jamming events³⁵⁵ include the following:

- a shotpeen ball lodged in a servo valve, causing the rudder to move full right on landing;
- shotpeen balls found in a servo valve during a PCU examination;

³⁵⁵ See section 1.18.1.1 for more details about these events.

- contamination of a PCU by metal particles, causing the rudder pedals to jam during taxi;
- internal PCU contamination and worn seals, causing the rudder to lock up on approach;
- internal PCU corrosion found during a PCU overhaul;
- a loose servo valve retaining nut, causing rudder binding during a flight check and reduced rates, stall, and reversals during testing;
- corrosion of a standby rudder PCU, causing full left rudder deflection during taxi;
- installation of an incorrect servo valve spring guide, allowing for rudder reversal when the primary slide was jammed to the secondary slide and a rapid rudder input was applied;
- fluid contamination of a yaw damper coupler, causing rapid full yaw damper inputs and a severe oscillatory roll;
- installation of an incorrect fastener in the summing lever bearing, resulting in a cracked bearing race; and
- a jammed or restricted input arm, causing full rudder to move to its full deflection.

The Safety Board is concerned that the new features of the redesigned main rudder PCU do not address all of these malfunctions, some of which are related to improper maintenance, installation, or modification. These malfunctions demonstrate that some jamming conditions resulted in a loss of rudder control. Other jamming conditions were fortuitously found during maintenance. However, because the main and standby rudder actuators receive maintenance only "on condition," possible jamming conditions could exist and not be discovered until they result in an in-flight failure.

Further, the Safety Board is concerned that, in three events during the 1980s, rudder system anomalies occurred in flight but remained unresolved during followup component testing. These events, two reports of in-flight "rudder lockup" (in 1982) and a rudder "hardover condition" (in 1984), indicated that potentially serious problems could exist and cause anomalous behavior without leaving evidence. (These events were first reported to the Safety Board by Parker in January 1999.) It is significant that the 1984 event involved a PCU that produced an in-flight hardover condition on two different aircraft within the operator's fleet. (According to Parker, the PCU was removed and tested after the first upset event. When no fault was found, the PCU was installed on another aircraft but subsequently failed another time. Once again, no fault was found during followup testing.)

The most troubling anomalies are those that could result in reverse rudder movement. During the investigation of the United flight 585 accident, many technical experts indicated that it was not possible to jam the main rudder PCU in such a way as to generate a reversal of the rudder movement. However, since that time, two such failure

modes have been identified in the original servo valve design. The first failure mode was discovered in tests after the July 1992 main rudder PCU jam during a flight control ground check. The tests demonstrated that, when the primary slide was jammed to the secondary slide, a jam/reversal scenario was possible. (The servo valve was subsequently redesigned to preclude the possibility of this reversal failure mechanism.) The second identified failure mode was discovered during the USAir flight 427 accident investigation. Thermal tests revealed the existence of a jam/reversal scenario (which prompted another redesign of the servo valve to address this potential reversal failure mechanism.) The Safety Board notes that the two failure modes associated with reversal were identified only after many years of 737 operation and only after extensive tests and examination during the investigation of the United flight 585 and USAir flight 427 catastrophic accidents.

The difficulty that was encountered in identifying these two reversal failure modes is not surprising, given the complexity of the 737 rudder system. The entire rudder system assembly—the standby rudder actuator, main rudder PCU servo valve, yaw damper, feel and centering mechanism, rudder trim actuator, torque tube, input rods, cranks, links, and summing levers—is an extremely complicated design. Further, each main rudder PCU servo valve must be individually hand-finished to pass the manufacturer's acceptance test procedures, so no one valve is exactly the same as another.

In addition to the failure modes and malfunctions of the 737 rudder system that have already been identified, the Safety Board is concerned that the causes of certain other reported 737 anomalies remain unresolved. For example, the Safety Board has reviewed many reports of 737 pilots feeling "bumps" on the rudder pedals, yet in several cases the cause has not been determined.

The Safety Board's concerns about the possibility that additional failures or malfunctions may result in uncommanded rudder motion are supported by the early service history of the redesigned servo valve currently being installed in the 737-NG and retrofitted in all other 737 series airplanes. For example, on February 19, 1999, an anomalous rudder response was noted during a rudder ground check in Seattle on a United Airlines 737 equipped with the redesigned servo valve. Both the flight crew and maintenance personnel found that greater force than usual was necessary to move the right rudder pedal. Preliminary investigative findings indicate that the anomalous rudder response was the result of a mispositioned servo valve spring guide. Maintenance records indicated that, 71 flight hours earlier, the servo valve was tested for indications of cracking of the secondary slide. (The test for cracking was performed twice on this valve. The PCU passed the acceptance test procedure after the first test. The acceptance test procedure was not performed after the second test.)

This event raises concern because it suggests that it is possible to successfully install a servo valve in a PCU when the spring guide is out of place. Although such a mispositioning would have been detected if an acceptance test procedure had been performed after the second cracking test, it is troubling that the mispositioned spring guide was not detected during postmaintenance systems tests after the PCU was reinstalled on the airplane. Further, the mispositioned spring guide was not detected during the numerous flight control checks and flights that occurred before the ground check during

which the anomalous rudder response was noted. Another troubling scenario is the possibility that the spring guide may only have been partially mispositioned at the time the PCU was reinstalled and became further mispositioned sometime later while the airplane was operating in service.

A second incident involving the redesigned servo valve occurred on February 23, 1999. A USAirways Metrojet 737 apparently experienced an unexplained rudder hardover in flight. The flight crew regained normal rudder control only after it activated the standby rudder system, as prescribed in USAirways' "Jammed or Restricted Rudder" abnormal procedure. The flight crew then made a successful emergency landing at Baltimore-Washington International Airport. This event could have resulted in an unrecoverable loss of control if it had occurred at a lower altitude or airspeed.

Preliminary results of kinematic analysis and computer simulations of the Metrojet incident using FDR data indicate that the rudder traveled slowly to its blowdown limit. Examination of the rudder system (including the servo valve) to date has found no evidence of a failure or jam either in the servo valve or outside the servo valve (such as a blockage in the rudder system feedback loop) that would explain an uncommanded rudder hardover.

In addition to its concern about these recent in-service events involving the redesigned servo valve, the Safety Board is also concerned that cracks have been found in the secondary slide legs of several of the redesigned servo valves and that one slide was found to be chipped.³⁵⁶ Boeing indicated that metal chips liberated from a crack are not likely to cause uncommanded rudder motion. However, Boeing's conclusions are based on preliminary analyses and testing. Little is known about the initiation or progression of the cracking or the migration of chips, and there is no long-term operational experience with the redesigned servo valve to identify with certainty how this cracking is, or will be, affected by in-service conditions.

The Safety Board recognizes that 737s have flown for over 92 million flight hours since the 737-100 was certificated in December 1967 and that the airplane's accident rate is comparable to that of similar-type airplanes. Nonetheless, the Safety Board concludes that, rudder design changes to 737-NG series airplanes and the changes currently being retrofitted on the remainder of the 737 fleet do not eliminate the possibility of other potential failure modes and malfunctions in the 737 rudder system that could lead to a loss of control.

Redundancy in critical flight control systems is a basic tenet in the design of commercial transport aircraft. It serves to reduce, to acceptably low levels, the probability of catastrophic outcomes from flight control malfunctions. Redundancy is especially important in the 737 rudder system because of the size and control power of the rudder (necessitated by the twin wing-mounted engine configuration of the airplane).

³⁵⁶ The chipped slide was found on a servo valve awaiting installation on an Olympic Airways airplane. Boeing stated that it believed the chip was caused by a rigging tool that was used to calibrate the servo valve.

The 737 is the only air carrier airplane with two wing-mounted engines that was designed with a single-panel rudder controlled by a single actuator, albeit with a dual-concentric servo valve design. Other rudder system designs use multiple rudder surfaces and/or multiple rudder actuators. For example, the rudder system designs of the Boeing 757 and 767, which were certificated in 1982 (2 years before certification of the 737-300 series), use three actuators and do not rely on dual-concentric servo valves. In the event of a jammed or failed valve, the three-actuator design permits the failed actuator to be immediately overpowered, or "broken out," by pilot input using the other two actuators so that the jammed or failed PCU no longer controls the movement of the flight control surface.

Although Boeing has indicated that three actuators were incorporated in the 757 and 767 design to allow for features such as autopilot control of the rudder during autoland and removal or reduction of the mass used to balance the rudder, the multiple-actuator design clearly provides an increased level of safety. Because the three actuators are fully independent (such that a valve jam would not have an adverse effect on another valve), they provide true redundancy to the 757 and 767 rudder system. It is noteworthy that the 757 and 767 have not experienced the rudder-related anomalies, incidents, or accidents that have occurred in the 737 series.

Although dual-concentric servo valves are used in some other aircraft control systems for activation of ailerons or elevators, the multiple control surfaces and breakout features in those systems were designed to ensure that a jam of one control surface does not affect other control surfaces. However, these redundant systems or breakout features do not exist in the design of the 737 rudder system.

Further, although the 737 rudder system has a standby rudder PCU that is independent of the main rudder PCU, that system would have to be manually activated by the flight crew in the event of a servo valve jam. If a jam were to occur close to the ground or result in an unusual attitude, the pilots could lose control of the airplane before they were able to diagnose the problem and engage the standby rudder. Therefore, redundancy in the current 737 rudder system is limited to the dual-concentric design of the main rudder PCU servo valve (and the dual load path design of the linkages in the rudder system).

The October 7, 1993, incident involving a British Airways 747-400, G-BNLY, illustrates the need for greater redundancy in flight control systems that include a dual-concentric servo valve. Shortly after takeoff, about 100 feet above ground level, the airplane's right elevator PCU reversed travel when a hydraulic pressure surge, resulting from retraction of the landing gear, caused the dual-concentric servo valve secondary slide to overtravel to the internal retract stop and the primary slide to move to the limit of the extend linkage stop. The flight crew was able to maintain control because the 747's elevators are operated by separate PCUs and are not interconnected. As a result, the flight crew was able to move the left-side elevators upward to counter the right-side downward deflection. Given the low altitude of the occurrence, the airplane would likely have crashed if the 747's elevators had been a single-control surface, single-actuator design.

The Safety Board's review of the dual-concentric servo valve design indicates that redundancy is compromised in the existing 737 main rudder PCU for several reasons. First, no method may exist by which a pilot can reliably detect the presence of a jammed primary or secondary slide within the main rudder PCU servo valve that drives the actuator.³⁵⁷ Second, the dual-concentric servo valve design allows for failure modes in which one slide can directly affect the operation of the other slide. Third, recent design changes do not eliminate the possibility that a maintenance error (such as the shotpeen balls that were discovered in main rudder PCU servo valves) could result in a servo valve anomaly. Last, although the dual load path is structurally redundant, it does not provide functional redundancy. The mechanical elements of the main rudder PCU external to the servo valve may be subject to jams (such as blockage between the input crank and the external body stops), possibly leading to uncommanded rudder motion that the dual-concentric design of the servo valve cannot overcome. These failure modes markedly reduce the redundancy that was intended to be provided by the dual-concentric design of the servo valve and, in effect, could result in a single-point failure in the 737 rudder PCU actuation system. Because no other full-time actuator could oppose an uncommanded rudder motion, an airplane operating with such a latent failure would require only a single additional event, such as a rapid rudder input or an additional jam, to potentially cause a rudder hardover.

The Safety Board considers it important that, if a failure/anomaly were to occur within a critical flight control system (such as the 737 rudder system), the transition to a backup system should occur automatically and immediately, making the system reliably redundant. A system in which the transition to a backup system depends on the pilots' prompt and proper perception of and reaction to the system anomaly is not reliably redundant. Accordingly, the Safety Board concludes that the dual-concentric servo valve used in all 737 main rudder PCUs is not reliably redundant.

During the initial certification of the 737-100 series, FAA certification officials expressed concern about the airplane's single-panel, single-actuator rudder system and recognized the possibility of undetected latent failures in the servo valve, thereby negating the system's redundancy. The rudder system's history of service difficulties (some of which still remain unresolved), particularly the servo valve's history of jamming, validates those concerns.

In October 1996, the Safety Board issued several safety recommendations to improve the existing 737 rudder system. Specifically, Safety Recommendations A-96-107, -109, -112, and -113 asked the FAA to

Require the Boeing Commercial Airplane Group, working with other interested parties, to develop immediate operational measures and long-term design changes for the 737 series airplane to preclude the potential for loss of control from an inadvertent rudder hardover. Once the operational

³⁵⁷ Although the Safety Board considers it critical that the main rudder PCU be inspected at regular intervals, such inspections do not guarantee the detection of latent failures within the main rudder system that occur between inspections.

measures and design changes have been developed, issue respective airworthiness directives to implement these actions. (A-96-107)

Require the Boeing Commercial Airplane Group to develop and install on all new-production 737 airplanes a cockpit indicator system that indicates rudder surface position and movement. For existing 737 airplanes, when implementing the installation of an enhanced-parameter flight data recorder, require the installation of a cockpit indicator system that indicates rudder surface position and movement. (A-96-109)

Require the Boeing Commercial Airplane Group to establish appropriate inspection intervals and a service life limit for the 737 main rudder power control unit. (A-96-112)

Require the Boeing Commercial Airplane Group to devise a method to detect a primary or a secondary jammed slide in the 737 main rudder power control unit servo valve and ensure appropriate communication of the information to mechanics and pilots. (A-96-113)

The Safety Board is disappointed that the FAA has taken no action to establish inspection intervals or a service life limit for the main rudder PCU or a method for detecting and annunciating a jammed servo valve slide to flight crews. The Board is also disappointed that the FAA has stated that a rudder position indicator would provide no practical information to the pilots. On July 15, 1997, Safety Recommendations A-96-107, -109, -112, and -113 were classified "Open—Unacceptable Response." (See section 1.18.11 for a full discussion of the FAA's actions and the Safety Board's comments on those actions.) A more direct and fundamental approach to correcting the deficiencies in the 737 rudder system is necessary.

Because of the complexity of the 737 rudder system (and the potential for unforeseen failure mechanisms), its lack of redundancy in the event of a single-point failure or a latent failure, and the continued absence of cues to help alert flight crews to latent failures, the Safety Board concludes that a reliably redundant rudder actuation system is needed for the 737, despite the significant improvements that have been made in the system's design. Accordingly, the Safety Board believes that the FAA should require that all existing and future 737s have a reliably redundant rudder actuation system. This redundancy could be achieved by developing a multiple-panel rudder surface or providing multiple actuators for a single-panel rudder surface. Further, Safety Recommendations A-96-107, -109, -112, and -113 are classified "Closed—Unacceptable Action/Superseded."

One possible way of incorporating multiple actuators into the 737 without extensive structural modification would be to modify the standby rudder system so that its actuator could be used as a second rudder actuator. Under the current 737 design, the standby rudder actuator powers the rudder by a separate hydraulic system that activates manually or automatically in the event of a hydraulic system failure. The standby rudder actuator was not intended to be used as a full-time actuator. However, design modifications might be possible to make the standby actuator an integral part of the main rudder control system. Although it is not clear whether the standby rudder system could

be modified to provide a truly redundant rudder system on all 737 series airplanes, it is possible that such a modification might provide the needed redundancy.

Another possible way to achieve redundancy in the rudder control system would be to modify it so that the standby rudder PCU would be automatically activated and the main rudder PCU would be automatically deactivated if the main rudder PCU actuator system moves the rudder without a pilot command. This redundancy could be achieved by monitoring the rudder position and comparing this position with the one being commanded by the pilot rudder pedal input. Mismatches between the two positions could then trigger a logic circuit that would command a hydraulic valve unit to automatically shift hydraulic control of the rudder from the main rudder PCU (that is, depressurize its hydraulics) to the standby rudder PCU. This action would allow the flight crew to resume normal control of the rudder using the standby rudder PCU. (The Safety Board recognizes that additional design issues must be considered so that the main rudder PCU is not deactivated when it should not be.)

Further, to gain a better understanding of the potential failure modes in the 737 rudder system, the Safety Board believes that the FAA should convene an engineering test and evaluation board to conduct a failure analysis to identify potential failure modes, a component and subsystem test to isolate particular failure modes found during the failure analysis, and a full-scale integrated systems test of the 737 rudder actuation and control system to identify potential latent failures and validate operation of the system without regard to minimum certification standards and requirements in 14 CFR Part 25. Participants in the engineering test and evaluation board should include the FAA; Safety Board technical advisors; the Boeing Company; other appropriate manufacturers; and experts from other government agencies, the aviation industry, and academia. A test plan should be prepared that includes installation of original and redesigned 737 main rudder PCUs and related equipment and exercises all potential factors that could initiate anomalous behavior (such as thermal effects, fluid contamination, maintenance errors, mechanical failure, system compliance, and structural flexure). The engineering board's work should be completed by March 31, 2000, and published by the FAA.

2.6.1 FAA Certification System

In light of the safety concerns about the 737 rudder system design, the Safety Board is concerned about the FAA's regulatory process that resulted in the certification of that system. The Safety Board concludes that, on the basis of the results of this investigation, the 737 rudder system design certificated by the FAA is not reliably redundant. Therefore, the Safety Board believes that the FAA should ensure that future transport-category airplanes certificated by the FAA provide a reliably redundant rudder actuation system.

The Safety Board also questions the FAA's interpretation of the term "normally encountered" in the context of 14 CFR Section 25.671(c)(3). Section 25.671(c)(3) states the following:

(c) The airplane must be shown by analysis, tests, or both, to be capable of continued safe flight and landing after any of the following failures or jamming in the flight control system and surfaces (including trim, lift, drag, and feel systems), within the normal flight envelope, without requiring exceptional piloting skill or strength. Probable malfunctions must have only minor effects on control system operation and must be capable of being readily counteracted by the pilot.

* * *

(3) Any jam in a control position normally encountered during takeoff, climb, cruise, normal turns, descent, and landing unless the jam is shown to be extremely improbable, or can be alleviated. A runaway of a flight control to an adverse position and jam must be accounted for if such runaway and subsequent jamming is not extremely improbable.

During certification of the 737-NG series airplanes, the FAA concluded that a normally encountered control position for the rudder would be a maximum of 2.5°. However, this interpretation seems unrealistic in light of the rudder's ability to travel as much as 26° in either direction and its criticality in countering a loss of engine power or crosswind gust on takeoff or landing. (It is unclear how a different interpretation would have affected the outcome of the 737-NG certification process.) Such a narrow interpretation may well reduce the level of protection that should be provided by a showing of compliance with this rule. Although the rudder may operate for much of the time in a narrow range, a jam could become critical during those times when deflections beyond this narrow range are necessary.

The Safety Board questions whether it is appropriate to define "normally encountered" so narrowly and even whether it is appropriate to include that phrase in 14 CFR Section 25.671. The Board agrees with the Critical Design Review team's position on this issue. The team stated that "if a control position is possible, it is there for a purpose, and the pilot can use that control authority." In October 1996, the Safety Board issued Safety Recommendation A-96-108, which asked the FAA to

Revise 14 CFR Section 25.671 to account for the failure or jamming of any flight control surface at its design-limited deflection. Following this revision, reevaluate all transport-category aircraft and ensure compliance with the revised criteria.

In response, the FAA indicated that the last sentence of 14 CFR Section 25.671(c)(3) already required that a jam of a flight control surface at its design-limited deflection be accounted for unless such a jam is extremely improbable. However, the Safety Board is concerned that the rule does not appear to require any analysis of failure or jamming of flight controls in positions beyond those normally encountered but short of a full deflection. For example, the FAA's finding that the 737-NG series airplanes complied with this rule was apparently based on Boeing's assertion that rudder position jams in a normally encountered position were controllable and that rate jams resulting in a rudder hardover were extremely improbable. There is no indication that Boeing or the FAA considered jams in any intermediate position.

The Safety Board concludes that transport-category airplanes should be shown to be capable of continued safe flight and landing after a jammed flight control in any position unless the jam can be shown to be extremely improbable. Accordingly, the Safety Board believes that the FAA should amend 14 CFR Section 25.671(c)(3) to require that transport-category airplanes be shown to be capable of continued safe flight and landing after jamming of a flight control at any deflection possible, up to and including its full deflection, unless such a jam is shown to be extremely improbable. Because the Safety Board recognizes that the language of Safety Recommendation A-96-108 may not have adequately expressed this concern, that recommendation is classified "Closed—Reconsidered/Superseded."

2.7 Flight Crew Procedures and Training

2.7.1 Unusual Attitude Training for Air Carrier Pilots

Before the USAir flight 427 accident, the Safety Board had issued a series of safety recommendations over a 24-year period, asking the FAA to require air carriers to train pilots in recoveries from unusual flight attitudes. Throughout this period, the Safety Board was generally not satisfied with the FAA's responses to these recommendations; specifically, the Board disagreed with the FAA's responses that cited the inadequacy of flight simulators as a reason for not providing pilots with the requested training. However, after the USAir flight 427 accident and the October 31, 1994, ATR-72 accident involving Simmons Airlines flight 4184 near Roselawn, Indiana,³⁵⁸ the FAA issued guidance to air carriers, acknowledging the value of flight simulator training in unusual attitude recoveries and encouraging air carriers to voluntarily provide this training to their pilots. The voluntary training programs that were implemented by many air carriers (including USAir) have been excellent. In October 1996, the Safety Board issued Safety Recommendation A-96-120, asking the FAA to

Require 14 CFR Part 121 and 135 operators to provide training to flight crews in the recognition of and recovery from unusual attitudes and upset maneuvers, including upsets that occur while the aircraft is being controlled by automatic flight control systems, and unusual attitudes that result from flight control malfunctions and uncommanded flight control surface movements.

The Safety Board's concerns about the role of automatic flight control systems in unusual attitude situations were validated when Comair flight 3272, an Embraer 120RT, crashed on January 9, 1997, near Monroe, Michigan. The investigation determined that an engaged autopilot masked the most salient cues to the flight crew of a developing uncommanded rolling moment.³⁵⁹ Similarly, the challenge posed to pilots by flight

³⁵⁸ For more information on this accident, see the discussion of Safety Recommendation A-96-120 in section 1.18.11.5.

³⁵⁹ National Transportation Safety Board. 1998. *In-Flight Icing Encounter and Uncontrolled Collision with Terrain, Comair Flight 3272, Embraer EMB-120RT, N265CA, Monroe, Michigan, January 9, 1997*. Aircraft Accident Report NTSB/AAR-98/04. Washington, DC.

control malfunctions was demonstrated by the circumstances of the accidents involving USAir flight 427 and United flight 585, the incident involving Eastwind Airlines flight 517 (which involved uncommanded rudder movement), and the accident involving Simmons Airlines flight 4184 (which involved uncommanded aileron movement).

The Safety Board recognizes the value of air carrier voluntary unusual attitude training programs. However, all air carriers may not be implementing such a program.³⁶⁰ Further, the FAA has not addressed flight control malfunctions (such as uncommanded rudder surface movements) in its guidance material for air carrier unusual attitude training programs. In addition, the unusual attitude training tool developed in 1998 by industry, labor unions, and the FAA does not include guidance on flight control malfunctions.

In January 1997, the FAA informed the Safety Board that it was considering issuance of a notice of proposed rulemaking (NPRM) to require air carriers to conduct unusual attitude training. However, as of March 1999, the FAA had not issued the NPRM. The FAA indicated, in informal correspondence with the Safety Board, that it might include an unusual attitude training requirement as part of a planned general revision to the regulations governing air carrier pilot training (14 CFR Part 121, Subparts N and O).

The Safety Board is concerned that the FAA has not yet taken the necessary regulatory action to require unusual attitude training for air carrier pilots. The Board is also concerned that the guidance and programs developed to date do not include scenarios involving flight control malfunctions. Accordingly, because of the lack of progress toward requiring for air carrier pilots unusual attitude training that addresses flight control malfunctions, such as uncommanded flight control surface movements, Safety Recommendation is classified A-96-120 "Open—Unacceptable Response." The Safety Board urges the FAA to take expeditious action to require such unusual attitude training.

2.7.2 Unusual Attitude Training for Boeing 737 Pilots

At the time of the USAir flight 427 accident, no air carrier training programs were specifically aimed at training 737 pilots to recognize and address a rudder jam or reversal. The guidance available at that time from Boeing advised pilots, as a first consideration, to maintain or regain full control of the airplane. Specifically, the guidance advised pilots to counter unwanted roll tendencies from a malfunctioning rudder with the application of up to full aileron control inputs. However, the guidance did not advise pilots that, at some airspeeds, an uncommanded full rudder input could not be successfully opposed by full wheel (aileron and spoiler) inputs and that a reduction in the airplane's angle-of-attack could improve the effectiveness of the roll controls relative to the effectiveness of the rudder. Boeing's guidance for relieving a jammed rudder informed pilots only that they should use maximum force to overpower the jam and specifically warned pilots against turning off flight control switches "unless the faulty control was positively identified."

³⁶⁰ According to the FAA's January 13, 1999, letter to the Safety Board's Director of the Office of Aviation Safety, at least 13 U.S.-based air carriers (including USAir) had implemented special events training (SET) programs by mid-1996. The letter indicated that "other carriers...as well as training center operators...were initiating SET programs."

No additional guidance was provided about the effects of flight control switch selections on rudder jam conditions.

The Safety Board recognizes that, even if unusual attitude training specifically targeted at the rudder reversal situation were provided to pilots on a recurrent basis, a rudder reversal is such a confusing and distracting event that no training could completely prepare pilots to diagnose and respond to (in the few seconds that would be available) a rudder reversal that occurred without warning. Consequently, the Safety Board cannot be certain that the pilots of USAir flight 427 would have recovered control of the airplane if they had received such training. However, the Safety Board concludes that pilots would be more likely to recover successfully from an uncommanded rudder reversal if they were provided the necessary knowledge, procedures, and training to counter such an event.

In December 1996, the FAA issued AD 96-26-07, requiring that the 737 Airplane Flight Manual be revised to include procedures for maintaining control of an airplane during an uncommanded yaw or roll or a jammed or restricted rudder condition. In response to this AD, Boeing established procedures in February 1997 to provide an effective means of regaining control of the airplane under most (but not all) flight conditions.³⁶¹ The "Uncommanded Yaw or Roll" procedure establishes the actions to be performed by pilots immediately, from memory, to halt the uncommanded motion of the airplane. The "Jammed or Restricted Rudder" procedure establishes a means of handling a variety of rudder malfunctions (including rudder reversal) in a systematic manner. These procedures were subsequently added to Boeing's 737 Operations Manual and adopted by U.S. air carriers.

The Safety Board recognizes that the hydraulic pressure reducer that is being retrofitted on earlier series 737 models, and the hydraulic pressure limiter being installed in the NG models, should provide 737 flight crews with a greater margin of controllability and additional response time for executing these required procedures. However, the ability to recover from an uncommanded yaw or roll or a jammed or restricted rudder (including a rudder reversal), within the time that would be available, requires training and practice in executing the specific procedures. In October 1996, the Safety Board issued Safety Recommendation A-96-118, asking the FAA to

Require the Boeing Commercial Airplane Group, working with other interested parties, to develop procedures that require 737 flight crews to disengage the yaw damper in the event of an uncommanded yaw upset as a memorized or learned action. Once the procedures are developed, require operators to implement these procedures.

The Safety Board had been concerned that the procedures described in AD 96-26-07 did not include disengagement of the yaw damper as an action to be performed immediately from memory. The Board's concern was based on the relatively

³⁶¹ During the comment period for AD 96-26-07, the Safety Board expressed its concerns to the FAA that these procedures might not be adequate if a rudder reversal were to occur at a low altitude, especially with an engine failure during takeoff. See section 2.5 for a discussion of the flight regimes in which flight crew action could not prevent an accident in the event of a rudder jam/reversal malfunction.

frequent occurrence (compared with other rudder system malfunctions) of yaw damper malfunctions in the 737, which might lead pilots to unnecessarily perform the actions in the "Jammed or Restricted Rudder" procedure. The Safety Board's review of the February 1997 changes to Boeing's 737 Operations Manual, and air carriers' adoption of those provisions, indicate that U.S. air carriers are currently providing flight crews with an immediate action procedure that should effectively handle yaw damper system malfunctions. Therefore, Safety Recommendation A-96-118 is classified "Closed—Acceptable Action."

The Safety Board is concerned that the "Jammed or Restricted Rudder" procedure established a pilot's ability to "center" the rudder pedals (that is, achieve a neutral rudder pedal position) as the criterion for successful resolution of a rudder malfunction. Specifically, the Board is concerned that, in a rudder reversal situation, compliance in the rudder system could allow the rudder pedals to reach the neutral position while the rudder surface remains deflected to the blowdown limit. As a result, the Safety Board concludes that a neutral rudder pedal position is not a valid indicator that a rudder reversal in the 737 has been relieved. Therefore, the Safety Board believes that the FAA should revise AD 96-26-07 so that procedures for addressing a jammed or restricted rudder do not rely on the pilots' ability to center the rudder pedals as an indication that the rudder malfunction has been successfully resolved, and require Boeing and U.S. operators of 737s to amend their Airplane Flight Manuals and Operations Manuals accordingly.

Although the procedures specified by AD 96-26-07 did not establish a requirement for air carriers to provide training to flight crews, Flight Standards Information Bulletin (FSIB) 98-03, issued in January 1998, directed the FAA's principal operations inspectors to require air carriers to "amend their training programs to provide initial and recurrent training in the recognition of and recovery from unusual attitudes and upsets caused by reverse rudder response." However, neither AD 96-26-07 nor FSIB 98-03 provided specific guidance on how training for these procedures was to be accomplished. In its comments on the NPRM for AD 96-26-07, the Safety Board expressed its concerns that 737 pilots needed to be explicitly trained on a regular basis in the execution of the new procedures. In February 1997, the Safety Board issued Safety Recommendation A-97-18, asking the FAA to

Require the Boeing Commercial Airplane Group to develop operational procedures for 737 flight crews that effectively deal with a sudden uncommanded movement of the rudder to the limit of its travel for any given flight condition in the airplane's operational envelope, including specific initial and periodic training in the recognition of and recovery from unusual attitudes and upsets caused by reverse rudder response. Once the procedures are developed, require 737 operators to provide this training to their pilots.

Although the new procedures are well documented in FAA, Boeing, and air carrier publications, 3 of 12 U.S. air carrier operators of the 737 contacted by the Safety Board in July 1998 were not providing any simulator training to their pilots on these procedures. (These 3 air carriers accounted for about 20 percent of the 1,070 total 737 airplanes operated by the 12 air carriers). Further, of the nine air carriers that were providing such

training, only five had specified in their training manuals that the procedures should be performed by students during simulator training at least to the point of selecting the hydraulic system B flight control switch to the standby rudder position. (These 5 air carriers accounted for about 40 percent of the total 737 airplanes operated by the air carriers.) Thus, pilots for more than one-half of U.S. air carrier operators of the 737 airplanes (7 of the 12 air carriers included in the Board's survey) were not being provided the opportunity to practice the responses to a jammed or restricted rudder (including a rudder reversal) that might be most effective in relieving or overcoming the effects of a jammed main rudder PCU servo valve.

Further, although Boeing has published and disseminated information about the crossover airspeed phenomenon,³⁶² only one-half of the 12 air carriers contacted by the Safety Board in July 1998 were providing 737 flight crews with a demonstration of crossover airspeed in a flight simulator. Moreover, the training materials for only one-third of the 12 air carriers (accounting for about 72 percent of the 737 airplanes) required a demonstration of the crossover airspeed to pilots in the flaps 1 configuration (in which the airplane can reach the crossover airspeed before the 1 G stickshaker speed). Thus, pilots for as many as two-thirds of the U.S. air carrier operators of the 737 were not being provided experience that demonstrated the inability to control the airplane at some speeds and configurations by using only the roll controls during a rudder hardover condition. The Safety Board is also concerned that flight tests conducted as part of the USAir flight 427 investigation showed that the simulator package developed by Boeing and implemented in the air carriers' training simulators did not adequately simulate the crossover airspeed phenomenon. In addition, the Safety Board is concerned that Boeing has not updated its existing simulator package, even though the data needed to do so is readily available as a result of these flight tests.

The Safety Board concludes that the training being provided to many 737 flight crews on the procedures for recovering from a jammed or restricted rudder (including a rudder reversal) is inadequate. Therefore, the Safety Board believes that the FAA should require all 14 CFR Part 121 air carrier operators of the 737 to provide their flight crews with initial and recurrent flight simulator training in the "Uncommanded Yaw or Roll" and "Jammed or Restricted Rudder" procedures in Boeing's 737 Operations Manual. The training should demonstrate the inability to control the airplane at some speeds and configurations by using the roll controls (the crossover airspeed phenomenon) and include performance of both procedures in their entirety. Because of this new safety recommendation and the FAA's failure to fully address Safety Recommendation A-97-18, the earlier recommendation is classified "Closed—Unacceptable Response/Superceded." In addition, the Safety Board believes that the FAA should require Boeing to update its 737 simulator package to reflect flight test data on crossover airspeed and then require all operators of the 737 to incorporate these changes in their simulators used for 737 pilot training.

³⁶² Boeing discussed crossover airspeed extensively in the July 1997 *Flight Operations Review* article entitled "737 Directional Control." (See section 1.18.10.2.3.)

Finally, the Safety Board is extremely concerned that, more than 4 years after the USAir flight 427 accident, two smaller U.S. 737 operators (accounting for 16 of the 1,070 total 737 airplanes operated by the 12 air carriers) were continuing to use minimum maneuvering speed schedules that permit operation of the 737 in the flaps 1 configuration at airspeeds (158 and 164 knots) that are as much as 30 knots slower than the 1 G crossover airspeed. (The FAA had accepted the use of these minimum maneuvering speed schedules.) In addition, the Board is concerned that the Boeing-recommended block maneuvering speeds schedule specifies 190 knots, which only slightly exceeds the 1 G crossover airspeed, as the minimum speed for a 737 operating at a gross weight of 110,000 pounds in the flaps 1 configuration. Only one-third of the 12 U.S. 737 air carrier operators contacted by the Safety Board in July 1998 (accounting for 66 percent of the 737 airplanes) actively promoted the practice of adding 10 knots to the 737 block maneuvering speeds (for which Boeing has expressed neither support nor disapproval).

The Safety Board concludes that the continued use by air carriers of airspeeds below the existing block maneuvering speed schedule presents an unacceptable hazard and that the existing block maneuvering speed for the flaps 1 configuration provides an inadequate margin of controllability in the event of a rudder hardover. Therefore, the Safety Board believes that the FAA should evaluate the 737's block maneuvering speed schedule to ensure the adequacy of airspeed margins above crossover airspeed for each flap configuration, provide the results of the evaluation to air carrier operators of the 737 and the Safety Board, and require Boeing to revise block maneuvering speeds to ensure a safe airspeed margin above crossover airspeed.

2.8 Flight Data Recorder Capabilities

The airplanes involved in the United flight 585 and USAir flight 427 accidents were required by existing regulations (14 CFR Section 121.343) to have FDRs that recorded 5 and 11 parameters, respectively.³⁶³ If these airplanes had been equipped with FDRs with additional parameters, that information would have undoubtedly allowed quick identification of critical control surface movements and their sources and other airplane system conditions that could have been involved in the loss of airplane control. Thus, investigators would have been able to more quickly rule out certain factors, when warranted, and focus on other areas.

The Safety Board has addressed the importance of improving the quality and amount of data recorded by FDRs in several recent aviation accident reports and safety recommendations. In February 1995, the Safety Board issued urgent Safety Recommendation A-95-25, urging the FAA to

Require that each Boeing 737 airplane operated under 14 CFR Parts 121 or 125 be equipped, by December 31, 1995, with a flight data recorder system that records, at a minimum, the parameters required by current regulations

³⁶³ As previously discussed (see section 1.11.2), although existing regulations required the FDR that was installed on the USAir flight 427 airplane to record 11 parameters, the accident airplane's FDR recorded 13 parameters.

applicable to that airplane plus the following parameters (recorded at the sampling rates specified in "Proposed Minimum FDR Parameter Requirements for Airplanes in Service"): lateral acceleration; flight control inputs for pitch, roll, and yaw; and primary flight control surface positions for pitch, roll, and yaw.³⁶⁴

The FAA indicated that it agreed with the intent of the Safety Board's recommendation. However, the FAA did not meet the recommendation's proposed December 31, 1995, retrofit completion date, characterizing it as "an extremely aggressive schedule." The Safety Board repeatedly expressed its disappointment with the FAA's lack of action and urged the FAA to act promptly because of the criticality of the issue and the persisting reports of unexplained 737 in-flight disturbances.

More than 1 year after the FAA's response to Safety Recommendation A-95-25 (and almost 6 months after the recommended December 31, 1995, FDR retrofit completion date), the Eastwind flight 517 incident occurred. The Safety Board's July 1, 1996, letter to the FAA indicated the Board's belief that the Eastwind incident could have become the third fatal 737 upset accident for which inadequate FDR information would have hampered an investigation. Because the FAA had not acted in the time frame proposed by the Safety Board in its urgent safety recommendation, the FDR recordings from the Eastwind incident airplane did not provide sufficient data to identify rudder surface and rudder pedal movements. If this information had been available, investigators would have been better able to understand the Eastwind incident and, more importantly, would likely have gained significant additional insight into previous upset events, such as the USAir flight 427 and United flight 585 accidents. In 1996, Safety Recommendation A-95-25 was placed on the Safety Board's list of Most Wanted Safety Improvements.

In its July 9, 1997, final rule, the FAA required that new and existing transport-category airplanes "be equipped to record the parameters recommended by the Board" with final compliance required by August 19, 2002. Although the Safety Board considered the FAA's action a major improvement over the former FDR requirements, the Board disagreed that the FAA's requirements for retrofitting existing airplanes included all parameters recommended by the Board in its urgent safety recommendation.³⁶⁵ Further, the Safety Board was disappointed with the extended time frame and incremental increases allowed for compliance with the new FDR requirements, especially for 737 airplanes.

In its July 22, 1997, letter to the Safety Board, the FAA stated that the retrofit modification should be accomplished "at the earliest practicable time" but no later than the next heavy maintenance check after August 18, 1999. During the Safety Board's investigation of the February 23, 1999, Metrojet upset event, the Board learned that the incident airplane was scheduled for a heavy maintenance check in March 1999 but was

³⁶⁴ See section 1.18.11.4 for more information on previous FDR safety recommendations.

³⁶⁵ The Safety Board recommended (but the FAA did not require) that airplanes manufactured before 1991 record data for the following parameters: pitch trim; thrust reverser position; flaps, leading edge slats, and ground spoiler positions; angle-of-attack; and outside and total air temperatures.

not scheduled to receive the required FDR upgrade until its heavy maintenance check in March 2001. Therefore, the Safety Board is concerned that some air carriers may have disregarded the directive to accomplish the upgrade at the earliest practicable time and may have interpreted the rule to require no action until after August 18, 1999. However, the Safety Board notes that at least one U.S. 737 operator (Southwest Airlines) has aggressively pursued the FDR upgrade within its fleet and anticipates having all its airplanes' FDRs upgraded by December 1999 (about 1½ years before the modification completion date mandated by the FAA).

As previously discussed, several 737 rudder-related events have been associated with the yaw damper system, which moves the rudder without any corresponding movement of the flight crew's rudder pedals. To adequately monitor this system, FDRs would have to record several parameters that are not required by the FAA's July 1997 final rule regarding upgraded FDRs. By documenting the yaw damper's operation (command voltage to the rudder and on/off discrete indication) and the resultant rudder surface movement, a yaw damper event could quickly be distinguished from a flight crew input or a rudder anomaly.

Additionally, upgraded FDRs are expected to record the pilots' flight control inputs and the flight control surface movements. However, the FAA is not requiring the FDRs on existing airplanes, including 737s,³⁶⁶ and those manufactured before August 2002 to be upgraded to record the pilots' flight control input forces. The Safety Board considers documentation of pilot flight control input forces to be critical in determining the pilots' role in a flight control-related event and notes that such documentation appears especially critical in the case of the 737. If pilot flight control input forces had been recorded for the USAir flight 427, United flight 585, and Eastwind flight 517 airplanes, these investigations would have been resolved more promptly, and actions to prevent future similar events would have been hastened.

Parameters such as pitch trim, thrust reverser position, and leading and trailing edge flap positions would also provide potentially valuable information to accident investigators. The Safety Board issued Safety Recommendations A-95-26 and A-95-27 in February 1995, stating that FDRs installed on all airplanes operated under 14 CFR Parts 121, 125, or 135 should be upgraded to record these parameters. Although such an upgrade would be easily accomplished on airplanes equipped with flight data acquisition units (FDAU), the FAA, to date, has not required that affected airplanes be upgraded accordingly.

The Safety Board concludes that the FDR upgrade modifications required by the FAA for existing airplanes are inadequate because they do not require the FDR to be modified to record yaw damper command voltage; yaw damper and standby rudder on/off

³⁶⁶ Title 14 CFR Section 25.1459(e) states that "any novel or unique design or operational characteristics of the aircraft shall be evaluated to determine if any dedicated parameters must be recorded on flight recorders in addition to or in place of existing requirements." The Safety Board notes that the 737's unique rudder actuation system design and rudder system service history justify the recording of additional parameters on 737 FDRs.

discrete indications; pitch trim; thrust reverser position; leading and trailing edge flap positions; and pilot flight control input forces for control wheel, control column, and rudder pedals. Further, the Safety Board concludes that, on the basis of the rudder-related anomalies discussed in this report, FDR documentation of yaw damper command voltage; yaw damper and standby rudder on/off discrete indications; and pilot flight control input forces for control wheel, control column, and rudder pedals is especially important in the case of the 737, and these parameters should be sampled on 737 airplanes at frequent intervals to provide optimal documentation.

Therefore, the Safety Board believes that the FAA should require that all 737 airplanes operated under 14 CFR Parts 121 or 125 that currently have a FDAU be equipped, by July 31, 2000, with an FDR system that records, at a minimum, the parameters required by FAA Final Rules 121.344 and 125.226, dated July 17, 1997, applicable to that airplane plus the following parameters: pitch trim; trailing edge and leading edge flaps; thrust reverser position (each engine); yaw damper command; yaw damper on/off discrete; standby rudder on/off discrete; and control wheel, control column, and rudder pedal forces (with yaw damper command; yaw damper on/off discrete; and control wheel, control column, and rudder pedal forces sampled at a minimum rate of twice per second).

Further, the Safety Board believes that the FAA should require that all 737 airplanes operated under 14 CFR Parts 121 or 125 that are not equipped with a FDAU be equipped, at the earliest time practicable but no later than August 1, 2001, with an FDR system that records, at a minimum, the parameters required by FAA Final Rules 121.344 and 125.226, dated July 17, 1997, applicable to that airplane plus the following parameters: pitch trim; trailing edge and leading edge flaps; thrust reverser position (each engine); yaw damper command; yaw damper on/off discrete; standby rudder on/off discrete; and control wheel, control column, and rudder pedal forces (with yaw damper command; yaw damper on/off discrete; and control wheel, control column, and rudder pedal forces sampled at a minimum rate of twice per second).

The Safety Board notes that 737 flight crews continue to report anomalous rudder behaviors, and it is possible that another catastrophic 737 upset-related accident could occur. If such an accident occurs before August 19, 2001, it is likely that the data recorded by the accident airplane's FDR will not be sufficient for investigators to readily identify the events leading to the upset and develop corrective actions to prevent future similar accidents. Therefore, the Safety Board concludes that the FAA's failure to require timely and aggressive action regarding enhanced FDR recording capabilities, especially on 737 airplanes, has significantly hampered the prompt identification of potentially critical safety-of-flight conditions and the development of safety recommendations to prevent future catastrophic accidents.

3. Conclusions

3.1 Findings

Note: Because the Safety Board's analysis of the USAir flight 427 accident also included analysis of the United flight 585 accident and the Eastwind flight 517 incident, some of the findings pertain to these two events.

1. The USAir flight 427 flight crew was properly certificated and qualified and had received the training and off-duty time prescribed by Federal regulations. No evidence indicated any preexisting medical or behavioral conditions that might have adversely affected the flight crew's performance during the accident flight.
2. The USAir flight 427 accident airplane was equipped, maintained, and operated in accordance with applicable Federal regulations. The airplane was dispatched in accordance with Federal Aviation Administration- and industry-approved practices.
3. All of USAir flight 427's doors were closed and locked at impact.
4. USAir flight 427 did not experience an in-flight fire, bomb, explosion, or structural failure.
5. A midair collision with other air traffic, a bird strike, clear air turbulence, or other atmospheric phenomena were not involved in the USAir flight 427 accident.
6. Asymmetrical engine thrust reverser deployment, asymmetrical spoiler/aileron activation, transient electronic signals causing uncommanded flight control movements, yaw damper malfunctions, and a rudder cable pull or break were not factors in the USAir flight 427 accident.
7. Although USAir flight 427 encountered turbulence from Delta flight 1083's wake vortices, the wake vortex encounter alone would not have caused the continued heading change that occurred after 1903:00.
8. About 1903:00, USAir flight 427's rudder deflected rapidly to the left and reached its left aerodynamic blowdown limit shortly thereafter.
9. Analysis of the human performance data shows that it is likely that the first officer made the first pilot control response to the upset event and manipulated the flight controls during the early stages of the accident sequence; although it is likely that both pilots manipulated the flight controls later in the accident sequence, it is unlikely that the pilots simultaneously manipulated the controls (possibly opposing each other) during the critical period in which the airplane yawed and rolled to the left.

10. Analysis of the human performance data (including operational factors) does not support a scenario in which the flight crew of USAir flight 427 applied and held a full left rudder input until ground impact more than 20 seconds later.
11. Analysis of the cockpit voice recorder, National Transportation Safety Board computer simulation, and human performance data (including operational factors) from the USAir flight 427 accident shows that they are consistent with a rudder reversal most likely caused by a jam of the main rudder power control unit servo valve secondary slide to the servo valve housing offset from its neutral position and overtravel of the primary slide.
12. The flight crew of USAir flight 427 recognized the initial upset in a timely manner and took immediate action to attempt a recovery but did not successfully regain control of the airplane.
13. The flight crew of USAir flight 427 could not be expected to have assessed the flight control problem and then devised and executed the appropriate recovery procedure for a rudder reversal under the circumstances of the flight.
14. It is very unlikely that the loss of control in the United flight 585 accident was the result of an encounter with a mountain rotor.
15. Analysis of the cockpit voice recorder, National Transportation Safety Board computer simulation, and human performance data (including operational factors) from the United Airlines flight 585 accident shows that they are consistent with a rudder reversal most likely caused by a jam of the main rudder power control unit servo valve secondary slide to the servo valve housing offset from its neutral position and overtravel of the primary slide.
16. The flight crew of United flight 585 recognized the initial upset in a timely manner and took immediate action to attempt a recovery but did not successfully regain control of the airplane.
17. The flight crew of United flight 585 could not be expected to have assessed the flight control problem and then devised and executed the appropriate recovery procedure for a rudder reversal under the circumstances of the flight.
18. Training and piloting techniques developed as a result of the USAir flight 427 accident show that it is possible to counteract an uncommanded deflection of the rudder in most regions of the flight envelope; such training was not yet developed and available to the flight crews of USAir flight 427 or United flight 585.
19. During the Eastwind flight 517 incident, the rudder reversed, moving to its right blowdown limit when the captain commanded left rudder, consistent with a jam of the main rudder power control unit servo valve secondary slide to the servo valve housing offset from its neutral position and overtravel of the primary slide.

20. It is possible that, in the main rudder power control units from the USAir flight 427, United flight 585, and Eastwind flight 517 airplanes (as a result of some combination of tight clearances within the servo valve, thermal effects, particulate matter in the hydraulic fluid, or other unknown factors), the servo valve secondary slide could jam to the servo valve housing at a position offset from its neutral position without leaving any obvious physical evidence and that, combined with a rudder pedal input, could have caused the rudder to move opposite to the direction commanded by a rudder pedal input.
21. The upsets of USAir flight 427, United flight 585, and Eastwind flight 517 were most likely caused by the movement of the rudder surfaces to their blowdown limits in a direction opposite to that commanded by the pilots. The rudder surfaces most likely moved as a result of jams of the secondary slides to the servo valve housings offset from their neutral position and overtravel of the primary slides.
22. When completed, the rudder system design changes to the Boeing 737 should preclude the rudder reversal failure mode that most likely occurred in the USAir flight 427 and United flight 585 accidents and the Eastwind flight 517 incident.
23. Rudder design changes to Boeing 737-next-generation series airplanes and the changes currently being retrofitted on the remainder of the Boeing 737 fleet do not eliminate the possibility of other potential failure modes and malfunctions in the Boeing 737 rudder system that could lead to a loss of control.
24. The dual-concentric servo valve used in all Boeing 737 main rudder power control units is not reliably redundant.
25. A reliably redundant rudder actuation system is needed for the Boeing 737, despite significant improvements made in the system's design.
26. The results of this investigation have disclosed that the Boeing 737 rudder system design certificated by the Federal Aviation Administration is not reliably redundant.
27. Transport-category airplanes should be shown to be capable of continued safe flight and landing after a jammed flight control in any position unless the jam can be shown to be extremely improbable.
28. Pilots would be more likely to recover successfully from an uncommanded rudder reversal if they were provided the necessary knowledge, procedures, and training to counter such an event.
29. A neutral rudder pedal position is not a valid indicator that a rudder reversal in the Boeing 737 has been relieved.
30. The training being provided to many Boeing 737 flight crews on the procedures for recovering from a jammed or restricted rudder (including a rudder reversal) is inadequate.

31. The continued use by air carriers of airspeeds below the existing block maneuvering speed schedule presents an unacceptable hazard, and the existing block maneuvering speed for the flaps 1 configuration provides an inadequate margin of controllability in the event of a rudder hardover.
32. The flight data recorder (FDR) upgrade modifications required by the Federal Aviation Administration for existing airplanes are inadequate because they do not require the FDR to be modified to record yaw damper command voltage; yaw damper and standby rudder on/off discrete indications; pitch trim; thrust reverser position; leading and trailing edge flap positions; and pilot flight control input forces for control wheel, control column, and rudder pedals.
33. On the basis of the rudder-related anomalies discussed in this report, flight data recorder documentation of yaw damper command voltage; yaw damper and standby rudder on/off discrete indications; and pilot flight control input forces for control wheel, control column, and rudder pedals is especially important in the case of the 737, and these parameters should be sampled on 737 airplanes at frequent intervals to provide optimal documentation.
34. The Federal Aviation Administration's failure to require timely and aggressive action regarding enhanced flight data recorder recording capabilities, especially on Boeing 737 airplanes, has significantly hampered investigators in the prompt identification of potentially critical safety-of-flight conditions and in the development of recommendations to prevent future catastrophic accidents.

3.2 Probable Cause

The National Transportation Safety Board determines that the probable cause of the USAir flight 427 accident was a loss of control of the airplane resulting from the movement of the rudder surface to its blowdown limit. The rudder surface most likely deflected in a direction opposite to that commanded by the pilots as a result of a jam of the main rudder power control unit servo valve secondary slide to the servo valve housing offset from its neutral position and overtravel of the primary slide.

4. Recommendations

As a result of the investigation of the USAir flight 427 accident, the National Transportation Safety Board makes the following recommendations to the Federal Aviation Administration:

Require that all existing and future Boeing 737s have a reliably redundant rudder actuation system. (A-99-20)

Convene an engineering test and evaluation board to conduct a failure analysis to identify potential failure modes, a component and subsystem test to isolate particular failure modes found during the failure analysis, and a full-scale integrated systems test of the Boeing 737 rudder actuation and control system to identify potential latent failures and validate operation of the system without regard to minimum certification standards and requirements in 14 Code of Federal Regulations Part 25. Participants in the engineering test and evaluation board should include the Federal Aviation Administration (FAA); National Transportation Safety Board technical advisors; the Boeing Company; other appropriate manufacturers; and experts from other government agencies, the aviation industry, and academia. A test plan should be prepared that includes installation of original and redesigned Boeing 737 main rudder power control units and related equipment and exercises all potential factors that could initiate anomalous behavior (such as thermal effects, fluid contamination, maintenance errors, mechanical failure, system compliance, and structural flexure). The engineering board's work should be completed by March 31, 2000, and published by the FAA. (A-99-21)

Ensure that future transport-category airplanes certificated by the Federal Aviation Administration provide a reliably redundant rudder actuation system. (A-99-22)

Amend 14 Code of Federal Regulations Section 25.671(c)(3) to require that transport-category airplanes be shown to be capable of continued safe flight and landing after jamming of a flight control at any deflection possible, up to and including its full deflection, unless such a jam is shown to be extremely improbable. (A-99-23)

Revise Airworthiness Directive 96-26-07 so that procedures for addressing a jammed or restricted rudder do not rely on the pilots' ability to center the rudder pedals as an indication that the rudder malfunction has been successfully resolved, and require Boeing and U.S. operators of Boeing 737s to amend their Airplane Flight Manuals and Operations Manuals accordingly. (A-99-24)

Require all 14 Code of Federal Regulations Part 121 air carrier operators of the Boeing 737 to provide their flight crews with initial and recurrent flight simulator training in the "Uncommanded Yaw or Roll" and "Jammed or Restricted Rudder" procedures in Boeing's 737 Operations Manual. The training should demonstrate the inability to control the airplane at some speeds and configurations by using the roll controls (the crossover airspeed phenomenon) and include performance of both procedures in their entirety. (A-99-25)

Require Boeing to update its Boeing 737 simulator package to reflect flight test data on crossover airspeed and then require all operators of the Boeing 737 to incorporate these changes in their simulators used for Boeing 737 pilot training. (A-99-26)

Evaluate the Boeing 737's block maneuvering speed schedule to ensure the adequacy of airspeed margins above crossover airspeed for each flap configuration, provide the results of the evaluation to air carrier operators of the Boeing 737 and the National Transportation Safety Board, and require Boeing to revise block maneuvering speeds to ensure a safe airspeed margin above crossover airspeed. (A-99-27)

Require that all Boeing 737 airplanes operated under 14 Code of Federal Regulations Parts 121 or 125 that currently have a flight data acquisition unit be equipped, by July 31, 2000, with a flight data recorder system that records, at a minimum, the parameters required by Federal Aviation Administration Final Rules 121.344 and 125.226, dated July 17, 1997, applicable to that airplane plus the following parameters: pitch trim; trailing edge and leading edge flaps; thrust reverser position (each engine); yaw damper command; yaw damper on/off discrete; standby rudder on/off discrete; and control wheel, control column, and rudder pedal forces (with yaw damper command; yaw damper on/off discrete; and control wheel, control column, and rudder pedal forces sampled at a minimum rate of twice per second). (A-99-28)

Require that all Boeing 737 airplanes operated under 14 Code of Federal Regulations Parts 121 or 125 that are not equipped with a flight data acquisition unit be equipped, at the earliest time practicable but no later than August 1, 2001, with a flight data recorder system that records, at a minimum, the parameters required by Federal Aviation Administration Final Rules 121.344 and 125.226, dated July 17, 1997, applicable to that airplane plus the following parameters: pitch trim; trailing edge and leading edge flaps; thrust reverser position (each engine); yaw damper command; yaw damper on/off discrete; standby rudder on/off discrete; and control wheel, control column, and rudder pedal forces (with yaw damper command; yaw damper on/off discrete; and control wheel, control column, and rudder pedal forces sampled at a minimum rate of twice per second). (A-99-29)

BY THE NATIONAL TRANSPORTATION SAFETY BOARD

James E. Hall
Chairman

John A. Hammerschmidt
Member

Robert T. Francis
Vice Chairman

George W. Black
Member

Member **John J. Goglia** did not participate.

March 24, 1999

5. Appendixes

Appendix A Investigation and Hearing

Investigation

The National Transportation Safety Board was initially notified of this accident about 1920 on September 8, 1994. A full go-team was assembled that evening, but because of the lack of availability of a Federal Aviation Administration (FAA) airplane or commercial flights, the team did not depart the Washington, D.C., area until the morning of September 9, 1994. The team arrived at the accident site about 0730. The following investigative teams were formed: Operations, Human Performance, Aircraft Structures, Aircraft Systems, Powerplants, Maintenance Records, Air Traffic Control, Survival Factors, Aircraft Performance, Meteorology, and Witnesses. Specialists were also assigned to stand by in the Safety Board laboratories for the cockpit voice recorder and flight data recorder. Because of the magnitude of the accident, two Safety Board investigators were assigned to most groups on scene. Accompanying the team were Board Member Carl Vogt, his special assistant, the Deputy Managing Director, and a representative of the Safety Board's Public Affairs office.

Parties to the investigation included the FAA; Boeing Commercial Airplane Group; Air Line Pilots Association; USAir, Inc.; National Air Traffic Controllers Association; CFM International; AVIALL; International Association of Machinists and Aerospace Workers; Transportation Workers Union No. 545; the Association of Flight Attendants; Parker Berta Aerospace/Parker Hannifin Corporation; and Monsanto Company. Assistance was also provided by the Federal Bureau of Investigation, Armed Forces Institute of Pathology, Hopewell Township, Pennsylvania State Police, Pennsylvania Emergency Management Agency, the Beaver County Coroner's Office, and emergency response personnel from Beaver and Allegheny Counties.

Additionally, air safety investigators from the aircraft accident investigation authorities from the United Kingdom, France, Denmark, Australia, and Canada participated in the investigation as technical observers in accordance with prior arrangements for such participation.

Public Hearing

Two sessions of a public hearing were conducted for this accident. The first session was held on January 23 through 27, 1995. The second session was held on November 15 through 17, 1995. Parties to the public hearing were the FAA, Boeing, Air Line Pilots Association, USAir, International Association of Machinists and Aerospace Workers, Parker Berta Aerospace/Parker Hannifin Corporation, and Monsanto Company.

Appendix B

Cockpit Voice Recorder Transcript

The following is a transcript of the Fairchild A-100 cockpit voice recorder (CVR) installed on the Boeing 737-300, N513AU, that crashed while approaching Pittsburgh International Airport, Pittsburgh, Pennsylvania, on September 8, 1994.

LEGEND

RDO	Radio transmission from accident aircraft
CAM	Voice or sound source recorded through cockpit area microphone
HOT	Voice or sound source recorded through cockpit hot microphone
PA	Voice or sound source recorded through public address system
JSAP	Voice or sound source recorded through jumpseat audio panel
-1	Voice identified as captain
-2	Voice identified as first officer
-3	Voice identified as female flight attendant
-4	Voice identified as male flight attendant
CTR-?	Radio transmission from unidentified Center controller
CLE1	Radio transmission from 1st Cleveland Center controller
CLE2	Radio transmission from 2nd Cleveland Center controller
CLE3	Radio transmission from 3rd Cleveland Center controller
CLE4	Radio transmission from 4th Cleveland Center controller
ATIS	Radio transmission from Pittsburgh automatic terminal information service
APR1	Radio transmission from 1st Pittsburgh approach controller
APR2	Radio transmission from 2nd Pittsburgh approach controller
US1417	Radio transmission from USAir flight 1417
US1499	Radio transmission from USAir flight 1499
US1874	Radio transmission from USAir flight 1874
US1462	Radio transmission from USAir flight 1462
US1674	Radio transmission from USAir flight 1674
DL1083	Radio transmission from Delta flight 1083
US374	Radio transmission from USAir flight 374

285LM	Radio transmission from aircraft 285 LM
US309	Radio transmission from USAir flight 309
*	Unintelligible word
@	Nonpertinent word
#	Expletive
%	Break in continuity
()	Questionable insertion
[]	Editorial insertion
....	Pause

Note: The CVR transcript reflects the final 30 minutes 56 seconds of the accident flight. Times are expressed in eastern daylight time, based on a 24-hour clock.

INTRA-COCKPIT COMMUNICATION

AIR-GROUND COMMUNICATION

TIME & SOURCE	CONTENT	TIME & SOURCE	CONTENT
START of RECORDING			
START of TRANSCRIPT			
1835:04 HOT-1	[sound similar to person yawning]	1832:29 CTR-?	... contact Chicago's Cleveland center one two six point niner seven.
1837:46 CAM	[interruption in CVR audio similar to passing of CVR tape splice]	1832:33 RDO-1	twenty six ninety seven, USAir four twenty seven, good day.
		1833:08 RDO-1	center USAir four twenty seven at two nine oh.
		1833:14 CLE2	USAir four twenty seven, Cleveland center roger.
		1833:32 CLE2	USAir four twenty seven, cleared direct to uh, Akron, rest of route unchanged give me the best forward airspeed in-trail spacing.
		1833:37 RDO-1	direct Akron, best forward, you got it, four twenty seven USAir.

INTRA-COCKPIT COMMUNICATION

TIME & SOURCE **CONTENT**

1843:32
HOT-1 had a four and a seven in it.
1843:34
HOT-2 ha ha ha.

AIR-GROUND COMMUNICATION

TIME & SOURCE **CONTENT**

1838:00
RDO-1 blocked.
1840:38
CLE2 USAir four twenty seven, contact Cleveland center one one niner point eight seven.
1840:43
RDO-1 nineteen eighty seven, USAir four twenty seven, good day.
1840:50
RDO-1 Cleveland, USAir four twenty seven at two niner zero.
1840:54
CLE3 USAir four twenty seven Cleveland center roger and what is the indicated airspeed now?
1840:57
RDO-1 uh, we're indicating uh, 'bout uh, three hundred uh, assigned.
1843:23
CLE3 USAir fourteen seventeen, contact Cleveland center one three three point three seven.
1843:27
US1417 three three three seven, USAir's uh, fourteen seventeen. good day.

INTRA-COCKPIT COMMUNICATION

AIR-GROUND COMMUNICATION

TIME & SOURCE	CONTENT	TIME & SOURCE	CONTENT
1843:37 HOT-1	do you wanta let 'em up for a while?		
1843:42 CAM	[sound of single chime similar to seat belt switch being moved]	1845:31 CLE3	USAir four twenty seven, descend and maintain flight level two four zero.
1845:55 HOT-2	ah you piece of #.	1845:35 RDO-1	out of two nine oh for two four oh, USAir four twenty seven.
1845:56 HOT-1	what?		
1845:58 HOT-2	I said, aw c'mon, you piece of #, this damn thing is so # slow.		
1846:07 HOT-2	there it is.	1847:23 CLE3	USAir four twenty seven contact Cleveland center one two eight point one five.
		1847:27 RDO-1	twenty eight fifteen, USAir four twenty seven. good

AIR-GROUND COMMUNICATION

TIME & SOURCE	CONTENT	TIME & SOURCE	CONTENT
1847:35 RDO-1		day. center, USAir four twenty seven descending two four oh.	
1847:38 CLE4		USAir four twenty seven Cleveland center roger.	
1850:11 DL1083		and center, Delta ten eighty three's with you leaving seventeen five going down to one one thousand.	
1850:15 CLE4		Delta ten eighty three Cleveland center, roger. cross CUTTA at one zero thousand. Pit altimeter three zero one one.	
1850:21 DL1083		CUTTA at ten thousand, Delta ten eighty three.	
1850:56 CLE4		USAir four twenty seven cross CUTTA at and maintain one zero thousand Pit altimeter three zero one one.	
1851:01 RDO-1		CUTTA at ten, thirty eleven, USAir four twenty seven.	

INTRA-COCKPIT COMMUNICATION

TIME & SOURCE	CONTENT
1850:18 CAM	[aural tone similar to altitude alert]
1851:08 HOT-2	ten, CUTTA.
1851:11 HOT-1	it's true.

INTRA-COCKPIT COMMUNICATION

AIR-GROUND COMMUNICATION

TIME & SOURCE	CONTENT	TIME & SOURCE	CONTENT
1851:18 HOT-1	I'm off.		
1851:18 HOT-2	alright.	1851:22 ATIS	..Pittsburgh tower arrival information Yankee. two one five two Zulu weather. two five thousand scattered. visibility one five. temperature seven five. dew point five one. wind, two seven zero at one zero. altimeter three zero one zero. multiple approaches ILS runway three two and ILS runway two eight right in use. notams, runway two eight right middle marker decommissioned. south entrance Air Force Reserve ramp closed. Morgantown vortac out of service. advise on initial contact you have information Yankee.
1851:54 HOT-1	three two and two eight right.		
1851:57 HOT-2	three two and two eight right?		
1851:58 HOT-1	yep.		
1851:59 HOT-?	*		
1852:18 HOT-2	oh why did it **?		
1853:15			

AIR-GROUND COMMUNICATION

INTRA-COCKPIT COMMUNICATION

TIME & SOURCE	CONTENT	TIME & SOURCE	CONTENT
---------------	---------	---------------	---------

CAM [sound similar to cockpit door being opened and closed]

1853:26

CAM-3 um, they didn't give us connecting flight information or anything. do you know what gate we're coming in on?

1853:29

CAM-1 not yet.

1853:30

CAM-3 any idea *

1853:31

CAM-1 no.

1853:32

CAM-3 doya' know what I'm thinkin' about? pretzels.

1853:34

HOT-1 pretzels.

1853:37

CAM-3 you guys need drinks here?

1853:38

CAM-1 uh, I could use a glass of somethin', whatever's open. water uh, water, a juice..

1853:44

CAM-2 I'll splita yeah. a water, a juice, whatever's back there I'll split one with 'im.

1853:48

CAM-3 OKedoky.

AIR-GROUND COMMUNICATION

TIME & SOURCE	CONTENT	TIME & SOURCE	CONTENT
1853:51 CAM-3	do you want me to make you my special fruity juice cocktail? (you wanna try it?)		
1853:56 CAM-1	how fruity is it?		
1853:57 CAM-3	(try it?)		
1853:58 HOT-2	alright, I'll be a guinea pig.		
1854:02 CAM	[sound similar to cockpit door being closed]		
1854:07 HOT-1	[sound similar to person taking a deep breath]	1854:19 CLE4	Delta ten eighty three, reduce speed to two ten. contact Pit approach one two one point two five.
		1854:24 DL1083	twenty one twenty five, good day.
		1854:27 CLE4	USAir four twenty seven cross CUTTA one zero thousand two five zero knots now.
		1854:30 RDO-1	ten two fifty over CUTTA, USAir four twenty seven.
1854:36 HOT-2	this thing's gonna scream and holler. I can't do that.		

AIR-GROUND COMMUNICATION

TIME & SOURCE	CONTENT	TIME & SOURCE	CONTENT
1854:42 HOT-1	thirty eleven.		
1854:43 HOT-2	thirty eleven set.		
1854:44 HOT-1	you can't make it?		
1854:45 HOT-2	it's gonna say it can't.		
1854:49 HOT-2	because its it it uh, it'll do it. I'll make it do it.		
1854:53 CAM	[sound of unidentified click]		
1854:55 HOT-2	see, it's callin' me names like it did you.	1856:16 CLE4	USAir four twenty seven reduce speed to two one zero now that's at the request of Pit approach I'll take the speed first.
		1856:22 RDO-1	OK speed back to two ten USAir four twenty seven. uh, we'll do our best to make the restriction.
		1856:27 CLE4	don't have to now. just uh, speed first uh, pd to ten.
		1856:31 RDO-1	you got it.

INTRA-COCKPIT COMMUNICATION

INTRA-COCKPIT COMMUNICATION

AIR-GROUND COMMUNICATION

TIME & SOURCE	CONTENT	TIME & SOURCE	CONTENT
1856:43 HOT-1	two ten, he said.	1856:32 CLE4	USAir four twenty seven, contact Pit approach one two one point two five.
1856:45 HOT-2	two ten? oh, I heard two fifty, #.	1856:36 RDO-1	twenty one twenty five, USAir four twenty seven, good day.
1856:49 HOT-1	I may have misunderstood him.	1856:52 RDO-1	approach, USAir four twenty seven is descending to ten.
1857:07 CAM	[sound similar to cockpit door being opened]	1856:55 APR	Shuttle twenty nine zero eight, turn right heading zero niner zero. contact approach one two three point niner five.
1857:08		1857:05 APR	USAir fourteen ninety nine, turn left heading one zero zero. contact approach one two four point one five.

AIR-GROUND COMMUNICATION

TIME & SOURCE	CONTENT	TIME & SOURCE	CONTENT
CAM-3	here it is.		
1857:09 HOT-1	alright.		
1857:09 HOT-2	alright. thank you, thank you.		
1857:10 CAM-3	(now ** be fooled) if you don't like, I didn't taste 'em so I don't know if they came out right.	1857:11 US1499	one hundred degrees and twenty four fifteen, US fourteen ninety nine.
		1857:14 APR	USAir eighteen seventy four, descend and maintain six thousand.

INTRA-COCKPIT COMMUNICATION

1857:14 HOT-1	that's good [simultaneous with previous ATC transmission]
1857:15 CAM-3	*
1857:16 HOT-2	that is good ..
1857:17 CAM-3	it's good.
1857:17 HOT-2	..that is different. be real, be real good with some dark

INTRA-COCKPIT COMMUNICATION

AIR-GROUND COMMUNICATION

TIME & SOURCE	CONTENT	TIME & SOURCE	CONTENT
1857:20 CAM-3	rum in it. yeah right. (can I get you something else?)	1857:23 APR	USAir four twenty seven, Pittsburgh approach. heading one six zero vector ILS runway two eight right final approach course. speed two one zero.
1857:26 HOT-2	what kind of speed? OK.	1857:29 RDO-1	we're, comin' back to two ten and uh, one sixty heading down to ten, USAir four twenty seven, and uh, we have Yankee.
1857:40 HOT-1	what runway did he say? OK.	1857:43 APR	USAir fourteen sixty two, Pittsburgh approach heading zero four zero vector ILS three two final approach course.
1857:43 HOT-2	***		
1857:45 HOT-1	it tastes like a **		
1857:46 HOT-2	good.		

INTRA-COCKPIT COMMUNICATION

AIR-GROUND COMMUNICATION

TIME & SOURCE	CONTENT	TIME & SOURCE	CONTENT
1857:47 HOT-1	there's little grapefruit in it.		
1857:49 CAM-3	no. [sound of laughter]	1857:54 APR	USAir sixteen seventy four turn left heading one zero zero. contact approach one two four point one five.
1857:54 HOT-2	** cranberry.		
1857:55 CAM-3	yeah. you saw that from the color.	1858:00 US1674	twenty four fifteen and a hundred on the heading US sixteen seventy four.
1858:02 CAM-1	how else is in it?		
1858:03 CAM-2	uh, sprite?	1858:03 APR	Delta ten eighty three, descend and maintain six thousand.
1858:04 CAM-3	diet sprite.		
1858:06 CAM-2	huh.		

INTRA-COCKPIT COMMUNICATION

AIR-GROUND COMMUNICATION

TIME & SOURCE	CONTENT	TIME & SOURCE	CONTENT
1858:08 CAM-3	and I guess you could do it with sprite. probly be a little better if you do.	1858:07 DL1083	six thousand, ten eighty three.
1858:10 CAM-1	yeah, there's more?		
1858:11 CAM-3	one more.		
1858:13 CAM-2	ah.		
1858:13 HOT-2	oh jay?		
1858:14 CAM-3	you got it.	1858:14 APR	USAir three seventy four, turn right heading one one zero.
1858:17 HOT-2	huh.		
1858:17 CAM-3	cranberry orange and diet sprite.		
1858:17 CAM-2	really nice.		

INTRA-COCKPIT COMMUNICATION

AIR-GROUND COMMUNICATION

TIME & SOURCE	CONTENT	TIME & SOURCE	CONTENT
1858:18 CAM-3	it's different. could ya keep comin' out aaah, whataya' got different and ..		
1858:20 CAM-1	I always mix the cranberry and the grapefruit, I like that.	1858:21 APR	USAir eighteen seventy four, reduce speed please to one niner zero then continue the descent to maintain six thousand.
1858:24 CAM	[sound of aural tone similar to altitude alert]		
1858:25 CAM-3	** OK, back to work.		
1858:26 CAM-2	OK.		
1858:29 CAM	[sound similar to cockpit door opening and closing]		
1858:29 HOT-2	I suspect we're gonna get the right side.	1858:33 APR	USAir four twenty seven, descend and maintain six thousand.
		1858:36 RDO-1	cleared to six, USAir four twenty seven.

INTRA-COCKPIT COMMUNICATION

AIR-GROUND COMMUNICATION

TIME & SOURCE	CONTENT	TIME & SOURCE	CONTENT
1858:36 HOT-1	[intermittent static sound (heard on captain's channel only) lasting for three seconds]		
1858:48 CAM	[sound of click similar to approach plate clip being snapped]		
1858:50 HOT-2	oh my wife would like that [non-pertinent comment]		
1858:56 HOT-1	cranberry orange and sprite.	1858:57 APR	USAir sixteen seventy four, contact approach one two four point one five.
1858:58 HOT-2	yeah.		
1859:04 HOT-2	I guess we ought to do a preliminary Pete.		
1859:06 HOT-1	altimeters and flight instruments thirty eleven?		
1859:08 HOT-2	my side.		
1859:11 HOT-1	aah, where are we landing data is ...	1859:12 285LM	Pit, two eight five Lima Mike is thirteen for uhh, ten with

INTRA-COCKPIT COMMUNICATION

AIR-GROUND COMMUNICATION

TIME & SOURCE	CONTENT	TIME & SOURCE	CONTENT
1859:14 HOT-2	posted on my side for a hundred and nine.	1859:15 APR	Alleghey's Hotel. November two eight five Lima Mike, Pittsburgh approach. direct Montour vector ILS runway two eight final approach course.
1859:16 HOT-1	thirty three, forty three an two hundred.	1859:21 285LM	Montour on the vectors, Lima Mike...
1859:22 HOT-1	shoulder harness?	1859:24 APR	USAir fourteen sixty two, descend and maintain six thousand.
1859:25 HOT-2	on.		
1859:28 CAM	[sound of clicks similar to shoulder harness being fastened]		
1859:28 HOT-1	approach brief?	1859:30 APR	USAir three seventy four, contact approach one two

INTRA-COCKPIT COMMUNICATION

AIR-GROUND COMMUNICATION

TIME & SOURCE	CONTENT	TIME & SOURCE	CONTENT
1859:31 HOT-2	plan two eight right. two seventy nine inbound, one eleven seven.		three point niner five, good day.
1859:36 HOT-2	[sound similar to deep inhale and exhale]	1859:41 APR	USAir three zero nine, Pittsburgh approach, heading zero five zero vector ILS runway three two final approach course.
1859:54 HOT-1	ah, don't do this to me.		
1859:56 HOT-2	[sound of chuckle] froze up did it?	1900:08 APR	Delta ten eighty three, turn left heading one three zero. reduce speed to one niner zero.
1900:12 HOT-1	[intermittent static sound (heard on captain's channel only) for seventeen seconds]		
1900:12 HOT-1	I hate it when you don't hear the other transmissions.	1900:13 DL1083	one thirty one ninety speed, Delta ten eighty three.
1900:14			

INTRA-COCKPIT COMMUNICATION

AIR-GROUND COMMUNICATION

TIME & SOURCE	CONTENT	TIME & SOURCE	CONTENT
HOT-2	[chuckle] yeah.	1900:15 APR	USAir four twenty seven turn left heading one four zero, reduce speed to one niner zero.
1900:24 CAM	[sound of three clicks similar to flap handle being moved]	1900:20 RDO-1	OK, one four zero heading and one ninety on the speed, USAir four twenty seven.
1900:26 CAM	[sound of single chime similar to seat belt chime]		
1900:26 HOT-2	oops, I didn't kiss 'em 'bye.		
1900:28 CAM	[clicking sound similar to trim wheel turning at auto-pilot trim speed]		
1900:31 HOT-2	what was the temperature, 'member?	1900:33 APR	five Lima Mike contact Pittsburgh departure one two four point seven five.
1900:34 HOT-1	seventy five.		
1900:35 HOT-2	seventy five?		

INTRA-COCKPIT COMMUNICATION

AIR-GROUND COMMUNICATION

TIME & SOURCE	CONTENT	TIME & SOURCE	CONTENT
1900:37 CAM	[clicking sound similar to trim wheel turning at auto-pilot trim speed]	1900:40 285LM	twenty four seventy five, Lima Mike.
1900:43 PA-4	... seatbelts and remain seated for the duration of the flight.		
1900:44 PA-2	folks, from the flight deck we should be on the ground in 'bout ten more minutes. uh, sunny skies, little hazy. temperature. temperature's ah, seventy five degrees. wind's out of the west around ten miles per hour. certainly appreciate you choosing USAir for your travel needs this evening, hope you've enjoyed the flight. hope you come back and travel with us again. this time we'd like to ask our flight attendants please prepare the cabin for arrival. ask you to check the security of your seatbelts. thank you.	1900:46 APR	Delta ten eighty three, turn left heading one zero zero.
		1900:48 DL1083	one zero zero, ten eighty three.
1901:06 CAM	[chime similar to seatbelt chime]	1901:04 RDO-1	did you say two eight left for USAir four twenty seven?

INTRA-COCKPIT COMMUNICATION

AIR-GROUND COMMUNICATION

TIME & SOURCE	CONTENT	TIME & SOURCE	CONTENT
1901:10 HOT-1	two eight right.	1901:06 APR	uh, USAir four twenty seven, it'll be two eight right.
1901:11 HOT-2	right, two eight right. that's what we planned on. autobrakes on one for it.	1901:08 RDO-1	two eight right, thank you.
1901:35 HOT-1	I can't ***.	1901:18 APR	Delta ten eighty three contact approach one two four point one five.
		1901:22 DL1083	twenty four fifteen, good day.
		1901:26 APR	USAir fourteen sixty two at six thousand, reduce speed to one niner zero.
1901:42 HOT-2	Bravo thirty nine that's not too bad that's ...	1901:36 APR	USAir three zero niner, descend and maintain six thousand then reduce speed to one niner zero.

INTRA-COCKPIT COMMUNICATION

AIR-GROUND COMMUNICATION

TIME & SOURCE	CONTENT	TIME & SOURCE	CONTENT
1901:48 HOT-2	.. 'bout half way.	1901:47 APR	USAir eighteen seventy four turn right heading one zero zero. contact approach one two three point niner five.
1901:50 CAM	[aural tone similar to altitude alert]		
1901:51 HOT-2	(then) ... (works)		
1901:56 HOT-1	seven for six.		
1901:58 HOT-2	seven for six.	1901:57 APR	USAir fourteen sixty two turn right heading zero eight zero.
1902:06 HOT-1	boy, they always slow you up so bad here.		
1902:08 HOT-2	that sun is gonna be just like it was takin' off in Cleveland yesterday too. I'm just gonna close my eyes. [sound of laughter] you holler when it looks like we're close. [sound of laughter]		
1902:24 HOT-1	[sound of chuckle] OK.		

INTRA-COCKPIT COMMUNICATION

AIR-GROUND COMMUNICATION

TIME & SOURCE	CONTENT	TIME & SOURCE	CONTENT
1902:32.9 CAM	[sound similar to aircraft engines increasing in RPM to a steady value]	1902:24 APR	USAir four twenty seven, turn left heading one zero zero. traffic will be one to two o'clock, six miles, northbound Jetstream, climbing out of thirty three for five thousand.
1902:34.8 CAM	[clicking sound similar to trim wheel turning at auto-pilot trim speed]	1902:32.0 RDO-1	we're looking for the traffic, turning to one zero zero, USAir four twenty seven.
1902:54.3 HOT-2	oh ya, I see zuh Jetstream.		
1902:57.0 HOT-1	[sound similar to three thumps]		
1902:57.3 HOT-1	sheeez.		
1902:57.5 HOT-2	zuh.		
1902:58.0 CAM	[sound of thump]		

AIR-GROUND COMMUNICATION

INTRA-COCKPIT COMMUNICATION

TIME & SOURCE	CONTENT	TIME & SOURCE	CONTENT
1902:58.5 HOT-1	[sound similar to person inhaling/exhaling quickly one time]		
1902:58.6 CAM	[sound of "clickety click"]		
1902:59.1 CAM	[sound of thump of less magnitude than the first thump]		
1902:59.3 HOT-1	whoa.		
1902:59.5 CAM	[sound of "clickety click"]		
1903:00.3 HOT-2	[sound similar to pilot soft grunting]		
1903:00.7 CAM	[sound of unknown click]		
1903:01.1 HOT-1	hang on.		
1903:01.1 CAM	[sound similar to aircraft engines increasing in RPM]		
1903:01.5 HOT-2	[sound similar to pilot loud grunting]		
1903:01.9 HOT-1	hang on.		

AIR-GROUND COMMUNICATION

INTRA-COCKPIT COMMUNICATION

TIME & SOURCE	CONTENT	TIME & SOURCE	CONTENT
1903:02.1 CAM	[sound of click and wailing horn similar to auto-pilot disconnect]		
1903:03.6 HOT-1	hang on.		
1903:04.4 HOT-2	oh #.		
1903:05.2 HOT-1	hang on.		
1903:07.5 CAM	[sound of increasing amplitude similar to onset of stall buffet]		
1903:07.9 CAM	[vibrating sound similar to aircraft stick shaker starts and continues to end of recording]		
1903:08.0 HOT-1	what the hell is this?		
1903:08.3 CAM	[sound of aural tone similar to altitude alert]		
1903:09.4 JSAP	traffic traffic		
1903:09.4 CAM	traffic traffic		
1903:09.6 HOT-1	what the ...		

INTRA-COCKPIT COMMUNICATION

AIR-GROUND COMMUNICATION

TIME & SOURCE	CONTENT	TIME & SOURCE	CONTENT
1903:09.9 HOT-2	oh...		
1903:10.6 HOT-1	oh God.. oh God.	1903:13.3 APR	USAir....
		1903:15.0 RDO-1	four twenty seven emergency.
1903:17.4 HOT-2	#.		
1903:18.1 HOT-1	pull		
1903:18.5 HOT-2	oh #.		
1903:19.1 HOT-1	pull		
1903:19.7 HOT-1	(pull)		
1903:20.8 HOT-2	God.		
1903:21.1 HOT-1	[sound of screaming]		
1903:22.5 HOT-2	no.		

AIR-GROUND COMMUNICATION

INTRA-COCKPIT COMMUNICATION

TIME & SOURCE	CONTENT	TIME & SOURCE	CONTENT
---------------	---------	---------------	---------

1903:22.8
END of RECORDING
END of TRANSCRIPT

Appendix C

History of Federal Aviation Administration Airworthiness Directives Related to the Boeing 737 Rudder System

FAA records indicate that 10 airworthiness directives (AD) related to the Boeing 737 rudder system have been issued since 1980. Each of these ADs is described below and summarized in the table that follows.

On April 21, 1980, AD 80-07-02 became effective. It required a test on Boeing 737 airplanes within 3 days to determine if the main rudder power control unit (PCU) and other flight components could fail. The AD was prompted by a finding that components manufactured by a company other than Parker were installed in the PCU by a repair station or operator.

On March 3, 1994, AD 94-01-07 became effective. It required a test of the main rudder PCU every 750 flight hours until the PCU was replaced with a PCU incorporating a redesigned servo valve. This test was used to determine if the PCU servo valve was in proper operating condition by evaluating rudder system hydraulic flow or internal leakage within the servo valve resulting from improperly positioned servo valve slides. The 750-hour test requirement was removed when the PCU was replaced with a redesigned servo valve. The USAir flight 427 aircraft had been tested for compliance with the AD on March 21, June 18, and August 8, 1994. AD 94-01-07 was superseded by AD 97-14-04 (which became effective on August 4, 1997).

On March 14, 1995, telegraphic AD 95-06-53 was issued regarding certain 737s that had PCUs serviced by a repair station. The FAA determined that assembly methods for the PCU servo valve did not guarantee that the servo valve primary and secondary slides would be properly set, which could result in the servo valve not functioning properly. The AD required removing or testing of the suspect parts within the next five flights. This action affected approximately 50 airplanes.

On November 27, 1996, AD 96-23-51 became effective. It required all 737 series airplanes to be inspected within 10 days and every 250 flight hours afterward. This AD was the result of findings related to testing of the main rudder PCU during the USAir flight 427 accident investigation. These findings indicated that a jam of the secondary slide to the servo valve housing and subsequent rudder input could result in the rudder moving opposite of its intended direction. The AD required that a full rudder pedal displacement be made to the travel limit of the rudder and then a sudden full pedal command be made to the opposing direction. If the pedals moved normally, the test was successful; if they did not, the rudder PCU was required to be replaced immediately. The 250-hour test requirement was removed when the PCU was replaced with one that incorporated a redesigned servo valve. AD 96-23-51 was superseded by AD 97-14-04 (which became effective on August 4, 1997).

On January 17, 1997, AD 96-26-07 became effective. The AD required revising the airplane flight manual (AFM) for all 737 series airplanes within 30 days to include procedures that would enable the flight crew to take "appropriate action to maintain control of the airplane during an uncommanded yaw or roll condition" and "correct a jammed or restricted flight control condition." The FAA stated that the AD had been prompted because such procedures were not defined adequately in the existing version of the 737 AFM. The AD established a "recall" procedure to be performed by flight crews immediately, from memory, in the event of an uncommanded yaw or roll. The FAA specified that air carriers could comply with the AD by inserting a copy of it in the AFM.

On March 19, 1997, AD 97-05-10 became effective. It required certain 737 main rudder PCUs to be removed or tested within 90 days to determine if they had been assembled by a repair station with an incorrect fastener used to retain the summing levers. This anomaly was discovered when an operator noted cracking of the summing lever bearing. The FAA found that the fastener installed by the repair station caused the bearing to crack. This AD affected approximately 200 PCUs.

On June 9, 1997, AD 97-09-15 became effective. It required an inspection of the yaw damper engage solenoid. If the solenoid part number was within a specified range, the solenoid valve was required to be replaced with a redesigned valve. This AD resulted from Safety Board's test findings in connection with the investigation of USAir flight 427 accident, which indicated that hydraulic fluid was contaminating the coils of the valve and causing it to fail. The redesigned valve utilized sealed coils that were impervious to hydraulic fluid. The AD required that the valves be replaced within 5 years or 15,000 flight hours after the AD's effective date or the next time the PCU was sent to a repair facility, whichever was earlier.

On August 1, 1997, AD 97-14-03 became effective. It requires the installation, within 3 years, of a newly designed rudder surface limiting device that reduces the rudder authority at flight conditions in which full rudder authority is not required. It also required the installation of a redesigned yaw damper system with improved reliability and fault monitoring capabilities. These actions were the result of Safety Recommendations A-96-107 and -110, which were issued on October 18, 1996, in connection with the USAir flight 427 accident investigation.

On August 4, 1997, AD 97-14-04 became effective. It required that all actions included in ADs 94-01-07 and 96-23-51 be implemented and that, within 2 years, all main rudder PCUs be replaced with a PCU that has a redesigned servo valve. The AD also required that the PCU's vernier control rod bolts be replaced with bolts that are less likely to fail and that a leak test be performed on the PCU within 4,000 to 6,000 flight hours of the AD's effective date and at 6,400 hour intervals thereafter. This leak test was designed to detect latent jams of the servo valve slides.

On January 20, 1998, AD 97-26-01 became effective. It required an inspection to detect galling on the standby rudder actuator input bearing and shaft within 18 months or 4,500 flight hours. The shaft and bearing are to be replaced with a redesigned shaft and bearing within 3 years of the AD's effective date. This AD, which affected approximately

2,800 airplanes, was the result of findings related to the investigation of the United Airlines flight 585 accident and Safety Recommendation A-96-115, issued on October 18, 1996, in connection with the USAir flight 427 accident investigation.

AD number	Title	Affected airplanes	Effective date	Compliance deadline	Description
80-07-02	Flight Control Systems	All model 707, 720, 727, 737, and 747 series airplanes that contain specific hydraulic components manufactured by Fortner Engineering and Manufacturing.	04/21/80	3 days after the AD's effective date.	Conduct a one-time manual input hardover test on the flight control systems (including the rudder, elevators, and ailerons).
94-01-07	Main Rudder PCU	Model 737 series airplanes, line positions 1 through 2453 (inclusive).	03/03/94	Within 750 flight hours after the AD's effective date.	Perform a test of the main rudder PCU to detect internal leakage of hydraulic fluid. Repeat test at 750-hour intervals unless replaced with new main rudder PCU. Superseded by AD 97-14-04.
95-06-53	Rudder Actuator Piston	All model 737 series airplanes.	03/14/95	Within 5 flights after the AD's effective date.	Compare part and serial numbers of the main rudder PCU with those on a list of suspect parts. If applicable, remove and replace PCU with serviceable part or perform specified testing.
96-23-51	Main Rudder PCU	All model 737 series airplanes.	11/27/96	Within 10 days after the AD's effective date.	Perform testing of the main rudder PCU in accordance with Boeing Alert Service Bulletin 737-27A1202. Repeat test at 250-hour intervals unless replaced with new main rudder PCU. Superseded by AD 97-14-04.
96-26-07	737 AFM Revision	All model 737 series airplanes.	01/17/97	Within 30 days after the AD's effective date.	Revise the AFM to include procedures that would enable the flight crew to take appropriate action to maintain control of the airplane during an uncommanded yaw or roll and correct a jammed/restricted flight control condition.

AD number	Title	Affected airplanes	Effective date	Compliance deadline	Description
97-05-10	Main Rudder PCU	Model 737 series airplanes with a main rudder PCU identified in Boeing Service Letter 737-SL-27-112-B, dated 02/06/97.	03/19/97	90 days after the AD's effective date.	Remove the main rudder PCU and replace the improper fastener with a correct fastener or perform specified testing.
97-09-15	Engage Solenoid Valve Inspection	All model 737-100 through -500 series airplanes.	06/09/97	5 years or 15,000 flight hours after the AD's effective date or the next time the PCU is sent to a repair facility.	Perform a one-time inspection of the engage solenoid valve of the yaw damper to determine the part number (P/N) of the valve. If the valve P/N falls within the range specified, replace the valve with a new one.
97-14-03	Rudder Authority and Yaw Damper System	All model 737-100 through -500 series airplanes.	08/01/97	Within 3 years of the AD's effective date.	Install a newly designed rudder limiting device that reduces the rudder authority during flight conditions for which full rudder authority is not required. Install a newly designed yaw damper system that improves reliability and fault monitoring capability.
97-14-04	Main Rudder PCU	All model 737-100 through -500 series airplanes.	08/04/97	Within 2 years after the AD's effective date.	Perform all actions required by ADs 94-01-07 and 96-23-51. Replace any main rudder PCU having Boeing P/N 65-44861 or P/N 65C37052 with a new main rudder PCU. Replace the vernier control rod bolts having Boeing P/N 69-27229 with new bolts. Perform a leak test of the main rudder PCU within 4,000 to 6,000 hours of the AD's effective date. Repeat the leak tests at 6,400-hour intervals.

AD number	Title	Affected airplanes	Effective date	Compliance deadline	Description
97-26-01	Standby Rudder PCU Input Shaft and Bearing Inspection	Model 737-100 through -500 series airplanes, line numbers 1 through 2814 (inclusive).	01/20/98	Within 18 months or 4,500 hours after the AD's effective date.	Perform an inspection to detect galling on the input shaft and bearing of the standby rudder PCU within 18 months or 4,500 hours after the AD's effective date, whichever occurs later. Replace the input bearing of the standby rudder PCU with an improved bearing within 3 years after the AD's effective date.

Appendix D

Critical Design Review Recommendations and Federal Aviation Administration Responses

Because the USAir flight 427 accident and other 737 accidents and incidents raised questions regarding the 737's flight control systems, on October 20, 1994, the FAA initiated a Critical Design Review (CDR) of the 737 flight control systems with emphasis on the roll control and directional flight control systems. The CDR team included seven flight control specialists from the FAA, Transport Canada, and the U.S. Air Force. The team's final report, entitled *B-737 Flight Control System Critical Design Review*, was issued on May 3, 1995.

The FAA's responses to the CDR team's 27 recommendations were presented in an August 27, 1998, letter to the Safety Board. The CDR team's recommendations and the FAA's responses were described in the FAA's letter as follows:

CDR Recommendation 1: Develop national policy and/or rulemaking as necessary and applicable to transport-category airplanes that defines "normal" with respect to jams. This definition should include consideration of a jam of a control surface at any position up to its full deflection as limited by design.

CDR Recommendation 2: Develop national policy requiring that, when alternate means for flying an airplane are employed, those means shall not require exceptional pilot skill and strength and that the pilot can endure the forces for a sufficient period of time to ensure a safe landing.

CDR Recommendation 3: Formally establish the transport-category airplane requirement for redundancy in the directional control system to maintain control in the event of a rotor burst for the most critical phase of flight. Determine whether this requirement should be applied to new type-certificate applications, derivative applications, or aircraft in production.

FAA Response to CDR Recommendations 1, 2, and 3: Public meeting on 12/03/96 held to discuss flight control jam "normally encountered" condition. Issue will go to new working group in ARAC [Aviation Rulemaking Advisory Committee]. Terms of reference for the harmonization of requirements has been developed to guide the effort. Schedule for completion to be determined.

CDR Recommendation 4: Develop national policy for transport-category airplanes requiring the determination of critical hydraulic flight control system and component sensitivity (jam potential and actuator performance) to contamination, requirements for sampling hydraulic fluid, and requirements for actuator components to eliminate or pass (shear) particulate contamination.

FAA Response to CDR Recommendation 4: SAE [Society of Automotive Engineers] A-6 Committee has made recommendations on

chip shear requirements; FAA review of requirements to be completed April 1998. SAE A-6 recommendations made on contamination to be completed October 1998.

CDR Recommendation 5: Develop and provide additional guidance in AC [Advisory Circular] 1309-1A confirming that transport-category airplane failure analysis action items are required flight procedures in response to the failure condition.

CDR Recommendation 6: Require the action items be practical.

FAA Response to CDR Recommendations 5 and 6: ARAC working group activity.

CDR Recommendation 7: Establish process in cooperation with AFS [the FAA's Flight Standards Service] to require flight crew action items be implemented or require revision of failure analysis to not require action item.

FAA Response to CDR Recommendation 7: Process for reviewing engineering determination of flight crew action following failure is under review.

CDR Recommendation 8: Review the adequacy of the 737 aileron transfer mechanism throughout the airplane operating envelope in the event of a sustained jam of the ailerons up to their limit deflection. Pilot skill and strength requirements should be consistent with the results of [CDR] Recommendation 2. Control margins from this condition should be sufficient to allow continued safe flight and landing, including necessary maneuvers such as a crosswind landing or go-around.

CDR Recommendation 9: Ensure that the capability of the 737 lateral [roll] control system to provide adequate directional control is clearly demonstrated throughout the airplane operating envelope after these failures, unless they are shown to be extremely improbable by the most rigorous methodology available.

FAA Response to CDR Recommendations 8 and 9: Aileron transfer mechanism data reviewed and approved 11/30/95. AD 96-26-07 addresses adequacy of lateral [roll] control to provide directional control. No further action planned.

CDR Recommendation 10: Determine the requirement for and the feasibility of incorporating additional means to protect these components [as addressed in Recommendations 8 and] in the main wheel well of the 737 from the effects of environmental debris.

CDR Recommendation 11: Ensure the incorporation of wheels based on TSO-C26 Revision C or later revision.

FAA Response to CDR Recommendations 10 and 11: AD 97-01-10 issued 08/12/97, and AD 97-18-06 issued 10/08/97. No further action planned.

CDR Recommendation 12: Require failure analysis of the 737 yaw damper identified components and any relevant tests be conducted to identify all failure modes, malfunctions, and potential jam conditions of these vital elements.

CDR Recommendation 13: Require corrective action(s) for those failure modes or malfunctions [as addressed in Recommendation 12] not shown to be extremely improbable.

FAA Response to CDR Recommendations 12 and 13: Analysis completed by the FAA on 11/30/95. No further action planned.

CDR Recommendation 14: Require appropriate action be taken to reduce the number of 737 yaw damper failure occurrences to an acceptable level.

FAA Response to CDR Recommendation 14: AD 98-02-01 in *Federal Register* 02/17/98; AD 97-14-03 issued 06/23/97; AD 97-09-15 issued 04/24/97 (currently being revised—NPRM for revision in *Federal Register* 11/13/97, docket number 97-NM157AD).

CDR Recommendation 15: Require appropriate action be taken to correct the referenced galling condition of the standby rudder on the 737.

FAA Response to CDR Recommendation 15: AD 97-26-01 was issued on 12/08/97; no further action planned.

CDR Recommendation 16: Review and revise, as appropriate, the 737 inspection tasks associated with the latent failures identified in Tables 3 and 4 in Section 10 [of the final CDR report] in accordance with MSG-3 [Maintenance Steering Group 3].

CDR Recommendation 17: Require that the identified latent failures have fixed-interval inspection frequencies, as provided by ACs 25.1309-1A and 25-19. Consideration should be given to interval ranges flexible enough to allow normal inspection schedules.

CDR Recommendation 18: Revise the 737 MRB/MPD [Maintenance Review Board/Maintenance Planning Document] inspection task description and interval for the following latent failures:

Latent failure	Recommended inspection interval	Tasks
Aileron transfer mechanism	≤ 1C	Operational check
	≤ 3C	Measure forces at wheel
Aileron spring cartridge	≤ 1C	Operational check conducted with the transfer mechanism inspection
Standby hydraulic system, including rudder function	≤ 1A	Operational check

FAA Response to CDR Recommendations 16, 17, and 18: MRB review completed, and corrections incorporated.

CDR Recommendation 19: Revise 737 flight crew training programs to ensure the use of the proper procedures for recovery from flightpath upsets and flight crew awareness regarding the loss of airplane performance due to a flight control system malfunction. Consideration should be given to flight crew action items as a consequence of the failure analysis developed for the relevant flight control system and the failure conditions/malfunctions examined in Appendix 5 [of the CDR final report]. (This may require Airplane Flight Manual or Operations Manual revision.)

FAA Response to CDR Recommendation 19: AD-96-26-07 addresses issue for the 737.

CDR Recommendation 20: Require that only PC- [production certificate] or PMA- [parts manufacturing approval] approved replacement parts be used when overhauling primary elements in the flight control system (hydraulic servos and bypass valves) of the 737 airplanes. Ensure replacement parts, as provided by a non-original equipment manufacturer (OEM) or fabricated under SFAR [Special Federal Aviation Regulation] 36 authority, that are used when overhauling primary elements in the flight control system have had their designs approved and processed through the ACO [Aircraft Certification Office] that originally approved the OEM parts. This means that the replacement parts will have undergone qualification in terms of design (including material, heat treat, dimensions, tolerances, and geometric controls), analysis, and tests (qualification and acceptance) equivalent to the OEM certified part. An analysis is necessary to verify that the replacement part will mate properly with the next assembly under all design tolerance conditions.

FAA Response to CDR Recommendation 20: Flight Standards Information Bulletin dated 02/13/96 provides guidance.

CDR Recommendation 21: Require any issuance of PMA for primary flight control servo and bypass valves be concurred with the Aircraft Certification Office that certified the original parts or assembly.

FAA Response to CDR Recommendation 21: Under review.

CDR Recommendation 22: Form a team composed of a systems engineer, a manufacturing inspector, and an airworthiness maintenance inspector to assess the repair procedures, process, and tooling used in every repair station approved by the FAA to overhaul the 737 PCU and its components. In addition, this team should reassess all 737 PCU PMAs and SFAR 36 data (design, manufacturing, and fabrication) approvals for adequacy in consideration of [CDR] Recommendations 20 and 21.

FAA Response to CDR Recommendation 22: Flight Standards Information Bulletin dated 02/13/96 provides guidance.

CDR Recommendation 23: Evaluate the adequacy of the 737 maintenance manual actions addressing flight control cable inspection, rigging procedures, and replacement criteria.

CDR Recommendation 24: Require control cable service life limits unless acceptable inspection and/or test procedures are developed and utilized to determine the continuing serviceability of the control cables.

FAA Response to CDR Recommendations 23 and 24: Cable maintenance practice revised during period of 11/95 through 12/96. Boeing Maintenance Manuals revised to provide for comprehensive control cable inspection. These two recommendations are completed.

CDR Recommendation 25: Determine the degree of incorporation of the following list of Service Bulletins (includes In-Service Activities Report) in the 737 fleet and, in consideration of the recommendations in Section 15 [of the CDR final report], reassess their safety impact and, as appropriate, require their incorporation on applicable models of the 737.

737 Service Bulletins

No.	Title	Date
B737-27-1060	Rudder Pressure Reducer and Relief Valve Inspection/Removal	Oct. 3, 1972
B737-27-1033	Improvement of Lateral Control Transfer Mechanism	Feb. 13, 1970
B737-27-1081	Inspection of Ground Spoiler Shutoff Valve Control Cable Assembly	Dec. 10, 1976
B737-27-1125	Flight Controls, Cable Guard Modification (Pitch)	Mar. 8, 1985
B737-27-1134	Flight Controls, Aileron Centering and Trim Mechanism Modification	July 11, 1986
B737-27-1152	Flight Controls, Aileron Trim Bracket Replacement	May 12, 1988; Dec. 22, 1988 (rev. 2)
B737-27-1154	Flight Controls, Aileron Pulley Bracket Inspection/Replacement	Aug. 25, 1988
B737-27-1155	Flight Controls, Aileron Centering Spring and Trim Mechanism Modification	Oct. 26, 1989
B737-29-1062	Hydraulic Power, Main and Auxiliary, Standby and Ground Service Pressure Filter Modification	Feb. 14, 1991

737 In-Service Activities Report

No.	Title	Date
95-04-2725-10	Rudder Power Control Unit (PCU) Yaw Damper Solenoid Valve configuration for use on Rudder PCU Spec. No. 10-60881-8 and -13	Feb. 24, 1995

FAA Response to CDR Recommendation 25: AD 97-01-10 issued 01/03/97; AD 97-03-14 issued 01/29/97; AD 97-04-01 issued 02/04/97. No further action planned.

CDR Recommendation 26: Determine the degree of incorporation of the following list of Service Letters in the 737 fleet and, in consideration of the recommendations in Section 15 [of the CDR final report], reassess their safety impact and, as appropriate, require their incorporation on applicable models of the 737.

Letter No.	Title	Date
B737-SL-27-16	Rudder Trim Control Actuator Lubrication	Aug. 25, 1980
B737-SL-27-24	Rudder Centering Unit Lubrication	June 28, 1983
B737-SL-27-30	Aileron/Elevator and Rudder Power Control Unit Cylinder Bore Rework	Apr. 1, 1985
B737-SL-27-57	Rudder Feel and Centering Unit Lubrication	Dec. 5, 1989
B737-SL-27-71-A	Aileron/Elevator PCU Flow Restrictor Filter Screen Contamination	June 19, 1992

FAA Response to CDR Recommendation 26: AD 97-05-09 issued 02/25/97, and AD 97-09-14 issued 04/24/97. No further action planned.

CDR Recommendation 27: Request that the NTSB form a special accident investigation team to begin a new combined investigation of both the 737 Colorado Springs and the Pittsburgh accidents. The accident investigation team should include an FAA representative from the CDR team and the NTSB aviation safety investigator that worked with the CDR team. This will ensure that all of the data from the CDR is available for review by the accident investigation team. It is further recommended that NTSB personnel on the team not be from the original accident investigation teams and that the NTSB include at least two accident investigators (one each—airplane systems and flight operation) from another competent aviation authority of the world who has experience with 737 airplanes.

FAA Response to CDR Recommendation 27: NTSB has formed a special group of consultants in support of the ongoing accident investigation.

Appendix E

List of Documented Boeing 737 Events

In addition to the USAir flight 427 accident, the Safety Board has investigated more than 100 events since 1980 involving the Boeing 737. The table below documents the date and location of these events and provides a brief description for each. (Abbreviations are defined at the end of the table.) Additional details for some of these events can be found in the factual information section of this report. This list should not be considered a complete list of every 737 rudder-related event that has occurred.

Date	Location	737 series	Carrier	Comment/event
06/11/80	Cheyenne, Wyoming	-200	Frontier	First officer incapacitation
09/24/89	LaGuardia Airport, New York	-400	USAir	Rudder trim mis-set; rejected takeoff
02/25/91	N/A	-200	United	Yaw anomalies on 585 airplane
03/03/91	Colorado Springs, Colorado	-200	United	Flight 585 accident
07/16/92	Chicago-O'Hare Airport, Illinois	-300	United	Rudder PCU anomaly during ground check
12/14/92	San Diego, California	-300	USAir	Rudder PCU malfunction
01/04/93	Seattle-Tacoma, Washington	-300	United	Hydraulic block/binding
04/16/93	Near Auckland, New Zealand	-200	Air New Zealand	Yaw damper anomaly
04/23/93	Stapleton, Denver, Colorado	-500	United	Wake vortex encounter with a 757
06/24/93	Orly Airport, Paris, France	-300	Air France	Descent rudder deflection
08/20/93	France	-300	Air France	Takeoff roll rudder deflection
08/22/93	Oklahoma City, Oklahoma	-200	Southwest	Yaw damper anomaly
08/24/93	France	-300	Air France	Two rudder deflections in flight
11/02/93	Manila, Philippines	-300	Philippine Airlines	Yaw damper anomaly
03/08/94	New Delhi, India	-200	Sahara Airlines	Loss of control during training flight
03/29/94	Oakland, California	-300	Southwest	First officer incapacitation

Date	Location	737 series	Carrier	Comment/event
03/31/94	Las Vegas, Nevada	-300	America West	Yaw damper anomaly
04/12/94	San Pedro Sula, Honduras	-300	Continental	Yaw damper anomaly
05/23/94	Phoenix, Arizona	-200	America West	Yaw damper anomaly
08/31/94	London, England	-200	British Airways	Yaw damper anomaly
09/02/94	Melbourne, Australia	-300	Ansett	Yaw damper anomaly
09/08/94	Aliquippa, Pennsylvania	-300	USAir	Flight 427 accident
09/21/94	Los Angeles, California.	-200	Canadian Air	Possible wake vortex encounter
10/24/94	Phoenix, Arizona	-300	Southwest	Wake vortex encounter with a 727
11/24/94	Philadelphia, Pennsylvania	-300	USAir	Yaw damper anomaly
12/02/94	Sacramento, California	-300	Southwest	"Pull to left" on takeoff roll
12/20/94	Raleigh-Durham, North Carolina	-300	USAir	Yaw damper anomaly
12/21/94	Coventry, England	-200	Air Algeria	CFIT; mis-set instrument
12/29/94	Van, Turkey	-400	Turkish Airways	CFIT
01/02/95	Houston, Texas	N/A	Southwest	Wake vortex encounter with MD-80
01/13/95	Jogjakarta, Indonesia	-300	Garuda Airlines	Landing, runway overrun
01/17/95	Yogyakarta, Indonesia	-200	N/A	Runway overrun
01/20/95	Atlanta, Georgia	-200	Air South	Runway overrun on landing
01/25/95	Albuquerque, New Mexico	-300	America West	Roll-off on takeoff
02/21/95	Australia	-400	Qantas	Wake vortex encounter with a 747
03/29/95	En route ONT to SJC	-300	Southwest	Yaw damper anomaly

Date	Location	737 series	Carrier	Comment/event
04/08/95	Vitoria, Brazil	-300	Trans Brasil	Off side of runway
04/13/95	Denver International, Colorado	-400	Mark Air	Hard landing
05/05/95	Dublin, Republic of Ireland	-400	Aer Lingus	Yaw damper anomaly
06/26/95	National Airport, Washington, D.C.	-300	USAir	Uncommanded roll
07/18/95	Ormond Beach, Florida	-300	USAir	Uncommanded roll
07/25/95	Charlotte, North Carolina	-300	USAir	Uncommanded roll
07/25/95	Richmond, Virginia	-400	USAir	Uncommanded roll
07/25/95	Mexico City, Mexico	-300	Continental	Yaw damper anomaly
07/28/95	London-Heathrow, United Kingdom	-400	British Airways	Rudder on hard landing
07/29/95	Love Field, Dallas, Texas	-300	Southwest	Ground collision
08/05/95	Charlotte, North Carolina	-300	USAir	Uncommanded roll
08/09/95	San Salvador, El Salvador	-200	AVIATECA	CFIT
08/10/95	New Orleans, Louisiana	-200	USAir	Uncommanded roll
08/17/95	Phoenix, Arizona	-400	USAir	Rudder after initial touchdown
08/20/95	Toronto, Ontario, Canada	-200	Canadian Airlines	Yaw damper anomaly
08/25/95	Fort Lauderdale, Florida	-300	USAir	Uncommanded roll
08/30/95	Cleveland, Ohio	-300	Continental	Uncommanded roll
09/12/95	Dallas-Fort Worth, Texas	-200	USAir	Uncommanded pitch-up
09/25/95	Denver International, Colorado	-200	United	Takeoff roll rudder deflection
09/29/95	Dayton, Ohio	-300	USAir	Rudder trim runaway
09/29/95	Charlotte, North Carolina	-300	USAir	Wake vortex encounter with a 757
10/14/95	Dallas-Fort Worth, Texas	-300	Delta	Yaw damper anomaly
10/15/95	Boscombe Down, England	-200	British Airways	Roll oscillations; maintenance flight

Date	Location	737 series	Carrier	Comment/event
10/22/95	San Francisco, California	-500	United	Pitch-up during maintenance flight
10/22/95	Pittsburgh, Pennsylvania	-300	USAir	Unexpected roll on approach
10/26/95	Dusseldorf, Germany	-300	Deutsche BA	Uncommanded roll
10/27/95	Munich, Germany	-300	Deutsche BA	Uncommanded roll
10/14/95	En route DFW to HSV	-300	Delta	Uncommanded rudder input
10/29/95	Portland, Maine	-300	USAir	Bird strike during takeoff
10/30/95	Las Vegas, Nevada	-500	Southwest	First officer eye struck by laser beam
10/31/95	En route PBI to PIT	-300	USAir	Uncommanded rolls
11/02/95	Charlotte, North Carolina	-400	USAir	Uncommanded roll
11/06/95	Sydney, Australia	-300	Ansett	Wake vortex encounter with a 747
11/13/95	Kaduna, Nigeria	-200	Nigerian Airlines	Runway overrun
11/25/95	Portland, Oregon	N/A	United	Turbulence on approach
11/29/95	DeGaulle Airport, Paris, France	-200	British Airways	Gear failure on landing rollout
12/02/95	New Delhi, India	-200	Indian Airlines	Runway overrun
12/03/95	Douale, Cameroon	-200	Cameroon	CFIT; landed in a swamp
12/28/95	Toulouse, France	-200	Euralair	No. 1 engine failure
01/02/96	Honolulu, Hawaii	-200	Aloha	Uncommanded lateral oscillations
01/18/96	Melbourne, Australia	-400	Qantas	Uncommanded roll
01/29/96	Stavanger, Norway	-400	Braathens BRT	Rudder failsafe bolt break
02/09/96	Chicago, Illinois	-200	United	Wake vortex encounter with a 727
02/22/96	National Airport, Washington, D.C.	-100	Continental	Runway overrun

Date	Location	737 series	Carrier	Comment/event
02/23/96	Colorado Springs, Colorado	N/A	America West	Clear air turbulence on approach
03/06/96	Arequipa, Peru	-200	Faucett	CFIT; impacted hill on final
03/13/96	Philadelphia, Pennsylvania	N/A	USAir	Wake turbulence
04/01/96	Chicago, Illinois	-300	Continental	Wake vortex encounter with a 777
04/07/96	Approach to San Francisco, California	-300	United	Vibration in rudder pedals
04/28/96	Denver, Colorado	-300	United	Engine failure after takeoff
05/14/96	Trenton, New Jersey	-200	Eastwind	Yaw "bumps" on climbout
05/25/96	N/A	-500	United	Yaw damper transfer valve jam
05/25/96	N/A	-300	United	Bent pin on yaw damper coupler
05/25/96	N/A	-300	United	Yaw damper trip/replace A/P access
06/09/96	Richmond, Virginia	-200	Eastwind	Flight 517 incident
06/22/96	Granite, Colorado	-200	Frontier	Clear air turbulence encounter
06/29/96	Phoenix, Arizona	-300	America West	Uncommanded roll
07/07/96	Nashville, Tennessee	-200	Southwest	Aborted takeoff; bird ingestion
07/10/96	Seattle, Washington	-300	Southwest	Rudder kick on takeoff
07/14/96	El Salvador	-200	TACA	Lateral oscillations after takeoff
08/29/96	Chattanooga, Tennessee	N/A	USAir	Clear air turbulence encounter
11/16/96	Phoenix, Arizona	-300	Southwest	Uncommanded yaw
12/12/96	Frankfurt, Germany	-400	Lufthansa	Rudder oscillations with PCU test
01/21/97	Boston, Massachusetts	-200	Delta	Yaw damper anomaly
03/02/97	Carajas, Brazil	-200	Varig	Hard landing and runway overrun
12/19/97	Palembang, Indonesia	-300	SilkAir	Loss of control; flight 185 accident

Date	Location	737 series	Carrier	Comment/event
03/11/98	Anchorage, Alaska	-200	Arco Alaska	Yaw damper anomaly
03/11/98	Spokane, Washington	-300	Southwest	Yaw damper anomaly
07/02/98	Brazil	-400	Trans Brasil	Yaw damper anomaly
08/07/98	En route PHL to LAS	-300	USAirways	Possible wake vortex encounter
08/12/98	En route CVG to GSO	-200	Delta	Yaw damper anomaly
08/98	N/A	-700	Southwest	Yaw excursion during takeoff roll
08/14/98	Juneau, Alaska	-400	Alaskan	Hard landing
11/01/98	Atlanta, Georgia	-200	AirTran	Hydraulic leak; maintenance flight
02/19/99	Seattle, Washington	-300	United	Anomalous rudder response
02/23/99	Salisbury, Maryland	-200	Metrojet	Rudder hardover in flight

Note: CFIT, controlled flight into terrain; A/P, autopilot; ONT, Ontario International Airport, California; SJC, San Jose International Airport, California; DFW, Dallas-Fort Worth International Airport, Texas; HSV, Huntsville International Airport, Alabama; PBI, West Palm Beach International Airport, Florida; PIT, Pittsburgh International Airport, Pennsylvania; PHL, Philadelphia International Airport, Pennsylvania; LAS, Las Vegas International Airport, Nevada; CVG, Cincinnati/Northern Kentucky International Airport, Covington, Kentucky; and GSO, Piedmont Triad International Airport, Greensboro, North Carolina.

Appendix F

Boeing's "Blue Water" Assessment Team

Since the introduction of the Boeing 737 series airplane, there have been maintenance reports of fluid in the electrical/electronic compartment (E/E bay). Occasionally, pilot reports of system problems were later determined to be caused by short circuiting of electrical components in the E/E bay as a result of the presence of fluids. Because of these events, Boeing established an assessment team (which included an FAA engineer) in 1995 to investigate fluid contamination of electrical and electrical boxes and the interfacing with electrical wiring and connectors within the 737 E/E bay.

The team reviewed equipment designs, maintenance practices, service data, operator fleet campaign results, and E/E bay component overhaul data and performed inspections of in-service airplanes. The team reviewed 653 Boeing 737 operator E/E bay service reports from January 1984 to February 1996. Fluid contamination was documented in 111 of these reports. The team also reviewed 13,905 service/repair station records pertaining to the maintenance of electrical boxes. Fluid-related contamination was documented in 366 of these reports. The team found that the position of a electrical box did not necessarily protect it from contamination. The team also found that forward lavatory waste water was the primary fluid source for E/E bay contamination. The assessment found that overservicing of the lavatory, cracked toilet tanks, failed gaskets, and damaged dump valves were the primary source of the leaks.

The 737 series is equipped with fluid barrier systems that are designed to contain or prevent fluids from reaching the E/E bay. These barriers include the floor panel moisture barrier, shrouds, and airstair drip pan. However, the assessment team found that the barriers can be damaged during service, allowing fluids to enter the E/E bay. The examination of several airplanes found that some shroud installations were completely missing; some were damaged, contaminated, or torn; and some were improperly installed.

The assessment team identified improvements aimed at preventing fluid leakage and contaminated electrical and electronic equipment. The team reported that it did not identify any substantial design deficiencies or common problems; however, it found that operator-specific maintenance and service practices may compromise the effectiveness of the moisture barrier systems.

The team's October 1996 final report indicated that the team did not uncover any evidence that a specific fluid leakage event would produce a near-term, unexpected, aircraft flightpath departure. However, the team made several recommendation to reduce the potential for fluid leakage into the E/E bay in 737 airplanes and noted any pertinent corrective actions. These recommendations included the following:

- Installation of a forward waste system flush/fill line shutoff valve and fluid sensor.
- Installation of an improved airstair drip pan access hatch gasket. (Addressed by Boeing Service Letter 737-SL-53-23, dated June 28, 1993.)
- Elimination of the E/E rack moisture shroud lack of coverage by verifying that the shroud is properly installed and incorporating an improved moisture shroud. (Boeing Service Bulletin 737-25-1317 was released to all operators, providing information regarding the replacement of the cloth moisture shroud with one manufactured from aluminum. Boeing determined that an improvement to the aluminum moisture shroud would increase the protection; therefore, once the improved moisture shroud parts are available, Service Bulletin 737-25-1317 will be superceded.)
- Incorporation of an improved floor moisture barrier system. (Boeing Service Letter 737-SL-53-034-B, dated February 21, 1997, provides for the modification of airplanes manufactured before January 1996.)
- Periodic inspection of the E/E bay moisture shrouds and drip pans. (Temporary revisions to sections 25-51-01 of the Boeing Maintenance Manual were released in July 1998 for 737-300, -400, and -500 series airplanes and in August 1998 for the -100 and -200 series airplanes. In November 1997, a revision to the maintenance planning document was released for the 737-300, -400, and -500 series airplanes, including a task to visually check the moisture shrouds and drip pans for obvious damage at every "1C" maintenance interval (MPD item B25-51-00-6A). The document is no longer being revised by Boeing for the -100 and -200 airplanes; however, operators of these airplanes were asked to incorporate the intent of the subject task item into their maintenance programs.
- Periodic inspection of lavatory system for signs of leakage. (Inspection procedures were added to section 38-32-0 of the Boeing Maintenance Manual.)