

Routing Sheet for Release of Unclassified Technical Information

Author/Originator: Douglas Moorcroft Code: 1532 Phone: x28108

Title of Proposed Release: "Installation of Modified German GHG Equipment in the USS Cochino (SS345)", NUWC TM-274333, dated 04MAY1951, currently unclassified, Distribution "E".

Intended for Public Release/Distribution at: Joint lecture describing evolution of active & passive sonar from WWII through the Cold War, by Timothy Straw and Thaddeus Bell to the Friends of Fort Trumbull, New London, CT

Brief Statement of Purpose of Release: A modified German GHG-type array was installed on the USS Cochino (SS-345) in the late 1940's, when LT(JG) Bell was serving on board. The lecture will include this GHG array.

Sponsor Approval: My sponsor has approved public release of this material: Sponsor Name: N/A Sponsor Organization: N/A

Security Guidelines Consulted: OPNAV Instruction 5513.5
Program-Specific Security Classification Guide (SCG): SCG No./Title
Militarily Critical Technologies List: MCTL Chapter: 05-02.2 Section: All
I have consulted the security guidelines listed above. [Signature] 28 MAY 2015
Author/Originator Signature/Date

Approvals:

1. Departmental:

Technical Reviewer: The proposed disclosure is technically accurate.

Security: This proposed disclosure is free of classified material.

Department Head: There is no programmatic impediment or corporate concern to disclosure of this information at this time.

2. Special Security (if applicable): SSO for SCI-indoctrinated personnel and/or SAP Security Officer for SAP-accessed personnel.

3. OPSEC: The proposed disclosure is free of critical technology information with potential intelligence value, or information that would adversely affect the security of the U.S.

4. Public Affairs Officer: The proposed disclosure is approved for public release; distribution is unlimited.

Approval Stamp:

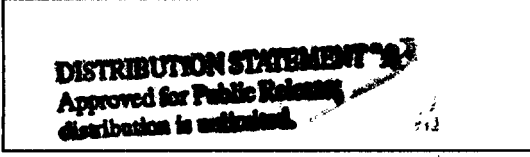

Remove Distro E statement

[Signatures and dates for Technical Reviewer, Security, Department Head, SSO, OPSEC, and PAO]

Note: Originator must send a copy of approved release to the Technical Library: e-mail electronic copy (preferably a portable document format (pdf) file) to #NPRI\_11422\_Library\_Admin or send hard copy to Technical Library, Code 11422, Bldg 101.

4 May 1951

D1H1b  
NE091201

U. S. Navy Underwater Sound Laboratory  
Fort Trumbull, New London, Connecticut

INSTALLATION OF THE MODIFIED GERMAN GHG  
EQUIPMENT IN THE USS COCHINO (SS345)

by

C. T. Milner

APPROVED FOR DISTRIBUTION

John M. Ide  
Chief Scientist

A. E. Krapf, Commander, USN  
Commanding Officer and Director

Declass in FULL per OPNAVINST 5513.16.02 by COMNAVSEA DECLASS TEAM on  
1/10/00 as listed in Project Lookback.

## DISTRIBUTION LIST

ONR, Code 108	ComSubRonEIGHT
" 466	ComSubDevGruTWO
" 470	Com, NOL
OpNav (Op-31)	CinCLant
" (Op-34)	CinCPac
" (Op-37)	CO, SurAsDevDet
" (Op-42)	" SubBase, N.L.
" (Op-43)	OinC, SubSchool, N.L.
Chief BuShips	Supt., USN PG School
BuShips, Code 300	Dir., OEG
" " 310	" NRL
" " 515	CO & Dir., USNEL
" " 800	" " DTMB
" " 810	EO, Philadelphia NavShyd
" " 816	SupShip, Groton
" " 839	Research and Development Board
" " 845	NADC, Johnsville, Pa.
" " 846	Weapons Systems Evaluation Group
" " 847	Committee on Undersea Warfare,
" " 848	Nat'l Research Council
" " 980	(via BuShips, Code 816)
" " 993	Navy Research Section,
Chief BuOrd	Library of Congress
BuOrd, Sec. Re4b	(via BuShips, Code 816)
Chief BuAer	British Joint Services Mission
ComOpDevFor	(via BuShips, Code 816)
ComSubLant	Naval Research Establishment,
ComSubPac	Halifax, N.S.
ComSubRonTWO	(via BuShips, Code 816)

### ABSTRACT

This report outlines the work of planning and installation of a modified German GHG sonic listening system in the USS COCHINO (SS345). Included are numerous figures which provide a pictorial history of the development and present the results of sea tests of the completed installation.

### AUTHORIZATION

U. S. Navy Underwater Sound Laboratory Problem  
D1H1b. NE091201.

CONFIDENTIAL

### ACKNOWLEDGMENT

The assistance of Messrs. G. S. Harris, C. J. Loda, C. I. Matthews, and W. M. Bush, as well as that of other Laboratory personnel, contributed greatly to the success of this undertaking. Personnel of the Electric Boat Company, too numerous for individual mention, gave their best efforts to provide a well executed installation. The personnel of the USS COCHINO (SS345), especially Commander L. B. McDonald, USN, and Lieutenant S. J. Cramer, Jr., USN, gave their wholehearted support throughout the entire test and evaluation period. The assistance of these and others who contributed in various ways to the success of the project is gratefully acknowledged.

CONFIDENTIAL

TABLE OF CONTENTS

	Page
INTRODUCTION . . . . .	1
PRELIMINARY CONSIDERATIONS . . . . .	3
EQUIPMENT DESIGN AND DEVELOPMENT . . . . .	6
Acoustic Design . . . . .	6
Electronic Modifications . . . . .	12
PRE-COMMISSIONING PROCEDURES . . . . .	18
Electrical Measurements . . . . .	18
Pre-Commissioning Checks . . . . .	18
SEA TESTS AND EVALUATION . . . . .	19
CONCLUSIONS AND RECOMMENDATIONS . . . . .	21
APPENDIX A--CONSTRUCTION AND INSTALLATION OF BALKON . . . . .	25
APPENDIX B--GRAPHIC REPRESENTATION OF THE EFFECT OF CHANGING THE LENGTH OF THE DELAY LINE BY MEANS OF A CONNECTION BLOCK . . . . .	31
APPENDIX C--FREQUENCY MEASUREMENTS OF COMPONENTS AND OVER-ALL SYSTEM . . . . .	37
APPENDIX D--OPERATING CHARACTERISTICS OF COMPONENTS AND OVER-ALL SYSTEM . . . . .	51

## LIST OF FIGURES

<u>Figure</u>		<u>Page</u>
	Frontispiece—Guppy Type Submarine, Showing Dome Location and Cut-In View of GHG Operating Console . . . Facing Page 1	
1	Comparison of Bows of Type XXI and USS COCHINO (SS345), Showing Array Installations . . . . .	2
2	Lines and Locations of Installations on the COCHINO and the German Types XXI and XXVI . . . . .	4
3	Einheits and Conventional German GHG Hydrophones . . . . .	5
4	Side View of Array for USS COCHINO (SS345), Showing Hydrophones in Place prior to Installation of CRS Window . . . . .	6
5	Side View of Array for USS COCHINO (SS345), Showing CRS Window in Place . . . . .	7
6	COCHINO Dome Structure . . . . .	8
7	Internal Construction of Type XXI Balkon Showing Interfering Members . . . . .	9
8	Sensitivity Curves of Hydrophones Used in COCHINO Array . . . . .	10
9	Directivity Patterns, at 5 kc, of Hydrophones Used in COCHINO Array . . . . .	10
10	Exterior Views of COCHINO Installation . . . . .	11
11	Exterior Views of Type XXI Installation . . . . .	13
12	GHG Installations on Other Types of U-Boats . . . . .	14
13	Hydrophone Junction Box Locations . . . . .	15
14	Port Preamplifier Location . . . . .	15
15	Preamplifier Power Supply Location . . . . .	15
16	Location of Components of GHG System . . . . .	15
17	Modified JP Amplifier, Front View . . . . .	16
18	Schematic Diagram Showing Modifications for JP Amplifier . . . . .	16
19	Schematic Diagram of Low-Pass Filter Set . . . . .	17
20	GHG Console, Cover Removed, Showing Connection Block for Tray Selection . . . . .	17
21	GHG Console, Cover Removed, Showing Relay and Tray Connection Blocks . . . . .	17
22	Scale-Model Brush Plate . . . . .	18
23	GHG Console Installation in Forward Room of COCHINO . . . . .	19
24	Sketch Showing "Lost-Bearing" Zones . . . . .	20
25	Target Bearing Transmitter, Mounted on Deck above Array, for Beam Pattern Measurements . . . . .	21

## LIST OF FIGURES (Cont'd)

<u>Figure</u>	<u>Appendix A</u>	<u>Page</u>
1	Lines of the Type XXI Balkon . . . . .	27
2	Manufacturer's Drawings of COCHINO Array, Showing Construction Details . . . . .	28
3	Plan View of COCHINO GHG Installation . . . . .	29
4	Lines of COCHINO Balkon . . . . .	30
 <b>Appendix B</b> 		
1	Reading of Bearing Indicator, in degrees, on COCHINO Console. Two Delay Trays in Use. Terminal 89 Connected to Terminals 90-91 on Connection Block . . . . .	33
2	Reading of Bearing Indicator, in degrees, on COCHINO Console. Three Delay Trays in Use. Terminal 89 Connected to Terminals 90-91 on Connection Block . . . . .	33
3	Reading of Bearing Indicator, in degrees, on COCHINO Console. Four Delay Trays in Use. Terminal 89 Connected to Terminals 90-91 on Connection Block . . . . .	34
4	Reading of Bearing Indicator, in degrees, on COCHINO Console. Two Delay Trays in Use . . . . .	34
5	Reading of Bearing Indicator, in degrees, on COCHINO Console. Three Delay Trays in Use . . . . .	35
6	Reading of Bearing Indicator, in degrees, on COCHINO Console. Four Delay Trays in Use . . . . .	35
 <b>Appendix C</b> 		
1	JP Amplifier Response; Bass-Boost Filter; Input Signal, 1 millivolt; Output across 600-ohm Load . . . . .	39
2	JP Amplifier Response; Flat Filter; Input Signal, 1 millivolt; Output across 600-ohm Load . . . . .	39
3	JP Amplifier Response; 500-cps Filter; Input Signal, 1 millivolt; Output across 600-ohm Load . . . . .	40
4	JP Amplifier Response; 3000-cps Filter; Input Signal, 1 millivolt; Output across 600-ohm Load . . . . .	40
5	JP Amplifier Response; 6000-cps Filter; Input Signal, 1 millivolt; Output across 600-ohm Load . . . . .	41



## LIST OF FIGURES (Cont' d)

<u>Figure</u>		<u>Page</u>
6	Over-all Response; JP Filter on BASS BOOST; Low-Pass Filter on OUT; Signal Fed through No. 7 Preamplifier with Bearing Set at 345°; Input Signal, 1 millivolt; Output across 600-ohm Load . . . . .	41
7	Over-all Response; JP Filter on BASS BOOST; Low-Pass Filter on 2000 cps; Signal Fed through No. 7 Preamplifier with Bearing Set at 345°; Input Signal, 1 millivolt; Output across 600-ohm Load . . . . .	42
8	Over-all Response; JP Filter on BASS BOOST; Low-Pass Filter on 3000 cps; Signal Fed through No. 7 Preamplifier with Bearing Set at 345°; Input Signal, 1 millivolt; Output across 600-ohm Load . . . . .	42
9	Over-all Response; JP Filter on BASS BOOST; Low-Pass Filter on 5000 cps; Signal Fed through No. 7 Preamplifier with Bearing Set at 345°; Input Signal, 1 millivolt; Output across 600-ohm Load . . . . .	43
10	Over-all Response; JP Filter on FLAT; Low-Pass Filter on OUT; Signal Fed through No. 7 Preamplifier with Bearing Set at 345°; Input Signal, 1 millivolt; Output across 600-ohm Load . . . . .	43
11	Over-all Response; JP Filter on FLAT; Low-Pass Filter on 2000 cps; Signal Fed through No. 7 Preamplifier with Bearing Set at 345°; Input Signal 1 millivolt; Output across 600-ohm Load . . . . .	44
12	Over-all Response; JP Filter on FLAT; Low-Pass Filter on 3000 cps; Signal Fed through No. 7 Preamplifier with Bearing Set at 345°; Input Signal, 1 millivolt; Output across 600-ohm Load . . . . .	44
13	Over-all Response; JP Filter on FLAT; Low-Pass Filter on 5000 cps; Signal Fed through No. 7 Preamplifier with Bearing Set at 345°; Input Signal, 1 millivolt; Output across 600-ohm Load . . . . .	45
14	Over-all Response; JP Filter on 500 cps; Low-Pass Filter on OUT; Signal Fed through No. 7 Preamplifier with Bearing Set at 345°; Input Signal, 1 millivolt; Output across 600-ohm Load . . . . .	45
15	Over-all Response; JP Filter on 500 cps; Low-Pass Filter on 2000 cps; Signal Fed through No. 7 Preamplifier with Bearing Set at 345°; Input Signal, 1 millivolt; Output across 600-ohm Load . . . . .	46

LIST OF FIGURES (Cont' d)

<u>Figure</u>		<u>Page</u>
16	Over-all Response; JP Filter on 500 cps; Low-Pass Filter on 3000 cps; Signal Fed through No. 7 Preamplifier with Bearing Set at 345°; Input Signal, 1 millivolt; Output across 600-ohm Load . . . . .	46
17	Over-all Response; JP Filter on 500 cps; Low-Pass Filter on 5000 cps; Signal Fed through No. 7 Preamplifier with Bearing Set at 345°; Input Signal, 1 millivolt; Output across 600-ohm Load . . . . .	47
18	Over-all Response; JP Filter on 3000 cps; Low-Pass Filter on OUT; Signal Fed through No. 7 Preamplifier with Bearing Set at 345°; Input Signal, 1 millivolt; Output across 600-ohm Load . . . . .	47
19	Over-all Response; JP Filter on 3000 cps; Low-Pass Filter on 3000 cps; Signal Fed through No. 7 Preamplifier with Bearing Set at 345°; Input Signal, 1 millivolt; Output across 600-ohm Load . . . . .	48
20	Over-all Response; JP Filter on 3000 cps; Low-Pass Filter on 5000 cps; Signal Fed through No. 7 Preamplifier with Bearing Set at 345°; Input Signal, 1 millivolt; Output across 600-ohm Load . . . . .	48
21	Over-all Response; JP Filter on 6000 cps; Low-Pass Filter on OUT; Signal Fed through No. 7 Preamplifier with Bearing Set at 345°; Input Signal, 1 millivolt; Output across 600-ohm Load . . . . .	49
22	Over-all Response; JP Filter on 6000 cps; Low-Pass Filter on 5000 cps; Signal Fed through No. 7 Preamplifier with Bearing Set at 345°; Input Signal, 1 millivolt; Output across 600-ohm Load . . . . .	49

Appendix D

1	Individual Hydrophone Self-Noise versus Depth and Speed . . . . .	53
2-5	System Self-Noise versus Operating Condition versus Angle of Train . . . . .	54
6-9	System Self-Noise versus Operating Condition versus Angle of Train . . . . .	55
10-13	System Self-Noise versus Operating Condition versus Angle of Train . . . . .	56

## LIST OF FIGURES (Cont' d)

<u>Figure</u>		<u>Page</u>
14	Comparison of Bearing versus Time for JT, GHG, and Periscope . . . . .	57
15-18	Noise-Beam Patterns, 4 Trays of Delay; 500-cps High-Pass Filter . . . . .	58
19-22	Noise-Beam Patterns, 4 Trays of Delay; 500-cps High-Pass Filter . . . . .	59
23-26	Noise-Beam Patterns, 4 Trays of Delay; 500-cps High-Pass Filter . . . . .	60
27-30	Noise-Beam Patterns, 4 Trays of Delay; 500-cps High-Pass Filter . . . . .	61
31-34	Noise-Beam Patterns, 4 Trays of Delay; 500-cps High-Pass Filter . . . . .	62
35-37	Noise-Beam Patterns, 4 Trays of Delay; 500-cps High-Pass Filter . . . . .	63
38-41	Noise-Beam Patterns, 2 Trays of Delay; 500-cps High-Pass Filter . . . . .	64
42-45	Noise-Beam Patterns, 2 Trays of Delay; 500-cps High-Pass Filter . . . . .	65
46-48	Noise-Beam Patterns, 2 Trays of Delay; 500-cps High-Pass Filter . . . . .	66
49-52	Noise-Beam Patterns, 4 Trays of Delay; 3000-cps High-Pass Filter . . . . .	67
53-56	Noise-Beam Patterns, 4 Trays of Delay; 3000-cps High-Pass Filter . . . . .	68
57-59	Noise-Beam Patterns, 4 Trays of Delay; 3000-cps High-Pass Filter . . . . .	69
60	Noise-Beam Pattern, 4 Trays of Delay; 3000- to 5000-cps Band-Pass Filter; Bearing Set at $030^{\circ}$ . . . . .	70
61	Noise-Beam Pattern, 4 Trays of Delay; 500- to 2000-cps Band-Pass Filter; Bearing Set at $090^{\circ}$ . . . . .	70
62	Noise-Beam Pattern, 4 Trays of Delay; Overlapped Filters, 6000-cps High-Pass and 5000-cps Low-Pass; Bearing Set at $090^{\circ}$ . . . . .	70
63	Noise-Beam Pattern, 4 Trays of Delay; 6000-cps High-Pass Filter; Bearing Set at $090^{\circ}$ . . . . .	71
64	Noise-Beam Pattern, 4 Trays of Delay; 500- to 3000-cps Band-Pass Filter; Bearing Set at $270^{\circ}$ . . . . .	71
65	Noise-Beam Pattern, 4 Trays of Delay; 3000- to 5000-cps Band-Pass Filter; Bearing Set at $270^{\circ}$ . . . . .	71

LIST OF FIGURES (Cont' d)

<u>Figure</u>		<u>Page</u>
66	Noise-Beam Pattern, 4 Trays of Delay, with Relay Jumper In; 500-cps High-Pass Filter; Bearing Set at 001° . . . . .	71
67	Noise-Beam Pattern, 4 Trays of Delay, with Relay Jumper Out; 500-cps High-Pass Filter; Bearing Set at 030° . . . . .	72
68	Noise-Beam Pattern, 4 Trays of Delay, with Relay Jumper In; 500-cps High-Pass Filter; Bearing Set at 090° . . . . .	72
69	Noise-Beam Pattern, 2 Trays of Delay, with Relay Jumper In; 500-cps High-Pass Filter; Bearing Set at 030° . . . . .	72
70	Noise-Beam Pattern, 4 Trays of Delay; Hydrophone Brushes 1-24 Removed; 500-cps High-Pass Filter; Bearing Set at 030° . . . . .	72
71	Noise-Beam Pattern, 4 Trays of Delay; Hydrophone Brushes 1-24 Removed; 500-cps High-Pass Filter; Bearing Set at 090° . . . . .	73
72	Noise-Beam Pattern, 4 Trays of Delay; Hydrophone Brushes 1-24 Removed; 500-cps High-Pass Filter; Bearing Set at 270° . . . . .	73
73	Noise-Beam Pattern, 4 Trays of Delay; Hydrophone Brushes 1-24 Removed; 500-cps High-Pass Filter; Bearing Set at 330° . . . . .	73
74	Noise-Beam Pattern, 4 Trays of Delay; All Even-Numbered Hydrophone Brushes Removed; 500-cps High-Pass Filter; Bearing Set at 030° . . . . .	73
75	Noise-Beam Pattern, 4 Trays of Delay; All Even-Numbered Hydrophone Brushes Removed; 500-cps High-Pass Filter; Bearing Set at 090° . . . . .	74
76	Noise-Beam Pattern, 4 Trays of Delay; All Even-Numbered Hydrophone Brushes Removed; 3000-cps High-Pass Filter; Bearing Set at 090° . . . . .	74

CONFIDENTIAL

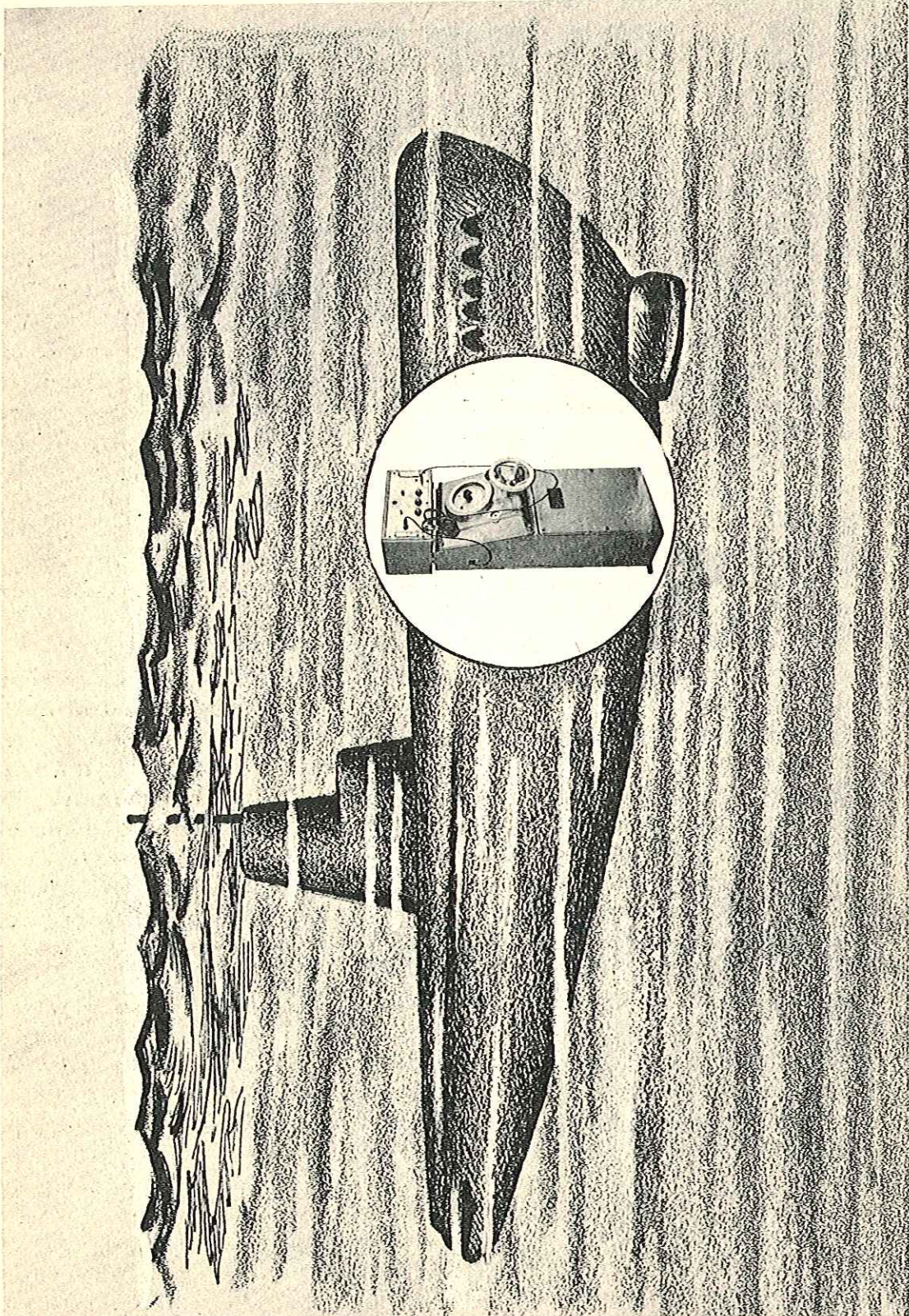

Frontispiece--Guppy Type Submarine, Showing Dome Location and Cut-In View of GHG Operating Console

CONFIDENTIAL

## INSTALLATION OF THE MODIFIED GERMAN GHG EQUIPMENT IN THE USS COCHINO (SS345)

### INTRODUCTION

In July 1948, the Underwater Sound Laboratory undertook, at the request of the Bureau of Ships, the installation of the German GHG equipment from the Ex-U-3008 in a United States submarine of the Guppy II class. The submarine ultimately selected to receive the installation was the USS COCHINO (SS345), which was then undergoing conversion. The installation was to be done at the Electric Boat Company, Groton, during the conversion period, and assistance was to be provided by the Laboratory. A series of conferences with Electric Boat Company personnel resulted in a decision to design a new balkon, or appendage, since the German structure was not adaptable for use on U. S. bow profiles. Plans for the new structure were prepared at the Boat Company according to Laboratory instructions and specifications. In the meantime, the components of the U-3008 system were removed at Portsmouth Naval Shipyard and forwarded to the Laboratory, where they underwent extensive modifications and tests.

Since the COCHINO was already partially converted and drydocking was scheduled for approximately 1 September, only six weeks remained in which to execute the design of the underwater appendage. The deadline was met, however; by the end of July, the design was completed, and late in August, fabrication and installation were well under way. By the end of September, the balkon had been attached and the hydrophones and main console installed. Operational evaluation of the equipment took place during the four-week period beginning 14 February 1949. With the onset of unfavorable weather, the simulated detection, approach, and attack problems which had been scheduled were necessarily cancelled. It was expected that the information would be obtained at a later date, but in October, while on a training mission in Arctic waters, the COCHINO met with the disaster which resulted in the loss of the submarine.

On the basis of experience obtained with the COCHINO, another modified GHG system was installed, in the spring of 1950, on the USS CLAMAGORE (SS343). The Laboratory modified a GHG console for this purpose, and a hydrophone array, similar to that on the COCHINO, was fabricated at the Philadelphia Naval Shipyard. Thus, when the CLAMAGORE was returned to service, the evaluation of performance, interrupted by the loss of the COCHINO, was resumed at Key West.

The material which follows is a record of the work done by the Laboratory in the development, installation, and evaluation of the GHG equipment for the COCHINO.

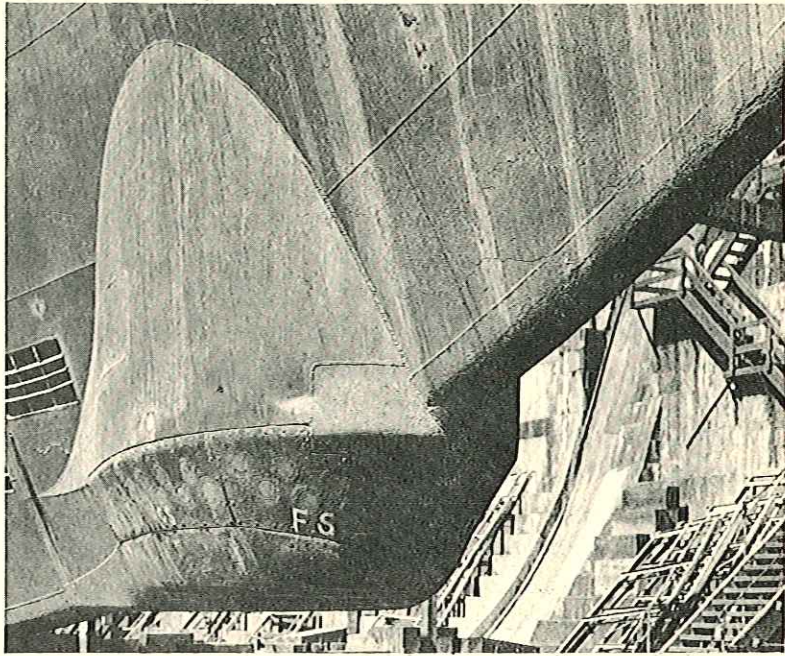

Fig. 1A - Type XXI Installation

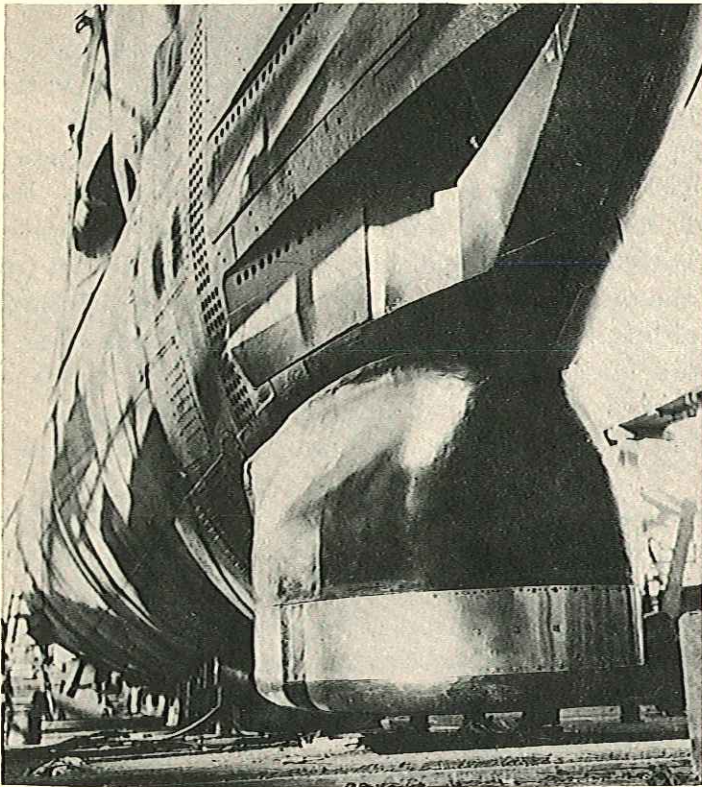

Fig. 1B - COCHINO Installation

Fig. 1 - Comparison of Bows of Type XXI and USS COCHINO (SS345), Showing Array Installations

PRELIMINARY CONSIDERATIONS

Once the submarine had been selected, a decision was necessary as to the type of underwater appendage to be used. A study of the factors involved showed that the existing structure on the U-3008 was not suitable and that existing plans were not applicable to the 345-class bow profile (see Fig. 1). As a result, an entirely new structure was needed. Because of the time limitation, a relatively simple design was suggested as being the most practicable. It was first proposed to use a structure composed mainly of aluminum, but since the hydrophones were of brass and the hull was of steel, it was feared that electrolysis might be excessive. Information compiled by the German scientist Dr. Eng. Maase, of the Atlas Werke, revealed that as a result of their experience, the Germans had been led to design a smooth outer fairwater in an attempt to improve the listening performance at high speeds.<sup>1</sup> A study was made of the design for the proposed Walter type XXVI U-boat, which was intended to be the ultimate in German submarine construction. As this balkon had vertical sides, it approached most nearly the requirements of the proposed appendage. The design finally developed represented what seemed to be the best possible compromise between what was desired and what could be accomplished in the time available. The two designs investigated and the final design to which they led are presented for comparison in Fig. 2. The lines of the type XXI are shown in Fig. 1, Appendix A; the lines of the COCHINO may be seen in Figs. 2 through 4 of the same appendix.

The choice of hydrophones was limited, since only two types were available in sufficient quantities (see Fig. 3). One lot was of the kind used in the conventional German systems; the other consisted of entirely new units which had been obtained from Germany by the Naval Research Laboratory. These units, of the X-cut Rochelle-salt crystal type, appeared to be those designed for the Einheits (single-cabinet) array and intended for use on the type XXVI.<sup>2</sup> As these hydrophones were new and also slightly more compact than the older ones, they were chosen for the purpose. No other suitable hydrophones could be found in this country.

A study of the lines of the COCHINO resulted in the decision to install the balkon at the lower extremity of the stem, starting at about Frame 6 and extending aft to about Frame 14. A troublesome factor in the German arrays was found to be the result of turbulences caused by sharp boundaries between the hull and

<sup>1</sup>Pertinent in this connection are the following reports by Dr. Eng. Maase: "Memorandum about German Group Listening Plants," Bremen, 13 December 1945 (USL Ser. 7188, N-D101) (CONFIDENTIAL); "Report on Tests of Effect of Self Noise on Multi-Unit Hydrophones Installation with Container Unit in U-3003 (Type XXI)," Pelzerhaken, 27 April 1945; and "Report on Trials of the Multi-Unit Hydrophone Installation on U-3003, Type XXI (Container Unit--Multi-Unit Hydrophone Installation)," Off Faaborg, February-March 1945. The last two reports appear in an ONI publication, Translation of German Document, Ser. TR/PG/26463/NID (CONFIDENTIAL).

<sup>2</sup>For further information with regard to the Einheits system, see NavTecMisEu Report No. 530-45, Sonar in the German Navy, 31 October 1945 (RESTRICTED).



CONFIDENTIAL

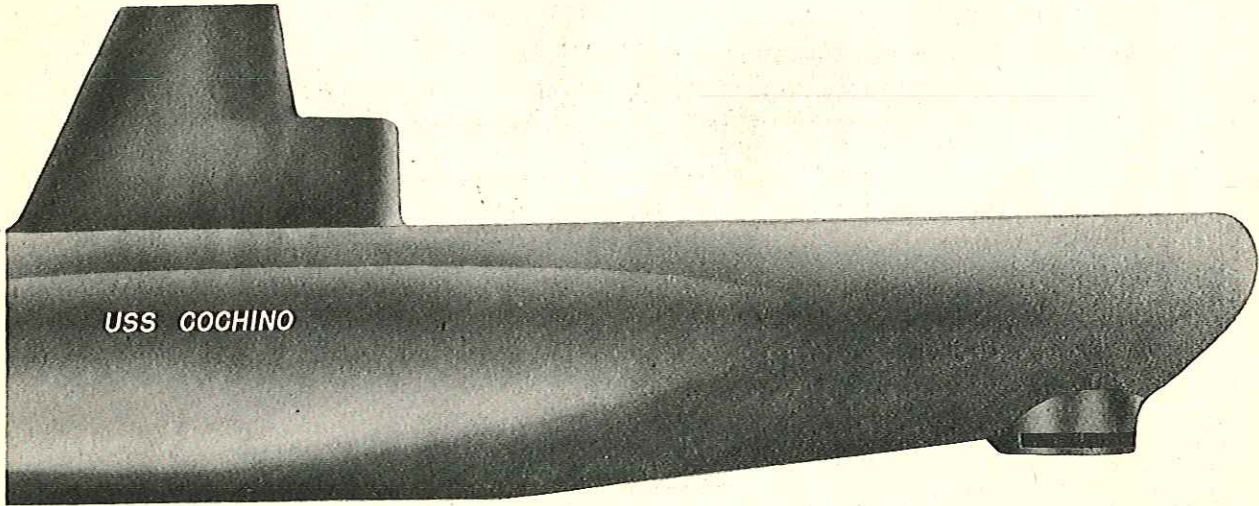
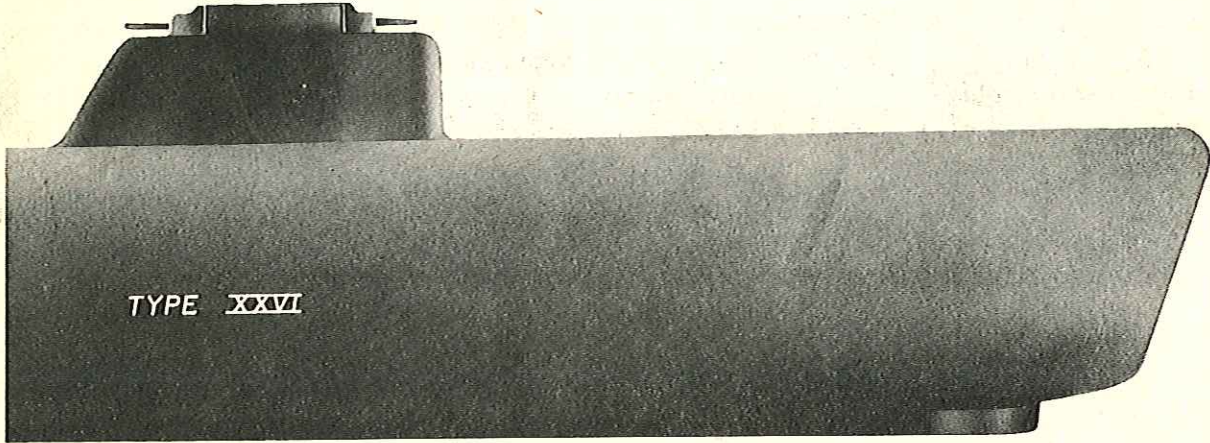
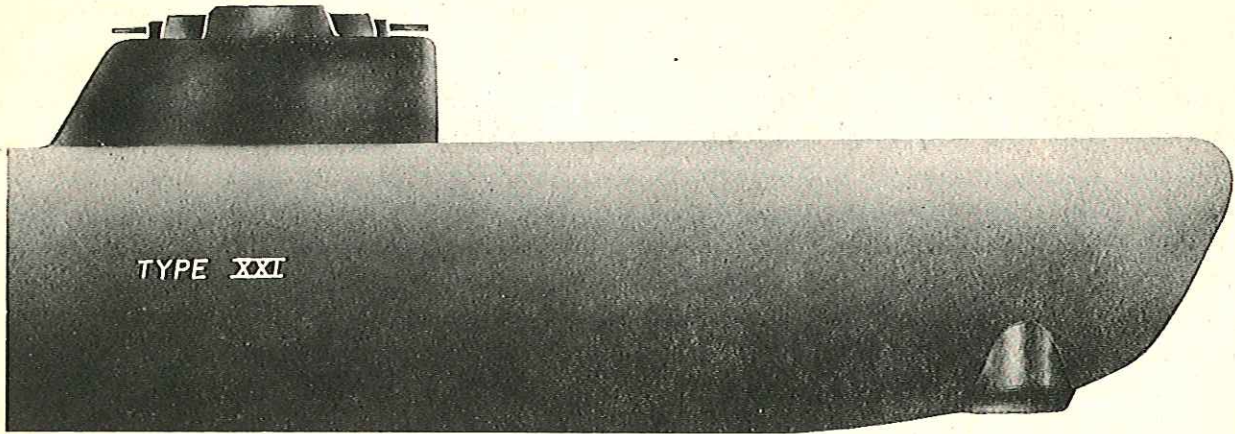

Fig. 2 - Lines and Locations of Installations on the COCHINO and the German Types XXI and XXVI

CONFIDENTIAL

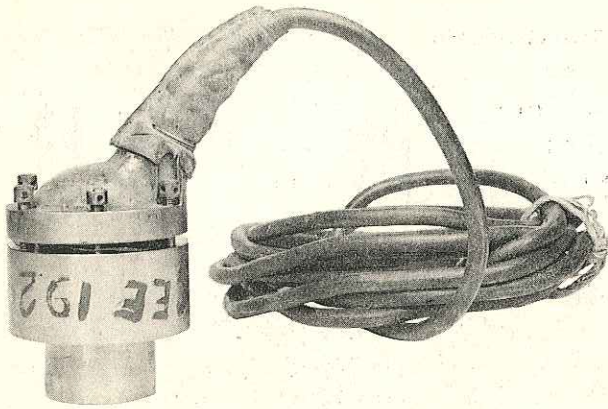

Fig. 3A - Einheits Hydrophone, Side View

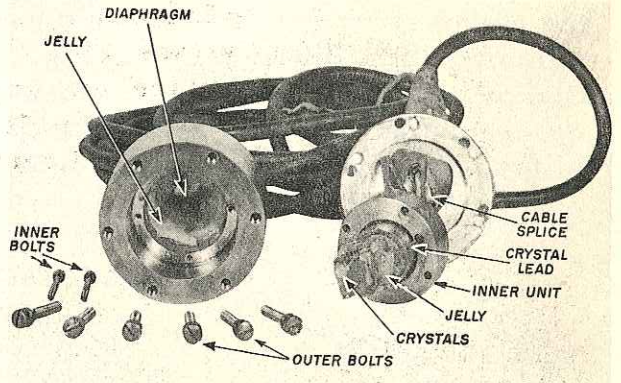

Fig. 3B - Einheits Hydrophone, Exploded View, Showing Construction Details

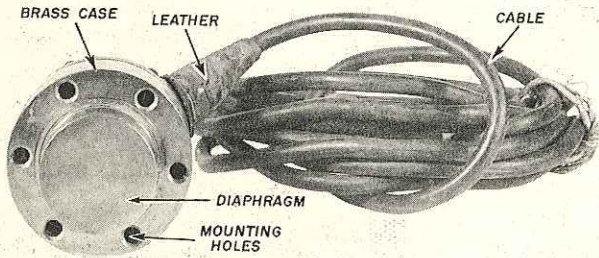

Fig. 3C - Einheits Hydrophone, Front View, Showing Diaphragm

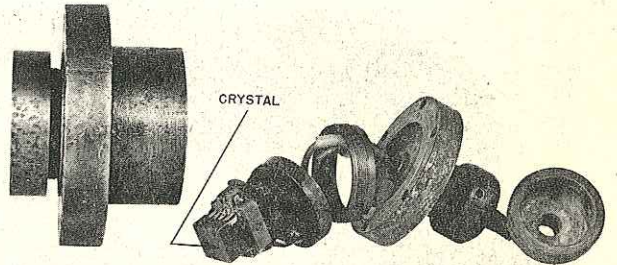

Fig. 3D - Conventional Hydrophone, Exploded View, Showing Construction Details

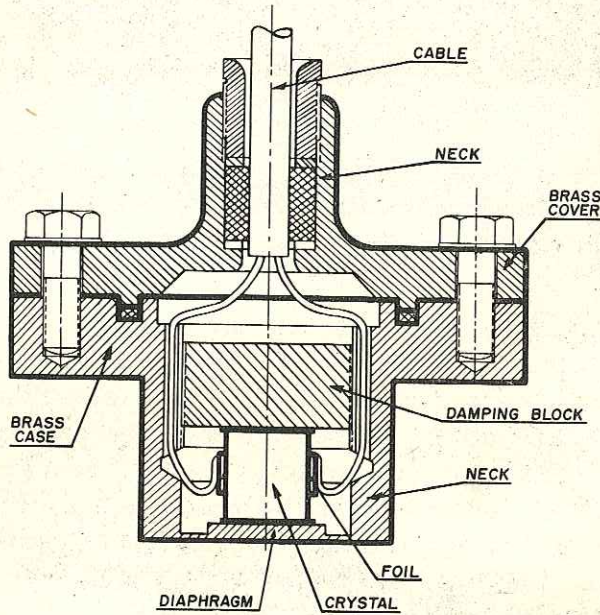

Fig. 3E - Line Drawing of Conventional Hydrophone, Showing Assembly Details

Fig. 3 - Einheits and Conventional German GHG Hydrophones

the balkon structure; the Laboratory design attempted to, and subsequently did, minimize this difficulty (see Fig. 1). Since the marine railway at the Boat Company has a knuckle in the forward end, only a limited vertical dimension could be attained. As a result, installation of a larger number of hydrophones in order to obtain some degree of vertical directivity was not possible.

## EQUIPMENT DESIGN AND DEVELOPMENT

### Acoustic Design

It was finally decided that an enclosure should be designed for an array of 48 hydrophones, staggered in two parallel rows, with a 6-inch separation between rows and 12 inches between hydrophones in each row (see Fig. 4). The

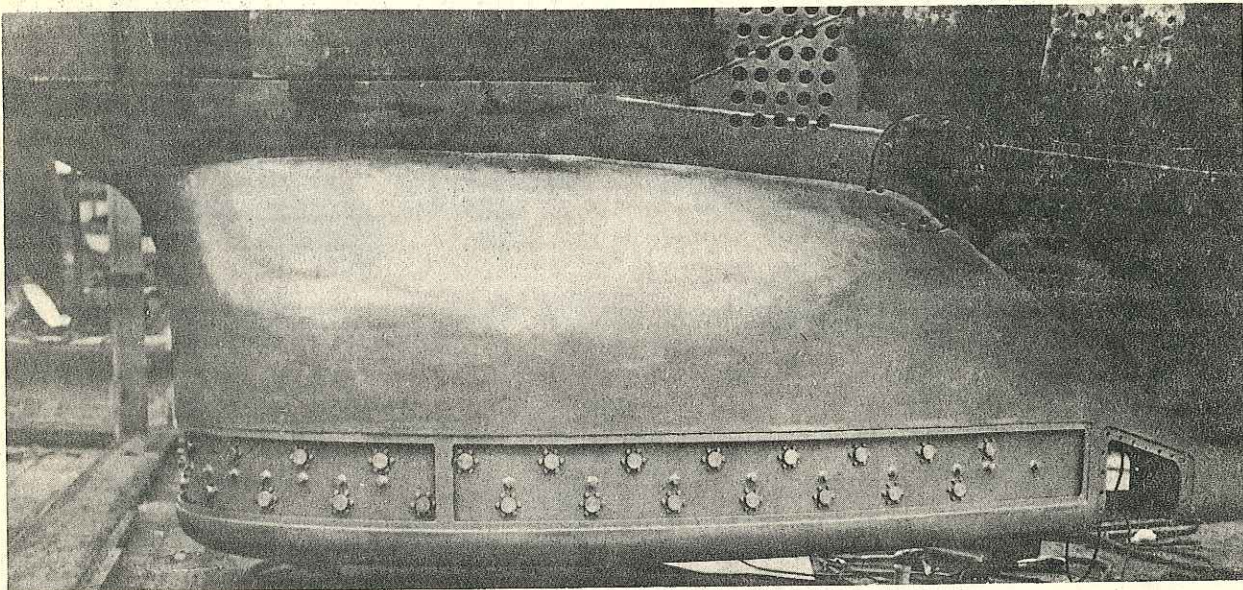

Fig. 4 - Side View of Array for USS COCHINO (SS345), Showing Hydrophones in Place prior to Installation of CRS Window

width of the array was to be the maximum possible in the location chosen. The available compensator limited the usable longitudinal dimension to about 11 feet. As the effective width was about 5-1/2 feet, the resulting (approximate) over-all outside dimensions were: width, 6 feet; length, 16 feet; and height, 4 feet. The effective array size was 5.5 by 11.2 feet as compared, for example, with a corresponding 5.5 by 7 feet for the array on the U-3008. As shown in Fig. 4, hydrophones were mounted in a vertically positioned plate of steel 3/8 of an inch thick, in such a manner that their diaphragms were spaced 13/16 of an inch behind a 16-gauge CRS window, pictured in Fig. 5. The assembly was designed to have as few as possible interfering members in the hydrophone area. Its construction may be more easily visualized by reference to the

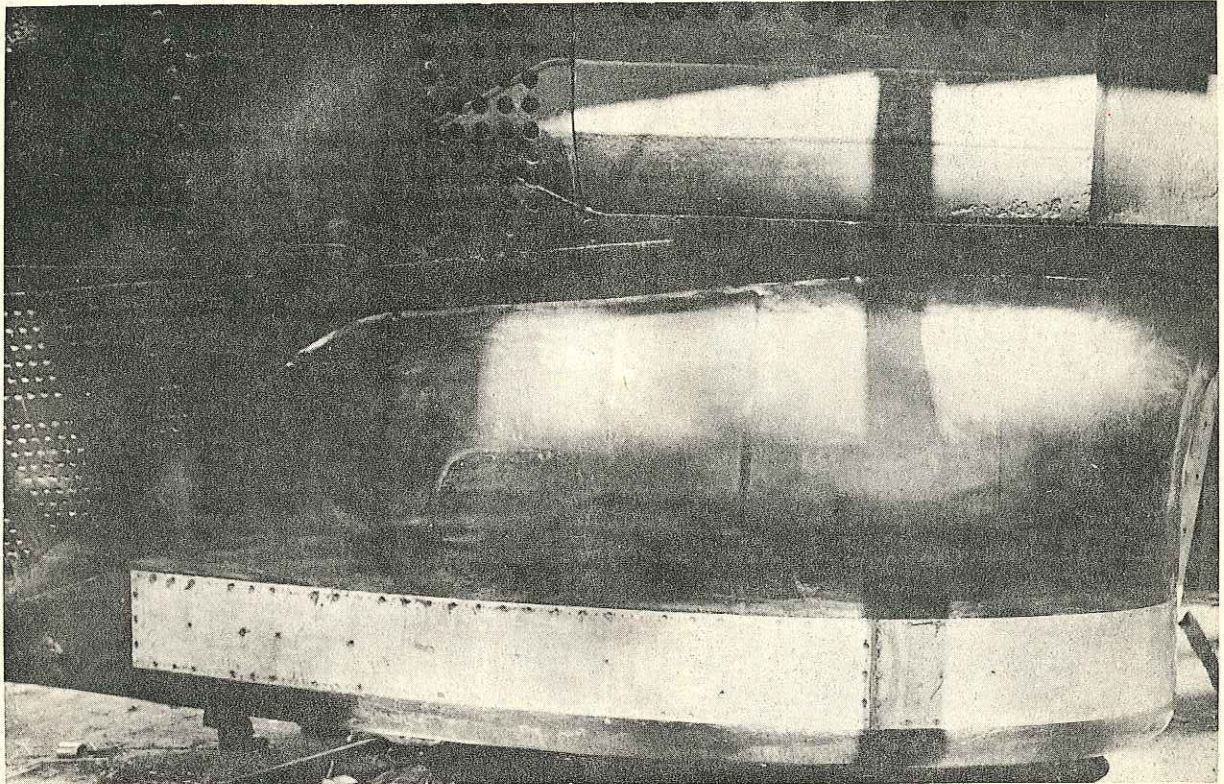

Fig. 5 - Side View of Array for USS COCHINO (SS345), Showing CRS Window in Place

manufacturer's photographs (Fig. 6), and the drawings included as Figs. 2 through 4, in Appendix A. The interfering members in the German system can be seen in Fig. 7.

While the balkon was being fabricated by the Electric Boat Company, the hydrophones chosen for the task were individually tested and calibrated. New cables, 50 feet long, were installed in each. The resulting sensitivity versus frequency curves for each individual unit and free-space directivity patterns in both planes at a frequency of 5 kc are illustrated in Figs. 8 and 9.

A comparison of external features of the COCHINO and German Type XXI installations may be made by reference to Figs. 1B, 10, 11, and 12.

The hydrophones, constructed as shown in Fig. 3C, are assumed to function as omnidirectional receivers for the frequency range of the equipment—500 to 5000 cps. As the effective hydrophone spacing is about a half wavelength at 5 kc, a 5-kc low-pass filter is included in the system. With frequencies higher than 5 kc there results an increase in the secondary lobe structure of the directivity pattern.

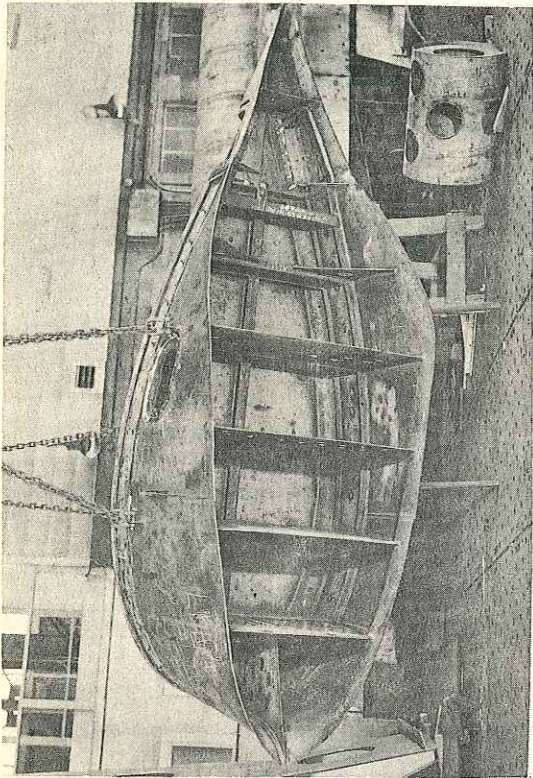

Fig. 6B - Interior View

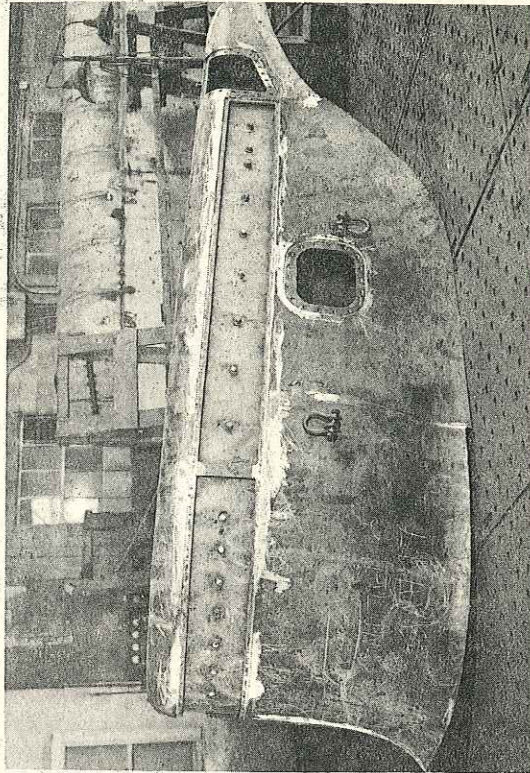

Fig. 6D - Side View, Inverted

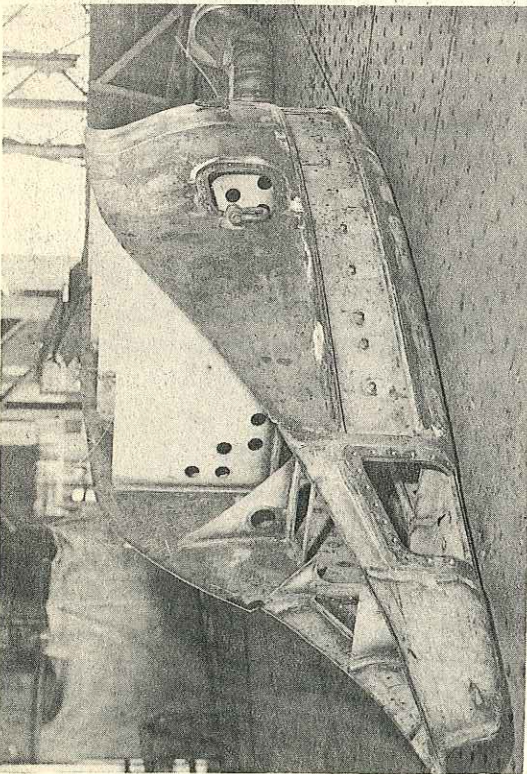

Fig. 6A - Rear-Quarter View

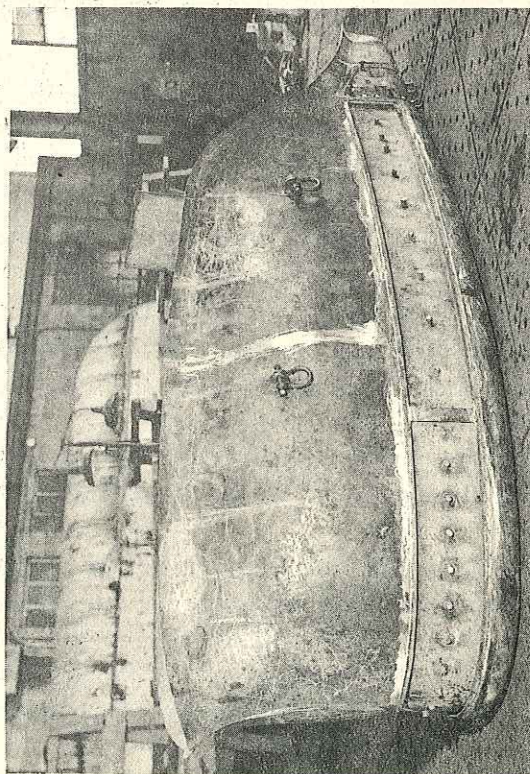

Fig. 6C - Front-Quarter View

Fig. 6 - COCHINO Dome Structure

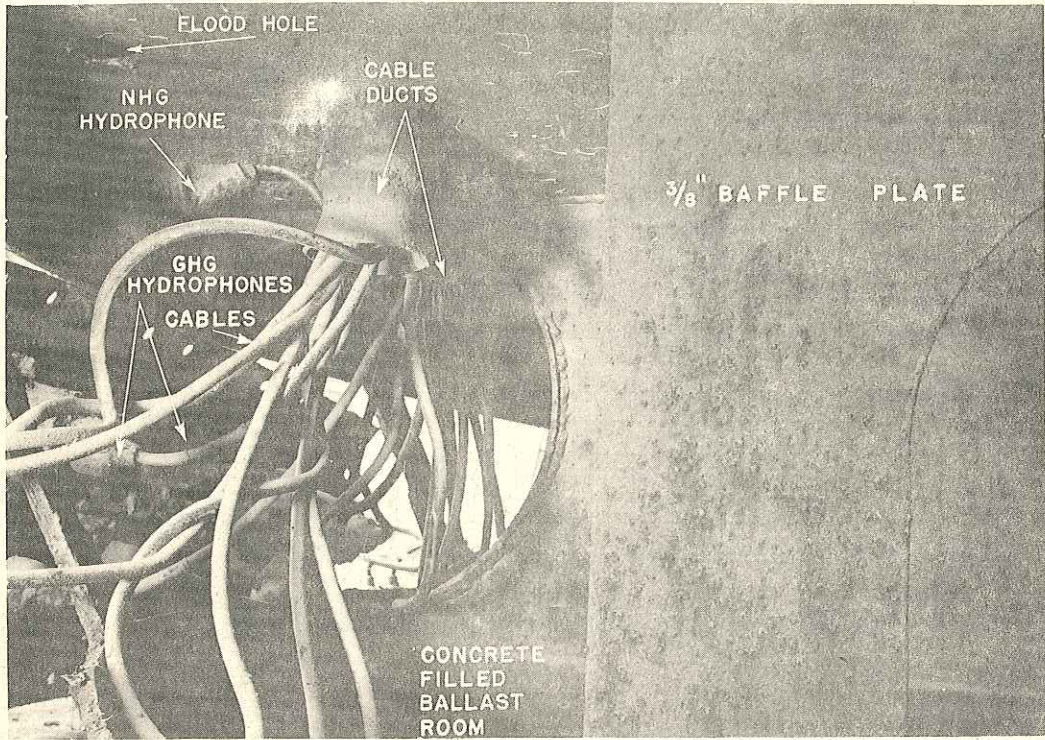

Fig. 7A - Looking Aft through Dome Structure

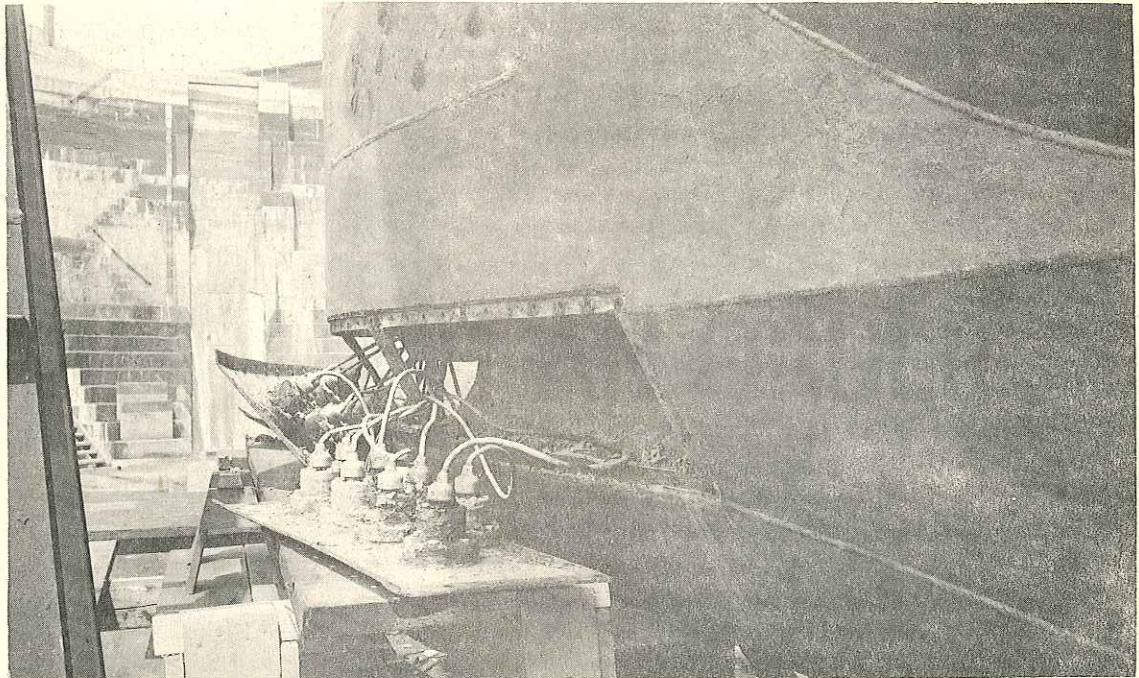

Fig. 7B - Looking Forward through Dome Structure

Fig. 7 - Internal Construction of Type XXI Balkon Showing Interfering Members

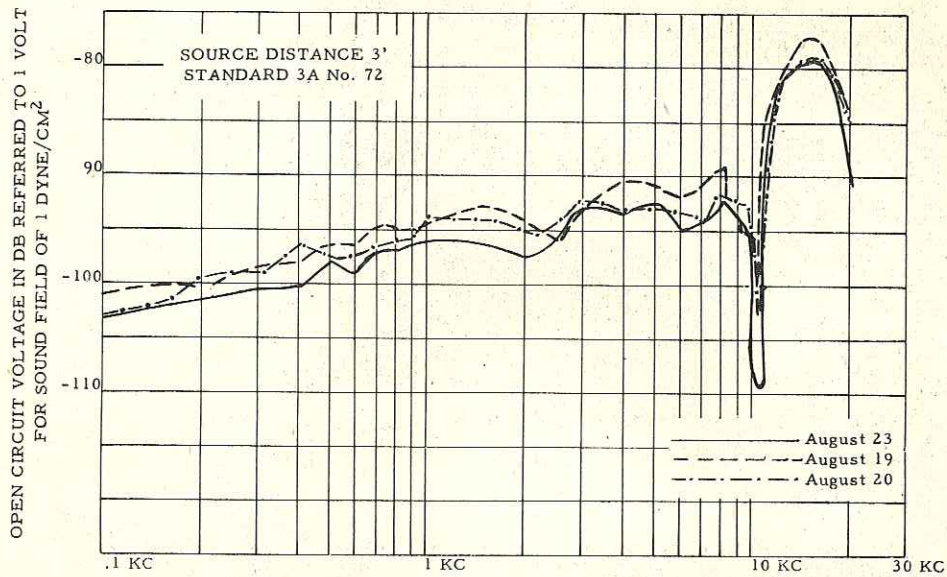

Fig. 8 - Sensitivity Curves of Hydrophones Used in COCHINO Array

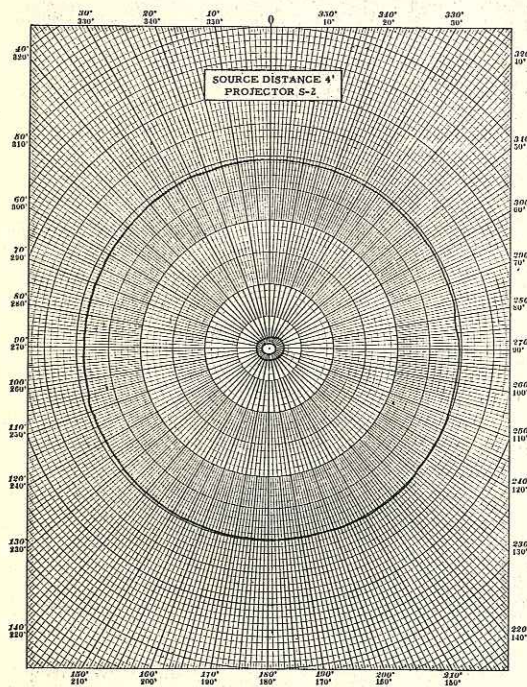

Fig. 9A - Vertical Plane

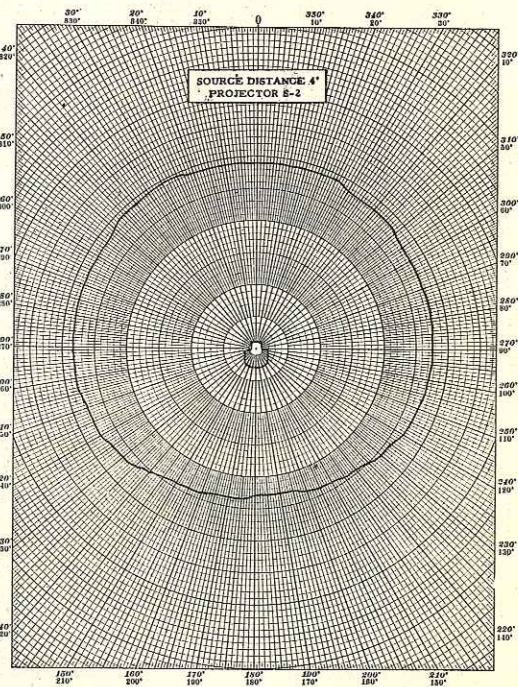

Fig. 9B - Horizontal Plane

Fig. 9 - Directivity patterns, at 5 kc, of Hydrophones Used in COCHINO Array

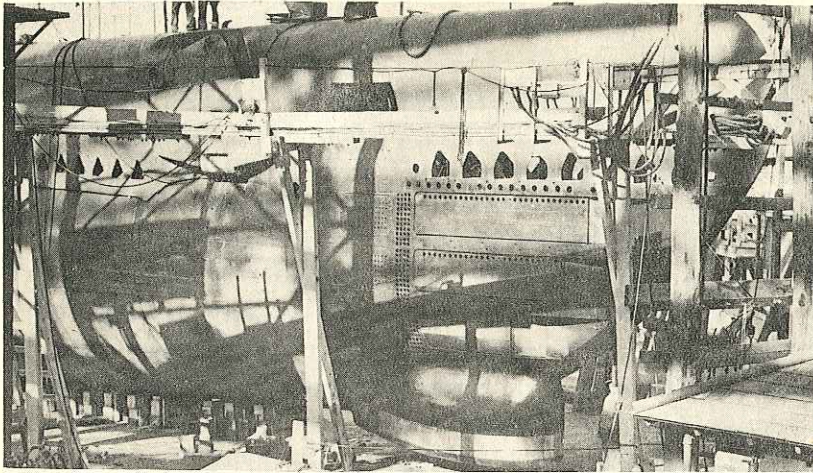

Fig. 10A - Over-all View

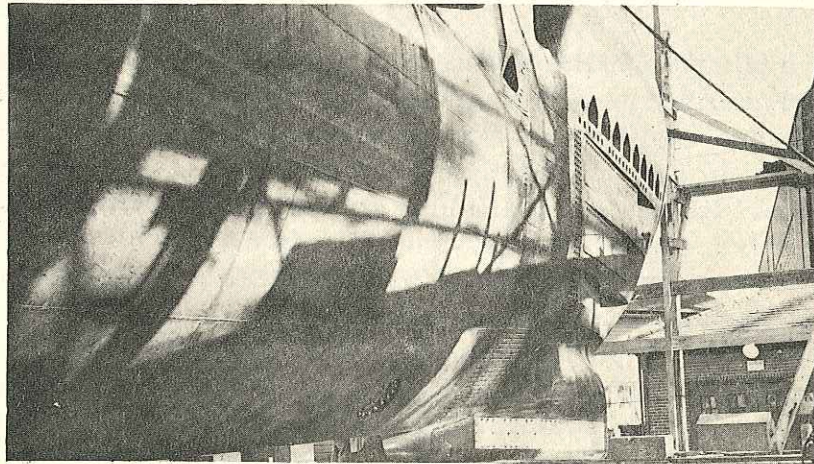

Fig. 10B - Rear View

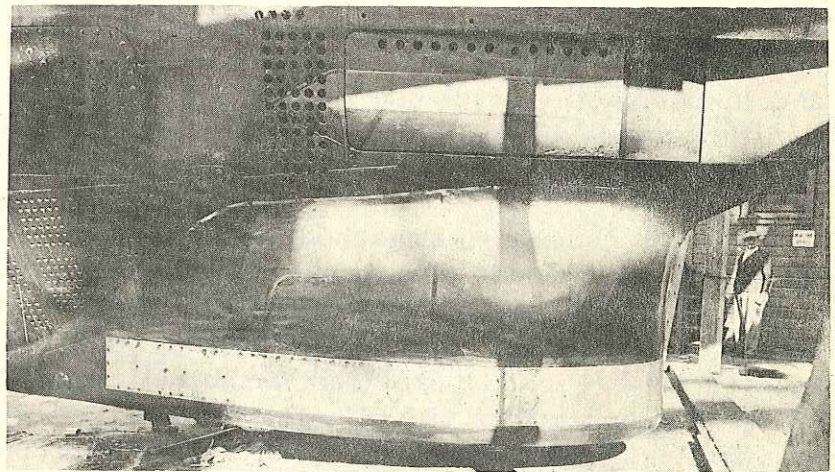

Fig. 10C - Side View

Fig. 10 - Exterior Views of COCHINO Installation



CONFIDENTIAL

## Electronic Modifications

One source of trouble in each of the German installations was that of electrically induced interference from various electrical equipments in the vessel. A prime offender was the main power supply for the GHG preamplifiers. In laying out the location of components of the electrical system for the COCHINO installation, an effort was made to eliminate the causes of such interference. The cables from each hydrophone were kept exactly the same length, and the junction boxes (Fig. 13) were located as near to their hull entrances as physically possible. As shown in Fig. 14, shielded leads then carried the signal to a more convenient location for the individual port and starboard preamplifier units. By locating the power supply on the overhead (see Fig. 15) at a point approximately midway between the main console and the preamplifiers, it was possible to obtain a substantial reduction in interference from this cause. The block diagram, Fig. 16, shows the relative locations of the components of the system.

As previous evaluation of the main audio amplifier used by the German system had revealed poor frequency-response characteristics and audio fidelity, it was decided to adapt a standard JP audio amplifier (see Fig. 17). The amplifier chosen was altered in several ways to provide suitable characteristics. The 500-cycle high-pass filter was modified to give a sharper slope in order to eliminate interference from low-frequency rumbles in own-ship noise output. Since the original carbon type potentiometer tended to become noisy with use, a step type gain control was added. The magnetizer output and the turn-count detector were removed, and a new input transformer was installed to match the amplifier input to the compensator output impedance. A tie-in connection to the 27-mc communication line was made to permit conning-tower orders to be heard directly by the operator. A drawing showing these modifications appears in Fig. 18.

A set of constant K low-pass filters was designed and inserted between the compensator output and the main amplifier input. A choice among 2000-, 3000-, and 5000-cycle low-pass filters was possible. The filter chosen, when used in conjunction with one of the high-pass filters provided in the main amplifier, made it possible to select from a wide range of frequency bandwidths. A wiring diagram of the low-pass filters is presented in Fig. 19.

The main console was checked over carefully, and a connection block (see Fig. 20) was provided to permit use of either one-half (2 trays), three-fourths (3 trays), or all (4 trays) of the available delay line. Another connection block, together with an additional jumper which modified the relay operation in the stack (shown in Fig. 21), provided for selection from a wide range of possible hydrophone connections. By adjusting the jumpers, it was possible to use only the hydrophones facing the target or all the hydrophones in the system. The effect of using one-half, three-fourths, or the entire delay, with and without the additional jumper, is graphically illustrated in Figs. 1 through 6, Appendix B.

CONFIDENTIAL

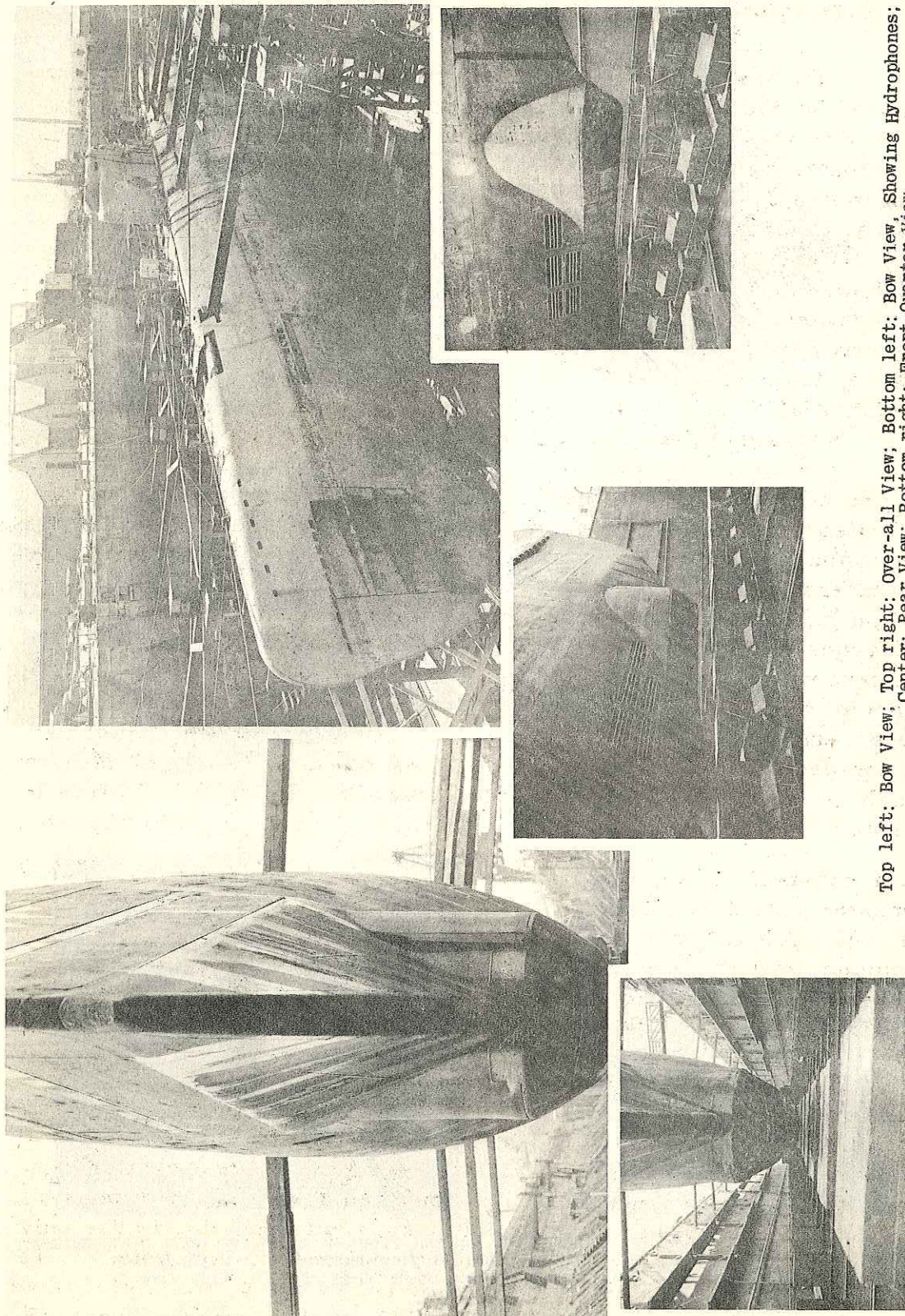

Top left: Bow View; Top right: Over-all View; Bottom left: Bow View, Showing Hydrophones;  
 Center: Rear View; Bottom right: Front-Quarter View.

Fig. 11 - Exterior Views of Type XXI Installation

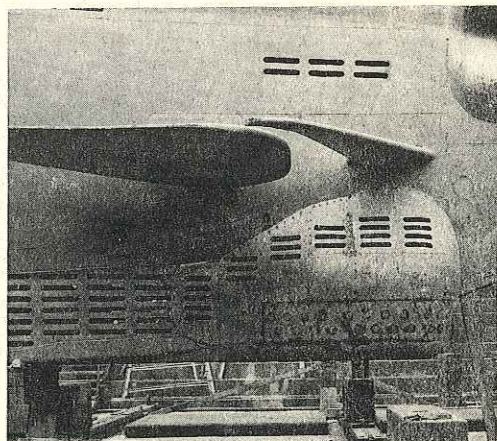
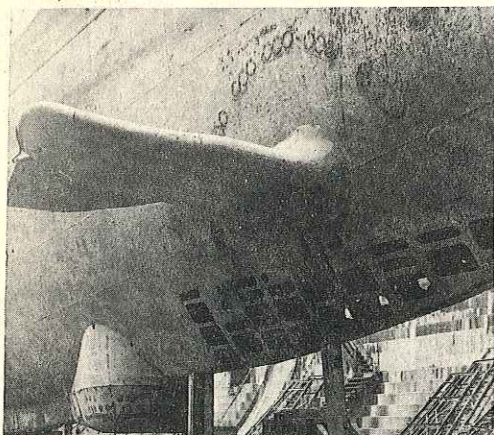
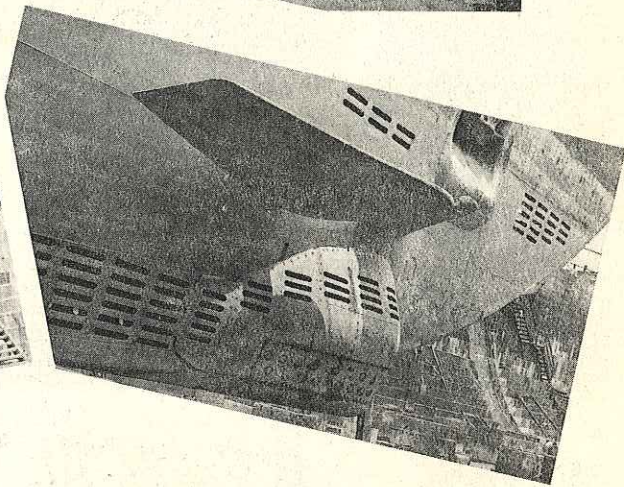
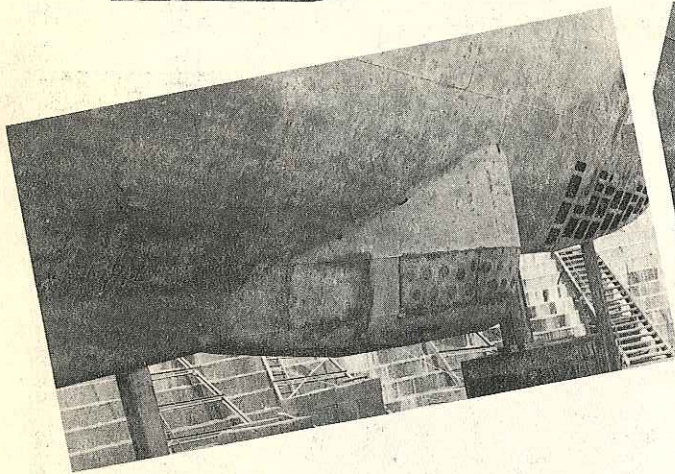
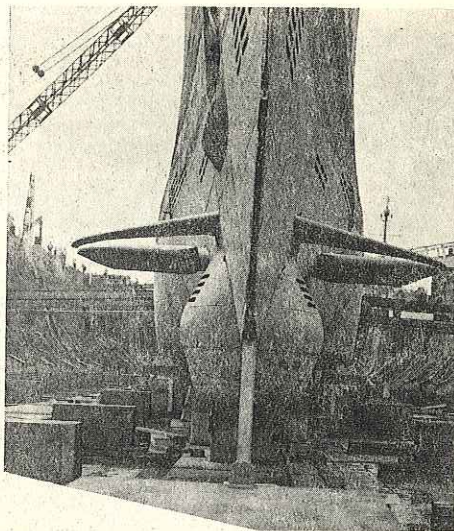
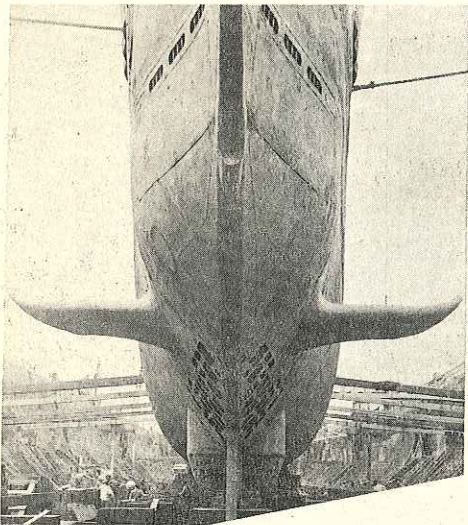

Top left: U-873 Balkon, Front View; Top right: U-234 Balkon, Front View; Center left: U-873 Balkon, Quarter View; Center right: U-234 Balkon, Quarter View; Bottom left: U-873 Balkon and Rumph (Hull-Mounted) Installation; Bottom right: U-234 Balkon, Side View.

Fig. 12 - GHG Installations on Other Types of U-Boats

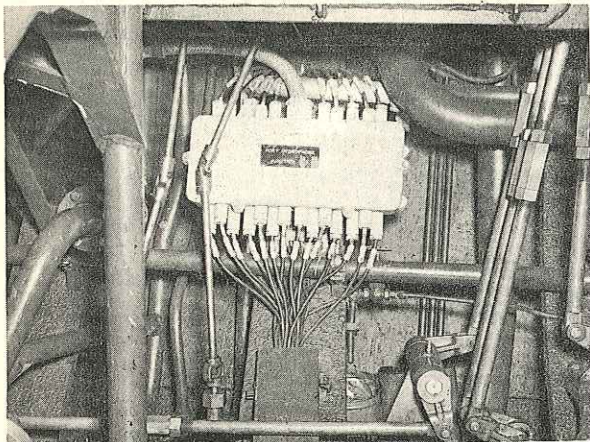

Fig. 13A - Junction Box, Port Side

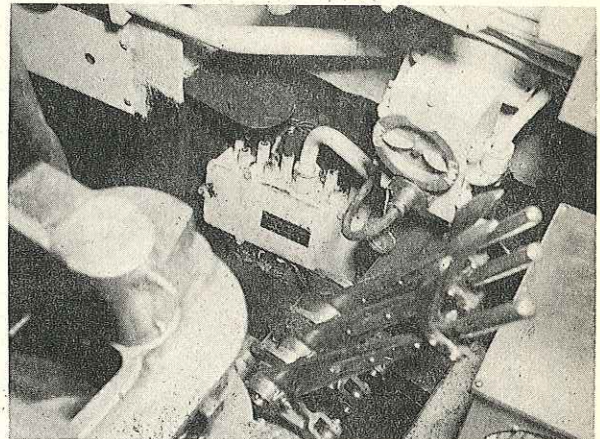

Fig. 13B - Junction Box, Starboard Side

Fig. 13 - Hydrophone Junction Box Locations

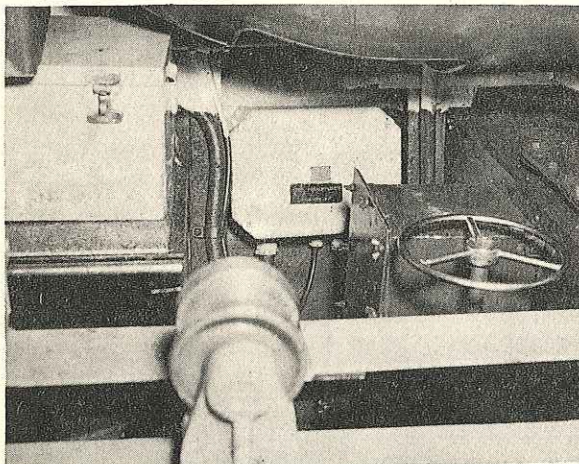

Fig. 14 - Port Preamplifier Location

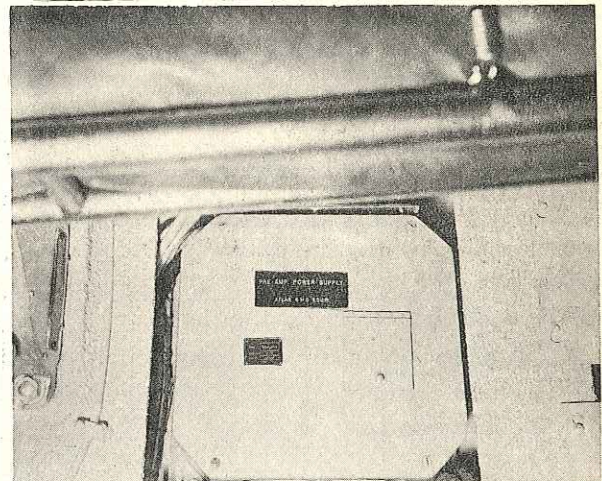

Fig. 15 - Preamplifier power Supply Location

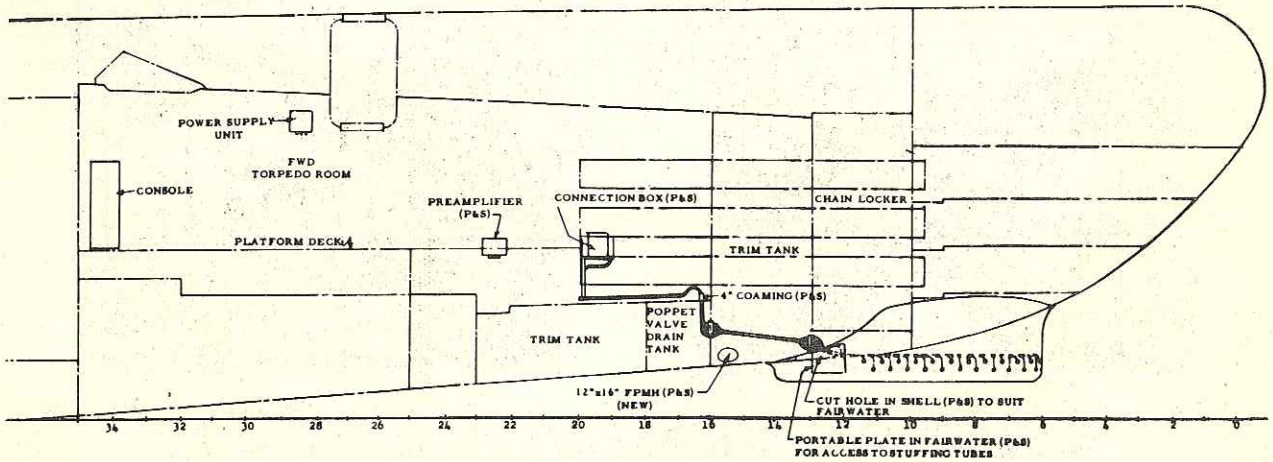

Fig. 16 - Location of Components of GHG System

**CONFIDENTIAL**

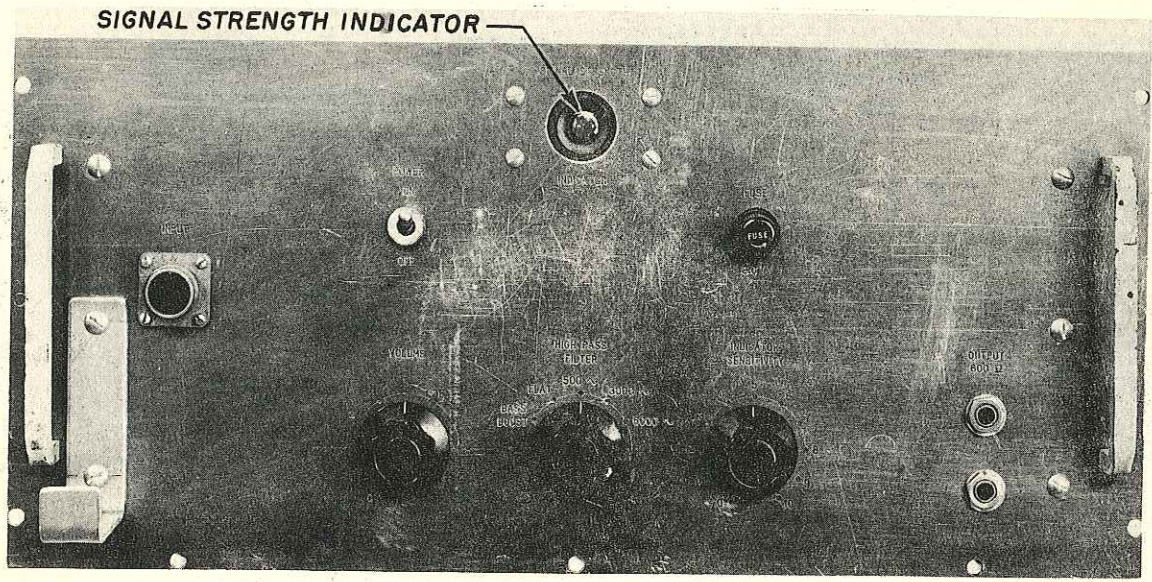

Fig. 17 - Modified JP Amplifier, Front View

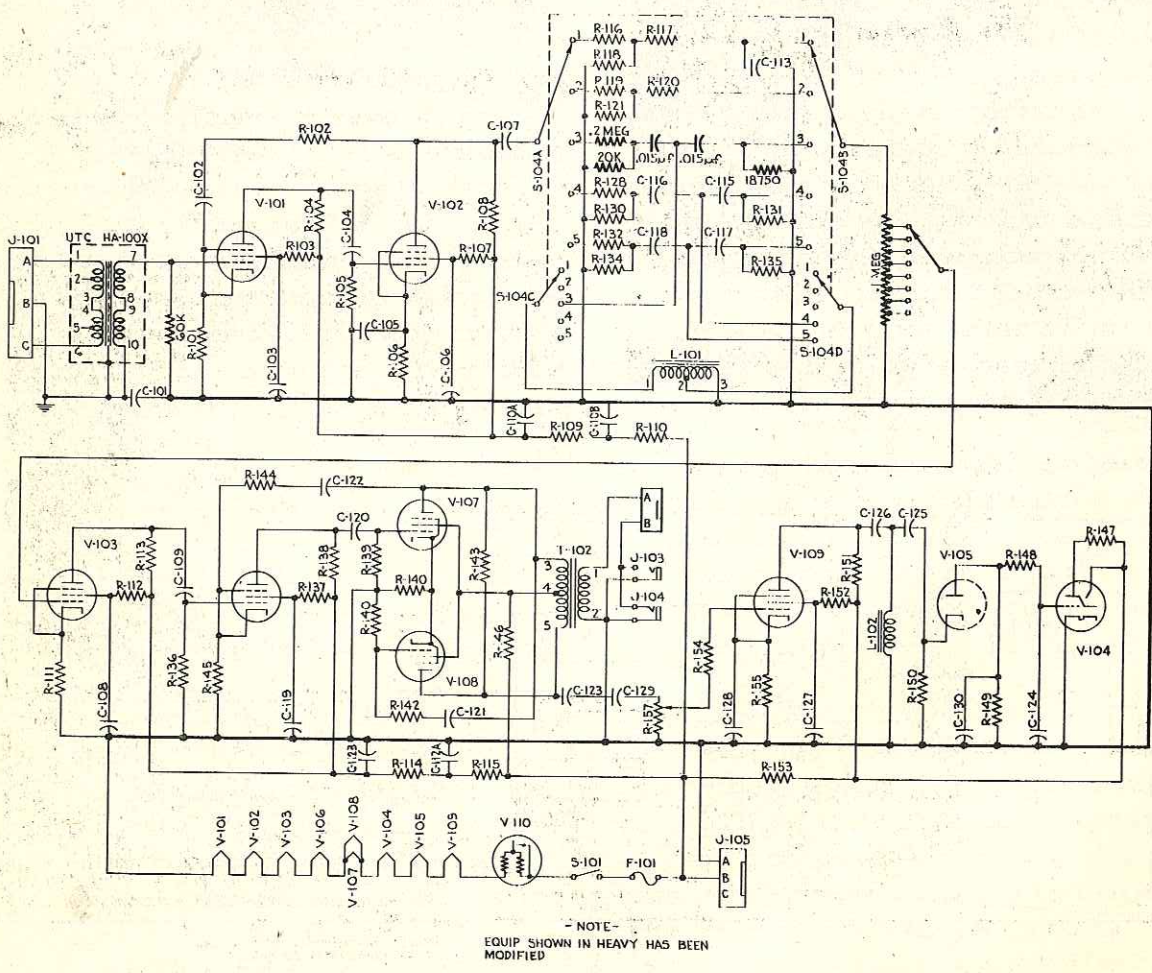

Fig. 18 - Schematic Diagram Showing Modifications for JP Amplifier

**CONFIDENTIAL**

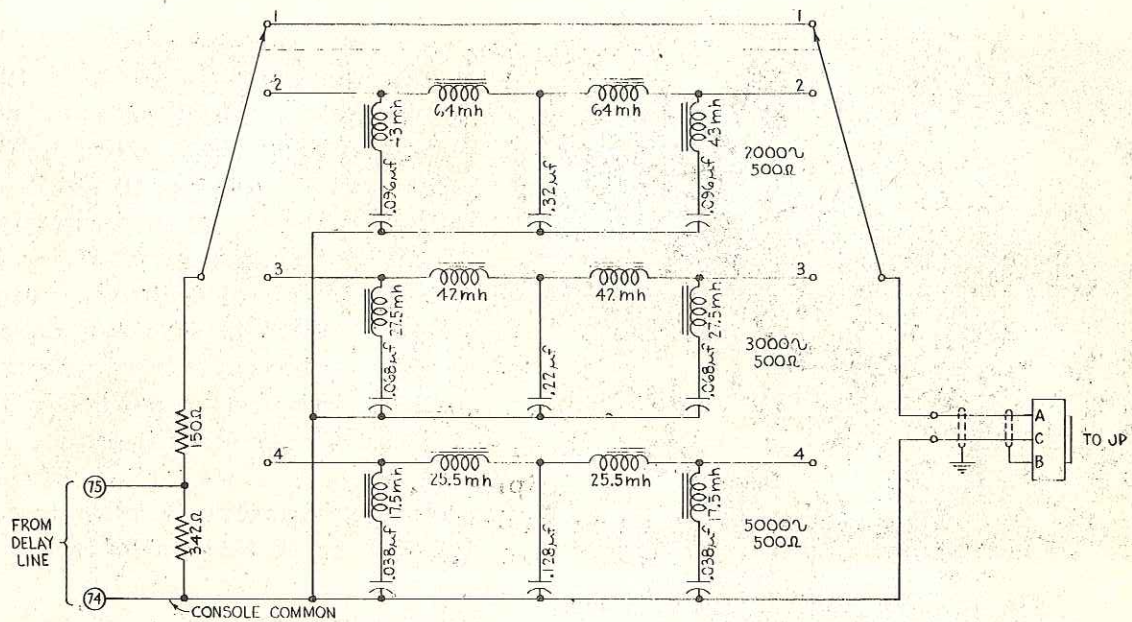

Fig. 19 - Schematic Diagram of Low-pass Filter Set

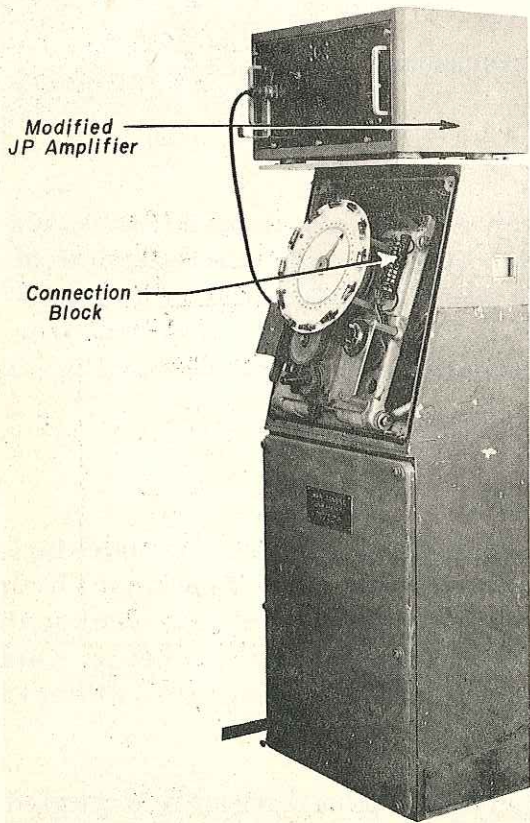

Fig. 20 - GHG Console, Cover Removed, Showing Connection Block for Tray Selection

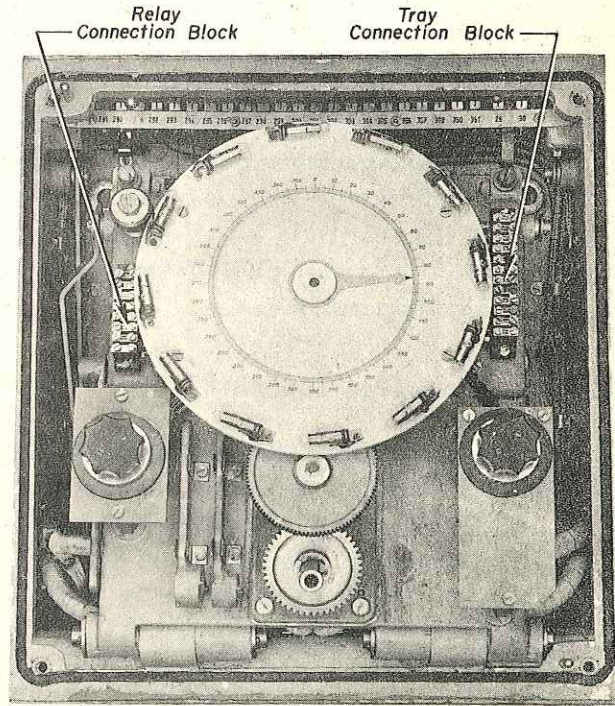

Fig. 21 - GHG Console, Cover Removed, Showing Relay and Tray Connection Blocks

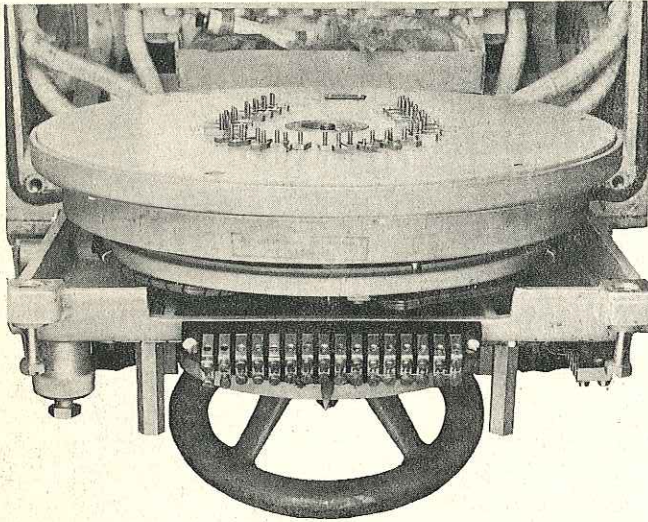

Fig. 22 - Scale-Model Brush Plate

A new compensator scale-model brush plate (see Fig. 22), corresponding to the hydrophone layout in the balkon, was built. A pilot-lamp dimmer control was installed in the position occupied by the volume control. Also provided was a memory pointer which could be fixed on any selected bearing, for reference while continuing a search. This feature was useful in tracking multiple targets or in verifying a possible contact. A plan to provide for installation of synchros for repeating bearings to the conning tower was devised, but

time did not permit completion of this work.<sup>3</sup>

## PRE-COMMISSIONING PROCEDURES

### Electrical Measurements

After all components of the system had been completely checked, a series of measurements was made to determine the operating characteristics of each component and of the over-all system. Following these tests, the equipment was dismantled and turned over to the Electric Boat Company for installation in the COCHINO. The measurements are recorded in Figs. 1 through 22, Appendix C.

### Pre-Commissioning Checks

The balkon was attached at the time of the COCHINO's September docking, and the hydrophones were installed during the next docking. The boat then was undocked, and the hydrophones were submerged for a few weeks; all packing glands in the hull and in the hydrophones checked out properly. One hydrophone failed at a later date, but its loss did not measurably affect the functioning of the equipment.

The main console was installed, facing aft, in the space formerly occupied by the forward-room station of the WFA sonar equipment (see Fig. 23). The

<sup>3</sup>This work was later accomplished in connection with the CLAMAGORE installation.

WFA equipment was modified to permit operation without the components which had to be removed.<sup>4</sup>

#### SEA TESTS AND EVALUATION

A four-week period, which began 14 February 1949, was devoted to operational evaluation of the equipment's performance. In order to determine hydrophone self-noise relative to operating condition, data were obtained in deep water (over 100 fathoms) for each of 16 hydrophones selected from the array. Runs were made covering a wide range of speeds and depths. Data for system self-noise under the same conditions as for individual hydrophones were also obtained. The results appear in Figs. 1 through 13, Appendix D.

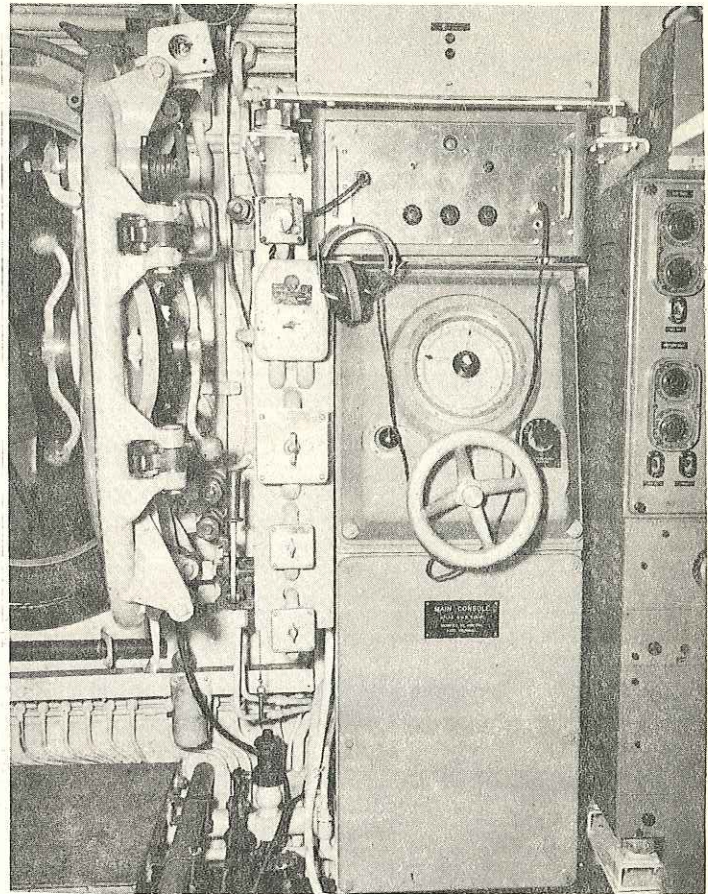

Fig. 23 - GHG Console Installation in Forward Room of COCHINO

With a target circling the submarine, several runs were made in Long Island Sound to compare relative target bearings obtained with JT, periscope, and GHG equipment; the results of these tests are shown in Fig. 14, Appendix D. The following procedure was observed: (1) at each position, namely, the GHG, JT, and periscope, an operator and an observer were stationed; (2) each observer started his stop watch at an "execute" signal; (3) each operator then called the bearing of the circling target as rapidly and as accurately as possible while his recorder noted the time and the bearing of each observation; and (4) the resulting data were then plotted versus a common time base so that the spread from a norm could be observed.

Several runs were made with a target submarine passing directly over and under the COCHINO to determine whether contact would be lost under these conditions. The drawing in Fig. 24 illustrates the "lost-bearing" zones. Also, torpedo firing runs and recordings demonstrating the usefulness of the equipment for tracking such runs were made.

<sup>4</sup> A 60-page manual, Preliminary Operating and Maintenance Instructions for Modified GHG Listening Equipment as Installed in the USS COCHINO, containing information on the characteristics of the equipment, photographs, and performance charts, was prepared and published.



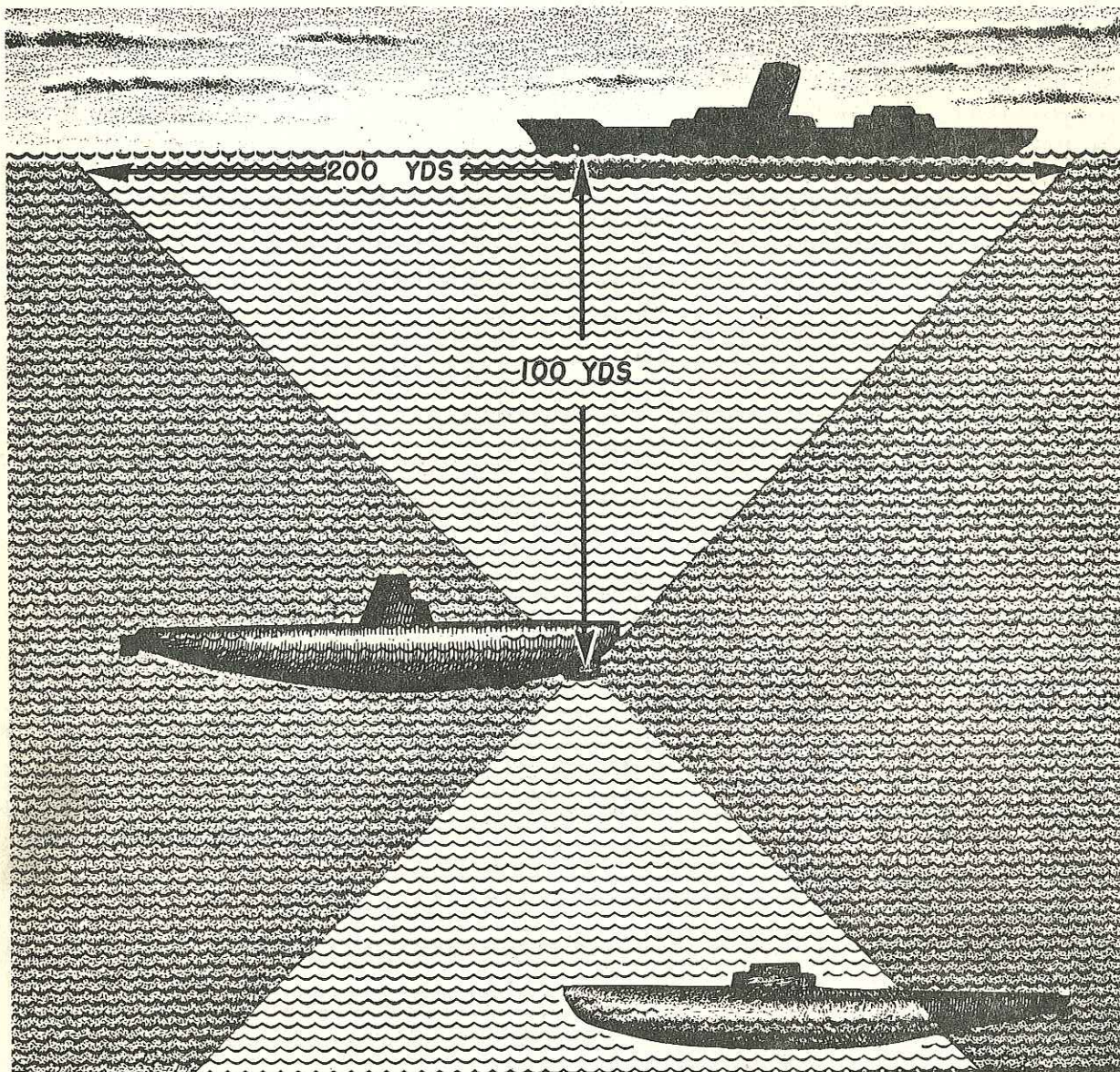

Fig. 24 - Sketch Showing "Lost-Bearing" Zones

Representative patterns (Figs. 15 through 76, Appendix D) were obtained for the system by mooring in the mouth of the Thames River and recording the output of the system while a motor launch made circling runs at a range of about 125 yards, with the array at the center of the circle. A TBT (Target Bearing Transmitter) was mounted on deck, centered over the array, as may be seen in Fig. 25, and a modified Sound Apparatus recorder was used to record the GHG output. The rotation of the TBT head topside drove the paper feed of the recorder at the rate of one foot of paper for each 360-degree rotation. The compensator was set on a bearing and left there while the launch circled at high speed about the 125-yard radius centered on the array. The

operator on deck kept the TBT trained on the stern of the launch, thus driving the recorder paper feed in synchronism with the rotation of the target. A bearing repeater below permitted visual observation at all times of the target's relative bearing, and this information was noted at appropriate intervals on the recorder tape. In two nights' operations, various filters, bearings, and hydrophone selections were investigated and approximately 60 beam patterns were obtained. The target noise was at all times well above the ambient.

Simulated detection approach, and attack problems were scheduled but were cancelled because of unfavorable weather.<sup>5</sup>

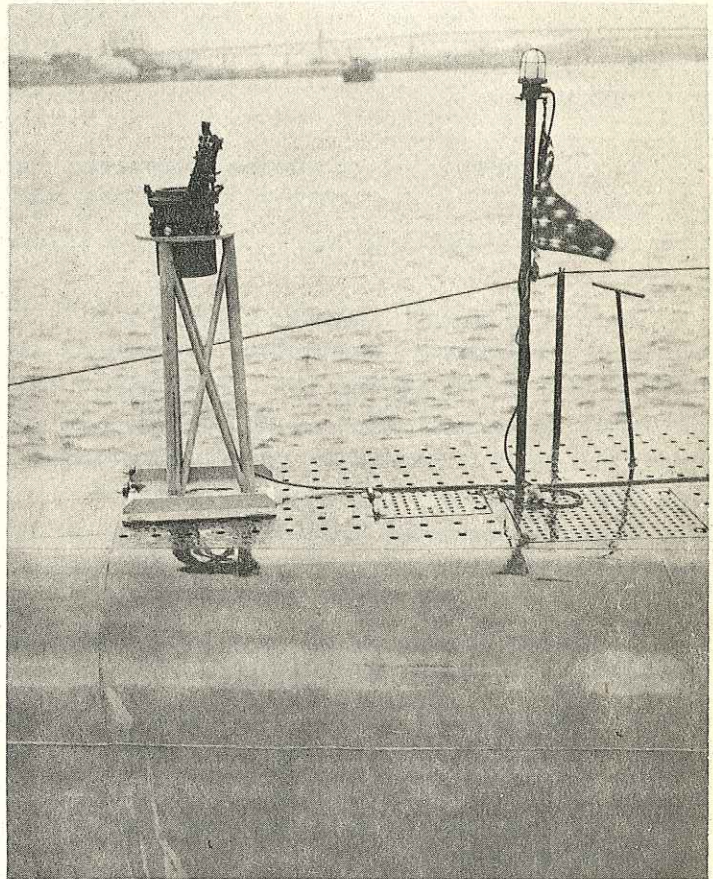

Fig. 25 - Target Bearing Transmitter, Mounted on Deck above Array, for Beam Pattern Measurements

#### CONCLUSIONS AND RECOMMENDATIONS

1. The performance of the modified GHG installation on the COCHINO was superior to that obtained with any GHG installation previously tested.
2. Interference due to electrically induced noise was so low that it could be considered eliminated. All previous German systems had interference from this source, so serious in most cases as to preclude the possibility of hearing any targets on certain fixed bearings.
3. The shape and location of the balkon provided highly effective shielding from own-ship noise due to propulsion machinery and screw cavitation.
4. Bearing determination to within approximately one degree was possible throughout the complete azimuth. Previous systems had been decidedly deficient over a sector about 40° wide centered about the stern. The

<sup>5</sup>It is expected that this information will be available as a result of the CLAMAGORE evaluation.

superiority of the system on the COCHINO was due to the balkon design and system modifications, which permitted the simultaneous use of all the hydrophones.

5. The provision of independent high- and low-pass filters made possible the selection of more effective listening bands and materially assisted in the detection of signals in the presence of masking sounds.

6. Beam patterns show relatively uniform main-lobe-width versus training angle. The image responses are undesirably high but can be reduced by a balkon structure having less attenuation and attendant phase distortions. The patterns observed when using only those hydrophones facing the target appear superior, a fact probably due to structural interference.<sup>6</sup> In order to obtain bearings about the stern, however, the remaining hydrophones are essential, and a cam-operated switch could be provided to permit use of the most desirable combination at all bearings.

7. Tests made with vertically displaced targets failed to show any appreciable errors in bearing. If the target approaches the vertical axis of the array by no less than fifty yards, continuous bearings may be observed. If the target passes through the vertical axis of the array, contact is lost for a very short interval. The actual lost-contact to regained-contact time was less for the GHG than for the WFA or the JT, mainly because of the rapidity of training.

8. In tracking torpedo runs, the equipment was effective, since its array location below the tubes prevented the rising impulse bubble from screening it from the torpedo immediately after firing. On several occasions the torpedo was tracked to the end of its run even though the submarine surfaced during the run.

9. During operation at normal surface speeds, the usefulness of the equipment was found to be limited, although loud, medium-range, and close-range targets were detected while operating at speeds up to 15 knots. Such detection may not be very reliable, however, as surface gradients and sea state would seriously alter detection ranges.

10. Operation while snorkeling appears feasible, and on several occasions medium-range targets were heard while running at about 10-knot snorkel speed. Noise due to snorkel exhaust or engines was well down in the listening background. Under these conditions good torpedo-detection ranges should be obtainable.

---

<sup>6</sup>This system of using only incident hydrophones was later employed in the CLAMAGORE installation.

11. In shallow water, considerable bottom-reflected sound was heard and caused rather severe interference; in deep water, this effect disappears completely. The same phenomenon was noted on the PRINZ EUGEN.

12. Superstructure rattles which cause severe interference with topside-mounted sonar are hardly more than a minor nuisance in the GHG listening system. As this type of self-noise has proved the most difficult to suppress, it is a highly significant factor in choosing the location of a listening array.

13. The use of the topside gear when bottomed or in very shallow water showed the desirability of employing both types of equipment. For fire-control work, the bearing accuracy of the JT or its equivalent is required.

14. The absence of rotating shafts through the hull and their noisy, motorized training systems made this equipment useful when running silent, as no sounds which could be transmitted into the water were generated by training the equipment.

15. The use of a large number of hydrophones makes for a more reliable system. Up to 25 per cent of the hydrophones may fail without seriously affecting the practical operation of the equipment. The circuit elements, being largely passive, are not so susceptible to failure as those in other comparable sonar systems.

16. In summary, the main desirable features of the GHG, as installed on the COCHINO, were the following:

- a. It provided listening under both surfaced and submerged operating conditions.
- b. It provided effective listening at the high operating speeds of Guppy submarines.
- c. It permitted effective listening while snorkeling.
- d. Its physical location reduced interference from own-ship superstructure rattles and provided effective shielding from own snorkel.
- e. It produced no sounds which could be radiated into the water.
- f. Its bearing accuracy was sufficient for the approach phase of an attack.

CONFIDENTIAL

g. It tracked targets passing above and below without incurring serious loss of contact.

h. It was an invaluable aid in tracking torpedoes.

i. Its performance indicated that it would be useful as a torpedo-detection device.

j. It was less complex than other comparable equipments and proved less susceptible to failure.

CONFIDENTIAL

APPENDIX A

CONSTRUCTION AND INSTALLATION  
DETAILS OF BALKON

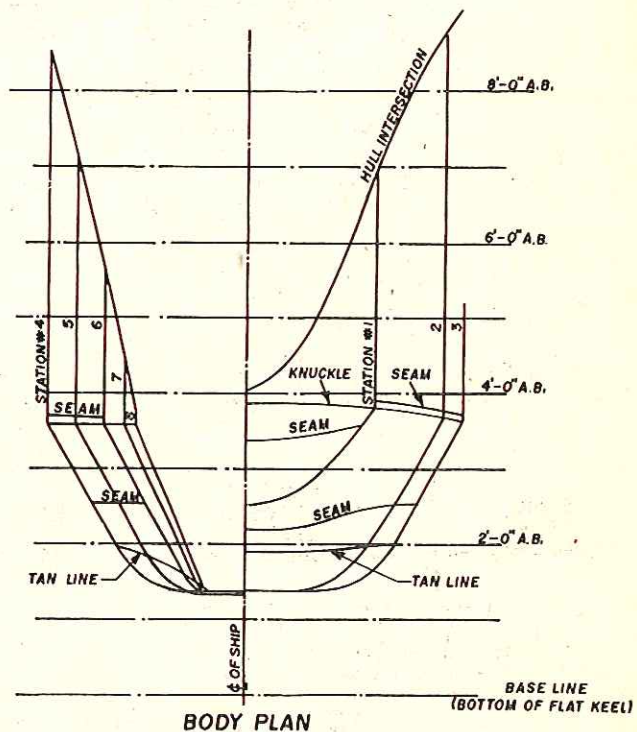
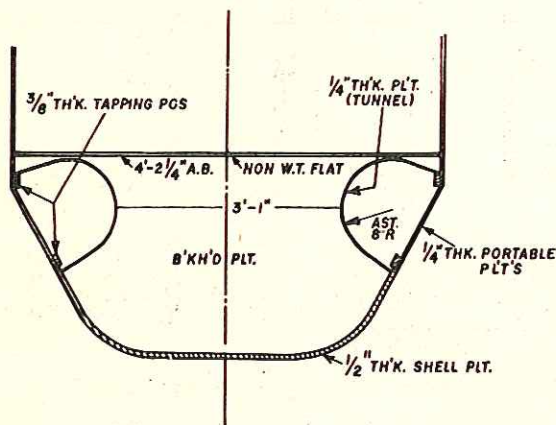
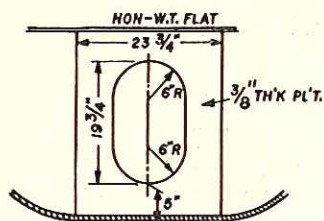
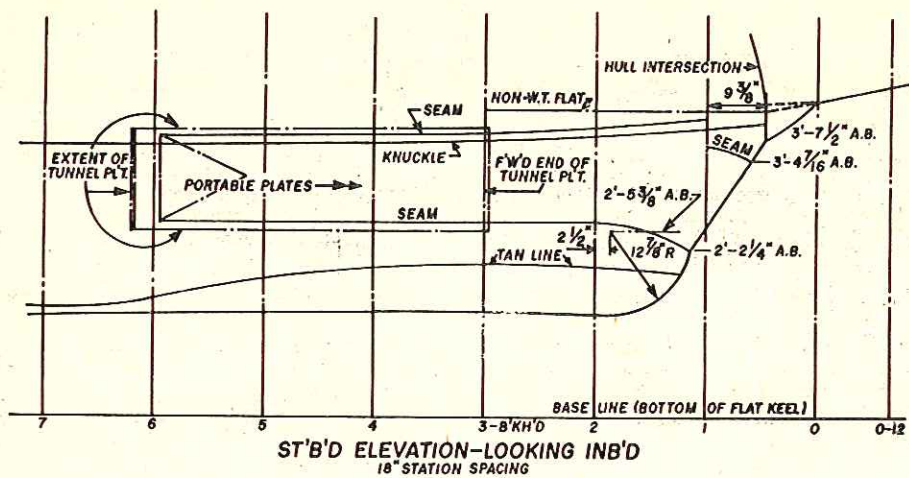

Fig. 1 - Lines of the Type XXI Balkon

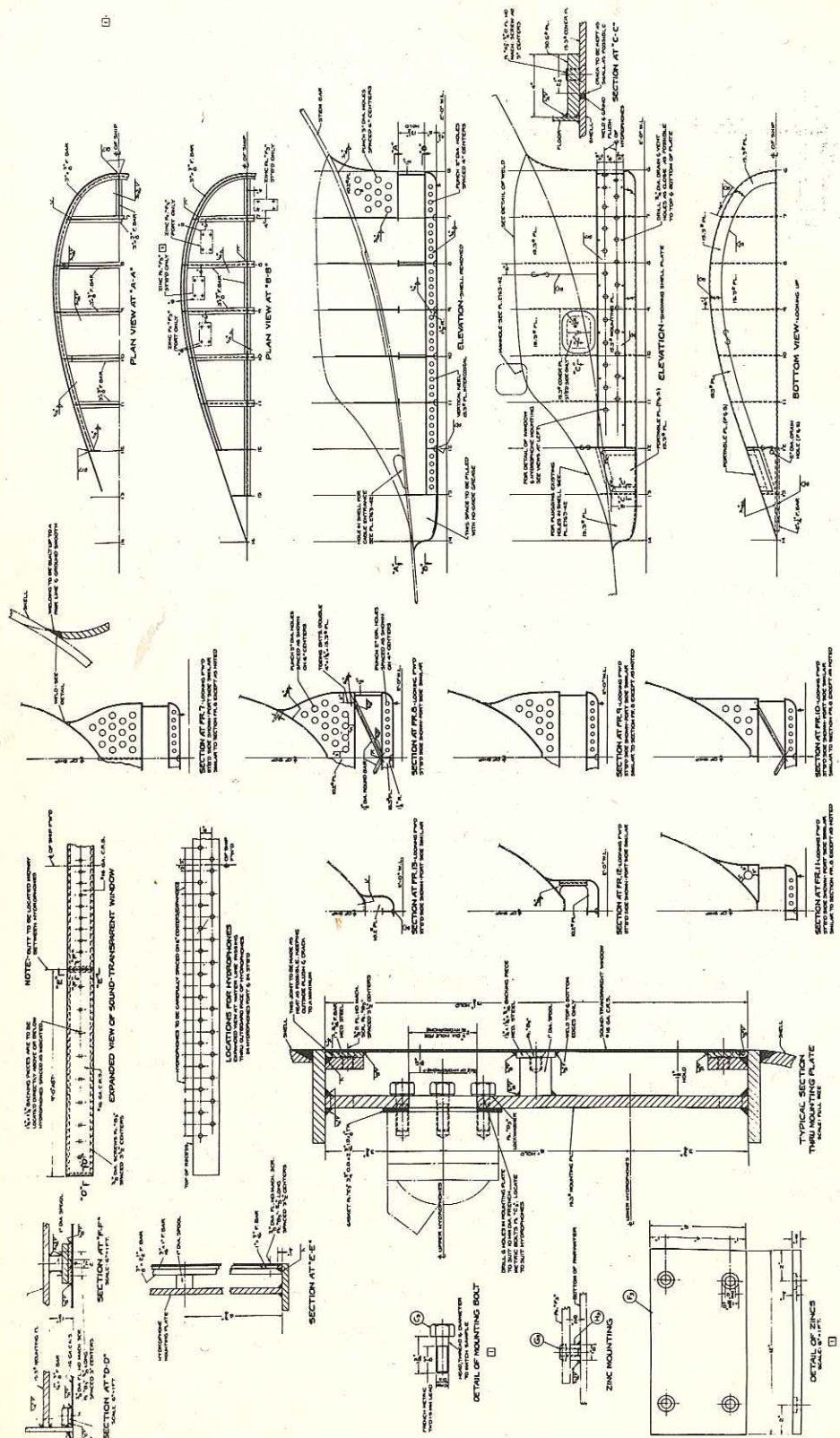

Fig. 2 - Manufacturer's Drawings of COCHINO Array, Showing Construction Details



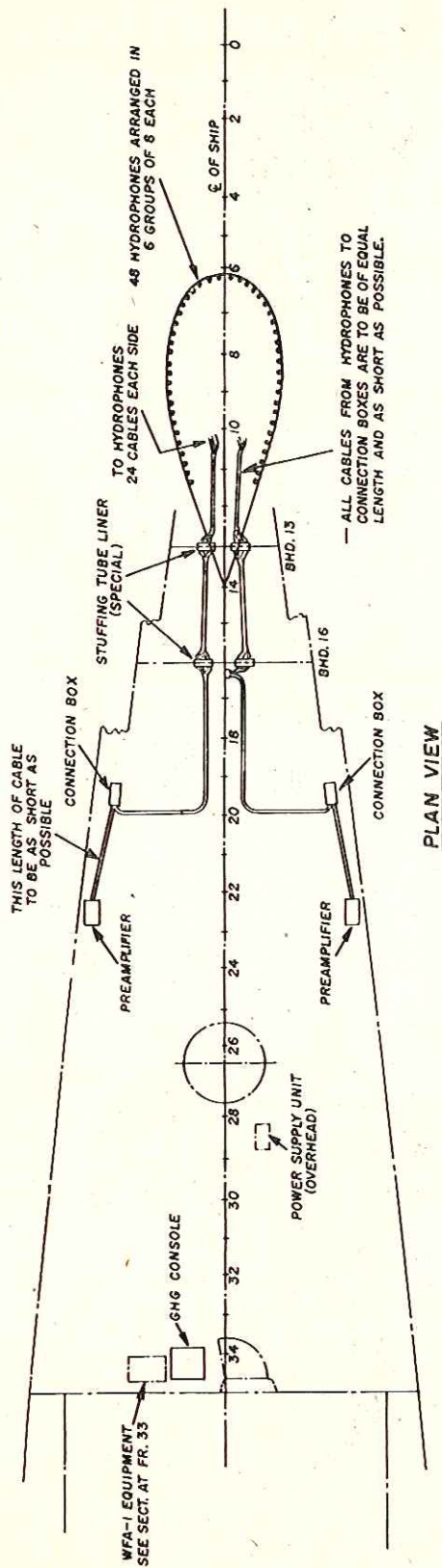

Fig. 3 - Plan View of COCHINO GHG Installation

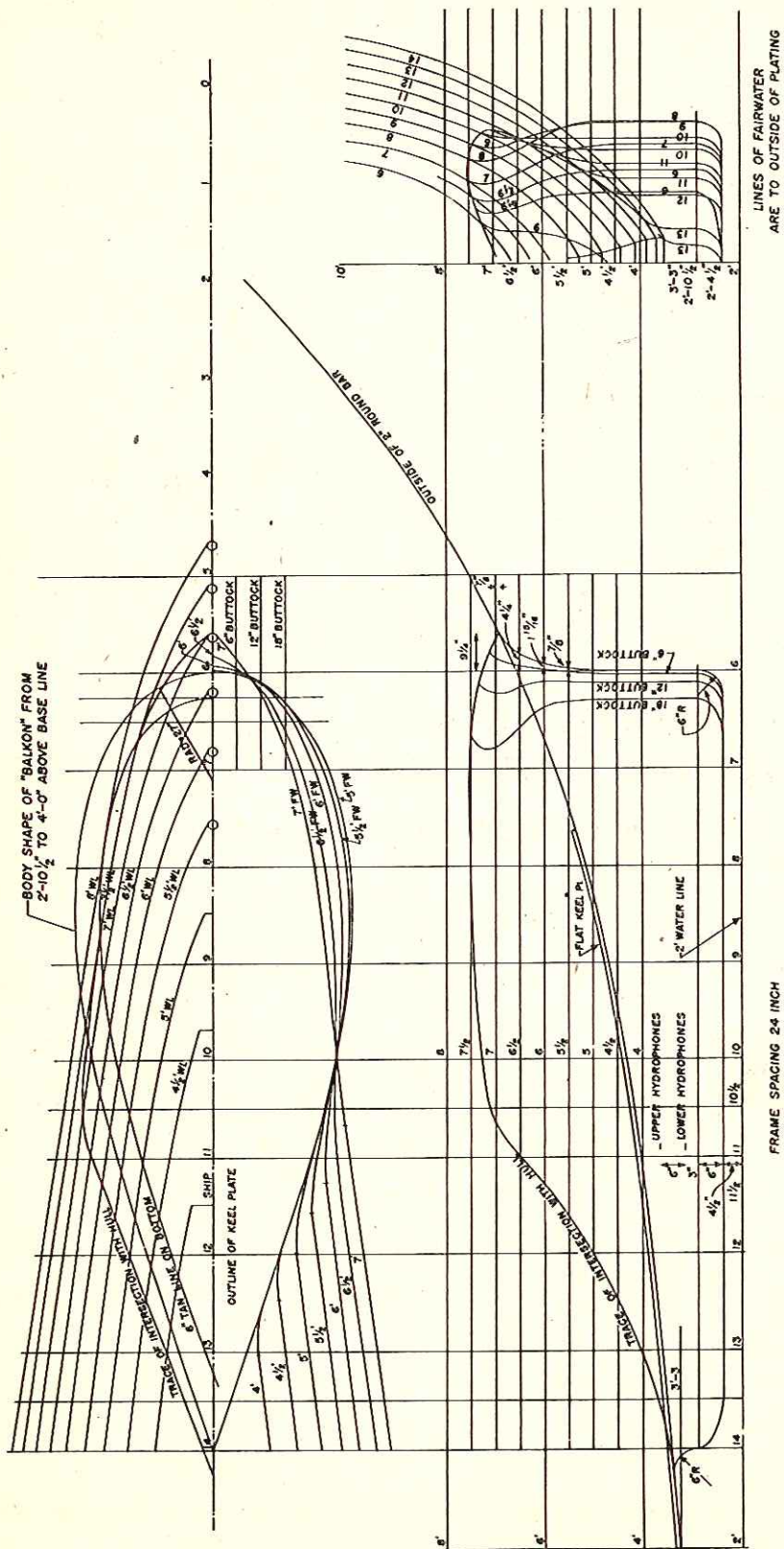

Fig. 4 - Lines of COCHINO Balkon

LINES OF FAIRWATER ARE TO OUTSIDE OF PLATING

FRAME SPACING 24 INCH

**APPENDIX B**

**GRAPHIC REPRESENTATION OF THE EFFECT OF  
CHANGING THE LENGTH OF THE DELAY LINE  
BY MEANS OF A CONNECTION BLOCK**

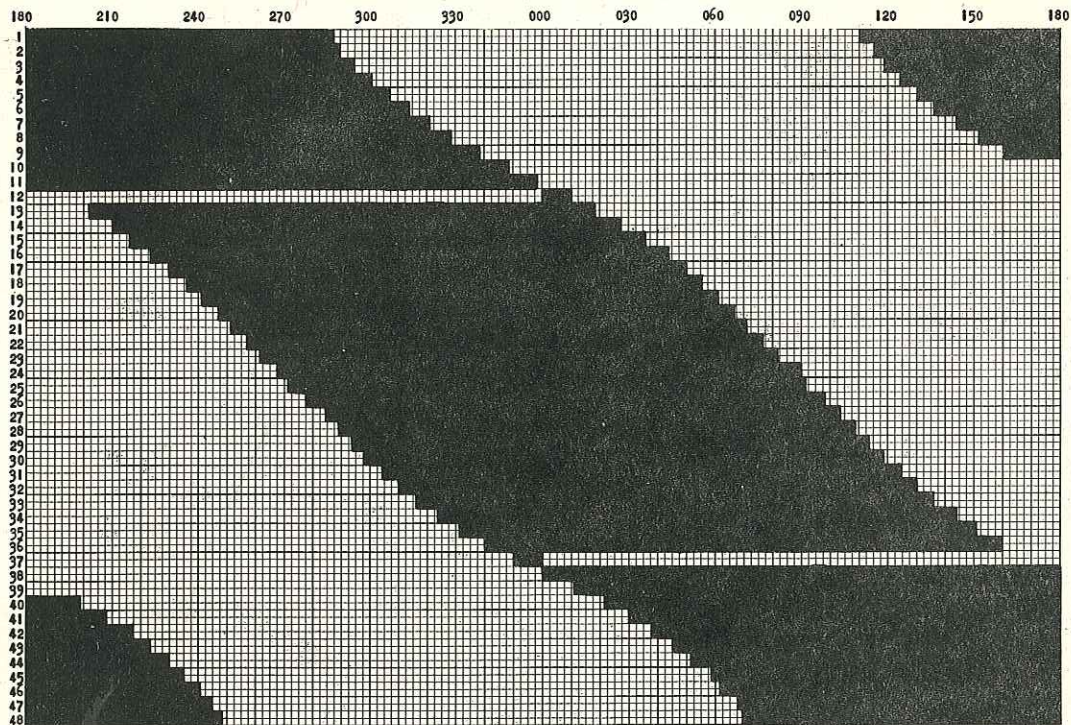

Fig. 1 - Reading of Bearing Indicator, in degrees, on COCHINO Console. Two Delay Trays in Use. Terminal 89 Connected to Terminals 90-91 on Connection Block. (Black area is operative area.)

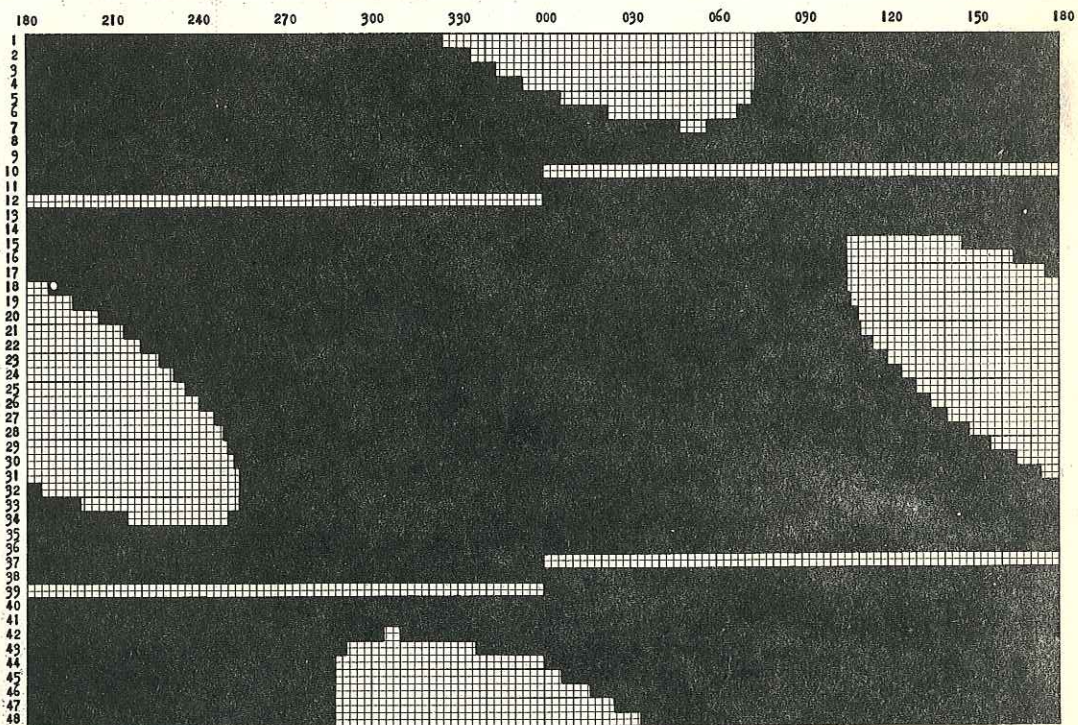

Fig. 2 - Reading of Bearing Indicator, in degrees, on COCHINO Console. Three Delay Trays in Use. Terminal 89 Connected to Terminals 90-91 on Connection Block. (Black area is operative area.)

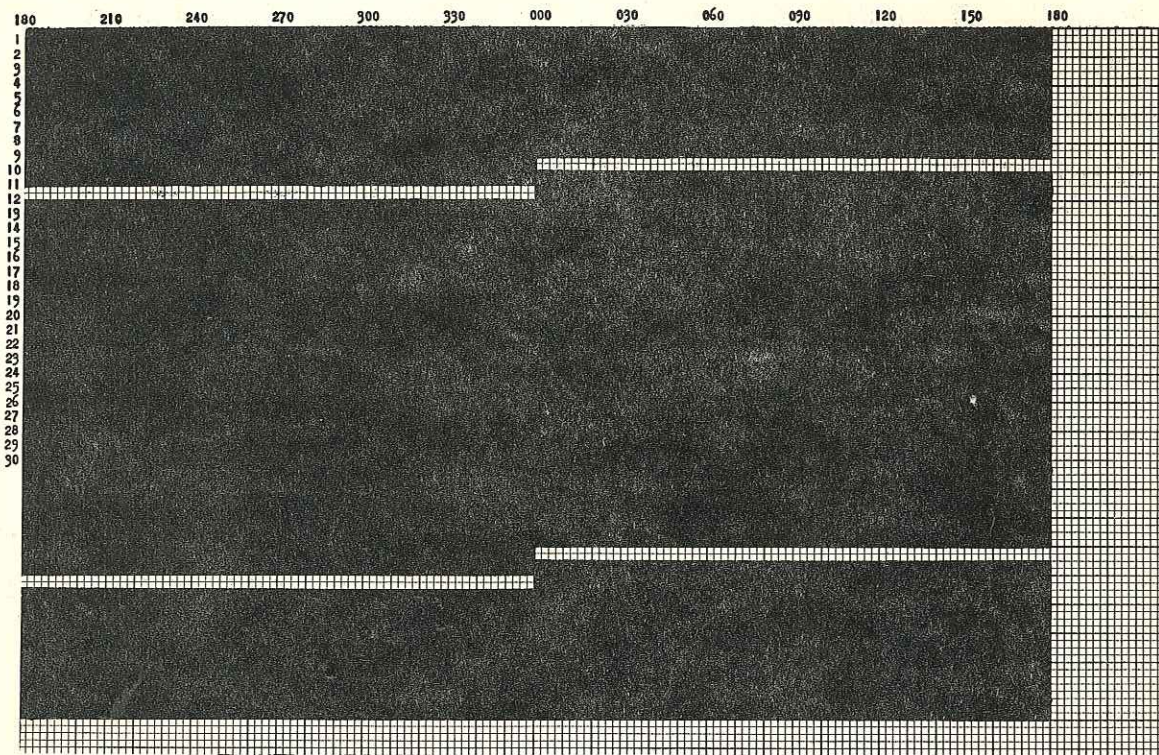

Fig. 3 - Reading of Bearing Indicator, in degrees, on COCHINO Console. Four Delay Trays in Use. Terminal 89 Connected to Terminals 90-91 on Connection Block. (Black area is operative area.)

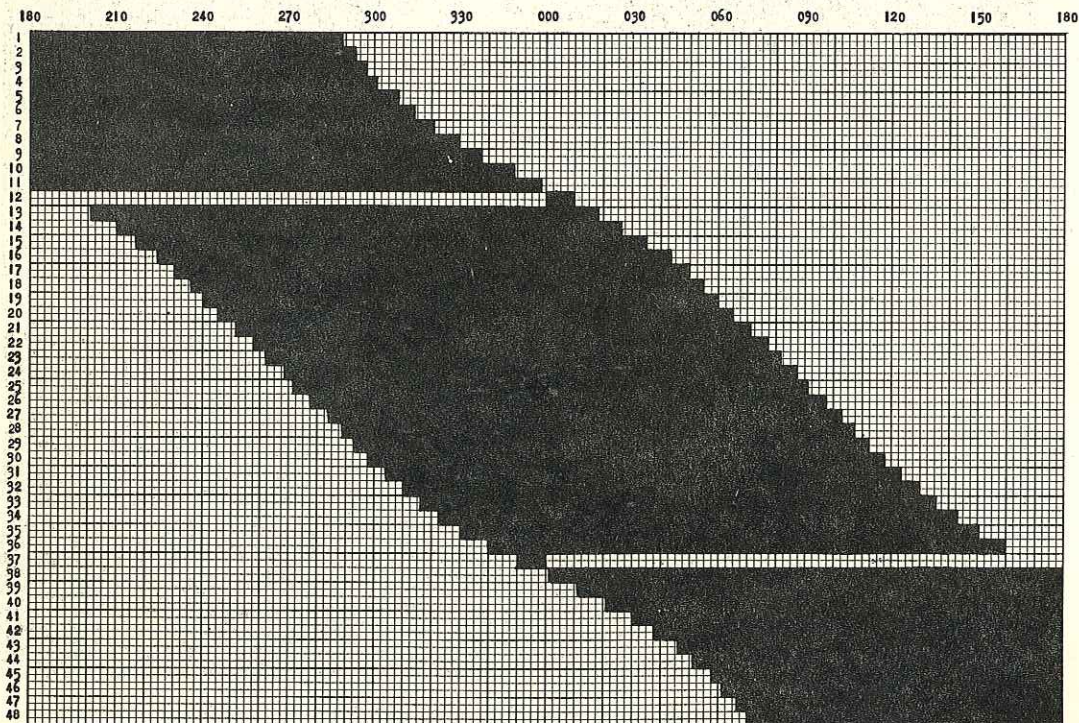

Fig. 4 - Reading of Bearing Indicator, in degrees, on COCHINO Console. Two Delay Trays in Use. (Black area is operative area.)

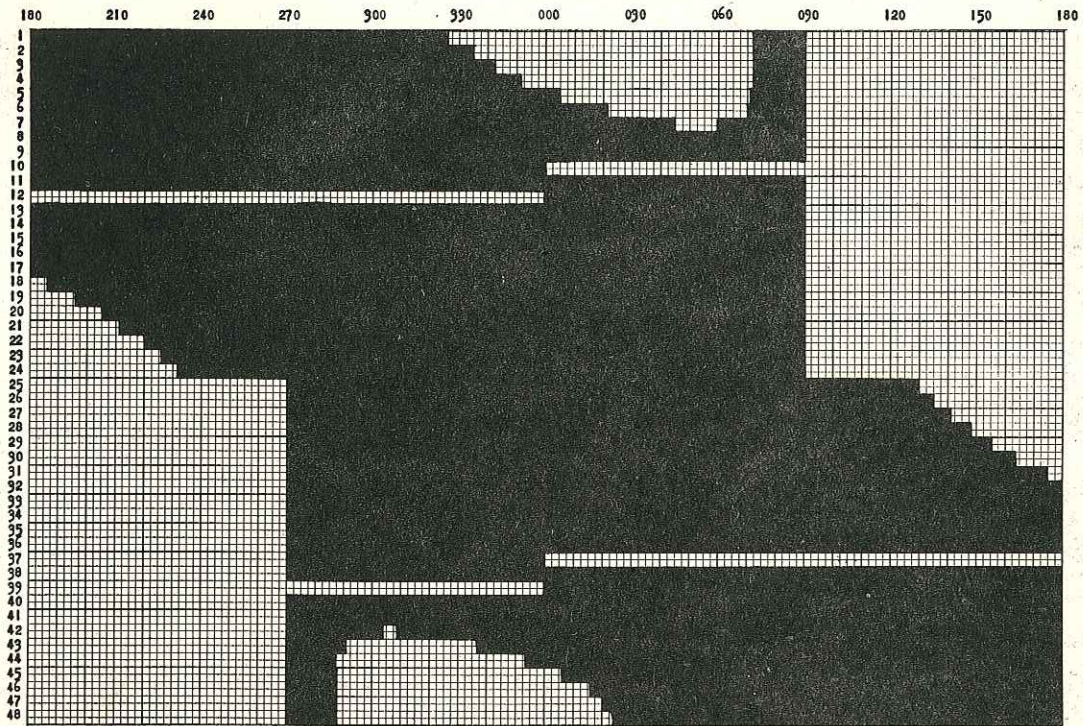

Fig. 5 - Reading of Bearing Indicator, in degrees, on COCHINO Console. Three Delay Trays in Use. (Black area is operative area.)

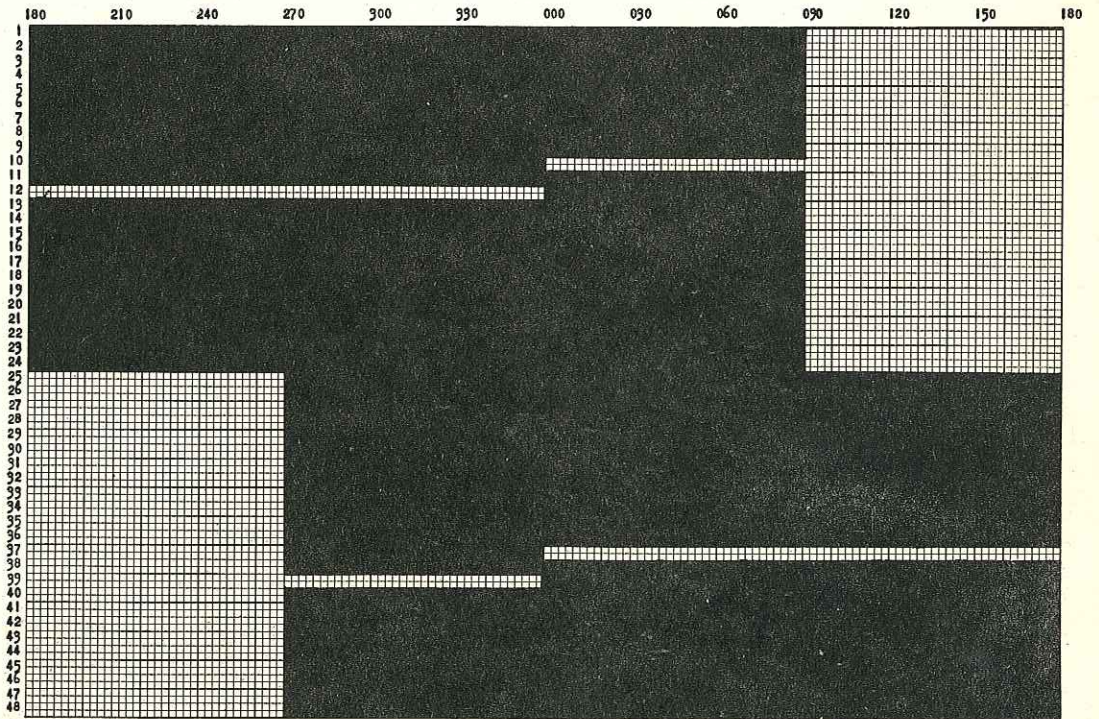

Fig. 6 - Reading of Bearing Indicator, in degrees, on COCHINO Console. Four Delay Trays in Use. (Black area is operative area.)

**APPENDIX C**

**FREQUENCY MEASUREMENTS  
OF COMPONENTS AND OVER-ALL SYSTEM**

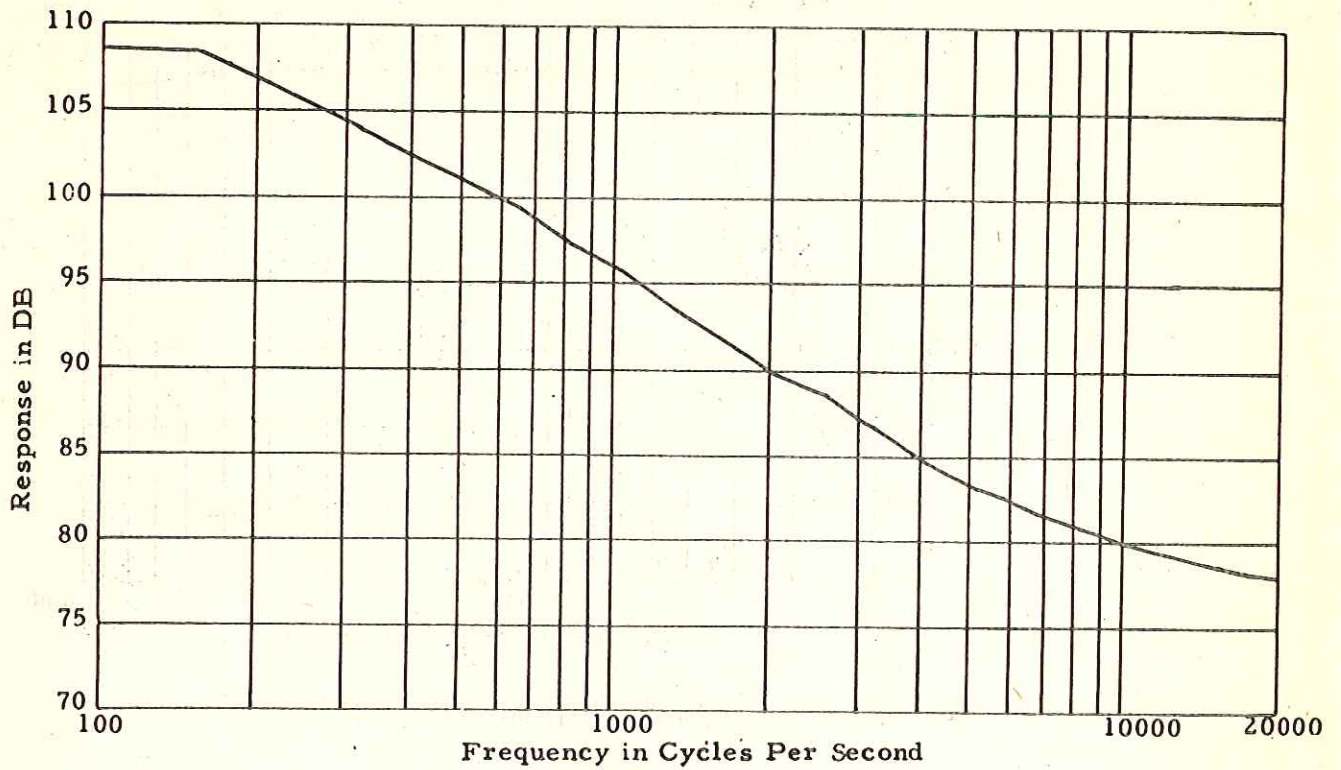

Fig. 1 - JP Amplifier Response; Bass-Boost Filter;  
Input Signal, 1 millivolt; Output across 600-ohm Load

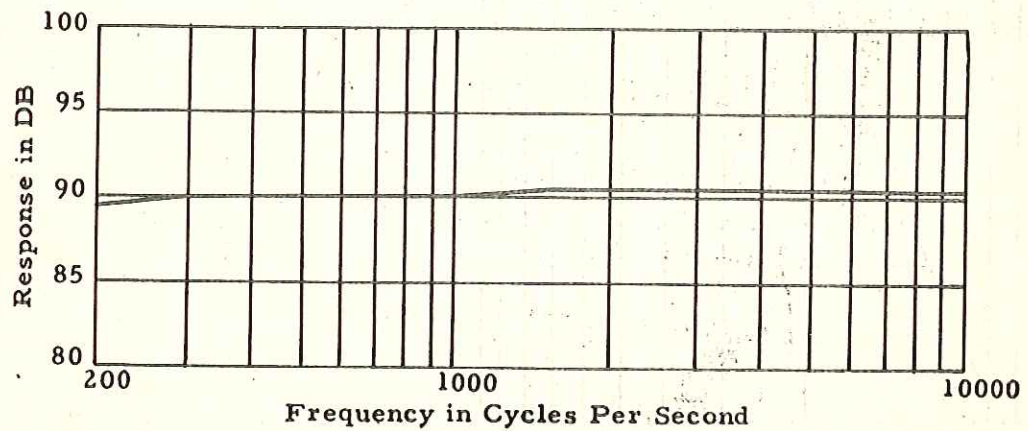

Fig. 2 - JP Amplifier Response; Flat Filter;  
Input Signal, 1 millivolt; Output across 600-ohm Load



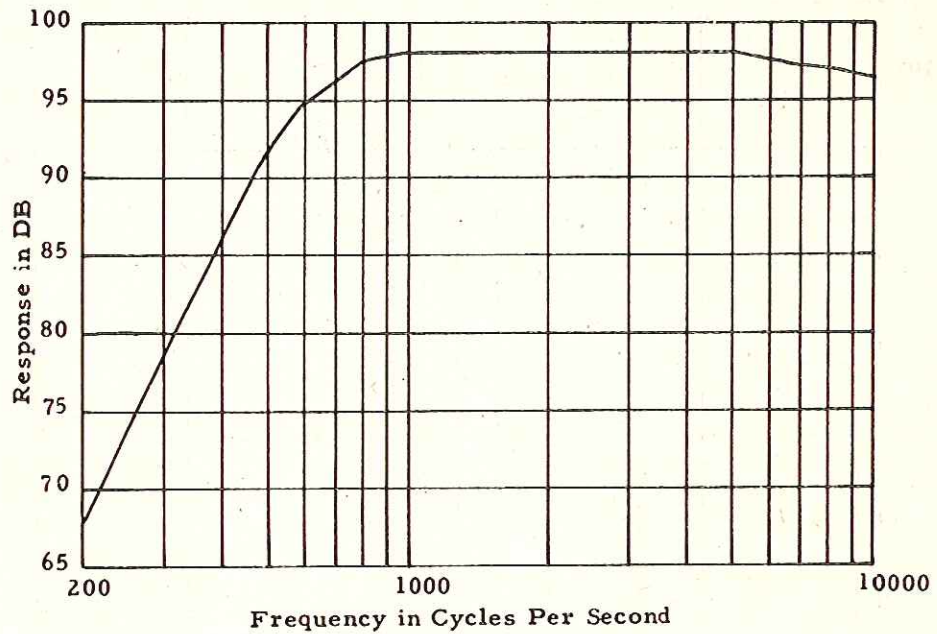

Fig. 3 - JP Amplifier Response; 500-cps Filter;  
Input Signal, 1 millivolt; Output across 600-ohm Load

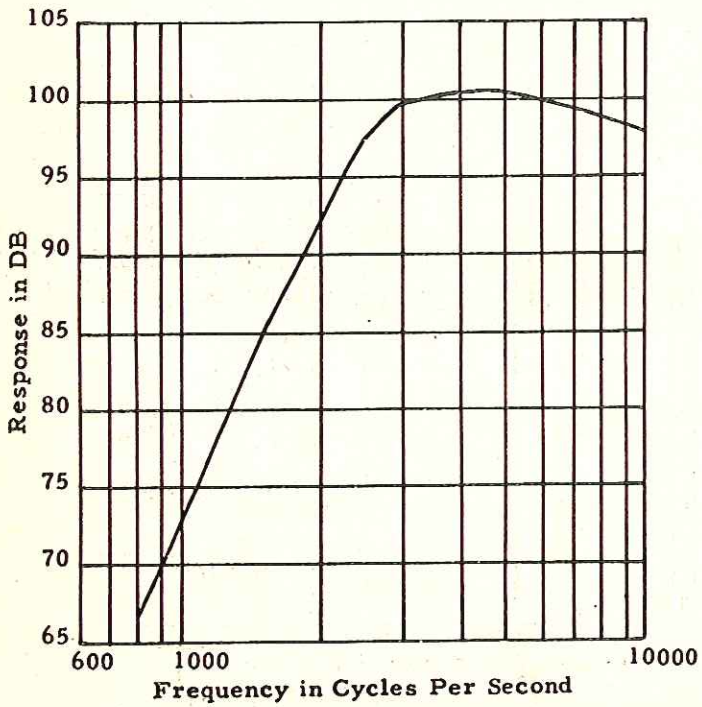

Fig. 4 - JP Amplifier Response; 3000-cps Filter;  
Input Signal, 1 millivolt; Output across 600-ohm Load

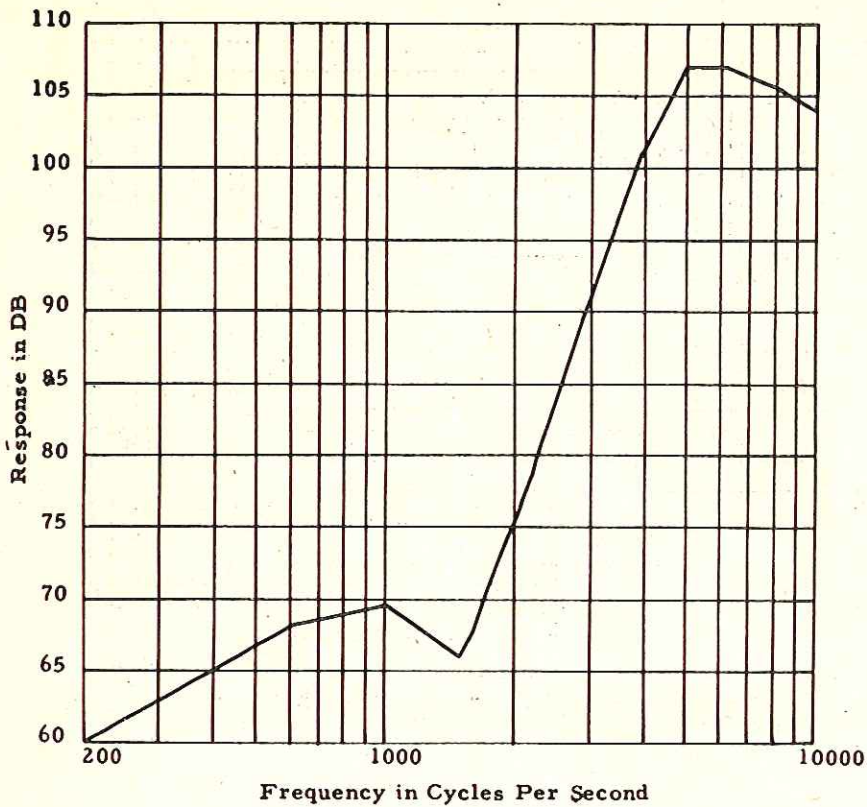

Fig. 5 - JP Amplifier Response; 6000-cps Filter; Input Signal, 1 millivolt; Output across 600-ohm Load

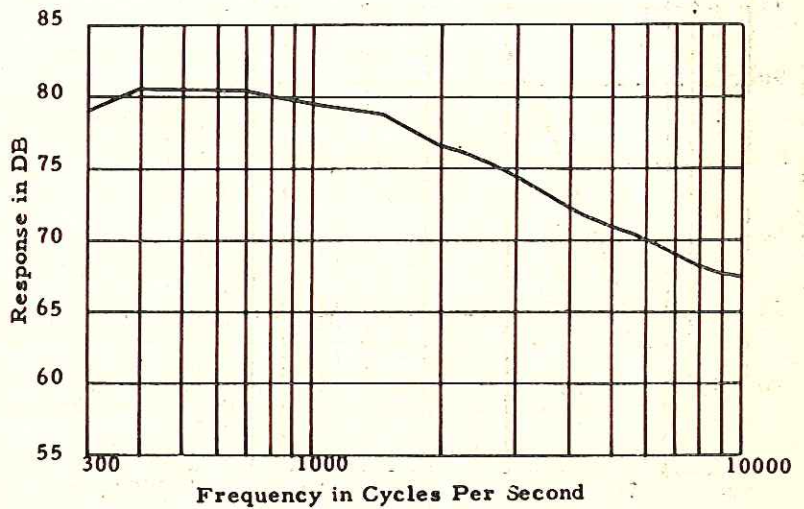

Fig. 6 - Over-all Response; JP Filter on BASS BOOST; Low-pass Filter on OUT; Signal Fed through No. 7 Preamplifier with Bearing Set at 345°; Input Signal, 1 millivolt; Output across 600-ohm Load

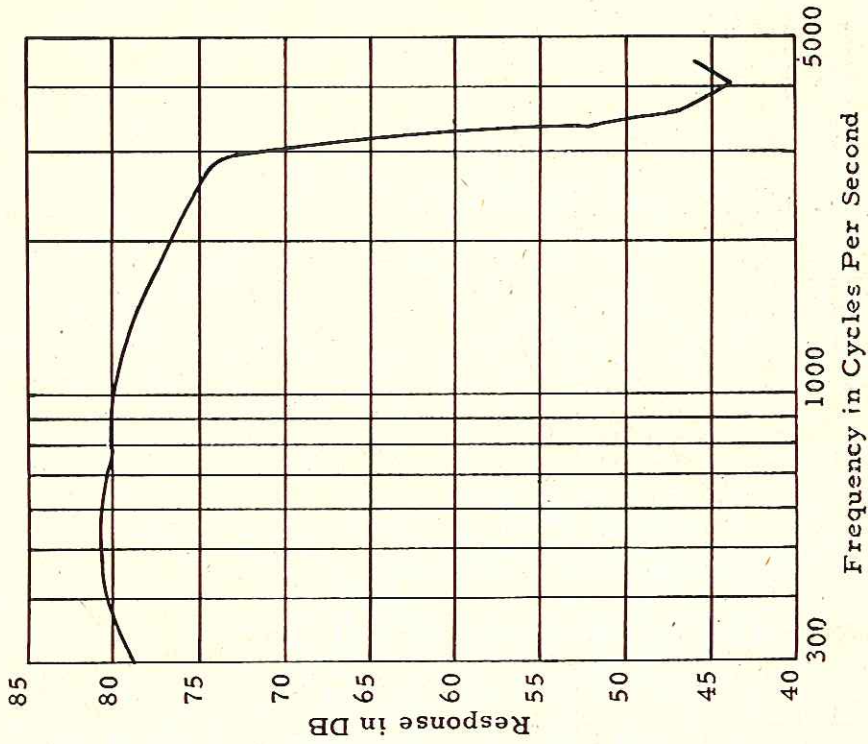

Fig. 8 - Over-all Response; JP Filter on BASS BOOST; Low-Pass Filter on 3000 cps; Signal Fed through No. 7 Pre-amplifier with Bearing Set at 345°; Input Signal, 1 millivolt; Output across 600-ohm Load

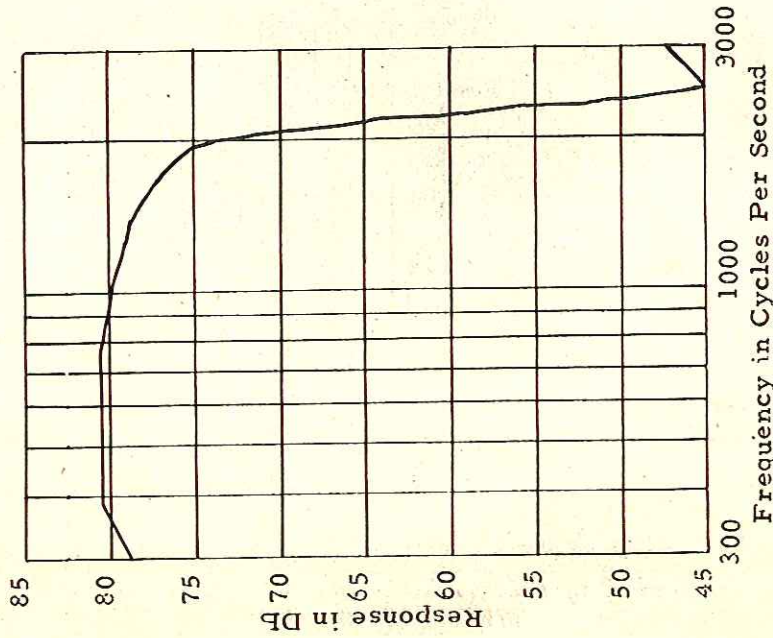

Fig. 7 - Over-all Response; JP Filter on BASS BOOST; Low-Pass Filter on 2000 cps; Signal Fed through No. 7 Pre-amplifier with Bearing Set at 345°; Input Signal, 1 millivolt; Output across 600-ohm Load

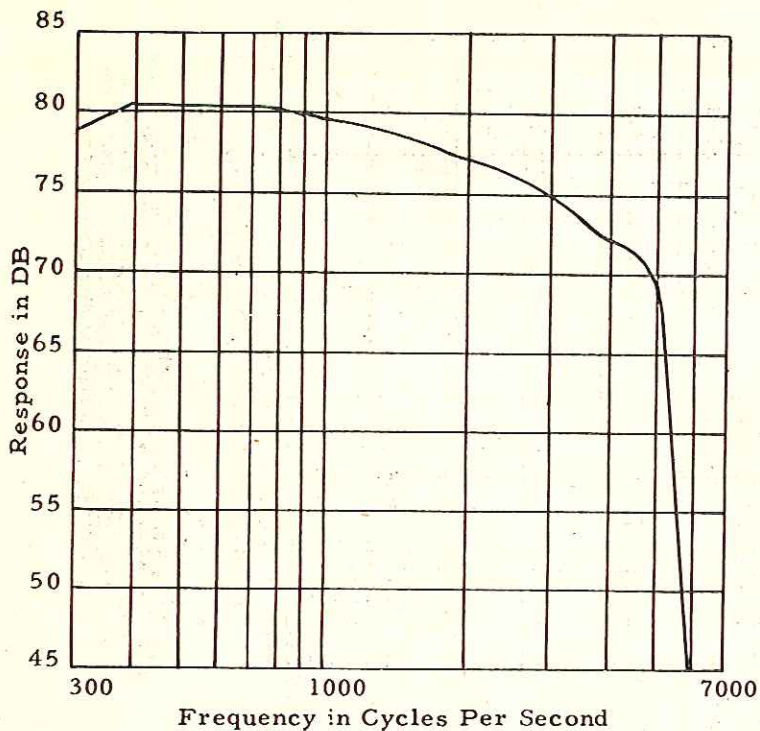

Fig. 9 - Over-all Response; JP Filter on BASS BOOST; Low-Pass Filter on 5000 cps; Signal Fed through No. 7 Preamplifier with Bearing Set at 345°; Input Signal, 1 millivolt; Output across 600-ohm Load

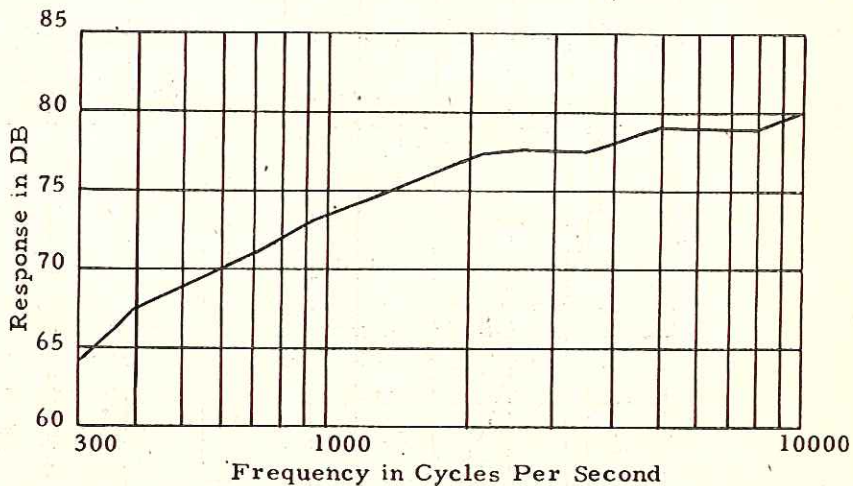

Fig. 10 - Over-all Response; JP Filter on FLAT; Low-Pass Filter on OUT; Signal Fed through No. 7 Preamplifier with Bearing Set at 345°; Input Signal, 1 millivolt; Output across 600-ohm Load

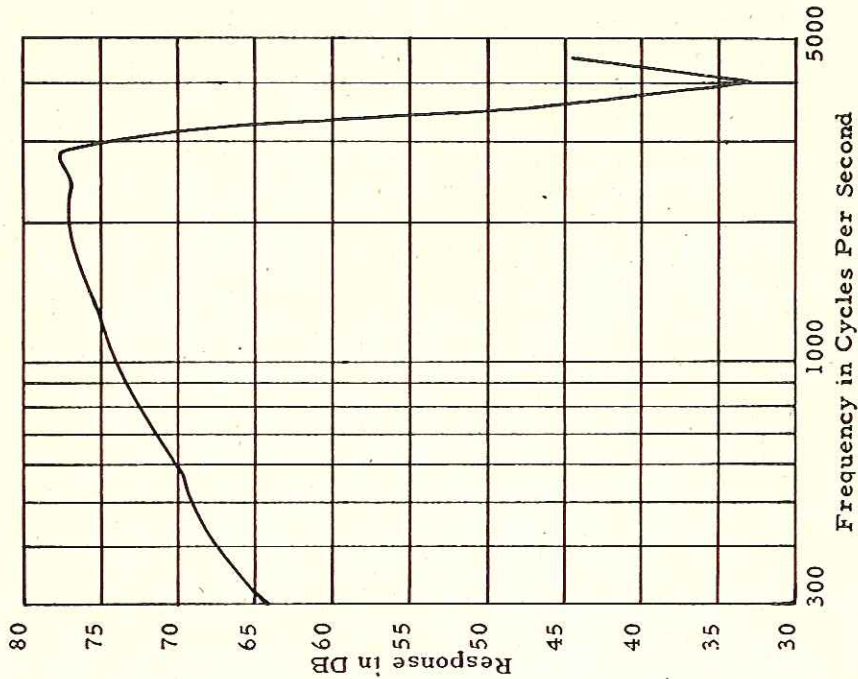

Fig. 12 - Over-all Response; JP Filter on FLAT; Low-Pass Filter on 3000 cps; Signal Fed through No. 7 preamplifier with Bearing Set at 3450; Input Signal, 1 millivolt; Output across 600-ohm Load

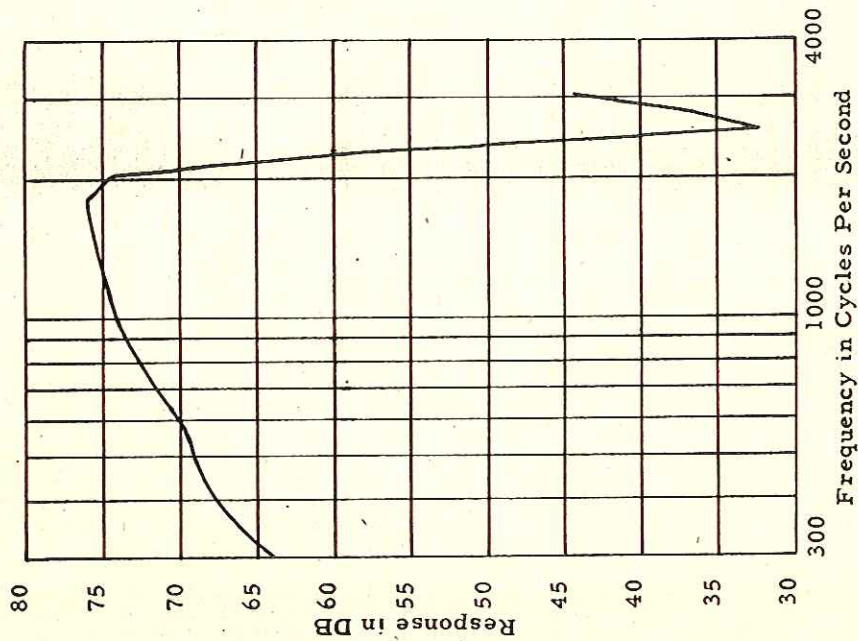

Fig. 11 - Over-all Response; JP Filter on FLAT; Low-Pass Filter on 2000 cps; Signal Fed through No. 7 preamplifier with Bearing Set at 3450; Input Signal, 1 millivolt; Output across 600-ohm Load

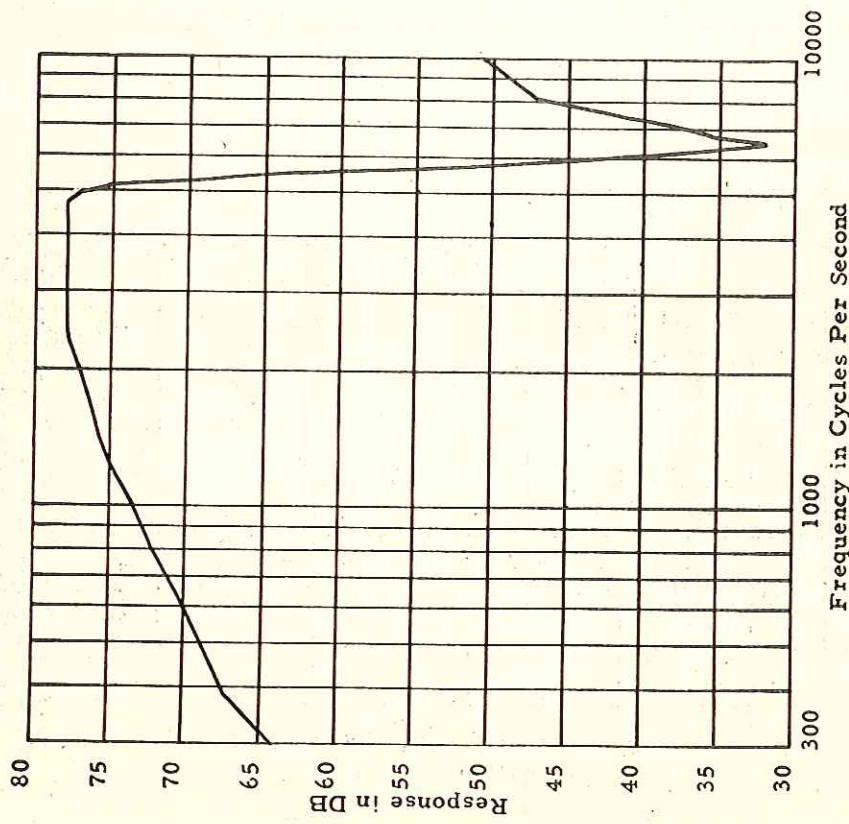

Fig. 13 - Over-all Response: JP Filter on FLAT;  
 Low-Pass Filter on 5000 cps; Signal Fed through  
 No. 7 Preamplifier with Bearing Set at 345°;  
 Input Signal, 1 millivolt;  
 Output across 600-ohm Load

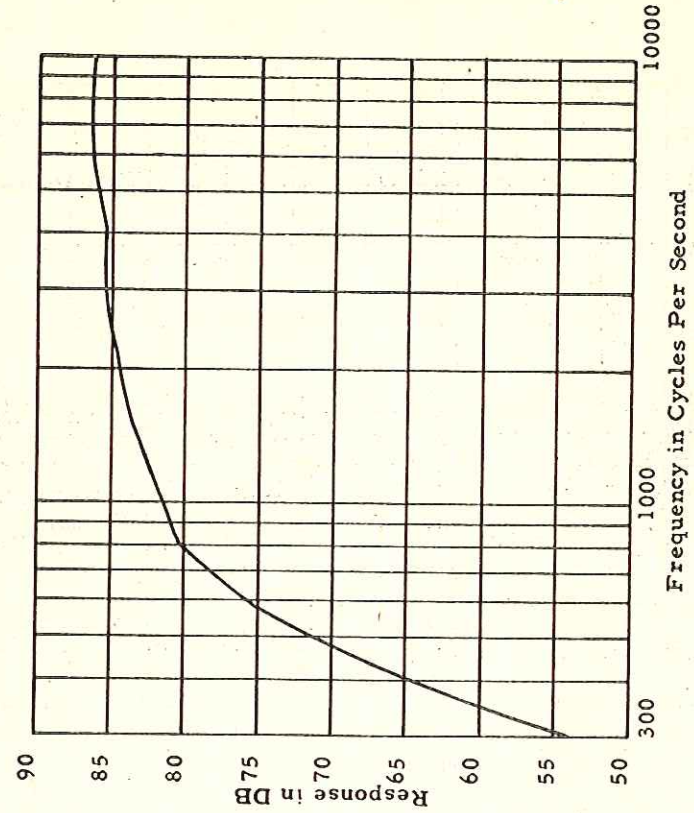

Fig. 14 - Over-all Response: JP Filter on 500 cps;  
 Low-Pass Filter on OUT; Signal Fed through No. 7  
 Preamplifier with Bearing Set at 345°;  
 Input Signal, 1 millivolt;  
 Output across 600-phm Load

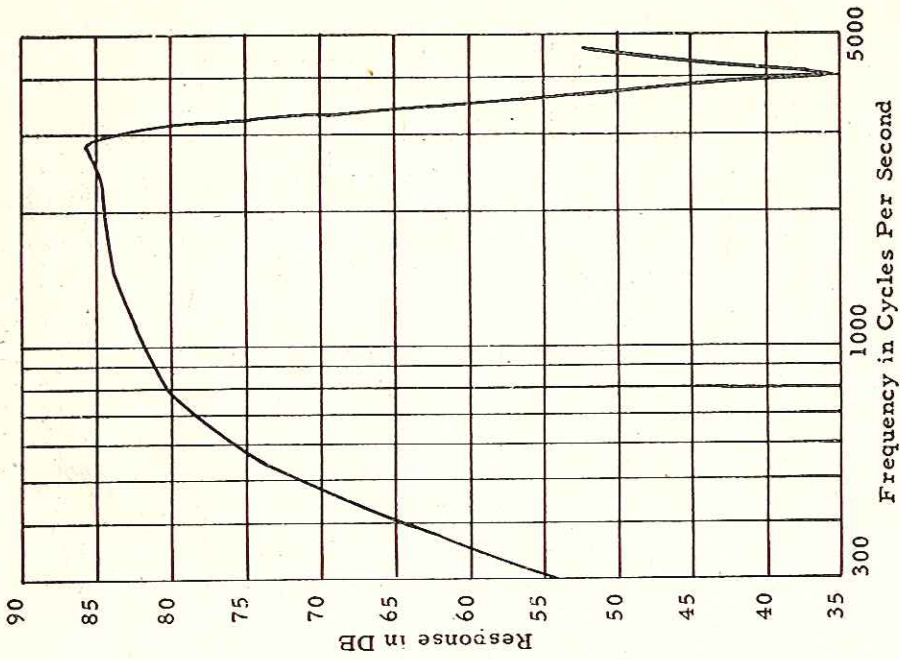

Fig. 15 - Over-all Response; JP Filter on 500 cps; Low-Pass Filter on 2000 cps; Signal Fed through No. 7 Preamplifier with Bearing Set at 345°; Input Signal, 1 millivolt; Output across 600-ohm Load

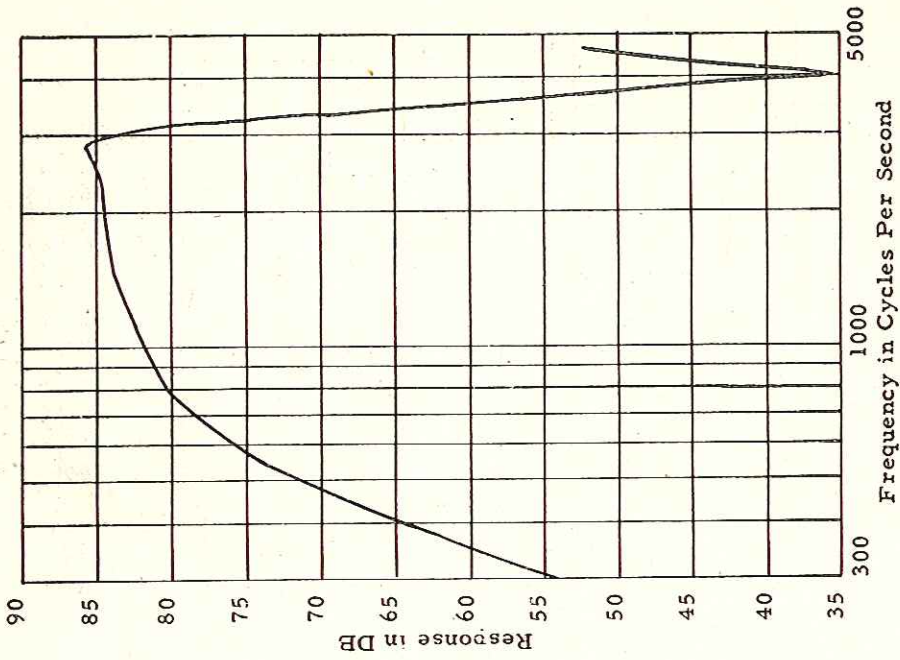

Fig. 16 - Over-all Response; JP Filter on 500 cps; Low-Pass Filter on 3000 cps; Signal Fed through No. 7 Preamplifier with Bearing Set at 345°; Input Signal, 1 millivolt; Output across 600-ohm Load

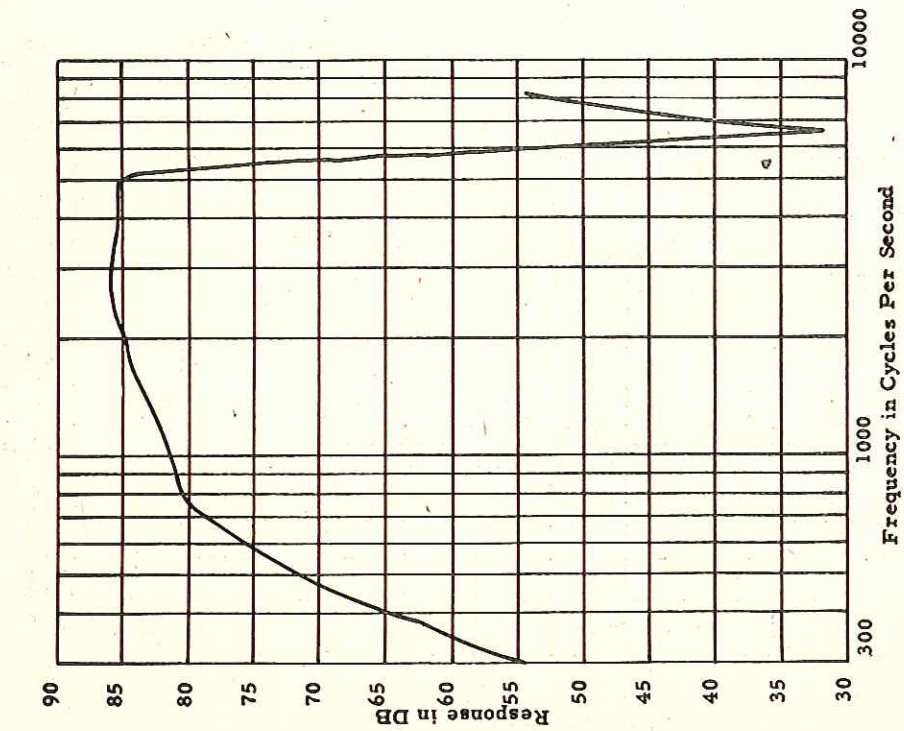

Fig. 17 - Over-all Response: JP Filter on 500 cps;  
 Low-Pass Filter on 5000 cps; Signal Fed through  
 No. 7 Preampifier with Bearing Set at 345°;  
 Input Signal, 1 millivolt;  
 Output across 600-ohm Load

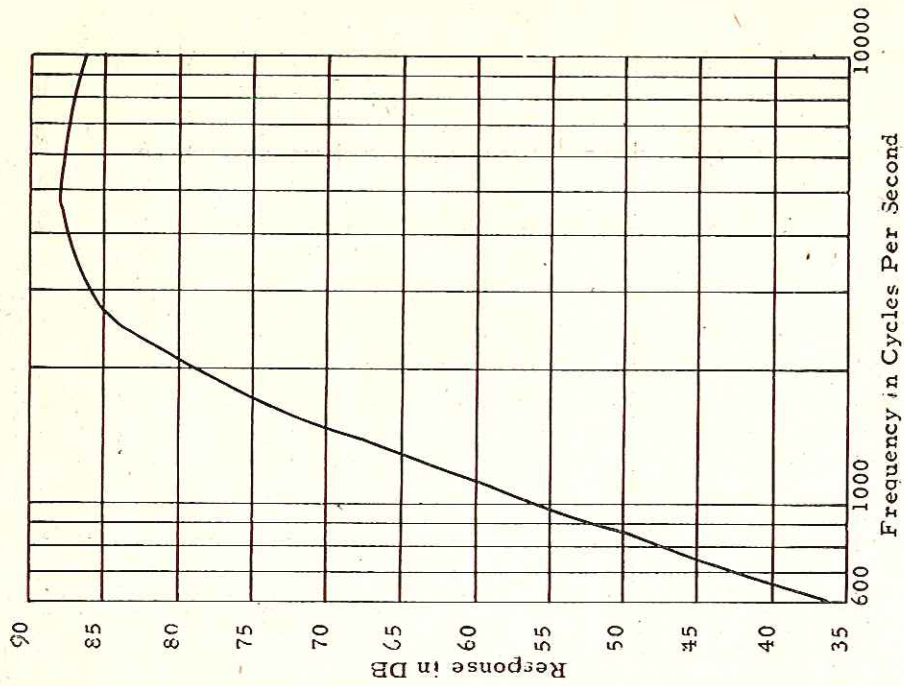

Fig. 18 - Over-all Response: JP Filter on 3000 cps;  
 Low-Pass Filter on OUT; Signal Fed through No. 7  
 Preampifier with Bearing Set at 345°;  
 Input Signal, 1 millivolt;  
 Output across 600-ohm Load



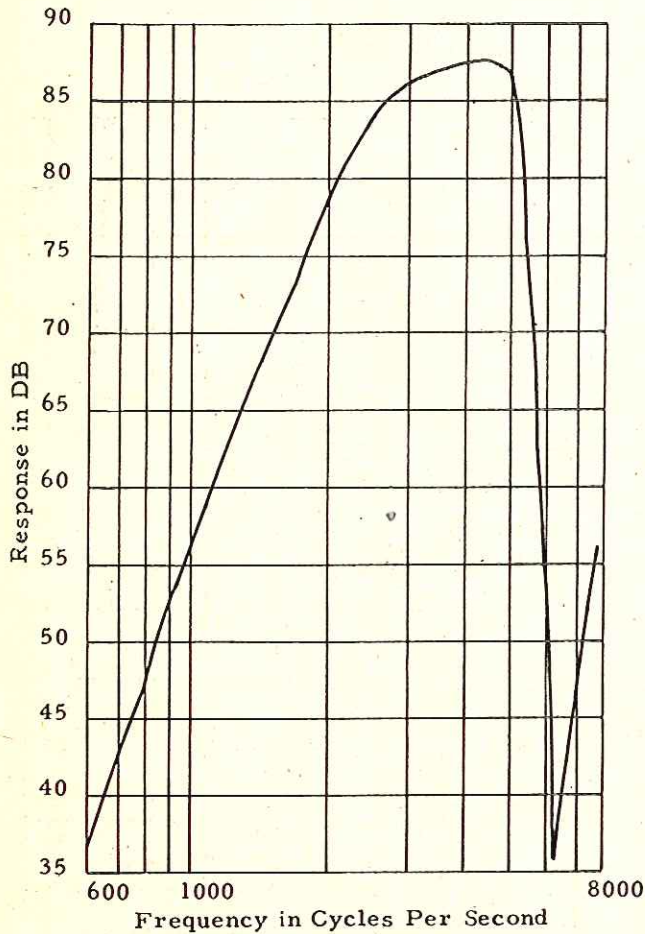

Fig. 20 - Over-all Response; JP Filter on 3000 cps; Low-Pass Filter on 5000 cps; Signal Fed through No. 7 Pre-amplifier with Bearing Set at 345°; Input Signal, 1 millivolt; Output across 600-ohm Load

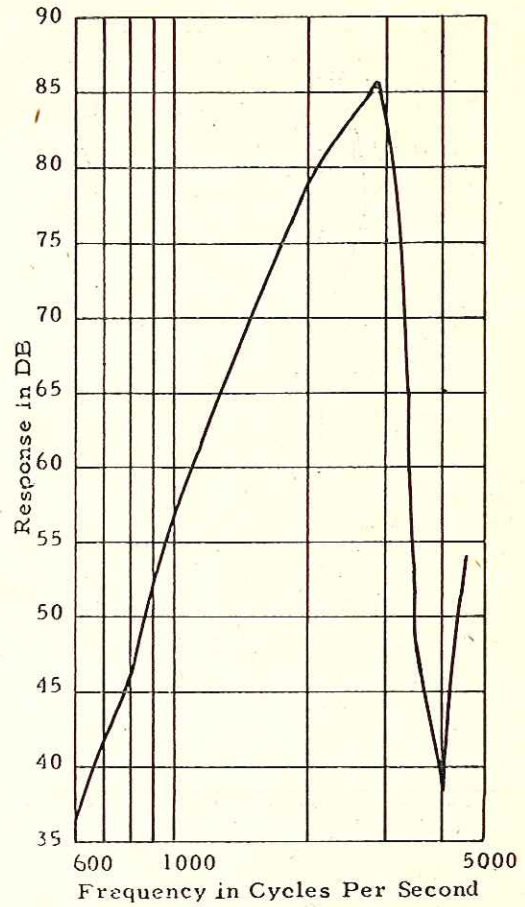

Fig. 19 - Over-all Response; JP Filter on 3000 cps; Low-Pass Filter on 3000 cps; Signal Fed through No. 7 Pre-amplifier with Bearing Set at 345°; Input Signal, 1 millivolt; Output across 600-ohm Load

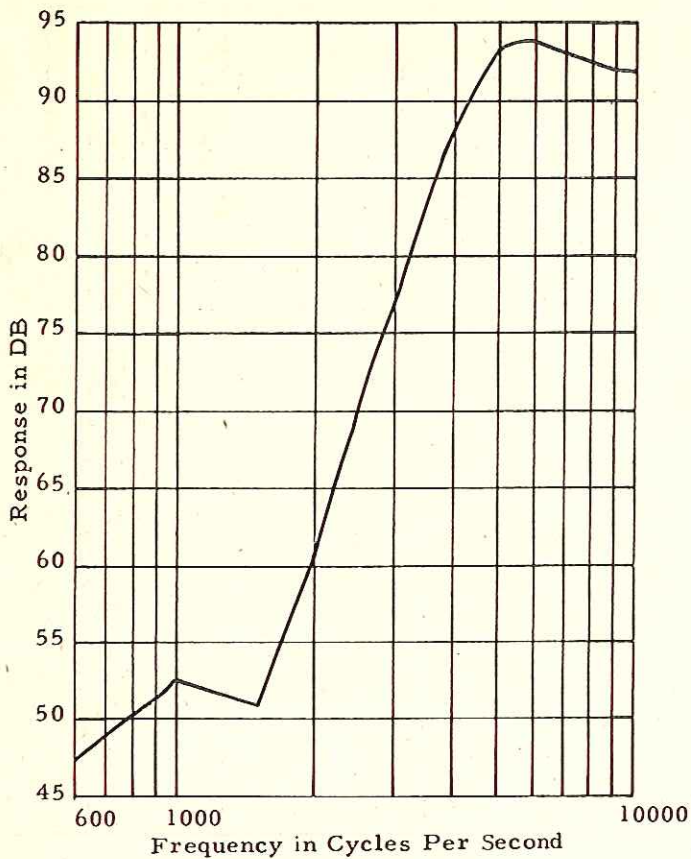

Fig. 21 - Over-all Response; JP Filter on 6000 cps;  
Low-Pass Filter on OUT; Signal Fed through No. 7  
preamplifier with Bearing Set at 345°;  
Input Signal, 1 millivolt;  
Output across 600-ohm Load

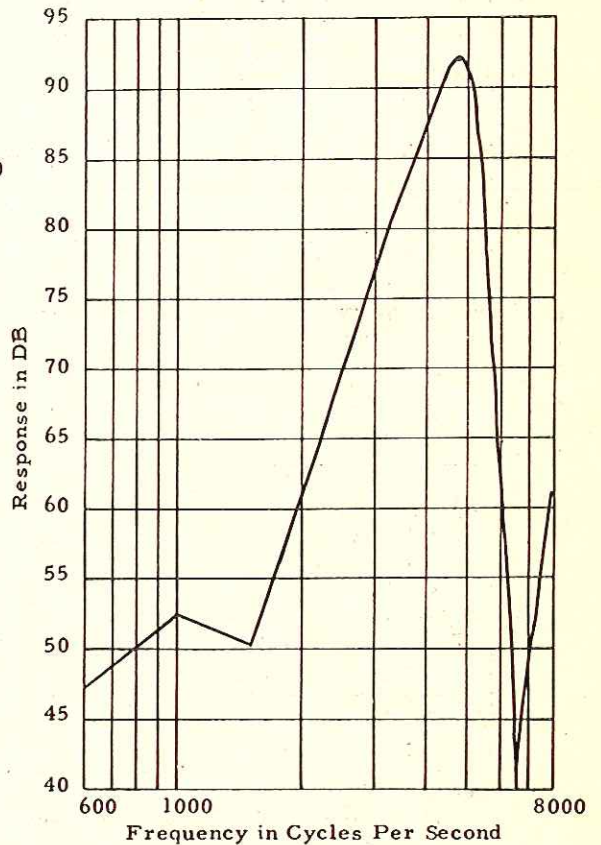

Fig. 22 - Over-all Response; JP Filter on 6000 cps;  
Low-Pass Filter on 5000 cps; Signal Fed through  
No. 7 Preamplifier with Bearing Set at 345°;  
Input Signal, 1 millivolt;  
Output across 600-ohm Load

CONFIDENTIAL

APPENDIX D

OPERATING CHARACTERISTICS  
OF COMPONENTS AND OVER-ALL SYSTEM

CONFIDENTIAL

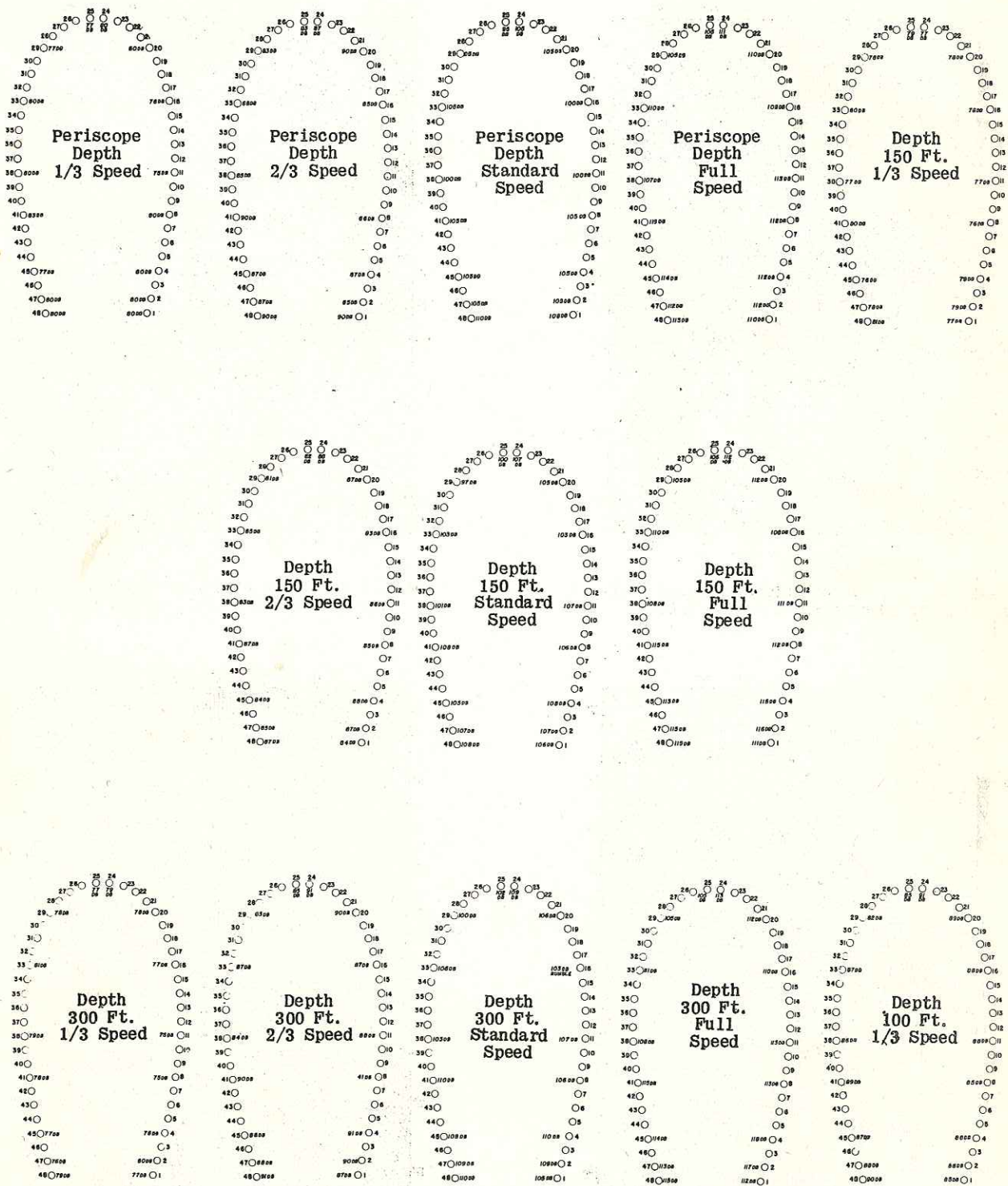

Fig. 1 - Individual Hydrophone Self-Noise versus Depth and Speed

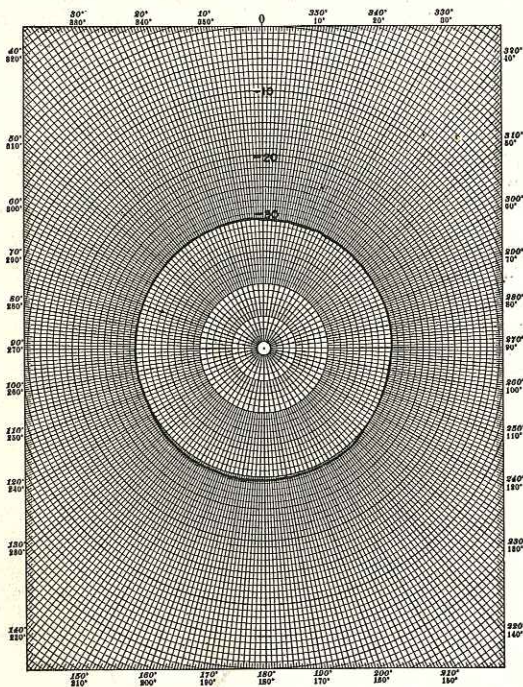

Fig. 2 - 2 Trays of Delay; 150-foot Depth; 500-cps High-Pass Filter; 1/3 Speed

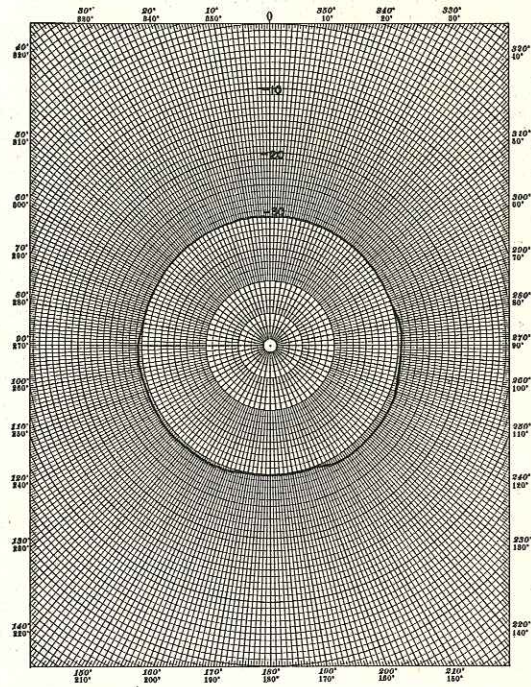

Fig. 3 - 3 Trays of Delay; 150-foot Depth; 500-cps High-Pass Filter; 1/3 Speed

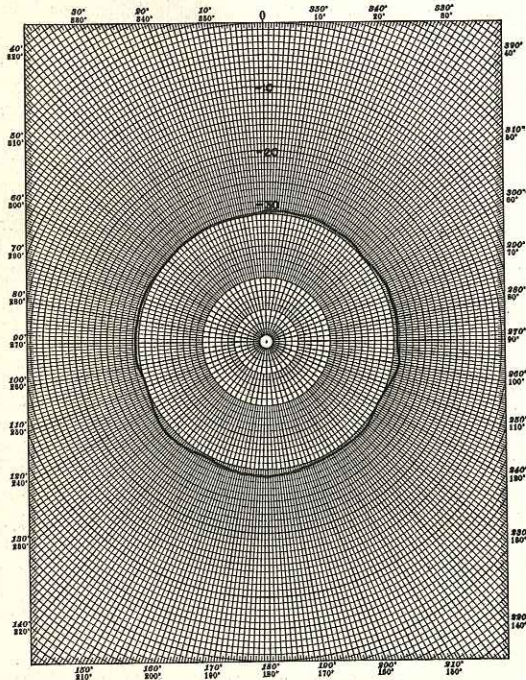

Fig. 4 - 4 Trays of Delay; 150-foot Depth; 500-cps High-Pass Filter; 1/3 Speed

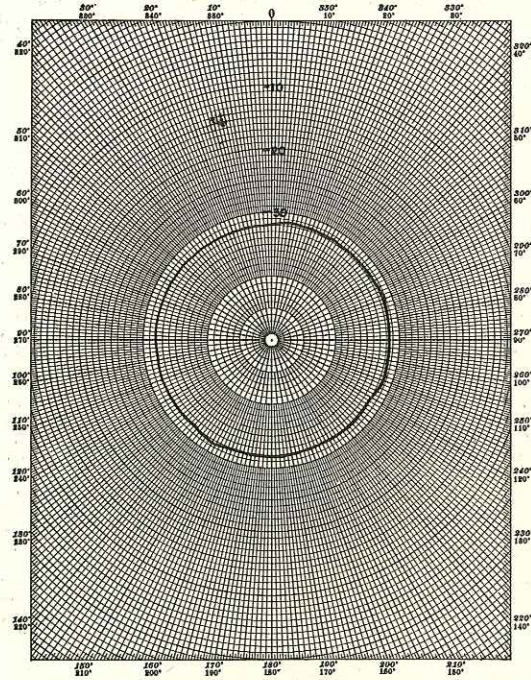

Fig. 5 - 2 Trays of Delay; 150-foot Depth; 500-cps High-Pass Filter; 2/3 Speed

Figs. 2-5 - System Self-Noise versus Operating Condition versus Angle of Train

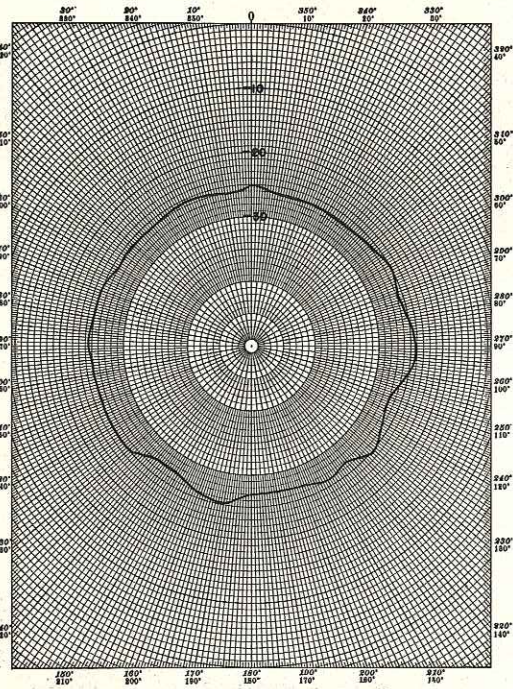

Fig. 6 - 2 Trays of Delay; 150-foot Depth; 500-cps High-Pass Filter; Standard Speed

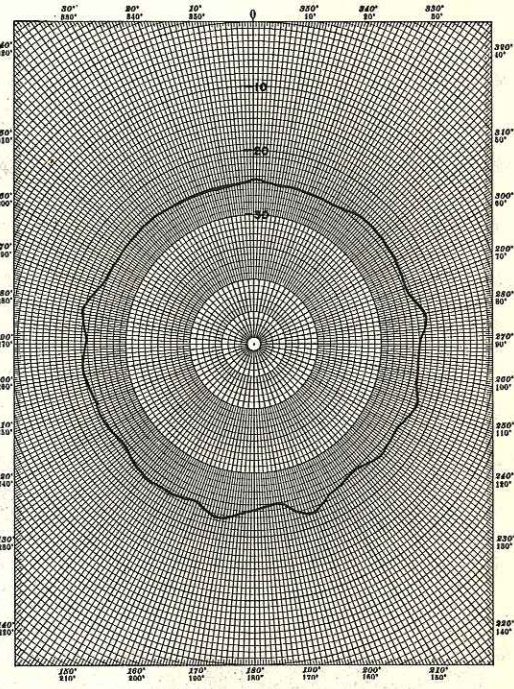

Fig. 7 - 4 Trays of Delay; 150-foot Depth; 500- to 5000-cps Band-Pass Filter; Standard Speed

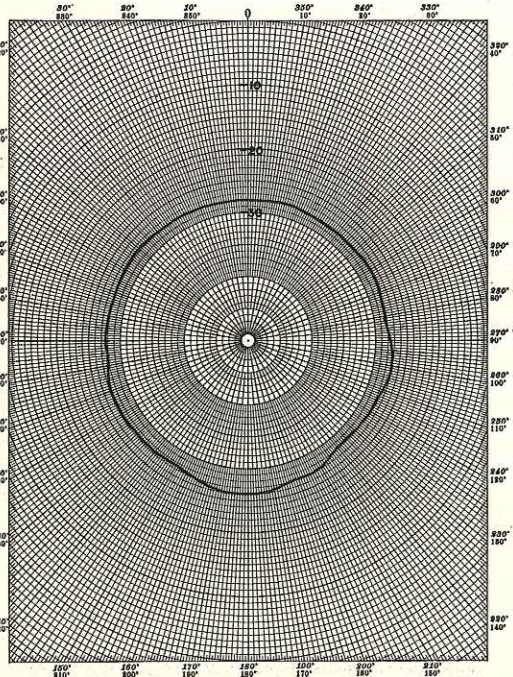

Fig. 9 - 4 Trays of Delay; 500- to 5000-cps Band-Pass Filter; 2/3 Speed; 1 Engine Snorkel

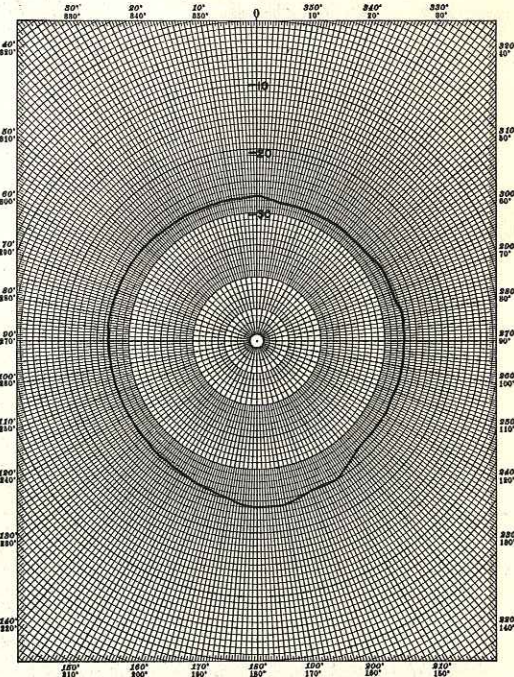

Fig. 8 - 4 Trays of Delay; 500- to 5000-cps Band-Pass Filter; 1/3 Speed; 1 Engine Snorkel

Figs. 6-9 - System Self-Noise versus Operating Condition versus Angle of Train

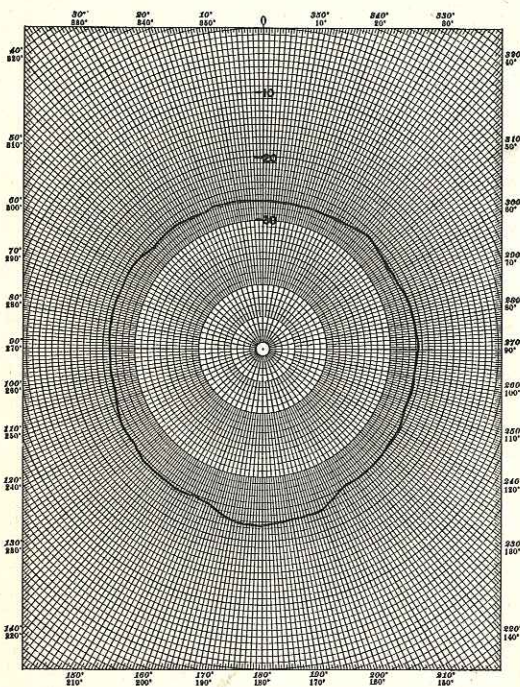

Fig. 10 - 4 Trays of Delay; 500-cps High-Pass Filter; Standard Speed; 1 Engine Snorkel

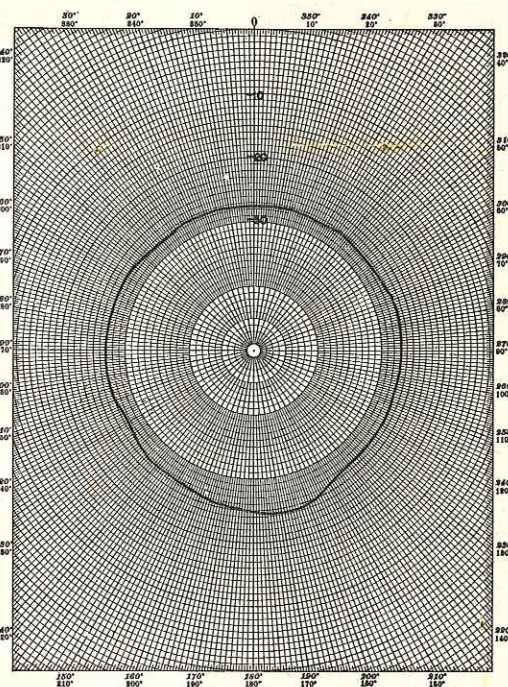

Fig. 11 - 4 Trays of Delay; 500- to 5000-cps Band-Pass Filter; 1/3 Speed; 2 Engines Snorkel

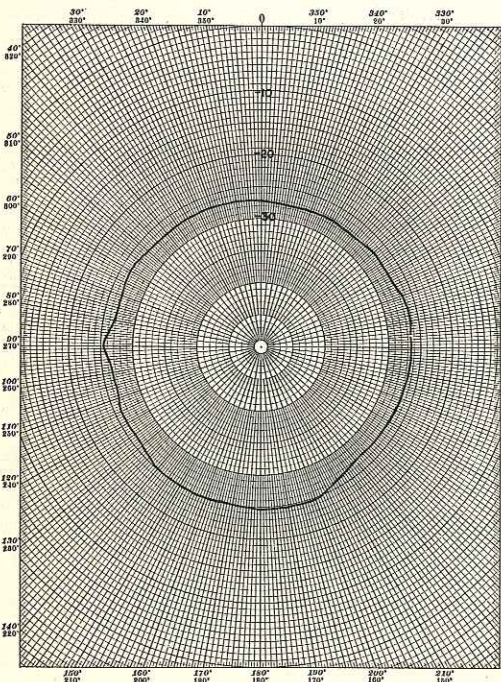

Fig. 12 - 4 Trays of Delay; 500- to 5000-cps Band-Pass Filter; 2/3 Speed; 2 Engines Snorkel

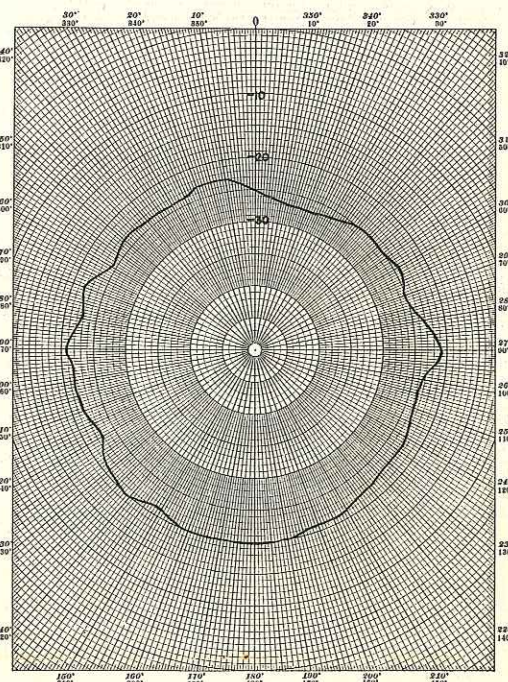

Fig. 13 - 4 Trays of Delay; 500- to 5000-cps Band-Pass Filter; Standard Speed; 2 Engines Snorkel

Figs. 10-13 - System Self-Noise versus Operating Condition versus Angle of Train

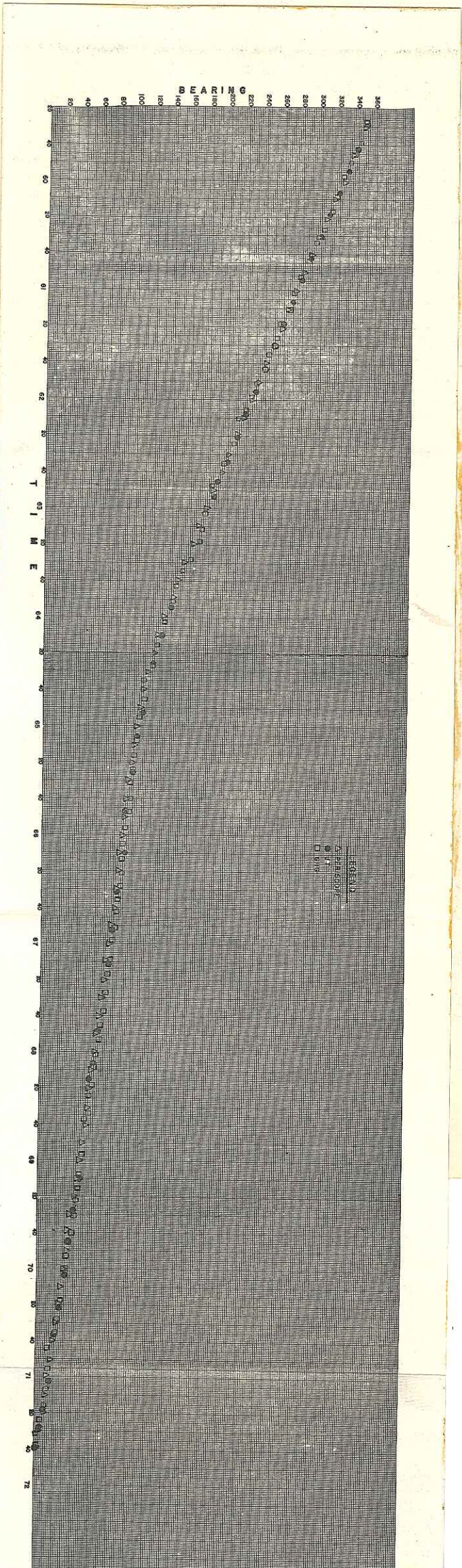

Fig. 14 - Comparison of Bearing versus Time for JT, GHG, and Periscope



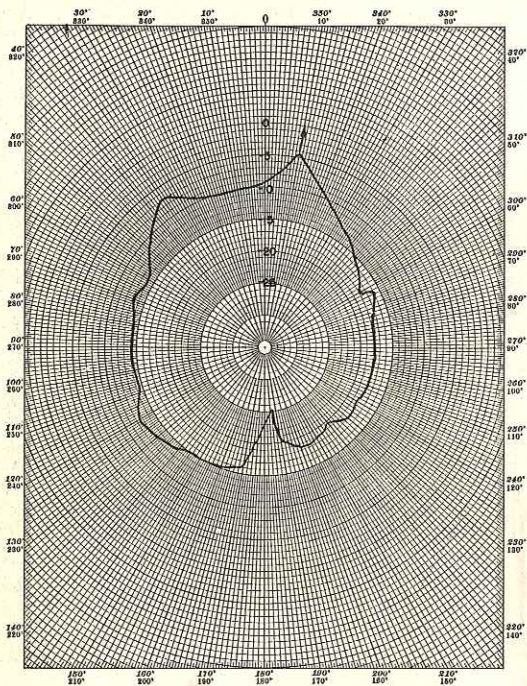

Fig. 15 - Bearing Set at 010°

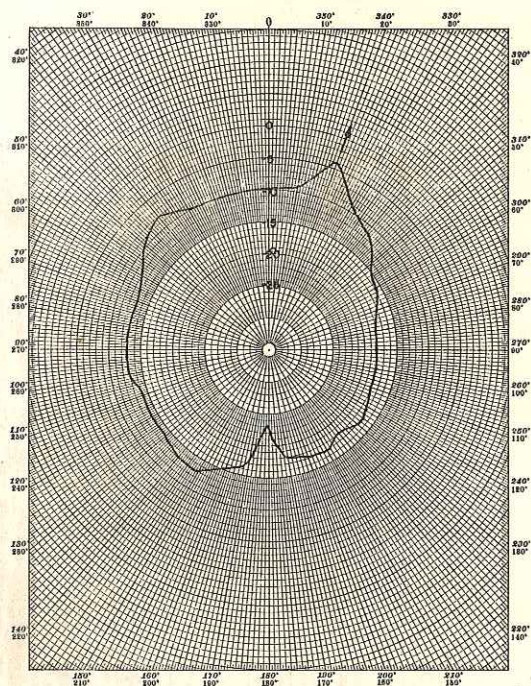

Fig. 16 - Bearing Set at 020°

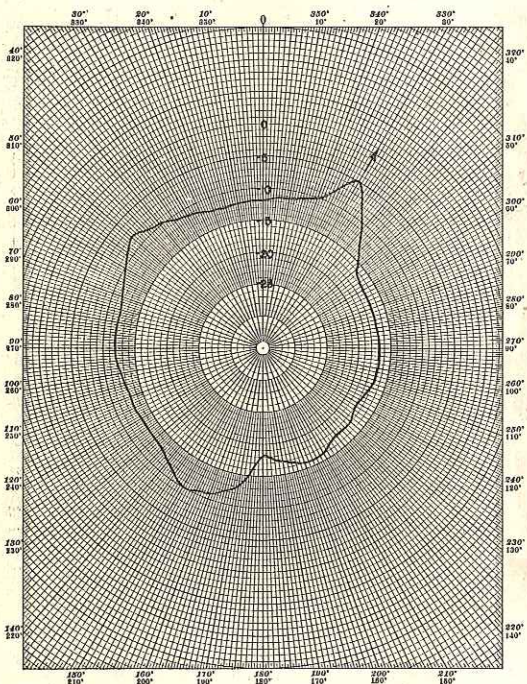

Fig. 17 - Bearing Set at 030°

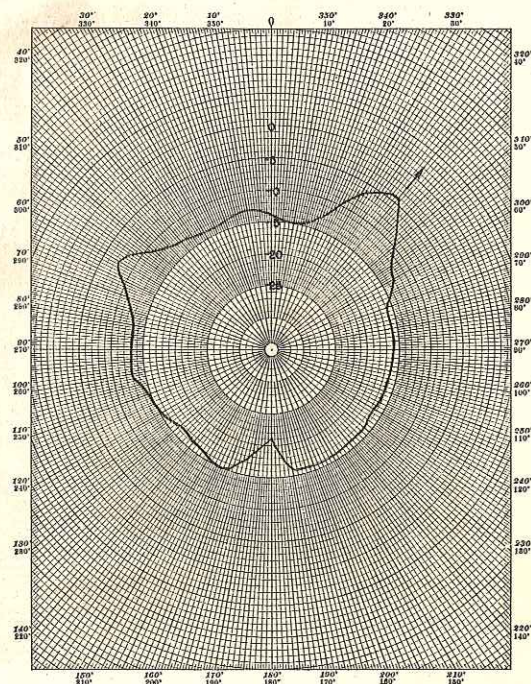

Fig. 18 - Bearing Set at 040°

Figs. 15-18 - Noise-Beam Patterns  
4 Trays of Delay; 500-cps High-pass Filter

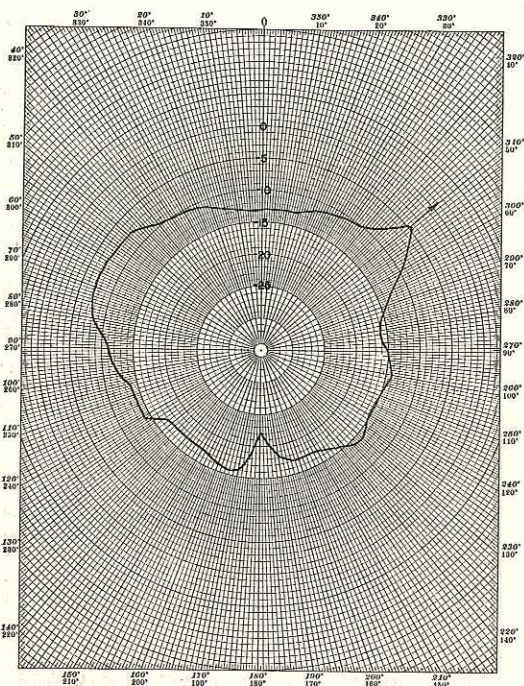

Fig. 19 - Bearing Set at 050°

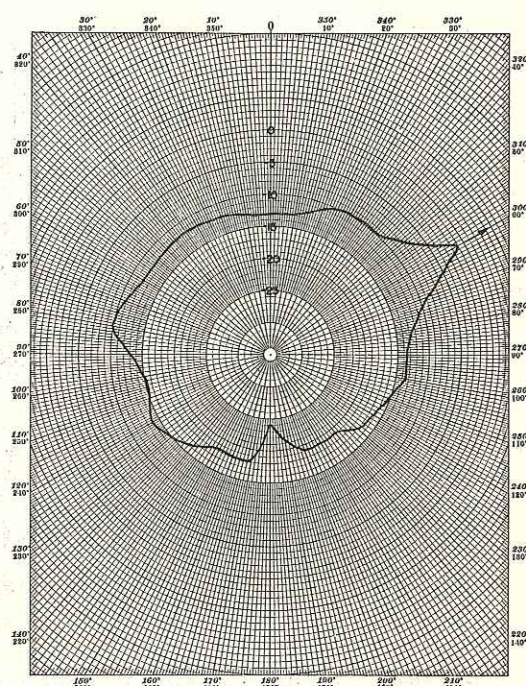

Fig. 20 - Bearing Set at 060°

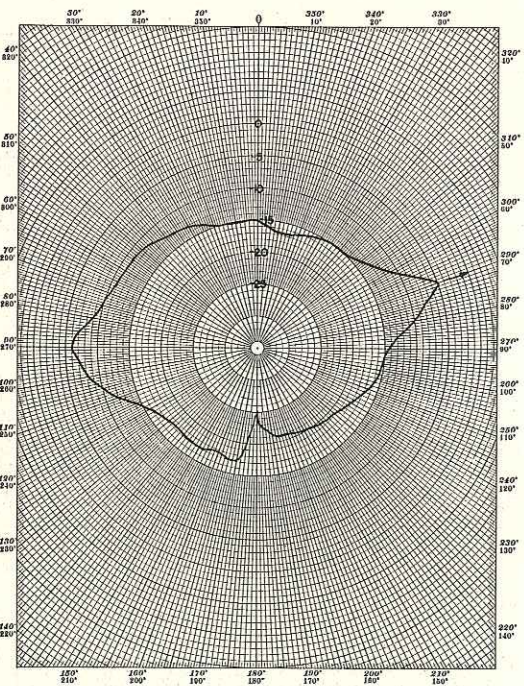

Fig. 21 - Bearing Set at 070°

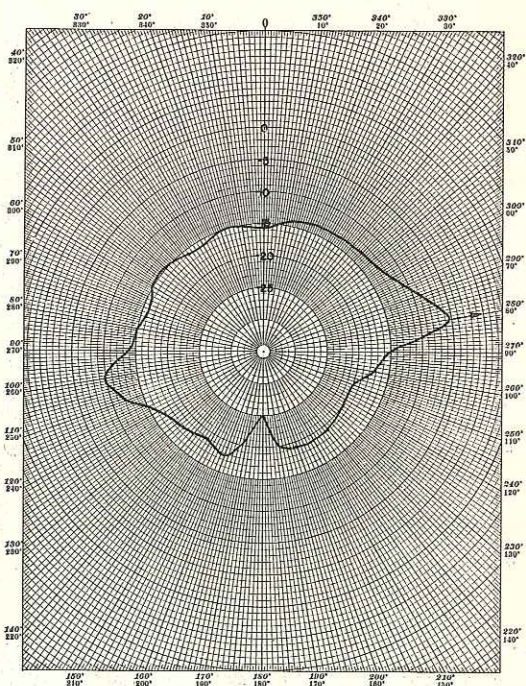

Fig. 22 - Bearing Set at 080°

Figs. 19-22 - Noise-Beam Patterns  
4 Trays of Delay; 500-cps High-Pass Filter

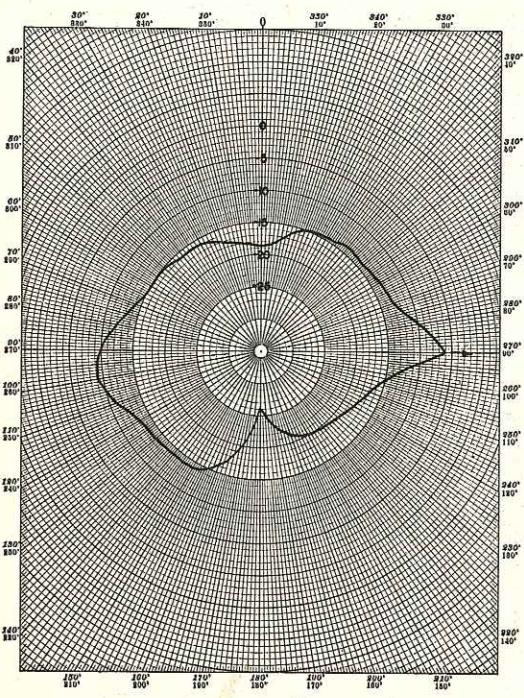

Fig. 23 - Bearing Set at 090°

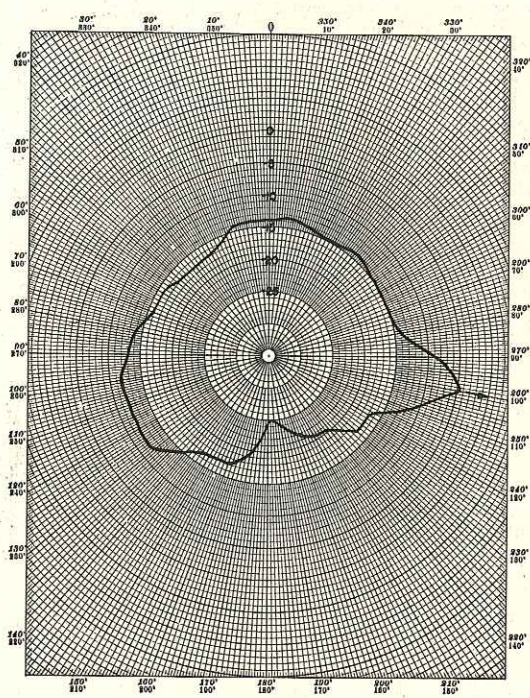

Fig. 24 - Bearing Set at 100°

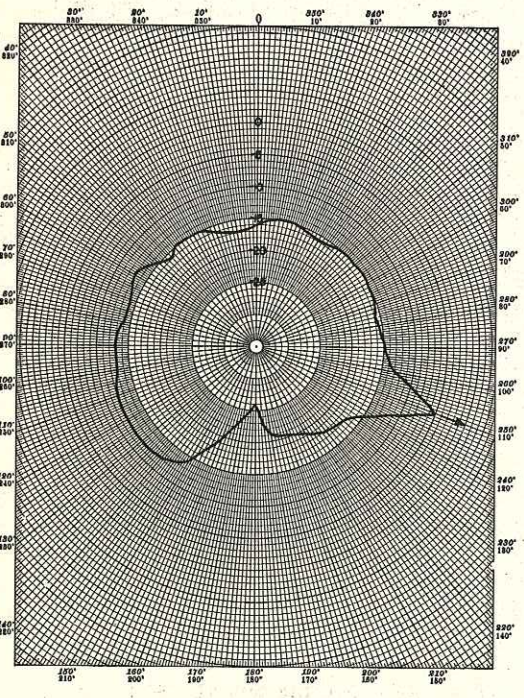

Fig. 25 - Bearing Set at 110°

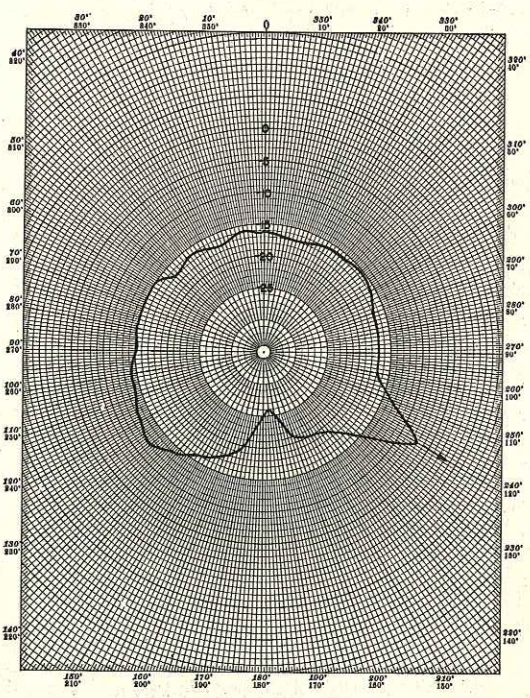

Fig. 26 - Bearing Set at 120°

Figs. 23-26 - Noise-Beam Patterns  
4 Trays of Delay; 500-cps High-Pass Filter

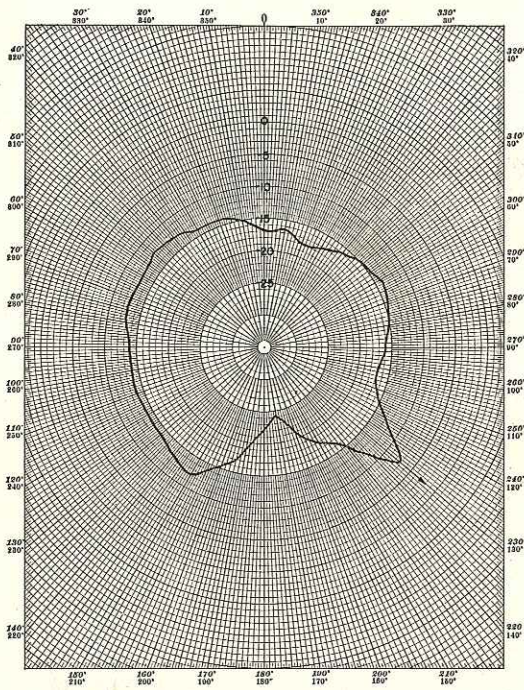

Fig. 27 - Bearing Set at 130°

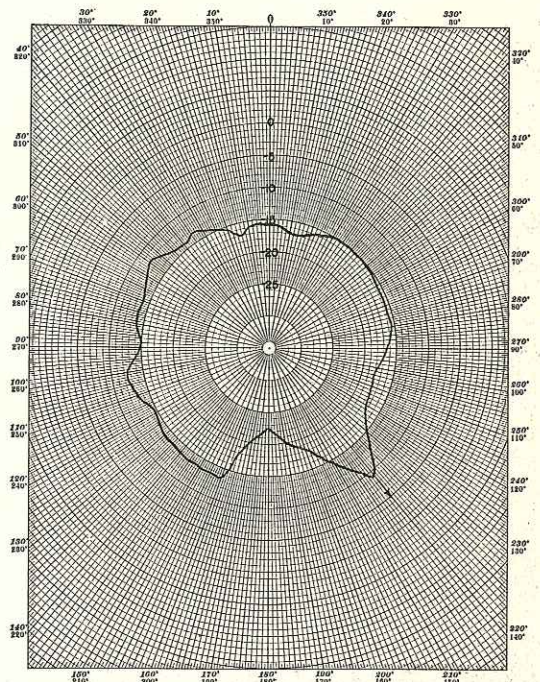

Fig. 28 - Bearing Set at 140°

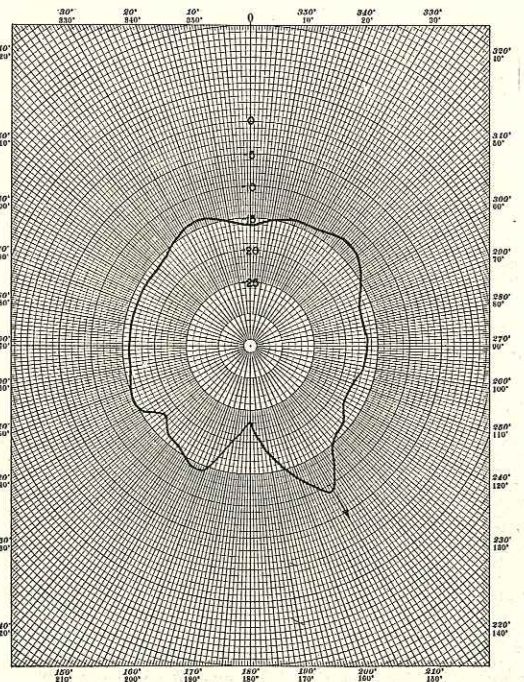

Fig. 29 - Bearing Set at 150°

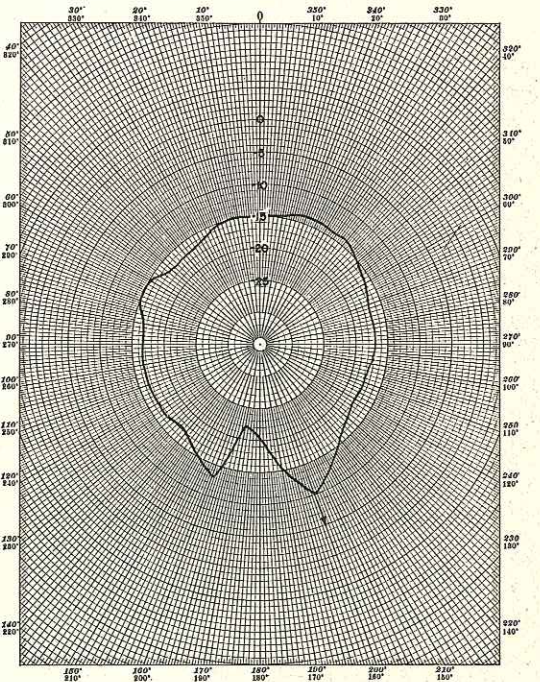

Fig. 30 - Bearing Set at 160°

Figs. 27-30 - Noise-Beam patterns  
4 Trays of Delay; 500-cps High-Pass Filter

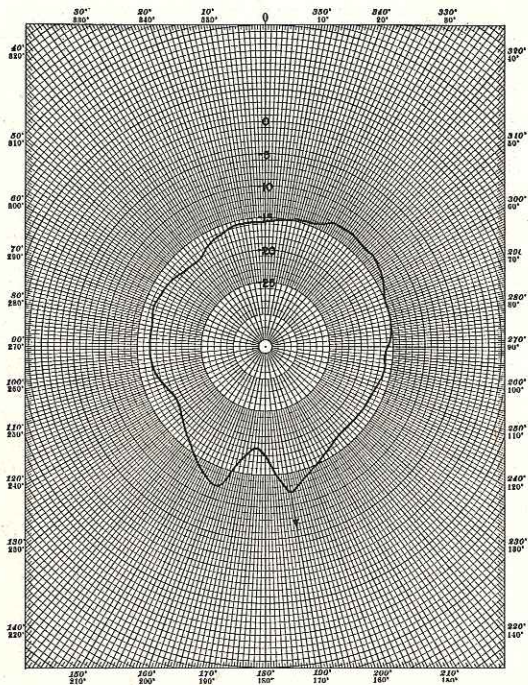

Fig. 31 - Bearing Set at 170°

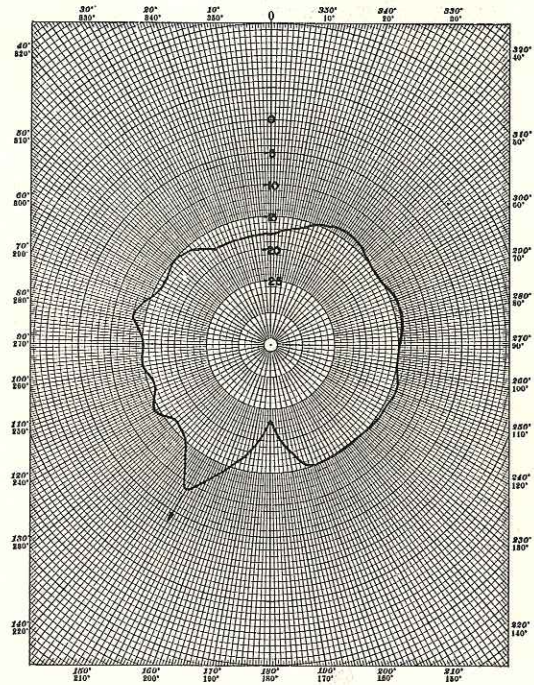

Fig. 32 - Bearing Set at 210°

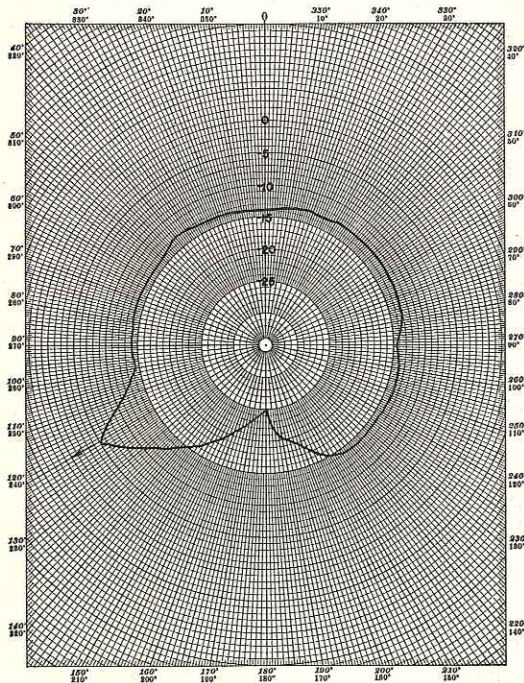

Fig. 33 - Bearing Set at 240°

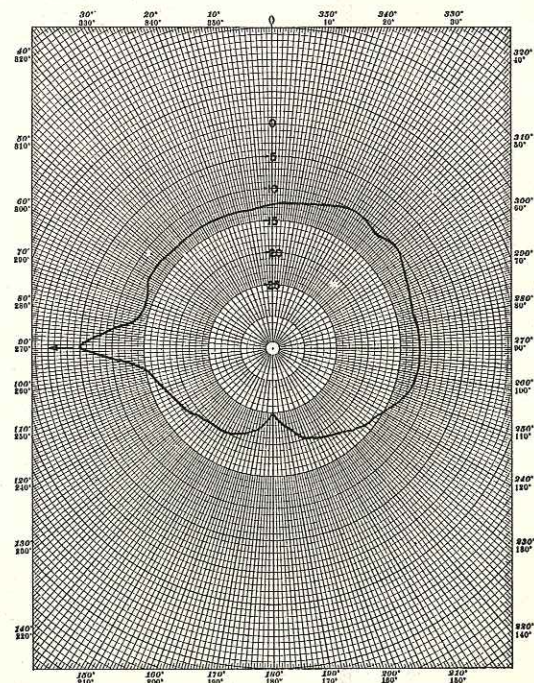

Fig. 34 - Bearing Set at 270°

Figs. 31-34 - Noise-Beam Patterns  
4 Trays of Delay; 500-cps High-Pass Filter

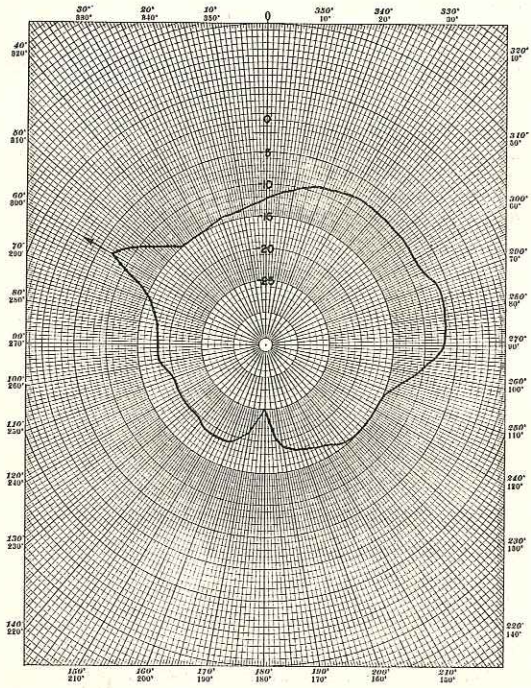

Fig. 35 - Bearing Set at 300°

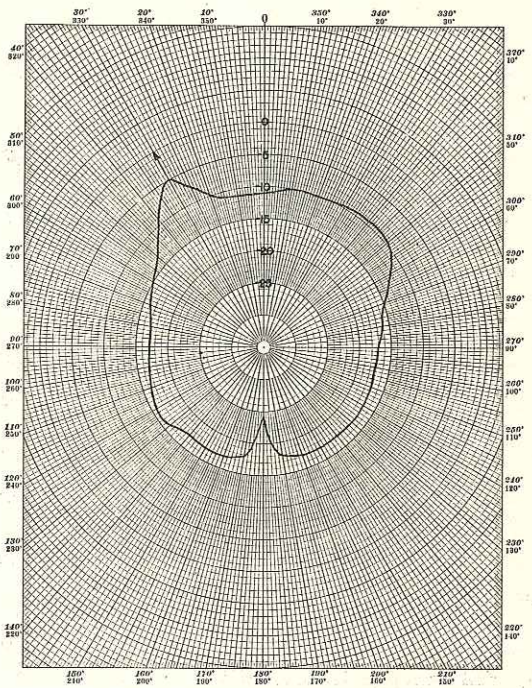

Fig. 36 - Bearing Set at 330°

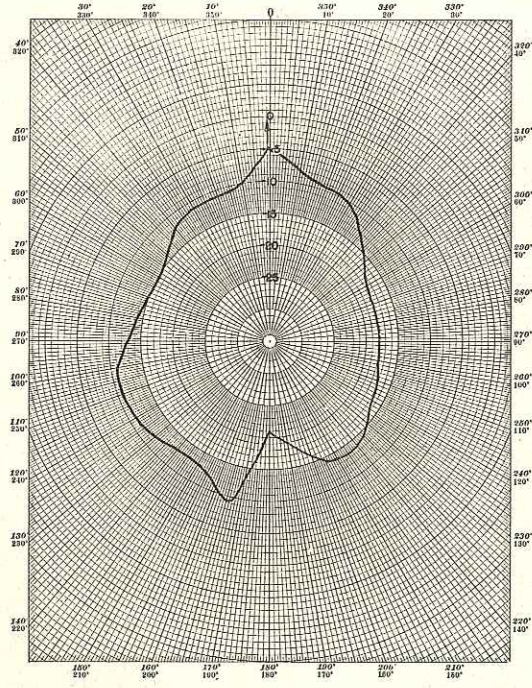

Fig. 37 - Bearing Set at 359°

Figs. 35-37 - Noise-Beam Patterns  
4 Trays of Delay; 500-cps High-Pass Filter

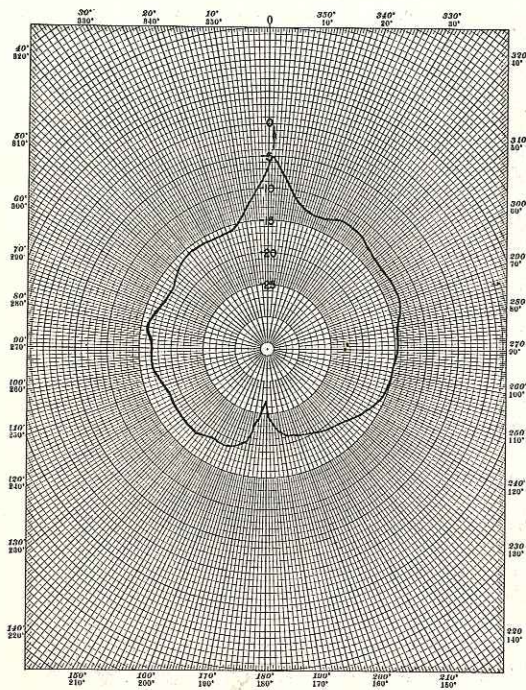

Fig. 38 - Bearing Set at 001°

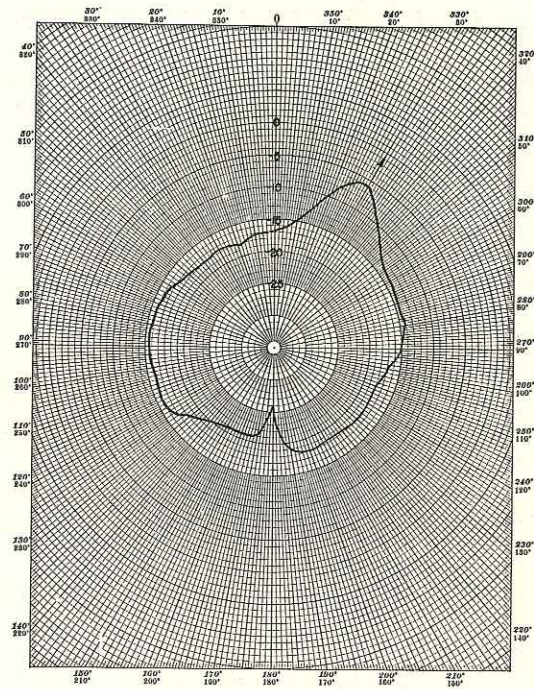

Fig. 39 - Bearing Set at 030°

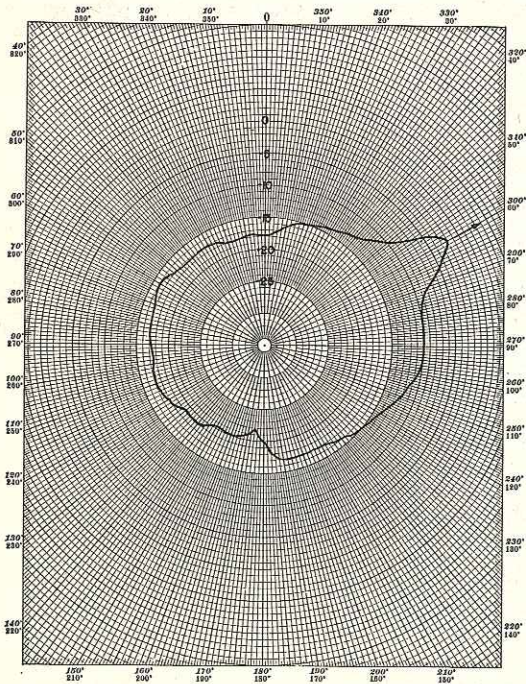

Fig. 40 - Bearing Set at 060°

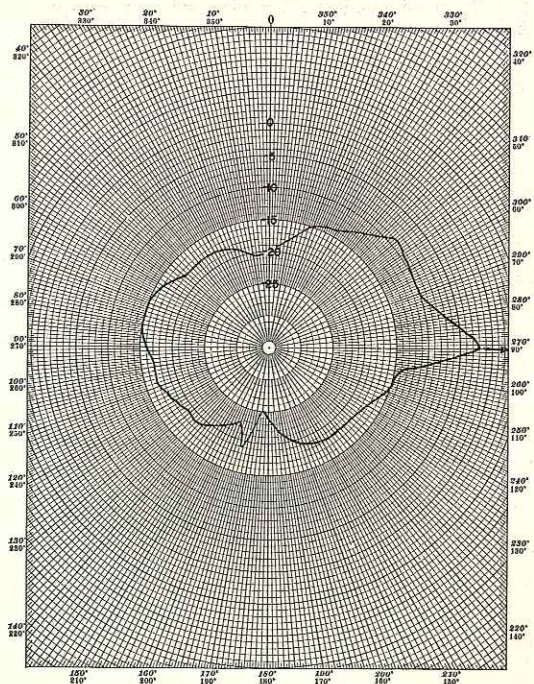

Fig. 41 - Bearing Set at 090°

Figs. 38-41 - Noise-Beam patterns  
2 Trays of Delay; 500-cps High-Pass Filter

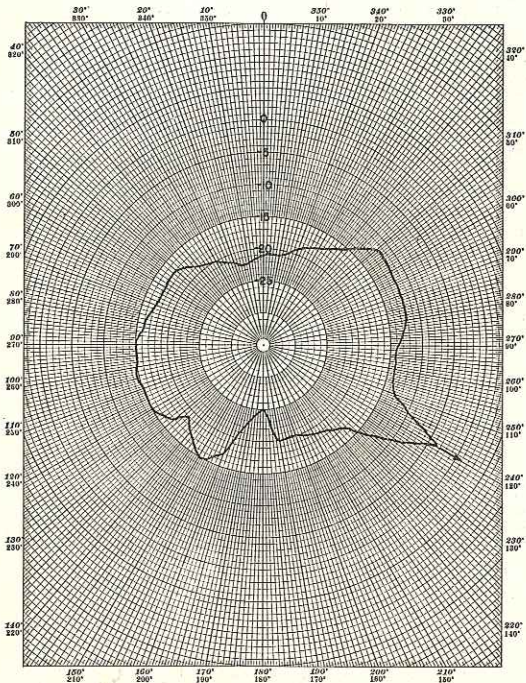

Fig. 42 - Bearing Set at 120°

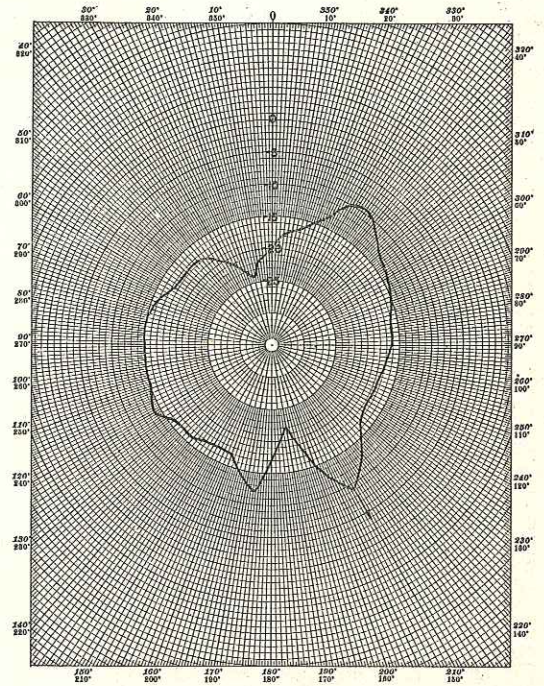

Fig. 43 - Bearing Set at 150°

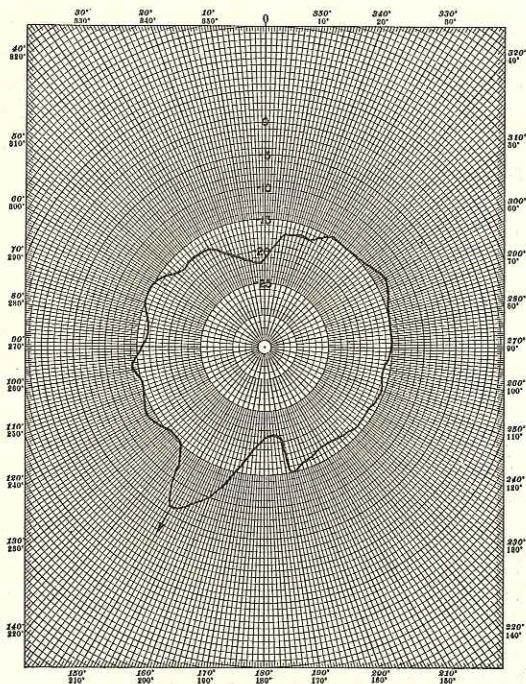

Fig. 44 - Bearing Set at 210°

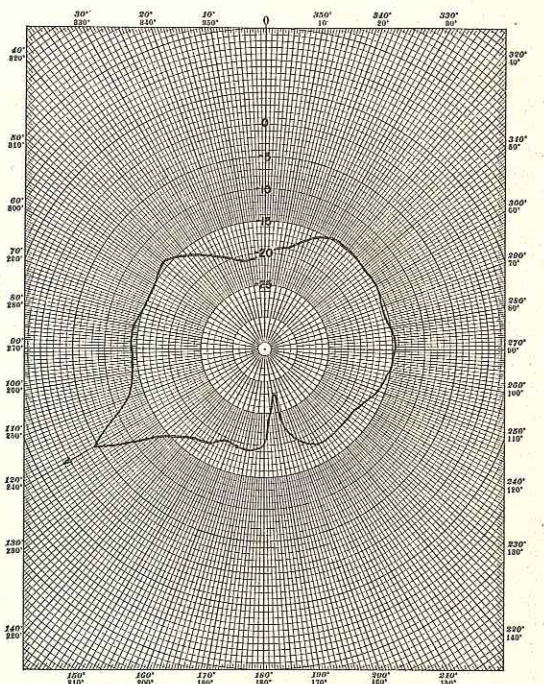

Fig. 45 - Bearing Set at 240°

Figs. 42-45 - Noise-Beam Patterns  
2 Trays of Delay; 500-cps High-Pass Filter



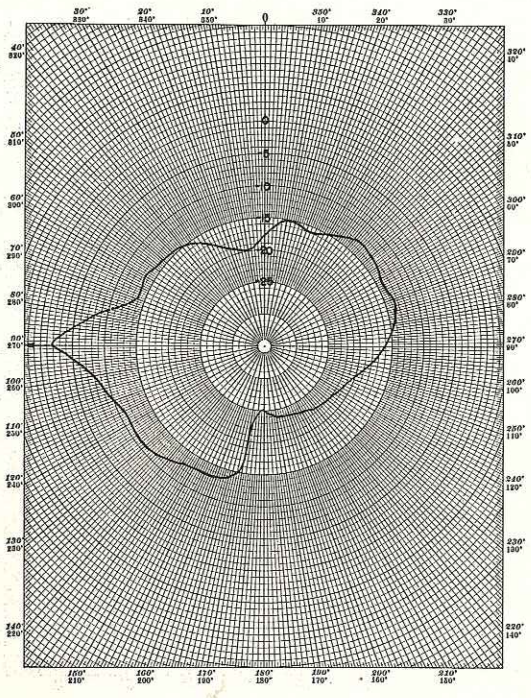

Fig. 46 - Bearing Set at 270°

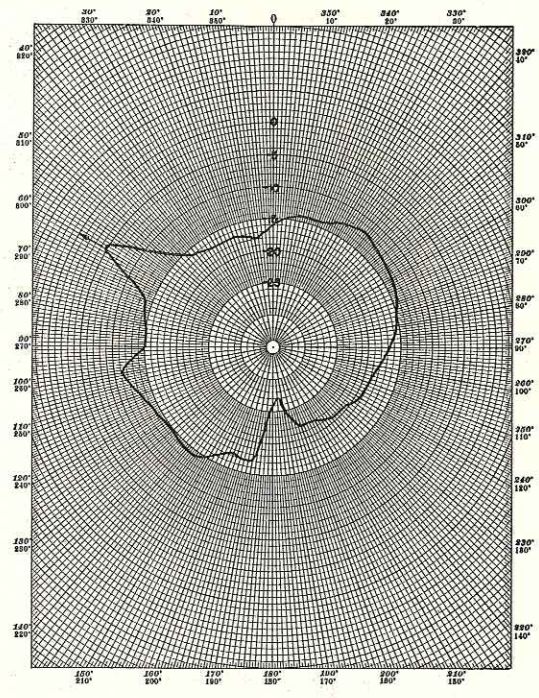

Fig. 47 - Bearing Set at 300°

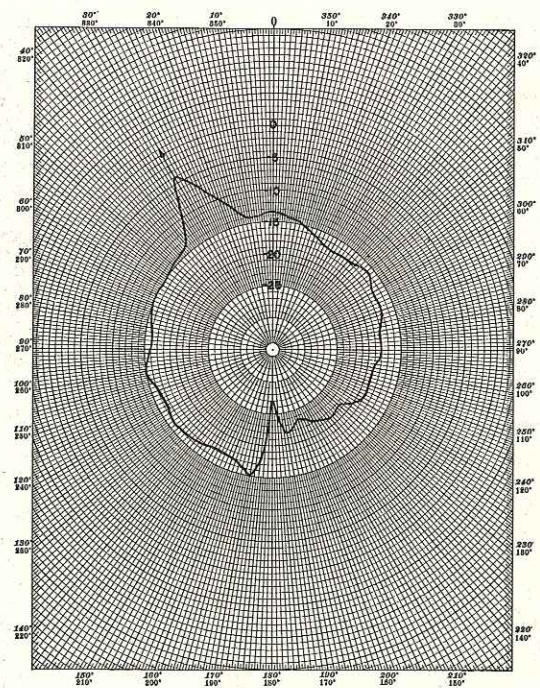

Fig. 48 - Bearing Set at 330°

Figs. 46-48 - Noise-Beam Patterns  
2 Trays of Delay; 500-cps High-Pass Filter

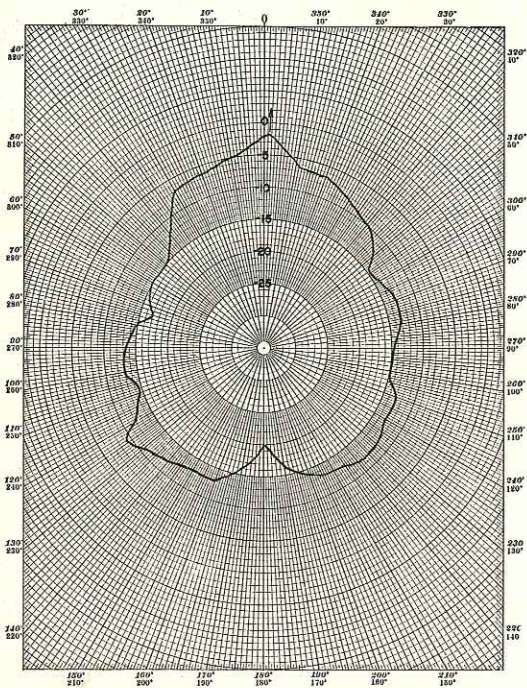

Fig. 49 - Bearing Set at 001°

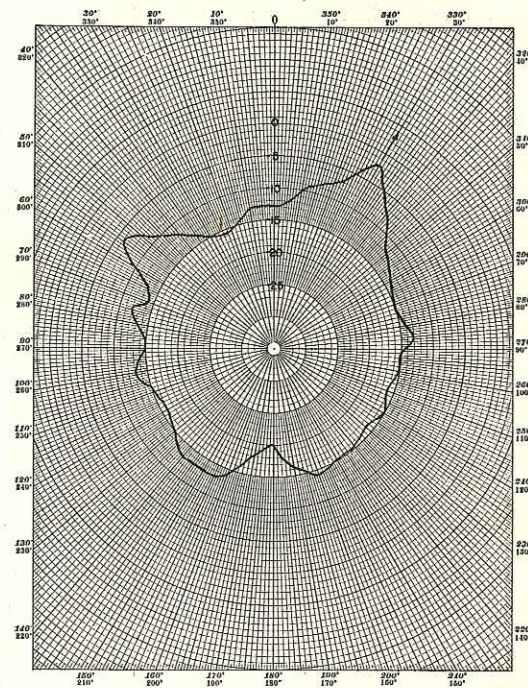

Fig. 50 - Bearing Set at 030°

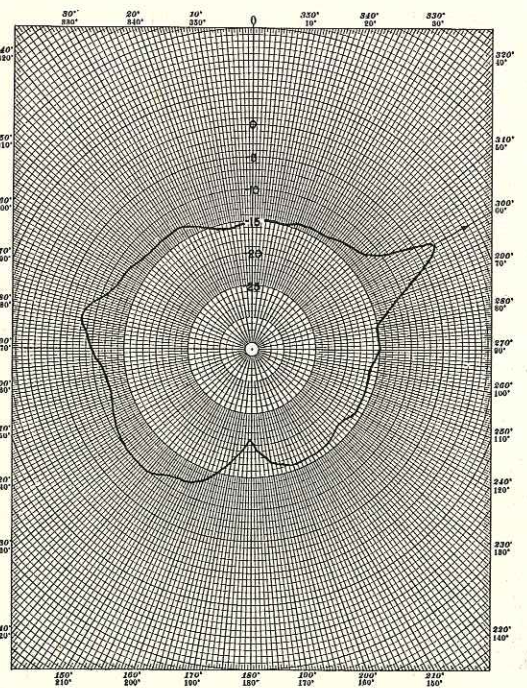

Fig. 51 - Bearing Set at 060°

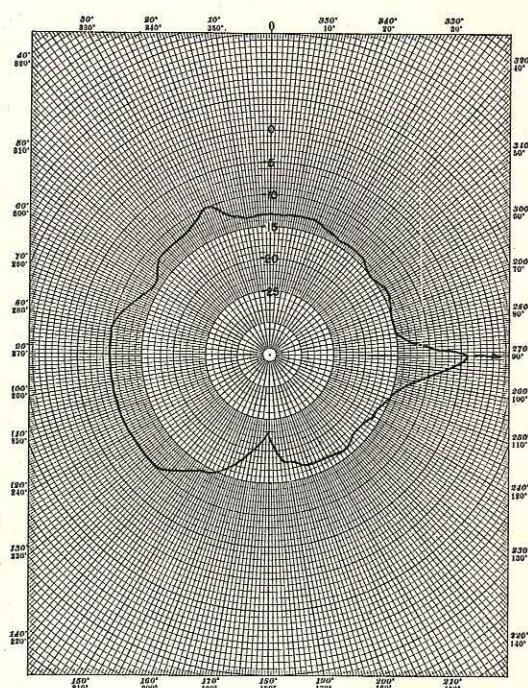

Fig. 52 - Bearing Set at 090°

Figs. 49-52 - Noise-Beam Patterns  
4 Trays of Delay; 3000-cps High-Pass Filter

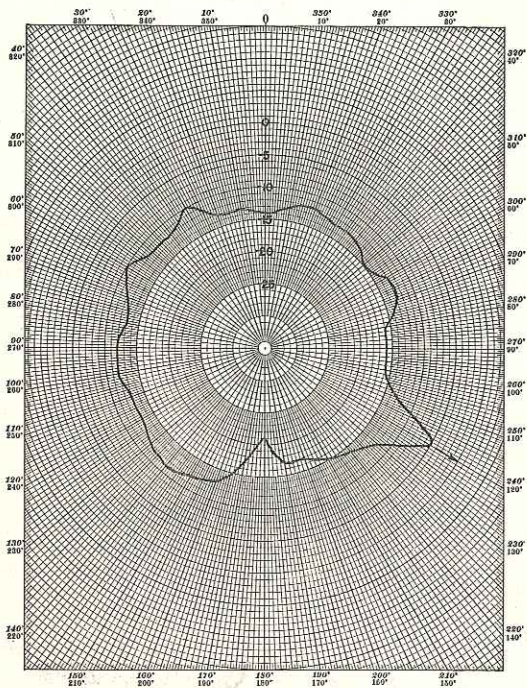

Fig. 53 - Bearing Set at 120°

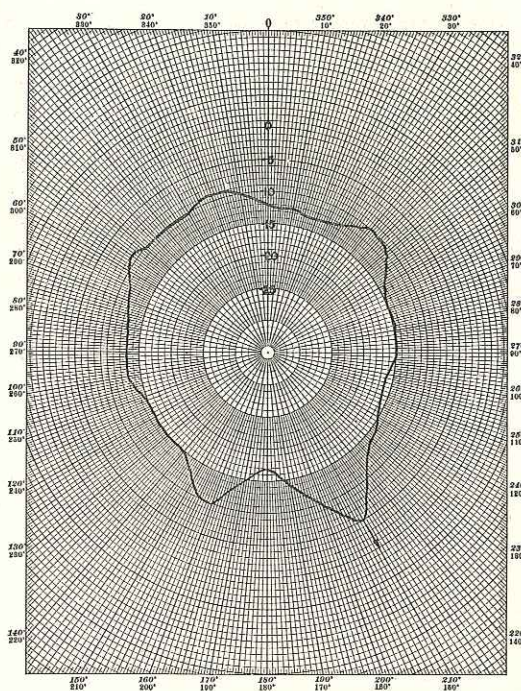

Fig. 54 - Bearing Set at 150°

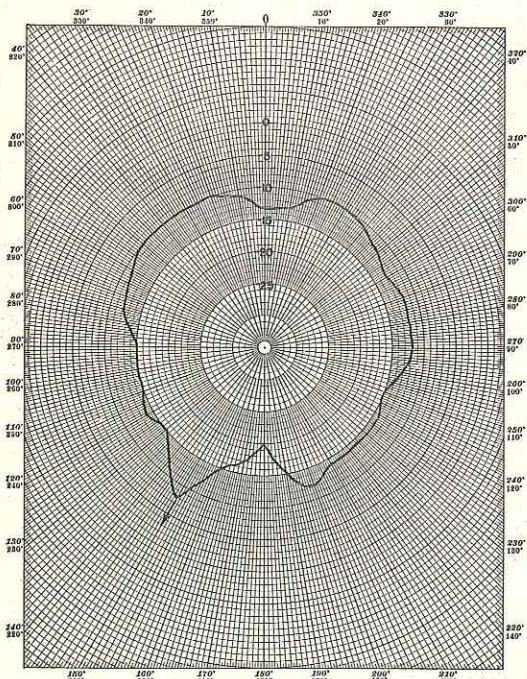

Fig. 55 - Bearing Set at 210°

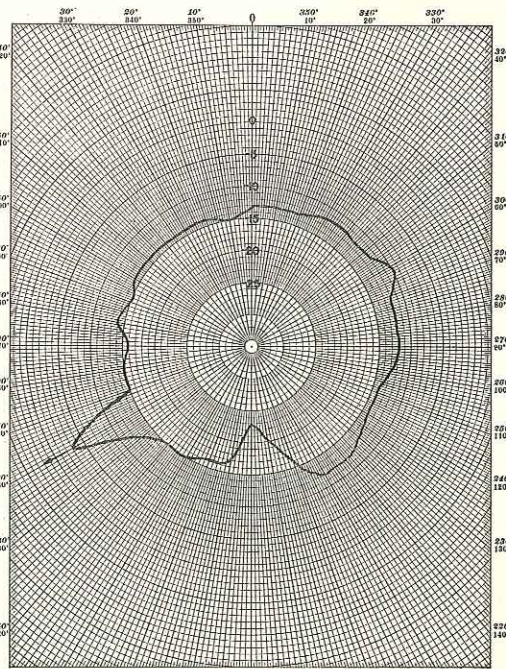

Fig. 56 - Bearing Set at 240°

Figs. 53-56 - Noise-Beam patterns  
4 Trays of Delay; 3000-cps High-Pass Filter

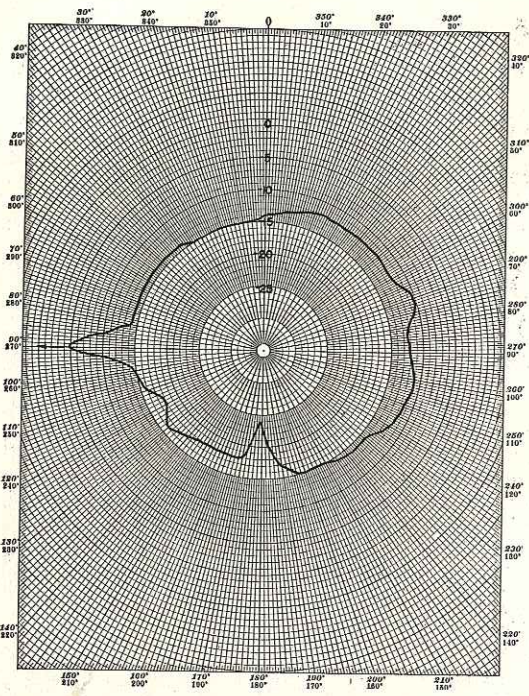

Fig. 57 - Bearing Set at 270°

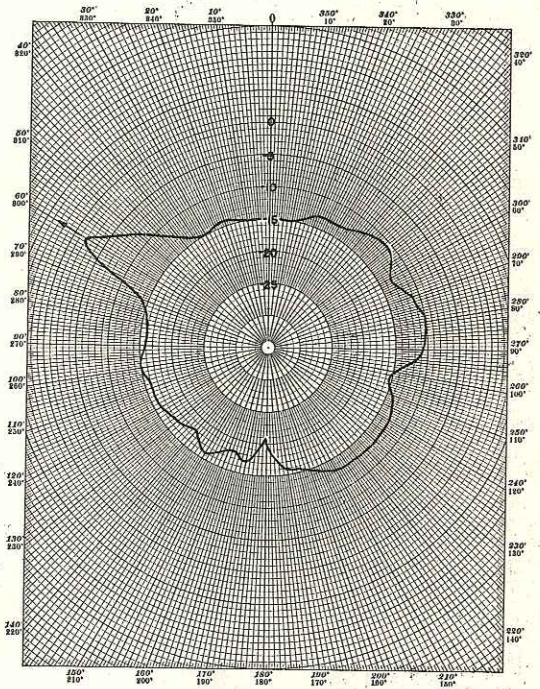

Fig. 58 - Bearing Set at 300°

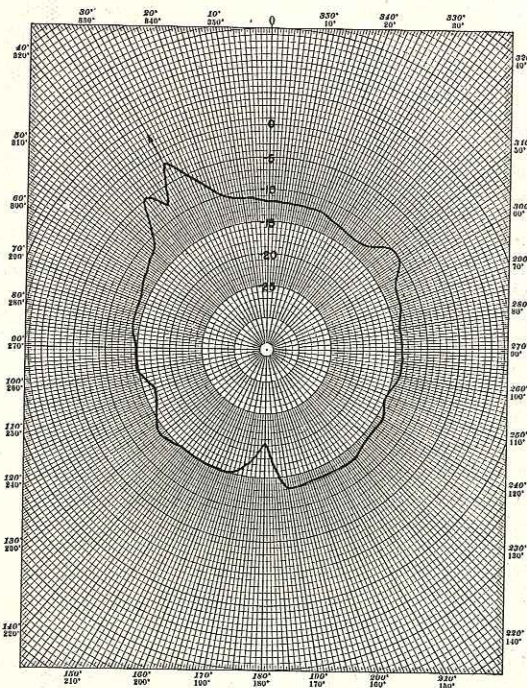

Fig. 59 - Bearing Set at 330°

Figs. 57-59 - Noise-Beam Patterns  
4 Trays of Delay; 3000-cps High-Pass Filter

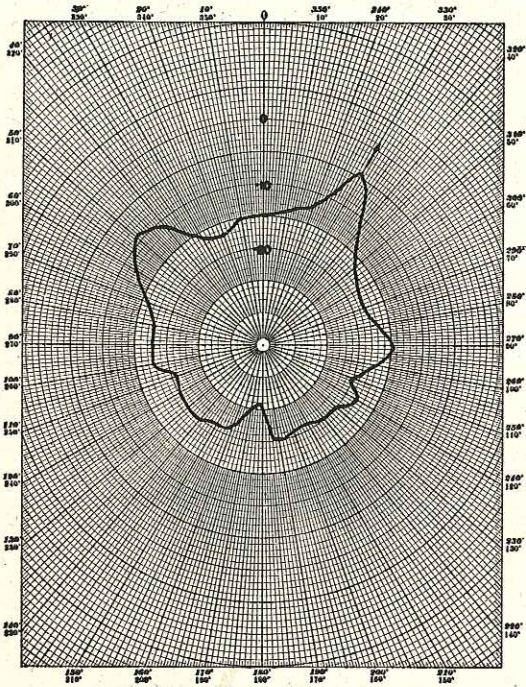

Fig. 60 - Noise-Beam Pattern  
4 Trays of Delay; 3000- to 5000-cps  
Band-Pass Filter; Bearing Set at 030°

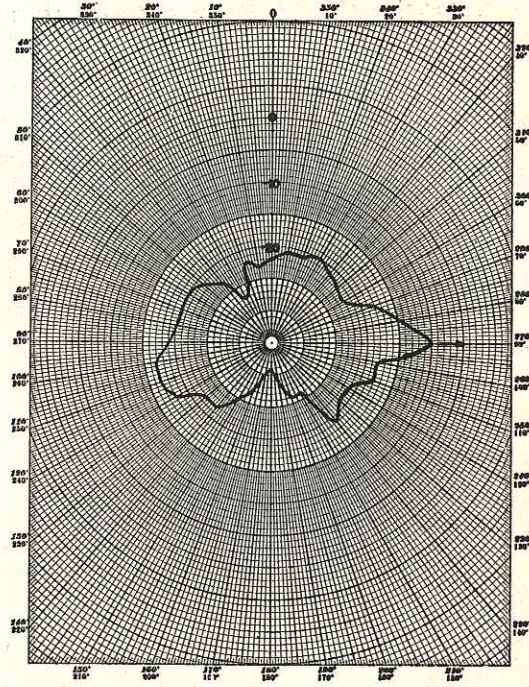

Fig. 61 - Noise-Beam Pattern  
4 Trays of Delay; 500- to 2000-cps  
Band-Pass Filter; Bearing Set at 090°

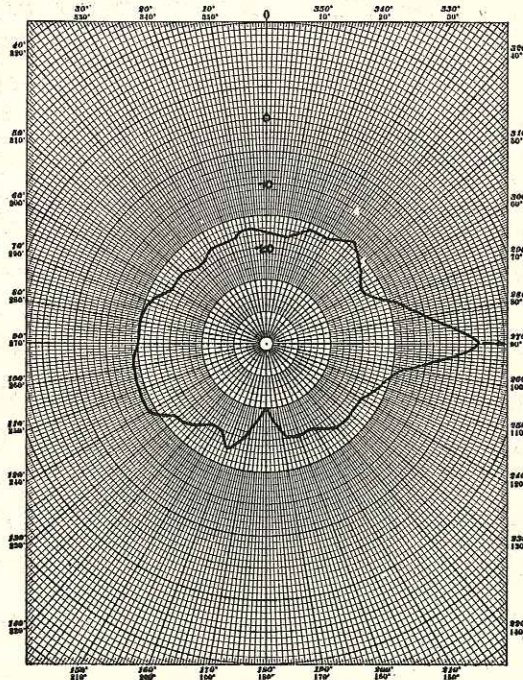

Fig. 62 - Noise-Beam Pattern  
4 Trays of Delay; Overlapped Filters,  
6000-cps High-Pass and 5000-cps Low-Pass;  
Bearing Set at 090°

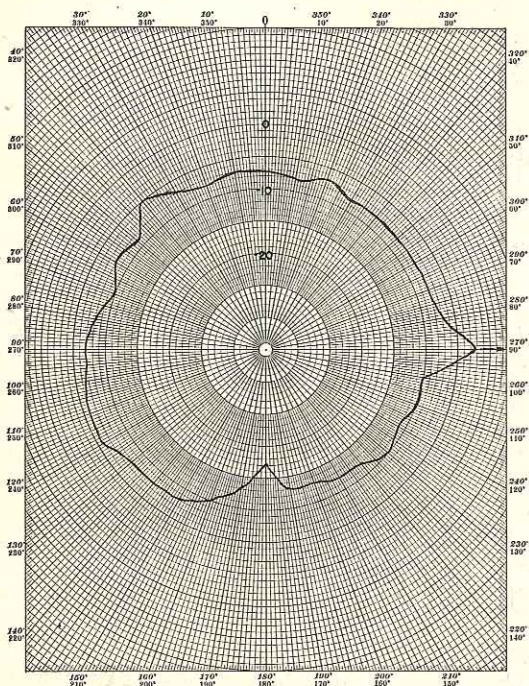

Fig. 63 - Noise-Beam Pattern  
4 Trays of Delay; 6000-cps High-Pass  
Filter; Bearing Set at 090°

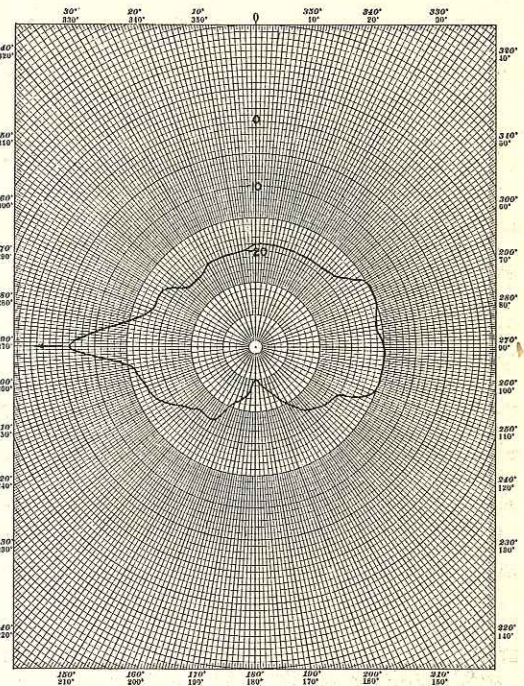

Fig. 64 - Noise-Beam Pattern  
4 Trays of Delay; 500- to 3000-cps Band-Pass  
Filter; Bearing Set at 270°

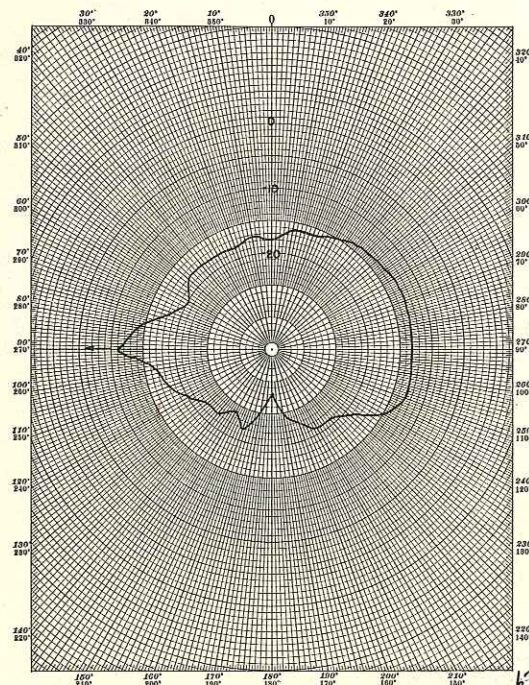

Fig. 65 - Noise-Beam Pattern  
4 Trays of Delay; 3000- to 5000-cps Band-Pass  
Filter; Bearing Set at 270°

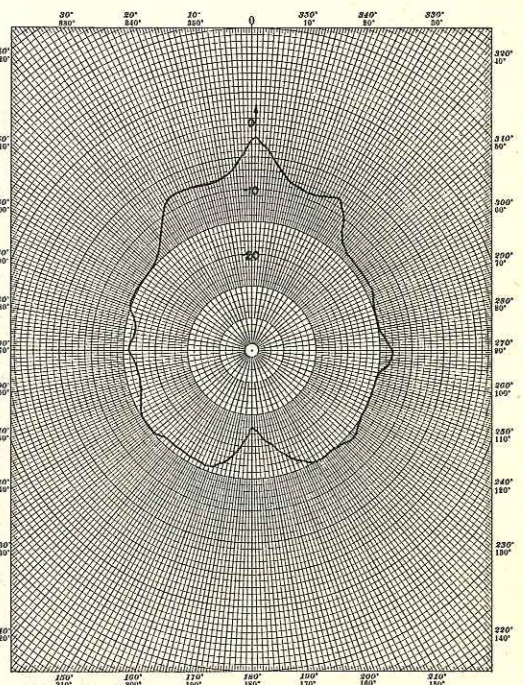

Fig. 66 - Noise-Beam Pattern  
4 Trays of Delay, with Relay Jumper In;  
500-cps High-Pass Filter; Bearing Set at 001°

CONFIDENTIAL

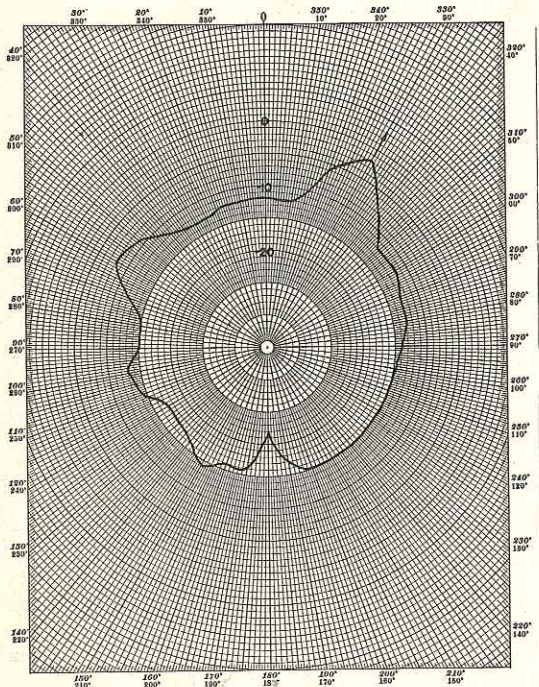

Fig. 67 - Noise-Beam Pattern  
4 Trays of Delay, with Relay Jumper Out;  
500-cps High-Pass Filter; Bearing Set at 030°

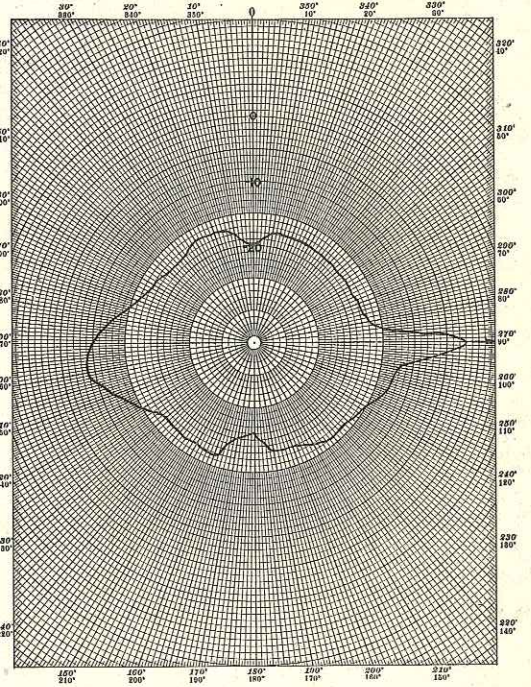

Fig. 68 - Noise-Beam Pattern  
4 Trays of Delay, with Relay Jumper In;  
500-cps High-Pass Filter; Bearing Set at 090°

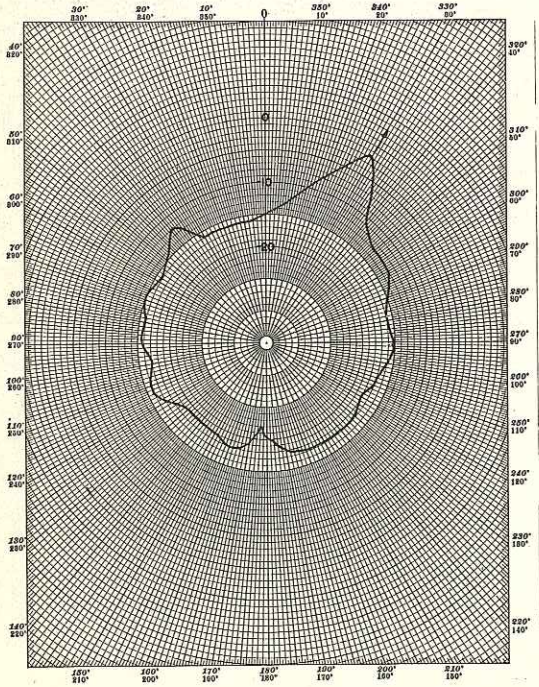

Fig. 69 - Noise-Beam Pattern  
2 Trays of Delay, with Relay Jumper In;  
500-cps High-Pass Filter; Bearing Set at 030°

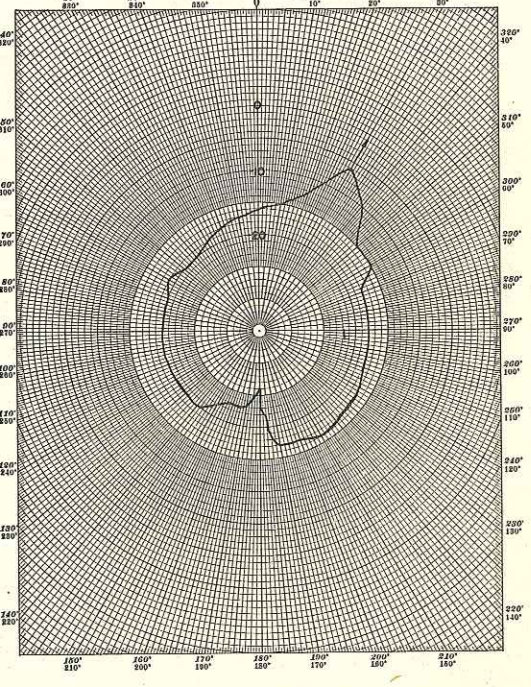

Fig. 70 - Noise-Beam Pattern  
4 Trays of Delay; Hydrophone Brushes 1-24  
Removed; 500-cps High-Pass Filter;  
Bearing Set at 030°

CONFIDENTIAL

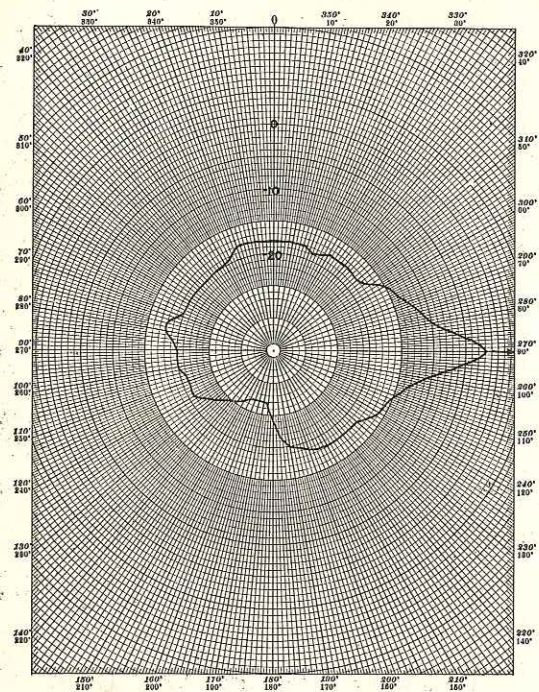

Fig. 71 - Noise-Beam Pattern  
 4 Trays of Delay; Hydrophone Brushes 1-24  
 Removed; 500-cps High-Pass Filter;  
 Bearing Set at 090°

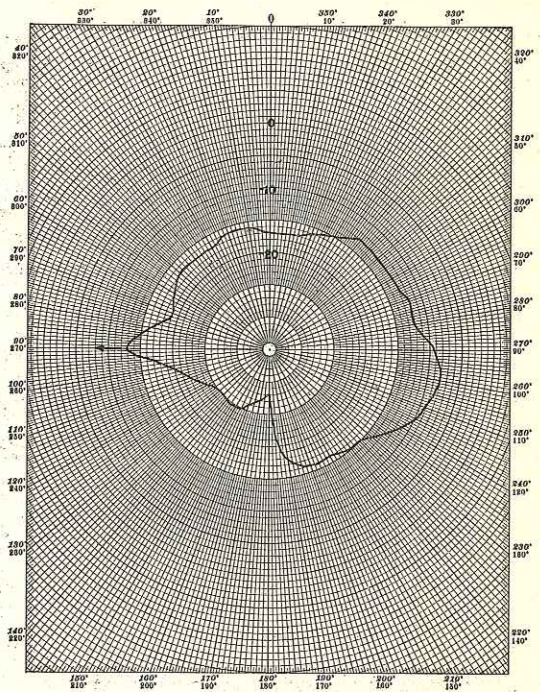

Fig. 72 - Noise-Beam Pattern  
 4 Trays of Delay; Hydrophone Brushes 1-24  
 Removed; 500-cps High-Pass Filter;  
 Bearing Set at 270°

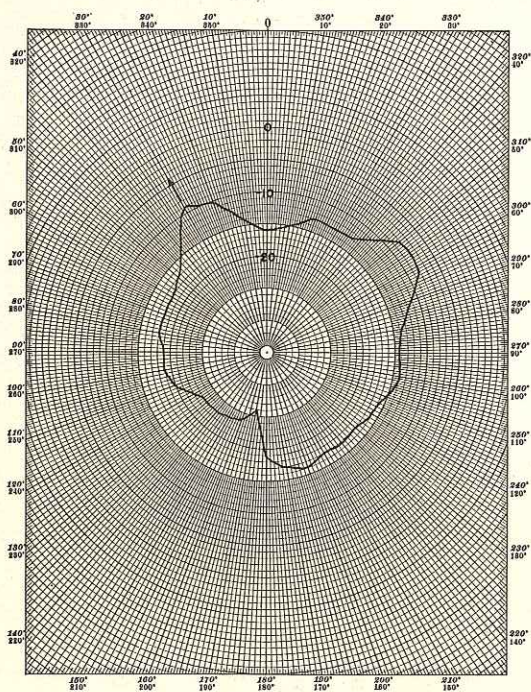

Fig. 73 - Noise-Beam Pattern  
 4 Trays of Delay; Hydrophone Brushes 1-24  
 Removed; 500-cps High-Pass Filter;  
 Bearing Set at 330°

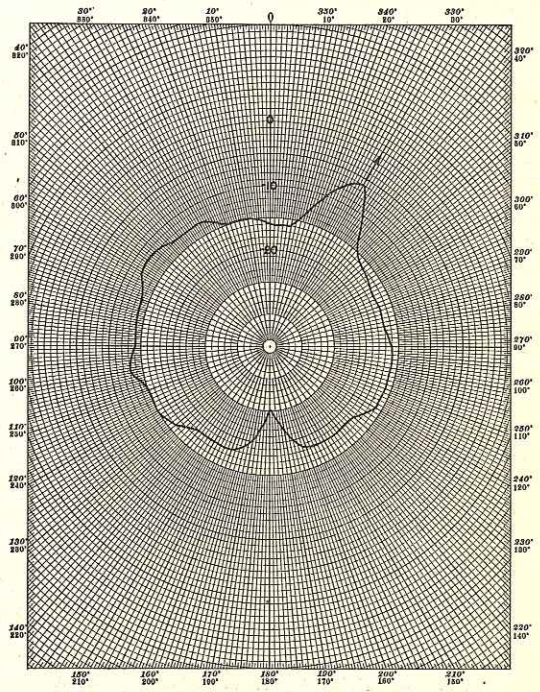

Fig. 74 - Noise-Beam Pattern  
 4 Trays of Delay; All Even-Numbered Hydrophone  
 Brushes Removed; 500-cps High-Pass Filter;  
 Bearing Set at 030°



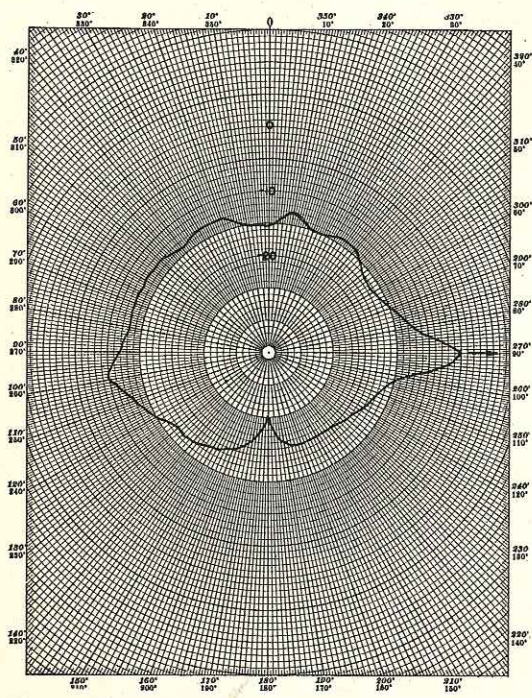

Fig. 75 - Noise-Beam Pattern  
4 Trays of Delay; All Even-Numbered Hydrophone  
Brushes Removed; 500-cps High-Pass Filter;  
Bearing Set at 090°

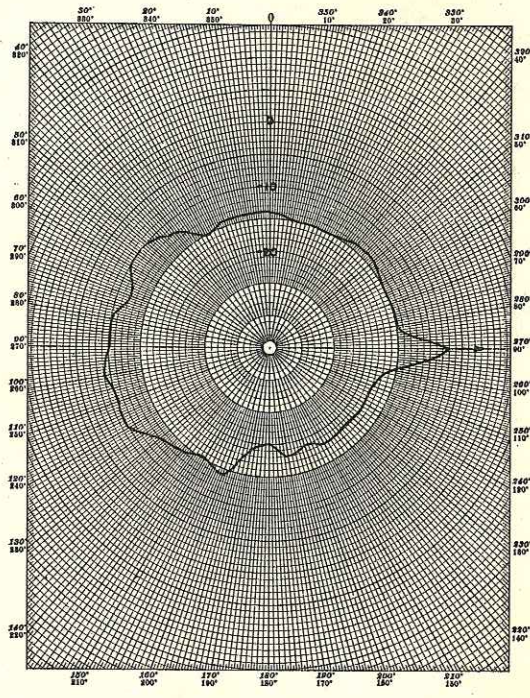

Fig. 76 - Noise-Beam Pattern  
4 Trays of Delay; All Even-Numbered Hydrophone  
Brushes Removed; 3000-cps High-Pass Filter;  
Bearing Set at 090°

1. Underwater sound—  
Detection
2. Underwater sound  
equipment
- I. Milner, C. T.
- II. NE091201, DIH1b

U. S. Navy Underwater Sound Laboratory  
INSTALLATION OF THE MODIFIED GERMAN  
GHG EQUIPMENT IN THE USS COCHINO  
(SS345), by C. T. Milner, May 4, 1951, 74p.  
illus. diags. (Rept. no. 134)

This report outlines the work of planning and  
installation of a modified German GHG sonic  
listening system in the USS COCHINO (SS345).  
Included are numerous figures which provide  
a pictorial history of the development and  
present the results of sea tests of the com-  
pleted installation.

U. S. Navy Underwater Sound Laboratory  
INSTALLATION OF THE MODIFIED GERMAN  
GHG EQUIPMENT IN THE USS COCHINO  
(SS345), by C. T. Milner, May 4, 1951, 74p.  
illus. diags. (Rept. no. 134)

This report outlines the work of planning and  
installation of a modified German GHG sonic  
listening system in the USS COCHINO (SS345).  
Included are numerous figures which provide  
a pictorial history of the development and  
present the results of sea tests of the com-  
pleted installation.

1. Underwater sound—  
Detection
2. Underwater sound  
equipment
- I. Milner, C. T.
- II. NE091201, DIH1b

U. S. Navy Underwater Sound Laboratory  
INSTALLATION OF THE MODIFIED GERMAN  
GHG EQUIPMENT IN THE USS COCHINO  
(SS345), by C. T. Milner, May 4, 1951, 74p.  
illus. diags. (Rept. no. 134)

This report outlines the work of planning and  
installation of a modified German GHG sonic  
listening system in the USS COCHINO (SS345).  
Included are numerous figures which provide  
a pictorial history of the development and  
present the results of sea tests of the com-  
pleted installation.

U. S. Navy Underwater Sound Laboratory  
INSTALLATION OF THE MODIFIED GERMAN  
GHG EQUIPMENT IN THE USS COCHINO  
(SS345), by C. T. Milner, May 4, 1951, 74p.  
illus. diags. (Rept. no. 134)

This report outlines the work of planning and  
installation of a modified German GHG sonic  
listening system in the USS COCHINO (SS345).  
Included are numerous figures which provide  
a pictorial history of the development and  
present the results of sea tests of the com-  
pleted installation.

1. Underwater sound—  
Detection
2. Underwater sound  
equipment
- I. Milner, C. T.
- II. NE091201, DIH1b

1. Underwater sound—  
Detection
2. Underwater sound  
equipment
- I. Milner, C. T.
- II. NE091201, DIH1b