

# MSA Safety Equipment Catalog

Volume 15, Number 1  
2013–2014



*Because every life has a **purpose...***



www.msasafety.com/msau

## What is MSA-U?

MSA-U is a feature-rich online training center that offers courses anytime, anywhere to maximize the users' competencies on MSA products, product technologies, and safety industry standards.

### Benefits

- Complete training, anytime, anywhere
- Easy course navigation
- Link to 'New' Training from the home page
- Select certificates achieved, from the home page
- From the home page, view courses you accessed
- Immediate feedback on test performance
- Detailed training reports available for managers
- Receive feedback on incorrect test answers
- www.msasafety.com/msau



A screenshot of the MSA-U Training Center website interface. The page has a dark header with the MSA-U Training Center logo on the left and the MSA logo with the tagline "The Safety Company" on the right. Below the header, there are navigation links for "Welcome!", "Home | My Account | Logout", and "Search". The main content area is divided into several sections: "My Courses" with a list of course titles like "Confined Space - Tech, Apps &amp; Sim", "Workshop Hazards - Core &amp; Use", and "Workshop Work Potential (Fall Protection, Fall Prev. Advantages and Resources - Tech, Distances &amp; ALTAD, 4 Multiple Detectors - F&amp;S"; "Course categories" with a list of categories like "Air-Purifying Respirators", "CBRN Detection", "Fall Protection Equipment", "Head Protection", "Permanent Gas &amp; Flame Detection", "Portable Gas Detection", "Supplied Air Respirators", "Thermal Imaging Cameras", and "Retired Products"; "My Certificates/Training" with links for "View Certificates - Between 10/16/11" and "Historical Records"; and a "NOTICE" section with text about receiving credit for passing a course. On the right side, there is a "Training News" section with a "New" icon and a "Calendar" section showing a calendar for March 2011. At the bottom, there are social media icons for Facebook, YouTube, and Twitter, and a footer with "Home | My Account | Logout" and "© MSA 2011. All Rights Reserved".

## Table of Contents

---

Air-Purifying Respirators .....	4–26
Air-Line Respirators .....	27–46
Self-Contained Breathing Apparatus .....	47–63
Cairns Fire Helmets .....	64–65
Gas Detection .....	66–101
Head, Eye, Face, and Hearing Protection .....	102–161
Fall Protection .....	162–241
Mining Equipment .....	242–245
Video Programs .....	246
Product Name Index .....	247–250
Part Number Index .....	251–257

## 99 Years of Products, Service and Expertise



### **Promoting Protection is Part of our History**

Mine Safety Appliances Company was founded in 1914 by two mining engineers who designed or improved safety, rescue and protective gear. MSA has continued to help protect people from hazards great and small, and today helps protect millions of workers in many industries worldwide. MSA has sold gas masks for military use since World War I. We have always understood the demands placed on crucial protective equipment in extremely hazardous conditions. MSA historically and steadfastly has helped first responders before, during, and after emergencies, from small house fires to multiple explosions at chemical plants, from hazardous materials spills to hurricanes.

MSA makes and markets respiratory protection, gas-and-flame-detection instruments, head, eye, face, and hearing protection, fire helmets, fall protection, thermal imaging cameras, and mining, emergency, and specialty equipment via a national network of trained distributors, product specialists and knowledgeable contacts. MSA has been a global company for decades, protecting millions of people around the world. What have we done for YOU lately?

### **MSA Offers More than Safety on the Job**

#### **Great Products**

MSA began making high-quality safety products in 1914. Technology enhances our innovation in product development, with computer-aided design and the latest rapid prototyping capability. MSA responds quickly as your needs change. Within most product groups is a wide selection of models, sizes, colors, materials, options, accessories and prices. Many components of MSA products are formulated, machined, tooled or molded in-house from raw materials, allowing for greater manufacturing control as well as quality assurance. MSA processes are certified as meeting ISO 9001-2008 quality assurance requirements of the International Standard Organization (ISO).

### **Great Plans for the Future**

MSA continues to enhance our operations and expand/improve our product lines by acquiring companies and/or new capabilities to better serve our customers. In 2010, MSA acquired General Monitors Inc., which, when combined with already extensive capabilities in portable and fixed gas products, created the World Leader in Fixed Gas and Flame Detection. This is just one example of how focusing on our core products—Fixed Gas & Flame Detection; Portable Gas Detection; Head Protection; Fall Protection; Respiratory Protection—means greater innovation and product development for you.

### **Great People and Resources**

Your personalized MSA service starts with a trained MSA-authorized distributor near you and the largest team of field representatives in the safety industry. They understand your hazards and the regulations with which you must comply, and will help to analyze your safety requirements and recommend solutions. MSA-authorized distributors are knowledgeable, well-trained and proficient at providing the services you need and also can assist in training your in-house trainer. Training your employees properly in the use, care and maintenance of our products is easy with MSA-U, our on-line application for 24/7 training. Go to [www.MSAafety.com/msau](http://www.MSAafety.com/msau) for a list of available programs. New programs are being added regularly.

MSA's website includes additional information about most products in this printed catalog, plus links to PDF versions of printed literature and other materials that you can print yourself. Go to [www.MSAafety.com](http://www.MSAafety.com).

To send us an e-mail message, use [info@MSAafety.com](mailto:info@MSAafety.com).



## Award-Winning Customer Service

### Every customer wants it. Every good business has it.

Our multiple-award-winning Customer Service Center proves that MSA strives for continuous improvement in customer satisfaction. Every year brings positive changes: better-trained associates with more advanced processes, resulting in improved service and faster solutions. Each Customer Service Associate's computer workstation can simultaneously handle a variety of applications, and an automated call distributor monitors and routes call flow to ensure peak performance. Customer Service continues to look for ways to improve its relationship with customers via surveys. Our goal is to provide exceptional customer service, which in turn creates customer loyalty.

The MSA Customer Service Center provides:

- Pre-Sales Support
  - Prepare quotations/bids
  - Product support and recommendations
- Sales Order Support
  - Process purchase orders
  - Provide price and availability information
  - Order status/delivery information
- Post-Sales Support
  - Product support—use and troubleshooting
  - Shipment tracking
  - Order/shipment issue resolution
  - Repair service notifications—return authorizations
  - Credit and corrected invoice requests

### Great International Sales

MSA's international sales capabilities start with MSA Sales Representatives who assist in choosing the right products for your applications and local approvals. Our extensive network of distributors, representatives and MSA-affiliate companies covers most major cities worldwide. Highly-trained international customer service associates guide your export orders from placement to delivery. MSA uses all major air and ocean freight forwarders and courier services due to their ability to consolidate multiple orders and minimize freight expenses. Associates understand international inspections, certifications, licensing and other customs issues necessary for successful importation.

To contact MSA International or to find the MSA affiliate company or distributor nearest you, please contact MSA International:

*Toll-free in the U.S.* ..... 1-800-MSA-7777  
*Outside the U.S.* ..... (+1) 724-776-8626  
*FAX* ..... (+1) 724-741-1553  
*Email* ..... International@MSAsafety.com

### To reach our Customer Service Center:

*Toll-free* . . . 1-800-MSA-2222 / 1-800-MSA-5555 (after-hours emergencies)  
*FAX* ..... 1-800-967-0398  
*Email orders* ..... placeorder@MSAsafety.com  
*MSA Voice Mail System* ..... 1-800-759-6423  
*Mailing Address* ..... Customer Service Center  
 MSA Corporate Center  
 1000 Cranberry Woods Dr.  
 Cranberry Twp, PA 16066

## Respiratory Protection



Respirators fall under two classifications: **air-purifying** and **air-supplied**. Air-purifying respirators are used against particulates, gases, and vapors. These are categorized as negative-pressure respirators that use chemical cartridges and/or filters; gas masks; and positive-pressure units such as powered air-purifying respirators (PAPRs). Air-supplied devices rely on a primary air source to deliver a steady flow of respirable air to the user's facepiece. These consist of Self-Contained Breathing Apparatus (SCBA) and air-line devices.



# About Respirators

**MSA Air-Purifying Respirators (APRs)** range from low-maintenance half-mask facepieces with cartridges and/or filters to the more complex PAPRs with full facepieces, or hoods.

- APRs for particulates use filters to capture dusts, mists, and fumes. Filters do not protect against gases or vapors, and generally become less effective as particles accumulate on the filter and plug spaces between the fibers. Filtering APRs require filter replacement when the user finds it difficult to breathe through them.
- Gas and vapor APRs employ chemical cartridges or canisters to remove hazardous gases or vapors from the air. They do not protect against airborne particles. Made to protect against specific gases or vapors, they provide protection only as long as the cartridge's absorbing capacity is not depleted.

The service life of a chemical cartridge depends upon many factors and can be estimated in various ways. Cartridges and canisters require an end-of-service-life indicator (ESLI) or a change schedule,

based on objective information or data that will ensure that canisters and cartridges are changed before the end of their useful life. You can access the MSA Cartridge Life Calculator on our website (MSAsafety.com). Click Resources, then Tools, then MSA Response Guide.

- Combination APRs, fitted with both particulate filters and gas/vapor cartridges, are worn in atmospheres that contain hazards of both particulates and gases.

**Supplied-Air Respirators (SARs)**, comprise air-line respirators, SCBA, and combination supplied-air respirators.

- Air-Line Respirators are used for extended periods in non-IDLH atmospheres. They use an air-line hose to deliver clean breathing air from a stationary source of compressed air for prolonged periods of time. Although comparatively lightweight, air-line respirators can limit users' mobility because of the air-line hose that must be attached.

- Self-Contained Breathing Apparatus (SCBA) have an open-circuit design that provides air rated for 30 to 60 minutes. They consist of a wearable, clean-air supply and a tight-fitting facepiece, and are used for short duration entrance or escape from atmospheres that are or may be IDLH. They offer relatively unrestricted movement.
- Combination SARs are air-line devices used for extended work periods in atmospheres that are or may be IDLH. They have an auxiliary self-contained air cylinder that can be used if the primary air supply fails. With certain restrictions, the air cylinder can also be used for entry into or escape from IDLH atmospheres, such as confined spaces.

## Respirator Selection

All respirators in use must be NIOSH-approved (NIOSH 42 CFR Part 84). Selecting respirators entails knowing what level of respiratory protection employees need, as well as which size respirator is right for any face and facial contours. Respiratory protective devices vary in design, application, and protective capability. Thus, the user must assess the inhalation hazard and understand the specific use limitations of available equipment to assure proper selection.



If your calculation shows that exposure concentrations exceed recommended limits and engineering/administrative controls do not reduce exposure below the permissible limit, tailor your respiratory protection program to the specific conditions based on:

- |                                  |  |                         |   |
|----------------------------------|--|-------------------------|---|
| • Toxicity (TLV or TWA)          | • Oxygen level                         | • Sorbent limitations   | • Type of use (routine, escape, or emergency entry) |
| • Maximum Expected Concentration | • IDLH concentration                   | • Facepiece fit         | • OSHA-assigned protection factor of respirator     |
|                                  | • Warning properties (adequate or not) | • Mobility requirements |   |

*All MSA Respirators are NIOSH-approved.*

# Air-Purifying Respirators

## Advantage® 420 Half-Mask Respirator

With its UniBond over-mold facepiece, AnthroCurve™ face seal, and low profile design, the Advantage 420 Respirator is the superior option for respiratory protection. The over-mold facepiece and face seal ensure the unit provides an excellent fit and comfort to the wearer. The unique yoke and harness design (patent pending) allows a user to easily don and doff the state-of-the-art respirator while maintaining a customized fit. Other features include a ComforTop™ headband, a built-in moisture release chin cup hole, and extra-wide head and neck straps.

### Features and Benefits

- Respirator boasts several features to increase comfort and provide customized fit
- Four-point yoke and harness design promotes easy donning and doffing
- Easily switches between lock-down and drop-down mode
- Designed for easy integration with other personal protective equipment
- Latex-free

### Ordering Information

	Small	Medium	Large	
ADVANTAGE 420 RESPIRATOR	10102182	10102183	10102184	Advantage 420 Assembly (includes facepiece, head cradle, elastic straps, buckle set, yoke with lever, two (2) inhalation valves, one (1) exhalation valve)
ADVANTAGE 420 RESPIRATOR SPARE PARTS AND ACCESSORIES	10097807	Harness Assembly with Buckles (includes head cradle, elastic straps, and buckle set)		
	10097883	Maintenance Valve Set (includes one (1) exhalation valve and two (2) inhalation valves)		
	10097886	Advantage 420 Maintenance Kit (includes harness assembly with buckles, one (1) exhalation valve, and two (2) inhalation valves)		
	10097810	Yoke with lever		
	10097881	Lever, package of 5		
	10097888	Inhalation valve, package of 10		
	10097891	Exhalation valve, package of 10		
	10097884	Buckle set, package of 5		
	10097887	Storage poly bag		
	468730	Vinyl storage bag with belt loops		
	809999	Advantage Adapter for threaded cartridges, package of 2		
	10009971	MSA Confidence Plus Germicidal Cleaner (32 oz.)		
	697383	Cleaning Towelettes (individually wrapped), package of 100		
	697444	Bitrex Qualitative Fit-Test Kit		
	10056424	Advantage Quantitative Fit Test Adapter		
	10097899	Instruction Manual, CD format		

See page 12 for Advantage filters and cartridges and page 13 for flexible pad-style filters.  
See page 13 for Comfo filters and cartridges.  
For more information, please see bulletin 1012-36-MC/July 2009.



### Applications include:

- Asbestos Abatement
- Painting
- Welding
- Sanding & Grinding

### Easy 3-Step Donning Process

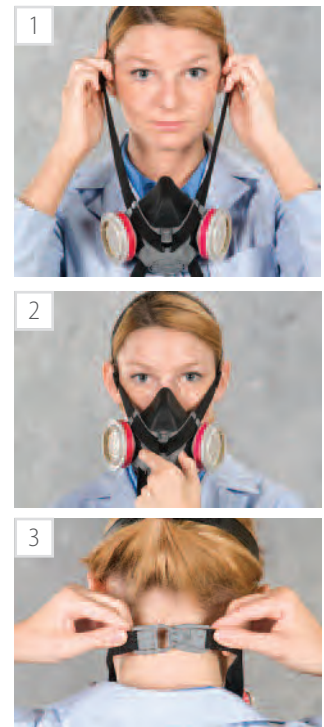



## Advantage 200 LS Half-Mask Respirator

The economical, lightweight Advantage 200 LS Respirator is extremely lightweight yet subtracts none of the toughness or performance. The unit's patented MultiFlex® System equalizes pressure on the face-seal area, ensuring the respirator doesn't collapse during wear. The respirator also has the AnthroCurve™ sealing surface, which instantly conforms to the wearer's face.

### Features and Benefits

- Lightweight, cost-efficient
- Thermoplastic rubber increases softness and decreases weight
- Multiflex system equalizes facial pressure
- AnthroCurve conforms to each user's face

### Ordering Information

	Small	Medium	Large	
ADVANTAGE 200 LS RESPIRATOR	815696	815692	815700	Advantage 200 LS Respirator, with 2-piece neckstrap
<i>facepiece only</i>	815448	815444	815452	Advantage 200 LS Respirator, with single neckstrap
ADVANTAGE 200 LS RESPIRATOR	816943	816939	816947	Advantage 200 LS Respirator, with OV-N95 cartridge
<i>with cartridge</i>	816701	816697	816705	Advantage 200 LS Respirator, with Multigas R95 cartridge

See page 12 for Advantage filters and cartridges and page 13 for flexible pad-style filters.



### Applications include:

- Asbestos Abatement
- Painting
- Welding
- Sanding & Grinding

## Comfo Classic® Half-Mask Respirator

The SoftFeel® facepiece of the Comfo Classic Half-Mask Respirator makes this unit dramatically more comfortable. The material increases the softness of both hycar rubber and silicone, which are the two facepiece materials available with Comfo Classic Respirators. The unit's unique face seal design also provides an exceptional fit.

### Features and Benefits

- SoftFeel rubber and Silicone facepieces enhance softness, increasing wearer comfort
- Face seal design provides tight, comfortable fit

### Ordering Information

	Small	Medium	Large	
COMFO CLASSIC FACEPIECES	808075	808074	808076	Comfo Classic Facepiece, SoftFeel hycar
	808072	808071	808073	Comfo Classic Facepiece, SoftFeel silicone

See page 13 for threaded Comfo cartridges and filters.



### Applications include:

- Asbestos Abatement
- Painting
- Welding
- Sanding & Grinding

# Air-Purifying Respirators

## Advantage 4000 Series Full-Facepiece Respirators

Designed to cover a wide variety of respiratory applications, our Advantage 4200 and 4100 Facepieces work with several different MSA respirators to provide comfortable, cost-efficient performance. Both twin-port and single-port facepieces are compatible with several MSA respirator models, including air-purifying respirators, supplied-air respirators, and powered air-purifying respirators. Available in silicone and hycar, these units come in three standard sizes for a snug fit. The facepieces also feature a rubber or net head harness, and every mask includes a standard nosecup for reduced fogging in low-temperature or high-moisture environments.

### Features and Benefits

- Facepieces are compatible with several MSA respirator models for comfortable, cost-efficient performance
- Option of three standard sizes ensures user will find a solid fit
- Standard nosecup reduces lens fogging
- Components lock into place in seconds for quick, convenient performance



rubber head harness



polyester net head harness



Kevlar net head harness



Advantage 4200 Respirator with polyester net head harness and GMA/OV cartridges

### Ordering Information

	Small	Medium	Large	
ADVANTAGE 4200 FACEPIECES <i>Twin-Port</i>	10083785	10083781	10083789	Advantage 4200 Facepiece, with polyester net head harness, hycar
	10083787	10083783	10083791	Advantage 4200 Facepiece, with rubber head harness, hycar
	10108570	10108568	10108572	Advantage 4200 Facepiece, with Kevlar net head harness, hycar
ADVANTAGE 4200 FACEPIECES <i>Twin-Port</i>	10083784	10083760	10083788	Advantage 4200 Facepiece, with polyester net head harness, silicone
	10083786	10083782	10083790	Advantage 4200 Facepiece, with rubber head harness, silicone
	10108569	10108567	10108571	Advantage 4200 Facepiece, with Kevlar net head harness, silicone
ADVANTAGE 4100 FACEPIECES <i>Single-Port</i>	10083797	10083793	10083801	Advantage 4100 Facepiece, with polyester net head harness, hycar
	10083799	10083795	10083803	Advantage 4100 Facepiece, with rubber head harness, hycar
	10108576	10108574	10108578	Advantage 4100 Facepiece, with Kevlar net head harness, hycar
ADVANTAGE 4100 FACEPIECES <i>Single-Port</i>	10083796	10083792	10083800	Advantage 4100 Facepiece, with polyester net head harness, silicone
	10083798	10083794	10083802	Advantage 4100 Facepiece, with rubber head harness, silicone
	10108575	10108573	10108577	Advantage 4100 Facepiece, with Kevlar net head harness, silicone

See page 12 for Advantage filters and cartridges and page 13 for flexible pad-style filters.

**Note:** The 4100 Facepiece can be converted for use with Advantage filter cartridges by adding the Twin-Cartridge Adapter Assembly P/N 10065328.

WELDER'S ACCESSORIES	10077063	Clip-On Welder's Adapter for Advantage 4200 Twin Port Facepiece; with cover lens, less filter plate
----------------------	----------	---



Welder's Adapter for Advantage 4200 Respirator

## Advantage 3000 Series Full-Facepiece Respirators

Designed to provide convenience and comfort, the Advantage 3000 Series Full Face Respirator is the ultimate choice for worker protection. Our state-of-the-art design allows for extremely low breathing resistance, while the standard nose cup reduces fogging and the pliable silicone facepiece increases comfort. The respirator also features a scratch-resistant, wraparound lens that eliminates distortion and increases peripheral vision. Pre-adjustable straps ensure the mask delivers a consistent fit, while the preset upper straps provide a tighter, more secure seal. Users can also opt for the European-style Advantage Head Harness, which dons like a catcher's mask. The 3100 Facepiece offers a single-port, standard thread filter connection. The 3200 Facepiece offers a twin-port, standard thread filter connection.

### Features and Benefits

- Full face respirator features state-of-the-art design to lower breathing resistance, while the nose cup reduces fogging and silicone faceplate increases comfort
- Scratch-resistant wraparound lens allows for wide field-of-vision, while adjustable straps offers consistent fit
- Single-port, standard thread filter connection

### Ordering Information

	Small	Medium	Large	
ADVANTAGE 3200 FACEPIECES	10028996	10028995	10031341	Advantage 3200 Facepiece, with rubber net head harness
<i>Twin-Port</i>	10031340	10031309	10083791	Advantage 3200 Facepiece, with Advantage European-style harness
ADVANTAGE 3100 FACEPIECES	10028999	10028998	10029000	Advantage 3100 Facepiece, with rubber net head harness
<i>Single-Port</i>	10031343	10031342	10031344	Advantage 3100 Facepiece, with Advantage European-style harness

See page 12 for Advantage filters and cartridges and page 13 for flexible pad-style filters.

### Applications

- Asbestos Abatement
- Welding
- Sanding & Grinding



Advantage 3200 Respirator with rubber harness and chemical cartridges



Advantage 3200 Respirator with European-style harness



Advantage 3100 Respirator with rubber harness

# Air-Purifying Respirators

## Ultra-Twin® Full-Facepiece Respirator

Designed to provide a secure fit and strong protection, Ultra-Twin Full-Facepiece Respirators offer several options that make it a clear choice for defense against toxic chemicals. The unit features an inturned lip for a comfortable seal against the face, a large chin cup for easy positioning, and 5 suspension headstraps with roller buckles that hold the facepiece in place while minimizing hair entanglement. The wide lens is scratch resistant, while a speaking diaphragm provides clear short-range communications. The unit also features a nose cup that helps eliminate lens fogging.

### Features and Benefits

- Feature an inturned lip, large chin cup, and 5 headstraps with roller buckles for secure, comfortable fit
- Speaking diaphragm provides clear communications
- Nosecup reduces lens fogging

### Ordering Information

	Small	Medium	Large	
ULTRA-TWIN FACEPIECES	471298	471286	471310	Ultra-Twin Facepiece, hycar
	480263	480259	480267	Ultra-Twin Facepiece, silicone

See page 13 for Comfo filters and cartridges. See page 15 for accessories, and pages 16–17 for fit test kits.



## Ultra Elite® Twin-Cartridge Full-Facepiece Respirator

Combining state-of-the-art features with MSA's precision engineering, the Ultra Elite Full Facepiece is our top model in this range. The ergonomic design makes this a comfortable unit, while the 5-point harness makes it easy to put it on or take it off. The distortion-free coated lens provides a high level of peripheral and downward vision. The face blank has a single-sealing flange and comes in rubber or silicone, while the speaking diaphragm provides excellent close-range communication.

### Features and Benefits

- State-of-the-art mask provides excellent comfort and protection
- Distortion-free lens allows wide field-of-view
- 5-point harness allows easy on/off
- Models include Hycar rubber and silicone versions
- Unique airflow prevents lens fogging

### Ordering Information

	Small	Medium	Large	
ULTRA ELITE FACEPIECES with twin-cartridge adapter	10016755	10016756	10016757	Ultra Elite Facepiece, SoftFeel silicone
ULTRA ELITE FACEPIECES less twin-cartridge adapter	480264	493020	493108	Ultra Elite Facepiece, SoftFeel hycar
	493072	493928	493116	Ultra Elite Facepiece, SoftFeel silicone



See page 13 for threaded filters and cartridges. See page 15 for accessories, and pages 16–17 for fit test kits.

**Note:** Ultra Elite Facepieces must be fitted with a Twin-Cartridge Adapter P/N 803622 to be used as a twin-cartridge respirator.



# Air-Purifying Respirators

## Advantage Respirator Cartridges

The Advantage line of particulate, chemical and combination cartridges is NIOSH-certified (to 42 CFR, Part 84) and provides lightweight, low-profile performance. Cartridges fit 200 LS and 420 Half-Mask, 1000, 3000 and 4000 Series Full-Facepiece Advantage Respirators.

			Acid Gases											Filter Type & Efficiency See Definitions below			See Notes below																												
			Organic Vapor	Chlorine	Sulfur Dioxide	Chlorine Dioxide	Hydrogen Chloride	Hydrogen Sulfide	Ammonia	Methylamine	Formaldehyde	Hydrogen Fluoride	Mercury Vapor																																
MSA Cartridge Description	Re-Order Part Number	Color Coding	OV	CL	SD	CD	HC	HS	AM	MA	FM	HF	MV	P100	R95	N95																													
Organic Vapor (GMA)	815355																2,3																												
Organic Vapor w/N95 Prefilter (GMA)	815355 w/815394 or 816357																2,3																												
Organic Vapor w/R95 Prefilter (GMA)	815355 w/815397																2,3																												
Organic Vapor/P100 (GMA)	815362																2,3,4																												
Acid Gas (GMB)	815356																2																												
Acid Gas w/N95 Prefilter (GMB)	815356 w/815394 or 816357								<i>escape only</i>								2																												
Acid Gas w/R95 Prefilter (GMB)	815356 w/815397								<i>escape only</i>								2																												
Acid Gas/P100 (GMB)	815363																2,4																												
Organic Vapor/Acid Gas (GMC)	815357																2,3																												
Organic Vapor/Acid Gas w/N95 Prefilter (GMC)	815357 w/815394 or 816357								<i>escape only</i>								2,3																												
Organic Vapor/Acid Gas w/R95 Prefilter (GMC)	815357 w/815397								<i>escape only</i>								2,3																												
Organic Vapor/Acid Gas/P100 (GMC)	815364																2,3,4																												
Ammonia/Methylamine (GMD)	815358																2,3																												
Ammonia/Methylamine w/N95 Prefilter (GMD)	815358 w/815394 or 816357																2,3																												
Ammonia/Methylamine w/R95 Prefilter (GMD)	815358 w/815397																2,3																												
Ammonia/Methylamine/P100 (GMD)	815365																2,3,4																												
Multigas (GME)	815359																2,3																												
Multigas w/ N95 Prefilter (GME)	815359 w/815394 or 816357								<i>escape only</i>								2,3																												
Multigas w/R95 Prefilter (GME)	815359 w/815397								<i>escape only</i>								2,3																												
Multigas/P100 (GME)	815366																2,3,4																												
Iodine Vapor/P100 (GMI)*	815641																2,4																												
Chlorine/Mercury Vapor (Mersorb)	815361																2																												
Chlorine/Mercury Vapor w/N95 Prefilter (Mersorb)	815361 w/815394 or 816357																2																												
Chlorine/Mercury Vapor w/ R95 Prefilter (Mersorb)	815361 w/815397																2																												
Chlorine/Mercury Vapor/P100 (Mersorb)	815368																2,4																												
Low-Profile P100	815369 Pack of 2 10123079 Pack of 100																1,4																												
N95 Snap-On Prefilter and Cover	815394 Pack of 10 816357 Box of 50 815392 Reusable Snap-On Cover, 2 in a Package		<b>⚠ WARNING</b>																																										
R95 Snap-On Prefilter and Cover	815397 Box of 20 815401 Reusable Snap-On Cover, 2 in a Package		An appropriate cartridge change-out schedule must be developed by a qualified professional, unless the cartridge/canister utilizes an end-of-service-life indicator. The change-out schedule must take into account all factors that may influence respiratory protection including specific work practices and other conditions unique to the worker's environment. If using against substances having poor warning properties, there is no secondary means of knowing when to replace the cartridges/canister. In such cases, take appropriate additional precautions to prevent overexposure, which may include a more conservative change-out schedule or using an air-supplied respirator or SCBA. Failure to follow this warning can result in serious personal injury or death. As a reference, below is a partial list of substances having poor warning properties:																																										
<b>Definitions</b>			<p><b>N95-Particulate Filter (95% filter efficiency level)</b> effective against particulate aerosols free of oil; time use restrictions may apply.</p> <p><b>R95-Particulate Filter (95% filter efficiency level)</b> effective against all particulate aerosols; time use restrictions may apply.</p> <p><b>P100-Particulate Filter (99.97% filter efficiency level)</b> effective against all particulate aerosols.</p>																																										
* Effective against, but not NIOSH-approved, for Iodine Vapor.			<table border="0"> <tr> <td>Acrolein</td> <td>Hydrogen cyanide</td> <td>Nitric acid</td> <td>Phosphorus trichloride</td> </tr> <tr> <td>Aniline</td> <td>Hydrogen selenide</td> <td>Nitro compounds</td> <td>Stibine</td> </tr> <tr> <td>Arsine</td> <td>Methanol</td> <td>Nitrogen oxides</td> <td>Sulfur chloride</td> </tr> <tr> <td>Bromine</td> <td>Methyl bromide</td> <td>Nitroglycerin</td> <td>Urethane or other diisocyanate-containing paints</td> </tr> <tr> <td>Carbon monoxide</td> <td>Methyl chloride</td> <td>Nitromethane</td> <td></td> </tr> <tr> <td>Diisocyanates</td> <td>Methylene chloride</td> <td>Phosgene</td> <td>Vinyl chloride</td> </tr> <tr> <td>Dimethyl sulfate</td> <td>Nickel carbonyl</td> <td>Phosphine</td> <td></td> </tr> </table>															Acrolein	Hydrogen cyanide	Nitric acid	Phosphorus trichloride	Aniline	Hydrogen selenide	Nitro compounds	Stibine	Arsine	Methanol	Nitrogen oxides	Sulfur chloride	Bromine	Methyl bromide	Nitroglycerin	Urethane or other diisocyanate-containing paints	Carbon monoxide	Methyl chloride	Nitromethane		Diisocyanates	Methylene chloride	Phosgene	Vinyl chloride	Dimethyl sulfate	Nickel carbonyl	Phosphine	
Acrolein	Hydrogen cyanide	Nitric acid	Phosphorus trichloride																																										
Aniline	Hydrogen selenide	Nitro compounds	Stibine																																										
Arsine	Methanol	Nitrogen oxides	Sulfur chloride																																										
Bromine	Methyl bromide	Nitroglycerin	Urethane or other diisocyanate-containing paints																																										
Carbon monoxide	Methyl chloride	Nitromethane																																											
Diisocyanates	Methylene chloride	Phosgene	Vinyl chloride																																										
Dimethyl sulfate	Nickel carbonyl	Phosphine																																											

### Notes

- Do not use in atmospheres containing less than 19.5 percent oxygen, in atmospheres containing gases or vapors or in atmospheres immediately dangerous to life and health.
- Do not use in atmospheres containing less than 19.5 percent oxygen, or in atmospheres immediately dangerous to life and health.
- Do not wear for protection against organic vapors with poor warning properties or those which generate high heats of reaction with the sorbent material in the cartridge.
- 99.97 percent efficient against 0.3 micron DOP.

## Comfo Respirator Cartridges

The Comfo line of particulate, chemical and combination cartridges is NIOSH-certified (to 42 CFR, Part 84). Cartridges fit Comfo Classic, Ultra-Twin, Ultra Elite Twin-Cartridge and Duo-Twin Respirators, and certain half-mask and full-face Advantage Respirators with Adapter (P/N 809999).

			Acid Gases											Filter Type & Efficiency					
MSA Cartridge Description	Re-Order Part Number	Color Coding	Organic Vapor	Chlorine	Sulfur Dioxide	Chlorine Dioxide	Hydrogen Chloride	Hydrogen Sulfide	Ammonia	Methylamine	Formaldehyde	Hydrogen Fluoride	Mercury Vapor	See Definitions on previous page			See Notes on p. 12		
			OV	CL	SD	CD	HC	HS	AM	MA	FM	HF	MV	P100	R95	N95			
Organic Vapor (GMA)	464031 (10 in pkg.)																	2,3	
Organic Vapor/P100 (GMA)	815178 (6 in pkg.)																	2,3,4	
Organic Vapor/P100 Short Stack (GMA)	815186 (6 in box)																	2,3,4	
Acid Gas (GMB)	464032 (10 in box)																		2
Acid Gas/P100 (GMB)	815179 (6 in box)																		2,4
Organic Vapor/Acid Gas (GMC)	464046 (10 in pkg.)																		2,3
Organic Vapor/Acid Gas/P100 (GMC)	815180 (6 in box)																		2,3,4
Organic Vapor/Acid Gas/P100 Short Stack (GMC)	815188 (6 in box)																		2,3,4
Ammonia/Methylamine (GMD)	464033 (10 in box)																		2,3
Ammonia/Methylamine/P100 (GMD)	815181 (6 in box)																		2,3,4
Multigas (GME)	492790 (10 in box)																		2,3
Multigas/P100 (GME)	815182 (6 in box)																		2,3,4
Iodine Vapor/P100 (GMI)*	815184 (6 in box)																	2,4	
Chlorine/Mercury Vapor (Mersorb)	466204 (10 in box)																		2
Chlorine/Mercury Vapor/P100 (Mersorb)	815185 (6 in box)																	2,4	
P100	815175 (10 in box)																	1,4	
Sparkfoe® P100	815176 (10 in box)																	1,4	
Low-Profile P100	815177 (10 in box)																	1,4	
Stand-alone and cover N95 and covers required for Comfo Respirators	816662 N95 (10 in pkg.) 816661 N95 (50 in box) 489353 Reusable snap-on cover (1 in pkg.; 2 req.)																	1	
Prefilter and Cover N95	816662 N95 (10 in pkg.) 816661 N95 (50 in pkg.) 489353 Reusable snap-on cover (1 in pkg.; 2 req.)																	1	
Prefilter and Cover R95	816287 R95 (20 in box) 489219 R95 Reusable snap-on cover (1 in pkg.; 2 req.)																	1	

\* Effective against, but not NIOSH-approved for Iodine Vapor. Note: See **WARNING** on previous page.

## Flexi-Filter® Pads for Advantage Respirators

These low-profile, flexible pads fit well under a welding hood and with other personal protective equipment. They offer great balance and weight distribution for maintaining a good face seal, while their swept-back design provides improved vision and comfort.

MSA Filter Description	Part No.	Color Coding	Filter Type & Efficiency			Notes
			P100	P95	N95	
Flexi-Filter P100	818342					1,4
Flexi-Filter P100 w/Nuisance Level OV, Ozone Removal	818343					1,4
Flexi-Filter P100 w/Nuisance Level AG, HF Removal	818344					1,4
Flexi-Filter N95	818346					1
Flexi-Filter N95 w/Nuisance Level OV Removal	818347					1
Flexi-Filter P95	818354					1
Flexi-Filter P95 w/Nuisance Level OV Removal	818355					1

THREADED RESPIRATOR CARTRIDGES FOR ULTRA FILTER RESPIRATORS	10010420	Round Ultra Filter Cartridge, box of 6
	10010421	Round Ultra Filter Cartridge, box of 50

# Air-Purifying Respirators

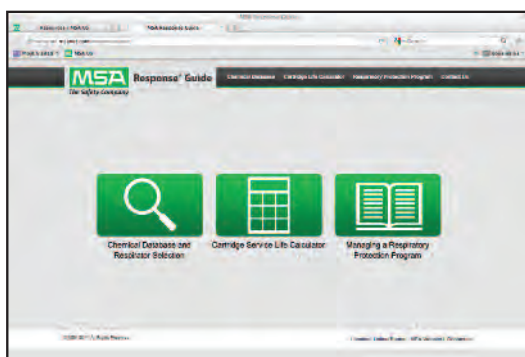

## Online Response® Respirator Selector

Available at [www.MSAafety.com/responseguide](http://www.MSAafety.com/responseguide)

- Helps identify the proper respirator you need
- Has broadest range of respiratory protective devices available
- Recommends respirators for more than 700 chemical hazards
- Has nearly 3,000 chemical synonyms
- Lists up to 27 categories of respirators, with MUCs
- Is generic in nature



## Cartridge Life Expectancy Calculator

Available at [www.MSAafety.com/responseguide](http://www.MSAafety.com/responseguide)

MSA's interactive web pages help users determine the life expectancy of specific respirator cartridges in various hazardous situations. This information provides guidance for how long a cartridge should be used before it must be replaced.



## Personal Safety Equipment Towelettes

Provides an excellent method for wiping and refreshing respirators, hardhats, and other safety equipment between full cleaning periods.



## MSA Confidence Plus® Germicidal Cleaner

Mix with warm water for a germicidal cleaner that is effective against various micro-organisms including immunodeficiency virus Type 1 (HIV-1, associated with AIDS). EPA-approved for use on safety equipment.

## Ordering Information

CLEANING ACCESSORIES	697383	Box of 100 individually wrapped towelettes, 7-1/4" x 5"
	697382	Canister with 220 towelettes, 4-1/4" x 6"
	10022871	"The Big Ones", box of 50 individually wrapped towelettes, 8" x 11"
	10009971	MSA Confidence Plus Germicidal Cleaner, 32 oz. bottle



## Facepiece Accessories

ADVANTAGE 420 ACCESSORIES	10097887	Storage poly bag
	468730	Carrying pouch with belt loops for half-mask respirators
	809999	Advantage Adapter for threaded cartridges, package of 2
	10056424	Advantage Quantitative Fit Test Adapter
	10097899	Instruction Manual, CD Format
ADVANTAGE 200 LS ACCESSORIES	809999	Advantage Adapter for threaded cartridges, package of 2
	10056424	Advantage Quantitative Fit Test Adapter
	468730	Carrying pouch for half-mask respirators
COMFO CLASSIC ACCESSORIES	812022	QuikChek II Fit-Test Adapter for Comfo Respirators
	803196	QuikChek II Replacement Kit with 25 ft of sampling tubing and 25 connectors, clips, and suction cups
	468730	Carrying pouch with belt loops for half-mask respirators
ADVANTAGE 3000 SERIES ACCESSORIES	10029298	Spectacle Kit for Advantage Respirators
	10056424	Advantage Quantitative Fit Test Adapter
	10031542	Cover Lens, clear, box of 25
	10031543	Cover Lens, smoke-tinted, box of 25
	D2056734	Black plastic carrying/storage case
ADVANTAGE 4000 SERIES ACCESSORIES	10029298	Spectacle Kit for Advantage Respirators
	10056424	Advantage Quantitative Fit Test Adapter, for Advantage 4200 Facepieces
	805078	QuikChek III Fit Test Adapter for Advantage 4100 Facepieces*
	10031542	Cover Lens, clear, box of 25
	10031543	Cover Lens, smoke-tinted, box of 25
	10077063	Clip-On Welders Adapter for Advantage 4200 Twin-Port Facepiece, with cover lens, less filter plate
	10065326	Clip-On Welders Adapter for Advantage 4100 Single-Port Facepiece, with cover lens, less filter plate
	D2056734	Black plastic carrying/storage case

\*Also requires RD40 Adapter P/N 10065330

ULTRA-TWIN/ ULTRAVUE ACCESSORIES	454819	Spectacle Kit for Ultra-Twin/Ultravue
	812022	QuikChek II Fit-Test Adapter for Ultra-Twin Respirator
	803196	QuikChek II Replacement Kit with 25 ft of sampling tubing and 25 connectors, clips, and suction cups
	817446	QuikChek IV Adapter for Ultravue/Ultra Elite facepieces with a 1/4-turn quick-disconnect, with Type H cartridge
	803622	Twin-Cartridge Adapter for Ultravue Facepieces
	456975	Cover Lens, clear, box of 25
	480326	Cover Lens, smoke-tinted, box of 25
	813138	Nosecup, black, small
	813139	Nosecup, black, medium
	813140	Nosecup, black, large
	D2056734	Black plastic carrying/storage case
ULTRA ELITE ACCESSORIES	804638	Spectacle Kit for Ultra Elite Respirator, side wire support
	493581	Spectacle Kit for Ultra Elite Respirator, center support
	805078	QuikChek III Fit-Test Adapter for Ultra Elite Respirators
	817446	QuikChek IV Adapter for Ultravue/Ultra Elite facepieces with a 1/4-turn quick-disconnect, with Type H cartridge
	803622	Twin-Cartridge Adapter for Ultra Elite Facepieces
	491500	Cover Lens, clear, box of 25
	805456	Cover Lens, smoke-tinted, box of 25
	D2056734	Black plastic carrying/storage case

# Air-Purifying Respirators

## MSA Respirator Fit Test Compliance

29 CFR Part 1910.134



Advantage 200LS Respirator



Advantage 420 Respirator



Comfo® Classic Respirator



Comfo Elite Respirator



Advantage 3100 Respirator



Advantage 3200 Respirator

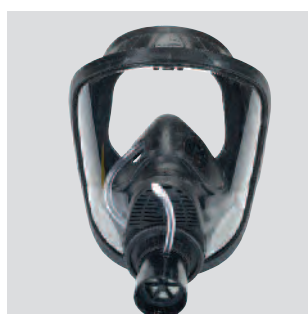

Advantage 4100 Respirator



Advantage 4200 Respirator



Advantage 1000 Respirator/  
Millennium® Respirator



Ultra-Twin Respirator



Ultravue Respirator



Ultra Elite Respirator

## Ordering Information

MSA RESPIRATOR FIT TEST KITS	697287	Saccharin Qualitative Fit Test Kit
	697444	Bitrex Qualitative Fit Test Kit
	697285	Replacement (Saccharin) Sensitivity Test
	697445	Solution, 55 ml bottle (Bitrex)
	697286	Replacement Fit-Test (Saccharin) Solution, 55 ml bottle
	697446	Replacement Fit-Test (Bitrex) Solution, 55 ml bottle
	697447	#1 Sensitivity Nebulizer
	697459	#2 Fit-Test Nebulizer
	697448	Test Hood (Same for Both)
	697325	"Using the Qualitative (Saccharin) Fit Test Kit" videotape
	697449	"Using the Qualitative (Bitrex) Fit-Test Kit" videotape
	801628	Banana Oil Qualitative Fit Test Kit

## Fit Test Compliance Reference Guide

Respirator Description	Class	Material	APF	OSHA Acceptable Fit Test Methods	Required Fit Factor Quantitative	MSA Fit Test Adapter Required	Cartridge Type	Probed Facepiece P/N (if applicable)	Controlled Negative Pressure (OHD) Quan Fit Test Adapter
Advantage 200 LS	Half-Mask Negative Pressure	TPR	10	Qualitative or Quantitative	100	Advantage Adapter #10056424	Bayonet or threaded with adapter #809999	S (816515), M (8165130), L (816517)	OHD P/N 9513-0210
Advantage 420	Half-Mask Negative Pressure	Silicone	10	Qualitative or Quantitative	100	Advantage Adapter #10056424	Bayonet or threaded w/adapter #809999	S (10107710), M (10107731), L (10107732)	OHD P/N 9513-0210
Comfo Classic	Full-Face Negative Pressure	Silicone	10	Qualitative or Quantitative	100	Quik Chek® II Adapter #812022	Threaded	S (808255), M (808249), L (808261)	OHD P/N 9513-0109
Comfo Elite	Full-Face Negative Pressure	Hycar™	10	Qualitative or Quantitative	100	Quik Chek II Adapter #812022	Threaded	S (808253), M (808247), L (808259)	OHD P/N 9513-0109
Comfo Elite	Full-Face Negative Pressure	Silicone	10	Qualitative or Quantitative	100	Quik Chek II Adapter #812022	Threaded	S (491862), M (491860), L (491864)	OHD P/N 9513-0109
Advantage 3100	Full-Face Negative Pressure	Silicone	50	Qualitative or Quantitative*	500	Quik Chek III Adapter #805078	N/A	N/A	OHD P/N 9513-0210
Advantage 3200	Full-Face Negative Pressure	Silicone	50	Qualitative or Quantitative*	500	Advantage Adapter #10056424	Bayonet or threaded w/adapter #809999	N/A	OHD P/N 9513-0210
Advantage 4100	Full-Face Negative Pressure	Hycar or Silicone	50	Qualitative or Quantitative*	500	Quik Chek III Adapter #805078	N/A	N/A	OHD P/N 9513-0217
Advantage 4200	Full-Face Negative Pressure	Hycar or Silicone	50	Qualitative or Quantitative*	500	Advantage Adapter #10056424	Bayonet threaded w/adapter #809999 @ NIOSH	N/A	OHD P/N 9513-0218
Advantage 1000	Full-Face Negative Pressure	Silicone	50	Qualitative or Quantitative*	500	Advantage Adapter #10056424	Bayonet	N/A	OHD P/N 9513-0219
Ultra-Twin	Full-Face Negative Pressure	Silicone	50	Qualitative or Quantitative*	500	Quik Chek II Adapter #812022	Threaded	S (482025), M (482024), L (482026)	OHD P/N 9513-0109
Ultra-Twin	Full-Face Negative Pressure	Hycar	50	Qualitative or Quantitative*	500	Quik Chek II Adapter #812022	Threaded	S (417683), M (465457), L (471684)	OHD P/N 9513-0109
Ultravue	Full-Face Negative Pressure	Silicone	50	Qualitative or Quantitative*	500	Quik Chek III Adapter #805078	N/A	S (482009), M (482008), L (482010)	OHD P/N 9513-0130
Ultravue	Full-Face Negative Pressure	Hycar	50	Qualitative or Quantitative*	500	Quik Chek III Adapter #805078	N/A	S (471681), M (465425), L (471682)	OHD P/N 9513-0130
Ultravue for use with ¼ turn quick disconnect	Full-Face Negative Pressure	Hycar or Silicone	50	Qualitative or Quantitative*	500	Quik Chek IV Adapter #817446	N/A	N/A	OHD P/N 9513-0130
Ultra-Elite	Full-Face Negative Pressure	Silicone	50	Qualitative or Quantitative*	500	Quik Chek III Adapter #805078	N/A	S (813211), M (813209), L (813213)	OHD P/N 9513-0210
Ultra-Elite	Full-Face Negative Pressure	Hycar	50	Qualitative or Quantitative*	500	Quik Chek III Adapter #805078	N/A	S (813210), M (813218), L (813212)	OHD P/N 9513-0210
Ultra-Elite for use with ¼ turn quick disconnect	Full-Face Negative Pressure	Hycar or Silicone	50	Qualitative or Quantitative*	500	Quik Chek IV Adapter #817446	N/A	N/A	OHD P/N 9513-0210
Millennium® Facepiece	Full-Face Negative Pressure	Hycar	50	Qualitative or Quantitative*	500 2000±	Quik Chek III Adapter #805078	Threaded	Probe Assembly (10006227)	OHD P/N 9513-0130
Ultra Elite Pressure-Demand	Full-Face Positive Pressure	Silicone	10,000 SCBA 1000 Air-Line	Qualitative or Quantitative	500†	APR Fit Test Adapter Kit, ¼ turn #10107257 (10029823 APR adapter only) APR Fit Test Adapter Kit, Slide Version #10107229 (10032511 APR adapter only) APR Fit Test Adapter Kit, Push-to-Connect #10107256 (10040052 APR adapter only) Quik Chek Adapter Kit, Firehawk #10044576‡	Bayonet	Negative Pressure S (813211), M (813209), L (813213)	OHD P/N 9513-0380
Ultra Elite Pressure-Demand	Full-Face Positive Pressure	Hycar	10,000 SCBA 1000 Air-Line	Qualitative or Quantitative	500†	APR Fit Test Adapter Kit, ¼ Turn #10107257 APR Fit Test Adapter Kit, Slide Version #10107229 APR Fit Test Adapter Kit, Push-to-Connect #10107256 Quik Chek Adapter Kit, Firehawk #10044576‡	Bayonet	Negative Pressure - S (813210), M (813218), L (813212)	OHD P/N 9513-0210
Ultra Elite Respirator	Full-Face Positive / Negative Pressure	Hycar	10,000 SCBA 50 APR	Qualitative or Quantitative	500† SCBA 2000± APR	Responder Fit Test Kit #10082555	Threaded	N/A	N/A

\* If only qualitative fit test is performed on a full-face negative pressure respirator, then an APF of only 10 can be assigned. If a quantitative fit test is performed, the APF is 50.

† For quantitative fit testing of pressure-demand facepiece, the facepiece must be tested in a negative pressure mode which requires a minimum fit factor of 500.

± MSA recommends a fit factor of 2000 if the application is a CBRN environment.

‡ The Quik-Chek Adapter allows quantitative fit tests to be performed on a pressure demand Ultra Elite Firehawk facepiece by only trained and qualified personnel. Special probed facepiece are not required.

## OptimAir® Mask-Mounted Powered Air-Purifying Respirator (PAPR) and OptimAir MM2K PAPR with Type HE OptiFilter® XL Filter

- Lightweight, compact design for long-life, high-performance and low maintenance
- Sealed, water-resistant battery fits inside most pockets
- Dual-rate charger recharges fully discharged battery in less than three hours
- Water-resistant HEPA filter for protection against particulate contaminants
- Choice of facepiece model in several configurations
- Facepiece, motor/blower and filter combine to produce high air flow
- Compact, easy to maneuver, simple to decontaminate
- Constant air flow also cools user's face



### OptimAir Mask-Mounted PAPR

OptimAir Mask-Mounted PAPR Kits consist of motor/blower, NiMH battery, dual-rate charger, one Type HE OptiFilter XL Cartridge, PVC decon belt, and choice of facepiece. Housing of polycarbonate/polyester construction and stainless steel connectors result in extreme durability. NIOSH-approved as mask-mounted PAPR. **OptimAir Mask-Mounted PAPR offers a full two-year warranty.**



### OptimAir MM2K PAPR

OptimAir MM2K PAPR assemblies include motor/ blower, NiMH battery, dual-rate battery charger, cable, one Type HE OptiFilter XL Cartridge, belt, and Advantage 3000 Facepiece. OptimAir MM2K PAPR for mold remediation/abatement, asbestos and nuclear applications offers long life, high performance and low maintenance in an economical package. NIOSH-approved as mask-mounted PAPR. **MSA OptimAir MM2K PAPR offers a full one-year warranty.**

## Specifications

### Weight:

- Motor/blower with cable 7.0 oz
- Battery pack 12.5 oz
- OptiFilter Cartridge, 3.5 oz

**Motor/blower:** approximately 1500 hours

**Battery:** nickel metal hydride rechargeable battery pack provides 8 hours (one shift) of continuous use. Battery pack delivers 4.8 volts (nominal).

**Battery life:** up to 1,000 charge/discharge cycles

**Battery charger:** rated service of 100-264 volts @ 50/60 Hz

### Limitations:

- OptimAir Mask-Mounted PAPR and OptimAir MM2K PAPR with Type HE OptiFilter XL Cartridge are approved as a high-efficiency particulate PAPRs
- OptimAir Mask-Mounted PAPR and OptimAir MM2K PAPR do not remove vapors or gases from air
- No filter is designed for all concentrations of all substances
- It is essential to determine contaminants present and to determine airborne concentrations and explosive limits before respirator selection
- OptimAir Mask-Mounted PAPR and OptimAir MM2K PAPR do not supply oxygen and should not be used unless surrounding air contains minimum 19.5% oxygen
- Respirators may be used in temperatures between 0°F and 120°F (-17°C to 49°C); however, if used in temperatures below 40°F (4.4°C), fully-charged battery may not operate for full 8 hours
- Replaceable filter cartridge for trapping particulate contaminants is minimum 99.97% efficient against 0.3 micron DOP

## Complete Assemblies for OptimAir Mask-Mounted PAPR and OptimAir MM2K PAPR

All assemblies include: motor/blower, NiMH battery, dual-rate battery charger and cable, one Type HE OptiFilter XL Cartridge, waist belt, and choice of facepiece.

ADVANTAGE 3100 PAPR	Head Harness	OPTIMAIR MASK-MOUNTED PAPR			OPTIMAIR MM2K PAPR			
		Small	Medium	Large	Small	Medium	Large	
	With rubber head harness	10095181	10095182	10095183	10034152	10034150	10034151	
	With Advantage Head Harness	10095184	10095185	10095186	10034155	10034153	10034154	
ADVANTAGE 4100 PAPR	Material	Small	Medium	Large	Small	Medium	Large	
		Black silicone with rubber harness	10095193	10095189	10095197	10084547	10084543	10084551
		Black Hycar Rubber with rubber harness	10095194	10095190	10095198	10084548	10084544	10084552
		Black silicone with net harness	10095191	10095187	10095195	10084545	10084541	10084549
	Black Hycar Rubber with net harness	10095192	10095188	10095196	10084546	10084542	10084550	

## Kits (less facepiece) for OptimAir Mask-Mounted PAPR and OptimAir MM2K PAPR and Replacement Facepieces

Upgrade Kit includes: motor/blower, NiMH battery, dual-rate battery charger and cable, one Type HE OptiFilter XL Cartridge, and waist belt. Use your present facepiece or order facepiece separately from ordering chart.

	Description	Part No.		
KITS	OptimAir Mask-Mounted PAPR Upgrade Kit	10095166		
	OptimAir MM2K PAPR Upgrade Kit	10025945		
REPLACEMENT FACEPIECES	Facepiece	Small	Medium	Large
Advantage 3100	Black silicone with rubber harness	10095193	10095189	10095197
	Black Hycar Rubber with rubber harness	10095194	10095190	10095198
REPLACEMENT FACEPIECES	Material	Small	Medium	Large
Advantage 4100*	Black silicone with net head harness	10083796	10083792	10083800
	Black Hycar Rubber with net head harness	10083797	10083793	10083801
REPLACEMENT FACEPIECES	Material	Small	Medium	Large
Ultra Elite	Silicone rubber head harness	493072	493028	493116
	Hycar Rubber head harness	493064	793020	493108

\*Also requires RD40 Adapter P/N 10065330

## Parts and Accessories

	Description	Part No.
OPTIMAIR MASK-MOUNTED PAPR	Battery pack assembly, packaged	10095162
	Motor/blower assembly, w/o cable, packaged	10095163
	Cable assembly, packaged	10095164
	Charger, packaged	10095165
OPTIMAIR MM2K PAPR	Cable assembly, OptimAir MM2K PAPR	10023480
	Battery pack, OptimAir MM2K PAPR	10023481
	Motor/blower, OptimAir MM2K PAPR, w/o cable	10023482
	Charger, dual-rate, OptimAir MM2K PAPR	10023483
OTHER ACCESSORIES	Flow check device	487995
	Adapter for flow check device	491046
	Replacement belt, PVC	473902
	Carrying/storage case, black plastic	D2056734
	MSA Confidence Plus Germicidal Cleaner, 32 oz. bottle	10009971

## OptiFilter Cartridges for OptimAir Mask-Mounted and MM2K PAPR

	MSA Purifying Element	Purifying Protection Code	Code Color	No. in Box	Part No.
OPTIFILTER CARTRIDGES	OptiFilter XL, Type HE	HE		20	10042346
	OptiFilter XL, Type HE	HE		6	496081

### Waist Belts for OptimAir Mask-Mounted and MM2K PAPRs

- PVC belt with slide-through friction buckle is comfortable and easy to decontaminate
- Standard—P/N 473902 clear polyvinylchloride (PVC) support belt
- Accommodates waist sizes of up to 48 inches
- Optional—P/N 492827 polyurethane-coated nylon belt
- No-decon applications—P/N 9961 uncoated nylon web waist belt

# Air-Purifying Respirators

## OptimAir® TL Powered Air-Purifying Respirator

The low-profile OptimAir TL Powered Air-Purifying Respirator (PAPR) combines state-of-the-art design with superior "smart" features. The unit packages the motor blower, cartridges, and battery in a single hip-hugging design for lightweight comfort and fit. The low-profile motor blower offers optimal airflow through a crushproof breathing tube, while the ergonomic battery pack allows for free movement within confined spaces. The unit automatically adjusts flow rates for altitude changes via an internal pressure sensor, while the cutting-edge design permits fast, accurate change-out of cartridges, hoods and batteries. The standard kit includes motor blower, smart charger, standard battery, hose, and decon belt.

- Audible and visual alarms indicate low flow indication and low battery voltage
- Available with standard and an extended life battery
- Less bulk and better weight distribution improves worker efficiency

## OptimAir TL Kits

Kits include: motor blower, battery, Smart Charger, breathing tube and decon belt.

OPTIMAIR TL KITS for facepieces	10081114	OptimAir TL Kit with standard battery
	10081115	OptimAir TL Kit with long-life battery
OPTIMAIR TL KITS for hoods	10081116	OptimAir TL Kit with standard battery
	10081117	OptimAir TL Kit with long-life battery

## Facepieces Only

	Small	Medium	Large	
ADVANTAGE 3100 FACEPIECE ONLY <i>single-port</i>	10028999	10028998	10029000	Advantage 3100, black silicone, with rubber head harness
	10031343	10031342	10031344	Advantage 3100, black hycar, with Advantage head harness
ADVANTAGE 4100 FACEPIECE ONLY* <i>single-port</i>	10083796	10083792	10083800	Advantage 4100, black silicone, with polyester net head harness
	10083798	10083794	10083802	Advantage 4100, black silicone, with rubber head harness
	10108575	10108573	10108577	Advantage 4100, black silicone, with Kevlar net head harness
	10083797	10083793	10083801	Advantage 4100, black hycar, with polyester net head harness
	10083799	10083795	10083803	Advantage 4100, black hycar, with rubber head harness
	10108576	10108574	10108578	Advantage 4100, black hycar, with Kevlar net head harness
ULTRA ELITE FACEPIECES ONLY <i>single-port</i>	493072	493028	493116	Ultra Elite, black silicone, with rubber head harness
	493064	493020	493108	Ultra Elite, black hycar, with rubber head harness

\*Also requires RD40 Adapter P/N 10065330

## Facepiece Accessories

FACEPIECE ACCESSORIES	10065330	RD-40 Inlet assembly, required for all Advantage 4100 facepieces
	10049630	Hose for facepiece
	10087129	Flow check device for facepiece only



OptimAir TL PAPR with  
Advantage 4100  
Facepiece



White Hood for OptimAir TL PAPR

## Applications

- Asbestos Abatement
- Welding
- Sanding & Grinding

## OptimAir TL Hoods

DESCRIPTION	Tychem® QC (polyethylene-coated Tyvek)	Tychem® SL (Saranex-coated Tyvek)
SINGLE BIB		
4-pack, threaded connector, with suspension	10083329	10083381
20-pack, threaded connector, less suspension	10095739 (WHITE) 10095748 (YELLOW)	10095741
4-pack, standard, with suspension	10083383	10083385
20-pack, standard, less suspension	10095740	10095742
DOUBLE BIB		
4-pack, threaded connector, with suspension	10083330	10083382
20-pack, threaded connector, less suspension	10095739 (WHITE) 10095748 (YELLOW)	10095745
4-pack, standard, with suspension	10083384	10083386
20-pack, standard, less suspension	10095744	10095746

## OptimAir TL Parts and Accessories

CARTRIDGES	10080455	P100 cartridge (6-pack)
	10080454	OV/AG P100 cartridge (6-pack)
	10080456	AG, AM, FM, P100 cartridge (6-pack)
	10068152	Spark Guard cartridge cover (single unit) (2 req.)
BATTERY AND CHARGERS	10076108	Standard battery for OptimAir TL PAPR
	10076110	Standard battery charger for OptimAir TL PAPR
	10076109	Long-life battery for OptimAir TL PAPR
	10076107	Long-life battery charger for OptimAir TL PAPR
DECON ACCESSORIES	10075799	Decon cover for OptimAir TL PAPR, 5-pack, natural
	10087152	Decon cover for OptimAir TL PAPR, 5-pack, yellow
	10091958	Decon cover for OptimAir TL PAPR, urethane, .12 ml thick, 5-pack, yellow
	10078201	Decon belt (backpack buckle)
	10074725	Decon belt (cam lock buckle)
MISCELLANEOUS	10085084	O-ring replacement, hose hood, 10-pack
	10049623	Comfort belt
	10081414	Cartridge receptacle cover
	10059112	Shoulder strap for OptimAir TL
	10088150	Blower unit only
HOOD SUSPENSIONS	10103864	20-pack
	10078469	1 each
HOODS FOR USE WITH OPTIMAIR 6A PAPR	10095747	Single-bib, 20-pack, 6A connector, with suspension
	10084820	Single-bib, 4-pack, 6A connector, with suspension
HOOD ACCESSORIES	10083843	Hose clamp for standard hood, 6-pack
	10049631	Hood hose
	10082281	Hood hose, extended length
	10078469	Suspension only, for Tyvek hood
	10083618	Sweatband for hood suspension, 10-pack
	10082441	Cover lens for hood, 10-pack
	10087130	Flow check device for hood only
	10089665	Fastener kit, hood to V-Gard® helmet
10082281	Extended length hose	

# Air-Purifying Respirators

## Welder's Adapter for Full-Facepiece Respirators

MSA Welder's Adapters are molded of polycarbonate plastic, which has high resistance to impact, heat, and welding splatter. The clip-on adapter attaches to the facepiece by molded-in clips. A large vision area—4-1/2" x 5-1/4"—provides an unobstructed view of work. The Welder's Adapter is supplied with an impact-resistant cover lens; the desired filter plate is ordered separately. Rayfoe™ Filter Plates are available in two standard shades—10 and 12.

The heat-resistant Welder's Hood is designed to protect the welder's head, neck, and shoulders from welding splatter and sparks. The Kevlar hood has a rubber seal which fits snugly over the Welder's Adapter. The hood also helps protect cartridges when an air-purifying respirator is used in welding operations.

### Ordering Information

WELDER'S ADAPTERS AND ACCESSORIES	472859	Clip-On Welder's Adapter for Ultravue and Ultra Twin Facepieces; with cover lens, less filter plate
	806482	Clip-On Welder's Adapter for Ultra Elite Facepiece; with cover lens, less filter plate
	10077063	Clip-On Welder's Adapter for Advantage 4200 Twin-Port Facepiece; with cover lens, less filter plate
	10065326	Clip-On Welder's Adapter for Advantage 4100 Single-Port Facepiece; with cover lens, less filter plate
	38347	Rayfoe Filter Plate, shade 10, heat-treated, 4-1/2 x 5-1/4
	38277	Rayfoe Filter Plate, shade 12, heat-treated, 4-1/2 x 5-1/4
	696095	Cover Lens
	486328	Welder's Hood, Kevlar



Welder's Adapter for Ultra Elite Facepiece



Kevlar Welder's Hood

## Advantage Technical Support CD

Instant information about MSA's Advantage 200 LS and 3000 Respirators.

- Single source for care & use information, instruction manuals, fit-testing forms, parts lists and cartridge information
- Enhances your use of MSA's lighter, softer half-mask and optically correct, comfortable full-face respirators
- Convenient, immediate, paperless retrieval
- Easy-to-use, interactive format
- Multilingual English/Spanish

### Ordering Information

Call MSA Customer Service at 1-800-MSA-2222 for your FREE copy!





## Chin-Type Gas Masks

Our lightweight Chin-Type Gas Masks use a replaceable canister to offer protection against particulate matter, vapors, and gases. The small canister and comfortable facepiece allow for downward head movement and high ease-of-use. Note: Not meant for fire fighting.

- Lightweight, comfortable gas masks offer protection against particulate matter, vapors, and gases
- Small round canister and comfortable facepiece provide easy downward head movement
- Canisters offer protection from: Phosphine/Ammonia/Chlorine-P100, Organic Vapor-P100, Hydrogen Fluoride/Chlorine/P100, Formaldehyde/Acid Gas/Chlorine Dioxide/Hydrogen Sulfide/P100



	Small	Medium	Large	
ADVANTAGE 3100 SINGLE-PORT FACEPIECES	10028999	10028998	10029000	Advantage 3100 Facepiece, black silicone, with rubber head harness
	10031343	10031342	10031344	Advantage 3100 Facepiece, black hycar, with Advantage head harness
ADVANTAGE 4100 SINGLE-PORT FACEPIECES	10083796	10083792	10083800	Advantage 4100 Facepiece, black silicone, with polyester net head harness
	10083798	10083794	10083802	Advantage 4100 Facepiece, black hycar, with polyester net head harness
ULTRAVUE FACEPIECES	480251	480247	480255	Ultravue Facepiece, black silicone
	471218	457126	471230	Ultravue Facepiece, black hycar
ULTRA ELITE FACEPIECES	493072	493028	493116	Ultra Elite Facepiece, black silicone
	493064	493020	493108	Ultra Elite Facepiece, black hycar

## Replacement Canisters and Accessories

REPLACEMENT CANISTERS	Single Canister	Box/12 Canisters	Color Coding	
	10059903*	10094314		Phosphine/Ammonia/Chlorine/P100 Canister (PH/AM/CL) <b>Maximum Use Conditions:</b> ammonia and chlorine: 0.05 % volume, 5000 ppm phosphine: 0.15% volume, 1500 ppm <b>Approval:</b> TC-14G-0274
	10067469*	10094315		Organic Vapor/P100 Canister (OV) also effective against organic iodides and iodide vapors <b>Maximum Use Conditions:</b> 0.05 % volume, 5000 ppm <b>Approval:</b> TC-14G-0279
	10067491*	10091352		Hydrogen Fluoride/Chlorine/P100 Canister (HF/CL) <b>Maximum Use Conditions:</b> hydrogen fluorine: 0.05 % volume, 5000 ppm chlorine: 0.10% volume, 5000 ppm <b>Approval:</b> TC-14G-0280
	10067470*	10094316		Formaldehyde/Acid Gas/Chlorine Dioxide/Hydrogen Sulfide/P100Canister (FM/AG/CD/HS) <b>Maximum Use Conditions:</b> formaldehyde: 0.05 % volume, 500 ppm acid gases and hydrogen sulfide: 0.50% volume, 5000 ppm chorine dioxide: 0.10% volume, 1000 ppm <b>Approval:</b> TC-14G-0280

\* Canister contains a P100-particulate filter (99.97% filter efficiency level) against all particulate amounts.

STORAGE CASES AND STORAGE ACCESSORIES		
	10075204	For Phosphine/Ammonia/Chlorine/P100 Gas Mask
	10075207	For Organic Vapor/P100 Gas Mask
	10075205	For Hydrogen Fluoride/P100 Gas Mask
	10075206	For Formaldehyde/Acid Gas/Chlorine Dioxide/Escape from Hydrogen Sulfide/P100 Gas Mask
	10071231	Wall bracket

ADDITIONAL PARTS FOR BELT-MOUNTING		
	10068195	Belt clip
	10068129	Breathing tube
	473902	PVC belt
	9961	Web support belt, uncoated
	492827	Polyurethane-coated nylon support belt
	10068152	Spark cover

# Air-Purifying Respirators

## Riot Control and CBRN Gas Masks

Protect law enforcement and military personnel from a variety of respiratory hazards with this full line of CBRN and riot control gas masks. Featuring flexible lenses, wider field of view, permeation-resistant construction and built-in speaking diaphragms, these masks provide protection with a comfortable fit and superior visibility. Available in a variety of styles and configurations.

- Provides respiratory protection against military warfare, civil unrest and CBRN threats
- High-performance, custom-fit comfort in a variety of military- and riot-style masks
- Attracts, regains and neutralizes contaminants
- Flexible lens with a wider field of view for superior visibility
- Easy on/off and adjustment
- Choose from a variety of styles including total head protection

### CBRN and Riot Control Gas Masks

	Small	Medium	Large	
MILLENNIUM® CBRN/ RIOT CONTROL GAS MASK	10051286	10051287	10051288	Millennium Gas Mask, with noseclip, drinking tube, and clear polycarbonate outsert <i>Order either Riot Control or CBRN canisters separately.</i>
ADVANTAGE 1000 RIOT CONTROL GAS MASK	813860	813859	813861	Advantage 1000 Riot Control Mask, complete with canister, noseclip, and identification tag
ULTRA ELITE CBRN GAS MASK	10052776	10052781	10052778	Ultra Elite CBRN Gas Mask, with rubber head harness
	10052780	10052779	10052777	Ultra Elite CBRN Gas Mask, with Speed-ON Head Harness <i>Order CBRN canisters separately.</i>



Millennium® Gas Mask  
(for use with CBRN or Riot Control canisters)



Advantage 1000 Riot Control Gas Mask



Ultra Elite CBRN Gas Mask

### Gas Mask Canisters and Accessories

RIOT CONTROL CANISTERS	818264	Millennium RC canisters, box of 6
	817590	Advantage 1000 RC canisters, box of 6
CBRN CANISTER	10046570	MSA CBRN canister, for Millennium and Ultra Elite Facepieces
LENS OUTSERT <i>For Millennium Facepiece</i>	10008907	Polycarbonate lens outsert, clear, small
	10008906	Polycarbonate lens outsert, clear, medium/large
	10008909	Polycarbonate lens outsert, tinted, small
	10008908	Polycarbonate lens outsert, tinted, medium/large
LENS OUTSERT <i>For Advantage 1000 Facepiece</i>	806463	Polycarbonate lens outsert, clear, small
	806462	Polycarbonate lens outsert, clear, medium/large
	806465	Polycarbonate lens outsert, tinted, small
	806464	Polycarbonate lens outsert, tinted, medium/large
ESP® II COMMUNICATION SYSTEM <i>For Millennium and Advantage 1000 Facepieces</i>	10026265	ESP II Communications System (1-piece, self-contained, electronic speech projection device) less battery
OTHER ACCESSORIES <i>For Millennium and Advantage 1000 Facepieces</i>	10034184	Gas Mask Pouch, Military Style
	817040	Black Nylon Bag
	816137	Advantage 1000/Millennium Spectacle Kit

## Responder® Powered Air-Purifying Respirator

With its industry-leading motor-blower and constantly filtered airflow, the belt-mounted Responder CBRN PAPR is ideal for first responders, military, and special ops personnel who require non-IDLH respiratory protection for up to 8 hours. The unit offers a choice of two MSA gas mask CBRN facepieces and three proprietary cartridges designed for CBRN, particulate and poisonous gases or vapors. The unit's constant airflow helps a user stay physically alert and focused, while also preventing fogging in the facepiece. Batteries can be "hot-swapped," and the blower's EMI shield ensures there is no interference with radio communications.

- Respirator provides constant filtered airflow, which reduces fatigue and prevents facepiece fogging
- Long-life unit provides non-IDLH respiratory protection for up to 8 hours
- Unit is compatible with MSA's Millennium and Ultra Elite facepieces



### Responder PAPR Complete Systems

You must choose Responder PAPR Kit, facepiece, and cartridge for complete system.

RESPONDER PAPR KITS <i>less facepiece and cartridge</i>		
	B-60141-030	Responder CBRN PAPR Kit with 30" Breathing Tube, LiSO <sub>2</sub> Battery
	B-60141-036	Responder CBRN PAPR Kit with 36" Breathing Tube, LiSO <sub>2</sub> Battery
	B-60170-030	Responder CBRN PAPR Kit with 30" Breathing Tube, NiMH Battery
	B-60170-036	Responder CBRN PAPR Kit with 36" Breathing Tube, NiMH Battery

	Small	Medium	Large	
GAS MASK FACEPIECES <i>with head harness, less cartridge</i>	10051286	10051287	10051288	Millennium Facepiece, hycar, with 6-point elastic head harness
	10052776	10052781	10052778	Ultra Elite Facepiece, hycar, with rubber head harness
	10052780	10052779	10052777	Ultra Elite Facepiece, hycar, with Speed-ON Head Harness

CARTRIDGES	10046570	CBRN Canister, each
	496081	OptiFilter XL cartridge, 6 pack
	10072237	PAPR GME Multigas HE cartridge, each
ACCESSORIES FOR RESPONDER PAPR	B-20040-001	NiMH Rechargeable Kit (2 NiMH Batteries, Charger & Cap)
	S-20036	NiMH Rechargeable Battery Pack
	B-20090-001	NiMH Rapid Battery Charger
	M-20020	LiSO <sub>2</sub> Mission Battery
	B-30060-001	NiMH Rechargeable Battery Cap Assembly
	S-30019	Web Belt Assembly
	B-10079-001	PAPR Carrying Case

### Applications

- CBRN Incidents
- Civil Disturbances
- Clandestine Labs



Millennium Facepiece



Ultra Elite Facepiece

# Air-Purifying Respirators

## Safe Escape® CBRN Respirator

The Safe Escape Hood from MSA gives you the protection you need to escape from a terrorist situation safely, quickly and easily—whether you work in a high-profile office environment, for a government agency or embassy, or as a law enforcement officer or first responder. Manufactured with a high-performance laminate material, the hood is designed to provide the latest in head and neck coverage with respiratory protection against CBRN agents.

### Features and Benefits

- Convenient respirator guards against chemical, biological, radiological or nuclear hazards
- Unit features self-adjusting cradle-type head straps
- Wide field of view provides excellent visibility and reduces claustrophobia
- High-stretch rubber neck seal ensures tight fit
- Nosecup reduces lens fogging
- Guards against: HD vapor, GB, ammonia, cyanogen chloride, cyclohexane, formaldehyde, hydrogen cyanide, hydrogen sulfide, nitrogen dioxide, phosgene, phosphine, sulfur dioxide

### Ordering Information

SAFE ESCAPE RESPIRATORS <i>in Hextreme Case</i>	10073702	Safe Escape Respirator, standard, universal size
	10073923	Safe Escape Respirator, tactical version, universal size
	10073703	Safe Escape Respirator, trainer version, universal size
ACCESSORIES	10066681	Safe Escape Respirator sizing kit
	10068310	Optional carrying straps and harness kit
	10068013	DVD training video for Safe Escape Respirator

*Note: The only difference between the standard and tactical versions is the outside labeling on Hextreme Case.*



*Hextreme Case*

## S-CAP™ Fire Escape Hood

Most victims of fire are not injured by heat or flames but rather by smoke and gases, especially carbon monoxide. The S-CAP Fire Escape Hood is simple to don and use and is effective within seconds, using a filter designed for a minimum rated service time of 15 minutes.

- Filters out CO and smoke
- Universal size
- Easily fitted with quick donning
- Minimal training required
- EN 403:2004 approved
- Highly visible yellow hood
- Adjustable head harness on the outside of the hood, with cotton neck seal for easy donning
- Wide field of view lens
- Heat-resistant against brief flame contact and elevated temperatures

### Ordering Information

S-CAP FIRE ESCAPE HOOD	10064644	S-CAP in cardboard box
	10064645	S-CAP in wall box



*Wall Box*





## A Guide to **Air-Line Systems**

Type-C Supplied-Air Respirators, more commonly referred to as air-line respirators, are designed to provide long-duration respiratory protection.

They generally consist of a full-facepiece or half-mask facepiece connected by an air-supply hose to an air source (either a compressor or bank of large air cylinders). When connected to the air source, the respirator delivers a supply of respirable air to the user.

Accessory equipment, such as pressure regulators, pressure relief valves, carbon monoxide monitors and filters for air compressors, may be necessary to ensure that the air is at the proper pressure and quality for breathing. Air quality must be Quality Verification Level Grade D or better as defined in ANSI Standard Z-86.1-1973 (Compressed Gas Association Specification G-7.1 Commodity Specification for Air).

Current air-line systems fall into two categories: **Pressure-Demand** and **Constant Flow**. The difference between the two is how the air is supplied.

Pressure-demand systems deliver air only when the user needs it. Thus, pressure-demand devices afford greater breathing efficiency.

In contrast, with a constant flow device, air flow to the respirator is continuous. However, because the air flow is continuous, constant flow air-line systems are generally used only with a compressor for a virtually unlimited air supply.

Type-C Supplied-Air Respirators are approved by the National Institute for Occupational Safety and Health (NIOSH) for use in atmospheres not immediately dangerous to life and health (IDLH) or from which the wearer can escape without wearing the respirator.

“Not immediately dangerous to life and health” means any hazardous atmosphere which may produce physical discomfort immediately, chronic poisoning after repeated exposure, or acute adverse physiological symptoms after prolonged exposure. (42 CFR, Part 84 subpart A, 84.2(x)).

This limitation is necessary because the air-line respirator depends entirely on an air supply not carried by the wearer. Therefore, if the air hose were severed or crimped, or the air compressor failed, the air supply to the wearer would be shut off. The wearer would be without respiratory protection and might not be able to safely escape from an IDLH atmosphere.

Another limitation of air-line respirators is that the air-supply hose limits the wearer to a fixed distance from the air source. As an air-line respirator user, it is your responsibility to supply the respirator with breathable air—Grade D or better. The following pages show complete hook-ups of various air-line systems, both pressure-demand and constant flow, from the air source to the respirator. The following information is a guide designed to aid you in hooking up your own air-line system.

# Air-Line Respirators

## Constant Flow Air-Line Respirators CF

Constant Flow Air-Line Respirators maintain a slight positive pressure of air inside the facepiece whether the wearer is inhaling or exhaling. This helps prevent contaminants from seeping in around the facepiece, even if there should be small breaks in the face-to-facepiece seal.

Constant Flow Air-Line Respirators maintain air flow at all times, rather than only on demand. Because of this, constant flow units almost always use a compressor as their air source. A constant flow unit would quickly exhaust the air from a cylinder or cascade system.

There are two types of Constant Flow Air-Line Respirators: one uses a tight-fitting facepiece; the other, a loose-fitting hood or helmet. Inlet air pressure must be able to maintain at least 4 cfm for a tight-fitting facepiece and 6 cfm for a loose-fitting hood.

The inlet pressure for Constant Flow Air-Line Respirators varies between 10-15 psig for low pressure systems and 35-40 psig for high pressure systems.

For Constant Flow Air-Line Hoods, the inlet pressure usually ranges between 10-15 psig and 85-100 psig, depending on the type. Also, depending on the inlet pressure, the length of approved air-supply hose for these systems is usually between 8-50 feet for low-pressure systems and 8-300 feet for high-pressure systems. Consult the instruction manual for your respirator to determine the specific inlet pressure and hose length.

### MSA Constant Flow Respirators with Tight-Fitting Facepieces include:

- Constant Flow Air-Line Respirator
- Constant Flow Duo-Twin™ Air-Line Respirator
- Constant Flow Duo-Flo™ Air-Line Respirator
- Abrasi-Blast™ Supplied-Air Respirator

### MSA Constant Flow Respirators with Loose-Fitting Hoods include:

- Versa-Hood™ Air-Supplied Hood

## Typical Plant-Supplied Air-Line Systems: Constant Flow or Pressure Demand System

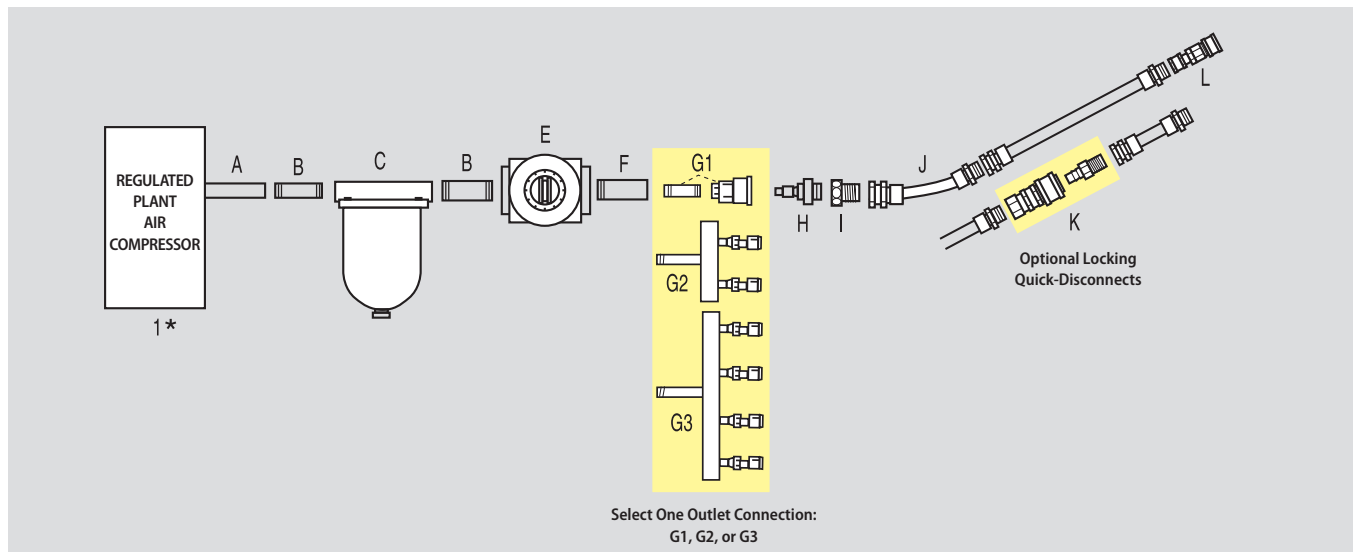

<b>1*</b>	PLANT AIR COMPRESSOR	not supplied by MSA
<b>A</b>	OUTLET FITTING FOR SYSTEM	Varies with system
<b>B</b>	NIPPLE	(1/2" x 1/2" x 1-1/2" NPT) P/N 68833
<b>C</b>	AIR LINE FILTER	P/N 81857
<b>E</b>	PRESSURE REGULATOR	P/N 66716
<b>F</b>	OUTLET CONNECTIONS	Bushing (1/2" M x 1/4" F) P/N 625528
<b>G1</b>	FEMALE SOCKET NIPPLE	Female Socket—P/N varies with type (See pg. 44—Col. 1) Nipple—1/4" x 1/4" NPT—(needed only w/Female Socket) P/N 459867
<b>G2</b>	2-OUTLET MANIFOLD	Foster Steel P/N 84416 Snap-Tite Aluminum P/N 486053 (See pg. 45)
<b>G3</b>	4-OUTLET MANIFOLD	Foster Steel P/N 474370 Snap-Tite Aluminum P/N 93931 (See pg. 45)

<b>H</b>	MALE PLUG WITH MALE 1/4" NPT	(See pg. 44—column 4)
<b>I</b>	UNION ADAPTER	(See pg. 44—column 3)
<b>J</b>	MSA AIR-SUPPLY HOSE	P/N varies with type (See pg. 44)
<b>K</b>	OPTIONAL LOCKING QUICK-DISCONNECT ASSEMBLIES for interconnecting lengths of MSA air-supply hose	CEJN Locking Quick-Disconnect Assembly (Chrome) P/N 479009  Snap-Tite Locking Quick-Disconnect Assembly (Aluminum) P/N 479010
<b>L</b>	FEMALE SOCKET ASSEMBLY	P/N varies with type (See pg. 44—column 5)

## Pressure-Demand Air-Line Respirators PD

Pressure-Demand Air-Line Respirators are designed to maintain a slight positive pressure of air inside the facepiece whether the wearer is inhaling or exhaling. This helps prevent contaminants from seeping in around the facepiece, even if there should be small breaks in the face-to-facepiece seal.

Pressure-Demand Air-Line Respirators are designed specifically for non-IDLH toxic atmospheres. The exception is if the respirator is equipped with an egress cylinder of air to use during escape.

Pressure-Demand Air-Line Units require an air supply from an uncontaminated compressed-air source as stipulated in General Industry Safety and Health Regulations, Part 1910.134 (OSHA) with the delivered air conforming to at least Grade D of ANSI Standard Z86.1.

A common air source for pressure-demand systems is a cylinder of air which can be set up in remote sites that might otherwise be impossible to reach with a large stationary compressor.

Another air source option for pressure-demand respirators is a cylinder cascade system. A cascade system consists of several air cylinders joined together in a bank by means of coupler tees. Generally, the banks

consist of three or more cylinders of either 244 cubic-feet or 330 cubic-feet-capacity. One or more workers can breathe from a cascade system.

If using a compressed air or a compressor system, each respirator generally requires 1.5 cfm per person and needs to maintain the inlet (working) pressure specified in the respirator instruction manual.

At a normal rate of consumption, a three-cylinder bank used with a pressure-demand unit will provide between 12 to 16.5 man-hours of air, depending on cylinder capacity.

### MSA Pressure-Demand Air-Line Units include:

- PremAire® Cadet Respirator (for non-IDLH atmospheres)
- PremAire Cadet Escape Respirator
  - with Escape Cylinder (for egress from IDLH atmospheres)
- PremAire Air-Line Respirator System:
  - with Escape Cylinder (for egress from IDLH atmospheres)
  - with Vortex Tube (for suit-cooling applications)
  - with Dual-Supply (to eliminate additional hose lengths)

## Typical Cascade Cylinder Air-Line Systems: Pressure Demand System

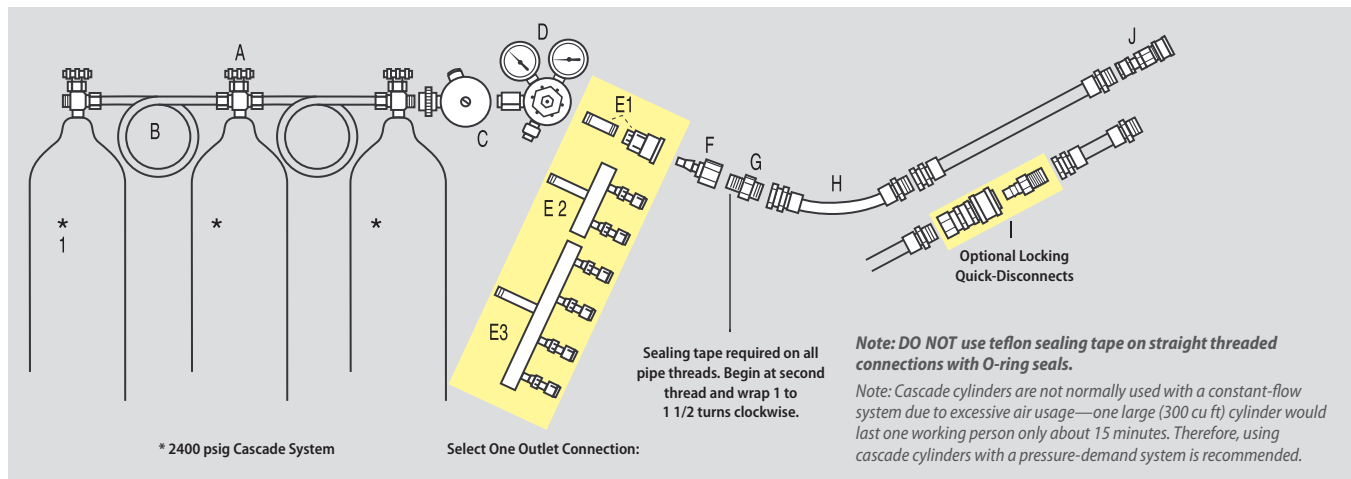

<b>1*</b>	AIR CYLINDER	not supplied by MSA
<b>A</b>	AIR TEE BLOCK	P/N 68850 or P/N 10081206 (See pg. 44)
<b>B</b>	AIR PIGTAIL	P/N 68851 or P/N 10081205 (See pg. 44)
<b>C</b>	AUDI-LARM WARNING DEVICE	P/N 85078 or P/N 492307 (See pg. 44)
<b>D</b>	AIR CYLINDER PRESSURE REGULATOR	P/N 68858 or P/N 633352 (See pg. 45)
<b>E1</b>	OUTLET CONNECTIONS	Female Socket—P/N varies with type (See pg. 42); Nipple 1/4" x 1/4" NPT (needed only w/Female Socket) P/N 459867
<b>E2</b>	2-OUTLET MANIFOLD	Foster Steel P/N 84416 Snap-Tite Aluminum P/N 486053 (See pg. 45)
<b>E3</b>	4-OUTLET MANIFOLD	Foster Steel P/N 47370 Snap-Tite Aluminum P/N 93931 (See pg. 45)

<b>F</b>	MALE PLUG WITH FEMALE 1/4" NPT	P/N varies with type (See pg. 42)
<b>G</b>	UNION ADAPTER	(See pg. 42)
<b>H</b>	MSA AIR-SUPPLY HOSE	P/N varies with type (See pg. 44)
<b>I</b>	OPTIONAL LOCKING QUICK-DISCONNECT ASSEMBLIES for interconnecting lengths of MSA air-supply hose	CEJN Locking Quick-Disconnect Assembly (Chrome) P/N 479009  Snap-Tite Locking Quick-Disconnect Assembly (Aluminum) P/N 479010
<b>J</b>	FEMALE SOCKET ASSEMBLY	P/N varies with type (See pg. 42)

# Air-Line Respirators

## Constant-Flow Air-Line Respirator CF

This Type-C, supplied-air respirator supplies a continuous flow of air to the facepiece from an external source. The complete assembly is available with either an Ultravue or Ultra Elite Full Facepiece, Comfo Half-Mask Facepiece or Comfo Welder's Facepiece, plus breathing tube, web support belt and air flow control valve. Use only in non-IDLH environments.



Constant Flow Air-Line Respirator with Ultravue Facepiece

### Features and Benefits

- Supplies long-duration respiratory protection
- Ideal for a wide range of applications including welding, painting and hazardous materials
- Maintains a slight positive pressure of air during both inhalation and exhalation to prevent contaminant seeping inside facepiece
- For use only in non-IDLH environments



Constant Flow Air-Line Respirator with Advantage 4000 Facepiece

Constant Flow Air-Line Respirator with Ultra Elite Facepiece

Constant Flow Air-Line Respirator with Comfo Facepiece

Constant Flow Air-Line Respirator with Welder's Comfo Facepiece

### Ordering Information

CONSTANT FLOW AIR-LINE RESPIRATOR KITS	Kits include: a Constant Flow Air-Line Respirator with an Advantage 4000 Facepiece (medium size, hycar rubber, polyester net head harness) with a High or Low Pressure Flow Control Valve, breathing tube and nylon belt assembly, Foster Steel quick-disconnects for connecting the respirator to the air supply hose, a 50 foot section of neoprene air supply hose complete with Foster Steel plug to attach the air supply hose to your air source.	10108494	Constant Flow Air-Line Respirator, LOW Pressure Control Valve
		10108593	Constant Flow Air-Line Respirator, HIGH Pressure Control Valve

	Advantage 4000 Facepiece	Ultra Elite Facepiece	Ultravue Facepiece	Comfo Facepiece	Welder's Comfo Facepiece	
CONSTANT FLOW COMPLETE ASSEMBLIES <i>High-pressure control valve (35–40 psig inlet pressure for 8–300 ft of hose)</i>	10088132	810829	460863	460865	460862	with Snap-Tite aluminum quick-disconnect
	10088134	810831	461717	480466	480600	with Foster steel quick-disconnect
	10088136	†	486258	†	†	with Hansen brass quick-disconnect
	10088135	810832	480629	480631	480671	with CEJN Locking chrome-plated brass quick-disconnect
CONSTANT FLOW COMPLETE ASSEMBLIES <i>Low-pressure control valve (10–15 psig inlet pressure for 8–50 ft of hose)</i>	10088107	806775	463300	463302	463281	with Snap-Tite aluminum quick-disconnect
	10088109	806776	480472	480474	480468	with Foster steel quick-disconnect
	10088121	806779	484836	484837	†	with Hansen brass quick-disconnect
	10088110	806777	480637	480639	480645	with CEJN Locking chrome-plated brass quick-disconnect

Note: Facepieces can also be ordered in silicone instead of hycar rubber. Three sizes of facepieces are available. For belts, MSA Air-Supply Hose and other accessories, see pages 44–45. For separate quick-disconnect plugs and sockets, see page 42. See pages 28–29 for typical Pressure Demand Air-Line and Constant Flow Air-Line Systems setup.

† Available by special order only. High-pressure control valves are also available with the following special order quick-disconnects: Snap-Tite brass or stainless steel, Foster brass, and Hansen brass, or stainless steel. Low-pressure control valves also available with: Snap-Tite brass or stainless steel, Foster brass, and Hansen brass. Please call your nearest MSA distributor for complete ordering information.



## Duo-Twin™ Respirators

The Duo-Twin Respirator comes in a Constant-Flow version; Constant-Flow respirators are normally used where an ample air supply is available, such as that provided by an air compressor. The MSA Duo-Twin Respirator features air-purifying cartridges, which also protect against a variety of contaminants. If the air supply should ever fail on the Constant-Flow unit, the user is automatically protected by the air-purifying cartridges.

This product is popular in the pharmaceutical, chemical, petrochemical, and nuclear industries. This MSA respirator should not be used in atmospheres containing less than 19.5% oxygen. NIOSH approved.



Duo-Twin Respirator with Advantage 4000 Facepiece

### Ordering Information

DUO-TWIN RESPIRATOR COMPLETE ASSEMBLIES	10091873	Constant Flow Duo-Twin Respirator with Advantage 4000 Facepiece – complete with facepiece, breathing tube, adapter assembly/regulator, web belt and Foster steel plug and socket assembly. Uses Advantage Respirator Cartridges listed on page 12.
	490143	Constant Flow Duo-Twin Respirator with Ultravue Facepiece – complete with facepiece, breathing tube, adapter assembly/regulator, web belt and Foster steel plug and socket assembly. Uses Comfo Respirator Cartridges listed on page 13.

## Duo-Flo™ Respirators

This combination air-supplied/air-purifying respirator is designed for use in adequately ventilated areas with at least 19.5% oxygen. Featuring a unique, switchable exhalation valve, these units are well suited for abatement work.

### Features and Benefits

- Fresh-air respirators for use in adequately ventilated areas
- Requires at least 19.5% oxygen for use
- Air-supplied mode permits long service use
- Air-purifying mode is for entry, egress and moving from station to station in a contaminated atmosphere



Constant-Flow Duo-Flo Respirator

Ultra Filter P100 cartridge

### Duo-Flo Respirator Designed for Torus and Wetwell Abrasive Blasting

MSA's custom designed products for torus and wetwell blasting include the Duo-Flo Respirator with a tight-fitting facepiece, a durable hood that provides head, neck and upper body protection and replacement 3-layer lens covers for workers engaged in abrasive blasting. The Constant Flow Duo-Flo Option is designed to handle both air-supplied and air-purifying (P100) modes of operation. The 3-layer cover lens allows for lens removal without stopping work. The shoulder-length hood is made of cotton-polyester material. It has an elastic neck and Velcro closures for comfortable sealing around the neck.

- APR filter for entry/egress
- Constant flow Airline with Type CE approval for blasting operation
- Customized blasting hood designed specifically for maximum vision and mobility
- Standard Ultravue Facepiece maximizes vision in tight quarters
- Easy integration with Fall Protection
- NIOSH approved

### Ordering Information

DUO-FLO RESPIRATOR COMPLETE ASSEMBLIES	466095	Constant Flow Duo-Flo Respirator w/full-face Ultravue Facepiece, includes one (1) P100 Ultra Filter
	10091952	Constant Flow Duo-Flo Respirator w/full-face Advantage 4000 Facepiece, includes one (1) P100 Ultra Filter
REPLACEMENT CARTRIDGES	10010420	Round Ultra Filter Cartridge, box of 6
	10010421	Round Ultra Filter Cartridge, box of 50
HOODS	10125492	Torus Blast Hoods, box of 20*
LENS COVERS	10125177	Replacement lens covers 3/stack, package of 5

# Air-Line Respirators

## Abrasi-Blast™ Supplied-Air Respirator CF

This supplied-air respirator provides respiratory and upper body protection for personnel engaged in abrasive blasting. Includes hood, facepiece with lens housing, breathing tube, lens cartridge, flow-control device, air-supply hose, and support belts. Ideal for a range of applications including blasting operations.

### Features and Benefits

- Provides respiratory and upper body protection
- Modular design allows customization for a range of applications
- Heavy, rubber hood protects against rebounding abrasive materials
- Removable flat-glass cover lens
- Choose waist-length or shoulder-length style



### Ordering Information

	Waist-Length Hood	Shoulder-Length Hood	
COMPLETE ASSEMBLIES WITH ADVANTAGE 4000 FACEPIECE	10089177	10089210	Abrasi-Blast Respirator with Advantage 4000 Facepiece Includes hood, medium facepiece with net head harness (10089910), lens housing, one lens cartridge (three 0.12" untempered glass cover lenses per cartridge), breathing tube (470734), web belt (9961), and adjustable valve connector with Snap-Tite (AL) socket assembly. Flow-control device: 35–40 psi. <b>Order air supply hose separately.</b>
COMPLETE ASSEMBLIES WITH DUO-FLO CONSTANT FLOW ADVANTAGE 4000 FACEPIECE	10116961	10116962	Abrasi-Blast Respirator with Duo-Flo Constant Flow Advantage 4000 Facepiece Includes hood, medium facepiece with net head harness (10089910), lens housing, one lens cartridge (three 0.12" untempered glass cover lenses per cartridge), breathing tube (457158), web belt (9961), and adjustable valve connector with Snap-Tite (AL) socket assembly. Flow-control device: 35–40 psi.
COMPLETE ASSEMBLIES WITH ULTRAVUE FACEPIECE  <i>Assemblies can be specially ordered with different options</i>	468716	468720	Abrasi-Blast Respirator with Ultravue Facepiece Includes one lens cartridge consisting of four 0.06-inch untempered glass cover lenses, flow control device, Snap-Tite aluminum quick-disconnect fitting, valve-connector body, facepiece (medium) with dual exhalation valves and lens housing, breathing tube, web belt, hypalon hood with collar, and air-hose connector. Inlet Pressure Range: 10–15 psi.
	468718	468722	Abrasi-Blast Respirator with Ultravue Facepiece Includes one lens cartridge consisting of four 0.06-inch untempered glass cover lenses, flow control device, Snap-Tite aluminum quick-disconnect fitting, valve-connector body, facepiece (medium) with dual exhalation valves and lens housing, breathing tube, web belt, hypalon hood with collar, and air-hose connector. Inlet Pressure Range: 35–40 psi.
	478116	478117	Abrasi-Blast Respirator with Ultravue Facepiece Includes one lens cartridge consisting of four 0.06-inch untempered glass cover lenses, flow control device, Snap-Tite aluminum quick-disconnect fitting, valve-connector body, facepiece (medium) with dual exhalation valves and lens housing, breathing tube, web belt, hypalon hood with collar, and air-hose connector. Abrasi-Blast Duo-Flo.

LENS CARTRIDGES  <i>12 cartridges per carton</i>	473798	0.09"-thick, untempered lens; 3 per cartridge; recommended use: medium blasting
	473800	0.09"-thick, tempered lens; 3 per cartridge; recommended use: medium blasting
	10013407	0.12"-thick, untempered, laminated lens; 1 per cartridge; recommended use: heavy blasting
	473802	0.12"-thick, untempered, laminated lens; 2 per cartridge; recommended use: heavy blasting
	481742	0.12"-thick, untempered, laminated lens; 3 per cartridge; recommended use: heavy blasting

## Versa-Hood™ Air-Supplied Respirator CF

Use this economical respirator wherever a Type-C air-supplied hood is required. Works with an air system or personal air compressor. The three-point Velcro system affixes the hood securely to an MSA V-Gard Cap, while adjustable suspensions minimize the need for a chinstrap. A disposable outer cover eliminates cleaning.

### Features and Benefits

- Use wherever a Type-C air-supplied hood is needed
- Disposable outer cover
- Twin lens system for double the hood life
- Air distribution system keeps lens fog free
- Knit collar for greater comfort
- Available in two lengths and two materials



### Ordering Information

#### Versa-Hood Assembly and 3/8-inch Hose System with Direct Connectors

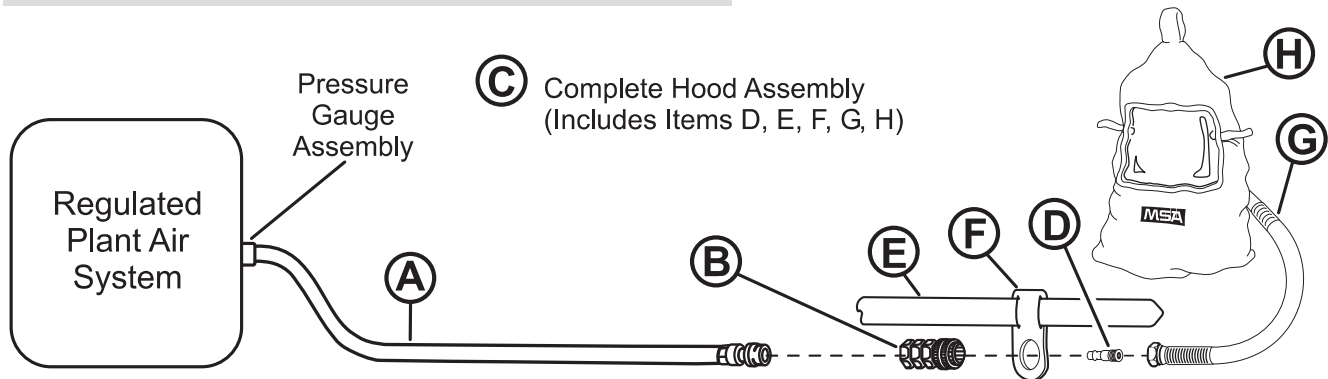

HOSE	A		Air-supply hose— see page 44
SOCKET ASSEMBLY	B	455019	Socket assembly for 3/8-inch hose system - Snap-Tite
	B	467044	Socket assembly for 3/8-inch hose system - Foster
COMPLETE HOOD ASSEMBLY	C	484689	Tyvek hood, shoulder-length, Snap-Tite aluminum plug
	C	484690	Tyvek hood, shoulder-length, Foster steel plug
	C	484693	Tyvek hood, waist-length, Snap-Tite aluminum plug
	C	484694	Tyvek hood, waist-length, Foster steel plug
HOOD ASSEMBLY COMPONENTS	D	66273	Male plug, Snap-Tite
	D	56549	Male plug, Foster
	E	473902	PVC support belt
	F	482618	Belt holder
	G	482702	Hood hose (1/4-inch NPT)
	H	482612	Shoulder-length Tyvek hood
	H	482610	Waist-length Tyvek hood
	H	816284	Shoulder-length Saranex hood
H	816283	Waist-length Saranex hood	

Note: This Versa Hood Assembly would typically require a compressor that puts out between 10 to 12 cfm per person at 10 to 40 psi. Required inlet pressure is based on airline hose length.

# Air-Line Respirators

## PremAire® Cadet Supplied-Air Respirator

Get air on demand with this high-performance, Type-C, supplied-air respirator. Mask-mounted regulator responds quickly to changing breathing requirements. Maintains a slight positive pressure to prevent contaminants from invading the face piece. Ideal for chemical and petrochemical processing, municipal utilities, and asbestos and lead paint abatement, as well as non-IDLH environments such as pharmaceutical applications and hazardous materials clean up.

### Features and Benefits

- Supplies on-demand respiratory protection
- Provides longer-duration air supply when used with a compressor
- Maintains a slight positive pressure of air during both inhalation and exhalation
- Well-suited for chemical, petrochemical, utility and industrial applications
- For use only in non-IDLH environments



### PremAire Cadet Respirator Kits

These PremAire Cadet Respirator Kits include PremAire Cadet Respirator with Advantage 4000 Facepiece (medium size, hycar rubber, polyester net head harness) with Push-To-Connect Firehawk® Regulator, nylon belt assembly, listed quick-disconnect for connecting respirator to air-supply hose, neoprene air supply hose 50-foot section complete with corresponding plug to attach air-supply hose to air source.

PREMAIRE CADET KITS	10108493	PremAire Cadet Air-Line Respirator with Foster Steel quick-disconnects, neoprene air supply hose 50-foot section with Foster Steel Plug
	10108594	PremAire Cadet Air-Line Respirator with Snap-Tite Aluminum quick-disconnects, neoprene air supply hose 50-foot section with Snap-Tite Aluminum Steel Plug
	10108495	PremAire Cadet Air-Line Respirator with TransportAire™ Portable Air-Supply Assembly: kit includes a PremAire Cadet Respirator with an Advantage 4000 Facepiece (medium size, hycar rubber, polyester net head harness) with Push-To-Connect Firehawk Regulator and nylon belt assembly, Snap-Tite Quick-Disconnect and a low-pressure TransportAire Portable Air Supply with 30-minute carbon fiber cylinder, and eight-foot coiled nylon air supply hose

### PremAire Cadet Respirator Assemblies

All listed configurations include: Ultra Elite Facepiece (medium size, hycar, rubber head harness) or Advantage 4000 Facepiece (medium size, hycar, polyester net head harness) with Push-To-Connect Firehawk Regulator and nylon belt assembly.

PREMAIRE CADET COMPLETE ASSEMBLIES <i>with Ultra Elite Facepiece</i>	10054790	with 30" IP (intermediate pressure) hose, no fittings
	10054793	with 30" IP (intermediate pressure) hose, Snap-Tite AL fittings
	10054791	with 42" IP (intermediate pressure) hose, no fittings
	10054792	with 42" IP (intermediate pressure) hose, Snap-Tite AL fittings
PREMAIRE CADET COMPLETE ASSEMBLIES <i>with Advantage 4000 Facepiece</i>	10081100	with 30" IP (intermediate pressure) hose, no fittings
	10081098	with 30" IP (intermediate pressure) hose, Snap-Tite AL fittings
	10081171	with 42" IP (intermediate pressure) hose, no fittings
	10081099	with 42" IP (intermediate pressure) hose, Snap-Tite AL fittings
PREMAIRE CADET ASSEMBLIES <i>without facepiece</i>	10121413	with 30" IP (intermediate pressure) hose, no fittings
	10121416	with 42" IP (intermediate pressure) hose, no fittings

Note: See page 42 to order quick-disconnects for use with the PremAire and PremAire Cadet Systems (column 2 for the plug and column 5 for the socket assembly).

## Facepieces for PremAire Cadet and PremAire Cadet Escape Respirators

MSA offers choice of two facepieces, the Ultra Elite Facepiece or the Advantage 4000 Facepiece for the PremAire Cadet family of respirators. Choose from three facepiece sizes (small, medium, or large) in either hycar or silicone rubber. Nosecups are available in two sizes, standard and large.

### Ultra Elite Facepiece



#### The Ultra Elite Facepiece features:

- One-way check valve preventing exhaled air from entering the mask-mounted regulator
- A rugged polycarbonate lens with scratch-resistant coating
- A mechanical speaking diaphragm for short-range communications
- Five adjustable rubber straps for exceptional head comfort, security, and safety
- Optional heat-resistant Kevlar net-style head harness

	Small	Medium	Large	
ULTRA ELITE FACEPIECES <i>Push-To-Connect Adapter</i>	10037650	10037648	10037652	hycar, rubber head harness, nose cup
	10043417	10043413	10043431	Silicone, rubber head harness, nose cup
	10043419	10043415	10043433	hycar, Speed-ON head harness, nose cup
	10043430	10043416	10043434	Silicone, Speed-ON head harness, nose cup

### Advantage 4000 Facepiece



#### The Advantage 4000 Facepiece features:

- Available adapters to convert the Advantage Facepiece to a Twin-Cartridge Respirator (using Advantage Cartridges) or an RD40 Facepiece
- One-way check valve preventing exhaled air from entering the mask-mounted regulator
- Rugged polycarbonate lens with scratch-resistant coating
- Four-point silicone head harness for exceptional comfort and security
- Optional polyester net or Kevlar net head harness

	Small	Medium	Large	
ADVANTAGE 4000 FACEPIECES <i>Push-To-Connect Adapter</i>	10075911	10075905	10075917	hycar, rubber head harness, nose cup
	10075910	10075904	10075916	Silicone, rubber head harness, nose cup
	10075915	10075909	10075921	hycar, polyester net head harness, nose cup
	10075914	10075908	10075920	Silicone, polyester net head harness, nose cup
	10108547	10108561	10108565	hycar, Kevlar net head harness, nose cup
	10108545	10108549	10108563	Silicone, Kevlar net head harness, nose cup

# Air-Line Respirators

## PremAire® Cadet Escape Respirator

This combination supplied-air respirator with SCBA is designed especially for escape from IDLH atmospheres. Versatile, comfortable, and affordable, it features a single-assembly first-stage regulator and cylinder valve. Small in size and profile, making it ideal for working in tight places.

### Features and Benefits

- One-piece assembly with both first-stage regulator and cylinder valve
- Small size and profile for confined spaces
- Downstream design and dual springs for maximum reliability
- Recessed pressure gauge for added protection
- Choice of cylinder hip placement for freedom and versatility
- Standby mount for second-stage regulator



### PremAire Cadet Escape Respirator Kits

The PremAire Cadet Escape Respirator Kits below include a PremAire Cadet Escape Respirator with an Advantage 4000 Facepiece (medium size, hycar rubber, polyester net head harness) with Push-To-Connect Firehawk Regulator and nylon harness, aluminum cylinder, and the listed quick-disconnect for connecting the respirator to the air supply hose, a 50-foot section of neoprene air supply hose complete with the corresponding plug to attach the air supply hose to your air source.

PREMAIRE CADET ESCAPE KITS		
10108496	PremAire Cadet Escape Air-Line Respirator, 5-minute aluminum egress cylinder, with Hansen Brass Quick-Disconnects, 50 foot section of neoprene air supply hose with Hansen Brass Plug	
10108592	PremAire Cadet Escape Air-Line Respirator, 10-minute aluminum egress cylinder, with Hansen Brass Quick-Disconnects, 50 foot section of neoprene air supply hose with Hansen Brass Plug	

### PremAire Cadet Escape Respirators

PREMAIRE CADET ESCAPE RESPIRATORS		
10087895	PremAire Cadet Escape Air-Line Respirator, 5-minute aluminum egress cylinder, nylon strap carrier/harness, less facepiece, less fittings, less case	
10087897	PremAire Cadet Escape Air-Line Respirator, 10-minute aluminum egress cylinder, nylon strap carrier/harness, less facepiece, less fittings, less case	
10092034	PremAire Cadet Escape Air-Line Respirator, 5-minute aluminum egress cylinder, nylon strap carrier/harness, Advantage 4000 Facepiece, hycar, polyester net head harness, Hansen brass fittings, less case	
10092036	PremAire Cadet Escape Air-Line Respirator, 10-minute aluminum egress cylinder, nylon strap carrier/harness, Advantage 4000 Facepiece, hycar, polyester net head harness, Hansen brass fittings, less case	
10093986	PremAire Cadet Escape Air-Line Respirator, 5-minute aluminum egress cylinder, nylon strap carrier/harness, Ultra Elite Facepiece, hycar, Kevlar net head harness, less fittings, with hard case	
10093987	PremAire Cadet Escape Air-Line Respirator, 10-minute aluminum egress cylinder, nylon strap carrier/harness, Ultra Elite Facepiece, hycar, Kevlar net head harness, less fittings, with hard case	
10093988	PremAire Cadet Escape Air-Line Respirator, 5-minute aluminum egress cylinder, nylon strap carrier/harness, Advantage 4000 Facepiece, hycar, polyester net head harness, less fittings, with hard case	

### Approvals

The PremAire Cadet Escape Respirator is approved by the National Institute for Occupational Safety and Health (NIOSH) as an Open-Circuit, Pressure-Demand, Escape, Self-Contained Breathing Apparatus or Combination, Open-Circuit, Pressure-Demand, Escape, Self-Contained Breathing Apparatus and Type-C, Supplied-Air Respirator (TC-13F-542,543,544,545). The respirator is approved for use at temperatures above -25°F. The compressed-air container shall be fully charged with air meeting the requirements of CGA C-7.1 Grade D or higher quality. When supplied with respirable air through an air supply hose, the air supply pressure range shall be 70-90 psig, the hose length shall be 8-300 feet, and the air supply shall meet the requirements of CGA C-7.1 Grade D or higher quality.

## The Assemble-To-Order System for PremAire Cadet Escape Respirator

Thousands of possible combinations lets you select just the right PremAire Cadet Escape Respirator for the job. The ATO System works by allowing users to create their own part numbers. Each digit of an ATO part number will represent a specific component, so that the entire part number represents a finished respirator built exactly to your desired specifications. Advantages of the ATO System include: you get the exact model of PremAire Respirator you need; no special orders, because all orders are customized; fresher cylinders from our continually rotated inventory; simplified ordering process; and timely delivery.

Type	Carrier & Harness Type	Pad Option	Escape Cylinder	MMR Regulator	Facepiece	Nosecup	Head Harness	Quick Disconnect	Case	QUANTITY
PC PremAire Cadet Escape	1 Nylon, strap carrier, standard 2 Kevlar, strap carrier, standard 3 Nylon, bag carrier, standard 4 Kevlar, bag carrier, standard  <i>Aluminum escape cylinders are not compatible with bag carriers</i>	0 None 1 Shoulder	A 5-minute aluminum B 10-minute aluminum C 5-minute carbon D 10-minute carbon E 15-minute carbon	A Firehawk, Push-To-Connect, solid cover C Firehawk, Slide, solid cover  <i>Firehawk slide regulators are not compatible with Advantage 4000 Facepiece</i>	A None B Ultra Elite, hycar, small C Ultra Elite, hycar, medium D Ultra Elite, hycar, large E Ultra Elite, silicone, small F Ultra Elite, silicone, medium G Ultra Elite, silicone, large H Advantage 4000, hycar, small J Advantage 4000, hycar, medium K Advantage 4000, hycar, large L Advantage 4000, silicone, small M Advantage 4000, silicone, medium N Advantage 4000, silicone, large	0 None 1 Ultra Elite, medium 2 Ultra Elite, large  <i>Nosecup standard with Advantage 4000 Facepiece</i>	0 None 1 Ultra Elite Rubber 2 Ultra Elite Speed-ON 3 Advantage 4000 Rubber 4 Advantage 4000 Poly Net 5 Advantage 4000 Kevlar Net	0 None A Snap-Tite, aluminum B Snap-Tite, stainless steel C Snap-Tite, brass D Hansen, stainless steel E Hansen, brass F Foster, steel G Foster, stainless steel H Foster, brass J Snap-Tite, locking, aluminum K Snap-Tite, locking, stainless steel M Snap-Tite, locking, brass N Foster, locking, stainless steel P Cejn, locking, chrome	0 None 1 Hard plastic case	
A-	PC									

# Air-Line Respirators

## PremAire® Air-Supplied Respirator System

This full-face, pressure-demand, Type-C supplied-air respirator features a patented waist-mounted manifold for incredible flexibility. Dual-supply option lets users connect from one pressurized continuous air source to another—without losing continuity of airflow. The vortex tube option delivers whole-body temperature control for added comfort.

### Features and Benefits

- Cost-efficient supplied-air respirator
- Modular system to match respiratory needs to the task at hand
- Lightweight, mask-mounted regulator provides high air flow
- Suitable for IDLH environments (with escape cylinder option)



### Traditional MSA Part Numbers

See the following page for Assemble-To-Order information. For customers who require faster delivery, the most popular PremAire system combinations can still be ordered with a traditional MSA part number. These assemblies come with a medium hycar Ultra Elite Facepiece and nosecup with rubber harness. For these assemblies, quick-disconnects must be ordered separately (see page 42; you need a male plug with female 1/4" NPT (column 2), and a female socket assembly (column 5).

PREMAIRE COMPLETE ASSEMBLIES	10045164	PremAire System Complete Assembly w/ Firehawk Slide-To-Connect Regulator, 5-minute 3AL aluminum cylinder, right-hip model, with case
with Firehawk STC Regulator	10045165	PremAire System Complete Assembly w/ Firehawk Slide-To-Connect Regulator, 10-minute 3AL aluminum cylinder, right-hip model, with case

### Replacement PremAire Respirator Facepieces

	Small	Medium	Large	
ADVANTAGE 4000 FACEPIECES for Firehawk PTC MMR Regulator	10075911	10075905	10075917	hycar, rubber head harness, nosecup
	10075910	10075904	10075916	Silicone, rubber head harness, nosecup
	10075915	10075909	10075921	hycar, polyester net head harness, nosecup
	10075914	10075908	10075920	Silicone, polyester net head harness, nosecup
ULTRA ELITE FACEPIECES for Firehawk PTC MMR Regulator	10037650	10037648	10037652	hycar, rubber head harness, nosecup, non-NFPA
	10043417	10043413	10043431	Silicone, rubber head harness, nosecup, non-NFPA
	10037651	10037649	10037653	hycar, EZ-Don Head Harness, nosecup, non-NFPA
	10043418	10043414	10043432	Silicone, EZ-Don Head Harness, nosecup, non-NFPA
	10043419	10043415	10043433	hycar, Speed-ON Head Harness, nosecup, non-NFPA
	10043430	10043416	10043434	Silicone, Speed-ON Head Harness, nosecup, non-NFPA
ULTRA ELITE FACEPIECES for Firehawk STC MMR Regulator	—	10039982	—	hycar, rubber head harness, nosecup, non-NFPA
	—	10039983	—	Silicone, rubber head harness, nosecup, non-NFPA



## The Assemble-To-Order System for PremAire Supplied-Air Respirator System

Type	Belt Assembly	Escape Cylinders	Dual-Supply	MMR Regulator	Facepiece Type	Facepiece	Facepiece Size	Nosecup	Head Harness	Quick Disconnect*	Case
PS PremAire System	1 Nylon 2 Urethane 3 Nomex	0 None 1 5-Min Right Hip Carbon Fiber 2 5-Min Left Hip Carbon Fiber 3 5-Min Right Hip Aluminum 4 5-Min Left Hip Aluminum 5 10-Min Right Hip Carbon Fiber 6 10-Min Left Hip Carbon Fiber 7 10-Min Right Hip Aluminum 8 10-Min Left Hip Aluminum	0 None 1 8" Hose less QD 2 15" Hose less QD	E Firehawk STC 30" Solid Cover F Firehawk STC 42" Solid Cover G Firehawk PTC 30" Solid Cover H Firehawk PTC 42" Solid Cover J Firehawk STC 30" No Bypass K Firehawk STC 42" No Bypass L Firehawk PTC 30" No Bypass M Firehawk PTC 42" No Bypass	0 None 1 Non-NFPA 2 NFPA <i>NFPA facepiece is Ultra Elite</i>	0 None 1 Ultra Elite, hycar 2 Ultra Elite, silicone E Advantage 4000, hycar F Advantage 4000, silicone <i>Firehawk slide regulators are not compatible with Advantage 4000 facepiece</i>	0 None S Small M Medium L Large	0 None (only if you have no FCPC) 1 Ultra Elite, medium 2 Ultra Elite, large <i>Nosecup standard with Advantage 4000 facepiece</i>	0 None 1 Ultra Elite Rubber 2 Ultra Elite, EZ-Don, small 3 Ultra Elite, EZ-Don, medium 4 Ultra Elite, EZ-Don, large 5 Ultra Elite Speed-ON 6 Advantage 4000 Rubber 7 Advantage 4000 Poly Net 8 Advantage 4000 Kevlar Net	A None B Snap-Tite, aluminum C Snap-Tite, stainless steel D Snap-Tite, brass E Hansen, stainless steel F Hansen, brass G Foster, steel H Foster, stainless steel I Foster, brass J Cejn, locking, chrome	0 None 1 Hard case
			<i>Must choose No Bypass option when ordering PremAire less an escape cylinder</i>			<i>Note: If you have selected the Dual-Supply option, you will need two of the same Quick-Disconnects. Just put one letter in the part number to indicate your selection, but when you calculate the price of your system, make sure you include a price for each Quick-Disconnect.</i>					
C-	PS										QUANTITY

\* Unit requires use of a quick-disconnect for connection to air-line to maintain approval. All quick-disconnects listed are non-locking except for the Cejn chrome (J). Note: See page 44 for air-line hoses. Note: This matrix must only be used for ordering complete PremAire Systems. This matrix cannot be used for ordering individual components (i.e., facepieces, escape cylinders, etc.). Please order components separately using their standard MSA part number.

For applications strictly limited to non-IDLH atmospheres, NIOSH requires that the respirator system be configured without a bypass on the Firehawk Mask-Mounted Regulator (MMR). Please contact MSA Customer Service for more information.

### PremAire System Upgrades

ESCAPE CYLINDER KITS <i>Includes carrier assembly, 1st stage regulator, hose and cylinder</i>	800696	Kit with fully-wound carbon fiber, 5-minute cylinder, for right hip
	800694	Kit with fully-wound carbon fiber, 5-minute cylinder, for left hip
	800697	Kit with fully-wound carbon fiber, 10-minute cylinder, for right hip
	800695	Kit with fully-wound carbon fiber, 10-minute cylinder, for left hip
VORTEX TUBE KITS	800706	Kit with 6" hose, cool-only version
	800710	Kit with 6" hose, warm/cool version
	801012	Kit with 12" hose, cool-only version
	801014	Kit with 12" hose, warm/cool version
DUAL-SUPPLY KITS	800044	Includes 8-inch extension hose, less quick-disconnect assembly
	800986	Includes 15-inch extension hose, less quick-disconnect assembly
PREMAIRE AIR-LINE FILTER KITS	811940	Filter Kit
	811984	Replacement filter element and gasket



Escape Cylinder Kit (for rt hip)



Vortex Tube Kit



Dual-Supply Kit



Air-Line Filter Kit

# Air-Line Respirators

## Compressed Air-Line Accessories

MSA compressed air-line accessories help ensure proper air supply. Our pressure regulator helps maintain desired operating pressure, while our manifolds supply single source air to up to four respirators. MSA compressed air-line accessories are designed especially for use with MSA air-line systems.

### Features and Benefits

- Enhance long-duration respiratory protection
- Ensure proper pressure and air quality
- Pressure regular reduces plant air system compressor pressure and maintains desired operating pressure
- Manifolds feature quick-disconnect assemblies and automatic shut-off outlets

## Industrial Air Cart



The Industrial Air Cart permits up to 4 NIOSH-approved air-line respirators to be connected to 2 one-hour 4,500 psig breathing apparatus cylinders (not included). See table below for cylinder ordering information. A 60-minute cylinder will provide maximum air supply.

### Features

- Two-wheel poly powder-coated cart, two sets of double-cylinder straps, air-line hose rack and adjustable pull handle.
- A 5,500 psig pressure regulator reduces the 4,500 psig cylinder air to the proper air-line respirator inlet pressure.
- Low-pressure cylinder alarm whistle.
- An outlet pressure gauge operates in 0-125 psig range.
- Four-outlet manifold is available with 4 outlet fitting options.

### Cart Weight and Dimensions

**Size:** 35" H x 21" W x 15.25" D

**Unit Weight:** 38.5 pounds without cylinders

For more complete information, see Bulletin 0114-28.

## Ordering Information

INDUSTRIAL AIR CART	10107537	Industrial air cart equipped with union adapters
	10107779	Industrial air cart equipped with Snap-Tite aluminum quick-disconnects
	10107780	Industrial air cart equipped with Foster steel quick-disconnects
	10107811	Industrial air cart equipped with Hansen brass quick-disconnects
CYLINDERS <i>All cylinder weights shown are approximate.</i>	807586	L-30* carbon-wrapped cylinder, 30-minute NIOSH service life rating, 2216 psig, weight (empty): 8 lb. 0 oz.
	816115	L-30+* carbon-wrapped cylinder, 30-minute NIOSH service life rating, 3000 psig, weight (empty): 9 lb. 8 oz.
	10127944-SP	H-30SL*, SuperLite, 30-minute NIOSH service life rating, 4500 psig, weight (empty): 6 lb. 9 oz.
	807570	H-45* carbon-wrapped cylinder, 45-minute NIOSH service life rating, 4500 psig, weight (empty): 9 lb. 7 oz.
	10127945-SP	H-45SL, SuperLite, 45-minute NIOSH service life rating, 4500 psig, weight (empty): 8 lb. 8 oz.
	10127946-SP	H-60SL*, SuperLite, 60-minute NIOSH service life rating, 4500 psig, weight (empty): 10 lb. 12 oz.
	469619	Fiberglass hoop-wound cylinder, 30-minute NIOSH service life rating, 2216 psig, weight (empty): 13 lb. 0 oz.
	809872	Aluminum cylinder, 30-minute NIOSH service life rating, 2216 psig, weight (empty): 18 lb. 0 oz.

\*These cylinders are capable of custom options. Contact MSA Customer Service at 1-800-MSA-2222 for more information. All weights approximate.



TransportAire System:  
High-Pressure  
Configuration

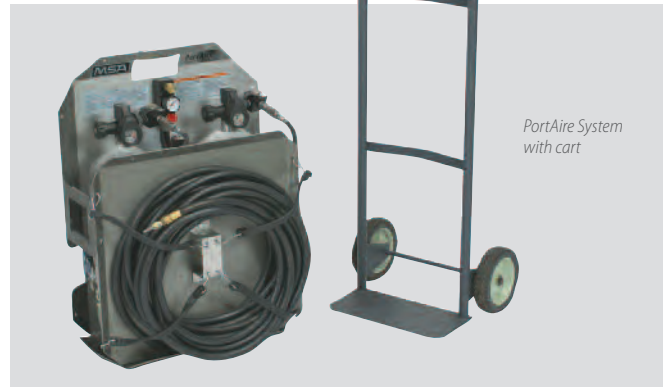

PortAire System  
with cart

## The TransportAire™ System

The TransportAire System is available in two versions: one for high-pressure cylinders and one for low-pressure cylinders. Both versions consist of an impact-resistant handle with urethane-coated nylon straps that fit around a standard MSA SCBA air cylinder (purchased separately), a regulator, and a regulator-to-hose adapter. An Audi-Larm device is provided standard on the high-pressure system and is available as an option for the low-pressure system. Both systems are designed for use with MSA supplied-air respirators equipped with a dual-supply option. A major advantage of the dual-supply option is improved mobility; workers need not remain tethered to a single air-supply hose throughout a work period. For more complete information, see Bulletin 0114-21.

## The PortAire® System

The PortAire System holds two standard SCBA air cylinders to provide firefighters, industrial personnel, confined-space workers, and others with a portable, compressed-air source any time an air-line device is required.

Designed for use with MSA pressure-demand supplied-air respirators, including dual-purpose self-contained breathing apparatus (SCBA), the PortAire System consists of a compact air-pressure regulating system housed in a lightweight, yet durable, anodized aluminum frame. For more complete information, see Bulletin 0114-21.

## Ordering Information

THE TRANSPORTAIRE SYSTEM	816693	TransportAire Assembly, high-pressure—complete with cylinder carrier, regulator, and regulator-to-hose adapter
	812217	TransportAire Assembly, low-pressure—complete with cylinder carrier, regulator, and regulator-to-hose adapter, and high-pressure Audi-Larm
	85078	Low-pressure Audi-Larm assembly
	491513	8-ft Coiled nylon hose
THE PORTAIRE SYSTEM	807052	PortAire Portable Air-Supply System with Audi-Larm low-pressure warning device, high-pressure regulator, and carrying frame with air-supply hose retainer (cylinders and air-line hose not included)
	807053	Quick-Fill Kit
	10017089	Wheeled Cart for PortAire Portable Air-Supply System
CYLINDERS <i>All cylinder weights shown are approximate.</i>	807586	L-30* carbon-wrapped cylinder, 30-minute NIOSH service life rating, 2216 psig, weight (empty): 8 lb. 0 oz.
	816115	L-30+* carbon-wrapped cylinder, 30-minute NIOSH service life rating, 3000 psig, weight (empty): 9 lb. 8 oz.
	10127944-SP	H-30SL*, SuperLite, 30-minute NIOSH service life rating, 4500 psig, weight (empty): 6 lb. 9 oz.
	807570	H-45* carbon-wrapped cylinder, 45-minute NIOSH service life rating, 4500 psig, weight (empty): 9 lb. 7 oz.
	10127945-SP	H-45SL, SuperLite, 45-minute NIOSH service life rating, 4500 psig, weight (empty): 8 lb. 8 oz.
	10127946-SP	H-60SL*, SuperLite, 60-minute NIOSH service life rating, 4500 psig, weight (empty): 10 lb. 12 oz.
	469619	Fiberglass hoop-wound cylinder, 30-minute NIOSH service life rating, 2216 psig, weight (empty): 13 lb. 0 oz.
	809872	Aluminum cylinder, 30-minute NIOSH service life rating, 2216 psig, weight (empty): 18 lb. 0 oz.

\*These cylinders are capable of custom options. Contact MSA Customer Service at 1-800-MSA-2222 for more information. All weights approximate.

# Air-Line Respirators

## Quick-Disconnects for Air-Line Respirators and Air-Supplied Hoods

Quick-disconnect assemblies connect air-supply hoses to the manifold and to the air source. If you want to use a quick-disconnect to interconnect lengths of air-supply hose, you must use a locking-type quick-disconnect—specifically, the locking quick-disconnects listed in the yellow box at the bottom of this page. For more complete information, see the Pocket Guide to Air-Line Systems (Bulletin 0114-14-MC).

### Quick-Disconnects and Adapters

AL-Aluminum; S-Steel; SST-Stainless Steel; BR-Brass

QUICK-DISCONNECT TYPE	Interchangeability	1	2	3	4	5*
		Female Socket 1/4" NPT	Male Plug w/Female 1/4" NPT	Union Adapter 1/4" NPT x 3/4" UNF	Male Plug w/Male 1/4" NPT (used when connecting Inlet Pressure Gauge)	Female Socket Assy. (used to connect Air-Supply Hose to Male Plug on Respirator)
SNAP-TITE (AL)	C	66272	66274	69542	66273	455019
SNAP-TITE (SST)	C	629673	629672	808358	629671	471778
SNAP-TITE (BR)	C	630305	630307	69542	630306	471777
HANSEN (SST)	A	628768	628208	808358	473502	471779
HANSEN (BR)	D	630311	630313	69542	630312	471501
FOSTER (S)	B	628770	55716	69542	56549	467044
FOSTER (SST)	B	636459	636460	808358	-----	801016
FOSTER (BR)	A	629980	629981	69542	473501	470194
SCHRADER (S)	B	SEE FOSTER(S)	SEE FOSTER(S)	SEE FOSTER(S)	SEE FOSTER(S)	SEE FOSTER(S)
CEJN LOCKING (CHROME-PLATED—BR)	E	631870	479026	69542	479020	479001
CEJN LOCKING (CHROME)	E	-----	479026	69542	479020	476956
SNAP-TITE LOCKING (AL)	F	-----	479027	69542	-----	479032
SNAP-TITE LOCKING (SST)	F	-----	479028	808358	479022	479033
SNAP-TITE LOCKING (BR)	F	-----	479029	69542	479023	479034
FOSTER LOCKING (SST)	D	636473	637851	808358	-----	800805

### Locking Quick-Disconnects

CEJN LOCKING	479009	CEJN Locking Quick-Disconnect Assembly, Socket and Plug (Chrome)
	476956	CEJN Locking Female Quick-Disconnect Socket (Chrome)
	476955	CEJN Locking Male (w/ Male 3/4" NPT) Quick-Disconnect Plug (Chrome)
SNAP-TITE LOCKING	479010	Snap-Tite Locking Quick-Disconnect Assembly, Socket and Plug (AL)
	479032	Snap-Tite Locking Female Quick-Disconnect Socket (AL)
	479015	Snap-Tite Locking Male (w/ Male 3/4" NPT) Quick-Disconnect Plug (AL)
	479011	Snap-Tite Locking Quick-Disconnect Assembly, Socket and Plug (SST)
	479033	Snap-Tite Locking Female Quick-Disconnect Socket (SST)
	479016	Snap-Tite Locking Male (w/ Male 3/4" NPT) Quick-Disconnect Plug (SST)

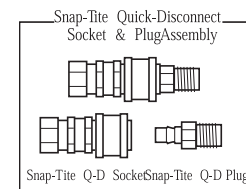
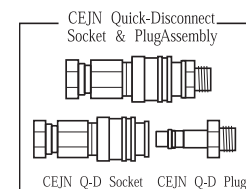

## Breathing Air Distribution System Filtration Box

The Breathing Air Distribution System filtration system is housed in a rugged polymer case. It is equipped with three-stage filtration, a pressure regulator, a four-outlet manifold and a continuous flow 115 VAC carbon monoxide monitor. The filtration box may be used in a portable or stationary position. Two models of filtration boxes are available – one box provides 50 cubic feet of air per minute and a second provides 100 cubic feet of air per minute.



*Portable Grade-D filtration system provides breathing air for up to four air-line respirators*

### Ordering Information

	For use in the United States (Carbon monoxide monitor set at 10 ppm)	For use in Canada (Carbon monoxide monitor set at 5 ppm)	
FILTRATION BOXES <i>50 CFM</i>	10107538	10113347	50 CFM Filtration Box four-outlet, carbon monoxide monitor, with union adapters
	10107814	10113349	50 CFM Filtration Box four-outlet, carbon monoxide monitor, with Snap-Tite aluminum quick-disconnects
	10107812	10113348	50 CFM Filtration Box four-outlet, carbon monoxide monitor, with Foster Steel quick-disconnects
	10107813	10113346	50 CFM Filtration Box four-outlet, carbon monoxide monitor, with Hansen Brass quick-disconnects
FILTRATION BOXES <i>100 CFM</i>	10107539	10113345	100 CFM Filtration Box four-outlet, carbon monoxide monitor, with union adapters
	10107816	10113343	100 CFM Filtration Box four-outlet, carbon monoxide monitor, with Snap-Tite aluminum quick-disconnects
	10107817	10113342	100 CFM Filtration Box four-outlet, carbon monoxide monitor, with Foster Steel quick-disconnects
	10107815	10113344	100 CFM Filtration Box four-outlet, carbon monoxide monitor, with Hansen Brass quick-disconnects

OTHER REPLACEMENT PARTS AND ACCESSORIES		
	10108138	Upright support bracket, 50 and 100 CFM units
	10107741	Remote audible alarm with mounted visual strobe and guard, includes 50 ft. cable and 9-12 VDC
	10107527	Calibration Kit (for U.S. models), 20 ppm CO, zero air, regulator and case, 17-liter size
	10107526	Calibration Kit (for Canadian models), 10 ppm CO, zero air, regulator and case, 17-liter size
	10116617	Calibration Gas, 20 ppm CO
	10116618	Calibration Gas, 10 ppm CO
	10116619	Calibration Gas, 0 ppm CO

BREATHING AIR DISTRIBUTION SUPPLY HOSES FOR INLET PORTS  <i>from plant air system to filtration box</i>		
	10113330	Hose, 50 feet, Industrial Interchange Connections, 1/2 inch NPT male and female
	10113341	Hose, 100 feet, Industrial Interchange Connections, 1/2 inch NPT male and female
	10113328	Quick-Disconnect Socket, Hansen Industrial, 1/2 inch male NPT
	10113329	Quick-Disconnect Plug, Hansen Industrial, 1/2 inch male NPT

	50 CFM	100 CFM	
FILTER CHANGE KITS	10107545	10107541	Filter Change Kit, first stage
	10107546	10107542	Filter Change Kit, second stage
	10107544	10107543	Filter Change Kit, third stage

# Air-Line Respirators

## Breathing Air Distribution System—Point of Attachment Box

The Breathing Air Distribution System point of attachment box is housed in a rugged polymer case. It is equipped with one-stage filtration, a pressure regulator and a four-outlet manifold. The point of attachment box may be used in a portable or stationary position.

POINT OF ATTACHMENT BOX 4-outlet	10107536	Point of attachment box, with union adapters
	10107822	Point of attachment box, with Snap-Tite aluminum quick-disconnects
	10107823	Point of attachment box, with Foster steel quick-disconnects
	10107821	Point of attachment box, with Hansen brass quick-disconnects
FILTER CHANGE KIT	10107545	Filter change kit



Portable Grade-D filtration system provides breathing air for up to four air-line respirators



## Approved Air-Supply Hose (3/8" ID)

Available in smooth, reinforced, lightweight polyvinylchloride (PVC); chemical-resistant black neoprene; or smooth, coiled nylon. Must be used with respirators in this section to maintain NIOSH certifications. Quick-Disconnects are sold separately (see p. 42).

### Air-Supply Hose Temperature Ranges

<b>Neoprene</b>	<b>PVC</b>	<b>Nylon</b>
-25° to 212°F	32° to 120°F	0° to 160°F

NEOPRENE AIR SUPPLY HOSE	PVC AIR SUPPLY HOSE	COILED NYLON AIR SUPPLY HOSE
481071	481051	491513*
8ft, with brass hose coupling	8ft, with brass hose coupling	8ft, with brass hose coupling
455020	471511	491514*
15ft, with brass hose coupling	15ft, with brass hose coupling	15ft, with brass hose coupling
455021	471512	491515*
25ft, with brass hose coupling	25ft, with brass hose coupling	25ft, with brass hose coupling
455022	471513	474043*
50ft, with brass hose coupling	50ft, with brass hose coupling	50ft, with brass hose coupling
481077	484225	
8ft, with stainless steel hose coupling	8ft, with stainless steel hose coupling	
481078	481057	
15ft, with stainless steel hose coupling	15ft, with stainless steel hose coupling	
481079	481058	
25ft, with stainless steel hose coupling	25ft, with stainless steel hose coupling	
481080	481059	
50ft, with stainless steel hose coupling	50ft, with stainless steel hose coupling	
	481060	
	100ft, with stainless steel hose coupling	



## Cascade System Accessories

The following components are used to assemble a 2400 psi cascade system, which consists of a bank of respirable-air cylinders (user-supplied) that supply a flow of air to pressure-demand air-supplied respirators. Air-supply hoses are listed separately at left.

CASCADE SYSTEM ACCESSORIES	Part Number	Description
	85078	Audi-Larm™ Warning Device, low-pressure CGA 346, 0–3000 psig
	492307	Audi-Larm™ Warning Device, high-pressure CGA 347, 0–5500 psig
	68850	Air Coupler Tee—low-pressure CGA 346, 0–3000 psig
	10081206	Air Coupler Tee—high-pressure CGA 347, 0–5500 psig
	68851	Air Pigtail—low-pressure CGA 346, 0–3000 psig
	10081205	Air Pigtail—high pressure CGA 347, 0–5500 psig
	68858	Air Cylinder Pressure Regulator, dual-gauge, 0–3000 psig
	633352	High-Pressure Air Cylinder Regulator, dual-gauge, 0–5500 psig
	55716	Male Air-supply Hose Adapter for Foster quick-disconnects (for PVC hose)
	69542	Union Adapter (required to attach male plug)

\* Recommended usable length 4–25ft



## Manifolds

Required when using multiple (2–4) respirators from a single air source; some of these manifolds have quick-disconnect assemblies with automatic shut-off outlets. Note: Gauge required when greater than 10' between air-line point of connection and the regulator.

MANIFOLDS 4-outlet	47370	Manifold, with Foster quick-disconnect
	93931	Manifold, with Snap-Tite quick-disconnect
	488914	Manifold, less quick-disconnect
MANIFOLDS 2-outlet	84416	Manifold, with Foster quick-disconnect
	486053	Manifold, with Snap-Tite quick-disconnect
	84418	Manifold, less quick-disconnect



## Air-line Filter

The MSA air-line filter removes a minimum of 99% of 0.3 micron and larger particulates, including dusts, mists, fumes, smoke, and petroleum vapors. Caution: It does not remove carbon monoxide. The air-line filter can be used at inlet pressures up to 125 psig. The pressure drop is one psig at a maximum rated air flow of 25 cfm.

AIR-LINE FILTER	81857	Air-line Filter - with 1/2" NPT female inlet and outlet
	488041	Air-line Filter - with 3/4"-16 straight threads
	484923	Replacement Filter Kit



## Pressure Regulator

MSA's pressure regulator is used with a plant air compressor system to reduce compressor pressure to the desired operating pressure. The regulator maintains pressure on the outlet side until readjusted for use with inlet pressure of up to 125 psig.

PRESSURE REGULATOR	66716	Pressure regulator
-----------------------	-------	--------------------



## Inlet Pressure Gauge

MSA offers an inlet pressure gauge that enables a user to check pressure at the inlet of the MSA Air Supply Hose, thereby assuring that air pressure is within the certified range. The gauge is supplied with Quick-Disconnect fittings.

INLET PRESSURE GAUGE	476734	Inlet pressure gauge, with Snap-Tite fitting
	476735	Inlet pressure gauge, with Foster or Schrader fitting
	476737	Inlet pressure gauge, with Hansen fitting
	492586	Inlet pressure gauge, less quick-disconnect*

\*See Column 4 plug and Column 3 union on page 42.



## Support Belts

MSA PVC belts are easy to decontaminate. If decontamination is not a factor, users may opt for an uncoated nylon web belt.

SUPPORT BELTS	9961	Web support belt (uncoated)
	473902	PVC support belt, clear
	492827	Polyurethane-coated nylon support belt, black

# Escape Respirators



## TransAire® 5 and TransAire 10 Escape Respirators

These self-contained devices help personnel escape dangerous and deadly atmospheres, including those with high concentrations of toxic gases or vapors or oxygen deficiency. Low profile, lightweight, and easy to carry, these escape respirators feature one-control operation for a swift exit.

### Features and Benefits

- Provides emergency air in toxic or oxygen-deficient conditions; 5- and 10-minute standard-flow air supply
- Compact and lightweight for easy egress from tight spaces
- Fog-reducing hoods in urethane or Teflon easily fit over eyeglasses and facial hair
- Rugged, high-density polyethylene carrying case available
- Washable nylon cloth carrier can be worn on the waist, neck or shoulder

### Ordering Information

TRANSAIRE 5 ESCAPE RESPIRATOR	10008292	TransAire 5 Escape Respirator complete (includes aluminum cylinder, carrier, hood tube, hood assembly)
	10066739	TransAire 5 Escape Respirator complete, less air (includes aluminum cylinder, carrier, hood tube, hood assembly)
TRANSAIRE 10 ESCAPE RESPIRATOR	10008293	TransAire 10 Escape Respirator complete (includes aluminum cylinder, carrier, hood tube, hood assembly)
	10083327	TransAire 10 Escape Respirator complete (includes fully-wound carbon fiber cylinder, carrier, hood tube, hood assembly)
	10066740	TransAire 10 Escape Respirator complete, less air (includes aluminum cylinder, carrier, hood tube, hood assembly)

Two-unit and single-unit wall mounting cases feature a chemical-resistant ABS plastic case which resists weathering, moisture, and corrosion to ensure escape respirators stay in ready-to-use condition.

ACCESSORIES	696192	Single-unit wall-mounting case
	696193	Two-unit wall-mounting case
	10012530	Single unit carrying case, yellow polyethylene, with handle, for all escape respirators



## Custom Air V® Escape Respirators

Escape toxic gasses, vapors or oxygen deficiency with this quick-use, hooded emergency respirator. Features a high flow rate of 72 liters per minute (lpm) and a continuous flow of air from the compressed air cylinder. The flexible urethane hood reduces fogging and fits over eyeglasses and facial hair. Lightweight and easy to carry, the unit can also be wall-mounted, as needed.

### Features and Benefits

- Provides emergency air in highly toxic or deadly environments
- 5-minute high-flow cylinder meets stringent air-flow requirements for extremely aerobic escape applications
- Quick-retracting protective cover saves precious time when donning the hood
- Weighs less than 5 pounds

### Ordering Information

CUSTOM AIR V ESCAPE RESPIRATOR	10008292	Custom Air V Escape Respirator complete (includes fully-wound carbon fiber cylinder, carrier, hood tube, hood assembly)
	10066739	Custom Air V Escape Respirator complete (includes aluminum cylinder, hood tube, hood assembly)







## About **Industrial SCBA**

Industrial Self-Contained Breathing Apparatus (SCBA) are designed for use in Immediately Dangerous to Life or Health (IDLH) atmospheres.

These are respirators that do not require compliance with NFPA-1981, the National Fire Protection Association's (NFPA) standard on open circuit breathing apparatus for firefighters.

Applications for Industrial Self-Contained Breathing Apparatus include industrial facilities, agricultural grain fumigation, water and waste water treatment plants, HazMat work, HVAC, oil, gas and petrochemical plants.

Industrial SCBA use compressed air cylinders that are available in low pressure (cylinders rated from 2216-3000 psig) and high pressure (cylinders pressurized to 4500 psig).

Optional air-line connections allow greater versatility.

All MSA SCBAs are "pressure-demand" apparatus designed to maintain a slight positive pressure of air inside the facepiece during inhalation and exhalation. Positive pressure helps prevent contaminants from seeping in around the facepiece, even if there should be small breaks in the face-to-facepiece seal.

The Industrial SCBA consists of the following basic components: Facepiece; mask-mounted regulator; first-stage regulator; carrier and harness assembly; cylinder; and end-of-service-time indicator (EOSTI).



# Self-Contained Breathing Apparatus (SCBA)

## AirHawk® II Industrial Air Mask

Lightweight, durable and economical, this SCBA is ideal for a variety of industrial-hazard applications. Choose from a variety of options for each of the system's six major components including: facepiece; mask-mounted regulator; first-stage regulator; carrier and harness assembly; cylinder; and end-of-service-time indicator (EOSTI).

### Features & Benefits

- Lightweight, durable, economical SCBA
- Pressure-demand maintains positive air pressure inside facepiece
- Choice of Ultra Elite or Advantage 4000 Facepiece
- Ergonomic carrier and harness assembly for comfortable, stable wear
- Detachable components for easy maintenance
- Easy-release friction buckles

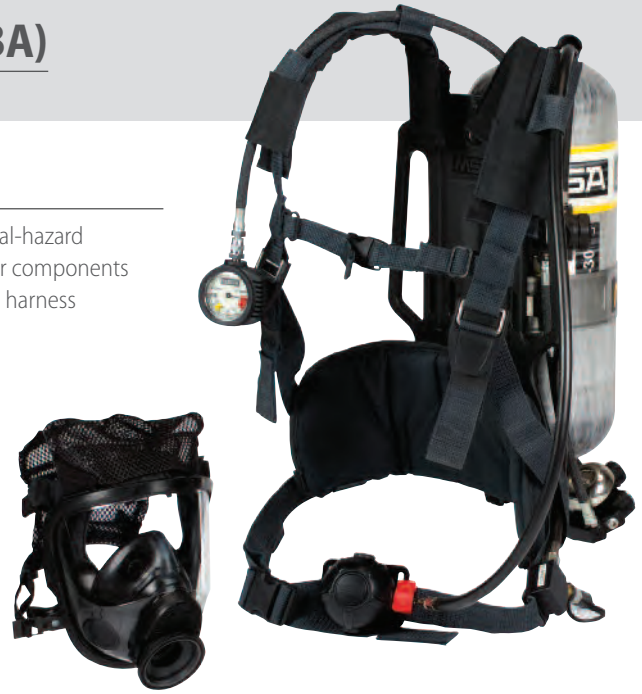

### Ordering Information

	Hard Case	No Case	Facepiece	Harness Carrier	Cylinder
AIRHAWK II SCBA LOW-PRESSURE (2216 PSIG)	10095800	10095801	Ultra Elite, medium hycar, <b>rubber</b> head harness	Nylon with chest strap	30-min aluminum
	10095802	10095803	Ultra Elite, medium hycar, <b>Speed-ON</b> Head Harness	Nylon with chest strap	30-min carbon
	10095804	CALL	Adv 4000, medium hycar, <b>polyester net</b> head harness	Nylon with chest strap	30-min aluminum
	CALL	10095805	Adv 4000, medium hycar, <b>rubber</b> head harness	Nylon with chest strap	30-min aluminum
	10095806	10095807	Adv 4000, medium hycar, <b>polyester net</b> head harness	Nylon with chest strap	30-min carbon
	CALL	10116783	No facepiece	Nylon with chest strap	No cylinder
AIRHAWK II SCBA HIGH-PRESSURE (4500 PSIG)	10116452	CALL	Ultra Elite, medium hycar, <b>Speed-ON</b> Head Harness	Kevlar with chest strap	45-min carbon low profile
	10116453	CALL	Adv 4000, medium hycar, <b>polyester net</b> head harness	Nylon with chest strap	45-min carbon low profile
	CALL	10116454	Adv 4000, medium hycar, <b>polyester net</b> head harness	Nylon without chest strap	45-min carbon
	CALL	10116781	Adv 4000, medium hycar, <b>rubber</b> head harness	Nylon without chest strap	30-min carbon
	CALL	10116782	No facepiece	Nylon with chest strap	No cylinder

### Storage Cabinets

Single-unit wall-mounting case. Chemical resistant ABS plastic case resists weathering, moisture, and corrosion to ensure SCBA stay in ready-to-use condition.

STORAGE CABINETS	10052744	Single case for SCBAs supplied with LP30, HP45, HP60 and low-profile cylinders
	10052745	Single case for SCBAs supplied with H30 cylinders only



# The Assemble-To-Order System for AirHawk II Air Mask

SCBA Type	Carrier/Harness Assembly	Lumbar Pad/Rescue Belt	Cylinder	MMR Regulator	Air-Line Options	Emergency Breathing System	Facepiece	Nosecup	Head Harness	Communications	Gauge/Integrated PASS	Case		
A2L 2216 AirHawk II Air Mask	A AirFrame, Nylon Harness, Fabric Band, Plastic Buckle, Double Pull	0 None 1 Shoulder Pad 2 Standard Lumbar Pad	0 None 1 3AL Aluminum 2 Hoop-Wound 3 30' Carbon	A Firehawk PTC, single hose, solid cover B Firehawk PTC, QC, solid cover, C Firehawk STC, single hose, solid cover D Firehawk STC, QC, solid cover S Firehawk PTC, threaded hose, solid cover T Firehawk, STC, threaded hose, solid cover	0 None 1 Snap-Tite Aluminum 2 Hansen SST 3 Hansen Brass 4 Foster Steel 5 Snap-Tite Locking Aluminum 6 Foster SST	0 None 1 Quick-Fill Shoulder Mounted 2 ExtendAire (EBS) with Dual Quick Connect Shoulder Mounted 3 Quick Fill & ExtendAire (EBS) with Dual Quick Connect	A None B Ultra Elite, hycar, Small C Ultra Elite, hycar, Medium D Ultra Elite, hycar, Large E Ultra Elite, Silicone, Small F Ultra Elite, Silicone, Medium G Ultra Elite, Silicone, Large H Advantage 4000, hycar, Small J Advantage 4000, hycar, Medium K Advantage 4000, hycar, Large L Advantage 4000, Silicone, Small M Advantage 4000, Silicone, Medium N Advantage 4000, Silicone, Large	0 None 1 Medium 2 Large	0 None 1 Ultra Elite, rubber, less neck strap 2 Ultra Elite, Speed-ON less neck strap 3 Ultra Elite, rubber, with neck strap 4 Ultra Elite, Speed-ON with neck strap 5 Advantage 4000, rubber 6 Advantage 4000, poly net 7 Advantage 4000, Kevlar net	A None B Clear-Command ready C Amp D Amp/RI	A Pressure Gauge B ICM Tx with Heat Sensor C ICM Tx without heat sensor D ICM TxR with heat sensor E ICM TxR without heat sensor F Pressure Gauge with HUD G ICM Tx with heat sensor with HUD H ICM Tx without heat sensor with HUD J ICM TxR with heat sensor with HUD K ICM TxR without heat sensor with HUD L HUD Only	0 None 1 Hard case 2 Soft case		
	A2H 4500 AirHawk II Air Mask	D AirFrame, Nylon Harness, Steel Band, Plastic Buckle, Double Pull, W/Chest Strap	C Rescue Belt, Long, 50 Ft. Rope E Rescue Belt, Swiveling, Standard, 50 Ft. Rope G Rescue Belt, Swiveling, Long, 50 Ft. Rope J Rescue Belt, Mid-Size, 50 Ft. Rope L Rescue Belt, Swiveling, Mid-Size, 50 Ft. Rope	0 None 1 30' Carbon 2 45' Carbon 3 45' Carbon Low-Profile 4 60' Carbon 5 30' Carbon less air 6 45' Carbon less air 7 45' Carbon Low-Profile less air 8 60' Carbon less air	Firehawk slide regulators are not compatible with Advantage 4000 Facepiece	Cannot use air-line option if rescue belt is chosen								
		E AirFrame, Kevlar Harness, Fabric Band, Plastic Buckle, Double Pull												
		F AirFrame, Kevlar Harness, Fabric Band, Plastic Buckle, Double Pull, W/Chest Strap												
		G AirFrame, Kevlar Harness, Steel Band, Plastic Buckle, Double Pull												
		H AirFrame, Kevlar Harness, Steel Band, Plastic Buckle, Double Pull, W/Chest Strap												
		J AirFrame, Reflective Kevlar Harness, Steel Band, Metal Buckle, Single Pull												
		K AirFrame, Reflective Kevlar Harness, Steel Band, Metal Buckle, Double Pull												
		L AirFrame, Reflective Kevlar Harness, Steel Band, Metal Buckle, Single Pull, W/Chest Strap												
		M AirFrame, Reflective Kevlar Harness, Steel Band, Metal Buckle, Double Pull, W/Chest Strap												

Options J and L can only be chosen if a rescue belt option is selected

NIOSH Approved.  
Non NFPA Compliant.

QUANTITY

PART NUMBER

Note: Standard Rescue Belt fits waist sizes up to 54 inches. Long Rescue Belt fits waist sizes up to 74 inches.

# Self-Contained Breathing Apparatus (SCBA)

## FireHawk® M7 Air Mask

This advanced air mask features seven life-safety design components, providing the highest quality and protection against fire ground hazards. It is the highest quality SCBA available and is virtually bulletproof against fire ground hazard. Lightweight and easy to use, it's a stellar performer against impact, water ingress, temperature extremes (up to 500°F), and Chemical Warfare agents—giving firefighters a lifesaving edge.

### Features and Benefits

- Patented PASS alarm performs at 500°F
- Lightweight and low-profile systems
- Facepiece cross-contamination check-valve
- Palm-sized regulators
- Comfortable Ultra Elite Facepiece
- Thermal alarm
- Time-remaining display
- Front and rear buddy lights
- Auto-dim HUD
- Large, drag-carrying handles
- Stainless steel cylinder band with cam-lock system

### Approvals and Certifications

NIOSH 42 CFR, Part 84 NIOSH CBRN NFPA 1981-2007 and NFPA 1982-2007 standards

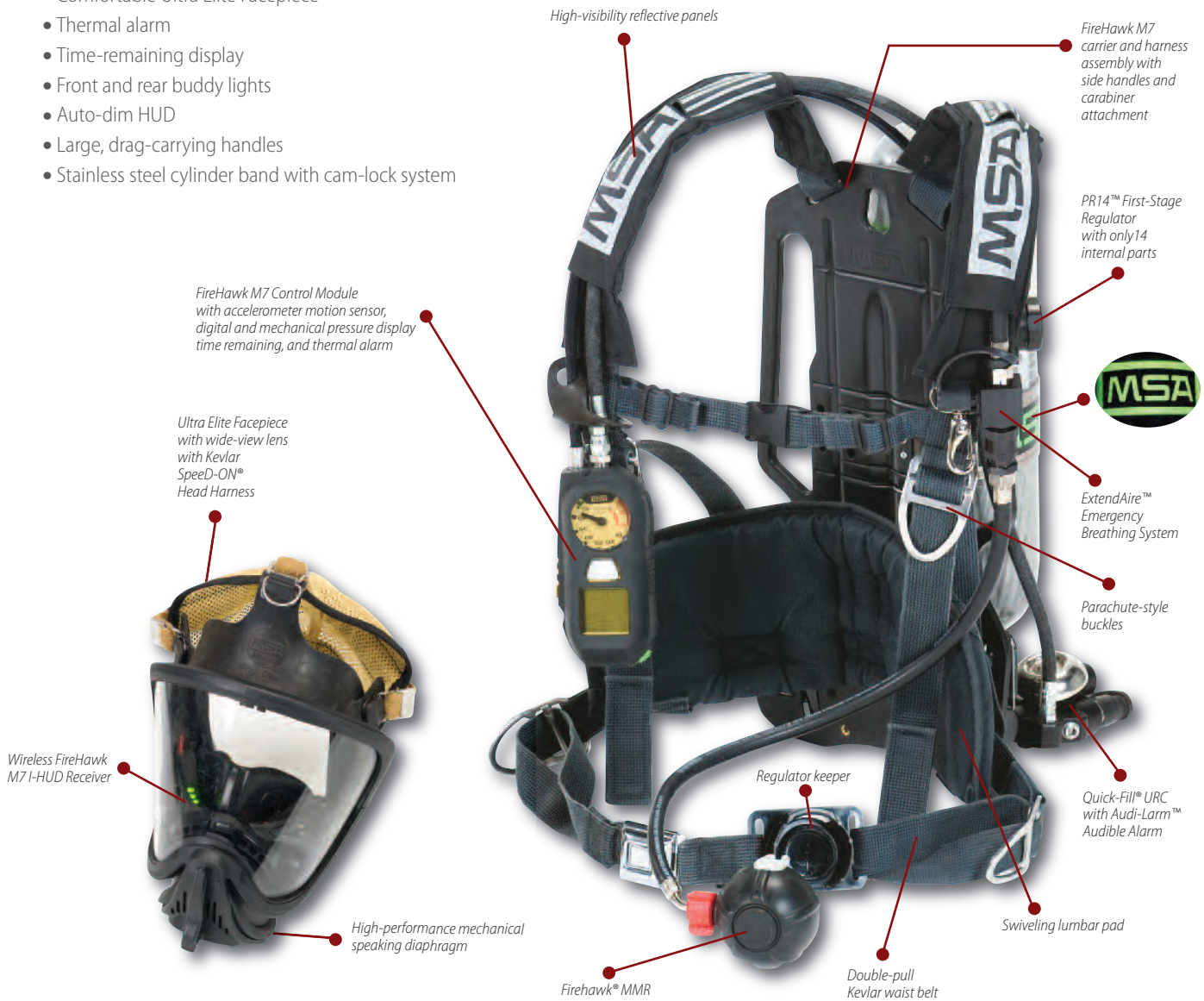

## The Assemble-To-Order System for FireHawk M7 Air Mask

Air Mask Pressure	Carrier/Harness Assembly	Lumbar Pad/Rescue Belt	Cylinder	MMR Type	Emergency Breathing System	Ultra Elite Facepiece	Nosecup	Head Harness	Communications	Gauge/Intergrated PASS	Heads-Up Display	Case	
L 2216	A Single Pull without chest strap B Single Pull with chest strap C Double Pull without chest strap D Double Pull with chest strap	0 None 1 Swiveling Lumbar Pad G Rescue Belt II w/hook, 50' H Rescue Belt II w/carabiner, 50' J Rescue Belt II w/hook, FireTech rope, 50'	0 None 1 3AL Aluminum with air 3 30' Carbon with air 4 3AL Aluminum, less air 6 30' Carbon, less air	A CBRN Firehawk STC, threaded B CBRN Firehawk STC, QC C CBRN Firehawk PTC, threaded D CBRN Firehawk PTC, QC	0 None 1 Quick-Fill 2 ExtendAire I 3 Quick-Fill and ExtendAire I A ExtendAire II B ExtendAire II with Quick-Fill C ExtendAire I & II D ExtendAire I & II with Quick-Fill	A None B hycar, Small C hycar, Medium D hycar, Large	0 None 1 Medium 2 Large	0 None 2 Speed-ON less neck strap 4 Speed-ON with neck strap	A None B Clear-Command ready with bracket C Clear-Command Amp D Clear-Command Amp/RI	A Pressure Gauge and HUD Transmitter B PASS with thermal alarm activated C PASS without thermal alarm activated D PASS, telemetry and thermal alarm E PASS, telemetry without thermal alarm	A M7 HUD B M7 I-HUD	0 None 1 Hard Case 2 Soft Case 3 Black Bag for Facepiece 4 Hard Case with Black Bag for Facepiece 5 Soft Case with Black Bag for Facepiece 6 Red Bag for Facepiece 7 Hard Case with Red Bag for Facepiece 8 Soft Case with Red Bag for Facepiece	
M 3000	Options A and B can only be chosen if a rescue belt option is selected	If choosing a rescue belt, the carrier/harness assembly must be a single pull (options A or B).	0 None 1 30' Carbon with air 2 30' Carbon less air	If choosing an ExtendAire option, the MMR type must be a QC (option B or D).	If choosing an Air Mask Pressure M, M is not compatible with Quick-Fill.								
H 4500			0 None 1 30' Carbon with air 2 45' Carbon with air 3 45' Carbon Low-Profile with air 4 60' Carbon with air 5 30' Carbon less air 6 45' Carbon less air 7 45' Carbon Low-Profile less air 8 60' Carbon less air										
B-M7													QUANTITY

NFPA 1981 and 1982-2007 edition compliant  
NIOSH 42 CFR Part 84 CBRN certified

*Value Configurations Option*

### FireHawk M7 Air Mask Less Pass

Your answer for basic, rugged, reliable SCBA protection at lower cost for applications where no PASS device is needed. All pneumatic and electronic components are the same as that of MSA's trusted FireHawk M7 Air Masks. The FireHawk M7 Value Air Mask meets NFPA 1981 and can be retrofitted for an integrated PASS device if needed. This SCBA meets NFPA 1981 and 1982 when a PASS device is added.

	Low Pressure	High Pressure	
FIREHAWK M7 LESS PASS	10121712	10121714	Double-pull harness, CBRN solid cover, slide-to-connect with threaded hose, pressure gauge, W/O PASS
	10121713	10121715	Double-pull harness, CBRN solid cover, push-to-connect with threaded hose, pressure gauge, W/O PASS

# Self-Contained Breathing Apparatus (SCBA)

## Facepiece Assemblies for FireHawk M7 Air Masks



### Ultra Elite Facepiece

Combining state-of-the-art features with MSA's precision engineering, the Ultra Elite Full-Face mask is our top model in this range. The ergonomic design makes this a comfortable unit, while the 5-point harness makes it easy to put it on or take it off. The distortion-free coated lens provides a wide field of vision, while the unique airflow prevents lens misting. The face blank has a single-sealing flange and comes in rubber or silicone, while the speaking diaphragm makes communication easy.

### Features and Benefits

- State-of-the-art mask provides excellent comfort and protection
- Distortion-free lens allows wide field-of-view
- 5-point harness allows easy on/off
- More than 40 different models include rubber and silicone versions
- Unique airflow prevents lens misting



### Firehawk® MMR

The Firehawk Second-Stage Regulator features a unique Slide-To-Connect (STC) attachment system that allows firefighters to hang the regulator on the facepiece in the "ready position," then simply push it into the facepiece when SCBA air is needed. Two large release buttons automatically turn off the flow of air as the regulator is doffed. A dual-swivel feature on the pressure hose provides maximum freedom-of-head movement and the silicone hose material ensures hose flexibility even at very cold temperatures.

In addition to the STC system, MSA also offers a second connection option for the Firehawk Regulator, the Push-to-Connect (PTC). The PTC's Adapter self-centers the Firehawk Regulator and the loud dual sound of the regulator engaging onto the facepiece provides you with confidence that the Firehawk PTC is securely attached to your facepiece—an action that takes just seconds.

### Ordering Information

	Small	Medium	Large	
ULTRA ELITE M7 FACEPIECE with Firehawk STC MMR Regulator	10084689	10084823	10084827	Speed-ON Head Harness, nosecup and FireHawk M7 HUD bracket, standard speaking diaphragm
	10084821	10084825	10084829	Speed-ON Head Harness, nosecup and FireHawk M7 HUD bracket, ClearCommand ready
ULTRA ELITE M7 FACEPIECE with Firehawk PTC MMR Regulator	10084690	10084824	10084828	Speed-ON Head Harness, nosecup and FireHawk M7 HUD bracket, standard speaking diaphragm
	10084822	10084826	10084830	Speed-ON Head Harness, nosecup and FireHawk M7 HUD bracket, ClearCommand ready
SPARE/ REPLACEMENT M7 HUD	10091446	FireHawk M7 HUD		
	10091447	FireHawk M7 HUD with bracket		



### MSA M7 I-HUD Receiver for FireHawk M7 Air Mask

- Wireless M7 I-HUD Receiver contoured shape fits securely inside firefighter's Ultra Elite Facepiece
- Nearly 40% lighter than external M7 HUD Receiver
- Placement inside facepiece eliminates snag point
- Unit automatically awakes and sleeps based upon pairing with SCBA
- Wireless magnetic radio transfers actual SCBA data via IEEE 802.11 network
- Enhanced light pattern for safety and security differentiation
- Displays SCBA cylinder pressure in quarter-cylinder increments
- If telemetry-equipped PASS device is used, M7 I-HUD Receiver displays evacuation alarm
- Red "buddy lights" in three locations alert other firefighters to low cylinder pressure, or motion alarm
- Powered by single, disposable CR2 lithium battery
- Low battery condition displays via single LED flash on display's left side; low battery SCBA condition displays as double flash
- TEST function button to verify functionality before use

### Durability Testing

- M7 I-HUD Receiver survives two-meter drop test when mounted inside Ultra Elite Facepiece
- IP67-rated to withstand extreme hot and cold environments
- Vibration testing to NFPA 1981 standards
- Protection against short-time water submersion for thorough facepiece cleaning

Note: M7 I-HUD Receiver is not compatible for use with FireHawk M7 Less PASS SCBA.

### Ordering Information

M7 I-HUD RECEIVER	10114190	Receiver, M7 I-HUD (for use with Ultra Elite Facepieces equipped with Hycar Rubber Nosecups)		
	Small	Medium	Large	
M7 I-HUD RECEIVER-READY FACEPIECE ASSEMBLIES	10121716	10121720	10121724	Standard I-HUD Receiver-ready
with Firehawk STC MMR Regulator	10121718	10121722	10121726	ClearCommand System-ready
M7 I-HUD RECEIVER-READY FACEPIECE ASSEMBLIES	10121717	10121721	10121725	Standard I-HUD Receiver-ready
with Firehawk PTC MMR Regulator	10121719	10121723	10121727	ClearCommand System-ready



### ClearCommand® Communications System

MSA's ClearCommand Communications System features an internally mounted microphone coupled with a large-diameter (50mm) amplified speaker for optimal clarity and volume. Using a proprietary circuit design, the system delivers more than twice the volume of a facepiece alone. The ClearCommand System doesn't block vision or mechanical communication. The Ultra Elite Facepiece's mechanical speaking diaphragm is still fully functional, even with the system installed.

# Self-Contained Breathing Apparatus (SCBA)

## Cylinders



### Ordering Information

CARBON-WRAPPED CYLINDERS	807586	L-30*, 30-minute NIOSH service life rating, 2216 psig, weight (empty): 8 lb. 0 oz.
	816115	L-30+*, 30-minute NIOSH service life rating, 3000 psig, weight (empty): 9 lb. 8 oz.
	10127944-SP	H-30SL*, SuperLite, 30-minute NIOSH service life rating, 4500 psig, weight (empty): 6 lb. 9 oz.
	807570	H-45*, 45-minute NIOSH service life rating, 4500 psig, weight (empty): 9 lb. 7 oz.
	10127945-SP	H-45SL, SuperLite, 45-minute NIOSH service life rating, 4500 psig, weight (empty): 8 lb. 8 oz.
	10127946-SP	H-60SL*, SuperLite, 60-minute NIOSH service life rating, 4500 psig, weight (empty): 10 lb. 12 oz.
FIBERGLASS HOOP-WOUND CYLINDER	469619	30-minute NIOSH service life rating, 2216 psig, weight (empty): 13 lb. 0 oz.
ALUMINUM CYLINDER	809872	30-minute NIOSH service life rating, 2216 psig, weight (empty): 18 lb. 0 oz.

NOTE: All weights shown are approximate. \*These cylinders are capable of custom options.

## Emergency Egress System: MSA Rescue Belt II System



Rappel to safety with this innovative, quick-release device for emergency egress. Ergonomically contoured, it easily stores rescue rope, hook or carabiner and descender. Ideal for extreme conditions, it features a web management system that also integrates a regulator holder. One belt fits all (up to 310 pounds, including equipment).

### Features & Benefits

- Single-handed pouch opening for rapid deployment of hook and descender
- Ergonomically contoured rope lumbar pad for handling ease and comfort
- Durable Ara-Shield construction
- Low-profile steel D-ring for positioning attachment
- 10- and 15-foot end markers
- Termination knot easily releases under load, even with gloved hands
- Quick-release system for SCBA drop in emergency situations
- No special tools or training required

### Ordering Information

RESCUE BELT II SYSTEM <i>For FireHawk M7 Air Mask</i>	10119369	with 50-ft aramid/nylon rope and Crosby hook
	10119370	with 50-ft aramid/nylon rope and carabiner
	10119391	with 50-ft FireTech 32 rope and Crosby hook
	10119392	with 50-ft FireTech 32 rope and carabiner
RESCUE BELT II SYSTEM <i>For FireHawk Air Mask</i>	10119393	with 50-ft aramid/nylon rope and Crosby hook
	10119394	with 50-ft aramid/nylon rope and carabiner
	10119395	with 50-ft FireTech 32 rope and Crosby hook
	10119396	with 50-ft FireTech 32 rope and carabiner



## FireHawk M7 Carrier and Harness Assembly



The one component of any SCBA that has the most impact on firefighter comfort is the carrier and harness assembly. The FireHawk M7 Carrier and Harness assembly places an emphasis on firefighter comfort while maintaining the robustness and reliability that is expected in the fire service. The carrier comes standard with large side handles and a central attachment point for pulling firefighters to safety in rescue scenarios. The swiveling lumbar pad provides maximum freedom of movement and comfort when crawling or climbing.

The assembly utilizes the proven components from previous generations of air masks such as the tunneled shoulder straps for hose containment, and tri-bar slides for easy removal/installation of the waist belt and shoulder straps. All units are equipped with double-pull waist belts and an optional chest strap is available.

### Ordering Information

FIREHAWK M7 CARRIER AND HARNES ASSEMBLIES	10086663	Low-pressure, with chest strap and swiveling lumbar pad
	10086662	High-pressure, with chest strap and swiveling lumbar pad
	10086664	Low-pressure, with chest strap
	10086665	High-pressure, with chest strap
ACCESSORIES	10083134	Replacement FireHawk M7 lumbar pad
	10012167	Chest strap kit

## Field Maintenance and Repair

MSA offers a complete program for maintenance and repair of MSA air masks. The program is supported with personalized training tailored to customers' needs and taught in the field by MSA-authorized personnel.

User maintenance covers procedures necessary to conduct general cleaning, inspection, and limited maintenance in accordance with the Occupational Safety and Health Administration (OSHA), National Fire Protection Association (NFPA), and the American National Standards Institute (ANSI) standards.

C.A.R.E. Certified Air Mask Repair Education covers all maintenance for both low- and high-pressure SCBA. Air Mask inspection and maintenance can be performed by MSA or a factory-authorized service center. Or, individuals can obtain training for C.A.R.E. certification from MSA. By having a C.A.R.E.-certified technician on staff, fire departments and other facilities with a large number of Air Masks can perform all inspection and maintenance in-house.

- All repairs and maintenance can be done in the field.
- A selection of overhaul kits, spare parts, and tool kits is available.
- Users may conduct periodic performance testing using an authorized MSA regulator tester.



# Self-Contained Breathing Apparatus (SCBA)

## MSA Accountability System



MSA's FireHawk M7 Accountability System revolutionizes fireground safety by combining the latest computer software with a high-performance radio module and the field-proven technology of MSA's ICM TxR Integrated PASS.

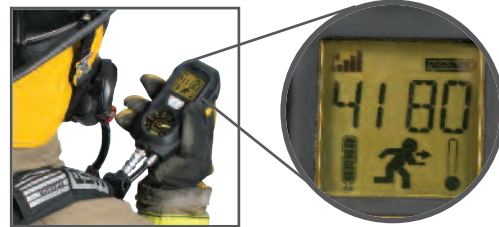

### A new way to monitor vital information

- Each MSA base station can monitor up to 50 firefighters, and you can use multiple base stations on a single computer.
- The FireHawk M7 Air Mask with telemetry transmits to incident command the firefighter's name, team assignment, cylinder pressure, service-time remaining, PASS alarms (motion or manual), thermal alarms, battery status, radio connectivity, and evacuation acknowledgement.

### A fireground management system

- Personalized ID tags for each firefighter tell incident command exactly who is on scene.
- An integrated PAR (personnel accountability report) timer helps manage radio calls to each team.
- Incident command can manually add firefighters who are not wearing an SCBA or mutual aid firefighters, so all personnel can be accounted for.

### Intuitive and easy to use

- Assign firefighters to teams by clicking on a firefighter's icon and dragging it to another team.
- A volume of critical information is available at a glance of the screen, due to the large number of firefighters that can be displayed and the pictorial format of the information.
- Receive both audible and visual indications of critical events such as PASS alarms or low-pressure alarms.

### A two-way evacuation feature

- An individual firefighter, a team of firefighters, or all firefighters can be evacuated with the click of a button.
- When incident command transmits the alarm through the FireHawk M7 Air Mask, they'll know the firefighter received it, because the unit automatically sends a confirmation message to the base station.
- Firefighters will hear the evacuation alarm on their own personal PASS device. Also, visual indications in the HUD and an icon on the control module will alert the firefighter that it is time to evacuate.
- By simply pressing a button on the control module, a firefighter can send a manual confirmation to acknowledge that they have received and understand the critically important evacuation message.
- Although certain concrete and steel commercial structures can challenge any radio signal, MSA's Accountability System coverage with radio technology provides highly reliable performance for a 1-mile line-of-sight range.
- Due to the spread-spectrum design, it does not interfere with other high-band radio frequency equipment.
- For additional safety, both base station and firefighter modules have an icon message to inform users if a firefighter falls out of radio signal range, so that alternate accountability measures, such as voice contact with teammates, can be taken.

## Ordering Information

ACCOUNTABILITY SYSTEM BASE STATION KITS	10072240	Accountability Base Station Kit (includes software, magnetic antenna kit, USB cable, wall-mount cable, and 8-24 volt power cable)
	10098767	Accountability Base Station Kit (includes software, fixed antenna kit, USB cable, wall mount cable, and 8-24 volt power cable)
ACCOUNTABILITY SYSTEM	10083876	M7 Control Module Reader / M7 ID tag writer
	10083875	M7 ID tags
	10075756	Antenna kit with magnetic base
	10098766	Antenna kit with fixed base
	10063880	USB cable
	10049410	8-24 volt, power cable
	10047342	Wall mount power cable

## Emergency Breathing Systems



### The Quick-Fill® System

The patented Quick-Fill System lets MSA air mask users refill and transfill air cylinders while the SCBA is worn, without removing the air cylinder—even in IDLH atmospheres. Use this MSA-exclusive option to:

- Fill an SCBA cylinder from a mobile compressor or cascade system in less than a minute.
- Transfill between two cylinders, providing an Emergency Breathing System.
- Extend the air supply over longer durations, using a remote compressed-air source.

Because performance is not affected, MSA air masks retain NIOSH certification during use of the Quick-Fill System.

Air masks compliant to recent NFPA standards have the Quick-Fill URC fitting located at the Audi-Larm warning device. A Quick-Fill hose with a quick-disconnect connects the air source to the adapter for air transfer. See Bulletin 0105-92-MC for a Question & Answer overview of Quick-Fill Systems.

### Ordering Information

QUICK-FILL SYSTEM REPLACEMENT PARTS	10111642	Quick-Fill Hose Kit in Pouch, 3-foot emergency transfill hose
	485331	Emergency transfill hose, less Kevlar pouch
	10111404	Replacement Pouch for Quick-Fill or ExtendAire II
	485391	Male stainless steel quick-disconnect with SAE-10 thread, complete with dust cover (also for use as a fitting for customized refilling systems)
	485392	Female quick-disconnect with SAE-4 thread, complete with dust cover

	25 ft	12 ft	10 ft	8 ft	6 ft	3 ft	
QUICK-FILL HOSES	485332	802690	802689	802688	802687	485331	FQD x FQD
	487907	802677	802675	802673	802671	492796	FQD x CGA-347 Outlet
	487909	802685	802683	802681	802679	487427	FQD x CGA-347 CN
	487906	802704	802703	802702	802701	802705	FQD x SAE-4
	487908	802678	802676	802674	802672	492797	FQD x CGA-346 Outlet
	487910	802686	802684	802682	802680	487428	FQD x CGA-346 CN

25-ft lengths are stocked; other "custom lengths" are available on a special material basis. All SAE Fittings are for high-pressure service. Female quick-disconnect fittings have dust covers.



### RescueAire™ II Portable Air-Supply System

The RescueAire II Portable Air-Supply System is designed to meet the needs of Rapid Intervention Teams (RITs). The system consists of a lightweight Carbon-Wrapped cylinder, Quick-Fill emergency breathing system, ExtendAire™ emergency breathing system, and an MMR regulator, supported by a flame- and heat-resistant harness. The RescueAire II is a complete system that can provide emergency breathing air for most any victim and is available in both low-pressure (2215 psig) and high-pressure (4500 psig) versions.

### Ordering Information

RESCUEAIRE II PORTABLE AIR-SUPPLY SYSTEM <i>Low-pressure (2215 psig)</i>	10100096	RescueAire II, w/Firehawk Responder MMR and L-30 cylinder
	10041196	RescueAire II, Firehawk STC MMR and L-30 cylinder
	10041230	RescueAire II, Firehawk PTC MMR and L-30 cylinder
	10100095	RescueAire II, w/Firehawk Responder MMR, less cylinder
	10041198	RescueAire II, Firehawk STC MMR, less cylinder
RESCUEAIRE II PORTABLE AIR-SUPPLY SYSTEM <i>High-pressure (4500 psig)</i>	10041232	RescueAire II, Firehawk PTC MMR, less cylinder
	10100097	RescueAire II, w/Firehawk Responder MMR and H-60 cylinder
	10041195	RescueAire II, Firehawk STC MMR and H-60SL cylinder
	10041199	RescueAire II, Firehawk PTC MMR and H-60SL cylinder
	10100094	RescueAire II, w/Firehawk Responder MMR, less cylinder
	10041197	RescueAire II, Firehawk STC MMR, less cylinder
10041231	RescueAire II, Firehawk PTC MMR, less cylinder	

# Self-Contained Breathing Apparatus (SCBA)

## The ExtendAire™ I and II Systems



The ExtendAire™ System



The ExtendAire II System upgrade

The ExtendAire System can be used as both an emergency breathing system and a dual-purpose device for MMR SCBA to allow firefighters to quickly and easily connect to an air-line.

The new ExtendAire II offers an integrated rescue hose into the PR14 First-Stage Regulator with both a male and female quick-connect fitting.

### Ordering Information

THE EXTENDAIRE I AND II SYSTEMS	812958	ExtendAire Air-line Hose with foster plug
	812973	40" Rescue Hose
	10031798	ExtendAire Upgrade Kit for Threaded Firehawk MMR
	10031797	ExtendAire Upgrade Kit for Quick-Connect Firehawk MMR
	10105883	ExtendAire II Upgrade Kit for PR14 Regulator

## Technical Rescue Cart

### Cart Weight and Dimensions

Size: 35" H x 21" W x 15" D

Unit Weight: 54.5 pounds without cylinders



The Technical Rescue Cart is a steel cart with a color-designated control panel that allows one side of the panel to be used for primary respirator breathing air and one side for tool/secondary air requirements.

Two 1-hour cylinders are used to provide air for respirators. High-pressure cascade (fire truck) cylinder air is used to operate pneumatic tools.

### Features

#### Breathing-Air Segment includes:

- Two-wheeled, poly-coated steel cart, two sets of double-cylinder straps, air-line hose rack and adjustable pull handle
- Low-pressure cylinder bell alarm
- Four-outlet manifold—available with four outlet fitting options

#### Tooling-Air Segment includes:

- CGA-347 fitting to attach to an auxiliary remote high-pressure air source
- Low-pressure pneumatic alarm whistle
- Four-outlet manifold with quick-disconnects

The Technical Rescue Cart is sold without air cylinders. The following MSA cylinders can be used with the cart:

- 60-minute, H-60SL carbon-wrapped cylinder, PN 10127946-SP
- 45-minute, H-45SL carbon-wrapped cylinder, PN 10127945-SP
- 30-minute, H-30SL carbon-wrapped cylinder, PN 10127944-SP

See p. 54 for cylinder ordering information. 60-minute cylinders will provide maximum air supply.

### Ordering Information

TECHNICAL RESCUE CART	10107835	Technical Rescue Cart equipped with union adapters
	10107818	Technical Rescue Cart equipped with Snap-Tite Aluminum Quick-Disconnects
	10107820	Technical Rescue Cart equipped with Foster Steel Quick-Disconnects
	10107819	Technical Rescue Cart equipped with Hansen Brass Quick-Disconnects

## ClearCommand® Helmet Communication System



The ClearCommand Helmet Communication radio interface system improves the sending and receiving of messages—even in high-noise environments. No pressure points means the system is comfortable to wear, and the reversible boom speaker assembly lets wearers position it over either ear. The system simply snaps onto fire or industrial helmet suspension.

### Features & Benefits

- High-tech communication system improves communication
- Bone-conduction voice transmitter virtually eliminates high ambient noise
- Custom-fit speaker transmits all communication to the ear
- Easily snaps onto helmet's ratchet suspension
- Reversible boom speaker assembly for positioning over either ear

### Ordering Information

<b>HELMET MICROPHONE ASSEMBLY</b>	10042902	Helmet Microphone Assembly (includes Custom Fitted Flannel Headband Liner)
-----------------------------------	----------	--

See pp. 60–61 for lapel mics, PTTs, and accessories.

## ClearCommand® Communications System for Ultra Elite Facepieces



MSA's ClearCommand Communications System is available in two versions, amplifier and amplifier with radio interface. The systems are designed for "shared-use" of the amplifier with a unique "bus-bar" arrangement, so individual issue is not required.

The ClearCommand systems feature an internally mounted microphone coupled with a large-diameter (50mm) amplified speaker for optimal clarity and volume. Using a proprietary circuit design, the system delivers more than twice the volume of a facepiece alone. Mounted in an out-of-the-way position, the ClearCommand System doesn't block vision or mechanical communication. The Ultra Elite Facepiece's mechanical voicemitter is still fully functional, even with the system installed.

The radio interface version features the same amplifier as the amp-only version, combined with an ear-speaker for incoming radio messages and a lapel mic assembly for interface with over 100 radios. The lapel mic can be used as a component of the ClearCommand System or as a stand-alone hand mic.

Both the amplifier and radio interface models are intrinsically safe, and meet the applicable requirements of NIOSH and NFPA 1981, 2002 edition.

### Ordering Information

<b>CLEARCOMMAND SYSTEM KITS</b>	10024074	Amplifier Kit, complete with microphone
	10051290	Amplifier Radio Interface Kit, w/ microphone, less PTT
	10023055	Microphone Kit, with mounting bracket

See pp. 60–61 for lapel mics, PTTs, and accessories.

# Self-Contained Breathing Apparatus (SCBA)

## Kits for Radio Interface

Radio Brand	Lapel Mics	Standalone PTT	Radio Model
BENDIX-KING	10042938	10045707	EPH, EPI, EPU, EPV, GPH, LPH, LPI, LPU, LPX, MPH
E.F. JOHNSON	10042942	10045711	5850, 5855, 5860, 5861, 5862, FM-5852, LX-2442/2443, ZX-2452/2453
	10091194	10055501	5100 series (511x, 5133, 514x, 518x)
	10042943	10045712	VIKING CL-500/5870/5876/5877/8560/8561/8565/8566/8570/8571/8587/8591, CH-HM91
GE ERICSSON			EDACS 300P
	10068237	10070362	Jaguar 700P/700PI, P700IP/7150/7170, HT-7150S/7170T, HA8V5X
	10042933	10045702	500P, KPC
	10042934	10045703	Monogram
	10042932	10045701	GF (PACUDX), MPA, MPD, MTL, PAPST5, TPX
	10042907	10045666	LPE-50/200, MRK, PK1ZGT, PRISM, PXI-26T
			PANTHER
	10042906	10045665	PC2005, PCS
ICOM			A22, A22E, A3E
	10093301		IC-F14
	10042944	10045713	IC-2A/2AT/2AE, ICH-2/6/12/16, ICU-2/6/12/16, IC-F11/F11S/F21/F21BR/F21S
	10042946	10045715	IC-F30/30LT/40/40LT
	10058090	10067523	IC-F30GS/F30GT/F40GS/40GT
	10072223	10064623	IC-F50/F60, M88, 4161
		10045714	Side connector IC-F3GS/F3GT/F4G-2/F4GT/F12/F12S/F22/F22S
KENWOOD	10042945	10045714	Top Load IC-F3S/F4S/F10/F20
	10042941	10045710	TK-190/280/290/290K/380/390/480/481/2140/2180/3140/3180/5210/5220, NX300/300K
	10042939	10045708	TK-208/220/240/248/250/260/270/270G/272/308/320/340/350/353/360/370/372/373G/430/2100-K2/2160/2170/2200/2202/3101K/3160/3170/3173/3200/3202/3212, TH-21/25A/41/45/75/91A/2102/3102, DEMITOSS 9 (JAPAN), FREETALK LINE
	10042940	10045709	TK-230/330
KYODO	10093729	10093730	KG-209
MACOM/HARRIS	10070362	10068237	P5100/5130/7100/7150/7200
MAXON	10042908	10045667	PC-50, SP100/120/130/140, Alan HP125/425
		10061404	PL-1145/2245/5161/5164
			SP-300/310/320/330/340
	10042947	10045716	SP-2000 Series, SP-2550/2850, SL-70W
	10042948	10045717	SP-5000 Series, CP-0500 Series
MIDLAND	10042951	10045720	70-145/148/154/245/254
	10042949	10045718	70-153
			70-160B/170B/260B
	10042950	10045719	70-165/166/265/266
	10042952	10045721	70-195/295
MOTOROLA	10042903	10045662	GP-900, HT-1000, JEDI, JT-1000, MT-1500/2000, MTS-2000, MTX, MTX-838/839/2000/8000/9000 Transcript Stealth, PR1500, PTX-1200/3600, XTS-1500/2500/3000/3500/5000/5000R
	10092733	10108643	APX-6000/7000, DGP-6150+, XPR-6500/6550/6580
	10049363	10061630	270, 280, FR-50/60, T289/5100/5200/5300/5320/5400/5410/5420/5600/5620/5700/5720/5800/5820/6200/6210/6220/6250/6300/6310/6320/6400/7200
	10042904	10045663	ASTRO, SABER, MX-1000/2000/3000
	10042921	10045690	ASTRO (QD), SABER (QD)
		10059441	AXU-4100, CP-100, SP-10/21
	10053716	10057505	EX-500/560/600
	10042924	10045693	EXPO, HT-10, RADIUS P10/50
	10042930	10045699	GP-350
	10042931	10045700	GP-350 (QD)
	10042925	10045694	HT-50/90/440, RADIUS P100
	10042909	10045668	HT-600/800/810/820, MT-1000, MTX-800/810/820/900/900S, RADIUS P200/500

Continued on next page

## Kits for Radio Interface

Continued from previous page

Radio Brand	Lapel Mics	Standalone PTT	Radio Model
MOTOROLA	10042922	10045691	GP-328/329/338/339/340/360/680, HT-750/1250/1550/1550-XLS, MTX-850/850-LS/950/8250/8250-LS/9250, PR-860, PRO 5150/7150/7350/7550/9150, PTX-700/760/780
	10042923	10045692	GP-328 (QD), HT-750 (QD)/1250 (QD), PRO 5150 (QD)
	10042928	10045697	MT-500
	10042927	10045696	MX-300/310/320/340/350/360
	10042920	10045669	MX-800/840, STX Series
	10042905	10045664	AP-73, CLS Series, CP-150/200/300, CT-150/185/250/250LS/450/450LS, EP-450, GP63/68/88/300/308/2000, GTX, GTX-8250, LTS-2000, MTX-638, P110/1225, MU-21CV/21CZ, PR-400, PRO 2150/3150, SP-10/21/50, SPIRIT-111, SPIRIT-Pro, SU-21C, XTN Series, XTV-2100, XU-2100, XV-1100, XZ-1100
	10042926	10045695	VISAR
	10061629	10061630	Talk About
RELM/SMARTCOM	10042953	10045722	Minicom 3200, MPS, MPU-08B/32, MPV-08/32, WHS150 RPV-516/516A/599AT
RITRON/JOBCOM	10042954	10045723	JBX-151, JMX-100/400 Series, RTX-150/450, SST Series
STANDARD	10042935	10045704	HX-240U/V
	10042936	10045705	HX-320
	10042937	10045706	HX-381/482/580T/581T/582T/585T/587T
TAIT			Orca 5000 Series, 5011, 5021, 5030, 5035, 5040, Elan, Excel, Eclipse 2150, T-3000
TEKK	10042955	10045724	T-20/40/50/60
UNIDEN	10042956	10045725	SPH Series, SPU Series
	10042957	10045726	SPS-310T/320TS
VERTEX	10058088	10073293	VX-2R/160/180/210/417/420/424/427
YAESU-VERTEX	10042958	10045727	FT-11R/41R/416/816, FTH-2005/2008/2009/7005/7008/7009
	10042962	10045779	FT-76
	10042960	10045729	FTH-2070
	10042959	10045728	F-10/40/50, FT-50R, VX-10/300, VX-400, VXF Series
	10042961	10045730	VX-500/510
	10058089	10061244	VX-600/600U/600UB/600V/600VB/800/900

## Parts and Accessories for Communication Systems

PARTS AND ACCESSORIES	10046087	Dust Cover
	10046123	Tall Guard Ring
	10046122	Short Guard Ring
	10046120	Belt Clip Assembly, Clothes Pin Type
	10046121	O-Ring, Single-Pin Connector
	10045778	Flannel Headband Liner

# Self-Contained Breathing Apparatus (SCBA)

## APR Adapter



The APR Adapter allows users to switch from a positive-pressure facepiece to a negative-pressure air-purifying respirator. The Adapter uses MSA's comprehensive line of air-purifying cartridges; select from Advantage cartridges or our CBA/RCA canisters to protect against a multitude of airborne contaminants.

The APR Adapter is designed for use in non-IDLH environments and is NIOSH-approved. Contact MSA for more information.

### Ordering Information

	Firehawk MMR STC Version	Firehawk MMR PTC Version	
APR ADAPTERS	10032511	10040052	APR Adapter
	10032927	10040055	APR Adapter Individual Kit
	10032925	10040054	APR Adapter Truck Kit
ACCESSORIES	10037809	Ultra Elite Facepiece, Anti-Fog Applique (10/pkg)	
	817590	CBA/RCA Canisters (box of 6)	
	809858	Replacement Baffle	
	813341	Replacement Bayonet Cover	
FIT TEST ADAPTER KITS	10107229	APR Fit Test Adapter Kit, Slide-to-Connect	
	10107256	APR Fit Test Adapter Kit, Push-to-Connect	

## Cleaning Accessories



### Ordering Information

CLEANING ACCESSORIES	10009971	MSA Confidence® Plus Germicidal Cleaner, 32 oz. bottle
	697383	Box of 100 individually wrapped towelettes, 7-1/4" x 5"
	697382	Canister with 220 towelettes, 4-1/4" x 6"
	10022871	"The Big Ones," Box of 50 individually wrapped towelettes, 8" x 11"

## Nosecups



### Ordering Information

NOSECUPS <i>for Ultra Elite Facepieces</i>	495188	Nosecup, medium, silicone
	495189	Nosecup, large, silicone
	10126378	Nosecup, medium, hycar
	10126379	Nosecup, large, hycar



## Spectacle Kits

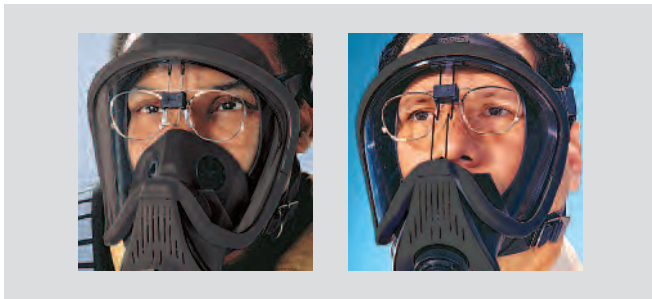

### Ordering Information

SPECTACLE KITS	804638	Ultra Elite Spectacle Kit (side wire support)
	493581	Ultra Elite Spectacle Kit (center support)

## Other SCBA Accessories

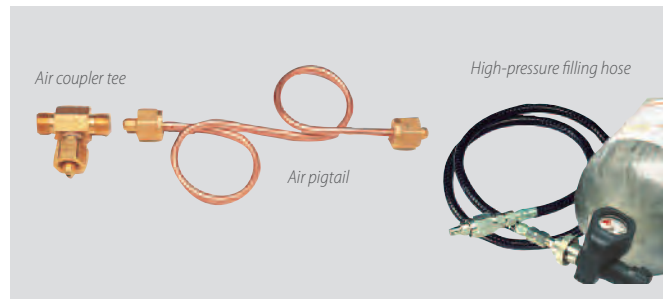

### Ordering Information

ACCESSORIES FOR FILLING LOW-PRESSURE CYLINDERS	68846	Air Outlet Connection, complete w/ Gauge
	68850	Air Coupler Tee
	68851	Air Pigtail
HIGH-PRESSURE FILLING HOSE	476156	Low-Pressure Air-Filling Hose, 5 feet long
	476105	High-Pressure Filling Hose Assembly (High-pressure filling hose provides a convenient means to connect and charge high-pressure air into a high-pressure 4500 psig cylinder)



# 5 Reasons to Choose Cairns® Helmets by MSA

We've been proudly manufacturing helmets for the fire service since 1836; first under the Gratacap banner, then as Cairns & Brothers, and now as MSA. And to this very day, when it comes to head protection, more first responders trust Cairns than any other fire helmet brand. Here are just a few reasons why:

## 1. Our helmets can take the heat.

Because Cairns Helmets are up to 66% cooler than fire helmets without an impact cap, our helmets actually reduce your stress level, which means you can make better decisions more quickly when time is of the essence.

## 2. Our helmets can take the beating.

When you consider the combined effectiveness of our helmet shell, crumple-zone front holder, impact cap, tube-lock system, suspension straps and chinstrap, our fire helmets offer the most complete impact absorption system on the market. And when you view those elements in light of our exclusive shell release system, there's simply no comparison.

## 3. Our shell release system can give you a second chance.

Suppose you are wearing any of our competitor's helmets: if that helmet is torn off your head by a structure collapse or a fall through a roof or floor, only your Nomex hood stands between your head and the chaos around you.

Frankly, you deserve better. That's why we invented shell release. In this dire situation, your Cairns impact cap is designed to separate from your helmet shell and remain on your head, shielding you from heat, debris and projectiles as you search for the nearest exit or await rescue.

## 4. Our retractable Defender® Visor loves a good challenge.

Unlike other integrated visors, only our Defender Visor is tough enough to meet NFPA 1971 and ANSI Z87.1+, yet simple enough that you can change out the lens without needing tools or requiring helmet disassembly. Plus, because the entire lens stows between our helmet shell and impact cap when it's not in use, the Defender Visor is protected from fire ground heat and debris, and it can't be lost or misplaced. No wonder it's our top-selling eye protection!

## 5. Our helmets cost less.

Although you may pay more upfront for Cairns Helmets, our helmets actually cost less than our competitors' when you account for quality, durability and ease of maintenance over their 10-year lifetime (per NFPA 1851). And when you factor in the added value of the safety features above, there's no contest.



## Traditional Structural Firefighting Helmets

### Leather Helmets

Since 1836, Cairns has been the original manufacturer of leather firefighting helmets. Today's Cairns leather helmets retain the authentic look and quality that generations of firefighters have trusted with their safety.

- Models: N5A New Yorker and N6A Houston
- Handcrafted from 100% top-grain steer hide
- Hardened by our natural resin system
- Can be custom fit with our comfort pad kit

### Composite and Thermoplastic Helmets

- Models: Cairns 1010, 1044 and 880 Tradition
- Our most popular style
- Meets NFPA 1971
- Provides superior and thermal impact protection
- Reduces risk of neck injury thanks to exclusive Shell Release System
- Available with our integral, retractable Defender Visor
- Available with DuraGlas® fiberglass composite or Ultem thermoplastic shell
- Available in a variety of colors and options



*NSA New Yorker*



*Cairns 1010 Helmet  
with Defender Visor*

## Modern Structural Firefighting Helmets

- Models: Cairns 660C, 664, HP3 and 360S/R
- Sleek, low-profile modern style
- Meets NFPA 1971
- Provides superior and thermal impact protection
- Reduces risk of neck injury thanks to exclusive Shell Release System
- Available with our integral, retractable Defender Visor
- Available with DuraGlas fiberglass composite or Ultem thermoplastic shell
- Available in a variety of colors and options



*Cairns 660C Helmet  
with Defender Visor*

## Modern Rescue Helmets

- Models: HP3 and 360R/R-13
- Sleek, low-profile modern style with no watershed
- Meets NFPA 1951
- Provides superior and thermal impact protection
- Available with our integral, retractable Defender Visor
- Available with DuraGlas fiberglass composite or Ultem thermoplastic shell
- Available in a variety of colors and options



*Cairns Commando  
HP3 Structural  
& Rescue Helmet  
with Defender Visor*

# Gas-Detection Instruments



## Portable Instrument Selection Quick Guide

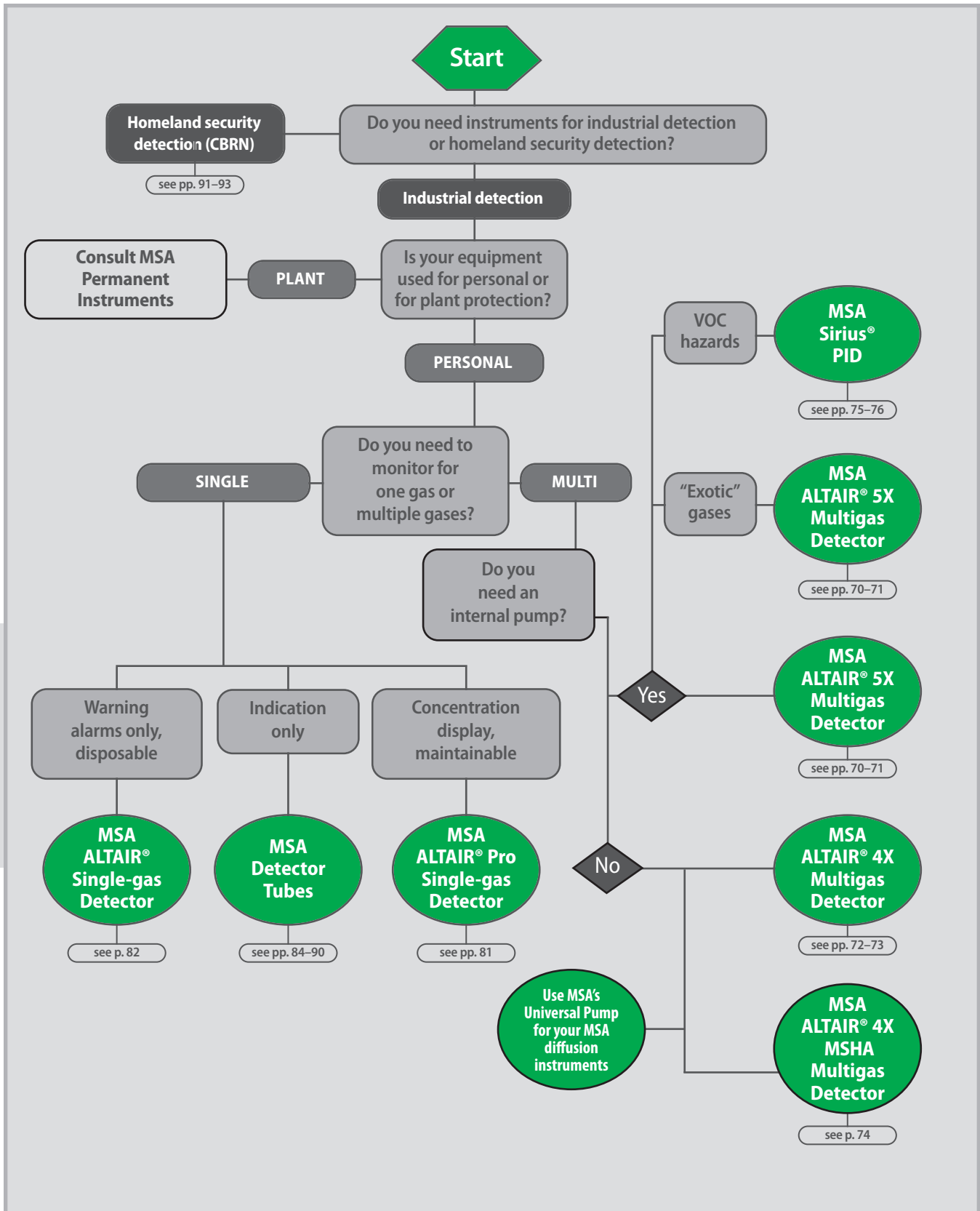

# Gas-Detection Instruments

## Understanding Environmental Surveillance

Battery-powered, direct-reading instruments are classified as two groups—**single-gas instruments** or **multiple-gas instruments**—typically monitoring one or a combination of the following atmospheric conditions:

1. *oxygen deficiency or enrichment*
2. *the presence of combustible gas*
3. *the presence of certain toxic gases*

Depending on the capabilities of the instrument, monitoring can be conducted simultaneously for oxygen and combustible gas, or for oxygen, combustible gas and toxic gases. These devices are commonly referred to as 2-in-1, 3-in-1, 4-in-1 or 5-in-1 alarms.

No matter which type of instrument is used to check environmental gas concentrations, regular monitoring should be performed because a contaminant's level of combustibility or toxicity might increase even if it initially appears to be low or non-existent. In addition, oxygen deficiency can occur unexpectedly.

### Atmospheric Composition

To determine the composition of an atmosphere, reliable instruments should be used to draw air samples. If possible, do not open the entry portal to the confined space before this step has been completed. Sudden changes in atmospheric composition within the confined space could cause violent reactions, or dilute the contaminants in the confined space, giving a false low initial gas concentration.



Figure 1



Figure 2

The results of the atmospheric testing will have a direct impact on the selection of protective equipment necessary for the tasks in the area. It may also dictate the duration of worker exposure to the environment of the space, or whether an entry will be made at all. Substance-specific detectors should be used whenever actual contaminants have been identified.

### Combustible Gases

In order for combustion to occur, there must be three elements:

1. *fuel*
2. *oxygen to support combustion*
3. *heat or a source of ignition*

This is known as the fire triangle, but if you remove any one of the legs, combustion will not occur (see *Figure 2*).

The percentage of combustible gas in the air is important, too. For example, a manhole filled with fresh air is gradually filled by a leak of combustible gas such as methane or natural gas, mixing with the fresh air. As the ratio of gas to air changes, the sample passes through three ranges: lean, explosive and rich (see *Figure 3*). In the lean range, there isn't enough gas in the air to burn. On the other hand, the rich range has too much gas and not enough air. However, the explosive range has just the right combination of gas and air to form an explosive mixture. Care must be taken, however, when a mixture is too rich, because dilution with fresh air could bring the mixture into the flammable or explosive range. An analogy is the automobile that won't start on a cold morning (a lean atmosphere because the liquid gasoline has not vaporized sufficiently), but can be flooded with too much gasoline (a rich atmosphere with too much

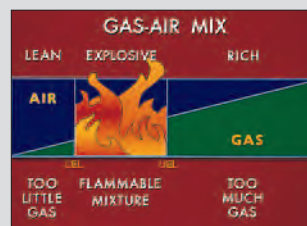

Figure 3

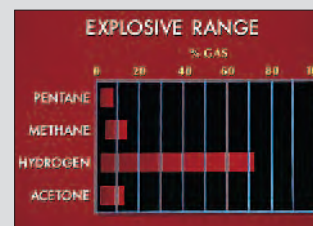

Figure 4

When testing permit-required spaces for acceptable entry conditions, always test in the following order:

1. *oxygen content*
2. *flammable gases and vapors*
3. *potential toxic air contaminants*

Comprehensive testing should be conducted in various locations within the work area. Some gases are heavier than air, and tend to collect at the bottom of a confined space. Others are lighter, and are usually in higher concentrations near the top of the confined space. Still others are the same molecular weight as air, so they can be found in varying concentrations throughout the space. This is why test samples should be drawn at the top, middle and bottom of the space to pinpoint varying concentrations of gases or vapors (see *Figure 1*).

vaporization). Eventually, when the right mixture of gas and air finally exists (explosive), the car starts.

### How Combustible Gas Monitors Work

To understand how portable combustible gas detection instruments work, it is first important to understand what is meant by the Lower Explosive Limit (LEL) and Upper Explosive Limit (UEL). When certain proportions of combustible vapors are mixed with air and a source of ignition is present, an explosion can occur. The range of concentrations over which this reaction can occur is called the explosive range. This range includes all concentrations in which a flash will occur or a flame will travel if the mixture is ignited (see *Figure 3*). The lowest percentage at which this can happen is the LEL; the highest percentage is the UEL.

Most combustible instruments display gas concentrations as a percentage of the LEL. Some models have gas readouts as a percentage by volume and others display both percent of LEL and percent combustible gas by volume. What's the difference? For example, the LEL of methane (the major component in natural gas) is 5 percent by volume, and the UEL is 15 percent by volume. If we slowly fill a room with methane, when the concentration reaches 2.5 percent by volume, it is 50 percent of the LEL; at 5 percent by volume it is 100 percent of the LEL. Between 5 and 15 percent by volume, a spark could set off an explosion.

Different gases need different percent by volume concentrations to reach 100 percent of the LEL (see Figure 4). Pentane, for example, has an LEL of 1.5 percent by volume. Instruments that measure in percent of the LEL are easy to use because, regardless of the gas, you are most concerned with how close the concentration is to the LEL.

### Single-Gas Monitors for Oxygen Deficiency

Oxygen indicators measure atmospheric concentrations of oxygen. Concentrations are generally measured over a range of 0 to 25 percent oxygen in air, with readings displayed on either digital readout or an analog meter.

Oxygen indicators are calibrated with uncontaminated fresh air containing a minimum of 20.8 percent oxygen. With some models, an alarm is activated when oxygen levels drop below 19.5 percent.

### Single-Gas Monitors for Toxic Gases

Compact, battery-powered devices can be used to measure levels of such gases as carbon monoxide (CO) or hydrogen sulfide (H<sub>2</sub>S), depending on the model selected. Toxic gas monitors use electrochemical cells (see Figure 6). If the gas of interest enters the cell, the reaction produces a current output proportional to the amount of gas in the sample. With these instruments, audible and visible alarms sound if the gas concentration exceeds a preset level. These devices are well suited for use in confined spaces containing motors or engines, which can generate large quantities of CO, as well as in sewers, waste treatment plants and "sour crude" processing stations which tend to have hazardous volumes of H<sub>2</sub>S.

### Multiple-Gas Monitors for Oxygen and Combustible Gas

In applications where it is necessary to determine oxygen and combustible gas levels simultaneously, 2-in-1 devices can be used. Sensors measure 0 to 100 percent of the LEL and oxygen from 0 to 25 percent. Remote sampling with a diffusion device requires either a pump module or an aspirator bulb adapter.

### Photoionization Devices for Toxic Gases and Vapors

A photoionization detector uses ultraviolet light to ionize molecules of chemical substances in a gaseous or vaporous state (see Figure 7). A real-time digital readout allows the user to make an immediate determination of gas and vapor concentrations. Depending upon calibration input, gas and vapors are measured over a 0.1 to 10,000 ppm scale. Some instruments automatically compensate for signal loss due to humidity, which is inherent in all PID detectors.

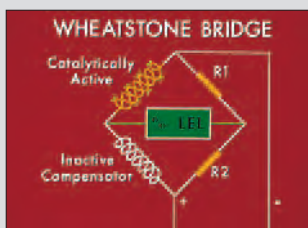

Figure 5

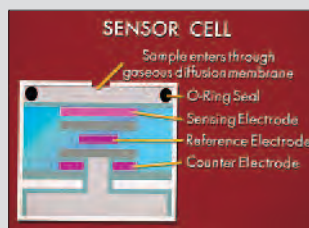

Figure 6

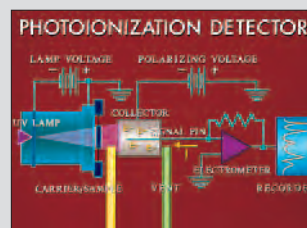

Figure 7

### Single-Gas Monitors for Combustible Gases

Single-gas instruments for monitoring combustible gases and vapors are generally calibrated on pentane and are designed for general-purpose monitoring of hydrocarbon vapors. Such instruments operate by the catalytic action of a heated platinum filament in contact with combustible gases (see Figure 5). The filament is heated to operating temperature by an electric current. When the gas sample contacts the heated filament, combustion on its surface raises the temperature in proportion to the quantity of combustibles in the sample. A Wheatstone bridge circuit, incorporating the filament as one arm, measures the change in electrical resistance due to the temperature increases. This change indicates the percentage of combustible gas present in the sample.

### Calibration

To ensure the accuracy of all monitoring and detection equipment, calibration should be performed regularly. If the instrument reading differs significantly from the values of the known standard, the instrument should not be used until it has been adjusted or, if necessary, repaired.

## ALTAIR® 5X Multigas Detector

The rugged, multi-featured ALTAIR 5X Multigas Detector boasts several options that provide maximum safety and make it easy to use in even the most demanding situations. It features large buttons for easy use, and its polycarbonate housing protects the detector from drops of up to 10 feet. The detector also boasts the exclusive MotionAlert™ Function, which lets others know if the user has become immobile, and InstantAlert™ Panic Button, a manual alarm that alerts others if a dangerous situation has arisen. Available glow-in-the-dark housing makes it easy to see in a confined space, while the large buttons and bright display makes operation possible even when the user is wearing gloves.

### Features and Benefits

- Rugged detector tests levels of LEL, O<sub>2</sub>, CO, H<sub>2</sub>S and SO<sub>2</sub>, and other toxic gases
- Rapid bump test gives results in under 15 seconds
- Versatile MSA Link™ Software allows user to transmit data to a computer
- MotionAlert option tells others that user has become immobile
- InstantAlert provides manual alarm to alert others of a dangerous situation
- Large buttons and bright display provide easy operation, even when user is wearing gloves
- Durable XCell sensors last longer than 3 years
- Rugged housing protects detector from drops of up to 10 feet
- Exclusive end-of-sensor warning cautions user when unit's sensor must be changed
- Polycarbonate housing is both dust-tight and water-tight



### Ordering Information

	Approvals/ U.S.	Approvals/ Canada	Configuration
ALTAIR 5X DETECTORS	Includes 3-year warranty, monochrome display, data logging, charger, integral pump, and tubing		
	10116924	10115118	LEL, O <sub>2</sub> , CO, H <sub>2</sub> S
	10116925	10115119	LEL, O <sub>2</sub> , CO, H <sub>2</sub> S, SO <sub>2</sub>
ALTAIR 5X DETECTOR INDUSTRIAL KITS	Includes monochrome display, integral pump, 10 ft sampling line, and 1 ft probe		
	10116926	10115120	LEL, O <sub>2</sub> , CO, H <sub>2</sub> S
	10116927	10115141	LEL, O <sub>2</sub> , CO, H <sub>2</sub> S, SO <sub>2</sub>
ALTAIR 5X DETECTOR DELUXE KITS	Includes color display, integral pump, 10 ft sampling line, and 1ft probe		
	10116928	10115142	LEL, O <sub>2</sub> , CO, H <sub>2</sub> S
	10116929	10115143	LEL, O <sub>2</sub> , CO, H <sub>2</sub> S, SO <sub>2</sub>
ACCESSORIES	10082834	USB IR receiver	
	10114837	Battery pack, Alkaline	
	10088099	MSA Link Software CD	

### Specifications

Gas Type	Range	Resolution
Combustible	0–100%	LEL 1% LEL
O <sub>2</sub>	0–30% vol	0.1% vol
CO	0–2000 ppm	1 ppm
H <sub>2</sub> S	0–200 ppm	1 ppm
SO <sub>2</sub>	0–20 ppm	0.1 ppm
Cl <sub>2</sub>	0–10 ppm	0.1 ppm
NH <sub>3</sub>	0–100 ppm	1 ppm
NO <sub>2</sub>	0–20 ppm	0.5 ppm
ClO <sub>2</sub>	0–1 ppm	0.01 ppm
PH <sub>3</sub>	0–5 ppm	0.1 ppm
HCN	0–30 ppm	0.5 ppm
CO <sub>2</sub>	0–10% vol	0.01% vol
Butane	0–25% vol	0.1% vol
Methane	0–100% vol	1% vol
Propane	0–100% vol	1% vol



MSA XCell sensors



## Assemble-To-Order (ATO) Options

To create your instrument configuration, select the instrument option codes and mark them in the boxes to the right.

<b>1</b>	<b>INSTRUMENT TYPE</b>	All ALTAIR 5X Multigas Detectors come standard with data logging and MotionAlert and InstantAlert features. Choose your instrument type, equipped with internal pump. The monochrome full-graphic display is standard; a high-resolution crystal-clear color display with logo customization is optional.	<b>Instrument Type</b> Pumped with monochrome display Pumped with color display Color and glow-in-the-dark case (unit must be configured with IR sensor)	<b>Code</b> A B H	<b>Selection</b>
<b>2</b>	<b>COMBUSTIBLE SENSOR</b>	Choose your combustible sensor calibration. To select 0-100% LEL pentane, please choose <b>L</b> ; for 0-5% Vol methane, choose <b>M</b> . For no combustible sensor, select <b>0</b> for none.	<b>Combustible Sensor Options</b> None LEL 1- 100% pentane 0-5% Vol methane	<b>Code</b> 0 L M	<b>Selection</b>
<b>3</b>	<b>SENSOR #1</b>	To have an oxygen sensor installed in your new ALTAIR 5X Multigas Detector, please select <b>K</b> ; if you plan on configuring the ALTAIR 5X Detector with two exotic sensors with CO/H <sub>2</sub> S, please select <b>1</b> for both CO and H <sub>2</sub> S sensors; for no sensor, enter <b>0</b> .	<b>Oxygen Sensor Options</b> None Oxygen 0-30% CO/H <sub>2</sub> S 0-2000 ppm and 0-200 ppm CO 0-2000 ppm H <sub>2</sub> S 0-200 ppm	<b>Code</b> 0 K 1 2 3	<b>Selection</b>
<b>4</b>	<b>SENSOR #2</b>	Choose your toxic gas sensor for the ALTAIR 5X Multigas Detector.	<b>Toxic Sensor 1 and 2 Options</b> None SO <sub>2</sub> 0-20 ppm Cl <sub>2</sub> 0-10 ppm NO <sub>2</sub> 0-20 ppm NH <sub>3</sub> 0-100 ppm PH <sub>3</sub> 0-5 ppm HCN 0-30 ppm ClO <sub>2</sub> 0-1 ppm NO 0-250 ppm	<b>Code</b> 0 A B C D E F G H	<b>Selection</b>
<b>5</b>	<b>SENSOR #3</b>	Choose your additional toxic gas sensor for the ALTAIR 5X Multigas Detector.	<b>Toxic 3 Sensor Options</b> None CO/H <sub>2</sub> S 0-2000 ppm and 0-200 ppm CO 0-2000 ppm H <sub>2</sub> S 0-200 ppm SO <sub>2</sub> 0-20 ppm Cl <sub>2</sub> 0-10 ppm NH <sub>3</sub> 0-100 ppm	<b>Code</b> 0 1 2 3 A B D	<b>Selection</b>
<b>6</b>	<b>ADVANCED SENSOR</b>	Add your IR sensor to complete your sensor suite in the ALTAIR 5X Multigas Detector. Combustible sensors are not available with CSA approvals.  * Check for availability	<b>Advanced Sensor Options</b> None CO <sub>2</sub> 0-10% Vol Butane 0-25% Vol Propane 0-100% Vol Methane 0-100% Vol	<b>Code</b> 0 B D F L	<b>Selection</b>
<b>7</b>	<b>PACKAGING</b>	For an economy plastic carrying case, choose <b>E</b> ; for red, choose <b>R</b> ; for standard carton packaging, choose <b>0</b> .	<b>Packaging Options</b> Standard carton Economy plastic Red economy	<b>Code</b> 0 E R	<b>Selection</b>
<b>8</b>	<b>APPROVAL LABEL</b>	Choose the applicable approval label for your area. For North America, choose <b>C</b> , for Europe choose <b>E</b> , for Australia, choose <b>A</b> .	<b>Approval Label Options</b> North America UL only (no catalytic combustible sensor in unit) Europe ATEX Australia	<b>Code</b> C T E A	<b>Selection</b>
<b>9</b>	<b>LOGO EXPRESS</b>	Upon startup, the ALTAIR 5X Multigas Detector can display your company logo or other information. Be sure to select color display for this option. To add your company logo, choose <b>L</b> and upload your logo to the web address which will be sent automatically to you via email. Your order with customized logo cannot be processed without uploading your logo.	<b>Logo Express Options</b> None Logo Express® Service	<b>Code</b> 0 L	<b>Selection</b>
<b>10</b>	<b>SAMPLING LINE AND PROBE KIT</b>	MSA's quality sampling lines and probes are durable, easy to use, offer high speed and convenience using our quick-connect fittings. If you are sampling Cl <sub>2</sub> , ClO <sub>2</sub> and/or NH <sub>3</sub> , please select option <b>2</b> ; for all other gases, select option <b>1</b> . For no sampling line and probe kit, select <b>0</b> .	<b>Sampling Line and Probe Kit Options</b> None 1 ft probe and 10 ft P/U line 1 ft probe and 10 ft teflon line (reactive gases)	<b>Code</b> 0 1 2	<b>Selection</b>

### Your Model Part Number

Please write in numbers from selections above in appropriate boxes and contact your Safety Products Distributor to place your order.

Selection      1      2      3      4      5      6      7      8      9      10

A-ALT5X-  -  -  -  -  -  -  -  -  -  -

# Gas-Detection Instruments

## ALTAIR 4X Multigas Detector

The ALTAIR 4X Multigas Detector surpasses industry standards in several crucial areas. Its four-year sensor life is 60% longer than the industry average, while its 24-hour run time exceeds the industry average by 71%. This versatile portable detector is a perfect match for industries ranging from fire fighting to welding, and its digital sensor output makes it less likely to suffer from RF interference. The unit features exclusive MotionAlert Function, which lets others know if the user has become immobile, and InstantAlert Panic Button, a manual alarm that alerts others of potentially dangerous situations. This rugged unit is designed to withstand a drop of up to 20 feet and uses less than half as much calibration gas as the industry average.

### Features and Benefits

- Dependable multigas detector tests for LEL, O<sub>2</sub>, CO, H<sub>2</sub>S and NO<sub>2</sub>.
- Economical construction saves users more than 50% on calibration gas, replacement sensors and maintenance
- Four-year sensor life means detector lasts 60% longer than the industry average
- Unit uses 50% less calibration gas per minute than the average detectors within the industry
- Two-tox CO/H<sub>2</sub>S sensor removes practically all cross-channel interference
- Large buttons and high-contrast screen make operation easy in low-light conditions
- Ribbed rubber housing provides secure grip and high durability
- Unit features 95+ db alarm and ultra-bright LEDs
- Exclusive end-of-sensor warning cautions user when unit's sensor must be changed
- MotionAlert option tells others that user has become immobile
- InstantAlert provides manual alarm to alert others of a dangerous situation

### Specifications

Gas Type	Range	Resolution
LEL	0–100% LEL	1% LEL
O <sub>2</sub>	0–30% vol	0.1% vol
CO	0–1999 ppm	1 ppm
H <sub>2</sub> S	0–200 ppm	1 ppm



ALTAIR 4X Multigas Detector – charcoal



ALTAIR 4X Multigas Detector – phosphorescent

### Ordering Information

ALTAIR 4X Multigas Detectors listed below come with North American approval, quick-start card, data logging, charger, calibration cap and tubing, CD manual. MotionAlert feature is now included as standard on all detectors.

ALTAIR 4X MULTIGAS DETECTORS	10107602	ALTAIR 4X Multigas Detector (LEL, O <sub>2</sub> , CO, H <sub>2</sub> S) Charcoal
	10110443	ALTAIR 4X Multigas Detector (LEL, O <sub>2</sub> , CO) Charcoal
	10110444	ALTAIR 4X Multigas Detector (LEL, O <sub>2</sub> ) Charcoal
	10107603	ALTAIR 4X Multigas Detector (Detector (LEL, O <sub>2</sub> , CO, H <sub>2</sub> S) Phosphorescent
	10110445	ALTAIR 4X Multigas Detector (LEL, O <sub>2</sub> , CO) Phosphorescent
	10110446	ALTAIR 4X Multigas Detector (LEL, O <sub>2</sub> ) Phosphorescent
SENSORS AND SPARE PARTS	10106722	Sensor Kit, XCell Ex Combustible
	10106729	Sensor Kit, XCell O <sub>2</sub>
	10106725	Sensor Kit, XCell CO/H <sub>2</sub> S two-tox
	10121213	Sensor Kit, XCell CO/H <sub>2</sub> S-LC two-tox
	10121217	Sensor Kit, XCell NO <sub>2</sub> /CO two-tox
	10110030	Front housing with integrated dust filters (Charcoal)
	10110029	Front housing with integrated dust filters (Phosphorescent)
	10106621	Main board with battery pack
	10110061	LCD frame assembly (frame, LCD, zebra strips, screws)
	10110062	Sensors gasket, Phillips screws (4x), self-tapping (2x)
10106623	CD manual, ALTAIR 4X Multigas Detector	
ACCESSORIES	10069894	Stainless steel suspender clip
	10046528	Universal Pump Probe (UL)
	10088099	MSA Link™ Software CD-ROM
	10082834	JetEye IR Adapter with USB connector
	10050333	Hand aspirator assembly
POWER SUPPLY	10086639	Charging cradle components
	10087913	North American power supply
	10092233	Charging cradle assembly
	10095774	Vehicle charger
	10127422	4-Unit multi-unit charger NA plug
	10143372	12-Unit multi-unit charger NA plug

For more accessories, please refer to page 79. See pages 94–101 for calibration accessories.

## Assemble-To-Order (ATO) Options

To create your instrument configuration, select the instrument option codes and mark them in the boxes to the right.

<b>A</b>	<b>INSTRUMENT TYPE</b>	The Altair 4X Multigas Detector comes standard with MSA's XCell Sensors and MotionAlert feature to indicate 'man-down'.	<b>Instrument Type</b> Altair 4X w/ XCell Sensors and MotionAlert feature	<b>Code</b> X	<b>Selection</b> X
<b>B</b>	<b>COMBUSTIBLE SENSOR</b>	Choose your combustible sensor calibration. To select 0-100% LEL pentane, please choose <b>L</b> ; for 0-5% Vol methane, choose <b>M</b> . For no combustible sensor, select <b>0</b> for none.	<b>Combustible Sensor Options</b> None LEL 1- 100% pentane 0-5% Vol methane	<b>Code</b> 0 L M	<b>Selection</b>
<b>C</b>	<b>OXYGEN SENSOR</b>	To have an oxygen sensor installed, please select <b>2</b> . For no sensor, enter <b>0</b> .	<b>Oxygen Sensor Options</b> None Oxygen 0-30%	<b>Code</b> 0 2	<b>Selection</b>
<b>D</b>	<b>TOXIC SENSOR</b>	To configure your new ALTAIR 4X Multigas Detector: • choose <b>0</b> for no toxic sensor • choose <b>A</b> for both CO and H <sub>2</sub> S sensors • choose <b>B</b> for CO • choose <b>C</b> for H <sub>2</sub> S • choose <b>J</b> for both NO <sub>x</sub> and CO sensors To select a low concentration H <sub>2</sub> S (H <sub>2</sub> S-LC) sensor with 0-100 ppm range and 0.1 ppm resolution: • choose option <b>G</b> for both CO and H <sub>2</sub> S-LC • choose option <b>H</b> for H <sub>2</sub> S-LC only	<b>Toxic Sensor Options</b> None 0-1999 ppm CO and 0-200 ppm H <sub>2</sub> S 0-999 ppm CO 0-200 ppm H <sub>2</sub> S 0-1999 ppm CO and 0-100 ppm H <sub>2</sub> S-LC 0-100 ppm H <sub>2</sub> S-LC 0-1999 ppm CO and 0-50 ppm NO <sub>x</sub>	<b>Code</b> 0 A B C G H J	<b>Selection</b>
<b>E</b>	<b>POWER SUPPLY</b>	Select the correct power supply for your region. Add an instrument cradle to firmly secure your instrument while charging on the shelf or on a vehicle.	<b>Power Supply Options</b> None North American European with cradle Australian with cradle North American with cradle Global	<b>Code</b> 0 N E A M G	<b>Selection</b>
<b>F</b>	<b>APPROVAL LABEL</b>	Choose the applicable approval label for your area. For Europe choose <b>E</b> , for North America choose <b>C</b> , and for Australia choose <b>A</b> .	<b>Approval Label Options</b> Europe ATEX North America Australia	<b>Code</b> E C A	<b>Selection</b>
<b>G</b>	<b>EXTENDED WARRANTY</b>	MSA includes a full 3-year warranty on the Altair 4X Multigas Detector, which includes sensors, battery and electronics. Choose <b>1</b> for an additional year (four years total).	<b>Extended Warranty Options</b> Three years standard warranty Extended warranty (four years total)	<b>Code</b> 0 1	<b>Selection</b>
<b>H</b>	<b>PACKAGING</b>	To order bulk packaging for up to 10 units, choose <b>1</b> (one instrument version per package); to order the standard single unit carton, choose <b>0</b> .	<b>Packaging Options</b> Single carton 10-unit bulk package	<b>Code</b> 0 1	<b>Selection</b>
<b>I</b>	<b>CASE COLOR OPTIONS</b>		<b>Case Color Options</b> Standard Charcoal Phosphorescent (glow-in-the-dark)	<b>Code</b> 0 G	<b>Selection</b>

### Your Model Part Number

Please write in numbers from selections above in appropriate boxes and contact your Safety Products Distributor to place your order.

Selection      **A**    **B**    **C**    **D**    **E**    **F**    **G**    **H**    **I**

A-ALT4X- X - [ ] - [ ] - [ ] - [ ] - [ ] - [ ] - [ ]

## ALTAIR 4X MSHA Multigas Detector

### Optimized for Miners

Building on years of design experience, MSA revolutionizes sensor technology with breakthroughs that improve mining application performance:

- Methane-optimized catalytic bead sensor provides increased stability over time
- Sensor response and clear times in less than 15 seconds
  - Reduces gas usage for bump testing and calibration
- Greater accuracy and repeatability within changing environmental conditions
  - Temperature, humidity and pressure
- Digital sensors offer increased RF (radio frequency) immunity
  - Eliminate false alarms from radios
- Accurate CO readings from 0-2000 ppm
- Industry-first CO/NO<sub>2</sub> combination sensor with wide range and fast response times
- Increased methane sensor poison resistance decreases down time and frequency of sensor replacements
- End-of-sensor life warning gives advanced notice of failing sensors
- Sensor life that greatly exceeds industry average

### Technical Specifications

Gas Type	Range	Resolution
CH <sub>4</sub>	0–5%	0.05%
O <sub>2</sub>	0–30% vol	0.1% vol
CO	0–1999 ppm	1 ppm
NO <sub>2</sub>	0–50 ppm	0.1 ppm
H <sub>2</sub> S	0–200 ppm	1 ppm



30 CFR Part 22, Methane Detector

30 CFR Part 75 Determination testing for methane and oxygen deficiency



ALTAIR 4X Multigas Detector



ALTAIR 4X Multigas Detector  
Optional glow-in-the dark housing for mining and confined space applications

### Ordering Information

ALTAIR 4X MSHA Multigas Detectors listed below come with 3-year warranty, data logging, charger, calibration cap, and tubing

ALTAIR 4X MSHA MULTIGAS DETECTORS	10125912	ALTAIR 4X Multigas Detector (CH <sub>4</sub> , O <sub>2</sub> , CO), charcoal case
	10125913	ALTAIR 4X Multigas Detector (CH <sub>4</sub> , O <sub>2</sub> , CO), phosphorescent case
	10125914	ALTAIR 4X Multigas Detector (CH <sub>4</sub> , O <sub>2</sub> , CO, NO <sub>2</sub> ), charcoal case
	10125915	ALTAIR 4X Multigas Detector (CH <sub>4</sub> , O <sub>2</sub> , CO, NO <sub>2</sub> ), phosphorescent case
REPLACEMENT SENSORS	10121212	XCell Ex-M Combustible Sensor
	10106729	XCell O <sub>2</sub> Sensor
	10106725	XCell CO/H <sub>2</sub> S Two-tox Sensor
ACCESSORIES	10121217	XCell CO/NO <sub>2</sub> Two-tox Sensor
	10127422	4-unit multi-unit charger NA plug
	10143372	12-unit multi-unit charger NA plug

## Assemble-To-Order (ATO) Options

To create your instrument configuration, select the instrument option codes and mark them in the boxes to the right.

<b>A</b>	<b>INSTRUMENT TYPE</b>	The Altair 4X MSHA Multigas Detector comes standard with MSA's XCell Sensors and MotionAlert feature to indicate 'man-down'. Please select your instrument's case color; select option <b>C</b> for charcoal and option <b>G</b> for phosphorescent (glow-in-the-dark).	<b>Instrument Type</b> Charcoal Phosphorescent (glow-in-the-dark)	<b>Code</b> C G	<b>Selection</b>
<b>B</b>	<b>COMBUSTIBLE SENSOR</b>	To have a methane-optimized combustible sensor installed in your new ALTAIR 4X Multigas Detector, please select <b>C</b> . For no combustible sensor, select <b>0</b> .	<b>Combustible Sensor Options</b> None 0-5% Vol methane	<b>Code</b> 0 C	<b>Selection</b>
<b>C</b>	<b>OXYGEN SENSOR</b>	To have an oxygen sensor installed, select <b>1</b> . For no sensor, enter <b>0</b> .	<b>Oxygen Sensor Options</b> None 0-30%	<b>Code</b> 0 1	<b>Selection</b>
<b>D</b>	<b>TOXIC SENSOR</b>	To further configure your new ALTAIR 4X Multigas Detector, choose <b>0</b> for no toxic sensor. Choose <b>A</b> for both CO and H <sub>2</sub> S sensors, choose <b>B</b> for CO, <b>C</b> for H <sub>2</sub> S, <b>D</b> for CO and NO <sub>2</sub> , and <b>E</b> for NO <sub>2</sub> .	<b>Toxic Sensor Options</b> None 0-1999 ppm CO and 0-200 ppm H <sub>2</sub> S 0-999 ppm CO 0-200 ppm H <sub>2</sub> S 0-1999 ppm CO and 0-50 ppm NO <sub>2</sub> 0-100 ppm NO <sub>2</sub>	<b>Code</b> 0 A B C D E	<b>Selection</b>
<b>E</b>	<b>POWER SUPPLY</b>	Select the correct power supply for your region. Add an instrument cradle to firmly secure your instrument while charging on the shelf or on a vehicle.	<b>Power Supply Options</b> None North American North American with cradle	<b>Code</b> 0 N M	<b>Selection</b>
<b>F</b>	<b>APPROVAL LABEL</b>	The ALTAIR 4X Multigas Detector is fully approved by MSHA.	<b>Approval Label Options</b> MSHA	<b>Code</b> M	<b>Selection</b> M
<b>G</b>	<b>EXTENDED WARRANTY</b>	MSA includes a full 3-year warranty on the ALTAIR 4X Multigas Detector, including sensors, battery and electronics. Choose <b>1</b> for an additional year (4 years total).	<b>Extended Warranty Options</b> Three years standard warranty Extended warranty (four years total)	<b>Code</b> 0 1	<b>Selection</b>

### Your Model Part Number

Please write in numbers from selections above in appropriate boxes and contact your Safety Products Distributor to place your order.

Selection      A      B      C      D      E      F      G  
 A-ALT4X-  -  -  -  -  -  -  -



## Assemble-To-Order (ATO) Options

To create your instrument configuration, select the instrument option codes and mark them in the boxes to the right.

<b>A</b>	<b>PHOTOIONIZATION DETECTOR LAMP OPTION</b>	To choose the standard 10.6 eV lamp for most VOC's, choose selection A.	<b>PID Lamp</b> PID with 10.6 eV Lamp (0-2000 ppm)	<b>Code</b> A	<b>Selection</b>
<b>B</b>	<b>COMBUSTIBLE SENSOR OPTION</b>	To choose to have your MSA 20L combustible sensor reading set to be displayed as 0-100% LEL, enter selection L. For a display of 0-5% methane, enter a M.	<b>Combustible Sensor</b> None LEL 1- 100% pentane 0-5% Vol methane	<b>Code</b> 0 L M	<b>Selection</b>
<b>C</b>	<b>OXYGEN SENSOR OPTION</b>	To choose tan oxygen sensor, enter selection 1. For no oxygen sensor, enter a 0.	<b>Oxygen Sensor</b> None Oxygen 0-25%	<b>Code</b> 0 1	<b>Selection</b>
<b>D</b>	<b>CARBON MONOXIDE SENSOR OPTION</b>	To choose a carbon monoxide sensor, enter selection 1. For no carbon monoxide sensor, enter a 0.	<b>Carbon Monoxide Sensor</b> None Carbon Monoxide 0-500 ppm	<b>Code</b> 0 1	<b>Selection</b>
<b>E</b>	<b>HYDROGEN SULFIDE SENSOR OPTION</b>	To choose a hydrogen sulfide sensor, enter selection 1. For no hydrogen sulfide sensor, enter a 0.	<b>Hydrogen Sulfide Sensor</b> None Hydrogen Sulfide 0-100 ppm	<b>Code</b> 0 1	<b>Selection</b>
<b>F</b>	<b>BATTERY PACK AND CHARGER OPTIONS</b>	You may choose between MSA's lithium-ion battery pack which includes a standard lithium-ion battery charger, or the convenience of an alkaline battery pack. You may also choose to have both battery pack types included with your new Sirius Multigas Detector.	<b>Battery Pack/Charger</b> None lithium-ion, includes charger and cord Replaceable alkaline Both lithium-ion and replaceable alkaline battery packs	<b>Code</b> 0 A B C	<b>Selection</b>
<b>G</b>	<b>VEHICLE CHARGER OPTION</b>	If you would like to order the vehicle charger, enter selection 1.	<b>Vehicle Charger</b> None Vehicle Charger	<b>Code</b> 0 1	<b>Selection</b>
<b>H</b>	<b>SAMPLING LINES</b>	MSA's Quick-Connect sampling lines are of the highest quality materials, guaranteed to provide accurate sampling concentrations. Sirius Multigas Detector sampling lines all include a Quick-Connect air-line fitting for easy attachment and tight seal. For sampling jet fuel, enter selection 3 for the 10' teflon sampling line option, or selection 4 for the 25' teflon sampling line option.	<b>Sampling Lines</b> None 10-foot polyurethane 25-foot polyurethane 10-foot teflon (for jet fuel sampling) 25-foot teflon (for jet fuel sampling) 3-foot polyurethane coiled	<b>Code</b> 0 1 2 3 4 5	<b>Selection</b>
<b>I</b>	<b>SAMPLING PROBES</b>	MSA's sampling probes are durable and comfortable to use. The built in Water-Stop filter ensures that your sampling system is not contaminated with dirt and debris if the probe tip is dipped in water. You must order a probe if you order a sampling line, as we strongly recommend that you operate the instrument with this filter in place.	<b>Sampling Probes</b> None 1-foot probe 3-foot probe 8-inch probe	<b>Code</b> 0 1 2 3	<b>Selection</b>
<b>J</b>	<b>CARRYING ATTACHMENTS</b>	While a high-strength stainless steel D-Ring is offered with this instrument at no extra charge, there are three other options for handling the instrument: the retractable carrying line for use with the D-Ring, the shoulder harness and the wrist harness to be used on the user's arm with a Level A suit.	<b>Carrying Attachments</b> None Retractable Carrying Line with Belt Clip Shoulder Harness Wrist Harness	<b>Code</b> 0 1 2 3	<b>Selection</b>
<b>K</b>	<b>INSTRUMENT JACKET AND BOOTS</b>	To offer the highest level of instrument protection, you may choose a protective black rubber boot and harness, or a cordura jacket. You may also order both options by choosing selection C.	<b>Instrument Jacket/Boots</b> None Black Boot with Harness Cordura Jacket with Harness Black Boot, Cordura Jacket and Harness	<b>Code</b> 0 B C D	<b>Selection</b>
<b>L</b>	<b>CALIBRATION KITS</b>	You may choose one of two calibration options for your Sirius Multigas Detector. The fixed-flow .25 lpm regulator includes a multigas calibration cylinder and also an isobutylene calibration gas cylinder if a PID selection is chosen. You may also order just the isobutylene calibration kit with gas cylinder.	<b>Calibration Kits</b> None Econo-Cal Fixed-Flow Regulator Calibration Kit (includes multigas and isobutylene cylinders) Model RP Fixed-Flow Regulator Calibration Kit (includes multigas and isobutylene cylinders) Isobutylene Calibration Kit (includes gas cylinder)	<b>Code</b> 0 1 2 3	<b>Selection</b>
<b>M</b>	<b>DATA COMMUNICATIONS</b>	If you need to track the readings and operations of your Sirius Multigas Detector, consider ordering the instrument with the optional built-in datalogging module. The option also provides TWA and STEL capabilities.	<b>Data Communications</b> None Data Link Module Data Link Module and Software Kit	<b>Code</b> 0 1 2	<b>Selection</b>
<b>N</b>	<b>PACKAGING</b>	Your new Sirius Multigas Detector may be protected by a standard black plastic case, or by a black premium field case. You may also choose the option of a long-term storage kit case for emergency response, large enough to hold the Sirius Multigas Detector, calibration cylinders, spare sensors, spare PID lamp and lithium-ion battery pack with charger, spare alkaline battery pack, lamp cleaning kit and simple-to-read and understand refresher instructions.	<b>Packaging</b> Standard shipping carton Standard black PVC case Premium black field case Long-term storage kit case Long-term storage kit basic (includes PID lamp and 4 replacement sensors)	<b>Code</b> 0 1 2 4 5	<b>Selection</b>
<b>O</b>	<b>PID LAMP CAP</b>	The standard easy-access lamp cap is included with your Sirius Multigas Detector at no extra charge. You may also choose a tamper-proof lamp cap.	<b>PID Lamp Cap</b> None Standard easy-access lamp cap Tamper-proof lamp cap	<b>Code</b> 0 S T	<b>Selection</b>

Your Model Part Number: Please write in numbers from selections above in appropriate boxes and contact your Safety Products Distributor to place your order.

Selection    **A**    **B**    **C**    **D**    **E**    **F**    **G**    **H**    **I**    **J**    **K**    **L**    **M**    **N**    **O**

A-SIRIUS-  -  -  -  -  -  -  -  -  -  -  -  -  -  -  -  -

## ALTAIR 5X Multigas Detector Accessories

SPARE PARTS/ REPLACEMENTS	10114835	Battery pack assembly, rechargeable
	10114837	Battery pack, alkaline (includes belt clip)
	10114839	Battery pack, rechargeable, IR
	10094830	Kit, belt clip replacement
	10083591	Filter cover assembly
	10114949	Maintenance kit
	10114950	Maintenance kit, Cl <sub>2</sub> , ClO <sub>2</sub> , NH <sub>3</sub>
	474555	Shoulder strap
	10050976	Retractable line with belt clip
	10040586	Carrying case, Cordura, UL only
	10099648	Holster, leather
	10099397	Vehicle charger
	10114853	Front housing with integrated filters
	10127427	Multi-unit charger, ALTAIR 5X Detector 4-unit
	CALIBRATION ACCESSORIES	710288
10034391		Cl <sub>2</sub> /NH <sub>3</sub> /ClO <sub>2</sub> Demand Regulator Kit
10050985		Kit, case with Gas Miser® Regulator, demand flow RP (includes tubing and fitting, less gas)
10041225		Calibration tubing with quick-disconnect fitting
10045035		58L RP 60 ppm CO, 20 ppm H <sub>2</sub> S, 15% O <sub>2</sub> , 1.45% CH <sub>4</sub>
10103262		58L RP 60 ppm CO, 20 ppm H <sub>2</sub> S, 15% O <sub>2</sub> , 1.45% CH <sub>4</sub> , 2.5% CO <sub>2</sub>
10117738		58L RP 60 ppm CO, 20 ppm H <sub>2</sub> S, 15% O <sub>2</sub> , 1.45% CH <sub>4</sub> , 10 ppm SO <sub>2</sub>
10048280		34L Econo-Cal® Cylinder, 60 ppm CO, 20 ppm H <sub>2</sub> S, 15% O <sub>2</sub> , 1.45% CH <sub>4</sub>
10048789		34L Econo-Cal Cylinder, 60 ppm CO, 15% O <sub>2</sub> , 1.45% CH <sub>4</sub>
10098855		34L Econo-Cal Cylinder, 60 ppm CO, 20 ppm H <sub>2</sub> S, 15% O <sub>2</sub> , 1.45% CH <sub>4</sub> , 10 ppm SO <sub>2</sub>
711068	34L Econo-Cal Cylinder, 10 ppm NO, air balance	
SAMPLING ACCESSORIES	10040665	Sampling line with quick-disconnect, 10-ft polyurethane
	10040664	Sampling line with quick-disconnect, 25-ft polyurethane
	10049058	Sampling line with quick-disconnect, 10-ft teflon
	10049057	Sampling line with quick-disconnect, 25-ft teflon
	10040667	Sampling line with quick-disconnect, 3-ft polyurethane coiled
	10105210	Sampling line with quick-disconnect for reactive gases, 5-ft polyurethane coiled
	10105251	Sampling line with quick-disconnect for reactive gases, 5-ft polyurethane straight
	10105839	Sampling line with quick-disconnect for reactive gases, 10-ft teflon straight
	10042621	Probe, 1-ft
	10042622	Probe, 3-ft
	801582	Filter, water stop, pack of 10
REPLACEMENT SENSORS	10106722	Kit, XCell Ex Sensor, combustible
	10106729	Kit, XCell O <sub>2</sub> Sensor
	10106725	Kit, XCell CO/H <sub>2</sub> S two-tox sensor
	10106375	Kit, replacement, HCN
	10106728	Kit, XCell Cl <sub>2</sub> Sensor replacement
	10080222	Kit, replacement, ClO <sub>2</sub>
	10106727	Kit, XCell SO <sub>2</sub> Sensor replacement
	10080224	Kit, replacement, NO <sub>2</sub>
	10106726	Kit, XCell NH <sub>3</sub> Sensor replacement
	10116638	Kit, replacement, PH <sub>3</sub>
	10114750	Kit, replacement, NO
	10105650	XCell Sensor plug
	10088192	Sensor plug, oxygen and toxics (20 mm)



## ALTAIR 4X Multigas Detector Accessories

CALIBRATION ACCESSORIES	467895	Regulator 0.25 lpm Model RP
	10089321	Calibration assembly (cap, tube, connector)
	10048280	34L Quad gas mix (1.45% CH <sub>4</sub> , 15% O <sub>2</sub> , 60 ppm CO, 20 ppm H <sub>2</sub> S)
	10045035	58L Quad gas mix (1.45% CH <sub>4</sub> , 15% O <sub>2</sub> , 60 ppm CO, 20 ppm H <sub>2</sub> S)
POWER SUPPLY	10086639	Charging cradle components
	10087913	North American power supply
	10092233	Charging cradle assembly
	10095774	Vehicle charger
	10127422	4-Unit multi-unit charger NA plug
ACCESSORIES	10069894	Stainless steel suspender clip
	10046528	Universal pump probe (UL)
	10088099	MSA Link™ Software CD-ROM
	10082834	JetEye IR Adapter with USB connector
	10050333	Hand aspirator assembly
SENSORS/ SPARE PARTS	10106722	Kit, XCell Ex combustible sensor
	10106729	Kit, XCell O <sub>2</sub> sensor
	10106725	Kit, XCell CO/H <sub>2</sub> S two-tox sensor
	10121213	Kit, XCell CO/H <sub>2</sub> S-LC two-tox sensor
	10121217	Kit, XCell CO/NO <sub>2</sub> two-tox sensor
	10110030	Front housing with integrated dust filters (Charcoal)
	10110029	Front housing with integrated dust filters (Phosphorescent)
	10106621	Main board with battery pack
	10110061	LCD frame assembly (frame, LCD, zebra strips, screws)
	10110062	Sensors gasket, Phillips screws (4x), self-tapping (2x)
SAMPLING LINES	10053795	5 foot polyurethane
	10053794	10 foot polyurethane
	10047370	25 foot polyurethane
	10047349	50 foot polyurethane



## Sirius Multigas Detector Accessories

BATTERY PACKS	10050347	Standard Rechargeable lithium-ion Battery Pack
	10052512	lithium-ion Battery Charger, consists of power supply and charge adapter
	10049412	Replaceable Alkaline Battery Pack
	10049098	Replaceable Alkaline Battery Pack less door
	10052513	Vehicle Charger (includes charge adapter)
SAMPLING ACCESSORIES	10040665	Sampling Line with Quick-Connect, 10' polyurethane
	10040664	Sampling Line with Quick-Connect, 25' polyurethane
	10049058	Sampling Line with Quick-Connect, 10' teflon
	10049057	Sampling Line with Quick-Connect, 25' teflon
	10040667	Sampling Line with Quick-Connect, 3' polyurethane coiled
	10042621	Probe, 1-foot
	10042622	Probe, 3-foot
PROTECTIVE JACKETS, BOOTS AND CARRYING ATTACHMENTS	10052514	Black Rubber Boot (includes harness)
	10050122	Cordura Jacket (includes harness)
	474555	Shoulder Harness only
	10050976	Retractable Carrying Line with Belt Clip
	10051803	Wrist Harness
LONG-TERM STORAGE KIT	10051176	Includes 4-Gas PID, lithium-ion and Alkaline Battery Packs, Vehicle Charger, 10' sampling line w/1' probe, retractable carrying line w/belt clip, Cordura jacket and black boot, Econo-Cal kit, Data Link w/software, 4 replacement sensors and PID Lamp, lamp cleaning kit, standard lamp cover and case
REPLACEMENT LAMPS AND SENSORS	10049692	10.6 eV Lamp
	10051717	4 Sensor Kit (LEL, O <sub>2</sub> , CO, H <sub>2</sub> S)
	10049808	Combustible Sensor (both LEL and CH <sub>4</sub> )
	10049806	Oxygen Sensor
	10049804	Carbon Monoxide Sensor
	10049805	Hydrogen Sulfide Sensor
	10049807	Long-Term Storage Oxygen Sensor (hermetically sealed for 2-year storage)
ACCESSORIES	10047463	Disposable Ionization Chamber
	10049691	Lamp Cleaning Kit
	10049680	Filter Replacement Kit with O-rings and replacement dust filters
	10050841	Standard Lamp Cover
	10050750	Tamper-Proof Lamp Cover
	636913	Sirius Multigas Detector Screwdriver
	10054667	Sirius Multigas Detector Instructional CD
	10050856	Sirius Multigas Detector Instructional Video
	10048887	Instruction Manual
CARRYING CASES	710948	Standard Black Plastic Case
	10052515	Premium Black Field Case w/foam insert
	10020541	Standard Red Plastic Case
	10051539	Long-Term Storage Kit Case with labeled foam insert

## Solaris MSHA Multigas Detector Accessories

SENSORS	10046944	Replacement CO Sensor
	10046945	Replacement H <sub>2</sub> S Sensor
	10059040	Replacement NO <sub>2</sub> Sensor
	10046946	Replacement O <sub>2</sub> Sensor
	10046947	Replacement Combustible Sensor
	10049406	4 Sensor replacement kit (CO, H <sub>2</sub> S, O <sub>2</sub> , Comb)
	10059039	4 Sensor replacement kit (NO <sub>2</sub> , CO, O <sub>2</sub> , Comb)
CARRYING CASES	10049053	Cordura Jacket (Orange)
	10054586	Cordura Jacket (Black w/velcro jacket)
	10064766	Leather Case
REPLACEMENT PARTS	10044994	Calibration Cap
	637266	Calibration cap fitting
	10046042	Horn Chamber Protective Insert
	10068059	Horn Cap Repair Kit
	10066049	Suspender stainless steel attachment clip
SAMPLING ACCESSORIES	10047595	Universal Pump Probe, MSHA Approval
	10050333	Solaris Aspirator Assembly
	10059116	Metal fitting for universal pump probe
SAMPLE LINE	10053795	5 foot polyurethane
	10053794	10 foot polyurethane
	10047370	25 foot polyurethane
	10047349	50 foot polyurethane
DATALOGGING	10082834	USB Infrared reader
	10088099	MSA Link Datalogging Software CD
POWER SUPPLY	10048185	Charger Cradle Assembly
	10047342	North American Power Supply
	10049410	Vehicle Charger
	10069498	Multi-unit Power Supply
	10069856	Multi-unit Charge Station (no cradles)
	10069857	Multi-unit Charge Station (with cradles)
CALIBRATION ACCESSORIES	10044995	Calibration cap assembly
	467895	Regulator 0.25 lpm Model RP
	10047392	Metal fitting for calibration

## ALTAIR Pro Single-Gas Detector



ALTAIR Pro family of gas detectors

Based on the industry-standard ALTAIR Single-Gas Detector—but with added features and functionality—ALTAIR Pro toxic gas and oxygen detectors combine reliable detection and LED/audible/flashing/vibrating alarms with clear, backlit LCD displays. Electrochemical sensors measure concentrations of toxic gas (ammonia, carbon monoxide, chlorine, chlorine dioxide, hydrogen cyanide, hydrogen sulfide, nitrogen dioxide, phosphine and sulfur dioxide) or percent oxygen. Purpose-built for superior dust and water protection, excellent impact resistance and excellent RFI performance.

### Features and Benefits

- Gas concentration (NH<sub>3</sub>, CO, Cl<sub>2</sub>, ClO<sub>2</sub>, HCN, H<sub>2</sub>S, NO<sub>2</sub>, PH<sub>3</sub> and SO<sub>2</sub>) or percent oxygen displayed on a large, clear, backlit LCD
- Unit detects CO, H<sub>2</sub>S, O<sub>2</sub>, NH<sub>3</sub>, Cl<sub>2</sub>, ClO<sub>2</sub>, NO<sub>2</sub>, SO<sub>2</sub>, HCN and PH<sub>3</sub>
- Automatically records the last 50 alarm/test events while simultaneously recording peak gas readings or low O<sub>2</sub> readings every three minutes in a periodic data log
- User can read data or change alarm set points by connecting unit to MSA Link via built-in IR communication port
- Adjustable alarm set points
- No-miss quad alarm system includes bright flashing LEDs, piercing audible alarm, LCD notification, and an internal vibrating alarm
- Rubberized armor housing and one-button operation for maximum durability and simplicity
- Easy alarm check, bump check, fresh air zero, and calibration
- Easily replaceable batteries and sensors

## Ordering Information

		Instrument Type	Low Alarm	High Alarm	STEL	TWA
ALTAIR PRO SINGLE-GAS DETECTORS	10074137	Oxygen (O <sub>2</sub> )	19.50%	23.00%	N/A	N/A
	10074135	Carbon Monoxide (CO)	25 PPM	100 PPM	100 PPM	25 PPM
	10076723	Carbon Monoxide (CO) Fire	25 PPM	100 PPM	100 PPM	25 PPM
	10076724	Carbon Monoxide (CO) Steel	75 PPM	200 PPM	200 PPM	75 PPM
	10074136	Hydrogen Sulfide (H <sub>2</sub> S)	10 PPM	15 PPM	15 PPM	10 PPM
	10076729	Hydrogen Cyanide (HCN)	4.5 PPM	10 PPM	10 PPM	4.7 PPM
	10076716	Chlorine (Cl <sub>2</sub> )	0.5 PPM	1.0 PPM	1.0 PPM	0.5 PPM
	10076717	Chlorine Dioxide (ClO <sub>2</sub> )	0.1 PPM	0.3 PPM	0.3 PPM	0.1 PPM
	10076736	Sulfur Dioxide (SO <sub>2</sub> )	2.0 PPM	5.0 PPM	5.0 PPM	2.0 PPM
	10076731	Nitrogen Dioxide (NO <sub>2</sub> )	2.0 PPM	5.0 PPM	5.0 PPM	2.0 PPM
	10076730	Ammonia (NH <sub>3</sub> )	25 PPM	50 PPM	35 PPM	25 PPM
	10076735	Phosphine (PH <sub>3</sub> )	0.3 PPM	1.0 PPM	1.0 PPM	0.3 PPM
	10076733	Oxygen Remote (O <sub>2</sub> -R)	19.50%	23.00%	N/A	N/A
ALTAIR PRO SINGLE-GAS DETECTORS  <i>Alternate Set Point Models</i>	10076732	Oxygen (O <sub>2</sub> )	18.00%	19.50%	N/A	N/A
	10076718	Carbon Monoxide (CO)	30 PPM	60 PPM	60 PPM	30 PPM
	10076719	Carbon Monoxide (CO)	35 PPM	100 PPM	100 PPM	35 PPM
	10076720	Carbon Monoxide (CO)	35 PPM	400 PPM	400 PPM	35 PPM
	10076721	Carbon Monoxide (CO)	50 PPM	200 PPM	200 PPM	50 PPM
	10076722	Carbon Monoxide (CO)	100 PPM	300 PPM	300 PPM	100 PPM
	10080532	Carbon Monoxide (CO) Steel	75 PPM	200 PPM	200 PPM	35 PPM
	10076728	Hydrogen Sulfide (H <sub>2</sub> S)	10 PPM	20 PPM	20 PPM	10 PPM
	10076725	Hydrogen Sulfide (H <sub>2</sub> S)	5 PPM	10 PPM	10 PPM	5 PPM
	10076727	Hydrogen Sulfide (H <sub>2</sub> S)	8 PPM	12 PPM	12 PPM	8 PPM
	10076726	Hydrogen Sulfide (H <sub>2</sub> S)	7 PPM	14 PPM	14 PPM	7 PPM

ACCESSORIES AND PARTS		
	467895	Regulator, 0.25 lpm
	10030325	Tubing, 16" (do not use with NH <sub>3</sub> , Cl <sub>2</sub> , and ClO <sub>2</sub> )
	10080534	Tubing, 16" Teflon-lined (NH <sub>3</sub> , Cl <sub>2</sub> , and ClO <sub>2</sub> )
	10074132	3V CR2 battery
	10069894	Clip, stainless steel
	10041105	Cell phone clip
	10041107	Lanyard clip
	10073346	Hardhat clip
	10040002	Clip, suspender (standard)
	10082834	JetEye IR USB adapter
	10088099	MSA Link software CD-ROM

## ALTAIR Maintenance-Free Single-Gas Detector

Designed for superior lifespan—patented sensors operate for over two years—and high performance, the ALTAIR Single-Gas Detector is the smart choice for market-leading, cost-effective gas monitors. Features sensor options for carbon monoxide, hydrogen sulfide, and oxygen coupled with LED/audible/vibrating alarms. Superior dust/water protection, high RFI resistance, and one-button operation provide heightened safety, plus increased durability and ease-of-use.

### Features and Benefits

- Sensor options for CO, H<sub>2</sub>S, and O<sub>2</sub>
- Patented electrochemical sensors and MSA-built button sensors
- Stainless steel and solid electrolyte construction virtually eliminate sensor leakage
- Automatically records the last 25 alarm/test events and can communicate data by connecting to MSA Link via built-in IR communication port
- No-miss triple alarm system includes bright flashing LEDs, piercing audible alarm, and an internal vibrating alarm
- Rubberized armor housing and one-button operation for maximum durability and simplicity



### Ordering Information

		Instrument Type	First Alarm	Second Alarm
ALTAIR SINGLE-GAS DETECTORS	10092522	Carbon Monoxide (CO)	25 PPM	100 PPM
	10092521	Hydrogen Sulfide (H <sub>2</sub> S)	10 PPM	15 PPM
	10092523	Oxygen (O <sub>2</sub> )	19.5% VOL	23% VOL
ALTAIR SINGLE-GAS DETECTORS  <i>Alternate Set Point Models</i>	10071334	Carbon Monoxide (CO)	30 PPM	60 PPM
	10071335	Carbon Monoxide (CO)	35 PPM	100 PPM
	10071336	Carbon Monoxide (CO)	35 PPM	400 PPM
	10071337	Carbon Monoxide (CO)	50 PPM	200 PPM
	10071338	Carbon Monoxide (CO)	100 PPM	300 PPM
	10071340	Hydrogen Sulfide (H <sub>2</sub> S)	10 PPM	20 PPM
	10071361	Hydrogen Sulfide (H <sub>2</sub> S)	5 PPM	10 PPM
	10071362	Hydrogen Sulfide (H <sub>2</sub> S)	8 PPM	12 PPM
	10071363	Hydrogen Sulfide (H <sub>2</sub> S)	7 PPM	14 PPM
	10071364	Oxygen (O <sub>2</sub> )	19.5% VOL	18% VOL

ACCESSORIES AND PARTS		
	710882	Cylinder, 60 ppm CO
	473180	Cylinder, 300 ppm CO
	467897	Cylinder, 40 ppm H <sub>2</sub> S, RP
	711062	Cylinder, 40 ppm H <sub>2</sub> S, Econo-Cal
	467895	Regulator, 0.25 lpm
	10040002	Clip, suspender (standard)
	10069894	Clip, stainless steel
	10041105	Cell phone clip
	10041107	Lanyard kit
	710946	FiveStar® Link® with IR (for event log)
	10030325	Tubing, 16"
	10073346	Hardhat clip

## ALTAIR Quick-Check Station

The ALTAIR QuickCheck Station uses several tests to make sure ALTAIR and ALTAIR Pro Detectors are fully ready for action. The station administers a bump test to make sure the detector responds to a specified concentration of gas. The station also uses a microphone and electronic check to ensure the detector's audible, visual and vibrating alarms are good to go. With easy-to-understand LEDs, the QuickCheck Station tells a user which test is being administered and whether the detector passed or failed.

### Features and Benefits

- Station administers a bump test and uses a microphone and electronic check to ensure a detector is ready for action
- Station is compatible with all 3 ALTAIR Detector versions (CO, H<sub>2</sub>S and O<sub>2</sub>) and with ALTAIR Pro O<sub>2</sub>, H<sub>2</sub>S, CO, CO Fire and CO Steel detectors
- Station comes in manual and automatic versions
- Easy-to-see LEDs give simple-to-understand test results



### Ordering Information

ALTAIR QUICK-CHECK STATION  <i>with Manual Regulator</i>	10076692	Gas Type: O <sub>2</sub> /CO/H <sub>2</sub> S/SO <sub>2</sub> /NO <sub>2</sub>
	10076701	Gas Type: Cl <sub>2</sub> /ClO <sub>2</sub>
	10076695	Gas Type: NH <sub>3</sub>
	10076698	Gas Type: HCN
ALTAIR QUICK-CHECK STATION  <i>with Automatic Regulator</i>	10076704	Gas Type: O <sub>2</sub> /CO/H <sub>2</sub> S/SO <sub>2</sub> /NO <sub>2</sub>
	10076713	Gas Type: Cl <sub>2</sub> /ClO <sub>2</sub>
	10076707	Gas Type: NH <sub>3</sub>
	10076710	Gas Type: HCN
REPLACEMENT AND ACCESSORY PARTS	10047342	North American Power Supply
	10049410	Vehicle Power Supply
	10077384	Regulator Tubing
	10077385	Front Housing Assembly
	10075893	Automatic Gas Regulator
	467895	Manual Regulator
	710386	Single Cylinder Holder

## Ventilation Smoke Tube Kits

MSA's Ventilation Smoke Tube Kits are for use where controlled generation of a visible smoke is desired in order to determine the velocity of slow-moving air currents and establish their direction and flow patterns in shafts, mines and tunnels. They can also be used in commercial buildings and industrial processing plants to determine velocity and flow patterns of heating, ventilating, and air-conditioning systems.

VENTILATION SMOKE TUBE KITS	458481	Ventilation Smoke Kit, including aspirator bulb, two rubber plugs, and six smoke-producing tubes contained in plastic carrying case
	5607	Ventilation Smoke Kit, including aspirator bulb, six tube caps, and two glass smoke-producing tubes contained in plastic carrying case
	458480	Ventilation smoke tubes, box of 12
	5645	Glass smoke tubes, box of 10



## Kwik-Draw® Detector Tube Pumps

MSA's Kwik-Draw and Kwik-Draw Deluxe Pumps can be used with an assortment of MSA detector tubes to spot-test atmospheres for a wide variety of toxic substances. They are designed for one-hand operation and consistent delivery of a sample draw volume of 100 milliliters (ml).

KWIK-DRAW DETECTOR TUBE PUMPS	488543	Kwik-Draw Basic Pump, with remote sampling adapter and carrying pouch
	487500	Kwik-Draw Deluxe Pump, with remote sampling adapter, carrying pouch and end-of-stroke indicator
ACCESSORIES	73067	Sampling line, 10 ft
	73068	Sampling line, 25 ft
	73069	Sampling line, 50 ft
	87970	Remote Sampling Adapter, required for above sampling lines
	488780	Solvent-Resistant Sampling Line, 25 ft, with reel
	488872	Tube Holder, required for 488780 line above
	813929	Detector Tube Handbook



## Detector Tubes

DETECTOR TUBE INDUSTRY ACTION SETS	655864	Agricultural Set, set of 12 tubes
	655868	Pulp and Paper Set, set of 12 tubes
	710981	Indoor Air Quality Set, set of 12 tubes
	655869	Pharmaceutical Set, set of 12 tubes
	655865	Petroleum Set, set of 12 tubes
	655866	Synthetics Manufacturing Set, set of 12 tubes
	655933	Chemical Vapor Deposition Process Set, set of 12 tubes
	655934	Etching Process Set, set of 12 tubes
	655935	Epitaxy Process Set, set of 12 tubes
CHEMICAL WARFARE AGENT DETECTOR TUBES	10007654	Nerve (Sarin, VX, GA, GD, etc.)
	10007653	Blister (Mustard Gas)
	10007650	Blister (Lewisite)
	10007652	Blister (variety, including Mustard Gas)
	10007651	Blood and Choking (CG, DP, AC, CK)
	10044998	Chemical Warfare Agent Detector Tube Kit, Single CWA Tube Sampler with Kwik-Draw Pump
	CARBON MONOXIDE DETECTOR TUBE CARDS	481954





Substance Measured	Detector Tube Applicable	Part No. (1 box of 10 tubes)	Measuring Range (ppm)	Threshold Limit Value 1998 ACGIH (ppm)
ACETALDEHYDE	Formaldehyde-0.1	497649	5-50	25 (ceiling)
ACETIC ACID	Acetic Acid-1	804138	1-80	10
ACETONE	Acetone-100	804141	100-10,000	500
	Qualitest QL	497665	n/a	
ACETYLENE DICHLORIDE, CIS AND TRANS (1,2 DICHLOROETHYLENE)	Trichloroethane-5	487343	10-500	200
	Qualitest QL	497665	n/a	
ACETYLENE TETRABROMIDE (1,1,2,2-TETRABROMOETHANE)	Trichloroethane-5	487343	5-200	1
	Qualitest QL	497665	n/a	
ACETYLENE TETRACHLORIDE (1,1,2,2-TETRACHLOROETHANE)	Trichloroethane-5	487343	50-1000	1
	Qualitest QL	497665	n/a	
AMMONIA	NH <sub>3</sub> -2	804405	2-500	25
	NH <sub>3</sub> -20	800300	20-1000	
	NH <sub>3</sub> -0.1%	804406	0.1-10 Vol.-%	
N-AMYL CHLORIDE (1-CHLOROPENTANE)	Trichloroethane-5	487343	5-550	-
ARSINE	AsH <sub>3</sub>	10072098	0.05-1	-
BENZENE	Aromatic HC	804132	5-500	.5
	C6H6-1	807024	1-100	
	C6H6-5	804411	5-100	
	Qualitest QL	497665	n/a	
	C6H6-0.5	655837*	0.5-10	
BROMINE	C12-0.2	803944	0.2-3	0.1
BROMOBENZENE	Aromatic HC	804132	30-720	-
BROMOETHANE (ETHYL BROMIDE)	Trichloroethane-5	487343	15-400	5
BROMOFORM (TRIBROMOMETHANE)	Trichloroethane-5	487343	7-200	0.5
BROMOMETHANE (METHYL BROMIDE)	Trichloroethane-5	487343	20-270	1
1,3-BUTADIENE	Ethylene-50	804428	100-1200	2
	Qualitest QL	497665	n/a	
N-BUTANE	Propane-200	804418	200-3800	800
	Qualitest QL	497665	n/a	
N-BUTANOL (BUTYL ALCOHOL)	Ethanol-100	804136	100-3900	50 (ceiling)
SEC. BUTANOL (SEC-BUTYL ALCOHOL)	Ethanol-100	804136	300-5100	100
1-BUTENE (1-BUTYLENE)	Ethylene-50	804428	100-5000	-
	Qualitest QL	497665	n/a	
2-BUTYLENE, CIS AND TRANS (2-BUTYLENE)	Ethylene-50	804428	200-5000	-
	Qualitest QL	497665	n/a	
BUTYL ALCOHOL (N-BUTANOL)	Ethanol-100	804136	100-3900	50 (ceiling)
SEC-BUTYL ALCOHOL (SEC-BUTANOL)	Ethanol-100	804136	300-5100	100
N-BUTYLAMINE	Triethylamine-5	804134	2-28	5 (ceiling)
ISO-BUTYLAMINE	Triethylamine-5	804134	3-36	-
SEC-BUTYLAMINE	Triethylamine-5	804134	2-18	-
T-BUTYLAMINE	Triethylamine-5	804134	2-14	-
N-BUTYLCHLORIDE (1-CHLOROBUTANE)	Trichloroethane-5	487343	5-170	-
	Qualitest QL	497665	n/a	
1-BUTYLENE (1-BUTENE)	Ethylene-50	804428	100-5000	-
	Qualitest QL	497665	n/a	
2-BUTYLENE (2-BUTENE, CIS AND TRANS)	Ethylene-50	804428	200-5000	-
	Qualitest QL	497665	n/a	
N-BUTYL MERCAPTAN	Ethylmercaptan-0.5	804589	1.5-15	0.5
T-BUTYL MERCAPTAN	Ethylmercaptan-0.5	804589	0.8-5	-
CARBON DIOXIDE	CO <sub>2</sub> -100	497606	100-3000	5000
	CO <sub>2</sub> -0.1%	487333	0.1-7.0 Vol.-%	
	CO <sub>2</sub> -1%	804419	1-20 Vol.-%	
CARBON DISULFIDE	CS <sub>2</sub> -2	492514	2-300	10
	Qualitest QL	497665	n/a	
CARBON MONOXIDE	CO-0.001 %	804421	0.001-0.3 Vol.-%	25
	CO-5	803943	5-1000	
	CO-10	487334	10-3000	
	CO-3000	815507	3000-70000	
	CO-0.1%	804423	0.1-1.0 Vol.-%	
	CO-0.3%	487335	0.3-7.0 Vol.-%	
	CO-10/color	47134	10-1000	
	(special orifice assembly for CO-10/color)	497652		
Qualitest QL	497665	n/a		
CHLORINE	Cl <sub>2</sub> -0.2	803944	0.2-30	0.5
	ClO <sub>2</sub> -0.05	804133	1-46	
	Cl <sub>2</sub> -50		50-500	

# Gas-Detection Instruments

Substance Measured	Detector Tube Applicable	Part No. (1 box of 10 tubes)	Measuring Range (ppm)	Threshold Limit Value 1998 ACGIH (ppm)
CHLORINE DIOXIDE	ClO <sub>2</sub> -0.05	804133	0.05–15	0.1
CHLOROBENZENE	Aromatic HC	804132	40–610	10
CHLOROBROMOMETHANE	Trichloroethane-5	487343	5–180	200
1-CHLOROBUTANE (N-BUTYLCHLORIDE)	Trichloroethane-5	487343	5–170	–
	Qualitest QL	497665	n/a	
CHLOROETHANE(ETHYL CHLORIDE)	Trichloroethane-5	487343	50–800	100
CHLOROETHYLENE (VINYL CHLORIDE)	VC-1	803950	1–70	5
	Trichloroethane-5	487343	20–550	
CHLOROFORM (TRICHLOROMETHANE)	Trichloroethane-5	487343	8–100	10
1-CHLOROPENTANE (N-AMYLCHLORIDE)	Trichloroethane-5	487343	5–550	–
1-CHLOROPROPANE (L-PROPYLCHLORIDE)	Trichloroethane-5	487343	5–220	–
2-CHLOROPROPANE (2-PROPYLCHLORIDE)	Trichloroethane-5	487343	8–1700	–
CYCLOHEPTANE	Hexane-20	497664	80–3300	–
CYCLOHEXANE	Hexane-20	497664	20–3400	300
	Qualitest QL	497665	n/a	
CYCLOHEXYLAMINE	Triethylamine-5	804134	7–38	10
CYCLOOCTANE	Hexane-20	497664	20–2100	–
CYCLOPENTANE	Hexane-20	497664	80–2700	600
N-DECANE	Hexane-20	497664	50–500	–
1,2-DIBROMOETHANE (ETHYLENE DIBROMIDE)	Trichloroethane-5	487343	25–700	–
DIBROMOMETHANE (METHYLENE DIBROMIDE)	Trichloroethane-5	487343	9–200	–
1,1-DICHLOROETHANE (ETHYLIDENE CHLORIDE)	Trichloroethane-5	487343	8–300	100
1,2-DICHLOROETHANE (ETHYLENE DICHLORIDE)	CH <sub>2</sub> Cl <sub>2</sub> -50	804416	30–720	10
1,1-DICHLOROETHYLENE (VINYLIDENE CHLORIDE)	Trichloroethane-5	487343	10–600	5
1,2-DICHLOROETHYLENE (ACETYLENE DICHLORIDE, CIS AND TRANS)	Trichloroethane-5	487343	10–500	200
DICHLOROMETHANE (METHYLENE CHLORIDE)	CH <sub>2</sub> Cl <sub>2</sub> -50	804416	50–1000	50
1,2-DICHLOROPROPANE (PROPYLENE DICHLORIDE)	Trichloroethane-5	487343	5–440	75
1,3-DICHLOROPROPANE (TRIMETHYLENE DICHLORIDE)	Trichloroethane-5	487343	5–220	–
DIESEL OIL	Qualitest QL	497665	n/a	
DIETHYLAMINE	Triethylamine-5	804134	3–27	5
DIMETHYLAMINE	Triethylamine-5	804134	3–27	5
2,2-DIMETHYLBUTANE	Hexane-20	497664	100–4900	–
ETHANOL (ETHYL ALCOHOL)	Ethanol-100	804136	100–6000	1000
	Qualitest QL	497665	n/a	
ETHENE (ETHYLENE)	Ethylene-50	804428	50–5000	–
	Qualitest QL	497665	n/a	
ETHYL ALCOHOL (ETHANOL)	Ethanol-100	804136	100–6000	1000
	Qualitest QL	497665	n/a	
ETHYLAMINE	Triethylamine-5	804134	4–55	5
ETHYL BENZENE	Tol.-5	803947	5–1800	100
ETHYL BROMIDE (BROMOETHANE)	Trichloroethane-5	487343	15–400	5
ETHYL CHLORIDE (CHLOROETHANE)	Trichloroethane-5	487343	50–8000	100
ETHYLENEDIAMINE	Triethylamine-5	804134	5–27	10
ETHYLENE DIBROMIDE (1,2-DIBROMOETHANE)	Trichloroethane-5	487343	25–700	–
ETHYLENE DICHLORIDE (1,2-DICHLOROETHANE)	CH <sub>2</sub> Cl <sub>2</sub> -50	804416	30–720	10
ETHYLIDENE CHLORIDE (1,1-DICHLOROETHANE)	Trichloroethane-5	487343	8–300	100
ETHYL MERCAPTAN	Ethylmercaptan-0.5	804589	0.5–80	0.5
FORMALDEHYDE	Formaldehyde-0.1	497649	0.1–55	0.3 (ceiling)
FORMIC ACID	Qualitest QL	497665	n/a	5
	Acetic Acid-1	804138	2–160	
FURFURYL ALCOHOL	Phenol-1	813778	on request	10
GASOLINE	Gasoline-30	492870	30–6000	300
	Qualitest QL	497665	n/a	
N-HEPTANE	Hexane-20	497664	20–2600	400
N-HEXANE	Hexane-20	497664	20–3200	50
HYDROGEN CHLORIDE	HCl-1	803948	1–30	5 (ceiling)
	Qualitest QL	497665	n/a	
HYDROGEN CYANIDE	HCN-2	803945	2–50	4.7 (ceiling)
HYDROGEN FLUORIDE	HF-1	804142	1–50	3 (ceiling)

Substance Measured	Detector Tube Applicable	Part No. (1 box of 10 tubes)	Measuring Range (ppm)	Threshold Limit Value 1998 ACGIH (ppm)
HYDROGEN SULFIDE	H <sub>2</sub> S-1	487339	1–200	10
	H <sub>2</sub> S-100	487340	0100–4000	
	H <sub>2</sub> S-0.1%	655932	0.1–4 Vol. %	
	Qualitest QL	497665	n/a	
ISOBUTANE (METHYLPROPANE)	Propane-200	804418	200–4200	–
ISOBUTANOL (ISOBUTYL ALCOHOL, 2-METHYLPROPYL ALCOHOL)	Ethanol-100	804136	100–2900	50
ISOBUTENE (ISOBUTYLENE, METHYLPROPENE)	Ethylene-50	804428	400–2600	–
ISO-BUTYLAMINE	Triethylamine-5	804134	3–36	–
ISOBUTYLENE (ISOBUTENE, METHYLPROPENE)	Ethylene-50	804428	400–2600	–
ISOBUTYL ALCOHOL (ISOBUTANOL, 2-METHYLPROPYL ALCOHOL)	Ethanol-100	804136	150–2900	50
ISOBUTYL METHYL KETONE	MEK-50	813334	50–6500	–
ISO OCTANE	Hexane-20	497664	100–3000	–
ISOPROPANOL (ISOPROPYL ALCOHOL, 2-PROPANOL)	Ethanol-100	804136	200–5000	400
	Qualitest QL	497665	n/a	
ISOPROPYL ALCOHOL (ISOPROPANOL, 2-PROPANOL)	Ethanol-100	804136	200–5000	400
	Qualitest QL	497665	n/a	
ISOPROPYLAMINE	Triethylamine-5	804134	5–30	5
ISOPROPYL MERCAPTAN	Ethylmercaptan-0.5	804589	0.5–5.5	–
KEROSENE	Qualitest QL	497665	n/a	–
KETONES	Qualitest QL	497665	n/a	–
LIQUIFIED PETROLEUM GASES	Gasoline-30	492870	Semiquantitative	–
	Qualitest QL	497665	n/a	
MERCURY	Hg–0.1 mg/m <sup>3</sup>	497663	0.1–0.8 mg/m <sup>3</sup> (0.01–0.08 ppm)	0.025 mg/m <sup>3</sup> (inorganic)
METHANE	Natural Gas	655789	Semiquant. 5000+	–
METHANOL (METHYL ALCOHOL)	Ethanol-100	804136	100–2350	200
METHYL ALCOHOL (METHANOL)	Ethanol-100	804136	100–2350	200
METHYLAMINE	Triethylamine-5	804134	4–55	5
METHYL BENZENE (TOLUENE)	Tol.-5	803947	5–1000	50
METHYL BROMIDE (BROMOMETHANE)	Trichloroethane-5	487343	9–200	5
	MeBr-200	710544	200–8000 ppm	
	MeBr-2	710391	2–100 ppm	
2-METHYL BUTANE	Hexane-20	497664	50–3000	–
METHYL CHLOROFORM (1,1,1-TRICHLOROETHANE)	Trichloroethane-5	487343	5–1500	350
	Qualitest QL	497665	n/a	
METHYLCYCLOHEXANE	Hexane-20	497664	80–4900	400
METHYLCYCLOPENTANE	Hexane-20	497664	150–3700	–
METHYLENE CHLORIDE (DICHLOROMETHANE)	CH <sub>2</sub> Cl <sub>2</sub> -50	804416	50–1000	50
METHYLENE DIBROMIDE (DIBROMOMETHANE)	Trichloroethane-5	487343	9–200	–
METHYL ETHYL KETONE (MEK)	MEK-50	813334	50–4000	200
	Qualitest QL	497665	n/a	
METHYL MERCAPTAN	Ethylmercaptan-0.5	804589	0.5–5	0.5
2-METHYL PENTANE	Hexane-20	497664	150–4500	–
3-METHYL PENTANE	Hexane-20	497664	100–3700	–
METHYLPROPANE (ISOBUTANE)	Propane-200	804418	200–4200	–
METHYLPROPENE (ISOBUTYLENE, ISOBUTENE)	Ethylene-50	804428	400–2600	–
2-METHYLPROPYL ALCOHOL (ISOBUTANOL, ISOBUTYL ALCOHOL)	Ethanol-100	804136	150–2900	50
NITROGEN DIOXIDE	NO <sub>2</sub> -0.5	487341	0.5–50	3
	NO <sub>2</sub> -2	804435	2–140	
NITROUS FUMES	Nitr.-0.5	487336	0.5–50	–
	Nitr.-2	804425	2–140	
	Nitr.-10	803946	10–300	
	Nitr.-50	804426	50–3000	
N-NONANE	Hexane-20	497664	50–2800	200
N-OCTANE	Hexane-20	497664	50–3000	300
OZONE	Ozone-0.05	804140	0.05–5	0.05 (ceiling)
PENTACHLOROETHANE	Trichloroethane-5	487343	10–300	–
N-PENTANE	Hexane-20	497664	50–3900	600
	Qualitest QL	497665	n/a	

# Gas-Detection Instruments

Substance Measured	Detector Tube applicable	Part No. (1 box of 10 tubes)	Measuring range (ppm)	Threshold Limit Value 1998 ACGIH (ppm)
PERCHLOROETHYLENE (TETRACHLOROETHYLENE)	Per-5	804429	5–200	25
	Per-10	487337	10–500	
	Qualitest QL	497665	n/a	
PHENOL	Phenol-1	813778	1–25	5
	Qualitest QL	497665	n/a	
PHOSGENE	Phosgene-0.1	803949	0.1–20	0.1
PHOSPHINE	PH <sub>3</sub> -0.05	497101	0.05–3	0.3
	PH <sub>3</sub> -0 1	485680	0.1–100	
	PH <sub>3</sub> -50	489119	50–2000	
PROPANE	Propane-200	804418	200–4000	2500
	Qualitest QL	497665	n/a	
N-PROPANOL (PROPYL ALCOHOL)	Ethanol-100	804136	100–3000	200
	Qualitest QL	497665	n/a	
2-PROPANOL (ISOPROPANOL, ISOPROPYL ALCOHOL)	Ethanol-100	804136	200–5000	400
	Qualitest QL	497665	n/a	
PROPENE (PROPYLENE)	Ethylene-50	804428	20–5000	–
	Qualitest QL	497665	n/a	
PROPYL ALCOHOL (N-PROPANOL)	Ethanol-100	804136	100-3000	200
	Qualitest QL	497665	n/a	
N-PROPYLAMINE	Triethylamine-5	804134	2–28	–
1-PROPYLCHLORIDE (1-CHLOROPROPANE)	Trichloroethane-5	487343	5–220	–
2-PROPYLCHLORIDE (2-CHLOROPROPANE)	Trichloroethane-5	487343	8–1700	–
PROPYLENE (PROPENE)	Ethylene-50	804428	20–5000	–
	Qualitest QL	497665	n/a	
PROPYLENE DICHLORIDE (1,2-DICHLOROPROPANE)	Trichloroethane-5	487343	5–440	75
N-PROPYL MERCAPTAN	Ethylmercaptan-0.5	804589	0.7–8.0	–
STYRENE	Styrene-10	804135	10–300	20
	Qualitest QL	497665	n/a	
SULFUR DIOXIDE	SO <sub>2</sub> -1	487338	0.5–25	2
	SO <sub>2</sub> -5	497662	5–120	
	SO <sub>2</sub> -100	497661	100–4000	
SULFUR HEXAFLUORIDE DECOMPOSITION PRODUCTS	SF <sub>6</sub> Decomposition Products	804433	0.5–15	1000
1,1,2,2-TETRABROMOETHANE (ACETYLENE TETRABROMIDE)	Trichloroethane-5	487343	5–200	1
1,1,2,2-TETRACHLOROETHANE	Trichloroethane-5	487343	50–1000	1
TETRACHLOROETHYLENE (PERCHLOROETHYLENE)	Per-5	804429	5–200	25
	Per-10	487337	10–500	
	Qualitest QL	497665	n/a	
TETRAHYDROFURAN	Ethanol-100	804136	Semi-quant	200
TOLUENE (METHYL BENZENE)	Tol.-5	803947	5–1000	50
	Qualitest QL	497665	n/a	
TRIBROMOMETHANE (BROMOFORM)	Trichloroethane-5	487343	7–200	0.5
1,1,1-TRICHLOROETHANE (METHYL CHLOROFORM)	Trichloroethane-5	487343	5–1500	350
	Qualitest QL	497665	n/a	
1,1,2-TRICHLOROETHANE (VINYLTRICHLORIDE)	Trichloroethane-5	487343	10–170	10
TRICHLOROETHENE (TRICHLOROETHYLENE)	Tri-5	487342	5–250	50
TRICHLOROETHYLENE (TRICHLOROETHENE)	Tri-5	487342	5–250	50
TRICHLOROMETHANE (CHLOROFORM)	Trichloroethane-5	487343	8–100	10
1,2,3-TRICHLOROPROPANE	Trichloroethane-5	487343	10–1200	10
TRIETHYLAMINE	Triethylamine-5	804134	5–30	1
TRIMETHYLAMINE	Triethylamine-5	804134	5–30	5
TRIMETHYLENE DICHLORIDE (1,3-DICHLOROPROPANE)	Trichloroethane-5	487343	5–220	–
2,2,4-TRIMETHYLPENTANE	Hexane-20	497664	100–3000	–
VINYL CHLORIDE (CHLOROETHYLENE)	VC-1	803950	1–70	5
	Qualitest QL	497665	n/a	
VINYLDENE CHLORIDE (1,1-DICHLOROETHYLENE)	Trichloroethane-5	487343	10–600	5
VINYLTRICHLORIDE (1,1,2-TRICHLOROETHANE)	Trichloroethane-5	487343	10–170	10
WATER VAPOR	H <sub>2</sub> O-10	655863	10–100% RH	–
O-XYLENE (1,2-XYLENE)	Tol.-5	803947	5–2500	100
	Qualitest QL	497665	n/a	
M-XYLENE (1,3-XYLENE)	Tol.-5	803947	5–2500	100

## HAZMATCAD® and HAZMATCAD® Plus Chemical Agent Detectors

The clear choices for initial assessment of chemical warfare agent or toxic industrial spill, the HAZMATCAD and HAZMATCAD Plus Chemical Agent Detectors detect both chemical warfare agents and selected toxic industrial chemicals (TICs). Ruggedly constructed, compact and lightweight, each is designed for ease of use and requires no prior training—a single button press begins automatic sampling and analysis. Utilizes both audible and visual alarms for clear, simple condition display.

### Features and Benefits

- HAZMATCAD utilizes Surface Acoustic Wave (SAW) microsensors
- HAZMATCAD Plus utilizes both SAW technology and electromechanical cells
- Single-key automatic sampling and analysis
- Alphanumeric system display with both audible and LED alarms
- Operates 8–12 hours using lithium-ion rechargeable batteries
- Rapid warm-up with self-diagnostic check
- RS 232 and IrDA communication ports store up to eight hours of data
- Includes battery charger, belt clip, two long-life lithium-ion rechargeable batteries, waterproof carrying case, vapor check source and operating manual



### HAZMATCAD Detector Kit Ordering Information

Kits include: HAZMATCAD Detector battery charger; belt clip; two Sony rechargeable batteries; hard, water-resistant carrying case; operating manual; vapor check source.

HAZMATCAD DETECTOR KITS	10055094	HAZMATCAD Detector	<i>Chemical Agents Detected: Nerve and Blister</i>
	10055095	HAZMATCAD Detector	<i>Chemical Agents Detected: Nerve, Blister and Hydrogen Cyanide</i>
	10055096	HAZMATCAD Detector	<i>Chemical Agents Detected: Nerve, Blister and Phosgene</i>
	10055097	HAZMATCAD Plus Detector	<i>Chemical Agents Detected: Nerve and Blister agents and TICs (phosgene, hydrogen cyanide, halogen and hydride gas)</i>

## HazMat Response Kit

The HazMat Response Detector Tube Kit can be used by firefighters, HazMat Response Teams and other workers to help classify unknown chemical gases and vapors at accident or spill sites.

### Features and Benefits

- Quickly classifies unknown chemical gases and vapors
- Quad-Port Sampler allows simultaneous testing with four detector tubes, meaning less time in IDLH atmosphere
- Flow-limiting orifices ensure even sample flow
- Portable and easy to handle
- Includes simple interpretation guide



### Ordering Information

HAZMAT RESPONSE KIT	807472	Includes 12 types of detector tubes, multiple tube holder, Kwik-Draw® Pump and interpretation guide
------------------------	--------	---

## SAFESITE® Multi-Threat Detection System



SafeMTX® Multi-Threat Detector



SafeCOM™ Command Center



HAZMATCAD Plus Detector with SAFECOMM Belt-Bridge



Sirius PID Multigas Detector with SAFECOMM Belt-Bridge

### SAFESITE Multi-Threat Detectors

Monitor, detect and alert to potential threats with these advanced detection systems. Provides critical information and data for rapid decision-making in the face of chemical, gas, radiation and other hazard-inducing conditions. Flexible, scalable and customizable, these detection systems offer superior preventive and countermeasure solutions for first responders, law enforcement, government agencies and more.

#### Features and Benefits

- State-of-the-art, 24/7 threat detection and advanced communication capabilities
- Detects a variety of threats, including chemical warfare agents, gamma radiation, volatile organic compounds, combustible gas and more
- Ideal for numerous applications, including homeland security, emergency response, public events, mass transportation and perimeter monitoring
- Multiple-system integration and management
- Wired or wireless network access
- Delivers precise results with fewer false positives



ADASHI First Responder Software helps emergency responders manage, communicate and respond to dangerous incidents.

### SAFECOMM Belt-Bridge with Sirius Wireless Interface

For thorough gas detection and seamless communication in emergency situations, the SAFECOMM Belt-Bridge with Sirius Wireless Interface provides excellent results. Used in conjunction with a Sirius Multigas Detector, the belt-bridge allows users to transmit data from a remote location to a SafeCOM Command Center. The work begins with the Sirius Multigas Detector, which features PID and detection for CO, H<sub>2</sub>S, O<sub>2</sub> and combustible gases. The detector sends its data to the user's belt-bridge via Bluetooth technology. The belt-bridge then converts the signal and transmits the data—plus the user's GPS location—to a SAFECOM command center via a one-watt, spread spectrum, frequency hopping 900 MHz radio for up-to-the-moment results when seconds count.

#### Features and Benefits

- Belt-Bridge converts data from Sirius Multigas Detector and transmits to SAFECOM Command Center up to two miles away
- Belt-Bridge uses a one-watt, spread spectrum, frequency hopping 900 MHz radio to ensure results are received
- GPS tracking provides real-time updating

Threat	Technology	Benefit
CHEMICAL WARFARE AGENTS	Surface acoustic wave (SAW)	Low false positives and false alarms, differentiates nerve and blister agents
GAMMA RADIATION	Cadmium zinc telluride (CZT)	Sensitive with adjustable threshold and 2 ranges. (0-100 mR/hr, 0.1 mR/hr resolution and 0-1000 mR/hr, 1 mR/hr resolution)
VOLATILE ORGANIC COMPOUNDS	Photo-ionization (PID)	10.6 eV lamp provides ppm readings for broadband toxics and VOC detection
TOXIC INDUSTRIAL CHEMICALS	Electrochemical	Detects many specific toxic gases such as chlorine, ammonia, hydrogen cyanide and hydrogen chloride
OXYGEN DEFICIENCY ENRICHMENT	Electrochemical	Oxygen monitoring for confined space
COMBUSTIBLE GAS	Catalytic bead	Wide range detection for hydrocarbons

## BIOSENSOR™ 2200R Biological Agent Detector

With its exclusive five minute time-to-answer, the BIOSENSOR 2200R Biological Agent Detector delivers state-of-the-art, rapid detection, analysis, and identification of biological agents in a handheld instrument. Harnessing bioassay technology for excellent sensitivity and low false positives, this highly accurate detection method provides rapid measurement of biohazards such as anthrax, ricin, botulism, SEB, and plague. Patent-pending dynamic surface generation combines the benefits of both the free solution and lateral flow types for faster analysis, a user-friendly format, and detector stability across multiple climates.

### Features and Benefits

- Highly accurate bioassay technology
- Five minute time-to-answer
- Tests both wet and dry samples
- Nondestructive tests allow for sample retention
- Uses positive and negative control cartridges
- Battery-operated with ability to run 50 tests on a single charge
- Fully decontaminable, IP67 rated housing
- Both visual and audible alarms for clear status indication
- One hour training time
- Integrated RFID (radio frequency identification) for automatic cartridge recognition
- Permanently housed in sturdy, lightweight Pelican case.



### Ordering Information

BIOSENSOR 220R BIOLOGICAL AGENT DETECTOR	10084834	MSA BIOSENSOR 2200R Biological Agent Detector Kit*, includes carry case, charger, cartridge starter kit (10084758), instruction manual, and quick start guide.
BIOSENSOR CARTRIDGE PLANS	10084758	MSA BIOSENSOR cartridge starter kit includes 3 Anthrax/Ricin dual kits**, 1 Anthrax, 1 Ricin, 3 positive control, 2 negative control cartridges, and 2 wet sample kits
	10084753	MSA BIOSENSOR Low volume cartridge plan includes 6 Anthrax/Ricin dual kits**, 2 Anthrax, 2 Ricin, 6 positive control, 2 negative control cartridges, and 2 wet sample kits
	10084754	MSA BIOSENSOR Medium volume cartridge plan includes 24 Anthrax/Ricin dual kits**, 6 Anthrax, 6 Ricin, 24 positive control, 6 negative control cartridges, and 4 wet sample kits
	10084755	MSA BIOSENSOR High volume cartridge plan includes 60 Anthrax/Ricin dual kits**, 8 Anthrax, 8 Ricin, 60 positive control, 8 negative control cartridges, and 6 wet sample kits.

\* Extended warranties available.

\*\* Each biohazard cartridge test kit includes a dry sample kit. Please contact your local MSA rep for more information.

## GALAXY® GX2 Automated Test System

The new GALAXY GX2 Automated Test System provides simple and intelligent testing and calibration of MSA ALTAIR® and ALTAIR PRO Single-Gas Detectors, as well as ALTAIR 4X and ALTAIR 5X Multigas Detectors, driven by the most advanced technology available in any portable gas detector: MSA XCell® Sensors.

This easy-to-use automated test stand offers high performance as either a stand-alone unit or an integrated portable detector management system, enabling total data access and control of your MSA ALTAIR Gas Detector fleet.

Once any ALTAIR Family Gas Detector is placed within the GALAXY GX2 System, it can be tested, calibrated and charged automatically.\* Flexibility allows for up to 10 test stations, four cylinder holders and multi-unit charger within one GALAXY GX2 System detector bank.



## Features and Benefits

- Color touchscreen for ease of setup and viewing; no touch operation is needed for calibration or bump test
- Visual indicators on GALAXY GX2 System and software
- RFID automated calibration gas setup, status alerts and traceability
- MSA Link Pro and MSA Link Software
- Global platform—many language options
- Significant cost of ownership reduction when used with MSA XCell Sensors
- Simultaneous testing of up to 10 gas detectors
- Securely configure gas detectors at the touch of a button
- MSA XCell Sensor Technology
- Your MSA ALTAIR Multigas Detectors are always ready for use\*

## Ordering Information

GALAXY GX2 SYSTEM TEST STAND/ 1 VALVE <i>for use with 1 calibration gas cylinder</i>	10128644	ALTAIR / ALTAIR PRO Single-Gas Detector, no-charging
	10128630	ALTAIR 4/4X Multigas Detector, charging*
	10128642	ALTAIR 4/4X Multigas Detector, no-charging
	10128626	ALTAIR 5/5X Multigas Detector, charging*
	10128628	ALTAIR 5/5X Multigas Detector, no-charging
GALAXY GX2 SYSTEM TEST STAND/ 4 VALVE <i>for use with 1–4 calibration gas cylinders</i>	10128643	ALTAIR / ALTAIR PRO Single-Gas Detector, no-charging
	10128629	ALTAIR 4/4X Multigas Detector, charging*
	10128641	ALTAIR 4/4X Multigas Detector, no-charging
	10128625	ALTAIR 5/5X Multigas Detector, charging*
	10128627	ALTAIR 5/5X Multigas Detector, no-charging
CALIBRATION GAS	10048280	Calibration gas cylinder (34L) 1.45% CH <sub>4</sub> , 15% O <sub>2</sub> , 60 ppm CO, 20 ppm H <sub>2</sub> S
	10045035	Calibration gas cylinder (54L) 1.45% CH <sub>4</sub> , 15% O <sub>2</sub> , 60 ppm CO, 20 ppm H <sub>2</sub> S
	10117738	Calibration gas cylinder (58L) 1.45% CH <sub>4</sub> , 15% O <sub>2</sub> , 60 ppm CO, 20 ppm H <sub>2</sub> S, 10 ppm SO <sub>2</sub>
	10098855	Calibration gas cylinder (34L) 1.45% CH <sub>4</sub> , 15% O <sub>2</sub> , 60 ppm CO, 20 ppm H <sub>2</sub> S, 10 ppm SO <sub>2</sub>
	10103262	Calibration gas cylinder (58L) 1.45% CH <sub>4</sub> , 15% O <sub>2</sub> , 60 ppm CO, 20 ppm H <sub>2</sub> S, 2.5% CO <sub>2</sub>

\* Contact your local sales representative regarding availability.



## Ordering Information

ACCESSORIES	Code	Description	ACCESSORIES	Code	Description
	10105756	Electronic cylinder holder		10127518	12" (TBR) Ethernet cable for test stand to test stand connection
	10125135	Non-electronic cylinder holder		10126657	DIN rail clip kit (2 clips & screws per kit)
	10127111	4 GB SD card		10062364	Type Omega DIN Rail 0.5m, perforated, steel, zinc-plated
	10123938	MSA Link Pro Software key		10062365	Type Omega DIN Rail 1m, perforated, steel, zinc-plated
	10123937	Digital secure USB key		10062366	Type Omega DIN Rail 2m, perforated, steel, zinc-plated
	10125907	End cap		10082834	USB IR dongle (for use with MSA Link Software)
	10127112	Laminated quick start guide		10034391	Demand flow regulator (universal)
	10127808	Sticker or receipt / sticker printer		710289	Large capacity (<3000 psi) demand regulator
	10126437	Detector sticker label roll		10127422	ALTAIR 4/4X Detector Multi-unit Charger, NA
	10126138	Receipt & sticker label roll		10127427	ALTAIR 5/5X Detector Multi-unit Charger, NA
	10145138	Printer ribbon		10126268	Vehicle power adapter

## Galaxy GX2 Assemble-To-Order (ATO) Options

To create your Galaxy GX2 Test System configuration, select the instrument option codes and mark them in the boxes to the right.

<b>A</b>	<b>TEST STAND INSTRUMENT TYPE</b>	Each instrument type has a dedicated GALAXY GX2 System test stand. 10 test stands can be banked together in any combination, allowing for ultimate flexibility.	<b>Test Stand Options</b> ALTAIR/ALTAIR Pro Detector ALTAIR 4/4X Detector ALTAIR 5/5X Detector	<b>Code</b> A B C	<b>Selection</b>
<b>B</b>	<b>ACTIVE CYLINDER PORTS</b>	Single valve test stands allow for only one calibration cylinder to be used. 4 valves allow for 1-4 calibration cylinders to be accessed.	<b>Calibration Cylinder Options</b> 1 Valve / 1 Cylinder 4 Valves / Up to 4 Cylinders	<b>Code</b> 1 4	<b>Selection</b>
<b>C</b>	<b>INSTRUMENT CHARGING</b>	Instrument charging allows for a single instrument to be charged per test stand. Only available on ALTAIR 4/4X and ALTAIR 5/5X Multigas Detector test stands. Choose Yes/1 if you wish to use the "always ready" function of ALTAIR 4X or ALTAIR 5X Detectors. <i>* Contact your local sales representative regarding availability.</i>	<b>Test Stand Options</b> No Yes	<b>Code</b> 0 1	<b>Selection</b>
<b>D</b>	<b>SMART CYLINDER HOLDER</b>	Smart cylinder holder provides calibration gas information and gas levels. Information such as part number, gas types, concentrations, expiration date, lot number, and real time pressure levels are automatically set up in the test stand. Smart cylinder holder provides end users with automated, remote warnings as to low or no gas and expired or nearly expired cylinders.	<b>Smart Cylinder Holder Options</b> None 1 Cylinder Holder 2 Cylinder Holders 3 Cylinder Holders 4 Cylinder Holders	<b>Code</b> 0 1 2 3 4	<b>Selection</b>
<b>E</b>	<b>MULTI-UNIT CHARGER</b>	Selection of ALTAIR 4/4X Detector and multi-unit charger provides charging for 1-4 ALTAIR 4/4X Detectors. Selection of ALTAIR 5/5X Detectors and multi-unit charger provides charging for 1-4 ALTAIR 5/5X Detectors.	<b>Multi-unit Charger Options</b> None Multi-unit charger	<b>Code</b> 0 1	<b>Selection</b>
<b>F</b>	<b>POWER CORD</b>	Each test stand (with the exception of Argentina version) comes with 6V power supply. Power cord option then chooses the appropriate power cord by region. None provides power supply and no power cord. Argentina version provides no power supply and no power cord.	<b>Power Cord Options</b> North America Europe United Kingdom Australia Argentina None	<b>Code</b> N E U A R 0	<b>Selection</b>
<b>G</b>	<b>MSA LINK™ PRO SOFTWARE</b>	Proactively manage safety by addressing gas exposure information and missing or failed calibration and bump tests. End user receives software on digitally-keyed USB drive.	<b>MSA Link Pro Software Options</b> None 1 MSA Link Pro Software USB Key	<b>Code</b> 0 1	<b>Selection</b>
<b>H</b>	<b>SECURE DIGITAL USB</b>	Allows end user to securely configure instrument set points at GALAXY GX2 System test stand. Must be inserted to process any setting changes to an instrument.	<b>Secure Digital USB Options</b> None Secure Digital USB Key	<b>Code</b> 0 A	<b>Selection</b>

### Your Model Part Number

Please write in numbers from selections above in appropriate boxes and contact your Safety Products Distributor to place your order.

Selection      A      B      C      D      E      F      G      H

A-GX2-  -  -  -  -  -  -  -  -  - 0

# Gas-Detection Instruments

## Regulators

Regulators are used to ensure you receive the required flow of calibration gas for your application. MSA regulators save customers money by delivering calibration test gas at a rate of .25 lpm versus competitors test gas which flows at a rate of .50 lpm.

### Features and Benefits

- Gas Miser® Demand Regulator: no additional maintenance is required for accurate calibration once attached to the calibration cylinder
- Gas Miser Manifold: allows test or calibration of up to four instruments at the same time using the same calibration gas
- Calibration Tubing: polyurethane tubing for use with calibration equipment
- Model RP Check Kits and Model R Check Kits: consist of a regulating valve which includes a cylinder pressure gauge, an adapter hose with sampling line connection, sensor adapters (where applicable), instructions, and a case fitted with room for two calibration check gas cylinders
- Model RP Check Kits
- Model RP Combination Regulators

### Ordering Information

REGULATORS	.25/1.5 LPM Flow Control	
467895	Model RP Cylinder	.25 lpm*
467896	Model RP Cylinder	1.5 lpm
<b>Gas Miser Demand Regulator</b>		
10034391	Model RP, Universal	
710289	Model BD-20, with CGA 590 fitting	
10148159	Model BD-20, with CGA 330 fitting	
<b>Model RP Combination Regulator</b>		
711175	Model RP Combination Regulator,	.25 lpm
711174	Model RP Combination Regulator,	1.5 lpm
<b>Gas Miser Manifold</b>		
710274	4-station Manifold	
<b>Model RP Calibration Check Kits</b>		
477150	Check Kit, Model RP, with 1.5 lpm regulator—	complete
477149	Check Kit, Model RP, with 0.25 lpm regulator—	complete



Gas Miser Model RP .25/1.5 LPM Flow Control Model RP



Model RP Combination Regulator Gas Miser Model BD-20



Gas Miser Manifold



Model RP Calibration Check Kit

## Calibration Gas

Each MSA Calibration Gas Cylinder is shipped with an individual copy of a material safety data sheet (MSDS) and an individual copy of a certificate of analysis. MSA certifies that the gas mixture in calibration gas cylinders was prepared gravimetrically, using NIST traceable weights. The lot number and nominal value of the gas constituents in percent by volume, percent by mass, PPM, or volume are specified on the cylinder. The uncertainty statement of the specified nominal value is also listed.

### Model RP and Model R Calibration Cylinders—Non-Reactive Gases, Steel Cylinder



#### Model RP Cylinder

- *Contents:* Pressure 1000 psig; approximately 100 liters at atmospheric pressure
- *Size:* 13-3/4" x 3"
- *Weight:* 2 lb 13 oz
- *Material:* Steel

Gas Fill	100 liters 1000 psi Model RP	19 liters 300 psi Model R	34 liters 500 psi Econo-Cal	Gas Mixture	Background
AIR	801050	—	—	air zero (THC < 1 ppm)	—
CARBON MONOXIDE	806255	—	—	400 ppm carbon monoxide	air
	473180	461769	—	300 ppm carbon monoxide	air
	809243	—	—	200 ppm carbon monoxide	air
	809242	—	—	100 ppm carbon monoxide	air
	809241	—	—	50 ppm carbon monoxide	air
	806734	—	—	100 ppm carbon monoxide	nitrogen
HYDROGEN	803102	—	—	0.8% hydrogen	air
ISOBUTYLENE	494450	—	10048279	100 ppm isobutylene	air
METHANE	491041	459942	—	2.5% methane	air
	801049	—	—	6.6% methane	nitrogen
OXYGEN	479857	468248	—	20.8% oxygen	nitrogen
	493580	476302	—	5.0% oxygen	nitrogen
NITROGEN	481317	—	—	100% nitrogen	—
NITROUS OXIDE	806736	—	—	100 ppm nitrous oxide	nitrogen
PENTANE	804532	—	—	0.75% pentane (50% LEL)	air
PROPANE	493579	—	—	0.6% propane	air
COMBINATION GAS CYLINDERS	10007047	—	—	0.35% pentane, 19.0% oxygen, 100 ppm carbon monoxide	nitrogen
	801051	—	—	0.6% propane, 15% oxygen, 60 ppm carbon monoxide	nitrogen
	10010162	—	—	1.45% methane, 300 ppm carbon monoxide, 15% oxygen	nitrogen
	813718	—	—	2.5% methane, 60 ppm carbon monoxide, 15% oxygen	nitrogen
	10040791	—	—	2.5% methane, 300 ppm carbon monoxide, 15% oxygen	nitrogen
	478192	—	—	1.45% methane, 15% oxygen	nitrogen

# Gas-Detection Instruments

## Model RP and Econo-Cal Calibration Cylinders—Reactive Gases, Aluminum Cylinders



### Model RP Cylinder

- *Contents:* Pressure 500 psig; approximately 58 liters at atmospheric pressure
- *Size:* 3-1/2" dia. x 14-1/2" high
- *Weight:* 1 lb 11 oz
- *Material:* Aluminum



### Econo-Cal Cylinder

- *Contents:* Pressure 500 psig; approximately 34 liters at atmospheric pressure
- *Size:* 2-3/4" dia. x 11-1/4" high
- *Weight:* 1 lb 1 oz
- *Material:* Aluminum

Gas Fill	58 liters 500 psi Model RP	34 liters 500 psi Econo-Cal	Gas Mixture	Background
AMMONIA	814866	711078	25 ppm ammonia	nitrogen
CHLORINE	806740	711066	10 ppm chlorine	nitrogen
	710331	711082	2 ppm chlorine	nitrogen
HYDROGEN SULFIDE	467897	711062	40 ppm hydrogen sulfide	nitrogen
	806253	711064	15 ppm hydrogen sulfide	nitrogen
	467898	711060	10 ppm hydrogen sulfide	nitrogen
NITRIC OXIDE	812144	711074	50 ppm nitric oxide	nitrogen
NITROGEN DIOXIDE	808977	711068	10 ppm nitrogen dioxide	air
PHOSPHINE	710533	711088	0.5 ppm phosphine	nitrogen
HYDROGEN CHLORIDE	710210	—	40 ppm hydrogen chloride	nitrogen
HYDROGEN CYANIDE	809351	711072	10 ppm hydrogen cyanide	nitrogen
SULFUR DIOXIDE	808978	711070	10 ppm sulfur dioxide	air
COMBINATION GAS CYLINDERS	804770	711058	1.45% methane, 15% oxygen, 300 ppm carbon monoxide, 10 ppm hydrogen sulfide	nitrogen
	10048788	10048790	1.45% methane, 15% oxygen, 20 ppm hydrogen sulfide	nitrogen
	—	10058023	1.45% methane, 15% oxygen, 300 ppm carbon monoxide, 2.5% carbon dioxide	nitrogen
	10045035	10048280	1.45% methane, 15% oxygen, 60 ppm carbon monoxide, 20 ppm hydrogen sulfide	nitrogen
	804769	711056	1.45% methane, 15% oxygen, 10 ppm hydrogen sulfide	nitrogen
	813720	711076	2.5% methane, 15% oxygen, 300 ppm carbon monoxide, 10 ppm hydrogen sulfide	nitrogen
	10048890	10048981	2.5% methane, 15% oxygen, 60 ppm carbon monoxide, 20 ppm hydrogen sulfide	nitrogen
	10048889	10048888	2.5% methane, 15% oxygen, 20 ppm hydrogen sulfide	nitrogen
	10050744	10058022	1.45% methane, 15% oxygen, 10 ppm hydrogen sulfide, 300 ppm carbon monoxide, 2.5% carbon dioxide	nitrogen
	10007049	—	0.35% pentane, 19% oxygen, 100 ppm carbon monoxide, 35 ppm hydrogen sulfide	nitrogen
10058021		1.45% methane, 15% oxygen, 300 ppm carbon monoxide, 2.5% carbon dioxide	nitrogen	

**Note:** Reactive gases have an expiration date listed on each cylinder. This is to ensure the highest quality and accuracy for instrument calibration. Most cylinders have an expiration date of 12 months. Check with MSA Customer Service for the exact shelf life of a particular calibration cylinder.

## Model RP Calibration Cylinder—Steel, 100% Methane



### Model RP Cylinder

- *Contents:* Pressure 1000 psig; approximately 58 liters of pure methane with odorant added to smell like natural gas in all commercial gas lines
- *Size:* 8-1/2" x 3"
- *Weight:* 1 lb 13 oz
- *Material:* Steel

Gas Fill	58 liters 1000 psi Model RP	Gas Mixture	Background
METHANE	711014	100% methane	nitrogen

## Model BD-20 Calibration Cylinders—Steel



### Model BD-20 Cylinder

- *Contents:* Pressure 2200 psig; approximately 552 liters (20 cu ft) of gas at atmospheric pressure
- *Size:* 25" x 4-1/4"
- *Weight:* 1 lb 9 oz
- *Material:* Steel

Gas Fill	34 liters 500 psi Econo-Cal	Gas Mixture	Background
CHLORINE	710566	10 ppm chlorine	nitrogen
	710565	2 ppm chlorine	nitrogen
HYDROGEN SULFIDE	710776	40 ppm hydrogen sulfide	nitrogen

# Gas-Detection Instruments

## Squirt Gas Bump Tester



### Squirt Gas Cylinder

- Contents: Pressure 155 psig; approximately 11 liters at 70°F

SQUIRT GAS BUMP TEST KIT	813411	Squirt Gas Bump Test Kit, less cylinder, but with required fittings and adapters, complete with instructions
--------------------------	--------	--

		Instrument	Combustible Methane	Combustible Pentane Simulant	Oxygen	Carbon Monoxide	Hydrogen Sulfide	Isobutylene	Balance
CYLINDERS FOR SQUIRT GAS	815307	Explosimeter®	2.5%	See cylinder	—	—	—	—	Air
	814350	Gasport®	2.5%	—	15% O <sub>2</sub>	60 ppm CO	—	—	Nitrogen
	814349	Gasport	2.5%	—	15% O <sub>2</sub>	300 ppm CO	35 ppm H <sub>2</sub> S	—	Nitrogen
	814497	Passport®, FiveStar	1.3%	50% LEL	15% O <sub>2</sub>	60 ppm CO	—	—	Nitrogen
	814559	Passport, FiveStar	1.3%	50% LEL	15% O <sub>2</sub>	300 ppm CO	35 ppm H <sub>2</sub> S	—	Nitrogen
	814978	MiniCO*** Responder	—	—	—	60 ppm CO	—	—	Air
	814979	MiniH <sub>2</sub> S** Responder	—	—	—	—	35 ppm H <sub>2</sub> S	—	Nitrogen
	815308	MicroGard***	1.3%	52% LEL	15% O <sub>2</sub>	—	—	—	Nitrogen
	815704	Passport PID II	—	—	—	—	—	100 ppm	Air

## Cylinder Holders



### Single Portable Cylinder Holder

- 6" wide x 13" long x 4" high



### Double Cylinder Holder, wall-mounted

- 17" high x 10" wide x 3-1/2" deep at base

CYLINDER HOLDERS	710386	Single Cylinder Holder, portable
	710483	Double Cylinder Holder, wall-mounted

## Calibration Cylinders Are Recyclable!

MSA has affiliated with the Association of Retarded Citizens, Butler County—a nonprofit organization that employs mentally retarded citizens—and established a Cylinder Recycling Center. The calibration cylinders are not refilled, but salvaged for scrap. All money generated from selling the scrap cylinders is placed in the ARC operating fund for salaries and operating costs.

Calibration cylinders are considered hazardous unless the cylinders are empty. MSA has developed special devalving tools that will ensure the cylinder is empty and render the cylinder non-fillable. For your convenience, MSA also offers a specially pre-addressed shipping box (also recyclable) which helps you pay the lowest shipping costs available.

The MSA Recycling Center limits the return of calibration cylinders to MSA-logoed cylinders only. Non-MSA cylinders will be rejected. Contact the Customer Service Center for additional details at 1-800-MSA-2222.



RECYCLING ACCESSORIES	711228	Devalving Tool, Model "RP" and Econo-Cal Cylinders
	711229	Devalving Tool, Model "R" cylinders
	711227	Shipping Box, Special, Pre-addressed



# Head, Eye, Face, and Hearing **Protection**





# Standards for Industrial Head Protection

## ANSI/ISEA Z89.1-2009 and CSA Z94.1-2005



ANSI/ISEA Z89.1-2009 and CSA Z94.1-2005 are voluntary industry standards that establish the types and classes of industrial helmets and provide performance and testing requirements for these helmets. ANSI/ISEA Z89.1-2009 is a revision of the standard covering industrial head protection; this revision supplants the 2003 revision. CSA Z94.1-2005 is a revision of the standard covering industrial head protection used in Canada; this revision supplants the 1992 revision. These standards include specifications for helmets designed to offer protection from top and/or lateral impact.

The three classes included in these standards indicate the helmet's electrical insulation rating:

**Class E (Electrical)** – Helmets intended to reduce the danger of exposure to high-voltage electrical conductors, proof-tested at 20,000 volts

**Class G (General)** – Helmets intended to reduce the danger of exposure to low-voltage electrical conductors, proof-tested at 2,200 volts

**Class C (Conductive)** – Helmets do not provide protection from electrical conductors

The test requirements for Industrial Head Protection per ANSI/ISEA Z89.1-2009 and CSA Z94.1-2005 are separated by helmet type: Type I helmets protect the wearer from top impact, while Type II helmets protect the wearer from top and lateral impact. The test requirements for ANSI/ISEA Z89.1-2009 and CSA Z94.1-2005 are available from the Industrial Safety Equipment Association ([www.safetysiteequipment.org](http://www.safetysiteequipment.org)) and [www.CSA.ca](http://www.CSA.ca), respectively.

## 2009 Additions to ANSI/ISEA Z89.1-2009

Three non-mandatory tests have been added to the updated ANSI/ISEA Z89.1 standard. Manufacturers who want to claim one or more of these features can test their helmets according to the new procedures and mark their product accordingly. These tests are as follows:

### 1 – Reverse Donning [↻]

In order for a helmet to be worn in reverse or a swing ratchet suspension to be used in a helmet, that particular helmet must be marked with the "double-arranged circle" to indicate that it meets the new ANSI/ISEA Z89.1-2009 non-mandatory reverse donning test.

### 2 – Lower Temperature [LT]

The traditional low temperature test for a helmet is -18°C or 0°F. Helmets that meet ANSI Z89.1 requirements for LOWER temperatures (-30°C or -22°F) can be marked with "LT" by the manufacturer.

### 3 – High-Visibility [HV]

Helmets that meet the non-mandatory requirements for high-visibility, including special tests for Chromaticity and Luminescence for added visibility, can be marked with "HV" by the manufacturer.

All MSA helmets have been tested per the mandatory and non-mandatory ANSI/ISEA Z89.1-2009 and CSA Z94.1-2005 requirements. MSA offerings include:

MSA Helmet	Standard(s)	Type	Class	↻/LT/HV
V-GARD CAP/HAT	ANSI/ISEA Z89.1-2009; CSA Z94.1-2005	TYPE I	CLASS E	↻/LT/HV
V-GARD 500 VENTED CAP	ANSI/ISEA Z89.1-2009	TYPE I	CLASS C	↻/LT/HV
V-GARD 500 NON-VENTED CAP	ANSI/ISEA Z89.1-2009	TYPE I	CLASS E	↻/LT/HV
SMOOTHDOME CAP	ANSI/ISEA Z89.1-2009; CSA Z94.1-2005	TYPE I	CLASS E	↻/LT/HV
TOPGARD CAP/HAT	ANSI/ISEA Z89.1-2009; CSA Z94.1-2005	TYPE I	CLASS E	↻/LT/HV
THERMALGARD CAP	ANSI/ISEA Z89.1-2009; CSA Z94.1-2005	TYPE I	CLASS G	↻/LT/HV
SKULLGARD CAP/HAT	ANSI/ISEA Z89.1-2009	TYPE I	CLASS G	↻/LT/HV
SUPER-V CAP	CSA Z94.1-2005	TYPE II	CLASS E	LT/HV
VANGUARD CAP*	ANSI/ISEA Z89.1-2009; CSA Z94.1-2005	TYPE II	CLASS E	LT/HV
COMFO CAP	ANSI/ISEA Z89.1-2009	TYPE I	CLASS G	LT

\*Vanguard Cap meets all applicable requirements for a Type II helmet as outlined in CSA Z94.1-2005 and ANSI/ISEA Z89.1-2009.

# Head, Eye, Face, and Hearing **Protection**

## V-Gard Protective Caps and Hats

### V-Gard Caps



white



blue



yellow



orange



red



green



gray



hi-viz™ orange



hi-viz yellow-green



bright lime green



dark blue



gold



robin's egg blue



brown



silver



tan



black



light buff



purple



pink

### V-Gard Hats



white



blue



yellow



orange



red



green



gray



hi-viz orange



hi-viz yellow-green



bright lime green

**Classification:** Type I

**Application:** General purpose

**Shell Material:** Polyethylene

**Available Styles:** Slotted Cap; Slotted Full-Brim Hat

**Sizes:** Cap: Small (6 – 7<sup>1</sup>/<sub>8</sub>"); Standard (6<sup>1</sup>/<sub>2</sub> – 8"); Large (7 – 8<sup>1</sup>/<sub>2</sub>")  
Hat: Standard (6<sup>1</sup>/<sub>2</sub> – 8")

**Standards:** ANSI/ISEA Z89.1-2009 (Class E); CSA Z94.1-2005 (Class E)

**Certification:** Third-party by SEI

**Customization:** Imprinting and striping available

NOTE: Small and Large V-Gard Caps are NOT CSA-certified. Standard-size V-Gard Caps and Hats are CSA-certified when assembled with MSA's Fas-Trac or 1-Touch Suspension ONLY.

Did you know that MSA offers a complete line of accessories?  
Turn to pages 103–127 for more information.



## Ordering Information

Color	Small V-Gard Slotted Cap		Standard V-Gard Slotted Cap			Large V-Gard Slotted Cap		V-Gard Slotted Full-Brim Hat		
	w/ Staz-On® Suspension	w/ Fas-Trac® Suspension	w/ Staz-On Suspension	w/ 1-Touch® Suspension <sup>1</sup>	w/ Fas-Trac Suspension <sup>1</sup>	w/ Staz-On Suspension	w/ Fas-Trac Suspension	w/ Staz-On Suspension	w/ 1-Touch Suspension <sup>1</sup>	w/ Fas-Trac Suspension <sup>1</sup>
<b>COMPLETE V-GARD ASSEMBLIES</b>										
WHITE	466354	477477	463942	10057441	475358	473284	477482	454733	10058321	475369
BLUE	466355	477478	463943	10057442	475359	476928	477483	454732	10058320	475368
YELLOW	466356	477479	463944	10057443	475360	473285	477484	454730	10058318	475366
ORANGE	—	—	463945	10057444	475361	—	—	454734	10058322	496075
RED	—	—	463947	10057446	475363	—	—	454736	10058324	475371
GREEN	—	—	463946	10057445	475362	—	—	454735	10058323	475370
GRAY	—	—	463948	10057447	475364	—	—	454731	10058319	475367
HI-VIZ® ORANGE <sup>2</sup>	—	—	488148	10057420	488146	—	489364	489360	10058326	10021292
HI-VIZ YELLOW-GREEN <sup>2</sup>	—	—	—	10061514	10061512	—	—	—	10061516	10061515
BRIGHT LIME GREEN	—	489368	815558	—	815565	—	—	815562	—	815570
DARK (CANADIAN) BLUE	—	—	—	—	802972	—	—	—	—	802975
GOLD	—	—	464852	—	475365	—	—	—	—	—
ROBIN'S EGG BLUE	—	—	463111	—	495853	—	—	—	—	—
BROWN	—	—	464658	—	495854	—	—	—	—	—
SILVER	—	—	484340	—	495855	—	—	—	—	—
TAN	—	—	461180	—	—	—	—	—	—	—
BLACK	—	—	475235	—	492559	—	—	—	—	—
LIGHT BUFF	—	—	478237	—	495856	—	—	—	—	—
PURPLE	—	—	488398	—	495858	—	—	—	—	—
PINK	—	—	—	—	495862	—	—	—	—	—
<b>SPECIAL V-GARD ASSEMBLIES</b>										
HI-VIZ ORANGE w/Yellow-Green Stripe <sup>2</sup>	—	—	—	10102195	10102193	—	—	—	—	—
HI-VIZ YELLOW-GREEN w/Red-Orange Stripe <sup>2</sup>	—	—	—	10102234	10102233	—	—	—	—	—
HI-VIZ YELLOW-GREEN w/Silver Stripe <sup>2</sup>	—	—	—	10102196	10102194	—	—	—	—	—
WHITE w/Lamp Bracket and Cord Holder (Class C)	—	—	460018	—	—	—	—	460069	—	815009
WHITE w/American Flag	—	—	474159	—	—	—	—	—	—	—
<b>V-GARD ASSEMBLY WITH SWING-RATCHET SUSPENSION</b>										
WHITE	10004689	White standard-size V-Gard Cap, w/Swing-Ratchet Suspension								

<sup>1</sup>Certified to CSA.

<sup>2</sup>V-Gard Cap/Hat meets the voluntary standard for hi-visibility as prescribed by ANSI/ISEA Z89.1-2009. Look for the official hi-visibility marking [HV] on the helmet's ANSI label.

**NOTE:** Small and Large V-Gard Caps are NOT CSA-certified. Standard size V-Gard Caps and Hats are CSA-certified when assembled with MSA's Fas-Trac or 1-Touch Suspension ONLY.

### ▲ WARNING

Do not mix suspension and helmet sizes. Make sure the sizes match (example: standard-size suspension with standard-size helmet). Use only MSA suspensions in an MSA helmet. Failure to comply with the above will reduce the energy-absorbing ability of the protective helmet, which can result in serious injury or death.

# Head, Eye, Face, and Hearing **Protection**

## Replacement Suspensions for V-Gard® Caps and Hats

Fas-Trac® Suspension



1-Touch® Suspension



Staz-On® Suspension



Swing-Ratchet Suspension

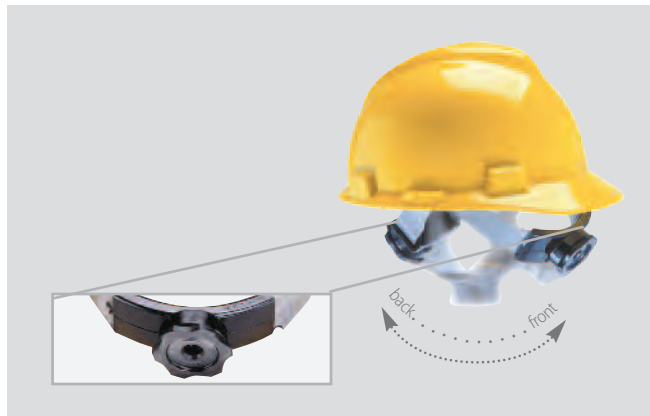

## Ordering Information

	Small	Standard	Large
FAS-TRAC SUSPENSION	492567	10087220	492568
1-TOUCH SUSPENSION	—	10061123	—
STAZ-ON SUSPENSION	467386	10087218	492566
SWING-RATCHET SUSPENSION	—	816645	—



## Logo Express® Service for MSA Industrial Helmets



### Custom Imprinting and Striping

A variety of MSA helmets can be customized with your logo, slogan, or striping. You can select the colors and the areas to be imprinted based on available options per our guidelines. MSA uses both single and multi-color imprinting techniques to provide a choice of up to four colors.

### Image 2000<sup>SM</sup>

A photographic process to reproduce high-quality, photo-stye images. Available on white MSA helmets only.

### Ordering Information

A minimum quantity of custom-imprinted caps or hats (of the same size and model) is required for initial and repeat orders.

For additional information, please contact your local MSA distributor or MSA Logo Express:  
1-800-MSA-LOGO (1-800-672-5646).

See Bulletin ID 0617-03-MC for more information.



# Head, Eye, Face, and Hearing **Protection**

## NFL V-Gard Classic Style Protective Caps



Arizona Cardinals



Dallas Cowboys



Miami Dolphins



Pittsburgh Steelers



Atlanta Falcons



Denver Broncos



Minnesota Vikings



San Diego Chargers



Baltimore Ravens



Detroit Lions



New England Patriots



San Francisco 49ers



Buffalo Bills



Green Bay Packers



New Orleans Saints



Seattle Seahawks



Carolina Panthers



Houston Texans



New York Giants



St. Louis Rams



Chicago Bears



Indianapolis Colts



New York Jets



Tampa Bay Buccaneers



Cincinnati Bengals



Jacksonville Jaguars



Oakland Raiders



Tennessee Titans



Cleveland Browns



Kansas City Chiefs



Philadelphia Eagles



Washington Redskins

## NFL V-Gard Classic Style Protective Caps

<b>Classification:</b>	Type I
<b>Application:</b>	General purpose
<b>Shell Material:</b>	Polyethylene
<b>Available Styles:</b>	Slotted Cap
<b>Suspension:</b>	1-Touch
<b>Sizes:</b>	Standard (6½ – 8")
<b>Standards:</b>	ANSI/ISEA Z89.1-2009 (Class E); CSA Z94.1-2005 (Class E)
<b>Certification:</b>	Third-party by SEI

ARIZONA CARDINALS	818384	Standard size
ATLANTA FALCONS	818385	Standard size
BALTIMORE RAVENS	818386	Standard size
BUFFALO BILLS	818387	Standard size
CAROLINA PANTHERS	818388	Standard size
CHICAGO BEARS	818389	Standard size
CINCINNATI BENGALS	818390	Standard size
CLEVELAND BROWNS	818391	Standard size
DALLAS COWBOYS	818392	Standard size
DENVER BRONCOS	818393	Standard size
DETROIT LIONS	818394	Standard size
GREEN BAY PACKERS	818395	Standard size
HOUSTON TEXANS	10031348	Standard size
INDIANAPOLIS COLTS	818396	Standard size
JACKSONVILLE JAGUARS	818397	Standard size
KANSAS CITY CHIEFS	818398	Standard size
MIAMI DOLPHINS	818399	Standard size
MINNESOTA VIKINGS	818400	Standard size
NEW ENGLAND PATRIOTS	818401	Standard size
NEW ORLEANS SAINTS	818402	Standard size
NEW YORK GIANTS	818403	Standard size
NEW YORK JETS	818404	Standard size
OAKLAND RAIDERS	818405	Standard size
PHILADELPHIA EAGLES	818406	Standard size
PITTSBURGH STEELERS	818407	Standard size
SAN DIEGO CHARGERS	818408	Standard size
SAN FRANCISCO 49ERS	818409	Standard size
SEATTLE SEAHAWKS	818410	Standard size
ST. LOUIS RAMS	818411	Standard size
TAMPA BAY BUCCANEERS	818412	Standard size
TENNESSEE TITANS	818413	Standard size
WASHINGTON REDSKINS	818414	Standard size

NFL Properties, the NFL, and its Member Clubs make no express or implied claims with respect to the effectiveness and safety of these products and have not manufactured or endorsed these products in any way.

# Head, Eye, Face, and Hearing **Protection**

## Freedom Series™ V-Gard Protective Caps and Hats



American Stars and Stripes



American Flag with 2 Eagles



Black with Red Maple Leaf

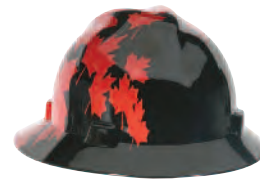

White with Red Maple Leaf



American Eagle



Dual American Flag



Camouflage



- Classification:** Type I
- Application:** General purpose
- Shell Material:** Polyethylene
- Available Styles:** Slotted Cap; Slotted Full-Brim Hat
- Sizes:** Standard (6½ – 8")
- Standards:** ANSI/ISEA Z89.1-2009 (Class E); CSA Z94.1-2005 (Class E)
- Certification:** Third-party by SEI
- Customization:** Imprinting and striping available

### Ordering Information

DESCRIPTION	Slotted V-Gard Cap (standard size)	Slotted V-Gard Hat (standard size)
AMERICAN FREEDOM SERIES ASSEMBLIES		
AMERICAN EAGLE	10079479	—
AMERICAN STARS AND STRIPES	10052945	10071157
AMERICAN FLAG WITH 2 EAGLES	10052947	10071159
CAMOUFLAGE	10103908	10104254
DUAL AMERICAN FLAG	10050611	—
CANADIAN FREEDOM SERIES ASSEMBLIES		
WHITE WITH RED MAPLE LEAF	10050613	10082234
BLACK WITH RED MAPLE LEAF	10082233	10082235
CAMOUFLAGE W/CANADIAN FLAG ON FRONT*	10104925	—

\* not pictured



## Specialty V-Gard Protective Caps

### V-Gard Caps with "Painted Look" Finish



rally cap



metallic gold cap



black fire cap



extreme hi-viz cap

- Classification:** Type I
- Application:** General purpose
- Shell Material:** Polyethylene
- Available Styles:** Slotted Cap
- Sizes:** Standard (6½ – 8")
- Standards:** ANSI/ISEA Z89.1-2009 (Class E);  
CSA Z94.1-2005 (Class E)
- Certification:** Third-party by SEI
- Customization:** Imprinting and striping available

### Ordering Information

RALLY CAP	10101535	Standard size, with Fas-Trac Suspension
METALLIC GOLD	10101854	Standard size, with Fas-Trac Suspension
BLACK FIRE	10092015	Standard size, with Fas-Trac Suspension
EXTREME HI-VIZ CAP*	10102180	Standard size, with Fas-Trac Suspension

\* Extreme Hi-Viz Cap meets the high-visibility requirements of ANSI/ISEA 107.



# Head, Eye, Face, and Hearing Protection

## V-Gard 500 Protective Caps

**Vented V-Gard 500 Caps** provide cooling vents for improved air circulation and comfort; the **Non-Vented V-Gard 500 Caps** provide users with dielectric head protection.



- Classification:** Type I
- Application:** General purpose
- Shell Material:** Polyethylene
- Available Styles:** Vented and Non-Vented Slotted Cap
- Sizes:** Standard (6½ – 8")
- Standards:** ANSI/ISEA Z89.1-2009 (Vented - Class C; Non-Vented Class E)
- Certification:** Third-party by SEI
- Customization:** Imprinting and striping available

## Ordering Information

DESCRIPTION	4-Point Fas-Trac (standard size)	6-Point Fas-Trac (standard size)
<b>VENTED STYLE</b>		
WHITE	10034018	10034027
BLUE	10034019	10034028
YELLOW	10034020	10034029
RED	10034022	10034031
GREEN	10034023	10034032
HI-VIZ ORANGE <sup>1</sup>	10034026	10034035
HI-VIZ YELLOW-GREEN <sup>1</sup>	10074819	10074820
<b>NON-VENTED STYLE</b>		
WHITE	10034088	10034097
<b>REPLACEMENT SUSPENSIONS</b>		
FOR V-GARD 500 CAPS	10034966	10034967

<sup>1</sup>Select V-Gard 500 Caps meets the voluntary standard for hi-visibility as prescribed by ANSI/ISEA Z89.1-2009. Look for the official hi-visibility marking [HV] on the helmet's ANSI label.

## SmoothDome® Protective Caps



**Classification:** Type I  
**Application:** General purpose; welding  
**Shell Material:** Polyethylene  
**Available Styles:** Slotted Cap  
**Sizes:** Standard (6½ – 8")  
**Standards:** ANSI/ISEA Z89.1-2009 (Class E); CSA Z94.1-2005 (Class E)  
**Certification:** Third-party by SEI  
**Customization:** Imprinting and striping available

### Ordering Information

DESCRIPTION	4-Point Fas-Trac (standard size)	6-Point Fas-Trac (standard size)
WHITE	10074067	10084078
BLUE	10074068	10084079
YELLOW	10074069	10084080
ORANGE	10074070	10084081
RED	10074071	10084082
GREEN	10074072	10084083
GRAY	10074073	10084084
HI-VIZ ORANGE <sup>1</sup>	10074077	10084088
HI-VIZ YELLOW-GREEN <sup>1</sup>	10074084	10084095
HI-VIZ ORANGE W/YELLOW-GREEN STRIPE <sup>1</sup>	10095987	10095988
HI-VIZ YELLOW-GREEN W/ORANGE STRIPE <sup>1</sup>	10095989	10095990
HI-VIZ ORANGE W/SILVER STRIPE <sup>1</sup>	10096141	—
HI-VIZ YELLOW-GREEN W/SILVER STRIPE <sup>1</sup>	10096142	—
<b>REPLACEMENT SUSPENSIONS</b>		
4-POINT FAS-TRAC SUSPENSION	10087220	
6-POINT FAS-TRAC SUSPENSION	10092163	
SWING-RATCHET SUSPENSION	816645	

<sup>1</sup>Select SmoothDome Caps meets the voluntary standard for hi-visibility as prescribed by ANSI/ISEA Z89.1-2009. Look for the official hi-visibility marking [HV] on the helmet's ANSI label.

# Head, Eye, Face, and Hearing Protection

## Topgard® Protective Caps and Hats



white

yellow

gray



blue

orange

green



red

hi-viz orange

white w/lamp bracket  
and cord holder

yellow full-brim hat



1-Touch Suspension



Fas-Trac Suspension



Swing-Ratchet Suspension

- Classification:** Type I
- Application:** General purpose; elevated temperature\*
- Shell Material:** Polycarbonate
- Available Styles:** Slotted Cap; Non-Slotted Full-Brim Hat
- Sizes:** Standard (6½ – 8")
- Standards:** ANSI/ISEA Z89.1-2009 (Class E);  
CSA Z94.1-2005 (Class E)
- Certification:** Third-party by SEI
- Customization:** Imprinting and striping available

\*Topgard Caps and Hats can withstand radiant heat loads up to but not exceeding 275°F.

## Ordering Information

DESCRIPTION	Topgard Slotted Cap (standard size)		Topgard Non-Slotted Hat (standard size)	
	w/ 1-Touch Suspension	w/ Fas-Trac Suspension	w/ 1-Touch Suspension	w/ Fas-Trac Suspension
TOPGARD ASSEMBLIES				
WHITE	454728	475385	454719	475393
YELLOW	454721	475378	454712	475387
GRAY	454722	475379	454713	—
BLUE	454723	475380	—	—
ORANGE	454725	475382	—	—
GREEN	454726	475383	—	—
RED	454727	475384	—	—
BRIGHT ORANGE	—	804396	—	804397
WHITE W/LAMP BRACKET AND CORD HOLDER	448914	—	—	—
REPLACEMENT SUSPENSIONS				
1-TOUCH SUSPENSION (6½–8)	10061127			
FAS-TRAC SUSPENSION (6½–8)	473333			
SWING-RATCHET SUSPENSION (6½–7¾)	816648			

## Thermalgard® Protective Caps



- Classification:** Type I
- Application:** General purpose; welding; elevated temperature\*
- Shell Material:** Glass-reinforced Nylon
- Available Styles:** Slotted Cap
- Sizes:** Standard (6½ – 8")
- Standards:** ANSI/ISEA Z89.1-2009 (Class G); CSA Z94.1-2005 (Class G)
- Certification:** Third-party by SEI
- Customization:** Imprinting and striping available

\*Thermalgard Caps can withstand radiant heat loads up to but not exceeding 350°F.



1-Touch Suspension



Fas-Trac Suspension



Swing-Ratchet Suspension

### Ordering Information

DESCRIPTION	w/ 1-Touch Suspension	w/ Fas-Trac Suspension
THERMALGARD ASSEMBLIES		
YELLOW	486964	486959
WHITE	486965	486960
RED	—	486961
ORANGE	486967	486962
BLUE	486968	486963
BRIGHT ORANGE	800359	800360
GREEN	487399	814343
STEEL GRAY	—	10095325
REPLACEMENT SUSPENSIONS		
1-TOUCH SUSPENSION (6½–8)	10061127	
FAS-TRAC SUSPENSION (6½–8)	473333	
SWING-RATCHET SUSPENSION (6½–7¾)	816648	

# Head, Eye, Face, and Hearing Protection

## Skullgard® Protective Caps and Hats



**Classification:** Type I  
**Application:** General purpose; elevated temperature\*  
**Shell Material:** Phenolic  
**Available Styles:** Non-Slotted Cap and Full-Brim Hat  
**Sizes:** Cap: Standard (6½ – 8"); Large (7– 8½")  
 Hat: Standard (6½ – 8")  
**Standards:** ANSI/ISEA Z89.1-2009 (Class G)  
**Certification:** Third-party by SEI  
**Customization:** Imprinting and striping available

\* Skullgard Caps and Hats can withstand radiant heat loads up to but not exceeding 350°F.



Staz-On Suspension



Fas-Trac Suspension



1-Touch Suspension



Swing-Ratchet Suspension



natural tan full-brim hat

## Ordering Information

DESCRIPTION	Skullgard Cap (standard size)			Skullgard Hat (standard size)	
	w/ Staz-On Suspension	w/ Fas-Trac Suspension	w/ Swing-Ratchet Suspension	w/ Staz-On Suspension	w/ Fas-Trac Suspension
SKULLGARD ASSEMBLIES					
NATURAL TAN	454617	475395	816651	454664	475407
WHITE	454618	475396	—	454665	475408
YELLOW	454619	475397	—	454666	—
RED	454620	—	—	—	—
GREEN	454621	—	—	454668	—
GRAY	454622	—	—	—	—
BLUE	454623	—	—	—	—
ORANGE	454626	—	—	454673	—
HI-VIZ RED-ORANGE*	458702	—	—	—	—

	w/ Staz-On Suspension	w/ Fas-Trac Suspension	
ALTERNATIVE SKULLGARD ASSEMBLIES			
SKULLGARD CAP	82018	475405	Large size, natural tan
	460409	—	Standard size, with lamp bracket and cord holder, natural tan
	—	482002	With welder's lugs, natural tan
SKULLGARD HAT	460389		Standard size, with lamp bracket and cord holder, natural tan

	Standard (6½–8)	Large (7–8½)
REPLACEMENT SUSPENSIONS		
STAZ-ON SUSPENSION	454231	468096
FAS-TRAC SUSPENSION	473334	478454
SWING-RATCHET SUSPENSION	816654 (6½–7½)	—
1-TOUCH SUSPENSION	10061128	—

\*Skullgard Cap meets the voluntary standard for hi-visibility as prescribed by ANSI/ISEA Z89.1-2009. Look for the official hi-visibility marking [HV] on the helmet's ANSI label.

## Super V® Protective Caps



- Classification:** Type II (CSA)
- Application:** Lateral protection
- Shell Material:** Polyethylene
- Available Styles:** Slotted Cap w/foam liner
- Sizes:** Standard (6½ – 8")
- Standards:** CSA Z94.1-2005 (Class E)
- Certification:** Third-party by SEI
- Customization:** Imprinting and striping available

### Ordering Information

DESCRIPTION	w/Fas-Trac Suspension
SUPER V ASSEMBLIES	
WHITE	C217091
YELLOW	C217093
RED	C217095
ORANGE	C217094
BLUE	C217092
NAVY GRAY	C217097
HI-VIZ ORANGE <sup>1</sup>	C217100
GREEN	C217096
GOLD	C217098
BLACK	C217140
SILVER	C217099
REPLACEMENT SUSPENSIONS (FOR SUPER V CAPS ONLY)	
FAS-TRAC SUSPENSION	818276

## Vanguard™ Protective Caps



- Classification:** Type II
- Application:** Lateral protection
- Shell Material:** Polyethylene
- Available Styles:** Slotted Cap w/foam liner
- Sizes:** Standard (6½ – 8")
- Standards:** ANSI/ISEA Z89.1-2009 (Class E); CSA Z94.1-2005 (Class E)
- Certification:** Third-party by SEI
- Customization:** Imprinting and striping available



### Ordering Information

DESCRIPTION	w/Fas-Trac Suspension
VANGUARD ASSEMBLIES	
WHITE	804940
YELLOW	804939
RED	804944
HI-VIZ ORANGE <sup>1</sup>	804947
BLUE	804946
REPLACEMENT SUSPENSIONS (FOR VANGUARD CAPS ONLY)	
FAS-TRAC SUSPENSION	804631

### ⚠ WARNING

Use only MSA's Fas-Trac Suspension designed for Vanguard or Super-V Protective Helmets. Use of any other suspension will reduce the energy-absorbing ability of the protective helmet, which can result in serious personal injury or death.

<sup>1</sup>Super V Cap and Vanguard Cap meet the voluntary standard for hi-visibility as prescribed by ANSI/ISEA Z89.1-2009. Look for the official hi-visibility marking [HV] on the helmet's ANSI label.

# Head, Eye, Face, and Hearing Protection

## Comfo-Cap® Protective Caps



- Classification:** Type I
- Application:** Mining
- Shell Material:** Polycarbonate
- Available Styles:** Non-Slotted Cap  
w/ lamp bracket and cord holder
- Sizes:** Standard (6½ – 8")
- Standards:** ANSI/ISEA Z89.1-2009 (Class G)
- Certification:** Third-party by SEI
- Customization:** Imprinting and striping available

## Bump Caps



- Classification:** Non-Impact
- Application:** Pest control, meter reading, food/beverage processing, meat packing, auto repair
- Shell Material:** Polyethylene
- Available Styles:** Non-Slotted Cap w/ plastic suspension
- Sizes:** Standard (6½ – 8")
- Standards:** None
- Certification:** Third-party by SEI
- Customization:** Imprinting and striping available

### Ordering Information

DESCRIPTION	w/Staz-On	w/Fas-Trac
<b>COMFO CAP ASSEMBLIES</b>		
WHITE	91522	475336
BLUE	91586	—
YELLOW	91585	—
ORANGE	91589	—
RED	91590	—
GREEN	91584	—
BLACK	82769	—
<b>REPLACEMENT SUSPENSIONS</b>		
STAZ-ON SUSPENSION	454231	
FAS-TRAC SUSPENSION	10061128	
1-TOUCH SUSPENSION	473334	

### Ordering Information

DESCRIPTION	w/Plastic Suspension
<b>BUMP CAP ASSEMBLIES</b>	
WHITE	10033652
BLUE	10033650
YELLOW	10033651
ORANGE	10033654
RED	10033653
GREEN	10033655
<b>REPLACEMENT SUSPENSION</b>	
PLASTIC SUSPENSION	10127527



## V-Gard Accessory System: V-Gard Frames for Caps

The V-Gard Accessory System offers helmet-mounted frames for various work conditions and MSA helmets. The sloped design allows liquids, chips and other materials to slide off the frame and away from the line of sight. Each frame, whether used with or without debris control, meets the applicable requirements for ANSI/ISEA Z87.1-2010, EN 166, CSA Z94.3, AS/NZS 1337, and many local standards.<sup>1</sup>

- Classification:** General purpose
- Market(s):** General industry, manufacturing, repair and maintenance, construction, oil and gas, forestry, shipbuilding, metalworking, automotive, mining
- Application(s):** Chipping, splash, chiseling, drilling, grinding, machining, power fastening, sanding, sawing
- Material:** High density polyethylene (HDPE)
- Color(s):** Black
- Available Styles:** Frame for Slotted Caps  
Universal Frame for Caps
- Size:** Fits MSA Safety Caps
- Features:** Offered with or without debris control
- Standards<sup>1</sup>:** ANSI/ISEA Z87.1-2010; EN 166; CSA Z94.3; and AS/NZS 1337
- Certification:** Third-party by Intertek, INSPEC International Ltd., CSA International and SAI Global Ltd.

### Ordering Information

V-GARD FRAMES FOR GENERAL PURPOSES	Part No.	Product Specifics
	10115730 	<ul style="list-style-type: none"> <li>• Fits all MSA Slotted Caps</li> <li>• Sold with replaceable debris control which creates tight seal between frame and cap</li> <li>• Stowable slot adaptors secure frame tightly in slotted MSA caps, and allow frame to work with or without earmuffs<sup>2</sup></li> <li>• Sliding adjustment blades allow visor to work with most half-mask respirators and other PPE worn under a visor</li> </ul>
	10121266 	<ul style="list-style-type: none"> <li>• Fits all MSA Slotted Caps<sup>3</sup></li> <li>• Debris control sold separately</li> <li>• Stowable slot adaptors secure frame tightly in slotted MSA caps, and allow frame to work with or without earmuffs<sup>2</sup></li> <li>• Sliding adjustment blades allow visor to work with most half-mask respirators and other PPE worn under a visor</li> </ul>
	10115822 	<ul style="list-style-type: none"> <li>• Fits all MSA Caps (Slotted or Non-Slotted)<sup>4</sup></li> <li>• Sold with replaceable debris control which creates tight seal between frame and cap</li> <li>• Heavy duty flat rubber strap allows easy and secure placement on all MSA caps, including non-slotted models</li> <li>• Design allows use with other PPE, including MSA earmuffs and respirators</li> </ul>
	10121268 	<ul style="list-style-type: none"> <li>• Fits all MSA Caps (Slotted or Non-Slotted)<sup>4</sup></li> <li>• Debris control sold separately</li> <li>• Heavy duty flat rubber strap allows easy and secure placement on all MSA caps, including non-slotted models</li> <li>• Design allows use with other PPE, including MSA earmuffs and respirators</li> </ul>

### ⚠ WARNING

Use V-Gard Frames ONLY with V-Gard Visors, to ensure compliance with safety standards. Misuse can result in death, permanent impairment of sight, or other serious injury.

<sup>1</sup>Standards requirements met by each V-Gard Frame/V-Gard Visor combination designated on each V-Gard Visor.

<sup>2</sup>Patent pending

<sup>3</sup>MSA recommends the use of debris control on V-Gard frames when wearing BOTH large V-Gard molded Visors and cap-mounted earmuffs.

<sup>4</sup>MSA does not recommend the use of the V-Gard Universal Frame with the MSA SmoothDome when using cap-mounted muffs and large V-Gard molded Visors. The V-Gard Frame for Slotted Caps should be worn with this particular combination.

# Head, Eye, Face, and Hearing Protection

## V-Gard Accessory System: V-Gard Frames for Caps

<b>Classification:</b>	Elevated temperature
<b>Market(s):</b>	Food manufacturing/canneries, steel mills, construction, open-pit mining, agriculture, oil/gas/petrochemical refineries, rubber manufacturing, and steam tunnels
<b>Application(s):</b>	Food processing, machine operation, maintenance, millwright, cutting, punching, extrusion, drilling, blasting, casting/conveying, chemical mixing, sanding
<b>Material:</b>	Polycarbonate
<b>Color(s):</b>	Grey
<b>Available Styles:</b>	Frame for Slotted Caps Universal Frame for Caps
<b>Size:</b>	Fits MSA Safety Caps
<b>Features:</b>	Offered with or without debris control Tested to withstand temperatures of 350°F (176.7°C), reducing warping, cracking or crazing All non-metal construction
<b>Standards<sup>1</sup>:</b>	ANSI/ISEA Z87.1-2010; EN 166; CSA Z94.3; and AS/NZS 1337.
<b>Certification:</b>	Third-party by Intertek, INSPEC International Ltd., CSA International and SAI Global Ltd.

## Ordering Information

V-GARD FRAMES FOR ELEVATED TEMPERATURE APPLICATIONS		Part No.	Product Specifics
		10115821	<ul style="list-style-type: none"> <li>Stowable slot adaptors secure frame tightly in slotted MSA caps, and allow frame to work with or without earmuffs<sup>2</sup></li> <li>Sliding adjustment blades allow visor to work with most half-mask respirators and other PPE worn under a visor</li> <li>Replaceable debris control tested against EN 166 molten metal requirements</li> </ul>
		10121267	<ul style="list-style-type: none"> <li>Stowable slot adaptors secure frame tightly in slotted MSA caps, and allow frame to work with or without earmuffs</li> <li>Sliding adjustment blades allow visor to work with most half-mask respirators and other PPE worn under a visor</li> <li>Debris control sold separately<sup>3</sup></li> </ul>
		10116522	<ul style="list-style-type: none"> <li>Heavy duty flat rubber strap allows easy and secure placement on all MSA caps, including non-slotted models<sup>4</sup></li> <li>Design allows use with other PPE, including MSA earmuffs and respirators</li> <li>Replaceable debris control tested against EN 166 molten metal requirements</li> </ul>
		10122446	<ul style="list-style-type: none"> <li>Heavy duty flat rubber strap allows easy and secure placement on all MSA caps, including non-slotted models<sup>4</sup></li> <li>Design allows use with other PPE, including MSA earmuffs and respirators</li> <li>Debris control sold separately<sup>3</sup></li> </ul>

<sup>1</sup>Standards requirements met by each V-Gard Frame/V-Gard Visor combination designated on each V-Gard Visor.

<sup>2</sup>Patent pending



<sup>3</sup>MSA recommends the use of debris control on V-Gard frames when wearing BOTH large V-Gard molded Visors and cap-mounted earmuffs.

<sup>4</sup>MSA does not recommend the use of the V-Gard Universal Frame with the MSA SmoothDome when using cap-mounted muffs and large V-Gard molded Visors. The V-Gard Frame for Slotted Caps should be worn with this particular combination.

## V-Gard Accessory System: V-Gard Frames for Full-Brim Helmets



<b>Classification:</b>	General purpose
<b>Market(s):</b>	General industry, manufacturing, repair and maintenance, construction, oil and gas, forestry, shipbuilding, metalworking, automotive, mining
<b>Application(s):</b>	Chipping, splash, chiseling, drilling, grinding, machining, power fastening, sanding, sawing
<b>Material:</b>	High density polyethylene (HDPE)
<b>Color(s):</b>	Black
<b>Available Styles:</b>	Universal Frame
<b>Size:</b>	Fits MSA Full-Brim Safety Helmets
<b>Features:</b>	Offered without debris control ONLY
<b>Standards<sup>1</sup>:</b>	ANSI/ISEA Z87.1-2010; EN 166; CSA Z94.3; and AS/NZS 1337
<b>Certification:</b>	Third-party by Intertek, INSPEC International Ltd., CSA International and SAI Global Ltd.

### Ordering Information

V-GARD FRAME FOR FULL-BRIM HELMETS FOR GENERAL PURPOSE	Image	Part No.	Product Specifics
		10116627 	<ul style="list-style-type: none"> <li>• Heavy duty flat rubber strap allows easy and secure placement on all MSA caps, including non-slotted models</li> <li>• Design allows use with other PPE, including MSA earmuffs and respirators</li> </ul>

<b>Classification:</b>	Elevated temperature
<b>Market(s):</b>	Food manufacturing/canneries, steel mills, construction, open-pit mining, agriculture, oil/gas/petrochemical refineries, rubber manufacturing, and steam tunnels
<b>Application(s):</b>	Food processing, machine operation, maintenance, millwright, cutting, punching, extrusion, drilling, blasting, casting/conveying, chemical mixing, sanding
<b>Material:</b>	Polycarbonate
<b>Color(s):</b>	Grey
<b>Available Styles:</b>	Universal Frame
<b>Size:</b>	Fits MSA Full-Brim Safety Helmets
<b>Features:</b>	Offered without debris control ONLY Tested to temperatures of 350°F (176.7°C), reducing warping, cracking or crazing All non-metal construction
<b>Standards<sup>1</sup>:</b>	ANSI/ISEA Z87.1-2010; EN 166; CSA Z94.3; and AS/NZS 1337
<b>Certification:</b>	Third-party by Intertek, INSPEC International Ltd., CSA International and SAI Global Ltd.

### Ordering Information

V-GARD FRAME FOR FULL-BRIM HELMETS FOR ELEVATED TEMPERATURE APPLICATIONS	Image	Part No.	Product Specifics
		10116628 	<ul style="list-style-type: none"> <li>• Heavy duty flat rubber strap allows easy and secure placement on all MSA caps, including non-slotted models</li> <li>• Design allows use with other PPE, including MSA earmuffs and respirators</li> </ul>











<sup>1</sup>Standards requirements met by each V-Gard Frame/V-Gard Visor combination designated on each V-Gard Visor.

# Head, Eye, Face, and Hearing Protection

## V-Gard Accessory System: General Purpose V-Gard Visors

<b>Classification:</b>	General purpose
<b>Market(s):</b>	General industry, manufacturing, repair and maintenance, construction, oil and gas, forestry, shipbuilding, metalworking, automotive, mining
<b>Application(s):</b>	Chipping, splash, chiseling, drilling, grinding, machining, power fastening, sanding, sawing
<b>Material:</b>	Polycarbonate
<b>Color(s):</b>	Clear
<b>Available Styles:</b>	Contoured or flat; visors and nitrometers; bulk pack
<b>Size:</b>	Varies. See "Product Specifics" in Ordering Information chart.
<b>Features:</b>	Maximum UV protection ("U6") Impact-rated (Z87+)
<b>Standards<sup>1</sup>:</b>	ANSI/ISEA Z87.1-2010; EN 166 (2C-1.2 MSA 1B); CSA Z94.3 and AS/NZS 1337
<b>Certification:</b>	Third-party by Intertek, INSPEC International Ltd., CSA International and SAI Global Ltd.

## Ordering Information









V-GARD VISORS FOR GENERAL PURPOSE APPLICATIONS	Part No.	Product Specifics
	10115836 	<ul style="list-style-type: none"> <li>8" (20.3 cm) x 17" (43.2 cm) x .04" (1.02mm)</li> <li>Contoured visor; closer fit and improved resistance to impact and splash hazards</li> </ul>
	10115837 	<ul style="list-style-type: none"> <li>8" (20.3 cm) x 17" (43.2 cm) x .04" (1.02mm)</li> <li>Nitrometer; for use with V-Gard Retractable or Standard Chin Protectors</li> <li>Contoured visor; closer fit and improved resistance to impact and splash hazards</li> </ul>
	10120108 	<ul style="list-style-type: none"> <li>8" (20.3 cm) x 17" (43.2 cm) x .04" (1.02mm)</li> <li>Bulk pack of 20</li> <li>Contoured visor; closer fit and improved resistance to impact and splash hazards</li> </ul>
	10117750	<ul style="list-style-type: none"> <li>8" (20.3 cm) x 17" (43.2 cm) x .04" (1.02mm)</li> <li>Flat visor; wider design improved resistance to impact and splash hazards</li> <li>Does not meet CSA Z94.3</li> </ul>
	10117781	<ul style="list-style-type: none"> <li>8" (20.3 cm) x 17" (43.2 cm) x .04" (1.02mm)</li> <li>Flat nitrometer; for use with V-Gard Retractable or Standard Chin Protectors</li> <li>Wider design improved resistance to impact and splash hazards</li> <li>Does not meet CSA Z94.3</li> </ul>
	10115863 	<ul style="list-style-type: none"> <li>9.5" (24.1 cm) x 17" (43.2 cm) x .04" (1.02mm)</li> <li>Contoured visor; closer fit and improved resistance to impact and splash hazards</li> </ul>
	10118094	<ul style="list-style-type: none"> <li>9.5" (24.1 cm) x 17" (43.2 cm) x .04" (1.02mm)</li> <li>Flat visor; wider design improved resistance to impact and splash hazards</li> <li>Does not meet CSA Z94.3</li> </ul>

<sup>1</sup> Unless otherwise noted.

## V-Gard Accessory System: General Purpose V-Gard Visors (Anti-fog/Anti-scratch Coatings)

<b>Classification:</b>	General purpose: humid conditions
<b>Market(s):</b>	General industry, manufacturing, repair and maintenance, construction, oil and gas, forestry, shipbuilding, metalworking, automotive, mining
<b>Application(s):</b>	Hot/humid conditions, chipping, splash, chiseling, drilling, grinding, machining, power fastening, sanding, sawing
<b>Material:</b>	Polycarbonate with anti-fog/anti-scratch coatings
<b>Color(s):</b>	Clear Green tint
<b>Available Styles:</b>	Contoured; visors and nitrometers
<b>Size:</b>	8" (20.3 cm) x 17" (43.2 cm) x .06" (1.52mm)
<b>Features:</b>	Anti-fog/anti-scratch coatings Impact-rated (Z87+) Maximum UV protection ("U6") Slightly thicker for industrial impact applications
<b>Standards:</b>	ANSI/ISEA Z87.1-2010 and CSA Z94.3
<b>Certification:</b>	Third-party by Intertek and CSA International

### Ordering Information





V-GARD VISORS FOR GENERAL PURPOSE APPLICATIONS		Part No.	Product Specifics
		10115839 	<ul style="list-style-type: none"> <li>• Contoured visor; closer fit and improved resistance to impact and splash hazards</li> <li>• Clear</li> </ul>
		10115841 	<ul style="list-style-type: none"> <li>• Nitrometer; for use with V-Gard Retractable or Standard Chin Protectors</li> <li>• Contoured visor; closer fit and improved resistance to impact and splash hazards</li> <li>• Clear</li> </ul>
		10115842 	<ul style="list-style-type: none"> <li>• Contoured visor; closer fit and improved resistance to impact and splash hazards</li> <li>• Green tint, reduces glare; not for use where a Shade IR visor is required</li> </ul>
		10115843 	<ul style="list-style-type: none"> <li>• Nitrometer; for use with V-Gard Retractable or Standard Chin Protectors</li> <li>• Contoured visor; closer fit and improved resistance to impact and splash hazards</li> <li>• Green tint, reduces glare; not for use where a Shade IR visor is required</li> </ul>

# Head, Eye, Face, and Hearing **Protection**

## V-Gard Accessory System: General Purpose V-Gard Visors

<b>Classification:</b>	General purpose
<b>Market(s):</b>	General industry, manufacturing, repair and maintenance, construction, oil and gas, forestry, shipbuilding, metalworking, automotive, mining
<b>Application(s):</b>	Chipping, splash, chiseling, drilling, grinding, machining, power fastening, sanding, sawing
<b>Material:</b>	Polycarbonate
<b>Color(s):</b>	Clear
<b>Available Styles:</b>	Contoured or flat; visors and nitrometers
<b>Size:</b>	8" (20.3 cm) x 17" (43.2 cm) x .06" (1.52mm)
<b>Features:</b>	Impact-rated (Z87+) Maximum UV protection ("U6") Slightly thicker for industrial impact applications
<b>Standards<sup>1</sup>:</b>	ANSI/ISEA Z87.1-2010; EN 166 (2C-1.2 MSA 1B); CSA Z94.3 and AS/NZS 1337
<b>Certification:</b>	Third-party by Intertek, INSPEC International Ltd., CSA International and SAI Global Ltd.

## Ordering Information

V-GARD VISORS FOR GENERAL PURPOSE APPLICATIONS		Part No.	Product Specifics
		10115840 	<ul style="list-style-type: none"> <li>Contoured visor; closer fit and improved resistance to impact and splash hazards</li> <li>Certified to EN166 molten metal/hot solids (2C-1.2 MSA1B89)</li> </ul>
		10117782	<ul style="list-style-type: none"> <li>Flat visor; wider design improved resistance to impact and splash hazards</li> <li>Does not meet CSA Z94.3</li> </ul>
		10117783	<ul style="list-style-type: none"> <li>Flat nitrometer; for use with V-Gard Retractable or Standard Chin Protectors</li> <li>Wider design improved resistance to impact and splash hazards</li> <li>Does not meet CSA Z94.3</li> </ul>

<sup>1</sup> Unless otherwise noted.

## V-Gard Accessory System: General Purpose V-Gard Visors (Heavy Duty with High-Performance Anti-fog/Anti-scratch Coatings)

<b>Classification:</b>	General purpose: heavy duty, humid conditions
<b>Market(s):</b>	General industry, manufacturing, repair and maintenance, construction, oil and gas, forestry, shipbuilding, metalworking, automotive, mining
<b>Application(s):</b>	Hot/humid conditions, chipping, splash, chiseling, drilling, grinding, machining, power fastening, sanding, sawing, outdoor work
<b>Material:</b>	Polycarbonate, with EN166-performance-rated anti-fog and anti-scratch coatings
<b>Color(s):</b>	Clear Green tint
<b>Available Styles:</b>	Molded
<b>Size:</b>	10.375" (26.4 cm) x 17" (43.2 cm) x .098" (2.5 mm)
<b>Features:</b>	EN 166 performance-rated anti-fog/anti-scratch (N, K marks, respectively) Impact-rated (Z87+) Maximum UV protection ("U6") Thick for heavy duty industrial impact applications
<b>Standards:</b>	ANSI/ISEA Z87.1-2010; EN 166 (2C-1.2 MSA 1B89KN); CSA Z94.3 and AS/NZS 1337
<b>Certification:</b>	Third-party by Intertek, INSPEC International Ltd., CSA International and SAI Global Ltd.

### Ordering Information



V-GARD VISORS FOR HEAVY DUTY GENERAL PURPOSE APPLICATIONS		Part No.	Product Specifics
		10115853 	<ul style="list-style-type: none"> <li>Molded visor for superior optics under heavy duty use</li> <li>Extended length for greater coverage of neck/face</li> <li>Performs well against many chemicals. Please refer to MSA's Chemical Application Quick Reference Guide (ID 0670-007/MC) for details</li> <li>Clear</li> </ul>
		10115854 	<ul style="list-style-type: none"> <li>Molded visor for superior optics under heavy duty use</li> <li>Extended length for greater coverage of neck/face</li> <li>Green tint, helps reduce glare; not for use where a Shade IR visor is required</li> </ul>

# Head, Eye, Face, and Hearing **Protection**

## V-Gard Accessory System: General Purpose V-Gard Visors (Non-Impact)

<b>Classification:</b>	General purpose: non-impact
<b>Market(s):</b>	General industry, manufacturing, repair and maintenance, construction, oil and gas, forestry, shipbuilding, automotive, mining
<b>Application(s):</b>	Flying chips and other light debris
<b>Material:</b>	Epoxy-coated steel mesh (20 x 20)
<b>Color(s):</b>	Black
<b>Available Styles:</b>	Flat
<b>Size:</b>	Varies. See "Product Specifics" in Ordering Information chart.
<b>Features:</b>	General protector (Z87); <b>not for impact hazards</b>
<b>Standards:</b>	ANSI/ISEA Z87.1-2010; EN 1731-F; and AS/NZS 1337
<b>Certification:</b>	Third-party by Intertek, INSPEC International Ltd., and SAI Global Ltd.

### Ordering Information

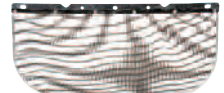
V-GARD VISORS FOR GENERAL PURPOSE APPLICATIONS		Part No.	Product Specifics
		10116557	<ul style="list-style-type: none"> <li>• 8" (20.3 cm) x 17" (43.2 cm)</li> <li>• Visor; plastic-edged mesh</li> <li>• Not for use against splash, impact, elevated temperatures or UV hazards</li> <li>• Can be worn with earmuffs</li> </ul>
		10116558	<ul style="list-style-type: none"> <li>• 8" (20.3 cm) x 17" (43.2 cm)</li> <li>• Nitrometer; for use with V-Gard Retractable or Standard Chin Protectors</li> <li>• Plastic-edged mesh</li> <li>• Not for use against splash, impact, elevated temperatures or UV hazards</li> <li>• Can be worn with earmuffs</li> </ul>
		10116556	<ul style="list-style-type: none"> <li>• 8" (20.3 cm) x 16.5" (41.9 cm)</li> <li>• Aluminum-bound mesh</li> <li>• Not for use against splash, impact, electrical or UV hazards</li> </ul>



## V-Gard Accessory System: Chemical and Splash V-Gard Visors

<b>Classification:</b>	Chemical and splash
<b>Market(s):</b>	General industry, heavy manufacturing, laboratories, chem/petrochemical, agriculture, pharmaceutical, oil and gas, mining
<b>Application(s):</b>	Chipping, splash, chemical mixing, grinding, machining, power fastening, sanding, sawing
<b>Material:</b>	Propionate
<b>Color(s):</b>	Clear
<b>Available Styles:</b>	Molded visor; molded nitrometer
<b>Size:</b>	Varies. See "Product Specifics" in Ordering Information chart.
<b>Features:</b>	Performs well against many types of chemicals. Please refer to MSA's Chemical Application Quick Reference Guide (ID 0670-007/MC) for details. Impact-rated (Z87+)
<b>Standards:</b>	ANSI/ISEA Z87.1-2010; EN 166 (MSA 1B 3); CSA Z94.3 and AS/NZS 1337
<b>Certification:</b>	Third-party by Intertek, INSPEC International Ltd., CSA International and SAI Global Ltd.

### Ordering Information

V-GARD VISORS FOR CHEMICAL AND SPLASH APPLICATIONS		Part No.	Product Specifics
		10115855 	<ul style="list-style-type: none"> <li>• 8" (20.3 cm) x 17" (43.2 cm) x .098" (2.5mm)</li> <li>• Visor</li> <li>• Extra-thick to help prevent warping, cracking or crazing under tough conditions</li> </ul>
		10115856 	<ul style="list-style-type: none"> <li>• 8" (20.3 cm) x 17" (43.2 cm) x .098" (2.5mm)</li> <li>• Nitrometer; for use with V-Gard Retractable or Standard Chin Protectors</li> <li>• Extra-thick to help prevent warping, cracking or crazing under tough conditions</li> </ul>
		10115851 	<ul style="list-style-type: none"> <li>• 9.25" (23.5 cm) x 18" (45.7 cm) x .098" (2.5mm)</li> <li>• Visor</li> <li>• Extra-thick to help prevent warping, cracking or crazing under tough conditions</li> <li>• Extended length and width for greater coverage of neck and face</li> </ul>

# Head, Eye, Face, and Hearing **Protection**

## V-Gard Accessory System: Chemical and Splash V-Gard Visors

<b>Classification:</b>	Chemical and splash
<b>Market(s):</b>	General industry, heavy manufacturing, laboratories, chem/petrochemical, agriculture, pharmaceutical, oil and gas, mining
<b>Application(s):</b>	Outdoor use, chipping, splash, chemical mixing, grinding, machining, sanding, sawing
<b>Material:</b>	Propionate
<b>Color(s):</b>	Green tint
<b>Available Styles:</b>	Molded
<b>Size:</b>	Varies. See "Product Specifics" in Ordering Information chart.
<b>Features:</b>	Maximum UV protection ("U6") Impact-rated (Z87+) Green tint helps alleviate eyestrain and reduces glare
<b>Standards:</b>	ANSI/ISEA Z87.1-2010 and CSA Z94.3
<b>Certification:</b>	Third-party by Intertek and CSA International





## Ordering Information

V-GARD VISORS FOR CHEMICAL AND SPLASH APPLICATIONS		Part No.	Product Specifics
		10115857 	<ul style="list-style-type: none"> <li>• 8" (20.3 cm) x 17" (43.2 cm) x .098" (2.5mm)</li> <li>• Visor</li> <li>• Glare-reducing green tint alleviates eye strain and fatigue</li> <li>• Extra-thick to help prevent warping, cracking or crazing under tough conditions</li> <li>• Not for use where a Shade IR visor is required</li> </ul>
		10115852 	<ul style="list-style-type: none"> <li>• 9.25" (23.5 cm) x 18" (45.7 cm) x .098" (2.5mm)</li> <li>• Visor</li> <li>• Glare-reducing green tint alleviates eye strain and fatigue</li> <li>• Extra-thick to help prevent warping, cracking or crazing under tough conditions</li> <li>• Extended length and width for greater coverage of neck and face</li> <li>• Not for use where a Shade IR visor is required</li> </ul>

## V-Gard Accessory System: Elevated Temperature V-Gard Visors (Heavy Duty with High-Performance Anti-fog/Anti-scratch Coatings)

<b>Classification:</b>	Elevated temperature
<b>Market(s):</b>	Food manufacturing/canneries, steel mills, construction, open-pit mining, agriculture, oil/gas/petrochemical refineries, rubber manufacturing, steam tunnels
<b>Application(s):</b>	Food processing, machine operation, maintenance, millwright, cutting, punching, extrusion, drilling, blasting, casting/conveying, chemical mixing, sanding
<b>Material:</b>	Polycarbonate with EN166 performance-rated anti-fog and anti-scratch coatings
<b>Color(s):</b>	Clear
<b>Available Styles:</b>	Molded
<b>Size:</b>	Varies. See "Product Specifics" in Ordering Information chart.
<b>Features:</b>	EN166 performance-rated anti-fog/anti-scratch coatings (N, K marks, respectively) Impact-rated (Z87+) Maximum UV protection ("U6")
<b>Standards:</b>	ANSI/ISEA Z87.1-2010; EN 166 (2C-1.2 MSA 1BT89KN); CSA Z94.3 and AS/NZS 1337
<b>Certification:</b>	Third-party by Intertek, INSPEC International Ltd., CSA International and SAI Global Ltd.

### Ordering Information

V-GARD VISORS FOR ELEVATED TEMPERATURE APPLICATIONS		Part No.	Product Specifics
		10115844 	<ul style="list-style-type: none"> <li>• 9.25" (23.5 cm) x 17" (43.2 cm) x .098" (2.5mm)</li> <li>• Extra-thick visor helps prevent warping, cracking or crazing under tough conditions</li> <li>• Conditioned to a high of 131°F (and a low of 23°F) and then tested to the medium impact rating in the EN166 standard (higher impact speed than ANSI/ISEA Z87.1-2010)</li> <li>• Visors do not reflect IR; not recommended for use against radiant heat hazards</li> </ul>
	10115846 	<ul style="list-style-type: none"> <li>• 9.25" (23.5 cm) x 18" (45.7 cm) x .098" (2.5mm)</li> <li>• Extra-thick visor helps prevent warping, cracking or crazing under tough conditions</li> <li>• Extended length for greater coverage of face and neck</li> <li>• Conditioned to a high of 131°F (and a low of 23°F) and then tested to the medium impact rating in the EN166 standard (higher impact speed than ANSI/ISEA Z87.1-2010)</li> <li>• Visors do not reflect IR; not recommended for use against radiant heat hazards</li> </ul>	

# Head, Eye, Face, and Hearing **Protection**

## V-Gard Accessory System: Elevated Temperature V-Gard Visors (Heavy Duty with High- Performance Anti-fog/Anti-scratch Coatings)

<b>Classification:</b>	Elevated temperature
<b>Market(s):</b>	Construction, open-pit mining, agriculture, oil/gas/petrochemical refineries
<b>Application(s):</b>	Food processing, machine operation, maintenance, millwright, cutting, punching, extrusion, drilling, blasting, casting/conveying, chemical mixing, sanding
<b>Material:</b>	Polycarbonate
<b>Color(s):</b>	Green tint
<b>Available Styles:</b>	Molded
<b>Size:</b>	Varies. See "Product Specifics" in Ordering Information chart.
<b>Features:</b>	EN166 performance-rated anti-fog/anti-scratch coatings (N, K marks, respectively) Impact-rated (Z87+) Green tint helps alleviate eyestrain and reduces glare Maximum UV protection ("U6")
<b>Standards:</b>	ANSI/ISEA Z87.1-2010; EN 166 (2.2 MSA 1BT89KN); CSA Z94.3 and AS/NZS 1337
<b>Certification:</b>	Third-party by Intertek, INSPEC International Ltd., CSA International and SAI Global Ltd.



### Ordering Information

V-GARD VISORS FOR ELEVATED TEMPERATURE APPLICATIONS		Part No.	Product Specifics
		10115845 	<ul style="list-style-type: none"> <li>• 9.25" (23.5 cm) x 17" (43.2 cm) x .098" (2.5mm)</li> <li>• Extra-thick visor helps prevent warping, cracking or crazing under tough conditions</li> <li>• Conditioned to a high of 131°F (and a low of 23°F) and then tested to the medium impact rating in the EN166 standard (higher impact speed than ANSI/ISEA Z87.1-2010)</li> <li>• Visors do not reflect IR; not recommended for use against radiant heat hazards. Not for use where a Shade IR visor is required.</li> </ul>
		10115849 	<ul style="list-style-type: none"> <li>• 9.25" (23.5 cm) x 18" (45.7 cm) x .098" (2.5mm)</li> <li>• Extra-thick visor helps prevent warping, cracking or crazing under tough conditions</li> <li>• Extended length for greater coverage of face and neck</li> <li>• Conditioned to a high of 131°F (and a low of 23°F) and then tested to the medium impact rating in the EN166 standard (higher impact speed than ANSI/ISEA Z87.1-2010)</li> <li>• Visors do not reflect IR; not recommended for use against radiant heat hazards. Not for use where a Shade IR visor is required.</li> </ul>

## V-Gard Accessory System: Elevated Temperature/Radiant Heat V-Gard Visors

<b>Classification:</b>	Elevated temperature/radiant heat
<b>Market(s):</b>	Metal industries, glass manufacturing, iron and steel foundries, chemical manufacturing, construction, general manufacturing, textile manufacturing, mining, oil and gas
<b>Application(s):</b>	Grinding, pouring, casting, blowing/melting, rolling, sawing, cutting, crimping, millwrighting, machining/operating, pipelining, pulping
<b>Material:</b>	Polycarbonate
<b>Color(s):</b>	Clear, reflective-coated
<b>Available Styles:</b>	Molded
<b>Size:</b>	9.5" (24.1 cm) x17.75" (45.09 cm) x .07" (8 mm)
<b>Features:</b>	Reflects >60% Infrared (IR) radiation (EN166 "R" mark) Impact-rated (Z87+) Maximum UV protection ("U6")
<b>Standards:</b>	ANSI/ISEA Z87.1-2010; EN 166 (2C-2.5 MSA 1BT3R); CSA Z94.3 and AS/NZS 1337
<b>Certification:</b>	Third-party by Intertek, INSPEC International Ltd., CSA International and SAI Global Ltd.

### Ordering Information



V-GARD VISORS FOR ELEVATED TEMPERATURE/RADIANT HEAT APPLICATIONS		Part No.	Product Specifics
		10115848 	<ul style="list-style-type: none"> <li>• Reflective coating reflects IR and helps dissipate heat</li> <li>• Thick visor helps prevent warping, cracking or crazing under tough conditions</li> <li>• Extended length for greater coverage of face and neck</li> </ul>

# Head, Eye, Face, and Hearing **Protection**

## V-Gard Accessory System: Elevated Temperature/Radiant Heat V-Gard Visors

<b>Classification:</b>	Elevated temperature/radiant heat
<b>Market(s):</b>	Metal industries, glass manufacturing, iron and steel foundries, chemical manufacturing, construction, general manufacturing, textile manufacturing, mining, oil and gas
<b>Application(s):</b>	Grinding, pouring, casting, blowing/melting, rolling, sawing, cutting, crimping, millwrighting, machining/operating, pipelining, pulping
<b>Material:</b>	Polycarbonate
<b>Color(s):</b>	Green tint, reflective-coated
<b>Available Styles:</b>	Molded
<b>Size:</b>	9.5" (24.1 cm) x17.75" (45.09 cm) x .07" (8 mm)
<b>Features:</b>	Reflects >60% Infrared (IR) radiation (EN166 "R" mark) Impact-rated (Z87+) Green tint helps alleviate eyestrain and reduces glare Maximum UV protection ("U6")
<b>Standards:</b>	ANSI/ISEA Z87.1-2010; EN 166 (2-4 MSA 1BT3R); CSA Z94.3 and AS/NZS 1337
<b>Certification:</b>	Third-party by Intertek, INSPEC International Ltd., CSA International and SAI Global Ltd.

## Ordering Information

V-GARD VISORS FOR ELEVATED TEMPERATURE/RADIANT HEAT APPLICATIONS		Part No.	Product Specifics
		10115850 	<ul style="list-style-type: none"><li>• Reflective coating reflects IR and helps dissipate heat</li><li>• Thick visor helps prevent warping, cracking or crazing under tough conditions</li><li>• Extended length for greater coverage of face and neck</li></ul>

## V-Gard Accessory System: Welding Application V-Gard Visors

- Classification:** Welding
- Market(s):** Fabrication, steel mills, shipbuilding, construction, open-pit mining, agriculture, oil/gas/petrochemical refineries, rubber manufacturing
- Application(s):** Welding, metal pouring, gas soldering, light cutting/brazing, manufacturing, impact and debris
- Material:** Polycarbonate
- Color(s):** Shade 3 IR, green
- Available Styles:** Molded
- Size:** 8" (20.3 cm) x 17" (43.2 cm) x .07" (1.8 mm)
- Features:** Protection from IR, up to Shade 3  
Impact-rated (Z87+)
- Standards:** ANSI/ISEA Z87.1-2010; EN 166 (4-3/3 MSA 1BT9); CSA Z94.3 and AS/NZS 1337
- Certification:** Third-party by Intertek, INSPEC International Ltd., CSA International and SAI Global Ltd.

### Ordering Information





V-GARD VISORS FOR WELDING APPLICATIONS		Part No.	Product Specifics
		10115859 	<ul style="list-style-type: none"> <li>• Visor</li> <li>• Thickness helps prevent pitting and warping from heat or weld spatter</li> </ul>
		10115860 	<ul style="list-style-type: none"> <li>• Nitrometer; for use with V-Gard Retractable or Standard Chin Protectors</li> <li>• Thickness helps prevent pitting and warping from heat or weld spatter</li> </ul>

# Head, Eye, Face, and Hearing **Protection**

## V-Gard Accessory System: Welding Application V-Gard Visors

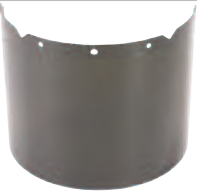
- Classification:** Welding
- Market(s):** Fabrication, steel mills, shipbuilding, construction, open-pit mining, agriculture, oil/gas/petrochemical refineries, rubber manufacturing
- Application(s):** Welding, metal pouring, gas soldering, light cutting/brazing, manufacturing, impact and debris
- Material:** Polycarbonate
- Color(s):** Shade 5 IR, green
- Available Styles:** Molded
- Size:** 8" (20.3 cm) x 17" (43.2 cm) x .07" (1.8 mm)
- Features:** Protection from IR, up to Shade 5  
Impact-rated (Z87+)
- Standards:** ANSI/ISEA Z87.1-2010; EN 166 (4-5/5 MSA 1BT9); CSA Z94.3 and AS/NZS 1337
- Certification:** Third-party by Intertek, INSPEC International Ltd., CSA International and SAI Global Ltd.

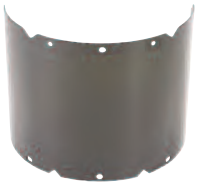
### Ordering Information

V-GARD VISORS FOR WELDING APPLICATIONS		Part No.	Product Specifics
		10115861 	<ul style="list-style-type: none"> <li>• Visor</li> <li>• Thickness helps prevent pitting and warping from heat or weld spatter</li> </ul>
		10115862 	<ul style="list-style-type: none"> <li>• Nitrometer; for use with V-Gard Retractable or Standard Chin Protectors</li> <li>• Thickness helps prevent pitting and warping from heat or weld spatter</li> </ul>



## V-Gard Accessory System: Arc Flash Application V-Gard Visors

<b>Classification:</b>	Arc
<b>Market(s):</b>	Manufacturing, utilities, construction, oil/gas/petrochemical
<b>Application(s):</b>	Maintenance, impact and debris, testing/repair
<b>Material:</b>	Polycarbonate
<b>Color(s):</b>	Special tint, light green
<b>Available Styles:</b>	Molded
<b>Size:</b>	9.25" (23.5 cm) x 18" (45.7 cm) x .065" (1.7 cm)
<b>Features:</b>	Rated to 12.9 cal/cm <sup>2</sup> (see "Product Specifics" in table below) Impact-rated (Z87+)
<b>Standards:</b>	ANSI/ISEA Z87.1-2010 ASTM F2178-2008 (Ref: NFPA 70E, HRC 2)
<b>Certification:</b>	Third-party by Intertek and ArcWear

### Ordering Information

V-GARD VISORS FOR ARC FLASH APPLICATIONS		Part No.	Product Specifics
		10115847	<ul style="list-style-type: none"> <li>• Visor</li> <li>• Extended length and width for greater coverage of face and neck</li> <li>• <b>Rated to 12.9 cal/cm<sup>2</sup></b> when tested to ASTM F2178-2008 (ref. NFPA 70E-2012, Hazard Risk Category 2), and when worn with a V-Gard Hard Hat (PN 475358) and V-Gard Frame (PN 10121266)</li> <li>• <i>Call MSA Customer Service (800-MSA-2222) for protection levels when using this V-Gard Arc Visor with other V-Gard Frames and MSA Helmet combinations</i></li> </ul>

<b>Classification:</b>	Arc
<b>Market(s):</b>	Manufacturing, utilities, construction, oil/gas/petrochemical
<b>Application(s):</b>	Maintenance, impact and debris, testing/repair
<b>Material:</b>	Polycarbonate
<b>Color(s):</b>	Special tint, light green
<b>Available Styles:</b>	Molded nitrometer
<b>Size:</b>	8" (20.3 cm) x 17.25" (43.8 cm) x .065" (1.7 cm)
<b>Features:</b>	Rated to 11.3 cal/cm <sup>2</sup> (see "Product Specifics" in table below) Impact-rated (Z87+)
<b>Standards:</b>	ANSI/ISEA Z87.1-2010 ASTM F2178-2008 (Ref: NFPA 70E, HRC 2)
<b>Certification:</b>	Third-party by Intertek and ArcWear

### Ordering Information



V-GARD NITROMETER WITH CHIN PROTECTOR FOR ARC FLASH APPLICATIONS		Part No.	Product Specifics
		10118480	<ul style="list-style-type: none"> <li>• Nitrometer; includes V-Gard Standard Chin Protector (required to achieve arc rating); must be assembled onto nitrometer by user</li> <li>• <b>Rated to 11.3 cal/cm<sup>2</sup></b> when tested to ASTM F2178-2008 (ref. NFPA 70E-2012, Hazard Risk Category 2), and when worn with a V-Gard Hard Hat (PN 475358) and V-Gard Frame (PN 10121266) and and V-Gard Standard Chin Protector (PN/10115827)</li> <li>• <i>Call MSA Customer Service (800-MSA-2222) for protection levels when using this V-Gard Arc Visor with other V-Gard Frames, V-Gard Chin Protectors and MSA Helmet combinations</i></li> </ul>

# Head, Eye, Face, and Hearing Protection

## V-Gard Chin Protectors





V-Gard Chin Protectors work with select V-Gard Nitrometers to help provide extra protection from impact and splash hazards to face and neck.

**Note:** MSA V-Gard Chin Protectors meet the applicable safety requirements as noted on the V-Gard Nitrometer Visor when worn in conjunction with V-Gard Frames and V-Gard Nitrometer Visors.

CHIN PROTECTORS		<b>P/N 10115828</b> Retractable Chin Protector	<ul style="list-style-type: none"> <li>• 3.82" (9.7 cm) in height, when unretracted</li> <li>• Unique retractable plates allow greater flexibility of head movement both up and down, as well as side-to-side</li> <li>• Opaque material ensures safety and standards compliance with clear, tinted, shaded and coated V-Gard Visors</li> </ul>
		<b>P/N 10115827</b> Standard Chin Protector	<ul style="list-style-type: none"> <li>• 2.86" (7.26 cm) in height</li> <li>• Opaque material ensures safety and standards compliance with clear, tinted, shaded and coated V-Gard Visors</li> <li>• Compact, lightweight design provides additional protection between chin and neck area</li> </ul>

## V-Gard Accessory System Kits

V-Gard Accessory System Kits are designed to offer easy customer solutions for a variety of needs – all in one convenient box.

V-GARD ACCESSORY SYSTEM KITS		<b>P/N 10118695</b> V-Gard Accessory System Kit with V-Gard Cap	<b>Contains:</b> <ul style="list-style-type: none"> <li>• White V-Gard Cap with ratchet suspension (PN 475358)</li> <li>• V-Gard Frame for Slotted Caps with debris control (PN 10115730)</li> <li>• V-Gard Clear, PC Visor, 8" (20.3 cm) x 17" (43.2 cm) x .04" (1.02 mm) (PN 10115836)</li> </ul>
		<b>P/N 10118697</b> V-Gard Accessory System Kit (without V-Gard Cap)	<b>Contains:</b> <ul style="list-style-type: none"> <li>• V-Gard Universal Frame for Caps with debris control (PN 10115822)</li> <li>• V-Gard Clear, PC Visor, 8" (20.3 cm) x 17" (43.2 cm) x .04" (1.02 mm) (PN 10115836)</li> </ul> <b>Does not contain a MSA safety helmet.</b>
		<b>P/N 10118694</b> V-Gard Forestry Kit	<b>Contains:</b> <ul style="list-style-type: none"> <li>• Hi-viz orange V-Gard Cap with ratchet suspension (PN 488146)</li> <li>• V-Gard Frame for Slotted Caps with debris control (PN 10115730)</li> <li>• V-Gard Mesh Nitrometer (PN 10116558)</li> <li>• V-Gard Retractable Chin Protector (PN 10115828)</li> <li>• Left/RIGHT, HIGH (NRR 28 db) Cap-Mounted Earmuffs (PN 10087422)</li> </ul>
		<b>P/N 10118696</b> V-Gard Accessory Arc Kit	<b>Contains:</b> <ul style="list-style-type: none"> <li>• White V-Gard Cap with ratchet suspension (PN 475358)</li> <li>• V-Gard Frame for Slotted Caps (PN 10121266)</li> <li>• V-Gard Arc Nitrometer with V-Gard Standard Chin Protector (PN 10118480); must be assembled by user prior to wearing to secure stated calorie rating.</li> <li>• <b>Rated to 11.3 cal/cm<sup>2</sup></b> when tested to ASTM F2178-2008 (ref. NFPA 70E-2012, Hazard Risk Category 2), and when worn with a V-Gard Hard Hat (PN 475358), V-Gard Frame (PN 10121266) and V-Gard Standard Chin Protector (PN/10115827)<sup>1</sup></li> </ul>

## V-Gard Accessory System Replacement Parts<sup>2</sup>

V-GARD ACCESSORY SYSTEM REPLACEMENT PARTS		<b>P/N 10117496</b> (2 pair)	<ul style="list-style-type: none"> <li>• Slot Adaptors (2 pair). For use with V-Gard Frames for Slotted Caps</li> </ul>
		<b>P/N 10116539</b>	<ul style="list-style-type: none"> <li>• Debris Control for V-Gard Cap Frames. Debris control exceeds EN requirements for molten metal</li> </ul>
		<b>P/N 10117495</b>	<ul style="list-style-type: none"> <li>• Heavy Duty Rubber Strap for V-Gard Universal Cap or Hat Frames</li> </ul>

<sup>1</sup> Call MSA Customer Service (800-MSA-2222) for protection levels when using this V-Gard Arc Visor with other V-Gard Frames, V-Gard Chin Protectors and MSA Helmet combinations.

<sup>2</sup> Use only genuine MSA V-Gard Accessory System replacement parts to help ensure compatibility and compliance. MSA does not warrant, guarantee, or promote the use of components manufactured by other companies when used in conjunction with MSA products.

## Helmet Accessories





### V-Gard Winter Liners

**Flame resistant (FR)** garments are made of special fibers that allow them to self-extinguish when exposed to flame or thermal ignition. Flame resistance cannot be removed by washing. Unlike many other winter liners in the market, ALL layers of fabric in V-Gard Supreme Liners are flame resistant, affording FR protection throughout the life of the product.<sup>1</sup>



**Flame retardant** garments have been chemically treated to resist burning when a flame is present. While chemical treatment can wear off after the first wash, all layers of ALL V-Gard Select products offer flame retardancy up to 50 washings.













<p>V-GARD SUPREME LINERS</p> 		<p><b>FP/N 10118421</b> Flame-Resistant V-Gard Supreme Liner</p>	<ul style="list-style-type: none"> <li>• Multiple layers of flame-resistant fabric</li> <li>• Fabric tested to withstand arc exposure to an ATPV of 8 cal/cm<sup>2</sup></li> <li>• Water repellant</li> <li>• Adjustable chinstrap</li> <li>• Inside neck pocket holds warming packet<sup>2</sup></li> </ul>
		<p><b>P/N 10118425</b> Flame-Resistant V-Gard Supreme Liner, Extended, 1-piece</p>	<ul style="list-style-type: none"> <li>• Multiple layers of flame-resistant fabric</li> <li>• Fabric tested to withstand arc exposure to an ATPV of 8 cal/cm<sup>2</sup></li> <li>• Water repellant</li> <li>• Inside neck pocket holds warming packet<sup>2</sup></li> <li>• Extended nape and wraparound collar for tucking into coat/shirt</li> <li>• Quilted flaps allow uncompromised hearing protection levels when using earmuffs</li> </ul>
		<p><b>P/N 10118427</b> Flame-Resistant V-Gard Supreme Liner, 2-piece</p>	<ul style="list-style-type: none"> <li>• Multi-layered flame-resistant top cap</li> <li>• Fabric tested to withstand arc exposure to an ATPV of 8 cal/cm<sup>2</sup></li> <li>• Water repellant</li> <li>• Inside neck pocket holds warming packet<sup>2</sup></li> <li>• Extended, zipper on/off high-bulk flame-resistant knit bottom</li> <li>• No metal parts</li> </ul>

<sup>1</sup>Garment care instructions must be followed. <sup>2</sup>Warming packets available at most sporting goods retailers; not sold with liners.



# Head, Eye, Face, and Hearing Protection

<p>V-GARD SELECT LINERS</p> 		<p><b>P/N 10129659</b> Flame-Retardant V-Gard Select Liner, 2-piece</p>	<ul style="list-style-type: none"> <li>• Double-layered flame retardant top cap, up to 50 washes<sup>1</sup></li> <li>• Extended, zipper on/off double-layer knit bottom; flame retardant, up to 50 washes</li> <li>• No metal parts</li> <li>• Water repellent</li> </ul>
		<p><b>P/N 10129654</b> Flame-Retardant V-Gard Select Liner, Extended, No Earflaps</p>	<ul style="list-style-type: none"> <li>• Two layers of fabric, flame retardant to 50 washes<sup>1</sup></li> <li>• Water repellent</li> <li>• Extended nape and wraparound collar for tucking into coat/shirt</li> <li>• For applications where earmuffs are not worn</li> </ul>
		<p><b>P/N 10118420</b> Flame-Retardant V-Gard Select Liner</p>	<ul style="list-style-type: none"> <li>• Two layers of fabric, flame retardant to 50 washes<sup>1</sup></li> <li>• Water repellent</li> <li>• Adjustable chinstrap</li> <li>• Quilted flaps allow uncompromised hearing protection levels when using earmuffs</li> </ul>
		<p><b>P/N 10118423</b> Flame-Retardant V-Gard Select Liner, Extended</p>	<ul style="list-style-type: none"> <li>• Two layers of fabric, flame retardant to 50 washes<sup>1</sup></li> <li>• Water repellent</li> <li>• Quilted flaps allow uncompromised hearing protection levels when using earmuffs</li> <li>• Extended nape and wraparound collar for tucking into coat/shirt</li> </ul>
		<p><b>P/N 10118424</b> Flame-Retardant V-Gard Select Liner, Extended, Bright with Reflective Striping</p>	<ul style="list-style-type: none"> <li>• Two layers of fabric, flame retardant to 50 washes<sup>1</sup></li> <li>• Water repellent</li> <li>• Quilted flaps allow uncompromised hearing protection levels when using earmuffs</li> <li>• Extended nape and wraparound collar for tucking into coat/shirt</li> <li>• Bright yellow-green liner and reflective striping improves visibility</li> </ul>
		<p><b>P/N 10118426</b> Flame-Retardant V-Gard Neck Gaiter</p>	<ul style="list-style-type: none"> <li>• Two layers of fabric, flame retardant to 50 washes<sup>1</sup></li> <li>• Water repellent</li> <li>• Elastic strip keeps gaiter comfortably snug to face or neck</li> <li>• Can be used with or without any V-Gard Liner for added warmth on face/neck</li> </ul>
<p>V-GARD VALUE LINERS</p>		<p><b>P/N 10118417</b> V-Gard Liner Knit Cap</p>	<ul style="list-style-type: none"> <li>• Stylish skullie cap</li> <li>• Design prevents liner from obstructing vision</li> <li>• 100% high bulk acrylic</li> </ul>
		<p><b>P/N 10118418</b> V-Gard Liner Knit Hat-Cap Cover</p>	<ul style="list-style-type: none"> <li>• 100% acrylic</li> <li>• Bright yellow-green for greater visibility</li> <li>• Full face tube mounts under or over brim of MSA caps or hats, covering ears, mouth, cheeks and neck</li> <li>• Extended nape and wraparound collar for tucking into coat/shirt</li> </ul>
		<p><b>P/N 10118419</b> V-Gard Value Liner</p>	<ul style="list-style-type: none"> <li>• 100% cotton twill</li> <li>• Adjustable chin strap</li> </ul>
		<p><b>P/N 10118422</b> V-Gard Value Liner, Extended</p>	<ul style="list-style-type: none"> <li>• 100% cotton twill</li> <li>• Extended nape and wraparound collar for tucking into coat/shirt</li> </ul>

<sup>1</sup>Reflective striping flame retardant to 25 washings.

## SunShade Hard Hat Accessory



MSA SunShades not only help to protect wearer's ears and neck from sun and heat, but also enhance worker visibility with contrasting color band and reflective striping. Fit most hats and caps. Features include:

- Breathable, bright mesh fabric.
- Choice of bright yellow-lime or orange colors.
- Hat clips help to keep SunShade from falling or rotating.

### Ordering Information

SUNSHADE HARD HAT ACCESSORY	10098032	SunShade, Yellow-Green, with reflective striping
	10098031	SunShade, Orange, with reflective striping

## Helmet Lights



MSA offers two helmet lights that fit into our special cap adapters. Both of the lights are FM and CSA-approved for intrinsic safety, and are non-incendive.

### Ordering Information

HELMET LIGHTS	697259*	VersaLite Helmet Light with 2 AA alkaline batteries
	697261**	Stealthlite Helmet Light (batteries not included)
	814322	Light holder for slotted cap, no metal parts

\*VersaLite Helmet Light does not include, but requires, slot adapter to work in helmet slots.  
 \*\*Stealthlite Helmet Light does not include, but requires, batteries and a light holder to work in helmet slots.

## Sun Shields



Protect ears and neck from sun and heat with these easily attachable brims. Extends brim all the way around the helmet. Made of flexible, resilient polyurethane, these brims feature a smoke-tinted, Lexan constructed front:

- Polyurethane brim extender protects against sun and heat
- Easily attaches to helmets and caps
- Smoke-tinted Lexan front for extra protection

### Ordering Information

SUN SHIELD HARD HAT ACCESSORY	697290	Sun Shield, for Standard V-Gard Caps only
	697410	Sun Shield, for V-Gard Hats only
	10039114	Sun Shield, for V-Gard 500 Caps only

## Custom Terri-Band Sweatband



Custom design fits all MSA suspensions. Washable, with plastic snaps.

### Ordering Information

CUSTOM TERRY SWEATBAND	10068911	Custom Terri-Band Sweatband (single)
	696688	Custom Terri-Band Sweatband (pkg of 10)

# Head, Eye, Face, and Hearing Protection

## Chinstraps

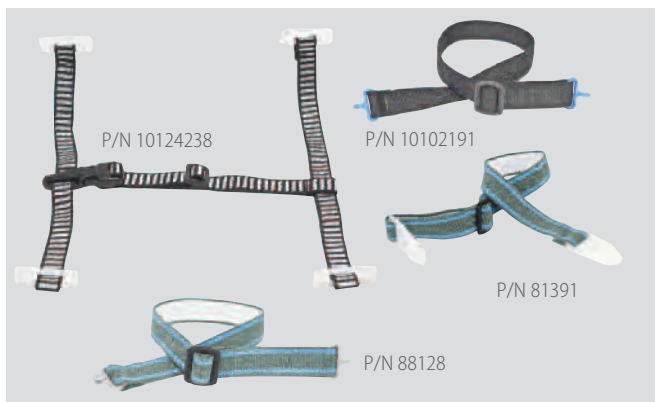

Put and keep MSA helmets in their place with these comfortable, adjustable chinstraps.

- 2-, 3- and 4-point chinstraps available
- Non-metal chinstraps keep helmets in place
- Attaches directly to shell or suspension (as noted)
- Flexible construction and adjustable design for long-wearing comfort
- Available in cotton, polyester, nylon, or Nomex® webbing

## Ordering Information

CHINSTRAPS		
	10124238	Chinstrap, 4-pt, 3/4" polyester webbing, attaches to suspension (pkg of 10)
	10102191 <sup>1</sup>	Chinstrap, 2-pt, 3/4" Nomex webbing, attaches to shell
	81390	Chinstrap, 2-pt, 3/4" cotton webbing, attaches to suspension
	81391	Chinstrap, 2-pt, 3/4" polyester webbing, attaches to suspension
	88129	Chinstrap, 2-pt, 3/4" cotton webbing, attaches to shell
	88128	Chinstrap, 2-pt, 3/4" polyester webbing, attaches to shell
	804629	Chinstrap, 3-pt, 3/4" nylon webbing, for Vanguard helmets only

<sup>1</sup>For elevated temperatures

## Medical Information Carrier System

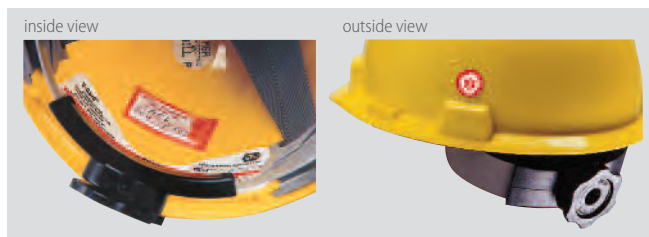

This simple helmet accessory provides crucial, lifesaving information in the event of a medical crisis on the job. Trilingual for today's multicultural workforce.

## Ordering Information

MEDICAL INFORMATION CARRIER SYETM	10013393	Medical Information Carrier System (pkg of 10)—English/Spanish/French
-----------------------------------	----------	---

## In-Service Helmet Label



Add this label to the inside of helmet with the date the helmet was first used to track the shell's service life. **MSA recommends that you replace the shell every 5 years and the suspension every 12 months.**

## Ordering Information

IN-SERVICE HELMET LABEL	804358	In-Service Helmet Label (sheet of 25)
-------------------------	--------	---------------------------------------

## Welding Adapter Kits

### Adapter Kits for Welding Shields and Defender+ Assembly

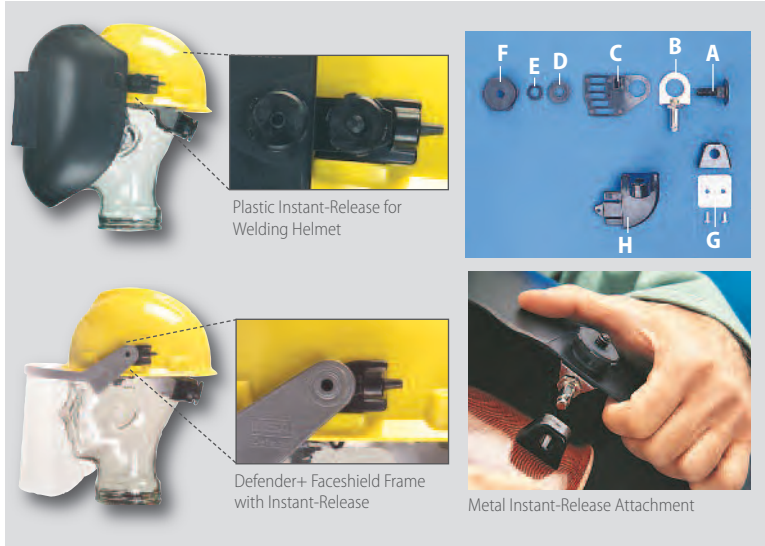

Plastic Instant-Release for Welding Helmet

Defender+ Faceshield Frame with Instant-Release

Metal Instant-Release Attachment

### Welding Shields and Accessories



MSA's thermal plastic welding shields protect workers' eyes and face from infrared burns, flying sparks, hot metal spatter and chips encountered in welding operations. The nylon welding shields come in a variety of styles.

For Shade 5 IR welding visors, see p. 133–134.

For Shade 5 IR welding spectacles, see p. 156.

Kits permit the easy attachment of Welding Shields and Sparkgard Faceshields with visors to MSA's helmets.

## Ordering Information

ADAPTER KITS FOR WELDING SHIELDS AND DEFENDER+ ASSEMBLY		
WELDING ADAPTER KITS	488525	Standard Adapter for Welding Helmets and Sparkgards
	806211	EC Adapter Kit (positive positioning type)
	456568	Sparkgard only
PLASTIC INSTANT-RELEASE ATTACHMENT*	10036456	Quick Disconnect Kit, welder's adapter, with lugs
DEFENDER+ FRAME WITH INSTANT-RELEASE ATTACHMENT	10037098	Defender+ frame for slotted cap, without lock-down
METAL INSTANT-RELEASE ATTACHMENT	485460	Instant-Release and lugs for slotted caps (A, B, C, D, E, F, H)
	468771	Lugs only, for instant-release slotted caps (H)
	48733	Lugs only, for instant-release non-slotted caps (G)
WELDING SHIELDS AND ACCESSORIES		
WELDING SHIELDS ONLY <i>Less headgear and attachments</i>	695943	Plate Size: 2" x 4¼", non-coated black, slim-line, lift front
	695946	Plate Size: 2" x 4¼", non-coated black, full-curved, lift front
	695888	Plate Size: 4½" x 5¼", coated silver, slim-line, fixed front
POLYCARBONATE PLATES <i>Meet ANSI/ISEA Z87.1</i>	791923	Plate Size: 2" x 4¼", shade 5
	791928	Plate Size: 2" x 4¼", shade 10
	791930	Plate Size: 2" x 4¼", shade 12
	38347	Plate Size: 4½" x 5¼", shade 10
	38277	Plate Size: 4½" x 5¼", shade 10
POLYCARBONATE COVER/BACK PLATES	791933	Plate Size: 2" x 4¼", clear
	696095	Plate Size: 4½" x 5¼", clear

\*Note: Cannot be used on Vented V-Gard 500 Caps.

# Head, Eye, Face, and Hearing **Protection**

## left/RIGHT® Electronic Helmet-Mounted Ear Muffs

Left/RIGHT Electronic Hearing Protection ear muffs are different from other hearing protectors, as individual muffs are specially designed to fit left and right ears to compensate for asymmetrical positioning of ears on the head.

Innovative headband design and thinner, more flexible sealing rings ensure optimal fit for wearer comfort. Large muffs provide more room for the ear, providing superior hearing protection regardless of the user's ear shape and size.

Unique left/RIGHT Electronic Hearing Protection fits users' individual hearing protection needs.

### Features and Benefits

- Innovative design
- Individual cups for the left and right ears
- Anatomically-shaped cushions
- Large cups with more room for your ears
- Microphone and speaker sound levels are limited to maximum 82 dB(A)



### left/RIGHT FM Pro Pushbutton Version

*Premium sound quality*

#### Built-in FM radio receiver:

- FM radio
- Excellent radio reception and superior sound quality
- Automatic tuning function and volume adjustment using three pushbuttons
- Battery save function
- Low battery warning system
- AUX input for .mp3 or communication radio connection

#### Attenuation Values:

- Helmet-mounted\*: SNR 27 dB, H=31 dB, M=24 dB, L=16 dB



### left/RIGHT CutOff Pro

*Protection without isolation*

#### Level-dependent hearing protector:

- Enables face-to-face communication while protected
- Enables the wearer to hear important sounds and warning signals
- Amplification of weak signals through the electronic system
- Battery save function
- Low battery warning system
- AUX input for for .mp3 or communication radio connection

#### Attenuation Values:

- Helmet-mounted\*: SNR 27 dB, H=31 dB, M=24 dB, L=16 dB



### left/RIGHT Dual Pro

*The ultimate hearing protector*

#### Combines the features of CutOff and FM radios:

- Individual balance adjustment between level-dependent and FM radio functions enables wearers to adjust to working environments
- Push-to-listen function for easy face-to-face communication
- Battery save function
- Low battery warning system
- AUX input for for .mp3 or communication radio connection

#### Attenuation Values:

- Helmet-mounted\*: SNR 27 dB, H=31 dB, M=24 dB, L=16 dB



## Ordering Information

left/RIGHT FM PRO PUSHBUTTON VERSION	10111829	Helmet-mounted version, blue (NRR 20)
left/RIGHT CUTOFF PRO	10111823	Helmet-mounted version, yellow (NRR 20)
	10111826	Helmet-mounted version, blue (NRR 20)
left/RIGHT DUAL PRO	10111832	Helmet-mounted version, blue (NRR 20)
ACCESSORIES	10094605	Hygiene Kit, consisting of cushions and inserts <i>To maintain ear muff sound attenuation performance, regularly replace cushions and inserts. Under normal use, replace your Hygiene Kit at least twice a year. Choose the Hygiene Kit that corresponds to your ear muff.</i>

\*Fits MSA V-Gard and V-Gard 500 Helmets. Contact your authorized MSA distributor for other MSA industrial safety helmets.



## Passive Helmet-Mounted Hearing Protection



left/RIGHT Passive  
Helmet-Mounted Ear Muffs

The MSA left/RIGHT Ear Muffs have dedicated right and left ear cups that are designed to fit ears of all shapes and sizes which offers increased comfort and protection.

- Precise fit provides maximum loud noise protection using minimal cup size
- Available in low, medium, and high attenuation

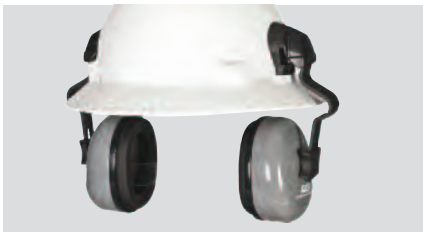

Sound Control™ SH  
for Slotted Full-Brim Hard Hats

- Spring design offers low pressure and a high level of comfort
- Three distinct wearing positions for ease of use
- Excellent grip makes it easy to adjust the cups, even when wearing gloves
- Provides maximum space for ears inside cups
- Soft ear cup material for extended wear
- Easy ear cup height adjustment
- Retain the Class E dielectric rating on the Slotted V-Gard Full-Brim Hard Hat

## Ordering Information

LEFT/RIGHT PASSIVE HELMET-MOUNTED EAR MUFFS	10087439	left/RIGHT cap model, LOW, white (NRR 21)
	10087429	left/RIGHT cap model, MEDIUM, blue (NRR 25)
	10087422	left/RIGHT cap model, HIGH, yellow (NRR 28)
SOUND CONTROL HPE CAP MODEL	10061272	HPE cap model, complete with brackets (NRR 27)
SOUND CONTROL EXC CAP MODEL	10061230	EXC cap model, complete with brackets (NRR 25)
SOUND CONTROL XLS CAP MODEL	10061535	XLS cap model, complete with brackets (NRR 23)
SOUND CONTROL SH FOR SLOTTED FULL-BRIM HARD HATS	10129327	Sound Control SH for <b>slotted</b> hats (NRR 25)
SOPRANO EAR MUFF KIT FOR FULL-BRIM HATS	10034487	Soprano Muff Kit for <b>non-slotted</b> full-brim hats (NRR 25)
SOUND BLOCKER 26 CAP-MOUNTED EAR MUFFS	10022021	Sound Blocker 26 cap model for <b>non-slotted</b> caps (NRR 26)



HPE, EXC and XLS Cap-Mounted Earmuffs

- Spring design offers low pressure and a high level of comfort
- Three distinct wearing positions
- Easy to adjust the cups, even when wearing gloves
- Providing the highest-rated protection available for low-frequency environments, **HPE Cap Mounted Muffs** are designed specifically for very high noise levels and are ideal for airfields, power plants and other areas with intense noise. Super-soft ear cushions guarantee all-day comfort.
- **EXC Cap-Mounted Muffs** offer excellent noise attenuation and unique molded inserts provide maximum space for ears inside.
- **Cost-efficient XLS Cap-Mounted Muffs** provides excellent protection in loud environments. Molded inserts provide maximum space for the ears within the cups.



Soprano Ear Muff Kit  
for Full-Brim Hard Hats

The Soprano Muff provides excellent hearing protection while fitting all MSA Skullgard and Topgard Full-Brim Hats. NOTE: The addition of the Soprano muff reduces helmet rating to Class C.



Sound Blocker™ 26  
Cap-Mounted Ear Muffs

Designed for use on MSA non-slotted cap models in high noise areas such as industrial plants and construction sites.

# Head, Eye, Face, and Hearing **Protection**

## left/RIGHT Electronic Hearing Protection Headbands

Left/RIGHT Electronic Ear Muffs are different from other hearing protectors, as individual muffs are specially designed to fit left and right ears to compensate for natural differences in left and right ears..

Innovative headband design and thinner, more flexible sealing rings ensure optimal fit for wearer comfort. Large muffs provide more room for the ear, providing superior hearing protection regardless of the user's ear shape and size.

### Features and Benefits

- Innovative design
- Individual cups for the left and right ears
- Anatomically-shaped cushions
- Large cups with more room for your ears
- Microphone and speaker sound levels are limited to maximum 82 dB(A)

## left/RIGHT AM/FM Rotating Knob Version

*Stay protected while listening to your favorite AM/FM radio station*

- Entry level AM/FM radio, ideal for lawn mowing and do-it-yourself applications
- Tune into your favorite radio station and maintain your hearing protection
- Large rotating knobs allow for easy tuning and volume adjustment
- Battery save function
- Available in white, yellow and blue

**Attenuation values:** SNR 24 dB, H=25 dB, M=21 dB, L=16 dB



## left/RIGHT FM Pro Pushbutton Version

*Premium sound quality*

### Built-in FM radio receiver:

- FM radio with excellent radio reception and superior sound quality
- Automatic tuning function and volume adjustment using three pushbuttons
- Battery save function
- Low battery warning system
- AUX input for .mp3 or communication radio connection

**Attenuation Values:** SNR 27 dB, H=31 dB, M=24 dB, L=15 dB



## left/RIGHT CutOff Pro

*Protection without isolation*

### Level-dependent hearing protector:

- Enables face-to-face communication while protected
- Enables the wearer to hear important sounds and warning signals
- Amplification of weak signals through the electronic system
- Battery save function
- Low battery warning system
- AUX input for .mp3 or communication radio connection

**Attenuation Values:** SNR 27 dB, H=31 dB, M=24 dB, L=15 dB



## left/RIGHT Dual Pro

*The ultimate hearing protector*

### Combines the features of CutOff and FM radios:

- Individual balance adjustment between level-dependent and FM radio functions enables wearers to adjust to working environments
- Push-to-listen function for easy face-to-face communication
- Battery save function
- Low battery warning system
- AUX input for .mp3 or communication radio connection

**Attenuation Values:** SNR 27 dB, H=31 dB, M=24 dB, L=15 dB



## Ordering Information

left/RIGHT AM/FM ROTATING KNOB VERSION	10087433	Medium headband, white (NRR 22 dB)
	10087431	Medium headband, yellow (NRR 22 dB)
	10087432	Medium headband, blue (NRR 22 dB)
left/RIGHT FM PRO PUSHBUTTON VERSION	10111829	Headband, blue (NRR 22 dB)
left//RIGHT CUTOFF PRO	10111823	Headband, yellow (NRR 22 dB)
	10111826	Headband, blue (NRR 22 dB)
left//RIGHT DUAL PRO	10111832	Headband, blue (NRR 22 dB)
ACCESSORIES	10094605	Hygiene Kit, consisting of cushions and inserts <i>To maintain ear muff sound attenuation performance, regularly replace cushions and inserts. Under normal use, replace your Hygiene Kit at least twice a year. Choose the Hygiene Kit that corresponds to your ear muff.</i>

## Passive Hearing Protection Headbands

### left/RIGHT Ear Muffs



The MSA left/RIGHT Ear Muffs have dedicated right and left ear cups that are designed to fit ears of all shapes and sizes which offers increased comfort and protection. The headband's breakthrough design simulates the head's curves to provide a comfortable and stable fit, balancing muffs with ear cup angle.

- Precise fit provides maximum loud noise protection using minimal cup size
- Headband adjusts up and down to provide custom fit for different head sizes
- Available in low, medium, and high attenuation

### Multi-Position Muff and Economuff



Designed for loud environments, the comfortable Multi-Position Muff and Economuff (NRR 20) are both inexpensive and effective. The multi-position incorporates a support strap that allows several different configurations, including over-the-head (NRR 24), behind-the-head (NRR 23), and under-the-chin (NRR 23).

### HPE Headband Muffs

Providing the highest-rated protection available for low-frequency environments, the MSA HPE Headband Muffs are designed specifically for very high noise levels and are ideal for airfields, power plants and other areas with intense noise. A padded headband and super-soft ear cushions guarantee all-day comfort while ensuring full-time protection.



- Wide headband with ventilated padding provides a firm and comfortable fit
- Easily adjustable headband force for individual fit
- Large space for the ears inside the cup

### EXC Headband Muffs

Excellent noise attenuation and max. space for ears inside.

- Extra wide headband
- Two point mounting system
- Sure-grip headband
- Unique molded inserts
- Light-weight only 218 g (7.7 oz)
- Spring design offers low-pressure and a high level of comfort
- Excellent grip makes it easy to adjust the cups, even when wearing gloves



## Ordering Information

left/RIGHT PASSIVE EAR MUFFS	10087436	left/RIGHT, LOW, white, headband model (NRR 21)
	10092878	Hygiene Kit, left/RIGHT, LOW
	10087426	left/RIGHT, MEDIUM, blue, headband model (NRR 25)
	10092879	Hygiene kit, left/RIGHT, MEDIUM
	10087399	left/RIGHT, HIGH, yellow, headband model (NRR 28)
	10092880	Hygiene Kit, left/RIGHT, HIGH
SOUND CONTROL HPE HEADBAND MUFF	10061271	HPE headband model (NRR 26)
	10061291	Hygiene Kit, complete with cushions and inserts
SOUND CONTROL EXC HEADBAND MUFF	10061229	EXC headband model (NRR 24)
	10061292	Hygiene Kit, complete with cushions and inserts
MULTI-POSITION MUFF	10061273	Economuff Multi-Position Earmuff <i>over-the-head (NRR 24), behind-the-head (NRR 23), and under-the-chin (NRR 23)</i>
ECONOMUFF	10004291	Economuff Earmuff (NRR 20)

# Head, Eye, Face, and Hearing Protection

## Ear Plugs and Bands

For personalized ear protection, MSA offers a variety of earplug styles, including some comparable to the protection provided by select MSA ear muffs. From disposable to reusable and from foam to silicone, these earplugs are easy to insert and comfortable to wear.

### Features and Benefits

- Perfect-fit protection
- Comfort-wear design
- Constructed of medical-grade silicone rubber or urethane foam
- Corded and non-corded versions available, depending on model

### Ordering Information



TRI-SEAL REUSABLE SILICONE EAR PLUGS	10005607	Corded, dispenser box of 100 individually packaged pairs (NRR 25)
FORMFIT ROUND DISPOSABLE FOAM EAR PLUGS	10009332	Round, corded, dispenser box of 200 pairs (NRR 29)
	10009333	Round, non-corded, dispenser box of 200 pairs (NRR 29)
COMFORT BAND HEARING PROTECTOR	10003344	Each, must order in multiples of 20 (NRR 23)



## Sightgard® Protective Eyewear

All MSA Sightgard Safety Glasses and Goggles listed in this catalog are compliant with the general protector and impact requirements of ANSI/ISEA Z87.1-2010. Many are also compliant with CSA Z94.3-2007 and/or listed with CSA International as certified (as noted).

### Eyewear Features

MSA Sightgard Protective Eyewear line offers great styles – great options – great value:

- Anti-fog coating and/or UV 400 additive offered on many styles.
- Anti-scratch coating provides excellent scratch resistance, extending lens life—a “must have” in abrasive work environments.
- Horizontal (sliding) or vertical (ratchet) temple adjustment models offer custom fit.
- Soft rubber nose bridges offer comfortable, non-slip support.
- Flexible rubber-tipped temples provide comfortable, all-day wearing.

### Try It! Program

Many studies have shown that if eyewear impairs vision or is uncomfortable, workers tend to wear it incorrectly to compensate or remove it altogether — strongly increasing the risk of serious injury, as well as workers’ compensation claims and other costs. **MSA wants to help.**

Our **FREE** sample “Try It!” program offers >100 products customers can sample *before* they buy them. Most MSA Sightgard safety eyewear are included. Just look for the “Try It!” symbol and call your MSA representative for your **free** sample!



### Choosing the Proper Lens

Choosing the right lens for the job will not only protect eyes, but could also improve the wearer’s working experience. Our Lens Color Reference Chart lists benefits and uses for common lens options.















LENS	Amber	Clear	Light or Dark Brown	Gradient	Gray	Indoor/Outdoor Mirror
COLOR/TINTS						
USE	Good for low-light conditions, especially at dawn/dusk and on foggy days. Increases contrast and enhances detail. Ideal lens for operations requiring optimum contrast of similar or small objects.	General purpose lens for indoor use, or outdoor use in low-light conditions. Provides maximum light transmission.	Enhances perception in changing light and shadow. Good for low light conditions.	Allows easy transition from inside to outside with same pair of glasses. Ideal for use while driving.	Most popular lens tint for outdoor use. Protects against visible glare without color degradation. Good choice for outdoor work, such as construction and landscaping.	Offers the same benefits as light mirror, but also allows easy transition from inside to outside with same pair of glasses. Ideal lens for occupations such as forklift drivers, dock workers, and truck drivers.
LENS	Light Mirror	Polarized	Rich Mirror	Shade 5 IR	Vermillion	Blue Blocker
COLOR/TINTS						
USE	Reduces glare and bright sunlight by reflecting light away from the lens. Enhances contrast without color degradation. Good general purpose lens for outdoor use.	Reduces intense sun glare reflected off shiny surfaces such as snow, water, sand and pavement. Improves contrast and depth perception. Great for outdoor use; not good for use while driving.	Superior glare reduction with heavy mirroring. Great lens for outdoor use in full sun conditions—favored by outdoor workers such as roofers, landscapers and builders.	Protects against low to medium infrared (IR) radiation up to Shade 5. Good choice for metal pouring, gas soldering, cutting and brazing operations.	Alleviates eye strain and fatigue by reducing glare caused by fluorescent and halogen lighting. Enhances contrast by absorbing all colors equally. Good choice for inspection operations or assembly work.	Blocks High-Energy Visible (HEV) light, also known as blue light (~400-500 nm). Blue light has been linked to certain eye diseases (such as macular degeneration) and to the suppression of melatonin (a hormone that helps regulate other hormones and stabilizes sleep patterns).

# Head, Eye, Face, and Hearing Protection

## Sightgard Safety Glasses: Indoor Humid Conditions

- Classification:** Indoor: humid environments
- Market(s):** Facility maintenance, repair and operations, construction, food and beverage, general manufacturing and industry, mining, oil and gas, pharmaceuticals, transportation, shipbuilding, automotive
- Application(s):** Assembly and mechanical, drilling, grinding, machining, painting, sanding, sawing
- Material:** Polycarbonate
- Features:** Anti-fog coating  
Clear lenses  
Impact-rated (Z87+)  
Anti-scratch coating (as noted)
- Standards<sup>1</sup>:** ANSI/ISEA Z87.1-2010 and CSA Z94.3 (as noted)
- Certification:** Third-party by Intertek and CSA International

### Ordering Information

HUMID INDOOR APPLICATIONS	Model	Part No.	Product Specifics
 	Alaska	10118473	<ul style="list-style-type: none"> <li>• Frameless; lightweight</li> <li>• Padded, adjustable nosebridge</li> </ul>
 	Arctic™ Elite	10038845	<ul style="list-style-type: none"> <li>• Rubber tipped temples and nosebridge for comfortable, yet secure fit</li> </ul>
 	Aurora™	10026005	<ul style="list-style-type: none"> <li>• Ratchet temple adjustment</li> <li>• Single, 7-base wrap curve lens</li> <li>• Tuff Stuff™ Anti-scratch Coating</li> </ul>
 	Blockz™	1016379	<ul style="list-style-type: none"> <li>• Brow shelf prevents debris from falling into eyes</li> <li>• Sliding temple adjustment</li> <li>• Tuff Stuff Anti-scratch Coating</li> </ul>
 	Essential Adjust 	10119761	<ul style="list-style-type: none"> <li>• Horizontal and vertical temple adjustment</li> </ul>
	Pyrenees™ 	10033718	<ul style="list-style-type: none"> <li>• Full side protection</li> <li>• Dual injected, soft-tipped temples</li> </ul>
	Voyager™ 	10065849	<ul style="list-style-type: none"> <li>• Single wrap-style lens</li> </ul>

<sup>1</sup> CSA International certified models are denoted with a  symbol

## Sightgard Safety Glasses: Outdoor, High Glare and Ultraviolet (UV) Exposure

- Classification:** Outdoor: high-glare with UV exposure
- Market(s):** Utility work, general industry, manufacturing, construction, oil and gas, forestry, shipbuilding, aviation, mining, transportation
- Application(s):** Chipping, chiseling, drilling, grinding, machining, power fastening, sanding, sawing, masonry, UV protection
- Material:** Polycarbonate
- Features:** Maximum UV protection (“U6”)   
 Rich mirrored or dark tinted lenses reduce glare   
 Impact-rated (Z87+)   
 Anti-fog anti-scratch coating (as noted)
- Standards<sup>1</sup>:** ANSI/ISEA Z87.1-2010 and CSA Z94.3 (as noted)
- Certification:** Third-party by Intertek and CSA International

### Ordering Information

OUTDOOR HIGH-GLARE/ UV EXPOSURE APPLICATIONS		Model	Part No.	Product Specifics
		Alaska	10110420	<ul style="list-style-type: none"> <li>Rich silver mirror on a grey tint lens reduces light transmission, keeping eyes comfortable in sunlight</li> <li>Frameless; lightweight</li> <li>Padded, adjustable nosebridge</li> </ul>
		Essential Adjust 	10119762	<ul style="list-style-type: none"> <li>Rich-blue mirrored lens reflects light</li> <li>Horizontal and vertical temple adjustment</li> </ul>
		Essential Euro Adjust 	10119753	<ul style="list-style-type: none"> <li>Dark brown tint lens</li> <li>Adjustable temples</li> <li>Anti-fog coating</li> </ul>
		Essential Euro Adjust 	10119755	<ul style="list-style-type: none"> <li>Rich-blue mirrored lens</li> <li>Adjustable temples</li> <li>Single, wide-wrap lens</li> </ul>
		Espresso GlareGone™	10106383	<ul style="list-style-type: none"> <li>Polarized filter lenses block intense light</li> <li>Dark brown tint lens helps further reduce glare</li> </ul>
		Racer™ Red	10106381	<ul style="list-style-type: none"> <li>Rich-red mirrored lens reflects light and reduces glare without color degradation</li> <li>Sporty, single, wide-wrap lens</li> <li>Anti-fog coating</li> </ul>
		Sentry™	10111729	<ul style="list-style-type: none"> <li>Rich silver mirror on grey tint lens</li> <li>Soft-tipped temples to prevent slipping</li> </ul>













<sup>1</sup> CSA International certified models are denoted with a symbol

# Head, Eye, Face, and Hearing Protection

## Sightgard Safety Glasses: Indoor/Outdoor

- Classification:** Indoor/outdoor
- Market(s):** General industry, manufacturing, construction, oil and gas, forestry, shipbuilding, automotive, food and beverage, mining, pharmaceuticals, primary metals, transportation
- Application(s):** Assembly and mechanical, chipping, chiseling, cleaning, drilling, grinding, machining, masonry, riveting, sanding, sawing, UV protection
- Material:** Polycarbonate, indoor/outdoor or light mirroring
- Features:** Maximum UV protection ("U6")  
Light mirror lenses provide glare reduction without significantly reducing light transmittance  
Impact-rated (Z87+)  
Anti-fog and/or anti-scratch coatings (as noted)
- Standards<sup>1</sup>:** ANSI/ISEA Z87.1-2010 and CSA Z94.3 (as noted)
- Certification:** Third-party by Intertek and CSA International

## Ordering Information

INDOOR/OUTDOOR APPLICATIONS		Model	Part No.	Product Specifics
		Arctic	10088179	<ul style="list-style-type: none"> <li>• Blue mirror reduces glare without causing color degradation</li> <li>• Popular, lightweight model</li> <li>• Full side coverage</li> <li>• Anti-scratch coating</li> </ul>
		Artic Elite	10059671	<ul style="list-style-type: none"> <li>• Indoor/outdoor mirror allows workers to go from bright to low light conditions</li> <li>• Rubber tipped temples and nosebridge for comfortable, yet secure fit</li> <li>• Anti-fog coating</li> </ul>
		Essential Adjust 	10119757	<ul style="list-style-type: none"> <li>• Indoor/outdoor mirror allows workers to go from bright to low light conditions</li> <li>• Horizontal and vertical temple adjustment</li> <li>• Anti-scratch coating</li> </ul>
		Essential Adjust 	10119758	<ul style="list-style-type: none"> <li>• Light silver mirror reduces glare</li> <li>• Horizontal and vertical temple adjustment</li> <li>• Anti-fog coating</li> </ul>
		Essential Euro Adjust 	10119754	<ul style="list-style-type: none"> <li>• Light silver mirror reduces glare</li> <li>• Adjustable temples</li> <li>• Single, wide-wrap lens</li> </ul>
		Vista™	10070916	<ul style="list-style-type: none"> <li>• Indoor/outdoor mirror allows workers to go from bright to low light conditions</li> <li>• Vertical temple adjustment</li> <li>• Lightweight, single lens</li> <li>• Tuff Stuff Anti-scratch Coating</li> </ul>













<sup>1</sup> CSA International certified models are denoted with a  symbol



## Sightgard Safety Glasses: Indoor

- Classification:** Indoor: temperate environments
- Market(s):** Facility maintenance, repair and operations, general manufacturing and industry
- Application(s):** Drilling, grinding, machining, sanding, sawing
- Material:** Polycarbonate, clear
- Features:** Impact-rated (Z87+)  
Anti-scratch coating (as noted)
- Standards<sup>1</sup>:** ANSI/ISEA Z87.1-2010 and CSA Z94.3 (as noted)
- Certification:** Third-party by Intertek and CSA International

### Ordering Information

TEMPERATE INDOOR APPLICATIONS		Model	Part No.	Product Specifics
		Arctic	697514	<ul style="list-style-type: none"> <li>• Frameless and lightweight</li> <li>• Among our most popular models!</li> <li>• Tuff Stuff Anti-scratch Coating</li> <li>• Full side coverage</li> </ul>
		Mini Arctic	10106378	<ul style="list-style-type: none"> <li>• Just like the Arctic—only designed for slender faces!</li> <li>• Tuff Stuff Anti-scratch Coating</li> </ul>
		Discovery™ II 	10106382	<ul style="list-style-type: none"> <li>• Flexible, nylon temple arms adjust to head width</li> <li>• Soft nose bridge</li> <li>• So light, you forget you have them on</li> </ul>
		Easyflex™	10070917	<ul style="list-style-type: none"> <li>• Temples and frame flex for a custom fit</li> <li>• Tuff Stuff Anti-scratch Coating</li> </ul>
		Sierra™ 	697550	<ul style="list-style-type: none"> <li>• Classic full coverage look</li> <li>• Adjustable temples</li> <li>• Integral side protection</li> <li>• Tuff Stuff Anti-scratch Coating</li> </ul>















<sup>1</sup> CSA International certified models are denoted with a  symbol

# Head, Eye, Face, and Hearing **Protection**

## Sightgard Safety Glasses: Outdoor with UV Exposure

- Classification:** Outdoor: UV exposure
- Market(s):** General industry, manufacturing, construction, oil and gas, forestry, shipbuilding
- Application(s):** Chipping, splash, chiseling, drilling, grinding, machining, power fastening, sanding, sawing
- Material:** Polycarbonate
- Features:** Maximum UV protection (“U6”)  
Grey tint lenses offer glare reduction with the least amount of color distortion  
Impact-rated (Z87+)  
Anti-fog coating (as noted)
- Standards<sup>1</sup>:** ANSI/ISEA Z87.1-2010 and CSA Z94.3 (as noted)
- Certification:** Third-party by Intertek and CSA International

### Ordering Information















OUTDOOR UV EXPOSURE APPLICATIONS		Model	Part No.	Product Specifics
		Alaska	10118474	<ul style="list-style-type: none"> <li>• Frameless; lightweight</li> <li>• Padded, adjustable nosebridge</li> <li>• Anti-fog coating</li> </ul>
		Essential Adjust 	10119756	<ul style="list-style-type: none"> <li>• Metallic taupe frame with horizontal and vertical temple adjustment</li> <li>• Anti-fog coating</li> </ul>
		Essential Adjust 	10119760	<ul style="list-style-type: none"> <li>• Gun metal silver frame with horizontal and vertical temple adjustment</li> <li>• Anti-fog coating</li> </ul>
		Feather Fit™	10106384	<ul style="list-style-type: none"> <li>• Comfortable rubber flange nosepiece</li> <li>• Rubber temple grips help glasses stay put under hot working conditions</li> </ul>
		Nuevo Wrap™ 	10106385	<ul style="list-style-type: none"> <li>• Stylish, full wrap coverage</li> <li>• Anti-fog coating</li> </ul>
		Voyager 	10065850	<ul style="list-style-type: none"> <li>• Single lens</li> <li>• Anti-scratch coating</li> </ul>

<sup>1</sup> CSA International certified models are denoted with a  symbol

## Sightgard Safety Glasses: Outdoor

- Classification:** Outdoor: general use
- Market(s):** Aviation, general manufacturing, mining, oil and gas, pharmaceuticals, primary metals, transportation
- Application(s):** Assembly and mechanical, chipping, chiseling, drilling, grinding, machining, sanding, sawing
- Material:** Polycarbonate
- Features:** Grey tint lenses offer glare reduction with the least amount of color distortion  
Anti-fog/anti-scratch coatings (as noted)  
Impact-rated (Z87+)
- Standards<sup>1</sup>:** ANSI/ISEA Z87.1-2010 and CSA Z94.3 (as noted)
- Certification:** Third-party by Intertek and CSA International

### Ordering Information

GENERAL OUTDOOR USE APPLICATIONS		Model	Part No.	Product Specifics
		Arctic	697515	<ul style="list-style-type: none"> <li>• Popular, lightweight model</li> <li>• Full side coverage</li> <li>• Anti-scratch coating</li> </ul>
		Arctic Elite	10038846	<ul style="list-style-type: none"> <li>• Rubber tipped temples and nosebridge for comfortable, yet secure fit</li> <li>• Anti-fog coating</li> </ul>
		Easyflex	10070918	<ul style="list-style-type: none"> <li>• Temples flex for a custom fit</li> <li>• Tuff Stuff Anti-scratch Coating</li> </ul>
		Easyflex	10070921	<ul style="list-style-type: none"> <li>• Rich-orange mirrored lens reflects light and reduces glare without color degradation</li> <li>• Temples flex for a custom fit</li> <li>• Tuff Stuff Anti-scratch Coating</li> </ul>
		Luxor™ 	697517	<ul style="list-style-type: none"> <li>• Horizontal temple adjustment</li> <li>• Wrap-style single lens</li> <li>• Tuff Stuff Anti-scratch Coating</li> </ul>
		Pyrenees 	10033719	<ul style="list-style-type: none"> <li>• Full side protection</li> <li>• Dual-injected soft-tipped temples</li> <li>• Anti-fog coating</li> </ul>
		Sierra 	10010572	<ul style="list-style-type: none"> <li>• Vented browguard</li> <li>• Horizontal temple adjustment</li> <li>• Anti-fog coating</li> <li>• Tuff Stuff Anti-scratch Coating</li> </ul>













<sup>1</sup> CSA International certified models are denoted with a  symbol

# Head, Eye, Face, and Hearing **Protection**

## Sightgard Safety Glasses: Low Light

- Classification:** Low light
- Market(s):** Transportation, inspection and repair, assembly, general industry, indoor construction, shipbuilding, automotive, food and beverage, pharmaceuticals
- Application(s):** Assembly, chipping, chiseling, drilling, grinding, machining, pouring/casting, power fastening, riveting, sanding, sawing
- Material:** Polycarbonate
- Features:** Contrast-enhancing lenses in various tints  
Impact-rated (Z87+)  
Anti-fog or anti-scratch coatings (as noted)
- Standards<sup>1</sup>:** ANSI/ISEA Z87.1-2010 and CSA Z94.3 (as noted)
- Certification:** Third-party by Intertek and CSA International

## Ordering Information













LOW LIGHT APPLICATIONS		Model	Part No.	Product Specifics
 		Blockz VM	10106380	<ul style="list-style-type: none"> <li>Vermillion lens increases contrast and enhances depth perception in low-to-medium light</li> <li>Horizontal temple adjustment</li> <li>Tuff Stuff Anti-scratch Coating</li> </ul>
 		Easyflex	10070919	<ul style="list-style-type: none"> <li>Amber lens increases contrast in low light</li> <li>Temples flex for a custom fit</li> <li>Tuff Stuff Anti-scratch Coating</li> </ul>
 		Essential Adjust 	10119759	<ul style="list-style-type: none"> <li>Light brown lens enhances perception under changing conditions of light and shadow</li> <li>Maximum UV protection</li> <li>Horizontal and vertical temple adjustment</li> <li>Anti-fog coating</li> </ul>
 		Pyrenees 	10033740	<ul style="list-style-type: none"> <li>Amber lens increases contrast in low light</li> <li>Full side protection</li> <li>Dual-injected soft-tipped temples</li> <li>Anti-fog coating</li> </ul>
 		Yellow Jacket™ 	10106386	<ul style="list-style-type: none"> <li>Amber gradient lens enhances perception under changing conditions of light and shadow</li> <li>Full side protection</li> <li>Maximum UV protection</li> </ul>

<sup>1</sup> CSA International certified models are denoted with a  symbol

## Sightgard Safety Glasses: Over-the-Glasses

- Classification:** Over-the-glasses
- Market(s):** Facility safety, maintenance, repair and operations, overhaul, general industry, manufacturing, construction; oil and gas; metalworking; automotive
- Application(s):** Assembly and mechanical, drilling, grinding, machining, masonry, power fastening, riveting, sanding, sawing
- Material:** Polycarbonate
- Features:** Impact-rated (Z87+)  
Maximum UV protection ("U6") (as noted)  
Anti-fog coating (as noted)
- Standards<sup>1</sup>:** ANSI/ISEA Z87.1-2010 and CSA Z94.3 (as noted)
- Certification:** Third-party by Intertek and CSA International

### Ordering Information

RX GLASSES REQUIRED APPLICATIONS		Model	Part No.	Product Specifics
		OvrG™	10110419	<ul style="list-style-type: none"> <li>• For use over small-to-medium Rx glasses</li> <li>• Integral nose pad for added comfort</li> <li>• Clear lenses</li> <li>• Anti-fog coating</li> </ul>
		OvrG II 	10118475	<ul style="list-style-type: none"> <li>• Clear lenses</li> <li>• For use over small-to-medium Rx glasses</li> <li>• Squared-off, stylish look</li> <li>• Maximum UV protection</li> <li>• 30% lighter weight than standard visitor specs</li> </ul>
		OvrG II 	10118476	<ul style="list-style-type: none"> <li>• Indoor/outdoor mirrored lens</li> <li>• For use over small-to-medium Rx glasses</li> <li>• Maximum UV protection</li> </ul>
		Plant Visitor 	10027944 697500 (10/box) 10008174 (144/box)	<ul style="list-style-type: none"> <li>• Classic look</li> <li>• Fits over most Rx glasses</li> <li>• Integral, vented side shields</li> </ul>
		Rx Overglasses	10008175	<ul style="list-style-type: none"> <li>• Clear lenses</li> <li>• Fits over most Rx glasses</li> <li>• Anti-fog coating</li> <li>• Horizontal and vertical temple adjustment</li> </ul>

<sup>1</sup> CSA International certified models are denoted with a  symbol

# Head, Eye, Face, and Hearing Protection

## Sightgard Safety Glasses: Specialty

- Classification:** Specialty: magnifiers
- Market(s):** Facility safety, maintenance, repair and operations, overhaul; general industry; manufacturing; construction; metalworking, automotive
- Application(s):** Fine assembly and detail work, drilling, grinding, machining, soldering; riveting, sanding
- Material:** Polycarbonate
- Features:** Magnification for workers who have difficulty seeing or are performing detail work  
Impact-rated (Z87+)  
Anti-fog coating  
Full side coverage  
Dual-injected soft-tipped temples
- Standards:** ANSI/ISEA Z87.1-2010 and CSA Z94.3
- Certification:** Third-party by Intertek and UL

### Ordering Information

MAGNIFICATION APPLICATIONS		Model	Part No.	Product Specifics
		Pyrenees MAG	10068832	• 1.5 bifocal magnification
		Pyrenees MAG	10065847	• 2.0 bifocal magnification

- Classification:** Specialty: welding
- Market(s):** General industry, manufacturing, construction, oil and gas, forestry, shipbuilding, metalworking; automotive, aviation
- Application(s):** Welding, chiseling, drilling, grinding, machining, masonry, pouring/casting, power fastening, riveting, sanding, sawing
- Material:** Polycarbonate
- Features:** Shade 5 IR (W5)  
Impact-rated (Z87+)
- Standards:** ANSI/ISEA Z87.1-2010
- Certification:** Third-party by Intertek



### Ordering Information

WELDING APPLICATIONS		Model	Part No.	Product Specifics
		Clearvue® IR	10012847	<ul style="list-style-type: none"> <li>• Classic look with Infrared (IR) radiation eye protection, up to Shade 5</li> <li>• Fits over most Rx glasses</li> <li>• Integral, vented side shields</li> </ul>

## Sightgard Safety Goggles

- Classification:** Chemical and splash
- Market(s):** Chemicals, construction, food and beverage, general manufacturing and industry, mining, oil and gas, pharmaceuticals, primary metals, transportation, shipbuilding, automotive
- Application(s):** Cleaning, chemical mixing and use, chipping, chiseling, drilling, grinding, machining, painting, power washing, sanding, sawing, splash
- Material:** Acetate lens
- Features:** Clear  
Impact-rated (Z87+)  
Splash-rated (D3)
- Standards<sup>1</sup>:** ANSI/ISEA Z87.1-2010 and CSA Z94.3
- Certification:** Third-party by Intertek and CSA International

### Ordering Information

CHEMICAL AND SPLASH APPLICATIONS		Model	Part No.	Product Specifics
 		FlexiChem™ iV	10106281	<ul style="list-style-type: none"> <li>• Soft, pliable goggle body ensures all-day comfort</li> <li>• Indirect vent helps eliminate fogging while retaining splash resistance</li> <li>• Acetate lens resists warping, cracking and crazing from chemical splash</li> <li>• Anti-fog coating</li> <li>• Flame-retardant strap</li> </ul>
				

- Classification:** Industrial: impact/splash
- Market(s):** Construction, food and beverage, general manufacturing and industry, mining, oil and gas, pharmaceuticals, primary metals, transportation, shipbuilding, automotive
- Application(s):** Chipping, chiseling, drilling, grinding, machining, painting, power washing, sanding, sawing, splash
- Material:** Polycarbonate
- Features:** Clear  
Anti-fog coating  
Indirect venting helps keep lens fog-free  
Impact-rated (Z87+)  
Splash-rated (D3)
- Standards<sup>1</sup>:** ANSI/ISEA Z87.1-2010 and CSA Z94.3
- Certification:** Third-party by Intertek, CSA International, UL

### Ordering Information

INDUSTRIAL IMPACT/SPLASH APPLICATIONS		Model	Part No.	Product Specifics
 		Clearvue 200	10029693	<ul style="list-style-type: none"> <li>• Smoke frame helps reduce peripheral light, reducing glare</li> </ul>
 		Vault™	10106282	<ul style="list-style-type: none"> <li>• Modern styling</li> <li>• Comfortable, thick strap</li> <li>• Tuff Stuff anti-scratch coating</li> </ul>
				



<sup>1</sup> CSA International certified models are denoted with a  symbol

# Head, Eye, Face, and Hearing Protection

## Sightgard Safety Goggles

- Classification:** General purpose: impact/splash
- Market(s):** Construction, general manufacturing and industry, oil and gas, pharmaceuticals, transportation, shipbuilding
- Application(s):** Splash chiseling, drilling, grinding, sanding, sawing
- Material:** Clear polycarbonate lenses
- Features:** Anti-fog coating  
Impact-rated (Z87+)  
Splash-rated (D3)  
Tuff Stuff Anti-scratch Coating
- Standards<sup>1</sup>:** ANSI/ISEA Z87.1-2010 and CSA Z94.3
- Certification:** Third-party by Intertek and CSA International

### Ordering Information

GENERAL PURPOSE IMPACT/SPLASH APPLICATIONS		Model	Part No.	Product Specifics
 		Sightgard NV 	10106268	• Non-vented for tighter seal
		Sightgard iV 	10106270	• Indirect-venting helps keep goggles fog-free



### Goggle Retainers

Sturdy neoprene-rubber accessory can be used with any protective cap or hat. Retains goggle on headwear when not in use and holds goggle securely when worn for eye protection.

MSA goggle retainers are manufactured for use ONLY with MSA goggles in order to comply with ANSI/ISEA Z87.1-2010.

GOGGLE RETAINERS		
	459458	Goggle Retainer, for caps
	449895	Goggle Retainer, for hats

<sup>1</sup> CSA International certified models are denoted with a  symbol



## Eyewear Accessories



Deluxe Eyewear Pouch

P/N: **10034943** Deluxe Eyewear Pouch  
*Features:* Black nylon spectacle case fits MSA protective eyewear  
 Nylon webbing belt loops  
 Hook-and-loop closure



Lanyard

P/N: **10020871** Deluxe Eyewear Lanyard (pk/12)  
*Features:* Holds eyewear securely  
 Lanyard strap slides over temple ends



Cleaning Accessories

P/N: **13016** 4 oz. Fogpruf™ Cleaner Refill  
 P/N: **10022087** Pre-moistened Towelettes (box of 100)







Eyewear Display Unit

P/N: **697518** Revolving Eyewear Display Unit, less glasses  
*Features:* High-quality display revolves easily  
 Holds 24 pairs of eyewear  
 Includes mirror

# Head, Eye, Face, and Hearing Protection

## Finding the Right Eyewear

Look for frames that complement your face size and shape.

				
<b>Round face</b>	<b>Diamond-shaped face</b>	<b>Square face</b>	<b>Slender face</b>	<b>Larger face</b>
Choose rectangular frames to sharpen round, soft faces	Choose oval frames to soften angled facial contours	Cat-eye frames provide sleek, curvy contours to square features	Choose small frames designed for slender faces to keep proper facial proportions and improve fit	Choose frames with flexible temples, spring-loaded, or serpentine hinges for a comfortable, custom fit

### Frame Material

Choose a frame material that suits your style and needs.

#### Polycarbonate

- More impact-resistant than standard plastic frames
- Thin, lightweight, and strong make it an ideal choice for work environments
- Endless color choices and finishes

#### Nylon

- Maintains shape and flexibility even in hot/cold environments
- Improved chemical resistance

#### Metal

- Strong, yet flexible
- Popular with younger workers
- May not be a good choice for all work environments

## MSA Logo Eyewear Program

### How it Works

Want to customize your Sightgard Protective Eyewear with a company logo or design for a truly distinctive look? Check out the following guidelines to get started, and then call MSA Customer Support at 1-800-MSA-2222 for prompt assistance with your customized order.

MINIMUM ORDER QUANTITY (MOQ)	1,152 eyewear pairs per logo/model/order.
SHIPMENT	MSA will not hold stock of customized eyewear. The entire MOQ will be shipped upon receipt of payment by MSA. Expedited delivery is available with some models. The customer is responsible for air freight costs when requesting expedited delivery.
FIRST ORDER LEAD TIME	Lead time is 75 – 90 days from the date the order is placed with MSA.
LOGO/DESIGN SUBMISSION	The logo/design graphic file can be sent as an e-mail attachment. (Do not embed graphic in e-mail.) Acceptable file formats include ONLY: .tif, .gif and .jpg. <b>NOTE: pdf formats are not acceptable.</b>
OTHER CONSIDERATIONS	<ul style="list-style-type: none"> <li>• MSA will place the order upon written customer approval of a picture of the eyewear with its logo/design, or the actual eyewear model with its logo/design, as preferred by customer.</li> <li>• Logos/designs cannot be applied to product packaging.</li> </ul>

Your company logo here!



## Safety Vests, Cones and First Aid



**Class II Safety Vest**

P/N: **10053455** ANSI Class II Safety Vest, order in multiples of 4

- Meets ANSI Class II Vest requirements for traffic up to 50 MPH
- Unique integral back pocket storage for when vest is not in use
- Horizontal and vertical stripes for excellent visibility even when bending
- Popular high-viz lime green color stands out better around orange traffic barriers
- UPC-A barcode for retail sale



**High Visibility Safety Vest**

P/N: **818040**

- One size fits all to accommodate most wearers
- Hook and loop closures keep vest closed
- Elastic straps automatically adjust to waistline
- UPC-A barcode for retail sale



**Reflective Safety Vest**

P/N: **817890**

- Reflective stripes provide increased visibility
- Hook and loop closures keep vest closed
- Elastic straps automatically adjust to waistline
- UPC-A barcode for retail sale



**Safety Cones**

P/N: **10073426** 12-inch cones, order in multiples of 20

P/N: **10073425** 18-inch cones, order in multiples of 10

P/N: **10073424** 28-inch cones, order in multiples of 6

- Available in 12", 18" or 28" sizes
- One-piece mold helps prevent cracking
- UPC-A barcode for retail sale



**All-Purpose First Aid Kit**

P/N: **10068529** All-Purpose First Aid Kit

- Portable kit with 20 unique emergency response items
- Latex-free kit contents
- Includes instant cold compress
- UPC-A barcode for retail sale



**160-Piece First Aid Kit**

P/N: **10049585** 160-Piece First Aid Kit

- Meets ANSI Z308.1-2009 Standard requirements for Type II First Aid Kit
- Dispenser tray helps keep contents organized
- Includes major wound bandage and instant cold pack
- UPC-A barcode for retail sale

# Fall Protection



# Approvals and Standards

## What is OSHA?

OSHA (Occupational Safety and Health Administration) rules and regulations are enforceable by law. Non-compliance with OSHA rules and regulations can result in stiff penalties and abatement periods.

## OSHA REGULATIONS UNDER TITLE 29 OF THE CODE OF FEDERAL REGULATIONS

### OSHA's Occupational Safety and Health Standards for General Industry

#### Subpart D, Walking/Working Surfaces

- Fixed Ladders, Ladder Safety Devices ..... 1910.27 (d) (5)
- Safety Requirements for Scaffolding, Boatswain's Chairs ..... 1910.28 (j) (4)

#### Subpart F

- Powered Platforms and Building Maintenance ..... 1910.66
- Personal Fall Arrest Systems ..... 1910.66, Appendix C

#### Subpart R

- Agricultural Operations ..... 1910.267
- Telecommunications ..... 1910.268
- Electric Power Generation, Transmission and Distribution ..... 1910.269

### OSHA's Safety and Health Standards for Construction

#### Subpart E, Personal Protective Equipment

- Safety Belts, Lifelines and Lanyards ..... 1926.104
- Safety Requirements for Scaffolding, Boatswain's Chairs ..... 1926.105

#### Subpart L, Scaffolding

- Boatswain's Chairs ..... 1926.450–454
- Aerial Lift Platforms ..... 1926.453 (b) (2) (v)

#### Subpart M, Fall Protection

- Scope, Application and Definitions ..... 1926.500
- Duty to Have Fall Protection ..... 1926.501
- Scope, Application and Definitions ..... 1926.502
- Duty to Have Fall Protection ..... 1926.503

#### Subpart R, Scaffolding

- Fall Protection ..... 1926.750

- Subpart M, Ladders ..... 1926.1053

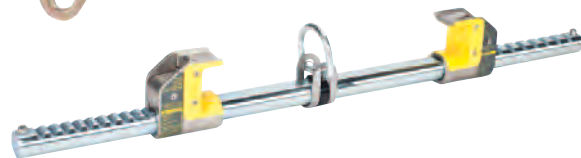

## Approvals and Standards

### What is ANSI?

ANSI (American National Standards Institute) is a voluntary standardization system and does not possess the ability to enforce its standards. ANSI facilitates development of national standards by establishing consensus among manufacturers and consumers. Many of OSHA's regulations are adopted from ANSI standards.

### ANSI Z359 Standard for Personal Fall Arrest

- ANSI Z359.0 .....Definitions
- ANSI Z359.1 .....Fall Arrest Systems, Subsystems and Components
- ANSI Z359.2 .....Minimum Requirements for a Comprehensive, Managed Fall Protection Program
- ANSI Z359.3 .....Work Positioning and Travel Restriction Systems, Subsystems and Components
- ANSI Z359.4 .....Assisted-Rescue and Self-Rescue Systems, Subsystems and Components
- ANSI Z359.6 .....Specifications and Design Requirements for Active Fall Protection Systems
- ANSI Z359.12 .....Connecting Components for Personal Fall Arrest Systems
- ANSI Z359.13 .....Personal Energy Absorbers and Energy Absorbing Lanyards
- ANSI Z359.14 .....Self-Retracting Devices

### What is CSA?

The Canadian Standards Association (CSA) Technical Committee Z259 sets standards for fall protection equipment and practices. The CSA Certification and Test Division is responsible for testing and certifying products to the CSA Z259 product standards. Other certification organizations, including the Safety Equipment Institute, also certify fall protection equipment to the CSA Z259 standards. Products that are certified to the Z259 fall protection standards carry compliance markings of the certifying agency, for example:  or *CSEI*. All Canadian Provinces and Territories require that fall protection equipment must be certified by a recognized third-party organization in compliance with Canadian standards (or meet equivalent levels of protection approved by the legislative authority).

### CANADIAN STANDARDS UNDER THE CSA Z259 FALL PROTECTION SERIES

- CAN/CSA Z259.10-06 .....Full Body Harnesses
- CAN/CSA Z259.11-05 .....Energy Absorbers and Lanyards
- CAN/CSA Z259.12-01 .....Connecting Components for Personal Fall Arrest Systems
- CAN/CSA Z259.13-04 .....Design of Active Fall Protection Systems
- CAN/CSA Z259.16-04 .....Design of Active Fall Protection Systems
- CAN/CSA Z259.2.1-1998 .....Fall Arresters, Vertical Lifelines and Rails
- CAN/CSA Z259.2.2-1999 .....Self-Retracting Devices for Personal Fall Arrest Systems
- CAN/CSA Z259.2.3-1999 .....Descent Control Devices



OUR COMMITMENT  
TO YOU...

## The MSA Fall Protection Promise

MSA promises to replace any MSA harness and/or textile lanyard FREE of charge if a user falls while properly using our product. If the fall occurs while using an MSA mechanical device, we will re-certify the device FREE of charge.

MSA believes that it is important to provide high quality products and recognize safe work practices.

*Products should be returned with a signed copy of the accident report to:*

MSA

Attn: Fall Protection Product Line Manager  
1100 Cranberry Woods Drive  
Cranberry Township, PA 16066-5204









## Need it **NOW**? Call MSA!

**Need it NOW!** is our fall protection delivery program that's designed to get you the products you need, when you need them — **NOW!**

Two tiers of priority shipping are offered under the **Need it NOW!** delivery program:

- Tier I includes MSA's most popular products. Tier I delivery offers same day or next-day shipping.
- Tier II delivery offers shipping within 5 days.

Products included in this program are identified by the following symbols:

- Symbols with a 1 denote Tier I product status  
- Symbols with a 2 denote Tier II product status  
- Black symbols denote that the maximum order quantity for priority shipping is 100 units  
- Red symbols denote that the maximum order quantity for priority shipping is 50 units  

Visit our website at [www.MSAafety.com](http://www.MSAafety.com) to view complete program terms and conditions.



# Fall Protection

## Attachment points



**Fall arrest systems** are an assembly of components and subsystems, including the necessary connectors, used to arrest the user in a fall from a working height and suspend the user until rescue can be effected.



**Suspension Systems** permit workers to sit and work safely while elevated. The system is designed to raise or lower, and support a worker at an elevated work station. This system alone cannot be relied upon to provide proper fall arrest protection.



**Restraint Systems** are an assembly of components and subsystems, including the necessary connectors, used to: (a) stabilize and partially support the user at an elevated work location and allow free use of both hands; (b) restrict the user's motion so as to prevent reaching a location where a fall hazard exists.



**Personnel-Riding Systems** provide a quick means of raising a user out of, or lowering a worker into, a working environment. The system supports full body weight for a short period of time, but should not be used for suspension. A retrieval system by itself may not provide all the protection a worker requires. Fall arrest and/or restraint systems may also be required.

## Harness Sizing Chart

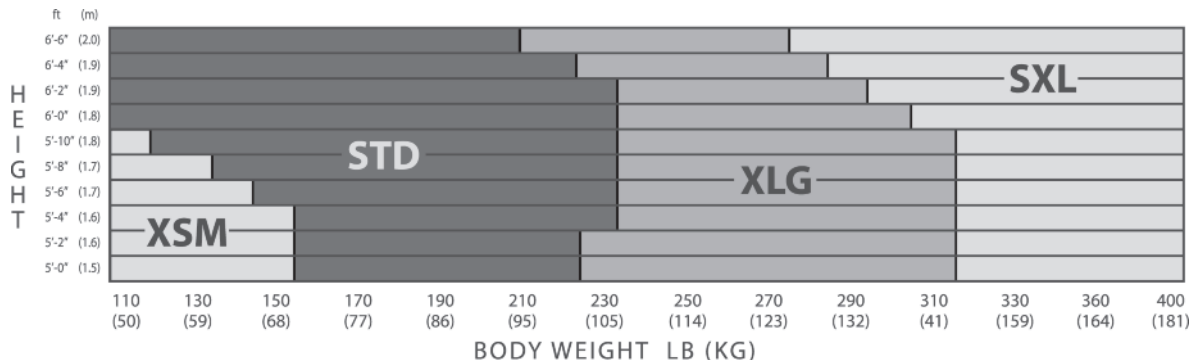



## Field ID and RFID



### What is Field ID?

Field ID is an extremely simple yet powerful electronic inspection and safety compliance management system. Field ID simplifies and expedites equipment tracking, inspection, and compliance data management for those responsible for administering fall protection programs.

### Field ID—A Resource Checklist

24/7 Web & Mobile Access	✓
Use Smartphones, Tablets and Mobile Devices in the Field	✓
Free Apple iOS and Google Android Apps	✓
Easy to Use & Simple Setup Process	✓
Live Online and Onsite Training Available	✓
RFID, NFC & Barcode Compatible	✓
Customizable Web Interface	✓
Scheduling & Email Notifications	✓
Instant Reporting	✓
Equipment & Asset Management	✓
GPS	✓
Multi-User Capabilities	✓
Safety Network Sharing	✓
Free Trial	✓
Live phone support from an award-winning third-party software provider	✓

### How do I begin using Field ID?

Visit [MSAnet.com/FieldID](http://MSAnet.com/FieldID) or email [msa@fieldid.com](mailto:msa@fieldid.com)



### RFID Field Retro Kit Ordering Information

Both kits come with:

- RFID chip
- Two means of attachment to product:
  - Key ring
  - Cable tie

Use either the key ring or cable tie method to securely attach the RFID chip to your product.

RFID FIELD RETRO KIT	10113493	RFID Field Retro Kit, pack of 5
	10113494	RFID Field Retro Kit, pack of 20

# Fall Protection

## EVOTECH® Full Body Harness



EVOTECH Full-Body Harness  
Part No. 10105944



For the latest design features that improve user comfort, ease of use, durability, and user safety, choose the **EVOTECH Full Body Harness**. The EVOTECH Harness is RFID enabled, offering the Field ID Safety Network with Field ID access to provide a reliable, on-line inspection and safety compliance (ISCM) management system.



EVOTECH Construction Harness  
Part No. 10112710



EVOTECH Tower Harness  
Part No. 10112760



## EVOTECH® Harness Features and Benefits

- Breathable padding with moisture-wicking material keeps users cooler
- No binding edge on shoulder padding prevents neck chafing
- Sub-Pelvic Strap with patented variable width webbing provides 50% more surface area for better weight distribution and improved comfort
- Patent-pending leg strap design keeps leg straps in place, increasing mobility and comfort
- Dual-color webbing—red pattern on outside, black on inside—promotes easy identification of twisted webbing
- Patent-pending web management system provides means of storing excess webbing
- 3-position back D-ring allows users to determine optimal lanyard connection position
- Web finials prevent fraying on web ends and simplify threading through buckles
- NanoSphere® coating on webbing repels dirt, grease, moisture, etc.
- Available with Suspension Trauma Safety Step to improve post-fall comfort and help prevent suspension trauma
- Reflective webbing integrated into harness webbing increases visibility in low-light environment
- Construction Harness features integral back pad and tool belt with dual-durometer padding for superior comfort in work positioning applications.

## EVOTECH Full-Body Harness and Construction Harness Assemble-To-Order Matrix

Approval	Style of Harness	D-ring Configuration	Color	Size	Leg Strap Type	D-ring Type	Chest Strap Type	Back Connection Type	Padding	Accessories
A ANSI OSHA C CSA	1 Vest Style 2 Vest Style Construction, Standard Hip D 3 Vest Style Construction, Cranked Hip D 4 Tower with Saddle, Standard D 5 Tower less Saddle, Standard D 6 Tower with Saddle, Crank D 7 Tower less Saddle, Crank D	1 Back 2 Back, Chest 3 Back, Chest, Hips 4 Back, Chest, Hips, Shoulders 5 Back, Hips 6 Back, Chest, Shoulders 7 Back, Shoulders 8 Back, Hips, Shoulders	1 Red	1 SM 2 STD 3 XL Vest Style XL Construction Style 4 SXL Vest Style SXL Construction Style	1 Quick-Connect 2 Tongue Buckle 3 Qwik-Fit	1 Steel	1 Quick-Connect 2 Qwik-Fit	0 D-ring only 1 Sure-Stop Shock Absorber 2 Dorsal Extension	0 None 1 Shoulder Pad 2 Leg Pads 3 Shoulder & Leg Pads	0 None 1 Safety Step 2 Medical ID Kit 3 Safety Step and Medical ID Kit
A-EVO			1			1				0

• Harnesses ordered using the ATO System are non-returnable.

# Fall Protection

## EVOTECH Harness Ordering Information

PART NO.	D-Ring Configuration				Size		Leg Strap Type			Chest Strap Type		Padding			Accessories		Standards
	Back	Back Chest	Back Chest Hips	Back Hips	Std	XLG	Quick-Connect	Tongue Buckle	Qwik-Fit	Quick-Connect	Qwik-Fit	None	Shoulder	Shoulder & Leg	None	Safety Step	OSHA/ANSI/CSA
10105889	■				■				■		■	■			■		■
10105890	■					■			■		■	■			■		■
<b>1</b> 10105931	■				■			■		■			■		■		■
<b>2</b> 10105932	■					■		■		■			■		■		■
<b>1</b> 10105933				■	■			■		■			■		■		■
<b>2</b> 10105935				■		■		■		■			■		■		■
10105936			■		■			■		■			■		■		■
10105939			■			■		■		■			■		■		■
<b>1</b> 10105940	■				■		■			■			■		■		■
<b>2</b> 10105941	■					■	■			■			■		■		■
<b>1</b> 10105942				■	■		■			■			■		■		■
<b>2</b> 10105943				■		■	■			■			■		■		■
10105944			■		■		■			■			■		■		■
10105945			■			■	■			■			■		■		■
10105946		■			■		■			■			■		■		■
10105947		■				■	■			■			■		■		■
10105948			■		■		■			■				■	■		■
10105949			■			■	■			■				■	■		■
10105950				■	■		■			■				■	■		■
10105951				■		■	■			■				■	■		■
10105952			■		■			■		■				■	■		■
10105953			■			■		■		■				■	■		■
10105956	■				■			■			■		■		■		■
10105957	■					■		■			■		■		■		■
10105960				■	■		■			■				■		■	■
10105961				■		■	■			■				■		■	■

## EvoTech Construction Harness Ordering Information

PART NO.	D-Ring Configuration		Size		Leg Buckle Type		Chest Buckle Type		Padding		Standards OSHA/ ANSI/ CSA
	Back, Chest, Hips	Back, Hips	Std	XLG	Quick-Connect	Tongue Buckle	Quick-Connect	Quick-Fit	Shoulder	Shoulder & Leg	
10112708	■		■			■	■		■		■
10112709	■			■		■	■		■		■
2 10112710		■	■			■	■		■		■
2 10112741		■		■		■	■		■		■
10112742	■		■		■		■		■		■
10112743	■			■	■		■		■		■
2 10112744		■	■		■		■		■		■
2 10112745		■		■	■		■		■		■
10112746		■	■		■		■			■	■
10112747		■		■	■		■			■	■
10112750		■	■			■	■			■	■
10112751		■		■		■	■			■	■
10112752	■		■			■	■			■	■
10112753	■			■		■	■			■	■
10112754	■		■			■		■	■		■
10112755	■			■		■		■	■		■

## EvoTech Tower Harness Ordering Information

PART NO.	Hip D-Ring Style		Size		Leg Buckle Type		Padding		Accessories		Standards OSHA/ ANSI/ CSA
	Standard	Crank	Std	XLG	Quick-Connect	Tongue Buckle	Shoulder	Shoulder & Leg	None	Safety Step	
10112758	■		■			■	■		■		■
10112759	■			■		■	■		■		■
10112760	■		■		■		■		■		■
10112761	■			■	■		■		■		■
10112762	■		■		■			■	■		■
10112763	■			■	■			■	■		■
10112764	■		■			■		■	■		■
10112765	■			■		■		■	■		■
10112770	■		■		■			■		■	■
10112771	■			■	■			■		■	■
10112772		■	■		■		■		■		■
10112773		■		■	■		■		■		■
10112774		■	■		■			■	■		■
10112775		■		■	■			■	■		■
10112776		■	■		■			■		■	■
10112777		■		■	■			■		■	■

## TechnaCurv® Full Body Harnesses



TechnaCurv Full Body Harnesses offer features never seen before in full-body harnesses: Curvilinear comfort system, Visco-Elastic shoulder padding, Secure-Fit buckles, and Sorbtek fabric on the shoulder and sub-pelvic pads. The harness is designed with downward adjusting torso straps on most models to ease fitting. MSA's assemble-to-order (ATO) process allows you to order exactly (and only) the options you want, providing you with the most comfortable, versatile, and safe harness available today.

### Features and Benefits

- Resists water, oil, grease, and dirt with Teflon fabric protected webbing which increases the life of the harness
- Uses Visco-Elastic shoulder padding for comfort
- Designed with downward adjusting torso straps to ease fitting
- Tower Harness model available with integral body belt and removable saddle
- Order through MSA's assemble-to-order process to get the options you want

### Value Added **NEW!**

The TechnaCurv Full Body Harness is now RFID-enabled, offering the Field ID Safety Network with Field ID Access to provide a reliable, online inspection and safety compliance (ISCM) management system.

## TechnaCurv Harness Ordering Information

PART NO.	Style		D-Ring Configuration			Size		Leg Buckle Type			Chest Buckle Type		Padding			Accessories			Standards		
	Vesttype	Pullover	Back	Back, Chest, Hips	Back, Hips	Std	XLG	Secure-Fit	Tongue Buckle	Qwik-Fit	Secure-Fit	Qwik-Fit	None	Shoulder	Shoulder & Leg	Integral Shock-Absorber	D-Ring Extension	Tool Belt Loop	OSHA/ANSI/CSA	ANSI/OSHA	
2 10041517	■		■			■				■		■	■							■	
10041518		■	■			■				■										■	
10041519	■		■				■			■		■	■							■	
10041590		■	■				■	■												■	
1 10041591	■		■			■			■			■	■							■	
1 10041592	■		■				■		■			■	■							■	
10041593		■	■			■			■											■	
10041594		■	■				■		■											■	
1 10041595	■				■	■			■			■	■							■	
10041596	■				■		■		■			■	■							■	
10041597		■			■	■			■											■	
10041598		■			■		■		■											■	
1 10041599	■		■			■			■			■		■						■	
10041600	■		■				■					■		■						■	
2 10041603	■				■	■			■			■		■						■	
10041604	■				■		■		■			■		■						■	
1 10041607	■			■		■			■			■	■							■	
10041608	■			■			■		■			■	■							■	
1 10041609		■		■		■			■				■							■	
10041610		■		■			■		■				■							■	
2 10041611	■			■		■			■			■		■						■	
10041612	■			■			■		■			■		■						■	
2 10041615	■			■		■		■	■			■			■					■	
10041616	■			■			■	■	■			■			■					■	
10052995	■		■			■		■			■			■							■
10053000	■				■	■		■			■			■							■
10053001	■		■			■				■		■		■				■	■		
10053008	■				■	■			■			■		■						■	
10084611	■		■			■			■			■	■				■			■	
10095353	■		■			■			■		■			■		■					■
10101776		■		■			■		■												■

# Fall Protection

## TechnaCurv® Full Body Harnesses



TechnaCurv Construction Harness  
Part No. 10063654



TechnaCurv Tower Harness  
Part No. 10048344

### TechnaCurv Construction Harness Ordering Information

PART NO.	Size		Leg Buckle Type		Chest Buckle Type		Webbing Color		Standards
	Std	XLG	Secure-Fit	Tongue Buckle	Secure-Fit	Qwik-Fit	Red	Green	OSHA/ANSI/CSA
2 10054402	■			■		■	■		■
10054720		■		■		■	■		■
10054403	■			■	■		■		■
10054761		■		■	■		■		■
10054719	■		■		■		■		■
10054762		■	■		■		■		■
10063654	■			■		■		■	■
10063656		■		■		■		■	■



## TechnaCurv Tower Harness Ordering Information

PART NO.	Style		Size		Leg Buckle Type			Chest Buckle Type		Padding			Standards
	Vestype	Pullover	Std	XLG	Secure-Fit	Tongue Buckle	Qwik-Fit	Secure-Fit	Qwik-Fit	None	Shoulder	Shoulder & Leg	OSHA/ANSI/CSA
2 10048344	■		■		■				■			■	■
10048345	■			■	■				■			■	■
10048348	■		■			■			■		■		■
10048349	■			■		■			■		■		■
10048342		■	■		■							■	■
10048343		■		■	■							■	■
10048432	■		■				■		■	■			■
10048433	■			■			■		■	■			■

## TechnaCurv Full-Body Harness Assemble-To-Order Matrix

Approval	Style of Harness	D-ring Configuration	Version	Size	Leg Buckles	D-ring Type	Chest Strap (Vest Style only)	Back D-ring Options	Padding	Tool Belt	Accessories	Lanyard Clip	QUANTITY
A Non-CSA C CSA	1 Vest Style	1 Back	1 Red/Black Webbing	1 XSM	1 Secure-Fit	1 Steel	0 None	0 None	0 None	0 None	0 None	0 None	0 None
	3 Tower (Vest Style)	2 Back, Chest 3 Back, Chest, Hips	2 Green/Black Webbing	2 STD 3 XLG 4 SXL	2 Tongue Buckle 3 Qwik-Fit		1 Secure-Fit 2 Tongue Buckle 3 Qwik-Fit	2 Integral Sure-stop Shock Absorber 3 18" Integral Dorsal D Extension (Non-Shock Absorbing)	1 Shoulder 2 Sub-Pelvic 3 Shoulder & Sub-Pelvic	1 Support Straps Only 2 Occidental Leather with Support Straps 3 Occidental Leather/Nylon with Support Straps 4 Modular Belt with Support Straps 5 Tradesman Belt 6 Belt Loops 7 Occidental Leather with Belt Loops 8 Occidental Leather/Nylon with Belt Loops 9 Modular Belt with Belt Loops 10 Tradesman Belt with Belt Loops	1 Medical ID Kit 2 Medical ID Kit and Safety Step 3 Safety Step	1 With 1 Attachment 2 With 2 Attachments	
	5 Tower (Vest Style less Saddle)	4 Back, Chest, Hips, Shoulders 5 Back, Hips 6 Back, Chest, Shoulders 7 Back, Shoulders 8 Back, Hips, Shoulders	3 Orange/Black Webbing										
	2 Pullover Style	1 Back											
	4 Tower (Pullover Style)	2 Back, Chest 3 Back, Chest, Hips											
	6 Tower (Pullover Style less Saddle)	4 Back, Chest, Hips, Shoulders 5 Back, Hips 6 Back, Chest, Shoulders 7 Back, Shoulders 8 Back, Hips, Shoulders											
A-NGH													

- Harnesses ordered using the ATO System are non-returnable.
- If a Vest Style Harness with a Chest D-ring is selected, the Secure-Fit Buckle is not available as an option for the Chest Strap. (All Tower Style Harnesses include a Chest D-ring.)
- Tower Harness Styles include back pad, tool belt and saddle. (Tool Belt options listed in ATO are not available on Tower Harness.)
- Only D-ring Configuration Options 3 and 4 are available on the Tower Harness Style.
- TechnaCurv Construction Harness is not available on ATO.

## Workman® Full-Body Harnesses



Workman Harness  
Part No. 10108768



Workman Harness  
Part No. 10072479



Quality, comfort, and value come together in the Workman line of products. Workman Full Body and Construction Harnesses feature lightweight components and durable webbing.

### Features and Benefits

- Optimum quality at an economical price
- Yellow polyester webbing for increased visibility
- Color-contrasting thigh and torso straps simplify donning
- Choice of Qwik-Fit or tongue-buckle leg straps for easy adjustment
- Web retainer collars to keep excess webbing neat
- Includes two lanyard keepers for added safety when lanyard leg is not in use
- All Workman Harnesses include a load-indicator to alert you when the harness has been involved in a fall event

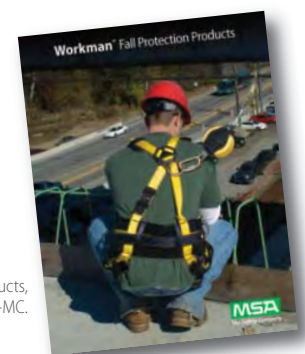

For more complete information on Workman Products,  
see Bulletin 2302-11-MC.

## Workman Harness Ordering Information

PART NO.	D-Ring Configuration				Size				Leg Buckle Type		Standards	
	Back	Back, Chest	Back, Chest, Hips	Back, Hips	XSM	STD	XLG	SXL	Tongue Buckle	Qwik-Fit	OSHA/ANSI/CSA	ANSI/OSHA
10072478	■				■					■	■	
<b>1</b> 10072479	■					■				■	■	
<b>1</b> 10072480	■						■			■	■	
<b>1</b> 10072481	■							■		■	■	
<b>2</b> 10072482				■	■					■	■	
<b>1</b> 10072483				■		■				■	■	
<b>1</b> 10072484				■			■			■	■	
<b>2</b> 10072485				■				■		■	■	
<b>2</b> 10072486	■				■				■		■	
<b>1</b> 10072487	■					■			■		■	
<b>1</b> 10072488	■						■		■		■	
<b>1</b> 10072489	■							■	■		■	
<b>2</b> 10072490				■	■				■		■	
<b>1</b> 10072491				■		■			■		■	
<b>1</b> 10072492				■			■		■		■	
<b>2</b> 10072493				■				■	■		■	
10108743		■			■				■		■	
10108744		■				■			■		■	
10108745		■					■		■		■	
10108767			■		■				■		■	
<b>2</b> 10108768			■			■			■		■	
10108769			■				■		■		■	
10108770			■					■	■		■	
<b>2</b> 10108772			■			■				■	■	
10125152			■			■				■		■
10125153			■				■			■		■

## Workman Construction Harness Ordering Information

PART NO.	Size				Padding		D-Ring Extension	Standards	
	XSM	STD	XLG	SXL	None	Shoulder		OSHA/ANSI/CSA	ANSI/OSHA
<b>2</b> 10072494	■				■			■	
<b>1</b> 10072495		■			■			■	
<b>1</b> 10072496			■		■			■	
<b>2</b> 10072497				■	■			■	
10077490	■					■		■	
<b>1</b> 10077571		■				■		■	
<b>1</b> 10077572			■			■		■	
<b>1</b> 10077573				■		■		■	
10122507		■				■	■		■
10122707	■					■	■		■
10122745			■			■	■		■
10122746				■		■	■		■



## Gravity™ Harnesses

Available in vest and cross-over styles and rated to a 400 pound capacity, Gravity Harnesses are suitable for controlled descent, positioning, ladder climbing, rescue, and fall arrest. A variety of options are available to meet your specific needs.

### Features and Benefits

- Color-contrasting thigh and torso straps simplify donning
- Integral belt and comfortable saddle assist with support, position, restraint, and climb movements
- Includes two lanyard keepers for added safety when lanyard leg is not in use
- Includes a load-indicator to alert you when the harness has been involved in a fall event

**For Gravity Harnesses with a belt, belt sizing is as follows:**

<i>XSM</i>	<i>SML</i>	<i>MED</i>	<i>LGE</i>	<i>XLG</i>
28" – 36"	32" – 40"	36" – 44"	40" – 48"	44" – 52"

### Harness Classes as defined in CSA Z259.10-06

Class A: Fall Arrest

Class D: Suspension & Controlled Descent

Class E: Evacuation

Class L: Ladder Climbing

Class P: Work Positioning

## Gravity Crossover Full-Body Harness Ordering Information



PART NO.	D-Ring Configuration				Size		Webbing Material	Webbing Color				Leg Buckle Type		Integral Energy-Absorber	Standards		
	Back	Back, Chest	Back, Chest, Hips	Back, Chest, Hips, Shoulders	Std	XLG	Nylon	Red/Blue	Black	High-Viz Orange	High-Viz Yellow	Tongue Buckle	Qwik-Fit		OSHA/ANSI/CSA	ANSI/OSHA	CSA/OSHA
SSH70920000	■				■		■	■					■		■		
SSH70920006	■				■		■				■		■		■		
SSH70920008	■				■		■			■			■		■		
SSH70920050	■					■	■	■					■		■		
SSH70920056	■					■	■				■		■		■		
SSH80920000			■		■		■	■					■		■		
SSH80920001			■		■		■		■				■		■		
SSH80920008			■		■		■			■			■		■		
SSH80920050			■			■	■	■					■		■		
SSH80920051			■			■	■		■				■		■		
SSH80925000			■		■		■	■					■		■		
SSH80925050			■			■	■	■					■		■		
SSH90920000		■			■		■	■					■		■		
SSH90920006		■			■		■				■		■		■		
SSH90920050		■				■	■	■					■		■		
SSH90920300		■			■		■	■					■	■			■
SSH90920350		■				■	■	■					■	■			■
SSH90925000		■			■		■	■					■		■		
SSH90925300		■			■		■	■					■	■			■
10067411				■	■		■	■					■			■	
10067415				■		■	■	■					■			■	

# Fall Protection

## Gravity Vesttype Full-Body Harness Ordering Information



Gravity Vesttype Harness  
Part No. SSH30620060



PART NO.	D-Ring Configuration		Size		Webbing Material		Webbing Color		Leg Buckle Type		Chest Buckle Type		Integral Energy-Absorber	Standards	
	Back, Chest, Hips	Back, Hips	Std	XLG	Nylon	Polyester	Red/Blue	Red/Black	Tongue Buckle	Qwik-Fit	Standard	Qwik-Fit		OSHA/ANSI/CSA	CSA/OSHA
10049522	■		■			■	■		■			■		■	
SSH30420000	■		■		■		■			■	■			■	
SSH30420050	■			■	■		■			■	■			■	
1 SSH30420060	■		■		■		■			■		■		■	
SSH30420070	■			■	■		■			■		■		■	
SSH30420300	■		■		■		■			■	■		■		■
SSH30420350	■			■	■		■			■	■		■		■
SSH30420360	■		■		■		■			■		■	■		■
SSH30620000		■	■		■		■			■	■			■	
SSH30620060		■	■		■		■			■		■		■	
SSH30630064		■	■			■		■		■		■		■	

## Gravity Derrick Harness Ordering Information



Gravity Derrick Harness  
Part No. SSH31535C364



Gravity Derrick Harness  
Part No. SSH915353004



PART NO.	Style		D-Ring Configuration			Size				Leg Buckle Type	Padding			Integral Energy-Absorber	Standards CSA/ OSHA
	Vesttype	Cross-over	Back, Chest, Saddle	Back, Chest, Hips, Saddle	Back, Waist, Rear, Saddle	SM	MED	LG	XLG	Tongue Buckle	None	Leg	Shoulder & Leg		
SSH31535B364	■				■	■				■	■			■	■
SSH31535C364	■				■		■			■	■			■	■
SSH31535D364	■				■			■		■	■			■	■
SSH31535E364	■				■				■	■	■			■	■
SSH91535B304		■	■			■				■		■		■	■
SSH91535C304		■	■				■			■		■		■	■
SSH91535D304		■	■					■		■		■		■	■
SSH91535E304		■	■						■	■		■		■	■
SSH91635B30438		■		■		■				■			■	■	■
SSH91635C30438		■		■			■			■			■	■	■
SSH91635D30438		■		■				■		■			■	■	■
SSH91635E30438		■		■					■	■			■	■	■

\*The harnesses listed above are not ANSI-compliant due to selected integral energy-absorber.

# Fall Protection

## Gravity Tower Harness Ordering Information

Gravity Tower Harnesses are a cross-over style design and include back, front, and hip D-rings. This model is offered in a universal size with a web saddle and tongue buckle leg straps. Harnesses also include an integral load indicator. Additional options are available as outlined in the chart below.

PART NO.	Hip D-Ring Style		Size		Webbing Material	Leg Buckle Type	Integral Energy-Absorber	Standards	
	Standard	Crank	MD	LG	Nylon	Tongue Buckle		OSHA/ANSI/CSA	CSA/OSHA
SSH91725C001	■		■		■	■		■	
SSH91725D001	■			■	■	■		■	
SSH91725C301	■		■		■	■	■		■
SSH91725D301	■			■	■	■	■		■
10032731		■		■	■	■		■	
10034041		■	■		■	■		■	



Gravity Tower Harness  
Part No. SSH91725C001



Gravity Rigger's Harness  
Part No. SSH60930001

## Gravity Rigger's Harness Ordering Information

Gravity Rigger's Harnesses are a cross-over style design and include back, front, and hip D-rings. This model is offered in black, polyester webbing and mating leg buckles. Harnesses also include an integral load indicator.

PART NO.	Size		Standards
	STD	XLG	OSHA/ANSI/CSA
SSH60930001	■		■
SSH60930051		■	■



## Gravity Welder Harness Ordering Information

- Kevlar/Nomex blend webbing is resistant to chemicals, weld splatter, and other high-heat applications



Gravity Welder Harness  
Part No. 10103216

Gravity Thermatek  
Harness  
Part No. 10020062

PART NO.	D-Ring Configuration		Size				Leg Buckle Type	Webbing Color		Standards	
	Back	Back, Hips	XSM	STD	XLG	SXG	Quick-Fit	Green	Black	OSHA/ANSI/ CSA	ANSI/OSHA
<b>Thermatek Welder Harness</b>											
10020067		■	■				■	■		■	
<b>2</b> 10020062		■		■			■	■		■	
10020066		■			■		■	■		■	
10020065		■				■	■	■		■	
<b>Gravity Welder Harness</b>											
10103213	■		■				■		■		■
<b>1</b> 10103216	■			■			■		■		■
<b>1</b> 10103217	■				■		■		■		■
10103218	■					■	■		■		■

## ArcSafe® Full-Body Harnesses



Maintenance and utility workers are protected from the hazard of high-energy electric arc flash while wearing ArcSafe Harnesses. This harness may also be used for retrieval from a confined space. The nylon web loop that is included adds comfort by reducing overall harness weight and also reduces potential of electrical arc to the harness.

### Features and Benefits

- SEI-certified to the requirements of the ASTM F887-05 standard for arc flash protection up to 40 cal/cm<sup>2</sup>
- Nylon web loop attachment points
- Meets all applicable OSHA regulations and ANSI Z359.1 standards
- Certified to CSA Z259.10-06
- Integral load indicator
- 400 pound capacity
- Y-shaped back web loop locator pad provides comfort by moving the webbing away from the wearer's neck
- Color-coded leg and torso straps simplify donning
- Downward-adjusting torso straps ease adjustment

## ArcSafe Harness Ordering Information

PART NO.	Style		D-Ring Configuration			Size		Leg Buckle Type		Dielectric Sleeves		Standards	
	Vesttype	Crossover	Back	Back, Belay	Back, Belay, Hips	Back, Hips	STD	XLG	Tongue Buckle	Qwik-Fit	Upper Body	Upper & Lower Body	OSHA/ANSI/CSA
10060101		■	■				■			■			■
10060102		■	■					■		■			■
10070463		■			■		■		■				■
10070464		■			■			■	■				■
10070471		■			■		■			■			■
10070472		■			■			■		■			■
10077853		■		■			■			■	■		■
10077855		■		■				■		■	■		■
10082569		■			■		■		■		■		■
10082570		■			■			■	■		■		■
10070423	■				■		■		■		■		■
10070424	■				■			■	■		■		■
10070431	■		■				■			■	■		■
10070432	■		■					■		■	■		■
10070439	■				■		■			■	■		■
10070440	■				■			■		■	■		■
10070443	■					■	■			■	■		■
10070444	■					■		■		■	■		■
10070451	■					■	■		■		■		■
10070452	■					■		■	■		■		■
10104611	■				■		■			■		■	■
10108731	■				■			■		■		■	■



# Fall Protection

## Harness Accessories

MSA Harness Accessories maximize user comfort and allow customization of harnesses.



Shoulder Pad  
Part No. 10028444



Shoulder Pads  
Part No. 10077489



EvoTech Shoulder Pads  
Part No. 10111358

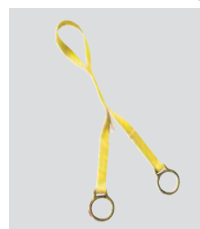

Double D-ring Extension  
Part No. 10043147



Lanyard Keepers  
Part No. 10113240



Cell Phone Holder  
Part No. 10117271



Lanyard Connector Adapter  
Part No. 505318



Tool Lanyard  
Part No. 10110670



Rescue Etrier  
folded (above), extended (left)  
Part No. 10063441

Suspension Trauma Safety Steps allows workers to relieve pressure by inserting a foot into the step loops and then standing up in the harness to increase blood flow to the legs.

## Ordering Information

PADS	507144		Economic Back Support Pad, nylon
	10028444		Shoulder pad
	10077489		Shoulder Pads, 1 set
	10111358		EvoTech Shoulder Pads
D-RING EXTENSIONS	10043147		Double D-Ring Extension, 1" nylon web, sewn loop
	10071688		Single D-Ring Extension, 1" nylon web, sewn loop
LANYARD CONNECTOR ADAPTER	505318	1	Lanyard Connector Adapter, nylon, 1 D-ring, 18" (Back D-Ring Extension)
LANYARD KEEPERS	10113240	1	Lanyard Keepers, MSA Velcro
LANYARD CLIP	SHW26	1	Lanyard Clip (Velcro key ring)
TOOL LANYARD	10110670	1	Tool lanyard
CELL PHONE HOLDER	10117271		Cell phone holder
	10063431	1	Suspension Trauma Safety Step with carabiner
TRAUMA SAFETY STEP	10063441	1	Suspension Trauma Safety Step without carabiner

## Energy-Absorbing Lanyards

Energy-absorbing lanyards are a component of a personal fall arrest system. They provide a means of connection between the back D-ring of MSA full body harnesses and a qualified anchorage and anchorage connector. The energy absorber keeps fall arrest forces below ANSI and OSHA limits and deceleration distance is controlled to a maximum of 42 inches. The lanyard is available in web, rope, and wire rope configurations with a variety of snaphooks.

## Snaphooks

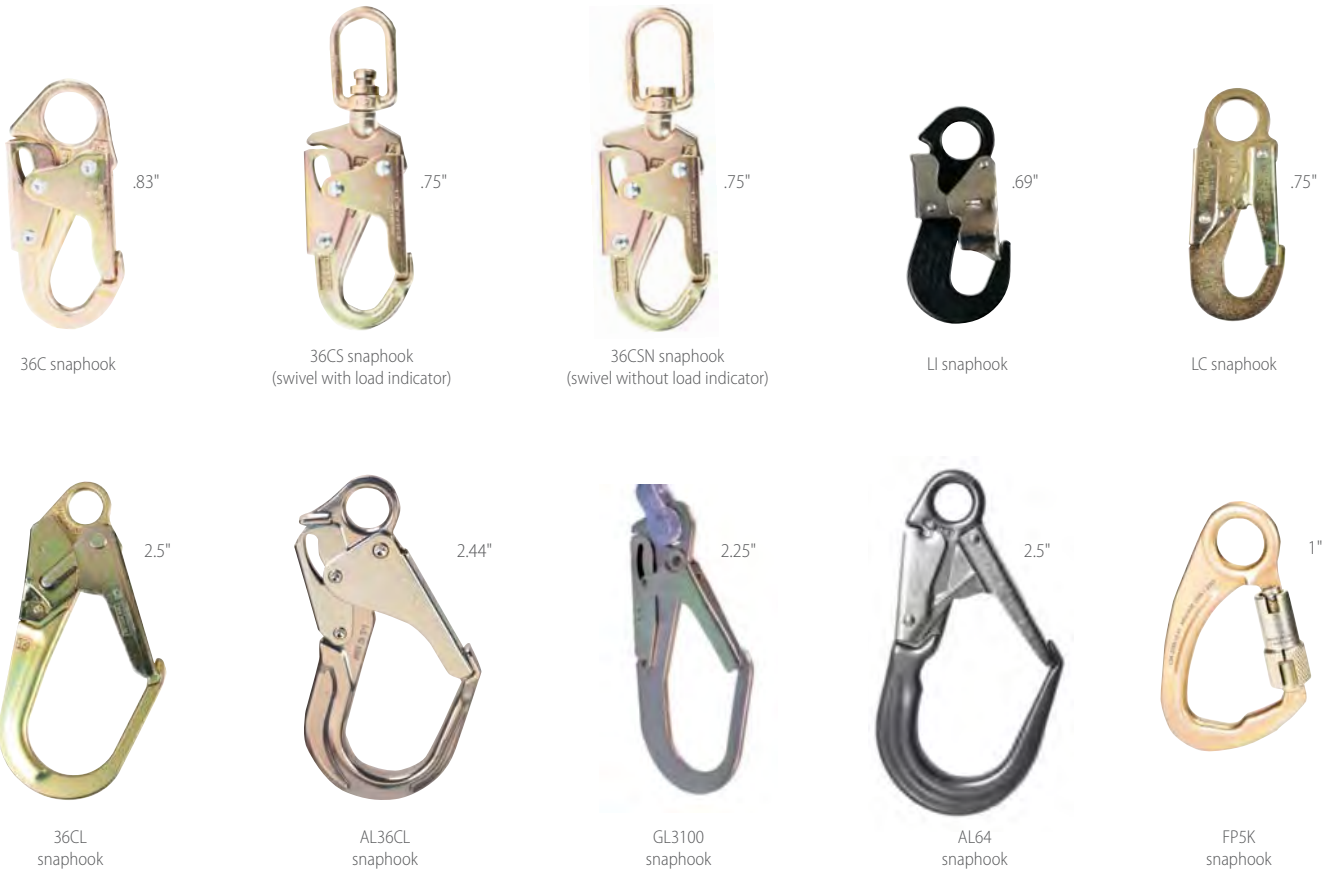

## Workman Energy-Absorbing Lanyards



Workman Energy-Absorbing Lanyard  
Part No. 10113157

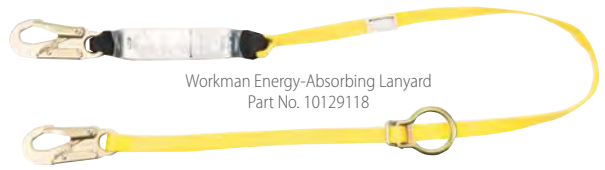

Workman Energy-Absorbing Lanyard  
Part No. 10129118



Workman Energy-Absorbing Lanyard  
Part No. 10113163



Workman Energy-Absorbing Lanyard  
Part No. 10129119



Workman Energy-Absorbing Lanyard  
Part No. 10129120



Workman Energy-Absorbing Lanyard  
Part No. 10129152



Workman Energy-Absorbing Lanyard  
Part No. 10129151



Workman Energy-Absorbing Lanyard  
Part No. 10129153

When a fall hazard is present, use a lightweight, low-profile Workman Energy-Absorbing Lanyard. The energy absorber not only limits force on the body in a fall, but also on the anchor location. The shock absorber includes a clear, durable protective cover over the labels to increase service life and allow for easy inspection.

- Tear-tape design to keep average fall arrest forces below 900 lbs.
- Choice of single- or twin-leg configurations
- Choice of adjustable or tie-back configurations

## Workman Energy-Absorbing Ordering Information

PART NO.	Harness Connection	Anchorage Connection	Type			Standards		
			Single-Leg	Twin-Leg	Tie-Back	ANSI 359.13	CSA Z259.11	OSHA
1 10129118	LC	LC	■		■			■
1 10129119	LC	(2) LC		■	■			■
1 10129120	LC	LC	■					■
1 10129151	LC	(2) GL3100		■				■
1 10129152	LC	(2) LC		■				■
1 10129153	LC	GL3100	■					■
1 10113157	36C	36C	■		■	■		■
1 10113158	36C	36C	■			■		■
1 10113159	36C	(2) 36C		■		■		■
1 10113162	36C	(2) 36C		■	■	■		■
1 10113163	36C	(2) 36CL		■		■		■
1 10113164	36C	36CL	■			■		■
1 10072472	36C	36C	■		■		■	■
1 10072473	36C	(2) 36C		■	■		■	■
1 10072474	36C	36C	■				■	■
1 10072475	36C	(2) 36CL		■			■	■
1 10073708	36C	(2) 36C		■			■	■
1 10076124	36C	36CL	■				■	■

## ArcSafe Energy-Absorbing Lanyards



Providing electrical arc flash protection, ArcSafe Lanyards use a tear-tape design to keep fall arrest forces and deceleration distances below ANSI, OSHA, and CSA limitations. ArcSafe Energy-Absorbing Lanyards connect the back D-ring of MSA full-body harnesses to a qualified anchorage and anchorage connector.

- Limits average fall arrest forces to 900 pounds or less
- Constructed of nylon webbing and length is adjustable
- Includes sewn loop on shock-absorber end and 36C snaphook on lanyard leg
- Incorporates a protective cover over the energy-absorber

### ArcSafe Energy-Absorbing Lanyard Ordering Information

PART NO.	Harness Connection	Anchorage Connection	Type			Standards		
			Single-Leg	Twin-Leg	Heavy Worker	ANSI Z359.13	CSA Z259.11	OSHA
<b>1</b> 10060139	Hitch Loop	36C	■				■	■
<b>1</b> 10060140	Hitch Loop	(2) 36C		■			■	■
10088253	Hitch Loop	(2) 36CL		■	■			■
10088255	Hitch Loop	36C	■		■			■
10088256	Hitch Loop	(2) 36CL		■			■	■
10088257	Hitch Loop	(2) 36C		■	■			■
<b>1</b> 10107200	Hitch Loop	36C	■			■		■
<b>1</b> 10107201	Hitch Loop	(2) 36C		■		■		■
10107202	Hitch Loop	(2) 36CL		■		■		■
10118808*	Hitch Loop	36C	■		■		■	
10118809*	Hitch Loop	(2) 36C		■	■		■	
10118810*	Hitch Loop	(2) 36CL		■	■		■	

\* E6 version



## FP5K® Tie-Back Energy-Absorbing Lanyards



The dependable FP5K Tie-Back Energy-Absorbing Lanyard uses an FP5K Carabiner which can be tied directly back to the lanyard. This product uses the Sure-Stop energy absorber to keep fall arrest forces within the limitations set by ANSI, OSHA, and CSA. It's unique carabiner body shape helps avoid confusion with standard connectors not designed for tie-back applications.

- 5,000 lb gate strength in any direction allows the FP5K carabiner to be tied back directly to the lanyard
- Monster-Edge Webbing with 12,000 pound minimum breaking strength
- Internal wear indicator consists of two yellow threads that, when visible, alert a user when the lanyard should be removed from service due to severe abrasion
- Available in both single- and twin-leg configurations

### FP5K Tie-Back Energy-Absorbing Lanyard Ordering Information

PART NO.	Harness Connection	Anchorage Connection	Adjustable Web	Fixed Cable	Type			Standards		
					Single-Leg	Twin-Leg	Heavy Worker	ANSI Z359.13	CSA Z259.11	OSHA
<b>1</b> 10107207	36C	FP5K	■		■			■		■
<b>1</b> 10107208	36C	FP5K	■			■		■		■
10064866	Hitch Loop	FP5K	■			■		■		■
10088073	36C	FP5K	■		■		■			■
10088074	36C	FP5K	■			■	■			■
<b>1</b> 10047084	36C	FP5K	■		■				■	■
<b>1</b> 10047085	36C	FP5K	■			■			■	■
10116028	FP5K	FP5K	■		■				■	■
10047086	36C	FP5K		■	■				■	■
10047087	36C	FP5K		■		■			■	■
10088075	36C	FP5K		■	■		■			■
10088076	36C	FP5K		■		■	■			■
10107209	36C	FP5K		■	■			■		■
10107210	36C	FP5K		■		■		■		■

## Diamond™ Energy-Absorbing Lanyards and Expanyards



Raising the standard for energy-absorbing lanyards, the FP Diamond Energy-Absorbing Lanyard's light weight and streamlined design contains a strong and durable polyester sheath that's abrasion and UV-resistant. FP Diamond Energy-Absorbing Lanyards connect the back D-ring of MSA full-body harnesses to a qualified anchorage and anchorage connector. The energy absorber keeps fall arrest forces and deceleration distances below ANSI, CSA, and OSHA limits.

- Keeps average fall arrest forces below 900 lbs
- Durable polyester sheath for increased abrasion and UV resistance
- Highly visible deployment tag
- Pouchless design for lighter weight and comfortable wear
- Single- and twin-leg configurations
- Single leg FP Diamond is bi-directional to make training easier
- Twin leg FP Diamond allows for 100% tie off
- Now available in Kevlar



### Diamond Lanyard Assemble-To-Order Matrix

Approval	Style of Lanyard	Single/ Twin Leg	Anchor Connector	Anchor Connector (2nd Leg - Twin Only)	User Connector	Length	QUANTITY
N OSHA C CSA A ANSI Z359.13	1 Non-Expanyard Polyester	1 Single Polyester	05 GL3100 Snaphook*	00 None	01 Hitch Loop*	0 4.5* Polyester, single-/ twin-leg	0
	2 Expanyard Polyester	Single Kevlar	07 LI Snaphook*	05 GL3100 Snaphook*	07 LI Snaphook*	Kevlar, single-leg	
	3 Non-Expanyard Kevlar	2 Twin Polyester Twin Kevlar	08 AL64 Snaphook*	07 LI Snaphook*	09 10089207 Carabiner	Kevlar, twin-leg	
			10 Sewn Loop	08 AL64 Snaphook*	10 SRCA853 Carabiner	1 5* Polyester, single-/ twin-leg	
			11 10089207 Carabiner	10 Sewn Loop	11 Sewn Loop	Kevlar, single-leg	
			12 SRCA853 Carabiner	11 10089207 Carabiner	12 36C Snaphook	Kevlar, twin-leg	
			13 SRCC740 Carabiner	12 SRCA853 Carabiner	13 36CS Snaphook	2 6' Polyester, single-/ twin-leg	
			14 SRCA722 Carabiner	13 SRCC740 Carabiner		Kevlar, single-leg	
			15 36C Snaphook	14 SRCA722 Carabiner		Kevlar, twin-leg	
			16 36CL Snaphook	15 36C Snaphook		3 10* Polyester single-leg	
				16 36CL Snaphook		Kevlar, single-leg	
A-DIA							

\*Diamond Expanyard is not available in 4.5', 5', and 10' lengths.  
• Diamond Lanyards ordered using the ATO system are non-returnable.

## Diamond Energy-Absorbing Lanyard/Expanyard Ordering Information (polyester, single-piece construction, fixed length)

PART NO.	Harness Connection	Anchorage Connection	Material		Type				Length (ft)					Standards			
			Polyester	Kevlar	Single-Leg	Twin-Leg	Triple-Leg	Expanyard	4	4.5	5	6	10	ANSI 359.13	CSA Z259.11	OSHA	
<b>1</b> 10023932	36C	36C	■		■							■			■	■	
<b>1</b> 10023933	36C	36CL	■		■							■			■	■	
10023936	36C	36C	■		■						■				■	■	
10023937	36CS	(2) 36C	■			■					■				■	■	
10023938	36C	36C	■		■								■			■	
<b>1</b> 10023970	36CS	(2) 36C	■			■						■			■	■	
<b>1</b> 10023971	36CS	(2) 36CL	■			■						■			■	■	
<b>1</b> 10045936	36C	36C	■		■				■			■			■	■	
<b>1</b> 10045938	36CS	(2) 36CL	■			■			■			■			■	■	
10053015	36C	36CL	■		■				■			■			■	■	
10059837	36CSN	(3) 36CL	■					■			■					■	
10074736	36C	36CL	■		■							■			■	■	
10076419	36C	36C	■		■						■					■	
10084612	Hitch Loop	36CL	■		■							■				■	
<b>2</b> 10088065	36C	36C	■		■							■		■		■	
10088066	36C	36CL	■		■							■		■		■	
<b>1</b> 10088067	36C	36C	■		■				■			■				■	
10088068	36C	36CL	■		■				■			■				■	
10088069	36C	(2) 36C	■			■						■		■		■	
10088070	36C	(2) 36CL	■			■						■				■	
10088071	36C	(2) 36C	■			■			■			■				■	
<b>1</b> 10088072	36C	(2) 36CL	■			■						■				■	
<b>2</b> 10088077	36CS	(2) 36CL	■			■				■							■
<b>NEW</b> 10125910	36C	36C		■	■							■		■		■	
<b>NEW</b> 10125921	36C	36CL		■	■							■		■		■	
<b>NEW</b> 10125922	36CS	(2) 36C		■		■						■		■		■	
<b>NEW</b> 10125923	36CS	(2) 36CL		■		■						■		■		■	

## Sure-Stop® Energy-Absorbing Lanyards



Using a tear tape design, the Sure-Stop Energy-Absorbing Lanyard keeps fall arrest forces and deceleration distances within the limitations set by ANSI, CSA, and OSHA. Energy absorbing lanyards are a component of a personal fall arrest system. They provide a means of connection between the back D-ring of MSA full-body harnesses and a qualified anchorage and anchorage connector.

- Tear tape design to keep average fall arrest forces below 900 lbs
- Available in adjustable or fixed lengths with your choice of rope, cable, or web
- Single- or twin-leg configurations
- Clear shock-absorber cover protects labels
- Heavy worker model available which uses gray webbing in the pouch to visually differentiate from standard lanyards

### Sure-Stop Web Energy-Absorbing Lanyard Ordering Information

PART NO.	Harness Connection	Anchorage Connection	Type						Standards		
			Fixed	Adjustable	Expanyard	Single-Leg	Twin-Leg	Tie-Back	ANSI Z359.13-2007	CSA Z259.11-05 E4	OSHA
10032698	36C	(2) 36CL	■					■			■
10073581	Steel Carabiner	(2) Steel Carabiner	■					■	■		■
<b>1</b> 10088213	36C	36C	■			■		■	■		■
<b>1</b> 10088214	36C	(2) 36C					■	■	■		■
10088215	Sewn Loop	(2) 36C					■	■	■		■
10088216	Sewn Loop	36C	■			■			■		■
10088217	Sewn Loop	(2) 36C	■				■		■		■
<b>1</b> 10088259	36C	36C		■		■			■		■
<b>1</b> 10088260	36C	36CL		■		■			■		■
10088261	36C	36C			■	■			■		■
10088262	36C	36CL			■	■			■		■
10088263	36C	(2) 36C			■		■		■		■
10088264	36C	(2) 36CL			■		■		■		■
10088265	36C	(2) 36C		■			■		■		■
<b>1</b> 10088266	36C	(2) 36CL		■			■		■		■
10088267	36C	(2) 36C	■				■		■		■
10088268	36C	(2) 36CL	■				■		■		■
10088269	Sewn Loop	(2) 36CL	■				■		■		■
10119639	36C	(2) 36C					■	■	■		■
SWL4068706LS	36C	36C	■			■				■	■

## Sure-Stop™ Energy-Absorbing Lanyards



### Sure-Stop Cable Energy-Absorbing Lanyard Ordering Information

PART NO.	Harness Connection	Anchorage Connection	Type				Length			Standards		
			Single-Leg	Twin-Leg	Heavy Worker	E6 Heavy Worker	4 ft	5 ft	6 ft	ANSI Z359.13	CSA Z259.11	OSHA
10088120	36C	36C	■					■	■			■
10088212	36C	(2) 36CL		■					■			■
10088234	36C	36C	■		■				■			■
10088235	36C	(2) 36C		■	■				■			■
10088236	36C	(2) 36CL		■	■				■			■
10118802	36C	36C	■			■			■		■	■
10118803	36C	(2) 36C		■		■			■		■	■
10118804	36C	(2) 36CL		■		■			■		■	■
SCL4067304LS	36C	36C	■				■					■
SCL4067305LS	36C	36C	■					■				■
SCL4067306LS	36C	36C	■						■			■



### Sure-Stop Rope Energy-Absorbing Lanyard Ordering Information

PART NO.	Harness Connection	Anchorage Connection	Type				Length		Standards		
			Single-Leg	Twin-Leg	Fixed	Adjustable	4 ft	6 ft	ANSI Z359.13	CSA Z259.11	
<b>2</b> 10088219	36C	36C	■		■			■	■		
10088220	36C	36C	■		■			■	■		
10088221	36C	36C	■			■		■	■		
10119236	36C	36C	■			■		■	■		
SNL4048404LS	36C	36C	■		■		■				■
SNL4048406LS	36C	36C	■		■			■			■

## Thermatek® Energy-Absorbing Lanyard



Specially designed for high-heat applications, Thermatek® Energy-Absorbing Lanyards feature a Tuffweld protective cover over the energy-absorber and a Kevlar back-up strap inside the energy-absorbing pouch. Energy Absorbing Lanyards connect the back D-ring of MSA full-body harnesses to a qualified anchorage and anchorage connector. The energy absorber keeps fall arrest forces and deceleration distances within the limitations set by ANSI, CSA, and OSHA.

- Designed to hold up to heat and for use in the welding industry
- Tuffweld protective cover that is superior to Nomex
- Kevlar back-up strap is resistant to charring and burning
- Thermatek 12 lanyard model arrests a free-fall up to 12 feet and keeps fall arrest forces below OSHA limits
- Available in Kevlar web



### Thermatek Cable Energy-Absorbing Lanyard Ordering Information

PART NO.	Harness Connection	Anchorage Connection	Type				Length		Standards		
			Single-Leg	12' Freefall	Heavy Worker	E6 Heavy Worker	5 ft	6 ft	ANSI Z359.13	CSA Z259.11	OSHA
<b>1</b> 10023485	36C	36C	■					■			■
10026060	36C	36C	■	■							■
10027104	36C	36C	■				■				■
<b>2</b> 10088246	36C	36C	■					■			■
10088247	36C	36C	■	■							■
10088248	36C	36C			■			■			■
10118812	36C	36C				■		■		■	

### Thermatek Web Energy-Absorbing Lanyard Ordering Information

PART NO.	Harness Connection	Anchorage Connection	Type			Standards		
			Fixed	Single-Leg	Twin-Leg	ANSI Z359.13-2007	CSA Z259.11-05 E4	OSHA
10106935	36C	36C	■	■				■
10107853	36C	(2) 36C	■		■			■
10118737	36C	36CL	■	■				■
10118738	36C	(2) 36CL	■		■			■

For more complete information on MSA lanyards for the heavy worker, see Bulletin 2302-34-MC.



## Workman Personal Fall Limiters (PFL)



The Workman Personal Fall Limiter (PFL) and the Workman Twin Leg Personal Fall Limiter are two of the most versatile fall protection devices available on the market today. The Workman PFL has a fast acting brake mechanism and the Workman Twin Leg PFL offers a great alternative to twin-leg energy-absorbing lanyards.

- Rugged, impact-absorbing protective bumpers for added durability
- A 400 lb. working capacity eliminates the need to custom order a product for a worker exceeding 310 lbs
- ATO ordering flexibility allows you to order the exact and only options you want

## Workman Web PFL Ordering Information

WORKMAN PFL— WEB VERSION							
PART NO.	Description	PFL Connection	Lifeline Connection	Standards			
				CSA Z259.2.2	ANSI Z359.14-2012	OSHA	
1	10093348	Workman PFL, 12' line length	None	LI Snaphook			■
1	10093349	Workman PFL, 12' line length	None	LC Snaphook			■
1	10093350	Workman PFL, 12' line length	1" Steel Carabiner	LC Snaphook			■
2	10093352	Workman PFL, 12' line length	Back D Connector	LC Snaphook			■
1	10093353	Workman PFL, 12' line length	1" Steel Carabiner	36C Snaphook		■	■
1	10093354	Workman PFL, 12' line length	None	36C Snaphook		■	■
	10093351	Workman PFL, 11' line length	Back D Connector	AL64 Snaphook			■
	10093355	Workman PFL, 10' line length	None	AL36C Snaphook	■		■
2	10093356	Workman PFL, 10' line length	None	36C Snaphook	■		■
2	10093357	Workman PFL, 10' line length	1" Steel Carabiner	36C Snaphook	■		■
	10093358	Workman PFL, 10' line length	Back D Connector	36C Snaphook	■		■

# Fall Protection

## Workman Cable PFL Ordering Information

WORKMAN PFL— CABLE VERSION						
PART NO.	Description	PFL Connection	Lifeline Connection	Standards		
				CSA Z259.2.2	ANSI Z359.14-2012	OSHA
10104708	Workman PFL, 12' line length	None	LI snaphook			■
10104709	Workman PFL, 12' line length	None	LC Snaphook			■
10104710	Workman PFL, 12' line length	1" Steel Carabiner	LC Snaphook			■
10104791	Workman PFL, 11' line length	Back D Connector	AL64 Snaphook			■
10104792	Workman PFL, 12' line length	Back D Connector	LC Snaphook			■
<b>2</b> 10104793	Workman PFL, 12' line length	1" Steel Carabiner	36C Snaphook		■	■
10104794	Workman PFL, 12' line length	None	36C Snaphook		■	■
10104795	Workman PFL, 10' line length	None	AL36C Snaphook	■		■
10104796	Workman PFL, 10' line length	None	36C Snaphook	■		■
10104797	Workman PFL, 10' line length	1" Steel Carabiner	36C Snaphook	■		■
10104798	Workman PFL, 10' line length	Back D Connector	36C Snaphook	■		■



## Workman Twin-Leg Personal Fall Limiter (PFL) Ordering Information

PART NO.	Description	Lifeline Connection	Standards		
			CSA Z259.2.2 - Type 1	ANSI Z359.14	OSHA
<b>1</b> 10118937	Workman Twin Leg PFL, 6' line length	36CL snaphook	■	■	■
<b>1</b> 10120050	Workman Twin Leg PFL, 6' line length	AL36CL snaphook	■	■	■
10129903	Workman Twin Leg PFL, 6' line length	LC snaphook	■		■
<b>1</b> 10120052	Workman Twin Leg PFL, 6' line length	36C snaphook	■	■	■
<b>1</b> 10125271	Workman Twin Leg Tie-Back PFL, 6' line length	FP5K Snaphook	■	■	■
<b>1</b> 10125272	Workman Twin Leg Tie-Back PFL, 7.5' line length	FP5K Snaphook	■		■
10122373	Optional lockout hardware	—	—	—	—

## Workman Personal Fall Limiter (PFL) Assemble-To-Order Matrix

Approvals	Line Length	PFL Connector	Lifeline Connector	Field Replaceable Line	QUANTITY
C CSA & OSHA A ANSI Z359.1 & OSHA O OSHA & ANSI A10.32 E EN360: 2002	06 6' Web 07 7' Web 08 8' Web 09 9' Web 10 10' Web 11 11' Web 12 12' Web 07G 7' Cable 08G 8' Cable 09G 9' Cable 10G 10' Cable 11G 11' Cable 12G 12' Cable	0 None 1 Back D-ring Connector 2 1" Aluminum Carabiner 3 1" Steel Carabiner 4 2" Aluminum Carabiner 5 2" Steel Carabiner 6 36CL Snaphook	0 LI Snaphook 1 Swivel Carabiner 2 1" Aluminum Carabiner 3 1" Steel Carabiner 5 AL64 Snaphook 6 LC Snaphook 8 36C Snaphook 9 36CSN Snaphook A Triple Lock Carabiner B 36CS Snaphook with Load Indicator D 36CL Snaphook	N No Y Yes	
A-PFL					

- Replaceable Lifeline feature not available on Workman PFL's with cable lifeline.
- Workman PFL's ordered using the ATO matrix are not returnable.
- Large snaphooks (AL64 and 36CL) available with Back D-ring Connector on PFL Connector only



## Workman Self-Retracting Lanyard (SRL)

With lightweight design, durable thermoplastic housing and impact-absorbing bumpers, the Workman SRL will not only be accepted by users, but also provides years of dependable service.

- RFID-enabled product for simplified product tracking and inspection
- 400-lb working capacity for increased versatility
- Integral, ergonomic carrying handle for easier transport and installation
- Available with galvanized or stainless steel lifeline to fit your varied applications
- Swivel snaphook with load indicator at lifeline end greatly limits twisting of cable; also alerts users that the Workman SRL has been involved in a fall
- Available in 30-ft and 50-ft lengths to provide the mobility you need
- Certification to ANSI Z359.14-2012 and CSA Z259.2.2 for compliance and peace of mind
- Meets all OSHA requirements



WORKMAN SELF-RETRACTING LANYARDS	PART NO.	NEW!	DESCRIPTION
	10119507	NEW!	Workman SRL, 30-ft, galvanized cable, 36CS snaphook
	10120724	NEW!	Workman SRL, 30-ft, stainless steel cable, 36CS snaphook
	10121834	NEW!	Workman SRL, 50-ft, galvanized cable, 36CS snaphook
	10121778	NEW!	Workman SRL, 50-ft, stainless steel cable, 36CS snaphook

## Short-Stop® and Sure-Lock Self-Retracting Lanyards

A fast-acting fall arrester limiting free-fall distance, deceleration distance, and fall arrest forces while allowing user freedom of movement. The Short-Stop and Sure-Lock Self-Retracting Lanyards are compact and lightweight.

- 7 or 10 ft web retractable 1-3/4" nylon webbing lifeline
- Easily installed and fast acting to minimize fall arrest forces
- 11/16" gate opening snaphook

Short-Stop SRL  
Part No. 10021840

Sure-Lock SRL  
Part No. SFP6902002



PART NO.	Description	Length	SRL Connection	Lifeline Connection
NEW! 10004277	Short-Stop	10'	None	LI Snaphook
10021840	Short-Stop	10'	10089207 carabiner	LI Snaphook
SFP6902001	Sure-Lock	7'	10089207 carabiner	LI Snaphook
SFP6902002	Sure-Lock	7'	10089207 carabiner	10089207 carabiner with swivel
SFP6902008	Sure-Lock	7'	10089207 carabiner	36CSN

# Fall Protection

## Aptura® LT 30 Self-Retracting Lanyard (SRL)

With its solid design and fast-acting brake mechanism, the Aptura LT 30 SRL is the lightest weight, most versatile SRL available on the market today.

- Durable, high-impact thermoplastic housing to increase service life
- Rugged, impact-absorbing protective bumpers for added durability
- Field-replaceable lifeline option
- Lightweight design starting at 7.5 pounds
- A standard lifeline length of 30' with lengths available from 13' to 30' in 1' increments
- A 400 pound working capacity as a standard feature
- No annual factory re-certification required due to high-quality construction
- An integral load indicator lets you know when it is time to remove the product from service
- ATO ordering flexibility allows you to order the exact and only the options you want



Aptura LT30  
Part No. 10053558

## Ordering Information

PART NO.	Description	SRL Connection	Lifeline Connection	Standards	
				CSA Z259.2.2	OSHA
10050504	Aptura LT30, 30' line length	None	AL36C	■	■
<b>1</b> 10053558	Aptura LT30, 30' line length	None	36C	■	■
<b>1</b> 10053559	Aptura LT30, 30' line length	1" Steel Carabiner	36C	■	■
<b>1</b> 10058886	Aptura LT30, 30' line length	None	36CS	■	■

## Aptura LT30 SRL Assemble-To-Order Matrix

Approvals	Line Length	SRL Connector	Lifeline Connector	Field Replaceable Line	QUANTITY
N Non-CSA C CSA	08 13' 09 14' 10 15' 11 16' 12 17' 13 18' 14 19' 15 20' 16 21' 17 22' 18 23' 19 24' 20 25' 21 26' 22 27' 23 28' 24 29' 25 30'	00 None 01 Back D-ring Connector (P/N 10089205) 02 1" Aluminum Carabiner (P/N SCRA883) 03 1" Steel Carabiner (P/N 10089207) 04 2" Aluminum Carabiner (P/N SRCA722) 05 2" Steel Carabiner (P/N 506308)	00 None (Sewn Loop) 05 LI Aluminum Snaphook 06 1" Steel Carabiner (P/N 10089207) 07 1" Aluminum Carabiner (P/N SRCA883) 08 1" Steel Swivel Carabiner 13 36C Snaphook 14 36CS Snaphook 15 LC Snaphook 16 36CSN Snaphook 17 AL36C Snaphook	N No Y Yes	
A-APT					

Note: Products ordered using the ATO System are non-returnable

## Dyna-Lock® Self-Retracting Lanyards (SRL)

The MSA Dyna-Lock Self-Retracting Lanyards (SRL) are fast-acting fall arresters that limit free-fall distance, deceleration distance and fall arrest forces while allowing user freedom of movement. The Dyna-Lock SRL is ideal for climbing applications where vertical mobility is needed.

### Features and Benefits

- Three independent locking mechanisms provide proven dependability in corrosive or freezing environments
- Integral energy absorber limits average fall arrest forces to 900 lbs or less
- Visual impact loading indicator on snaphook that alerts the user when the unit has been subjected to a load
- Wire rope available in galvanized or stainless steel
- Swivel snaphook to prevent birdcaging or kinking of lifeline
- Roller nozzle reduces wear on cable
- Durable stainless steel and extruded aluminum housing on web Dyna-Lock SRLs
- Durable galvanized steel housing on cable Dyna-Lock SRLs
- Integral carrying/mounting handle
- 4.5 feet per second locking speed



## Dyna-Lock SRL Ordering Information

PART NO.	Description	Length	Standards	
			CSA Z259.2.2/OSHA	ANSI Z359.14-2012/OSHA
1 506202	Galvanized Wire Rope	30'		■
1 506204	Galvanized Wire Rope	50'		■
506206	Galvanized Wire Rope	70'		■
506208	Galvanized Wire Rope	95'		■
2 506203	Stainless Steel Wire Rope	30'		■
2 506205	Stainless Steel Wire Rope	50'		■
506207	Stainless Steel Wire Rope	70'		■
506209	Stainless Steel Wire Rope	95'		■
1 506615	Nylon Web	20'		■
1 10017931	Stainless Steel Wire Rope	20'		■
10088390	Backpacker, Web	20'		■
10006470	Galvanized Wire Rope	30' (10M)	■	
2 10006468	Galvanized Wire Rope	50' (16M)	■	
10006466	Galvanized Wire Rope	70' (22M)	■	
10006464	Galvanized Wire Rope	95' (30M)	■	
10006469	Stainless Steel Wire Rope	30' (10M)	■	
10006467	Stainless Steel Wire Rope	50' (16M)	■	
10006465	Stainless Steel Wire Rope	70' (22M)	■	
10006463	Stainless Steel Wire Rope	95' (30M)	■	
10006447	Nylon Web	20' (6M)	■	
2 10017933	Stainless Steel Wire Rope	20' (6M)	■	
10006446	Backpacker, web	20' (6M)	■	

# Fall Protection

## Restraint Lanyards

Restraint lanyards are primarily used for travel restriction (to restrain a worker from reaching a fall hazard) and work positioning (stabilizing a worker at an elevated location) applications. All restraint lanyards meet applicable OSHA regulations. Compliance to CSA is noted in the tables below.



## Web Restraint Lanyard Ordering Information

PART NO.	Material			Type				Harness Connection	Anchorage Connection	Length					Standards	
	Web	Nylon	Polyester	Single	Twin	Adj	Fixed			2 ft	3 ft	4 ft	5 ft	6 ft	CSA Z259.11-05 E4	OSHA
505197	1"	■		■			■	36C	36C					■	■	■
<b>1</b> 505204	1"	■		■		■		36C	36C					■	■	■
505210	1"		■	■			■	36C	36C					■	■	■
505211	1"		■	■			■	LOOP	36C					■	■	■
505217	1"	■		■		■		LOOP	36C					■	■	■
10056762	1"	■		■		■		FP5K	36C			■		■	■	■
<b>2</b> 10056763	1"	■			■		■	36C	(2) FP5K				■	■	■	■
10072499	1"		■	■		■		36C	36C					■	■	■
SWL3268702LS	1"	■		■			■	36C	36C	■				■	■	■
SWL3268703LS	1"	■		■			■	36C	36C		■			■	■	■
<b>2</b> SWL3268704LS	1"	■		■			■	36C	36C			■		■	■	■
SWL3268706LS	1"	■		■			■	36C	36C					■	■	■
<b>2</b> 505088	1"	■		■		■		36C	36C					■	■	■

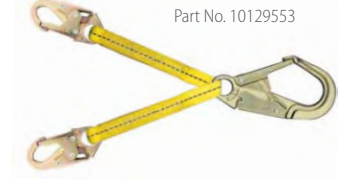

## Rebar Assemblies Ordering Information

PART NO.	Description	Standards	
		OSHA	CSA Z259.11-05
<b>1</b> 10107326	Rebar chain assembly, 36CL snaphook with 2.5" (57mm) gate	■	
10072498	Rebar web assembly, 13" legs, with sliding large snaphook	■	■
10129553	Rebar web assembly, 18" legs, with sliding large snaphook	■	
415957	Rebar web assembly, 36CL large snaphook with 2.5" (64mm) gate	■	■

## Restraint Lanyards

### Sure-Grab™ Positioning Lanyard

Connects to the user's harness or belt for travel restriction or work positioning applications. Features fast and easy length adjustment. Meets applicable OSHA regulations.



Part No. SNYR537DH306

### Sure-Grab™ Positioning Lanyard Ordering Information

SURE-GRAB POSITIONING LANYARDS	SNYR537DH306 <b>2</b>	Sure-Grab positioning lanyard, manual, closed body, c/w 5/8" x 6' blue Static Kernmantle, chrome locking swivel snaphook, right-handed version
	SNYL537DH306	Sure-Grab positioning lanyard, manual, closed body, c/w 5/8" x 6' blue Static Kernmantle, chrome locking swivel snaphook, left-handed version

### Lineman's Pole Strap

The Lineman's Pole Strap is used to assist a lineman in climbing wooden poles and for work positioning. Meets applicable OSHA regulations.



Part No. 415834

### Lineman's Pole Strap Ordering Information

LINEMAN'S POLE STRAP	415834	Lineman's pole strap, nylon, adjustable to maximum length of 70"
----------------------	--------	--

## Energy-Absorbing Sub-Assembly Lanyards



Part No. 10088064

### Energy-Absorbing Sub-Assembly Lanyard Ordering Information

PART NO.	Material		Harness Connection	Anchorage Connection	Heavy Worker	Standards		
	Nylon	Polyester				OSHA	CSA Z259.11-05	ANSI Z359.13
SSA4002LS	■		36C	D-Ring		■	■	
10088064	■		36C	D-Ring		■		■
10090058	■		36C	D-Ring	■	■		

## Anchorage Connectors

- Have a minimum breaking strength of 5,000 lb.
- Are compatible for use with MSA fall arrest and confined space entry/retrieval components
- Meet ANSI Z359.1-2007 and all applicable OSHA regulations



Part No. 10042794



Part No. 10042792

### PointGuard™ Anchorage Connector Strap

- PointGuard Concrete Anchorage Connector Strap couples a single personal fall arrest system to an anchorage
- PointGuard Residential Anchorage Connector Strap provides a secure point of attachment for residential construction applications

POINTGUARD ANCHORAGE CONNECTOR STRAP	10042792	<b>1</b>	PointGuard residential anchorage connector strap, 3' with D-ring
	10042794	<b>1</b>	PointGuard concrete anchorage connector strap, 4' with D-ring
	10042793		PointGuard residential anchorage connector strap, 3'
	10042795		PointGuard concrete anchorage connector strap, 4'
	10097493		PointGuard residential anchorage connector strap, 3' with D-ring, box of 50
	10094384		PointGuard concrete anchorage connector strap, 4' with D-ring, box of 50



Part No. 10023487



Part No. 505282



Part No. SFP2267503

### Anchorage Connector Straps/BoomBelt

- Anchorage Connector Strap provides a temporary means of connecting to an anchor point
- Double D-ring Anchorage Connector Strap is used as a removable anchor strap for connection to an anchorage point
- Boom Belt is used to prevent catapult accidents

ANCHORAGE CONNECTOR STRAPS	505282	<b>1</b>	Anchorage connector strap, nylon, 5' length
	505298		Anchorage connector strap, polyester, 5' length
	10023490	<b>1</b>	Anchorage connector strap, double D-ring, 5' length
	SFP2267503		Double D-ring anchorage connector strap, 3' length
	SFP2267504	<b>1</b>	Double D-ring anchorage connector strap, 4' length
	SFP2267506		Double D-ring anchorage connector strap, 6' length
	10023487		Anchorage connector strap, Kevlar web
BOOM BELT	SSB22040		Boom belt, 1-3/4" nylon webbing, adjustable, one size fits all

Part No. SFP2267402



Part No. SFP3267504

### Anchorage Slings

- SuretyMan Anchorage Sling is sewn into an endless loop that can be hitched to an anchorage point using various configurations

ANCHORAGE SLINGS	SFP2267402		SuretyMan anchorage sling, 2' length
	SFP2267404		SuretyMan anchorage sling, 4' length
	SFP2267406		SuretyMan anchorage sling, 6' length
	SFP3267504	<b>1</b>	Anchorage cable sling, 4' length
	SFP3267506	<b>1</b>	Anchorage cable sling, 6' length

## Anchorage Connectors



10K MEGA Swivel (D-Ring only)  
Part No. 10144954



MEGA Swivel Hybrid  
Part No. 10144957



5K MEGA Swivel (Steel)  
Part No. 10144944



Weld-on Puck  
Part No. 10144958  
(shown with 10K MEGA swivel D-Ring)



5k Drop-Through Anchorage Connector  
Part No. 10144960



5K Removable Concrete Anchor  
Part No. 10081594



10K Removable Concrete Anchor  
Part No. 10081570



5K Toggle Lok Anchor  
Part No. 10144961

5K MEGA ANCHORAGE CONNECTORS <i>zinc-plated steel</i>	10144944	5K MEGA anchorage connector kit (steel)
	10144945	5K MEGA anchorage connector kit (concrete)
	10144946	5K MEGA D-ring
	10144947	5K MEGA bolt (steel)
	10144948	5K MEGA bolt (concrete)
5K MEGA ANCHORAGE CONNECTORS <i>stainless steel</i>	10144949	5K MEGA anchorage connector kit SST (steel)
	10144950	5K MEGA anchorage connector kit SST (concrete)
	10144951	5K MEGA SST D-ring
	10144952	5K MEGA SST bolt (steel)
	10144953	5K MEGA SST bolt (concrete)
10K MEGA SWIVEL ANCHORAGE CONNECTORS <i>zinc</i>	10129084	10K MEGA swivel anchorage connector (steel)
	10129085	10K MEGA swivel anchorage connector (concrete)
	10144954	10K MEGA D-ring
	10144955	10K MEGA bolt, Grade 8 (steel)
	10144956	10K MEGA bolt (concrete)
	10144957	10K MEGA swivel hybrid kit
REMOVABLE CONCRETE ANCHORS	10081594	5K removable concrete anchor
	10081570	10K removable concrete anchor
ANCHORAGE CONNECTORS	10144958	10K Weld-on puck, for MEGA swivel
	10144959	10K Backplate, for MEGA swivel
	10144960	5K Drop-through anchorage connector, 8.5 feet
	10144961	5K Toggle Lok anchor
	10144962	5K MEGA SST install tool for concrete bolt anchorage connector

## Anchorage Connectors



Bolt D-ring with Hole  
Part No. 10003213



ManSafe Freestanding Post\*  
Part No. 10055719

\* D-ring Kit (Part No. 10101146)  
must be purchased separately.



Large Hook  
with Strap  
Part No. 10002820



Chain anchorage  
connector  
Part No. 10003206

D-Plate Anchorage  
Connector  
Part No. 506632



## Anchorage Connector Components

For use in fall arrest and confined space entry applications.

- Anchorage Connector Extension features a 3,600 lb rated snaphook on one end and a 3" O-ring on the other
- Bolt D-ring with Hole Anchorage Connector is a permanent anchor connector designed for coupling a single fall arrest system to an anchorage such as beams or girders
- D-Plate Anchorage Connector provides a permanent anchorage point
- Chain Anchorage Connector is a temporary component for use near sharp edges or in high heat
- Large Hook with Strap is a temporary, overhead anchorage connector
- ManSafe Freestanding Constant Force Post is tested and approved for use on concrete, single-ply membrane, asphalt sanded, asphalt stone-chipped, and steel roof profiles (See Bulletin 2301-59-MC for more information.)

ANCHORAGE CONNECTOR EXTENSIONS	505233	<b>1</b>	Anchorage connector extension, 5', 36C, O-ring
	10082683		Anchorage Connector extension, 12', 36C, O-ring
	10087003		Anchorage Connector extension, 6', FP5K, O-ring
	10073847		Anchorage Connector extension, 5', FP5K, O-ring
	10003206		Chain anchorage connector
	10002820		Large hook with strap
ANCHORAGE CONNECTORS	10003213	<b>1</b>	Bolt D-ring with hole only
	10062597		Single bolt anchor
	506632	<b>1</b>	D-plate anchorage connector, zinc-plated steel
	506669		D-plate with 8 x 8 galvanized back plate
	506672		D-plate with 8 x 8 aluminum back plate
MANSAFE FREESTANDING POST	10055717		ManSafe Freestanding Constant Force Post, 440 lbs (200 kg)
	10055718		ManSafe Freestanding Constant Force Post, 660 lbs (300 kg)
	10055719		ManSafe Freestanding Constant Force Post, 880 lbs (400 kg)
	10055716		220 lb (100 kg) Upgrade kit for ManSafe Freestanding Constant Force Post
	10101146		D-ring Kit (bolt and washers) for ManSafe Freestanding Constant Force Post (requires Part No. 10127545)
	10127545		Mansafe Post ( requires Part No. 10101146)



## Anchorage Connectors



## Beam Grips and BeamGlide™ Trolley

- Workman FP Stryder/Beam Grips attach to I-beam flange—no tools required
- BeamGlide Trolley provides horizontal mobility and keeps anchorage connector directly overhead—fits all beams

WORKMAN FP STRYDER	10144431 <b>1</b>	Workman FP Stryder Anchorage Connector, Standard version, fits beam flange widths from 4" to 13.5"
	10144432	Workman FP Stryder Anchorage Connector, XL version, fits beam flange widths from 14" to 23.5"
BEAM GRIPS	506682	BeamGrip for beams with flange width: 3.94" to 5.64" flange thickness: .205" to .659"
	415171	BeamGrip for beams with flange width: 5.525" to 8.07" flange thickness: .36" to 1.09"
	415172	BeamGrip for beams with flange width: 8.06" to 10.475" flange thickness: .56" to .935"
	415173	BeamGrip for beams with flange width: 10.265" to 12.8" flange thickness: .605" to 1.25"
	506643	D-Ring insert for BeamGrip
	506673	Swivel D-Ring
	10072789	506682 BeamGrip with swivel D-Ring
BEAMGLIDE TROLLEY	506266	BeamGlide Trolley, removable model (customer must provide specs)
	506252	BeamGlide Trolley, permanent model (customer must provide specs)
	506379	Trolley End Stops (pair)



## Roof Anchors

Available in permanent or reusable models, roof anchors provide an anchor point for personal fall arrest systems on roofs for maintenance work, repair, and new construction.

ROOF ANCHORS	10016468 <b>2</b>	Permanent roof anchor, 2" x 4"
	10017593	Permanent roof anchor, 2" x 6"
	10017594	Permanent roof anchor, 2" x 8"
	10017595	Permanent roof anchor, 2" x 10"
	10017596	Permanent roof anchor, 2" x 12"
	416068 <b>2</b>	Temporary roof anchor, 3-pack
	10102686 <b>1</b>	Workman reusable roof anchor

# Fall Protection

## Anchorage Connectors



Rail-Slider  
Part No. SFPRS6000

### Rail-Slider™

- Rail-Slider Provides fall protection during horizontal movement on railway bridges (carabiner required—see below)

RAIL-SLIDER	SFPRS6000 <b>2</b>	Rail-Slider, steel, galvanized, for 80 - 136 # rail, used on train/crane type rail
	10030608	Rail-Slider, steel, galvanized, for 141 # rail, used on train/crane type rail

## Carabiners

MSA offers a wide variety of carabiners for almost every application. All carabiners have a minimum breaking strength of 5,000 lbs.



Part No. 506259



Part No. SRCC641



Part No. 10089205



Part No. SRCA722



Part No. 506572



Part No. 10089207



Part No. SRCA883



Part No. SRCA613



Part No. 506308



Part No. 10089209



Part No. SRCC740



Part No. SRCC642



## Fall Protection Kits



### Workman Fall Protection Kits

Kits include the Workman Vest-Style Harness, the Workman Energy-Absorbing Lanyard, the PointGuard Anchor Strap, and a duffel bag. Meets OSHA and CSA.

WORKMAN FALL PROTECTION KITS	10092166	Workman Fall Protection kit includes STD size Vest-Style Harness with Qwik-Fit Leg Straps; Workman Energy-Absorbing Lanyard, single-leg, adjustable; PointGuard Anchor Strap; duffel bag
	10092167	Workman Fall Protection kit includes STD size Vest-Style Harness with Tongue-Buckle Leg Straps; Workman Energy-Absorbing Lanyard, single-leg, adjustable; PointGuard Anchor Strap; duffel bag
	10092168	Workman Fall Protection kit includes XLG size Vest-Style Harness with Qwik-Fit Leg Straps; Workman Energy-Absorbing Lanyard, single-leg, adjustable; PointGuard Anchor Strap; duffel bag
	10092169	Workman Fall Protection kit includes XLG size Vest-Style Harness with Tongue-Buckle Leg Straps; Workman Energy-Absorbing Lanyard, single-leg, adjustable; PointGuard Anchor Strap; tote bag



### Workman Aerial Kits

Kits include the Workman Vest-Style Harness, the Workman Energy-Absorbing Lanyard, and a convenient storage bag that can be attached to an aerial lift. Meets OSHA and CSA.

WORKMAN AERIAL KITS	10092170	Workman Aerial Kit includes STD size Vest-Style Harness with Qwik-Fit leg straps; Workman Energy-Absorbing Lanyard, single-leg, adjustable; carry bag
	10092191	Workman Aerial Kit includes STD size Vest-Style Harness with Tongue-Buckle leg straps; Workman Energy-Absorbing Lanyard, single-leg, adjustable; carry bag
	10092192	Workman Aerial Kit includes XLG size Vest-Style Harness with Qwik-Fit leg straps; Workman Energy-Absorbing Lanyard, single-leg, adjustable; carry bag
	10092193	Workman Aerial Kit includes XLG size Vest-Style Harness with Tongue-Buckle leg straps; Workman Energy-Absorbing Lanyard, single-leg, adjustable; tote bag

### Thermatek Kit

Kits include the Thermatek Harness, the Thermatek Energy-Absorbing Lanyard, the Thermatek Anchorage Connector Strap and a carrying bag. Meets OSHA.

	with 36C Snaphooks	
THERMATEK KITS	10026061	Kit with Thermatek 6 Lanyard
	10026064*	Kit with Thermatek 12 Lanyard

\* Includes 12' freefall lanyard



## Fall Protection Kits



### RCD® (Remote Connect/Disconnect) System

By using the strap tool the user can install the anchorage connector strap to an approved overhead anchorage point. By using the connect/disconnect tool the user can attach any lifeline with a 36C snaphook to the overhead anchorage connector strap, use the same tool to remove the lifeline from the overhead anchorage and then to remove the anchorage connector strap.

RCD (REMOTE CONNECT/DISCONNECT) SYSTEM	501443	Remote Connect/Disconnect System
	RCD System includes:	
	505314	RCD Anchor Strap
	506507	Telescoping Pole
	506509	Strap Connecting Tool
	10129597	Remote Connect/Disconnect Tool
507405	Large tote bag	

### Anthron Descent Device System

The Anthron Descender is a manually operated, controlled descent device most commonly used for suspended work positioning, self-evacuation, or rescue operations. A cam assembly provides friction on the rope to hold a load or allow the load to descend at a controlled rate. The system consists of a 7/16" (11mm) rope, the Anthron Descender, and two carabiners. Proper roping and rigging diagrams are on the side of the device, which can be installed or removed at any point on the rope and has a working load of 300 pounds (136 kg).

- Device can be installed/removed at any point on the rope.
- Proper roping/rigging diagrams on the side of the Anthron Descender
- Working load of 300 lbs (136 kg)
- System consists of a 7/16" (11 mm) rope, Anthron Descender, and 2 carabiners

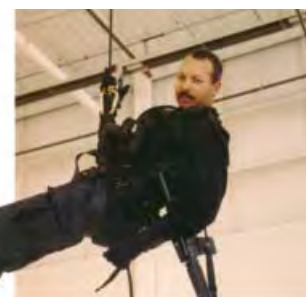

Anthron System in use



Anthron Descender

ANTHRON DESCENT DEVICE SYSTEM	SDC726050	Anthron system includes: Anthron descender, 2 carabiners, 50' rope
	SDC726100	Anthron system includes: Anthron descender, 2 carabiners, 100' rope
	SDC726150	Anthron system includes: Anthron descender, 2 carabiners, 150' rope

Anthron systems and replacement ropes available in lengths of 25' increments from 50' up to 600'

## Roofers' Kits



Workman Roofers' Kit  
Part No. 10074476



	Part No.	
<b>ROOFERS KITS with WORKMAN VEST STYLE HARNESS &amp; TRAILING ROPE GRAB</b> <i>Meet OSHA and CSA</i>	10074476 <b>2</b>	<ul style="list-style-type: none"> <li>• STD size Workman harness with tongue-buckle leg straps</li> <li>• 50' rope lifeline with trailing rope grab, roof anchor, and storage bucket</li> </ul>
	10074475	<ul style="list-style-type: none"> <li>• STD size Workman harness with Qwik-Fit leg straps</li> <li>• 25' rope lifeline with trailing rope grab, roof anchor, and storage bucket</li> </ul>
	10074477	<ul style="list-style-type: none"> <li>• STD size Workman harness with tongue-buckle leg straps</li> <li>• 25' rope lifeline with trailing rope grab, roof anchor, and storage bucket</li> </ul>
	10074584	<ul style="list-style-type: none"> <li>• XLG size Workman harness with Qwik-Fit leg straps</li> <li>• 25' rope lifeline with trailing rope grab, roof anchor, and storage bucket</li> </ul>
	10074582	<ul style="list-style-type: none"> <li>• XLG size Workman harness with tongue-buckle leg straps</li> <li>• 25' rope lifeline with trailing rope grab, roof anchor, and storage bucket</li> </ul>
<b>ROOFERS KITS with WORKMAN VEST STYLE HARNESS &amp; MANUAL ROPE GRAB</b> <i>Meet OSHA</i>	10074480	<ul style="list-style-type: none"> <li>• STD size Workman harness with Qwik-Fit leg straps</li> <li>• 25' rope lifeline with manual rope grab, roof anchor, and storage bucket</li> </ul>
	10092959	<ul style="list-style-type: none"> <li>• STD size Workman harness with tongue-buckle leg straps</li> <li>• 25' rope lifeline with manual rope grab, roof anchor, and storage bucket</li> </ul>

	with 25' vertical lifeline	with 50' vertical lifeline	
<b>ROOFERS KITS WITH GRAVITY VEST STYLE HARNESS</b> <i>Meet OSHA</i>	10074475	10074477	<ul style="list-style-type: none"> <li>• Gravity Harness, Vest-Style STD size, with Qwik-Fit chest and leg straps, and back D-ring; includes integral Sure-Stop Shock-Absorber with D-ring</li> <li>• Manual Rope Grab Fall Arrester with Sure-Stop Energy-Absorbing Lanyard and manual-lock carabiner</li> <li>• 50' - 5/8" Rope, polysteel/polyester, with LS snaphook</li> <li>• Temporary roof anchor (3)</li> <li>• Woodscrews, #12 x 2.5" Phillips flathead, zinc</li> <li>• Roofer's kit tote bag</li> </ul>
	10074474	10074476	<ul style="list-style-type: none"> <li>• Gravity Harness, Vest-Style STD size, with Qwik-Fit chest and leg straps, and back D-ring</li> <li>• Manual Rope Grab Fall Arrester with Sure-Stop Energy-Absorbing lanyard and snaphook</li> <li>• 25' - 5/8" Rope, polysteel/polyester, with snaphook</li> <li>• 6-gallon bucket with lid</li> </ul>

## Rope Grabs and Vertical Lifelines

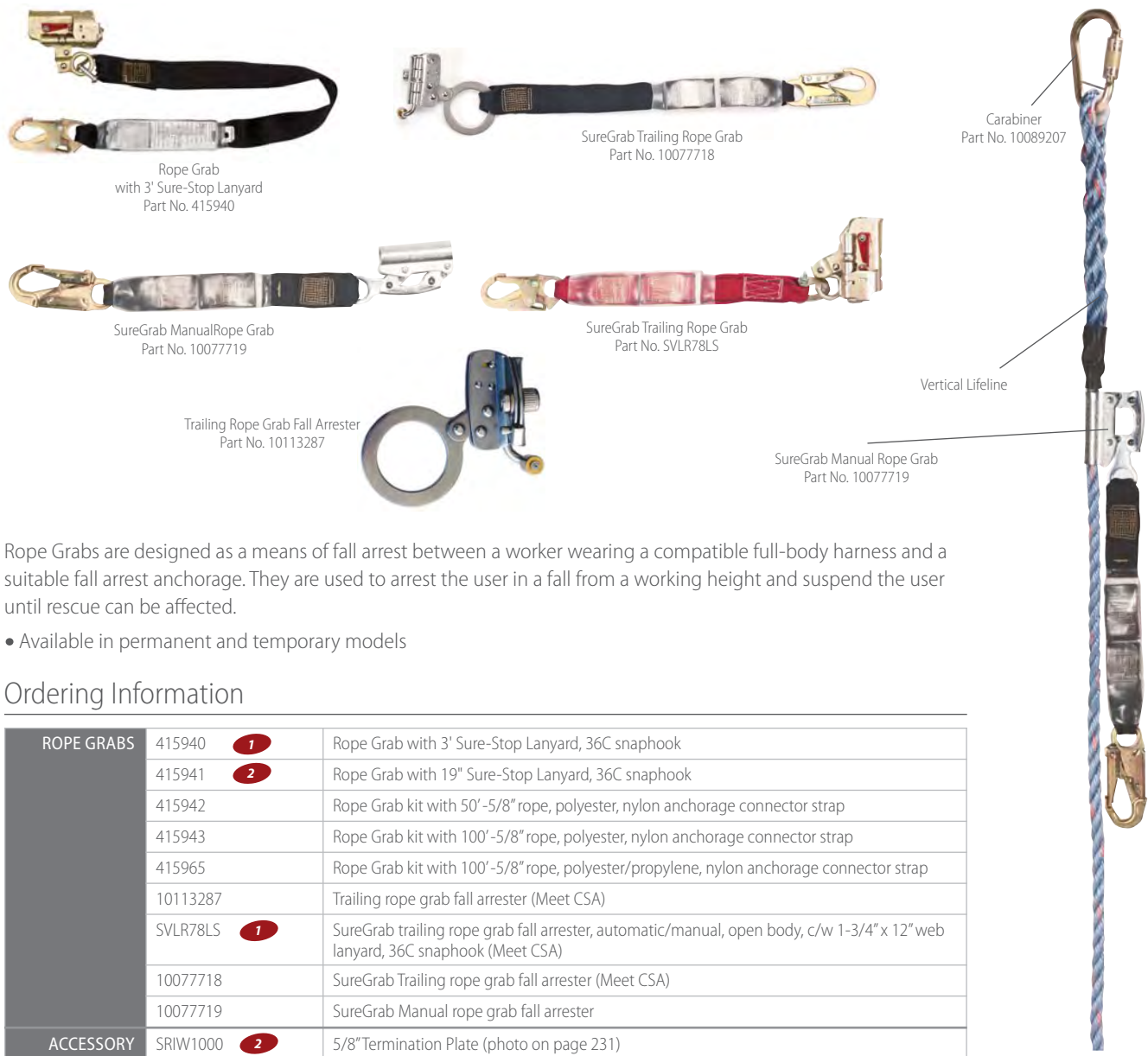

Rope Grabs are designed as a means of fall arrest between a worker wearing a compatible full-body harness and a suitable fall arrest anchorage. They are used to arrest the user in a fall from a working height and suspend the user until rescue can be affected.

- Available in permanent and temporary models

### Ordering Information

ROPE GRABS	LENGTH		DESCRIPTION
	25 ft	50 ft	
415940	1		Rope Grab with 3' Sure-Stop Lanyard, 36C snaphook
415941	2		Rope Grab with 19" Sure-Stop Lanyard, 36C snaphook
415942			Rope Grab kit with 50' -5/8" rope, polyester, nylon anchorage connector strap
415943			Rope Grab kit with 100' -5/8" rope, polyester, nylon anchorage connector strap
415965			Rope Grab kit with 100' -5/8" rope, polyester/propylene, nylon anchorage connector strap
10113287			Trailing rope grab fall arrester (Meet CSA)
SVLR78LS	1		SureGrab trailing rope grab fall arrester, automatic/manual, open body, c/w 1-3/4" x 12" web lanyard, 36C snaphook (Meet CSA)
10077718			SureGrab Trailing rope grab fall arrester (Meet CSA)
10077719			SureGrab Manual rope grab fall arrester
ACCESSORY			DESCRIPTION
SRIW1000	2		5/8" Termination Plate (photo on page 231)

VERTICAL LIFELINES	LENGTH							DESCRIPTION
	25 ft	50 ft	60 ft	75 ft	100 ft	150 ft	200 ft	
415865		415869	—	415870	415871	415872	415873	5/8" polyester rope, w/36C Snaphook on one end
416048		416049	—	416050	416051	416052	416053	5/8" polyester/polypropylene rope, w/twist-lock carabiner on one end
—	—	—	SLLNL672060LS	—	—	—	—	5/8" nylon rope, white 3-strand, w/snap on one end
—	—	—	—	—	SLLNL672100LS	—	—	5/8" nylon rope, white 3-strand, w/snap on one end

## Workman Tripod and Workman Confined Space Entry Kits

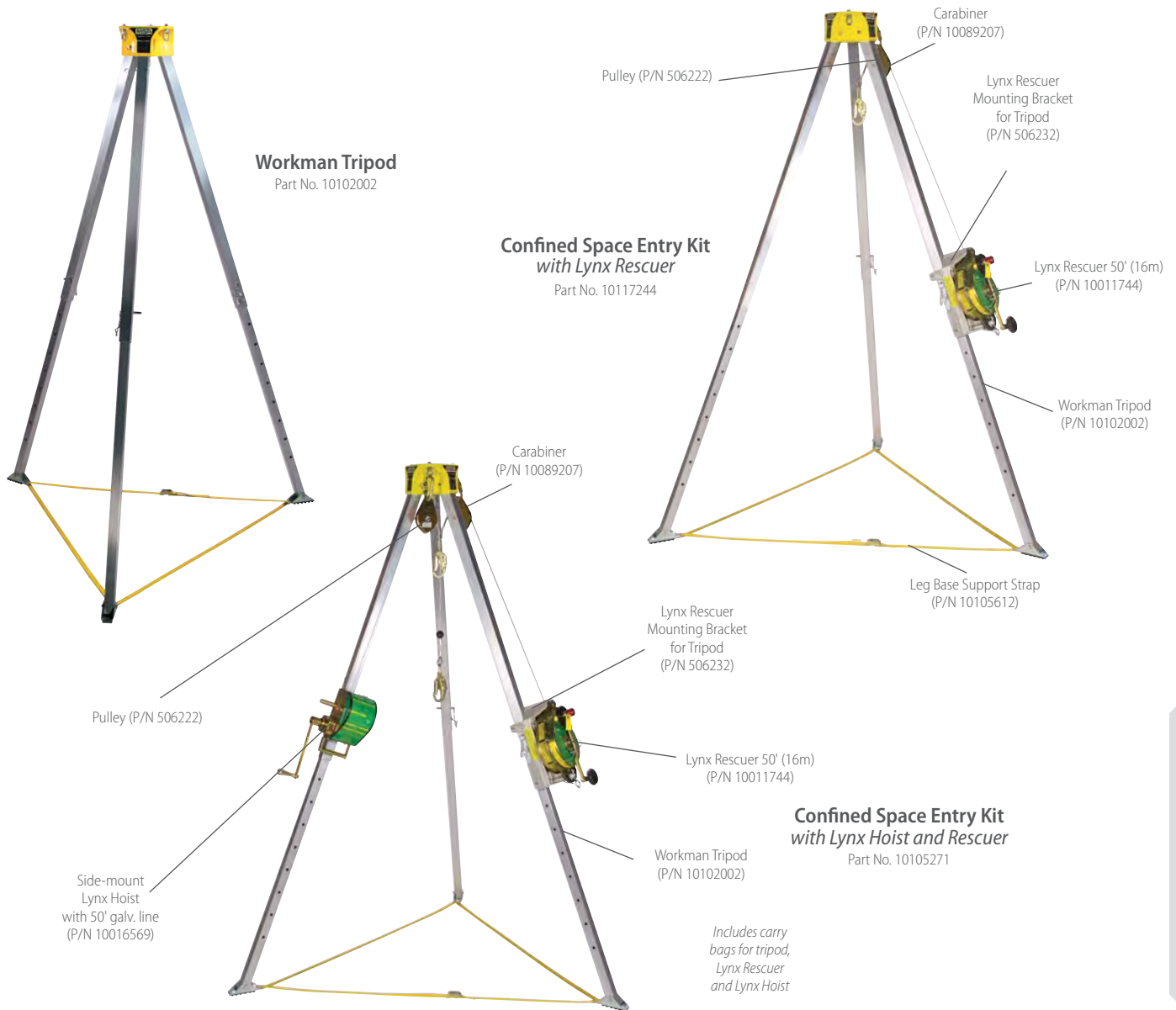

MSA Tripods make confined space entry with vertical descent easy. The Workman Tripod features internal leg-locking mechanism, maximum height indicator on the tripod legs, cut-resistant leg pin retention chains, recessed product labels, reduced weight and integral carrying strap. The Workman Tripod can be set up and dismantled without the use of tools.

- Automatic hinge lock legs with incremental adjustment
- Skid resistant feet

Complete confined space entry kits for multiple confined space applications. Features three tripod kits and two folding davit kits with a single part number for simplified ordering.

- Allow for non-entry rescue of a confined space entrant and great portability
- Lift and lower materials and personnel via the hoist while having the ability to use an SRL

## Workman Tripod and Workman Confined Space Entry Kits

### Ordering Information

 <b>WORKMAN TRIPOD</b>	10102002	<b>2</b>	Workman Tripod	
	<b>CONFINED SPACE ENTRY KITS</b>	10125297		Confined Space Entry Kit with Lynx Hoist and Dynevac II Rescuer, 50'
		10125298		Confined Space Entry Kit with Dynevac II Rescuer, 95'
		10105271	<b>2</b>	Confined Space Entry Kit with Lynx Hoist and Lynx Rescuer, 50'
		10115109		Confined Space Entry Kit with Lynx Hoist and Lynx Rescuer, CSA version, 50'
		10117244		Confined Space Entry Kit with Lynx Rescuer, 50'
		10115110		Confined Space Entry Kit with Lynx Rescuer, CSA version, 50'
<b>REPLACEMENT PARTS AND ACCESSORIES</b>	10105612		Leg base support strap	
	10089207		Carabiner	
	506222		Pulley	
	10011744		Lynx Rescuer, 50'	
	10013077		Replacement key for Lynx Rescuer	
	10016569		Side Mount Lynx Hoist, 50'	
	506232		Lynx Rescuer mounting bracket	
	10105656		Tripod duffel bag	
	507151		Hoist/Rescuer carrying bag	





## Dynevac® II Self-Retracting Lanyard, Field Resettable Model

- Self Retracting Lanyard with emergency retrieval capabilities
- Allows user to reset device from retrieval mode to fall arrest mode
- Same unit can be used in the field and for training situations
- Provides fall arrest and emergency lifting and lowering for confined space entry
- Available in 50 foot and 95 foot lengths

Dynevac II SRL with  
Emergency Rescuer  
Part No. 10127293



### Dynevac II SRL Ordering Information

			ANSI	CSA
DYNEVAC II SELF-RETRACTING LANYARDS	10007782	50' (16m) Self Retracting Lanyard with Emergency Rescuer, 3/16" diameter stainless steel line		■
	10007783	95' (30m) Self Retracting Lanyard with Emergency Rescuer, 3/16" diameter stainless steel line		■
	10127293	50' (16m) Self Retracting Lanyard with Emergency Rescuer, 3/16" diameter stainless steel line	■	
	10127295	95' (30m) Self Retracting Lanyard with Emergency Rescuer, 3/16" diameter stainless steel line	■	

## Lynx® Rescuer, Field Resettable Model with Lockout

Rescuers provide fall arrest and emergency lifting and lowering for confined space. The same unit can be used in the field and for training situations.

- Emergency retrieval capabilities and the easiest, quickest reset mechanism on the market
- Reset on location or return to MSA for service
- Use same unit for field and training situations

Lynx Rescuer  
Part No. 10011744



### Ordering Information

			ANSI	CSA
LYNX RESCUER	10011744	50' (16m) Self-Retracting Lanyard with Emergency Rescuer, 3/16" diameter stainless steel line	■	
	10023016	50' (16m) Self-Retracting Lanyard with Emergency Rescuer, 3/16" diameter stainless steel lin		■
	10011745	95' (30m) Self-Retracting Lanyard with Emergency Rescuer, 3/16" diameter stainless steel line	■	
	10023017	95' (30m) Self-Retracting Lanyard with Emergency Rescuer, 3/16" diameter stainless steel line		■
ACCESSORY	10013077	Replacement key for Lynx Rescuer		

## Lynx Personnel/Material Hoist



A rugged, versatile and economical hoist for lifting, lowering and positioning of personnel and materials in confined space applications. Designed for a maximum workload of 310 lbs for personnel (10:1 design factor) and 620 lbs for materials (5:1 design factor), the Lynx personnel/material hoist provides an all steel construction with an internal energy absorber that operates even when usable length of line is fully extracted. Side, boom and socket mount hoists have integral brackets for attachment to the Workman tripod, davit systems, and qualified anchorage connectors. Each unit has a galvanized or stainless steel wire rope line with a self-locking swivel snaphook. **An optional air drive adapter enables powered lifting and lowering with separate air-powered drive assembly.**

### Features and Benefits

- Designed for lifting, lowering, and positioning of personnel and materials
- Maximum work load of 310 lbs for personnel and 620 lbs for materials
- Anti-backlash crank handle with a lifting/lowering speed of 25 ft per minute
- Integral shock absorber
- Load-limiting clutch prevents overloading of hoist
- Emergency drive allows manual bypass of load-limiting clutch for extra lifting capacity in an emergency
- Air drive adapter enables powered lifting/lowering with optional air-powered drive assembly
- Includes a galvanized or stainless steel wire rope line with a self-locking swivel snaphook
- Primary gear backed up by two independent secondary brakes

### Lynx Hoist Ordering Information

LYNX HOISTS	10016569	Side mount with emergency air drive adapter*, galvanized wire rope, 50' (16m)
	10016568	Side mount with emergency air drive adapter*, galvanized wire rope, 105' (32m)
	10016567	Side mount with emergency air drive adapter*, stainless steel wire rope, 50' (16m)
	10016566	Side mount with emergency air drive adapter*, stainless steel wire rope, 105' (32m)
	10016683	Boom mount with emergency air drive adapter*, galvanized wire rope, 50' (16m)
	10016682	Boom mount with emergency air drive adapter*, galvanized wire rope, 105' (32m)
	506420	Lynx Hoist air drive assembly

\* Air drive assembly must be purchased separately (P/N 506420)

## Bosun Chair

Designed to be used in conjunction with our full-body Harnesses, the Bosun Chair, attached to the chest D-ring, will keep the user in an upright position while suspended for long durations.

- Padded seat for comfort
- Adjustable web assembly ensures security

### Bosun Chair Ordering Information

BOSUN CHAIR	SSH3505017	Bosun Chair, 5" x 16-1/2" padded seat, black nylon straps, 2 carabiners
-------------	------------	---



## Spreader Bars

SPREADER BARS	507130	Spreader bar, 14"
	507131	Spreader bar, 22"

## Davits

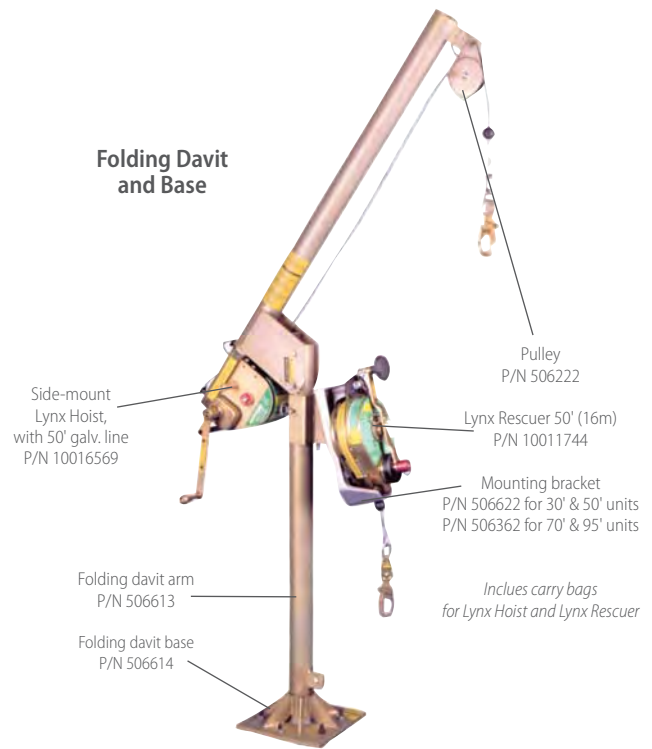
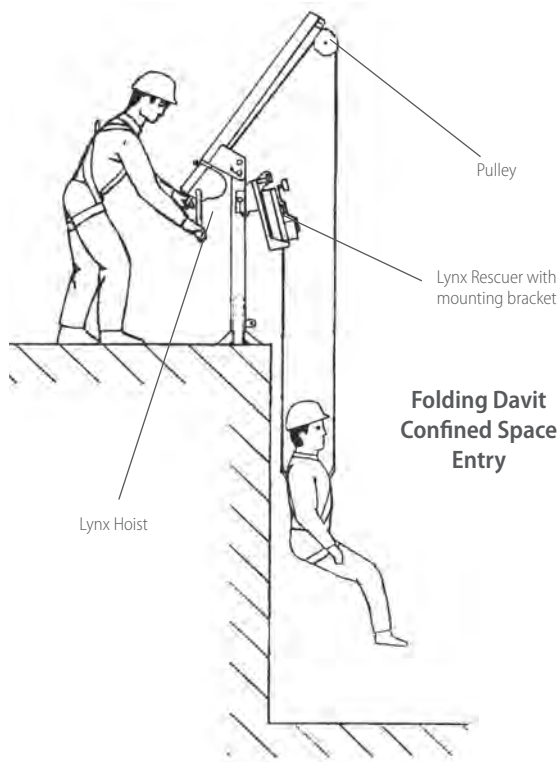

### Folding Davit and Base

The Folding Davit and Base is a portable and economical anchorage connector used where a tripod will not work. Available with a zinc-plated alloy-steel Davit Arm and your choice of zinc-plated carbon steel or stainless steel Davit Base. This lightweight device provides a 24-inch reach and 77 inches of head clearance. It pivots 360-degrees and can readily maneuver personnel and materials between spaces below the deck where it is mounted. The Folding Davit may be carried from base to base and installed in minutes. Meets or exceeds ANSI Z359.1 and applicable OSHA requirements. Mounting brackets and pulleys sold separately.

### Column Davit and Base

The Column Davit and Base are used for more permanent conditions where a tripod will not work. Available with a zinc-plated alloy-steel Davit Arm and zinc-plated carbon steel or stainless steel bases. Provides a 30 inch reach and 77 inches of head clearance. Pivots 360 degrees. Meets or exceeds applicable OSHA requirements. Mounting brackets and pulleys sold separately.

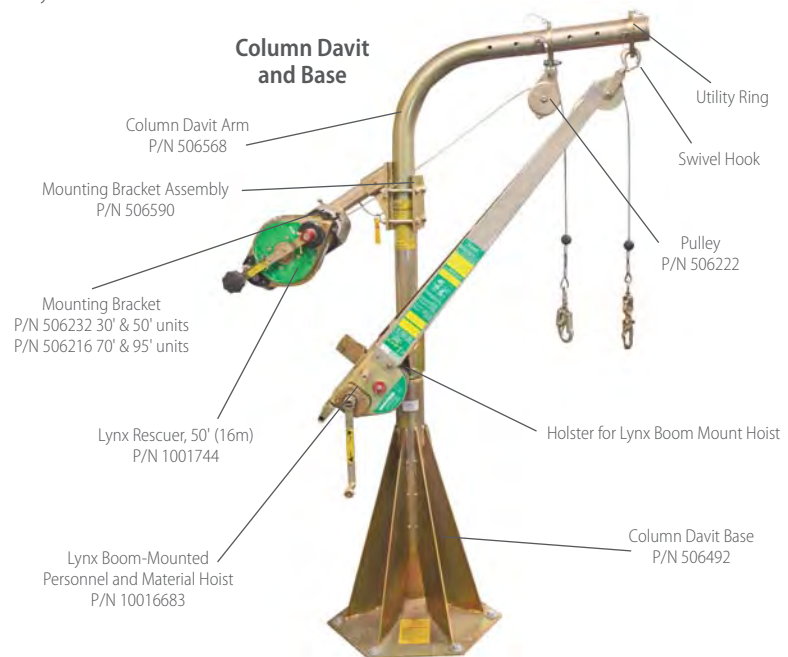

## Davits

### Ordering Information

FOLDING DAVIT	506613	Folding davit arm, 24" reach, 77" working height, swivels to extend over work area, folds for ease of transport and storage
	506614	Folding davit base
	506622	Mounting bracket for mounting 30' and 50' Dyna-Lock, Dynevac II, and Lynx Rescuer
	506362	Mounting bracket for mounting 70' and 95' Dynevac II and Lynx Rescuer (excludes Dyna-Lock)
	506222	Pulley
COLUMN DAVIT	506568	Column davit arm, 30" reach, 77" working height, boom arm swivels to extend over work area
	506492	Column davit base
	506232	Mounting bracket for mounting 30' and 50' Dyna-Lock, Dynevac II, and Lynx Rescuer (requires P/N 506590)
	506216	Mounting bracket for mounting 70' and 95' Dynevac II and Lynx Rescuer (excludes Dyna-Lock) (requires P/N 506590)
	506590	Mounting bracket assembly (requires P/N 506216 or 506232)
	506222	Pulley
	506603	Holster to store Lynx Boom Mount Hoist (when not in use)
	10016683	Lynx Boom Mount Hoist
VERTICAL DAVIT LADDER MOUNT	506668	Vertical davit arm
	506667	Receptacle for vertical davit arm
PUSH-PULL DAVIT	415837	Push-Pull davit – ladder mount, bolts to ladder and retracts to allow hatch cover to close, extends 60" above hatch when extended

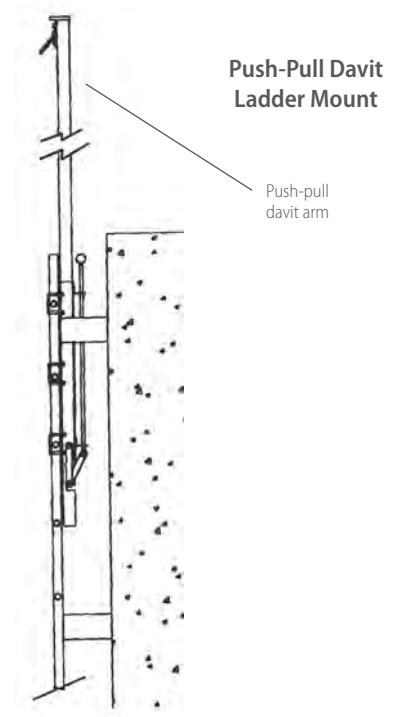
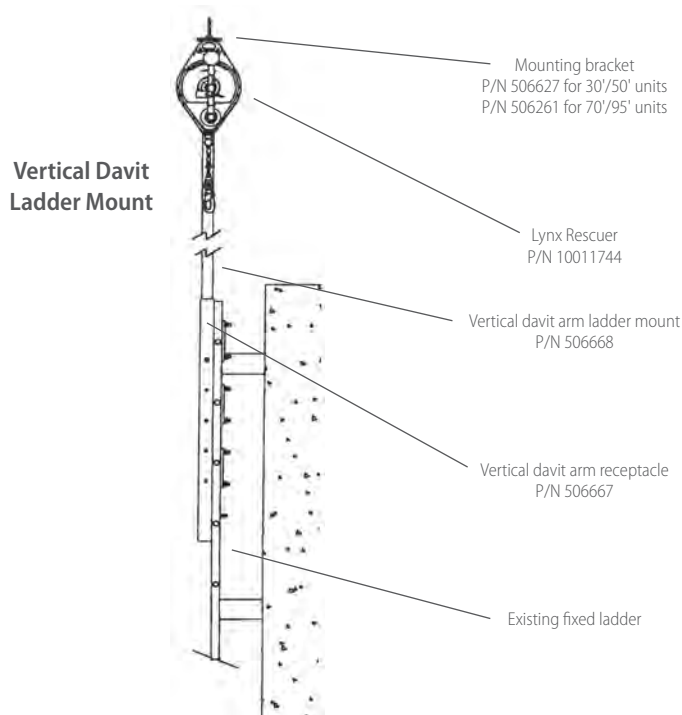

## Ladder Climbing Equipment: SureClimb™ Cable Systems

SureClimb Cable Systems are designed to provide fall protection when climbing or descending ladders or vertical structures up to 300 feet in height.

- Available in permanent and temporary models
- Uses a stainless steel fall arrester
- Uses a 5/16" galvanized steel cable

### SureClimb Temporary System

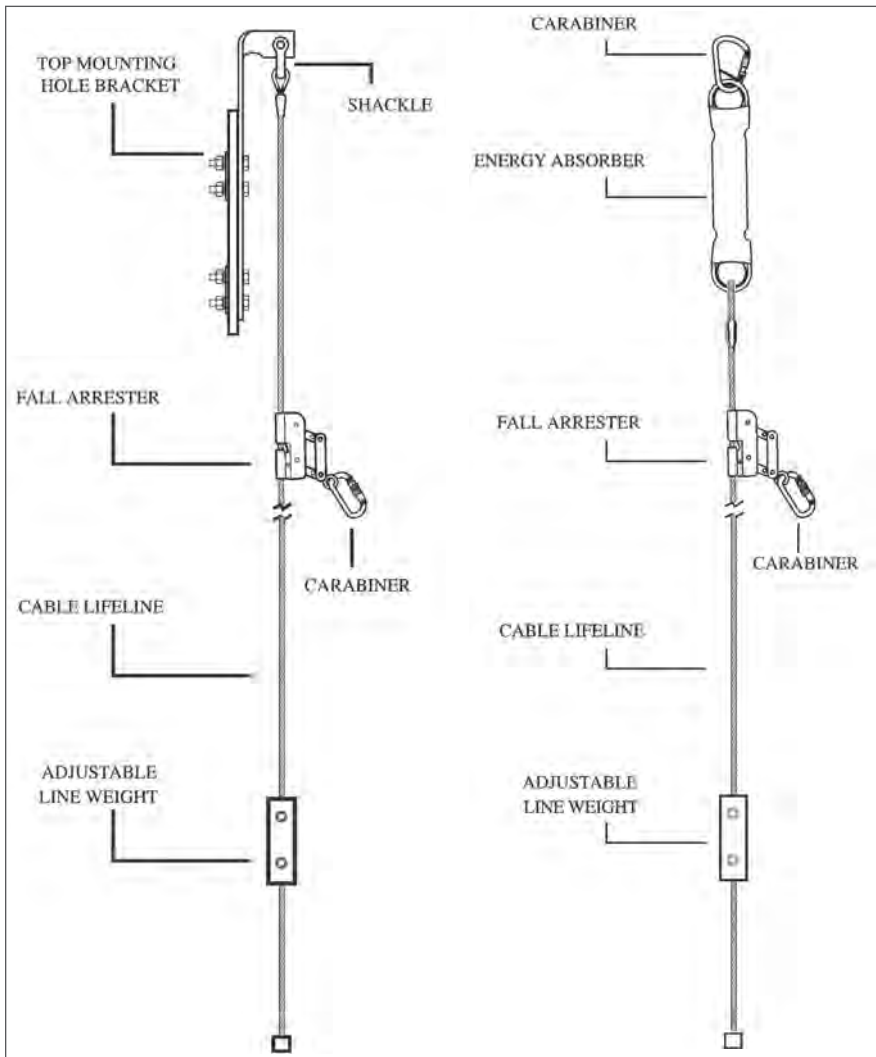

SureClimb Temporary System  
with Integral Energy Absorber  
Part No. SFPLS353050



SureClimb Slider  
Part No. 10040010

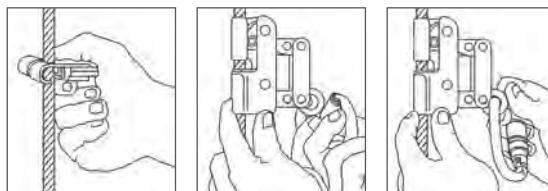

*SureClimb Slider can be attached and removed anywhere along the length of cable*

## Ladder Climbing Equipment: SureClimb Cable Systems

### SureClimb Permanent System

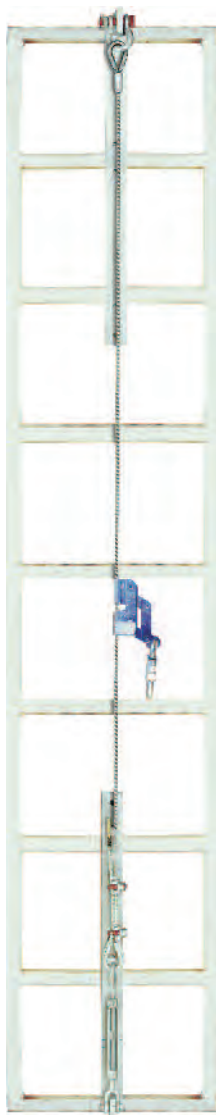
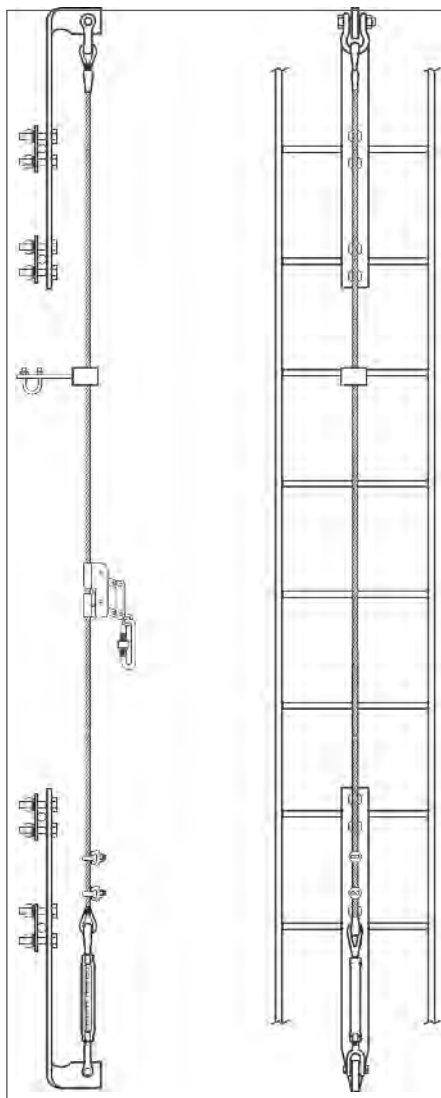

SureClimb Permanent Cable System, 50ft  
Part No. SFPLS350050

### SureClimb Cable Systems Ordering Information

TEMPORARY SURECLIMB SYSTEM <i>Additional lengths available from 50' up to 200' in 50' increments</i>	SFPLS353050	Temporary SureClimb System, 50' (16m), with integral shock absorber
	SFPLS353100	Temporary SureClimb System, 100' (30m), with integral shock absorber
	SFPLS353200	Temporary SureClimb System, 200' (61m), with integral shock absorber
PERMANENT SURECLIMB SYSTEM <i>Additional lengths available from 20' up to 300' in 10' increments</i>	SFPLS350050	Permanent SureClimb System, 50' (16m)
	SFPLS350100	Permanent SureClimb System, 100' (30m)
	SFPLS350150	Permanent SureClimb System, 150' (46m)
	SFPLS350200	Permanent SureClimb System, 200' (61m)
ACCESSORIES	10040010	SureClimb Slider (fall arrester) w/carabiner (for both temporary and permanent cable systems)
	10036032	SureClimb Extension Davit and Base Assembly (for temporary cable system)

## Ladder Climbing Equipment: Dyna-Glide® Climbing System

This system is used to arrest falls from heights where workers may be climbing up ladders, towers, or almost any structure. These systems enhance the way a climber is able to perform the necessary work. Our systems can be mounted to already-installed ladders, to corners of lattice towers, and to other suitably strong structures your crew needs to climb. Using different MSA mounting assemblies, Dyna-Glide systems can be attached to almost any structure that is permissible to climb. Systems can be constructed to continuously protect climbers—whether they're traveling vertically, horizontally, or around curves, corners, or obstacles. For added performance, the Dyna-Glide system can be used by more than one person at a time.

- Limits total fall distance to inches
- Components for complete rescue systems
- Allows for vertical and horizontal mobility
- Galvanized or stainless steel for corrosion resistance
- Your choice of Ladder Rail Combination (LRC) or Rail only
- Provides smooth travel—there's no binding of the fall arresters inside the rail
- Detachable, lightweight, stainless steel, and aluminum mechanism for hands-free ascent and descent
- Variety of accessories to enhance mobility and provide continuous protection, convenience, and comfort (if needed)

### Two Examples of Dyna-Glide Assembly & Applications

#### Ladder Rail Combination Assembly (LRC) System

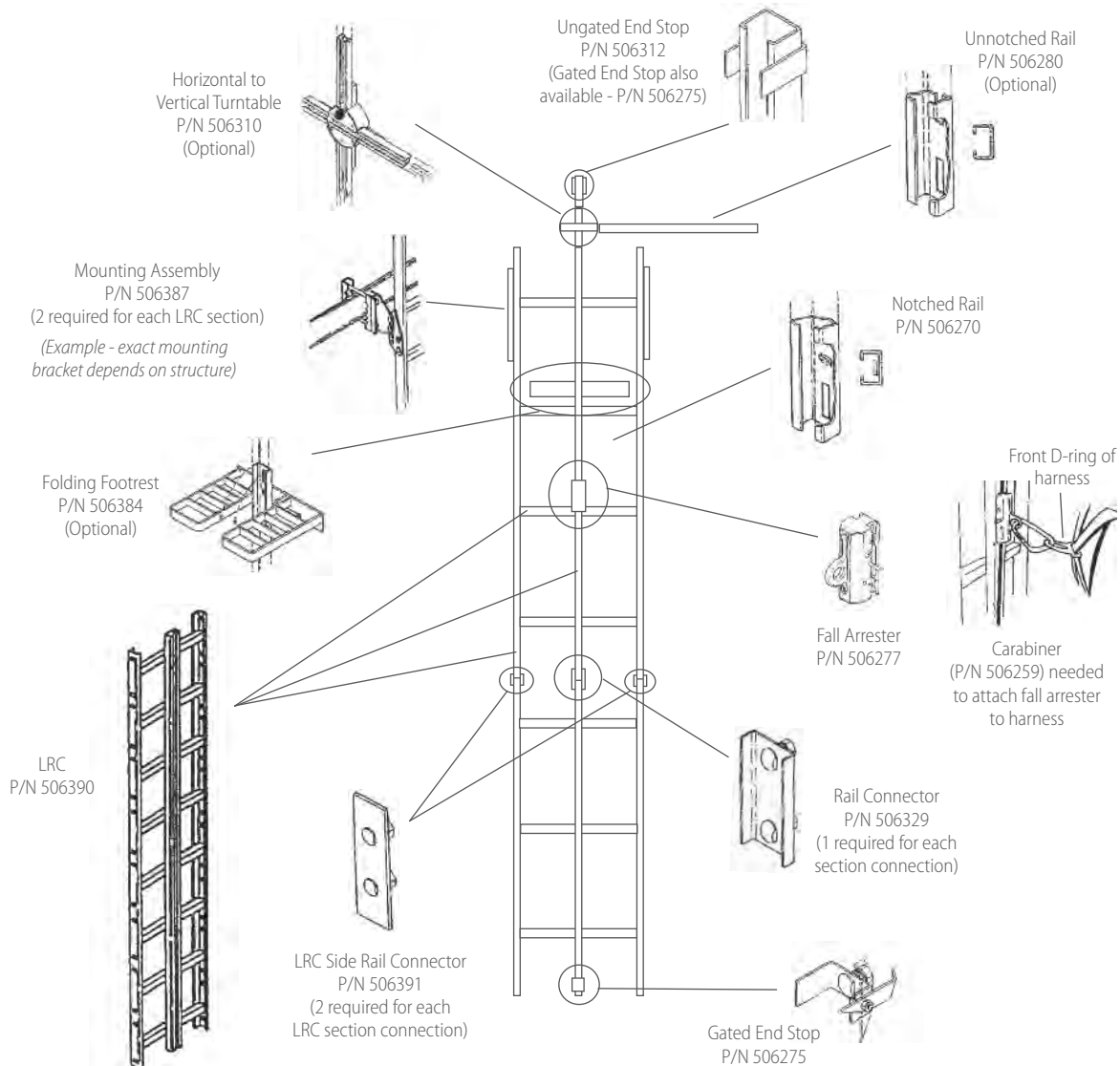

## Ladder Climbing Equipment: Dyna-Glide® Climbing System

### Rail Only System Assembly

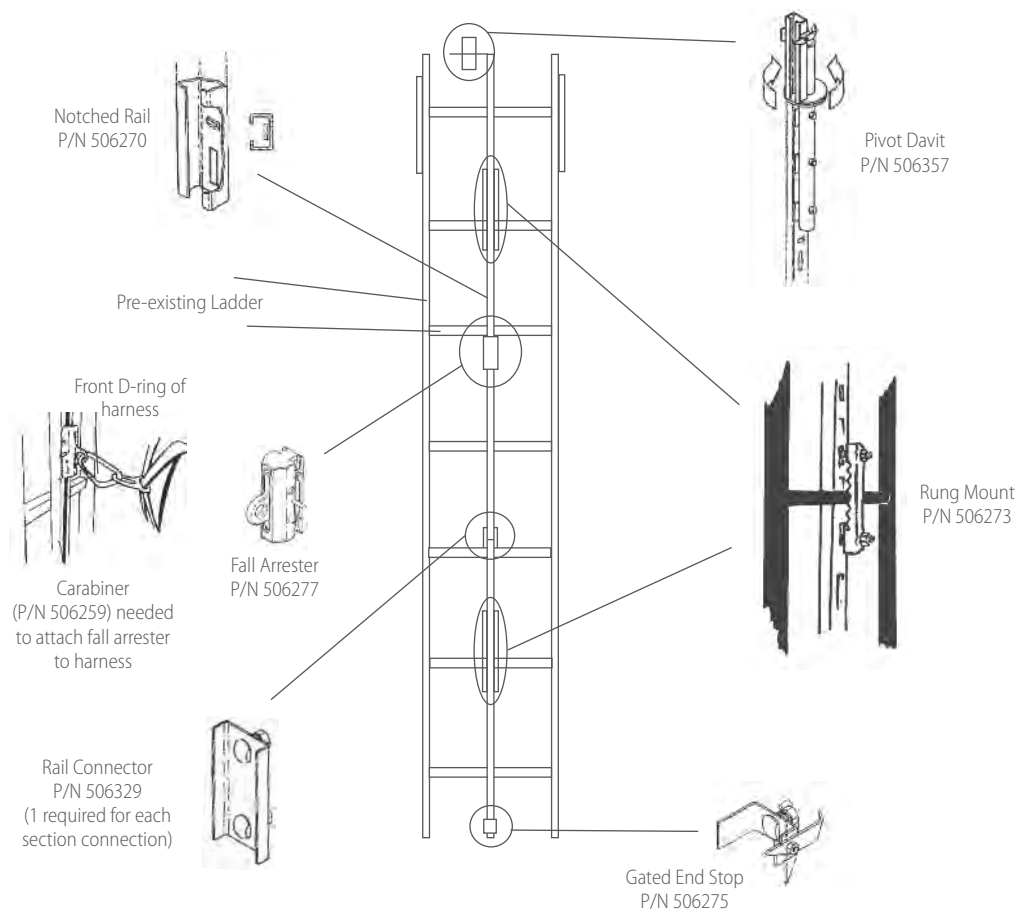

### Dyna-Glide System Ordering Information

DYNA-GLIDE SYSTEM	506270	Straight Notched Rail, galvanized, standard length 7' 4-3/16"
	506273	Rung Mount Assembly, galvanized
	506274	Gated top end stop, stainless steel
	506275	Gated bottom end stop, stainless steel
	506277	Fall arrester (CSA Part No. 415752)
	506282	Mounting base angle corner, galvanized
	506283	Mounting angle corner, galvanized
	506312	Ungated top end stop, stainless steel
	506329	Rail connector, galvanized
	506388	Ladder/Rail Combination (LRC) standoff bracket, galvanized, standard length 7' 4-3/16"
	506389	LRC standoff bracket, bottom, galvanized
	506390	LRC, galvanized (CSA Part No. 10006461)
	506391	LRC side rail connector, galvanized



For more complete information on the Dyna-Glide System, see the Dyna-Glide Catalog (Bulletin 2300-22-MC).



## Gravity Dyna-Line® Temporary Synthetic Horizontal Lifeline

Designed for easy installation and removal, the Dyna-Line Horizontal Lifeline is the temporary horizontal lifeline system created for a wide range of applications. Can be mounted to any suitable 5,000-pound rated anchorage point and can be rigged using many standard components, eliminating the need for special or "engineered" equipment. Has an integral line tensioner that allows proper tensioning of the lifeline before use. The Dyna-Line is the ultimate system for your crews.

- Highly visible 12-strand red rope will not hockle and minimizes fall distance due to its low stretch properties
- Can be used with any suitable 5000 lb. rated anchorage
- Single-Worker or Two-Worker system
- Load indicator on the Single-Worker kit and an energy absorber on the Two-Worker system clearly indicates that the system has seen fall arrest forces and should be removed from use
- Can be rigged using many standard components, reducing the need for special or engineered equipment
- Lengths up to 200 ft. System comes in a handy bucket for lengths up to 60 ft.



Synthetic Dyna-Line Temporary Horizontal Lifeline Part No. 10013152

New Bypass Feature!



Dyna-Line Rope HLL Minimum Clearance Required Below Working Surface				
Line Length	1-Worker System		2-Worker System	
	6' Lanyard	SRL	6' Lanyard	SRL
10 ft	14'10"	12'5"	15'10"	13'2"
20 ft	15'9"	13'8"	17'2"	14'9"
30 ft	16'10"	15'1"	19'4"	16'6"
40 ft	18'	16'4"	21'4"	18'3"
50 ft	19'3"	17'6"	23'2"	20'1"
60 ft	20'6"	18'9"	25'1"	22'

- Clearances based on Lifeline 4' above working surface
- Calculations based on tests using 220 lb test torso

## Gravity Dyna-Line Temporary Synthetic Horizontal Lifeline Ordering Information

DYNA-LINE TEMPORARY HORIZONTAL LIFELINE <i>For single worker</i>	10013150	Dyna-Line Temporary Horizontal Lifeline for single worker, 30' rope (9m)
	10013151	Dyna-Line Temporary Horizontal Lifeline for single worker, 60' rope (18m)
	10022826	Dyna-Line Temporary Horizontal Lifeline for single worker, 200' rope (61m)
DYNA-LINE TEMPORARY HORIZONTAL LIFELINE <i>For two workers</i>	10013152*	Dyna-Line Temporary Horizontal Lifeline for two workers, 30' rope* (9m)
	10013153* <b>1</b>	Dyna-Line Temporary Horizontal Lifeline for two workers, 60' rope* (18m)
	10019085*	Dyna-Line Temporary Horizontal Lifeline for two workers, 100' rope* (30m)
	10022827*	Dyna-Line Temporary Horizontal Lifeline for two workers, 200' rope* (61m)

\* Includes anchor straps



### Value Added

- Bypass shuttles will soon be available on all two-worker temporary horizontal lifelines
- Allows users to pass each other on the same system while maintaining 100% tie-off

## Gravity Sure-Line™ Temporary Synthetic Horizontal Lifeline

Designed for quick and easy installation at temporary work sites, the Sure-Line Horizontal Lifeline is suspended between two approved anchor points to provide worker fall protection during horizontal movement. This lightweight system is rated for two people.

- Incorporates a combination clamp/thimble that allows for effortless tensioning of the lifeline
- Available in 20 ft, 40 ft, or 60 ft lengths in two models (with and without turnbuckles)
- Includes an integral energy absorber

SureLine Rope HLL Minimum Clearance Required Below Working Surface				
Line Length	1-Worker System		2-Worker System	
	6' Lanyard	SRL	6' Lanyard	SRL
10 ft	14'3"	12'5"	14'7"	13'2"
20 ft	15'6"	13'9"	17'	15'
30 ft	17'1"	15'2"	19'4"	16'7"
40 ft	18'6"	16'5"	21'8"	18'4"
50 ft	20'	17'8"	24'2"	20'3"
60 ft	21'5"	19'1"	26'	22'2"

- Clearances based on Lifeline 4' above working surface
- Calculations based on tests using 220 lb test torso



## Gravity SureLine Temporary Synthetic Horizontal Lifeline Ordering Information

SURELINE TEMPORARY HORIZONTAL LIFELINE	SHL1009035BLK	SureLine Temporary Horizontal Lifeline, 35' (11m) black rope
	SHL1009060BLK <b>2</b>	SureLine Temporary Horizontal Lifeline, 60' (18m) black rope

## Gravity Sure-Line Temporary Cable Horizontal Lifeline

Designed for quick and easy installation at temporary work sites, the Sure-Line Horizontal Lifeline is suspended between two approved anchor points to provide worker fall protection during horizontal movement. This lightweight system is rated for two people.

- Incorporates a combination clamp/thimble that allows for effortless tensioning of the lifeline
- Available in 20 ft, 40 ft, or 60 ft lengths in two models (with and without turnbuckles)
- Includes an integral shock absorber

SureLine Cable HLL Minimum Clearance Required Below Working Surface				
Line Length	1-Worker System		2-Worker System	
	6' Lanyard	SRL	6' Lanyard	SRL
10 ft	14'1"	12'2"	14'6"	13'2"
20 ft	15'1"	13'1"	16'7"	14'8"
30 ft	16'2"	14'	19'	16'4"
40 ft	17'3"	14'9"	21'	18'
50 ft	18'4"	15'7"	22'7"	19'6"
60 ft	19'5"	16'5"	24'3"	21'4"

- Clearances based on Lifeline 4' above working surface
- Calculations based on tests using 220 lb test torso

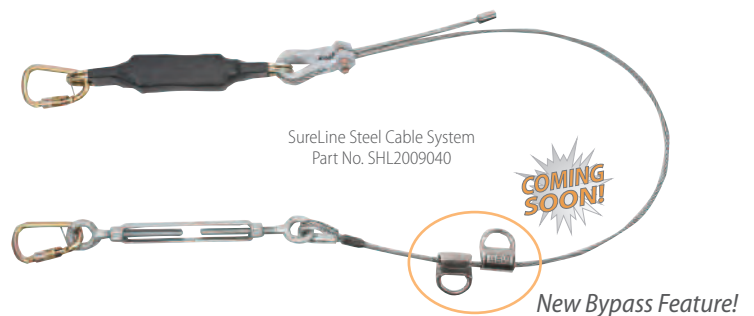

## Gravity SureLine Temporary Cable Horizontal Lifeline Ordering Information

STEEL CABLE HORIZONTAL LIFELINE SYSTEM	SHL2009040 <b>2</b>	Steel Cable Horizontal Lifeline System with turnbuckle, 40' (12 m)
	SHL2009060 <b>1</b>	Steel Cable Horizontal Lifeline System with turnbuckle, 60' (18 m)
IRON WORKER CABLE HORIZONTAL LIFELINE SYSTEM	SHL2009040IW	Iron Worker Cable Horizontal Lifeline System without turnbuckle, 40' (12 m)
	SHL2009060IW	Iron Worker Cable Horizontal Lifeline System without turnbuckle, 60' (18 m)

## Horizon® Permanent Horizontal Lifeline

This complete above-beam cable horizontal lifeline system allows for a continuous tie off point along the line of travel. Below Beam Horizontal Lifelines kits come in 30 ft or 60 ft lifeline lengths. Each kit includes: beam grips, end fittings, shock absorber, lifeline, open wedge socket, turnbuckle.

### ⚠ WARNING

OSHA regulations state "Horizontal Lifeline Systems shall be designed, installed and used under supervision of a qualified person, as part of a complete fall arrest system, which maintains a safety factor of at least two." A qualified person is defined as "one with a recognized degree or professional certificate and/or extensive knowledge and experience in the subject field, who is capable of design, analysis, evaluation and specifications in the subject work, project or product." MSA can recommend a qualified person to design and install a Horizontal Lifeline System.

## Horizon Horizontal Lifeline Basic Below Beam Mount Sub-System

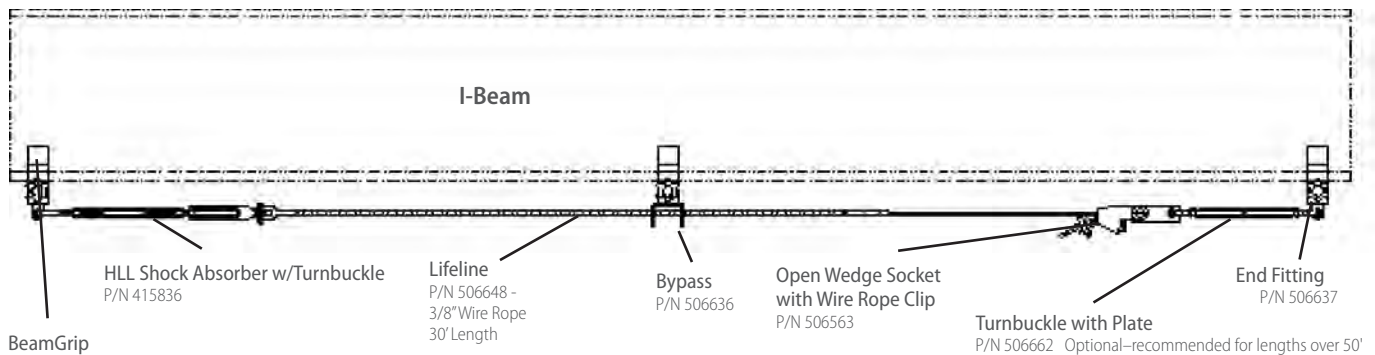

**BeamGrip**  
Part No. depends on flange width and thickness, see part no. list below.

**Parts required for this system:** 3 BeamGrips (Part No. depends on size of beam flange);  
1 - 415836; 1 - 506648 (30'); 1 - 506636; 1 - 506563; 1 - 506662; 2 - 506637

## Horizon Horizontal Lifeline Basic Below Beam Mount Sub-System Ordering Information

HORIZON HORIZONTAL LIFELINE  <i>Beam Mount</i>	506682	BeamGrip for beams with flange width: 3.94" to 5.64", flange thickness: .205" to .659"
	415171	BeamGrip for beams with flange width: 5.525" to 8.07", flange thickness: .36" to 1.09"
	415172	BeamGrip for beams with flange width: 8.06" to 10.475", flange thickness: .56" to .935"
	415173	BeamGrip for beams with flange width: 10.265" to 12.8", flange thickness: .605" to 1.25"
	415836	Horizontal lifeline shock absorber
	506563	3/8" open wedge socket
	506636	BeamGrip bypass fitting
	506637	BeamGrip end fitting
	506648	3/8" wire rope, galvanized, length must be specified at the time of order
	506662	12" turnbuckle with plate
	506663	Snatch block pulley for 3/8" wire rope
	506254	Snatch block pulley for 1/2" wire rope
	506255	Snatch block pulley for 5/8" wire rope
HORIZON HORIZONTAL LIFELINE KITS  <i>Beam Mount</i>	10030270	HLL Kit #1, 30' (9m) Below Beam system, for I-beams with flange width 5.525"–8.07" and flange thickness .36"–1.09"
	10030271	HLL Kit #2, 60' (18m) Below Beam system, for I-beams with flange width 5.525"–8.07" and flange thickness .36"–1.09"
	10030272	HLL Kit #3, 30' (9m) Below Beam system, for I-beams with flange width 8.06"–10.475" and flange thickness .56"–.935"
	10030273	HLL Kit #4, 60' (18m) Below Beam system, for I-beams with flange width 8.06"–10.475" and flange thickness .56"–.935"

## Horizon Horizontal Lifeline Basic Stanchion Mount Sub-System

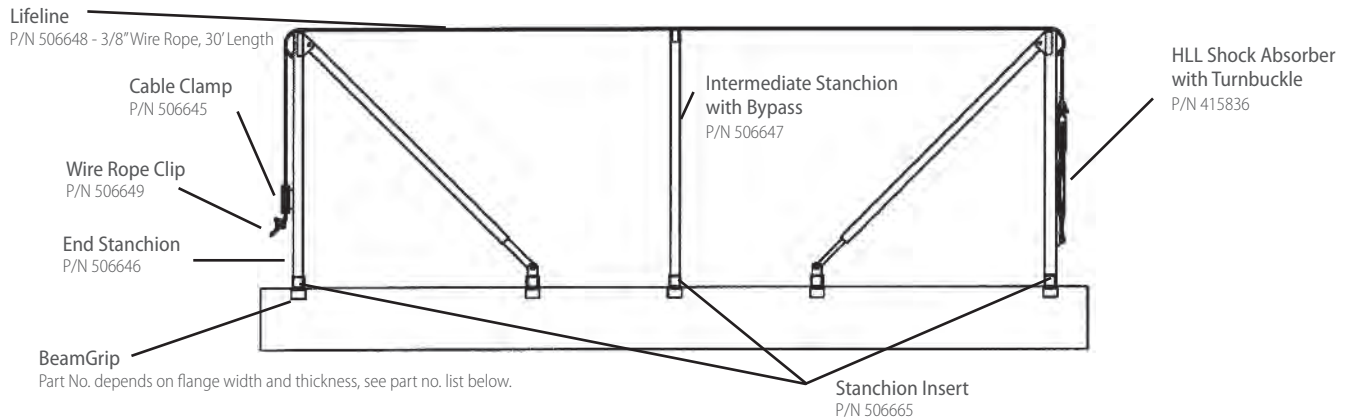

Parts required for this system: (5) BeamGrips—part no. depends on size of Beam Flange; (2) 506646; (1) 506647; (1) 506648 – 30'; (1) 506645; (1) 415836; (3) 506665; (1) 506649.

## Horizon Horizontal Lifeline Basic Stanchion Mount Sub-System Ordering Information

<b>HORIZON HORIZONTAL LIFELINE</b> <i>Stanchion Mount</i>	506682	BeamGrip for beams with flange width: 3.94" to 5.64", flange thickness: .205" to .659"
	415171	BeamGrip for beams with flange width: 5.525" to 8.07", flange thickness: .36" to 1.09"
	415172	BeamGrip for beams with flange width: 8.06" to 10.475", flange thickness: .56" to .935"
	415173	BeamGrip for beams with flange width: 10.265" to 12.8", flange thickness: .605" to 1.25"
	415836	Horizontal lifeline shock absorber
	506645	Cable clamp
	506646	BeamGrip end stanchion
	506647	BeamGrip bypass stanchion
	506648	3/8" wire rope, 30', galvanized
	506649	Wire rope clip 3/8"
	506663	Snatch block pulley for 3/8" wire rope
	506254	Snatch block pulley for 1/2" wire rope
	506255	Snatch block pulley for 5/8" wire rope
	506665	BeamGrip stanchion insert
<b>HORIZON HORIZONTAL LIFELINE KITS</b> <i>Stanchion Mount</i>	10030274	HLL Kit #5, 30' (9m) Stanchion system, for I-beams with flange width 5.525"–8.07" and flange thickness .36"–1.09"
	10030275	HLL Kit #6, 60' (18m) Stanchion system, for I-beams with flange width 5.525"–8.07" and flange thickness .36"–1.09"
	10030276	HLL Kit #7, 30' (9m) Stanchion system, for I-beams with flange width 8.06"–10.475" and flange thickness .56"–.935"
	10030277	HLL Kit #8, 60' (18m) Stanchion system, for I-beams with flange width 8.06"–10.475" and flange thickness .56"–.935"

### Horizontal Lifeline Kit Component Parts

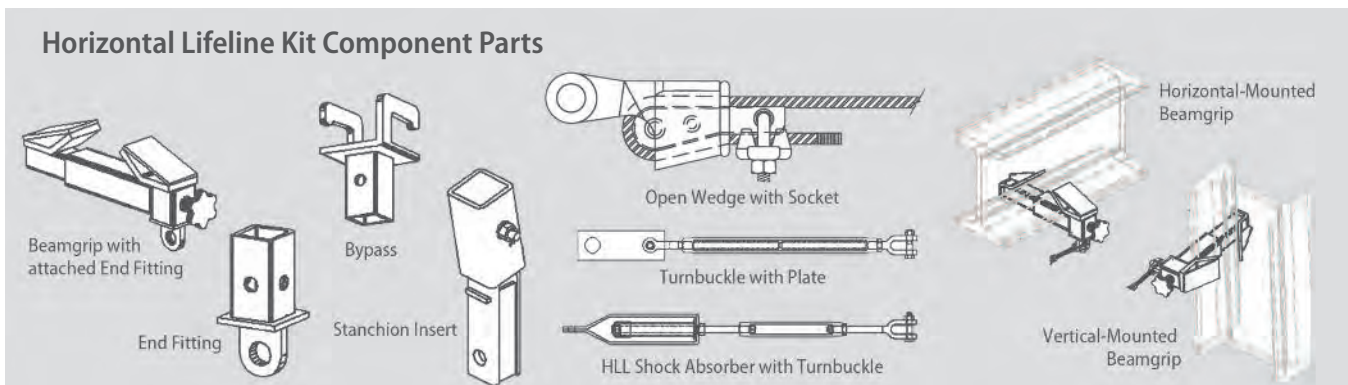

## Horizontal Lifeline Stanchions

MSA offers several Horizontal Lifeline Stanchion Kits to meet a variety of applications and provide fall protection for multiple workers.

- Quick and easy installation
- For use as a single-point anchor attachment for workers while installing lifelines

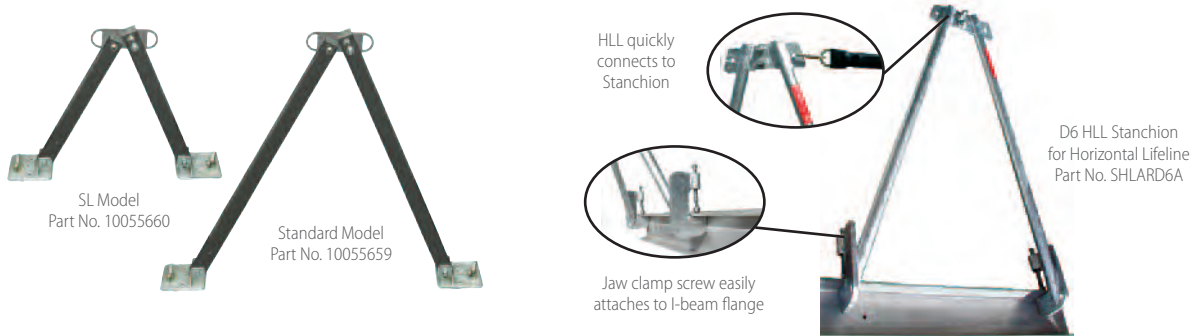

## Horizontal Lifeline Stanchion Ordering Information

SKYLINK STANCHION	10055659	Skylink Stanchion, Standard model - 44" height (pour-in-place Pigtail or concrete expansion anchors must be ordered separately)
	10055660	Skylink Stanchion, SL model - 23" height (pour-in-place Pigtail or concrete expansion anchors must be ordered separately)
	10055721	3.25" concrete expansion anchor with nut and washer
	10059805	0.5" x 12" pour in place "Pigtail" anchor with washer and vinyl cap
SKYLINK STANCHION KITS	10059806	Skylink Stanchion Kit including 2 Standard stanchions with 60' 1-worker Dyna-Line 10013151 (without anchor straps) and 4 Pigtail anchors
	10059807	Skylink Stanchion Kit including 2 Standard stanchions with 60' Sure-Line for Iron Workers (p/n SHL2009060IW) and 4 Pigtail anchors
	10059808	Skylink Stanchion Kit including 2 SL stanchions with 60' 2-worker Dyna-Line (p/n 10013153) and 4 Pigtail anchors
	10059809	Skylink Stanchion Kit including 2 SL stanchions with 60' Sure-Line for Iron Workers (p/n SHL2009060IW) and 4 Pigtail anchors
D6 STANCHION	SHLARD6A	D6 HLL Stanchion A-frame design, galvanized steel

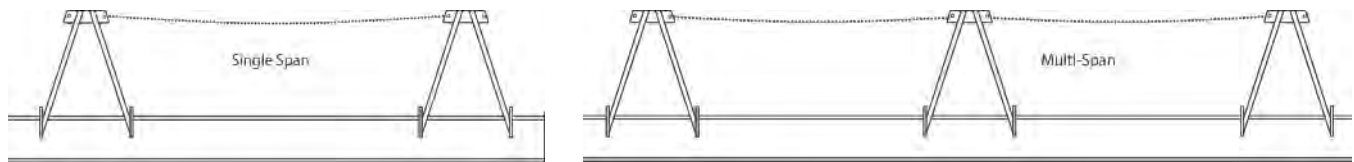

Line Length	1-Worker System		2-Worker System	
	6' Lanyard	SRL	6' Lanyard	SRL
10 ft	13'4"	5'0"	13'11"	5'4"
20 ft	14'4"	5'6"	14'10"	6'3"
30 ft	15'0"	6'1"	15'7"	6'9"
40 ft	15'9"	6'9"	16'3"	7'5"
50 ft	16'4"	7'3"	16'9"	8'0"
60 ft	16'9"	7'9"	17'5"	8'6"
70 ft	17'5"	8'3"	17'10"	9'0"
80 ft	17'11"	8'9"	18'5"	9'6"
90 ft	18'4"	9'3"	18'11"	10'0"
100 ft	18'9"	9'7"	19'5"	10'5"

• Calculations based on tests using 220 lb test torso

## Sure-Rail™ Horizontal Lifeline

Customizable to your application, the Sure-Rail Horizontal Lifeline is typically used in areas with limited clearance below the working surface. This system consists of galvanized steel 1/2x2x10 rail sections, an aluminum rail trolley with stainless steel wheels, end stops, and various mounting hardware. This product provides ease of movement, little or no deflection in the rail limits fall distance and fall arrest forces on the body. The design of the Sure-Rail Horizontal Lifeline allows for even distribution of fall arrest forces to the structure, and its twin-track configuration allows users to bypass each other without having to disconnect and reconnect.

- Available in many standard configurations, can also be customized
- Twin-track configuration allows users to bypass each other without having to disconnect and reconnect
- Spring-loaded end stops provide easy insertion/removal of the trolley
- Bent rails are available for travel around corners

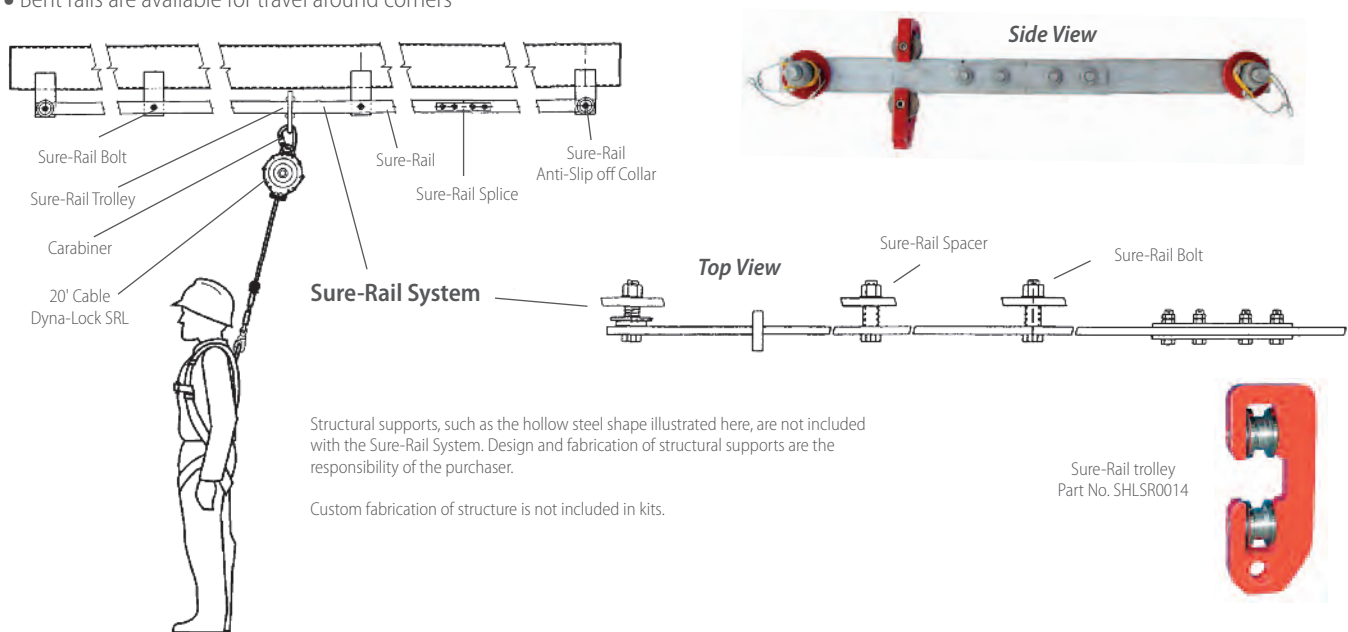

Structural supports, such as the hollow steel shape illustrated here, are not included with the Sure-Rail System. Design and fabrication of structural supports are the responsibility of the purchaser.

Custom fabrication of structure is not included in kits.

Sure-Rail trolley  
Part No. SHLSR0014

## Ordering Information

SURE-RAIL HORIZONTAL LIFELINE	SHLSR00104	Sure-Rail trolley
	SHLSR0021000	Sure-Rail, galvanized, predrilled, 1/2" (12mm) x 2" (50mm) x 10' (3m)
	SHLSR00501	Sure-Rail splice, galvanized, with bars and hardware [required every 10' (3m)]
	SHLSR00601	Sure-Rail spacer, galvanized [required every 5' (1.5m)]
	SHLSR00703	Sure-Rail anchorage bolt, galvanized [required every 5' (1.5m)]
	SHLSR00801	Sure-Rail anti-slip off collar, steel, painted [required at both ends of system]

SURE-RAIL TRUCK/RAIL CAR LOADING KITS	10030601	Sure-Rail truck/rail car loading kit, 60'		
	10030602	Sure-Rail truck/rail car loading kit, 80'		
	<b>Kits include:</b>		<b>Qty. with 80 ft Kit</b>	<b>Qty. with 60 ft Kit</b>
	SHLSR0021000	1/2" x 2" rail	8	6
	SHLSR00501	Splice joining hardware	8	6
	SHLSR00601	Spacers	16	12
	SHLSR00703	Standard anchorage bolts	16	12
	SHLSR00801	Anti-slip off collars	2	2
	SHLSR00104	Sure-Rail trolley	1	1
10089207	Carabiner	1	1	

## Rescue Equipment: FP Rescue™ Pulleys & Components

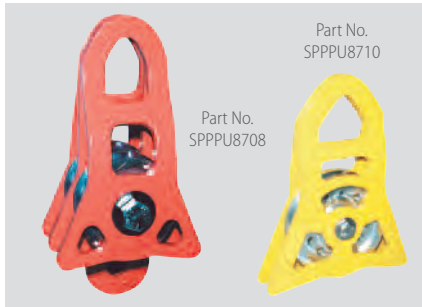

### SuretyMan™ Pulleys

Designed to meet the rigorous standards of the professional rescuer. Built with high grade aluminum side plates and sheaves, oilite bearings, stainless steel bolts, washers, and lock nuts make these some of the best pulleys available. The aluminum side plates swivel and rotate to allow the pulley to be attached anywhere along the rope. The top holes of the side plates are large enough to accept three carabiners. Contain Prusik design (squared corners of the side plates) to provide rope security with a Prusik hitch. Pulleys accept 3/8" (1 cm) to 1/2" (1.3 cm) static kernmantle ropes. Side plates are powder coated. Strength: 2" (5 cm) Double 8,100 lb (36 kN), 4" (10 cm) Double 11,200 lb (49 kN).



### SuretyMan Mini Knot Passing Pulley

The SuretyMan Mini Knot Passing Pulley was designed for the professional rescue team concerned with size and weight. The SuretyMan Mini Knot Passing Pulley features:

- Ample room for the passing of knots
- Locking pin
- Size: 9-1/2" (24 cm) tall, 4" (10 cm) wide, 3" (7.6 cm) deep
- Weight: 1.9 lb (.89 kg)
- Aluminum sheave (will not score like some plastic sheaves)
- Half the size and weight of some of the larger, bulkier knot passing pulleys

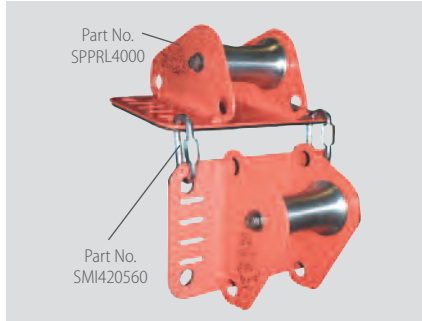

### SuretyMan Edge Roller

The best way to protect your rope from sharp edges and reduce rope friction. High quality construction. The 6" x 10" (15.3 cm x 24.4 cm) base is rubber covered to reduce slippage. The bottom and side plate feature attachment holes for ease of security in any situation. Added slots in the base plate accept tube webbing for security. Two edge rollers are required (sold separately). Two quick links are required (sold separately). Edge roller is 4" (10 cm) tall. Weight: 2.8 lb (1.3 kg).

## FP Rescue Pulley & Edge Roller Ordering Information

RESCUE PULLEYS AND COMPONENTS	Part No.	Description
	SPPPU8708	SuretyMan Pulley, 2" (5 cm) double, Std/Prusik, orange, aluminum, weight: .83 lb (375 g)
	SPPPU8710	SuretyMan Pulley, 4" (10 cm) single, Std/Prusik, yellow, aluminum, weight: 1.2 lb (545 g)
	SPPPU8717	SuretyMan Pulley, 4" (10 cm) double, Std/Prusik, orange, aluminum, weight: 1.8 lb (840 g)
	SPPPU8720	SuretyMan Mini Knot Passing Pulley, yellow, weight: 1.9 lb (.89 kg)
	SPPRL4000	SuretyMan Edge Roller, aluminum, weight: 2.8 lb (1.3 kg) [two required]
	SMI420560	Quick Link 5/16" (8 mm) for use with SuretyMan Edge Roller [two required]

## Rescue Equipment: FP Rescue Pulleys & Components



SuretyMan Q-Eight  
Part No. SRSFFE2120

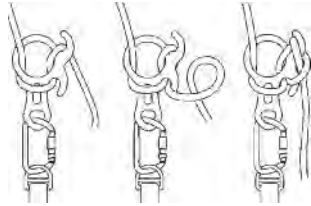

Locking off the Q-Eight

### SuretyMan Q-Eight

- Ears/cleat are positioned to make tie off very easy and safe
- Aluminum, anodized gold
- Ears/cleat still prevent larks footing (girth hitch)
- Strength 13,000 lbs (58 kN)
- Designed for 7/16" (11 mm) diameter rope
- Weight 8 oz (.24 kg)(will work with 1/2" (12 mm) diameter rope)



SuretyMan Rescue Eight, Steel  
Part No. SRSF5045

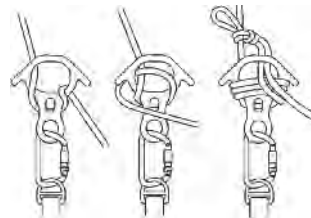

Locking off the Rescue Eight

### SuretyMan Rescue Eight

- Designed for rope diameters from 7/16" (11 mm) to 5/8" (16 mm)
- Available in aluminum or steel
- Strength 6,720 lb (30 kN)
- Weight 1.5 lb (675 g)
- Designed for the fire service, rescue, and police tactical operations



Stealth Rigging Plate Part  
No. SRSR5990

Stretcher Rigging Plate Part  
No. SRSR5980

### SuretyMan Rigging Plates

Stealth Riggins Plate: Anchor on the point and the wings will rotate toward the load for a straighter line of pull. Material: aluminum. Weight: .46 lb (250g). Strength: 11,000 lb (48 kN). Color: Teal

Stretcher Rigging Plate: Designed to unclutter and organize litter rigging points, reducing the chance of error. Material: aluminum. Weight: .74 lb (330g). Strength: 12,200 lb (54 kN). Color: Teal



Carabiner  
No. SRCC641

### SuretyMan Carabiner

- Traditional large "D" design
- Carbon steel, zinc-plated
- Developed for fire and rescue communities
- Strength 12,364 lbs (55 kN)
- Manual locking
- Weight 11 oz (311g)
- Certified to meet NFPA 1993-1995, Class "G"
- Gate opening 1.2" (32mm)

## FP Rescue Components Ordering Information

RESCUE COMPONENTS	Part No.	Description
	SRSF5077	SuretyMan Rescue Eight, aluminum
	SRSFFE2120	SuretyMan Q-Eight
	SRSR5990	SuretyMan Stealth Rigging Plate, aluminum, teal
	SRSR5980	SuretyMan Stretcher Rigging Plate, aluminum, teal
	SRCC641	Carabiner, 1.2" (32mm) gate, steel, NFPA



## Rescue Equipment: FP Rescue Ropes

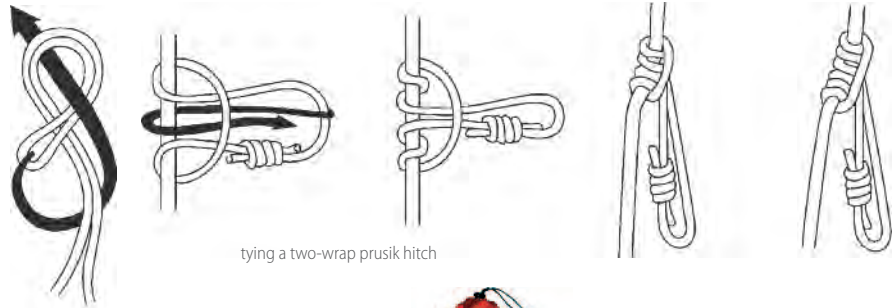

tying a two-wrap prusik hitch

Superior flexibility provided by unique double-twist cable core construction gives MSA Rescue Ropes resistance four times greater than other static kernmantle ropes. Designed with load absorbing capabilities to provide additional margin of safety in the event a dynamic force is applied.

- Multiple rescue and rigging applications
- With rope identification tag, rope will meet NFPA requirements



tying a figure eight on a bight



Rope Bag #1  
Part No. SRB430105



Rope Bag #2  
Part No. SRB430201



Termination Plate  
Part No. SRIW1000

## Ordering Information

FP RESCUE ROPES	SRP508760050	7/16" (11 mm), nylon, 6,500 lb (2,948 kg), black, 50'
	SRP504860SL050	1/2" (12 mm), nylon, 9,100 lb (4,128 kg), white/orange tracer, 50'
	SRP508960050	5/8" (16 mm), nylon, 11,400 lb (5,171 kg), black, 50'
	SRP530961050	1/2" (12 mm) polyester, 9,100 lb (4,128 kg), red, 50'
	SRP510660SL050	3/8" (10 mm), nylon, 5,000 lb (2,269 kg), white/blue tracer, 50'
	SRP544000050	7/16" (11 mm), nylon, 6,500 lb (2,948 kg), olive, 50'
	SRP504866SL050	1/2" (12 mm), nylon, 9,000 lb (4,083 kg), white/blue tracer, 50'
	SRP504863SL050	1/2" (12 mm), nylon, 9,000 lb (4,083 kg), red/white tracer, 50'
	SRP500860	8 mm Accessory Cord, nylon. Use with 1/2"-5/8" (1.3cm-1.6cm) main line, black, 3,100 lb (1,406 kg)
	SRP500900	9 mm Accessory Cord, nylon. Use with 1/2"-5/8" (1.3cm-1.6cm) main line, 3,600 lb (1,632 kg)
	SRP500500050	5 mm Accessory Cord, nylon, 1,275 lb (578 kg), 50'
	SRP5020550050	5.5 mm Titian Cord, SPECTRA Core, nylon, 4,500 lb (2,042 kg), 50'
	SRP500700050	7 mm Accessory Cord, nylon. Use with 3/8"-1/2" (1cm-1.3cm) main line, red, 2,600 lb (1,179 kg), 50'
ROPE BAGS	SRB430101	Rope Bag #1, orange, holds 120-ft / 1/2" (36.6m / 12 mm) rope
	SRB430105	Rope Bag #1, black, holds 120-ft / 1/2" (36.6m / 12 mm) rope
	SRB430201	Rope Bag #2, orange, holds 200-ft / 1/2" (60.1m / 12 mm) rope
	SRB430205	Rope Bag #2, black, holds 200-ft / 1/2" (60.1m / 12 mm) rope
	SRB430301	Rope Bag #3, orange, holds 300-ft / 1/2" (91.4m / 12 mm) rope
	SRB430305	Rope Bag #3, black, holds 300-ft / 1/2" (91.4m / 12 mm) rope
	SRB430601	Rope Bag #6, orange, holds 600-ft / 1/2" (182.8m / 12 mm) rope
SRB430605	Rope Bag #6, black, holds 600-ft / 1/2" (182.8m / 12 mm) rope	
ACCESSORY	SRIW1000	Termination plate 5/8"

# Fall Protection

## Rescue Equipment: FP Rescue Workwinch and Tripod

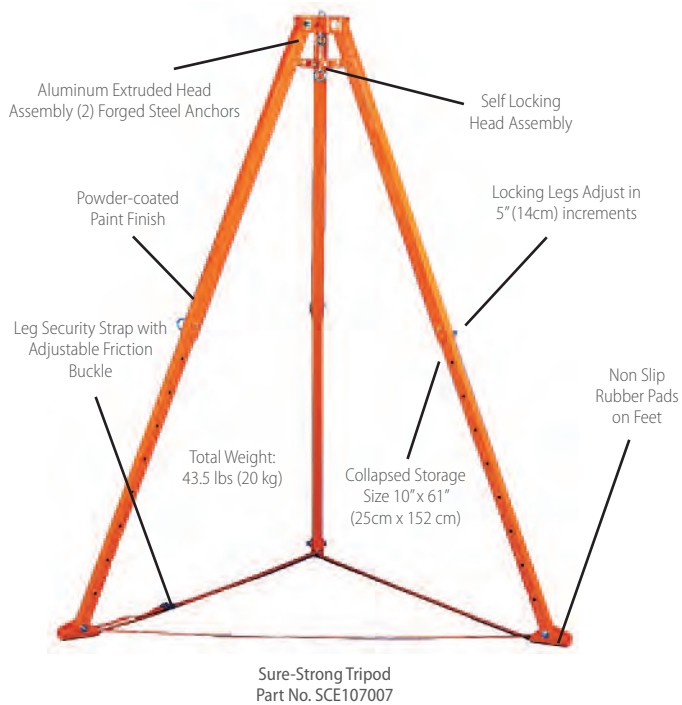

- Sure-Strong® Tripod: portable, collapsible and designed for use in confined space applications for anchorage above a manhole or other confined space entry
- Sure-Strong Tripod is compatible with the Lynx Rescuer, Dynevac II, and Lynx Boom Mount Hoist
- Sure-Strong Workwinch: used for work positioning, material handling, or as a means of retrieval in an emergency
- Sure-Strong Workwinch: used in conjunction with a fall protection system and a Sure-Strong Tripod



Sure-Strong Workwinch  
Part No. SCE1074411200

## Fall Protection Rescue Kit



The Fall Protection Rescue kit is designed to be an “out of the bag” rescue system. This kit combines a remote hook and extension pole with a rescue utility system. The remote hook and extension pole allows for remote attachment of a rescue line to a victim. The Rescue Utility System allows a rescuer to raise or lower the victim to safety. This kit should be used with a back-up system (not included).

## Ordering Information

### Ordering Information

SURE-STRONG RESCUE EQUIPMENT	Part No.	Description
	SCE107007	Sure-Strong 7' (2m) tripod, aluminum, 10,000 lb (48 kN)
	SCE107010HD	Sure-Strong 10' (3m) tripod, aluminum, 10,000 lb (48 kN)
	SCE1074411200	Sure-Strong Workwinch, 200' (61m) galvanized wire rope, with bracket (compatible with Lynx Tripod and Sure-Strong Tripod)

FALL PROTECTION RESCUE KIT	Part No.	Description
	10030025	Fall Protection Rescue Kit

## SuretyMan Rescue Utility System

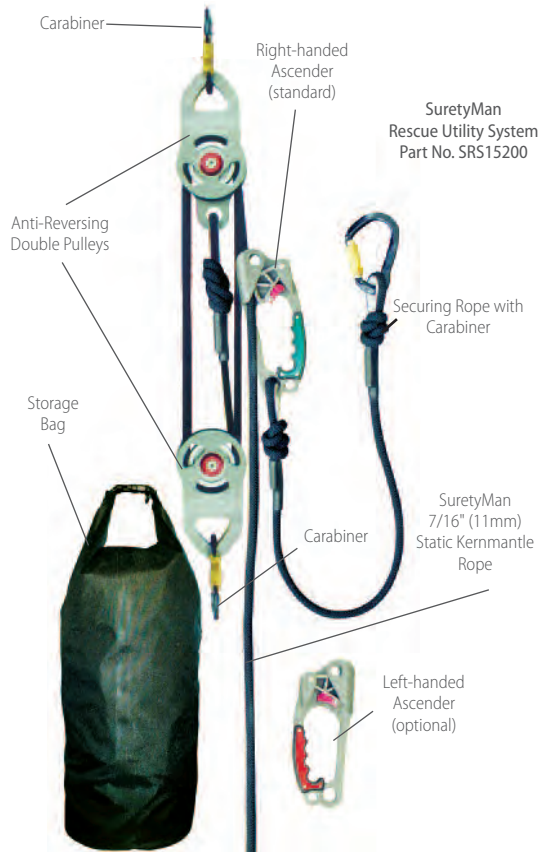

### SuretyMan Rescue Utility System Applications

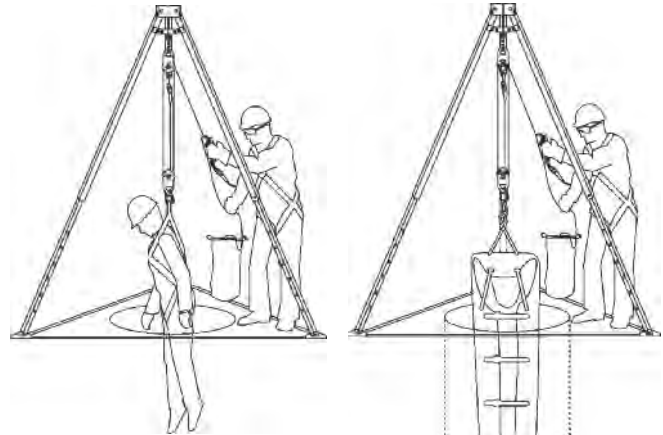

The SuretyMan Rescue Utility System can be used in conjunction with the Sure-Strong Tripod

The SuretyMan Rescue Utility System can be used in conjunction with the Sure-Strong Tripod and Sked Rescue system

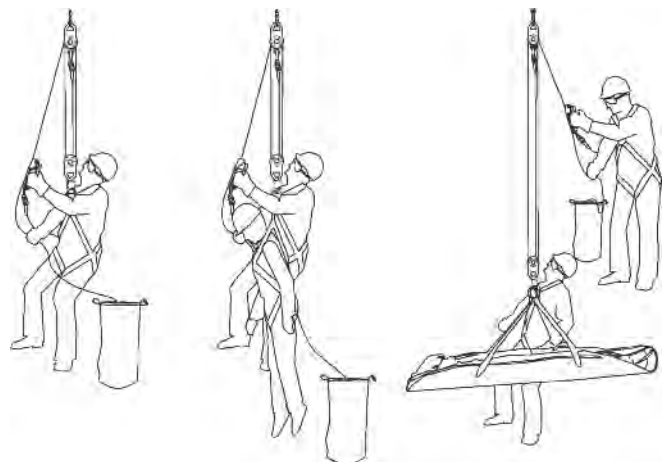

The SuretyMan Rescue Utility System can be used for self-rescue and/or victim rescue applications

The SuretyMan Rescue Utility System can be used in conjunction with the Sked Rescue system

The SuretyMan Rescue Utility System is primarily used for raising and lowering people or equipment in rescue and industrial work access and confined space applications. Pulleys are equipped with a built-in anti-reversing lock. Offers rapid deployment, is virtually maintenance free, and is rated for two-person load.

- Compact and lightweight with a standard system weight of 17 pounds (7.7 kg)
- Rated capacity of 600 pounds (272 kg) for personnel and materials
- Offers a standard rope length of 200 feet (66m) with a maximum rope length of 800 feet (267m)

NOTE: Due to 4:1 mechanical advantage, user should order system with 4 times the rope necessary for the application. For example, a 50' application requires 200' of rope.

### SuretyMan Rescue Utility System Ordering Information

SURETYMAN RESCUE UTILITY SYSTEM	Part No.	Description
	SRS15200 <b>2</b>	SuretyMan Rescue Utility System, 200' (61m) length
	SRS15300	SuretyMan Rescue Utility System, 300' (91.4m) length
	SRS15400	SuretyMan Rescue Utility System, 400' (122m) length
	10093608	SuretyMan Rescue Utility System, 500' (152.4m) length
	10033360	SuretyMan Rescue Utility System, 600' (182.9m) length
	10101135	SuretyMan Rescue Utility System, 800' (272m) length
	10037101	Left-hand ascender with securing rope
	10035698	Right-hand ascender with securing rope

## Basic High Angle Rescue Kits

The Basic High Angle Rescue Kits were designed for the Fire Department planning to assemble a high angle rescue team. A complete high angle rescue system consists of two kits: a Belay System Kit, and a Raising/Lowering System Kit.



## Basic High Angle Rescue Kit Ordering Information

BELAY SYSTEM KIT	10030023	Belay System Kit
	Belay System Kit includes:	
	SRCC641	3 large "D" shaped rescue carabiners, NFPA approved Class G
	SRP504860SL	200' (61m) 1/2" rope, orange and white, NFPA approved
	SRP500900	33' (10m) 9mm accessory cord for making load- release hitch
	SRP500860	65" (1.65m) 8mm accessory cord & 53" (1.35m) accessory cord, make up the tandem Prusiks
	SFP2267406	6' (1.8m) SuretyMan anchorage sling
	SRB430301	#3 rope bag, orange
RAISING/LOWERING SYSTEM KIT	10030024	Raising/Lowering System Kit
	Raising/Lowering System Kit includes:	
	SRCC641	3 large "D" shaped rescue carabiners, NFPA approved Class G
	SRP504860SL	200-ft (61m) 1/2" rope, orange and white, NFPA approved
	SRP500900	33-ft (10m) 9mm accessory cord for making load- release hitch
	SRP500860	65" (1.65m) 8mm accessory cord & 53" (1.35m) accessory cord, make up the tandem Prusiks
	SRP500860	53" (1.35m) 8mm accessory cord for creating the Prusik to connect the raising system
	SPPPU8710	2 Single Pulleys, 4" (100mm) Prusik minding pulleys
	SRS14001	Brake Bar Rack, lowering device is NFPA approved
	SFP2267406	6-ft (1.8m) SuretyMan anchorage sling
SRB430305	#3 rope bag, black	

## Confined Space/Head First Extraction System

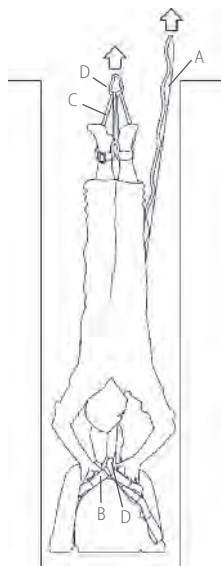

A specialized rescue product designed for extreme cases in which a rescuer needs to be lowered head-first into a confined space to perform a rescue. The Confined Space/Head First Extraction System (HFES) allows the rescuer to be lowered comfortably into a confined space head first, harness the victim, and raise both victim and rescuer out of a confined space. Consists of an adjustable lifting strap (A), an adjustable victim strap (B), one pair of ankle harnesses (C), two carabiners (D), and a storage bag. This small, compact system can be used with any confined space retrieval equipment such as tripods and davits.

- Leaves both hands free for the rescuer to assist in the retrieval of another person
- Small, compact system

## Ordering Information

CONFINED SPACE/ HEAD FIRST EXTRACTION SYSTEM	SRS3100	Confined Space/ Head First Extraction System
ACCESSORIES	SRS3103	Rescue Anklets
	507002	Rescue Wristlets

## Bucket Truck Evacuation Kit



The Bucket Truck Evacuation Kit was created to provide all necessary equipment to allow a worker to safely evacuate an aerial bucket that has become inoperative.

## Ordering Information

BUCKET TRUCK EVACUATION KIT	SKITSMT001	Bucket Truck Evacuation Kit
	Bucket Truck Evacuation Kit includes:	
	SRB430205	#2 Rope Bag
	SCE405010	10-ft Synthetic Ladder with Swivel Snaphook
	SSB22040	Boom Anchor Strap
SDC726075	Anthon system, which includes anthon device, carabiners (2), 75' (22m) 7/16" rope	

## Escape Kit



The Escape Kit was created as a tool for emergency egress when trapped in an upper floor of a building. This kit is lightweight and easy to use.

### Ordering Information

ESCAPE KIT	10030026	Escape Kit
	Escape Kit includes:	
	SRCA853	Carabiners
	SRP500900	60' (18.3 m) 9mm rope
	—	Mini Q-Eight
—	Small stuff sack	

## Rescue Pole/Remote Hook

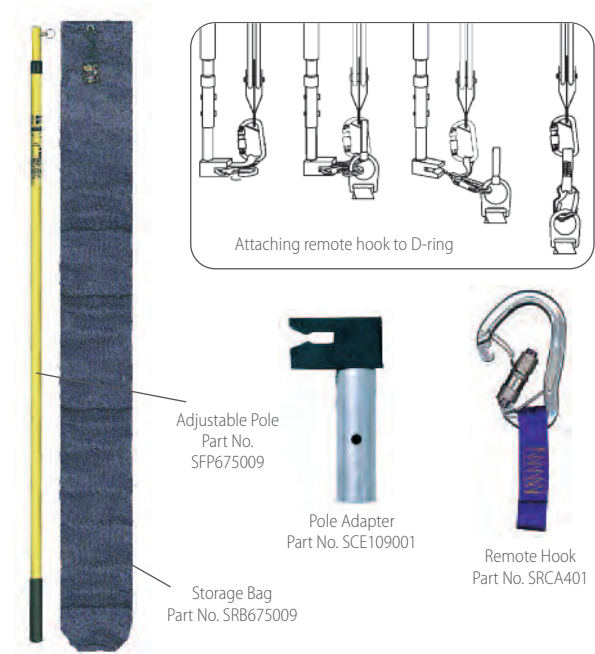

The Rescue Pole/Remote Hook is designed as a rescue tool for the retrieval of a worker suspended in a fall arrest system or for remote rescue access. In most cases, the need for the rescuer to go to the fallen worker (victim) is limited. The Rescue Pole can be used in a wide variety of rescue applications and will serve as an excellent tool to help perform a safer, efficient rescue. The system consists of an adjustable fiberglass pole, pole adapter, and remote hook. A nylon storage bag is optional.

### Ordering Information

RESCUE POLE/ REMOTE HOOK	SFP675009	Adjustable pole, fiberglass 6' (1.8m) to 12 ft (3.6m)
	SFP675012	Adjustable pole, fiberglass 8' (2.4m) to 24 ft (7.3m)
	SRCA401	Remote hook, aluminum, with web sling
	SCE109001	Pole adapter, aluminum/rubber
	SCE109003	Pole adapter, 6' (1.8m), aluminum/rubber
	SRB675009	Storage bag for SFP675009

## SKED Basic Rescue System



Sked Basic Rescue System  
Part No. SRSSK200

The best solution for confined space, high angle or technical rescue, and traditional land-based applications, the Sked stretcher is a revolutionary design which provides outstanding patient protection and security. The Sked stretcher comes equipped for horizontal hoisting by helicopter or vertical hoisting in caves or industrial confined spaces. When the patient is secured, the stretcher becomes rigid. The durable plastic provides protection for the patient while allowing extrication through the most demanding confined spaces. The stretcher is rolled for storage in a tough cordura backpack which is included in the system. The system ships at 19 lb (8.6 kg) and comes complete for most applications.

Each Sked Basic Rescue System comes complete with:

- Sked Stretcher
- Vertical lift sling
- Cordura backpack/towing harness
- Tow strap
- Horizontal lift slings
- Removable webbing handles

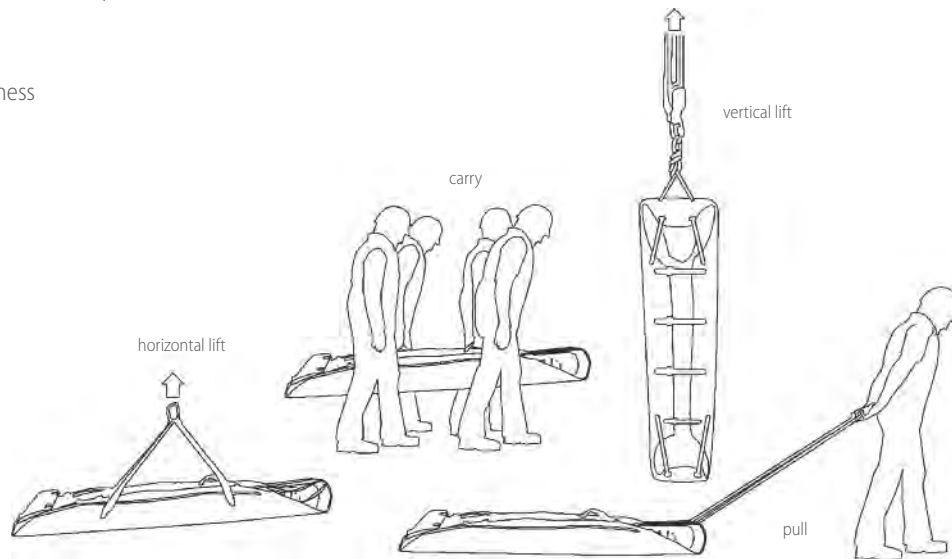

### Ordering Information

SKED BASIC RESCUE SYSTEM	SRSSK200	Sked Basic Rescue System, International orange
--------------------------	----------	--

## Rescue Equipment: Cradles, Ladder and Etrier

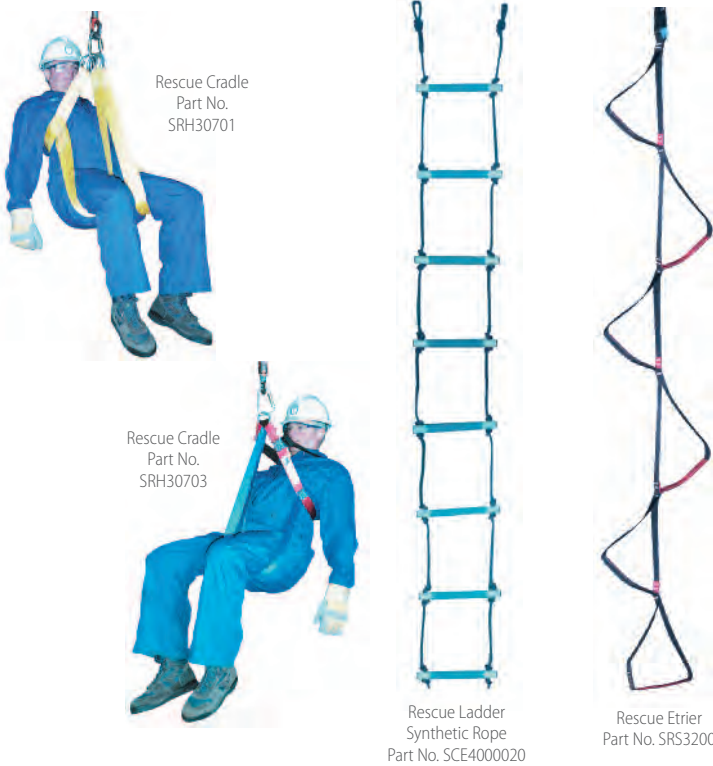

### Rescue Cradles

The Rescue Cradle is available in two model types. The SRH30701 model is designed to allow easy placement on a person. Equipped with 4" (10 cm) polyester webbing and 4 - 3" (7.6 cm) D-rings. One size fits all.

The Rescue Cradle, model SRH30703, is designed to be very similar to the SRH30701 model, except it is constructed with 1 - 3/4" (4.4 cm) nylon webbing, 2" (5 cm) attachment ring, and an elastic shoulder strap.

### Rescue Ladder

Our Rescue Ladder has synthetic rope with reinforced fiberglass rungs. Applications include: confined space access, theatrical stage rigging, mine access, and many others.

### Rescue Etrier

Etrier is French for a set of ascending web stirrups sewn or tied together. The Etrier is useful for stretcher tendering and other vertical activities including getting over difficult edges. The six-foot loops are reinforced/ stiffened for easier foot placement and abrasion resistance.

Length: 7 ft (2.1 m). Weight: 9 oz (280 g).

## Ordering Information

CRADLES	SRH30701	Rescue Cradle, 4 D-rings, 4" (10 cm) polyester webbing
	SRH30703	Rescue Cradle, 2" attachment ring, 1-3/4" (4.45 cm) nylon webbing
LADDER	SCE400020	Rescue Ladder, synthetic rope, 20 ft (6.1 m)
ETRIER	SRS3200	Rescue Etrier, 1" web, 7 ft (2.1 m)

## General Accessories



### Hands-off™ Chisel Grip

The Hands-Off Chisel Grip keeps hands away from the point of contact. The Hands-Off Chisel Grip is ergonomically designed to match the specific shape of the human hand for a comfortable and firm grip.

- Permits faster, safer, more accurate work
- Easy adjustment to hold a variety of chisels and stakes up to 1" in diameter
- Vibration-absorbing handle
- Eases awkward hand positioning
- Economical
- Spark resistant

### Ergonomic Tool Holders

- Holds wrenches, chisels, etc.
- Vibration-absorbing design
- Attach to broom handles and mops for better grip
- Eases awkward hand positioning

## Ordering Information

CHISEL GRIP	10040018	1	Hands-Off Chisel Grip
TOOL HOLDER	507005	2	Tool Holder, 18"
	507006	2	Tool Holder, spark resistant, 18"
TAGLINE SRL Accessory	505230		95'
	10147490		50'
	10125759		30'
	10147631		10'





## MSA Safety-At-Heights Training

### Authorized Person for Safety at Heights

- For At-Risk Workers, Supervisors, and Managers
- The chance to experience a controlled fall using an energy-absorbing lanyard
- Hands-on and application oriented exercises
- 1-1/2 day format

**Key Topics Include:**

- Dynamics of a fall
- Fall hazard recognition
- Procedures for continuous Safety at Heights
- Impact forces
- Selection, application, and use of fall protection systems

### Competent Person for Equipment Inspection

- For At-Risk Workers, Supervisors, and Managers
- Physical inspection of fall protection equipment
- 1/2 day format
- Emphasis on the formal equipment inspection process

**Key Topics Include:**

- Formal inspection and documentation process
- Equipment cleaning, storage, and disposal
- Identification of hazards impacting equipment integrity
- OSHA and ANSI inspection requirements

### Competent Person for Safety at Heights

- For Supervisors, Safety Professionals, and Managers
- 3 day format
- Comprised of the Authorized Person for Safety at Heights, Inspection, and Management & Rescue Planning courses
- Safety at Heights Management & Rescue Planning
- For Supervisors, Safety Professionals, and Managers
- Emphasis on assessment, implementation, and management of a fall hazard control program
- Perform rescue simulations from an elevated structure
- Emphasis on planning for rescue after a fall

**Key Topics Include:**

- Fall Hazard survey and profile
- At-Risk Worker selection and issues
- Rescue equipment, personnel, and training considerations
- Fall protection systems selection
- Regulatory and standards review (OSHA, ANSI)
- Round-table discussion of fall protection issues

### Training Centers

- Butler, PA
- Houston, TX
- Denver, CO
- Chicago, IL
- Edmonton, AB, Canada
- Queretaro, Mexico

**Or, Let Us Train You at YOUR Facility**

### Tower Climbing Safety

- For At-Risk Workers, Supervisors, and Safety Professionals
- Experience a controlled fall using an energy absorbing lanyard
- 1 day format
- Hands-on exercises utilizing various tower climbing systems

**Key Topics Include:**

- Selection, application, and use of fall protection systems
- Dynamics of a fall
- Regulatory and standards (OSHA) review including the Telecommunications standard

### MSA Custom Training Courses

- Focus on safety issues unique to your company
- Compliment your existing safety program
- Hands-on training in your daily work environment
- Custom training structures at your facility

### REGISTRATION INFORMATION

We invite you to attend our next training session, which will prove to be a comprehensive and valuable experience.

Register by phone or fax:

Phone: 1-866-347-6093 • Fax: 724-776-4520.

**Visit [www.MSAafety.com](http://www.MSAafety.com) for the current training schedule.**

Course	Length	Course #
AUTHORIZED PERSON FOR SAFETY AT HEIGHTS	1-1/2 days	ZT-APHEIGHTS
COMPETENT PERSON FOR EQUIPMENT INSPECTION	1/2 day	ZT-CPINSPECT
SAFETY AT HEIGHTS MANAGEMENT AND RESCUE PLANNING	1 day	ZT-MGRESCUE
COMPETENT PERSON FOR SAFETY AT HEIGHTS	3 days	ZT-CPHEIGHTS
TOWER CLIMBING SAFETY	1 day	ZT-TOWER
MSA CUSTOM TRAINING COURSES	Course length, cost, and schedule will be determined upon request.	

## Calculating Total Fall Distance

Knowing how to calculate Total Fall Distance is just as important as selecting the proper harness, lanyard, anchorage connector, and anchorage point for the specific task to be performed. Total Fall Distance (TFD) is defined as the sum of Freefall Distance (FFD), Deceleration Distance (DD), Harness Effects (HEFF), and Vertical Elongation (VEL). It is also wise to include a Safety Factor (SF) of at least one foot in the formula. Total Fall Distance can be calculated using the following formula:

$$\text{TFD} = \text{FFD} + \text{DD} + \text{HEFF} + \text{VEL} + \text{SF}$$

Before we can begin to calculate Total Fall Distance, we first need to define the variables in the formula above.

**Freefall Distance (FFD):** The vertical distance a worker travels between the onset of a fall until just prior to the point where the Fall Arrest System begins to arrest the fall. Federal OSHA limits this distance to 6' or less. To keep FFD to a minimum, always try to keep your anchor point as far above the back D-ring of the harness as possible.

**Deceleration Distance (DD):** The vertical distance a worker travels between the activation of the Fall Arrest System and final fall arrest. Federal OSHA limits this distance to 3.5' or less. The DD that each energy-absorbing fall arrest device will permit is typically stated on the product label.

**Harness Effects (HEFF):** The stretch of a harness during fall arrest. This is typically one foot or less for a properly-fitted harness. However, some harnesses use elastic-type webbing that can increase the harness effects to two feet or more.

**Vertical Elongation (VEL):** The stretch in the lifeline of the Personal Fall Arrest System. Vertical Elongation is measured on the part of the lifeline that is under tension during deceleration and final fall arrest. This variable will change drastically depending upon the type of Fall Arrest System you are using. For example, most energy-absorbing lanyards are designed to have a maximum deceleration distance of 3.5' which includes the vertical elongation of the lanyard. However, if you are using a rope grab system or a horizontal lifeline, vertical elongation must be calculated based on the stretch of the vertical or horizontal lifelines in those systems. You will need to check the specific manufacturers' product for exact stretch percentages.

**Safety Factor (SF):** An additional factor of safety to ensure that you have the required clearance below your working surface. This variable should be at least one foot, but can reflect any number with which you feel comfortable.

For illustration purposes, we will use the following equipment:

- Full Body Harness (non-elastic)
- 6' Energy-Absorbing Lanyard
- Fixed, Rigid Anchorage Connector (such as a D-Plate bolted to a structural I-beam)

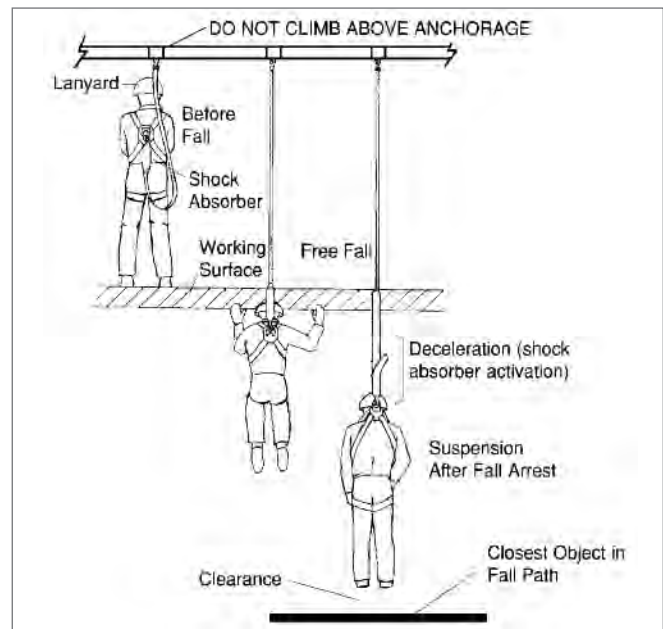

Figure 1

In *Figure 1*, we see a worker with a 6' Energy-Absorbing Lanyard on an elevated platform. In this example, let's assume that his attachment point is 2' above the back D-ring of the harness. For every 1' the lanyard attachment point is above the harness back D-ring, 1' is deducted from the Freefall Distance. For every 1' that the lanyard attachment point is below the harness back D-ring, 1' is added to the Freefall Distance (see *Table 1*). In this scenario, if the worker falls, the Freefall Distance (FFD) will equal 4' since the lanyard attachment point is 2' above the back D-ring of the harness.

So, our formula so far looks like this:  $\text{TFD} = 4' + \text{DD} + \text{HEFF} + \text{VEL} + \text{SF}$

The next variable to consider is Deceleration Distance (DD). Federal OSHA requires that this distance not exceed 3.5'. Since all manufacturers' product is slightly different, you should read the label on the product you intend to use to determine the maximum deceleration distance of that product. When calculating Total Fall Distance, the maximum deceleration distance that a product will permit should always be used. In our example, the maximum deceleration distance would be 3.5'.

$$\text{TFD} = 4' + 3.5' + \text{HEFF} + \text{VEL} + \text{SF}$$

The Harness Effects variable is relatively constant at less than one foot. This will vary slightly due to the adjustment of the harness, so we generally use one foot to account for these slight differences. However, elastic-type harnesses can have more than one foot of stretch, possibly two feet or more, and that additional distance must be accounted for in your calculation. In our example, we are using a non-elastic harness to keep our Total Fall Distance to a minimum.

$$\text{TFD} = 4' + 3.5' + 1' + \text{VEL} + \text{SF}$$

## Calculating Total Fall Distance

FreeFall Distance for various Energy-Absorbing Lanyard Lengths and Elevations of Anchorage Connection Point.	Length of Energy-Absorbing Lanyard			
	6'	5'	4'	3'
Distance of Anchorage Connection Point Above (+) or Below (-) Harness Fall Arrest D-Ring				
+3	3	2	1	0
+2	4	3	2	1
+1	5	4	3	2
0	6	5	4	3
-1	7	6	5	4
-2	8	7	6	5
-3	9	8	7	6
-4	10	9	8	
-5	11	10		
-6	12			
	FreeFall Distance			

Table 1

Most manufacturers design their Energy-Absorbing Lanyards so that the vertical elongation of the lanyard is included in the OSHA mandated 3.5' maximum deceleration distance. However, if we were using a rope grab or horizontal lifeline, or if you were attaching to a non-rigid anchorage connector, VEL would need to be calculated based on the specifications of those components in your Fall Arrest System. Since we are using a 6' Energy-Absorbing Lanyard in our example and the VEL is already considered in the lanyard design, we will enter a "0" for the VEL variable.

$$TFD = 4' + 3.5' + 1' + 0' + SF$$

The final variable of the formula is the Safety Factor. It is always a good idea to include at least a 1' safety factor; however, the safety factor could reflect any number that makes you comfortable with your calculation.

Now we can solve our Total Fall Distance Formula:

$$TFD = 4' + 3.5' + 1' + 0' + 1'$$

$$TFD = 9.5'$$

Now we know that if the worker in *Figure 1* would happen to fall, his Total Fall Distance will be 9.5'.

### But what does this number really mean?

It means that the clearance between the working surface and the next closest object in the fall path must be at least 9.5'. It is important to remember that Total Fall Distance is not always measured from the working surface to the ground, because sometimes the ground is not the closest object beneath the working platform. If there is any type of obstruction in the fall path of the worker (see *Figure 2*), your available clearance is measured from the working platform to the top of that obstruction. Sometimes these distances can be very short, and a fall protection means other than a 6' energy-absorbing lanyard is necessary. Total Fall Distance calculations can become more complex than those demonstrated here. The numbers and variables will change depending upon the type of Personal Fall Arrest System used. For example, when calculating Total Fall Distances for Horizontal Lifeline Systems you have additional variables to consider, such as cable deflection and the number of people on the system. The important thing to remember is that calculating Total Fall Distance is just as important as selecting the right product for the job. Forgetting to calculate Total Fall Distance is just as dangerous as forgetting to put on your harness before you begin to perform any work at heights.

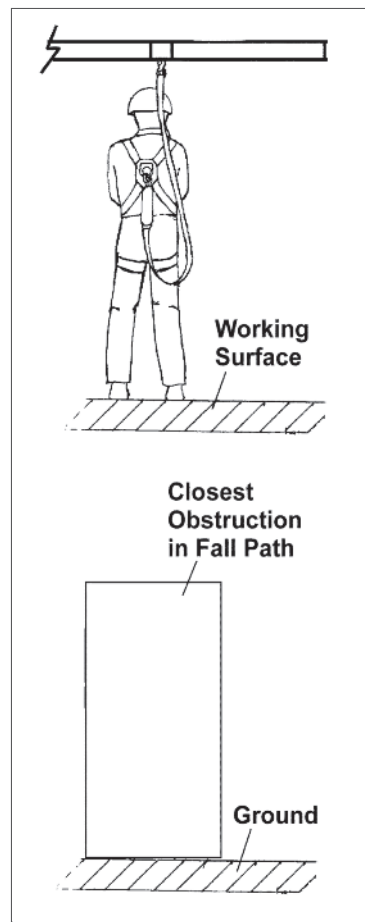

Figure 2

Mining **Equipment**



## Comfo-Cap® Protective Caps



- Classification:** Type I
- Application:** Mining
- Shell Material:** Polycarbonate
- Available Styles:** Non-Slotted Cap
- Sizes:** Standard (6½ – 8")
- Standards:** ANSI/ISEA Z89.1-2009 (Class G)
- Certification:** Third-party by SEI
- Customization:** Imprinting and striping available

### Ordering Information

DESCRIPTION	w/Staz-On	w/Fas-Trac
<b>COMFO CAP ASSEMBLIES</b>		
WHITE	91522	475336
BLUE	91586	—
YELLOW	91585	—
ORANGE	91589	—
RED	91590	—
GREEN	91584	—
BLACK	82769	—
<b>REPLACEMENT SUSPENSIONS</b>		
STAZ-ON SUSPENSION	454231	
FAS-TRAC SUSPENSION	10061128	
1-TOUCH SUSPENSION	473334	

## W65 Self-Rescuer Respirator



Housed in a rugged stainless steel case and weighing only 2.2 pounds, the durable W65 Self-Rescuer provides emergency protection against carbon monoxide gas resulting from underground fires or explosions. The one-time-use device is for escape purposes only. The unit should not be used in atmospheres containing less than 19.5 percent oxygen or in atmospheres containing other toxic gases and vapors.

- Convenient, portable self-rescuer provides emergency protection against CO
- Lightweight unit weighing only 2.2 pounds

### Ordering Information

W65 SELF-RESCUER RESPIRATOR COMPETE ASSEMBLIES	455299	W65 Self-Rescuer Respirator, complete in carton
	461100	W65 Self-Rescuer Respirator, w/protective boot and neoprene holster
HOLSTER <i>Adapts Self-Rescuer to belts up to 2-1/2 inches in width</i>	455535	Leather Holster
	460027	Neoprene Holster
PROTECTIVE BOOT	449428	Protective Boot
SELF-RESCUER TRAINING MODEL	455696	Training Model, in red case

## Miner's Support System and Multipurpose Pouch

The Miner's Support System from MSA is a lightweight but sturdy miner's belt that offers comfort, lumbar support, versatility and durability. It enables the miner to carry the cap lamp battery pack, filter self-rescuer, SCSR, tools, etc., on the job. A one-inch reflective strip sewn over a two-inch nylon strap makes the support system highly visible. For more complete information, see Bulletin 0115-03.

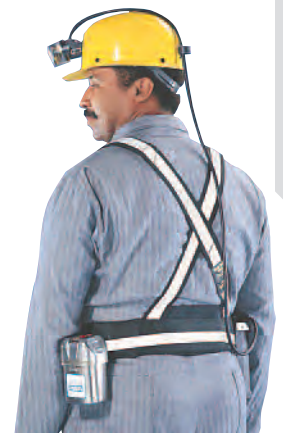

### Ordering Information

MINER'S SUPPORT SYSTEM	696757	Miner's Support System, small (28–34)
	696758	Miner's Support System, medium (34–44)
	696759	Miner's Support System, large (44–52)
MULTIPURPOSE MINER'S POUCH	803100	Multipurpose Miner's Pouch
	804655	Multipurpose Miner's Pouch with Velcro closure

## ALTAIR 4X MSHA Multigas Detector

### Optimized for Miners

Building on years of design experience, MSA revolutionizes sensor technology with breakthroughs that improve mining application performance:

- Methane-optimized catalytic bead sensor provides increased stability over time
- Sensor response and clear times in less than 15 seconds
  - Reduces gas usage for bump testing and calibration
- Greater accuracy and repeatability within changing environmental conditions
  - Temperature, humidity and pressure
- Digital sensors offer increased RF (radio frequency) immunity
  - Eliminate false alarms from radios
- Accurate CO readings from 0-2000 ppm
- Industry-first CO/NO<sub>2</sub> combination sensor with wide range and fast response times
- Increased methane sensor poison resistance decreases down time and frequency of sensor replacements
- End-of-sensor life warning gives advanced notice of failing sensors
- Sensor life that greatly exceeds industry average

### Technical Specifications

Gas Type	Range	Resolution
CH <sub>4</sub>	0–5%	0.05%
O <sub>2</sub>	0–30% vol	0.1% vol
CO	0–1999 ppm	1 ppm
NO <sub>2</sub>	0–50 ppm	0.1 ppm
H <sub>2</sub> S	0–200 ppm	1 ppm



30 CFR Part 22, Methane Detector

30 CFR Part 75 Determination testing for methane and oxygen deficiency



ALTAIR 4X Multigas Detector



ALTAIR 4X Multigas Detector  
Optional glow-in-the dark housing for mining and confined space applications

### Ordering Information

ALTAIR 4X MSHA Multigas Detectors listed below come with 3-year warranty, data logging, charger, calibration cap, and tubing

ALTAIR 4X MSHA MULTIGAS DETECTORS	10125912	ALTAIR 4X Multigas Detector (CH <sub>4</sub> , O <sub>2</sub> , CO), charcoal case
	10125913	ALTAIR 4X Multigas Detector (CH <sub>4</sub> , O <sub>2</sub> , CO), phosphorescent case
	10125914	ALTAIR 4X Multigas Detector (CH <sub>4</sub> , O <sub>2</sub> , CO, NO <sub>2</sub> ), charcoal case
	10125915	ALTAIR 4X Multigas Detector (CH <sub>4</sub> , O <sub>2</sub> , CO, NO <sub>2</sub> ), phosphorescent case
	REPLACEMENT SENSORS	10121212
10106729		XCell O <sub>2</sub> Sensor
10106725		XCell CO/H <sub>2</sub> S Two-tox Sensor
10121217		XCell CO/NO <sub>2</sub> Two-tox Sensor
ACCESSORIES	10127422	4-unit multi-unit charger NA plug
	10143372	12-unit multi-unit charger NA plug



MSA XCell sensors

## Assemble-To-Order (ATO) Options

To create your instrument configuration, select the instrument option code and mark them in the boxes to the right.

<b>A</b>	<b>INSTRUMENT TYPE</b>	The Altair 4X Multigas Detector now comes standard with MSA's new XCell Sensors and MotionAlert feature to indicate 'man-down'. Please select your instrument's case color; select option <b>C</b> for charcoal and option <b>G</b> for phosphorescent (glow-in-the-dark).	<b>Instrument Type</b> Charcoal Phosphorescent (glow-in-the-dark)	<b>Code</b> C G	<b>Selection</b> <input type="checkbox"/>
<b>B</b>	<b>COMBUSTIBLE SENSOR</b>	To have a combustible sensor installed in your new ALTAIR 4X Multigas Detector, please select <b>C</b> . For no combustible sensor, please select <b>0</b> .	<b>Combustible Sensor Options</b> None 0-5% Vol methane	<b>Code</b> 0 C	<b>Selection</b> <input type="checkbox"/>
<b>C</b>	<b>OXYGEN SENSOR</b>	To have an oxygen sensor installed in your new ALTAIR 4X Multigas Detector, please select <b>1</b> . For no sensor, enter <b>0</b> .	<b>Oxygen Sensor Options</b> None 0-30%	<b>Code</b> 0 1	<b>Selection</b> <input type="checkbox"/>
<b>D</b>	<b>TOXIC SENSOR</b>	To configure your new ALTAIR 4X Multigas Detector, choose 0 for no toxic sensor. Choose <b>A</b> for both CO and H <sub>2</sub> S sensors, choose <b>B</b> for CO, <b>C</b> for H <sub>2</sub> S, <b>D</b> for CO and NO <sub>2</sub> , and <b>E</b> for NO <sub>2</sub> .	<b>Toxic Sensor Options</b> None 0-1999 ppm CO and 0-200 ppm H <sub>2</sub> S 0-999 ppm CO 0-200 ppm H <sub>2</sub> S 0-1999 ppm CO and 0-50 ppm NO <sub>2</sub> 0-100 ppm NO <sub>2</sub>	<b>Code</b> 0 A B C D E	<b>Selection</b> <input type="checkbox"/>
<b>E</b>	<b>POWER SUPPLY</b>	Select the correct power supply for your region. Add an instrument cradle to firmly secure your instrument while charging on the shelf or on a vehicle.	<b>Power Supply Options</b> None North American North American with cradle	<b>Code</b> 0 N M	<b>Selection</b> <input type="checkbox"/>
<b>F</b>	<b>APPROVAL LABEL</b>	The ALTAIR 4X Multigas Detector is fully approved by MSHA.	<b>Approval Label Options</b> MSHA	<b>Code</b> M	<b>Selection</b> <input checked="" type="checkbox"/> M
<b>G</b>	<b>EXTENDED WARRANTY</b>	MSA includes a full 3-year warranty on the ALTAIR 4X Multigas Detector, including sensors, battery and electronics. Choose <b>1</b> for an additional year (4 years total).	<b>Extended Warranty Options</b> Three years standard warranty Extended warranty (four years total)	<b>Code</b> 0 1	<b>Selection</b> <input type="checkbox"/>

### Your Model Part Number

Please write in numbers from selections above in appropriate boxes and contact your Safety Products Distributor to place your order.

Selection      **A**    **B**    **C**    **D**    **E**    **F**    **G**

A-ALT4X-  -  -  -  -  -  -  -

# Video Programs

Order programs below online at [www.goavmod.com/MSA](http://www.goavmod.com/MSA). Available on DVD or as a download.

	Title and Comments	Running Time	Year Released
<b>AIR-PURIFYING RESPIRATORS</b>	Proper Donning & Use of the Advantage 420 Respirator	10 min.	2009
	Proper Care & Use of the Advantage 4000 Full-Face Respirator – <i>available in French, English and Spanish</i>	15 min.	2010
	Care and Use of the A-1000 and Millennium Gas Mask For use by First Responders and Law Enforcement personnel. This program uses and shows cartridges and canisters approved for use prior to 2004, DOES NOT cover specific CBRN canisters.	24 min.	2003
	Proper Care & Use of the Advantage 1000 Full-Face Respirator	15 min.	1994
	Proper Care & Use of the Comfo Classic Respirator – <b>UPDATED</b>	20 min.	2012
	Use & Maintenance of the Ultra-Twin Respirator	22 min.	1995
	Proper Care & Use of the OptimAir MM PAPR for the Abatement Industries – <b>UPDATED to include the OptimAir MM2K</b>	20 min.	2012
	Overview of OptimAir TL PAPR – <b>UPDATED</b>	15 min.	2013
	Proper Care & Use of the Responder Powered Air-Purifying Respirator	25 min.	2009
	Fit Testing MSA Respirators with the Qualitative Fit Test Kit	10 min.	2010
<b>SUPPLIED-AIR RESPIRATORS</b>	Proper Care & Use of the PremAire Supplied-Air Respirator System	43 min.	1994
	Proper Care & Use of the PremAire Cadet System	32 min.	1993
	Donning & Using the PremAire Cadet Escape Respirator	20 min.	2008
	Proper Care & Use of the Hip-Air Apparatus	28 min.	1992
	Proper Care & Use of the Pressure-Demand Air-Line Respirator	44 min.	1986
	Proper Care & Use of Constant-Flow Air-Line Respirators	27 min.	1992
	How to Use & Maintain the Custom Air V Escape Respirator	18 min.	1988
	Proper Care & Use of Your Response Escape Hood from MSA	11:15 min.	2002
	Proper Care and Use of the Xtreme Air Mask with HUD/RIC	40 min.	2003
	Proper Care and Use of the M7 Air Mask and Rescue Belt II – <b>UPDATED</b>	35 min.	2008
	Proper Care and Use of the M7 Responder Air Mask—Covers SCBA (35 min.), PAPR (25 min.), and APR (20 min.) options	80 min.	2008
	FireHawk Disassembly & Reassembly Instructional Program	11:46 min.	2002
	Proper Care and Use of the AirHawk II SCBA	25 min.	2009
	Proper Care and Use of the Quick-Fill System	min.	1992
<b>TICS</b>	Proper Care & Use of the Evolution 5000 Family of TICs—Covers 5200, 5600, and 5800, each in own 15 min. program.	45 min.	2008
<b>PORTABLE INSTRUMENTS</b>	Proper Use of the Altair 5 Multigas Detector	20 min.	2009
	Proper Use of the Altair 5X Multigas Detector – <b>NEW</b>	20 min.	2011
	Proper Use of the Altair 4X Multigas Detector	20 min.	2010
	Proper Use of the Altair 4 Multigas Detector	20 min.	2008
	Proper Use of the Altair 4 QuickCheck System	10 min.	2009
	Proper Care & Use of the Orion Multigas Monitor	29 min.	2001
	Orion G Multigas and Leak Detector Goose Neck and Coiled Hose Version, Rev.01	15 min.	2003
	Proper Care & Use of the Explosimeter Indicator, Model 2A	24 min.	1982
	Proper Care and Use of the Pulsar Single-Gas Detector	8 min.	2001
	Overview of the Galaxy Gas Tester	10 min.	2004
Overview of Galaxy GX2 Gas Tester – <b>NEW</b>	10 min.	2012	
<b>FALL PROTECTION</b>	Proper Care & Use of the EVOTECH Harness	10 min.	2010
	Harnesses—Donning and Doffing Instructions for the Pullover, Vestype, FP Pro and Tradesman Harnesses	—	—
	Using the RCD (Remote Connect/Disconnect) System	6:30 min.	1998
	Assembly and Use of the Horizon Rebar Anchorage System	10:22 min.	2000
	Davit Systems	9:59 min.	1999
	Assembling the Fall-Rescue Work System	9:07 min.	1999
	Dyna-Line Horizontal Lifelines	—	—
	Elements of Fall Protection	—	—
	Gravity Harnesses—Donning and Doffing Instructions	—	—
	Facing the Real Dangers of Confined Spaces	28 min.	1993
Workman Tripod Assembly	—	2010	
Use of the Suspension Trauma Safety Step	15 min.	2008	
<b>HEAD PROTECTION</b>	Proper Care & Use of MSA Head Protection – <b>UPDATED</b>	20 min.	2011



## Product Index

<b>A</b>	
Abrasi-Blast Supplied-Air Respirator	32
Accountability System for Fire Service	56
Adapter for Comfo Cartridges	15
Adapter, SCBA to APR	62
Adder Copper Protective Eyewear	122
Advantage Respirators	6–9, 24
Advantage Tech CD	22
Aerial Kits (Workman)	209
Air Cart	58
Air Cylinders	40, 54
Air Masks (SCBA) and Accessories	47–63
Air-Line Filter	45
Air-Line Respirators	27–45
Air-Purifying Respirators	6–26
Air-Supply Hose	44, 63
AirHawk II Industrial Air Mask	48–49
Alaska Protective Eyewear	148–149, 152
ALTAIR 4X Multigas Detector	72–73
ALTAIR 4X MSHA Multigas Detector	74, 244
ALTAIR 5X Multigas Detector	70–71
ALTAIR Pro Single-Gas Detector	81
ALTAIR Quick-Check Station	83
ALTAIR Maintenance-Free Single Gas Detector	82
Anchorage Connectors	204–208
Anthron Descender	210
Approvals and Standards Information	
for Eye and Face Protection	147
for Fall Protection	163–164
for Head Protection	103
APR	see "Air-Purifying Respirators"
APR Adapter for SCBA	62
Aptura LT30 Self-Retracting Lanyard	200
ArcSafe Harness	1814–185
ArcSafe Lanyards	190
Arc Shield Visors	135
Arctic Elite Protective Eyewear	148, 150, 153
Arctic Protective Eyewear	150, 151, 153
Assemble-To-Order (ATO) System	
for AirHawk II Industrial Air Mask	49
for ALTAIR 4X Multigas Detector	73
for ALTAIR 4X MSHA Multigas Detector	75
for ALTAIR 5X Multigas Detector	71
for FireHawk M7 Air Mask	51
for Galaxy GX2 Automated Test System	95
for the PremAire Cadet Escape Combination SAR	37
for the PremAire Supplied-Air Respirator System	39
for Sirius PID Multigas Detector	77
Aurora Protective Eyewear	148
Automated Test System for Portable Instruments (Galaxy GX2)	94–95
<b>B</b>	
Backpacker Self-Retracting Lanyard	201
Banana Oil Fit Test Kit	16
Basic High Angle Rescue Kits	234
Batteries/Chargers	See specific product accessories page
BeamGrip	207
Belts	
for Air-Line Respirators	45
for Gas Masks	23
for OptimAir TL PAPR	21
BIOSENSOR 2200R Biological Agent Detector	93
Bitrex Qualitative Fit Test Kit	16
Black Fire Cap (specialty V-Gard Cap)	111
Blockz Protective Eyewear	148
Blockz VM Protective Eyewear	154
Boots	See specific instrument accessories page
Bosun Chair	216
Breathing Air Distribution System Boxes	43–44
Bucket Truck Evacuation Kit	235
Bump Caps	118
<b>C</b>	
C.A.R.E. Program	55
Cable Energy-Absorbing Lanyards	195
Cairns Fire Helmets	64–65
Calibration for Instruments	94–101
Calibration Check Gas Cylinders	97–100
Calibration Check Kit, Model RP	96
Canisters for Gas Masks	See specific gas mask page
Caps and Hats and Accessories	103–143
Carabiners	208
Carrier and Harness Assembly for SCBA	55
Carrying Pouch for Air-Purifying Respirators	15
Carrying/Storage Cases for Respirators	15
Cartridge Adapter	15
Cartridges	
Advantage	12
Flexi-Filter pads	13
for OptimAir TL PAPRs	21
OptiFilter XL (for Mask-Mounted PAPRs)	19
Comfo	13
Cartridge Life Expectancy Calculator	14
Cascade System Accessories	44
CBRN Respirators	
Escape	28
Gas Masks	24
PAPR	25
SCBA	49–51
Chargers	See specific product/accessories page
Chemical and/or Splash Applications	
Goggles for	158–159
Visors for	127–128
Chemical Warfare Agent Detector Tubes	86
Chinstraps for Protective Caps and Hats	140
Chin-Type Gas Masks	23
Chisel Grip	238
Cleaner	
for Facepieces	14
for Eyewear	157
ClearCommand Communications System	59–61
Clearview IR Protective Eyewear	156
Clearvue 200 Goggles	157
Climbing Equipment	219–222
CO Detector Tube Cards	86
Comfo Cartridge Adapter for Advantage Respirators	15
Comfo Classic Respirators	7
Comfo Filters/Cartridges	13
Comfo-Cap (mining headwear)	118, 243
Comfort Band Hearing Protector	146
Communication System for Fire Helmets	59–61
Communication System for Ultra Elite Facepieces	59–61
Concrete Anchors	205
Cones, Safety	161
Confidence Plus Germicidal Cleaner	14
Confined Space Equipment	213–218
Confined Space Extraction System	235
Constant Flow Air-Line Respirator	30
Cover Lens for Respirators	15
Cradles, Rescue	238
Custom Air V Escape Respirator	46
Custom Imprinting, for Caps and Hats	107
Cylinder Holders, for Check Gas Calibration	100
Cylinders	
Calibration Check Gas	97–100
for Portable Air Supply Systems	40
for SCBA	54
Recycling (Calibration Cylinders)	101

## Product Index

### D

Data Logging	See specific instrument accessories page
Davits	217–218
Defender+ Faceshield Frames	141
Derrick Harnesses	181
Descent Devices	210
Detector Tube Handbook	86
Detector Tube Pumps	86
Detector Tubes	86–89
Discovery II Protective Eyewear	151
Duo-Flo Respirators	31
Duo-Twin Respirators	31
Dyna-Glide Climbing Protection System	221–222
Dyna-Line Horizontal Lifelines	223
Dyna-Lock Self-Retracting Lanyards	201
Dynevac II Self-Retracting Lanyards	215

### E

Ear Muffs	144–146
Ear Plugs	146
Easy-Flex Protective Eyewear	151, 153, 154
Economuff	145
Economuff Multi-Position Muff	145
Elevated-Temperature Applications	
Hard Hats for	114–116
Visors for	120–121, 129–132
Emergency Egress System for SCBA (Rescue Belt)	54
Energy-Absorbing Lanyards	187–196
Energy-Absorbing Sub-Assembly	203
Escape Hoods/Respirators	26, 36–37, 46
Escape Kit	236
ESP II Communications System for Advantage 1000 and Millennium Respirators	24
Espresso Protective Eyewear	149
Essential Adjust Protective Eyewear	148–150, 152, 154
Essential Euro Adjust Protective Eyewear	149–150
Etrier	238
EVOTECH Full-Body Harnesses	168–171
EXC Cap Models	143
EXC Muffs	145
Expanyard Energy-Absorbing Lanyards	192–193
ExtendAire System	58
Extreme Hi-Viz Cap (specialty V-Gard)	111
Eye Protection and Accessories	147–160
Eyewear Cleaning Accessories	157
Eyewear Display Unit	157
Eyewear Lanyards	157
Eyewear Pouch	157

### F

Facepiece Fit-Test Kits	16–17
Facepieces	
for APRs	6–10
for Gas Masks	24
for PAPRs	18–20
for PremAire	35, 38
for SCBA	52
Faceshield Frames	119–121
Fall Protection Rescue Kit	232
Fall Protection Systems	162–212
Fas-Trac Suspensions	See appropriate Helmet page
FeatherFit Protective Eyewear	152
Field Maintenance for SCBA	55
Filters/Cartridges	See specific product accessories page
Filtration Box	43
Fire Helmets	64–65
FireHawk M7 Air Mask	50–53
First Aid Kits	161

Fit Testing for Respiratory Products	16–17
Fixed-Crown Suspension	See appropriate Helmet page
Flexi-Chem iV Goggles	157
Flexi-Filter Pads for Advantage Respirators	13
Flow-Check Devices for PAPRs	19, 21
FormFit Disposable Ear Plugs	146
FP Rescue Components	229
FP Rescue Kits	232–237
FP Rescue Ropes	231
FP5K Snaphook	187
FP5K Energy-Absorbing Lanyard	191
Freedom Series Helmets	110

### G

Galaxy GX2 Automated Test System for Instruments	94–95
Gas Masks	23–24
Gas Miser Demand Regulator	96
Gas Miser Manifold	96
General Purpose Applications	
Helmets for	104–116
Helmet Frames for	119
Helmet Visors for	122–126
Goggle Retainers	159
Goggles	158–159
Gold Helmet, metallic (specialty V-Gard Cap)	111
Gravity Harnesses	178–182
Gravity Harness Roofer's Kits	211

### H

Hands-Off Chisel Grip	238
Hard Hats and Accessories	104–136
Harness and Carrier Assemblies for SCBA	55
Harnesses and Accessories, Fall Protection	168–186
Hats and Caps and Accessories	104–136
HazMat Response Kit	91
HAZMATCAD/HAZMATCAD Plus Hazardous Material Chemical Agent Detectors	91
Head Protection and Accessories	104–136
Hearing Protection and Accessories	142–146
Helmets	
for fire service	64–65
for industry	104–118
Helmet Communication System	59–61
Helmet Lights	139
High Angle Rescue Kits	234
Hoist	213–214
Hoods, Air-Supplied	32–33, 46
Horizon Horizontal Lifeline	225–227
Horizontal Lifelines	223–228
Hose, Air-Supply	44, 63
Hoses, Quick-Fill for SCBA	57
HPE Cap Models	143
HPE Muffs	145

### I

Image 2000 Service for Imprinting Caps and Hats	107
Imprinting for Caps and Hats	107
In-Service Helmet Label	140
Industrial Air Cart	40
Industry Action Sets (Detector Tubes)	84
Instant Release Attachments for Welding Shields	141
Inlet Pressure Gauge	45
Instrumentation	66–101

### J

Jackets	See specific instrument accessories page
---------	--

**L**

Ladder Climbing Equipment .....219–222

Ladders, Rescue .....238

Lanyards

- Energy-Absorbing .....187–196
- Eyewear .....157
- Positioning .....203
- Restraint .....202–203
- Self-Retracting .....199–201

left/RIGHT Cap-Mounted Hearing Protectors .....142

left/RIGHT Earmuffs .....144

Lens Covers for Air-Purifying Respirators .....15

Lens Outsert for CBRN and Riot Control Respirators .....24

Lights for Caps and Hats .....139

Lineman's Pole Strap .....203

Logo Express .....107

Logo Program for MSA Eyewear .....160

Luxor Protective Eyewear .....153

Lynx Hoist .....216

Lynx Rescuer .....215

**M**

M7 (FireHawk) Air Mask .....50–53

Maintenance for SCBA .....55

Manifold for Instrument Calibration .....96

Manifolds for Air-Line Systems .....45

Mansafe Freestanding Constant Force Post .....206

Medical Information Carrier System for Helmets .....140

Millennium Riot Control and CBRN Gas Masks .....24

Miner's Cap .....118, 243

Miner's Support System & Multipurpose Pouch .....243

Mining Equipment .....242–244

Model BD-20 Calibration Cylinders .....99

Model Econo-Cal Calibration Cylinders .....98

Model R Calibration Cylinders .....97

Model RP Calibration Cylinders .....97–99

MSA-U Online Training .....inside front cover

Muffs .....144–146

Muff, Multi-Position .....145

Multigas Instruments and Accessories .....70–80

**N**

Need It NOW! Program .....165

NFL V-Gard Helmets .....108–109

Nosecaps

- for Air-Purifying Respirators .....15
- for SCBA .....62

Nuevo Wrap Protective Eyewear .....152

**O**

1-Touch Suspension .....See appropriate Helmet page

Online Response Respirator Selector .....14

Online Training (MSA-U) .....inside front cover

OptiFilter XL Cartridges .....19

OptimAir Mask-Mounted PAPR .....18–19

OptimAir TL PAPR .....20–21

OvrG and OverG II Protective Eyewear .....155

Oxygen Indicators (Single Gas) .....82–84

**P**

PAPRs and Accessories .....18–21, 25

Personal Fall Limiter (PFL) .....197–198

Personal Safety Equipment Towelettes .....62

Plant Visitor Protective Eyewear .....155

Point of Attachment Box .....44

PointGuard Anchorage Connector .....204

Portable Air-Supply Systems .....40–44

PortAire Portable Air-Supply System .....41

Pouch

- for APR .....15
- for eyewear .....157

Powered Air-Supplied Respirator Systems (PAPRs) and Accessories .....18–21, 25

PremAire Cadet Escape Supplied-Air Respirator .....36–37

PremAire Cadet Supplied-Air Respirator .....34–35

PremAire Supplied-Air Respirator System .....38–39

PremAire System Upgrade Kits .....39

Pressure Gauge (inlet) .....45

Pressure Regulator .....45

Probes .....See specific instrument accessories page

Pulleys .....229

Pumps, Detector Tube .....84

Pyrenees Protective Eyewear .....148, 153–154, 156

**Q**

Quick-Disconnects for Air-Line Respirators and Air-Supplied Hoods .....42

Quick-Fill System for SCBA .....57

QuickCheck Station for ALTAIR Single-gas Detectors .....83

QuikChek Adapters for APR Facepieces .....17

**R**

Racer Red Protective Eyewear .....149

Radio Cables for Communications Systems .....60–61

Rally Cap (specialty V-Gard Cap) .....111

Rail-Slider .....208

Rayfoe Welder's Plates .....22

RCD (Remote Connect/Disconnect) System .....210

Rebar Assemblies .....202

Recycling Tools, for Calibration Cylinders .....101

Regulators, for Calibration Cylinders .....96

Release Attachments for Welding Shields .....141

Repair for SCBA .....55

Rescue Belt for SCBA .....54

Rescue Equipment .....229–238

Rescue Pole .....236

RescueAire II Portable Air-Supply System .....57

Respirator Carrying/Storage Case .....15

Respirators

- About .....5
- Air-Line .....27–45
- CBRN .....24–25, 50–51
- Escape .....26, 36–37, 46
- Full-Face Air-Purifying .....8–10
- Gas Masks .....23–24
- Half-Mask Air-Purifying .....6–7
- Homeland Security .....24–25
- Powered Air-Purifying .....18–21, 25
- Riot Control .....24–25
- SCBA .....47–55

Responder CBRN PAPR .....25

Response Respirator Selector Online .....14

Restraint Lanyards .....202–203

Riot Control Gas Masks .....24

Roof Anchors .....207

Roofer's Kits .....211

Rope Energy-Absorbing Lanyards .....195

Ropes .....231

Rx Overglasses .....155

**S**

Safety Glasses .....148–156

Safety Goggles .....158–159

Safety Vests .....161

Saccharin Qualitative Fit-Test Kit .....16

Safe Escape CBRN 15-minute Escape Respirator .....26

SafeSite Multi-Threat Detection System .....92

Sample Lines .....See specific instrument accessories page

## Product Index

SCBA	47–63
Accessories	62–63
APR Adapter	62
ATO Part Number Ordering	49, 51
Communication Systems	59–61
Cylinders	54
Emergency Breathing Systems	57
Industrial	48–49
NFPA-Compliant	50–51
Rescue Belt	54
Self-Contained Breathing Apparatus	See “SCBA”
Self-Rescuers (Escape Respirators)	2, 46
Self-Retracting Lanyards	199–201
Sensors	See specific instrument accessories page
Sentry Protective Eyewear	149
Sierra Protective Eyewear	151, 153
Sightgard NV and Sightgard IV Goggles	158
Sightgard Protective Eyewear and Accessories	147–159
Sirius PID Multigas Detector and Accessories	79–80
SKED Basic Rescue System	237
Skylink Horizontal Lifeline Stanchions	227
Skullgard Protective Caps and Hats	116
SmoothDome Slotted Cap	113
Solaris Multigas Detector Accessories	80
Soprano Muff	143
Sound Blocker Cap Model	143
Sound Control Hearing Protection	143, 145
Spectacle Kits for Facepieces	63
Sports Helmets	108–109
Squirt Gas Bump Tester	100
Standards and Approvals Information	
for Eye and Face Protection	147
for Fall Protection	163–164
for Head Protection	103
Staz-On Suspensions	See appropriate Helmet page
Storage Cabinets for SCBA	48
Storage/Carrying Case for Respirators	15
Storage Cases for Chin-Type Gas Masks	23
SunShade Hard Hat Accessory	139
Sun Shields for Caps and Hats	139
Super-V Helmets	117
Supplied-Air Respirator Systems	27–63
Sure-Climb Cable Systems	219–220
Sure-Grab Positioning Lanyard	203
Sure-Grab Rope Grabs	212
Sure-Line Horizontal Lifeline	224
Sure-Rail Horizontal Lifeline	228
Sure-Stop Energy-Absorbing Lanyards	194–195
Sure-Strong Tripods	232
Suretyman Pulleys	229
Suretyman Rescue Eight	230
Suretyman Rescue Utility System	233
Suretyman RQ3 Q-Eight	230
Suspension Trauma Safety Step	186
Suspensions	See appropriate Helmet page
Sweatband for Caps and Hats	139
Swing-Ratchet Suspensions	See appropriate Helmet page
<b>T</b>	
TechnaCurv Construction Harnesses	174
TechnaCurv Full-Body Harnesses	172–175
TechnaCurv Tower Harnesses	174–175
Thermalgard Caps and Hats	115
Thermatek Energy-Absorbing Lanyard	196
Thermatek Harnesses	183
Tie-Back Energy-Absorbing Lanyard	191
Tissues for Cleaning Eyewear	157
Tool Holders	238
Topgard Protective Caps and Hats	114
Total Fall Distance, Calculator	240–241

Towelettes	
for cleaning APR Facepieces	14
for cleaning Eyewear	157
Tower Harnesses	174–175, 182
Training	
Fall Protection	239
Online (MSA-U)	inside front cover
TransAire 5 and TransAire 10 Escape Respirators	46
TransportAire Portable Air-Supply System	41
Tripods	213–214, 232
Tri-Seal Reusable Ear Plugs	146
Tubes, Detector	84–90
Twin-Cartridge Adapter for Ultra Elite/Ultravue Facepieces	15
Twin-Cartridge Respirators	6–10

## U

Ultra Elite CBRN Gas Mask	23
Ultra Elite M7 Facepiece	52
Ultra Elite Twin-Cartridge Respirator	10
Ultra-Twin Respirators	10

## V

V-Gard Accessory System	119–136
V-Gard Protective Caps and Hats	104–111
V-Gard 500 Protective Hats and Caps	112
Vanguard Helmets for Lateral Protection	117
Vault Goggles	158
Vented Cap (V-Gard 500)	112
Ventilation Smoke Tube Kit	84
Versa-Hood Air-Supplied Hood	33
Vests, Safety	161
Video Programs on MSA Products	245
Visors	122–136
Vista Protective Eyewear	150
Voyager Protective Eyewear	148, 152

## W

W65 Self-Rescuer	243
Web Energy-Absorbing Lanyards	188–194
Web Restraint Lanyards	202
Welding	
Energy-Absorbing Lanyards for	
Welding Applications	196
Hard Hat for Welding Applications	113
Harnesses for Welding Applications	183
Helmet Frames for Welding Applications	120–121
Visors for Welding Applications	133–135
Welder's Accessories for Respirators	22
Welder's Plates	22
Wire Screen Visors	126
Workman Confined Space Entry Kit2	213–214
Workman Harnesses	176–177
Workman PFLs	197–198
Workman Roofer's Kits	211
Workman Energy-Absorbing Lanyards	188–189
Workman Tripod	209

## X

XLS Cap Models	143
----------------	-----

## Y

Yellow Jacket Protective Eyewear	154
----------------------------------	-----

## Part Number Index

5607	86, 91	415957	202	460027	243	473180	84, 97	478192	97	484690	33
5645	86, 91	415965	212	460389	116	473284	105	478237	105	484693	33
9961	23, 45	416048	212	460409	116	473285	105	478454	116	484694	33
13016	157	416049	212	460862	30	473501	42	479001	42	484836	30
38277	22	416050	212	460863	30	473502	42	479011	42	484837	30
38347	22	416051	212	460865	30	473333	114, 115	479015	42	484923	45
38277	141	416052	212	461180	105	473334	116, 118	479016	42	485053	45
38347	141	416053	212	461100	243	473334	243	479020	42	485331	57
47134	87	416068	207	461717	30	473798	32	479022	42	485332	57
47370	29, 45	415836	225, 226	461769	97	473800	32	479023	42	485391	57
48733	141	417683	17	463111	105	473802	32	479026	42	485392	57
55716	42, 44	448914	114	463281	30	473902	19, 23, 33, 45	479027	42	485460	141
56549	33, 42	449428	243	463300	30	474043	44	479028	42	485680	90
66272	42	449895	159	463302	30	474159	105	479029	42	486053	28
66274	42	454231	116, 118	464031	13	474555	78, 80	479032	42	486258	30
66273	33, 42	454231	243	464032	13	475235	105	479033	42	486328	22
66716	28, 45	454617	116	464033	13	475336	118	479034	42	486959	115
68833	28	454618	116	463942	105	475358	105	479009	28, 29, 42	486960	115
68846	63	454619	116	463943	105	475359	105	479010	28, 29, 42	486961	115
68858	29, 44	454620	116	463944	105	475360	105	479857	97	486962	115
68850	29, 44, 63	454621	116	463945	105	475361	105	480259	10	486963	115
68851	29, 44, 63	454622	116	463946	105	475362	105	480247	23	486964	115
69542	42, 44	454623	116	463947	105	475363	105	480263	10	486965	115
73067	86	454626	116	463948	105	475364	105	480251	23	486967	115
73068	86	454664	116	464046	13	475365	105	480264	10	486968	115
73069	86	454665	116	464658	105	475366	105	480267	10	487333	87
81390	140	454666	116	464852	105	475367	105	480255	23	487334	87
81391	140	454668	116	465425	17	475368	105	480326	15	487335	87
81857	28, 45	454673	116	465457	17	475369	105	480466	30	487336	89
82018	116	454712	114	466095	31	475370	105	480468	30	487337	90
82769	118	454713	114	466204	13	475371	105	480472	30	487338	90
82769	243	454719	114	466354	105	475378	114	480474	30	487339	89
84418	45	454819	15	466355	105	475379	114	480600	30	487340	89
84416	28, 29, 45	454721	114	466356	105	475380	114	480629	30	487341	89
85078	29, 41, 44	454730	105	467044	33, 42	475382	114	480631	30	487427	57
87970	86	454722	114	467386	106	475383	114	480637	30	487428	57
88128	140	454731	105	467896	96	475384	114	480639	30	487399	115
88129	140	454723	114	467898	98	475385	114	480645	30	487500	86
91522	118	454732	105	467897	84, 98	475387	114	480671	30	487343	87, 88, 90
91584	118	454733	105	468096	116	475393	114	481051	44	487906	57
91585	118	454725	114	468248	97	475395	116	481057	44	487907	57
91586	118	454734	105	467895	79, 81, 83, 84, 85, 96	475396	116	481058	44	487908	57
91589	118	454726	114	468716	32	475397	116	481059	44	487909	57
91590	118	454735	105	468718	32	475405	116	481060	44	487910	57
91522	243	454727	114	468730	6, 15	475407	116	481071	44	487995	19
91584	243	454736	105	468720	32	475408	116	481077	44	488041	45
91585	243	454728	114	468722	32	475336	243	481078	44	488146	105
91586	243	455020	44	468771	141	476105	63	481079	44	488148	105
91589	243	455021	44	469619	40, 41, 54	476156	63	481080	44	488398	105
91590	243	455022	44	470194	42	476302	97	481317	97	488543	86
93931	45	455019	33, 42	471218	23	476734	45	481742	32	488525	141
415171	207, 225, 226	455299	243	471230	23	476735	45	482008	17	488780	86
415172	207, 225, 226	455535	243	471286	10	476737	45	482009	17	488872	86
415173	207, 225, 226	455696	243	471298	10	476955	42	482010	17	488914	45
415834	203	456568	141	471310	10	476956	42	481954	86	489119	90
415837	218	456975	15	471501	42	476928	105	482024	17	489219	13
415865	212	457126	23	471511	44	477149	96	482025	17	489353	13
415869	212	458480	86, 91	471512	44	477150	96	482026	17	489360	105
415870	212	458481	86, 91	471513	44	477477	105	482002	116	489364	105
415871	212	458702	116	471681	17	477478	105	482610	33	489368	105
415872	212	459458	159	471682	17	477479	105	482612	33	490143	31
415873	212	459867	28	471684	17	477482	105	482618	33	491046	19
415940	212	459867	29	471777	42	477483	105	482702	33	491041	97
415941	212	459942	97	471778	42	477484	105	484225	44	491500	15
415942	212	460018	105	471779	42	478116	32	484340	105	491514	44
415943	212	460069	105	472859	22	478117	32	484689	33	491515	44

## Part Number Index

491513	.....41, 44	506209	.....201	628768	.....42	697518	.....157	802673	.....57	804428	.....87, 88, 89, 90
491860	.....17	506216	.....218	628770	.....42	697550	.....153	802674	.....57	804769	.....98
491862	.....17	506252	.....207	629671	.....42	710210	.....98	802675	.....57	804770	.....98
491864	.....17	506259	.....208	629672	.....42	710288	.....78	802676	.....57	804655	.....243
492307	.....29, 44	506266	.....207	629673	.....42	710274	.....96	802677	.....57	804589	.....87, 88, 89, 90
492514	.....87	506270	.....222	629980	.....42	710331	.....98	802678	.....57	804939	.....117
492586	.....45	506273	.....222	629981	.....42	710289	.....95, 96	802679	.....57	804940	.....117
492559	.....105	506274	.....222	630305	.....42	710391	.....89	802680	.....57	804944	.....117
492566	.....106	506275	.....222	630306	.....42	710386	.....85, 100	802681	.....57	804946	.....117
492567	.....106	506277	.....222	630307	.....42	710483	.....100	802682	.....57	804947	.....117
492568	.....106	506282	.....222	630311	.....42	710533	.....98	802683	.....57	805078	.....15, 17
492790	.....13	506283	.....222	630312	.....42	710544	.....89	802684	.....57	805456	.....15
492796	.....57	506308	.....208	630313	.....42	710565	.....99	802685	.....57	806253	.....98
492797	.....57	506312	.....222	631870	.....42	710566	.....99	802686	.....57	806211	.....141
492827	.....23, 45	506329	.....222	633352	.....29, 44	710776	.....99	802687	.....57	806255	.....97
492870	.....88, 89	506362	.....218	636459	.....42	710882	.....84	802688	.....57	806462	.....24
493020	.....10, 20, 23	506379	.....207	636460	.....42	710948	.....80	802689	.....57	806463	.....24
493028	.....19, 20, 23	506388	.....222	636473	.....42	710946	.....84	802690	.....57	806464	.....24
493064	.....19, 20, 23	506389	.....222	636913	.....80	710981	.....86	802701	.....57	806465	.....24
493072	.....10, 19, 20, 23	506390	.....222	637266	.....81	711014	.....99	802702	.....57	806482	.....22
493108	.....10, 19, 20, 23	506391	.....222	637851	.....42	711056	.....98	802703	.....57	806775	.....30
493116	.....10, 19, 20, 23	506420	.....216	655789	.....89	711058	.....98	802704	.....57	806776	.....30
493581	.....15, 63	506222	.....214, 218	655837	.....87	711060	.....98	802705	.....57	806777	.....30
493579	.....97	506232	.....214, 218	655864	.....86	711064	.....98	802972	.....105	806779	.....30
493580	.....97	506254	.....225, 226	655865	.....86	711066	.....98	802975	.....105	806734	.....97
493928	.....10	506255	.....225, 226	655866	.....86	711070	.....98	803102	.....97	806736	.....97
494450	.....97	506492	.....218	655863	.....90	711072	.....98	803196	.....15	806740	.....98
495188	.....62	506507	.....210	655868	.....86	711074	.....98	803100	.....243	807052	.....41
495189	.....62	506509	.....210	655869	.....86	711076	.....98	803622	.....15	807053	.....41
495853	.....105	506572	.....208	655931	.....86	711078	.....98	803943	.....87	807024	.....87
495854	.....105	506568	.....218	655933	.....86	711082	.....98	803944	.....87	807472	.....91
495855	.....105	506563	.....225	655934	.....86	711088	.....98	803945	.....88	807570	.....40, 41, 54
495856	.....105	506590	.....218	655932	.....89	711062	.....84, 98	803946	.....89	807586	.....40, 41, 54
495858	.....105	506615	.....201	655935	.....86	711068	.....78, 98	803948	.....88	808071	.....7
495862	.....105	506603	.....218	695888	.....141	711174	.....96	803949	.....90	808072	.....7
496081	.....19, 25	506613	.....218	695943	.....141	711175	.....96	803950	.....88, 90	808073	.....7
496075	.....105	506614	.....218	695946	.....141	711227	.....101	803947	.....88, 89, 90	808074	.....6, 7
497101	.....90	506632	.....206	696095	.....22	711228	.....101	804135	.....90	808075	.....6, 7
497606	.....87	506622	.....218	696095	.....141	711229	.....101	804141	.....87	808076	.....6, 7
497652	.....87	506643	.....207	696192	.....46	791923	.....141	804140	.....89	808247	.....17
497661	.....90	506636	.....225	696193	.....46	791928	.....141	804142	.....88	808249	.....17
497662	.....90	506637	.....225	696688	.....139	791930	.....141	804132	.....87, 88	808253	.....17
497663	.....89	506645	.....226	696757	.....243	791933	.....141	804133	.....87, 88	808255	.....17
497649	.....87, 88	506646	.....226	696758	.....243	793020	.....19	804138	.....87, 88	808259	.....17
497664	.....88, 89, 90	506647	.....226	696759	.....243	800044	.....39	804134	.....87, 88, 89, 90	808261	.....17
497665	.....87, 88, 89, 90	506649	.....226	697285	.....16	800300	.....87	804136	.....87, 88, 89, 90	808358	.....42
501443	.....210	506669	.....206	697286	.....16	800359	.....115	804405	.....87	808977	.....98
505088	.....202	506672	.....206	697287	.....16	800360	.....115	804406	.....87	808978	.....98
505197	.....202	506673	.....207	697325	.....16	800694	.....39	804358	.....140	809241	.....97
505204	.....202	506667	.....218	697259	.....139	800695	.....39	804411	.....87	809242	.....97
505210	.....202	506668	.....218	697261	.....139	800696	.....39	804419	.....87	809243	.....97
505211	.....202	506662	.....225	697290	.....139	800697	.....39	804421	.....87	809351	.....98
505217	.....202	506665	.....226	697382	.....14, 62	800706	.....39	804396	.....114	809858	.....62
505233	.....206	506648	.....225, 226	697445	.....16	800710	.....39	804423	.....87	809872	.....40, 41, 54
505230	.....238	506663	.....225, 226	697446	.....16	800805	.....42	804397	.....114	809999	.....6, 15
505282	.....204	507002	.....235	697447	.....16	800986	.....39	804425	.....89	810829	.....30
505298	.....204	507005	.....238	697448	.....16	801012	.....39	804426	.....89	810831	.....30
505318	.....186	507006	.....238	697383	.....6, 14, 62	801014	.....39	804429	.....90	810832	.....30
505314	.....210	507144	.....186	697449	.....16	801016	.....42	804433	.....90	811940	.....39
506202	.....201	506682	.....207, 225, 226	697444	.....6, 16	801049	.....97	804435	.....89	811984	.....39
506203	.....201	507130	.....216	697459	.....16	801050	.....97	804416	.....88, 89	812022	.....15, 17
506204	.....201	507131	.....216	697410	.....139	801051	.....97	804532	.....97	812144	.....98
506205	.....201	507151	.....214	697500	.....155	801628	.....16	804418	.....87, 89, 90	812217	.....41
506206	.....201	507405	.....210	697515	.....151	801582	.....78	804638	.....15, 63	812958	.....58
506207	.....201	625528	.....28	697514	.....153	802671	.....57	804631	.....117	812973	.....58
506208	.....201	628208	.....42	697517	.....151	802672	.....57	804629	.....140	813138	.....15

## Part Number Index

813139	15	815565	105	818409	109	10016757	10	10030271	225	10037101	233
813140	15	815570	105	818410	109	10016568	216	10030272	225	10037649	38
813209	17	815692	7	818411	109	10016682	216	10030273	225	10037651	38
813210	17	815696	7	818412	109	10016569	214, 216	10030274	226	10037653	38
813211	17	815700	7	818413	109	10016683	216, 218	10030275	226	10037648	35, 38
813212	17	815704	100	818414	109	10017089	41	10030276	226	10037650	35, 38
813213	17	816137	24	1016379	148	10017593	207	10030277	226	10037652	35, 38
813218	17	816115	40, 41, 54	8165130	17	10017594	207	10030608	208	10037809	62
813341	62	816287	13	10002820	206	10017595	207	10030601	228	10038445	148
813334	89	816283	33	10003206	206	10017596	207	10030602	228	10038846	151
813411	100	816284	33	10003213	206	10017931	201	10031309	9	10039114	139
813718	97	816357	12	10003344	146	10017933	201	10031340	9	10039982	38
813720	98	816515	17	10004291	145	10019085	223	10031341	9	10039983	38
813859	24	816517	17	10004277	199	10020062	183	10031342	9, 20, 23	10040054	62
813860	24	816661	13	10004689	105	10020065	183	10031343	9, 20, 23	10040055	62
813861	24	816662	13	10005607	146	10020066	183	10031344	9, 20, 23	10040052	17, 62
813778	88, 90	816697	7	10006227	17	10020067	183	10031348	109	10040002	83, 84
813929	86	816701	7	10006446	201	10020541	80	10031542	15	10040010	220
814349	100	816705	7	10006447	201	10020871	157	10031543	15	10040018	238
814350	100	816693	41	10006463	201	10021292	105	10031797	58	10040586	78
814343	115	816651	116	10006464	201	10021840	199	10031798	58	10040589	80
814322	139	816654	116	10006465	201	10022087	157	10032511	17, 62	10040664	78, 80
814497	100	816645	106, 113	10006466	201	10022871	14, 62	10032698	194	10040665	78, 80
814559	100	816648	114, 115	10006467	201	10022826	223	10032731	182	10040667	78, 80
814866	98	816939	7	10006468	201	10022827	223	10032925	62	10040791	97
814978	100	816943	7	10006469	201	10023055	59	10032927	62	10041195	57
814979	100	816947	7	10006470	201	10023016	215	10033360	233	10041196	57
815009	105	817040	24	10007047	97	10023017	215	10033650	118	10041197	57
815175	13	817446	15, 17	10007049	98	10023480	19	10033651	118	10041198	57
815176	13	817590	24, 62	10007650	86	10023481	19	10033652	118	10041199	57
815177	13	817890	161	10007651	86	10023482	19	10033653	118	10041105	83, 84
815178	13	818040	161	10007652	86	10023483	19	10033654	118	10041107	83, 84
815179	13	818264	24	10007653	86	10023485	196	10033655	118	10041230	57
815180	13	818342	13	10007654	86	10023487	204	10033718	148	10041231	57
815181	13	818343	13	10007782	215	10023490	204	10033719	151	10041232	57
815182	13	818344	13	10007783	215	10023932	193	10033740	154	10041225	78
815184	13	818346	13	10008174	155	10023933	193	10034018	112	10041517	173
815185	13	818347	13	10008175	155	10023936	193	10034019	112	10041518	173
815186	13	818354	13	10008292	46	10023937	193	10034020	112	10041519	173
815188	13	818355	13	10008293	46	10023938	193	10034022	112	10041590	173
815355	12	818276	117	10008906	24	10024074	59	10034023	112	10041591	173
815356	12	818384	109	10008907	24	10023970	193	10034026	112	10041592	173
815357	12	818385	109	10008908	24	10023971	193	10034027	112	10041593	173
815358	12	818386	109	10008909	24	10025945	19	10034028	112	10041594	173
815359	12	818387	109	10009332	146	10026005	148	10034029	112	10041595	173
815361	12	818388	109	10009333	146	10026060	196	10034031	112	10041596	173
815362	12	818389	109	10009971	6, 14, 19, 62	10026061	209	10034032	112	10041597	173
815363	12	818390	109	10010162	97	10026064	209	10034035	112	10041598	173
815364	12	818391	109	10010420	13, 31	10026265	24	10034150	19	10041599	173
815365	12	818392	109	10010421	13, 31	10027104	196	10034151	19	10041600	173
815366	12	818393	109	10010572	151	10027944	155	10034152	19	10041603	173
815368	12	818394	109	10011745	215	10028444	186	10034153	19	10041604	173
815369	12	818395	109	10011744	214, 215	10028995	9	10034154	19	10041607	173
815392	12	818396	109	10012167	55	10028996	9	10034155	19	10041608	173
815394	12	818397	109	10012530	46	10028998	9, 20, 23	10034088	112	10041609	173
815307	100	818398	109	10012847	156	10028999	9, 20, 23	10034184	24	10041610	173
815308	100	818399	109	10013150	223	10029000	9, 20, 23	10034097	112	10041611	173
815397	12	818400	109	10013151	223	10029298	15	10034041	182	10041612	173
815401	12	818401	109	10013152	223	10029823	17	10034391	78, 95, 96	10041615	173
815444	7	818402	109	10013153	223	10029693	158	10034966	112	10041616	173
815448	7	818403	109	10013407	32	10030023	234	10034967	112	10042346	19
815452	7	818404	109	10013077	214, 215	10030025	232	10034943	157	10042621	78, 80
815507	87	818405	109	10013393	140	10030024	234	10035698	233	10042622	78, 80
815641	12	818406	109	10016468	207	10030026	236	10036032	220	10042902	59
815558	105	818407	109	10016755	10	10030325	83, 84	10036456	141	10042903	60
815562	105	818408	109	10016756	10	10030270	225	10037098	141	10042904	60

## Part Number Index

10042905	.61	10044994	.81	10046944	.81	10050985	.78	10054791	.34	10061273	.145
10042906	.60	10044995	.81	10046945	.81	10050976	.78, 80	10054792	.34	10061291	.145
10042907	.60	10044998	.86	10046946	.81	10051117	.76	10054793	.34	10061292	.145
10042908	.60	10045164	.38	10046947	.81	10051141	.76	10054719	.174	10061404	.60
10042909	.60	10045165	.38	10047084	.191	10051142	.76	10054720	.174	10061512	.105
10042920	.61	10045035	.78, 79, 94, 98	10047085	.191	10051143	.76	10054761	.174	10061514	.105
10042921	.60	10045662	.60	10047086	.191	10051144	.76	10054762	.174	10061515	.105
10042922	.61	10045663	.60	10047087	.191	10051146	.76	10055501	.60	10061516	.105
10042923	.61	10045664	.61	10047342	.56	10051147	.76	10055659	.227	10061629	.61
10042924	.60	10045665	.60	10047392	.81	10051148	.76	10055660	.227	10061630	.60, 61
10042925	.60	10045666	.60	10047342	.81, 85	10051149	.76	10055716	.206	10062364	.95
10042926	.61	10045667	.60	10047349	.79, 81	10051150	.76	10055717	.206	10062365	.95
10042927	.61	10045668	.60	10047370	.79, 81	10051151	.76	10055718	.206	10062366	.95
10042928	.61	10045669	.60	10047463	.80	10051152	.76	10055719	.206	10062597	.206
10042930	.60	10045690	.61	10047595	.81	10051153	.76	10055721	.227	10063431	.186
10042931	.60	10045691	.61	10048185	.81	10051154	.76	10056424	.6, 15, 17	10063441	.186
10042932	.60	10045692	.61	10048279	.97	10051177	.76	10056762	.202	10063654	.174
10042933	.60	10045693	.60	10048342	.175	10051178	.76	10056763	.202	10063656	.174
10042934	.60	10045694	.60	10048343	.175	10051179	.76	10057420	.105	10063880	.56
10042792	.204	10045695	.61	10048344	.175	10051176	.80	10057441	.105	10064644	.26
10042935	.61	10045696	.61	10048345	.175	10051181	.76	10057442	.105	10064645	.26
10042793	.204	10045697	.61	10048348	.175	10051182	.76	10057443	.105	10064623	.60
10042936	.61	10045699	.60	10048349	.175	10051183	.76	10057444	.105	10064766	.81
10042794	.204	10045700	.60	10048432	.175	10051184	.76	10057445	.105	10064866	.191
10042937	.61	10045701	.60	10048433	.175	10051185	.76	10057446	.105	10065330	.20
10042938	.60	10045702	.60	10048280	.78, 79, 94, 98	10051186	.76	10057447	.105	10065326	.15, 22
10042795	.204	10045703	.60	10048789	.78	10051187	.76	10057505	.60	10065849	.148
10042939	.60	10045704	.61	10048788	.98	10051188	.76	10058021	.98	10065850	.150
10042940	.60	10045705	.61	10048790	.98	10051286	.24, 25	10058022	.98	10065847	.156
10042941	.60	10045706	.61	10048887	.80	10051287	.24, 25	10058023	.98	10066049	.81
10042942	.60	10045707	.60	10048888	.98	10051288	.24, 25	10058088	.61	10066681	.26
10042943	.60	10045708	.60	10048889	.98	10051290	.59	10058089	.61	10066739	.46
10042944	.60	10045709	.60	10048890	.98	10051539	.80	10058090	.60	10066740	.46
10042945	.60	10045710	.60	10048981	.98	10051717	.80	10058318	.105	10067469	.23
10042946	.60	10045711	.60	10049053	.81	10051803	.80	10058319	.105	10067470	.23
10042947	.60	10045712	.60	10049098	.80	10052511	.76	10058320	.105	10067491	.23
10042948	.60	10045713	.60	10049057	.78, 80	10052512	.80	10058321	.105	10067523	.60
10042949	.60	10045714	.60	10049058	.78, 80	10052513	.80	10058322	.105	10067411	.179
10042950	.60	10045715	.60	10049363	.60	10052514	.80	10058323	.105	10067415	.179
10042951	.60	10045716	.60	10049410	.56	10052515	.80	10058324	.105	10068013	.26
10042952	.60	10045717	.60	10049406	.81	10052744	.48	10058326	.105	10068059	.81
10042953	.61	10045718	.60	10049412	.80	10052745	.48	10058886	.200	10068129	.23
10042954	.61	10045719	.60	10049410	.81, 85	10052776	.24, 25	10059039	.81	10068152	.21, 23
10042955	.61	10045720	.60	10049623	.21	10052777	.24, 25	10059040	.81	10068195	.23
10042956	.61	10045721	.60	10049630	.20	10052778	.24, 25	10059112	.21	10068237	.60
10042957	.61	10045722	.61	10049631	.21	10052779	.24, 25	10059116	.81	10068310	.26
10042958	.61	10045723	.61	10049522	.180	10052780	.24, 25	10059441	.60	10068529	.161
10042959	.61	10045724	.61	10049585	.161	10052781	.24, 25	10059671	.152	10068832	.156
10042960	.61	10045725	.61	10049680	.80	10052945	.110	10059903	.23	10068911	.139
10042961	.61	10045726	.61	10049691	.80	10052947	.110	10059837	.193	10069498	.81
10042962	.61	10045727	.61	10049692	.80	10052995	.173	10059805	.227	10069856	.81
10043147	.186	10045728	.61	10049804	.80	10053000	.173	10059806	.227	10069857	.81
10043414	.38	10045729	.61	10049805	.80	10053001	.173	10059807	.227	10069894	.72, 79, 83, 84
10043418	.38	10045730	.61	10049806	.80	10053008	.173	10059808	.227	10070362	.60
10043432	.38	10045778	.61	10049807	.80	10053015	.193	10059809	.227	10070423	.185
10043413	.35, 38	10045779	.61	10049808	.80	10053455	.161	10060101	.185	10070424	.185
10043415	.35, 38	10046042	.81	10050122	.80	10053558	.200	10060102	.185	10070431	.185
10043416	.35, 38	10045936	.193	10050347	.80	10053559	.200	10060139	.190	10070432	.185
10043417	.35, 38	10045938	.193	10050333	.72, 79, 81	10053716	.60	10060140	.190	10070439	.185
10043419	.35, 38	10046087	.61	10050504	.200	10053794	.79, 81	10061123	.106	10070440	.185
10043430	.35, 38	10046120	.61	10050611	.110	10053795	.79, 81	10061244	.61	10070443	.185
10043431	.35, 38	10046121	.61	10050613	.110	10054402	.174	10061127	.114, 115	10070444	.185
10043433	.35, 38	10046122	.61	10050750	.80	10054403	.174	10061128	.116, 118	10070451	.185
10043434	.35, 38	10046123	.61	10050744	.98	10054586	.81	10061128	.243	10070452	.185
10044576	.17	10046570	.24, 25	10050841	.80	10054667	.80	10061229	.145	10070463	.185
10044576†	.17	10046528	.72, 79	10050856	.80	10054790	.34	10061271	.145	10070464	.185



## Part Number Index

10070471 .....185	10074070 .....113	10076728 .....83	10083783 .....8	10086662 .....55	10088260 .....194
10070472 .....185	10074071 .....113	10076729 .....83	10083784 .....8	10086663 .....55	10088261 .....194
10070916 .....152	10074072 .....113	10076730 .....83	10083785 .....8	10086664 .....55	10088262 .....194
10070918 .....151	10074073 .....113	10076731 .....83	10083786 .....8	10086665 .....55	10088263 .....194
10070917 .....153	10074077 .....113	10076732 .....83	10083787 .....8	10086639 .....72,79	10088264 .....194
10070921 .....151	10074084 .....113	10076733 .....83	10083788 .....8	10087129 .....20	10088265 .....194
10070919 .....154	10074132 .....83	10076735 .....83	10083789 .....8	10087130 .....21	10088266 .....194
10071231 .....23	10074135 .....83	10076736 .....83	10083790 .....8	10087152 .....21	10088267 .....194
10071157 .....110	10074136 .....83	10077063 .....8, 15, 22	10083791 .....8, 9	10087003 .....206	10088268 .....194
10071159 .....110	10074137 .....83	10077384 .....85	10083795 .....8, 20	10087218 .....106	10088269 .....194
10071334 .....84	10074474 .....211	10077385 .....85	10083799 .....8, 20	10087220 .....106, 113	10088099 .....70, 72, 79, 81, 83
10071335 .....84	10074475 .....211	10077490 .....177	10083803 .....8, 20	10087399 .....145	10088390 .....201
10071336 .....84	10074476 .....211	10077489 .....186	10083793 .....8, 19, 20	10087426 .....145	10089177 .....32
10071337 .....84	10074477 .....211	10077571 .....177	10083797 .....8, 19, 20	10087431 .....144	10089210 .....32
10071338 .....84	10074480 .....211	10077572 .....177	10083794 .....8, 20, 23	10087432 .....144	10089321 .....79
10071340 .....84	10074725 .....21	10077573 .....177	10083801 .....8, 19, 20	10087433 .....144	10089205 .....208
10071361 .....84	10074582 .....211	10077853 .....185	10083798 .....8, 20, 23	10087436 .....145	10089209 .....208
10071362 .....84	10074584 .....211	10077855 .....185	10083802 .....8, 20, 23	10087895 .....36	10089665 .....21
10071363 .....84	10074736 .....193	10078201 .....21	10083792 .....8, 19, 20, 23	10087897 .....36	10089207 .....208, 214, 228
10071364 .....84	10074819 .....112	10078469 .....21	10083843 .....21	10087913 .....72, 79	10090058 .....203
10071688 .....186	10074820 .....112	10079479 .....110	10083796 .....8, 19, 20, 23	10088107 .....30	10091194 .....60
10072098 .....87	10075204 .....23	10080222 .....78	10083800 .....8, 19, 20, 23	10088109 .....30	10091352 .....23
10072237 .....25	10075205 .....23	10080224 .....78	10083875 .....56	10088110 .....30	10091446 .....52
10072223 .....60	10075206 .....23	10080454 .....21	10083876 .....56	10088121 .....30	10091447 .....52
10072240 .....56	10075207 .....23	10080455 .....21	10084078 .....113	10088132 .....30	10091873 .....31
10072478 .....177	10075756 .....56	10080456 .....21	10084079 .....113	10088134 .....30	10091958 .....21
10072479 .....177	10075799 .....21	10080532 .....83	10084080 .....113	10088135 .....30	10091952 .....31
10072480 .....177	10075904 .....35, 38	10080534 .....83	10084081 .....113	10088136 .....30	10092034 .....36
10072481 .....177	10075893 .....85	10081098 .....34	10084082 .....113	10088150 .....21	10092036 .....36
10072482 .....177	10075905 .....35, 38	10081099 .....34	10084083 .....113	10088065 .....193	10092015 .....111
10072483 .....177	10075908 .....35, 38	10081100 .....34	10084084 .....113	10088066 .....193	10092163 .....113
10072472 .....189	10075909 .....35, 38	10081114 .....20	10084088 .....113	10088067 .....193	10092166 .....209
10072484 .....177	10075910 .....35, 38	10081115 .....20	10084095 .....113	10088068 .....193	10092167 .....209
10072473 .....189	10075911 .....35, 38	10081116 .....20	10084541 .....19	10088069 .....193	10092168 .....209
10072485 .....177	10075914 .....35, 38	10081117 .....20	10084542 .....19	10088070 .....193	10092169 .....209
10072474 .....189	10075915 .....35, 38	10081171 .....34	10084543 .....19	10088071 .....193	10092170 .....209
10072486 .....177	10075916 .....35, 38	10081205 .....29, 44	10084544 .....19	10088073 .....191	10092233 .....72, 79
10072475 .....189	10075917 .....35, 38	10081206 .....29, 44	10084545 .....19	10088072 .....193	10092191 .....209
10072487 .....177	10075920 .....35, 38	10081414 .....21	10084546 .....19	10088074 .....191	10092192 .....209
10072488 .....177	10075921 .....35, 38	10081570 .....205	10084547 .....19	10088075 .....191	10092193 .....209
10072489 .....177	10076107 .....21	10081594 .....205	10084548 .....19	10088064 .....203	10092521 .....84
10072490 .....177	10076108 .....21	10082281 .....21	10084549 .....19	10088076 .....191	10092522 .....84
10072491 .....177	10076109 .....21	10082233 .....110	10084550 .....19	10088077 .....193	10092523 .....84
10072492 .....177	10076110 .....21	10082234 .....110	10084551 .....19	10088192 .....78	10092733 .....60
10072493 .....177	10076124 .....189	10082235 .....110	10084552 .....19	10088120 .....195	10092878 .....145
10072494 .....177	10076419 .....193	10082441 .....21	10084689 .....52	10088179 .....152	10092879 .....145
10072495 .....177	10076692 .....85	10082555 .....17	10084690 .....52	10088212 .....195	10092880 .....145
10072496 .....177	10076695 .....85	10082569 .....185	10084611 .....173	10088213 .....194	10092959 .....211
10072497 .....177	10076698 .....85	10082570 .....185	10084612 .....193	10088214 .....194	10093301 .....60
10072498 .....202	10076701 .....85	10082683 .....206	10084820 .....21	10088215 .....194	10093348 .....197
10072499 .....202	10076704 .....85	10083134 .....55	10084753 .....93	10088216 .....194	10093349 .....197
10072789 .....207	10076707 .....85	10082834 .....70, 72, 79, 81, 83, 95	10084754 .....93	10088217 .....194	10093350 .....197
10073293 .....61	10076710 .....85	10083329 .....21	10084755 .....93	10088219 .....195	10093351 .....197
10073346 .....83, 84	10076713 .....85	10083330 .....21	10084758 .....93	10088220 .....195	10093352 .....197
10073424 .....161	10076716 .....83	10083327 .....46	10084821 .....52	10088221 .....195	10093353 .....197
10073425 .....161	10076717 .....83	10083381 .....21	10084822 .....52	10088234 .....195	10093354 .....197
10073426 .....161	10076718 .....83	10083382 .....21	10084823 .....52	10088235 .....195	10093355 .....197
10073702 .....26	10076719 .....83	10083383 .....21	10084824 .....52	10088236 .....195	10093356 .....197
10073703 .....26	10076720 .....83	10083384 .....21	10084825 .....52	10088246 .....196	10093357 .....197
10073581 .....194	10076721 .....83	10083385 .....21	10084826 .....52	10088247 .....196	10093358 .....197
10073708 .....189	10076722 .....83	10083386 .....21	10084827 .....52	10088253 .....190	10093729 .....60
10073923 .....26	10076723 .....83	10083618 .....21	10084828 .....52	10088248 .....196	10093730 .....60
10073847 .....206	10076724 .....83	10083591 .....78	10084829 .....52	10088255 .....190	10093608 .....233
10074067 .....113	10076725 .....83	10083760 .....8	10084830 .....52	10088256 .....190	10093986 .....36
10074068 .....113	10076726 .....83	10083781 .....8	10084834 .....93	10088257 .....190	10093987 .....36
10074069 .....113	10076727 .....83	10083782 .....8	10085084 .....21	10088259 .....194	10093988 .....36

## Part Number Index

10094314	23	10098031	139	10105943	170	10107732	17	10111358	186	10114949	78
10094315	23	10098032	139	10105944	170	10107741	43	10111642	57	10114950	78
10094316	23	10098766	56	10105945	170	10107779	40	10111729	149	10115118	70
10094384	204	10098767	56	10105946	170	10107780	40	10111823	144	10115119	70
10094605	144	10098855	78, 94	10105947	170	10107811	40	10111826	144	10115120	70
10094830	78	10099397	78	10105948	170	10107812	43	10111829	144	10115141	70
10095162	19	10099648	78	10105949	170	10107813	43	10111832	144	10115142	70
10095163	19	10100094	57	10105950	170	10107814	43	10112708	171	10115143	70
10095164	19	10100095	57	10105951	170	10107815	43	10112709	171	10115109	214
10095165	19	10100096	57	10105952	170	10107816	43	10112710	171	10115110	214
10095166	19	10100097	57	10105953	170	10107817	43	10112741	171	10115730	119
10095181	19	10101146	206	10105956	170	10107821	44	10112742	171	10115821	120
10095182	19	10101135	233	10105957	170	10107822	44	10112743	171	10115822	119
10095183	19	10101535	111	10105960	170	10107823	44	10112744	171	10115836	122
10095184	19	10101776	173	10105961	170	10107818	58	10112745	171	10115837	122
10095185	19	10101854	111	10106268	159	10107819	58	10112746	171	10115839	123
10095186	19	10102002	214	10106270	159	10107820	58	10112747	171	10115827	136
10095187	19	10102180	111	10106281	158	10107835	58	10112750	171	10115828	136
10095188	19	10102193	105	10106282	158	10107853	196	10112751	171	10115840	124
10095189	19	10102194	105	10106375	78	10108138	43	10112752	171	10115841	123
10095190	19	10102195	105	10106381	149	10108494	30	10112753	171	10115842	123
10095191	19	10102196	105	10106378	153	10108493	34	10112754	171	10115843	123
10095192	19	10102233	105	10106383	149	10108495	34	10112755	171	10115844	129
10095193	19	10102234	105	10106380	154	10108496	36	10112758	171	10115845	130
10095194	19	10102686	207	10106384	150	10108567	8	10112759	171	10115846	129
10095195	19	10103213	183	10106382	153	10108568	8	10112760	171	10115851	127
10095196	19	10103216	183	10106385	150	10108569	8	10112761	171	10115853	125
10095197	19	10103217	183	10106386	154	10108570	8	10112762	171	10115848	131
10095198	19	10103218	183	10106621	72, 79	10108571	8	10112763	171	10115849	130
10095325	115	10103262	78, 94	10106623	72, 79	10108545	35	10112764	171	10115854	125
10095353	173	10103864	21	10106726	78	10108572	8	10112765	171	10115852	128
10095739	21	10103908	110	10106727	78	10108547	35	10112770	171	10115847	135
10095740	21	10104254	110	10106728	78	10108549	35	10112771	171	10115850	132
10095741	21	10104611	185	10106722	72, 78, 79	10108561	35	10112772	171	10115855	127
10095742	21	10104708	198	10106725	244	10108563	35	10112773	171	10115856	127
10095744	21	10104709	198	10106729	244	10108565	35	10112774	171	10115857	128
10095745	21	10104710	198	10106725	72, 74, 78, 79	10108573	8, 20	10112775	171	10115863	122
10095746	21	10104791	198	10106729	72, 74, 78, 79	10108574	8, 20	10112776	171	10115859	133
10095747	21	10104792	198	10106935	196	10108575	8, 20	10112777	171	10115860	133
10095748	21	10104793	198	10107257	17	10108576	8, 20	10113157	189	10115861	134
10095800	48	10104794	198	10107229	17, 62	10108577	8, 20	10113158	189	10115862	134
10095801	48	10104795	198	10107256	17, 62	10108578	8, 20	10113159	189	10116028	191
10095802	48	10104796	198	10107200	190	10108593	30	10113162	189	10116452	48
10095803	48	10104797	198	10107201	190	10108592	36	10113163	189	10116453	48
10095804	48	10104798	198	10107202	190	10108594	34	10113164	189	10116454	48
10095805	48	10104925	110	10107207	191	10108643	60	10113328	43	10116522	120
10095806	48	10105210	78	10107208	191	10108731	185	10113329	43	10116617	43
10095807	48	10105251	78	10107209	191	10108743	177	10113330	43	10116618	43
10095774	72, 79	10105271	214	10107210	191	10108744	177	10113341	43	10116619	43
10095987	113	10105650	78	10107326	202	10108745	177	10113342	43	10116539	136
10095988	113	10105612	214	10107526	43	10108767	177	10113343	43	10116556	126
10095989	113	10105756	95	10107527	43	10108768	177	10113344	43	10116557	126
10095990	113	10105656	214	10107537	40	10108769	177	10113345	43	10116558	126
10096141	113	10105839	78	10107536	44	10108770	177	10113346	43	10116638	78
10096142	113	10105883	58	10107538	43	10110029	72, 79	10113347	43	10116627	121
10097493	204	10105889	170	10107539	43	10110030	72, 79	10113348	43	10116628	121
10097807	6	10105890	170	10107541	43	10110061	72, 79	10113349	43	10116781	48
10097810	6	10105931	170	10107542	43	10110062	72, 79	10113240	186	10116782	48
10097881	6	10105932	170	10107543	43	10110443	72	10113493	167	10116783	48
10097883	6	10105933	170	10107544	43	10110444	72	10113494	167	10116961	32
10097884	6	10105935	170	10107546	43	10110445	72	10114190	53	10116924	70
10097886	6	10105936	170	10107545	43, 44	10110446	72	10114750	78	10116962	32
10097888	6	10105939	170	10107602	72	10110420	149	10114835	78	10116925	70
10097891	6	10105940	170	10107603	72	10110419	155	10114839	78	10116926	70
10097887	6, 15	10105941	170	10107710	17	10110670	186	10114853	78	10116927	70
10097899	6, 15	10105942	170	10107731	17	10111404	57	10114837	70, 78	10116928	70

## Part Number Index

10116929	70	10120724	199	10126657	95	B-60170-030	25	SSH91725C301	182	SRS5980	230
10117271	186	10121212	74	10127111	95	B-60141-036	25	SSH91725D001	182	SRS5990	230
10117244	214	10121213	72, 79	10127112	95	B-60141-030	25	SSH91725D301	182	SRB430101	231
10117495	136	10121266	119	10127293	215	B-30060-001	25	SHW26	186	SRB430105	231
10117496	136	10121267	120	10127295	215	S-30019	25	SWL4068706LS	194	SRB430201	231
10117750	122	10121268	119	10127427	78, 95	B-20090-001	25	SCL4067304LS	195	SRB430601	231
10117781	122	10121217	72, 74, 79	10127518	95	B-20040-001	25	SCL4067305LS	195	SRB430605	231
10117782	124	10121413	34	10127527	118	S-20036	25	SCL4067306LS	195	SRP500500050	231
10117783	124	10121416	34	10127422	244	M-20020	25	SNL4048404LS	195	SRP500700050	231
10117738	78, 94	10121212	244	10127422	72, 74, 79, 95	B-10079-001	25	SNL4048406LS	195	SRP5020550050	231
10118094	122	10121217	244	10127545	206	D2056734	15, 19	SFP6902001	199	SRP504860L050	231
10118417	138	10121712	51	10127808	95	C217091	117	SFP6902002	199	SRP5048635L050	231
10118418	138	10121713	51	10127944-SP	40, 41, 54	C217092	117	SFP6902008	199	SRP5048665L050	231
10118419	138	10121714	51	10127945-SP	40, 41, 54	C217093	117	SWL3268702LS	202	SRP508760050	231
10118420	138	10121715	51	10127946-SP	40, 41, 54	C217094	117	SWL3268703LS	202	SRP508960050	231
10118421	137	10121716	53	10128625	94	C217095	117	SWL3268704LS	202	SRP510660SL050	231
10118422	138	10121717	53	10128626	94	C217096	117	SWL3268706LS	202	SRP530961050	231
10118423	138	10121718	53	10128627	94	C217097	117	SNYL537DH306	203	SRP544000050	231
10118424	138	10121719	53	10128628	94	C217098	117	SNYR537DH306	203	SCE107007	232
10118425	137	10121720	53	10128629	94	C217099	117	SSA4002LS	203	SCE107010HD	232
10118426	138	10121721	53	10128630	94	C217100	117	SFP2267402	204	SCE1074411200	232
10118427	137	10121722	53	10128641	94	C217140	117	SFP2267404	204	SRS15200	233
10118480	135	10121723	53	10128642	94	SSH70920000	179	SFP2267503	204	SRS15300	233
10118473	148	10121724	53	10128643	94	SSH70920006	179	SFP2267504	204	SR515400	233
10118474	150	10121725	53	10128644	94	SSH70920008	179	SFP2267506	204	SRP504860SL	234
10118475	155	10121726	53	10129084	205	SSH70920050	179	SFP3267504	204	SRS14001	234
10118476	155	10121727	53	10129085	205	SSH70920056	179	SFP3267506	204	SCE405010	235
10118694	136	10121778	199	10129118	189	SSH80920000	179	SFPRS6000	208	SDC726075	235
10118695	136	10121834	199	10129119	189	SSH80920001	179	SRC613	208	SKITSMT001	235
10118696	136	10122446	120	10129120	189	SSH80920008	179	SRC722	208	SRS3100	235
10118697	136	10122373	198	10129151	189	SSH80920050	179	SRC642	208	SRS3103	235
10118737	196	10122507	177	10129152	189	SSH80920051	179	SRC740	208	SCE109001	236
10118738	196	10122707	177	10129153	189	SSH80925000	179	SDC726050	210	SCE109003	236
10118802	195	10122745	177	10129553	202	SSH80925050	179	SDC726100	210	SFP675009	236
10118803	195	10122746	177	10129654	138	SSH90920000	179	SDC726150	210	SFP675012	236
10118808	190	10123937	95	10129659	138	SSH90920006	179	SLLNL672060LS	212	SRB675009	236
10118804	195	10123938	95	10129597	210	SSH90920050	179	SLLNL672100LS	212	SRC4001	236
10118809	190	10124238	140	10143372	72, 74	SSH90920300	179	SVLR78LS	212	SRS5K200	237
10118810	190	10125177	31	10143372	244	SSH90920350	179	SSH3505017	216	SCE400020	238
10118812	196	10125135	95	10144431	207	SSH90925000	179	SFPLS350050	220	SRH30701	238
10118937	198	10125152	177	10144432	207	SSH90925300	179	SFPLS350100	220	SRH30703	238
10119369	54	10125153	177	10144944	205	SSH30420000	180	SFPLS350150	220	SRS3200	238
10119370	54	10125271	198	10144945	205	SSH30420050	180	SFPLS350200	220	SFP2267406	204, 234
10119236	195	10125272	198	10144946	205	SSH30420060	180	SFPLS353050	220	SSB22040	204, 235
10119391	54	10125297	214	10144947	205	SSH30420070	180	SFPLS353100	220	SRW1000	212, 231
10119392	54	10125298	214	10144948	205	SSH30420300	180	SFPLS353200	220	SRC853	208, 236
10119393	54	10125492	31	10144949	205	SSH30420350	180	SHL1009035BLK	224	SPPPU8710	229, 234
10119394	54	10125912	74	10144950	205	SSH30420360	180	SHL1009060BLK	224	SRB430301	231, 234
10119395	54	10125913	74	10144951	205	SSH30620000	180	SHL2009040	224	SRB430305	231, 234
10119396	54	10125914	74	10144952	205	SSH30620060	180	SHL2009040IW	224	SRP500860	231, 234
10119507	199	10125915	74	10144953	205	SSH30630064	180	SHL2009060	224	SRB430205	231, 235
10119639	194	10125759	238	10144954	205	SSH31535B364	181	SHL2009060IW	224	SRC641	208, 230, 234
10119753	149	10125907	95	10144955	205	SSH31535C364	181	SHLARD6A	227	SRP500900	231, 234, 236
10119755	149	10125910	193	10144956	205	SSH31535D364	181	SHLSR00104	228		
10119754	152	10125921	193	10144957	205	SSH31535E364	181	SHLSR0021000	228		
10119756	150	10125922	193	10144958	205	SSH91535B304	181	SHLSR00501	228		
10119757	152	10125923	193	10144959	205	SSH91535C304	181	SHLSR00601	228		
10119761	148	10125912	244	10144960	205	SSH91535D304	181	SHLSR00703	228		
10119758	152	10125913	244	10144961	205	SSH91535E304	181	SHLSR00801	228		
10119760	150	10125914	244	10144962	205	SSH91635B30438	181	SMI420560	229		
10119762	149	10125915	244	10145138	95	SSH91635C30438	181	SPPPU8708	229		
10119759	154	10126138	95	10147490	238	SSH91635D30438	181	SPPPU8710	229		
10120108	122	10126268	95	10147631	238	SSH91635E30438	181	SPPPU8720	229		
10120050	198	10126378	62	10148159	96	SSH60930001	182	SPPRL4000	229		
10120051	198	10126379	62	101021911	140	SSH60930051	182	SRSF5077	230		
10120052	198	10126437	95	B-60170-036	25	SSH91725C001	182	SRSFFE2120	230		

# MSA—The Safety Company

---

*Our business is safety. We've been the world's leading manufacturer of high-quality safety products since 1914. MSA products may be simple to use and maintain, but they're also highly-sophisticated devices and protective gear — the result of countless R&D hours, relentless testing, and an unwavering commitment to quality that saves lives and protects thousands of men and women each and every day. Many of our most popular products integrate multiple combinations of electronics, mechanical systems, and advanced materials to ensure that users around the world remain protected in even the most hazardous of situations.*

*Our dedication to safety has been the key to our impressive year-over-year growth. In 8 of the past 10 years we've achieved record growth numbers, with annual revenues of more than \$1 billion.*

---

## Our Mission

MSA's mission is to see to it that men and women may work in safety and that they, their families, and their communities may live in health throughout the world.

---

**MSA: Because every life has a purpose.**

Note: This Bulletin contains only a general description of the products shown. While uses and performance capabilities are described, under no circumstances shall the products be used by untrained or unqualified individuals and not until the product instructions including any warnings or cautions provided have been thoroughly read and understood. Only they contain the complete and detailed information concerning proper use and care of these products.



**ID 5555-82-MC / March 2013**  
© MSA 2013 Printed in U.S.A.

**MSA Corporate Center**  
1000 Cranberry Woods Drive  
Cranberry Township, PA 16066 USA  
Phone 724-776-8600  
[www.MSAafety.com](http://www.MSAafety.com)

**U.S. Customer Service Center**  
Phone 1-800-MSA-2222  
Fax 1-800-967-0398

**MSA Canada**  
Phone 1-800-672-2222  
Fax 1-800-967-0398

**MSA Mexico**  
Phone 01 800 672 7222  
Fax 52 - 44 2227 3943

**MSA International**  
Phone 724-776-8626  
Toll Free 1-800-672-7777  
Fax 724-741-1559

**Offices and representatives worldwide**  
For further information: