

Archaeological Excavation and Survey of Scheduled Coastal Alum Working Sites at Boulby, Kettleless, Sandsend and Saltwick, North Yorkshire



ARS Ltd Report No-2015/42
OASIS No: archaeo15-208500

Compiled By:
Samantha Bax, Rupert Lotherington PCIfA and Dr Gillian
Scott
Archaeological Research Services Ltd
The Eco Centre
Windmill Way
Hebburn
Tyne and Wear
NE31 1SR

Checked By:
Chris Scott MCIfA
Tel: 0191 4775111
admin@archaeologicalresearchservices.com
www.archaeologicalresearchservices.com



Contents

List of Figures	3
List of Tables	7
<i>Executive Summary</i>	8
1 Introduction	11
2 Results.....	16
3 Specialist reports	101
4 Discussion.....	105
5 Publicity, Confidentiality and Copyright	118
6 Statement of Indemnity.....	118
7 Acknowledgements	118
References	118
Appendix 1- Context Register	121
Appendix 2- Photograph Register	125
Appendix 3- Figures	129
Appendix 4- Appendix to Sandsend Alum Quarries, North Yorkshire- Aerial Survey Interpretation and Mapping Report.....	150

List of Figures

Figure 1:	Post-excavation photograph of Trench 1. (Scale- 2 x 2m & 2 x 1m).	18
Figure 2:	NNW-facing section through south-western cistern (106) (Scale- 1 x 1m & 1 x 2m).....	18
Figure 3:	NW-facing section through south-western cistern (106) (Scale- 2 x 1m).....	20
Figure 4:	NE-facing section through cistern (322) displaying collapse deposit (114) (Scale- 1 x 2m & 1 x 1m).....	23
Figure 5:	West facing oblique view of structure (118). (Scale 1 x 1m).....	24
Figure 6:	SE-facing section through linear/liquor trough F.131 (Scale- 1 x 1m & 1 x 2m).....	25
Figure 7:	SE-facing section through potential liquor trough F.131. (Scale- 1 x 1m & 1 x 2).....	26
Figure 8:	SW-facing view of structure (207). (Scale- 1 x 1m).....	27
Figure 9:	NNE-facing view of structure (207) bordered by parallel beamslots F.209 and F.211. (Scale- 1 x 2m).....	28
Figure 10:	Post excavation view of potential post-pit cut [215] (Scale- 1 x 0.10m).....	29
Figure 11:	Building platform levelling deposits (205) and (204) associated with quarry dross [221]. (Scale- 1 x 1m).....	30
Figure 12:	NE facing view of wall (304) with deposits (312) and (301) visible overlying the structure. (Scale- 1 x 1m & 1 x 2m).....	31
Figure 13:	SE facing view of wall (304). Note sockets [307], [309] and [311]. (Scale- 2 x 1m).....	32
Figure 14:	S-facing view of Trench 3. (Scale- 2 x 1m).....	33
Figure 15:	S-facing view of Trench 1 displaying retaining wall (103) (Scale- 2 x 1m).....	35
Figure 16:	SW-facing view of retaining wall (103) (Scale- 2 x 1m).....	35
Figure 17:	ENE facing section through Trench 2 (Scale- 2 x 1m).....	36
Figure 18:	S-facing view of Trench 2 (Scale- 2 x 1m).....	37
Figure 19:	NW facing section through calcining clamp (Scale- 1 x 1m & 1 x 2m).....	39
Figure 20:	SW-facing view of Trench 3 displaying thermal layer (306) and retaining wall (302) (Scale- 2 x 1m).....	40
Figure 21:	SW-facing view Trench 3 displaying thermal layer (306) levelling deposit (307) (Scale- 2 x 1m).....	41
Figure 22:	NNW facing view of Trench 1 (Scale- 2 x 2m & 1 x 1m).....	43
Figure 23:	NNE facing view of drain F.214. Note revetting wall (Scale- 1 x 1m & 1 x 2m).....	44
Figure 24:	NW-facing section through wall (220) and deposits (207), (212), (219) and (221) (Scale- 1 x 2m).....	45
Figure 25:	ENE facing view of Trench 1 displaying compacted working surfaces (216) and 219) (Scale- 1 x 1m & 1 x 2m).....	46
Figure 26:	NE facing view of Trench 1 (Scale- 1 x 1m & 1 x 2m).....	47

**Archaeological Excavation and Survey of Coastal Alum Working Sites at Boulby,
Kettlewell, Sandsend and Saltwick, North Yorkshire**

Figure 27:	West facing view of the slipway at Saltwick (Scale- 1 x 1m & 1 x 2m).....	49
Figure 28:	East facing view of the slipway at Saltwick (Scale- 1 x 1m & 1 x 2m).....	49
Figure 29:	NNW facing view of the slipway at Saltwick. (Scale- 1 x 1m & 1 x 2m).....	50
Figure 30:	NNW facing view of the slipway at Saltwick displaying the grooves/tracks cut into the superior surface of the stonework. (Scale- 1 x 1m & 1 x 2m).....	51
Figure 31:	N facing view of the slipway and associated stone-cut trackway within the foreshore.....	52
Figure 32:	SSW facing view of the slipway	53
Figure 33:	Results of the Aerial Photography and Lidar Transcription	55
Figure 34:	View into Gaytress Quarry, looking south-west	58
Figure 35:	Spoil heap within Gaytress Quarry looking south-east	59
Figure 36:	Western extent of Gaytress Quarry	59
Figure 37:	French drain within the quarry floor at Gaytress Quarry	60
Figure 38:	Northern extent of Gaytress Quarry	61
Figure 39:	Area to the east of the Witby, Redcar and Middlesbrough Railway	61
Figure 40:	Possible barrowway looking south-east	62
Figure 41:	South bank of the possible barrowway.....	63
Figure 42:	Top of the possible barrowway, looking north-east	63
Figure 43:	Drainage gully and railway cut	64
Figure 44:	Retaining wall adjacent to a rubble-filled French drain within the quarry floor at Gaytress Quarry	65
Figure 45:	The lower quarry area on the eastern side of the railway line	65
Figure 46:	Remains of a stone retaining wall on the eastern face of the southern 'arm' of the lower quarry	66
Figure 47:	Remains of a stone retaining wall on the western face of the northern 'arm' of the lower quarry.....	67
Figure 48:	Stone-lined water channel to the north of the area of steeping pits	68
Figure 49:	East-west aligned bank to the north of the area of steeping pits...	68
Figure 50:	Stone-lined banked feature interpreted as a possible reservoir	69
Figure 51:	A 90° angle forming the south-east corner of a rectangular feature interpreted as a possible reservoir.....	70
Figure 52:	Possible building platform in the lower quarry area.....	71
Figure 53:	View into Ness End Quarry from the top of Asylum Hill.....	72
Figure 54:	View into Ness End Quarry from the top of Asylum Hill	73
Figure 55:	Partially eroded lip of unquarried shale around the east and north-east sides of Ness End Quarry.....	73
Figure 56:	Spoil heap on the south-eastern extent of Ness End Quarry.....	75
Figure 57:	Asylum Hill looking north.....	75
Figure 58:	Sandsend Quarries from Sandsend Village to the south.....	76
Figure 59:	Erosion to the south-east end of Asylum hill.....	76
Figure 60:	Square-shaped depression on the top of Asylum Hill.....	77

**Archaeological Excavation and Survey of Coastal Alum Working Sites at Boulby,
Kettlewell, Sandsend and Saltwick, North Yorkshire**

Figure 61:	Square-shaped depression on the top of Asylum Hill, looking north.....	77
Figure 62:	Embanked railway line across the quarry floor of Ness End.....	78
Figure 63:	Possible barrowway (Feature 7) running around the base of Asylum Hill.....	80
Figure 64:	Possible barrowway (Feature 26) running eastwards from the quarry face at Ness End.....	80
Figure 65:	The likely continuation of the possible barrowway (Feature 26) on the east side of the railway line.....	81
Figure 66:	Inclined routeway (Feature 13).....	81
Figure 67:	Inclined routeway (Feature 13).....	82
Figure 68:	View of Feature 10 from the railway embankment.....	83
Figure 69:	Possible barrowway (Feature 10).....	84
Figure 70:	Structural remains at the south-eastern end of Feature 10.....	84
Figure 71:	Structural remains at the south-eastern end of Feature 10.....	85
Figure 72:	Structural remains eroding from the cliff face within Ness End Quarry.....	85
Figure 73:	Lower quarry area (Feature 31) seen from the top of Asylum Hill.	87
Figure 74:	Sandstone retaining wall on the south side of the northern 'arm' of the lower quarry.....	87
Figure 75:	Sandstone wall eroding from the south side of the southern 'arm' of the lower quarry.....	88
Figure 76:	Bank along the top of the southern 'arm' of the lower quarry.....	88
Figure 77:	Retaining wall at the base of the working face in the lower quarry floor.....	89
Figure 78:	Stone-lined channel on the east side of the steeping pits, looking north.....	90
Figure 79:	Continuation of the liquor channel eroded to the south of the steeping pits.....	90
Figure 80:	Stone-lined tank feature at the north end of the liquor channel....	91
Figure 81:	Stone lined tank feature at the north end of the liquor channel....	92
Figure 82:	Channel cutting Feature 26 and running towards the steeping pits	92
Figure 83:	Representative view of a steeping pit, looking west.....	93
Figure 84:	The interior of Deep Grove Quarry.....	94
Figure 85:	The north-eastern extent of Deep Grove Quarry.....	95
Figure 86:	The large-scale railway embankment within Deep Grove Quarry..	95
Figure 87:	The south-western two-thirds of the quarry floor at Deep Grove.	97
Figure 88:	Hollowway running south-west into Deep Grove Quarry.....	98
Figure 89:	'Crossroads' area to the north-east of Deep Grove Quarry, looking south.....	99
Figure 90:	Drainage gully, looking east-north-east.....	99
Figure 91:	Drainage gully, looking west-south-west.....	100
Figure 92:	Vertical view of wooden planks.....	101
Figure 93:	Site location.....	129
Figure 94:	Trench Location Plan, Boulby, N.Yorks.....	130
Figure 95:	Trench Location Plan, Kettlewell, N.Yorks.....	131

Figure 96:	Trench Location Plan, Saltwick, N.Yorks.....	132
Figure 97:	Plan of Storage Cisterns (106) and (322) in Trench 1, Boulby, N.Yorks.....	133
Figure 98:	NW-facing section of Southern Cistern (106) – Boulby.....	134
Figure 99:	SE-facing section of Southern Cistern (106)- Boulby.....	134
Figure 100:	ESE-facing Elevation of Southern Cistern (106) – Boulby.....	135
Figure 101:	SE-facing section of Northern Cistern (322) – Boulby.....	136
Figure 102:	NE-facing section through interior of Northern Cistern (322) – Boulby.....	136
Figure 103:	SE facing section through F.131.....	137
Figure 104:	SE facing section through Trench 1.....	137
Figure 105:	Mid-Excavation Plan of Trench 2 – Boulby.....	138
Figure 106:	Post-Excavation Plan of Trench 2 – Boulby.....	138
Figure 107:	NW-facing section of Trench 2 – Boulby.....	139
Figure 108:	SW-facing section of Trench 2 – Boulby.....	139
Figure 109:	NW-facing section of Trench 2 – Boulby.....	139
Figure 110:	S-facing section of Trench 3 – Boulby.....	140
Figure 111:	S-facing section of Trench 3 – Boulby.....	140
Figure 112:	NW-facing section of Trench 3 – Boulby.....	141
Figure 113:	N-facing section of Trench 3 – Boulby.....	141
Figure 114:	Plan of Trench 1 – Kettlewell.....	142
Figure 115:	113- N-facing section through Trench 1 – Kettlewell.....	143
Figure 116:	SW-facing section through Trench 2 – Kettlewell.....	143
Figure 117:	Mid-excavation plan of structure (302) in Trench 3 – Kettlewell....	144
Figure 118:	Post-excavation plan of Trench 3 – Kettlewell.....	144
Figure 119:	NE-facing section through Trench 3 – Kettlewell.....	145
Figure 120:	NW-facing section through Trench 3 – Kettlewell.....	145
Figure 121:	Plan of Trench 1 - Saltwick, N.Yorks.....	146
Figure 122:	SW-facing section of Trench 1 – Saltwick.....	147
Figure 123:	E and SE-facing sections of Trench 1 – Saltwick.....	147
Figure 124:	N-facing section of Trench 1 – Saltwick.....	147
Figure 125:	Plan of Slipway – Saltwick.....	148
Figure 126:	SW-facing section of Slipway – Saltwick.....	148
Figure 127:	SE-facing section of Slipway – Saltwick.....	148
Figure 128:	NW-facing section of Slipway – Saltwick.....	148
Figure 129:	Interpretative survey of Sandsend Quarries.....	149

List of Tables

Table 1	Features identified within Gaytress Quarry.....	57
Table 2	Features identified within Ness End Quarry.....	71
Table 3	Features identified within Deep Grove Quarry.....	93
Table 4	Features identified within Deep Grove Quarry.....	97
Table 5	Description of wooden finds.....	101
Table 6	AutoCAD map layer content and drawing conventions.	150
Table 7	An example attached data table.....	150

List of Graphs

Graph 1	XRF spectrum of an ore sample.....	103
Graph 2	Expanded low Z end of the spectrum	104
Graph 3	XRF spectrum derived from scrapings of the white surface deposit....	104

Executive Summary

Project Name: Archaeological Excavation and Survey of Coastal Alum Working Sites at Boulby, Kettleless, Sandsend and Saltwick, North Yorkshire

Site Code: BOUL14, SALT14, KETT14, SAND14

Planning Authority: North York Moors National Park Authority's Monument Management Scheme

Geology: Alum Shales of the Whitby Mudstone Formation

NGR: Boulby- NZ 75312 19597, Kettleless- NZ 83476 15919, Saltwick- NZ 83476 15919, Sandsend- NZ 85770 13250

Date: March 2015

In September 2014 Archaeological Research Services Ltd was commissioned by the North York Moors National Park Authority, as part of the Monument Management Scheme, to undertake a programme of archaeological excavations of the coastal Alum working sites at Boulby, Kettleless and Saltwick, as well as photographic survey of the Scheduled slipway/ramp at Saltwick and aerial photography and Lidar transcription and walkover survey at Sandsend. The archaeological excavations and survey works were conducted as part of a mitigation strategy addressing the threat of coastal erosion at the Scheduled alum working sites at Saltwick Nab (NHLE 1018336, Legacy SM 31332), Kettleless (NHLE 1018144, Legacy SM 29545), Sandsend (NHLE 1018139, Legacy SM 29539) and Boulby (NHLE 1017779, Legacy SM 29537). The archaeological work may also allow for a reassessment to be made of the presence of the Scheduled Monuments at Saltwick Nab, Kettleless and Boulby on the Heritage at Risk register and allow a better assessment to be made of the level of risk at Sandsend.

The archaeological works at Boulby comprised the excavation of three trenches targeted across a putative pump house, two liquor cisterns and an associated potential building platform. The Boulby excavations supplemented the work of previous archaeological excavations conducted by Chapman during the 1960s and 1970s. The work characterised the mode of construction and the decommissioning/disuse of the two cisterns and confirmed that the potential building platform housed a probable timber structure perhaps related to the cisterns. The building platform was also shown to be constructed against a previously active quarry face, serving to illustrate both the changing landscape of the New Works during its operational life-span and the limited space within which the quarry functioned. The trench across the putative pump house revealed the remains of a well-built stone building, however, no evidence of the building's function was uncovered. The work carried out at Boulby illustrates the complexity of phasing of remains which exists at the site. This appears to add to the picture from earlier excavations by Chapman, and completes much of this picture in understanding those remains located at the extreme coastal edge and therefore most acutely at risk of erosion in the short term.

The potential for further work at Boulby has been outlined within the discussion of these results. Future management priorities may be to investigate those areas identified as potentially containing further information regarding the phasing and function of the

excavated remains, however this should be balanced against the contribution that this information is likely to make to our understanding of the alum industry as a whole. The mitigation works were focused on those elements of the site most at risk of coastal erosion and can therefore be seen to have mitigated the effects of coastal erosion to these most at risk remains. Boulby is presently categorised as 'At Risk' in the English Heritage Heritage at Risk Register. In light of the mitigation works undertaken it is considered that this risk status could be reduced. However from a health and safety perspective, if further work is considered to be a priority for the site, it is recommended that such work be undertaken in the short term, prior to further deterioration of the site.

The excavation trenches at Kettlewell were targeted across a putative calcining place and putative calcining clamp which were identified during an earthwork survey conducted by English Heritage in 2002. The excavations of the calcining place confirmed that this interpretation is likely to be correct owing to the sequence of deposits encountered and the presence of a retaining wall, although no evidence of heat affection was uncovered. The trench placed within a putative clamp structure revealed a clamp for the calcining of ironstone, rather than alum shale, and may have represented a diversification of production during the later 19th century. Kettlewell is one of the better understood sites within the survey and the targeted excavations have answered specific research questions in relation to the site, as well as demonstrating significant evidence of the likely re-use of this alum site for the extraction and refinement of ironstone. This is significant evidence in the consideration of later features and/or other "clamps" at other quarry sites. The information gleaned from excavation, together with the detailed earthwork survey, can now be better used as a model from which to interpret earthwork evidence at other sites, particularly potential "clamp" or "spoil heap" features.

The excavations at Kettlewell were focused on areas which were considered to be the most at risk, most significant elements of the quarry works. As such the excavation has been successful in mitigating some of the loss of the site to coastal erosion. Whilst other at risk features have been noted at the site, such as the bank of steeping pits on the eastern side of the quarry and the remains of the later alum house on its western side, it is considered that the location of these features and their present levels of erosion makes further investigation by traditional archaeological means extremely difficult. Nevertheless significant archaeological deposits, which have the potential to contribute both to site specific research questions, as well as industry-scale research objectives, are subject to active and ongoing erosion. Kettlewell is presently categorised as 'At Risk' in the English Heritage Heritage at Risk Register and, whilst the excavations have mitigated some of the loss to coastal erosion, this categorisation is deemed to be still appropriate in light of the ongoing erosion at the site.

Two trenches were excavated at Saltwick and produced archaeological evidence that supplemented the survey data compiled by York Archaeological Trust detailing the location of cisterns, warehouses, burnt heaps and tanks on the quarry floor. The work at Saltwick displayed evidence for heavily compacted working surfaces overlain by later dumps of shale quarry waste pointing to a dynamic and changing working environment

with the limited space provided on the quarry floor. This work, which was focused on an existing significant erosion scar, has shown that multi-phase, archaeological deposits remain preserved in-situ within the quarry floor and are at risk of further erosion damage. The immediate mitigation provided by the current phase of work is only considered as a short term solution to this erosion problem, which is considered certain to continue. As only a small portion of the archaeological resource was investigated, it is difficult to say what its potential is for contributing to a wider understanding of the alum industry as a whole. Despite this, the minimal amount of work carried out at Saltwick to date makes the work carried out as part of this project more significant. Saltwick is presently categorised as 'At Risk' in the English Heritage Heritage at Risk Register, this categorisation is deemed to be appropriate in light of the ongoing erosion at the site.

The archaeological work at Saltwick also included the production of a detailed photographic and drawn record of the foreshore slipway/ramp feature in order to mitigate the uncontrollable loss of this feature through ongoing erosion. The work conducted upon the foreshore slipway/ramp has brought the record of that feature to a point where it is not envisaged that any further work on site would improve its understanding. It is therefore recommended that consideration be given to de-scheduling of the slipway/ramp component.

The investigations at Sandsend Alum Quarries consisted of a staged process of aerial photography and Lidar transcription followed by an interpretative walkover survey. The aim was firstly to provide a better understanding of the features present, and secondly to assess the level of risk to significant features from coastal erosion. The survey has added significant detail to our knowledge of the features present within this Scheduled Monument, along with their location and their level of preservation. In terms of the risk posed by coastal erosion, this monument has been previously assessed as being at risk of low levels of erosion in the long term, i.e. 80-100 years (Eadie 2014, 45). The features most at risk of erosion are the sets of steeping pits within Gaytress and Ness End Quarries. These are also the features which could arguably provide the most knowledge gain in terms of the development of the industry. The steeping pits at Gaytress are closer to the eroding cliff edge and are likely to be the earlier of the two. These steeping pits are at risk of almost complete destruction within the next 100 years. The steeping pits at Ness End are set further back from the cliff edge and are unlikely to be lost to coastal erosion within the next 100 years. Nevertheless it is likely that coastal erosion could severely limit the extent to which they could be safely investigated within the next 80-100 years. Active low level erosion of structural remains was also noted at two locations on the seaward edge of Ness End Quarry and structural remains were also recorded close to the cliff edge in the same general location. The risk level at Sandsend is currently set at 'Vulnerable'. In light of the results of the present survey an argument could be made to increase this risk level to 'At Risk', since significant parts of the monument are eroding at the cliff edge (albeit gradually) and the risk of landslips does mean that substantial portions of these remains could conceivably be lost in a single event. Detailed survey and/or investigation of the areas close to the cliff edge may allow for the present 'Vulnerable' status to be retained.

1. Introduction

1.1 In September 2014 Archaeological Research Services Ltd (ARS Ltd.) was commissioned by the North York Moors National Park Authority, as part of the Monument Management Scheme, to undertake a programme of archaeological excavations of the coastal Alum working sites at Boulby, Kettleless and Saltwick, as well as aerial and landscape walkover survey at Sandsend. This work follows an assessment undertaken by ARS Ltd. in 2014 which investigated six scheduled alum working sites, at risk of coastal erosion within the North York Moors National Park (NYMNP). This assessment aimed to provide an up-to-date condition statement of each, and to develop suitable management and mitigation strategies for the most significant, most at risk, remains. The assessment identified that the Alum working sites at Boulby, Saltwick Nab, Sandsend, Stoupe Brow and Kettleless, required further work in order to mitigate the effects of coastal erosion (Eadie, 2014). The archaeological excavations and survey works detailed within this report were therefore conducted as part of a mitigation strategy addressing the threat of coastal erosion at the Scheduled alum working sites at Saltwick Nab (NHLE 1018336, Legacy SM 31332), Kettleless (NHLE 1018144, Legacy SM 29545), Sandsend (NHLE 1018139, Legacy SM 29539) and Boulby (NHLE 1017779, Legacy SM 29537). The archaeological work was intended to enable the Scheduled Monuments at Saltwick Nab, Kettleless and Boulby to be removed from the Heritage at Risk register and a better assessment to be made at Sandsend, which is presently assessed as 'Vulnerable'.

1.2 The Alum working site at Boulby is located below coastal cliffs characterised by high vertical or steeply sloping cliff tops which rise to height of c.230m above sea-level (Chapman 1975). A rock platform foreshore is near continuous over this stretch of coast as far as Runswick Bay and it has variable degrees of landslide material and cliff scree forming a toe to the cliff (NECAG 2007, PDZ7, 231). The solid geology in the area of Boulby is comprised of Lias Group mudstone, siltstones, limestone and sandstone consisting of Jurassic Redcar Mudstone Formation overlain by Staithes Sandstone Formation. No superficial geology is recorded in the vicinity of the alum works (BGS 2014). The excavations conducted at Boulby were centred on grid reference NZ 75312 19597. The Kettleless Alum Works (NZ 83322 15969) lay on the north-eastern side of Runswick Bay, on the coast immediately to the north-east of Kettleless village. This site is c.4km north-west of Sandsend Alum Works. Additionally, the excavation area at Kettleless was bordered by sea cliffs supporting the Cleveland Way to the south and by the North Sea to the east, north and west. The solid geology in the area of Kettleless Alum Works is composed of a Jurassic Whitby Mudstone Formation with no superficial geology recorded (BGS 2014). The site at Saltwick Nab was situated 0.9 miles east of Whitby and was approximately centred upon grid reference NZ 83476 15919. The excavation area was also bordered by sea cliffs supporting the Cleveland Way to the south and west. The solid geology in the area of Saltwick Nab Alum Quarry is composed of Jurassic Whitby Mudstone Formation with no superficial geology recorded (BGS 2014). Sandsend Alum Quarry and its associated Alum House (NZ 85770 13250) lay on the western side of Sandsend Wyke on the coast immediately to the north of Sandsend

village, c.4km west of Whitby. The solid geology at Sandsend was composed of Whitby Mudstone formation overlain by superficial deposits of Devensian-Diamicton Till.

Archaeological and Historical Background

1.3 Alum is a chemical used as a fixative agent in the textile industry and was manufactured from certain varieties of shale. Alum was initially imported from the continent during the medieval period, but in 1607 a potential source was identified at Guisborough facilitating domestic alum production. Shale quarrying and alum production continued to flourish in the north of England until the mid-19th century when new techniques utilising shale acquired from coal mining became a more prolific industrial process. Approximately fifty alum sites have been identified throughout England, of which twenty-two principal sites were established in North Yorkshire (Miller, 2002). It is beyond the scope of this report to provide a lengthy history of the alum industry, however for an up to date and authoritative summary the reader is directed to Jecock (2009).

1.4 Research and investigation into the coastal alum working sites of North Yorkshire has been the subject of sporadic surveys and research excavation for over 50 years and contributed to the scheduling of the monuments in the late 1990's following completion of the English Heritage Monuments Protection Programme (MPP). The MPP Step 3 report recognised that most of these sites were suffering from coastal erosion and, as representative of early industries at the forefront of the industrial revolution, they should be a high priority for protection from coastal erosion and the subject of considered excavation and survey (Gould 1993). A brief description of the previous research and works conducted upon the monuments examined as part of this report is detailed below.

Boulby- (NHLE 1017779, Legacy SM 29537)

1.5 The Boulby works, were considered one of the most productive and long-lived of the northern alum production centres and displayed an operational life-span ranging from c.1650 until the early 1870's. The scheduled area covering the location of the alum quarry includes remains from both the earliest and later phases of working. The site is described in the MPP Stage 3 documentation as 'amongst the most visually impressive in the country' and 'the best example nationally of a technically advanced 19th century alum quarrying complex'.

1.6 As previously indicated, excavations were conducted prior to the scheduling of the Boulby works in the late 1960s – 1980s by Chapman and the results were published annually as single-paragraph summaries, with one longer paper published in the Cleveland Industrial Archaeologist in 1975 (see bibliography for full list of Chapman publications). The excavations focused on the clearance of steeping pits along the seaward side of the quarry, one circular cistern, a blacksmiths shop, and an associated liquor channel with surviving timber elements (Chapman 1975, 32).

1.7 The RCHME (now English Heritage) conducted an aerial photography transcription and earthwork survey of the Boulby remains in 1993 which was supplemented by an interpretive report detailing over 120 discrete features (Blood 1993). The survey was reproduced at 1:2500 scale and is held by the North Yorks Moors National Park Authority (NYMNP). Additionally, the North East Rapid Coastal Zone Assessment (NERCZA) Phase 1 report describes a series of foreshore features including a deep-water channel cut into the foreshore with associated post-holes, some still containing timber posts. Some survey work has been completed on these foreshore elements (Millar 2002, 97-8), however, the NERCZA concludes that detailed survey of the foreshore is a priority for future research (Tolan-Smith 2008, 104).

Kettleiness- (NHLE 1018144, Legacy SM 29545)

1.8 Kettleiness was operational intermittently from 1728 to 1861 and the scheduled area covers the location of both the alum quarry and the later alum house. The earliest alum house was destroyed by a landslip in 1829 so the existing alum house remains are known to be of 19th century date when the alum house was rebuilt.

1.9 The scheduled area was subject to rigorous investigation by English Heritage in 2002 which included photogrammetric and aerial photographic transcription supplemented by a Level 3 earthwork survey. This was published as an English Heritage Archaeological Investigation Report in 2003 (Jecock et al 2003) and also included a limited survey of historical documentation. The remains identified included clamps, pits, cisterns, building remains and the liquor channel. Networks of rutways (HER: 7550), remains of a staith (HER: 7551), and a deep water channel that possibly originated as part of an ironstone mine (HER: 7552) were also noted on the foreshore around the site. The NERCZA Phase 1 report states that these features were being recorded by the Nautical Archaeological Society (NAS) North-East (Tolan-Smith 2008, 5), although it is unclear whether this recording was ever completed and, if so, where it has been published. The NERCZA Phase 2 survey provided only a basic assessment of the remains at Kettleiness owing to them having been so thoroughly recorded previously by English Heritage. The report concludes that the site is at high risk of coastal erosion (Burn 2010, 298). Although the earthwork survey of Kettleiness has provided a high level of detail and an interpretation of the remains, the site has not been the subject of archaeological excavation specifically aimed at testing these interpretations. This is particularly important in those instances where only tentative interpretations could be made based on the earthwork remains.

Saltwick- (NHLE 1018336, Legacy SM 31332)

1.10 Saltwick Nab was operational from 1649 to 1791 and the scheduled area covers the location of the alum quarry. The site was occupied intermittently and until 1770 raw liquor was transported by boat to South Shields for processing. A stone built structure on the foreshore to the south-east of the alum house is likely to be the original harbour

and in 1770 an alum house (non-scheduled HER: 12070) was erected on the foreshore behind it, using the harbour effectively as a breakwater. A second quarry was also developed at the south-eastern end of the bay at Black Nab (non-scheduled HER: 6037), this is generally considered to be later than the quarry at Saltwick Nab.

1.11 Archaeological investigation at Saltwick has so far been focused on the alum house which is subject to active erosion. The excavations were carried out under the direction of Gary Marshall with the Scarborough Archaeological and Historical Society and were published as a society research report in 1994 (Marshall 1994). Alongside Peak, the alum house at Saltwick forms the basis of the discussion of the processes undertaken at alum houses in Ian Miller's *Steeped in history; the alum industry of North-East Yorkshire* (2002). Whilst the research report is informative, it is not considered to be a technical or exhaustive account of the excavations and as the evidence is weaved into an interpretation it is difficult to establish exactly where the excavations took place and how extensive they were.

1.12 The scheduled quarry at Saltwick Nab, the non-scheduled quarry at Black Nab, the alum house and their foreshore features have been surveyed at 1:500 and 1:2500 scale by York Archaeological Trust (held in NYMNP A HER). The Saltwick survey revealed cisterns, warehouses, burnt heaps and tanks on the quarry floor. The YHRCZA (2011) also noted several features during the rapid walkover survey, some of which were included in the earlier surveys and some of which were not; although these were generally foreshore features rather than features within the quarry floor (Buglass and Brigham 2011, 38-39). The YHRCZA also noted deterioration in the condition of the scheduled slipway, which lies in the inter-tidal zone, between their two surveys, undertaken in 2006 and 2011 (Buglass and Brigham 2011, 38). The YHRCZA concluded that systematic mapping analysis, perhaps utilizing Lidar data, of the entirety of Saltwick Bay should be a priority for the future in order to identify all the remains associated with the alum industry before they are lost to coastal erosion (Buglass and Brigham 2011, 40 and 92).

1.13 Based on this information it is clear that the alum quarry and its associated slipway has been the subject of only limited investigation and recording and whilst the non-scheduled alum house has been excavated, it is unclear to what extent.

Sendsend- (NHLE 1018139, Legacy SM 29539)

1.14 Sandsend was operational from 1733 to 1855-60 and the scheduled area covers the location of the alum quarry and the alum house separately. The earliest quarry phase, Gaytress, lies closest to Sandsend village and the alum house. Two further quarry phases were established progressing further north at Ness End and Deep Grove (Figure 129). After the alum works shut down the quarry site was incorporated into the Whitby, Redcar and Middlesbrough Union Railway and an embanked line was built over the remains of the quarry in 1883. The railway line may have truncated remains of the former quarry. Cementstone mining was also undertaken within the quarries, towards

the end of their working life as alum production centres up until the 1930s. More recently the site was used as a military training centre and this will also have had an impact upon any surviving remains.

1.15 There have been no formal archaeological investigations at Sandsend, save for an assessment of the liquor tunnels which were found to contain surviving timber troughs to carry liquor from the quarry to the alum house (Pybus 1983). Phases 1 and 2 of the North East Rapid Coastal Zone Assessment (NERCZA) assessed the remains of the alum quarry at Sandsend as being at high risk of coastal erosion (Tolan-Smith 2008, 94; Burn 2010, 297). NERCZA Phase 1 concluded that detailed survey of the remains of the quarry should be a priority for the future (Tolan-Smith 2008, 244).

Method Statement

1.16 The North York Moors National Park Authority Research and Management Framework (v.3, 2013) outlines some of the significant questions which still remain to be answered about the regional alum industry, in particular about the early days of the industry and the development of the industrial processes, and it identifies a number of priorities for research and management which include further recording and investigation at the sites suffering significantly from coastal erosion. As previously mentioned, the aim of the archaeological excavations was to address the above research and management objectives and facilitate the lowering of the 'Risk' status attached to the Boulby Alum Quarries and Works (NHLE 1017779, Legacy SM 29537); the Kettlewell Alum Works (NHLE 1018144, Legacy SM 29545), the Saltwick Nab Alum Quarry (NHLE 1018336, Legacy SM31332); and Sandsend Alum Quarries (NHLE 1018139, Legacy SM 29539).

1.17 The mitigation measures employed at each site varied according to the level of previous investigation, the particular research questions in place and the levels of assessed risk of coastal erosion. The mitigation works include excavation, aerial photography and Lidar transcription, drawn and photographic recording and walkover survey.

1.18 All elements of archaeological excavation were carried out in accordance with the Chartered Institute for Archaeologists (CIfA) Standards and Guidance for Archaeological Excavation (2013) and with the IfA Code of Conduct (2014). Each trench was opened by hand and excavated using a single context recording system until either the natural substrate was identified or a safe working depth had been reached. The remote location of each site prevented vehicular access therefore no trenches were excavated using a mechanical excavator. Additionally, due to the proximity to the cliff edge at Boulby, Kettlewell and Saltwick, all excavation work was carried out under strict health and safety conditions. All deposits were recorded according to the normal principles of stratigraphic excavation. Each context was recorded on pro-forma records which included the following: character and contextual relationships; detailed description (dimensions and shape; soil components, colour, texture and consistency);

interpretation and phasing as well as cross-references to the drawn, photographic and finds registers.

1.19 Aerial photograph transcription was carried out to National Mapping Programme (NMP) standards (Winton 2012). All the available photography was analysed under magnification and where possible in stereo. The lidar and Bluesky orthorectified photography formed the basis of the mapping, supplemented with additional photography as necessary. The photography was scanned at 400dpi for rectification using the specialist software Aerial 5.29, for which the Ordnance Survey MasterMap with a scale of 1:1250 formed the base for control. The rectified image was output as an uncompressed TIF with an accompanying World file (.TFW). The Ordnance Survey MasterMap and historical mapping acted as additional guides for interpretation, together with the National Record for the Historic Environment (NRHE). The features were mapped in AutoCAD 2007 from the imported lidar and photography, using the appropriate map layers and recording in the attached data table (See Appendix: Tables 6 & 7). Where appropriate, earthworks were mapped in greater detail than is ordinarily carried out for NMP projects. This was achieved using T-hachures. The mapped features were output from AutoCAD as shapefiles.

1.20 Walkover survey was undertaken using the aerial photography and Lidar transcription as a base map from which to assess the survival of mapped features and provide an interpretation. Identified features were photographed and the base map amended to include further details identified during the walkover survey.

1.21 All photographic images were taken in monochrome as well as digital format, and contain a graduated photographic scale, where practicable.

2 Results

2.1 Boulby

2.1.1 The archaeological works at Boulby comprised the excavation of three trenches targeted across the pump house, two liquor cisterns and an associated building platform. Trench 1 measured approximately 12.62m x 4.90m x 1.68m and was excavated across the two potential liquor cisterns in order to best record their form and construction. Trench 2 measured 5m x 2m x 1.10m and was targeted across a probable building platform c.2m east of Trench 1. Trench 3 measured 3.03m x 2.16m x 0.86m and was excavated through the interior of the pump house located 67.4m west of Trench 1. Trench 3 sought to evaluate the deposits within the interior of the pump house and to assess the buildings function.

Trench 1

2.1.2 Trench 1 measured 12.62m x 4.90m x 1.68m and was excavated across two circular structures, interpreted to be cisterns for the storage of liquor, and a potential

liquor trough (Figure 97). The uppermost deposits visible within Trench 1 were greyish-brown, topsoil deposits (101), (115) and (124), displaying a maximum depth of 0.40m. Following the removal of topsoil, two quadrants were excavated within the interior of the cistern structures. The quadrant placed across the interior of the south-western cistern (106) was situated within the northern corner of the structure and measured 2.37m x 2.36m x 1.68m. Topsoil (101) was the uppermost deposit within the interior of the south-western cistern (106) (Figures 98 & 99). The quadrant excavated across the interior of the north-eastern cistern (322) was located at the eastern corner of the structure and measured 2.24m x 2.4m x 1.24m at its extents (Figure 1 & 112). Topsoil (115) was the uppermost identifiable deposit within the interior of the north-eastern cistern (322). Topsoil (124) sealed structure (118) and deposits (120), (135) and (139). Topsoil (124) was the uppermost deposit in Trench 1, exterior to cisterns (106) and (322).

South-Western Cistern (106)

2.1.3 The quadrant excavated through the south-western cistern (106) identified that topsoil (101) overlay a moderately sorted, red shale layer (102) at a depth of 0.42m below the present ground level (Figure 3 & 99). The form and composition of deposit (102) was similar to the backfilled construction deposit (119) (Figure 97). Consequently, red shale (102) was interpreted as a collapse deposit related to cistern structure (106). Red shale layer (102) abutted the interior face of cistern structure (106) and sealed a greyish-brown, sandy-silt deposit (103) measuring 2.35m x 2.15m x 0.08m (Figure 2 & 99). Deposit (103) was likely formed by wind/waterborne deposition and was interpreted as a 'dis-use' deposit formed within the south-western cistern (106), following a cessation of alum production within the Boulby alum works. Dis-use deposit (103) overlay a well sorted, red shale deposit (104) which measured 1.16m x 2.15m x 0.24m at its maximum visible extents.

2.1.4 Deposit (104) displayed a similar composition to deposit (102) and may have been formed by similar wind/waterborne depositional forces. Both deposits (104) and (103) abutted cistern structure (106) and overlay a whitish-yellow, silty-clay (105). Deposit (105) was identifiable at a depth of 0.66m below present ground level and adhered to both the inner face of structure (106) and partially overlay the inner skin of stonework (116). Deposit (105) was also identifiable between the inner face of the outer skin of stonework (106) and the outer face of the inner skin of stonework (116) (Figure 2 & 99). Consequently, it seems likely that deposit (105) was deliberately inserted into the structure of south-western cistern (106) during construction and may be interpreted as a waterproofing seal for the retention of alum liquor within the cistern. Additionally, the form of deposit (105), above the inner step of stonework (116), was interpreted as slumping or collapse of a water-proofing seal which had been applied to the inner face of stonework (106) at a greater height than remained present at the time of excavation (Figure 2). A similar, yellow clay seal (108) was identified within the north-eastern cistern (322) and should be interpreted as fulfilling the same function as deposit (105). Both deposits have a clear relationship to the inner face of stonework within both

cisterns. This inner face appears not to have been altered through robbing or collapse, as it is of the same constant height where exposed in both cisterns and with a flat top, suggesting no robbing or collapse has occurred. This can be contrasted with the outer leaf of stonework, which was uneven in height and has clearly seen collapse and robbing.



Figure 1- Post-excitation photograph of Trench 1. Note the south-western cistern (106) in the foreground and the north-eastern cistern (322) in the background. (Scale- 2 x 2m & 2 x 1m)



Figure 2- NNW-facing section through south-western cistern (106) (Scale- 1 x 1m & 1 x 2m)

2.1.5 Deposit (107) was present below (103) and (104), abutted inner skin (116), abutted outer skin of stonework (106) and overlay deposits (144) and (142) (Figure 2, 3, 98 & 99). Deposit (107) displayed a similar whitish-yellow, silty-clay composition to waterproofing seal (105). It was also noted that deposit (107) contained occasional, large, sub-rounded sandstone inclusions and had a diffuse interface with (105). Consequently, (107) was interpreted as collapse from a clay lining which likely adhered to the inner face of the outer skin of stonework (106) within the south-western cistern. Deposits (142) and (144) were both comprised of a poorly sorted, orangey-grey, silty clay containing frequent small to large, sub-angular and sub-rounded stony inclusions. Deposit (142) measured 1.20m x 2.15m x 0.22m and deposit (144) measured 1.63m x 0.37m x 0.07m at their maximum respective extents. It should also be noted that numerous stone inclusions were dressed and displayed punched, herringbone tooling. Consequently, the form and composition of deposits (142) and (144) was indicative of structural collapse. Deposit (144) overlay a poorly sorted, reddish-orange, silty-clay deposit (143) containing frequent inclusions of heat affected shale and moderate small to large, sub-rounded, stony inclusions (Figure 3 & 99). Deposit (143) also contained a horizontal, whole, timber with a sub-circular cross-section and a maximum diameter of 0.17m. Additionally, destruction or collapse deposit (142) overlay a similar poorly sorted, reddish-orange, silty-clay (141). Deposits (141) and (143) displayed a depth of 0.18m and 0.19m respectively and were interpreted to be representative of either collapse or deliberate deposition following cistern dis-use. Additionally, dis-use deposits (141), and (143) overlay a fine, whitish-yellow, silty-clay (140) with a maximum depth of 0.07m. Deposit (140) abutted the inner skin of stonework (116) and sealed the flagged, stone floor (117) of the south-western cistern (106). The location and composition of deposit (140) was suggestive of a 'use' deposit related to the function of cistern (106) and was interpreted as residue which had settled upon the base of the cistern during liquor storage (Figure 2, 3, 98 & 99). It should also be noted that a similar residue, deposit (112), was identified at the base of the north-eastern cistern (322) (Figure 101 & 102).

2.1.6 As previously indicated, the afore-mentioned deposits were contained within the south-western cistern structure (106) exposed during the excavation of Trench 1. The structural components of the south-western cistern were comprised of an outer skin of stonework (106), an inner skin of stonework (116) and a flagged sandstone surface (117) (Figure 2, 3 & 97). Cistern (106) measured 5.16m x 4.54m x 1.68m at its maximum extents and was constructed from curved, dressed sandstone blocks built to regular courses. The majority of the sandstone blocks contained punched herringbone tooling generally without margins (Figure 100). The individual sandstone blocks within (106) measured an average 0.46m x 0.25m x 0.27m and displayed evidence for the use a greyish-white, lime mortar bonding material. Additionally, two sub-square sockets, measuring 0.11m x 0.12m, were identified within the inner face of wall (106) (Figure 5). Both sockets were interpreted to be sockets for the insertion of timber joists, potentially related to the support of a planked cistern lid. The outer face of (106) abutted a shale natural substrate (121), a red shale quarry waste deposit (119) and a poorly sorted, silty-clay deposit (136) (Figure 97). The inner face of wall (106) was abutted by the afore-

mentioned interior deposits (101), (102), (105) and (107), in addition to clay seal deposit (105) (Figure 2, 3, 98 & 99). Deposit (105) was abutted by an inner skin of regularly coursed, curved stonework (116) which was identified at a depth of 1.10m below present ground level. No bonding materials were identified within wall (116) and the construction materials utilised were similar in form to the sandstone blocks present within (106). It should also be noted that the inner face of wall (116) was stained a similar shade of yellow to residue deposit (140). The inner skin of stonework (116) and clay seal (105) overlay a flagged, sandstone surface (117) measuring 1.77m x 2.01m x 0.08m at its maximum visible extents. The individual sandstones were sub-square in plan, displayed no evidence for the use of bonding materials and measured an average 0.57m x 0.37m x 0.08m (Figure 2, 3 & 97). A number of these blocks contained punched herringbone tooling generally without margins.



Figure 3 – NW-facing section through south-western cistern (106). Note clay seal (105) between walls (106) and (116) (Scale- 2 x 1m)

2.1.7 It seems likely that wall (106) and surface (117) were built within a probable sub-rectangular construction cut [126]. Construction cut [126] was identified truncating the natural shale substrate (121) at the NW extent of Trench 1. No other evidence for construction cut [126] was revealed within Trench 1, however, the overall shape and form of [126] can be extrapolated from the presence of notable deposits and their relationship to cisterns (106) and (322). For example, wall (106) abutted the natural shale substrate (121) at the WNW extent of Trench 1 and both cistern structures were butted by re-deposited red shale quarry waste (119/110) and a poorly sorted clay, backfill deposit (136) (Figure 97). The presence of deliberately backfilled deposits in association with the exterior of the cistern structures strongly supports the possibility

that both cisterns had been constructed within a broadly NE-SW aligned foundation trench [126].

2.1.8 Following the insertion of wall (106) into cut [126], it seems reasonable to assume that clay seal (105) was then applied to the inner face of (106). Wall (116) was probably constructed as a retaining wall for clay (105) and was formed following the seals formation. Surface (117) abutted the outer face of (116) and was therefore inserted following the construction of the outer skin (116). Additionally, the poorly sorted, yellowish-orange deposit (136) abutting the outer face of wall (106) was likely deposited concurrent to the insertion of the cistern stonework (Figure 97). Furthermore, the outer wall of the north-eastern cistern (322) displayed a similar relationship to clay (136) and suggested that both the north-eastern and south-western cistern may have been constructed at a broadly contemporaneous date. It is noteworthy that the material used for packing deposit (136) was a compact clay and dis-similar to the back-filled deposits of red shale quarry waste (119/110) at the WNW and ENE extents of Trench 1 (Figure 5 & 97). It is not unreasonable to assume that deposit (136) was inserted to provide firm structural support for both cisterns due to the additional internal pressures exerted during liquor storage. Deposit (136) was overlain by a number of large, sub-rounded stones (137) measuring an average 0.4 x 0.2m x 0.18m. Stony layer (137) measured 3.89m x 0.74m x 0.18m abutted (106) and was interpreted as a consolidation deposit intended to retain the integrity of the upper surface of clay packing (136). Deposit (136) was identified immediately below topsoil (124).

North-Eastern Cistern (322)

2.1.9 As previously mentioned, Trench 1 was also excavated across a second cistern (322) located 2.07m north-east of cistern (106) (Figure 1 & 97). The uppermost deposit visible within the north-eastern cistern (322) was a greyish-brown, topsoil (115) which was identical to deposits (101) and (124) (Figure 4, 101 & 102). Deposit (115) sealed the eastern extent of Trench 1 and had maximum depth of 0.15m. A greyish-brown, silty-clay subsoil (145), measuring 2.42m x 4.96m x 0.19m, was identified below topsoil (115) and overlay deposit (114). Deposit (114) displayed a poorly sorted, orangey-grey, silty-clay composition and contained frequent small to large sub-rounded sandstone inclusions (Figure 4, 101 & 102). It should also be noted that a moderate frequency of dressed, sandstone, masonry fragments were also identified within (114). Deposit (114) measured 1.68m x 2.2m x 0.88m at its maximum visible extents and overlay a both whitish-yellow, silty-clay (112) and a yellowish-orange silty-clay (108). The irregular form and poorly sorted composition of (114) was indicative of structural collapse.

2.1.10 Deposit (114) partially overlay deposit (108) which was identifiable at a depth of 0.34m below present ground level and adhered to the inner face of structure (322) and partially overlay the inner skin of stonework (109). Deposit (108) was also identifiable between the outer skin of stonework (322) and the inner skin of stonework (109) (Figure 4, 101 & 102). It should also be noted that deposit (108) displayed near identical composition and form to similarly located clay seal (105) in the south-western

cistern (106). Consequently, it seems likely that deposit (108) was deliberately inserted into the structure of the north-eastern cistern (322) during construction and may be interpreted as a waterproofing seal for the retention of alum liquor. The presence of deposit (108) within the SE facing section of cistern (322) suggested that the clay seal had extended above inner skin (109) and originally adhered to the interior face of (322), prior to collapse. Again, it seems likely that the inner leaf of stonework was preserved to its full height, given its constant height and the lack of any identifiable disturbance from robbing or collapse. This may also suggest that the inner leaf of the structure could also have continued above this point in a different form, such as some form of wooden construction. No certain evidence for this was uncovered, although this may provide a function for the identified sub-square sockets within the south-western cistern. As previously indicated, deposit (114) also sealed a well sorted, whitish-yellow, silty-clay (112). Deposit (112) measured 1.65m x 2.2m x 0.03m and overlay a flagged, sandstone surface (111). It should be noted that deposit (112) was very similar to deposit (140) at the base of the south-western cistern (106). Consequently, deposit (112) was interpreted as a similar 'use' deposit, likely related to the settling of material from the alum liquor stored within cistern (322). An additional poorly sorted, greyish-brown, collapse deposit (113) was identifiable overlying 'use' deposit (112) within the SE facing section of cistern (322)(Figure 4, 101 & 102). It is of note that a length of timber planking was recovered from collapse deposit (113) and was interpreted to have served as a constituent part of a planked lid sealing the operational cistern from the elements.

2.1.11 Deposits (115), (114) and (112) represented the deposit sequence within the interior of cistern structure (322) (Figure 4). The structural components of the north-eastern cistern (322) were composed of the outer skin of stonework (322), the inner skin of stonework, (109) and a flagged, sandstone surface (111). Cistern (322) measured 5.30m x 4.58m x 1.38m at its maximum extents and was constructed from curved, dressed sandstone blocks built to regular courses (Figure 1 & 4). The individual sandstone blocks displayed evidence for the application of a greyish-white, lime mortar bonding material and measured an average 0.42m x 0.28m x 0.26m. The outer face of (322) abutted a red shale, quarry waste deposit (110) and a poorly sorted, silty-clay deposit (136). The inner face of wall (322) was abutted by the afore-mentioned interior deposits (115), (114) and (112), in addition to clay seal deposit (108) (Figure 4, 101 & 102). Deposit (108) was abutted by an inner skin of unbonded, regularly coursed, curved stonework (109) which was identified at a depth of 0.70m below present ground level. It should also be noted that, similar to the inner skin of stonework within cistern (106), the outer face of wall (109) was stained a shade of yellow comparable to the whitish-yellow, residue deposit (110). The inner skin of stonework (109) and clay seal (108) overlay a flagged, sandstone surface (111) measuring 2.47m x 1.65m x 0.10m at its maximum visible extents. The individual sandstones were sub-square in plan, displayed no evidence for the use of bonding materials and measured an average 0.58m x 0.39m x 0.10m. A number of these blocks contained punched herringbone tooling generally without margins. Sandstone surface (111) also sloped from the western corner of the excavated quadrant to the eastern, seaward edge of Trench 1. This was not interpreted

to be an intended structural design and was likely caused by erosion to the cliffs edge which resulted in progressive subsidence to cistern (322).



Figure 4- NE-facing section through cistern (322) displaying collapse deposit (114) (Scale- 2m + 1m)

2.1.12 The similarity between the structural form of cistern (322) and cistern (106) supported the interpretation that both structures had been constructed within a larger sub-rectangular foundation trench [126]. The physical relationship displayed by the red shale quarry waste deposit (110) and the outer skin of stonework (322) certainly suggested that deposit (110) had been deliberately backfilled behind the cistern following its construction. It is possible that cistern (322) was built against a pre-quarried edge and that backfill (110) was inserted into the space remaining between cistern (322) and the natural substrate following construction.

2.1.13 A third, fragmentary structure (118), measuring 4.58m x 0.32m x 0.62m, was identified at the NW extent of Trench 1 (Figure 5). Structure (118) was built from similarly sized, dressed, sandstone construction materials as cisterns (106) and (322). Additionally, the sandstone blocks were built to regular courses and displayed evidence for the use of a greyish-white, lime mortar. Structure (118) was visible within the SE facing section at the western extent of Trench 1 and only revealed the surviving southern face of the structure. Consequently, no interior deposit sequence was identified and no formal identification for the function of structure (118) was assigned.

2.1.14 As previously mentioned, the uppermost deposit within the NW extent of Trench 1 was a greyish-brown topsoil (124) with a maximum visible depth of 0.42m (Figure 5 & 104). Topsoil (124) overlay structure (118), backfill (139) and a brownish-

grey, sandy-silt subsoil (135). Subsoil (135) partially overlay structure (118), a whitish-yellow, silty-clay (120) and a brownish-red shale deposit (125). Shale deposit (125) displayed a moderately sorted composition, measured 1.41m x 0.52m x 0.13m and was overlain by both subsoil (135) and structure (118). The form of deposit (125) was suggestive of a levelling layer for structure (118) composed of red shale, quarry waste. Deposit (120) measured 3.45m x 0.32m x 0.29m and was overlain by both structure (118) and shale levelling deposit (125). As previously mentioned, deposit (120) was composed of a whitish-yellow, silty-clay and should be interpreted as an additional levelling deposit for structure (118). Levelling deposit (120) also overlay the natural shale substrate (121). Deposits (120), (121) and (125) were truncated by land drain F.139 which was comprised of a near-vertically sided cut [145] filled by a reddish-orange, ceramic pipe and a poorly sorted, greyish-brown, silty-clay (139) (Figure 104).

2.1.15 It is worth noting that the red shale fill (119) of cistern foundation cut [126] abutted the southern face of structure (118). It could be assumed that structure (118) may predate cisterns (106) and (322). However, it seems unlikely that a large construction trench would be excavated at such a short distance from a pre-existing building (118) without the risk of undermining the foundations and causing damage to structural integrity. Consequently, the presence of construction deposit (119) abutting structure (118) might be indicative that the cisterns and building (118) were formed at a contemporaneous date and had related functions. The most plausible hypothesis for the function of structure (118) might therefore relate to liquor transportation to and from the cisterns.



Figure 5- West facing oblique view of structure (118). Note also the socket hole within the wall of the cistern (106), interpreted as a socket for a planked lid on the cistern. (Scale 1 x 1m)

2.1.16 A NW-SE aligned linear F.131 was identified 0.63m east of structure (118) (Figure 6, 7 & 103). F.131 was comprised of cut [323] filled by deposits (128), (129), (130), (131) and (146). The uppermost deposit within cut [323] was composed of a bluish-yellow, silty-clay (131) measuring 0.86m x 0.65m x 0.33m and containing occasional small to medium sandstone inclusions. Deposit (131) was sealed by subsoil (132), a buried topsoil deposit (133) and was interpreted as an erosion deposit indicative of collapsing sides. A poorly sorted, brownish-red, sandy shale deposit (130) was identified below collapse layer (131). Deposit (130) measured 0.84m x 0.30m x 0.20m at its maximum visible extents and was interpreted as a deliberately deposited dump of red shale quarry waste within dis-used linear F.131 (Figure 6, 7 & 103). Deposit (130) overlay a poorly sorted deposit of bluish-yellow, silty-clay (129) measuring 0.84m x 0.30m x 0.10m. Deposit (129) overlay a further moderately sorted deposit of red shale quarry waste (128) measuring 0.84m x 0.27m x 0.17m (Figure 6, 7 & 103). Both (128) and (129) were interpreted as being formed by deliberate man-made depositional events. The earliest identifiable deposit within cut [323] was a well sorted, greyish-brown, sandy-silt (146) with a maximum depth of 0.04m. The form and composition of deposit (146) was indicative of natural silting within cut [323] following initial excavation.



Figure 6- SE-facing section through linear/liquor trough F.131 (Scale- 1 x 1m & 1 x 2m)

2.1.17 Cut [323] displayed a concave profile, a gradual break of slope at the top, a gradual break of slope at the bottom and a rounded, even base (Figure 6, 7 & 103). Cut [323] truncated red shale backfill deposit (110) and clay packing deposit (136). No finds indicating feature function or date were recovered from F.323. However, the proximity

of F.131 to cisterns (106) and (322) was notable as during Chapmans' excavations stone and wooden channels/troughs were identified between the cisterns (Miller, 2002). The channels functioned as liquor transportation routes between the steeping pits and storage cisterns. The similar location of F.131 to the liquor channels identified during Chapmans' excavations is notable and may indicate that F.131 served as a channel for the support of a wooden liquor transportation trough which was inserted following cistern construction. However, it is worth noting that the depth of potential liquor channel F.131 in relation to both cistern (106) and (322) is considered to be impractical for the siphoning of liquor from the cisterns into a trough. Additionally, the stonework within the south-western corner quadrant of cistern (322) was identified as slumping towards the location of F.131. Consequently, potential liquor channel F.131 may have been inserted following the dis-use of cisterns (106) and (322). Further excavation south-west of cistern (322) would be required in order to prove the above interpretation. It should also be noted that no evidence for F.131 was visible within Trench 2.



Figure 7- SE-facing section through potential liquor trough F.131. Note continuation of linear depression demarcating the route of the trough north of Trench 1. (Scale- 1 x 1m & 1 x 2m)

Trench 2

2.1.18 Trench 2 was situated 1.94m SE of Trench 1 and measured 5m x 2m x 1.10m at its maximum visible extents (Figure 8-11, 94, 105, 106). A greyish-brown topsoil (201) represented the uppermost deposit within Trench 2 and sealed a 0.18m thick, light, greyish-brown, subsoil deposit (202). No datable finds were recovered from deposits (201) and (202). Subsoil (202) sealed structure (207) and deposits (203), (204), (206), (209), (211), (213), (216) and (218) (Figure 8-11). Structure (207) measured 1.4m x 0.65m x 0.21m and was comprised of three large sub-square, shaped sandstone blocks. No bonding material was identified and the stone blocks measured an average 0.52m x 0.34m x 0.22m. No foundation cut was revealed indicating that structure (207) was not trench built and was likely constructed directly onto a mid bluish-white, silty-clay levelling layer (205)/(208) (Figure 105 & 106). Structure (207) was abutted by deposit (206) and partially overlain by red shale, quarry waste deposit (203). Deposit (203) was intermittently visible across Trench 2 at a variable depth of 0.18m below present ground level. Deposit (203) had a maximum thickness of 0.26m and was interpreted as a quarry waste naturally deposited across Trench 2 following dis-use and abandonment. Shale waste deposit (203) partially overlay clay deposit (206). Deposit (206) was comprised of a brownish-yellow, sandy-clay situated within the proposed south-western, interior of structure (207). Deposit (206) abutted the south-western face of structure (207) and was interpreted as an interior levelling deposit, likely intended as foundation support for flagging stones. No interior use deposits relating to the function or date of structure (207) were identified.



Figure 8- SW-facing view of structure (207). Note parallel beamslot F.211 at the northern extent of the Trench. (Scale- 1 x 1m)

2.1.19 Levelling deposit (205)/(208) overlay a sandy-sandstone layer (204) which was truncated by linears F.209, F.211 and pit F.214. Linear F.209 was aligned on a broadly NE-SW orientation and was comprised of cut [210] filled by deposit (209) (Figure 9 & 105). Cut [210] displayed a sharp break of slope at the top, a sharp break of slope at the bottom and a flat, even base. Cut [210] also measured 2.99m x 0.35m x 0.14m and was filled by a moderately sorted, brownish-red shale deposit (209). Fill (209) was likely deliberately deposited within cut [210] following dis-use. Linear F.209 was interpreted as contemporaneous with NW-SE aligned linear F.211 which intersected with F.209 0.18m south of the northern extent of Trench 2 (Figure 9 & 105). Cut [212] measured 0.95m x 0.28m x 0.06m at its maximum visible extents and displayed near identical form to cut [210]. Cut [212] was filled by a moderately sorted, brownish-red shale deposit (211) which displayed a similar form to deposit (210). Consequently both F.209 and F.211 were interpreted as beam-slots providing support for a structure associated with wall (207).



Figure 9- NNE-facing view of structure (207) bordered by parallel beamslots F.209 and F.211. (Scale- 1 x 2m)

2.1.20 A sub-oval pit F.214 was identified 0.20m SE of beamslot F.211. Pit F.214 was sealed by a sub-square, shaped sandstone block (213) measuring 0.4m x 0.3m x 0.11m (Figure 10, 105 & 106). Sandstone block (213) was interpreted as structural tumble from wall (207) and had collapsed over pit F.214 following abandonment. Pit F.214 measured 0.82m x 0.5m x 0.2m and was comprised of cut [215] filled by deposit (214). Cut [215] had irregular but broadly concave sides and gradual breaks of slope at both the top and bottom. Fill (214) was the only identifiable fill within cut [215] and was composed of a

poorly sorted, brownish-red, shale deposit. The form of pit F.214 was tentatively interpreted to be a post pit for a structural member, such as a timber upright. However, the heavily disturbed form of the sides of [215], coupled with the poorly sorted red shale deposit (214), may indicate that the structural member had been deliberately robbed away. Additionally, the proximity of post pit F.214 to beam-slots F.209 and F.211 may suggest that the three features were structurally associated and may have been further related to wall (207). No finds were recovered from F.209, F.211 and F.214.



Figure 10- Post excavation view of potential post-pit cut [215] (Scale- 1 x 0.10m)

2.1.21 Pit F.214 truncated both levelling deposit (208) and a linear alignment of small, sub-angular sandstones (216) which was interpreted to be an earlier drain (Figure 105 & 107). Drain F.216 measured 0.92m x 0.1m x 0.08m, abutted wall (207) and was sealed by subsoil (202). It should be noted, however, that F.216 was only visible in section and had been heavily disturbed by the insertion of post-pit F.214.

2.1.22 As previously mentioned a sandy deposit (204) containing frequent fragments of small, sub-angular, sandstone inclusions was identified below levelling clay (205/208). Deposit (204) was displayed a maximum depth of 1.2m and was interpreted to represent a deliberate dump of quarry waste which may have been used as an initial levelling layer, prior to the deposition of (205/208). It is worth noting that deposit (204) continued beyond the limit of excavation and therefore had a maximum depth exceeding 1.2m. The very high concentration of sandstone within deposit (204), may also be indicative of a wider re-use of the sandstone overburden which may have capped the natural shale substrate. Deposits (204) and (205/208) have therefore been interpreted as forming a building platform upon which a structure, associated with wall

(207) and beamslots F.209/F.211, were later built. It should be noted however, that the lack of bonding material adhering to structure (207) may be indicative of a surface and not a wall. Consequently, it should also be considered that deposits (204) and (205/208) may have formed a building platform in support of a stone surface.

2.1.23 Deposit (204) overlay a greyish-brown, sandy-silt deposit (220) with a maximum visible depth of 0.2m (Figure 11 & 109). Deposit (220) was likely formed by wind or waterborne deposition and also overlay the natural shale substrate (217). It is worth noting that the interface between the natural shale substrate (217) and deposit (220) was diffuse and sloped at a broadly 45° angle. The unusual sloping form of the natural substrate was indicative of a man-made edge [221] and was interpreted to be a probable quarry face or dross excavated into the natural shale (217) (Figure 11 & 109). Consequently, the building platform composed of levelling layers (204) and (205/208) was interpreted to have been constructed against a pre-existing quarry face [221]. Furthermore, the presence of a silty layer (220) overlying the natural shale (217) suggested that quarry dross [221] had likely been exposed for a period of time prior to the construction of the building platform. No datable finds were recovered from deposits (205/208) or (204).



Figure 11- Building platform levelling deposits (205) and (204) associated with quarry dross [221].
(Scale- 1 x 1m)

Trench 3

2.1.24 Trench 3 was located 67.4m NW of Trench 1 and measured 3.03m x 2.16m x 0.86m at its maximum visible extents (Figure 12, 13, 94 & 111). The uppermost

identifiable deposit within Trench 3 was a 0.36m thick, greyish-brown topsoil (301) (Figure 12-14, 110 & 113). Topsoil (301) sealed a greyish-brown, sandy-silt (302) which was identifiable across the full extent of Trench 3 and displayed a maximum depth of 0.15m. Deposit (302) contained frequent fragments of shaped sandstone and occasional fragments of ceramic pantile. The well sorted composition of deposit (302) was indicative of a naturally deposited dis-use deposit formed following abandonment of the site. Topsoil (301) also sealed a yellowish-orange, silty-clay (312) measuring 1.07m x 0.09m x 0.18m (Figure 113). Deposit (312) abutted wall (304) and was interpreted as the naturally accumulated fill of a robber trench [322] excavated in order to remove structure (304). No finds were recovered from deposit (312).



Figure 12- NE facing view of wall (304) with deposits (312) and (301) visible overlying the structure.
(Scale- 1 x 1m & 1 x 2m)

2.1.25 Dis-use deposit (302) also overlay and partially abutted wall (304) which was identified along the length of the northern and eastern sides of Trench 3 (Figure 14 & 113). Wall (304) displayed a maximum potential thickness of 1m and survived to a height of 1.05m (Figure 12-14, 110, 112). Wall (304) was constructed from dressed sandstone masonry with a greyish-white mortar bond. The individual stone blocks measured an average 0.46m x 0.28m x 0.24m and were built to regular courses. Three sub-square sockets [307], [309] and [311] were noted within the north-west face of the south-eastern wall (304) (Figure 14 & 111). Socket [307] measured 0.10m x 0.7m, socket [309] measured 0.15m x 0.10m and socket [311] measured 0.10m x 0.11m. All of the sockets [307], [309] and [311] were filled by respective deposits of loose, greyish-brown sandy, silt (306), (308) and (310). Deposits (306), (308) and (310) likely represented a natural accumulation of silts following dis-use and can be interpreted as the same as

deposit (302). Additionally, socket [309] showed evidence of damage to its borders and displayed traces of brownish-red, oxidised metal adhering to the rear interior face. Consequently, [307], [309] and [311] were interpreted as potential machine sockets or facets for metal structural beams. As previously mentioned, deposits (301), (302), (303) and (312) abutted wall (304) at its eastern and northern extents. Wall (304) was also abutted by flagged sandstone surface (305) (Figure 12-14 & 113).



Figure 13- SE facing view of wall (304). Note sockets [307], [309] and [311]. (Scale- 2 x 1m)

2.1.26 Greyish-brown, dis-use deposit (302) also sealed a reddish-yellow, sandy-silt deposit (303) containing frequent, fragmentary, red shale inclusions. Deposit (303) occupied the full extent of Trench 3 and displayed a maximum depth of 0.20m. Deposit (303) was also heavily compacted and overlay flagged sandstone surface (305) (Figure 12-14, 111 & 113). Consequently, (303) was interpreted as an occupation or trampled 'use' deposit related to the operation of structure (304).

2.1.27 Surface (305) measured 3.03m x 2.16m x 0.86m at its maximum visible extents and was constructed from sub-rectangular sandstone flags (Figure 12-14, 111). The individual flagstones measured an average 0.54m x 0.35m and were laid to a single irregular course. No bonding material was identified. Several of these blocks contained punched herringbone tooling generally without margins. Diamond shaped sockets [316], [318] were identified 1.31m NE of the eastern-most extent of Trench 3 (Figure 12-14, 111). Socket [316] measured 0.08m x 0.07m x 0.02m and socket [318] measured 0.09m x 0.10m x 0.02m at their maximum extents. Additionally, sockets [316] and [318] were orientated on a broadly N-S alignment and may have been associated with wall sockets [307], [309] and [311]. Although no residue relating to the function of sockets [316] and

[318] was identified, both were interpreted as facets for the support of timber or metal uprights. Additionally, it is not unreasonable to assume that both sockets [316] and [318] may have also served as facets in support of operating machinery. Two additional sockets, [314] and [320] were identified at the western and northern extents of Trench 3 (Figure 14 & 111). Socket [314] was sub-square in plan and measured 0.15m x 0.14m x 0.04m at its maximum visible extent. The base of cut [314] displayed broad chiselled ridges that sloped at a shallow gradient from SE-NW. Socket [320] was sub-rectangular in plan and measured 0.13m x 0.18m x 0.03m at its maximum extents. The sides of [320] were vertical and the base displayed broad, 0.01m ridges, similar to those identified at the base of [314]. The base of socket [320] also displayed a shallow sloping gradient from NE-SW. Both sockets were interpreted to be structural facets sloped so as to insert uprights into position within the confines of a roofed structure. Consequently, both facets [314]/[320], and their associated structural components, were inserted following construction of building (304). The sloped facets may have been a later modification in response to a requirement for increased structural support or due to the insertion or modification of machinery.



Figure 14- S-facing view of Trench 3. Note facets [314], [316], [318] and [320] cut into flagstone surface (305). (Scale- 2 x 1m).

2.1.28 Sockets [314], [316], [318] and [320] provided some indication for the function of structure (304) but little decisive evidence. It is not unreasonable to assume that metal uprights or braces existed within structure (304), nor is it implausible to assume that the afore-mentioned supports related to machinery. However, the absence of recovered machine parts or more diagnostic structural modifications prevented any definitive conclusion with reference to the buildings function. Additionally, the lack of

any deposits related to domestic activity suggested that (304) did not serve as a dwelling or structure of domestic association. Consequently, structure (304) was tentatively assigned the role of machinery housing. Potentially a pump house related to the transportation of alum liquor.

2.2 Kettlewell

2.2.1 The archaeological works at Kettlewell comprised the excavation three trenches in the location of the putative calcining clamp and calcining places (Figure 95). Trench 1 measured 2.7m x 3.16m and was excavated across the south-western edge of the north-eastern calcining place. Trench 2 measured 3.11m x 1.85m and was placed across the interior of the north-eastern calcining place. Both trenches 1 & 2 were excavated in order to sufficiently characterise the deposits and to gain greater understanding of the processes conducted within the calcining places. Trench 3 measured 3m x 2m and was excavated across the north-eastern extent of a potential calcining clamp in order to sufficiently characterise the deposits and confirm the present interpretation.

Trench 1

2.2.2 Trench 1 measured 2.70m x 3.16m x 1.4m and was excavated through a greyish-brown topsoil deposit (101) (Figure 15, 16, 95, 114 & 115). Topsoil (101) displayed a maximum visible depth of 0.21m and contained occasional small sub-angular stony inclusions. Deposit (101) overlay a brownish-grey, clayey-silt (102) containing frequent inclusions of friable shale. Deposit (102) overlay natural substrate (104), abutted wall (103) and was interpreted as colluvial 'hill-wash' formed by naturally occurring depositional processes. Natural substrate (104) was identified at a depth of 1.4m below ground level and was comprised of a bluish-grey shale with occasional clastic inclusions. Deposit (104) was overlain by both colluvium (102) and wall (103). It is not unreasonable to assume that natural substrate (104) was exposed by shale quarrying prior to the construction of wall (103).

2.2.3 Structure (103) measured 1.71m x 1.19m x 0.23m at its maximum visible extents and was constructed from unbonded, regularly coursed, squared sandstone. The sandstone blocks measured an average 0.48m x 0.21m x 0.20m and were constructed on the natural shale substrate (104). No foundation trench was visible and indicated that structure (103) was likely constructed as a retaining wall for management and maintenance of the sloping topography (Figure 15, 16, 114 & 115). No datable finds were found in association with structure (103) but it likely dated from the 18th or 19th Century.



Figure 15- S-facing view of Trench 1 displaying retaining wall (103) (Scale- 2 x 1m)



Figure 16- SW-facing view of retaining wall (103) (Scale- 2 x 1m)

2.2.4 Trench 2 measured 3.11m x 1.85m x 1.5m and was located at the base of the north-easternmost potential calcining place (Figure 95) The uppermost deposit in Trench 1 was a greyish-brown topsoil (201) (Figure 17 & 116). Topsoil (201) displayed a depth of 0.09m, contained a moderate quantity of small, sub-rounded stony inclusions and overlay subsoil deposit (202). Subsoil (202) was comprised of a brownish-grey, clayey-silt with a maximum thickness of 0.09m. Additionally, subsoil (202) sealed a bluish-grey, clayey-silt (203) containing frequent inclusions of friable shale. Deposit (203) had a maximum depth of 0.84m and was interpreted as colluvium formed by gradual erosion of the exposed sides of the potential calcining place. Colluvium (203) sealed a dark, bluish-grey, clayey-silt deposit (204) which was identified at a depth of 1.02m below and had a maximum visible depth of 0.89m (Figure 17 & 116). Deposit (204) continued below the limit of excavation and was interpreted as an additional colluvial deposit formed by naturally occurring depositional processes. No finds or features of archaeological significance were identified within Trench 2. It is also worth noting that the natural substrate was not identified and no deposits of anthropogenic form were present within Trench 2. Consequently, it was not possible to test the validity of the hypothesis that Trench 2 was situated within the base of a probable calcining place (Jecock, 2003).



Figure 17- ENE facing section through Trench 2 (Scale- 2 x 1m)



Figure 18- S-facing view of Trench 2 (Scale- 2 x 1m)

2.2.5 Trench 3 measured 2.88m x 1.98m x 1.39m at its maximum visible extents and was excavated through a greyish-brown, topsoil deposit (301) (Figure 95, 117 & 118). Topsoil (301) displayed a maximum visible depth of 0.23m and contained occasional, sub-angular, stony inclusions. Topsoil (301) overlay a poorly sorted, reddish-orange deposit (303) comprised of heavily degraded fragments of iron-stone and reddish-brown sandy-silt. The degradation and colour of the ironstone was attributed to decay caused by prolonged exposure to high temperatures. The frequent ironstone inclusions had a sub-angular form and displayed average dimensions of 0.22m x 0.16m x 0.21m. Deposit (303) overlay an orangey-brown, silty-clay deposit (304) measuring 1.98m x 1.98m x 0.07m at its maximum visible extents. It was noted that deposit (304) displayed a diffuse interface with an underlying bluish-grey, silty-clay deposit (305) (Figure 19, 20, 119 & 120). The composition and form of both (303) and (304) were similar and indicated that both deposits were likely deposited by the same process. Consequently, (304) was interpreted as a discolouration of (305) caused by exposure to high temperatures and should not be regarded as an individual depositional event. Deposit (305) measured 2.88m x 1.98m x 0.23m at its maximum visible extents and overlay deposits (306) and (308). It should be noted that, despite the well sorted composition of (305) and (304), both layers were interpreted as being formed by deliberate, man-made, depositional processes.

2.2.6 Layer (306) was a poorly sorted layer of sub-angular sandstone measuring 1.33m x 1.98m x 0.26m. The sandstone was not bonded and displayed limited evidence of working beyond being roughly hewn during quarrying (Figure 19, 20, 119 & 120). The stones were not laid to courses but were likely deliberately deposited over levelling

deposit (307) and (310). Layer (306) also abutted the upper visible course of retaining wall (302). No dating evidence was recovered from layer (306). The comparatively large size of the stones identified within deposit (306) were interpreted as constituting a potential thermal layer for facilitating the movement of air within the sub-structure of the putative calcining clamp.

2.2.7 Deposit (308) displayed a greyish-blue composition, contained frequent fragments of degraded shale and occasional inclusions of bluish-yellow clay. As previously mentioned, deposit (308) was overlain by clay (305), abutted structure (302) and overlies the natural shale substrate (309) (Figure 19, 20, 119 & 120). Deposit (308) measured 0.74m x 1.98m x 0.52m at its maximum visible extents and was interpreted as a retaining layer, deposited as structural support for wall (302). No finds or dating evidence was recovered from deposit (308).

2.2.8 Wall (302) was constructed from roughly hewn sandstone, built to regular courses and displayed no evidence for the use of any bonding material (Figure 19, 20, 117-120). No construction cut was visible within adjoining deposits (307) and (308). Consequently, wall (302) was interpreted as a retaining wall constructed following the deposition of levelling deposit (307). Wall (302) was built directly over the natural shale substrate (309).

2.2.9 Deposit (307) was abutted by the SSW face of wall (302) and was overlain by thermal layer (306). Deposit (307) measured 0.19m x 1.98m x 0.54m at its maximum visible extents and was comprised of a moderately sorted, bluish-grey, silty-clay containing frequent, degraded, shale inclusions. Deposit (307) was overlain by both thermal layer (306) and a poorly sorted, yellowish-grey, silty clay (310). Both deposits (307) and (310) were interpreted as deliberately deposited levelling or foundation layers for the initial creation of the putative calcining clamp.

2.2.10 The bluish-grey, natural shale substrate was identified at a depth of 1.43m below ground level and was physically overlain by retaining deposit (308), wall (302) and levelling deposit (307).

2.2.11 Trench 3 was targeted across the location of a potential calcining clamp representative of the pre-refinement stage within alum production (Figure 95). A calcining clamp was constructed from consecutive layers of fuel and alum shales to form a calcining pile or heap. The fuel within the clamp would then be ignited and therefore great care was taken to cover the heap in clay to prevent loss of gases or any rapid decline in temperature (Miller, 2002). The shales within the clamp would turn a reddish-orange shade following exposure to prolonged heat and would then be removed prior to placement within the steeping pits. Additionally, the presence of a sealing layer of deliberately deposited clay (305) was suggestive of the insulating layer utilised within calcining clamps as described above. The use of large stones within layer (306) may be representative of an attempt to assist air flow into the interior of the clamp, although the introduction of significant air flow to the base of such clamps has been argued to be

undesirable by Jecock (2009). Consequently, although no alum shale or combustible fuels were identified within Trench 3, the form and character of the deposits encountered were suggestive of a calcining clamp, although in this case, it seems, for the pre-refinement of locally sourced ironstone rather alum shale.

2.2.12 Such calcining of ironstone would convert low-iron carbonates into richer oxides, remove some of the sulphur and reduce moisture content, thus leaving the enriched ore cheaper to transport (McDonnell and Harrison, 2003). Calcining of ironstone at the production site, before transportation elsewhere, was carried out at Rosedale and Warren Moor in clamps. At Rosedale, Swainby and Wreckhills the ironstone was calcined in stone-built kilns, and in cylindrical kilns encased in riveted iron plates at Liverton (McDonnell and Harrison, 2003). As this process carried out a burn at low temperature, using only approximately 1 ton of coal to every 25 tons of ironstone (*ibid.*), the lack of any significant fuel (e.g. coal) deposit within the small excavation of Trench 3 is perhaps understandable. Following specialist analysis of the ironstone (see Section 3.2) from Trench 3, it also seems most likely that the clamp was not actually fired following construction. This may suggest that the clamp was abandoned before firing, or that it was not successful in converting the raw ore, given that the sample analysed was recovered from the outermost edge of the ironstone deposit encountered within the clamp. Nonetheless, this feature is of significant interest with relation to the local ironstone industry and highlights the further possibility of the exploitation of eroded foreshore ironstone deposits at coastal locations (as suggested by McDonnell, see Section 3.2 of this report).



Figure 19 – NW facing section through calcining clamp (Scale- 1 x 1m & 1 x 2m)



Figure 20- SW-facing view of Trench 3 displaying thermal layer (306) and retaining wall (302) (Scale- 2 x 1m)



Figure 21- SW-facing view Trench 3 displaying thermal layer (306) levelling deposit (307) (Scale- 2 x 1m)

2.3 Saltwick

2.3.1 The archaeological works at Saltwick Nab comprised the excavation of two trenches on the seaward extent of the quarry and the detailed photographic and drawn recording of the scheduled foreshore slipway. Trench 1 measured 10m x 3.3m and was excavated through the partially eroded quarry edge deposits and sought to sufficiently

characterise both the deposit sequence and any identified structural remains. Trench 2 measured 3m x 2m x 0.43m and was located c.50m south of Trench 1.

Trench 1

2.3.2 Trench 1 measured 10.08m x 4.86m x 1.13m at its maximum extents and was targeted across the eroding quarry edge deposits associated with the Saltwick Nab alum quarry (Figure 96 & 121). The uppermost deposit within Trench 1 was a 0.73m thick, greyish-brown topsoil (201). Topsoil (201) and sealed a 0.24m thick, greyish brown subsoil (202) and a brownish-red shale deposit (208). Shale deposit (208) displayed a maximum thickness of 0.89m and was composed of moderately sorted, red shale quarry waste within a reddish-brown silt matrix. Consequently, layer (208) was interpreted as a deliberately deposited 'dump' of alum production waste following the dis-use of this area of the quarry. Subsoil (202) and layer (208) sealed further deliberately deposited layers of quarry waste material, (203), (205), (206) and (211) (Figure 22, 122 & 123). Deposit (203) measured 1.8m x 1m x 0.3m and was composed of poorly sorted, brownish-red shale fragments. Deposit (203) overlay a naturally deposited, greyish-brown, sandy-silt deposit (204) which measured 0.9m x 0.82m x 0.10m. Deposit (204) likely represented a brief cessation in activity within this area of the quarry and overlay a 0.6m thick, deliberate 'dump' of red shale quarry waste (205) (Figure 22, 23 & 123). Deposit (205) also overlay a 0.3m thick, yellowish-grey, silty-clay (206) containing frequent fragments of red shale which was interpreted as a further deliberate dump of quarry waste material. As previously mentioned, an additional quarry waste 'dump' deposit (211) was sealed by layer (208) (Figure 22, 23 & 122). Deposit (211) measured 4.39m x 1.2m x 0.53m and was composed of a poorly sorted, greyish-yellow clay containing frequent fragments of red shale. The presence of close related layers of deliberately deposited quarry waste material may be indicative of increased activity within the Saltwick alum works. Deposits (203), (205), (206) and (211) may have represented an increase in localised alum production and the disposal of large volumes of associated waste. Additionally, deposits (203), (205), (206) and (211) could be equally representative of a movement of waste material within the confines of the quarry in order to access and exploit previously untapped shale.



Figure 22- NNW facing view of Trench 1 (Scale- 2 x 2m & 1 x 1m)

2.3.3 Deposits (206) and (208) also overlay an orangey-grey, silty-clay layer (207). Deposit (207) measured 3.86m x 4.5m x 0.23m at its maximum visible extents and was heavily compacted. The form and indurated compaction of layer (207) was suggestive of a roughly consolidated working surface. No finds or dating evidence was recovered from surface (207). Surface (207) sealed deposits (212), (222) and linear F.214 (Figure 23, 23, 122 & 123). Linear F.214 measured 5.10m x 0.52m x 0.61m and bisected the western extent of Trench 1 on a N-S and E-W aligned axis. Linear F.214 was also comprised of cut [210] filled by deposit (214). Cut [210] displayed near vertical sides, a flat, uneven base and sharp breaks of slope at both the top and bottom. Cut [210] also truncated deposits (212), (217), (218) and (219) (Figure 22, 23 & 124). As previously mentioned, deposit (214) was the only identifiable fill of cut [210] and displayed a poorly sorted, brownish-orange, silty-clay composition. Additionally, deposit (210) also contained frequent small, sub-angular sandstone inclusions and occasional fragments of worked timber. Due to the poorly sorted composition of deposit (214), linear F.214 was interpreted as a deliberately back-filled drainage trench.

2.3.4 As previously noted, linear F.214 truncated an orangey-grey, silty-clay deposit (212) with a maximum depth of 0.38m. Deposit (212) was identifiable across the full extent of Trench 1 and was interpreted to be a levelling layer for the formation of surface (207). Levelling deposit (212) also overlay a 0.20m thick, orangey-red, silty-clay deposit (215) containing frequent red shale inclusions (Figure 22-24 & 122-124). Deposit (215) displayed a loosely compacted and poorly sorted composition so was interpreted to be a potential dump or spread of alum production waste material. Levelling layer

(212) also overlay an additional spread or dump of red shale alum production waste (221). Deposit (221) measured 1.1m x 0.80m x 0.32m at its maximum visible extents and contained no datable finds.



Figure 23- NNE facing view of drain F.214. Note revetting wall (Scale- 1 x 1m & 1 x 2m)



Figure 24- NW-facing section through wall (220) and deposits (207), (212), (219) and (221) (Scale- 1 x 2m)

2.3.5 Deposits (221), (212) and (207) all abutted an E-W aligned sandstone wall (220) which was situated at the south-western extent of Trench 1 (Figure 24 & 124). Wall (220) measured 1.81m x 0.38m x 0.89m at its maximum extents and was constructed using unbonded, shaped sandstone blocks built to irregular courses. Wall (220) survived to a height of six courses and the individual sandstone blocks measured an average 0.36m x 0.29m x 0.12m. Additionally, the southern face of wall (220) abutted the natural shale substrate (213). Consequently, wall (220) was interpreted as having a dual function of retaining wall for the consolidation and preservation of the working quarry floors and also to partially block dis-used drain F.214.

2.3.6 It should also be noted that levelling deposit (212) also overlay reddish-grey, silty-clay deposits (216) and (217) (Figure 22-24 & 122-124). Deposit (216) was identified at a depth of 0.96m below ground level at the eastern extent of Trench 2. Deposit (217) was located at the western extent of Trench 2 and was identified at a depth of 1.1m below ground level. Both deposits were heavily compacted, displayed a similar composition and maintained a broadly contemporaneous stratigraphic relationship. Consequently, deposits (216) and (217) were considered to be representative of the same fragmentary working surface. No finds or dating evidence was recovered from deposits (216) or (217). Surfaces (216) and (217) overlay a heavily indurated, brownish-red, silty-clay (219) containing frequent, small, red shale inclusions. Deposit (219) was identifiable across the full extent of Trench 1 and displayed a variable thickness of 0.4m. A reddish-grey, silty-clay deposit (218) measuring a maximum of 0.08m was identified adhering to the surface of (219) at the eastern and western extents of Trench 1. Layer (218) was interpreted to be fragmentary evidence for an occupation or 'use' deposit. No

datable finds were recovered from deposit (218). Surface (219) sealed the natural shale substrate (213) at a depth of 1.6m below present ground level.



Figure 25- ENE facing view of Trench 1 displaying compacted working surfaces (216) and 219) Note the breach in the unquarried shale bank within the background (Scale- 1 x 1m & 1 x 2m)

2.3.7 It was noted that an unquarried bank of natural shale remained in situ at the seaward extent of the quarry (Figure 25). Although the bank of shale remained outside of excavation Trench 1 its presence was considered significant as an intended sea break created in order to protect the quarry floor from seaward impact. It was hypothesised that the erosion scar upon which Trench 1 was targeted, had been created by a breach within the shale bank. Additional breaches to the shale bank were also identified, across the seaward extent of the unexcavated quarry, north of Trench 1.

Trench 2

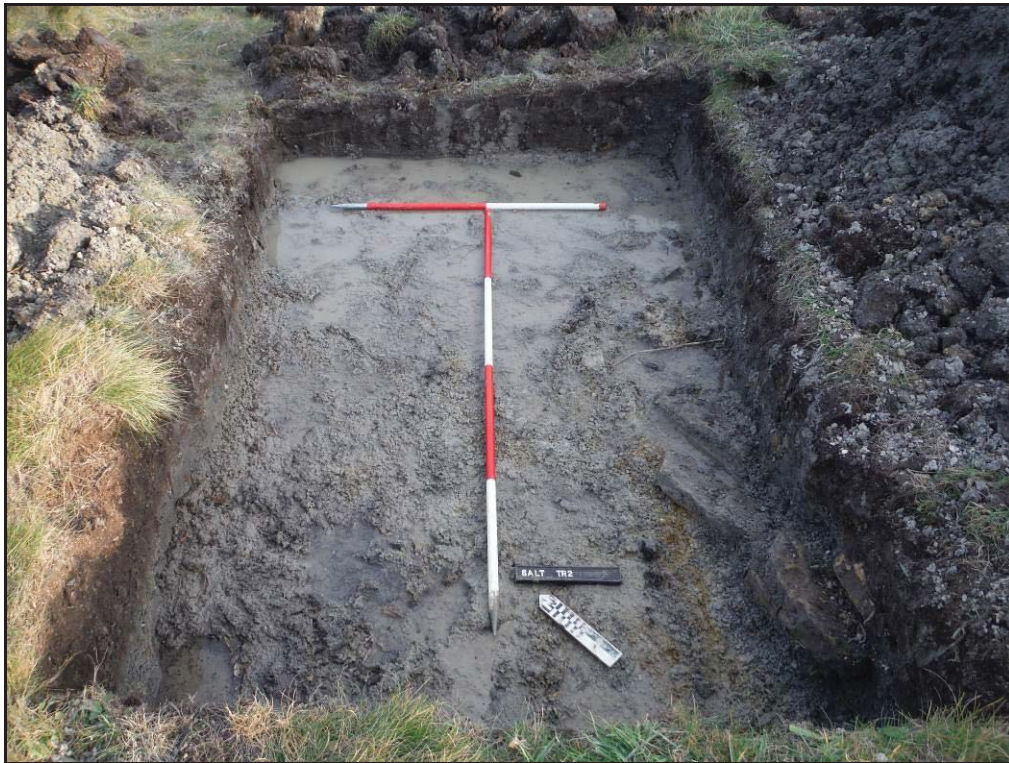


Figure 26- NE facing view of Trench 1 (Scale- 1 x 1m & 1 x 2m)

2.3.8 Trench 2 measured 3m x 2m x 0.45m at its maximum extents and was located 43.98m SE of Trench 1 (Figure 26 & 96). Trench 2 was excavated across eroding quarry edge deposits associated with the Saltwick alum works but was compromised by a high water table which prevented excavation below a depth of 0.45m below ground level. The uppermost deposit within Trench 2 was a brownish-grey, topsoil (101). Topsoil (101) displayed a maximum depth of 0.16m and overlay subsoil (102). Subsoil (102) was visible across the full extent of Trench 2 and had a maximum depth of 0.13m. Subsoil (103) overlay both a bluish-grey, silty-clay (103) and a poorly sorted, deposit of large sub-angular sandstone fragments. Deposit (103) was visible across the base of Trench 2 and continued beyond the limits of excavation (Figure 26). Sandstone (104) was visible principally in section and displayed a maximum depth of 0.16m. Both clay deposit (103) and sandstone layer (104) were tentatively interpreted to be collapse deposits of the superficial geological substrate from the nearby cliff edge. The exposed deposits within Trench 2 were not considered to be of archaeological significance.

Saltwick Slipway

2.3.9 A detailed photographic and digital record of the slipway (Figures 27-32 & 125-128) was also compiled in order to further facilitate the reduction of the 'risk' status attached to the Saltwick Nab Quarry (HHLE 1017779, Legacy SM 29537, HER 6036).

2.3.10 The slipway measured 12.5m x 3.26m x 1.10m at its maximum current extents and was constructed from large, sub-square, shaped sandstone blocks (Figure 27-32 & 125-128). The individual sandstone blocks measured an average 0.98m x 0.67m x 0.68m and displayed no evidence for the use of any bonding materials during construction. Two courses of stonework were identifiable 3.39m south of the northern extent of the quarry. The remaining stonework was constructed to a single, regular course. Additionally, the slipway was aligned on a broadly NNW-SSE orientation and sloped from a maximum height of 1.10m at its northern extent to 0.17m above ground level at its southern extent. Two parallel, near vertically sided grooves had been cut into the superior surface of the slipway and were interpreted as a rutway. The rutway's tracks were similarly aligned on a NNW-SSE orientation and measured an average 11.9m x 0.14m x 0.09m at their maximum extents (Figure 27-32 & 125-128). Associated rutways were also identified cut into the stone geology of the foreshore and ran, on a curving NE-SW alignment, from the southern extent of the slipway.

2.3.11 The slipway was interpreted as being used for the transportation of materials, associated with alum production, during the 17th or 18th century. The presence of the rutway on the surface of the slipway and within the stone foreshore may indicate that materials were transported by wheeled carts to and from the alum quarry into shallow bottomed boats which were located at the northern extent of the structure. Similarly, it would not be unreasonable to assume that the slipway originally extended northwards towards Saltwick Nab and that materials were run across the Nab and down the slipway towards the non-scheduled harbour located upon the southern shore of Saltwick Bay. It should be noted, therefore, that the structural form and composition of the slipway was similar to the materials identified within the harbour and may suggest that both structures were broadly contemporaneous. However, both of the afore-mentioned interpretations are speculative and should not be considered definitive explanations for the function of the slipway.



Figure 27- West facing view of the slipway at Saltwick (Scale- 1 x 1m & 1 x 2m)



Figure 28- East facing view of the slipway at Saltwick (Scale- 1 x 1m & 1 x 2m)

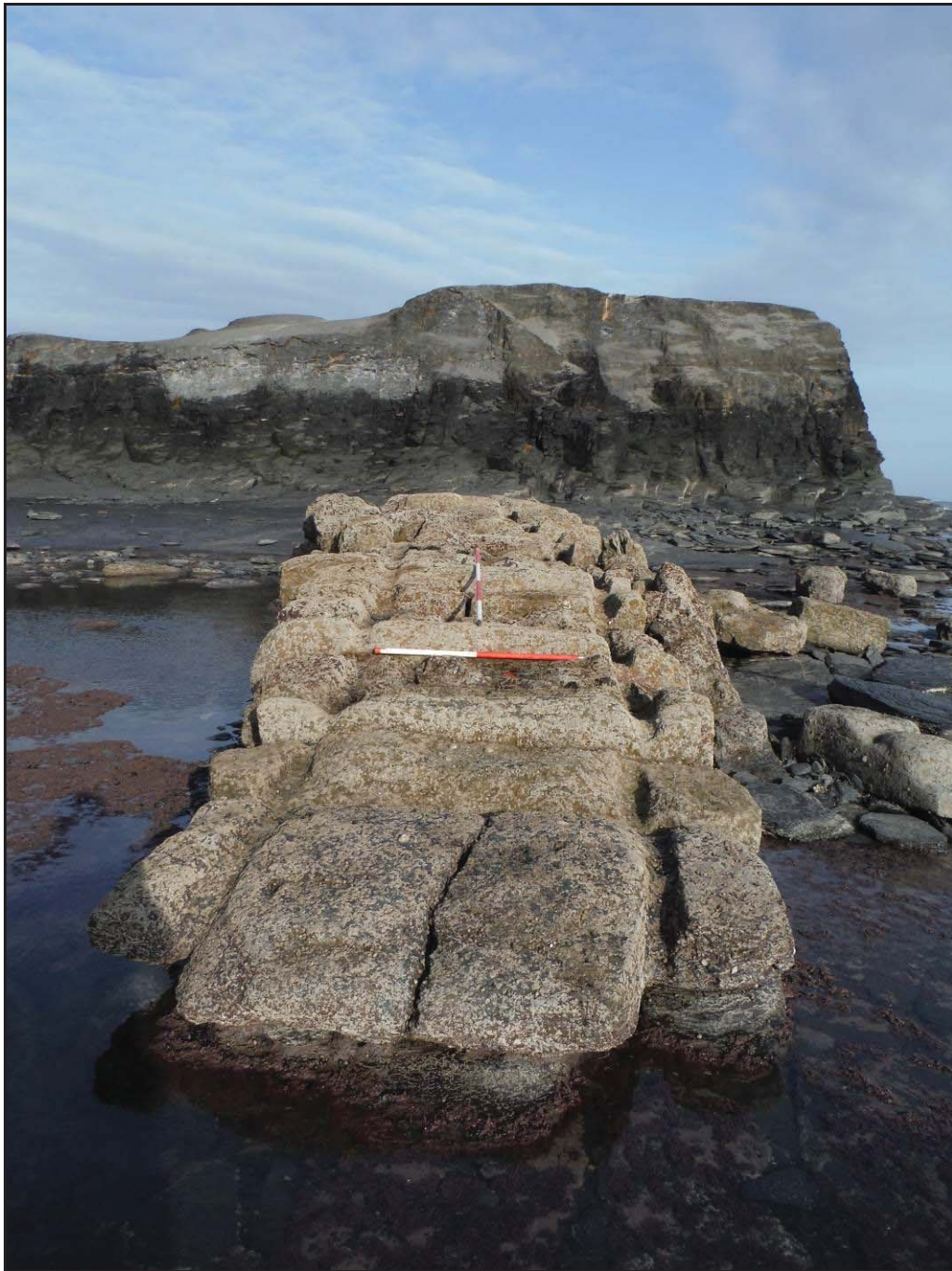


Figure 29- NNW facing view of the slipway at Saltwick. Note the two parallel grooves/tracks within the superior surface of the stonework. (Scale- 1 x 1m & 1 x 2m)



Figure 30 –NNW facing view of the slipway at Saltwick displaying the grooves/tracks cut into the superior surface of the stonework. (Scale- 1 x 1m & 1 x 2m).

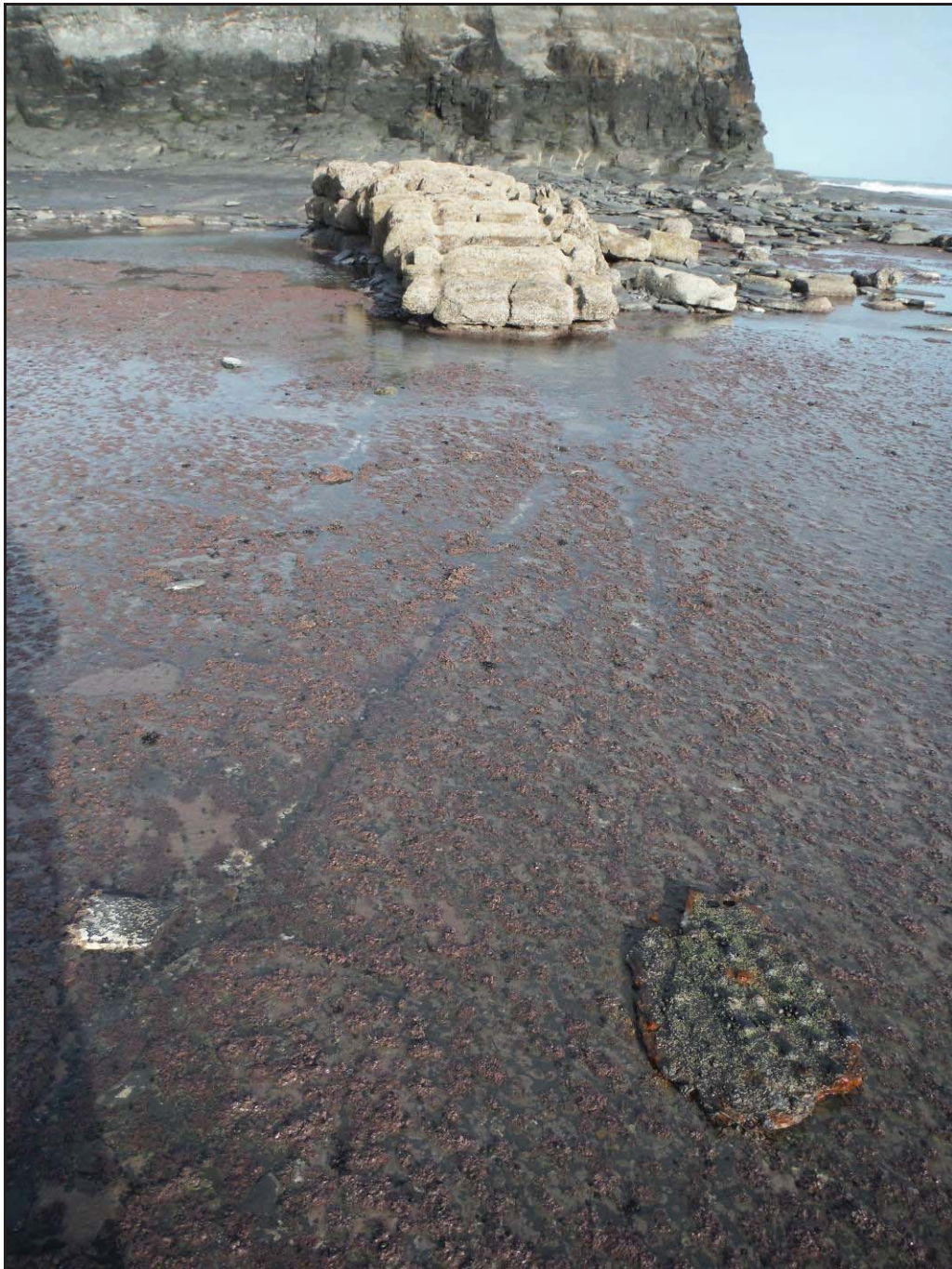


Figure 31- N facing view of the slipway and associated stone-cut trackway within the foreshore.



Figure 32- SSW facing view of the slipway. Note the orientation of slipway in relation to the non-scheduled harbour in the background.

2.4 Sandsend

2.4.1 The archaeological works at Sandsend Alum Quarries consisted of a staged survey starting with an aerial photography and Lidar transcription exercise, followed by a walkover survey to characterise the remains of, and, where possible, to offer an interpretation of the identified features.

Aerial Photography and Lidar Transcription – by Samantha Bax

2.4.2 Photography

A cover-search of the English Heritage Archive identified 100 photographs of the site. These consisted of 51 vertical and 49 oblique photographs. The vertical photography was dated from 1940 to 2000, from which the 1946 RAF photography was particularly useful due to the crisp nature of some earthworks and lesser vegetation coverage. The oblique photography was equally diverse, spanning the period from 1940 to 2008 and consisted of RAF and specialist modern photography. Digital vertical photography was obtained from Durham University (funded by ICL Fertilisers) and Bluesky orthorectified vertical photography with an accuracy of at least 1m. Bing Maps Aerial and Google Earth imagery were also consulted.

2.4.3 Lidar

1 metre resolution Environment Agency Lidar data was provided in ASCII format. This was processed using the Relief Visualization Toolbox 1.1 to produce 16-direction hillshade geoTIFFs, with the sun elevation angle set to 30 degrees. It was important to use both the lidar DTM and DSM due to vegetation coverage across part of the site.

2.4.4 The dating of monuments recorded from aerial surveys relies on recognising morphologically characteristic forms; this was relatively straightforward due to the site specific nature of the post medieval alum quarry survey. The six-inch map published in 1856 was particularly useful (available here: <http://maps.nls.uk/view/102344215>), providing detail on the layout of the quarries before the construction of the Whitby, Redcar and Middlesbrough Union Railway, completed in 1883.

2.4.5 The mapped features were largely either associated with the quarry activities or the Whitby, Redcar and Middlesbrough Union Railway line subsequently constructed through the site. The scheduled area is known to have been made up of three adjacent quarries. The earliest, Gaytress (Figure 33: **Feature 1**), is located at the southern end, closest to the site of the alum house and the village. The quarrying extended north, to Ness End (Figure 33: **Feature 2**) and finally to Deep Grove (Figure 33: **Feature 3**) quarry. The limit of each quarry and the identified area of the quarry floors were recorded as extents of area. T-hachures were used to record prominent breaks of slope in the worked face of the quarry, avoiding undulating surfaces and areas of erosion and slumping.

2.4.6 The construction of the railway has had a significant impact on the site and was mapped to the extent of the scheduled area (Figure 33: **Feature 4**). The earthworks of the railway inclined plane were defined as an extent of area, with additional detail illustrated with T-hachures and banks where present. The T-hachures serve to illustrate where the railways construction truncated existing features, and where ground was built up to maintain a uniform gradient for the track.

2.4.7 Numerous spoil heaps were recorded across the site; these were most distinctive in Deep Grove quarry (Figure 33: **Feature 5**), where subsequent cementstone quarrying is also recorded. From the aerial survey evidence, it was not possible to distinguish the cementstone quarrying from the morphologically similar earthworks associated with the preceding alum quarrying.

2.4.8 The largest single spoil heap (Figure 33: **Feature 6**), named Asylum Hill on the Ordnance Survey Map of 1895 (available here: <http://maps.nls.uk/view/100941788>), is located within Ness End Quarry. A series of trackways lead across the spoil heap and a well-defined bank curves around the northern and western extent of the mound, which may be a tramway (Figure 33: **Feature 7**) leading to an area of quarrying and processing west of the railway. A central ditch extending along the length of the potential tramway could have been caused by the modern footpath, although its presence on 1940s photography may indicate an earlier origin.

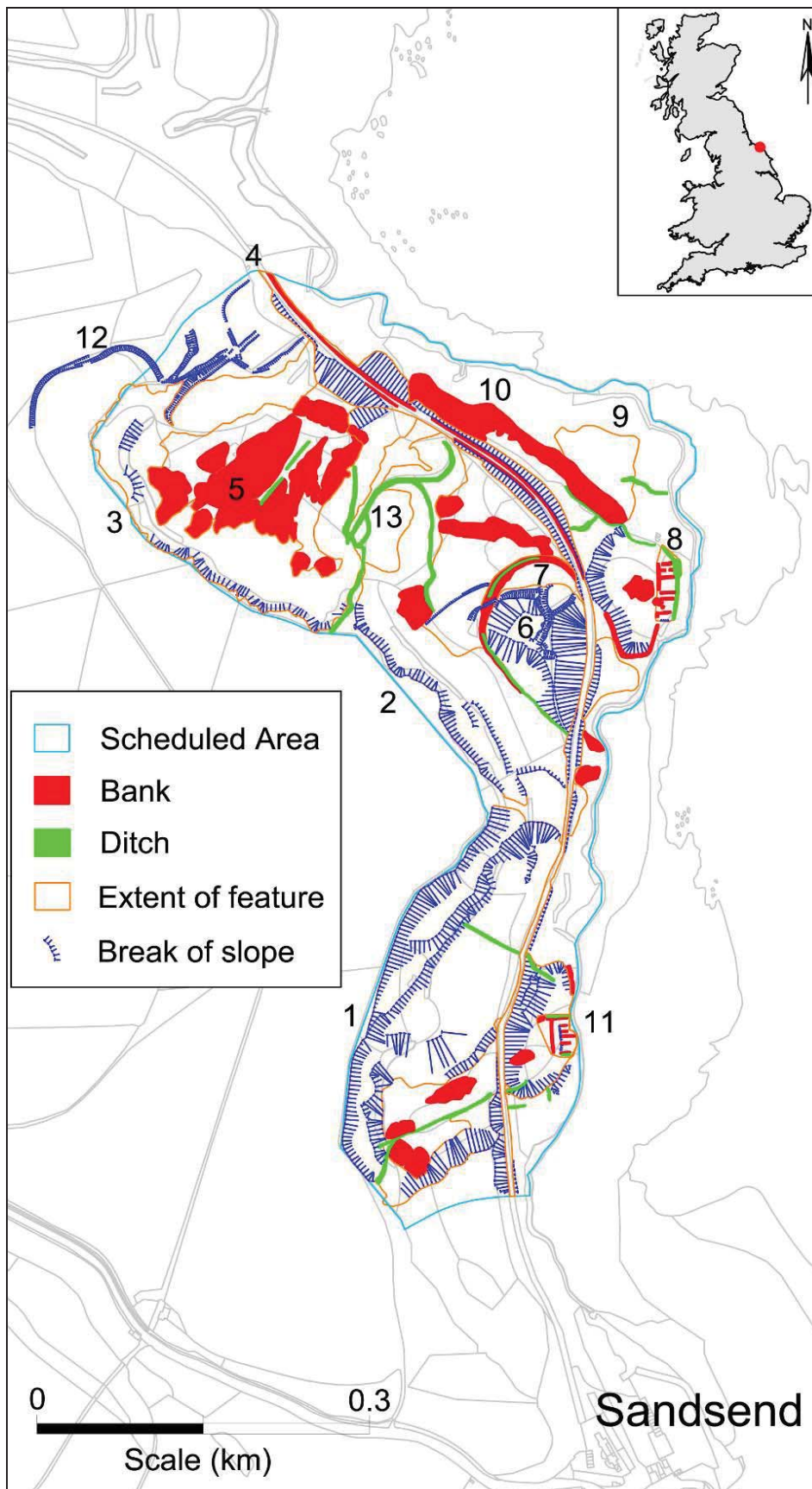


Figure 33- Results of the Aerial Photography and Lidar Transcription.

2.4.9 The alum processing features are located on the coastal edge and comprise of a linear water channel widened at the northern end and extending north-south, from which a number of linear banks extend west (Figure 33: **Feature 8**). These are likely to be remains of steeping tanks, and are depicted on the 1856 six-inch 1:10,560 scale map as a row of 10 narrow rectangular enclosures. The depicted features are morphologically alike to the illustrated and labelled Steeping Pits in Deep Grove quarry on the same map, now destroyed or masked by the large earthwork bank of the railway inclined plane. The gully is clearly extant on the 2009 Bluesky photography. The other elements are difficult to identify due to vegetation cover but are likely to be extant also. A lack of control points on the source photography resulted in some of the rectification being less accurate. In these instances an extent of area was mapped around the features to indicate this.

2.4.10 Water may have been supplied to the steeping tanks by a closely located pond or reservoir to the north (Figure 33: **Feature 9**). Historic mapping indicates a trackway existed between the pond and steeping tanks, which may support this association. The pond is defined on the south-west side by a linear bank (Figure 33: **Feature 10**). The bank encasing the pond has clearly been modified in places, but may have natural origins indicated by a rise in height of the north-west extent, where it may have connected to the dividing ledge between Deep Grove and Ness End quarries prior to the construction of the railway.

2.4.11 Gaytress quarry, to the west of the railway is densely covered by vegetation. East of the railway, further evidence of quarrying and alum processing was recorded. Similarly to the steeping tanks, these features were also depicted on historic mapping and are labelled as cisterns. The morphology of these features would suggest, however, that they were in fact steeping pits. The features are depicted as a row of parallel rectangular enclosures, larger and fewer in number than steeping tanks at Ness End. The remains of the cisterns/steeping pits consist of a number of parallel linear banks, with an adjoining east-facing slope at the west end and an outer bank and ditch (Figure 33: **Feature 11**). Photograph rectification proved problematic here also, hindered by the close proximity to the coastal edge and vegetation coverage, which may have reduced the accuracy of the mapping. A number of possible drains or water channels in the area of the cistern/steeping pits could be associated with the alum processing; most are recorded on historic mapping.

2.4.12 Trackways or hollow ways to the north of Deep Grove quarry (Figure 33: **Feature 12**), and on the dividing ledge between Deep Grove and Ness End quarries (Figure 33: **Feature 13**), appear to have originated with the quarrying activity and continue in use today as footpaths. Other footpaths with clear modern origins were numerous across the site and were not mapped.

2.4.13 Summary

In addition to defining the extent of the alum quarrying, the aerial survey has identified earthwork evidence of alum processing in two areas of the quarry floor. Historic

Ordnance Survey mapping depicts these features and identifies these processing activities as steeping and settling. The survival of features as extant earthworks within the quarries is considerable. A rapid evaluation of the effect of coastal erosion on the earthworks appears minimal, this said, the earthworks most at risk: those closely located to the coastal edge, are comprised of those associated with the processing activities, and which may provide the most significant information on the quarry. Further detailed investigation of the site would be particularly beneficial targeting the identified processing earthworks to better establish the condition and nature of the features, and better understand how the site developed to accommodate the quarry expansions.

Interpretative Walkover Survey

2.4.14 An interpretative walkover survey of Sandsend Alum Quarries was undertaken following the production of the aerial photography and Lidar transcription map and report. The transcription map was used as a base map for this survey and the report highlighted particular areas within the quarries where further investigation of the physical remains would be beneficial.

2.4.15 Where previously unmapped features were encountered, these were added to the aerial photography and Lidar transcription map using extents and T-hachures where appropriate. These additions were made in sketched format onto a scaled drawing, but do not comprise an accurate measured survey. Other features mapped through the transcription were amended, where appropriate, during the course of the survey in order to facilitate interpretation or phasing of remains, or to illustrate the present state of these features. The amalgamated results of the transcription and walkover survey are presented as Figure 129. The numbering of components was continued from the transcription exercise and some features that were not numbered in the transcription have been numbered as part of the walkover to facilitate discussion and interpretation. All feature numbers are shown on Figure 129.

2.4.16 Gaytress Quarry

2.4.16.1 The earliest quarry at Sandsend was Gaytress, the southernmost of the three, closest to the former Alum House. The features identified within Gaytress Quarry are detailed in Table 1 and described in the following sections.

Features Identified through AP and Lidar transcription		Features Identified through walkover survey	
No.	Description	No.	Description
1	Gaytress Quarry extent	15	Possible barrowway
11	Steeping pits / cisterns	16	Possible reservoir
4	Whitby, Redcar and Middlesbrough Railway	17	Possible building platform
14	Dumps of spoil	18	French drains
23	Dump of slag	19	Stone wall

24	Lower eastern quarry area	20	Possible cementstone mines
25	Water channel	21	Ridge of unquarried shale
		22	Subsidence/removal of Feature 4

Table 1: Features identified within Gaytress Quarry

2.4.16.2 **Feature 1** records the extent of Gaytress Quarry (Figure 34) which is mapped as an elongated C-Shape facing east. The quarry extends for c.270m north/south and c.160m east/west (the eastern extent being under coastal erosion). The quarrying activities at Gaytress involved the removal of sandstone overburden and the subsequent quarrying of the alum shale beneath. Across the length of the quarry the sandstone overburden has been removed, however, a hillock of unquarried shale is present roughly in the centre of the quarry area, extending eastwards from the former working face (**Feature 21**). This hillock may represent a former extent of Gaytress quarry, in its first phase, with the present extent of the quarry representing a northwards expansion of the quarry, though under the same name.



Figure 34- View into Gaytress Quarry, looking south-west.

2.4.16.3 At the western extent of the quarry floor, areas of spoil dumps and land slippage (**Feature 14**) were noted on the aerial photography and Lidar transcription and confirmed by the site walkover (Figure 35). Probable cementstone mining activity (**Feature 20**) was also noted in the form of at least two openings in the back of the quarry beneath the sandstone overburden (Figure 36). These features were not investigated further at the time of the walkover survey, but are already mentioned within the Scheduling description of the site. Further investigation would only be possible with the application of specialist health and safety provision.



Figure 35- Spoil heap within Gaytress Quarry looking south-east (Scale- 1 x 1m).



Figure 36- Western extent of Gaytress Quarry showing the entrance to a possible cementstone mine, looking west.

2.4.16.4 **Feature 18** was noted throughout Sandsend Quarries and records the presence of various French drains across the site which appear generally to have been used to drain the quarry floors. The French drains are c.0.5m wide and are variously filled with loose sandstone rubble and/or slag (Figure 37). The drains most likely relate to works undertaken as part of the construction of the Whitby, Redcar and Middlesbrough Railway (**Feature 4**). One such French drain was recorded as a ditch on the aerial photography and Lidar transcription, whilst an adjacent drain was added to the interpretative plan of the site in order to represent their spacing across the Scheduled area. French drains are generally considered to be a trench filled with gravel or rock, or sometimes containing a perforated pipe, that redirects surface water and groundwater away from a certain area.



Figure 37- French drain within the quarry floor at Gaytress Quarry, looking south-east. The drain is filled with sandstone rubble in the foreground and slag material in the background.

2.4.16.5 **Feature 4** records the Whitby, Redcar and Middlesbrough Union Railway which was constructed across the quarry site by 1883, following the closure of the alum works. Within Gaytress Quarry the railway has been largely cut into the existing quarry floor on its west side and runs along the top edge of a lower quarry area on its east side. At the northern and possibly the southern extents of the quarry the railway cuts through arms of unquarried shale that project eastwards from the working face of the quarry demarcating its extents (Figure 38). The former track is now a public footpath. An area

of subsidence or deliberate removal of the former route of the railway was noted (**Feature 22**) alongside a possibly associated dump of slag (**Feature 23**) to the east of the track within a lower quarry floor on this side (Figure 39). The dump of slag may be material derived from the dismantled section of the railway line.



Figure 38- Northern extent of Gaytrass Quarry looking northwards through the cut made for the Whitby, Redcar and Middlesbrough Railway (scale = 1m).



Figure 39- Area to the east of the Whitby, Redcar and Middlesbrough Railway, looking north, showing a dump of slag material sloping down from the left of the photograph onto the quarry floor (Scale- 1 x 1m).

2.4.16.6 Within the quarry floor to the west side of the railway line, three features probably associated with the former alum workings were identified. The first is a possible barrowway (**Feature 15**) aligned north-east/south-west and running adjacent to the north side of the 'arm' of unquarried shale forming the southern extent of Gaytress Quarry. The possible barrowway consists of a flat raised bank of earth and sandstone (Figure 40). The sandstone contained within the earthwork is occasionally squared blocks, however, no evidence was found during the walkover to suggest that the earthwork was constructed of or retained by stone. In plan the feature is wedge-shaped with a V-shaped terminal on its south-western extent. On its north-east side the possible earthwork is cut by the railway line and an associated drainage gully running parallel (Figure 43). On the eastern side of the railway line the line of the feature could not be traced. In profile, the bank on the southern side of the earthwork is more pronounced, with a height of c.1.4m as opposed to the bank on the north side which stands to c.0.6m (Figures 40 and 41). The feature is c.6m wide (Figure 42). The orientation of the feature suggests that it may have been used to transport material from the working face of the quarry either to the steeping pits identified to the east (**Feature 11**), or to the cliff edge for dumping or transportation. The elevation of the feature would require that a winch or inclined plane was in operation for goods to be lowered over the cliff edge, however no evidence of either remains.



Figure 40- Possible barrowway looking south-east (Scale- 1 x 1m).



Figure 41- South bank of the possible barrowway, looking east (Scale- 1 x 1m).



Figure 42- Top of the possible barrowway, looking north-east (Scale- 1 x 1m).



Figure 43- Drainage gully and railway cut on the north-eastern extent of the possible barrowway, looking north (Scale- 1 x 1m).

2.4.16.7 **Feature 19** records a stone-built retaining wall within the quarry floor which is situated to the immediate north of a recorded French drain (**Feature 18**) (Figure 44). The wall is constructed of unbonded, non-coursed, roughly-squared sandstone blocks. The line of the wall was traced for a length of at least 15m and it stands to a height of c.0.7m. The purpose of this wall is unknown, although its close proximity to the French drain may indicate an associative function between the two.

2.4.16.8 Also within the quarry floor, to the west of the railway, a water channel (**Feature 25**) was mapped as part of the aerial photography and Lidar transcription phase and was confirmed through walkover. This water channel is located to the north of the possible barrowway (**Feature 15**) and runs from the western extent of the quarry eastwards towards the cliffs. This water channel does not appear to have been formally managed, but it is likely that it was the key water supply to the steeping pits (**Feature 11**) identified to the east of the railway line. The water channel is culverted under the railway line and emerges to the east of the track as a naturalised channel flowing over the edge of a lower eastern quarry area (**Feature 24**) towards a possible reservoir (**Feature 16**) and the steeping pits (**Feature 11**) (Figure 45). Although it is possible that the insertion of the railway altered the route of this channel, no evidence of a former channel was located elsewhere during the course of the walkover survey and it also

appears to be in this location on the Ordnance Survey map of 1856, prior to the railway's construction.



Figure 44- Retaining wall adjacent to a rubble-filled French drain within the quarry floor at Gaytress Quarry, looking north-west (Scale- 1 x 1m).



Figure 45- The lower quarry area on the eastern side of the railway line looking south-east. Note water channel entering the quarry floor from a culvert beneath the railway in the background.

2.4.16.9 On the east side of the railway line a further area of quarrying has created a further, lower, C-shaped quarry floor (**Feature 24**) within which a number of alum working-related features have been identified (Figure 45). This further quarry area is aligned in the same way as the main Gaytress Quarry and it extends for c.100m from north to south and c.50m from east to west. The extent of the lower quarry is demarcated by ridges of unquarried shale. The walkover survey recorded the presence of sandstone retaining walls on the terminals of the 'arms' forming the northern and southern extents of the quarry area (Figure 46 and 47). That on the southern side survives as only a small number of aligned dressed-stone blocks, however on the north side the level of preservation was higher and the retaining wall could be traced for a length of c.10m. The retaining walls and the sloping nature of these 'arms' (Figure 47) may indicate that they were used as barrowways to transport material to the steeping pits (**Feature 11**) within, however there was not enough evidence present to confirm this identification. Though neither was an alternative means of transporting material to these steeping pits identified.



Figure 46- Remains of a stone retaining wall on the eastern face of the southern 'arm' of the lower quarry area, looking west (Scale- 1 x 1m).



Figure 47- Remains of a stone retaining wall on the western face of the northern 'arm' of the lower quarry area, looking north-east (Scale- 1 x 1m).

2.4.16.10 The aerial photography and Lidar transcription recorded the presence of banks and ditches within this lower quarry floor which were labelled as cisterns on the Ordnance Survey Map of 1856 (**Feature 11**). The morphology of these features would suggest, however, that they were in fact steeping pits, and are probably the earliest surviving steeping pits at the site. Unfortunately the area where these features were mapped was too densely overgrown to access during the walkover survey in order to assess the current condition of these features. Nevertheless further associated features were identified within this lower quarry area which indicate that the level of survival of remains in this location is good. The further identified features comprise of stone-lined water channels and linear banks to the north of the mapped steeping pits (Figure 48 and 49), a stone-lined possible reservoir (**Feature 16**) to the west of the mapped steeping pits and a possible building platform (**Feature 17**) to the north-west of that. The whole of this area is wet and boggy testifying to the current lack of management of the water course that is presumed to have been present in this area.



Figure 48- Stone-lined water channel to the north of the area of steeping pits mapped as part of the transcription exercise, but most likely associated with those features, looking south (Scale- 1 x 1m).



Figure 49- East-west aligned bank to the north of the area of steeping pits mapped as part of the transcription exercise, but most likely associated with those features, looking south (Scale- 1 x 1m).

2.4.16.11 **Feature 16** has been interpreted as a possible reservoir which would sit to the immediate west of the mapped steeping pits and could represent management of the water supply to these features. The feature comprises a stone-lined north/south aligned earthen bank with a width of c.3m, which was mapped during the aerial photography and Lidar transcription (Figure 50). This forms a sharp 90° angle with a stone-lined section of the southern 'arm' of the lower quarry area (Figure 51). This arrangement, together with features already mapped, forms the south-eastern corner of a rectangular feature. The ground within the possible reservoir is very boggy and over 0.5m of a ranging pole could be inserted into these deposits with ease. The water channel from the main quarry floor (**Feature 25**) also feeds into this area and this appears to be the original arrangement (see Section 2.4.16.8). No evidence of an outlet into the steeping pits was observed during the walkover survey, however, this may exist within the overgrown and inaccessible area of the steeping pits. A pump is shown near to this location on the Ordnance Survey 6 inch map 1856 which may therefore have been associated with this reservoir. Jecock has suggested that this pump was possibly associated with the liquor trough transporting liquor from the later steeping pits at Ness End (Jecock pers. comm.), so there may be an element of phasing within these remains that further investigation could elucidate.



Figure 50- Stone-lined banked feature interpreted as a possible reservoir, looking north-east (Scale- 1 x 1m).



Figure 51- A 90° angle forming the south-east corner of a rectangular feature interpreted as a possible reservoir, looking south (Scale- 1x 1m).

2.4.16.12 **Feature 17** records the possible remains of a building platform within the lower quarry floor. Only a very small portion of this feature was visible beneath a dump of slag material (**Feature 23**) that is likely to be much later in date and associated with the destruction of part of the railway. The remains consist of a raised flat area containing a high quantity of sandstone rubble (Figure 52). The sandstone may represent build-up material to create a platform for building. The area of the platform that is visible beneath the slag dump extends for c.2m from north to south and c.8m from east to west. The possible platform is located on the immediate north-west corner of the possible reservoir (**Feature 16**). A building in this location is likely to have had a function associated either with the control of water flow, or with the management of the steeping pits.



Figure 52- Possible building platform in the lower quarry area, looking north-west (Scale- 1 x 1m).

2.4.17 Ness End Quarry

2.4.17.1 The second earliest quarry at Sandsend was Ness End, the middle quarry of the three. The features identified within Ness End Quarry are detailed in Table 2 and described in the following sections.

Features Identified through AP and Lidar transcription		Features Identified through walkover survey	
No.	Description	No.	Description
2	Ness End Quarry extent	27	Stone retaining wall
8	Steeping pits	28	Structural remains
4	Whitby, Redcar and Middlesbrough Railway	29	Building platform
6	Asylum Hill spoil heap	32	Lip of unquarried shale
7	Possible barrowway	34	Liquor trough
9	Possible reservoir		
10	Bank		
13	Trackways/hollowways		
26	Possible barrowway		
30	Spoil heaps		
31	Lower eastern quarry area		
33	Bank along the top edge of Feature 31		

Table 2: Features identified within Ness End Quarry

2.4.17.2 **Feature 2** records the extent of Ness End Quarry (Figure 53 and 54) which is mapped as a wide C-shape facing north-east. The quarry extends for c.230m north-west/south-east and c.320m north-east/south-west (the eastern and north-eastern extent being under coastal erosion). The quarrying activities at Ness End involved the removal of sandstone overburden and the subsequent quarrying of the alum shale beneath. In this respect Ness End is the same as Gaytress Quarry in its operation. Unlike Gaytress, however, there appears to have been a lip of unquarried shale (**Feature 32**) retained around the eastern and north-eastern extent of the quarry (Figure 55). This lip of shale effectively serves as a seawall and creates a bowl-like quarry floor behind. It likely protected the quarry and alum workings from offshore winds and erosion. Such a feature has been noted at Saltwick Nab Alum Quarry (Eadie 2014, 25) and may have been common practice, but lost to erosion at a number of sites. The lip of shale is partially eroded and survives as a series of characteristic lumps at the north-east end of the quarry site.



Figure 53- View into Ness End Quarry from the top of Asylum Hill, looking west.



Figure 54- View into Ness End Quarry from the top of Asylum Hill, looking north-west.



Figure 55- Partially eroded lip of unquarried shale around the east and north-east sides of Ness End Quarry.

2.4.17.3 Within the quarry floor a small number of discrete spoil heaps (**Feature 30**) were identified during the aerial photography and Lidar transcription and confirmed through site walkover (Figure 56). For the most part these spoil heaps are relatively small, however one very large spoil heap exists on the central south side of the quarry floor which is named as Asylum Hill on the Ordnance Survey map of 1895 (**Feature 6**). Asylum Hill is a prominent feature of the quarry, easily identifiable from the village of Sandsend to the south (Figure 57 and 58). Erosion to the south-east end of the heap indicates that it is formed of sandstone (Figure 59), which suggests that the sandstone overburden at Ness End was not all tipped over the cliff edge, as is thought to have been the case at Gaytress. The mound has steeply sloping sides and a flat top. Its purpose is unknown, however, its relationship with other features within the quarry (e.g. **Feature 7**) suggests that it was in place during much of the quarry's operational phase. Such a large mound of material within the confines of the quarry floor would have made the movement of material around the quarry awkward, so it must be assumed that the purpose of Asylum Hill was one of some importance. The Ordnance Survey map of 1856 shows a small building on the top of the hill labelled as a shed. A large roughly square-shaped depression (**Feature 29**) on the top of the hill was recorded as part of the site walkover (Figure 60 and 61), although this appears to be much larger than the 'shed' shown on the historic map. A building in this location would have had good views of the entire quarry operation and may therefore have had an administrative or management function. Several trackways crossing the mound were noted during the transcription exercise. A similar flat-topped mound with steeply sloping sides is present within Boulby Alum Mines which is thought to have been created out of a former working platform (Blood 1993, 9). The Boulby mound is still engaged with the quarry face, whereas Asylum Hill is a discrete feature, perhaps having been mined around. The mound is cut by the Whitby, Redcar and Middlesbrough Railway (**Feature 4**).

2.4.17.4 **Feature 4** records the Whitby, Redcar and Middlesbrough Union Railway which was constructed across the quarry site by 1883, following the closure of the alum works. Within Ness End Quarry the railway has been cut through the arms of unquarried shale forming the quarry's southern and north-eastern extents and it has been cut through Asylum Hill (**Feature 6**) (Figure 57). In the remainder of the quarry, however, the railway line has been embanked through the middle of the former quarry floor and immediately adjacent to the top edge of a lower eastern quarry area (**Feature 31**) (Figure 62). The former track is now a public footpath and the remains of slag and stone in linear bands across the track indicates the presence of the former track bed, with the voids of the former sleepers being filled by more modern materials.



Figure 56- Spoil heap on the south-eastern extent of Ness End Quarry, indicative of other small heaps within the quarry floor.



Figure 57- Asylum Hill looking north. Note that the mound is cut by the Whitby, Redcar and Middlesbrough Railway.



Figure 58- Sandsend Quarries from Sandsend Village to the south. Asylum Hill is the mound of material around the centre of the cliff edge.



Figure 59- Erosion to the south-east end of Asylum hill shows that it is made up predominantly of sandstone.



Figure 60- Square-shaped depression on the top of Asylum Hill, viewed from the northern extent of the quarry, looking south-east. Also visible in this photograph is the possible barrowway around the base of the mound.



Figure 61- Square-shaped depression on the top of Asylum Hill, looking north.



Figure 62- Embanked railway line across the quarry floor of Ness End, looking south-east.

2.4.17.5 Within the quarry floor to the west side of the railway line, two probable barrowways and a series of routeways were identified (**Feature 7, 13 and 26**). **Feature 7** is interpreted as a probable barrowway and appears to be built-up against the base of Asylum Hill (**Feature 6**), skirting around its west and north sides (Figure 63). It possibly connects with a bank running along the top edge of a lower quarry area (**Feature 33**) on the east side of the railway line, however this relationship is masked by the railway embankment. It may also have served a purpose connected to the spoil heaps on the east side of the railway line at its southern extent (**Feature 30**), although again this relationship is obscured by the railway embankment and vegetation. The possible barrowway is c.6m wide in total and runs for a length of c.190m as a built-up feature, before it becomes a ditched feature along the south-west end of Asylum Hill for a length of c.55m. This ditched feature may or may not be part of the barrowway. The purpose of this barrowway is likely to have been the movement of material around the quarry floor, and in particular the movement of material past the obstacle that Asylum Hill must have presented. As the ditched feature does not appear to have a gradual or constant fall it seems unlikely to be any type of water management feature and would seem most likely to represent part of the barrowway (**Feature 7**).

2.4.17.6 **Feature 26** is interpreted as a possible barrowway. It is a fairly regular, flat-topped ridge of unquarried shale with a total width of c.8m. It runs for a length of c.100m roughly east-west from the working face towards the railway line (Figure 64). Beyond the railway line the possible barrowway can be traced until it meets another possible barrowway (**Feature 10**) which appears to be later than **Feature 26** and truncates, or overlies it (Figure 65). As mapped, it appears as though **Feature 26** turns

slightly north-east to meet **Feature 10**, however this is likely to be due to Feature 26 respecting the top edge of a lower quarry area in this location rather than it signifying a relationship between **Feature 26** and **Feature 10**. To the west of the railway line the barrowway (**Feature 26**) meets another possible barrowway (**Feature 7**) just before the railway embankment, however this area of **Feature 26** appeared to have suffered from erosion and/or remodelling. Whether this remodelling was carried out during the working life of the quarry, or later, could not be established. On the north side of the possible barrowway (**Feature 26**) the quarry floor is filled with a pool of water. Rather than being a reservoir, this pool was probably formed following the construction of the railway line when the flow of water through the quarry was interrupted.

2.4.17.7 **Feature 13** is recorded in the aerial photography and Lidar transcription as a series of trackways or hollowways. The route is an incline cut into the south side of the 'arm' of unquarried shale that defines the northern extent of Ness End Quarry (Figure 66). It then runs around the top of the 'arm' before joining with another incline cut into the north side of the 'arm' which is effectively the southern extent of Deep Grove Quarry (Figure 67). At the top of the 'arm' of unquarried shale the routeway encircles a notable depression which is shown on the First Edition Ordnance Survey map occupied by an unlabelled building. There is no indication of whether the southern and northern inclines of **Feature 13** are of different phases, or are both of the same phase, but it is possible that the southern incline originally served a purpose within Ness End, before being extended when Deep Grove Quarry came into operation. Taken as a whole, the feature provides access between the two quarries and out of the quarries towards the fields to the west. The routeway may have communicated with **Feature 10**, which is a probable barrowway located on the east side of the railway line (**Feature 4**), although the railway line obscures this relationship. The incline on the south side of the 'arm' is at an angle that would be consistent with barrowing material, however, that on the north side appears too steep for this purpose, unless some form of winding gear was in operation. This might give credence to the notion that the southern and northern inclines may be of different phases.



Figure 63- Possible barrowway (Feature 7) running around the base of Asylum Hill, looking north-east.



Figure 64- Possible barrowway (Feature 26) running eastwards from the quarry face at Ness End towards the steeping pits, looking east-south-east (Scale- 1 x 1m). Note the feature is truncated by the railway embankment and an area of erosion and/or remodelling is present just in front of it.



Figure 65- The likely continuation of the possible barrowway (Feature 26) on the east side of the railway line, looking west (Scale- 1 x 1m).

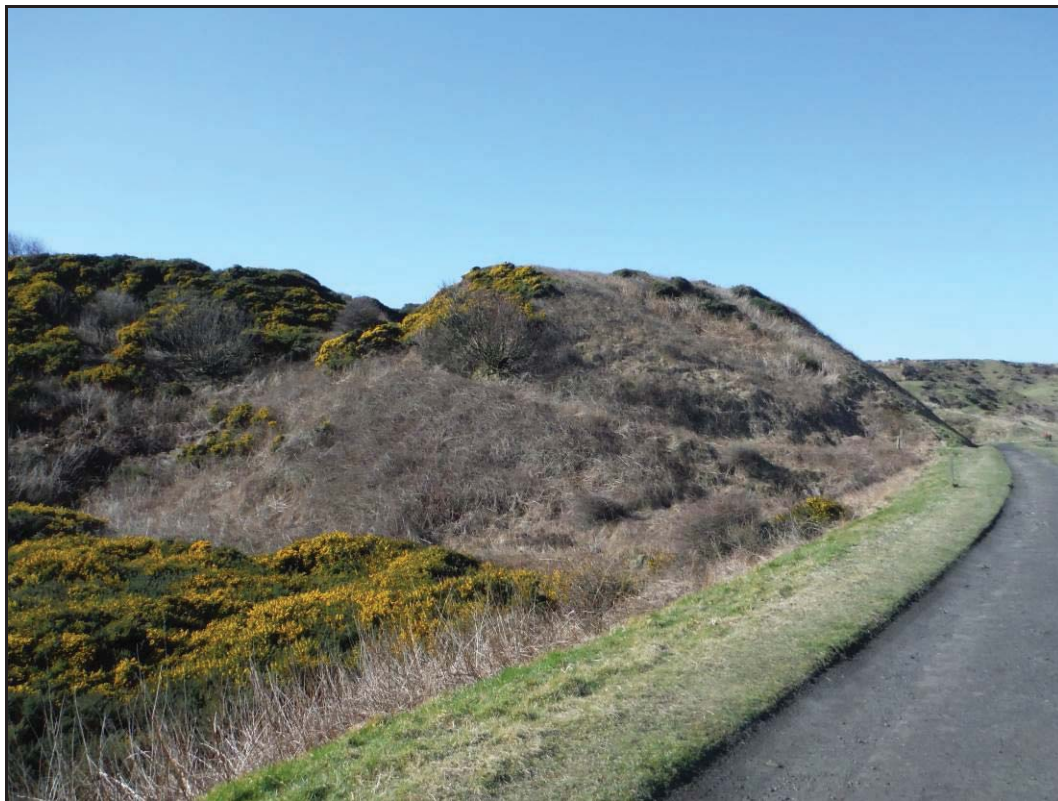


Figure 66- Inclined routeway (Feature 13) cut into the south side of the projecting 'arm' of unquarried shale forming the northern extent of Ness End Quarry.



Figure 67- Inclined routeway (Feature 13) cut into the north side of the projecting 'arm' of unquarried shale forming the southern extent of Deep Grove Quarry.

2.4.17.8 Aside from these features the aerial photography and Lidar transcription exercise mapped two short linear depressions in the quarry floor. These were both water filled at the time of the walkover survey, however, their purpose could not be ascertained, nor could they be categorically identified as alum-working features.

2.4.17.9 On the east side of the railway line the quarry floor continues at the same level as on the west side, except for a lower quarry area at the south-eastern end of the quarry floor (**Feature 31**), which contains an area of identified steeping pits (**Feature 8**). Dealing first with the features located at the higher level, the aerial photography and Lidar transcription identified two key features in this area, **Features 9** and **10**, interpreted as a reservoir and bank respectively. However, the walkover survey provides a further discussion of these features. **Feature 10** is interpreted as a probable barrowway. It consists of a prominent ridge of material that does not appear to be unquarried shale, but rather built-up material (Figures 68 and 69). It runs for a length of c.170m and has a flat top with a sharp break of slope. The top of the feature has a width of c.4.5m. The relationship between **Feature 10** and **Feature 13** is obscured by the later railway embankment (**Feature 4**), however, the alignment of the two features suggests that they may once have formed a single routeway/barrowway. Taken together the two features could provide a routeway running from the interior of Deep Grove Quarry to the area of identified steeping pits at Ness End Quarry (**Feature 8**). This suggests that, at some stage during its operation, the later quarry at Deep Grove may have made use of

the, probably earlier, steeping pits at Ness End. **Feature 10** clearly runs up to the area of identified steeping pits (**Feature 8**) so it likely had a function related to bringing material to and from this area. This barrow run also appears to overlie the eastern end of **Feature 26** although excavation would be required to establish this relationship with certainty. The construction of **Feature 10**, together with its apparently being later than **Feature 26**, suggests that it is an artefact of the dynamic nature of the quarry floor. This feature may have been used to transport material from the later Deep Grove Quarry.

2.4.17.10 Towards the south-eastern extent of **Feature 10**, there are structural remains (**Feature 28**) protruding from loose shale deposits. These take the form of short, single leaf, alignments of dressed sandstone blocks (Figures 70 and 71). The remains appear to be contained within a cut into natural unquarried shale deposits. The structural remains may represent three walls of a building, however, too little was exposed to confirm this. A building in this location may have been related to processes taking place in the adjacent steeping pits (**Feature 8**). The remains appear to pre-date **Feature 10**, however excavation would be needed to confirm this relationship.

2.4.17.11 Further structural remains were also noted eroding out of the cliff to the east of **Feature 28** (Figure 72). These are likely to be part of a separate structure, however, there was no surface evidence of this feature.



Figure 68- View of Feature 10 from the railway embankment, looking south-east.



Figure 69- Possible barrowway (Feature 10), looking south-east (Scale 1 x 1m).



Figure 70- Structural remains at the south-eastern end of Feature 10, looking north-west (Scale- 1 x 1m).



Figure 71- Structural remains at the south-eastern end of Feature 10, looking west (Scale- 1 x 1m).



Figure 72- Structural remains eroding from the cliff face within Ness End Quarry, looking north.

2.4.17.12 **Feature 9** was identified as a reservoir in the aerial photography and Lidar transcription. This identification was largely based on the appearance of the feature on the First Edition Ordnance Survey map. The walkover identified this area as a shallow hollow, but it was not holding water. The south-western extent of the hollow was formed by the possible barrowway **Feature 10** and the eastern extent was formed by the lip of unquarried shale around the eastern end of Ness End Quarry (**Feature 32**) (Figure 55). **Feature 10** has been interpreted as being part of a later phase of quarry workings. If the reservoir is indeed a feature, then it must also belong to this later phase of works and makes use of **Features 32** and **10** which were constructed for other purposes. As mapped the reservoir is triangular in plan with a length of c.100m and a width of c.60m. Without the map evidence this feature would not have been identified as a reservoir, however, the map evidence is compelling. Nevertheless, it is possible that water collected in this area due to the construction of **Feature 10** and that the pool was mapped with the appearance of a reservoir by the Ordnance Survey in error.

2.4.17.13 In the south-eastern corner of the quarry floor a lower quarry area (**Feature 31**) has been excavated similar to that seen within Gaytress Quarry (**Feature 24**) (Figure 73). This lower quarry floor contains an area of steeping pits (**Feature 8**) identified through the aerial photography and Lidar transcription. The lower quarry is C-shaped in plan, and aligned roughly north/south. It extends for c.100m from north to south and c.90m from east to west. The eastern extent is subject to erosion. The extent of the lower quarry is demarcated by ridges of unquarried shale. The walkover survey recorded the presence of a sandstone retaining wall on south side of the northern 'arm' of the quarry (Figure 74). This arrangement is similar to that noted within Gaytress Quarry. A similar section of sandstone walling was noted eroding from the south side of the southern 'arm' of the quarry and may also be a retaining wall (Figure 75), although its alignment suggests that it may also be a separate feature entirely. Along the top of the northern and southern 'arms' of the quarry the walkover survey also identified possible barrowways. That on the north has been discussed as the continuation of **Feature 26**, and that on the south was identified through aerial photography and Lidar transcription (**Feature 33**). The southern bank runs along the top of the 'arm' which slopes down to the level of the quarry floor (Figure 76). It is possible that this was used as a routeway or barrow run and it may have been related to **Feature 7** on the west side of the railway. The possible barrowways could have been used to transport material to the steeping pits (**Feature 8**).

2.4.17.14 The walkover survey also recorded a short section of retaining wall at the base of the working face at around the centre of the C-shaped quarry (**Feature 27**). This was different in character to the retaining walls noted on the northern and southern 'arms' (Figure 77) and was located in area which was very damp, possibly representing a seasonal water course. This retaining wall is likely to be related to the erection of the railway (**Feature 4**) which runs very close to the top edge of the quarry face at this location.



Figure 73- Lower quarry area (Feature 31) seen from the top of Asylum Hill, looking east.



Figure 74- Sandstone retaining wall on the south side of the northern 'arm' of the lower quarry, looking north-west (Scale- 1 x 1m).



Figure 75- Sandstone wall eroding from the south side of the southern 'arm' of the lower quarry, looking south.



Figure 76- Bank along the top of the southern 'arm' of the lower quarry, looking south-west (Scale- 1 x 1m).



Figure 77- Retaining wall at the base of the working face in the lower quarry floor, looking west (Scale- 1 x 1m).

2.4.17.15 Within the lower quarry the aerial photography and Lidar transcription identified the remains of a series of steeping pits (**Feature 8**). The mapped features included a water channel and a series of linear banks defining the individual tanks. The walkover survey confirmed the easternmost extents of a number of these features, however, further west the quarry floor was too overgrown to allow for inspection. The walkover survey recorded a stone-lined channel running north/south along the eastern extent of the identified steeping pits (Figure 78). This ran for a length of c.60m before meeting the eroding cliff edge at its southern extent. This end of the channel was heavily eroded and no longer retained the stone-lining (Figure 79). Yellow staining was present to the base of the channel in this location, however, indicating its potential use for the transportation of liquor or slam. This, together with the trajectory of the channel heading towards the alum house, led to its interpretation as a liquor channel (**Feature 34**). A similar arrangement of the liquor channel running along the seaward edge of a series of longitudinal steeping pits is also seen in Chapman's excavation of the New Works site at Boulby Alum Quarries (Chapman 2002).



Figure 78- Stone-lined channel on the east side of the steeping pits, looking north (Scale- 1 x 1m).



Figure 79- Continuation of the liquor channel eroded to the south of the steeping pits, looking south.

2.4.17.16 At the north end of the possible liquor channel (**Feature 34**) there was a small rectangular stone-lined tank feature (Figure 80 and 81). This was holding water at the time of the walkover survey. The purpose of this feature is not known and its relationship with the liquor channel could not be established during the walkover, however, it appears to relate to the system of steeping pits (**Feature 8**). The aerial photography and Lidar transcription shows the stone-lined tank as being fed from a channel running along the south-west end of **Feature 10** and down the side of the quarry edge (**Feature 31**). This channel cuts the possible barrowway **Feature 26** at its junction with **Feature 10** at which point the channel appears to have been crudely culverted under the possible barrowway (Figure 82). Further upstream the channel runs alongside **Feature 10** and also contains a pool. This area, however, is sandwiched between the inserted railway embankment (**Feature 4**) and the inserted barrowway (**Feature 10**) so it is difficult to say with any certainty that the water courses within it are representative of the original quarry workings. The identified channel may or may not be the intended feed for the steeping pits, or they may represent a feed during one phase of its history. It is likely that if **Feature 9** was indeed a reservoir that this would have somehow fed the steeping pits, however no channel is now present between the two. Aside from the water channel and tank, the steeping pits (**Feature 8**) themselves were recorded as a series of indistinct linear banks, some of which contained short sections of exposed sandstone walling (Figure 83). The area of the steeping pits was overgrown with heather at its eastern end and denser vegetation towards its western end. It is likely that there is good preservation of features beneath the vegetation however.



Figure 80- Stone-lined tank feature at the north end of the liquor channel, looking south.



Figure 81- Stone lined tank feature at the north end of the liquor channel (Scale- 1 x 1m).



Figure 82- Channel cutting Feature 26 and running towards the steeping pits, looking south (Scale- 1 x 1m). Note that the channel appears to have been crudely culverted under the barrowway.



Figure 83- Representative view of a steeping pit, looking west (Scale- 1 x 1m). Stonework on left and right sides of the photograph demarcate the extent of the pit.

2.4.18 Deep Grove Quarry

2.4.18.1 The latest quarry at Sandsend was Deep Grove, the northernmost of the three, and furthest from the former Alum House. The features identified within Deep Grove are detailed in Table 3 and described in the following sections.

Features Identified through AP and Lidar transcription		Features Identified through walkover survey	
No.	Description	No.	Description
3	Deep Grove Quarry extent	35	Lower north-eastern quarry area
5	Dumps of Spoil	36	Water channel and possible reservoir
4	Whitby, Redcar and Middlesbrough Railway	37	Bank of spoil / unquarried shale defining possible reservoir

Table 3: Features identified within Deep Grove Quarry

2.4.18.2 **Feature 3** records the extent of Deep Grove Quarry (Figure 84) which is mapped as an elongated C-shape facing north-east. The quarry extends for c.200m north-west/south-east and c.225m north-east/south-west (the north-eastern extent being under coastal erosion). The quarrying activities at Deep Grove involved the removal of sandstone overburden and the subsequent quarrying of the alum shale beneath. In this respect Deep Grove is the same as Gaytress and Ness End Quarries in its operation. Unlike Ness End, however, there does not appear to have been a lip of unquarried shale

retained around the seaward edge of the quarry, or at least this feature no longer survives (Figure 85). The north-eastern third of the quarry floor has been quarried to a lower level than the western two-thirds.

2.4.18.3 **Feature 4** records the Whitby, Redcar and Middlesbrough Union Railway which was constructed across the quarry site by 1883, following the closure of the alum works. Within Deep Grove Quarry the railway has been substantially built-up from the height of the existing quarry floor, as it crosses over the lower quarry floor on the north-east side of the quarry (Figure 86). The First Edition Ordnance Survey map shows a set of steeping pits within the lower quarry floor in the area now occupied by the railway embankment. These features are likely to survive beneath the railway, most likely with a good level of preservation. At the south-eastern extent of the quarry the railway is cut through the 'arm' of unquarried shale that defines the extent of the quarry, although this does not appear to have happened on the north-western extent of the quarry, where the railway runs past the north-eastern end of the 'arm'.



Figure 84- The interior of Deep Grove Quarry, looking west.



Figure 85- The north-eastern extent of Deep Grove Quarry showing no lip of unquarried shale around its seaward edge.



Figure 86- The large-scale railway embankment within Deep Grove Quarry, looking north-west.

2.4.18.4 Within the quarry floor to the west of the railway the aerial photography and Lidar transcription recorded a series of spoil dumps and land slippages (**Feature 5**). These were confirmed by the site walkover which noted the characteristic profile of the spoil heaps, being V-shaped in plan with a flat top (Figure 84 and 87). This indicates that spoil would be barrowed along the top of the heap and tipped off the far end, in this case the north-eastern end. Alum working generally does not create large amounts of spoil, so it must be assumed that these heaps were comprised of the sandstone overburden which was no longer being tipped over the cliff edge at this date, or they may be related to later cementstone mining which is known to have taken place at this site.

2.4.18.5 Between the spoil heaps (**Feature 5**) the aerial photography and Lidar transcription also recorded a water channel (**Feature 36**) running north-east/south-west for c.70m (Figure 87). The spoil heaps respect this water channel, suggesting that it may have been an important water supply to the alum workings. The channel feeds into a pool of water before spilling over the top edge of the lower north-eastern quarry area (**Feature 35**) and running into a culvert beneath the railway embankment. The triangular pool is essentially formed on all three sides by the spoil heaps, although that along its north-eastern edge appears to be a deliberate bank of material created for this purpose (**Feature 37**). The pool may have been used as a reservoir and a means to control the flow of water into the now built-over steeping pits. The culvert emerging from the far side of the railway embankment was wrongly identified as a liquor trough in the initial assessment report (Eadie 2014, 40).

2.4.18.6 The lower north-eastern quarry area (**Feature 35**) has been largely built-over by the railway and the walkover survey did not identify any alum working related features in the visible portions of this quarry floor (Figure 85).



Figure 87- The south-western two-thirds of the quarry floor at Deep Grove, occupied by large spoil heaps, looking north. Note also the central water channel feeding in to a roughly triangular reservoir defined by the prominent bank of material along its north-eastern edge.

2.4.19 Beyond Deep Grove Quarry

2.4.19.1 Further features were identified beyond the north-western extent of Deep Grove Quarry, but still within the Scheduled Area. These are detailed in Table 4 and are discussed in the following sections.

Features Identified through AP and Lidar transcription		Features Identified through walkover survey	
No.	Description	No.	Description
12	Trackways/hollowways	38	Drainage channel
		39	Spoil heap

Table 4: Features identified within Deep Grove Quarry

2.4.19.2 The aerial photography and Lidar transcription identified a series of hollowways that communicate with the interior north-western corner of Deep Grove Quarry (**Feature 12**). These hollowways were interpreted as possibly being related to alum quarrying activities. The site walkover confirmed the existence of these hollowways as well as mapping further examples and features within this area (Figure 88). The hollowways converge at a small ‘crossroads’, from which hollowways run north-west, north, north-east, south-east and south-west (Figure 89). This clustering suggests that material from within Deep Grove Quarry was being transported elsewhere via these various tracks. It is possible that these features relate to cementstone mining rather

than alum quarrying, since cementstone mining is known to have taken place within Deep Grove from 1811 to 1933 (NHLE description). The hollowway leading north terminates in V-shaped flat topped platform suggesting that this area is built-up of spoil (**Feature 39**), whilst the hollowway leading north-east terminates at a short cliff, where perhaps a hoist could have been employed to drop material down to a lower level for transportation. Both of these features appear to respect the line of the railway, rather than being cut by it, which may give some credence to them being remains of a later process than this site.

2.4.19.3 The site walkover also identified a substantial gully running east-north-east from the 'crossroads' (**Feature 38**). This ran as a U-shaped ditched feature for a length of c.50m, the final c.20m of which contained carved stone blocks to direct the flow (Figure 90 and 91). Similar carved stone drain blocks are present at the Pithill building at Boulby Alum Quarries and within Peak Alum House. A similar gulley, or 'stone gutter' was also identified at Kettlewell where it was interpreted as part of the water supply to steeping tanks. At Kettlewell there was also evidence that the gutter had capping stones presumably to preserve the cleanliness of the water. Whilst the route of the gully cannot be traced beyond its mapped extent on Figure 129, it may have served the purpose of bring water into the works.

2.4.19.4 The area containing these identified features is currently fenced off and used for sheep grazing. There are also notable rabbit warrens throughout the area which are likely to be causing damage to any surviving below ground archaeological deposits.



Figure 88- Hollowway running south-west into Deep Grove Quarry (Scale- 1 x 1m).



Figure 89- 'Crossroads' area to the north-east of Deep Grove Quarry, looking south (Scale- 1 x 1m).



Figure 90- Drainage gully, looking east-north-east (Scale- 1 x 1m).



Figure 91- Drainage gully, looking west-south-west, showing carved stone drainage channel (Scale- 1 x 1m).

3 Specialist Reports

3.1 Wooden Objects Assessment

Chris Scott MCIfA

Introduction

3.1.1 Three wooden planks were recovered from the upper part of a fragmentary working/ floor surface [216] within Trench 1 at Saltwick Nab Alum Quarry. The planks are all in average condition with all three heavily abraded/worn and only partially surviving.

Description

3.1.2 The planks are all rectangular in section, roughly sawn, with a distinctive dished trough extending along the full length of their presumed upper surface. Their measurements and description are given in Table 5.

Description	Length	Width	Depth
Largely complete plank, rectangular in section with a distinct dished groove on upper surface. Worn completely through at its centre. Plank may have been sawn at an angle at both ends.	1.38m	0.14m	0.04m
Partially surviving plank, rectangular in section with a distinct dished groove on upper surface. Worn completely through and apparently destroyed at one end. Plank appears to have been sawn with a flat face at surviving end.	1.32m	0.14m	0.04m
Partially surviving plank, rectangular in section with a distinct dished groove on upper surface. Worn completely through at its centre and apparently partially destroyed at one end. Plank appears to have been sawn with an angled face at its surviving end. This angled face appears to suggest it may have been intended to overlie another board.	1.09m	0.13m	0.05m

Table 5: Description of wooden finds.



Figure 92- Vertical view of wooden planks (Scale- 1 x 1m).

Assessment

3.1.3 The longitudinal groove, rough sawn nature of the boards, their context and their approximately standard sizing, all indicate that they are likely to be “barrow boards”. These would most often be ash boards imported into the quarry to be used for providing hard trackway surfaces for wheeling barrows over. Archival work on the Alum industry variously notes the widespread use of barrow boards within quarries, and also mentions the need for their continual replacement through wear, such that they were sometimes replaced by iron plates as a more hardwearing alternative (Chapman 2002).

3.1.4 The demonstrable wear on the planks and their position on top of a quarry floor, is most suggestive of their use as barrow boards. What has not been noted previously,

as far as the author is aware, is the fact that these boards appear to have been worked prior to use to create a hollowed track for barrow wheels to be run along during use. The boards cannot be dated typologically, but their position within the archaeological stratigraphy of the site suggests they date to the 19th Century.

Recommendations

3.1.5 No further analysis is recommended. If additional work is undertaken at the site, the results of this assessment should be added to any further relevant object assessment produced.

3.1.6 Beamish Museum has a large collection of similar mining/ quarrying related items and could be considered as the most suitable repository for these items. Alternatively, Whitby Museum may be the most appropriate local repository.

3.1.7 The items would benefit from careful conservation cleaning and appropriate drying/ preservation before long-term storage or display.

3.2 Iron Ore Assessment

Dr Gerry McDonnell

Introduction

3.2.1 A sample of possible iron ore with white staining from Trench 3 was submitted for examination to confirm or refute the identification. The sample was morphologically examined and then analysed by X-ray Fluorescence (the methodology is provided in the Appendix).

XRF Methodology

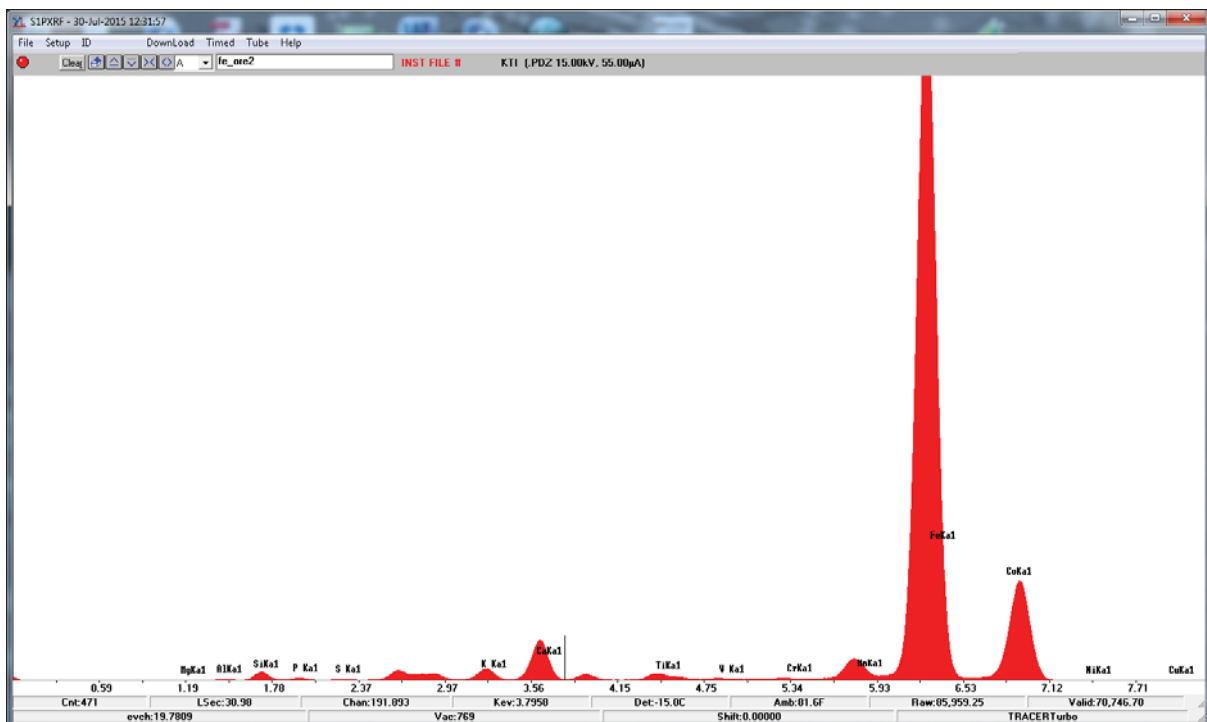
The instrument is a Bruker S1 Turbosdr hand-held XRF instrument operating at 15kV. A beam of x-rays is generated in the instrument and focussed on a fresh fractured surface of the sample, the x-rays interact with the elements present in the sample resulting in the emission of secondary x-rays which are characteristic (in terms of their energy and wavelength) of the elements present in the sample. The energy of the secondary x-rays are measured and a spectrum generated showing a level of background noise with peaks of the elements present superimposed on the background noise. Samples will analysed for 30 live seconds, the spectrum is stored . All elements heavier than magnesium (Mg, Z=12), can be detected. The technique is non-destructive.

Results

3.2.2 The sample appears to be a nodular iron ore of the type present in the Cleveland Ironstone Formation, but with white/grey deposits on some external surfaces. The XRF analysis of a fresh surface of the ore (Graph 1) shows a typical 'ore' spectrum, dominated by iron (Fe). The low atomic number end of the spectrum (Graph 2) shows that silica (Si) and calcium (Ca) are the dominant elements, and both phosphorus (P) and aluminium (Al) are present which is expected in the chamositic siderites of the Cleveland Ironstone Formation. The colour of the hand specimen and the streak test (brown) shows that the ore is in its raw state and not roasted. Analysis of scrapings of the white deposit (Graph 3) indicates that it is rich in calcium (Ca) in comparison to the ore sample. The obvious source of this deposit is shell (Calcium Carbonate) and may indicate that the ore lumps were recovered from below high water. The white deposit does not derive from the alum deposits which would be enhanced in aluminium (Al) and potassium (K).

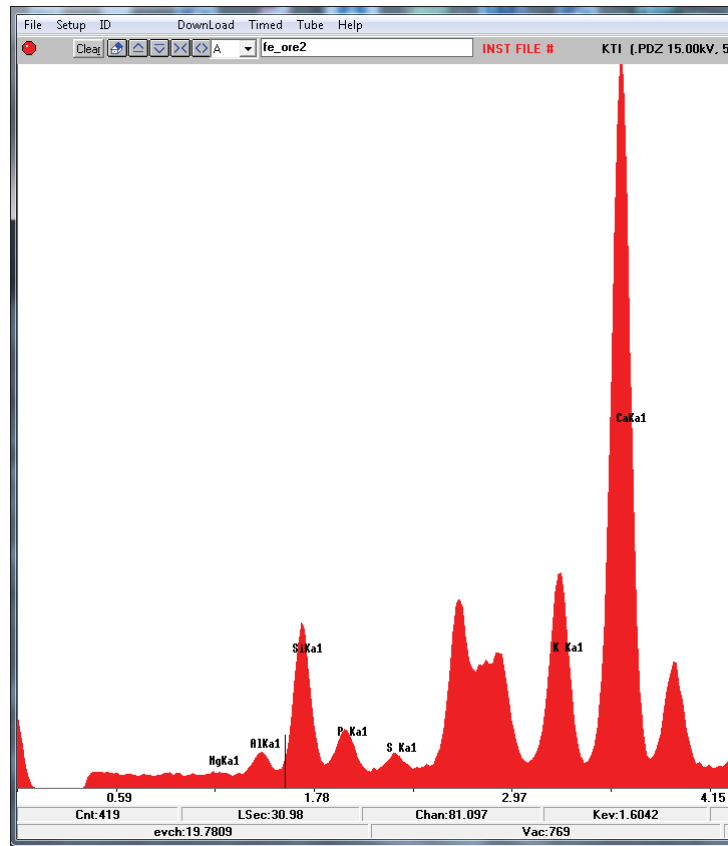
Conclusion

3.2.3 The sample is a piece of raw iron ore, typical of the Cleveland Ironstone Formation. The ores were often roasted close to the ore deposit prior to their transport to the smelting furnace. The white/grey surface deposit is rich in calcium, which is not present in high levels in the ore and may derive from seashell, which is not likely to have been deliberately added to the ore at the mining/roasting stage.

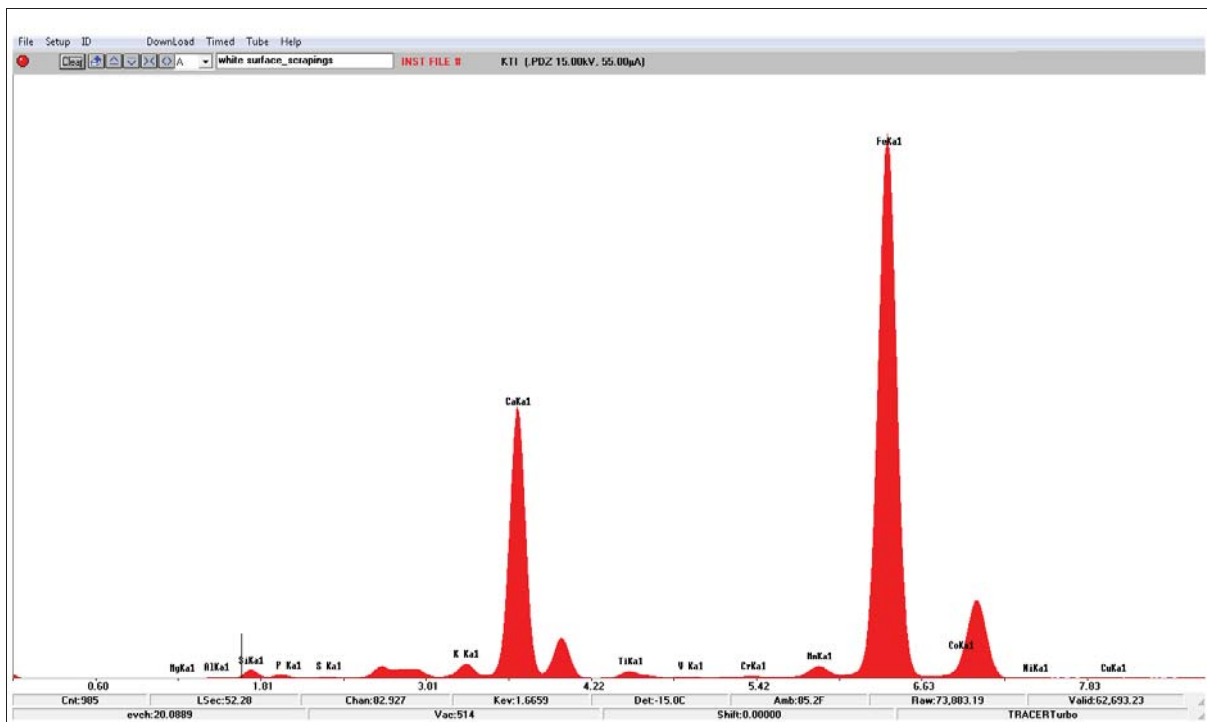


Graph 1: XRF spectrum of an ore sample.

Archaeological Excavation and Survey of Coastal Alum Working Sites at Boulby, Kettlewell, Sandstead and Saltwick, North Yorkshire



Graph 2: Expanded low Z end of the spectrum



Graph 3: XRF spectrum derived from scrapings of the white surface deposit.

4 Discussion

4.1 As previously mentioned, the excavations and survey works detailed within this report were conducted in order to address the recognised threat of coastal erosion to scheduled alum working sites at Saltwick Nab (NHLE 1018336, Legacy SM 31332), Kettlewell (NHLE 1018144, Legacy SM 29545), Sandsend (NHLE 1018139, Legacy SM 29539) and Boulby (NHLE 1017779, Legacy SM 29537). A principal purpose of the archaeological work conducted was to enable the afore-mentioned Scheduled Monuments (Boulby, Kettlewell and Saltwick Nab) to be removed from the Heritage at Risk register and for a better assessment to be made at Sandsend, which is presently assessed as 'Vulnerable'. The excavation and survey work therefore focused on characterising all identified structures and deposits in the most 'at risk', most significant, parts of the monuments. The results should therefore allow for an informed decision to be reached regarding the risk status of each monument.

4.2 It is beyond the scope of this report to detail an exhaustive account of the technical elements of alum manufacture; however, a basic discussion has been outlined below. For an in-depth discussion of the current state of understanding of the process of alum manufacture, the reader is directed to Jecock (2009). The precise practices of alum manufacture are considered to vary between different alum works but the overall stages are believed to be broadly similar (Almond, 1975; Miller, 2002). Alum was formed by the combination of aluminium sulphate, an alkaline sulphate (either ammonium or potassium) and water. The alum works detailed within this report derived the requisite aluminium sulphates from the natural geological shale formations which are visible within the cliffs bordering Whitby (Blood, 1993). The initial stage of alum manufacture was therefore concerned with gaining access to the alum shale and the removal, by hand, of the overlying sandstone. The alum shale seam was then quarried in a series of stepped terraces which allowed the quarry to be progressively enlarged and deepened. The individual terraces were termed 'desses' and could become so inaccessible due to their narrow width and extreme height that quarry workers might have to be lowered onto the quarry ledge by ropes (Thornton, 2000). In order to separate the desired aluminium sulphate from the quarried shale it was necessary to subject the shale to prolonged high temperatures. The quarried shale was therefore transported, by barrow, to a calcining place where it was deposited above a layer of combustible fuel and then fired. According to a contemporary account, 8 or 9 months often passed between construction of the clamp and the moment when the shale was considered suitable for removal (Young, 1817). The calcined shale was then removed from the clamp and inserted into a series of tanks or steeping pits. The calcined shale was then mixed with water and a small quantity of alum liquor. The steeping process allowed the aluminium sulphate within the shale to dissolve into the water and become separated from the calcined shale. The resulting solution was termed alum liquor. The steeping tanks were often stepped and interconnected by a series of sluice gates. The alum liquor would be progressively siphoned between steeping pits and subjected to the same steeping process as detailed above (Blood, 1993). By this method the alum liquor became increasingly concentrated and further impurities would fall from suspension within the

alum liquor and settle at the base of the steeping pits. The most notable residue identified at the base of the steeping tanks, subsequent to the steeping process, was a yellow iron silicate residue, termed by contemporary alum makers as 'slam' (Jecock, 2003). Following the steeping process the alum liquor was then siphoned or pumped off via stone or wooden troughs to the Alum House where the liquor was boiled to further concentrate the solution and then an alkaline sulphate (either ammonium sulphate from human urine, or potassium sulphate derived from kelp) was added to create the desired alum crystals. As previously mentioned the above description of alum production should be regarded as a general outline of the process and not a comprehensive account of alum manufacture. Understandably, techniques varied with reference to the evolution of the technologies utilised and the economic capabilities of individual alum works.

Boulby

4.3 The excavations conducted at Boulby supplemented the work of previous archaeological excavations conducted by Chapman during the 1960's and 1970's (Chapman, 1969-84). Chapman categorised the two cisterns and building platform within Trenches 1 and 2 as being associated with the New Works which were established in 1784 by the Bakers (Chapman, 1975). Furthermore, Chapman also considered the circular structures (106 and 322), present within Trench 1, to be cisterns for the containment of iron silicate 'slam' residue, likely recovered from the steeping pits at the western extent of the New Works (Figure 94). It was noted that the Boulby alum works was producing Epsom salts, from 'slam', for sale in London during the early nineteenth century (Chapman, 2002). Furthermore, Chapman believed that cisterns (106/322) were supplied with 'slam' from a culverted liquor trough leading from the New Works (Chapman, 2002). The trough which was considered to feed cisterns (106/322) was fed from a central east-west aligned trough c.40m west of Trench 1 (Figure 94).

4.4 As previously mentioned, the excavations in Trench 1 noted the presence of a yellow 'use' deposit (112/140) at the base of cisterns (106 and 322)(Figure- 98, 99, 101 & 102). Additionally, both the northern and southern cisterns displayed a bright yellow staining upon the internal face of their respective stonework (109/116) which was also considered be related to the cisterns storage function. It is not unreasonable to assume that the staining present upon the interior faces of the inner steps of stonework (109/116) and deposits (112) and (140) may have represented iron silicate residue associated with 'slam' storage as Chapman suggested (Chapman, 2002). However, the presence of a potential 'slam' deposit at the base of both cisterns (106) and (322) does not prove that the cisterns were utilised for the purpose of 'slam' storage. For example, 'slam' was principally recovered from the steeping pits following the containment of alum liquor. Similarly, fine particles and other contaminants, inclusive of 'slam' could also drop out of suspension from alum liquor during prolonged liquor storage and settle at the base of the holding tanks (Jecock, 2003). Consequently, the possible presence of

‘slam’ at the base of cisterns (106) and (322) does not conclusively prove that the cisterns were utilised for the exclusive storage of ‘slam’.

4.5 Additionally, the trough which Chapman considered to be related to the transportation of ‘slam’ to cisterns (106/322) was interpreted to be associated with F.131 (Chapman, 2002). It should be noted that no evidence for any structures associated with a trough were identified within F.131. However, a broadly E-W aligned linear earthwork led from the location of F.131 into a culvert west of Trench 1. The culvert contained structural evidence for a liquor or slam trough and suggested that F.131 probably contained a continuation of the same trough.

4.6 As previously indicated, Chapman interpreted F.131 as having supported a trough which fed ‘slam’ into cisterns (106) and (322) (Chapman, 2002). F.131 was interpreted to be liquor/slam trough which branched from a central, SE-NW aligned, liquor trough located c. 40m west of Trench 1. However, the archaeological evidence indicated that F.131 post-dated cisterns (106) and (322) as cut [323] truncated cistern construction deposits (110) and (136) (Figure- 97). It might be possible to argue that a trough necessary for the supply of liquor or slam was inserted following the initial construction of cisterns (106) and (322). However, should we assume that the troughs were gravity-fed then the depth of F.131 in relation to the surviving cistern stonework would suggest that any ‘slam’ fed into the cisterns would need to be inserted through the side wall of the cistern. No evidence for any purpose-built opening was identified within either cistern (106) or (322). It should also be noted that the projected route of F.131 would likely truncate the southern wall of cistern (322). Consequently, it seems likely that potential liquor/slam trough F.131 should be regarded as post-dating cisterns (106) and (322) and may not have been related to the insertion or removal of liquor or slam from the afore-mentioned structures. Additionally, no datable finds were recovered from either F.131 or cisterns (106) and (322). Consequently, although the archaeological evidence suggested that both the cisterns and potential liquor/slam transportation trough F.131 were operational at separate phases, the degree of time separating both phases remains unknown. Further excavation work at the intersection between the potential liquor troughs (071) and (068), as categorised by the RCHME survey, might provide further information with reference to phasing and could provide more definitive evidence for the feature’s function (Blood, 1993).

4.7 The deposit sequence within cisterns (106) and (322) was also noteworthy as no deposits related to long term dis-use were identified overlying ‘use’ deposits (112) and (140) (Figure-98, 99, 101 & 102). Deposits (112) and (140) were overlain by poorly sorted deposits (113), (114), (141) and (143) which contained very high concentrations of structural debris, likely derived from cisterns (106) and (322). The poorly sorted composition of deposits (113), (114), (141) and (143) seems most likely to relate to intentional decommissioning of the cisterns, or the robbing of structural material immediately after they had become abandoned or were no longer required. It should be noted that the sharply sloping flagstone floor (111) within cistern (322) could have been

evident during the operational life-span of the cisterns and been indicative of land movement, and that this may have contributed to their disuse.

4.8 As previously mentioned, structure (118) was located at the south-western extent of Trench 1 and was interpreted to be of a broadly contemporaneous date with cisterns (106) and (322) (Figure- 97). Unfortunately, no indication of structure function was derived from the archaeological evidence within Trench 1. It seems most likely that the side of the structure nearest the cisterns was its external face, and the rest of the structure lay away from the cisterns, given the fact that no more of it was encountered at the margins of Trench 1. As such it seems unlikely that this is part of a building which contained or enclosed the cisterns, giving rise to the greater likelihood that they were not enclosed at all. Further understanding of structure (118) would likely be gained by a partial extension of the south-west corner of Trench 1. Additional excavation within the area might identify interior 'use' deposits and diagnostic structural features. Additionally, it might be of value to conduct an excavation to the north-west of Trench 1 in order to highlight the relationship between potential trough F.131 and construction cut [126].

4.9 The archaeological evidence within Trench 2 partially supported the hypothesis that the sub-rectangular raised area east of cisterns (106) and (322) should be interpreted as a potential building platform (Blood, 1993). The presence of deliberately deposited levelling layers (204), (205) and (208) were indicative of a deliberate, attempt to create a structural foundation. Furthermore, it is not unreasonable to assume that levelling deposits (204), (205) and (208) were intended for the support of a possible timber building characterised by beamslots F.209 and F.211 in association with a flagged stone, interior surface (207). The relatively low frequency of structural evidence, coupled with the absence of substantial foundation trenches precluded the possibility that a large stone building was constructed upon the building platform. Unfortunately, no understanding of building function was gained due to an absence of both 'use' deposits and diagnostic finds within Trench 2. However, the close proximity of the building platform to the cisterns within Trench 1 might indicate that the probable timber structure within Trench 2 was likely associated with the cistern's function. Although no dating evidence was recovered it seems likely that the building platform probably dated from at least the formation of the New Works in 1784. It should be noted, therefore, that the 1856 OS map indicated that no structure was present upon the building platform by the mid-19th century (Blood, 1993). The fragmentary preservation of surface (207), coupled with the heavily compacted form of the underlying deposit (205) was suggestive of deliberate structural removal. Consequently, it is not unreasonable to assume that the structure situated on the building platform, was only operational until the mid-19th century before being decommissioned and deliberately removed. Similarly, it should be noted that the level of detail within the 1856 OS map might not have recorded the presence of insubstantial structures of the type present upon the building platform in Trench 2.

4.10 Trench 2 also served to illustrate both the changing landscape of the New Works during its operational life-span and the limited space within which the quarry functioned. For example, the building platform was constructed upon a previously active quarry face which had fallen into dis-use. The deposition of material, against the sloping quarry dross, to create a level surface may not have been an ideal foundation for the construction of a building. It is probable that the building platform was constructed within its respective location due to space restrictions within the quarry floor. The deliberate removal of the building located on the platform most likely reflects dynamic and continual change to working arrangements throughout the life of the quarry.

4.11 Chapman interpreted the stone structure (304) in Trench 3 to be a probable pump house for the movement of water from a large rectangular reservoir located immediately south-west of the trench. No deposits related to building function were identified within the interior of structure (304). However, limited structural evidence for industrial activity was identified within building (304). For example, the presence of sockets [307], [309], [311], [314], [316], [318] and [320] indicated that timber or metal supports, potentially related to the installation of industrial machinery, were inserted into both the walls and floor of structure (304). Additionally, the presence of sloped sockets [314/320] indicated that timber or metal uprights were inserted into structure (304) following building construction and may be also related to a modification or installation of machinery. Unfortunately, the lack of diagnostic finds precluded any conclusive interpretation of structure function and prevented confirmation of Chapman's pump house hypothesis. An extension to the southern edge of Trench 3 might produce more conclusive archaeological evidence for structure function.

4.12 Excavation Trenches 1 and 2 tested the validity of Chapman's theories regarding cisterns (106) and (322) in addition to the associated building platform. Both of the features were considered to be most immediately at risk from coastal erosion. The results indicate that further excavations targeted across the northern boundary of Trench 1 might be considered of relatively significant value. For instance, a 1-2m extension to the northern extent of Trench 1 might provide more detailed information regarding the function of structure (118) and characterise any possible relationship with cisterns (106) and (322) for example was the building built around, and therefore housing the cisterns, or was it simply an adjacent structure, clipped by the excavation trench, meaning that the cisterns lay exposed? It seems most likely that the structure was external to the cisterns as no additional walling was uncovered at any other point around the perimeter of Trench 1. Similarly, a trench extension might also provide further evidence for the function of F.131 and aid our understanding of its phasing in relation to the cisterns. Although these research questions remain, the consideration of any further work should balance the value of increased, but limited, site-specific knowledge against the value that such increased knowledge may have to our regional or national understanding of the alum industry.

4.13 Trench 3 sought further clarification as to the function of this building, interpreted by Chapman as a pump house, however, the absence of occupation or 'use'

deposits within Trench 3 precluded any further discussion of its purpose and suggest that further excavation work upon the potential pump house structure would provide limited information gain.

4.14 In summary the targeted excavation work carried out at Boulby has been most significant in illustrating the complexity of phasing of remains which exists at the site. This appears to add to the picture from earlier excavations by Chapman, and completes much of this picture in understanding those remains located at the coastal edge and therefore most acutely at risk of erosion in the short term. As much of the understanding of steeping pits and cisterns, considered to be transferable across alum sites, is based on the excavations by Chapman at Boulby, it is worth considering the results of the recent work in these terms; perhaps the value of this excavation work is enhanced through it showing the likely developmental complexity of steeping operations within alum quarries.

4.15 Future management priorities for the site at Boulby may be to investigate those areas identified as potentially containing further information regarding the phasing and function of the excavated remains, however, as stated, this should be balanced against the contribution that this information is likely to make to our understanding of the alum industry as a whole. The mitigation works have been focused on those elements of the site most at risk of coastal erosion and can therefore be seen to have mitigated the effects of coastal erosion to these most at risk remains. Boulby is presently categorised as 'At Risk' in the English Heritage Heritage at Risk Register. In light of the mitigation works thus undertaken it is considered that this risk status could be reduced. However from a health and safety perspective, if further work is considered to be a priority for the site, it is recommended that such work be undertaken in the short term, prior to further deterioration of the site.

Kettleiness

4.16 The Kettleiness alum quarry has already been the subject of an extensive investigation by English Heritage in 2002, which included an aerial photographic transcription and a detailed earthwork survey. The report was published as an English Heritage Archaeological Investigation Report in 2003 (Jecock et al 2003) and contained a limited compilation of relevant historical documentation. The excavation trenches, detailed within this report, were targeted across a putative calcining place and probable calcining clamp which were identified during the earthwork survey. Both features were identified due to their diagnostic form and Trenches 1, 2 and 3 sought to clarify their interpretations.

4.17 Trench 1 was excavated across the western shoulder of a probable calcining place at the south-eastern extent of the Kettleiness quarry (Figure- 95). Prior to excavation a fragmentary wall (103) was identified at the western extent of the possible calcining place. The archaeological evidence within Trench 1 indicated that wall (103) likely served as a revetting wall and was constructed against a near vertical face of unquarried

shale (Figure- 114 & 115). Additionally, the natural shale at the base of Trench 1 had been excavated into a relatively flat but gently inclined slope. This inclined slope seems unlikely to have been formed naturally and may be representative of an intention to create a gently sloping barrowway which would gradually ascend the interior face of, and encircle, the calcining place. A tentative interpretation might be that a sloping platform could provide access to a calcining clamp, providing the kind of tipping area discussed by contemporary observers of such operations, allowing shale to be continually added to the upper surface of the clamp during burning (Jecock, 2009: 62). Similarly, the sloping banks of natural shale which encircled the possible calcining place at Kettlewell were also identified at the calcining places within the Loftus and Boulby alum works (Miller, 2002). The rising baulks of unquarried shale at the Loftus and Boulby alum quarries were interpreted to serve as partial windbreaks intended to protect the calcining clamps from the high coastal winds and to aid regulation of clamp burning temperatures (Miller, 2002 & Jecock, 2003). Therefore, it is not unreasonable to assume that the sloping bank of unquarried natural shale at the base of Trench 1 was formed for the purposes of protecting the clamp from the elements as well as assisting its construction.

4.18 The revetting wall (103) at the western extent of Trench 1 was likely intended to further consolidate and protect the possible calcining place during and after construction. Similar structures were also associated with areas for calcining at the Loftus alum quarry and serve to support Jecock's interpretation that Trenches 1 and 2 were targeted across a probable calcining place (Miller, 2002). It should however be noted that no evidence was found for the reddening of this stonework, or of fire affecting the surrounding shale bedrock. Despite this, this structure is difficult to interpret in any other way, and still sits alongside other structures, such as those at Boulby, which despite the lack of evidence for heat affection continue to be interpreted as calcining places (Jecock, 2009: 60-62).

4.19 Trench 2 was excavated across the base of the possible calcining place and produced no evidence to suggest that a clamp had been constructed within that location. Only deposits related to erosion and slippage of the encircling shale banks were identified and no evidence related to clamp construction was encountered (Figure- 17, 18 & 116). However, it is worth noting that the natural geology was not visible at the base of Trench 2 and deeper excavation might reveal evidence for possible clamp construction.

4.20 As previously mentioned, Trench 3 was excavated across a putative calcining clamp located south of the probable calcining place (Figure- 95). The archaeological material identified within Trench 3 produced both depositional and structural evidence for well-documented clamp construction techniques. For example, retaining wall (302) was identified at the base of Trench 3 abutting levelling deposits (307) and (310) and overlying the natural shale geology (309) (Figure- 117-120). Similarly placed sandstone retaining walls were identified by Chapman during excavation of the possible calcining clamps at the Boulby alum works (Chapman, 2002), although these have also been

interpreted as spoil heaps (Jecock 2009). Chapman concluded that because the calcining clamps were constructed upon soft natural shales, the retaining walls were constructed around the clamp bases in order to prevent degradation of the clamp and provide firmer structural support (Chapman, 2002). The evidence, coupled with the broadly curving orientation of wall (302), indicated that a sandstone retaining wall, similar perhaps to those identified at Boulby, encircled the base of the putative calcining clamp at Kettlewell. It seems equally likely that these retaining structures were regularly required for structures of all kinds due to the softness of the materials being heaped, and their natural propensity to slip and form a more relaxed slope profile.

4.21 Additionally, it is worth noting that Chapman also identified stone-lined tunnels built into the base of a possible calcining clamp at Boulby (Chapman, 2002). He interpreted the tunnels as air-ducts providing ventilation to the interior of the calcining heap and highlighted the potential provision of airways during clamp construction. He considered that ventilation within the clamp structure would assist fuel combustion and be desirable for internal temperature regulation, while Miller considered that the use of air-ducts might not be vital for clamp construction and may represent an attempt to refine clamp technology during the later stages of the industry (Miller, 2002). However, Miller conceded that the economics of various alum works limited uniform production techniques and that interstitial spaces within the clamp could similarly facilitate the passage of air (Miller, 2002). Separately, Jecock (2009: 61) has interpreted these tunnels as a buried structure containing a liquor trough, questioning the need for this type of provision within an alum clamp. At Kettlewell, Trench 3 displayed a layer comprised of large, sub-rounded, sandstone fragments (306) (Figure-117 & 120). The relatively uniform size of the sandstone fragments indicated that the stones had been specifically selected for inclusion within layer (306). The large interstitial spaces between the sandstone fragments in layer (306) would likely assist the passage of air into the interior of the structure in the manner which Miller hypothesised. Additionally, should we assume that sandstone layer (306) extended across the full extent of the putative clamp structure then air could be evenly distributed across the base of the structure and assist in clamp temperature regulation. It was noted that clay deposit (305) overlay layer (306) and would have prevented air-flow into the structure (Figure- 119 & 120). However, levelling deposits (307) and (310) were likely intended to raise layer (306) above the height of the sandstone retaining wall (302) and it might be possible that pipes or similar features were inserted through the clay layer to introduce air-flow into (306). It might equally be considered possible that this layer was placed beneath the clamp to prevent the downward progress of fire within the clamp into the combustible shale bedrock, or as a way of preventing the clamp from becoming too hot internally as cold air was able to pass beneath it.

4.22 Additionally, clay layer (305) would likely serve to restrict the emission of warm air and therefore provide insulation to layer (306). Contemporary accounts also suggested that repairing a seal and preventing any uncontrolled emission of air from (or equally into) the structure was a requisite feature of clamp maintenance and was strictly managed (Banks quoted in Miller, 2002). The clay layer (305) is therefore interpreted as

a thermal seal within the putative clamp structure at Kettleless and might well represent a recognised component of post-medieval clamp construction.

4.23 However, Trench 3 produced no calcined or uncalcined shale layers within the clamp structure. The presence of ironstone layer (303) would suggest that the clamp may have been constructed for the roasting of ironstone and not for calcining shale. It is worth noting that a decline in the alum industry occurred in the 1870's when more efficient technologies for extracting alum from colliery waste became available. The North Yorkshire communities whose livelihoods were supported by the alum industry were partially aided by an expansion of the ironstone industry which was exploiting the Main Seam of Cleveland Ironstone (Tolan-Smith, 2008). The similarities between the mode of construction evident within the excavated clamp at Kettleless and the calcining clamps detailed upon other alum production sites might suggest that the Kettleless clamp was constructed by individuals familiar with clamp construction. It is not unreasonable to assume that the possible ironstone refinement clamp at Kettleless might date from the late 19th century, during a period of decline within the alum industry. Similarly, the Kettleless alum works ceased operating in 1871 and the presence of the clamp might be representative of an attempt to diversify into the expanding ironstone industry using familiar clamp technologies.

4.24 At Kettleless, one of the better understood sites within the survey, the investigations carried out as part of this project have specifically answered the research question in increasing understanding of a putative calcining clamp (Jecock et al 2003, 23-29), and re-interpreting it as an ironstone refining feature, providing significant evidence of the likely re-use of this alum site for the exploitation and refinement of ironstone. This is also significant evidence in the consideration of later features and/or other "clamps" at other quarry sites. Excavation of the putative calcining places (Jecock et al 2003, 23-29) at the site conversely produced some evidence, in the form of stone revetment walling and a flat rising platform, which suggested the interpretation of these features was potentially accurate. The information gleaned from excavation, together with the detailed earthwork survey can now be better used as a model from which to interpret earthwork evidence at other sites.

4.25 The excavations at Kettleless were also focused on areas which were considered to be the most 'at risk', most significant elements of the quarry works. As such the excavation has been successful in mitigating some of the loss of the site to coastal erosion. Whilst other 'at risk' features have been noted at the site, such as the bank of steeping pits on the eastern side of the quarry and the remains of the later alum house on its western side, it is considered that the location of these features and their present levels of erosion makes further investigation by traditional archaeological means extremely difficult. Nevertheless significant archaeological deposits, which have the potential to contribute both to site specific research questions, as well as industry-scale research objectives, are subject to active and ongoing erosion at the site which indicates that the present 'at risk' categorisation of the monument is still appropriate.

Saltwick

4.26 The excavation works conducted at Saltwick supplemented survey data compiled by York Archaeological Trust which revealed the location of cisterns, warehouses, burnt heaps and tanks on the quarry floor. The YHRCZA (2011) also noted several features during the rapid walkover survey, although these were generally foreshore features rather than features within the quarry floor (Buglass and Brigham 2011, 38-39). Additionally, previous excavation works, conducted by Gary Marshall of the Scarborough Archaeological and Historical Society, were focused upon the alum house and not the quarry floor. Consequently, the current phase of works represented an opportunity to supplement the limited investigation and recording which has previously taken place upon the site.

4.27 The archaeological material within Trench 1 displayed evidence for near continuous activity, related to alum production, across the majority of the stratigraphic sequence (Figure- 121, 122-124). For example, the presence of 0.58m of heavily compacted and inter-related working surfaces (207), (216), (217), and (219), suggested that the movement of both individuals and alum production waste across the quarry floor was intensive. Additionally, the absence of consolidation or periodic disuse deposits between the trampled working surfaces also supported the interpretation that the area of the quarry into which Trench 1 was excavated was subject to near continuous activity. The existence of drain F.214 and its later decommissioning also suggested that the working landscape of the quarry floor required modification. The prospect of a changing quarry landscape does not seem unreasonable when considering the challenges affecting a working environment concerned with the movement of large quantities of quarried material within a relatively confined area. The exact function of this area of the quarry floor was unclear. However, the presence of barrow board fragments and significant quantities of red shale might indicate that the area of the quarry over which Trench 1 was located, was used for quarry waste movement and storage (Figure 92). It should also be noted that retaining wall (220) was not considered to have been related to the large square structure identified within the historic OS mapping data (Figure 26 & 96). It is unfortunate that the high water table within Trench 2 prevented more extensive investigations but does highlight the possibility of greater finds preservation within the unexcavated areas of the quarry floor. It should also be noted that the waterlogging within Trench 2 may have been related to a break-down within the water transportation system which was likely present on-site during the operation of the quarry.

4.25 Excavation of Trench 1 proved that multi-phase, archaeological deposits remain preserved in-situ within the quarry floor and likely extend up to the seaward edge of the site. As previously mentioned, Trench 1 was targeted across an erosion scar, which had likely been created by a breach within a lip of unquarried shale present at the seaward extent of the quarry floor. It should be noted therefore, that well preserved, multi-phase archaeological material, related to alum production, is under active erosion in areas where the lip of unquarried shale has collapsed, or was not present. Several such

breaches were identified at the seaward edge of the quarry north of Trench 1. Consequently, the high frequency of preserved archaeological material coupled with a relatively limited understanding of the Saltwick alum quarry indicate that additional work may be required, in order to mitigate against further loss.

4.26 The photographic and illustrative recording conducted upon the foreshore slipway, likely represented the maximum information gain that is feasible, barring laser scanning, or dismantling of the structure.

4.27 The Scheduled Loading Ramp or “slipway” has been exhaustively recorded in line with the management recommendation; to a point where it is not envisaged that any further work on site would improve understanding of this feature. Targeted evaluation at the quarry edge has characterised the archaeological resource and mitigated the immediate effects of coastal erosion at points in the scheduled area where significant erosion scars had developed, acutely cutting into in-situ deposits within the quarry floor. This immediate mitigation is only considered as a short term solution to this erosion, which is considered certain to continue. As such the work carried out has shown that a significant archaeological resource consisting of well-preserved structural remains, at times buried under much less significant dumps of later quarry waste, does exist within the quarry. As only a small portion of this resource was investigated, it is difficult to say what its potential is for contributing to a wider understanding of the alum industry as a whole. Despite this, the minimal amount of work carried out at Saltwick Nab to date has in itself made the work carried out as part of this project more significant in increasing understanding of the resource there. In light of these conclusions it is recommended that consideration is given to de-scheduling of the slipway component, but that the present ‘at risk’ categorisation on the quarry remains is retained.

Sendsend

4.28 The aerial photography and Lidar transcription and subsequent walkover survey at Sandsend Alum Quarries has added significant detail to our knowledge of the features present within this Scheduled Monument, along with their location and their level of preservation. The features identified relate to the quarrying of sandstone, alum shale and possibly cementstone, the transportation of material around the quarry, the creation of spoil heaps, the processing of calcined alum shale in steeping pits and possibly also the transportation of alum liquor to the alum house (Figure 129). Alum quarries were necessarily very dynamic environments where further quarrying would necessitate the abandonment or destruction of earlier processing features. As such, the picture presented at Sandsend represents the quarries only in their final phase of operation. This final phase appears to have been similar at each of the three quarries, where the steeping pits were located within a lower quarry area situated along the seaward edge, whilst quarrying continued landward at a higher level above them. The surveys suggest that material was being transported to the steeping pits using barrow runs along the top of the lower quarry edge and down its sides, which slope down to the level of the lower quarry floor. Stone retaining walls were identified at the base of these

possible barrow runs in most cases. Within this similarity some differences were noted between the three quarries; firstly Gaytress Quarry does not contain the same scale or quantity of spoil heaps that are present within Ness End and Deep Grove, suggesting that the sandstone overburden was being transported off site, or tipped over the cliff edge at Gaytress. This practice evidently stopped in the later two quarries where the sandstone was arranged into spoil heaps, that at Asylum Hill (Feature 6) within Ness End is the largest of these and must have presented an obstacle to the smooth running of the quarry. Whether the sandstone was being stored indefinitely, or to be transported off site is not known, however the presence of a possible barrow run around the base of Asylum Hill (Feature 7) suggests that it was a more or less permanent feature. A further difference noted between the three quarries was that at Ness End the quarry appears to have retained a lip of unquarried shale around its seaward edge (Feature 32) in a similar fashion to that recorded at Saltwick Nab Alum Quarry. This feature was not present, or did not survive, at Gaytress or Deep Grove. It was possible also to identify some phasing of features, particularly to the east of the railway at Ness End Quarry and this has been discussed in the results section. Despite this, it has not been possible to postulate on the arrangement of any of the quarries prior to the final phase of operation that we now see. One area where more obvious phasing, and perhaps developmental evidence of the steeping process, may be apparent is between the two sets of probably surviving steeping pits situated within Gaytress and Ness End Quarries (the steeping pits at Deep Grove have been built-over by the railway embankment).

4.29 The Scheduled Monument Description of Sandsend Quarries states that ‘remains of other structures such as workshops, offices, stores and a laboratory survive on the quarry floor’ (NHLE: 1018139), however no such structures were identified by either method of survey employed in the present assessment. This reference, which is very specific as to the buildings’ functions, either, erroneously refers to a different site, or these structures have been removed since the site was scheduled in 1998. The latter is probably the more likely explanation, suggesting that remains of such structures may survive below ground with the quarry.

4.30 The purpose of the survey at Sandsend was firstly to provide a better understanding of the features present, and secondly to assess the level of risk to significant features, due primarily to coastal erosion. The initial assessment report carried out in 2014 concluded that the level of erosion at Sandsend was not as high as at other Scheduled alum working sites along the North Yorkshire Coast. The site was assessed as being at risk of low levels of erosion in the long term, i.e. 80-100 years (Eadie 2014, 45). This assessment still holds true, however it can now be stated that the features most at risk of erosion are those which have the potential to provide the most knowledge gain in terms of the development of the industry. These features are namely the sets of steeping pits within Gaytress and Ness End Quarries (Features 8 and 11). Of these, the steeping pits at Gaytress (Feature 11) are closer to the eroding cliff edge and are arguably the earlier of the two. These steeping pits (Feature 11) are at risk of almost complete destruction within the next 100 years. The steeping pits at Ness End are set further back from the cliff edge and, barring a large-scale landslide, they are unlikely to

be lost to coastal erosion within the next 100 years. Nevertheless it is likely that coastal erosion could severely limit the extent to which they could be safely investigated within the next 80-100 years. Both sets of steeping pits also suffer from vegetation growth that will be causing damage to below-ground deposits and structures. Any works to these areas would require significant vegetation clearance. Active erosion of structural remains was also noted at two locations on the seaward edge of Ness End Quarry (Features 28 and 33, Figure 72 and 75) and structural remains were also recorded close to the cliff edge in the same general location. The full extent and purpose of these remains could not be established without excavation. These features are subject to active and on-going low levels of coastal erosion.

4.31 Aside from the risks posed by coastal erosion, the walkover survey indicates that vegetation growth is a significant problem throughout Gaytress and Ness End quarries. This is particularly the case within the two lower quarry areas on the seaward edge, but it also precludes the identification of finer earthwork remains throughout the higher quarry floors. Such finer earthworks were identified to the north-east of Ness End quarry (Feature 12) in an area where sheep grazing is currently managing the vegetation. This area suffers from significant animal burrowing, however, which will be causing damage to these earthworks and any associated buried archaeological deposits. The current investigation has failed to provide a robust interpretation of the purpose of these features, which appear to be of a different character, and possibly also a different phase, to other earthworks within the Scheduled Area. The earthworks also appear to extend beyond the boundary of the Scheduled Area to the north and north-west. Further detailed earthwork survey of these remains, that includes their full extent, could provide a more robust understanding of their purpose than the present assessment has been able to do.

4.32 At Sandsend an interpretive site walkover survey following Lidar and AP transcription work has added significantly to the understanding of the breadth of remains the quarries there contain, as well as their position in relation to the coastal edge, and therefore relative risk of erosion. This work has certainly contributed widely to our understanding of the alum industry, through providing a much more robust evidence base for the type and variation of remains at Sandsend. These can now much more successfully be compared and contrasted with other well understood or surveyed sites, such as Kettlewell, allowing the production of more targeted research across the group of alum sites, rather than seeking to gain basic or repetitive evidence on a site by site basis.

4.33 The risk level at Sandsend is currently set at 'Vulnerable'. In light of the results of the present survey an argument could be made to increase this risk level to 'At Risk', since significant parts of the monument are eroding at the cliff edge (albeit gradually) and the risk of landslips does mean that substantial portions of these remains could conceivably be lost in a single event. Detailed survey and/or investigation of the areas close to the cliff edge may allow for the present 'Vulnerable' status to be retained. The risk level should not, however, be reduced beyond 'Vulnerable' owing to the ongoing

erosion risk and the problems with vegetation on the site. As a further note it should be highlighted that erosion of structural remains continues beyond the boundary of the Scheduled Area, between it and the Scheduled Alum House. Here parts of the liquor transportation system have been identified in the eroding cliff face, together with features cut into the natural shale, which are potentially further steeping pits or cisterns (Jecock *pers. comm.*) These features, together with features on the foreshore, were once an integral part of, and therefore contribute to the significance of, the Scheduled areas and should not therefore be ignored when formulating mitigation strategies for the site, or when assessing its level of risk.

5 Publicity, Confidentiality and Copyright

Any publicity will be handled by the client. Archaeological Research Services Ltd will retain the copyright of all documentary and photographic material under the Copyright, Designs and Patent Act (1988).

6 Statement of Indemnity

All statements and opinions contained within this report arising from the works undertaken are offered in good faith and compiled according to professional standards. No responsibility can be accepted by the author/s of the report for any errors of fact or opinion resulting from data supplied by any third party, or for loss or other consequence arising from decisions or actions made upon the basis of facts or opinions expressed in any such report(s), howsoever such facts and opinions may have been derived.

7 Acknowledgements

Archaeological Research Services Ltd would like to thank all those who contributed to the outcome of this project, in particular Mags Waughman of the North York Moors National Park Authority, Marcus Jecock of English Heritage, David Pybus and Gerry McDonnell for their guidance and kind assistance. Thanks are also due to The National Trust, the Mulgrave Estate and Len Tabner for providing access to the various alum working sites for the purposes of this archaeological work. Finally, thanks are also due to the staff of Spartan Rescue Ltd. for their professionalism and technical assistance with access and safety requirements.

References

Blood, K. 1993. *Cleveland; Boulby Alum Mine*. RCHME survey report.

Buglass, J. Brigham, T. 2011. *Rapid coastal zone assessment survey: Yorkshire and Lincolnshire: Whitby to Reighton Phase 2*. Humber Archaeology Report No. 327.

Burn, A. 2010. *North East rapid coastal zone assessment: Phase 2*. Archaeological Research Services Report 2010/42.

- Chapman, S.K. 1969. 'Easington, Boulby alum works', *Yorkshire Archaeological Journal* 42, 240.
- Chapman, S.K. 1970. 'Easington, Boulby alum works', *Yorkshire Archaeological Journal* 42, 390.
- Chapman, S.K. 1972. 'Easington, Boulby alum works', *Yorkshire Archaeological Journal* 44, 225.
- Chapman, S.K. 1973. 'Easington, Boulby alum works', *Yorkshire Archaeological Journal* 45, 207.
- Chapman, S.K. 1973. 'Easington, Boulby alum works', *Yorkshire Archaeological Journal* 46, 150.
- Chapman, S.K. 1975. 'Excavations at the Boulby alum works', *Cleveland Industrial Archaeologist* 2, 23-47.
- Chapman, S.K. 1976. 'Easington, Boulby alum works', *Yorkshire Archaeological Journal* 48, 11.
- Chapman, S.K. 1978. 'Easington, Boulby alum works', *Council for British Archaeology* 1978 4, 8.
- Chapman, S.K. 1979. 'Easington, Boulby alum works', *Council for British Archaeology* 1979 4, 8.
- Chapman, S.K. 1984. 'Easington, Boulby alum works', *Council for British Archaeology* 1984, 85.
- Chapman, S.K. 2002. 'Boulby Alum Mine', in Miller, I. (ed) *Steeped in history; the alum industry of North-East Yorkshire*. North York Moors National Park Authority.
- Deegan A. 2007. *The Yorkshire Coast and Humber Estuary rapid coastal zone assessment project; air photo mapping project*. West Yorkshire: Alison Deegan.
- Eadie, G. 2014. Assessment of Scheduled Coastal Alum Working Sites within the North York Moors National Park, Archaeological Research Services, unpublished report no. 2014/31
- English Heritage. 1991. *Management of Archaeological Projects*. London: English Heritage
- Green, D. 2000. 'Evidence of the alum industry on the foreshore at Ravenscar', *Cleveland Industrial Archaeologist* 26, 3-11.

- Jecock, M., Dunn, C., Carter, A. and Clowes, M. 2003. *The alum works and other industry at Kettlewell, North Yorkshire; an archaeological and historical survey*. English Heritage: Archaeological Investigation Report Series AI/24/2003.
- Jecock, M. 2009. 'A fading memory: the North Yorkshire coastal alum industry in the light of recent analytical field survey by English Heritage', *Industrial Archaeology Review* XXXI 1, 54-73.
- Marshall, G. 1990. The Ravenscar alum works; new evidence from archaeological and historical sources, *Transactions of the Scarborough Archaeological and Historical Society* 28.
- Marshall, G. 1991. *The Ravenscar alum works; an interpretation based on historical and archaeological evidence*. National Trust
- Marshall, G. 1992. 'Excavation of the raw liquor cistern at the Ravenscar Alum Works', *Scarborough Archaeological and Historical Society interim reports* 16.
- Marshall, G. 1994. *Saltwick alum works interpretation*. Scarborough Archaeological and Historical Society Research Report 11.
- Marshall, G. 2002. 'The alum house-its reconstruction based on archaeological and documentary evidence', in Miller, I. (ed) *Steeped in history; the alum industry of North-East Yorkshire*. North York Moors National Park Authority.
- McDonnell, G. and Harrison, S. 2003. 'Iron and steel production' in Butlin, R.A. (ed). *Historical Atlas of North Yorkshire*. Westbury p.174-177.
- Miller, I. (ed.) 2002. *Steeped in history; the alum industry of North-East Yorkshire*. North York Moors National Park Authority.
- National Trust. 2000. *Ravenscar alum works interpretation of archaeological evidence*. National Trust Report Volume 1.
- North East Coastal Authorities Group. 2007. *Shoreline Management Plan 2; River Tyne to Flamborough Head*. North East Coastal Authorities Group Report No: 9PO184.
- Page, W. (ed.) 1923. *Victoria County History: a history of the County of York North Riding: Volume 2*. London: Institute of Historical Research
- Pybus, D. 1983. 'The alum hole at Sandsend', *Transactions of the Scarborough Archaeological and Historical Society* 25.

Thornton, C.E. 2000. 'Sir Joseph Banks account of alum making at Kettlewell, North Yorkshire', *Cleveland Industrial Archaeology*, XXVI, pp13-18

Tolan-Smith, C. 2008. *North East rapid coastal zone assessment (NERCZA) Phase 1 report*. Archaeological Research Services 2008/81.

Young, G. 1817, *A History of Whitby and Streonshalh Abbey* (Whitby: Clark & Medd)

Websites: British Geological Survey: www.bgs.ac.uk

Appendix 1- Context Registers

Boulby

CONTEXT	DESCRIPTION
101	Topsoil
102	Red shale
103	Greyish brown silty disuse deposit
104	Red shale
105	Yellow clay
106	Walls of cistern
107	Clay immediately overlain by (104)
108	Yellow clay lining of (322)
109	Inner ring wall within E cistern
110	Red shale filling construction cut of (322)
111	Floor of E cistern
112	Yellow clay
113	Disuse deposit in E cistern
114	Demolition/backfill deposit in E cistern
115	Accumulated topsoil in E cistern
116	Inner ring wall in W cistern
117	Floor of W cistern
118	Blockwork masonry wall
119	Red shale backfill
120	Yellow clay levelling
121	In-situ shale
122	Terracotta pipe
123	Cut for (122)
124	Topsoil
125	Red shale levelling
126	Construction cut for W cistern
127	Buried soil within cut (323)

**Archaeological Excavation and Survey of Coastal Alum Working Sites at Boulby,
Kettlewell, Sandsend and Saltwick, North Yorkshire**

128	Red shale dump within (323)
129	Yellow/blue clay within (323)
130	Red shale dump within (323)
131	Yellow/blue clay dump/collapse within (323)
132	Silty clay subsoil over (134)
133	Buried soil horizon over (132)
134	Striated windblown clay deposit over (133)
135	Silty subsoil over (134)
136	Backfill clay bank between E and W cisterns
137	Stonework between cisterns
138	Silty clay deposit at SE extent of TR1
139	Shale filling pipe cut (light brown silt with shale inclusions)
140	Yellow clay at base of south-westernmost cistern over (117)
141	Brown/orange sandy silt
142	Blue/grey silty clay over (141)
143	Red shale over (140)
144	Grey silt over (143)
145	Subsoil below (115)
146	Primary fill of cut [323]
322	E cistern structure
323	Cut of probable liquor trough truncating (322)
201	Topsoil
202	Mid grey-brown silty-clay subsoil
203	Reddish-grey stony/shale deposit
204	Sandstone rubble and sand deposit
205	Mottled grey/blue clay-silt
206	Fairly clean yellow clay with rubble
207	Sandstone foundation
208	Mottled grey/blue silty-clay
209	Red shale fill of beam slot [210]
210	NE/SW aligned beam slot
211	Red shale fill of beam slot [212]
212	NW/SE aligned beam slot cut into (208)
213	Stone base external to (207)
214	Red shale and clay fill of cut [215]
215	NE/SW aligned cut into (208)
216	Possible stone drain aligned NE/SW
217	Unquarried shale natural
218	Dark brown rubbly silty-clay
219	Ashy light grey silt deposit
220	Skim of mid-grey clay over (217)
221	Cut of quarry dross in (217)
301	Topsoil – dark brown silty-clay
302	Grey silt

**Archaeological Excavation and Survey of Coastal Alum Working Sites at Boulby,
Kettleiness, Sandsend and Saltwick, North Yorkshire**

303	Orangey-red silt and shale
304	Wall
305	Flagged floor
306	Fill of socket (307), grey silt
307	Socket in wall (304)
308	Fill of socket (309), grey silt
309	Socket in wall (304)
310	Fill of socket (311), grey silt
311	Socket in wall (304)
312	Yellow clay deposit in NW corner of Trench
313	Fill of floor socket (314)
314	Socket in floor (305)
315	Fill of floor socket (316)
316	Socket in floor (305)
317	Fill of floor socket (318)
318	Socket in floor (305)
319	Fill of floor socket (320)
320	Socket in floor (305)
321	Nail holes in wall (305)

Kettleiness

CONTEXT	DESCRIPTION
101	Topsoil
102	Brownish-grey clayey-silt
103	Revetting wall
104	Natural shale
201	Topsoil
202	Subsoil
203	Dark grey clayey-silt erosion deposit
204	Dark bluish-grey clayey-silt erosion deposit
301	Topsoil
302	Retaining wall
303	Heat-effected ironstone
304	Heat-effected clay
305	Bluish grey clay with shale inclusions
306	Large assorted stones (thermal layer)
307	Orangey-blue silty levelling clay
308	Mid orangey-grey packing clay
309	Natural shale
310	Mid bluish-orange levelling clay

Saltwick

CONTEXT	DESCRIPTION
101	Topsoil
102	Dark brownish-grey silty clay subsoil
103	Light grey silty clay
104	Sandstone rubble
201	Topsoil
202	Subsoil
203	Red shale dump
204	Grey/yellow shale dump
205	Red shale dump
206	Grey shale/clay dump
207	Orange shale with grey clay inclusions
208	Red shale dump
209	Grey clay/shale dump
210	Cut of drain
211	Yellow shale dump
212	Grey clay
213	Natural shale
214	Light orange silty-clay fill of [210]
215	Orange silty-clay dump
216	Compacted burnt shale/silty clay surface
217	Compacted burnt shale/silty clay partial surface (same as (216))
218	Firm dark-grey/black silty clay surface with burnt and unburnt shale inclusions (beneath (216))
219	Grey/dark red silty clay deposit with burnt and unburnt shale inclusions
220	Retaining wall of yellow sandstone
221	Orange shale dump

Appendix 2- Photograph Register

Boulby

SHOT No.	DIRECTION OF VIEW	SCALE	CONTEXT NO.s	DESCRIPTION	PHOTO BY
1	SSE	2x1m	(304) (305)	Floor and wall NNW facing section T3	GE
2	SSE	2x1m	(304) (305)	Floor and wall NNW facing section T3	GE
3	SSE	2x1m	(304) (305)	Floor and wall NNW facing section T3	GE
4	SSE	2x1m	(304) (305)	Floor and wall NNW facing section T3	GE
5	SSE	2x1m	(304) (305)	Floor and wall NNW facing section T3	GE
6	SSE	2x1m	(304) (305)	Floor and wall NNW facing section T3	GE
7	ENE	1x1m 1x2m	(304) (305)	WSW facing elevation	GE
8	SSE	2x1m	(304) (305)	NNW facing elevation	GE
9	W	1x2m	(301) (302) (304)	W facing section of (304)	GE
10	W	1x10cm	(314)	Plan view of floor sockets	GE
11	W	1x10cm	(316)	Plan view of floor sockets	GE
12	W	1x10cm	(318)	Plan view of floor sockets	GE
13	W	1x10cm	(320)	Plan view of floor sockets	GE
14	SSE	1x10cm	(307)	Socket in (304)	GE
15	SSW	1x1m	(314) (321)	Slots in (305) for post erection and associated hole in wall	GE
16	NE	1x10cm	(215)	Cut and fill with stone	GE
17	NE	1x10cm	(215)	Cut and fill with stone and foundation (207)	GE
18	NE	1x2m	TR2	Mid-excavation (working shot)	GE
19	SE	1x1m	TR2	Mid-excavation (working shot)	GE
20	E	1x1m	TR2	Mid-excavation (working shot)	GE
21	SW	1x1m	TR2	Mid-excavation (working shot)	GE
22	ENE	1x1m 1x2m	TR2	Mid-excavation (working shot)	GE

**Archaeological Excavation and Survey of Coastal Alum Working Sites at Boulby,
Kettlewell, Sandsend and Saltwick, North Yorkshire**

23	WSW	1x1m 1x2m	TR2	Mid-excavation (working shot)	GE
24	SSE	1x10cm	(215)	Cut under stone (post-ex)	GE
25	SSE	1x10cm	(215)	Cut under stone (post-ex)	GE
26	WSW	1x10cm	(215)	Cut under stone (post-ex)	GE
27	WSW	1x10cm	(215)	Cut under stone (post-ex)	GE
28	ESE	1x1m	(206) (207)	Clean yellow clay and sandstone foundation before clay excavated	GE
29	NNW	1x1m	(206) (207)	Clean yellow clay and sandstone foundation before clay excavated	GE
30	ENE	1x1m 1x2m	(205)	Clean yellow clay (206) removed	GE
31	NNE	1x1m	(205) (207)	Detail of silty clay	GE
32	N	1x1m 2x2m	(105)	Structure (106)	RL
33	N	1x1m 2x2m	(105)	Structure (106)	RL
34	NE	1x1m 2x2m	(105)	Structure (106)	RL
35	SE	1x1m	(107)	Possible barrow board	RL
36	SE	1x1m	(107)	Possible barrow board	RL
37	NE	1x1m	-	SW facing section of TR2	TL
38	NE	1x1m	-	SW facing section of TR2	TL
39	SE	1x2m	-	NW facing section of TR2	TL
40	SE	1x2m	-	NW facing section of TR2	TL
41	SE	1x2m	-	NW facing section of TR2	TL
42	SE	1x1m 1x2m	-	NW facing section of TR1	RL
43	SE	1x1m 1x2m	-	NW facing section of TR1	RL
44	SW	2x1m	-	NE facing section of TR1	RL
45	SW	2x1m	-	NE facing section of TR1	RL
46	SW	2x1m	-	NE facing section of TR1	RL
47	NE	1x1m	(208)	SW facing section of SD1	LW
48	NE	1x1m	(208)	SW facing section of SD1	LE
49	NW	1x1m	-	SE facing section of SD2	GE
50	NE	1x1m	-	SW facing section of SD2	GE
51	NE	1x1m	-	SW facing section of SD2	GE
52	NE	1x1m	-	NE facing section of SD2	GE
53	NE	1x1m	-	NE facing section of SD2	GE
54	N	1x1m 1x2m	(322)	S facing section of TR3	RL

**Archaeological Excavation and Survey of Coastal Alum Working Sites at Boulby,
Kettlewell, Sandsend and Saltwick, North Yorkshire**

55	NE	1x1m 1x2m	(322)	S facing section of TR3 (oblique)	RL
56	SW	1x1m 1x2m	(322)	NE facing section of TR3	RL
57	SW	1x1m 1x2m	(322)	NE facing section of TR3	RL
58	N	1x1m 1x2m	(323)	S facing section of TR3	RL
59	N	1x1m 1x2m	(323)	S facing section of TR3	RL
60	N	1x1m 1x2m	(323)	S facing section of TR3 and extant earthwork	RL

Kettlewell

SHOT No.	DIRECTION OF VIEW	SCALE	CONTEXT NO.s	DESCRIPTION	PHOTO BY
1	SW	2x1m	(102) (103)	SW facing shot of STR103	RL
2	SW	2x1m	(102) (103)	SW facing shot of STR103	RL
3	SE	2x1m	(102) (103)	SE facing shot of TR1	RL
4	S	2x1m	(102) (103)	S facing shot of TR1	RL
5	SW	2x1m	(201) (203)	NE facing section of TR2	RL
6	WSW	2x1m	(201) (202) (203) (204)	ENE facing section of TR2	RL
7	WSW	2x1m	(201) (202) (203) (204)	ENE facing section of TR2	RL
8	S	2x1m	(201) (202) (203) (204)	S facing shot of TR2	RL
9	SW	1x1m	(302)	Locating shot of STR302 within TR3	RL
10	SW	1x1m	(302)	Locating shot of STR302 within TR3	RL
11	WSW	2x1m	(302)	Working shot of TR3	RL
12	NW	1x2m	-	SE facing section of TR3	RL

**Archaeological Excavation and Survey of Coastal Alum Working Sites at Boulby,
Kettlewell, Sandsend and Saltwick, North Yorkshire**

--	--	--	--	--	--

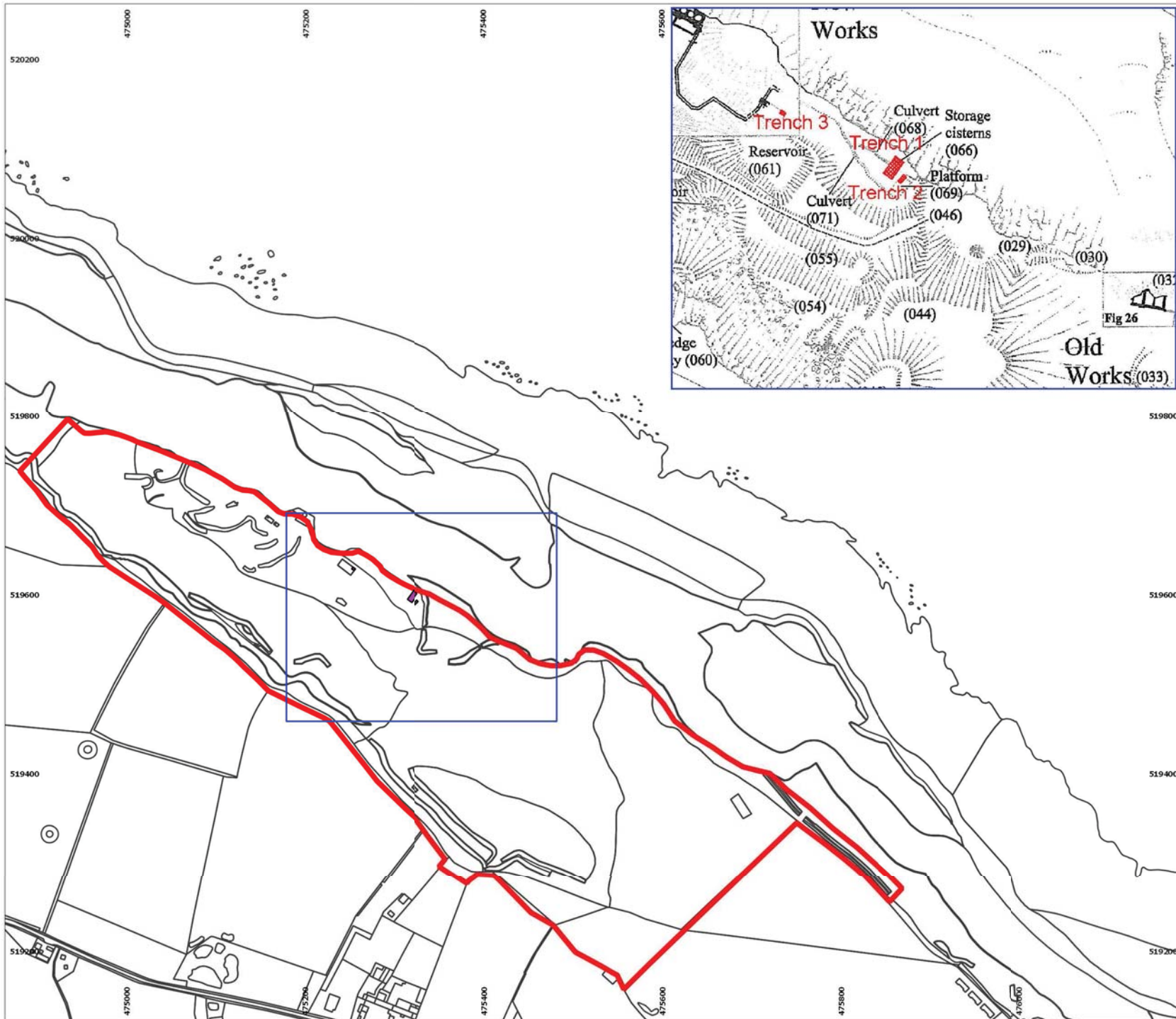
Saltwick

SHOT No.	DIRECTION OF VIEW	SCALE	CONTEXT NO.s	DESCRIPTION	PHOTO BY
1	SW	1x1m 1x2m	TR1	SW overview shot of TR1	GE
2	NE	1x1m 1x2m	TR1	NE overview shot of TR1	GE
3	NE	1x1m 1x2m	TR1	NE overview shot of TR1	GE
4	SW	1x1m	TR1	NE facing section of TR1	GE
5	NW	1x2m	TR1	SE facing section of TR1	GE
6	S	1x2m	(220)	S facing shot of STR 220	CS
7	E	1x2m 1x1m	(216) (218) (219)	E facing shot of TR2	CS
8	NE	1x2m 1x1m	(216) (218) (219)	NE facing shot of TR2	CS
9	N	1x2m 1x1m	(210) (214)	N facing shot of [210]	CS
10	W	1x2m	(210) (214)	W facing shot of turn in [210]	CS
11	E		TR2	E facing working shot of TR2	CS
12	S	1x2m 1x1m	(210) (214)	S facing shot of [210]	CS
13	W	1x1m	(201) (202) (203) (204) (205) (217)	E facing section of TR2	CS
14	NW	1x2m 1x1m	(201) (202)	NW facing shot of SE facing corner of TR2	CS
15	-	-	-	Working shots of TR2	CS
16		1x2m 1x1m	(216) (219)	NE corner of wood relationship in sondage of TR2	TL

Appendix 3- Figures

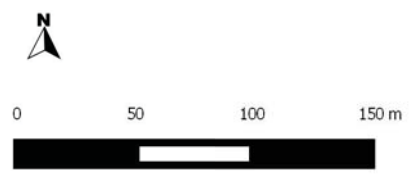


Figure 93- Site location



**Figure 94: Trench Location Plan
Boulby, N. Yorks**

- Key**
- Scheduled Monument
 - Trench Location



Site name: Boulby
 Date: April 2015
 Drawn by: GS

This drawing: Copyright ARS Ltd
 Ordnance Survey mapping
 (if applicable);
 Crown Copyright.
 All rights reserved.
 Reproduced with permission.
 Licence no. 100045420



Archaeological Research Services Ltd
 The Eco Centre
 Whitton Way
 Hildon
 Tyne and Wear
 NE31 1SR
 Tel: 0191 4775111
 www.archaeologicalresearchservices.com

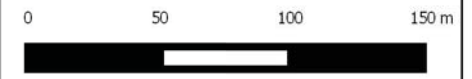




Figure 95: Location of Trenches at Kettleness, N. Yorks

Key

-  Scheduled Monument
-  Trench Location



Site name: Kettleness
 Date: April 2015
 Drawn by: GS

This drawing: Copyright ARS Ltd
 Ordnance Survey mapping
 (if applicable):
 Crown Copyright.
 All rights reserved.
 Reproduced with permission.
 Licence no. 100045420

Archaeological Research Services Ltd
 The Eco Centre
 Whitham Way
 Hildesheim
 Tyne and Wear
 NE31 1SR
 Tel: 0191 4775111
 www.archaeologicalresearchservices.com



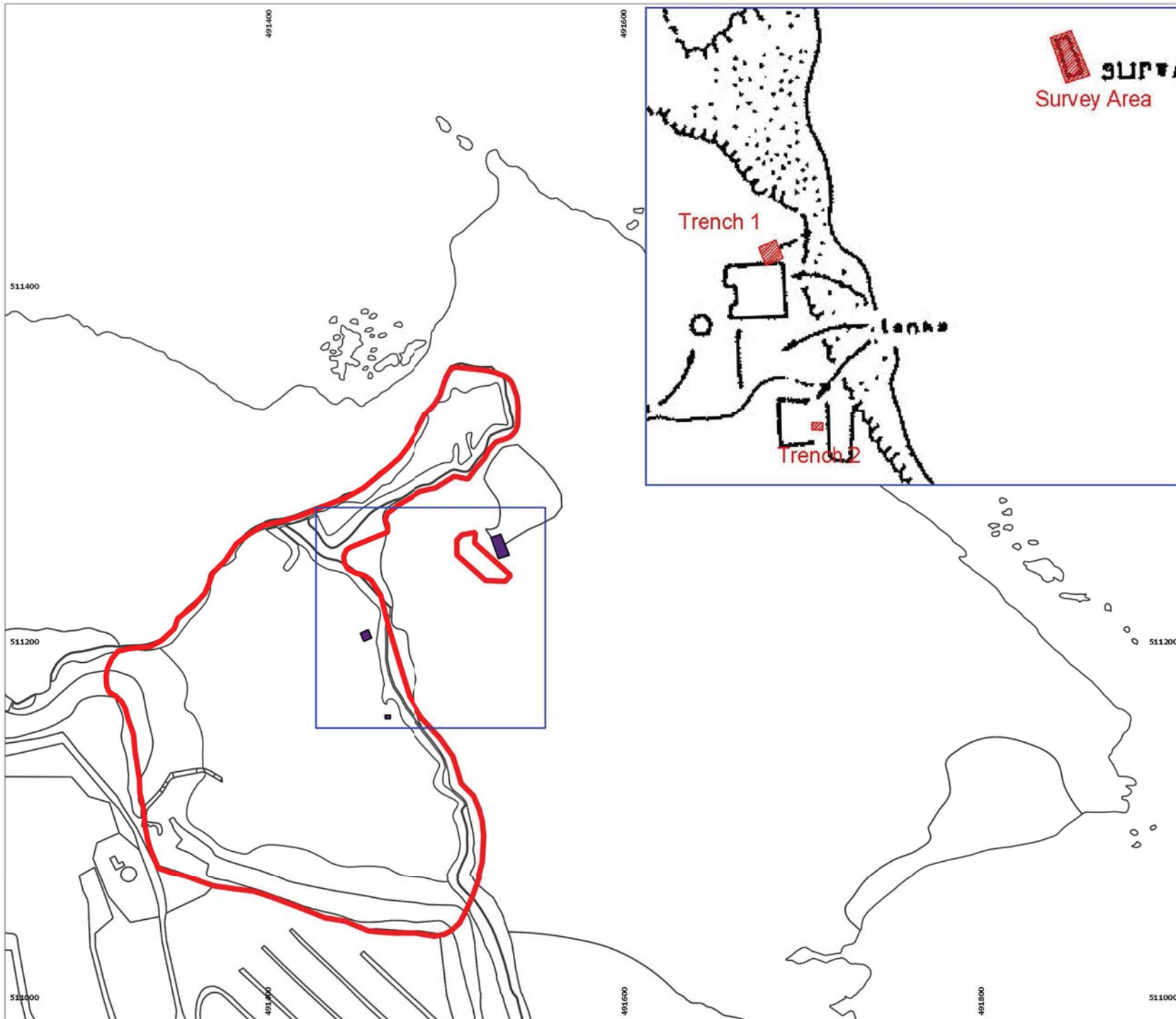


Figure 96: Location of Trenches and Survey Area at Saltwick Nab, N. Yorks

Key

-  Trench Location
-  Scheduled Area



0 50 100 150 200 m



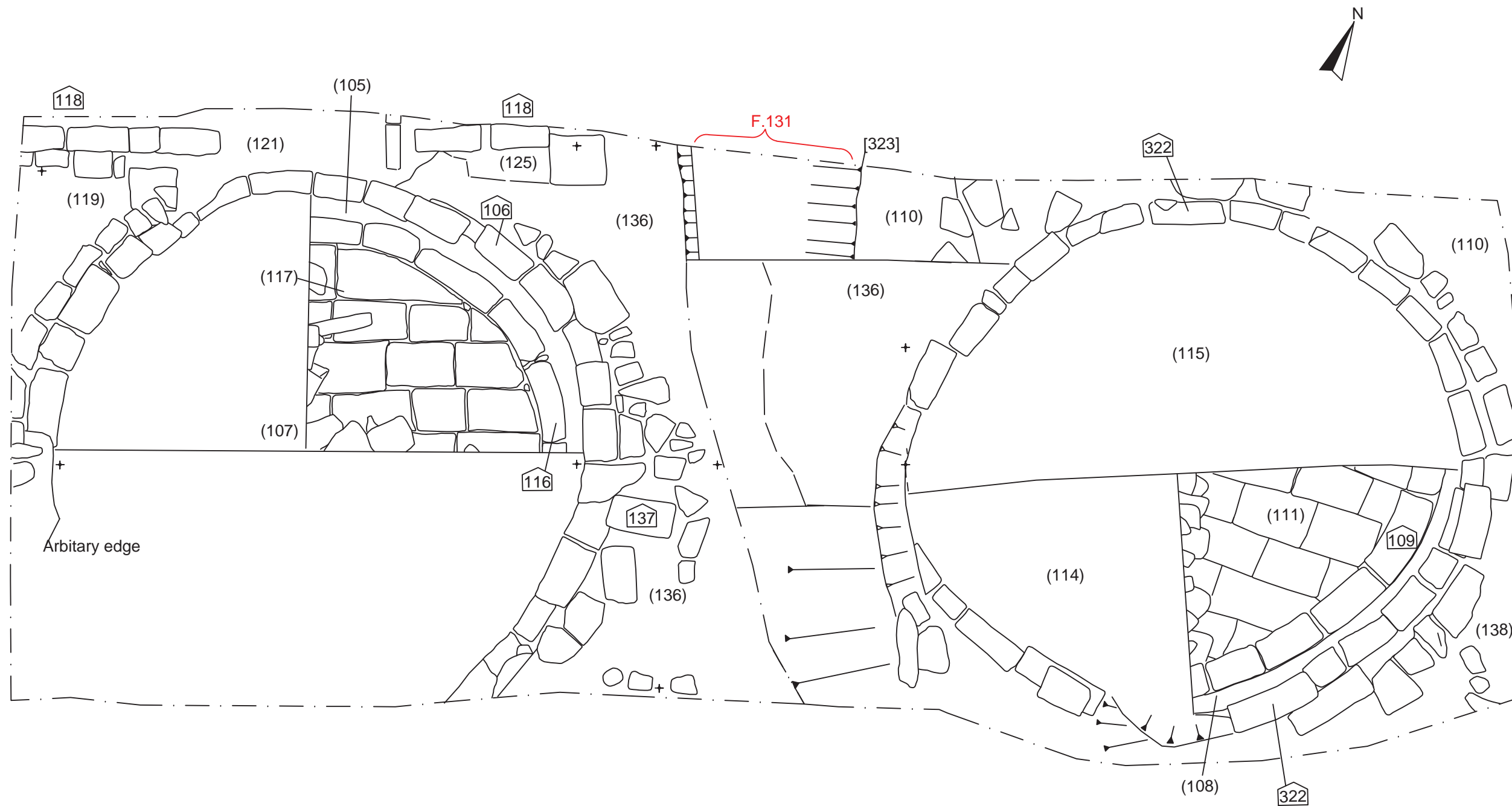
Site name: Saltwick Nab
 Date: April 2015
 Drawn by: GS

This drawing: Copyright ARS Ltd
 Ordnance Survey mapping
 (if applicable):
 Crown Copyright.
 All rights reserved.
 Licence no. 100045420

Archaeological Research Services Ltd
 The Eco Centre
 Whitton Way
 Hildesay
 Tyne and Wear
 NE31 1SR
 Tel: 0191 4775111
 www.archaeologicalresearchservices.com



Key:



Copyright/ Licencing
This Drawing
© A.R.S. Ltd

Ordnance Survey data if applicable
© Crown Copyright, all rights reserved
reproduction with permission.
Licence No. 100045420

Figure 98- NW-facing section of Southern Cistern (106) - Boulby

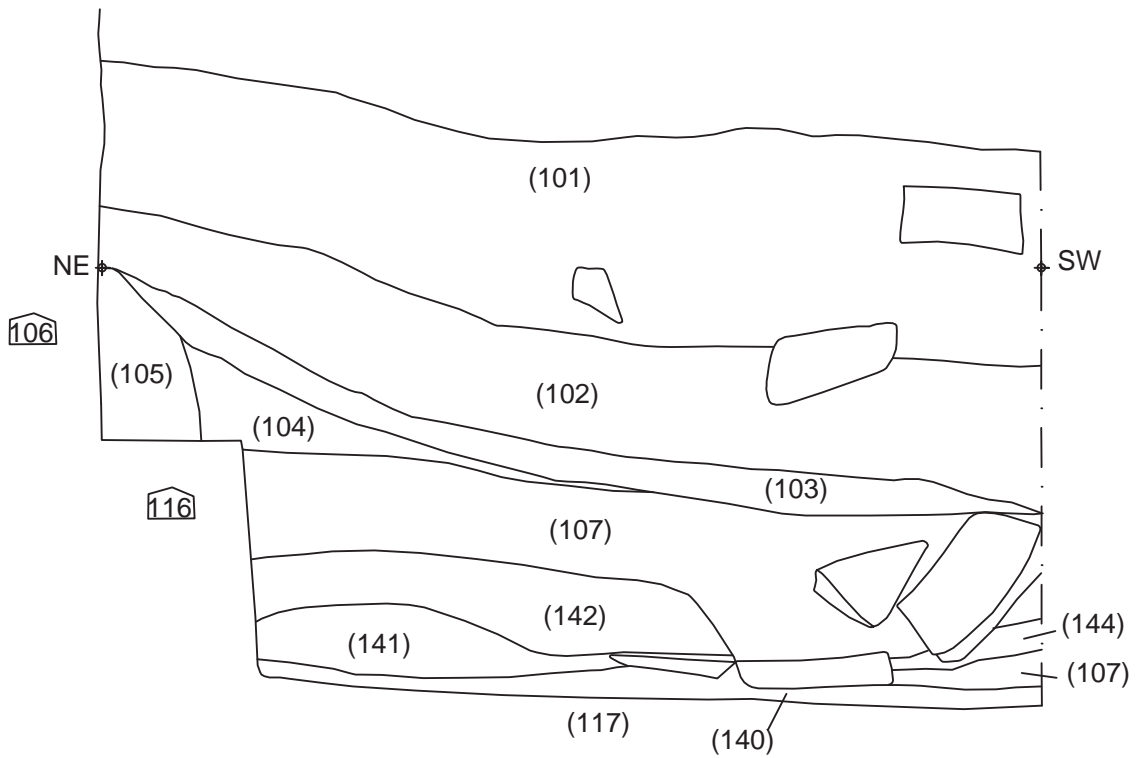
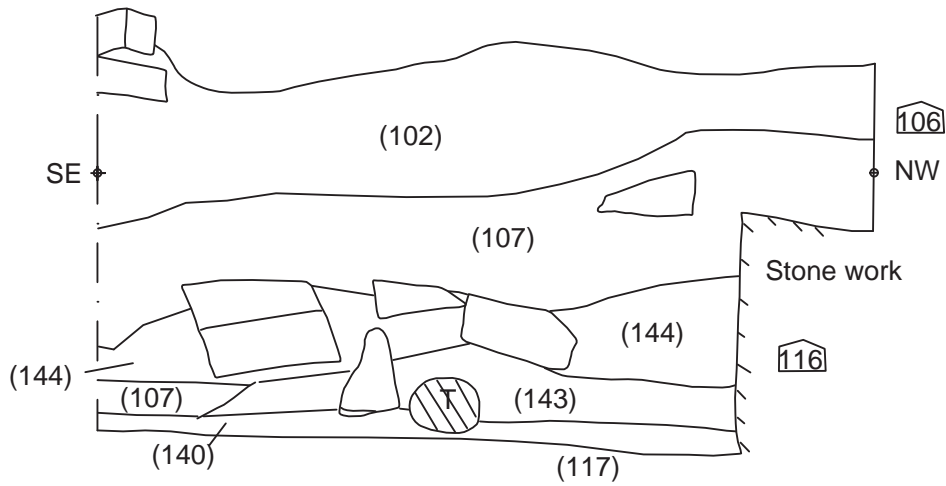


Figure 99- SE-facing section of Southern Cistern (106)- Boulby



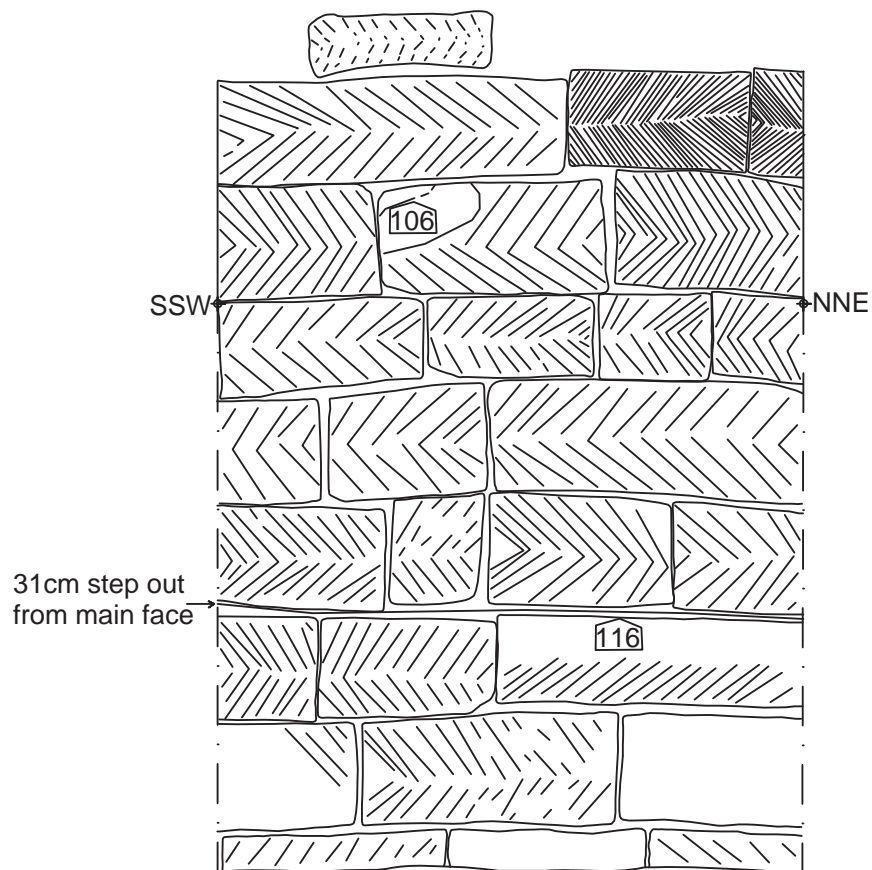
Title: Figure 98 & 99- Sections of Southern Cistern (106) - Boulby
 Scale: 1:20@A4
 Drawn: GS, DGC & RL

Key:

Copyright/ Licencing
 This Drawing
 © A.R.S. Ltd

Ordnance Survey data if applicable
 © Crown Copyright, all rights reserved
 reproduction with permission.
 Licence No. 100045420

Figure 100- ESE-facing Elevation of Southern Cistern (106) - Boulby



Title: Figure 100- ESE-facing Elevation of Southern Cistern (106)- Boulby
Scale: 1:20@A4
Drawn: GS & RL

Key: NB- Punched Herringbone Tooling was indicative of toolmark pattern and direction. The toolmarks should be regarded as indicative, not actual.

Copyright/ Licencing
This Drawing
© A.R.S. Ltd

Ordnance Survey data if applicable
© Crown Copyright, all rights reserved
reproduction with permission.
Licence No. 100045420

Figure 101- SE-facing section of Northern Cistern (322) - Boulby

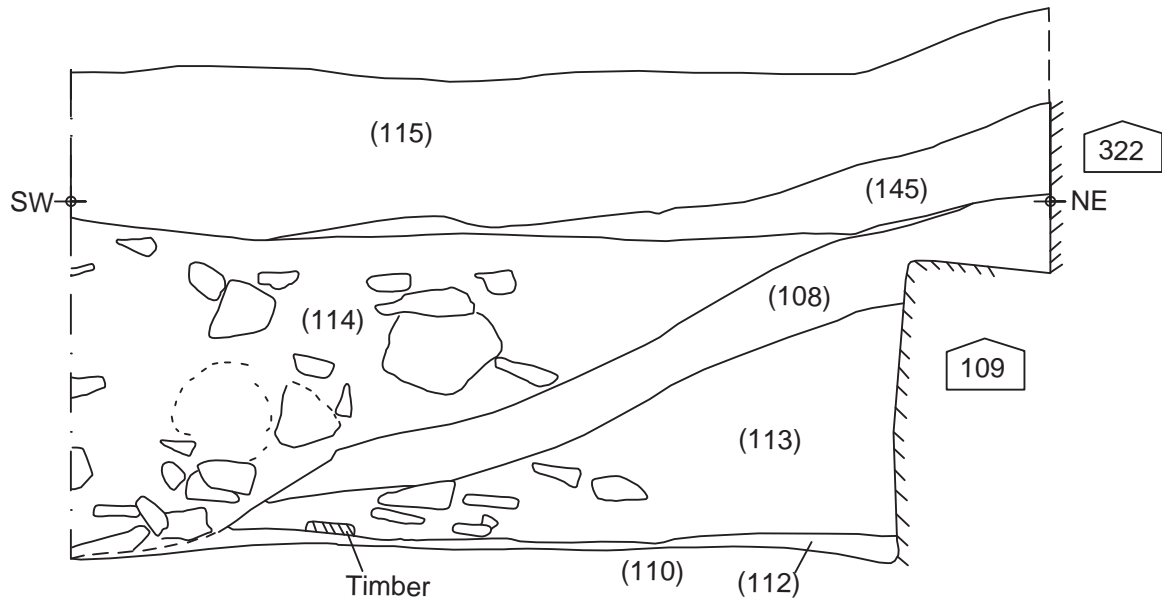
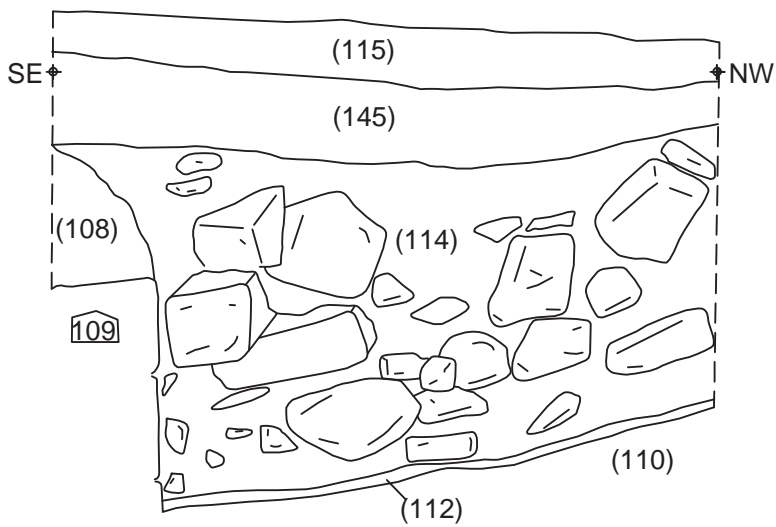


Figure 102- NE-facing section through interior of Northern Cistern (322) - Boulby



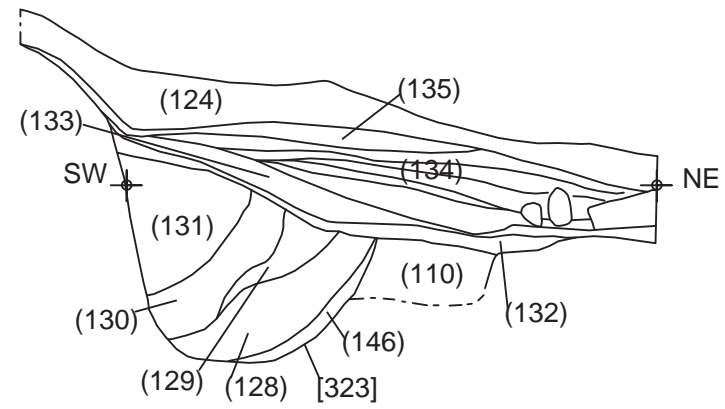
Title: Figure 101 & 102- Sections of Northern Cistern (322) - Boulby
 Scale: 1:20@A4
 Drawn: GS, DGC & RL

Key:

Copyright/ Licencing
 This Drawing
 © A.R.S. Ltd

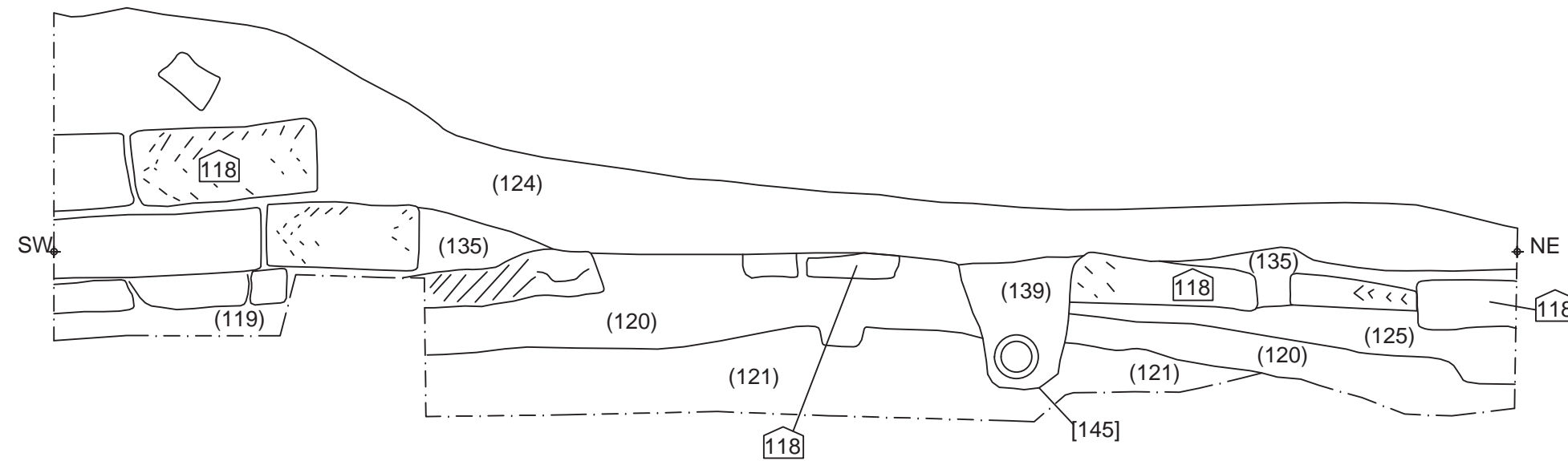
Ordnance Survey data if applicable
 © Crown Copyright, all rights reserved
 reproduction with permission.
 Licence No. 100045420

Figure 103- SE-facing section of F.131 - Boulby



Key:

Figure 104- SE-facing section of Trench 1 - Boulby



Copyright/ Licencing
This Drawing
© A.R.S. Ltd

Ordnance Survey data if applicable
© Crown Copyright, all rights reserved
reproduction with permission.
Licence No. 100045420

Figure 105- Mid-Excavation Plan of Trench 2 - Boulby

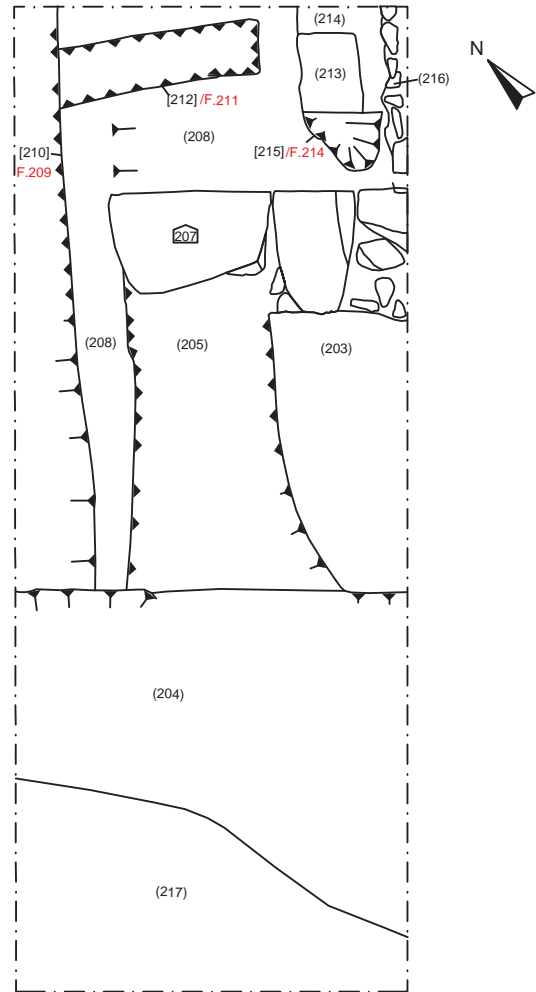
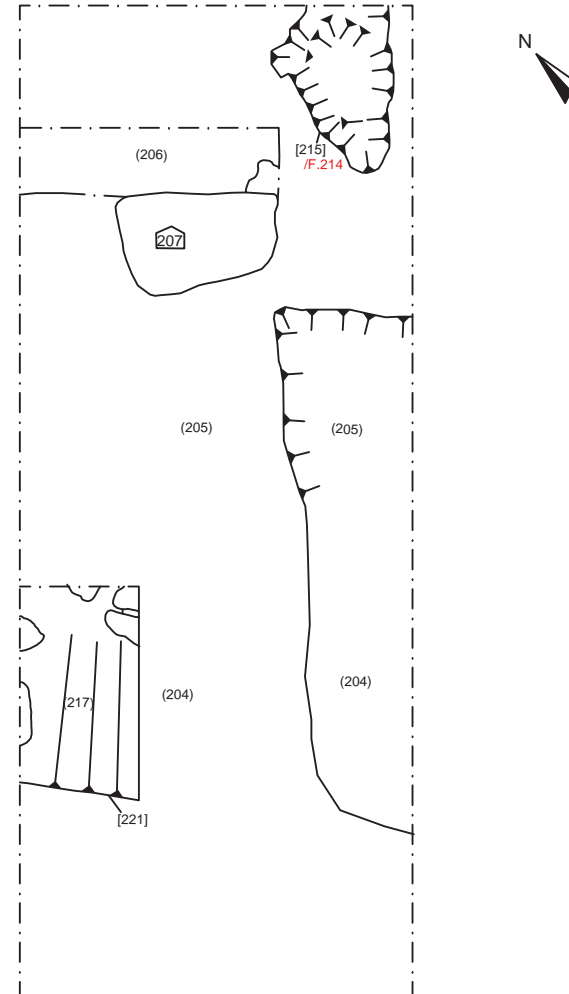


Figure 106- Post-Excavation Plan of Trench 2 - Boulby



Key:



Copyright/ Licencing
This Drawing
© A.R.S. Ltd

Ordnance Survey data if applicable
© Crown Copyright, all rights reserved
reproduction with permission.
Licence No. 100045420

Figure 107- NW-facing section of Trench 2 - Boulby

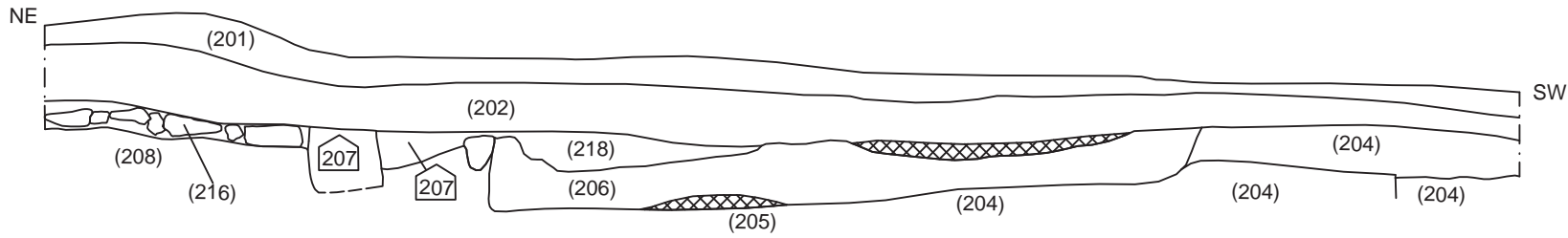


Figure 108- SW-facing section of Trench 2 - Boulby

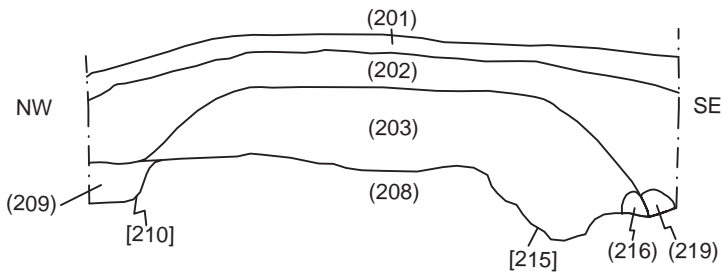
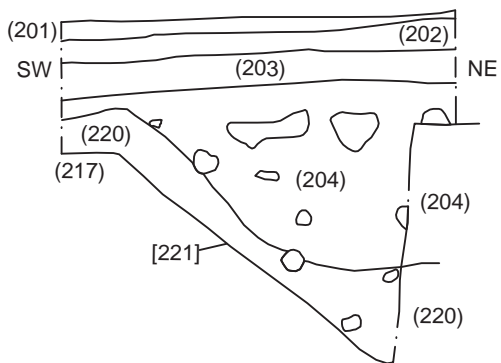


Figure 109- NW-facing section of Trench 2 - Boulby



Key:



Copyright/ Licencing
This Drawing
© A.R.S. Ltd

Ordnance Survey data if applicable
© Crown Copyright, all rights reserved
reproduction with permission.
Licence No. 100045420

Figure 110- S-facing section of Trench 3 - Boulby

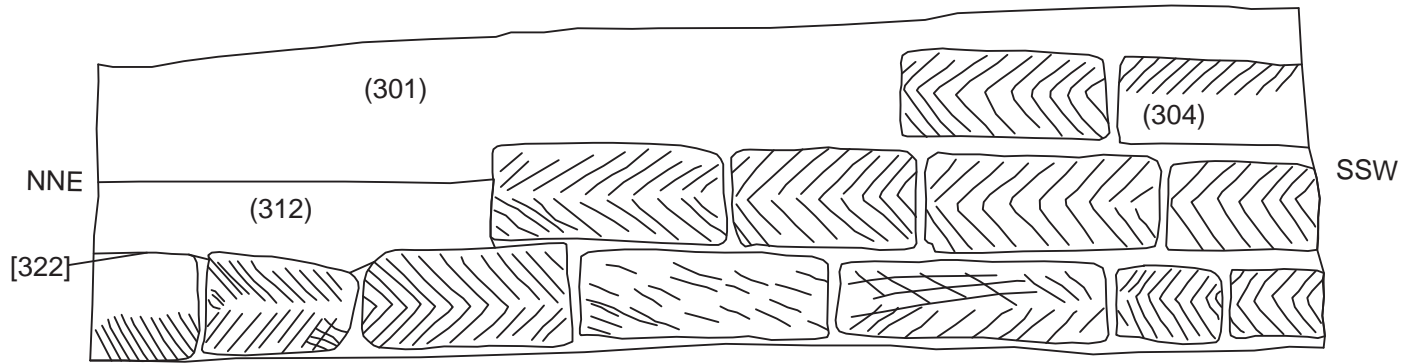
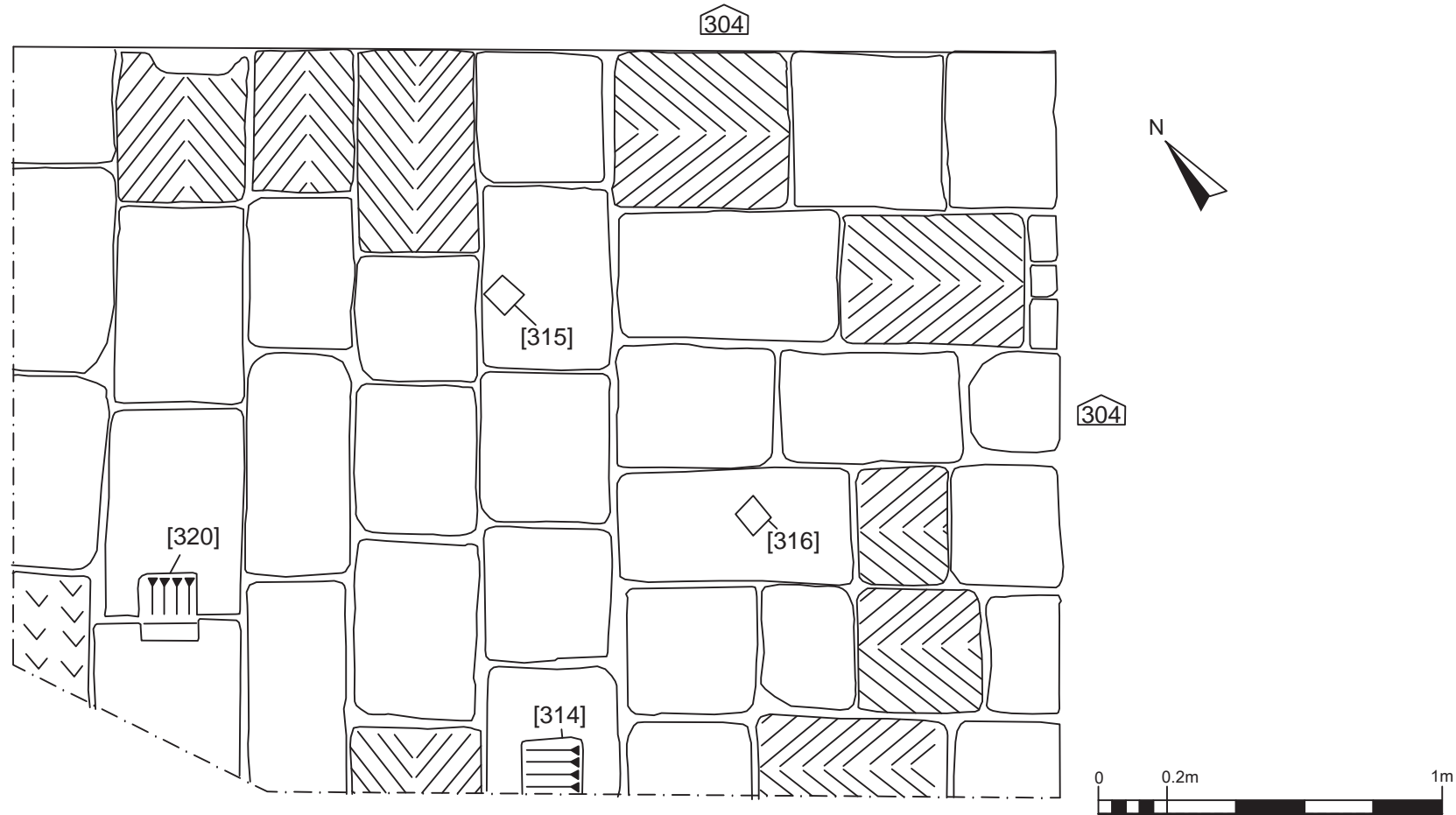


Figure 111- Plan of Trench 3- Boulby



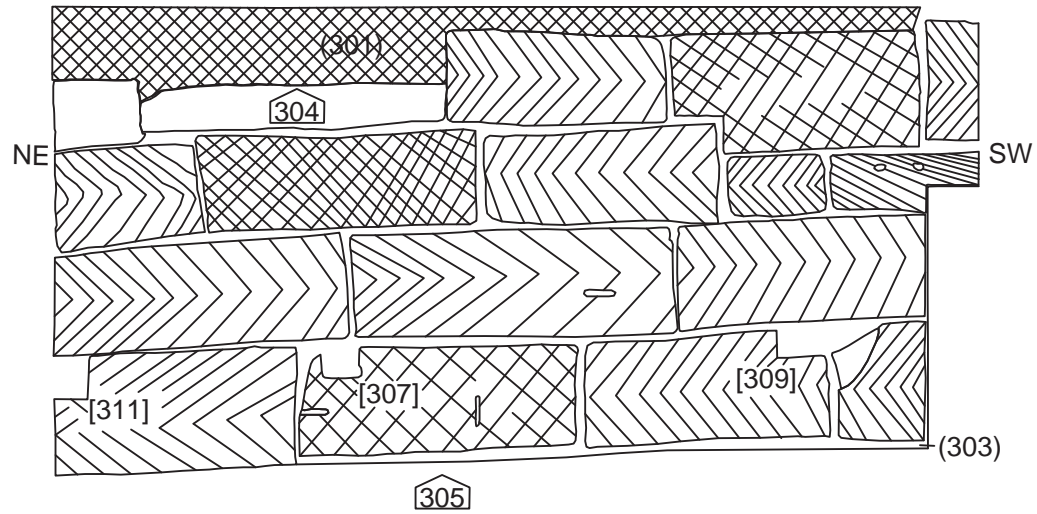
Title: Figure 110 & 111- Section and Plan of Trench 3, Boulby, N.Yorks
 Scale: 1:20@A4
 Drawn: DGC & RL

Key: NB- Punched Herringbone Tooling was indicative of toolmark pattern and direction. The toolmarks should be regarded as indicative, not actual.

Copyright/ Licencing
 This Drawing
 © A.R.S. Ltd

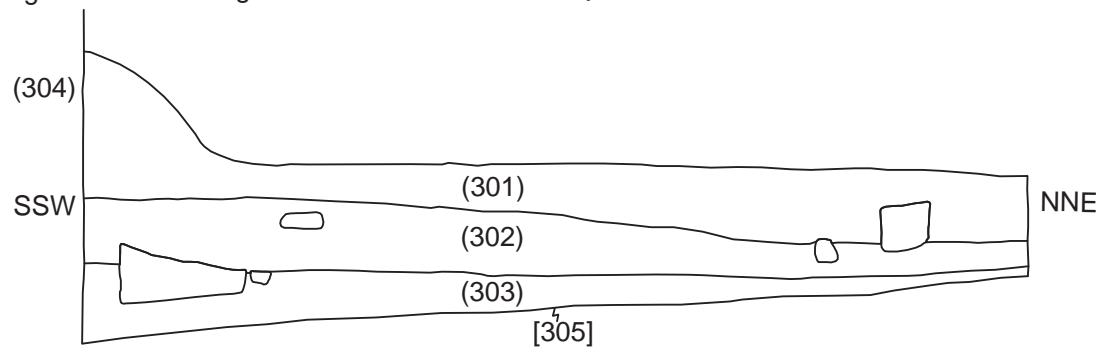
Ordnance Survey data if applicable
 © Crown Copyright, all rights reserved
 reproduction with permission.
 Licence No. 100045420

Figure 112- NW-facing section of Trench 3 - Boulby



Key: NB- Punched Herringbone Tooling was indicative of toolmark pattern and direction. The toolmarks should be regarded as indicative, not actual.

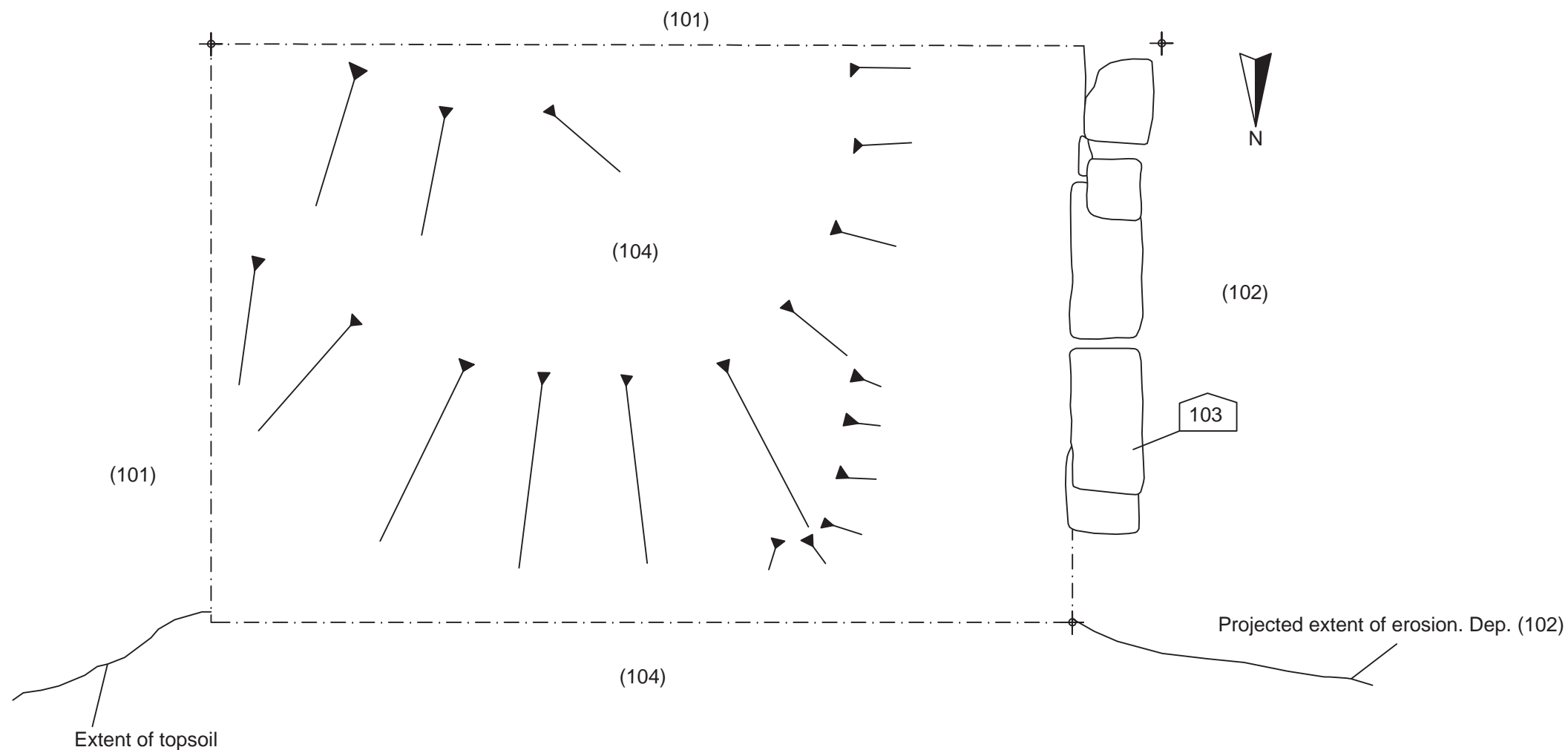
Figure 113- N-facing section of Trench 3 - Boulby



Copyright/ Licencing
This Drawing
© A.R.S. Ltd

Ordnance Survey data if applicable
© Crown Copyright, all rights reserved
reproduction with permission.
Licence No. 100045420

Figure 114- Plan of Trench 1 - Kettleless



Title: Figure 114- Plane of Trench 1 -
Kettleless, N.Yorks
Scale: 1:20@A3
Drawn: RL

Key:

Copyright/ Licencing
This Drawing
© A.R.S. Ltd

Ordnance Survey data if applicable
© Crown Copyright, all rights reserved
reproduction with permission.
Licence No. 100045420

Figure 115- N-facing section through Trench 1 - Kettleless

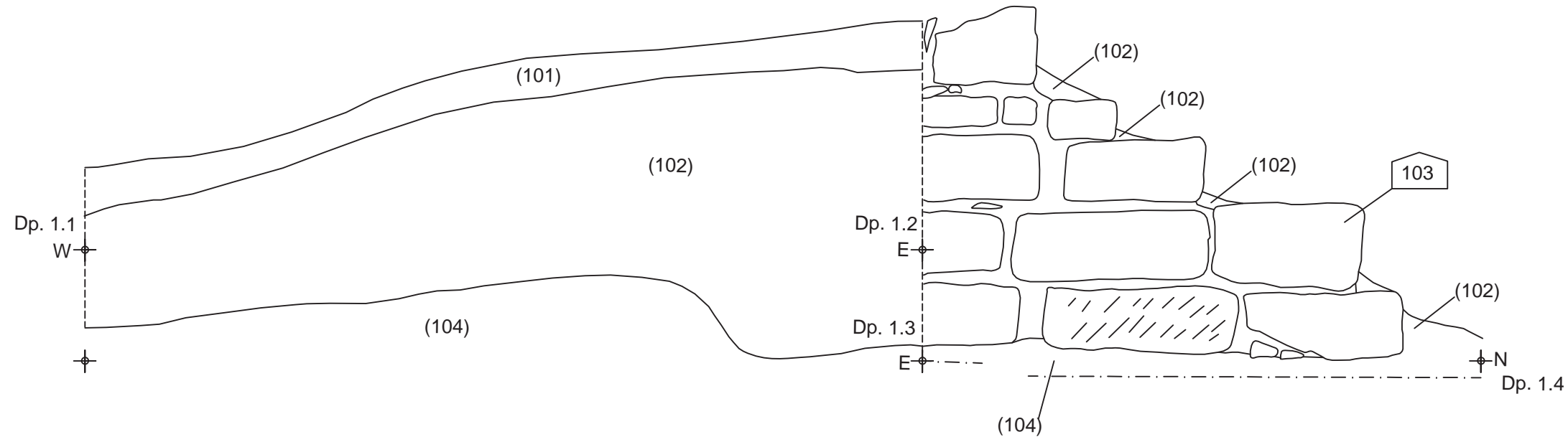
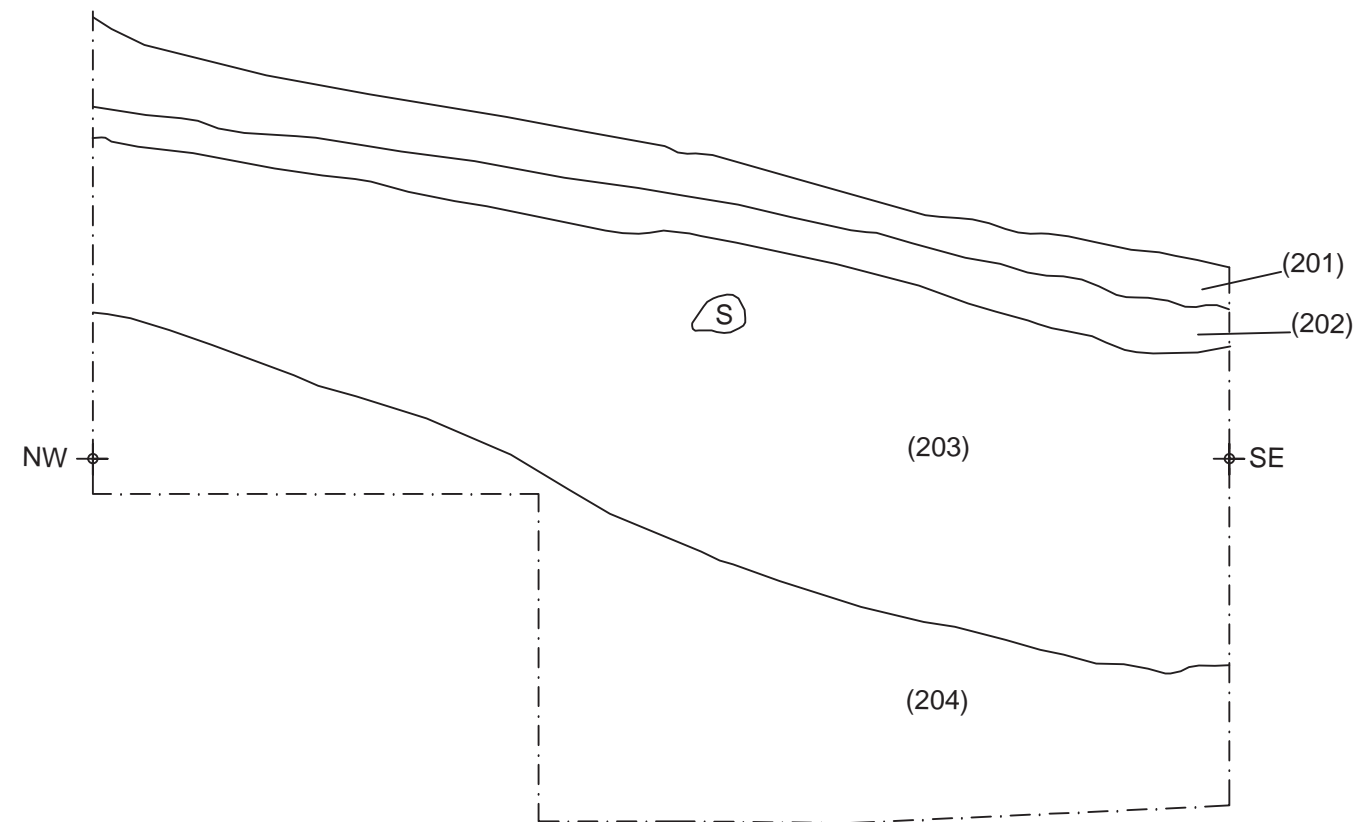


Figure 116- SW-facing section through Trench 2 - Kettleless



Title: Figure 115 & 116- Sections through Trench 1 and 2 - Kettleless, N.Yorks
 Scale: 1:20@A3
 Drawn: RL

Key:



Copyright/ Licencing
 This Drawing
 © A.R.S. Ltd

Ordnance Survey data if applicable
 © Crown Copyright, all rights reserved
 reproduction with permission.
 Licence No. 100045420

Figure 117- Mid-excavation plan of structure (302) in Trench 3 - Kettlewell

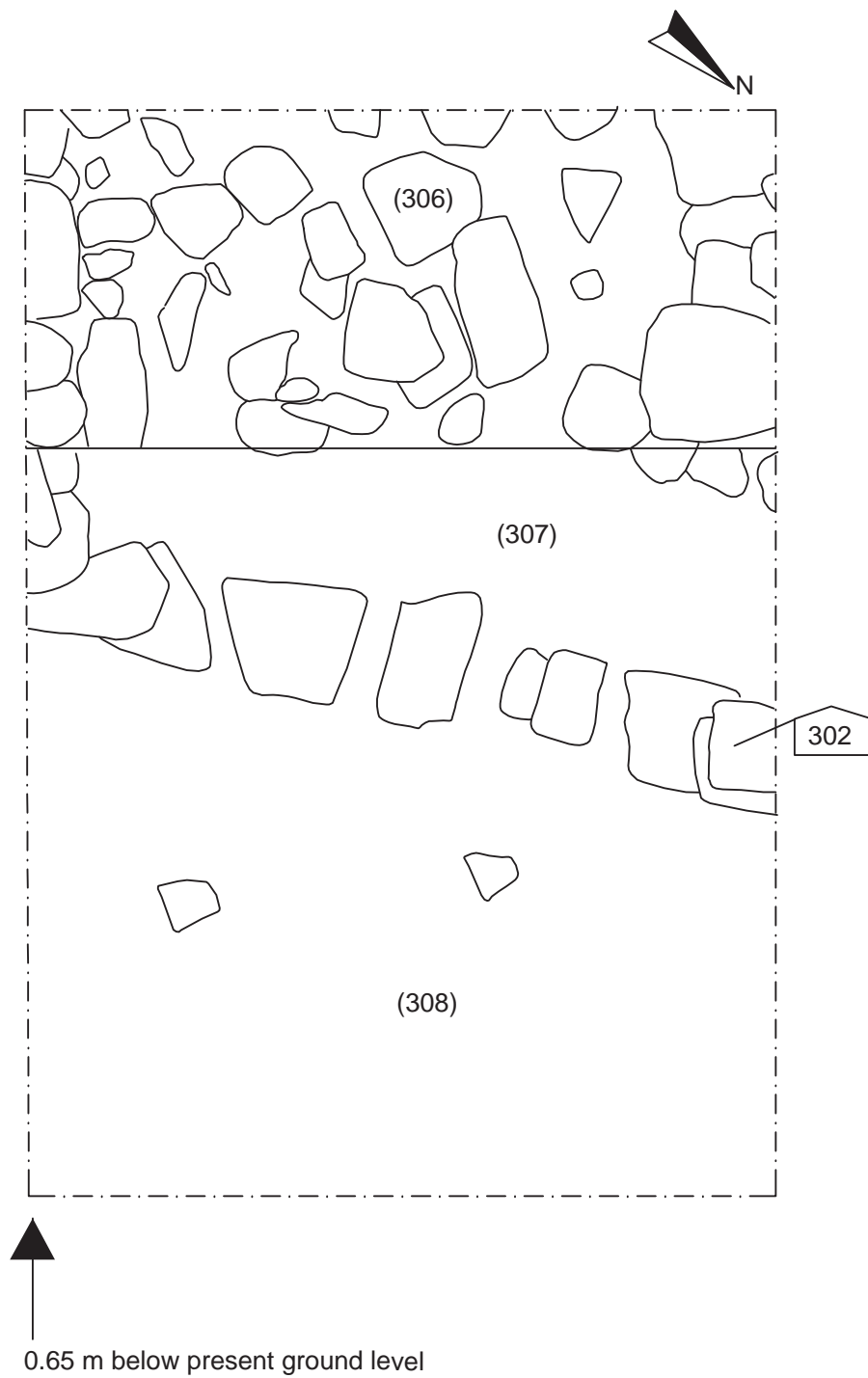
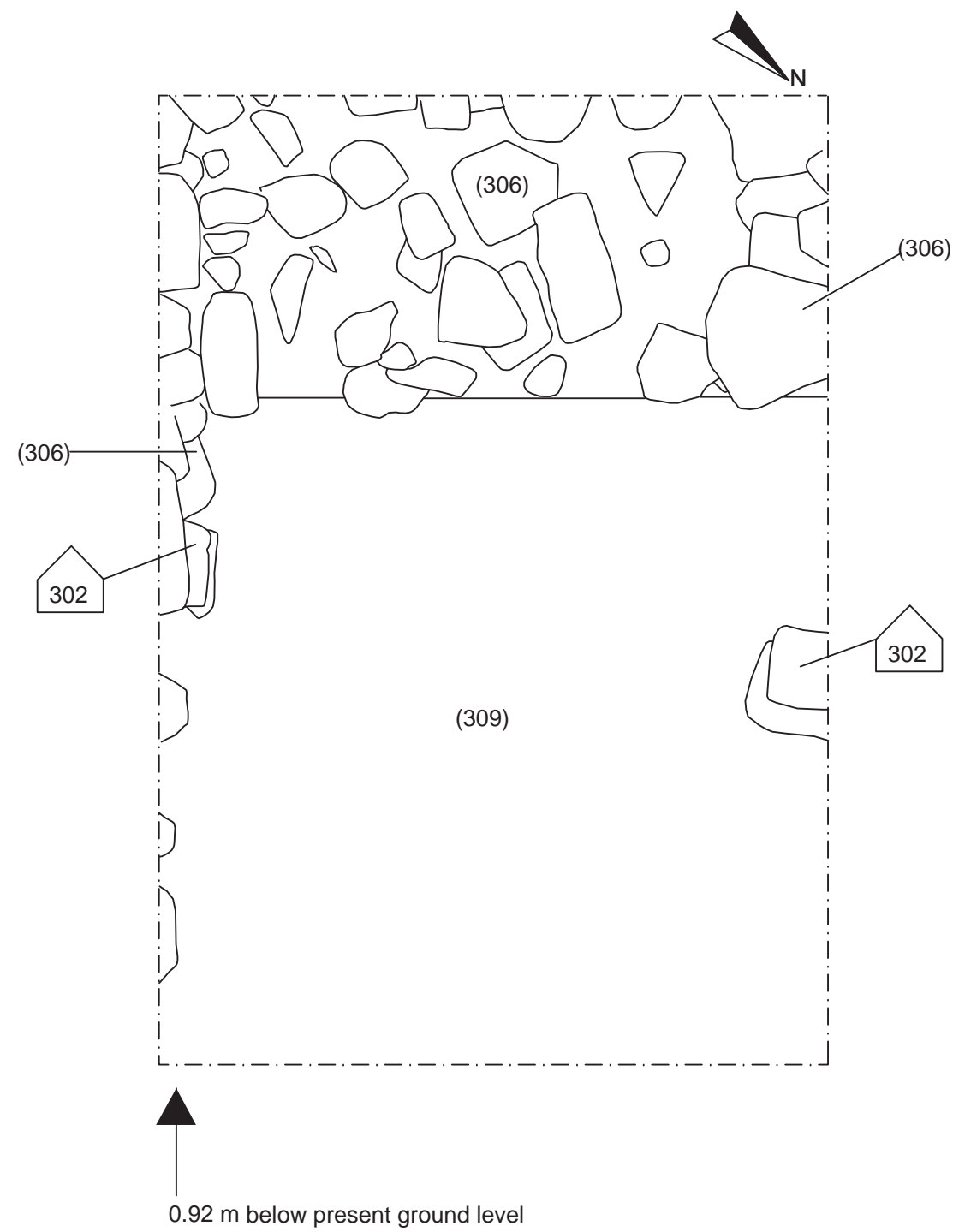


Figure 118- Post-excavation plan of Trench 3 - Kettlewell



Key:

Copyright/ Licencing
This Drawing
© A.R.S. Ltd

Ordnance Survey data if applicable
© Crown Copyright, all rights reserved
reproduction with permission.
Licence No. 100045420



Figure 119- NE-facing section through Trench 3 - Kettleless

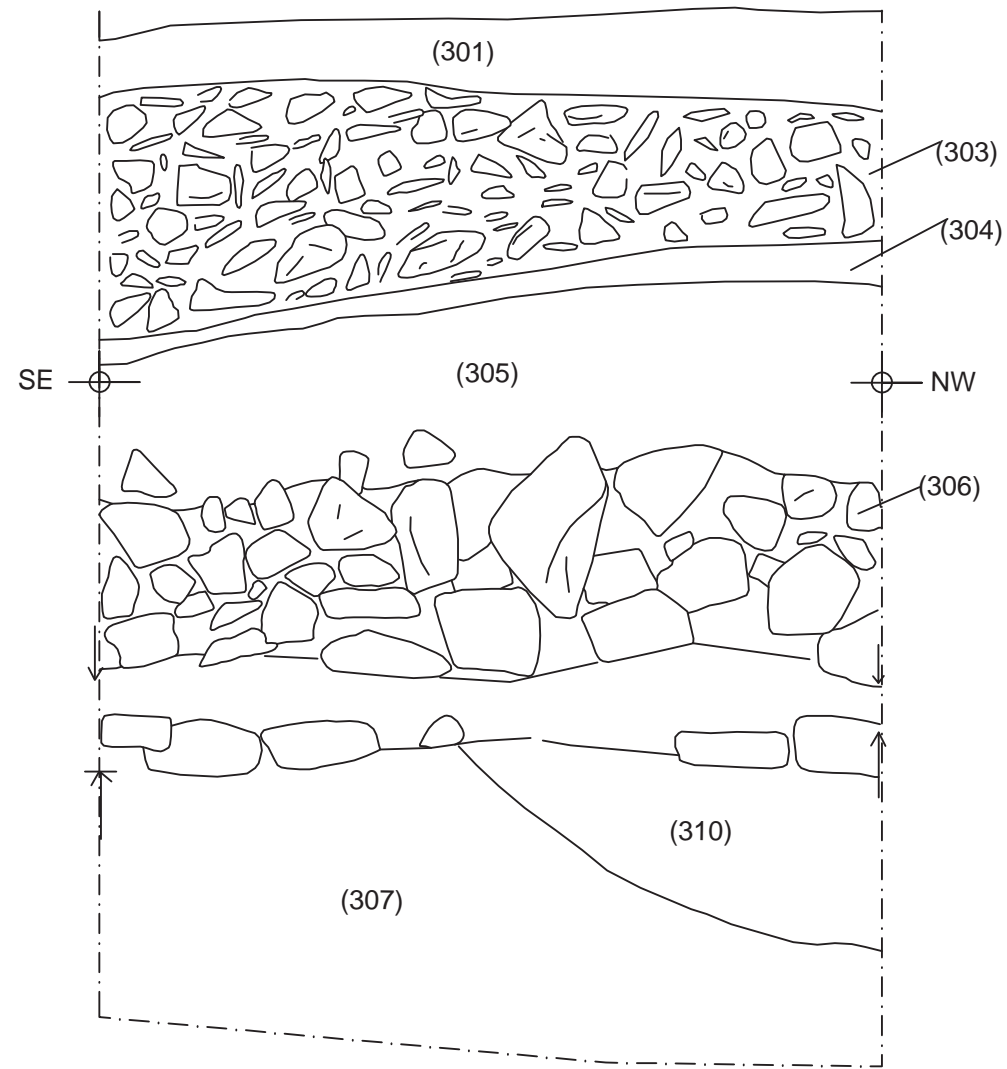
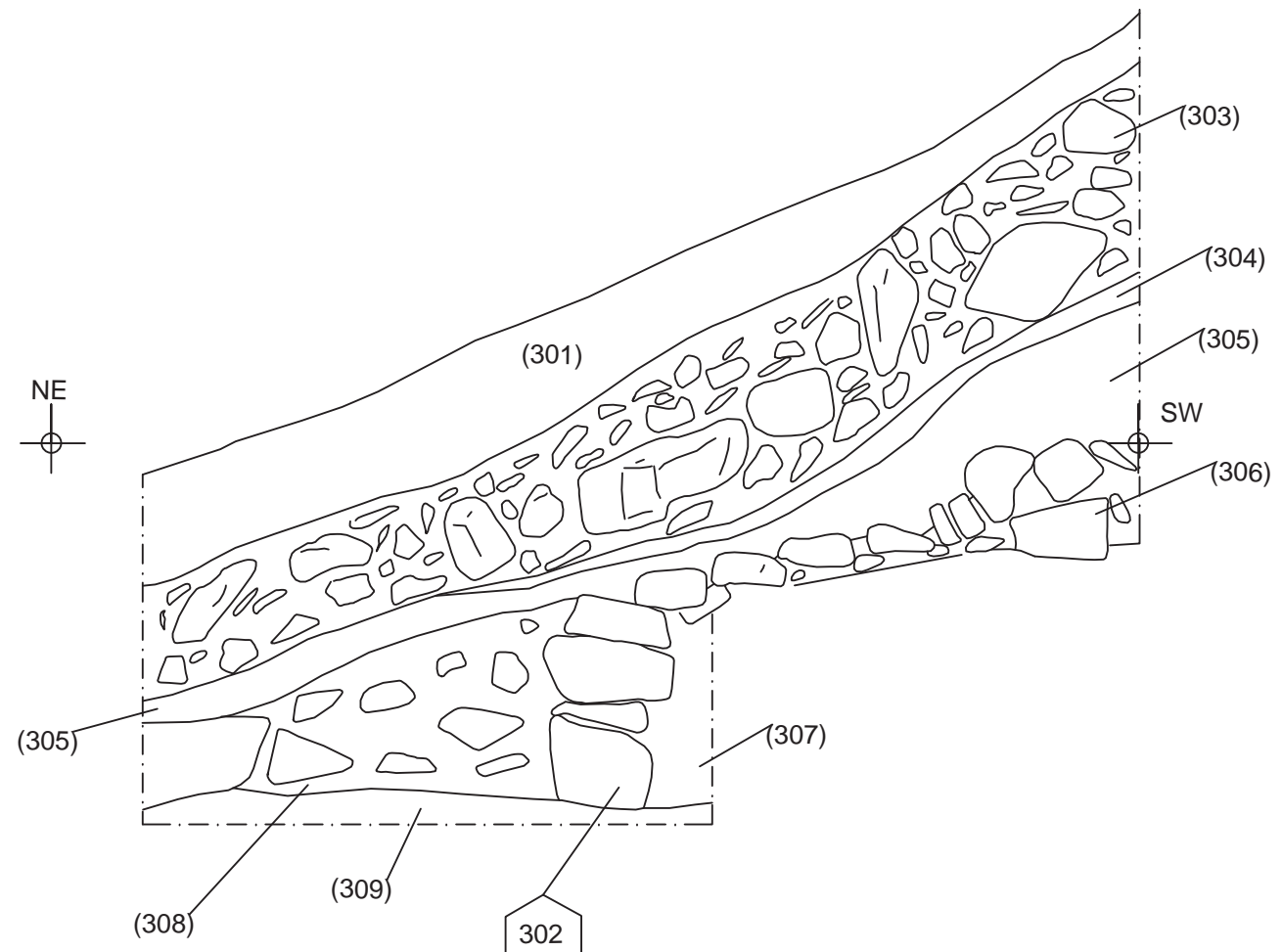


Figure 120- NW-facing section through Trench 3 - Kettleless



Title: Figure 119 & 120- Sections through Trench 3 - Kettleless, N.Yorks
 Scale: 1:20@A3
 Drawn: RL

Key:

Copyright/ Licencing
 This Drawing
 © A.R.S. Ltd

Ordnance Survey data if applicable
 © Crown Copyright, all rights reserved
 reproduction with permission.
 Licence No. 100045420

Figure 122- SW-facing section of Trench 1 - Saltwick

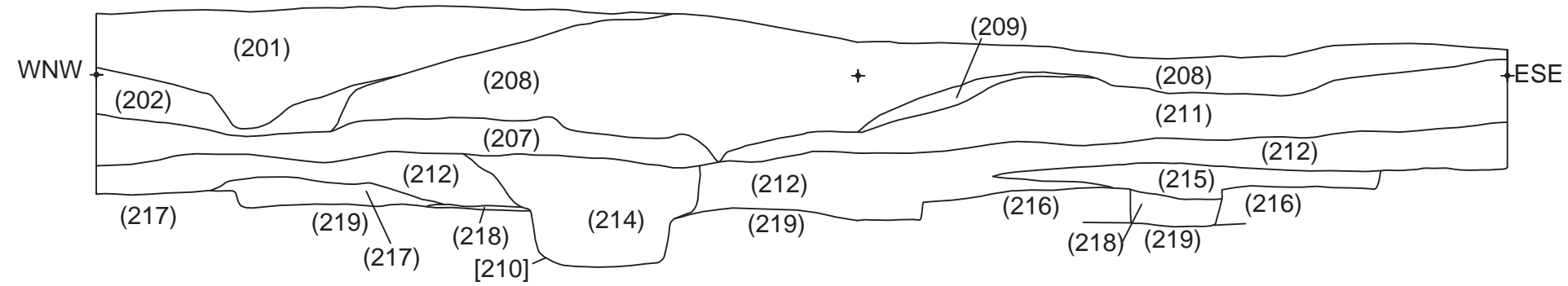


Figure 123- E and SE-facing sections of Trench 1 - Saltwick

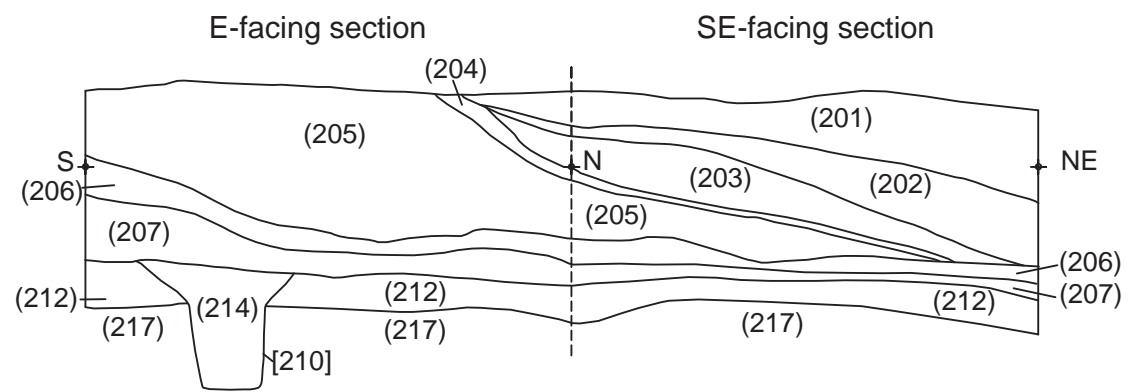
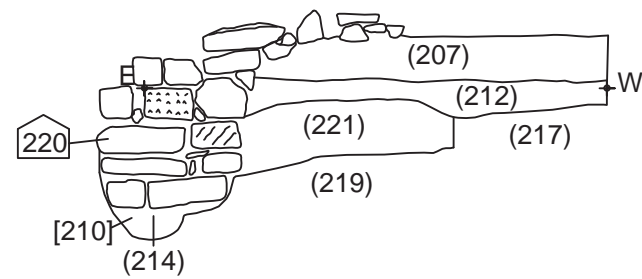


Figure 124- N-facing section of Trench 1 - Saltwick



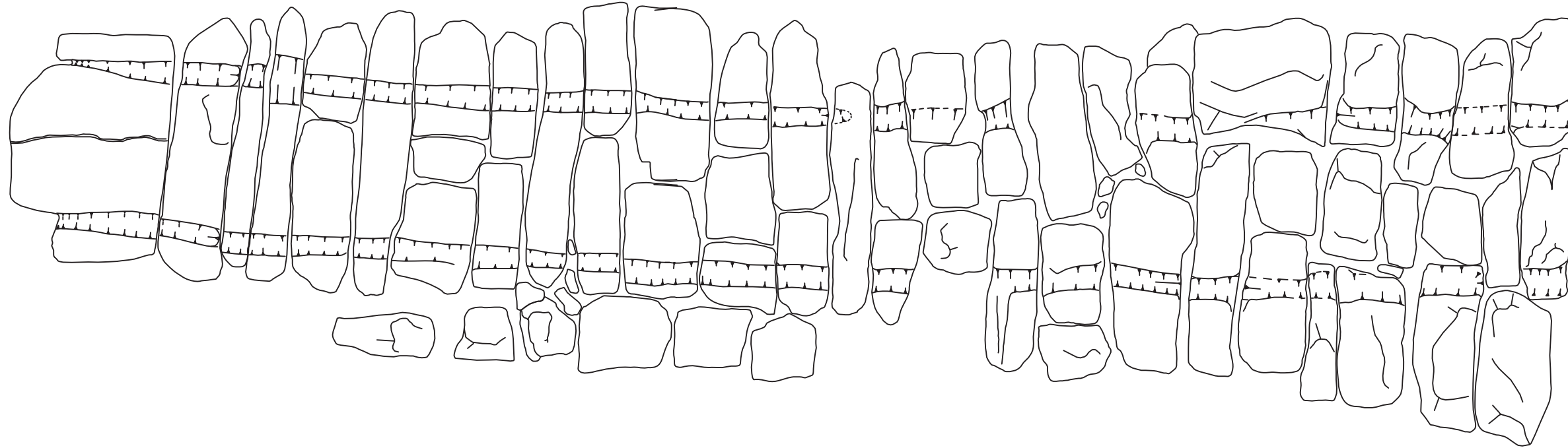
Key:



Copyright/ Licencing
This Drawing
© A.R.S. Ltd

Ordnance Survey data if applicable
© Crown Copyright, all rights reserved
reproduction with permission.
Licence No. 100045420

Figure 125- Plan of Slipway - Saltwick



Title: Figure 125 - 128- Plan and Sections of Slipway - Saltwick, N.Yorks
 Scale: 1:40@A3
 Drawn: DGC & GS

Key:

Figure 126- SW-facing section of Slipway - Saltwick

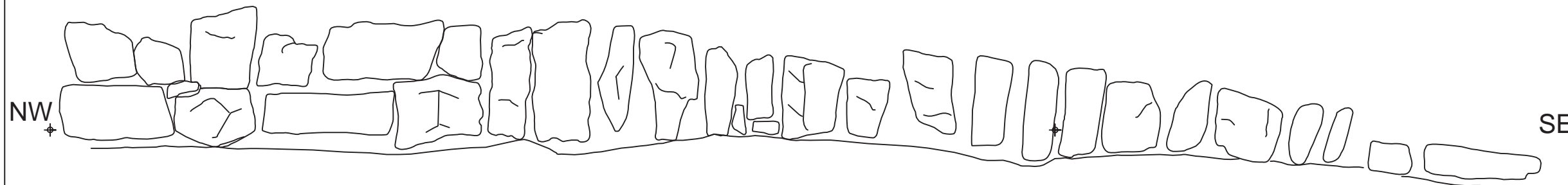


Figure 127- SE-facing section of Slipway - Saltwick

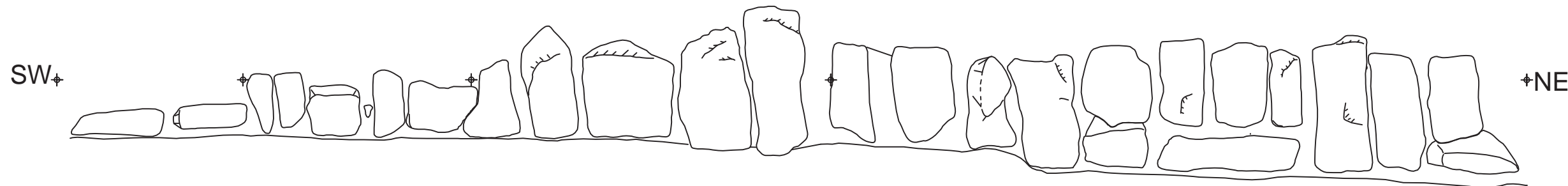
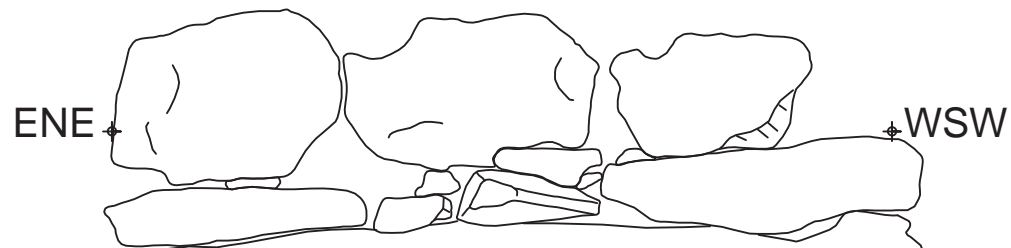


Figure 128- NW-facing section of Slipway - Saltwick



Copyright/ Licencing
 This Drawing
 © A.R.S. Ltd

Ordnance Survey data if applicable
 © Crown Copyright, all rights reserved
 reproduction with permission.
 Licence No. 100045420

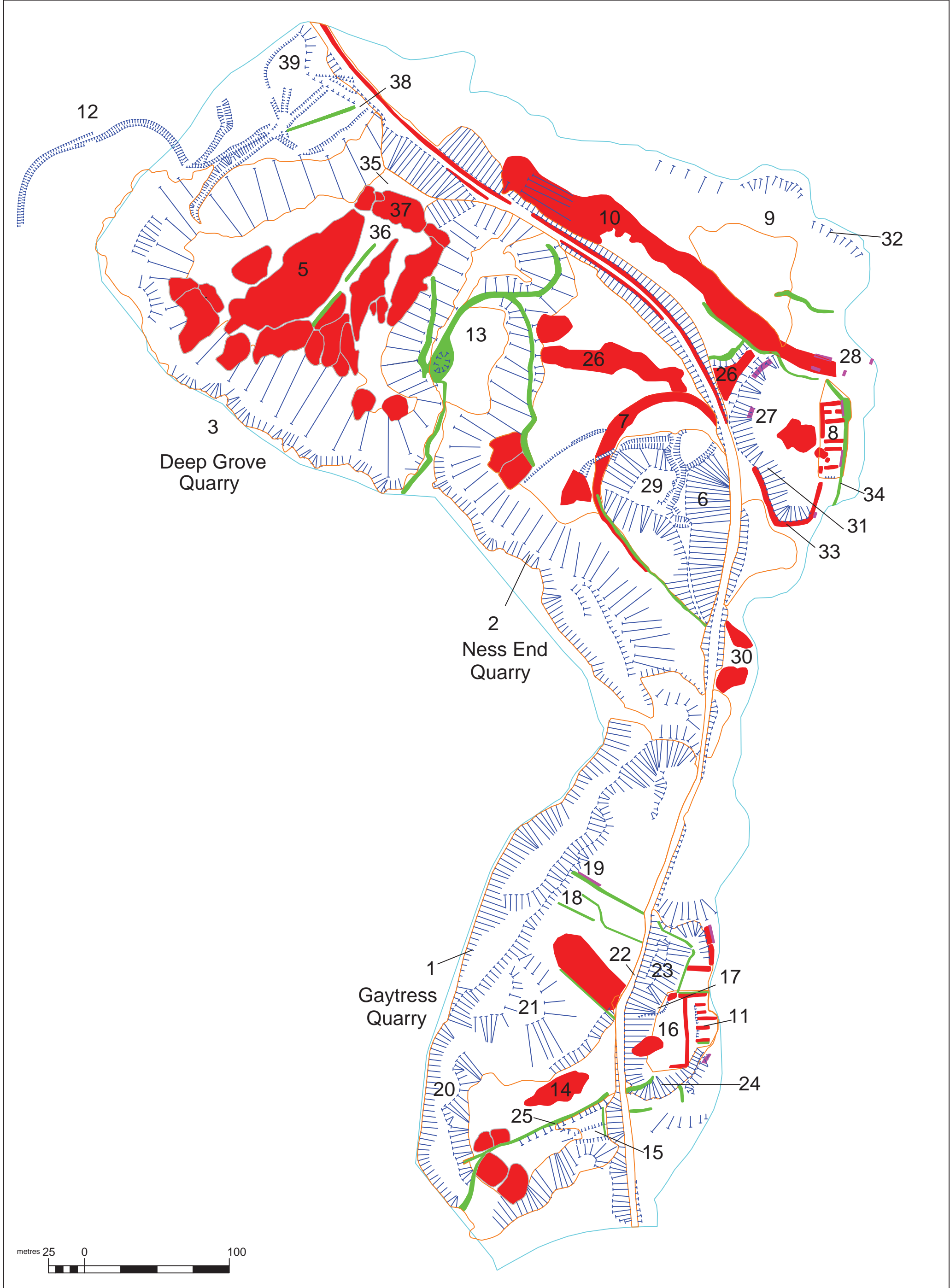


Figure 129: Interpretative survey of Sandsend Alum Quarries

Scale: 1:250 @ A3

Key:

- Scheduled Area
- Extent of feature
- Bank

- Ditch
- Stone structure
- Break of slope
- 20 Feature No.



Copyright/ Licencing
This Drawing
© A.R.S. Ltd

Ordnance Survey data if applicable
© Crown Copyright, all rights reserved
reproduction with permission.
Licence No. 100045420

Appendix 4 – Appendix to Aerial Photography and Lidar Transcription Report

DRAWING CONVENTIONS

Table 6. AutoCAD map layer content and drawing conventions. NMP layers not used are not listed.

Layer Name	Layer content	Attached data tables	Layer colour
0	Non-standard NMP layer None (AutoDesk Map 3D 2008 requirement)	none	7 (white)
BANK	Closed polygons for features such as banks, platforms, mounds and spoil heaps	MONUMENT	1 (red)
DITCH	Closed polygons for cut features such as ditches, ponds, pits or hollow-ways	MONUMENT	3 (green)
EXTENT_OF_FEATURE	Closed polygons outlining complex or extensive remains such as mining	MONUMENT	30 (orange)
T-HACHURE	Polyline T-hachure convention to schematise sloped features indicating the top of slope and direction of slope	MONUMENT	5 (blue)

Table 7. An example attached data table.

FIELD NAME	FIELD CONTENT	Sample data
MONARCH	NRHE Unique Identifier (UID)	1118514
PERIOD	date of features (EH Thesaurus)	POST MEDIEVAL
NARROW TYPE	monument type (EH Thesaurus)	SPOIL HEAP
BROAD TYPE	Monument type (parent term) (EH Thesaurus)	ALUM QUARRY
EVIDENCE 1	Form of remains (as mapped) (EH Thesaurus)	EARTHWORK
PHOTO 1	NRHE or other reference for the photograph from which the feature was plotted and its date of photography	LIDAR NZ8513 Environment Agency DTM 7-8 Dec 2008 - 3-4 Sep 2012
EVIDENCE 2	Form of remains (latest evidence) (EH Thesaurus)	EARTHWORK
PHOTO 2	NRHE or other reference for the photograph used to describe the latest evidence and its date	Bluesky (GeoPerspectives) Aerial Photographic Data NZ8513 (2009)

PHOTOGRAPHY SOURCES

English Heritage Archive:

Vertical photography references:

RAF/106G/UK/1700 FP 1201 27-AUG-1946
RAF/106G/UK/1700 FP 1202 27-AUG-1946
RAF/106G/UK/1700 RP 3263 27-AUG-1946
RAF/106G/UK/1700 RP 3264 27-AUG-1946
RAF/58/B/62 Vp2 5103 13-SEP-1948
RAF/58/B/62 Vp2 5104 13-SEP-1948
RAF/58/B/62 Vp2 5119 13-SEP-1948
RAF/58/B/62 Vp2 5120 13-SEP-1948
RAF/58/B/62 Vp2 5121 13-SEP-1948
RAF/58/B/62 Vp2 5128 13-SEP-1948
RAF/58/B/62 Vp2 5129 13-SEP-1948
RAF/58/B/62 Vp2 5130 13-SEP-1948
MAL/65082 V 82 21-SEP-1965
MAL/65082 V 83 21-SEP-1965
MAL/65082 V 86 21-SEP-1965
MAL/65082 V 87 21-SEP-1965
MAL/65083 V 3 21-SEP-1965
MAL/65083 V 4 21-SEP-1965
MAL/73050 V 204 11-SEP-1973
MAL/73050 V 205 11-SEP-1973
MAL/73050 V 214 11-SEP-1973
MAL/73050 V 215 11-SEP-1973
MAL/73050 V 216 11-SEP-1973
RAF/4E/BR42/B VG 25 25-JUL-1940
RAF/4E/BR42/B VG 26 25-JUL-1940
RAF/4E/BR42/B VG 27 25-JUL-1940
RAF/4H/BR72 VL 1 12-APR-1941
RAF/4H/BR72 VL 2 12-APR-1941
RAF/4H/BR72 VL 3 12-APR-1941
AF/00C/515 V 9679 19-JUL-2000
AF/00C/515 V 9680 19-JUL-2000
AF/00C/515 V 9681 19-JUL-2000
AF/00C/515 V 9701 19-JUL-2000
AF/00C/515 V 9702 19-JUL-2000
AF/00C/515 V 9703 19-JUL-2000
AF/00C/515 V 9704 19-JUL-2000
OS/70153 V 61 27-MAY-1970
OS/66209 V 130 15-AUG-1966
OS/66209 V 131 15-AUG-1966
OS/66209 V 191 15-AUG-1966
OS/66209 V 192 15-AUG-1966
OS/66209 V 193 15-AUG-1966
OS/66209 V 194 15-AUG-1966
OS/66209 V 195 15-AUG-1966
OS/66209 V 196 15-AUG-1966

OS/93214 V 35 06-JUN-1993
OS/93214 V 36 06-JUN-1993
OS/93214 V 37 06-JUN-1993
OS/93214 V 41 06-JUN-1993
OS/93214 V 42 06-JUN-1993
OS/93214 V 43 06-JUN-1993

Oblique photography references:

NMR 17226/33 22-JAN-1999
NMR 17226/34 22-JAN-1999
NMR 17226/35 22-JAN-1999
NMR 17226/36 22-JAN-1999
NMR 17226/37 22-JAN-1999
NMR 17226/38 22-JAN-1999
NMR 17226/39 22-JAN-1999
NMR 17226/40 22-JAN-1999
NMR 17217/11 22-JAN-1999
NMR 17217/12 22-JAN-1999
NMR 17217/13 22-JAN-1999
NMR 17217/14 22-JAN-1999
NMR 17217/15 22-JAN-1999
NMR 17217/16 22-JAN-1999
NMR 20731/49 16-NOV-2007
NMR 20731/50 16-NOV-2007
NMR 20823/13 24-SEP-2008
NMR 20823/14 24-SEP-2008
NMR 20823/15 24-SEP-2008
NMR 20825/14 24-SEP-2008
NMR 20825/15 24-SEP-2008
NMR 20825/16 24-SEP-2008
NMR 20825/17 24-SEP-2008
NMR 20825/18 24-SEP-2008
NMR 20825/19 24-SEP-2008
NMR 20825 / 20/24 SEP 2008
NMR 20825 / 21/24 SEP 2008
AFL 60656_EPW02914 SEP-1929
NMR 20825/22 24-SEP-2008
NMR 20825/23 24-SEP-2008
NMR 20825/24 24-SEP-2008
NMR 20825/25 24-SEP-2008
NMR 20825/26 24-SEP-2008
NMR 20825/27 24-SEP-2008
MSO 31049/PO-Q31 06-JUL-1940
MSO 31049/PO-Q32 06-JUL-1940
MSO 31049/PO-Q33 06-JUL-1940
MSO 31049/PO-Q34 06-JUL-1940
MSO 31049/PO-Q35 06-JUL-1940
MSO 31049/PO-Q36 06-JUL-1940
RAF 30375/PO-0097 01-MAY-1964

RAF 30375/PO-0099 01-MAY-1964
RAF 30375/PO-0100 01-MAY-1964
RAF 30375/PO-0101 01-MAY-1964
RAF 30375/PO-0102 01-MAY-1964
RAF 30375/PO-0103 01-MAY-1964
RAF 30375/PO-0104 01-MAY-1964
RAF 30375/PO-0105 01-MAY-1964
RAF 30375/PO-0106 01-MAY-1964

- Bluesky (GeoPerspectives) Aerial Photographic Data (2009): NZ8513 and NZ8613.
- Unreferenced vertical photography also accessed from Durham University.