



Manual be.IP 4isdn

Operation as a Fax Server

Copyright© Version 10.2.10 RC (SVN 11184) 09/2021 bintec elmeg GmbH

Legal Notice

Warranty

This publication is subject to change.

bintec elmeg GmbH offers no warranty whatsoever for information contained in this manual. bintec elmeg GmbH is not liable for any direct, indirect, collateral, consequential or any other damage connected to the delivery, supply or use of this manual.

Copyright © bintec elmeg GmbH.

All rights to the data included, in particular the right to copy and propagate, are reserved by bintec elmeg GmbH.

Open source software in this product

Along with other components, this product contains open source software that has been developed by third party suppliers and which is licensed under an open source software license. These open source software files are subject to copyright. For a current list of the open source software programs and the open source software licenses, go to www.bintec-elmeg.com.

GEMA

This product uses internal music for calls on hold for which approval from GEMA (German Society for Musical Performance and Mechanical Reproduction Rights) is not required. This has been confirmed by GEMA with the following approval certification. The approval certification can be viewed at the following web address: www.bintec-elmeg.com. System hold music: elmeg Song, Hold the line.

Table of Contents

Chapter 1	Introduction	1
Chapter 2	Setup	2
2.1	be.IP 4isdn	2
2.1.1	Setting up and connecting	2
2.1.2	Connectors	4
2.1.3	Connections (on the side)	4
2.1.4	Mounting brackets	4
2.1.5	LEDs	5
2.1.6	Scope of supply	6
2.1.7	General Product Features	7
2.2	Reset	8
2.3	Support-Information	9
Chapter 3	Mounting	10
3.1	Connecting terminals	10
3.1.1	Internal ISDN connection	10
3.2	Reset button	10
3.3	Wall mounting	10
3.4	Pin Assignments	11
3.4.1	Ethernet interfaces	11
3.4.2	ISDN interface	12
3.4.3	VDSL interface	13
3.4.4	Serial interface	13
Chapter 4	Basic configuration	15
4.1	Preparations	15

4.1.1	Systemsoftware	15
4.1.2	System requirements	15
4.1.3	Gathering data	16
4.1.4	Setting up a PC	17
4.2	Configuring the system	18
4.2.1	Network setting (LAN)	19
4.2.2	Enter SIP provider	19
4.3	Setting up an internet connection	19
4.3.1	Internet connection via the internal VDSL modem	19
4.3.2	Other internet connections	19
4.3.3	Testing the configuration.	20
4.4	User access	20
4.5	Software updates for be.IP 4isdn	21
Chapter 5	Access and configuration.	23
5.1	Access via LAN	23
5.1.1	HTTP/HTTPS	23
5.2	Configuration.	23
5.2.1	Configuration interface	23
Chapter 6	Assistants	34
Chapter 7	System Management.	35
7.1	Status.	35
7.2	Global Settings	37
7.2.1	System	38
7.2.2	Passwords	44
7.2.3	Date and Time	47
7.2.4	Timer	50

7.2.5	System Licences	53
7.3	Access Codes	55
7.3.1	Alternative Access Codes	55
7.4	Interface Mode / Bridge Groups	56
7.4.1	Interfaces	58
7.5	Administrative Access	61
7.5.1	Access	61
7.5.2	SSH	62
7.5.3	SNMP	65
7.6	Remote Authentication	66
7.6.1	RADIUS	67
7.6.2	Options	72
7.7	Certificates	72
7.7.1	Certificate List	73
7.7.2	CRLs	80
7.7.3	Certificate Servers	81
Chapter 8	Physical Interfaces	82
8.1	Ethernet Ports	82
8.1.1	Port Configuration	83
8.2	ISDN Ports (PBX)	84
8.2.1	ISDN Internal	85
8.2.2	ISDN Configuration	87
8.3	DSL Modem	87
8.3.1	DSL Configuration	87
Chapter 9	VoIP (PABX)	90
9.1	Settings	90
9.1.1	SIP Provider	90

9.1.2	Locations	101
9.1.3	Codec Profiles	103
9.1.4	Options	106
Chapter 10	Call Routing	108
10.1	Outgoing Services	108
10.1.1	Call Forwarding	108
10.1.2	Dial Control	110
Chapter 11	Applications	112
11.1	Call Data Records	112
11.1.1	Outgoing	112
11.1.2	Incoming	113
11.1.3	General	113
11.2	Call List	115
11.2.1	Incoming	115
11.2.2	Outgoing	116
11.2.3	General	117
Chapter 12	LAN	118
12.1	IP Configuration	118
12.1.1	Interfaces	118
12.2	VLAN	130
12.2.1	VLANs	131
12.2.2	Port Configuration	131
12.2.3	Administration	132
Chapter 13	Wireless LAN Controller	133
13.1	Wizard	133
13.1.1	Wireless LAN Controller Wizard	133

13.1.2	Wireless LAN Controller VLAN Configuration	139
13.2	Controller Configuration	140
13.2.1	General	140
13.2.2	AP Autoprofile	143
13.3	AP configuration	144
13.3.1	Access Points	144
13.3.2	Radio Profiles	148
13.3.3	Wireless Networks (VSS)	153
13.4	Monitoring	162
13.4.1	WLAN Controller	162
13.4.2	Access Points	163
13.4.3	Active Clients	164
13.4.4	Wireless Networks (VSS)	165
13.4.5	Client Management	165
13.5	Neighbor Monitoring	165
13.5.1	Neighbor APs	165
13.5.2	Own Access Points	166
13.5.3	Rogue APs	166
13.5.4	Rogue Clients	167
13.6	Maintenance	168
13.6.1	Firmware Maintenance	168
Chapter 14	Networking	170
14.1	Routes	170
14.1.1	IPv4 Route Configuration	170
14.1.2	IPv6 Route Configuration	175
14.1.3	IPv4 Routing Table	177
14.1.4	IPv6 Routing Table	178
14.1.5	Options	179
14.2	IPv6 General Prefixes	180

14.2.1	General Prefix Configuration	180
14.3	NAT	181
14.3.1	NAT Interfaces	182
14.3.2	NAT Configuration	183
14.3.3	NAT - Configuration example.	188
14.4	Load Balancing	191
14.4.1	Load Balancing Groups	192
14.4.2	Special Session Handling	195
14.4.3	Load balancing - Configuration example	198
14.5	QoS	201
14.5.1	IPv4/IPv6 Filter	201
14.5.2	QoS Classification	205
14.5.3	QoS Interfaces/Policies	207
14.6	Access Rules	214
14.6.1	Access Filter	215
14.6.2	Rule Chains	219
14.6.3	Interface Assignment	220
Chapter 15	Multicast.	222
15.1	General	223
15.1.1	General	224
15.2	IGMP	224
15.2.1	IGMP	224
15.2.2	Options	227
15.3	Forwarding	228
15.3.1	Forwarding	228
Chapter 16	WAN.	230
16.1	Internet + Dialup	230

16.1.1	PPPoE	231
16.1.2	Dual Stack Lite	239
16.1.3	PPTP	240
16.1.4	PPPoA	244
16.1.5	IP Pools	252
16.2	ATM	253
16.2.1	Profiles	253
16.2.2	Service Categories	258
16.2.3	OAM Controlling	260
16.3	Real Time Jitter Control	264
16.3.1	Controlled Interfaces	264
Chapter 17	VPN	265
17.1	IPSec	265
17.1.1	IPSec Peers	266
17.1.2	Phase-1 Profiles	282
17.1.3	Phase-2 Profiles	289
17.1.4	XAUTH Profiles	294
17.1.5	IP Pools	296
17.1.6	Options	296
17.2	be.IP Secure Client	300
17.3	LISP Light	300
17.3.1	Router (ITR/ETR)	302
17.3.2	Local/Remote-Sites	304
17.3.3	EID Prefix Segregation (LISP Instances)	306
Chapter 18	Firewall	308
18.1	Policies	309
18.1.1	IPv4 Filter Rules	310
18.1.2	IPv6 Filter Rules	312

18.1.3	Options	314
18.2	Interfaces	316
18.2.1	IPv4 Groups	316
18.2.2	IPv6 Groups	317
18.3	Addresses	317
18.3.1	Address List	317
18.3.2	Groups	318
18.4	Services	319
18.4.1	Service List	319
18.4.2	Groups	321
18.5	Configuration.	322
18.5.1	SIF - Configuration example	322
Chapter 19	Local Services	327
19.1	DNS	327
19.1.1	Global Settings	328
19.1.2	DNS Servers	331
19.1.3	Static Hosts	333
19.1.4	Domain Forwarding	334
19.1.5	Dynamic Hosts	336
19.1.6	Cache	336
19.1.7	Statistics	336
19.2	HTTPS	337
19.2.1	HTTPS Server	337
19.3	DynDNS Client	338
19.3.1	DynDNS Update	338
19.3.2	DynDNS Provider	340
19.4	DHCP Server	342
19.4.1	IP Pool Configuration	342
19.4.2	DHCP Configuration	343

19.4.3	IP/MAC Binding	347
19.4.4	DHCP Relay Settings	348
19.4.5	DHCP - Configuration example	349
19.5	DHCPv6 Server	352
19.5.1	DHCPv6 Server	354
19.5.2	DHCPv6 Global Options	355
19.5.3	Stateful Clients	357
19.5.4	Stateful Clients Configuration.	357
19.6	CAPI Server	358
19.6.1	User	358
19.6.2	Options	359
19.7	Scheduling	359
19.7.1	Trigger	360
19.7.2	Actions	365
19.7.3	Options	376
19.7.4	Configuration example - Time-controlled Tasks (Scheduling)	377
19.8	Surveillance	380
19.8.1	Hosts	380
19.8.2	Interfaces	383
19.8.3	Ping Generator	384
19.9	UPnP	384
19.9.1	Interfaces	385
19.9.2	General	386
19.10	HotSpot Gateway	387
19.10.1	HotSpot Gateway	389
19.10.2	Options	392
19.11	Wake-On-LAN	392
19.11.1	Wake-On-LAN Filter	392
19.11.2	WOL Rules	396
19.11.3	Interface Assignment	398

19.12	Trace Interface	398
19.12.1	Trace Interface	399
19.12.2	Trace VoIP/SIP	399
Chapter 20	Maintenance	400
20.1	Log out Users	400
20.1.1	Log out Users	400
20.2	Diagnostics	401
20.2.1	Ping Test	401
20.2.2	DNS Test	401
20.2.3	Traceroute Test	402
20.3	Software & Configuration	402
20.3.1	Options	402
20.4	Reboot	407
20.4.1	System Reboot	407
20.5	Factory Reset	408
Chapter 21	External Reporting	409
21.1	Syslog	409
21.1.1	Syslog Servers	409
21.2	IP Accounting	411
21.2.1	Interfaces	411
21.2.2	Options	412
21.3	Alert Service	413
21.3.1	Alert Recipient	413
21.3.2	Alert Settings	415
21.4	SNMP	417
21.4.1	SNMP Trap Options	417
21.4.2	SNMP Trap Hosts	418

21.5	SIA	418
21.5.1	SIA	419
Chapter 22	Monitoring	420
22.1	Internal Log	420
22.1.1	System Messages	420
22.2	IPSec	420
22.2.1	IPSec Tunnels	420
22.2.2	IPSec Statistics	422
22.3	Interfaces	423
22.3.1	Statistics	423
22.3.2	Network Status	424
22.4	Bridges	424
22.4.1	br<x>	424
22.5	HotSpot Gateway	425
22.5.1	HotSpot Gateway	425
22.6	QoS	425
22.6.1	QoS	425
Chapter 23	User Access	427
23.1	Status	427
23.2	Phonebook	429
23.2.1	System Phonebook	429
23.2.2	User Phonebook	429
23.3	Call Data Records	430
23.3.1	Outgoing	430
23.3.2	Incoming	431
23.4	Call List	431

23.4.1	Incoming	431
23.4.2	Outgoing	432
23.5	Settings	433
23.5.1	Feature Settings	433
23.5.2	General Settings	437
	Glossary.	439
	Index	477

Chapter 1 Introduction



Important

Read these notes on the application of your **be.IP 4isdn** carefully. Features not included in this manual are not supported!

Our Media Gateway **be.IP 4isdn** with its integrated business router offers easy entry into the world of IP technology.

The device has been designed with the migration of existing ISDN PABXs to All-IP connections in mind. "Migration", in this context, means that you are enabled to continue using your ISDN PABX with all its connected terminals like telephones and fax devices without having to change the actual PABX configuration. Since our gateway offers four ISDN ports, it is suitable for locations with multiple ISDN point-to-multi-point or point-to-point connections. If the four ports prove to be insufficient, you can link two **be.IP 4isdn**. The resulting unit enables you to migrate an ISDN PABX with up to eight ISDN connections and 16 simultaneously used voice channels to an ALL-IP connection.

If you are in need of voice trans-coding, our Media Gateway **be.IP 4isdn** is a perfect choice, as well. Due to the use of additional DSPs the number of simultaneously available connections is significantly higher than with other devices of the be.IP series - even without the use of ISDN.

Of course, the device also supports all of the common fax applications through CAPI at the ISDN port. If your company runs a server-based Email system that a third party CAPI interface expands by fax, voice mail and voice messaging, a **be.IP 4isdn** operating in Media Gateway mode enables you to control ISDN interfaces on virtualized server systems, too.

Third party CAPI applications connected directly to an ISDN connection often do no longer work with All IP connections. For this, **be.IP 4isdn** offers "Fax mode" operation and hence the possibility to operate your existing systems directly at a SIP connection through CAPI - entirely without the use of ISDN. Our CAPI2SIP solution will migrate your CAPI applications into the ALL IP era.



Note

The operation described as "PBX" mode in the configuration interface corresponds to the "Fax Server" mode in **be.IP 4isdn**, since operation as a telephone system is not supported.

Chapter 2 Setup

2.1 be.IP 4isdn

This chapter will show you how to set your device up, connect it and get it working in just a few minutes.

We shall then explain, step-by-step, more detail about the configuration. A detailed online help system gives you extra support.

The PDF version of this document contains a slim version of the manual. It comprises all information on installation as well as the description of all configuration parameters, but no screen shots. An HTML-based version containing the screen shots is available as a ZIP file in the download section of your device. Unpack the ZIP file into a folder of your choice and call "start.html" in a web browser.

2.1.1 Setting up and connecting

be.IP 4isdn is operated at a purely IP-based connection. Telephony is exclusively VoIP-based, but your choice of connected devices is not restricted in any way. You can connect SIP, analogue and ISDN phones as well as PCs.

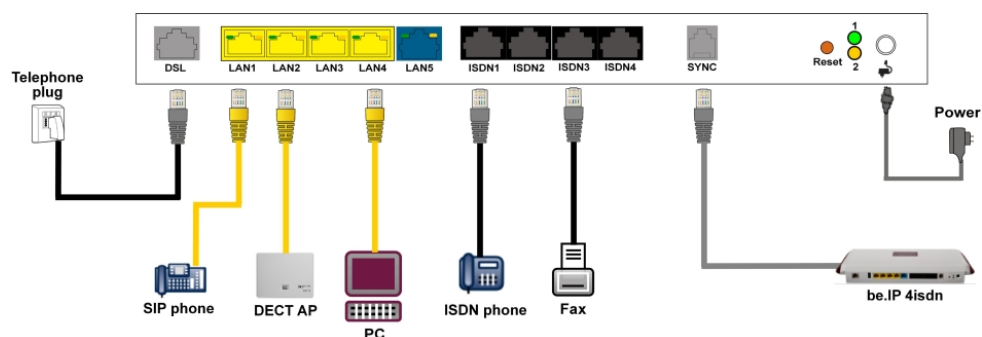

Caution

Please read the safety instructions carefully before installing and starting up your device.

**Caution**

Using an incorrect power supply unit may damage your device! You should only use the power supply unit provided!

Set up and connect in the following sequence:

- (1) Installation
When operational, **be.IP 4isdn** needs to be wall-mounted in an upright position or well ventilated inside of a device rack (please read chapter *Mounting* on page 10 carefully).
- (2) Mains connection
Connect the network connection on the device with the power supply unit provided to a 230 V mains socket.
- (3) DSL
Connect the **DSL** connector to the TAE plug using the grey cable.
- (4) ISDN telephones
Connect an ISDN telephone at the internal ISDN connector of the **be.IP 4isdn**. To do this, use the cable provided with the terminal.
- (5) SIP telephones
Connect your SIP telephones to the 10/100/1000 Base-T Ethernet interfaces. In a last step connect your PC and follow the instructions from the installation poster.
- (6) PC
Connect a suitable PC to one of the Ethernet ports of **be.IP 4isdn** using an Ethernet cable. Should you run into any problems with the connection between your PC and your **be.IP 4isdn**, read the corresponding sections on the basic configuration of your device.
- (7) SYNC
The SYNC connector enables you to connect a second **be.IP 4isdn** using a SYNC cable. This provides an additional four ISDN connections.

**Note**

The additional connections are available in Media Gateway mode only!

- (8) VoIP
For a pure IP connection without ISDN refer to the instruction provided by your service provider.

2.1.2 Connectors



1	DSL interface Annex B/J
2	10/100/1000 Base-T Ethernet interface (LAN 1 - LAN4)
3	Etherne WAN interface (LAN5)
4	Interface for ISDN telephones (ISDN1 - ISDN4)
5	SYNC interface
6	Socket for the power supply unit

2.1.3 Connections (on the side)

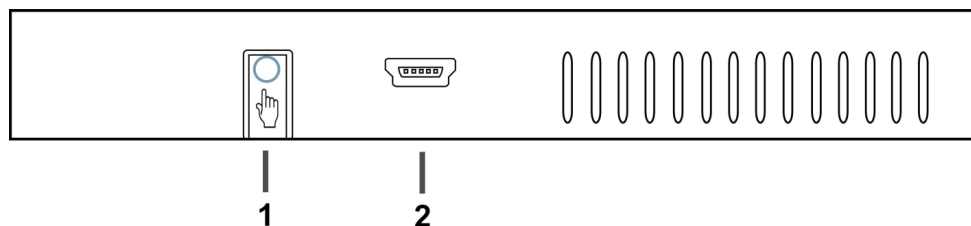

1	Function key
2	Console

2.1.4 Mounting brackets

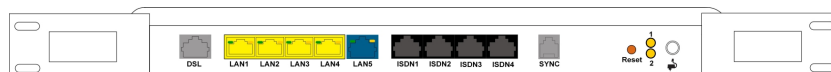

Due to the position of the devices in a rack it is recommended to use remote antenna. Attach the mounting brackets to the device using the supplied screws. The mounting brackets and screws are available as an accessory (Part No. MN40285514).



Note

During operation in a rack the ambient temperature must not exceed 40 °C.

2.1.5 LEDs

The LEDs provide information on the device's activities and statuses.

The LEDs on your **be.IP 4isdn** are arranged as follows:

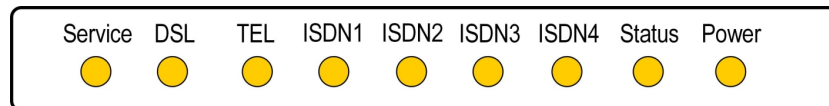

In operation mode, the LEDs display the following status information for your device:

LED status display

LED	Status	Information
Service	on	Undergoing automatic maintenance
	off	No automatic maintenance
DSL	on	Connection established
	slow flashing	Synchronisation running
	off	No synchronisation
TEL	flickering	Data transfer
	on	Telephony ready at IP connector (Voice over IP)
	off	Telephony not configured
ISDN1 to ISDN 4	on	ISDN telephone system connected
	off	On standby or not functioning
Status	on	After switching on: Device is started
		While operation: Fault
	slow flashing	The device is active
Power	on	The power supply is connected
	off	No power supply

The LEDs for the Ethernet sockets LAN 1-4 (LAN) and LAN5 (WAN) show the following status information:

Ethernet-LEDs

LED	Colour	Status	Information
LAN 1 to 4 (Link/Act)	Green	on	Ethernet connection established

LED	Colour	Status	Information
LAN 1 to 4 (Link/Act)	Green	flashing	Data transmission via Ethernet
LAN 1 to 4 (Link/Act)		off	No Ethernet connection
LAN 1 to 4 (Speed)	Green	on	1000 Mbit/s transfer rate
LAN 1 to 4 (Speed)	Orange	on	100 Mbit/s transfer rate
LAN 1 to 4 (Speed)		off	10 Mbit/s transfer rate
LAN 5 (Link/Act)	Green	on	WAN Ethernet connection established
LAN 5 (Link/Act)	Green	flashing	Data transmission via ETH5t
LAN 5 (Link/Act)		off	No Ethernet connection
LAN 5 (Speed)	Green	on	1000 Mbit/s transfer rate
LAN 5 (Speed)	Orange	on	100 Mbit/s transfer rate
LAN 5 (Speed)		off	10 Mbit/s transfer rate

LEDs back view

The LEDs are linked to those on the top of the device and show the identical behavior.

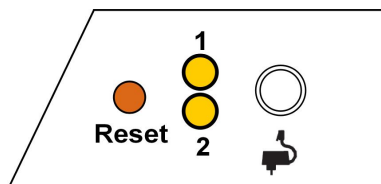

- 1 Status Yellow
- 2 Service Yellow

2.1.6 Scope of supply

Your device is supplied with the following parts:

Product Name	Cables/Accessories	Documentation
be.IP 4isdn	One Ethernet LAN cable (yellow) One Ethernet WAN cable (blue) One VDSL cable (grey) Power supply unit	Installation poster Safety instructions

Product Name	Cables/Accessories	Documentation
	19" kit and screws	

2.1.7 General Product Features

Die allgemeinen Produktmerkmale umfassen die Leistungsmerkmale und die technischen Voraussetzungen für Installation und Betrieb Ihres Geräts.

General Product Features be.IP 4isdn

Property	
Dimensions and weights:	
Equipment dimensions without cable (B x H x D):	328 x 193 x 44 mm
Weight	approx. 900 g
Transport weight (incl. documentation, cables, packaging)	approx. 1,800 g
Memory	128 MB SDRAM
LEDs	20 (9x Function, 1 x Service, 5x2 Ethernet)
Power consumption of the device	max. 30 W 12 V DC
Voltage supply	12 V DC, 2,5 A
Environmental requirements:	
Storage temperature	-25 °C to +70 °C
Operating temperature	0 °C to +40 °C
Relative atmospheric humidity	max. 85%
Room classification	Operate only in dry rooms
Available interfaces:	
VDSL interface	Internal VDSL modem
Ethernet IEEE 802.3 LAN (4-port switch)	Permanently installed (twisted pair only), 10/100/1000 mbps, autosensing, MDIX
DMZ interfaces	Permanently installed (twisted pair only), 10/100/1000 mbps,

Property	
	autosensing, MDIX
ISDN interfaces (ISDN1 to ISDN4)	4 internal ISDN interfaces, ISDN termination
SYNC interface	SYNC
Serial interface V.24	Permanently installed, supports Baud rates: 1200 to 115200 Baud
Available sockets:	
VDSL interface	1 x RJ45 socket (grey)
Ethernet interfaces LAN1 to LAN4	4 x RJ45 socket with integrated LEDs
Ethernet interface LAN5 (WAN)	1 x RJ45 socket with integrated LEDs
BRI interface ISDN1 to ISDN4	4 x RJ45 socket (black)
SYNC interface	1 x RJ45 socket
Serial interface V.24	5-pole mini USB socket
Barrel connector socket for power supply	

2.2 Reset

The reset is performed by using the reset button at the terminal area.

The device is rebooted by quickly pressing the key (ca. one second). Pressing the key is equivalent to an interruption of the power supply. Saved data are preserved, but all connections are interrupted.

If you press the reset key for approx. 30 seconds, the device performs a factory reset. Connection data for incoming and for outgoing phone calls are preserved. The configuration is deleted and all passwords are reset.

The reset has finished once the status LED flashes continuously again after approx. 30 seconds.

2.3 Support-Information

If you have any questions about your new product, please contact a local, certified retailer for prompt technical support. Resellers have been trained by us and receive privileged support.

Further information on our support and service offers can be found on our web site at www.bintec-elmeg.com.

Chapter 3 Mounting



Warning

To avoid electric shocks, please take care when connecting telecommunications networks (TNV electric circuits). LAN ports also use RJ connectors.



Caution

To ensure that the **be.IP 4isdn** can operate free of faults, it must be mounted upright on a wall or well ventilated inside of a device rack. The device should not be exposed to direct sunlight or other sources of heat. Please note, too, the gaps that you need to comply with (see [Wall mounting](#) on page 10).

3.1 Connecting terminals

3.1.1 Internal ISDN connection

The internal ISDN connection on the **be.IP 4isdn** gives each internal ISDN connection a 2.5 watt power supply for connecting a maximum of two unpowered ISDN terminals. In its ex works state, the internal ISDN connection is set up as a "short passive bus" ("S0 bus"). It is the simple bus cabling in an ISDN system with a length of up to 120 m.

3.2 Reset button

The reset button which allows you to restart the device or to reset it to the ex works state is located at the terminal area (cf. [Reset](#) on page 8).

3.3 Wall mounting

The various assembly processes are described in this section. Please comply with these processes.

- (1) Find an installation site which is a maximum of 1.5 metres away from a 230 V mains socket and 2.5 metres from the network operator's transfer point.
- (2) To prevent devices interfering with each other, do not install the device close to electronic devices such as hi-fi systems, office equipment or microwave ovens. Neither

should you install it near heat sources such as radiators, or in damp rooms.

- (3) Comply with the gaps as indicated at the bottom in the picture.
- (4) Mark the drilling holes in the wall.
- (5) Check that all the points where the **be.IP 4isdn** is attached to the wall can bear its weight. Ensure that there are no utility lines, cables etc located in the area where the holes are marked.
- (6) Drill the holes at the points marked (if inserting into rawlplugs, use a 5 mm masonry drill). Insert the rawlplug.
- (7) Screw the top two screws in in such a way that there is still a gap of about 5 mm between the screw head and the wall.
- (8) Hang the **be.IP 4isdn** with the rear brackets from above behind the screw heads.
- (9) If necessary, install the sockets for the terminals. Connect the socket installation to that of the device. The sockets are used for a permanent installation, for example in a hallway. When they are installed, the connecting cables are connected to the connectors on the device,
- (10) Plug the connectors on the device into the sockets.
- (11) Connect the **be.IP 4isdn** to the external connections. To do this, you can follow the instructions given on the installation poster provided.
- (12) Plug the power supply unit into the 230 V socket.
- (13) Plug the barrel connector on the power supply unit into the corresponding socket on your device.
- (14) Now you are ready to use the device.

3.4 Pin Assignments

3.4.1 Ethernet interfaces

The devices feature an Ethernet interface with integrated 4 port switch (ETH1 - ETH4).

The 4-port switch is used to connect individual PCs or other switches. The connection occurs via RJ45 sockets.

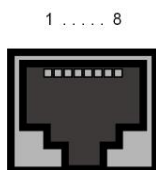

The pin assignment for the Ethernet 10/100/1000 Base-T interface (RJ45 connector) is as

follows:

RJ45 socket for Ethernet connection

Pin	Function
1	Pair 0 +
2	Pair 0 -
3	Pair 1 +
4	Pair 2 +
5	Pair 2 -
6	Pair 1 -
7	Pair 3 +
8	Pair 3 -

3.4.2 ISDN interface

The connection is made via an RJ45 socket:

1 8

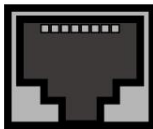

The pin assignment for the ISDN interface (RJ45 socket) is as follows:

RJ45 socket for ISDN connection

Pin	Function (NT)
1	Not used
2	Not used
3	Receive (+) 2a
4	Transmit (+) 1a
5	Transmit (-) 1b
6	Receive (-) 2b
7	Not used
8	Not used

3.4.3 VDSL interface

The **be.IP 4isdn** has an xDSL interface. The VDSL interface is connected via an RJ45 plug.

Only the two inner pins are used for the VDSL connection.

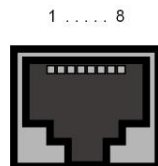

The pin assignment for the vDSL interface (RJ45 socket) is as follows:

RJ45 socket for VDSL connection

Pin	Function
1	Not used
2	Not used
3	Not used
4	Line 1a
5	Line 1b
6	Not used
7	Not used
8	Not used

3.4.4 Serial interface

Your device has a serial interface for connection to a console. This supports Baud rates from 1200 to 115200 Bps.

The interface is designed as a 5-pole mini USB socket.

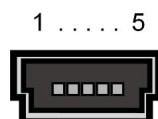

The pin assignment is as follows:

Pin assignment of the mini USB socket

Pin	Position
1	Not used
2	TxD
3	RxD
4	Not used
5	GND

Chapter 4 Basic configuration

The way to obtain the basic configuration is explained below step-by-step. A detailed online help system gives you extra support.

4.1 Preparations

Your device is factory configured as a DHCP server so that it can provide PCs on your LAN that have no IP configuration with all the information required for a connection. How you set up the PC that you want to do the basic configuration on so that it automatically gets an IP configuration is described in [Setting up a PC](#) on page 17.



Note

If you already run a DHCP server on your LAN, it is recommended that you connect only a single PC to your **be.IP 4isdn** so that a separate network is created.

4.1.1 Systemsoftware

Your device contains the version of the system software available at the time of production. More recent versions may have since been released.

You can easily update it using the configuration interface in the **Maintenance->Software & Configuration** menu. For a description of the procedure, see [Software updates for be.IP 4isdn](#) on page 21.

4.1.2 System requirements

To configure the device, your PC must meet the following system requirements:

- Suitable operating system (Windows, Linux, MAC OS)
- A web browser (Internet Explorer, Firefox, Chrome) in the current version
- Installed network card (Ethernet)
- Installed TCP/IP protocol
- High colour display to show the graphics correctly

4.1.3 Gathering data

You will quickly collect the main data for doing the configuration with the configuration interface.

Before you start the configuration, you should gather the data for the following purposes:

- Network settings (only if you intend to integrate your device into an existing network infrastructure)
- SIP provider
- Internet access

The following table shows examples of possible values for the necessary access data. You can enter your personal data in the "Your values" column, so that you can refer to these values later when needed.

Basic configuration

For a basic configuration of your device, you need information that relates to your network environment:

Network settings

Access data	Example value	Your values
IP address of your gateway	192.168.0.251	
Netmask of your gateway	255.255.255.0	

SIP provider

Access data	Example value	Your values
Description	Enter the name of your SIP provider, e.g. <i>Sipgate</i> .	
Authentication ID	Enter you ID, e.g. your Email Address	
Password	Enter your password that you received from your SIP provider.	
Registrar	Enter the appropriate re-	

Access data	Example value	Your values
	gistrar, e. g. <i>sipgate.de.</i>	
Call number	e. g. <i>123456</i>	

Data for internet access over xDSL

Access data	Example value	Your values
Provider name	<i>GoInternet</i>	
Protocol	<i>PPP over Ethernet (PPPoE)</i>	
Encapsulation	<i>LCC Bridged no FCS</i>	
VPI (Virtual Path Identifier)	<i>1</i>	
VCI (Virtual Circuit Identifier)	<i>32</i>	
Connection ID (12-digit)	<i>000123456789</i>	
T-Online number (usually 12 digits)	<i>06112345678</i>	
Joint user account	<i>0001</i>	
Password	<i>TopSecret</i>	

4.1.4 Setting up a PC

To access your device via the network and to be able to do a configuration using the configuration interface, the PC used for the configuration has to satisfy some prerequisites.

- Make sure that the TCP/IP protocol is installed on the PC.

Checking the TCP/IP protocol

Proceed as follows to check whether you have the protocol installed:

- (1) Click the Windows Start button and then **Settings -> Control Panel -> Network Connections** (Windows XP) or **Control Panel -> Network and Sharing Center-> Change Adapter Settings** (Windows 7).

- (2) Click on **LAN Connection**.
- (3) Click on **Properties** in the status window.
- (4) Look for the **Internet Protocol (TCP/IP)** entry in the list of network components.

Installing the TCP/IP protocol

If you cannot find the **Internet Protocol (TCP/IP)** entry, install the TCP/IP protocol as follows:

- (1) First click **Properties**, then **Install** in the status window of the **LAN Connection**.
- (2) Select the **Protocol** entry.
- (3) Click **Add**.
- (4) Select **Internet Protocol (TCP/IP)** and click on **OK**.
- (5) Follow the on-screen instructions and restart your PC when you have finished.

Configuring a Windows PC as a DHCP client

Assign an IP address to your PC as follows:

- (1) Initially, proceed as described to display the network properties.
- (2) Select **Internet Protocol (TCP/IP)** and click on **Properties**.
- (3) Choose **Determine IP address automatically**.
- (4) Also choose **Determine DNS server address automatically**.
- (5) Close all the windows by selecting **OK**.

Your PC should now meet all the prerequisites for configuring your device.



Note

You can now launch the configuration interface for doing the configuration by entering the preconfigured IP address of your device (192.168.0.251) in a supported browser (Internet Explorer 6 or later, Mozilla Firefox 1.2 or later) and entering the pre-set login data (**User:** *admin*, **Password:** *admin*).

4.2 Configuring the system

4.2.1 Network setting (LAN)

If you intend to integrate your device into an existing network infrastructure, select the **Assistants->First steps->Basic Settings** menu for the network settings. For the LAN IP configuration, the **Address Mode** is set to **Static** by default, since your system is delivered ex works with a fixed IP. Enter the necessary **IP Address** for your device in your LAN and the associated **Netmask**. Leave all the other settings and click **OK**. Save the configuration by clicking on the Save Configuration button above the menu navigation.

4.2.2 Enter SIP provider

As an option, you may enter SIP providers for external telephone connections. Please note the description in the online help for the menu **VoIP->Settings->SIP Provider->New**.

4.3 Setting up an internet connection

You can establish an Internet connection with your device.

4.3.1 Internet connection via the internal VDSL modem

To make it easier to configure an VDSL internet connection, the configuration interface has a wizard to guide you through the connection set-up process simply and quickly.

- (1) In the user interface, go to the **Assistants->Internet** menu.
- (2) Use **New** to create a new entry, and copy the **Connection Type** *Internal ADSL Modem*.
- (3) Follow the steps shown by the wizard. The wizard has its own online help, which offers all of the information you may require.
- (4) Once you have exited the wizard, save the configuration by clicking on the **Save configuration** button above the menu navigation.

4.3.2 Other internet connections

In addition to an VDSL connection over the internal VDSL modem, you can connect your device to the internet with other types of connection or via an external modem. The **Internet** wizard in the configuration interface provides support with configurations of this type.

4.3.3 Testing the configuration

Once you have finished configuring your device, you can test the connection in your LAN and to the Internet.

Carry out the following steps to test your device:

- (1) Test the connection from any device in the local network to your device. In the Windows Start menu, click **Run** and enter `ping` followed by a space and then the IP address of your device (e.g. `192.168.0.251`). A window appears with the message "Reply from...".
- (2) Test the Internet access by entering www.bintec-elmeg.com in the Internet browser.



Note

Incorrectly configured terminals may lead to unwanted connections and higher charges! Monitor your device and make sure it only sets up connections at the times you want it to. Watch the light indicators on your device (indicators for ISDN, DSL and the Ethernet interfaces).

4.4 User access

Those who administer and set up the system can set up a personalised configuration access for the users. This will enable the users to view their main personal settings and customise some of them.



Note

Those who administer and set up the system can access the settings and data of all the users. It is only the personal telephone book (**User Phonebook**) which the user can set up for themselves which can only be managed and viewed with the personal user login data.

To log into the configuration interface with the access data you have been assigned, enter your **user name** and your **password** in the login window.

The administrator configures the user accesses in the **Numbering->User Settings->Users** menu.

Users can also find help with the available configuration options in the online help system.

4.5 Software updates for be.IP 4isdn

The range of functions in the **be.IP 4isdn** is continuously being extended. For new software versions can be carried out easily with the **GUI**.

A functional Internet connection is required for any kind of an automatic update.

Proceed as follows:

- (1) Go to the **Maintenance->Software & Configuration** menu.
- (2) Select under **Action** *Update system software* and under **Source Location** *Current software from Update Server*.
- (3) Confirm with **Go**.

Alternatively, you can carry out a software update in the **User** view. On the **Status** page, click **Update** under **Firmware Update** to start the process. Do not interrupt the Internet connection or the power supply.

After installation of the new system software, the system must be restarted.

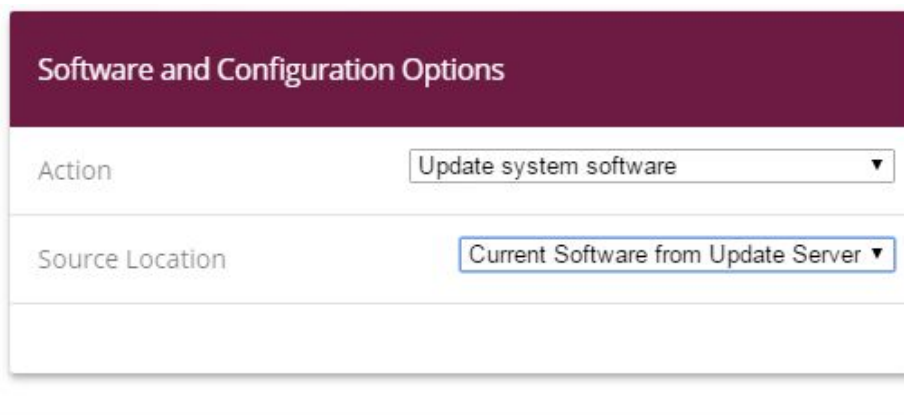

The screenshot shows a web interface titled "Software and Configuration Options". It contains two dropdown menus. The first menu, labeled "Action", has "Update system software" selected. The second menu, labeled "Source Location", has "Current Software from Update Server" selected. Below the menus is a large empty rectangular area, likely for a confirmation message or progress indicator.

START

The device will now connect to the download server and check whether an updated version of the system software is available. If so, your device will be updated automatically. When installation of the new software is complete, you will be invited to restart the device.

**Caution**

Once you have clicked on **Go** the update cannot be cancelled/interrupted. If an error occurs during the update, do not re-start the device and contact support.

Chapter 5 Access and configuration

5.1 Access via LAN

Access via one of your device's Ethernet interfaces allows you to open the configuration interface in a web browser.

5.1.1 HTTP/HTTPS

With a current web browser, you can use the HTML interface to configure your device. For this, enter the following in your web browser's address field

- `http://192.168.0.251`

or

`https://192.168.0.251`

5.2 Configuration

The configuration is done using the HTML configuration interface.

5.2.1 Configuration interface

The configuration interface is a web-based graphic user surface that you can use from any PC with an up-to-date Web browser via an HTTP or HTTPS connection.

With the configuration interface you can perform all the configuration tasks easily and conveniently. It is integrated in your device and is available in English.

The settings you make are applied with the **OK** or **Apply** button in the relevant menu, and you do not have to restart the device.

If you finish the configuration and want to save your settings so that they are loaded as the boot configuration when you reboot your device, save these by clicking the **Save configuration** button.

You can also use the configuration interface to monitor the most important function parameters of your device.

System Information		Resource Information	
Uptime	2 Day(s) 3 Hour(s) 3 Minute(s)	CPU Usage	0%
System Date	Sunday, 2000 Nov 12. 00:36:13	Memory Usage	46.4/127.9 MByte (36%)
Serial Number	BE2CCA015030025	Internal Storage	0.044/3.963 GByte (1%)
BOSS Version	V.10.1 Rev. 7 (Beta 19) IPv6, IPSec, PBX from 2016/03/15 00:00:00	Active Sessions (SIF, RTP, etc...)	3
Last configuration stored	Friday, 2000 Nov 03. 20:48:25	Active IPSec Tunnels	0 / 1
Night Mode Status	Off		

5.2.1.1 Open the configuration interface

- (1) Check whether the device is connected and switched on and that all the necessary cables are correctly connected.
- (2) Check the settings of the PC from which you want to configure your device.
- (3) Open a web browser.
- (4) Enter `http://192.168.0.251` in the address field of the web browser.
- (5) You will be prompted to change the administrator password. Change the login password.

You are now in the status menu of your device's configuration interface.

5.2.1.2 Operating elements

Configuration interface window

The configuration interface window is divided into three areas:

- The header
- The navigation bar
- The main configuration window

Navigation

Header

The screenshot shows the configuration interface for be.IP 4isdn. On the left is a dark red navigation menu with the following items: Assistants, System Management, Physical Interfaces, VoIP, Terminals, Call Routing, Applications, LAN, Wireless LAN Controller, Networking, Multicast, WAN, VPN, Firewall, Local Services, Maintenance, External Reporting, and Monitoring. The main configuration window is titled 'System Information' and 'Resource Information'. It contains the following data:

System Information		Resource Information	
Uptime	0 Day(s) 2 Hour(s) 41 Minute(s)	CPU Usage	0%
System Date	Thursday, 2009 Jan 01, 03:41:04	Memory Usage	39.7/127.9 MByte (30%)
Serial Number	RNOCAAM16500007	ISDN Usage Internal	0 / 8 B Channels
BOSS Version	V.10.1.21.10 IPv6, IPsec, MGW from 2016/12/19 00:00:00	Active Sessions (SIF, RTP, etc...)	3
Last configuration stored	No boot config stored	Active IPsec Tunnels	0 / 0
		DSP Channels	SoftCoder 0 / 4 LANTIQ 0 / 5 M 8 DSP V2 0 / 8

Main configuration window

Header

The header bar contains the following elements from left to right: a hamburger menu icon, the text 'be.IP 4isdn' and 'bintec elmeg' with a logo, a 'Logout' button with a question mark icon, and a 'SAVE CONFIGURATION' button. In the center, there are 'LANGUAGE' and 'VIEW' dropdown menus, with 'Standard' selected in the 'VIEW' menu.

Configuration interface header bar

Menu	Function
	Opens the navigation bar.
	<p>Logout: If you want to end the configuration, click this button to log out of your device. A window is opened offering you the following options:</p> <ul style="list-style-type: none"> Continue with the configuration, Save the configuration and close the window, Exit the configuration without saving.
	<p>Online Help: Click this button if you want help with the menu now active. The description of the sub-menu where you are now is displayed.</p>
	<p>Language: From the dropdown menu, select the language in which the configuration interface is to be displayed. Here, you</p>

Menu	Function
<p>LANGUAGE</p> <p>English</p> <p>Deutsch</p>	<p>can select the language in which you want to carry out the configuration. <i>German</i> and <i>English</i> are available.</p>
<p>VIEW</p> <p>Initial operation</p> <p>User</p> <p>Expert</p> <p>Full Access</p>	<p>View: Select the desired view from the dropdown menu. <i>Full Access</i>, <i>Expert</i> and <i>User</i> can be selected. Also the Initial operation can be start again from here.</p>
<p>SAVE CONFIGURATION</p>	<p>Save configuration button.</p> <p>If you click the Save configuration button, you will be asked "Do you really want to save the current configuration as a boot configuration?"</p> <p>You can</p> <ul style="list-style-type: none"> • Save configuration • Save configuration with boot backup

Navigation bar

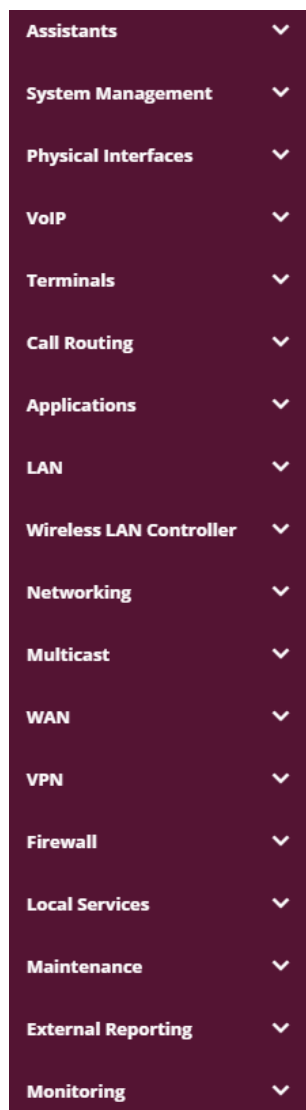

The navigation bar contains the main configuration menus and their sub-menus.

Click the main menu you require. The corresponding sub-menu then opens.

If you go to the sub-menu you want, the entry selected will be displayed in color. After selecting the sub-menu the navigation bar will be closed.

Status page

If you open the configuration interface the status page of your device is displayed after you log in. The most important data of your device can be seen on this at a glance.

Main configuration window

The sub-menus generally contain several pages. These are called using the buttons at the top of the main window. If you click a button, the window is opened with the basic parameters. You can extend this by clicking the **Advanced Settings** tab, which displays the additional options.





Configuration elements

The various actions that you can perform when configuring your device in the configuration interface are triggered by means of the following buttons:

Buttons

Button	Function
APPLY	Updates the view.
CANCEL	If you do not want to save a newly configured list entry, cancel this and any settings made by pressing Cancel .
OK	Confirms the settings of a new entry and the parameter changes in a list.
GO	Immediately starts the configured action.
NEW	Calls the sub-menu to create a new entry.
ADD	Inserts an entry in an internal list.



Symbols

Icon	Function
	Deletes the list entry.
	Displays the menu for changing the settings of an entry.
	Displays the details for an entry.
	Voicemail message can be intercepted.
	Messages will be saved.

Icon	Function
	Select the button to go to the elmeg IP1x0 telephone user interface administrator page.
	Moves an entry. A combo box opens in which you can choose the list entry that selected entry is to be placed in front of/after.
	Creates another list entry first and opens the configuration menu.
	Sets the status of the entry to <i>Inactive</i> .
	Sets the status of the entry to <i>Active</i> .
	Indicates "Dormant" status for an interface or connection.
	Indicates "Up" status for an interface or connection.
	Indicates "Down" status for an interface or connection.
	Indicates "Blocked" status for an interface or connection.
	Indicates that data traffic is encrypted.
	Triggers a WLAN bandscan.
	Displays the next page in a list.
	Displays the previous page in a list.



List options

Menu	Function
Update Interval	<p>Here you can set the interval in which the view is to be updated.</p> <p>To do this, enter a period in seconds in the input field and confirm it with APPLY.</p>
Filter	You can have the list entries filtered and displayed according to certain criteria.

Menu	Function
	<p>You can determine the number of entries displayed per page by entering the required number in Viewxper page.</p> <p>Use the  and  buttons to scroll one page forward and one page back.</p> <p>You can filter according to certain keywords within the configuration parameters by selecting the filter rule you want under Filter in x <Option> y and entering the search word in the input field.  launches filter operation.</p>
Configuration elements	<p>Some lists contain configuration elements.</p> <p>You can therefore change the configuration of the corresponding list entry directly in the list.</p>

Automatic Refresh Interval Seconds **APPLY**

Configuration of the update interval

View per page   Filter in 

Filter list

On the **status page** you can open the option **Automatic Refresh Interval** using the button

⋮

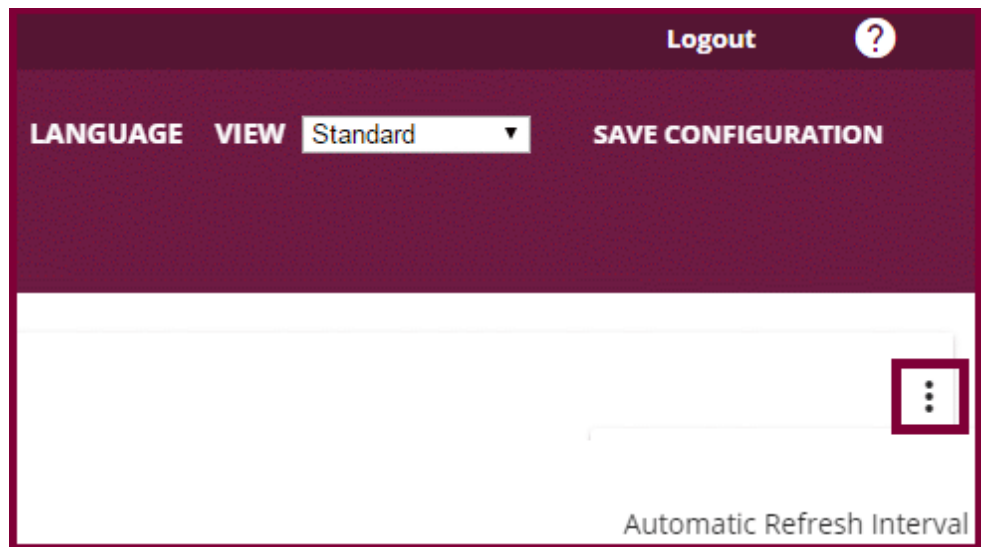

Click **Automatic Refresh Interval**.



Enter the time and click **APPLY**.

Structure of the configuration menu

The menus contain the following basic structures:







Menu structure

Menu	Function
Basic configuration menu/list	<p>When you select a menu from the navigation bar, the menu of basic parameters is displayed first. In a sub-menu containing several pages, the menu containing the basic parameters is displayed on the first page.</p> <p>The menu contains either a list of all the configured entries or the basic settings for the function concerned.</p>

Menu	Function
Sub-menu 	The New button is available in each menu in which a list of all the configured entries is displayed. Click the button to display the configuration menu for creating a new list entry.
Sub-menu 	Click this button to process the existing list entry. You go to the configuration menu.
Menu 	Click this tab to display extended configuration options.

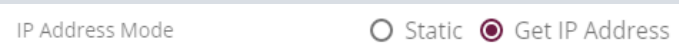
The following options are available for the configuration:

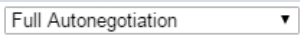
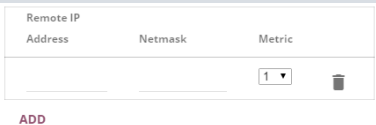
Configuration elements

Menu	Function
Eingabefelder	<p>e.g. empty text field</p>  <p>Text field with hidden input</p>  <p>Enter the data.</p>
Radiobuttons	<p>e.g.</p>  <p>Select the corresponding option.</p>
Checkbox	<p>e.g. activation by selecting checkbox</p> 
Dropdown-Menüs	<p>e.g.</p>  <p>Click the arrow to open the list. Select the required option using the mouse.</p>
Interne Listen	<p>e.g.</p>  <p>Click ADD . A new list entry is created. Enter the corresponding data. If list input fields remain empty, these are not saved when you confirm with OK. Delete the entries by clicking the  icon.</p>

Display of options that are not available

Options that are not available because they depend on the selection of other options are generally hidden. If the display of these options could be helpful for a configuration decision, they are instead greyed out and cannot be selected.



Important

Please look at the messages displayed in the sub-menus. These provide information on any incorrect configurations.

5.2.1.3 Menus

The configuration options of your device are contained in the sub-menus, which are displayed in the navigation bar in the left-hand part of the window.



Note

Please note that not all devices have the full range of functions. Use your product specification to check which software your device has.

Chapter 6 Assistants

The **Assistants** menu offers step-by-step instructions for the following basic configuration tasks.

Choose the corresponding task from the navigation bar and follow the instructions and explanations on the separate pages of the Wizard.

Chapter 7 System Management

The **System Management** menu contains general system information and settings.

You see a system status overview. Global system parameters such as the system name, date/time, passwords and licences are managed and the access and authentication methods are configured.

7.1 Status

If you log into the **GUI**, your device displays the status page in the **Users** view.

Here you can find links to the configuration assistants that will support you with an easy configuration of the most important settings.

Moreover, you can carry out a **Firmware Update**. Click **Update** to start the process.



Note

Do not interrupt the Internet connection or the power supply.

After installation of the new system software, the system must be restarted.

In the **Full Access** and **Expert** views of your device, the status page displays the most important system information.

You see an overview of the following data:

- System status
- Your device's activities: Resource utilisation, active sessions and tunnels
- Status and basic configuration of the LAN, WAN, ISDN, and ADSL interfaces
- Information on plugged add-on modules (if any)

You can customise the update interval of the status page by entering the desired period in seconds as **Automatic Refresh Interval** and clicking on the **Apply** button.



Caution

Under **Automatic Refresh Interval** do not enter a value of less than 5 seconds, otherwise the refresh interval of the screen will be too short to make further changes!

The menu **System Management->Status** consists of the following fields:

Fields in the System Information menu.

Field	Value
Uptime	Displays the time past since the device was rebooted.
System Date	Displays the current system date and system time.
Serial Number	Displays the device serial number.
BOSS Version	Displays the currently loaded version of the system software.
Last configuration stored	Displays day, date and time of the last saved configuration (boot configuration in flash).
Night Mode Status	Displays whether your device is in normal operation (<i>OFF</i>) or in night operation (<i>On</i>).

Fields in the Resource Information menu.

Field	Value
CPU Usage	Displays the CPU usage as a percentage.
Memory Usage	Displays the usage of the working memory in MByte in relation to the available total working memory in MByte. The usage is also displayed in brackets as a percentage.
Memory Card	Shows the status of any optional external memory card that has been inserted, and the size of the memory in GBytes or MBytes.
Active Sessions (SIF, RTP, etc...)	Displays the total of all SIF, TDRS, and IP load balancing sessions.
Active IPSec Tunnels	Displays the number of currently active IPSec tunnels in relation to the number of configured IPSec tunnels.
DSP Channels	Shows the currently used DSP channels.

Fields in the VoIP Trunk Lines menu

Field	Value
No.	Displays the consecutive number of the SIP provider (your IP telephony provider).
Description	Displays the description of the SIP provider that has been entered upon creation of the provider.
Registrar	Displays the server your system connects to in order to enable IP phone calls.
Access Type	Displays if your connection is a point to multipoint or point to

Field	Value
	point (DDI) connection.
Status	Displays the current status of the connection to this SIP provider.

Fields in the **Physical Interfaces** menu.

Field	Value
Interface - Connection Information - Link	<p>The physical interfaces are listed here and their most important settings are shown (ISDN: only the first 4 ports are listed). The system also displays whether the interface is connected or active.</p> <p>Interface specifics for Ethernet interfaces:</p> <ul style="list-style-type: none"> • IP address • Netmask • Not configured <p>Interface specifics for ISDN interfaces:</p> <ul style="list-style-type: none"> • Configured • Not configured <p>Interface specifics for xDSL interfaces:</p> <ul style="list-style-type: none"> • Last Change • DSL operation mode • DSL Speed • DSL Volume

Fields in the **WAN Interfaces** menu.

Field	Value
Description - Connection Information - Link	All the WAN interfaces are listed here and their most important settings are shown. The system also displays whether the interface is active.

7.2 Global Settings

The basic system parameters are managed in the **Global Settings** menu.

7.2.1 System

The **System Management->Global Settings->System** menu is used for entering your system's basic data.

The menu consists of the following fields:

Fields in the menu **Basic Settings**

Field	Value
System Name	<p>Enter the system name of your device. This is also used as the PPP host name.</p> <p>A character string of up to 255 characters is possible.</p> <p>The device type is entered as the default value.</p>
Location	<p>Enter the location of your device.</p>
Contact	<p>Enter the relevant contact person. Here you can enter the e-mail address of the system administrator, for example.</p> <p>A character string of up to 255 characters is possible.</p> <p>Only for compact systems: The default value is <i>BINTECELMEG</i>.</p>
Maximum Number of Syslog Entries	<p>Enter the maximum number of syslog messages that are stored internally in the device.</p> <p>Possible values are <i>0</i> to <i>1000</i>.</p> <p>The default value is <i>50</i>. You can display the stored messages in Monitoring->Internal Log.</p>
Maximum Message Level of Syslog Entries	<p>Select the priority of system messages above which a log should be created.</p> <p>System messages are only recorded internally if they have a higher or identical priority to that indicated, i.e. all messages generated are recorded at syslog level <i>Debug</i>.</p> <p>Possible values:</p> <ul style="list-style-type: none"> • <i>Emergency</i>: Only messages with emergency priority are recorded.

Field	Value
	<ul style="list-style-type: none"> • <i>Alert</i>: Messages with emergency and alert priority are recorded. • <i>Critical</i>: Messages with emergency, alert and critical priority are recorded. • <i>Error</i>: Messages with emergency, alert, critical and error priority are recorded. • <i>Warning</i>: Messages with emergency, alert, critical, error and warning priority are recorded. • <i>Notice</i>: Messages with emergency, alert, critical, error, warning and notice priority are recorded. • <i>Information</i> (default value): Messages with emergency, alert, critical, error, warning, notice and information priority are recorded. • <i>Debug</i>: All messages are recorded.
Maximum Number of Accounting Log Entries	<p>Enter the maximum number of login process entries that are stored internally in the device.</p> <p>Possible values are <i>0</i> to <i>1000</i>.</p> <p>The default value is <i>20</i>.</p>
Show Manufacturer Names	<p>Here you can determine if the manufacturer part of a MAC address is to be "translated". The manufacturer part takes up to eight characters at the beginning of the MAC address. Instead of, e.g., <i>00:a0:f9:37:12:c9</i>, <i>BintecCo_37:12:c9</i> is displayed if this option is enabled.</p>
Autosave Configuration	<p>Here you can choose whether configuration changes are automatically saved.</p> <p>The option is enabled per default.</p> <p>You can find a detailed description of this function below.</p>

Autosave Configuration

Whenever you make a change to the current configuration using the GUI, this change becomes immediately active once you confirm the change (e.g. with the **OK** button). Additionally, the status of the configuration is stored, the syslog (syslog level = *debug*) shows *new config state: modified*. As soon as this state has been reached, and the next bit of HTTP(S) traffic between the browser and the GUI is registered, the change is confirmed

and cleared for saving. The syslog shows *new config state: confirmed*.

As soon as this state has been reached and the configuration session via the browser is terminated without the user actively saving the new configuration, your device automatically saves the new configuration once the HTTP(S) session has timed out. The syslog first informs about the termination of the active session (e.g. *delete httpSessionStat entry admin at Fri Apr 21 11:04:34 2017 (keep alive timeout)*), and then confirms the configuration *auto save on session termination*.

In case a configuration error has locked you out of the GUI, the implicit confirmation of the change (*new config state: confirmed*) does not take place, and it is not saved after session termination. A reboot of your device then resets the change.

Transfer to busy subscriber

In configuration, you can define whether transfer of a call to an engaged subscriber is possible, or whether the caller hears the busy tone on Off and the call is thus ended. Otherwise, the caller remains on hold and hears the music-on-hold. If the target subscriber hangs up, the subscriber on hold hears the ringing tone if *With Ringing Tone* has been selected, or Music on Hold if *With Music on Hold* has been selected until the target subscriber accepts the call. The target subscriber is called and can take the call on hold.

Fields in the menu System Settings

Field	Value
Transfer Signalling	<p>Set how the connecting to an internal subscriber shut be managed.</p> <p>Possible values:</p> <ul style="list-style-type: none"> • <i>With Ringing Tone</i> (default value): While being transferred, the caller hears music on hold from the system; after being transferred, the ringing tone. • <i>With Music On Hold</i>: The caller hears the system's on-hold music until the target subscriber accepts the call.
Transfer to busy extension	<p>Set whether a caller may be transferred to a busy subscriber.</p> <p>The function is activated with <i>Enabled</i>.</p> <p>The function is disabled by default.</p>
Rerouting to Number	<p>Set the destination to which incoming calls should be diverted to, e. g. in the case of a misdial.</p> <p>Possible values:</p>

Field	Value
	<ul style="list-style-type: none"> • <i>None - Busy Tone</i>: The caller hears the engaged tone by default and cannot be redirected to a destination. • <i><Extension number></i>: By default, the incoming call is routed to the number selected. <p>The default value is the preset internal number <i>40 (Team global)</i>.</p>
Interconnect external calls	<p>When brokering with two external subscribers, select whether they are to be connected after you hang up.</p> <p>The function is activated with <i>Enabled</i>.</p> <p>The function is disabled by default.</p>

Country settings

Your business is an international company with subsidiaries in several countries. Despite the differences in network implementation in the different countries, you want to use the same system in each subsidiary. By setting the respective country variants, the system can be adjusted to the particular features of the network in the required country.

As the system requirements vary from country to country, the functionality of certain features needs to be customised. The basic settings for different country variants are stored in the system.

Fields in the menu Country Settings

Field	Value
Country Profile	<p>Select the country in which you want to use the system.</p> <p>Note: This does not change the language of the text in the system menu of system telephones.</p> <p>Possible values:</p> <ul style="list-style-type: none"> • <i>Deutschland (default value)</i> • <i>Nederland</i> • <i>Great Britain</i> • <i>België</i> • <i>Italia</i> • <i>Danmark</i>

Field	Value
	<ul style="list-style-type: none"> • <i>España</i> • <i>Sverige</i> • <i>Norge</i> • <i>France</i> • <i>Portugal</i> • <i>Österreich</i> • <i>Schweiz</i> • <i>Česko</i> • <i>Slovenija</i> • <i>Polska</i> • <i>Magyarország</i> • <i>Ellada</i>
International Prefix / Country Code	<p>Enter the country code.</p> <p>You need this entry if, e. g., you wish to automatically generate an international number under SIP Provider. You dial, as usual, the national prefix e. g. 05151 909999 and the system then automatically dials +495151 909999. If you fail to enter the country code, you may misdial, as the system will then dial +5151 909999. Without the entry Generate international phone number and International Prefix / Country Code, the full number plus the country code always has to be dialled in the case of SIP providers.</p> <p>Note: Not every SIP provider supports this setting.</p>
National Prefix / City Code	<p>Enter the national prefix and the area code for the location where your system is installed. With a point-to-point ISDN access, this area code is essential, because otherwise e. g. no automatic external callback is possible.</p>

The menu **Advanced Settings** consists of the following fields:

Fields in the menu **Charge Settings**

Field	Value
Charge Rate Factor	<p>Enter the factor for the connection costs.</p> <p>The default value is <i>0.00</i>.</p>

Field	Value
Currency	Here, enter the name of the currency, e. g. <i>EUR</i> , (max. three characters). This entry is just a name which is not involved in any calculation of the tariff unit factor. Special characters are not permitted.
Charge Information (S0 / Upn Extension)	Select the transmission method for charge information on the internal S0 bus. Possible values: <ul style="list-style-type: none"> • <i>Keypad</i>: Depending on country and provider, the charging information is transmitted so as to allow direct display by the terminal. • <i>Functional</i>: The charge information is transmitted in binary, coded form, and the terminal first needs to decode it (EURO ISDN). • <i>Both</i> (default value): Both protocols are recognised.

Fields in the menu **Day Mode**

Field	Value
Global Rerouting	Select the call variant in day modus that shall apply to the overall system if no specific redirect has been set up. The default value is <i>Variant 1</i> .

Night operation

You can switch the system to night operation and thus enable particular call variants for the team signalling, the door intercom signalling and the rejection functions.

An advanced switching of the call variants is possible via a code or the calendar that has been configured for night operation. You configure a calendar for night operation in the **Applications->Calendar->Calendar->New** menu.

Fields in the menu **Night Mode**

Field	Value
Team Signalling	Select the call variants for team signalling in night operation. The default value is <i>Variant 1</i> .
Doorcom Signalling	Select the door intercom variants for door intercom signalling in

Field	Value
	<p>night operation.</p> <p>The default value is <i>Variant 1</i>.</p>
Rerouting of Incoming Distribution	<p>Select the call variants for reject to message in night operation.</p> <p>The default value is <i>Variant 1</i>.</p>
Extension Rerouting	<p>Select the call variants for reject to direct dial-in in night operation.</p> <p>The default value is <i>Variant 1</i>.</p>
Global Rerouting	<p>Select the call variants for general rejection in night operation.</p> <p>The default value is <i>Variant 1</i>.</p>
Alarm Input	<p>Select the call variants for alarm in night operation.</p> <p>The default value is <i>Variant 1</i>.</p>

7.2.2 Passwords

Setting the passwords is another basic system setting.



Note

All bintec elmegbintec elmeg devices are delivered with the same username and password and the same PINs. As long as the passwords or PINs remain unchanged, they are not protected against unauthorised use.

When you log onto your device for the first time, you are prompted to change the password. You need to change the system administrator password in order to be able to configure your device.

Make sure you change all passwords and PIN's to prevent unauthorised access to the device.

The **System Management->Global Settings->Passwords** menu consists of the following fields:

Fields in the System Password menu.

Field	Value
System Admin Password	<p>Enter the password for the user name <code>admin</code>.</p> <p>The default password is <code>admin</code>.</p> <p>This password is also used with SNMPv3 for authentication (MD5) and encryption (DES).</p> <p>Some devices have an individual password configured ex works. In this case you can find the password printed on the type label on the bottom of your device.</p>
Confirm Admin Password	Confirm the password by entering it again.

PIN1 and PIN2

You can use various protection functions to prevent misuse of your system. Your system settings protect you by means of a 4-digit PIN1 (pin number). Access from outside (remote access) is protected by a 6-character PIN2.

PIN1 is a 4-digit pin number that allows you to protect system settings from unauthorised access. PIN2 is a 6-digit pin number that prevents unauthorised external subscribers from being able to use your system. These functions can only be used after entering a 6-digit PIN2.

Various settings are protected by the system's PIN1. In the basic setting, the PIN1 is set to *none*.

The following performance features are protected using PIN2:

- Remote access for Follow me, room monitoring

Fields in the Configuration via Phone (4-Digit Numeric PIN) menu.

Field	Value
PIN1	<p>Enter PIN1.</p> <p>The default value is <i>none</i>.</p> <p>With the 4-digit PIN1 (PIN number) you protect your system settings through configuration via telephone.</p>

Fields in the Remote Access to Phone (6-Digit Numeric PIN) menu.

Field	Value
Remote Access (e.g. Follow me, Room Monitoring)	<p>Select whether a remote access of your system is to be permitted.</p> <p>The function is activated with <i>Enabled</i>.</p> <p>The function is disabled by default.</p>
PIN2	<p>Only if Remote Access (e.g. Follow me, Room Monitoring) is enabled.</p> <p>Enter the PIN2.</p> <p>The default value is <i>000000</i>.</p> <p>Through the 6-digit PIN2 you protect from external access (remote access).</p>

Fields in the **SNMP Communities** menu.

Field	Value
SNMP Read Community	<p>Enter the password for the user name <i>read</i>.</p> <p>The default password is <i>admin</i>.</p>
SNMP Write Community	<p>Enter the password for the user name <i>write</i>.</p> <p>The default password is <i>admin</i>.</p>

Field in the **Global Password Options** menu

Field	Value
Show passwords and keys in clear text	<p>Define whether the passwords are to be displayed in clear text (plain text).</p> <p>The function is enabled with <i>Show</i></p> <p>The function is disabled by default.</p> <p>If you activate the function, all passwords and keys in all menus are displayed and can be edited in plain text.</p> <p>One exception is IPSec keys. They can only be entered in plain text. After pressing OK or calling the menu again, they are displayed as asterisks.</p>

7.2.3 Date and Time

You need the system time for tasks such as correct time-stamps for system messages, or accounting.

You have the following options for determining the system time (local time):

ISDN/Manual

The system time can be updated via ISDN, i.e. with every existing external connection the date and time are taken from the ISDN. The date and time can also be entered manually, e. g. if time and date are not sent in the ISDN or no time server is provided. The time remains for approx. 3 hours after the system's power supply is switched off.

The clock switches from summer to winter time (and back) automatically. This is independent of the exchange time or the ntp server time. Summer time starts on the last Sunday in March by switching from 2 a.m. to 3 a.m. The calendar-related or schedule-related switches that are scheduled for the missing hour are then carried out. Winter time starts on the last Sunday in October by switching from 3 a.m. to 2 a.m. The calendar-related or schedule-related switches that are scheduled for the additional hour are then carried out.

Time server

You can obtain the system time automatically, e.g. using various time servers. To ensure that the device uses the desired current time, you should configure one or more time servers.



Note

If a method for automatically deriving the time is defined on the device, the values obtained in this way automatically have higher priority. A manually entered system time is therefore overwritten.

The menu **System Management->Global Settings->Date and Time** consists of the following fields:

Fields in the **Basic Settings** menu.

Field	Description
Time Zone	Select the time zone in which your device is installed. You can select Universal Time Coordinated (UTC) plus or minus the deviation in hours or a predefined location.

Field	Description
	compact systems: The default value is <i>Europe/Berlin</i> .
Current Local Time	The current date and current system time are shown here. The entry cannot be changed.

Fields in the **Manual Time Settings** menu.

Field	Description
Set Date	Clicking into the field for adding a date brings up a standard calendar. Clicking the desired date will enter it into the configuration interface.
Set Time	Enter a new time. Format: <ul style="list-style-type: none"> • Hour: hh • Minute: mm

Fields in the **Automatic Time Settings (Time Protocol)** menu.

Field	Description
ISDN Timeserver	Determine whether the system time is to be updated via ISDN. If a time server is configured, the time is only determined over ISDN until a successful update is received from this time server. Updating over ISDN is deactivated for the period in which the time is determined by means of a time server. The function is activated with <i>Enabled</i> . The function is enabled by default.
First Timeserver	Enter the primary time server, by using either a domain name or an IP address. In addition, select the protocol for the time server request. Possible values: <ul style="list-style-type: none"> • <i>SNTP</i> (default value): This server uses the simple network time protocol via UDP port 123. • <i>Time Service / UDP</i>: This server uses the Time service with UDP port 37.

Field	Description
	<ul style="list-style-type: none"> • <i>Time Service / TCP</i>: This server uses the Time service with TCP port 37. • <i>None</i>: This time server is not currently used for the time request.
Second Timeserver	<p>Enter the secondary time server, by using either a domain name or an IP address.</p> <p>In addition, select the protocol for the time server request.</p> <p>Possible values:</p> <ul style="list-style-type: none"> • <i>SNTP</i> (default value): This server uses the simple network time protocol via UDP port 123. • <i>Time Service / UDP</i>: This server uses the Time service with UDP port 37. • <i>Time Service / TCP</i>: This server uses the Time service with TCP port 37. • <i>None</i>: This time server is not currently used for the time request.
Third Timeserver	<p>Enter the third time server, by using either a domain name or an IP address.</p> <p>In addition, select the protocol for the time server request.</p> <p>Possible values:</p> <ul style="list-style-type: none"> • <i>SNTP</i> (default value): This server uses the simple network time protocol via UDP port 123. • <i>Time Service / UDP</i>: This server uses the Time service with UDP port 37. • <i>Time Service / TCP</i>: This server uses the Time service with TCP port 37. • <i>None</i>: This time server is not currently used for the time request.
Time Update Interval	<p>Enter the time interval in minutes at which the time is automatically updated.</p> <p>The default value is <i>1440</i>.</p>

Field	Description
Time Update Policy	<p>Enter the time period after which the system attempts to contact the time server again following a failed time update.</p> <p>Possible values:</p> <ul style="list-style-type: none"> • <i>Normal</i> (default value): The system attempts to contact the time server after 1, 2, 4, 8, and 16 minutes. • <i>Aggressive</i>: For ten minutes, the system attempts to contact the time server after 1, 2, 4, 8 seconds and then every 10 seconds. • <i>Endless</i>: For an unlimited period, the system attempts to contact the time server after 1, 2, 4, 8 seconds and then every 10 seconds. <p>If certificates are used to encrypt data traffic in a VPN, it is extremely important that the correct time is set on the device. To ensure this is the case, for Time Update Policy, select the value <i>Endless</i>.</p>
Internal Time Server	<p>Select whether the internal timeserver is to be used.</p> <p>The function is activated by selecting <i>Enabled</i>. Time requests from a client will be answered with the current system time. This is given as GMT, without offset.</p> <p>The function is enabled by default. Clients' time requests are answered in the LAN.</p>

7.2.4 Timer

In the **Timer** menu you can configure the times at which particular system features are to be switched on by default.

The menu **System Management->Global Settings->Timer** consists of the following fields:

Fields in the Basic Settings menu.

Field	Description
Call Forwarding (CFNR)	<p>Enter the time in seconds after which a Call Forwarding (CFNR) will be executed.</p> <p>Possible values are 1 to 99.</p>

Field	Description
	The default value is <i>15</i> .
Direct Call	<p>Enter the time in seconds after which the configured number will be dialled when the receiver is lifted.</p> <p>You wish to set up a telephone for which the connection to a specific number is established without entering the number (e.g. emergency telephone). You are not at home. However, there is someone at home who needs to be able to reach you quickly and easily by telephone if necessary (e. g. children or grandparents). If you have set up the "Direct Call" function for one or more telephones, the receiver of the corresponding telephone only needs to be lifted. After a time period without further entries set in configuration, the system automatically dials the configured direct call number.</p> <p>If you do not dial within the specified period from picking up the receiver, automatic dialling is initiated.</p> <p>Possible values are <i>1</i> to <i>30</i>.</p> <p>The default value is <i>5</i>.</p>
External Door Connections	<p>If an external telephone requests a door intercom call, here you can set the time in seconds after which this call is forcefully terminated.</p> <p>Possible values:</p> <ul style="list-style-type: none"> • <i>infinite</i> • <i>60 seconds</i> • <i>120 seconds</i> • <i>180 seconds</i> (default value) • <i>240 seconds</i> • <i>300 seconds</i>

Fields in the Advanced Settings menu.

Field	Value
Explicit Call Transfer	Enter the time in seconds after which the initiating subscriber is to be called back or hear call waiting if the required subscriber could not be reached.

Field	Value
	<p>You have passed a caller to another subscriber by brokering or transfer. This subscriber cannot be reached or is engaged. But you wish to prevent the subscriber terminating the call or being diverted by the system after a time. You achieve this using an automatic callback to your telephone. In the case of calls which are transferred with no message (special call transfer, UbA), a callback or call waiting (if there is already a new call) is made to the initiating subscriber after the time entered here.</p> <p>Possible values are 10 to 179.</p> <p>The default value is 30.</p>
<p>Transfer to busy extension</p>	<p>Enter the time in seconds after which a subscriber in the waiting loop is reconnected with the switchboard.</p> <p>The switchboard wishes to pass a call to a particular employee. However, this person is currently on the phone. The call can then be switched to the subscriber's waiting loop. If the call is not taken in the time entered here, the switchboard is called again.</p> <p>Possible values are 10 to 600.</p> <p>The default value is 30.</p>
<p>System Parking (Open Enquiry)</p>	<p>Enter the time in seconds after which an open hold for enquiry is terminated and the subscriber called back or given a call waiting.</p> <p>You are making a call and want to transfer it to a colleague. Unfortunately, you do not know where this colleague is. System Parking (Open Enquiry) holds the caller in the system's queue. You can now make an announcement from your telephone to notify your colleague that the call is waiting. Using a code for the open hold for enquiry, the colleague can take the call on any telephone.</p> <p>If a call waiting in the queue is not taken by a subscriber within the time entered here, the initiating subscriber is called back or given a call waiting.</p> <p>Possible values are 10 to 600.</p> <p>The default value is 30.</p>

7.2.5 System Licences

This chapter describes how to activate the functions of the software licences you have purchased.

The following licence types exist:

- Licences already available in the device's ex works state
- Free extra licences
- Extra licences at additional cost

The data sheet for your device tells you which licences are available in the device's ex works state and which can also be obtained free of charge or at additional cost. You can access this data sheet at www.bintec-elmeg.com.

Entering licence data

You can obtain the licence data for extra licences via the online licensing pages in the support section at www.bintec-elmeg.com. Please follow the online licensing instructions. (Please also note the information on the licence card for licences at additional cost.) You will then receive an e-mail containing the following data:

- **Licence Key** and
- **Licence Serial Number**.

You enter this data in the **System Management->Global Settings->System Licences->New** menu.

In the **System Management->Global Settings->System Licences->New** menu, a list of all registered licences is displayed (**Description**, **Licence Type**, **Licence Serial Number**, **Status**).

Possible values for Status

Licence	Meaning
OK	Subsystem is activated.
Not OK	Subsystem is not activated.
Not supported	You have entered a licence for a subsystem your device does not support.

In addition, above the list is shown the **System Licence ID** required for online licensing.

**Note**

To restore the standard licences for a device, click the **Default Licences** button (standard licences).

7.2.5.1 Edit or New

Choose the  icon to edit existing entries. Choose the **New** button to enter more licences.

Activating extra licences

You activate extra licences by adding the received licence information in the **System Management->Global Settings->System Licences->New** menu.

The menu **System Management->Global Settings->System Licences->New** consists of the following fields:

Fields in the Basic Settings menu.

Field	Value
Licence Serial Number	Enter the licence serial number you received when you bought the licence.
Licence Key	Enter the licence key you received by e-mail.

**Note**

If *Not OK* is displayed as the status:

- Enter the licence data again.
- Check your hardware serial number.

If *Not Supported* is displayed as the status, you have entered a license for a sub-system that your device does not support. This means you cannot use the functions of this licence.

Deactivating a licence

Proceed as follows to deactivate a licence:

- (1) Go to **System Management->Global Settings->System Licences->New**.
- (2) Press the  icon in the line containing the licence you want to delete.
- (3) Confirm with **OK**.

The licence is deactivated. You can reactivate your additional licence at any time by entering the valid licence key and licence serial number.

7.3 Access Codes

In your day-to-day work you have employed codes to use particular features and you wish to use them again with your new system. However, other codes are set for these features in the basic setting. No problem - you can change the codes for different features. So you can use your usual codes for these features in the future.

7.3.1 Alternative Access Codes

You use the **Alternative Access Codes** menu to configure the system's access number plan.

The access number can be set individually for some performance features in the system configuration. The access number preset in the system is supplemented with a call number from the system's internal number plan. For performance features **Open inquiry** and **Bundles**, several access codes can be assigned. The performance feature with modified access number is operated as described for the corresponding performance feature. You can use the modified access number (internal number) or the access number described in the user guide (excluding dialling code).

The **System Management->Access Codes->Alternative Access Codes** menu consists of the following fields:

Fields in the **Basic Settings** menu.

Field	Description
Line Access Digit	Select the exchange code. Possible values: <ul style="list-style-type: none"> • <i>None</i> • 0 (default value) • 6 • 7 • 8 • 9
Pick-up Group	Enter the new code for performance feature Pick-up (group) .

Field	Description
Pick-up (Extension)	Enter the new code for performance feature Pick-up (internal subscriber) .
Assign project codes	Enter the new code for performance feature Assign project codes .
Speed Dial	Enter the new code for performance feature Speed Dial .
Trunk Group Selection	<p>Create the new access numbers for the Trunk Group Selection feature.</p> <p>To do this, first click Add to create a bundle selection, select the bundle and enter the access number you require for the bundle.</p>
System Parking (Open Enquiry)	<p>Create the new access numbers for the System Parking (Open Enquiry) feature.</p> <p>To do this, first click Add to create a queue in which the caller is to be held, and enter the access number you require for the queue. You can create a maximum of 10 entries.</p>

7.4 Interface Mode / Bridge Groups

In this menu, you define the operation mode for your device's interfaces.

Routing versus bridging

Bridging connects networks of the same type. In contrast to routing, bridges operate at layer 2 of the OSI model (data link layer), are independent of higher-level protocols and transmit data packets using MAC addresses. Data transmission is transparent, which means the information contained in the data packets is not interpreted.

With routing, different networks are connected at layer 3 (network layer) of the OSI model and information is routed from one network to the other.

Conventions for port/interface names

If your device has a radio port, it receives the interface name WLAN. If there are several radio modules, the names of wireless ports in the user interface of your device are made up of the following parts:

- (a) WLAN
- (b) Number of the physical port (1 or 2)

Example: *WLAN1* The name of the Ethernet port is made up of the following parts:

- (a) ETH
- (b) Number of the port

Example: *ETH1*

The name of the interface connected to an Ethernet port is made up of the following parts:

- (a) Abbreviation for interface type, whereby *en* stands for internet.
- (b) Number of the Ethernet port
- (c) Number of the interface

Example: *en1-0* (first interface on the first Ethernet port)

The name of the bridge group is made up of the following parts:

- (a) Abbreviation for interface type, whereby *br* stands for bridge group.
- (b) Number of the bridge group

Example: *br0* (first bridge group)

The name of the wireless network (VSS) is made up of the following parts:

Abbreviation for interface type, whereby *vss* stands for wireless network.

- (a) Number of the wireless module
- (b) Number of the interface

Example: *vss1-0* (first wireless network on the first wireless module)

The name of the bridge link is made up of the following parts:

- (a) Abbreviation for interface type
- (b) Number of the wireless module on which the bridge link is configured
- (c) Number of the bridge link

Example: *wds1-0* (first bridge link on the first wireless module)

The name of the client link is made up of the following parts:

- (a) Abbreviation for interface type
- (b) Number of the wireless module on which the client link is configured
- (c) Number of the client link

Example: *sta1-0* (first client link on the first wireless module)

The name of the virtual interface connected to an Ethernet port is made up of the following parts:

- (a) Abbreviation for interface type
- (b) Number of the Ethernet port
- (c) Number of the interface connected to the Ethernet port
- (d) Number of the virtual interface

Example: *en1-0-1* (first virtual interface based on the first interface on the first Ethernet port)

7.4.1 Interfaces

You define separately whether each interface is to operate in routing or bridging mode.

If you want to set bridging mode, you can either use existing bridge groups or create a new bridge group.

The default setting for all existing interfaces is routing mode. When selecting the option *New Bridge Group* for **Mode / Bridge Group**, a bridge group, i.e. *br0, br1* etc. is automatically created and the interface is run in bridging mode.

The **System Management->Interface Mode / Bridge Groups->Interfaces** menu consists of the following fields:

Fields in the Interfaces menu.

Field	Description
Interface Description	Displays the name of the interface.
Mode / Bridge Group	Select whether you want to run the interface in <i>Routing Mode</i> or whether you want to assign the interface to an existing (<i>br0, br1</i> etc.) or new bridge group (<i>New Bridge Group</i>). When selecting <i>New Bridge Group</i> , a new bridge group is automatically created after you click the OK button.
Configuration Interface	Select the interface via which the configuration is to be carried out. Possible values: <ul style="list-style-type: none"> • <i>Select one</i> (default value): Ex works setting The right configuration interface must be selected from the other options.

Field	Description
	<ul style="list-style-type: none"> • <i>Ignore</i>: No interface is defined as configuration interface. • <i><Interface name></i>: Select the interface to be used for configuration. If this interface is in a bridge group, it is assigned the group's IP address when it is taken out of the group.

7.4.1.1 Add

Choose the **Add** button to edit the mode of PPP interfaces.

The **System Management->Interface Mode / Bridge Groups->Interfaces->Add** menu consists of the following fields:

Fields in the Interfaces menu.

Field	Description
Interface	Select the interface whose status should be changed.

Edit for devices the Wlxxxxn and RS series

For WLAN clients in bridge mode (so-called MAC Bridge) you can also edit additional settings via the  icon.

You can realise bridging for devices behind access clients with the MAC Bridge function. In wildcard mode you cannot define how Unicast non-IP frames or non-ARP frames are processed. To use the MAC bridge function, you must carry out configuration steps in several menus.

- (1) Select **GUI** menu **Wireless LAN->WLAN->Radio Settings** and click the icon to modify an entry.
- (2) Select **Operation Mode** = *Access Client* and save the settings with **OK**.
- (3) Select the **System Management->Interface Mode / Bridge Groups->Interfaces** menu. The additional interface **sta1-0** is displayed.
- (4) For interface **sta1-0** select Mode / Bridge Group = *br0 (<IPAddress>)* and **Configuration Interface**= *en1-0* and save the settings with **OK**.
- (5) Click the **Save configuration** button to save all of the configuration settings. You can use the MAC Bridge.

The **System Management->Interface Mode / Bridge Groups->Interfaces->**  menu consists of the following fields:

Fields in the Layer-2.5 Options menu.

Field	Value
Interface	Shows the interface that is being edited.
Wildcard Mode	<p>Select the Wildcard mode you want to use on the interface.</p> <p>Possible values:</p> <ul style="list-style-type: none"> • <i>none</i> (default value): Wildcard mode is not used. • <i>static</i>: With this setting, you must enter the MAC address of a device that is connected over IP under Wildcard MAC Address. Each packet without IP and without ARP is forwarded to this device. This occurs even when the device is no longer connected. • <i>first</i>: If you choose this setting, the MAC address of the first non-IP unicast frame or non-ARP unicast frame, which occurs on any of the Ethernet interfaces, is used as the wildcard MAC address. This wildcard MAC address can only be reset by rebooting the device or by selecting another wildcard mode. • <i>last</i>: If you choose this setting, the internal WLAN MAC address is used to establish a connection to the access point. As soon as a non-IP unicast frame or non-ARP unicast frame appears, it is forwarded to the MAC address from which the last non-IP unicast frame or non-ARP unicast frame was received on the Ethernet interface of the device. This wildcard MAC address is renewed with each non-IP unicast frame or non-ARP unicast frame.
Wildcard MAC Address	<p>Only for Wildcard Mode = <i>static</i></p> <p>Enter the MAC address of a device that is connected over IP.</p>
Transparent MAC Address	<p>Only for Wildcard Mode = <i>static, first</i></p> <p>Choose whether or not the Wildcard MAC Address are used in addition as WLAN MAC address to establish the connection to the access point.</p> <p>The function is enabled with <i>Enabled</i>.</p> <p>The function is disabled by default.</p>

7.5 Administrative Access

In this menu, you can configure the administrative access to the device.

7.5.1 Access

In the **System Management->Administrative Access->Access** menu, a list of all IP-capable interfaces is displayed.

For an Ethernet interface you can select the access parameters *Telnet, SSH, HTTP, HT-TPS, Ping, SNMP* and for the ISDN interfaces *ISDN Login*.



Note

Not all of the options above will be available in every bintec elmeg device. Consult the data sheet of your device which connection types are supported!

For PABX systems only: You can also authorise your device for maintenance work from bintec elmeg's Customer Service department. To do this you enable either **Service Login (ISDN Web-Access)** or **Service Call Ticket (SSH Web Access)**, depending on the service you require, and select the **OK** button. Follow the instructions given by Telekom's Customer Service!

Service Login (ISDN Web-Access) is disabled by default. If the option is activated, it is deactivated again after ca. 30 minutes.

The menu **Advanced Settings** consists of the following fields:

Fields in the menu Advanced Settings

Field	Description
Restore Default Settings	Only when you make changes to the administrative access configuration are relevant access rules set up and activated. You can restore the default settings with the  icon.

7.5.1.1 Add

Select the **Add** button to configure administrative access for additional interfaces.

The **System Management->Administrative Access->Access->Add** menu consists of the following fields:

Fields in the menu Access

Field	Description
Interface	Select the interface for which administrative access is to be configured.

7.5.2 SSH

Your devices offers encrypted access to the shell. You can enable or disable this access in the **System Management->Administrative Access->SSH Enabled** menu (standard value). You can also access the options for configuring the SSH login.

You need an SSH client application, e.g. PuTTY, to be able to reach the SSH Daemon.

If you wish to use SSH Login together with the PuTTY client, you may need to comply with some special configuration requirements, for which we have prepared FAQs. You will find these in the Service/Support section at www.bintec-elmeg.com.

To be able to reach the shell of your device via an SSH client, make sure the settings for the SSH Daemon and SSH client are the same.

**Note**

If configuration of an SSH connection is not possible, restart the device to initialise the SSH Daemon correctly.

The **System Management->Administrative Access->SSH** menu consists of the following fields:

Fields in the menu SSH (Secure Shell) Parameters

Field	Value
SSH service active	Select whether the SSH Daemon is to be enabled for the interface. The function is activated by selecting <i>Enabled</i> . The function is enabled by default.
SSH Port	Here you can enter the port via which the SSH connection is to be established. The default value is <i>22</i> .

Field	Value
Maximum number of concurrent connections	<p>Enter the maximum number of simultaneously active SSH connections.</p> <p>The default value is <i>1</i>.</p>

Fields in the menu **Authentication and Encryption Parameters**

Field	Value
Encryption Algorithms	<p>Select the algorithms that are to be used to encrypt the SSH connection.</p> <p>Possible options:</p> <ul style="list-style-type: none"> • <i>3DES</i> • <i>Blowfish</i> • <i>AES-128</i> • <i>AES-256</i> <p>By default <i>3DES</i>, <i>Blowfish</i> and <i>AES-128</i> are enabled.</p>
Hashing Algorithms	<p>Select the algorithms that are to be available for message authentication of the SSH connection.</p> <p>Possible options:</p> <ul style="list-style-type: none"> • <i>MD5</i> • <i>SHA-1</i> • <i>RipeMD 160</i> <p>By default <i>MD5</i>, <i>SHA-1</i> and <i>RipeMD 160</i> are enabled.</p>

Fields in the menu **Key Status**

Field	Value
RSA Key Status	<p>Shows the status of the RSA key.</p> <p>If an RSA key has not been generated yet, <i>Not generated</i> is displayed and a link, <i>Generate</i>, is provided. If you select the link, the generation process is triggered and the view is updated. The <i>Generating</i> status is displayed. When generation has been completed successfully, the status changes from <i>Generating</i> to <i>Generated</i>. If an error occurs during the generation, <i>Not generated</i> and the <i>Generate</i> link are displayed</p>

Field	Value
	<p>again. You can then repeat generation.</p> <p>If the <i>Unknown</i> status is displayed, generation of a key is not possible, for example because there is not enough space in the FlashROM.</p>
ECDSA Key Status	<p>Shows the status of the ECDSA key.</p> <p>If no ECDSA key has yet been generated, <i>Not generated</i> is displayed and a link, <i>Generate</i>, is provided. If you select the link, the generation process is triggered and the view is updated. The <i>Generating</i> status is displayed. When generation has been completed successfully, the status changes from <i>Generating</i> to <i>Generated</i>. If an error occurs during the generation, <i>Not generated</i> and the <i>Generate</i> link are displayed again. You can then repeat generation.</p> <p>If the <i>Unknown</i> status is displayed, generation of a key is not possible, for example because there is not enough space in the FlashROM.</p>
ED25519 Key Status	<p>Shows the status of the ED25519 key.</p> <p>If an ED25519 key has not been generated yet, <i>Not generated</i> is displayed and a link, <i>Generate</i>, is provided. If you select the link, the generation process is triggered and the view is updated. The <i>Generating</i> status is displayed. When generation has been completed successfully, the status changes from <i>Generating</i> to <i>Generated</i>. If an error occurs during the generation, <i>Not generated</i> and the <i>Generate</i> link are displayed again. You can then repeat generation.</p> <p>If the <i>Unknown</i> status is displayed, generation of a key is not possible, for example because there is not enough space in the FlashROM.</p>

The menu **Advanced Settings** consists of the following fields:

Fields in the menu **Advanced Settings**

Field	Value
Login Grace Time	<p>Enter the time (in seconds) that is available for establishing the connection. If a client cannot be successfully authenticated during this time, the connection is terminated.</p>

Field	Value
	The default value is <i>600</i> seconds.
Compression	Select whether data compression should be used. The function is activated by selecting <i>Enabled</i> . The function is disabled by default.
TCP Keepalives	Select whether the device is to send keepalive packets. The function is activated by selecting <i>Enabled</i> . The function is enabled by default.
Logging Level	Select the syslog level for the syslog messages generated by the SSH Daemon. Possible settings: <ul style="list-style-type: none"> • <i>Information</i> (default value): Fatal and simple errors of the SSH Daemon and information messages are recorded. • <i>Fatal</i>: Only fatal errors of the SSH Daemon are recorded. • <i>Error</i>: Fatal and simple errors of the SSH Daemon are recorded. • <i>Debug</i>: All messages are recorded.

7.5.3 SNMP

SNMP (Simple Network Management Protocol) is a network protocol used to monitor and control network elements (e.g. routers, servers, switches, printers, computers etc.) from a central station. SNMP controls communication between the monitored devices and monitoring station. The protocol describes the structure of the data packets that can be transmitted, as well as the communication process.

The data objects queried via SNMP are structured in tables and variables and defined in the MIB (Management Information Base). This contains all the configuration and status variables of the device.

SNMP can be used to perform the following network management tasks:

- Surveillance of network components
- Remote controlling and configuration of network components

- Error detection and notification

You use this menu to configure the use of SNMP.

The menu **System Management->Administrative Access->SNMP** consists of the following fields:

Fields in the **Basic Settings** menu.

Field	Value
SNMP Version	<p>Select the SNMP version your device is to use to listen for external SNMP access.</p> <p>Possible values:</p> <ul style="list-style-type: none"> • <i>v1</i>: SNMP Version 1 • <i>v2c</i>: Community-Based SNMP Version 2 • <i>v3</i>: SNMP Version 3 <p>By default, <i>v1</i>, <i>v2c</i> and <i>v3</i> are enabled.</p> <p>If no option is selected, the function is deactivated.</p>
SNMP Listen UDP Port	<p>Shows the UDP port (<i>161</i>) at which the device receives SNMP requests.</p> <p>The value cannot be changed.</p>
SNMP multicast discovery	<p>Enable or disable the function SNMP multicast discovery.</p> <p>The function is enabled with <i>Enabled</i>.</p> <p>The function is enabled by default.</p>



Tip

If your SNMP Manager supports SNMPv3, you should, if possible, use this version as older versions transfer all data unencrypted.

7.6 Remote Authentication

This menu contains the settings for user authentication.

7.6.1 RADIUS

RADIUS (Remote Authentication Dial In User Service) is a service that enables authentication and configuration information to be exchanged between your device and a RADIUS server. The RADIUS server administrates a database with information about user authentication and configuration and for statistical recording of connection data.

RADIUS can be used for:

- Authentication
- Accounting
- Exchange of configuration data

For an incoming connection, your device sends a request with user name and password to the RADIUS server, which then searches its database. If the user is found and can be authenticated, the RADIUS server sends corresponding confirmation to your device. This confirmation also contains parameters (called RADIUS attributes), which your device uses as WAN connection parameters.

If the RADIUS server is used for accounting, your device sends an accounting message at the start of the connection and a message at the end of the connection. These start and end messages also contain statistical information about the connection (IP address, user name, throughput, costs).

RADIUS packets

The following types of packets are sent between the RADIUS server and your device (client):

Packet types

Field	Value
ACCESS_REQUEST	Client -> Server If an access request is received by your device, a request is sent to the RADIUS server if no corresponding connection partner has been found on your device.
ACCESS_ACCEPT	Server -> Client If the RADIUS server has authenticated the information contained in the ACCESS_REQUEST, it sends an ACCESS_ACCEPT to your device together with the parameters used for setting up the connection.

Field	Value
ACCESS_REJECT	Server -> Client If the information contained in the ACCESS_REQUEST does not correspond to the information in the user database of the RADIUS server, it sends an ACCESS_REJECT to reject the connection.
ACCOUNTING_START	Client -> Server If a RADIUS server is used for accounting, your device sends an accounting message to the RADIUS server at the start of each connection.
ACCOUNTING_STOP	Client -> Server If a RADIUS server is used for accounting, your device sends an accounting message to the RADIUS server at the end of each connection.

A list of all entered RADIUS servers is displayed in the **System Management->Remote Authentication->RADIUS** menu.

7.6.1.1 Edit or New

Choose the  icon to edit existing entries. Choose the **New** button to add RADIUS servers.

The **System Management->Remote Authentication->RADIUS->New** menu consists of the following fields:

Fields in the **Basic Parameters** menu.

Field	Value
Authentication Type	Select what the RADIUS server is to be used for. Possible values: <ul style="list-style-type: none"> • <i>PPP Authentication</i> (default value only for PPP connections): The RADIUS server is used for controlling access to a network. • <i>Accounting</i> (for PPP connections only): The RADIUS server is used for recording statistical call data. • <i>Login Authentication</i>: The RADIUS server is used for

Field	Value
	<p>controlling access to the SNMP shell of your device.</p> <ul style="list-style-type: none"> • <i>IPSec Authentication</i>: The RADIUS server is used for sending configuration data for IPSec peers to your device. • <i>WLAN (802.1x)</i>: The RADIUS server is used for controlling access to a wireless network. • <i>XAUTH</i>: The RADIUS server is used for authenticating IPSec peers via XAuth.
Vendor Mode	<p>Only for Authentication Type = <i>Accounting</i></p> <p>In hotspot applications, select the mode define by the provider.</p> <p>In standard applications, leave the value set to <i>Default</i>.</p> <p>Possible values for hotspot applications:</p> <ul style="list-style-type: none"> • <i>France Telecom</i>: For France Telecom hotspot applications. • <i>bintec HotSpot Server</i>: For hotspot applications.
Server IP Address	Enter the IP address of the RADIUS server.
RADIUS Secret	Enter the shared password used for communication between the RADIUS server and your device.
Default User Password	Some Radius servers require a user password for each RADIUS request. Enter the password that your device sends as the default user password in the prompt for the dialout routes on the RADIUS server.
Priority	<p>If a number of RADIUS server entries were created, the server with the highest priority is used first. If this server does not answer, the server with the next-highest priority is used.</p> <p>Possible values from <i>0</i> (highest priority) to <i>7</i> (lowest priority).</p> <p>The default value is <i>0</i>.</p> <p>See also Policy in the Advanced Settings.</p>
Entry active	<p>Select whether the RADIUS server configured in this entry is to be used.</p> <p>The function is activated by selecting <i>Enabled</i>.</p>

Field	Value
	The function is enabled by default.
Group Description	<p>Define a new RADIUS group description or assign the new RADIUS entry to a predefined group. The configured RADIUS servers for a group are queried according to Priority and the Policy .</p> <p>Possible values:</p> <ul style="list-style-type: none"> • <i>New</i> (default value): Enter a new group description in the text field. • <i>Default Group 0</i>: Select this entry for special applications, such as Hotspot Server configuration. • <i><Group Name></i>: Select a predefined group from the list.

The **Advanced Settings** menu consists of the following fields:

Fields in the **Advanced Settings** menu.

Field	Value
Policy	<p>Select how your device is to react if a negative response to a request is received.</p> <p>Possible values:</p> <ul style="list-style-type: none"> • <i>Authoritative</i> (default value): A negative response to a request is accepted. • <i>Non-authoritative</i> : A negative response to a request is not accepted. A request is sent to the next RADIUS server until your device receives a response from a server configured as authoritative.
UDP Port	<p>Enter the UDP port to be used for RADIUS data.</p> <p>RFC 2138 defines the default ports 1812 for authentication (1645 in older RFCs) and 1813 for accounting (1646 in older RFCs). You can obtain the port to be used from the documentation for your RADIUS server.</p> <p>The default value is <i>1812</i>.</p>
Server Timeout	<p>Enter the maximum wait time between ACCESS_REQUEST and response in milliseconds.</p>

Field	Value
	<p>After timeout, the request is repeated according to Retries or the next configured RADIUS server is requested.</p> <p>Possible values are whole numbers between <i>50</i> and <i>50000</i>.</p> <p>The default value is <i>1000</i> (1 second).</p>
Alive Check	<p>Here you can activate a check of the accessibility of a RADIUS server in Status <i>Down</i> .</p> <p>An Alive Check is carried out regularly (every 20 seconds) by sending an ACCESS_REQUEST to the IP address of the RADIUS server. If the server is reachable, Status is set to <i>alive</i> again. If the RADIUS server is only reachable over a switched line (dialup connection), this can cause additional costs if the server is <i>down</i> for a long time.</p> <p>The function is activated by selecting <i>Enabled</i>.</p> <p>The function is enabled by default.</p>
Retries	<p>Enter the number of retries for cases when there is no response to a request. If an response has still not been received after these attempts, the Status is set to <i>down</i>. In Alive Check = <i>Enabled</i> your device attempts to reach the server every 20 seconds. If the server responds, Status is set back to <i>alive</i> .</p> <p>Possible values are whole numbers between <i>0</i> and <i>10</i>.</p> <p>The default value is <i>1</i>. To prevent Status being set to <i>down</i>, set this value to <i>0</i>.</p>
RADIUS Dialout	<p>Only for Authentication Type = <i>PPP Authentication</i> and <i>IPSec Authentication</i>.</p> <p>Select whether your device receives requests from RADIUS server dialout routes. This enables temporary interfaces to be configured automatically and your device can initiate outgoing connections that are not configured permanently.</p> <p>The function is activated by selecting <i>Enabled</i>.</p> <p>The function is disabled by default.</p> <p>If the function is active, you can enter the following options:</p>

Field	Value
	<ul style="list-style-type: none"> • <i>Reload Interval</i>: Enter the time period in seconds between update intervals. <p>The default entry here is 0 i.e. an automatic reload is not carried out.</p>

7.6.2 Options

This setting possible here causes your device to carry out authentication negotiation for incoming calls, if it cannot identify the calling party number (e.g. because the remote terminal does not signal the calling party number). If the data (password, partner PPP ID) obtained by executing the authentication protocol is the same as the data of a listed remote terminal or RADIUS user, your device accepts the incoming call.

The menu **System Management->Remote Authentication->Options** consists of the following fields:

Fields in the Global RADIUS Options menu.

Field	Description
Authentication for PPP Dialin	<p>By default, the following authentication sequence is used for incoming calls with RADIUS: First CLID, then PPP and then PPP with RADIUS.</p> <p>Options:</p> <ul style="list-style-type: none"> • <i>Inband</i>: Only inband RADIUS requests (PAP,CHAP, MS-CHAP V1 & V2) (i.e. PPP requests without CLID) are sent to the RADIUS server defined in Server IP Address. • <i>Outband (CLID)</i> : Only outband RADIUS requests (i.e. requests for calling line identification = CLID) are sent to the RADIUS server. <p><i>Inband</i> is enabled by default, <i>Outband (CLID)</i> is disabled by default.</p>

7.7 Certificates

An asymmetric cryptosystem is used to encrypt data to be transported in a network, to generate or check digital signatures and the authenticate users. A key pair consisting of a public key and a private key is used to encrypt and decrypt the data.

For encryption the sender requires the public key of the recipient. The recipient decrypts the data using his private key. To ensure that the public key is the real key of the recipient and is not a forgery, a so-called digital certificate is required.

This confirms the authenticity and the owner of a public key. It is similar to an official passport in that it confirms that the holder of the passport has certain characteristics, such as gender and age, and that the signature on the passport is authentic. As there is more than one certificate issuer, e.g. the passport office for a passport, and as such certificates can be issued by several different issuers and in varying qualities, the trustworthiness of the issuer is extremely important. The quality of a certificate is regulated by the German Signature Act or respective EU Directives.

Certification authorities that issue so-called qualified certificates are organised in a hierarchy with the Federal Network Agency as the higher certifying authority. The structure and content of a certificate are stipulated by the standard used. X.509 is the most important and the most commonly used standard for digital certificates. Qualified certificates are personal and extremely trustworthy.

Digital certificates are part of a so-called Public Key Infrastructure (PKI). PKI refers to a system that can issue, distribute and check digital certificates.

Certificates are issued for a specific period, usually one year, i.e. they have a limited validity period.

Your device is designed to use certificates for VPN connections and for voice connections over Voice over IP.

7.7.1 Certificate List

A list of all existing certificates is displayed in the **System Management->Certificates->Certificate List** menu.

7.7.1.1 Edit

Click the  icon to display the content of the selected object (key, certificate, or request).

The certificates and keys themselves cannot be changed, but a few external attributes can be changed, depending on the type of the selected entry.

The **System Management->Certificates->Certificate List->**  menu consists of the following fields:

Fields in the Edit parameters menu.

Field	Description
Description	Shows the name of the certificate, key, or request.
Certificate is CA Certificate	<p>Mark the certificate as a certificate from a trustworthy certification authority (CA).</p> <p>Certificates issued by this CA are accepted during authentication.</p> <p>The function is enabled with <i>True</i>.</p> <p>The function is disabled by default.</p>
Certificate Revocation List (CRL) Checking	<p>Only for Certificate is CA Certificate = <i>True</i></p> <p>Define the extent to which certificate revocation lists (CRLs) are to be included in the validation of certificates issued by the owner of this certificate.</p> <p>Possible settings:</p> <ul style="list-style-type: none"> • <i>Disabled</i>: No CRLs check. • <i>Always</i>: CRLs are always checked. • <i>Only if a CRL Distribution Point is present</i> (default value): A check is only carried out if a CRL Distribution Point entry is included in the certificate. This can be determined under "View Details" in the certificate content. • <i>Use settings from superior certificate</i>: The settings of the higher level certificate are used, if one exists. If it does not, the same procedure is used as that described under "Only if a CRL Distribution Point is present".
Force certificate to be trusted	<p>Define that this certificate is to be accepted as the user certificate without further checks during authentication.</p> <p>The function is enabled with <i>True</i>.</p> <p>The function is disabled by default.</p>



Caution

It is extremely important for VPN security that the integrity of all certificates manually marked as trustworthy (certification authority and user certificates) is ensured. The displayed "fingerprints" can be used to check this integrity: Compare the displayed values with the fingerprints specified by the issuer of the certificate (e.g. on the Internet). It is sufficient to check one of the two values.

7.7.1.2 Certificate Request

Registration authority certificates in SCEP

If SCEP (Simple Certificate Enrollment Protocol) is used, your device also supports separate registration authority certificates.

Registration authority certificates are used by some Certificate Authorities (CAs) to handle certain tasks (signature and encryption) during SCEP communication with separate keys, and to delegate the operation to separate registration authorities, if applicable.

When a certificate is downloaded automatically, i.e. if **CA Certificate** = -- *Download* -- is selected, all the certificates needed for the operation are loaded automatically.

If all the necessary certificates are already available in the system, these can also be selected manually.

Select the **Certificate Request** button to request or import more certificates.

The menu **System Management->Certificates->Certificate List->Certificate Request** consists of the following fields:

Fields in the Certificate Request menu.

Field	Description
Certificate Request Description	Enter a unique description for the certificate.
Mode	Select the way in which you want to request the certificate. Possible settings: <ul style="list-style-type: none"> • <i>Manual</i> (default value): Your device generates a PKCS#10 for the key. This file can then be uploaded directly in the browser or copied in the  menu using the View details field. This file must be provided to the CA and the received

Field	Description
	<p>certificate must then be imported manually to your device.</p> <ul style="list-style-type: none"> • <i>SCEP</i> : The key is requested from a CA using the Simple Certificate Enrolment Protocol.
Generate Private Key	<p>Only for Mode = <i>Manual</i></p> <p>Select an algorithm for key creation.</p> <p><i>RSA</i> (default value) and <i>DSA</i> are available.</p> <p>Also select the length of the key to be created.</p> <p>Possible values: <i>512, 768, 1024, 1536, 2048, 4096</i>.</p> <p>Please note that a key with a length of 512 bits could be rated as unsecure, whereas a key of 4096 bits not only needs a lot of time to create, but also occupies a major share of the resources during IPSec processing. A value of 768 or more is, however, recommended and the default value is 1024 bits.</p>
SCEP URL	<p>Only for Mode = <i>SCEP</i></p> <p>Enter the URL of the SCEP server, e.g. <code>http://scep.bintec-elmeg.com:8080/scep/scep.dll</code></p> <p>Your CA administrator can provide you with the necessary data.</p>
CA Certificate	<p>Only for Mode = <i>SCEP</i></p> <p>Select the CA certificate.</p> <ul style="list-style-type: none"> • In <code>-- Download --</code>: In CA Name, enter the name of the CA certificate of the certification authority (CA) from which you wish to request your certificate, e.g. <i>cawindows</i>. Your CA administrator can provide you with the necessary data. <p>If no CA certificates are available, the device will first download the CA certificate of the relevant CA. It then continues with the enrolment process, provided no more important parameters are missing. In this case, it returns to the Generate Certificate Request menu.</p> <p>If the CA certificate does not contain a CRL distribution point (Certificate Revocation List, CRL), and a certificate server is not configured on the device, the validity of certificates from</p>

Field	Description
	<p>this CA is not checked.</p> <ul style="list-style-type: none"> • <name of an existing certificate>: If all the necessary certificates are already available in the system, you select these manually.
RA Sign Certificate	<p>Only for Mode = <i>SCEP</i></p> <p>Only for CA Certificate not = <i>-- Download --</i></p> <p>Select a certificate for signing SCEP communication.</p> <p>The default value is <i>-- Use CA Certificate --</i>, i.e. the CA certificate is used.</p>
RA Encrypt Certificate	<p>Only for Mode = <i>SCEP</i></p> <p>Only if RA Sign Certificate not = <i>-- Use CA Certificate --</i></p> <p>If you use one of your own certificates to sign communication with the RA, you can select another one here to encrypt communication.</p> <p>The default value is <i>-- Use RA Sign Certificate --</i>, i.e. the same certificate is used as for signing.</p>
Password	<p>Only for Mode = <i>SCEP</i></p> <p>You may need a password from the certification authority to obtain certificates for your keys. Enter the password you received from the certification authority here.</p>

Fields in the **Subject Name** menu.

Field	Description
Custom	<p>Select whether you want to enter the name components of the subject name individually as specified by the CA or want to enter a special subject name.</p> <p>If <i>Enabled</i> is selected, a subject name can be given in Summary with attributes not offered in the list. Example: "CN=VPNServer, DC=mydomain, DC=com, c=DE".</p> <p>If the field is not selected, enter the name components in Com-</p>

Field	Description
	Common Name, E-mail, Organizational Unit, Organization, Locality, State/Province and Country. The function is disabled by default.
Summary	Only for Custom = enabled. Enter a subject name with attributes not offered in the list. Example: "CN=VPNServer, DC=mydomain, DC=com, c=DE".
Common Name	Only for Custom = disabled. Enter the name according to CA.
E-mail	Only for Custom = disabled. Enter the e-mail address according to CA.
Organizational Unit	Only for Custom = disabled. Enter the organisational unit according to CA.
Organization	Only for Custom = disabled. Enter the organisation according to CA.
Locality	Only for Custom = disabled. Enter the location according to CA.
State/Province	Only for Custom = disabled. Enter the state/province according to CA.
Country	Only for Custom = disabled. Enter the country according to CA.

The menu **Advanced Settings** consists of the following fields:

Fields in the **Subject Alternative Names** menu.

Field	Description
#1, #2, #3	For each entry, define the type of name and enter additional

Field	Description
	<p>subject names.</p> <p>Possible values:</p> <ul style="list-style-type: none"> • <i>None</i> (default value): No additional name is entered. • <i>IP</i>: An IP address is entered. • <i>DNS</i>: A DNS name is entered. • <i>E-mail</i>: An e-mail address is entered. • <i>URI</i>: A uniform resource identifier is entered. • <i>DN</i>: A distinguished name (DN) name is entered. • <i>RID</i>: A registered identity (RID) is entered.

Fields in the Options menu

Field	Description
Autosave Mode	<p>Select whether your device automatically stores the various steps of the enrolment internally. This is an advantage if enrolment cannot be concluded immediately. If the status has not been saved, the incomplete registration cannot be completed. As soon as the enrolment is completed and the certificate has been downloaded from the CA server, it is automatically saved in the device configuration.</p> <p>The function is enabled with <i>Enabled</i>.</p> <p>The function is enabled by default.</p>

7.7.1.3 Import

Choose the **Import** button to import certificates.

The menu **System Management->Certificates->Certificate List->Import** consists of the following fields:

Fields in the Import menu.

Field	Description
External Filename	Enter the file path and name of the certificate to be imported, or use Browse... to select it from the file browser.
Local Certificate De-	Enter a unique description for the certificate.

Field	Description
scription	
File Encoding	<p>Select the type of coding so that your device can decode the certificate.</p> <p>Possible values:</p> <ul style="list-style-type: none"> • <i>Auto</i> (default value): Activates automatic code recognition. If downloading the certificate in auto mode fails, try with a certain type of encoding. • <i>Base64</i> • <i>Binary</i>
Password	<p>You may need a password to obtain certificates for your keys.</p> <p>Enter the password here.</p>

7.7.2 CRLs

In the **System Management->Certificates->CRLs** menu, a list of all CRLs (Certification Revocation List) is displayed.

If a key is no longer to be used, e.g. because it has fallen into the wrong hands or has been lost, the corresponding certificate is declared invalid. The certification authority revokes the certificate and publishes it on a certificate blacklist, so-called CRL. Certificate users should always check against these lists to ensure that the certificate used is currently valid. This check can be automated via a browser.

The Simple Certificate Enrollment Protocol (SCEP) supports the issue and revocation of certificates in networks.

7.7.2.1 Import

Choose the **Import** button to import CRLs.

The **System Management->Certificates->CRLs->Import** menu consists of the following fields:

Fields in the CRL Import menu.

Field	Description
External Filename	<p>Enter the file path and name of the CRL to be imported, or use Browse... to select it from the file browser.</p>

Field	Description
Local Certificate Description	Enter a unique description for the CRL.
File Encoding	<p>Select the type of encoding, so that your device can decode the CRL.</p> <p>Possible values:</p> <ul style="list-style-type: none"> • <i>Auto</i> (default value): Activates automatic code recognition. If downloading the CRL in auto mode fails, try with a certain type of encoding. • <i>Base64</i> • <i>Binary</i>
Password	Enter the password required for the import.

7.7.3 Certificate Servers

A list of certificate servers is displayed in the **System Management->Certificates->Certificate Servers** menu.

A certification authority (certification service provider, Certificate Authority, CA) issues your certificates to clients applying for a certificate via a certificate server. The certificate server also issues the private key and provides certificate revocation lists (CRL) that are accessed by the device via LDAP or HTTP in order to verify certificates.

7.7.3.1 New

Choose the **New** button to set up a certificate server.

The **System Management->Certificates->Certificate Servers->New** menu consists of the following fields:

Fields in the Basic Parameters menu.

Field	Description
Description	Enter a unique description for the certificate server.
LDAP URL Path	Enter the LDAP URL or the HTTP URL of the server.

Chapter 8 Physical Interfaces

In this menu, you configure the physical interfaces that you have used when connecting your gateway. The configuration interface only shows the interfaces that are available on your device. In the **System Management->Status** menu, you can see a list of all physical interfaces and information on whether the interfaces are connected or active and whether they have already been configured.

8.1 Ethernet Ports

An Ethernet interface is a physical interface for connection to the local network or external networks.

The Ethernet ports **ETH1** to **ETH4** are assigned to a single logical Ethernet interface in ex works state. The logical Ethernet interface `en1-0` is assigned and is preconfigured with the **IP Address** `192.168.0.250` and **Netmask** `255.255.255.0` .



Note

To ensure your system can be reached, when splitting ports make sure that Ethernet interface `en1-0` with the preconfigured IP address and netmask is assigned to a port that can be reached via Ethernet. If in doubt, carry out the configuration using a serial connection via the **Serial 1** interface.

ETH1 - ETH4

The interfaces can be used separately. They are logically separated from each other, each separated port is assigned the desired logical Ethernet interface in the **Ethernet Interface Selection** field of the **Port Configuration** menu. For each assigned Ethernet interface, another interface is displayed in the list in the **LAN->IP Configuration** menu, and the interface can be configured completely independently.

VLANs for Routing Interfaces

Configure VLANs to separate individual network segments from each other, for example (e.g. individual departments of a company) or to reserve bandwidth for individual VLANs when managed switches are used with the QoS function.

8.1.1 Port Configuration

Port Separation

Your device makes it possible to run the switch ports as one interface or to logically separate these from each other and to configure them as independent Ethernet interfaces.

During configuration, please note the following: The splitting of the switch ports into several Ethernet interfaces merely logically separates these from each other. The available total bandwidth of max. 1000 mbps full duplex for all resulting interfaces remains the same. For example, if you split all the switch ports from each other, each of the resulting interfaces only uses a part of the total bandwidth. If you group together several switch ports into one interface, the full bandwidth of max. 1000 mbps full duplex is available for all the ports together.

The menu **Physical Interfaces->Ethernet Ports->Port Configuration** consists of the following fields:

Fields in the Switch Configuration menu.

Field	Description
Switch Port	Shows the respective switch port. The numbering corresponds to the numbering of the Ethernet ports on the back of the device.
Ethernet Interface Selection	Assign a logical Ethernet interface to the switch port. You can select from four interfaces, <i>en1-0</i> to <i>en1-4</i> . In the basic setting, switch port 1 - 4 has the <i>en1-0</i> interface assigned to it.
Configured Speed / Mode	Select the mode in which the interface is to run. Possible values: <ul style="list-style-type: none"> • <i>Full Autonegotiation</i> (default value) • <i>Auto 1000 mbps only</i> • <i>Auto 100 mbps only</i> • <i>Auto 10 mbps only</i> • <i>Auto 100 mbps / Full Duplex</i> • <i>Auto 100 mbps / Half Duplex</i> • <i>Auto 10 mbps / Full Duplex</i>

Field	Description
	<ul style="list-style-type: none"> • <i>Auto 10 mbps / Half Duplex</i> • <i>Fixed 1000 mbps / Full Duplex</i> • <i>Fixed 100 mbps / Full Duplex</i> • <i>Fixed 100 mbps / Half Duplex</i> • <i>Fixed 10 mbps / Full Duplex</i> • <i>Fixed 10 mbps / Half Duplex</i> • <i>None</i>: The interface is created but remains inactive.
Current Speed / Mode	<p>Shows the actual mode and actual speed of the admin interface.</p> <p>Possible values:</p> <ul style="list-style-type: none"> • <i>1000 mbps / Full Duplex</i> • <i>100 mbps / Full Duplex</i> • <i>100 mbps / Half Duplex</i> • <i>10 mbps / Full Duplex</i> • <i>10 mbps / Half Duplex</i> • <i>Down</i>
Flow Control	<p>Select whether a flow control should be conducted on the corresponding interface.</p> <p>Possible values:</p> <ul style="list-style-type: none"> • <i>Disabled</i> (default value): No flow control is performed. • <i>Enabled</i>. Flow will be controlled. • <i>Auto</i>: Flow will be controlled automatically.

8.2 ISDN Ports (PBX)

The ISDN connections of the system are as internal ISDN connections provided for connecting various ISDN terminals (system telephones, ISDN telephones, ...).



Note

Without an adapter which is available as an accessory, both ISDN connections can only be operated as internal ISDN connections (NT mode). If you have connected the adapter, you can switch the corresponding port to external operation (TE mode) in this menu.

Note that switching the operation mode is only possible if your device has been manufactured in 2016. You can determine if this is the case if a unique WLAN password is printed on the type label of your device.

8.2.1 ISDN Internal

You configure your system's internal ISDN interfaces in the **Physical Interfaces->ISDN Ports->ISDN Internal** menu.

The internal ISDN interfaces are designed for connecting different kinds of ISDN terminals (system phones, ISDN phones, etc.)

Two predefined entries with the parameters **Name** = *S/U 1*, **Usage** = *S0*, **Default MSN** = *30 (ISDN 30)*

and *S/U 2*, **Function** = **Default MSN** *S0* and **Default MSN** = *35 (ISDN 35)*

are displayed.

Internal ISDN connections are always point-to-multipoint connections

When connecting terminals to an internal ISDN connection, please note that not all commercially available ISDN terminals can use the performance features offered by the system via your key interface.

The **Physical Interfaces->ISDN Ports->ISDN Internal** menu consists of the following fields:

Fields in the ISDN Internal menu

Field	Description
Name	<p>Displays the designation of the ISDN interface.</p> <p>Possible values:</p> <ul style="list-style-type: none"> <i>S/U</i>: 4 wire (S) <i>/</i>: Displays the port on the module to which the ISDN interface is connected.

Field	Description
	Example: <i>S/U 2</i> = The interface is in port 2 and is used as an S-connector.
Function	Displays the function of the ISDN interface. Possible values: <ul style="list-style-type: none"> • <i>UPN</i>: Interface for UPN terminals. • <i>S0</i>: Interface for ISDN S0 connection.
default MSN	Shows whether a standard MSN has been assigned for an internal S0 bus. You cannot access configured S0 terminals via a standard MSN. As standard MSN, you can dial internal numbers that have been configured in the Numbering->User Settings->Users menu and which have been assigned to a terminal in the Terminals menu.
Status	Displays the status of the interface.

8.2.1.1 Edit

Choose the  button to edit an entry.

The menu **Physical Interfaces->ISDN Ports->ISDN Internal->**  consists of the following fields:

Fields in the Basic Settings menu

Field	Description
default MSN	Dial the required extension. You can dial under the numbers that you have configured in the Numbering->User Settings->Users->Numbers menu. Possible values: <ul style="list-style-type: none"> • <i>Not configured</i> • <i><Number></i>

8.2.2 ISDN Configuration

Switching the ISDN connections to external operation (TE mode) requires an adapter that is available as an accessory. Otherwise, both ISDN connections can only be operated as internal connections (NT mode). If you have attached the respective adapter, you can switch the corresponding port to external operation in this menu.

SYNC Interface Settings



Note

This function is available only for **be.IP 4isdn!**

Here you can select if your device is to generate (*Standard*) or receive (*slave*) the ISDN clock signal when connecting two devices via the sync interface in order to increase the number of available ISDN ports.

8.3 DSL Modem

The ADSL modem is ideal for high-speed Internet access and remote access use in SMEs or remote offices.

8.3.1 DSL Configuration

In this menu, you make the basic settings for your ADSL connection.

The menu **Physical Interfaces->DSL Modem->DSL Configuration** consists of the following fields:

Fields in the DSL Port Status menu.

Field	Description
DSL Chipset	Shows the key of the installed chipset.
Physical Connection	Shows the current ADSL operation mode. The value cannot be changed. Possible values: <ul style="list-style-type: none"> • <i>Unknown</i>: The ADSL link is not active. • <i>ANSI T1.413</i>: ANSI T1.413

Field	Description
	<ul style="list-style-type: none"> • <i>ADSL1</i>: ADSL classic, G.DMT, ITU G.992.1 • <i>G.lite G992.2</i>: Splitterless ADSL, ITU G.992.2 • <i>ADSL2</i>: G.DMT.Bis, ITU G.992.3 • <i>ADSL2 DELT</i>: ADSL2 Double Ended Line Test • <i>ADSL2 Plus</i>: ADSL2 Plus, ITU G.992.5 • <i>ADSL2 Plus DELT</i>: ADSL2 Plus Double Ended Line Test • <i>READSL2</i>: Reach Extended ADSL2 • <i>READSL2 DELT</i>: Reach Extended ADSL2 Double Ended Line Test. • <i>ADSL2 ITU-T G.992.3 Annex M</i> • <i>ADSL2+ ITU-T G.992.5 Annex M</i> • <i>ADSL2 Annex J</i> • <i>ADSL2+ Annex J</i>

Fields in the **Current Line Speed** menu.

Field	Description
Downstream	Displays the data rate in the receive direction (direction from CO/DSLAM to CPE/router) in bits per second. The value cannot be changed.
Upstream	Displays the data rate in the send direction (direction from CPE/router to CO/DSLAM) in bits per second. The value cannot be changed.

Fields in the **DSL Parameter** menu.

Field	Description
DSL Mode	<p>Select the DSL Mode.</p> <p>Possible values:</p> <ul style="list-style-type: none"> • <i>Inactive</i>: The VDSL interface is not active. • <i>ETSI T1.413</i>: ETSI T1.413 • <i>ADSL1</i> :ADSL1 / G.DMT is used. • <i>ADSL Automode</i> (default value if the device is operated as a PBX): Automatic detection of ADSL mode <i>ADSL1</i>, <i>ADSL2</i> or <i>ADSL2 Plus</i>

Field	Description
	<ul style="list-style-type: none"> • <i>ADSL2</i>: ADSL2 / G.992.3 is used. • <i>ADSL2 Plus</i>: ADSL2 Plus / G.992.5 is used. • <i>VDSL</i>: VDSL2 (ITU-T G.993.2) • <i>VDSL/ADSL Multimode</i>: Automatic detection of DSL mode <i>ADSL1</i>, <i>ADSL2</i>, <i>ADSL2 Plus</i> or <i>VDSL</i>
Transmit Shaping	<p>Select whether the data rate in the send direction is to be reduced. This is only needed in a few cases for special DSLAMs.</p> <p>Possible values:</p> <ul style="list-style-type: none"> • <i>Default (Line Speed)</i> (default value): The data rate in the send direction is not reduced. • <i>128,000 bps to 2,048,000 bps</i>: The data rate in the send direction is reduced to a maximum of 128,000 bps to 2,048,000 bps in defined steps. • <i>User-defined</i>: The data rate is reduced to the value entered in Maximum Upstream Bandwidth. <p>The default value is <i>Default (Line Speed)</i>.</p>
Maximum Upstream Bandwidth	<p>Only for Transmit Shaping = <i>User-defined</i></p> <p>Enter the maximum data rate in the send direction in bits per second.</p>
SNR Margin	<p>The signal-to-noise ratio (SNR) can be controlled via the slider from 0 to 5 dB. Change the value only for DLS line problems.</p>

The menu **Advanced Settings** consists of the following fields:

Fields in the **Advanced Settings** menu.

Field	Description
DSL Line Profile	<p>Select the internet service provider you require and, in doing so, implicitly select the modem parameter set used by this provider.</p> <p><i>Deutsche Telekom</i> is entered as the default value.</p> <p>If your provider is not shown in the list, use the <i>default</i> setting.</p>

Chapter 9 VoIP (PABX)

Voice over IP (VoIP) uses the IP protocol for voice and video transmission.

The main difference compared with conventional telephony is that the voice information is not transmitted over a switched connection in a telephone network, but divided into data packets by the Internet protocol and these packets are then passed to the destination over undefined paths in a network. This technology uses the existing network infrastructure for voice transmission and shares this with other communication services.

9.1 Settings



You set up your VoIP connections in the **VoIP->Settings** menu.

You can telephone over the internet using all internally connected telephones. The number of connections depends on various parameters:

- The availability of the system's free channels.
- The available bandwidth of the DSL connection.
- The configured, available SIP providers.
- The SIP-out licenses that have been entered.

9.1.1 SIP Provider

You configure the SIP provider you want in the **VoIP->Settings->SIP Provider** menu.

You change the status of the SIP provider by pressing the  button or the  button in the **Action** column.

After about one minute, registration with the provider has taken place and the status is automatically set to  (active).

9.1.1.1 Edit or New

Choose the  icon to edit existing entries. Select the **New** button to create new entries.

The menu **VoIP->Settings->SIP Provider->New** consists of the following fields:

Fields in the Basic Settings menu.

Field	Description
Description	You can enter a name for the SIP provider. A 20 digit alpha-numeric sequence is possible.
Provider Status	Select whether this VoIP provider entry is enabled (<i>Enabled</i> , default value) or not (<i>disabled</i>).
Access Type	Select which type of VoIP phonenumbers you wish to configure. Possible values: <ul style="list-style-type: none"> • <i>Single Number(s)</i> (default value): Enter the individual DSL phonenumbers. • <i>Direct Dial-In</i>: Enter a basic number in conjunction with an extension number block.
Authentication ID	Enter your provider's authentication ID. A 64 digit alpha-numeric sequence is possible.
Password	At this point, you can assign a password. A 64 digit alpha-numeric sequence is possible.
User Name	Enter the user name you received from your VoIP provider. A 64 digit alpha-numeric sequence is possible.
Domain / Realm	Enter a new domain name or a new IP address for the SIP proxy server. If you do not make an entry, the entry in the Registrar field is used. Note: Enter a name or IP address only if this is explicitly specified by the provider.

Fields in the **Outgoing Signalisation Settings** menu.

Field	Description
Outgoing Signalisation	Select the signal you want for outgoing calls. Possible values: <ul style="list-style-type: none"> • <i>Standard</i> (default value) • <i>Global CLIP no Screening Number</i> • <i>Individual CLIP no Screening Number</i>

Field	Description
	<ul style="list-style-type: none"> • <i>Fixed Out DDI</i> (Only for Access Type = <i>Direct Dial-In</i>)
Global CLIP no Screening Number	<p>Only for Outgoing Signalisation <i>Global CLIP no Screening Number</i></p> <p>Enter the number that is to be displayed to the person called with any outward connection.</p> <p>This number is not checked.</p>
Signal remote caller number	<p>Only for Outgoing Signalisation = <i>Global CLIP no Screening Number</i> and <i>Individual CLIP no Screening Number</i></p> <p>You can display the number of an external subscriber if it is signalled.</p> <p>The function is enabled with <i>Enabled</i>.</p> <p>The function is disabled by default.</p>
Signal fixed out number	<p>Only for Outgoing Signalisation = <i>Fixed Out DDI</i></p> <p>Enter the number that is to be displayed to the person called with any outward connection.</p>

Fields in the Registrar menu.

Field	Description
Registrar	Enter the DNS name or IP address of the SIP server. A 26 digit alpha-numeric sequence is possible.
Registrar Port	Enter the number of the port to be used for the connection to the server. The default value is <i>5060</i> . A 5 digit sequence is possible.
Transport Protocol	<p>Select the transport protocol for the connection.</p> <p>Possible values:</p> <ul style="list-style-type: none"> • <i>UDP</i> (default value) • <i>TCP</i> • <i>TLS</i>

Field	Description
	<ul style="list-style-type: none"> <i>Automatic</i> - With this setting, your device supports automatic negotiation of the protocol with your provider's servers. For this setting to work, this negotiation must also be supported by the provider.

Fields in the STUN menu.

Field	Description
STUN server	<p>Enter the name or the IP address of the STUN server.</p> <p>STUN = Simple Traversal of User Datagram Protocol (UDP) Through Network Address Translators (NATs)</p> <p>A STUN server is required to allow VoIP devices access to the internet behind an active NAT. This determines the current public IP address for the connection, which is used for precise remote addressing.</p> <p>Maximum number of characters: 32.</p>
Port STUN server	<p>Enter the number of the port to be used for the connection to the STUN server.</p> <p>The default value is <i>3478</i>. A 5 digit sequence is possible.</p>

Fields in the Timer menu.

Field	Description
Registration Timer	<p>Enter the time in seconds within which the SIP client must re-register to prevent the connection from disconnecting automatically.</p> <p>The default value is <i>600</i>.</p>

The menu **Advanced Settings** consists of the following fields:

Fields in the Advanced Settings menu.

Field	Description
Proxy	<p>Enter the DNS name or IP address of the SIP server. A 26 digit alpha-numeric sequence is possible.</p>
Proxy Port	<p>Enter the number of the port to be used for the connection to the proxy. The default value is <i>5060</i>. A 5 digit sequence is possible.</p>

Field	Description
	sible.
Transport Protocol	<p>Select the transport protocol for the connection.</p> <p>Possible values:</p> <ul style="list-style-type: none"> • <i>UDP</i> (default value) • <i>TCP</i> • <i>TLS</i> • <i>Automatic</i> - With this setting, your device supports automatic negotiation of the protocol with your provider's servers. For this setting to work, this negotiation must also be supported by the provider.

Fields in the Further Settings menu

Field	Description
From Domain	Enter the SIP provider's "From Domain". It is used after the @ as sender data in the SIP header of the SIP data packages.
Number of allowed simultaneous Calls	<p>Select the maximum number of calls that shall be simultaneously possible Please also note the settings for bandwidth management here.</p> <p>Possible values:</p> <ul style="list-style-type: none"> • <i>International</i> (default value): An unlimited number of simultaneous calls is possible. • 1 • 2 • 3 • 4 • 5 • 10
Location	<p>Select the location of the SIP server. Locations are defined in the VoIP->Settings->Locations menu.</p> <p>Possible values:</p> <ul style="list-style-type: none"> • <i>Any Location</i> (default value): The server is not operated at any defined location.

Field	Description
	<ul style="list-style-type: none"> • <i><Location Name></i>
Codec Profiles	<p>Select the codec profile for this SIP server. Codec profiles are defined in the VoIP->Settings->Codec Profiles menu.</p> <p>Possible values:</p> <ul style="list-style-type: none"> • <i>System Default</i> (default value): The server is operated with a codec profile predefined in the system. • <i><Codec profile name></i>
Dial End Monitoring Time	<p>Select the time in seconds (after dialling the last digit of a call number) after which the system begins external dialling. The default value is 5.</p>
Call Hold inside the PBX system	<p>The network-centric functions call hold, call switching, 3-way conference call and call waiting can be enabled by disabling the option Call Hold inside the PBX system. The functions are then no longer provided by the PABX, but by the public network, instead. A corresponding contract with provider and customer is required which includes a bandwidth limitation (number of simultaneously usable voice channels).</p> <p>If a SIP provider - such as Deutsche Telekom - offers multiple SIP accounts / numbers via a single connection, this option should be deactivated for each of them. This is required to support the bandwidth limitation for several numbers via a single network connection.</p> <p>If an external call is held, no MoH is played through the PABX, but the public network provides MoH or an announcement for the remotely held party.</p>
Call Forwarding extern (SIP 302)	<p>Select whether calls are to be redirected externally with the SIP provider. The call is forwarded using SIP status code 302.</p> <p>The function is activated by selecting <i>Enabled</i>.</p> <p>The function is disabled by default.</p>
Generate international phone number	<p>If you enable this function and, under Global Settings, you have entered the Country Profile (49 for Germany), the 0049 is generated automatically in front of the number when a number with an area code is dialled.</p>

Field	Description
	<p>The function is activated by selecting <i>Enabled</i>.</p> <p>The function is disabled by default.</p>
Generate national subscriber number	<p>If you enable this function and, under Global Settings, you have entered the National Prefix / City Code (e.g. 40 for Hamburg), the number dialed is automatically prefixed with 040.</p> <p>The function is activated by selecting <i>Enabled</i>.</p> <p>The function is disabled by default.</p>
Deactivate number suppression	<p>If you enable this function, the number is always sent, independently of whether you have switched Suppress outgoing CLIP (CLIR) on or off for an extension.</p> <p>The function is activated by selecting <i>Enabled</i>.</p> <p>The function is disabled by default.</p> <p>If the function is disabled, you have additional options.</p> <p>In order to ensure that your system can forward anonymous calls with SIP connections you can specify in which part of the SIP header information the string "anonymous call" is transferred. The information can be transferred in multiple parts. For most providers you can simply keep the preconfigured setting <i>Privacy ID = Enabled</i>. For the service provider 1 & 1 you need to additionally enable <i>Privacy Header</i>.</p> <p>Possible values:</p> <ul style="list-style-type: none"> • <i>Display</i> • <i>Users</i> • <i>Domain</i> • <i>Privacy Header</i> • <i>Privacy User</i> • <i>Privacy ID</i>
SIP Header Field: FROM Display	<p>Not for Trunk Mode = <i>Off</i></p> <p>The sender ID is placed in the "Display" field of the SIP header.</p>

Field	Description
	<p>Possible values:</p> <ul style="list-style-type: none"> • <i>None</i> (default value): The sender ID is not sent. • <i>Username</i>: The user-configured user name is displayed. • <i>Caller Address</i>: The user-configured number the called party is displayed. • <i>Billing Number</i>: The actual phone number from which the calls is initiated (e.g. for billing purposes) is displayed.
<p>SIP Header Field: FROM User</p>	<p>Not for Trunk Mode = <i>Off</i></p> <p>The sender ID is sent in the "User" field of the SIP header.</p> <p>Possible values:</p> <ul style="list-style-type: none"> • <i>Username</i>(default value): The user-configured user name is displayed. • <i>Caller Address</i>: The user-configured number the called party is displayed. • <i>Billing Number</i>: The actual phone number from which the calls is initiated (e.g. for billing purposes) is displayed.
<p>SIP Header Field: P-Preferred</p>	<p>Not for Trunk Mode = <i>Off</i></p> <p>The so-called "p-preferred-identity" field is added to the SIP header and contains the sender ID.</p> <p>Possible values:</p> <ul style="list-style-type: none"> • <i>None</i> (default value): The sender ID is not sent. • <i>Username</i>: The user-configured user name is displayed. • <i>Caller Address</i>: The user-configured number the called party is displayed. • <i>Billing Number</i>: The actual phone number from which the calls is initiated (e.g. for billing purposes) is displayed.
<p>SIP Header Field: P-Asserted</p>	<p>Not for Trunk Mode = <i>Off</i></p> <p>The so-called "p-asserted-identity" field is added to the SIP header and contains the sender ID.</p> <p>Possible values:</p>

Field	Description
	<ul style="list-style-type: none"> • <i>None</i> (default value): The sender ID is not sent. • <i>Username</i>: The user-configured user name is displayed. • <i>Caller Address</i>: The user-configured number the called party is displayed. • <i>Billing Number</i>: The actual phone number from which the calls is initiated (e.g. for billing purposes) is displayed.
Substitution of International Prefix with "+"	<p>Select whether the prefix (e.g. 00) should be replaced by + for international numbers.</p> <p>The function is activated by selecting <i>Enabled</i>.</p> <p>The function is disabled by default.</p>
PBX coupling	<p>Select whether another PABX can log into your system. In this way, several PABX systems can be linked.</p> <p>The function is activated by selecting <i>Enabled</i>.</p> <p>The function is disabled by default.</p>
Delete SIP bindings after Restart	<p>If after registering with a provider a reset of the system should occur, for example, or a power failure, depending on the provider, another registration may prove impossible. Enabling these performance features allows re-registration after restart.</p> <p>The function is activated by selecting <i>Enabled</i>.</p> <p>The function is disabled by default.</p>
Upstreaming Device with NAT	<p>If you enable this function, you can use a gateway with NAT and still make VoIP calls. Without this function, it may not be possible to call you with VoIP if you use a gateway with NAT.</p> <p>The function is activated by selecting <i>Enabled</i>.</p> <p>The function is disabled by default.</p>
Early media support	<p>Select whether you'll allow exchange of voice and audio data before a receiver accepts a call.</p> <p>The function is enabled with <i>Enabled</i>.</p> <p>The function is enabled by default.</p>

Field	Description
Registration type	<p>Specify how registration and authentication at a provider are to be handled, or if they can be omitted completely. In the latter case, the relevant data are sent to a particular IP address that is already known to the correspondent. Registration and authentication are not then needed and the Registration function is disabled. An example of this method is Microsoft Exchange SIP.</p> <p>If a registration is required, it can be carried out in either of two ways:</p> <ul style="list-style-type: none"> • <i>Single</i>: With this option, a single MSN is registered with the SIP provider. • <i>Bulk (BNC)</i>: With this option, a SIP Trunk (DDI) is registered with the SIP provider, i.e. several numbers are registered under a single address.
T.38 FAX support	<p>Select whether faxes shall be transmitted with T.38.</p> <p>The function is enabled with <i>Enabled</i>.</p> <p>The function is enabled by default.</p> <p>If the function is disabled, faxes are transmitted with G.711.</p>
Substitution of Incoming Number Prefix	<p>For incoming calls, if the call number should be forwarded in the system in modified form: in the first input field enter the sequence of the incoming number to be replaced by the number sequence entered in the second input field.</p>
Send SIP UPDATE	<p>This function ensures that after a call transfer the number of the new call partner is displayed for the initial calling party.</p> <div data-bbox="539 1265 1316 1421" style="border: 1px solid gray; background-color: #f0f0f0; padding: 10px; margin-top: 10px;"> <p> Note</p> <p>Note that this function is not supported by all service providers.</p> </div> <p><i>Enabled</i> activates the functions.</p> <p>The function is not enabled by default.</p>
Request URI	<p>In some applications (especially in DDI connections) the target</p>

Field	Description
	address of a SIP call needs to be extracted from the Request URI. By activating this option the address is preferably read from this field of the invite. The option is not active per default.
Check Source IP	As a response to a DNS SRV request, your SIP provider transmits the addresses of valid registration servers. If you activate this option, each SIP invite has its source IP checked against these valid addresses. If it does not originate from one of them, the invite is ignored. The option is not active per default.
TLS certificate check	Only for DDI / SIP trunk connections. If a connection is encrypted using TLS (Transport Layer Security) a validity check on the server certificate of the remote station is performed. The option is not active per default.

Fields in the **Codec Settings** menu

Field	Description
Codec Profiles	<p>Select the location of the SIP server. Locations are defined in the VoIP->Settings->Codec Profiles menu.</p> <p>Possible values:</p> <ul style="list-style-type: none"> • <i>System Default</i> (default value): The server is not operated at any defined location. • <i><Codec-Profil-Name></i>
Video	Select if calls between IP telephones are to support the transmission of video data. Video transmission can only be negotiated between the participants if both support this feature.
SRTP	Select if calls via this SIP provider may be secured with SRTP (Secure Real-Time Transport Protocol).
MediaSec	<p><i>MediaSec</i>: MediaSec negotiates the protection of RTP data with the SIP servers.</p> <p>For seamless support, automatic negotiation of the transport protocol is mandatory. Fixed transport protocol settings (UDP and TCP) may cause problems during registration. Additionally, the use of SRTP must be allowed. Your VoIP provider must support MediaSec.</p>

9.1.2 Locations

In the **VoIP->Settings->Locations** menu you configure the locations of the VoIP subscribers who have been configured on your system, and define the bandwidth management for the VoIP traffic.

Individual locations can be set up for using the bandwidth management. A location is identified from its fixed IP address or DynDNS address or from the interface to which the device is connected. The available VoIP bandwidth (up- and downstream) can be set up for each location.

Only for compact systems: A predefined entry with the parameters **Description** = *LAN*, **Parent Location** = *None*, **Type** = *Interfaces*, **Interfaces** = *LAN_EN1-0* is displayed.

Fields in the Registration behavior for VoIP subscribers without assigned location menu.

Field	Description
Default Behavior	<p>Specify how the system is to behave when VoIP subscribers for whom no location has been defined are being registered.</p> <p>Possible values:</p> <ul style="list-style-type: none"> • <i>Registration for Private Networks Only</i> (default value): The VoIP subscriber is only registered if they are within the private network. • <i>No Registration</i>: The VoIP subscriber is never registered. • <i>Unrestricted Registration</i>: The VoIP subscriber is always registered.

9.1.2.1 Edit or New

Choose the  icon to edit existing entries. Select the **New** button to create new entries.

The menu **VoIP->Settings->Locations->New** consists of the following fields:

Fields in the Basic Settings menu.

Field	Description
Description	Enter the description of the entry.
Parent Location	You can cascade the SIP locations as you wish. Define here which SIP location that has been defined constitutes the high-

Field	Description
	level node for the SIP location to be configured here.
Type	<p>Select whether the location is to be defined through IP addresses/DNS names or interfaces.</p> <p>Possible values:</p> <ul style="list-style-type: none"> • <i>Addresses</i> (default value): The SIP location is defined via IP addresses or DNS names. • <i>Interfaces</i>: The SIP location is defined via the available interfaces.
Addresses	<p>Only for Type = <i>Addresses</i></p> <p>Enter the IP addresses of the devices at the SIP locations.</p> <p>Click Add to configure new addresses.</p> <p>Enter the IP address or DNS name that you want under IP Address/DNS Name.</p> <p>Also enter the required Netmask.</p>
Interfaces	<p>Only for Type = <i>Interfaces</i></p> <p>Indicate the interfaces to which the devices of a SIP location are connected.</p> <p>Click Add to select a new interface.</p> <p>Under Interface, select the interface you want.</p>
Upstream Bandwidth Limitation	<p>Determine whether the upstream bandwidth is to be restricted.</p> <p>The bandwidth is reduced with <i>Enabled</i>.</p> <p>The function is disabled by default.</p>
Maximum Upstream Bandwidth	<p>Enter the maximum data rate in the send direction in kBits per second.</p>
Downstream Bandwidth Limitation	<p>Determine whether the downstream bandwidth is to be restricted.</p> <p>The bandwidth is reduced with <i>Enabled</i>.</p>

Field	Description
	The function is disabled by default.
Maximum Downstream Bandwidth	Enter the maximum data rate in the receive direction in kBits per second.

The menu **Advanced Settings** consists of the following fields:

Fields in the **Advanced Settings** menu.

Field	Description
DSCP Settings for rtp Traffic	<p>Select the Type of Service (TOS) for RTP data.</p> <p>Possible values:</p> <ul style="list-style-type: none"> • <i>DSCP Binary Value</i> (default value): Differentiated Services Code Point according to RFC 3260 is used to signal the priority of IP packets (indicated in binary format, 6 bit). The preconfigured value is <i>101110</i>. • <i>DSCP Decimal Value</i>: Differentiated Services Code Point according to RFC 3260 is used to signal the priority of IP packets (indicated in decimal format). • <i>DSCP Hexadecimal Value</i>: Differentiated Services Code Point according to RFC 3260 is used to signal the priority of IP packets (indicated in hexadecimal format). • <i>TOS Binary Value</i>: The TOS value is specified in binary format, e.g. 00111111. • <i>TOS Decimal Value</i>: The TOS value is specified in decimal format, e.g. 63. • <i>TOS Hexadecimal Value</i>: The TOS value is specified in hexadecimal format, e.g. 3F.

9.1.3 Codec Profiles

In the **VoIP->Settings->Codec Profiles** , you can define the various codec profiles to control voice quality and set up specific provider-dependent default settings.

When setting up the codec, remember that a good voice quality requires a corresponding bandwidth so that the number of simultaneous calls will be restricted. The remote terminal also has to support the relevant codec choice.

9.1.3.1 Edit or New

Choose the  icon to edit existing entries. Select the **New** button to create new entries.

The menu **VoIP**->**Settings**->**Codec Profiles**->**New** consists of the following fields:

Fields in the **Basic Parameters** menu.

Field	Description
Description	Enter a description for the entry.
Codec Proposal Sequence	<p>Choose the order in which the codecs are offered for use by the system. If the first codec cannot be used, the second is tried and so on.</p> <p>Possible values:</p> <ul style="list-style-type: none"> • <i>Default</i> (default value): the codec in the first position in the menu will be used if possible. • <i>Quality</i>: The codecs are sorted by quality. The codec with the best quality is used if possible. • <i>Low Bandwidth</i>: The codecs are sorted by required bandwidth. If possible, the codec with the lowest bandwidth requirement is used. • <i>High Bandwidth</i>: The codecs are sorted by required bandwidth. If possible, the codec with the highest bandwidth requirement is used.
G.711 uLaw	<p>Only for Codec Proposal Sequence not <i>default</i></p> <p>ISDN codec with US characteristic</p> <p>G.711 uLaw passes audio signals in the range of 300-3500 Hz and samples them at the rate of 8,000 samples per second. At 64 kbit/s bit rate the mean opinion score (MOS) is 4,4. This audio codec uses μlaw quantization.</p>
G.711 aLaw	<p>Only for Codec Proposal Sequence not <i>default</i></p> <p>ISDN codec with EU characteristic</p> <p>G.711 aLaw passes audio signals in the range of 300-3400 Hz and samples them at the rate of 8,000 samples per second. At 64 kbit/s bit rate the mean opinion score (MOS) is 4,4. This au-</p>

Field	Description
	<p>dio codec uses alaw quantization.</p>
G.722	<p>Only for Codec Proposal Sequence not <i>default</i></p> <p>G.722 passes audio signals in the range of 50-7000 Hz and samples them at the rate of 16,000 samples per second. At 64 kbit/s bit rate the mean opinion score (MOS) is 4,5.</p>
G.729	<p>Only for Codec Proposal Sequence not <i>default</i></p> <p>G.729 passes audio signals in the range of 300-2400 Hz and samples them at the rate of 8,000 samples per second. At 8 kbit/s bit rate the mean opinion score (MOS) is 3,9.</p>
G.726 (16 kbit/s)	<p>Only for Codec Proposal Sequence not <i>default</i></p> <p>G.726 (16 kbit/s) passes audio signals in the range of 200-3400 Hz and samples them at the rate of 8,000 samples per second. At 16 kbit/s bit rate the mean opinion score (MOS) is 3,7.</p>
G.726 (24 kbit/s)	<p>Only for Codec Proposal Sequence not <i>default</i></p> <p>G.726 (24 kbit/s) passes audio signals in the range of 200-3400 Hz and samples them at the rate of 8,000 samples per second. At 24 kbit/s bit rate the mean opinion score (MOS) is 3,8.</p>
G.726 (32 kbit/s)	<p>Only for Codec Proposal Sequence not <i>default</i></p> <p>G.726 (32 kbit/s) passes audio signals in the range of 200-3400 Hz and samples them at the rate of 8,000 samples per second. At 32 kbit/s bit rate the mean opinion score (MOS) is 3,9.</p>
G.726 (40 kbit/s)	<p>Only for Codec Proposal Sequence not <i>default</i></p> <p>G.726 (40 kbit/s) passes audio signals in the range of 200-3400 Hz and samples them at the rate of 8,000 samples per second. At 40 kbit/s bit rate the mean opinion score (MOS) is 4,2.</p>
DTMF	<p>Only for Codec Proposal Sequence not <i>default</i></p> <p>Select whether the DTMF Outband codec is to be used. First the system attempts to use RFC 2833. If the remote terminal does not use this standard, SIP Info is used.</p>

Field	Description
	<p>The function is activated by selecting <i>Enabled</i>.</p> <p>The function is enabled by default.</p>
G.726 Codec settings	<p>Only for Codec Proposal Sequence not <i>default</i></p> <p>Select the coding method for the G.726 codec.</p> <p>Possible values:</p> <ul style="list-style-type: none"> • <i>I.366</i> • <i>RFC3551 / X.420</i>

9.1.4 Options

In the **VoIP->Settings->Options** menu, you'll find general VoIP settings.

The menu consists of the following fields:

Fields in the **Basic Settings** menu.

Field	Description
RTP Port	<p>Enter the port via which the RTP data is to be transported.</p> <p>The default value is <i>10000</i>.</p>
Client Registration Timer	<p>Here, enter a default value for the time in seconds within which the SIP clients must re-register to prevent the connection from disconnecting automatically.</p> <p>The default value is <i>60</i>.</p>

The menu **Advanced Settings** consists of the following fields:

Fields in the **Advanced Settings** menu.

Field	Description
DSCP Settings for sip Traffic	<p>Select the Type of Service (TOS) for SIP data.</p> <p>Possible values:</p> <ul style="list-style-type: none"> • <i>DSCP Binary Value</i> (default value): Differentiated Services Code Point according to RFC 3260 is used to signal the priority of IP packets (indicated in binary format, 6 bit). The

Field	Description
	<p>default value is <i>110000</i>.</p> <ul style="list-style-type: none"> • <i>DSCP Decimal Value</i>: Differentiated Services Code Point according to RFC 3260 is used to signal the priority of IP packets (indicated in decimal format). • <i>DSCP Hexadecimal Value</i>: Differentiated Services Code Point according to RFC 3260 is used to signal the priority of IP packets (indicated in hexadecimal format). • <i>TOS Binary Value</i>: The TOS value is specified in binary format, e.g. 00111111. • <i>TOS Decimal Value</i>: The TOS value is specified in decimal format, e.g. 63. • <i>TOS Hexadecimal Value</i>: The TOS value is specified in hexadecimal format, e.g. 3F.
SIP Port	<p>Specify the port SIP data are to be transferred through.</p> <p>The default value is <i>5060</i>.</p>
	<p> Note</p> <p>If you change the port during operation, the change only becomes effective after the next reboot of your device.</p>
Client Subscription Timer	<p>Enter a value for the amount of time in seconds after which a SIP client must have re-registered all its configured busy lamp field keys in order for the status information not to get lost.</p> <p>The default value is <i>300</i>.</p> <p>You can usually keep the default value, but in case you have many keys configured, it may be a good idea to increase it.</p>

Fields in the SIP over TLS menu

Field	Description
Local Certificate	<p>You can select a certificate for the use with SIP over TLS.</p> <p>The default certificate is the internal certificate of your device.</p>

Chapter 10 Call Routing

The functions for external calls and automatic route selections for external calls are defined in call routing.

10.1 Outgoing Services

In the **Call Routing->Outgoing Services** menu, you can configure the performance features **Direct Call**, **Call Forwarding**, **Dial Control** and **Priority Numbers**.

10.1.1 Call Forwarding

In the **Call Routing->Outgoing Services->Call Forwarding** menu, you configure call forwarding of external calls for an internal subscriber.

You are temporarily away from your office, but don't want to miss a call. With call forwarding to another number, e.g. your mobile, you can receive your calls even when you are not at your desk. You can forward calls on your number to any call number. It can occur *Immediately*, *On no reply* or *On Busy*. Call forwarding *On no reply* and *On Busy* can exist concurrently. If you are not near your telephone, for example, the call is forwarded to another number (e.g. your mobile phone) after a short period. If you are making a call at your desk, other caller may receive the busy signal. You can forward these callers e.g. to a colleague or the secretary by using call forwarding on busy.

Every internal subscriber to the system can forward her calls to another number. Calls can be forwarded to internal subscriber numbers, internal team numbers or external numbers. When the number to which calls shall be forwarded is entered, the system automatically checks whether it's an internal or external number.

In a team, call forwarding can be set up for one subscriber in the team. This call continues to be signalled to the other team subscribers. Call forwarding to an internal or external subscriber is performed in the system.

Call forwarding to an internal number is performed in the system. If an internal call to an external number is to be forwarded, forwarding also occurs in the system. Here, the connection is on the bundle cleared for the subscriber doing the setup. If call forwarding occurs via an ISDN connection, one B channels remains in use; in case of forwarding from external to external, it's both B channels. Two possibilities exist for call forwarding of an external call to an external number:

- Call forwarding in the exchange: Call forwarding is conducted at the exchange if only one subscriber is entered in the call allocation for an external call. For call forwarding in the

exchange, the performance features Call Deflection (point-to-multipoint connection) or Partial Rerouting (point-to-point connection) must be enabled with the network operator for the relevant ISDN connections.

- Call forwarding in the system: Call forwarding occurs in the system if the required performance features for call forwarding at the exchange are not available for the relevant ISDN connections. If several telephones (e. g. a team), some of which have set up call forwarding, receive an external call, the corresponding call forwarding is performed in the system. Here, the external connection is set up over a bundle's B channel, cleared for the subscriber initiating the setup. This B-channel remains assigned for the duration of active call forwarding.



Note

If the system is connected to the external ISDN (if supported by you device), for external-to-external connections, the system systematically attempts to initiate call forwarding via the exchange. For teams, there can be manual definition of whether call forwarding shall occur via the exchange or the system. If the system possesses no ISDN connections, or if Call Deflection (point-to-multipoint connection) or Partial Rerouting (point-to-point connection) has not been ordered from the network operator, call forwarding occurs solely in the system.

10.1.1.1 Edit or New

Choose the  icon to edit existing entries. Select the **New** button to create new entries.

The **Call Routing->Outgoing Services->Call Forwarding->New** menu consists of the following fields:

Fields in the Basic Settings menu

Field	Description
Internal Number	Select the internal number to which the incoming calls shall be forwarded.
Type of Call Forwarding	Select when incoming calls shall be forwarded to the specified internal number. Possible values: <ul style="list-style-type: none"> • <i>Immediately</i> • <i>On Busy</i> • <i>On no reply</i> (default value)

Field	Description
	<ul style="list-style-type: none"> • <i>On busy / On no reply</i>
Target Number "On no reply"	Enter the number to which incoming calls shall be forwarded after time.
Target Number "On busy"	Enter the number to which incoming calls shall be forwarded on busy.
Target Number "Immediate"	Enter the number to which incoming calls shall be forwarded immediately.

10.1.2 Dial Control

In the **Call Routing->Outgoing Services->Dial Control** menu, you block specific numbers/partial numbers, or release these .

You wish to prevent dialling of specific numbers in the system, e. g. the numbers of expensive value-added services. Enter these numbers or partial numbers into the dial ranges list of blocked numbers. All subscribers subject to dial ranges cannot dial these numbers. However, if you should need specific numbers from a blocked sector, you can clear these via the dial ranges list of cleared numbers.

You can block specific numbers or prefixes with the blocked numbers list. You can clear the blocked numbers or prefixes with the cleared numbers list. If a number entered as a cleared number is longer than one entered as a blocked number, this number can be dialled. When you dial a number, dialling after the blocked digit is terminated and you hear the busy tone. You can assign each user individually to the dial ranges in the user settings.

Example: Blocked number *01*, all external numbers that begin with *01* are blocked. Cleared number *012345*, dialling can proceed. All external numbers that begin with *012345* can be dialled. If two identical numbers (same number sequence and same number of digits, e. g. *01234* and *01234*) are entered in the list of cleared numbers as well as the list of blocked numbers, dialling of the number is prevented.



Note

Subscribers who enjoy full or partial dialling access (no outside line access) are authorised for dialling of cleared numbers via the list of cleared numbers.

Please ensure that the area code is entered in the configuration, otherwise, the block can be circumvented in the local network by prefixing the area code.

10.1.2.1 Edit or New

Choose the  icon to edit existing entries. Select the **New** button to create new entries.

The **Call Routing->Outgoing Services->Dial Control->New** menu consists of the following fields:

Fields in the **Basic Settings** menu.

Field	Description
Inhibited number	Enter the number that cannot be dialled.
Enabled number	Enter the number for which dialling is explicitly permitted.

Chapter 11 Applications

Internal telephone performance features of the system are set up under **Applications**.

11.1 Call Data Records

In the **Applications->Call Data Records** menu, you configure the recording of incoming and outgoing calls.

The capture of call data records provides an overview of the telephone usage in your company.

All external calls can be saved in the device in the form of call data records. These data records contain important information about the individual calls.

You must enable recording of connection data in the **Numbering->User Settings->Class of Services->Applications** menu. The function is not activated in the ex works state.

11.1.1 Outgoing

The **Applications->Call Data Records->Outgoing** menu contains information that permits the monitoring of outgoing activities.

The menu consists of the following fields:

Fields in the Outgoing menu.

Field	Description
Date	Displays the connection date.
Time	Displays the time at call start.
Duration	Displays the duration of the connection.
User	Displays the user who called.
Int. No.	Displays the user's internal number.
Called Name	Displays the name that called.
Called Number	Displays the dialled number.

Field	Description
Project Code	Displays the call project number, if any.
Interface	Displays the interface over which the external connection was routed.
Costs	Displays the connection charge, but only if the provider transmits the corresponding data.

11.1.2 Incoming

The **Applications->Call Data Records->Incoming** menu contains information that permits the monitoring of incoming activities.

The menu consists of the following fields:

Fields in the Incoming menu.

Field	Description
Date	Displays the connection date.
Time	Displays the time at call start.
Duration	Displays the duration of the connection.
User	Displays the user who was called.
Int. No.	Displays the user's internal number.
Caller Name	Displays the name of the caller.
External Number	Displays the caller's number.
Project Code	Displays the call project number, if any.
Interface	Displays the interface over which the connection from outside was routed.

11.1.3 General

In the **Applications->Call Data Records->General** menu, you can define how connection data are saved in the system.

The menu consists of the following fields:

Fields in the **Basic Settings** menu.

Field	Description
Web Access Username	Enter a user name for the call data administrator.
Web Access Password	Enter a password for the call data administrator.
Save outgoing calls	<p>Select which outgoing connections should be saved.</p> <p>Possible values:</p> <ul style="list-style-type: none"> • <i>None</i> (default value) • <i>All</i> • <i>With Project Code only</i>
Save incoming calls	<p>Select which incoming connections should be saved.</p> <p>Possible values:</p> <ul style="list-style-type: none"> • <i>None</i> (default value) • <i>All</i> • <i>With Project Code only</i>
Privacy Number Truncation	<p>Select whether to save the number in abbreviated form.</p> <p>If, for data privacy reasons, the number is to be only partially displayed, you can select the number of positions not to be displayed here. For Outgoing Calls and for Incoming Calls you can separately enter the number of hidden digits. The hiding of digits occurs from right to left.</p> <p>Possible values:</p> <ul style="list-style-type: none"> • <i>No</i> (default value) • <i>All</i> • <i>1 to 9</i>
Transfer call data records via Serial 2	<p>For modular PABX systems only</p> <p>Select whether to export call data records over the serial interface (Serial 2) after each call which enables you to connect an external charge metering software solution (hotel application).</p>

Field	Description
	The function is activated by selecting <i>Enabled</i> .
	The function is disabled by default.

Fields in the Actions menu.

Field	Description
Export call data records	If you wish to save the current connection data record in an external file, click Export and save the file under the desired storage location and file name.
Delete call data records	If you wish to delete the current connection data record from the system storage, click Delete .

11.2 Call List

The menu **Applications->Call List** lists details of incoming and outgoing calls. Which kind of calls and how many of them are included can be specified in the submenu **General**.

11.2.1 Incoming

The **Applications->Call List->Incoming** menu contains information that permits the monitoring of incoming activities.

The menu consists of the following fields:

Fields in the Incoming menu

Field	Description
Date	Displays the connection date.
Time	Displays the time at call start.
Type	Displays the type of the connection.
User	Displays the user who was called.
Int. No.	Displays the user's internal number.
Caller Number	Displays the caller's number.

Field	Description
Trunk Number	Displays the port number.
Interface	Displays the interface over which the connection from outside was routed.
Delete	You can use the Select all and Deselect all buttons for all the devices displayed.

11.2.2 Outgoing

The **Applications->Call List->Outgoing** menu contains information that permits the monitoring of outgoing activities.

The menu consists of the following fields:

Fields in the Outgoing menu

Field	Description
Date	Displays the connection date.
Time	Displays the time at call start.
Type	Displays the type of the connection.
User	Displays the user who was called.
Int. No.	Displays the user's internal number.
Called Number	Displays the caller's number.
Trunk Number	Displays the port number.
Interface	Displays the interface over which the connection from outside was routed.
Delete	You can use the Select all and Deselect all buttons for all the devices displayed.

11.2.3 General

In the **Applications->Call List->General** menu, you can define how the connection data is saved in the system.

The menu consists of the following fields:

Fields in the **Basic Settings** menu

Field	Description
Record calls	<p>Select which kind of calls are to be included.</p> <p>Possible values:</p> <ul style="list-style-type: none"> • <i>None</i> • <i>Incoming only</i> (default value) • <i>All</i>
Record connected calls	<p>Select if accepted calls are to be included, too. This can significantly increase the number of included calls and decrease the amount of time the list can cover until the maximum number of calls is reached and the first calls are deleted from the list.</p>
Max Call List entries for System Calls	<p>Specify the maximum amount of system calls that are included in the list. The maximum number is <i>1000</i>. System calls include, e.g., call transfers to extern, calls being accepted by an announcement, team calls that are not accepted by a single user.</p>
Max Call List entries per User	<p>Specify the maximum amount of user calls (calls initiated or accepted by a configured user) that are included in the list. The maximum number is <i>200</i>.</p>

Chapter 12 LAN

In this menu, you configure the addresses in your LAN and can structure your local network using VLANs.

12.1 IP Configuration

In this menu, you can edit the IP configuration of the LAN and Ethernet interfaces of your device.



12.1.1 Interfaces

The existing IP interfaces are listed in the **LAN->IP Configuration->Interfaces** menu. You can edit the IP configuration of the interfaces or create virtual interfaces for special applications. Here is a list of all of the interfaces (logical Ethernet interfaces and others created in the subsystems) configured in the **System Management->Interface Mode / Bridge Groups->Interfaces** menu.

Use the  to edit the settings of an existing interface (bridge groups, Ethernet interfaces in routing mode).

You can use the **New** button to create virtual interfaces. However, this is only needed in special applications (e.g. BRRP).

Depending on the option selected, different fields and options are available. All the configuration options are listed below.

Change the status of the interface by clicking the  or the  button in the **Action** column.

Press the  button to display the details of an existing interface.



Note

For IPv4 note that:

If your device has obtained an IP address dynamically from a DHCP server operated in your network for the basic configuration, the default IP address is deleted automatically and your device will no longer function over this address.

However, if you have set up a connection to the device over the default IP address or have assigned an IP address with the **Dime Manager** in the basic configuration, you

will only be able to access your device over this IP address. The device will no longer obtain an IP configuration dynamically over DHCP.

Example of subnets

If your device is connected to a LAN that consists of two subnets, you should enter a second **IP Address / Netmask**.

The first subnet has two hosts with the IP addresses 192.168.42.1 and 192.168.42.2, for example, and the second subnet has two hosts with the IP addresses 192.168.46.1 and 192.168.46.2. To be able to exchange data packets with the first subnet, your device uses the IP address 192.168.42.3, for example, and 192.168.46.3 for the second subnet. The netmasks for both subnets must also be indicated.

Here is an example for an IPv6 address:

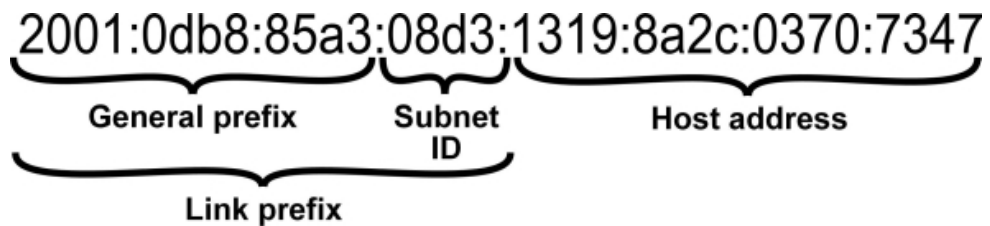

Your device can act either as router or as device at one interface. In general, it acts as router at the LAN interfaces, and as host at the WAN and PPP interfaces.

If your device acts as router, its own IPv6 addresses can be created as follows: a Link Prefix can be derived from a General Prefix or you can manually specify a static value. One host address can be created through `Auto eui-64`, for additional host addresses you can specify static values.

If your device acts a router, it commonly distributes the configured link prefix to the hosts through Router Advertisements. A DHCP server may distribute additional information to the hosts, e.g., the address of a timer server. A client can create its own host address either through Stateless Address Autoconfiguration (SLAAC) or have this address assigned by a DHCP server.

In order to make use of the router mode described above, use the following settings in the menu **LAN->IP Configuration->Interfaces->New: IPv6 Mode = Router, Transmit Router Advertisement = Enabled, DHCP Server Enabled and IPv6 Addresses = Add.**

If your device acts as host, it has a Link Prefix assigned by another router through Router Advertisements. The host address is then automatically derived through SLAAC. Additional information like, e.g., the General Prefix of the provider or the address of a time server can

be received through DHCP. Use the following settings in the menu **LAN->IP Configuration->Interfaces->New: IPv6 Mode = Client, Accept Router Advertisement = Enabled** and **DHCP Client = Enabled**.

12.1.1.1 Edit or New

Choose the  icon to edit existing entries. Choose the **New** button to create virtual interfaces.

The **LAN->IP Configuration->Interfaces->/New** menu consists of the following fields:

Fields in the **Basic Parameters** menu.

Field	Description
Based on Ethernet Interface	<p>This field is only displayed if you are editing a virtual routing interface.</p> <p>Select the Ethernet interface for which the virtual interface is to be configured.</p>
Interface Mode	<p>Only for physical interfaces in routing mode and for virtual interfaces.</p> <p>Select the configuration mode of the interface.</p> <p>Possible values:</p> <ul style="list-style-type: none"> • <i>Untagged</i> (default value): The interface is not assigned for a specific purpose. • <i>Tagged (VLAN)</i>: This option only applies for routing interfaces. <p>You use this option to assign the interface to a VLAN. This is done using the VLAN ID, which is displayed in this mode and can be configured. The definition of a MAC address in MAC Address is optional in this mode.</p>
VLAN ID	<p>Only for Interface Mode = Tagged (VLAN)</p> <p>This option only applies for routing interfaces. Assign the interface to a VLAN by entering the VLAN ID of the relevant VLAN.</p> <p>Possible values are <i>1</i> (default value) to <i>4094</i>.</p>
MAC Address	Enter the MAC address associated with the interface. For virtual

Field	Description
	<p>interfaces, you can use the MAC address of the physical interface under which the virtual interface was created by activating Use built-in, but VLAN IDs must be different. You can also allocate a virtual MAC address. The first 6 characters of the MAC are preset (but can be changed).</p> <p>If Use built-in is active, the predefined MAC address of the allocated physical interface is used.</p> <p>Use built-in is activated by default.</p>

Fields in the Basic IPv4 Parameters menu.

Field	Description
Security Policy	<p>Select the security settings to be used with the interface.</p> <p>Possible values:</p> <ul style="list-style-type: none"> • <i>Trusted</i>: All IP packets are allowed through except for those which are explicitly prohibited.. • <i>Untrusted</i>: Only those packets are transmitted that can be attributed to a connection that has been initiated from a trusted zone. <p>You can configure exceptions for the selected setting in the Firewall on page 308 menu.</p>
Address Mode	<p>Select how an IP address is assigned to the interface.</p> <p>Possible values:</p> <ul style="list-style-type: none"> • <i>Static</i> (default value): The interface is assigned a static IP address in IP Address / Netmask. • <i>DHCP</i>: An IP address is assigned to the interface dynamically via DHCP.
DHCP Metric	<p>It is possible to assign a metric for gateway route received by an interface via DHCP. This may be necessary when configuring backup connections to ensure a clean switch to the backup and back again.</p> <p>The default value is <i>1</i>. In case of a backup solution, this option should be set to a higher value so the backup route does not receive a too high priority.</p>

Field	Description
IP Address / Netmask	<p>Only for Address Mode = <i>Static</i></p> <p>With Add, add a new address entry, enter the IP Address and the corresponding Netmask of the virtual interface.</p>

Fields in the **Basic IPv6 Parameters** menu.

Field	Description
IPv6	<p>Select whether this interface should use Internet Protocol version 6 (IPv6) for data transmission.</p> <p>The function is activated by selecting <i>Enabled</i>. The function is disabled by default.</p>
Security Policy	<p>Only for IPv6 = <i>Enabled</i></p> <p>Select the security settings to be used with the interface.</p> <p>Possible values:</p> <ul style="list-style-type: none"> • <i>Trusted</i> (default value): All IP packets are allowed through except for those which are explicitly prohibited. <p>We recommend you use this setting if you want to use IPv6 on your LAN.</p> <ul style="list-style-type: none"> • <i>Untrusted</i>: Only those packets are transmitted that can be attributed to a connection that has been initiated from a trusted zone. <p>We recommend you use this setting if you want to use IPv6 outside of your LAN.</p> <p>You can configure exceptions for the selected setting in the Firewall on page 308 menu.</p>
IPv6 Mode	<p>Only for IPv6 = <i>Enabled</i></p> <p>Select whether the interface is to be operated in host or in router mode. Depending on your selection different parameters are presented for you to configure.</p> <p>Possible values:</p> <ul style="list-style-type: none"> • <i>Router (Transmit Router Advertisement)</i> (default value): Select whether Router Advertisements are to be sent via the interface.

Field	Description
	<p>Using Router Advertisements the list of prefixes is propagated and the router propagates itself as the standard gateway.</p> <p>The function is activated by selecting <i>Enabled</i>.</p> <p>The function is enabled by default.</p> <ul style="list-style-type: none"> • <i>Host</i>: The interface is operated in host mode.
DHCP Server	<p>Only for IPv6 = <i>Enabled</i> and IPv6 Mode = <i>Router (Transmit Router Advertisement)</i></p> <p>Specify if your device is to act as DHCP server, i.e., if it is to transmit DHCP options in order to distribute information about the DNS servers to the clients.</p> <p>Enable this option if hosts are to create IPv6 addresses through SLAAC.</p> <p>The function is activated by selecting <i>Enabled</i>.</p> <p>The function is enabled by default.</p>
IPv6 Addresses	<p>Only for IPv6 = <i>Enabled</i></p> <p>You can assign IPv6 Addresses to the selected interface..</p> <p>Add allows you to create one or more address entries.</p> <p>A new windows opens that allows you to specify an IPv6 address consisting of a Link Prefix and a host identifier.</p> <p>If your device operates in host mode (IPv6 Mode = <i>Host</i>, Accept Router Advertisement <i>Enabled</i> and DHCP Client = <i>Enabled</i>), its IPv6 addresses are determined through SLAAC. You need not configure an IPv6 address manually, but you can enter additional addresses if desired.</p> <p>If your device is operating in router mode (IPv6 Mode = <i>Router (Transmit Router Advertisement)</i>, and DHCP Server = <i>Enabled</i>), you need to configure its IPv6 addresses here.</p>
Accept Router Advertisement	<p>Only for IPv6 = <i>Enabled</i> and IPv6 Mode = <i>Host</i></p> <p>Select if Router Advertisements are to be received on the selec-</p>

Field	Description
	<p>ted interface. Router Advertisements are used, e.g., to create the prefix list.</p> <p>The function is activated by selecting <i>Enabled</i>.</p> <p>The function is enabled by default.</p>
DHCP Client	<p>Only for IPv6 = <i>Aktiviert</i> and IPv6 Mode = <i>Host</i></p> <p>Select if your device is to act as DHCP client, i.e., if it is to receive DHCP options in order to obtain information about the DNS servers.</p> <p>The function is activated by selecting <i>Enabled</i>.</p> <p>The function is enabled by default.</p>

Use **Add** to create more entries.

Fields in the **Basic Parameters** menu.

Field	Description
Advertise	<p>Only for IPv6 Mode = <i>Router (Transmit Router Advertisement)</i></p> <p>Here you can determine if the prefix being defined in the current window is propagated per Router Advertisement over the selected interface.</p> <p>The function is activated by selecting <i>Enabled</i>.</p> <p>The function is enabled by default.</p>

Fields in the **Link Prefix** menu.

Field	Description
Setup Mode	<p>Select in which way the Link Prefix is to be determined.</p> <p>Possible values:</p> <ul style="list-style-type: none"> • <i>From General Prefix</i> (default value): The Link Prefix is derived from a General Prefix. • <i>Static</i>: You can enter the link prefix.
General Prefix	<p>Only for Setup Mode = <i>From General Prefix</i></p>

Field	Description
	Select the General Prefix the Link Prefix is to be derived from. You can choose from the General Prefixes available under Network->IPv6 General Prefixes->General Prefix Configuration->New .
Auto Subnet Configuration	<p>Only if Setup Mode = <i>From General Prefix</i> and if a General Prefix has been selected.</p> <p>Select if the subnet is to be created automatically. Automatic subnet creation will use ID 0 for the first subnet, ID 1 for the second, etc.</p> <p>Possible values for the sub net ID are: 0 - 255.</p> <p>The subnet ID describes the fourth of the four 16 bit fields of a Link Prefix. Upon subnet creation the decimal ID value is converted to a hexadecimal one.</p> <p>The function is activated by selecting <i>Enabled</i>.</p> <p>The function is enabled by default.</p> <p>If the function is disabled, you can define a subnet by entering a Subnet ID.</p>
Subnet ID	<p>Only if Auto Subnet Configuration is not active.</p> <p>Enter a Subnet ID in order to define a subnet. The subnet ID describes the fourth of the four 16 bit fields of a Link Prefix.</p> <p>Possible values are 0 - 255.</p> <p>Upon subnet creation the decimal ID value is converted to a hexadecimal one.</p>
Link Prefix	<p>Only for Setup Mode = <i>Static</i></p> <p>You can specify the Link Prefix of an IPv6 address. This prefix must end with <code>::</code>. Its predetermined length is 64.</p>

Fields in the Host Address menu.

Field	Description
Generation Mode	Determine if the Host Identifier of the IPv6 address is to be automatically derived from the MAC address through EUI-64.

Field	Description
	<p>The function is activated by selecting <i>Enabled</i>.</p> <p>The function is enabled by default.</p> <p>EUI-64 triggers the following process:</p> <ul style="list-style-type: none"> • The hexadecimal 48 bit MAC address is split into 2 x 24 bit. • <i>FFFE</i> is inserted into the created gap in order to obtain 64 bit. • The hexadecimal notation of the 64 bit is converted to a binary notation. • Bit no. 7 of the first 8 bit field is set to <i>1</i>.
Static Addresses	<p>Independently of the automatic creation described under Generation Mode, you can manually specify the Host Identifier of one or more IPv6 addresses with Add. Its predefined length is <i>64</i>. Start any entry with <i>: : .</i></p>

The fields in the **Advanced** menu are part of the prefix information sent inside of Router Advertisements if **Advertise** is enabled. The menu **Advanced** consists of the following fields:

Fields in the **Advanced IPv6 Settings** menu

Field	Description
On Link Flag	<p>Select whether the On-Link Flag (L-Flag) should be set. This allows the host to enter the prefix from the prefix list.</p> <p>The function is activated by selecting <i>True</i>.</p> <p>The function is enabled by default.</p>
Autonomous Flag	<p>Select whether the Autonomous Address Configuration Flag (A-Flag) should be set. This allows the host to use the prefix and the 64 bit interface ID, to derive its address.</p> <p>The function is activated by selecting <i>True</i>.</p> <p>The function is enabled by default.</p>
Preferred Lifetime	<p>Enter a time period in seconds. During this time, addresses derived from the prefix through SLAAC are preferred.</p> <p>The default value is <i>604800</i> seconds.</p>
Valid Lifetime	<p>Enter a time period in seconds, for which the prefix is valid.</p>

Field	Description
	The default value is <i>2592000</i> seconds.
	 <p>Note</p> <p>The value for the valid lifetime should be lower than the one configured for the option Router Lifetime under Advanced IPv6 Settings.</p>

The menu **Advanced Settings** consists of the following fields:

Fields in the **Advanced IPv4 Settings** menu.

Field	Description
DHCP MAC Address	<p>Only for Address Mode = <i>DHCP</i></p> <p>If Use built-in is activated (default setting), the hardware MAC address of the Ethernet interface is used. In the case of physical interfaces, the current MAC address is entered by default.</p> <p>If you disable Use built-in, you enter a MAC address for the virtual interface, e.g. <i>00:e1:f9:06:bf:03</i>.</p> <p>Some providers use hardware-independent MAC addresses to allocate their clients IP addresses dynamically. If your provider has assigned you a MAC address, enter this here.</p>
DHCP Hostname	<p>Only for Address Mode = <i>DHCP</i></p> <p>Enter the host name requested by the provider. The maximum length of the entry is 45 characters.</p>
DHCP Broadcast Flag	<p>Only for Address Mode = <i>DHCP</i></p> <p>Choose whether or not the BROADCAST bit is set in the DHCP requests for your device. Some DHCP servers that assign IP addresses by UNICAST do not respond to DHCP requests with the set BROADCAST bit. In this case, it is necessary to send DHCP requests in which this bit is not set. In this case, disable this option.</p> <p>The function is activated by selecting <i>Enabled</i>.</p> <p>The function is enabled by default.</p>

Field	Description
Create Default Route	<p>Only for Address Mode = <i>DHCP</i></p> <p>Select, whether a default route is to be defined for this interface.</p> <p>The function is activated by selecting <i>Enabled</i>.</p> <p>The function is enabled by default.</p>
Proxy ARP	<p>Select whether your device is to respond to ARP requests from its own LAN on behalf of defined remote terminals.</p> <p>The function is activated by selecting <i>Enabled</i>.</p> <p>The function is disabled by default.</p>
TCP-MSS Clamping	<p>Select whether your device is to apply MSS Clamping. To prevent IP packets fragmenting, the MSS (Maximum Segment Size) is automatically decreased by the device to the value set here.</p> <p>The function is activated by selecting <i>Enabled</i>.</p> <p>The function is disabled by default. Once enabled, the default value <i>1350</i> is entered in the input field.</p>

Fields in the **Advanced IPv6 Settings** menu

Field	Description
Router Lifetime	<p>Only for IPv6 = <i>Enabled</i>, IPv6 Mode = <i>Router (Transmit Router Advertisement)</i> and Transmit Router Advertisement = <i>Enabled</i></p> <p>Enter a time period in seconds. The router remains in the default router list throughout this interval.</p> <p>The default value is <i>600</i> seconds. The maximum value is <i>65520</i> seconds. A value of <i>0</i> means that the router is not a default router, and will not be entered in the default router list.</p>



Note

The value for the **Router Lifetime** should be higher than the shortest valid lifetime for a link prefix configured for this interface under **Basic IPv6 Parameters**.

Field	Description
Router Preference	<p>Only for IPv6 = Enabled, IPv6 Mode = Router (Transmit Router Advertisement) and Transmit Router Advertisement = Enabled</p> <p>Select your router's preference for choice of default router. This is useful for cases where a node receives advertisements from multiple routers, or for back-up scenarios.</p> <p>Possible values:</p> <ul style="list-style-type: none"> • <i>High</i> • <i>Medium</i> (default value) • <i>Low</i>
DHCP Mode	<p>Only for IPv6 = Enabled, IPv6 Mode = Router (Transmit Router Advertisement) and Transmit Router Advertisement = Enabled</p> <p>Select the information to be forwarded to the DHCP client.</p> <div data-bbox="541 830 1315 985" style="border: 1px solid #ccc; background-color: #f0f0f0; padding: 10px; margin: 10px 0;"> <p> Note</p> <p>To achieve this, your router must not be set up as a DHCP server.</p> </div> <p>By selecting <i>Other - DNS Servers, SIP Servers</i> (default value) no address-related information, such as i.e. DNS, VoIP, etc., is passed through.</p> <p>Enable this option if hosts inside of the network are to automatically create their IP addresses through SLAAC. In this case, the router sends only data via DHCP that are not address-related.</p> <p>By selecting <i>Managed - IPv6 Address Management</i> hosts receive IPv6 addresses as well as not address-related information through DHCP.</p>
DNS Propagation	<p>Only for IPv6 Mode = Router (Transmit Router Advertisement) and Transmit Router Advertisement Enabled</p> <p>Select if and in which way DNS server addresses are to be propagated in Router Advertisements. A maximum of two DNS server addresses is propagated.</p>

Field	Description
	<p>Possible values:</p> <ul style="list-style-type: none"> • <i>Off</i>: No DNS server address propagation • <i>Self</i>: The device sends its own IP address as DNS server address. If the device has multiple addresses, they are used in the following order: <ul style="list-style-type: none"> • Global addresses • ULA (Unique Local Addresses) • Link local addresses • <i>Other</i>: Statically configured as well as dynamically learned DNS server entries are propagated according to their priority. If there are no entries, no address is propagated.

12.2 VLAN

By implementing VLAN segmentation in accordance with 802.1Q, you can configure VLANs on your device. The wireless ports of an access point, in particular, are able to remove the VLAN tag of a frame sent to the clients and to tag received frames with a pre-defined VLAN ID. This functionality makes an access point nothing less than a VLAN-compliant switch with the enhancement of grouping clients into VLAN groups. In general, VLAN segmenting can be configured with all interfaces.

VLAN for Bridging and VLAN for Routing

In the **LAN->VLAN** menu, VLANs (virtual LANs) are configured with interfaces that operate in Bridging mode. Using the **VLAN** menu, you can make all the settings needed for this and query their status.



Caution

For interfaces that operate in Routing mode, you only assign a VLAN ID to the interface. You define this via the parameters **Interface Mode** = *Tagged (VLAN)* and field **VLAN ID** in menu **LAN->IP Configuration->Interfaces->New**.

12.2.1 VLANs

In this menu, you can display all the VLANs already configured, edit your settings and create new VLANs. By default, the *Management* VLAN with **VLAN Identifier** = 1 is available, to which all interfaces are assigned.

12.2.1.1 Edit or New

Choose the  icon to edit existing entries. Select the **New** button in order to create new VLANs.

The **LAN->VLAN->VLANs->New** menu consists of the following fields:

Fields in the **Configure VLAN** menu.

Field	Description
VLAN Identifier	Enter the number that identifies the VLAN. In the  menu, you can no longer change this value. Possible values are 1 (default value) to 4094.
VLAN Name	Enter a unique name for the VLAN. A character string of up to 32 characters is possible. The predefined VLAN name is <i>Management</i> .
VLAN Members	Select the ports that are to belong to this VLAN. You can use the Add button to add members. For each entry, also select whether the frames to be transmitted from this port are to be transmitted <i>Tagged</i> (i.e. with VLAN information) or <i>Untagged</i> (i.e. without VLAN information).

12.2.2 Port Configuration

In this menu, you can define and view the rules for receiving frames at the VLAN ports.

The **LAN->VLANs->Port Configuration** menu consists of the following fields:

Fields in the **Port Configuration** menu.

Field	Description
Interface	Shows the port for which you define the PVID and processing

Field	Description
	rules.
PVID	Assign the selected port the required PVID (Port VLAN Identifier). If a packet without a VLAN tag reaches this port, it is assigned this PVID.
Drop untagged frames	If this option is enabled, untagged frames are discarded. If the option is disabled, untagged frames are tagged with the PVID defined in this menu.
Drop non-members	If this option is enabled, all tagged frames that are tagged with a VLAN ID to which the selected port does not belong are discarded.

12.2.3 Administration

In this menu, you make general settings for a VLAN. The options must be configured separately for each bridge group.

The **LAN->VLANs->Administration** menu consists of the following fields:

Fields in the Bridge Group br<ID> VLAN Options menu

Field	Description
Enable VLAN	Enable or disable the specified bridge group for VLAN. The function is enabled with <i>Enabled</i> . The function is not activated by default.

Chapter 13 Wireless LAN Controller

By using the wireless LAN controller, you can set up and manage a WLAN infrastructure with multiple access points (APs). The WLAN controller has a Wizard which assists you in the configuration of your access points. The system uses the CAPWAP protocol (Control and Provisioning of Wireless Access Points Protocol) for any communication between controller and access points.

In smaller WLAN infrastructures with up to six APs, one of the AP's assumes the master function and manages the other AP's as well as itself. In larger WLAN networks a gateway, e.g. such as a **bintec R1202**, assumes the master function and manages the AP's.

Provided the controller has "located" all of the APs in its system, each of these shall receive a new passport and configuration in succession, i.e. they are managed via the WLAN controller and can no longer be amended "externally".

With the **WLAN controller** you can

- automatically detect individual access points (APs) and connect to a WLAN network
- Load the system software into the APs
- Load the configuration into the APs
- Monitor and manage APs

Please refer to your gateway's data sheet to find out the number of APs that you can manage with your gateway's wireless LAN controller and details of the licenses required.

13.1 Wizard

The **Wizard** menu offers step-by-step instructions for the set up of a WLAN infrastructure. The Wizard guides you through the configuration.



Note

We highly recommended that you use the Wizard when initially configuring your WLAN infrastructure.

13.1.1 Wireless LAN Controller Wizard

Here you can configure all of the various settings that you require for the actual wireless LAN controller.

13.1.1.1 Basic Settings

The wireless LAN controller uses the following settings:

Regulatory domain

Select the regulation area here. The selection here determines the countries that you can select for the option **Region**. The default value is *ETSI* (European Telecommunications Standards Institute).

Region

Select the country in which the wireless controller is to be operated.

Please note: The range of channels that can be used varies depending on the country setting.

Interface

Select the interface to be used for the wireless controller.

DHCP Server

Select whether an external DHCP server shall assign IP addresses to the APs or if you wish to assign fixed IP addresses yourself. Alternatively, you can use your device as a DHCP server. For this internal DHCP server, CAPWAP option 138 is active in order to allow communication between the controller and access points.

If you use static IP addresses in your network, you must enter these to all APs manually. The IP addresses of the wireless LAN controller must be entered for each AP in the **System Management->Global Settings->System** menu in the **Manual WLAN Controller IP Address** field.

Please note: Make sure that option 138 is active when using an external DHCP server.

If you wish to use a bintec elmeg Gateway for example as a DHCP server, click on the **GUI** menu for this device under **Local Services->DHCP Server->DHCP Configuration->New->Advanced Settings** in the **DHCP Options** field on the **Add** button. Select as **Option** *CAPWAP Controller* and in the **Value** field enter the IP address of the WLAN controller.

IP Address Range

If the IP addresses are to be assigned internally, you must enter the start and end IP address of the desired range.

Please note: If you click on **Next**, a warning appears which informs you that continuing will overwrite the wireless LAN controller configuration. By clicking on **OK** you signal that you

agree with this and wish to continue with the configuration.

13.1.1.2 Radio Profile

Select which frequency band your WLAN controller shall use.

If the *2.4 GHz Radio Profile* is set then the 2.4 GHz frequency band is used.

If the *5 GHz Radio Profile* is set then the 5 GHz frequency band is used.

If the corresponding device contains two wireless modules, you can **Use two independent radio profiles**. This assigns *2.4 GHz Radio Profile* to module 1 and *5 GHz Radio Profile* to module 2.

The function is activated by selecting *Enabled*.

The function is disabled by default.

13.1.1.3 Wireless Network

All of the configured wireless networks (VSS) are displayed in the list. At least one wireless network (VSS) is set up. This entry cannot be deleted.

Click on  to edit an existing entry.

You can also delete entries using the  icon.

With **Add**, you can create new entries. You can create up to eight wireless networks (VSS) for a wireless module.



Note

If you wish to use the default wireless network that is set up, you must at least change the **Preshared Key** parameters. Otherwise you will be prompted.

13.1.1.3.1 Change or add wireless networks

Click on  to edit an existing entry.

With **Add**, you can create new entries.

The following parameters are available

Network Name (SSID)

Enter the name of the wireless network (SSID).

Enter an ASCII string with a maximum of 32 characters.

Also select whether the **Network Name (SSID)** *Visible* is to be transmitted.

IGMP Snooping

IGMP snooping reduces the data traffic and thus the network load.

The function is activated by selecting *Enabled*.

Security Mode

Select the security mode (encryption and authentication) for the wireless network.

Please note: *WPA Enterprise* means 802.11x.

WPA Mode

Select for **Security Mode** = *WPA-PSK* or *WPA Enterprise*, whether you wish to use WPA, WPA 2, WPA3 or a combination.

Preshared Key

Enter the WPA password for **Security Mode** = *WPA-PSK*.

Enter an ASCII string with 8 - 63 characters.



Important

Change the default Preshared Key! If the key has not been changed, your device will not be protected against unauthorized access!

Radius Server

When using *WPA Enterprise*, you can control access to a wireless network via a RADIUS server.

With **Add**, you can create new entries.

Enter the IP address and the password of the desired RADIUS server.

EAP Preauthentication

For **Security Mode** = *WPA Enterprise*, select whether the EAP preauthentication function is to be *Enabled*. This function tells your device that WLAN clients, which are already connected to another access point, can first carry out 802.1x authentication as soon as they are within range. Such WLAN clients can then simply connect over the existing network connection with your device.

VLAN

Select whether the VLAN segmentation is to be used for this wireless network.

If you wish to use VLAN segmentation, enter a value between 2 and 4094 in the input field in order to identify the VLAN. (VLAN ID 1 is not possible!).



Note

Before you continue, please ensure that all access points that the WLAN controller shall manage are correctly wired and switched on.

13.1.1.4 Start automatic installation

You will see a list of all detected access points.

If you wish to change the settings of a detected AP, click on  in the corresponding entry.

You will see the settings for all selected access points. You can change these settings.

The following parameters are available in the **Access Point Settings** menu:

Location

Displays the stated locality of the AP. You can enter another locality.

Assigned Wireless Network (VSS)

Displays the wireless networks that are currently assigned.

The following parameters are available in the wireless module 1 menu:

(The parts wireless module 1 and wireless module 2 are displayed if the AP has two wireless modules.)

Operation Mode

Select the mode in which the wireless module is to be operated.

Possible values:

- *On* (default value): The wireless module is used as an access point in your network.
- *Off*: The wireless module is not active.

Active Radio Profile

Displays the wireless module profile that is currently selected. You can select another wireless module profile from the list if more than one wireless module profile is being set up.

Channel

Displays the channel that is assigned. You can select an alternative channel.

The number of channels you can select depends on the country setting. Please consult the data sheet for your device.



Note

Configuring the network name (SSID) in Access Point mode means that wireless networks can be logically separated from each other, but they can still physically interfere with each other if they are operating on the same or closely adjacent wireless channels. So if you are operating two or more radio networks close to each other, it is advisable to allocate the networks to different channels. Each of these should be spaced at least four channels apart, as a network also partially occupies the adjacent channels.

In the case of manual channel selection, please make sure first that the APs actually support these channels.

Transmit Power

Displays the transmission power in dBm. You can select another transmission power.

With **OK** you apply the settings.

Select the access points that your WLAN controller shall manage. In the **Manage** column, click on the desired entries or click on **Select all** in order to select all entries. Click the **Deselect all** button to disable all entries and to then select individual entries if required (e.g. for large lists).

Click on **Start** in order to install the WLAN and automatically assign the frequencies.



Note

If there are not enough licenses available, the message "The maximum number of access points that can be supported has been exceeded". Please check your licenses. If this message is displayed then you should obtain additional licenses if appropriate.

During the installation of the WLAN and the allocation of frequencies, on the messages displayed you will see how far the installation has progressed. The display is continuously up-

dated.

Provided that non-overlapping wireless channels are located for all access points, the configuration that is set in the Wizard is transferred to the access points.

When the installation is complete, you will see a list of the **Managed** access points.

Under **Configure the Alert Service for WLAN surveillance**, click **Start** to monitor your managed APs. You are taken to the **External Reporting->Alert Service->Alert Recipient** menu with the default setting **Event** = *Managed AP offline*. You can specify that you wish to be notified by e-mail if the *Managed AP offline* event occurs.

Click under **New Neighbor scan** on **Start**, to rescan adjacent AP's. You will receive a warning that the wireless modules of the access points must also be disabled for a certain period of time. When you start the process with **OK**, a progress bar is displayed. The located AP display is updated every ten seconds.

13.1.2 Wireless LAN Controller VLAN Configuration

In order to separate WLANs (VSS) from each other, you can activate the VLAN function and assign a VLAN ID during the configuration of a VSS. For the separation from other interfaces to work properly, you need to create a virtual interface with its own IP configuration, and, if applicable, a corresponding DHCP pool which provides IP addresses to clients connecting to this VLAN. You can make this settings - as usual - in the menus **LAN->IP Configuration** and **Local Services->DHCP Server**, correspondingly; or you make use of the menu offered here. All settings you make here are automatically transferred to the other menus, as well.

You are shown an overview of VLANs that have already been created with their VLAN IDs and their corresponding IP and DHCP configuration. In order to edit an entry, select the  icon in the respective line. To create a new entry, select **New**. A new entry can only be created for a VSS with a VLAN ID that does not yet have a VLAN configuration.

13.1.2.1 Edit or Neu

Select the  symbol in order to edit an existing entry. Select the **New** button in order to create additional VLANs.

The menu **Wireless LAN Controller->Wizard->Wireless LAN Controller VLAN Configuration->New** consists of the following fields:

Fields in the menu VSS VLAN Network Configuration

Field	Description
VLAN ID	Select an existing VLAN from the pull down menu. Only those

Field	Description
	IDs without a configuration are offered.
IP Address/Netmask	Specify the IP configuration of the new interface. Make sure that the address has not been used before.
DHCP Server	<p>In order to provide clients connecting to this VLAN with an IP configuration, you can either use an external DHCP server, or you can use the integrated one of your device.</p> <p>Possible values:</p> <ul style="list-style-type: none"> • <i>External or static</i>: Select this option if you are already operating a DHCP server in your network, or if clients connecting to this VLAN have a static IP configuration. Make sure that an external DHCP server can be reached from the VLAN. • <i>Internal</i>: Select this option if you intend to use your device as DHCP server for this VLAN.
IP Address Range	<p>Only for DHCP Server = <i>Internal</i></p> <p>Specify the first and the last IP address which your device is to distribute inside the VLAN. Make sure that the address range corresponds to the IP address of the interface for this VLAN, and that it does not overlap with other IP address pools.</p> <p>The DHCP configuration automatically assumes your device to be the gateway. The lease time is 120 minutes. If you want to adjust these settings, go to the menu Local Services->DHCP Server->DHCP Configuration.</p>

13.2 Controller Configuration

In this menu, you make the basic settings for the wireless LAN controller.

13.2.1 General

The **Wireless LAN Controller->Controller Configuration->General** menu consists of the following fields:

Fields in the Basic Settings menu.

Field	Description
Status	<p>Enable the Status option to make the basic settings for the wireless LAN controller.</p> <p>The function is disabled by default.</p>
Delete the complete WLAN Controller configuration	<p>Only for Status = disabled.</p> <p>You can delete a configuration using the  icon.</p>
Regulatory domain	<p>Select the regulation area here. The selection here determines the countries that you can select for the option Region. The default value is <i>ETSI</i> (European Telecommunications Standards Institute).</p>
Region	<p>Select the country in which the wireless LAN controller is to be operated.</p> <p>Possible values are all the countries configured on the device's wireless module.</p> <p>The range of channels that can be used varies depending on the country setting.</p> <p>The default value is <i>Germany</i>.</p>
Interface	<p>Select the interface to be used for the wireless controller.</p>
DHCP Server	<p>Select whether an external DHCP server shall assign IP addresses to the APs or if you wish to assign fixed IP addresses yourself. Alternatively, you can use your device as a DHCP server. For this internal DHCP server, CAPWAP option 138 is active in order to allow communication between the controller and access points.</p> <p>Please note: Make sure that option 138 is active when using an external DHCP server.</p> <p>If you wish to use a bintec elmeg Gateway for example as a DHCP server, click on the GUI menu for this device under Local Services->DHCP Server->DHCP Pool->New->Advanced Settings in the DHCP Options field on the Add button. Select as Option <i>CAPWAP Controller</i> and in the Value field enter the IP address of the WLAN controller.</p>

Field	Description
	<p>If you use static IP addresses in your network, you must enter these to all APs manually. The IP addresses of the wireless LAN controller must be entered for each AP in the System Management->Global Settings->System menu in the Manual WLAN Controller IP Address field.</p> <p>Possible values:</p> <ul style="list-style-type: none"> • <i>External or static</i> (default value): An external DHCP server with an CAPWAP option 138 enabled assigns the IP addresses to the APs or you can give static IP addresses to the APs. • <i>Internal</i>: Your device, on which the CAPWAP option 138 is active, assigns the IP addresses to the APs.
IP Address Range	<p>Only for DHCP Server = <i>Internal</i></p> <p>Enter the start and end IP address of the range. These IP addresses and your device must originate from the same network.</p>
AP location	<p>Select whether the APs that the wireless LAN controller is to manage are located in the LAN or the WAN.</p> <p>Possible values:</p> <ul style="list-style-type: none"> • <i>Local (LAN)</i> (default value) • <i>Remote (WAN)</i> <p>The <i>Remote (WAN)</i> setting is useful if, for example, there is a wireless LAN controller installed at head office and its APs are distributed to different branches. If the APs are linked via VPN, it may be that a connection is terminated. If this happens, the relevant AP with the setting <i>Remote (WAN)</i> maintains its configuration until the connection is reestablished. It then boots up and the controller and the AP then resynchronize.</p>
AP LED mode	<p>Select the lighting scheme of the AP LEDs.</p> <p>Possible values:</p> <ul style="list-style-type: none"> • <i>State</i> (default value): All LEDs show their standard behavior. • <i>Flashing</i>: Only the status LED flashes once per second.

Field	Description
	<ul style="list-style-type: none"> <i>Off</i>: All LEDs are deactivated.

13.2.2 AP Autoprofile

The Wireless LAN Controller offers the option of automatically including and configuring an access point that is being integrated into the network accessible by the WLAN Controller. In order to be able to automatically assign a configuration to a new access point you have to configure a profile that is valid for all new access points that match certain criteria.

13.2.2.1 Edit or New

The **Wireless LAN Controller->Controller Configuration-> AP Autoprofile->New** menu consists of the following fields:

Fields in the Access Point Filter menu

Field	Description
MAC Address	<p>Enter the MAC address of an access point that is to be configured automatically when it is integrated into the network.</p> <p>By default, All is activated so that the entry matches every new access point.</p>
IP Address / Netmask	<p>Enter an IP address and a netmask. You can enter host as well as network addresses so that you can filter for individual access points as well as for groups of access points from a specific subnet.</p>

Fields in the Access Point Settings menu

Field	Description
Location	Specify the location of the AP.
Description	Enter a unique description for the AP.

Fields in the Radio 1 or in the Radio 2

Field	Description
Operating Mode	<p>Select if the access point to which this profile is applied should enable the respective radio module.</p> <p>The function is activated by selecting <i>Enabled</i>. The function is enabled by default.</p>
Active Radio Profile	Only for Operating Mode = <i>Enabled</i>



Field	Description
	Select a radio profile. Possible values: <ul style="list-style-type: none"> • <i>2.4 GHz Radio Profile</i> • <i>5 GHz Radio Profile</i>
Assigned Wireless Network (VSS)	Only for Operating Mode = <i>Enabled</i> Add a new radio profile with Add .

13.3 AP configuration

In this menu, you will find all of the settings that are required to manage the access points.

13.3.1 Access Points

In the **Wireless LAN Controller** -> **AP configuration** -> **Access Points** menu a list of all APs found with the wizard is displayed.

You will see an entry with a parameter set for each access point (**Location**, **Name**, **IP Address**, **LAN MAC Address**, **Channel**, **Search Channel**, **Status**, **Action**). Choose whether the selected Access Point is to be managed by the WLAN Controller by clicking the  button or the  button in the **Action** column.

You can disconnect the Access Point from the WLAN Controller and therefore remove it from your WLAN infrastructure by click on the  button. The Access Point then receives the *Discovered* status, but is no longer *Managed*.

Click on the **START** button under **Channel reallocation** in order to reassign any assigned channels, e.g. when a new access point has been added.

Possible values for Status

Status	Meaning
Discovered	The AP has registered at the wireless LAN controller. The controller has prompted the required parameters from the AP.
Initializing	The WLAN controller and the APs "communicate" via CAPWAP. The configuration is transferred and enabled to the APs.
Managed	The AP is set to "Managed" status. The controller has sent a configuration to the AP and has enabled this. The AP is managed centrally from the controller and cannot be configured via

Status	Meaning
	the GUI .
No License Available	The AP does not have an unassigned licence for this AP.
Offline	The AP is either administratively disabled or switched off or has its power supply cut off etc.

13.3.1.1 Edit

Choose the  icon to edit existing entries.

You can also delete entries using the  icon. If you have deleted APs, these will be located again but shall not be configured.

The data for wireless module 1 and wireless module 2 are displayed in the **Wireless LAN Controller-> AP configuration-> Access Points->**  menu if the corresponding device has two wireless modules. With devices featuring a single wireless module, the data for wireless module 1 are displayed.

The menu consists of the following fields:

Fields in the Access Point menu

Field	Description
Device Type	Here you can see various relevant information about this access point, such as: ...the type of access point being managed.
Serial Number	... the serial number of the managed device.
LAN MAC Address	... the MAC address of the LAN interface of the managed device.
Radio Module 1 supported features	Information about the features supported by the access point: <ul style="list-style-type: none"> • Operation band(s) • Bandwidth • Wireless Mode • Spatial Streams • Data Rate Trimming • WPA 3

Fields in the Access Point Settings menu.

Field	Description
Device	Displays the type of device for the AP.
Location	Displays the locality of the AP. The locations are given numbers if no location has been entered. You can enter another locality.
Name	Displays the name of the AP. You can change the name.
Description	Enter a unique description for the AP.
CAPWAP Encryption	<p>Select whether communication between the controller and access points is to be encrypted.</p> <p>The function is activated by selecting <i>Enabled</i>.</p> <p>The function is enabled by default.</p> <p>You can override the encryption in order to view the communication for debugging purposes.</p>

Fields in the Wireless module1 or in the Wireless module 2 menu.

Field	Description
Operation Mode	<p>Displays the mode in which the wireless module is to be operated. You can change the mode.</p> <p>Possible values:</p> <ul style="list-style-type: none"> • <i>On</i> (default value): The wireless module is used as an access point in your network. • <i>Off</i>: The wireless module is not active.
Active Radio Profile	Displays the wireless module profile that is currently selected. You can select another wireless module profile from the list if more than one wireless module profile is being set up.
Channel	<p>Displays the channel that is assigned. You can select another channel.</p> <p>The number of channels you can select depends on the country setting. Please consult the data sheet for your device.</p> <p>Access Point mode</p>

Field	Description
	<p>Configuring the network name (SSID) in Access Point mode means that wireless networks can be logically separated from each other, but they can still physically interfere with each other if they are operating on the same or closely adjacent wireless channels. So if you are operating two or more radio networks close to each other, it is advisable to allocate the networks to different channels. Each of these should be spaced at least four channels apart, as a network also partially occupies the adjacent channels.</p> <p>In the case of manual channel selection, please make sure first that the APs actually support these channels.</p> <p>Possible values (according to the selected wireless module profile):</p> <ul style="list-style-type: none"> • For Active Radio Profile = 2.4 GHz Radio Profile Possible values are <i>1</i> to <i>13</i> and <i>Auto</i> (default value). • For Active Radio Profile = 5 GHz Radio Profile Depending on the selected module profile, possible values are <i>36</i>, <i>40</i>, <i>44</i>, <i>48</i> and <i>Auto</i> (default value)
Used Channel	<p>Only for managed APs.</p> <p>Displays the channel that is currently in use.</p>
Transmit Power	<p>Displays the transmission power. You can select another transmission power.</p> <p>Possible values:</p> <ul style="list-style-type: none"> • <i>Max.</i> (default value): The maximum antenna power is used. • <i>5 dBm</i> • <i>8 dBm</i> • <i>11 dBm</i> • <i>14 dBm</i> • <i>16 dBm</i> • <i>17 dBm</i>
Assigned Wireless	<p>Displays the wireless networks that are currently assigned.</p>

Field	Description
Network (VSS)	

13.3.2 Radio Profiles

An overview of all created wireless module profiles is displayed in the **Wireless LAN Controller-> AP configuration->Radio Profiles** menu. A profile with 2.4 GHz and a profile with 5 GHz are created by default; the 2.4 GHz profile cannot be deleted.

For each wireless module profile you will see an entry with a parameter set (**Radio Profiles, Configured Radio Modules, Operation Band, Wireless Mode**).

13.3.2.1 Edit or New

Choose the  icon to edit existing entries. Select the **New** button in order to create new wireless module profiles.

The **Wireless LAN Controller-> AP configuration->Radio Profiles->  / New** menu consists of the following fields:

Fields in the menu Radio Profile Definition

Field	Description
Description	Enter the desired description of the wireless module profile.
Operation Mode	Define the mode in which the wireless module profile is to be operated. Possible values: <ul style="list-style-type: none"> • <i>Off</i> (default value): The wireless module profile is not active. • <i>Access Point</i>: Your device is used as an access point in your network.
Operation Band	Select the frequency band of the wireless module profile. Possible values: <ul style="list-style-type: none"> • <i>2.4 GHz In/Outdoor</i> (default value): Your device is operated at 2.4 GHz inside or outside buildings. • <i>5 GHz Indoor</i>: Your device is operated at 5 GHz inside buildings. • <i>5 GHz Outdoor</i>: Your device is operated at 5 GHz outside

Field	Description
	<p>buildings.</p> <ul style="list-style-type: none"> • <i>5 GHz In/Outdoor</i>: Your device is operated at 5 GHz inside or outside buildings. • <i>5.8 GHz Outdoor</i>: Only for so-called Broadband Fixed Wireless Access (BFWA) applications. The frequencies in the frequency range from 5755 MHz to 5875 MHz may only be used in conjunction with commercial offers for public network accesses and requires registration with the Federal Network Agency.

Fields in the menu Performance Settings

Field	Description
Wireless Mode	<p>Select the wireless technology that you want the access point to use.</p> <p>For the <i>2,4 GHz In/Outdoor</i> Operation Band all modes from <i>802.11b</i> up to the current <i>802.11ax</i> are available (but not <i>802.11ac</i> which is used only in 5GHz mode), as well as combinations of these modes. Keep in mind that not all access points and not all clients always support the latest modes.</p> <p>For Operation Band = <i>5 GHz Indoor</i>, <i>5 GHz Outdoor</i>, <i>5 GHz In/Outdoor</i> or <i>5,8 GHz Outdoor</i> all modes from <i>802.11a</i> to the current <i>802.11ax</i> are available (but not <i>802.11b</i> and <i>g</i> which are not specified for 5-GHz), as well as combinations of these modes. Keep in mind that not all access points and not all clients always support the latest modes.</p>
Bandwidth	<p>Only for Operation Band = <i>5 GHz</i> and not for Wireless Mode <i>802.11a</i>.</p> <p>Select how many channels are to be used.</p> <p>Possible values:</p> <ul style="list-style-type: none"> • <i>20 MHz</i> (default value): One channel with 20 MHz bandwidth is used. • <i>40 MHz</i>: Two channels each with 20 MHz bandwidth are used. In the case one channel acts as a control channel and the other as an expansion channel. • <i>80 MHz</i>: Four channels with 20 MHz bandwidth each are used. Thus a bandwidth of 80 MHz is available.

Field	Description
Number of Spatial Streams	<p>Select how many data streams are to be used in parallel.</p> <p>Possible values: 1 to 4. The available options depend on the combination of the operation band and wireless mode as well as on the access point model.</p>
Airtime fairness	<p>This function is not available for all devices.</p> <p>The Airtime fairness function ensures that the access point's send resources are distributed intelligently to the connected clients. This means that a powerful client (e. g. an 802.11n client) cannot achieve only a poor flow level, because a less powerful client (e. g. an 802.11a client) is treated in the same way when apportioning.</p> <p>The function is enabled with <i>Enabled</i>.</p> <p>The function is disabled by default.</p> <p>This function is only applied to unprioritized frames of the WMM Class "Background".</p>
Cyclic Background Scanning	<p>Not all devices support this function.</p> <p>You can enable the Cyclic Background Scanning function so that a search is run at regular intervals for neighboring or rogue access points in the network. This search is run without negatively impacting the function as an access point.</p> <p>Enable or disable the function Cyclic Background Scanning.</p> <p>The function is enabled with <i>Enabled</i>.</p> <p>The function is not activated by default.</p>

The menu **Advanced Settings** consists of the following fields:

Fields in the menu **Advanced Settings**

Field	Description
Channel Plan	<p>Select the desired channel plan.</p> <p>The so-called channel plan allows the automatic selection of channels based on specific choices. This ensures that channels do not overlap, i.e., a gap of at least four channels is maintained between the channels used. This is useful if multiple access</p>

Field	Description
	<p>points with overlapping radio cells are used.</p> <p>Possible values:</p> <ul style="list-style-type: none"> • <i>All</i>: All channels can be chosen during channel selection. • <i>World Mode</i> (for Operation Band = 2.4 GHz, default value): Automatic channel selection uses only the non-overlapping channels 1, 6, 11. • <i>ETSI Mode</i> (for Operation Band = 2.4 GHz): Automatic channel selection uses only the non-overlapping channels 1, 5, 9, 13. • <i>No weather radar channels</i> (for Operation Band = 5 GHz, default value): The weather radar channels are excluded from channel selection. <p>Possible values:</p> <p>36, 40, 44, 48, 52, 56, 60, 64, 100, 104, 108, 112, 116, 132, 136, 140.</p> <ul style="list-style-type: none"> • <i>Indoors No DFS/TPC</i>: These channels can be used inside buildings. DFS (Dynamic Frequency Selection) and TPC (Transmitter Power Control) are not enabled. <p>Possible values:</p> <p>36, 40, 44, 48.</p> <ul style="list-style-type: none"> • <i>No outdoor channels</i> (for Operation Band = 5 GHz): This channel plan combines channels 36 to 64, which are specified for indoor applications only. Especially 5GHz WLAN-capable multimedia devices such as smart TVs, which often do not support the 5GHz outdoor channels (from channel 100 upwards), can be optimally integrated into the WLAN network. • <i>User defined</i>: Select the desired channels.
User Defined Channel Plan	<p>Only for Channel Plan = <i>User defined</i></p> <p>The currently selected channels are displayed here.</p> <p>With Add you can add channels. If all available channels are displayed, you cannot add any more entries.</p> <p>You can also delete entries using the  icon.</p>

Field	Description
Switch Channel on Jammer	Activate this option if the access point should change the radio channel if the connection is affected by interferences.
Short Guard Interval	Enable this function to reduce the guard interval (= time between transmission of two data symbols) from 800 ns to 400 ns.
Max. Transmission Rate	<p>Select the transmission speed.</p> <p>Possible values:</p> <ul style="list-style-type: none"> • <i>Auto</i> (default value): The transmission speed is determined automatically. • <i><Value></i>: According to setting for Operation Band, Bandwidth, Number of Spatial Streams and Wireless Mode various fixed values in mbps are available.
Beacon Period	<p>Enter the time in milliseconds between the sending of two beacons.</p> <p>This value is transmitted in Beacon and Probe Response Frames.</p> <p>Possible values are <i>1</i> to <i>65535</i>.</p> <p>The default value is <i>100</i>.</p>
DTIM Period	<p>Enter the interval for the Delivery Traffic Indication Message (DTIM).</p> <p>The DTIM field is a data field in transmitted beacons that informs clients about the window to the next broadcast or multicast transmission. If clients operate in power save mode, they come alive at the right time and receive the data.</p> <p>Possible values are <i>1</i> to <i>255</i>.</p> <p>The default value is <i>2</i>.</p>
RTS Threshold	<p>Here you can specify the data packet length threshold in bytes (1..2346) as of which the RTS/CTS mechanism is to be used. This makes sense if several clients that are not in each other's wireless range are run in one access point.</p>

Field	Description
Short Retry Limit	<p>Enter the maximum number of attempts to send a frame with length less than or equal to the value defined in RTS Threshold. After this many failed attempts, the packet is discarded.</p> <p>Possible values are <i>1</i> to <i>255</i>.</p> <p>The default value is <i>7</i>.</p>
Long Retry Limit	<p>Enter the maximum number of attempts to send a data packet of length greater than the value defined in RTS Threshold. After this many failed attempts, the packet is discarded.</p> <p>Possible values are <i>1</i> to <i>255</i>.</p> <p>The default value is <i>4</i>.</p>
Fragmentation Threshold	<p>Enter the maximum size as of which the data packets are to be fragmented (i.e. split into smaller units). Low values are recommended for this field in areas with poor reception and in the event of radio interference.</p> <p>Possible values are <i>256</i> to <i>2346</i>.</p> <p>The default value is <i>2346</i>.</p>

13.3.3 Wireless Networks (VSS)

An overview of all created wireless networks is displayed in the **Wireless LAN Controller** -> **AP configuration** -> **Wireless Networks (VSS)** menu. A wireless network is created by default.

For every wireless network (VSS), you see an entry with a parameter set (**VSS Description**, **Network Name (SSID)**, **Number of associated radio modules**, **Security**, **Status**, **Action**).

Under **Assign unassigned VSS to all radio modules** click on the **Start** button to assign a newly-created VSS to all wireless modules.

13.3.3.1 Edit or New

Choose the  icon to edit existing entries. Choose the **New** button to configure additional wireless networks.

The **Wireless LAN Controller**-> **AP configuration**->**Wireless Networks (VSS)**->**New** menu consists of the following fields:

Fields in the menu **Service Set Parameters**

Field	Description
Network Name (SSID)	<p>Enter the name of the wireless network (SSID).</p> <p>Enter an ASCII string with a maximum of 32 characters.</p> <p>Also select whether the Network Name (SSID) is to be transmitted.</p> <p>The network name is displayed by selecting <i>Visible</i>.</p> <p>It is visible by default.</p>
Intra-cell Repeating	<p>Select whether communication between the WLAN clients is to be permitted within a radio cell.</p> <p>The function is activated by selecting <i>Enabled</i>.</p> <p>The function is enabled by default.</p> <p>Users of the guest WLAN should normally have access to the Internet but no access to the company's intranet. To prevent this, the option must be disabled. be.</p>
U-APSD	<p>Select whether the Unscheduled Automatic Power Save Delivery (U-APSD) mode is to be enabled.</p> <p>The function is activated by selecting <i>Enabled</i>.</p> <p>The function is enabled by default.</p>
IGMP Snooping	<p>IGMP snooping reduces the data traffic and thus the network load, as Multicast packets from the LAN are not forwarded. Only those Multicast packets will be forwarded that are requested by the respective clients. When you enable IGMP snooping, IGMP snooping, therefore, provides the framework in which Multicast is applied.</p> <p>The function is activated by selecting <i>Enabled</i>.</p> <p>The function is disabled by default.</p>

Fields in the menu **Security Settings**

Field	Description
Security Mode	<p>Select the security mode (encryption and authentication) for the wireless network.</p> <p>Possible values:</p> <ul style="list-style-type: none"> • <i>OWE-Transition</i> <p>The <i>OWE-Transition</i> setting does not require the input of a Preshared Key and is suitable for open guest networks. It is suitable for networks that are to be used by WPA3-capable clients, but also by older, non-WPA3-capable clients. Data transmission between access point and client is encrypted for clients supporting WPA3. For clients not supporting WPA3, data transmission is unencrypted.</p> <ul style="list-style-type: none"> • <i>OWE</i> <div data-bbox="544 741 1315 862" style="border: 1px solid gray; padding: 5px; margin: 10px 0;">  <p>Note</p> <p>OWE only works with clients supporting WPA3 and OWE.</p> </div> <ul style="list-style-type: none"> • The <i>OWE</i> setting does not require the input of a Preshared Key and is suitable for open guest networks. Nevertheless, data transmission between the access point and the clients is encrypted. • <i>Inactive</i> (default value): Neither encryption nor authentication • <i>WEP 40</i>: WEP 40 bits • <i>WEP 104</i>: WEP 104 bits • <i>WPA-PSK</i>: WPA Preshared Key • <i>WPA Enterprise</i>: 802.11x
Transmit Key 1-4	<p>Only for Security Mode = <i>WEP 40</i> or <i>WEP 104</i></p> <p>Select one of the keys configured in WEP Key as a standard key.</p> <p>The default value is <i>Key 1</i>.</p>
WEP Key 1-4	<p>Only for Security Mode = <i>WEP 40</i>, <i>WEP 104</i></p> <p>Enter the WEP key.</p>

Field	Description
	Enter a character string with the right number of characters for the selected WEP mode. For <i>WEP 40</i> you need a character string with 5 characters, for <i>WEP 104</i> with 13 characters.
WPA Mode	<p>For Security Mode = <i>WPA-PSK</i> and <i>WPA Enterprise</i></p> <p>Possible values:</p> <ul style="list-style-type: none"> • <i>WPA</i>: WLAN clients that support WPA can connect. • <i>WPA2</i>: WLAN clients that support WPA2 can connect. • <i>WPA3</i>: Only WLAN clients that support WPA3 can connect. • <i>WPA and WPA2</i>: WLAN clients that support WPA1 or WPA2 can connect. • <i>WPA2 and WPA3</i> (default value): WLAN clients that support WPA2 or WPA3 can connect.
WPA Cipher	<p>For Security Mode = <i>WPA-PSK</i> or <i>WPA Enterprise</i> and for WPA Mode = <i>WPA</i> or <i>WPA and WPA2</i></p> <p>Select the type of encryption you want to apply.</p> <p>Possible values:</p> <ul style="list-style-type: none"> • <i>AES</i>: AES is used. • <i>TKIP</i>: TKIP is used. • <i>AES and TKIP</i> (default value): AES or TKIP is used.
WPA2 Cipher	<p>For Security Mode = <i>WPA-PSK</i> or <i>WPA Enterprise</i> and for WPA Mode = <i>WPA2</i> or <i>WPA and WPA2</i></p> <p>Select the type of encryption you want to apply.</p> <p>Possible values:</p> <ul style="list-style-type: none"> • <i>AES</i>: AES is used. • <i>AES and TKIP</i> (default value): AES or TKIP is used.
WPA2/3 Cipher	<p>For Security Mode = <i>WPA PSK</i> or <i>WPA Enterprise</i> and for WPA Mode = <i>WPA2 and WPA3</i> only AES encryption is supported. No further settings are required.</p>
WPA3 Cipher	<p>For Security Mode = <i>WPA PSK</i> or <i>WPA Enterprise</i> and for</p>

Field	Description
	<p>WPA Mode = <i>WPA3</i> AES encryption with the following AES variants is supported:</p> <ul style="list-style-type: none"> • AES • AES-GCMP • AES-256 • AES-GCMP-256.
Preshared Key	<p>Only for Security Mode = <i>WPA-PSK</i></p> <p>Enter the WPA password.</p> <p>Enter an ASCII string with 8 - 63 characters.</p>
	<p> Note</p> <p>Change the default Preshared Key! If the key has not been changed, your device will not be protected against unauthorized access!</p>
Radius Server	<p>Only for Security Mode = <i>WPA Enterprise</i> You can control access to a wireless network via a RADIUS server.</p> <p>With Add, you can create new entries. Enter the IP address and the password of the RADIUS server.</p>
EAP Preauthentication	<p>Only for Security Mode = <i>WPA Enterprise</i></p> <p>Select whether the EAP preauthentication function is to be activated. This function tells your device that WLAN clients, which are already connected to another access point, can first carry out 802.1x authentication as soon as they are within range. Such WLAN clients can then simply connect over the existing network connection with your device.</p> <p>The function is activated by selecting <i>Enabled</i>.</p> <p>The function is enabled by default.</p>

Fields in the menu Client load balancing

Field	Description
Max. number of clients - hard limit	<p>Enter the maximum number of clients that can be connected to this wireless network (SSID)</p> <p>The maximum number of clients that can register with a wireless module depends on the specifications of the respective WLAN module. This maximum is distributed across all wireless networks configured for this radio module. No more new wireless networks can be created and a warning message will appear if the maximum number of clients is reached.</p> <p>Possible values are whole numbers between <i>1</i> and <i>254</i>.</p> <p>The default value is <i>32</i>.</p>
Max. number of clients - soft limit	<p>Not all devices support this function.</p> <p>To avoid a radio module being fully utilized, you can set a "soft" restriction on the number of connected clients. If this number is reached, new connection queries are initially rejected. If the client cannot find another wireless network and, therefore, repeats its query, the connection is accepted. Queries are only definitively rejected when the Max. number of clients - hard limit is reached.</p> <p>The value of the Max. number of clients - soft limit must be the same as or less than that of the Max. number of clients - hard limit.</p> <p>The default value is <i>28</i>.</p> <p>You can disable this function if you set Max. number of clients - soft limit and Max. number of clients - hard limit to identical values.</p>
Client Band select	<p>Select whether the 5 GHz band is preferred.</p> <p>Possible values:</p> <ul style="list-style-type: none"> • <i>Disabled - optimized for fast roaming</i>: the 5 GHz band is not preferred, fast roaming is used. • <i>5 GHz band preferred</i>: the 5 GHz band is preferred to be used if available.

Field	Description
	<div style="border: 1px solid gray; padding: 5px; margin-bottom: 10px;">  <p>Note</p> <p>For the <i>5 GHz band preferred</i> setting, configure the same SSID in both client bands.</p> </div> <ul style="list-style-type: none"> • <i>AP Steering</i> (Access Point Steering): With Access Point Steering, a WLAN client may not only be directed to another comfort band, but also to another access point. This requires the activation of 802.11k/v.
802.11r (Fast BSS Transition):	802.11r enables an uninterrupted connection even with strongly encrypted WLAN networks when the WLAN client switches from one access point to another.
Radio Resource Management (802.11k) and Network assisted Roaming (802.11v)	802.11k/v exchanges information between WLAN client and WLAN access point and uses this information to control the load distribution between several access points more efficiently. These two options are usually activated together, but can also be configured separately. 802.11v controls the exchange of information about the current network topology, while 802.11k controls intelligent client roaming based on the topology data.

Fields in the menu **MAC-Filter**

Field	Description
Access Control	<p>Select whether only certain clients are to be permitted for this wireless network.</p> <p>The function is activated by selecting <i>Enabled</i>.</p> <p>The function is disabled by default.</p>
Allowed Addresses	Use Add to make entries and enter the MAC addresses (MAC Address) of the clients to be permitted.
Dynamic blacklisting	You can use the Dynamic blacklisting function to identify clients that want to gain possibly unauthorized access to the network and block them for a certain length of time. A client is blocked if the number of unsuccessful login attempts with a specified time exceeds a certain number. This threshold value and the duration of the block can be configured. A blocked client is blocked at all the APs that are managed by the wireless LAN

Field	Description
	<p>controller for the VSS concerned, so neither are they able to log into a different radio cell in that VSS. If a client needs to be blocked permanently, this can be done in the Wireless LAN Controller->Monitoring->Rogue Clients menu.</p> <p>The function is activated by selecting <i>Enabled</i>.</p> <p>The function is activated by default.</p>
Failed attempts per Time	<p>Enter the number of failed attempts that have to originate from a specific MAC address during a certain time for a blacklist entry to be created.</p> <p>Default values are <i>10</i> failed attempts during <i>60</i> seconds.</p>
Blacklist blocktime	<p>Enter the time for which an entry in the dynamic blacklist remains valid.</p> <p>Default value is <i>500</i> seconds.</p>

Fields in the menu VLAN

Field	Description
VLAN	<p>Select whether the VLAN segmentation is to be used for this wireless network.</p> <p>The function is activated by selecting <i>Enabled</i>.</p> <p>The function is disabled by default.</p>
VLAN ID	<p>Enter the number that identifies the VLAN.</p> <p>Possible values are <i>2</i> to <i>4094</i>.</p> <p>VLAN ID <i>1</i> is not possible as it is already in use.</p>

Fields in the menu Bandwidth limitation for each WLAN client

Field	Description
Rx Shaping	<p>Select a bandwidth limitation in the receive direction.</p> <p>Possible values are</p> <ul style="list-style-type: none"> • <i>No limit</i> (default value) • <i>0,25 Mbit/s, 0,5 Mbit/s, 1 Mbit/s up to 10 Mbit/s</i> in single Mbit/s steps, <i>15 Mbit/s, 20 Mbit/s, 30 Mbit/s,</i>

Field	Description
	<i>40 Mbit/s and 50 Mbit/s.</i>
Tx Shaping	<p>Select a bandwidth limitation in the transmit direction.</p> <p>Possible values are</p> <ul style="list-style-type: none"> • <i>No limit</i> (default value) • <i>0,25 Mbit/s, 0,5 Mbit/s, 1 Mbit/s up to 10 Mbit/s</i> in single Mbit/s steps, <i>15 Mbit/s, 20 Mbit/s, 30 Mbit/s, 40 Mbit/s and 50 Mbit/s.</i>

Fields in the menu Data-rate trimming

Field	Description
2,4 GHz band rate profile	<p>Data Rate Trimming allows you to optimize the performance of your wireless LAN. You can block low transfer rates and enforce the use of higher rates. Clients slowing down other clients through the use of low transfer rates are disconnected from the access point.</p> <p>Select the rate profile to be applied:</p> <ul style="list-style-type: none"> • <i>All (Min. 1 MBit/s)</i> - All clients supporting a transfer rate of 1 MBit/s are allowed to connect to the access point. • <i>Min. 6 MBit/s (no 802.11b devices)</i>- see above, for clients with a minimum supported rate of 6 Mbit/s; clients using the obsolete standard 802.11b are not allowed. • <i>Min. 12 MBit/s (no 802.11b devices)</i>- see above, for clients with a minimum supported rate of 12 Mbit/s • <i>Min. 24 MBit/s (no 802.11b devices)</i>- see above, for clients with a minimum supported rate of 24 Mbit/s
5 GHz band rate profile	<p>Possible values:</p> <ul style="list-style-type: none"> • <i>All (Min. 6 MBit/s)</i> - All clients supporting a transfer rate of 6 MBit/s are allowed to connect to the access point. • <i>From 12 MBit/s</i> - see above, for clients with a minimum supported rate of 12 Mbit/s • <i>From 24 MBit/s</i> - see above, for clients with a minimum supported rate of 24 Mbit/s

Fields in the menu Low RSSI threshold management

Field	Description
RSSI threshold	<p>The option RSSI threshold allows you to define a threshold for the expected strength of a client signal. If the signal strength of a client falls below this value for longer than determined by the Grace time, the client is disconnected from the access point. This forces the client to connect to a different access point offering the best possible signal strength.</p> <p>Specify the lower RSSI threshold in dBm. A client falling below this value for longer than allowed by the grace time is disconnected.</p> <p>The default value is <i>-110</i> dBm.</p>
Grace time	<p>Specify the time (in seconds) during which the signal strength of a client may fall below the RSSI threshold without the client being disconnected.</p> <p>The default value is <i>5</i> seconds.</p>

13.4 Monitoring

This menu is used to monitor your WLAN infrastructure.



Note

In order to ensure adequate timing between the WLAN Controller and the connected APs, the internal time server of the WLAN Controller should be enabled.

13.4.1 WLAN Controller

In the **Wireless LAN Controller->Monitoring->WLAN Controller** menu, an overview of the most relevant Wireless LAN Controller parameters is displayed. The display is refreshed every 30 seconds.

Values in the Overview list

Status	Meaning
AP discovered	Displays the number of discovered access points.
AP offline	Displays the number of access points not connected to the Wireless LAN Controller.
AP managed	Displays the number of managed access points.

Status	Meaning
APs manageable with currently installed licenses	bintec elmeg devices come with a free license for access point management. The number of manageable access points varies from device type to device type.
Maximum number of manageable APs by this device with full licenses	Due to different hardware equipment, bintec elmeg devices can manage a certain number of access points.
WLAN Controller: VSS throughput	Displays the data traffic in receive and transmit direction in bytes per second.
CPU usage [%]	Displays the percentaged CPU load over time.
Memory usage [%]	Displays the percentaged memory consumption over time.
Connected clients/VSS	Displays the number of connected clients per wireless network (VSS) over time.

13.4.2 Access Points

The menu **Wireless LAN Controller->Monitoring-> Access Points** shows a survey of all detected access points. Each access point is displayed along with the following parameters: **Location, Name, IP Address, LAN MAC Address, Channel, Tx Bytes** and **Rx Bytes**. Moreover, you can see if an access point is in *Managed* or *Discovered* state.

Via the  icon, you can open an summary with additional details about the **Access Points**.

13.4.2.1 Overview

In the **Overview** menu, additional information about the selected access point is displayed. The display is refreshed every 30 seconds.

Values in the Overview list

Status	Meaning
Throughput	Displays the received and transmitted data traffic per radio module over time.
Connected clients	Displays the number of connected clients per radio module over time.

13.4.2.2 Radio 1

In the **Radio Module** menu, the received and transmitted data traffic per client is displayed over time. Each graph in the display is distinctly assigned to a client by its color and MAC address.

Values in the Radio list

Status	Meaning
Throughput/client	Displays the received and transmitted data traffic per client over time.

13.4.3 Active Clients

In the **Wireless LAN Controller->Monitoring->Active Clients** menu, current values of all active clients are displayed.

For each client you will see an entry with the following parameter set: **Location, AP Name, VSS, Client MAC, Client IP Address, Signal : Noise (dBm) , Tx Bytes, Rx Bytes, Tx Discards, Rx Discards, Status, Uptime.**

Possible values for Status

Status	Meaning
None	The client is no longer in a valid status.
Logon	The client is currently logging on with the WLAN.
Associated	The client is logged on with the WLAN.
Authenticate	The client is in the process of being authenticated.
Authenticated	The client is authenticated.

Via the  icon, you can open a summary with additional details about the **Active Clients**.

Value in the list WLAN Client list

Status	Meaning
Throughput	Displays the data traffic - separated into received and transmitted traffic - for the selected WLAN client over time.
Signal	Displays the signal strength of the selected WLAN client over time.

13.4.4 Wireless Networks (VSS)

In the **Wireless LAN Controller->Monitoring->Wireless Networks (VSS)** menu, an overview of the currently used AP is displayed. You see which wireless module is assigned to which wireless network. For each wireless a parameter set is displayed (**Location, AP Name, VSS, MAC Address (VSS), Channel, Status**).

13.4.5 Client Management

The **Wireless LAN Controller->Monitoring->Client Management** menu displays information on the client management by the access points. You can, e.g., see the number of connected clients, the number of clients that are affected by the **2,4/5 GHz changeover** and the number of rejected clients.

You can delete the values of an entry using the  symbol.

13.5 Neighbor Monitoring

This menu serves the monitoring of remote access points.

13.5.1 Neighbor APs

In the **Wireless LAN Controller->Neighbor Monitoring->Neighbor APs** menu, the adjacent AP's found during the scan are displayed. **Rogue APs**, i.e. APs which are not managed by the WLAN controller but are using an SSID managed by the WLAN controller are highlighted in red.



Note

Check the rogue APs shown carefully, as an attacker could attempt to spy on data in your network using a rogue AP.

Although each AP is found more than once, it is only displayed once with the strongest signal. You see the following parameters for each AP: **SSID, MAC Address, Signal dBm, Channel, Security, Last seen, Strongest signal received by, Total detections**.

The entries are displayed in alphabetical order by **SSID**. **Security** shows the security settings of the AP. Under **Strongest signal received by**, you will see the parameters **Location** and **Name** of the APs in which the displayed AP was found. **Total detections** shows how often the corresponding AP was found during the scan.

Click under **New Neighborscan** on **Start**, to rescan adjacent AP's. You will receive a warning that the wireless modules of the access points must also be disabled for a certain period of time. When you start the process with **OK**, a progress bar is displayed. The located AP display is updated every ten seconds.

13.5.2 Own Access Points

This menu displays information about controller-managed access points as they "see" by each other. This provides useful information about the network created by your managed access points and helps you with identifying potential WLAN issues.

The menu includes information such as the access point name, the channel it is operating on, its signal strength and when it was last seen by which access point and on which channel.

13.5.3 Rogue APs

APs which are using an SSID from their own network but are not managed by **Wireless LAN Controller** are displayed in the **Wireless LAN Controller->Neighbor Monitoring->Rogue APs** menu. **Rogue APs** which have been found for the first time are displayed with a red background.

For each rogue AP you will see an entry with the following parameter set: **SSID, MAC Address, Signal dBm, Channel, Last seen, Detected via AP, Accepted**.



Note

Check the rogue APs shown carefully, as an attacker could attempt to spy on data in your network using a rogue AP.

You can class a rogue AP as trustworthy by enabling the **Accepted** checkbox. If an alarm has been configured, this is then removed and no longer sent. The red background disappears.

Click under **New Neighborscan** on **Start**, to rescan adjacent AP's. You will receive a warning that the wireless modules of the access points must also be disabled for a certain period of time. When you start the process with **OK**, a progress bar is displayed. The located AP display is updated every ten seconds.

13.5.4 Rogue Clients

The **Wireless LAN Controller->Neighbor Monitoring->Rogue Clients** menu displays the clients which have attempted to gain unauthorized access to the network and which are therefore on the blacklist. The blacklist is configured for each VSS in the **Wireless LAN Controller-> AP configuration->Wireless Networks (VSS)** menu. You can also add a new entry to the static blacklist.

Possible values for Rogue Clients

Status	Meaning
Rogue Client MAC Address	Displays the MAC address of the client on the blacklist.
Network Name (SSID)	Displays the SSID involved.
Attacked Access Point	Displays the AP concerned.
Signal dBm	Displays the signal strength of the client during the attempted access.
Type of attack	This displays the type of potential attack, e. g. an incorrect authentication.
First seen	Displays the time of the first registered attempted access.
Last seen	Displays the time of the last registered attempted access.
Static Blacklist	You can categorize a rogue client as untrustworthy by selecting the checkbox in the Static Blacklist column. The block on the client does not then end automatically, rather you need to lift it manually.
Delete	You can delete entries with the  symbol.

13.5.4.1 New

Choose the **New** button to configure additional blacklist entries.

The menu consists of the following fields:

Fields in the New Blacklist Entry menu

Field	Description
Rogue Client MAC Address	Enter the MAC address of the client you intend to include in the static blacklist.
Network Name (SSID)	Pick the wireless network you want to exclude the rogue client from.

13.6 Maintenance

This menu is used for the maintenance of your managed APs.

13.6.1 Firmware Maintenance

In the **Wireless LAN Controller->Maintenance->Firmware Maintenance** menu, a list of all **Managed Access Points** is displayed.

For each managed AP you will see an entry with the following parameter set: **Update firmware, Location, Device, IP Address, LAN MAC Address, Firmware Version, Status**.

Click the **Select all** button to select all of the entries for a firmware update. Click the **Deselect all** button to disable all entries and to then select individual entries if required (e.g. if there is a large number of entries and only individual APs are to be given software updates).

Possible values for Status

Status	Meaning
Image already exists.	The software image already exists; no update is required.
Error	An error has occurred.
Running	The operation is currently in progress.
Done	The update is complete.

The **Wireless LAN Controller->Maintenance->Firmware Maintenance** menu consists of the following fields:

Fields in the Firmware Maintenance menu

Field	Description
Action	<p>Select the action you wish to execute.</p> <p>After each task, a window is displayed showing the other steps that are required.</p> <p>Possible values:</p> <ul style="list-style-type: none"> • <i>Update system software</i>: You can also start an update of the system software. • <i>Save configuration with state information</i>: You can save a configuration which contains the AP status information.

Field	Description
Source Location	<p>Select the source for the action.</p> <p>Possible values:</p> <ul style="list-style-type: none">• <i>HTTP server</i> (default value): The file is stored respectively on a remote server specified in the URL.• <i>Current Software from Update Server</i>: The file is on the official update server. (Only for Action= Update system software)• <i>TFTP server</i>: The file is stored respectively on a TFTP server specified in the URL.
URL	<p>Only for Source Location = HTTP server or TFTP server</p> <p>Enter the URL of the update server from which the system software file is loaded or on which the configuration file is saved.</p>

Chapter 14 Networking

14.1 Routes

Default Route

With a default route, all data is automatically forwarded to one connection if no other suitable route is available. If you set up access to the Internet, you must configure the route to your Internet Service Provider (ISP) as a default route. If, for example, you configure a corporate network connection, only enter the route to the head office or branch office as a default route if you do not configure Internet access over your device. If, for example, you configure both Internet access and a corporate network connection, enter a default route to the ISP and a network route to the head office. You can enter several default routes on your device, but only one default route can be active at any one time. If you enter several default routes, you should thus note differing values for **Metric**.

14.1.1 IPv4 Route Configuration

A list of all configured routes is displayed in the **Network->Routes->IPv4 Route Configuration** menu.

In the ex works state, a predefined entry with the parameters **Destination IP Address** = `192.168.0.0`, **Netmask** = `255.255.255.0`, **Gateway** = `192.168.0.250`, **Interface** = `LAN_EN1-0`, **Route Type** = `Network Route via Interface` is displayed.

14.1.1.1 Edit or New

Choose the  icon to edit existing entries. Choose the **New** button to create additional routes.

If the *Extended* option is selected for the **Route Class**, an extra configuration section opens.

The **Network->Routes->IPv4 Route Configuration->New** menu consists of the following fields:

Fields in the menu Basic Parameters

Field	Description
Route Type	Select the type of route.

Field	Description
	<p>Possible values:</p> <ul style="list-style-type: none"> • <i>Default Route via Interface</i>: Route via a specific interface which is to be used if no other suitable route is available. • <i>Default Route via Gateway</i>: Route via a specific gateway which is to be used if no other suitable route is available. • <i>Host Route via Interface</i>: Route to an individual host via a specific interface. • <i>Host Route via Gateway</i>: Route to an individual host via a specific gateway. • <i>Network Route via Interface</i> (default value): Route to a network via a specific interface. • <i>Network Route via Gateway</i>: Route to a network via a specific gateway. <p>Only for interfaces that are operated in DHCP client mode:</p> <p>Even if an interface is configured for DHCP client mode, routes can still be configured for data traffic via that interface. The settings received from the DHCP server are then copied, along with those configured here, to the active routing table. This enables, e. g., in the case of dynamically changing gateway addresses, particular routes to be maintained, or routes with different metrics (i. e. of differing priority) to be specified. However, if the DHCP server sends static routes, the settings configured here are not copied to the routing.</p> <ul style="list-style-type: none"> • <i>Default Route Template per DHCP</i>: The information of the gateway to be used is received via DHCP and integrated into the route. • <i>Host Route Template per DHCP</i>: The settings received by DHCP are supplemented by routing information about a particular host. • <i>Network Route Template per DHCP</i>: The settings received by DHCP are supplemented by routing information about a particular network.

Field	Description
	 <p>Note</p> <p>When the DHCP lease expires or when the device is restarted, the routes that consist from the combination of DHCP settings and those made here are initially deleted once more from the active routing. If the DHCP is reconfigured they are re-generated and re-activated.</p>
Interface	Select the interface to be used for this route.
Route Class	<p>Select the type of Route Class.</p> <p>Possible values:</p> <ul style="list-style-type: none"> • <i>Standard</i> (default value): Defines a route with the default parameters. • <i>Extended</i>: Select whether the route is to be defined with extended parameters. If the function is active, a route is created with extended routing parameters such as source interface and source IP address, as well as protocol, source and destination port, type of service (TOS) and the status of the device interface.

Fields in the menu **Route Parameters**

Field	Description
Local IP Address	<p>Only for Route Type = <i>Default Route via Interface, Host Route via Interface or Network Route via Interface</i></p> <p>Enter the own IP address of the router on the selected interface.</p>
Destination IP Address/Netmask	<p>Only for Route Type <i>Host Route via Interface or Network Route via Interface</i></p> <p>Enter the IP address of the destination host or destination network.</p> <p>When Route Type = <i>Network Route via Interface</i></p> <p>Also enter the relevant netmask in the second field.</p>

Field	Description
Gateway IP Address	<p>Only for Route Type = <i>Default Route via Gateway, Host Route via Gateway</i> or <i>Network Route via Gateway</i></p> <p>Enter the IP address of the gateway to which your device is to forward the IP packets.</p>
Metric	<p>Select the priority of the route.</p> <p>The lower the value, the higher the priority of the route.</p> <p>Value range from 0 to 15. The default value is 1.</p>

Fields in the menu **Extended Route Parameters**

Field	Description
Description	Enter a description for the IP route.
Source Interface	<p>Select the interface over which the data packets are to reach the device.</p> <p>The default value is <i>None</i>.</p>
Source IP Address/ Netmask	Enter the IP address and netmask of the source host or source network.
Layer 4 Protocol	<p>Select a protocol.</p> <p>Possible values: <i>AH, Any, ESP, GRE, ICMP, IGMP, L2TP, OSPF, PIM, TCP, UDP</i>.</p> <p>The default value is <i>Any</i>.</p>
Source Port	<p>Only for Layer 4 Protocol = <i>TCP</i> or <i>UDP</i></p> <p>Enter the source port.</p> <p>First select the port number range.</p> <p>Possible values:</p> <ul style="list-style-type: none"> • <i>Any</i> (default value): The route is valid for all port numbers. • <i>Single</i>: Enables the entry of a port number.

Field	Description
	<ul style="list-style-type: none"> • <i>Range</i>: Enables the entry of a range of port numbers. • <i>Privileged</i>: Entry of privileged port numbers: 0 ... 1023. • <i>Server</i>: Entry of server port numbers: 5000 ... 32767. • <i>Clients 1</i>: Entry of client port numbers: 1024 ... 4999. • <i>Clients 2</i>: Entry of client port numbers: 32768 ... 65535. • <i>Not privileged</i>: Entry of unprivileged port numbers: 1024 ... 65535. <p>Enter the appropriate values for the individual port or start port of a range in Port and, for a range, the end port in to Port.</p>
Destination Port	<p>Only for Layer 4 Protocol = <i>TCP</i> or <i>UDP</i></p> <p>Enter the destination port.</p> <p>First select the port number range.</p> <p>Possible values:</p> <ul style="list-style-type: none"> • <i>Any</i> (default value): The route is valid for all port numbers. • <i>Single</i>: Enables the entry of a port number. • <i>Range</i>: Enables the entry of a range of port numbers. • <i>Privileged</i>: Entry of privileged port numbers: 0 ... 1023. • <i>Server</i>: Entry of server port numbers: 5000 ... 32767. • <i>Clients 1</i>: Entry of client port numbers: 1024 ... 4999. • <i>Clients 2</i>: Entry of client port numbers: 32768 ... 65535. • <i>Not privileged</i>: Entry of unprivileged port numbers: 1024 ... 65535. <p>Enter the appropriate values for the individual port or start port of a range in Port and, for a range, the end port in to Port.</p>
DSCP / TOS Value	<p>Select the Type of Service (TOS).</p> <p>Possible values:</p> <ul style="list-style-type: none"> • <i>Ignore</i> (default value): The type of service is ignored. • <i>DSCP Binary Value</i>: Differentiated Services Code Point according to RFC 3260 is used to signal the priority of IP packets (indicated in binary format). • <i>DSCP Decimal Value</i>: Differentiated Services Code Point

Field	Description
	<p>according to RFC 3260 is used to signal the priority of IP packets (indicated in decimal format).</p> <ul style="list-style-type: none"> • <i>DSCP Hexadecimal Value</i>: Differentiated Services Code Point according to RFC 3260 is used to signal the priority of IP packets (indicated in hexadecimal format). • <i>TOS Binary Value</i>: The TOS value is specified in binary format, e.g. 00111111. • <i>TOS Decimal Value</i>: The TOS value is specified in decimal format, e.g. 63. • <i>TOS Hexadecimal Value</i>: The TOS value is specified in hexadecimal format, e.g. 3F. <p>Enter the relevant value for <i>DSCP Binary Value</i>, <i>DSCP Decimal Value</i>, <i>DSCP Hexadecimal Value</i>, <i>TOS Binary Value</i>, <i>TOS Decimal Value</i> and <i>TOS Hexadecimal Value</i>.</p>
Mode	<p>Select when the interface defined in Route Parameters -> Interface is to be used.</p> <p>Possible values:</p> <ul style="list-style-type: none"> • <i>Dialup and wait</i> (default value): The route can be used if the interface is "up". If the interface is "dormant", then dial and wait until the interface is "up". • <i>Authoritative</i>: The route can always be used. • <i>Dialup and continue</i>: The route can be used when the interface is "up". If the interface is "dormant", then select and use the alternative route (rerouting) until the interface is "up". • <i>Never dialup</i>: The route can be used when the interface is "up". • <i>Always dialup</i>: The route can be used when the interface is "up". If the interface is "dormant", then dial and wait until the interface is "up". In this case, an alternative interface with a poorer metric is used for routing until the interface is "up".

14.1.2 IPv6 Route Configuration

A list of all configured IPv6 routes is displayed in the **Network->Routes->IPv6 Route Configuration** menu.

14.1.2.1 Edit or New

Choose the  icon to edit existing entries. Choose the **New** button to create additional routes.

Routes without an  icon have been created by the router automatically and cannot be edited.

The **Network->Routes->IPv6 Route Configuration->New** menu consists of the following fields:

Fields in the Route Parameters menu

Field	Description
Description	Enter a description for the IPv6 route.
Route Active	Select if the route is to be active or inactive.. With <i>Enabled</i> the status of the route will be set to active. The function is enabled by default.
Route Type	Select the type of route. Possible values: <ul style="list-style-type: none"> • <i>Default Route via Interface</i> : Route via a specific interface which is used if no other adequate route is available. • <i>Default Route via Gateway</i>: Route via a specific gateway which is used if no other adequate route is available. • <i>Host Route via Interface</i>: Route to a single host via a specific interface. • <i>Host Route via Gateway</i>: Route to a single host via a specific gateway. • <i>Network Route via Interface</i>: Route to a network via a specific interface. • <i>Network Route via Gateway</i> (default value): Route to a network via a specific gateway.
Destination Interface	Select the IPv6 interface to be used for this route. You can choose from those interfaces available under LAN->IP Configuration->Interfaces->New that are IPv6-enabled.

Field	Description
Source Address / Length	<p>Enter the source IPv6 address along with the corresponding prefix length.</p> <p>: : describes an unspecific address.</p> <p>By default the prefix length <i>64</i> is predefined.</p>
Destination Address / Length	<p>Enter the destination IPv6 address along with the corresponding prefix length.</p> <p>: : describes an unspecific address.</p> <p>By default the prefix length <i>64</i> is predefined.</p>
Gateway Address	Enter a the IPv6 address for the next hop.
Metric	<p>Select the priority of the route.</p> <p>The lower the value, the higher the priority of the route.</p> <p>Value range from <i>0</i> to <i>15</i>. The default value is <i>1</i>.</p>

14.1.3 IPv4 Routing Table

A list of all IPv4 routes is displayed in the **Network->Routes->IPv4 Routing Table** menu. The routes do not all need to be active, but can be activated at any time by relevant data traffic.

In the ex works state, a predefined entry with the parameters **Destination IP Address** = *192.168.0.0*, **Netmask** = *255.255.255.0*, **Gateway** = *192.168.0.250*, **Interface** = *LAN_EN1-0*, **Route Type** = *Network Route via Interface*, **Protocol** = *Local* is displayed.

Fields in the menu IPv4 Routing Table

Field	Description
Destination IP Address	Displays the IP address of the destination host or destination network.
Netmask	Displays the netmask of the destination host or destination network.
Gateway	Displays the gateway IP address. Nothing is displayed here

Field	Description
	when routes are received by DHCP.
Interface	Displays the interface used for this route.
Metric	Displays the route's priority. The lower the value, the higher the priority of the route.
Route Type	Displays the route type.
Extended Route	Displays whether a route has been configured with advanced parameters.
Protocol	Displays how the entry has been created , e.g. manually (<i>Local</i>) or via one of the available protocols.
Delete	You can delete entries with the  symbol.

14.1.4 IPv6 Routing Table

A list of all configured IPv6 routes is displayed in the **Network->Routes->IPv6 Routing Table** menu.

Fields in the IPv6 Routing Table menu

Field	Description
Route	Displays the source and destination address, which is used for this route, as well as the gateway IP address. Nothing is displayed here when routes are received by DHCP.
Interface	Displays the interface used for this route.
Metric	Displays the route's priority. The lower the value, the higher the priority of the route.
Protocol	Displays how the entry has been created , e.g. manually (<i>Local</i>) or via one of the available protocols.

14.1.5 Options

Back Route Verify

The term Back Route Verify describes a very simple but powerful function. If a check is activated for an interface, incoming data packets are only accepted over this interface if outgoing response packets are routed over the same interface. You can therefore prevent the acceptance of packets with false IP addresses - even without using filters.

In the ex works state, the two entries *en1-0* and *ethoa35-5* are displayed by default setting *Enable for specific interfaces*.

The **Networking->Routes->Options** menu consists of the following fields:

Fields in the Back Route Verify menu.

Field	Description
Mode	<p>Select how the interfaces to be activated for Back Route Verify are to be specified.</p> <p>Possible values:</p> <ul style="list-style-type: none"> • <i>Enable for all interfaces</i>: Back Route Verify is activated for all interfaces. • <i>Enable for specific interfaces</i> (default value): A list of all interfaces is displayed in which Back Route Verify is only enabled for specific interfaces. • <i>Disable for all interfaces</i>: Back route verify is disabled for all interfaces.
No.	<p>Only for Mode = <i>Enable for specific interfaces</i></p> <p>Displays the serial number of the list entry.</p>
Interface	<p>Only for Mode = <i>Enable for specific interfaces</i></p> <p>Displays the name of the interface.</p>
Back Route Verify	<p>Only for Mode = <i>Enable for specific interfaces</i></p> <p>Select whether <i>Back Route Verify</i> is to be activated for the interface.</p> <p>The function is enabled with <i>Enabled</i>.</p>

Field	Description
	By default, the function is deactivated for all interfaces.

14.2 IPv6 General Prefixes

IPv6 General Prefixes are usually distributed by IPv6 providers. They can be statically assigned or obtained through DHCP. In most cases, they define /48 or /56 networks. You can derive /64 subnets from these prefixes and have them distributed in your network.

General Prefixes have two key advantages:

- A single route is sufficient for all traffic between the provider and the customer.
- If your provider assigns a new General Prefix through DHCP or changes the static General Prefix assigned to you, there is little or no configuration to be done: In the case of DHCP you obtain the new General Prefix automatically; and in the case of a statically assigned General Prefix, you need to introduce it into your system once. All subnets and IPv6 addresses derived from the General Prefix change automatically after an update.

In order to IPv6 you need to configure how subnets and IPV6 addresses are created and distributed (see Configuring IPv6 addresses in [Interfaces](#) on page 118 and the menu **LAN->IP Configuration->Interfaces** for the IPv6-relevant parameters.

14.2.1 General Prefix Configuration

A list of all configured IPv6 prefixes is displayed in the **Networking->IPv6 General Prefixes->General Prefix Configuration** menu.

14.2.1.1 Edit or New

Choose the  icon to edit existing entries. Choose the **New** button to create additional prefixes.

Fields in the Basic Parameters menu.

Field	Description
General Prefix active	Select if the prefix is to be active or inactive.. With <i>Enabled</i> the status of the prefix will be set to active. The function is enabled by default.
Name	Enter a name for the General Prefix.

Field	Description
	A meaningful name helps selecting the General Prefix from a prefix list.
Type	<p>Specify how the address range is to be assigned.</p> <p>Possible values:</p> <ul style="list-style-type: none"> • <i>Dynamic</i> (default value): The general prefix will be set dynamically by DHCP transmission, e.g. from a provider. • <i>Static</i>: The prefix is fixed, e. g. by a provider.
From Interface	<p>Only with Type = <i>Dynamic</i></p> <p>Select the IPv6 interface from which a General Prefix is to be obtained.</p> <p>You can choose from all interfaces that are available under LAN->IP Configuration->Interfaces->New and that fulfill the following conditions:</p> <ul style="list-style-type: none"> • IPv6 is <i>Enabled</i>. • IPv6 Mode = <i>Host</i> • DHCP Client is <i>Enabled</i>.
Used Prefix / Length	<p>Only with Type = <i>Static</i></p> <p>Enter the prefix to be used. Enter the corresponding length. This prefix must end with ::.</p> <p>The default value is <i>48</i>.</p>
Prefix Length	<p>For a dynamically assigned prefix, you only need to enter the prefix length here. You can ask your service provider for the length of the assigned prefix if necessary. The default length here is <i>56</i>.</p>

14.3 NAT

Network Address Translation (NAT) is a function on your device for defined conversion of source and destination addresses of IP packets. If NAT is activated, IP connections are still only allowed by default in one direction, outgoing (forward) (= protective function). Exceptions to the rule can be configured (in [NAT Configuration](#) on page 183).

Specific instructions for configuring NAT, see the end of the chapter [NAT - Configuration](#)

example on page 188.

14.3.1 NAT Interfaces

A list of all NAT interfaces is displayed in the **Networking->NAT->NAT Interfaces** menu.

For every NAT interface, the *NAT active*, *Loopback active*, *Silent Deny* and *PPTP Passthrough* can be selected.

In addition, *Portforwardings* displays how many port forwarding rules were configured for this interface.

Options in the menu NAT Interfaces

Field	Description
NAT active	Select whether NAT is to be activated for the interface. The function is disabled by default.
Loopback active	The NAT loopback function also enables network address translation for connectors whereby NAT is not activated. This is often used in order to interpret queries from the LAN as if they were coming from the WAN. You can use this to test the server services. The function is disabled by default.
Silent Deny	Select whether IP packets are to be silently denied by NAT. If this function is deactivated, the sender of the denied IP packet is informed by means of an appropriate ICMP or TCP RST message. The function is disabled by default.
PPTP Passthrough	Select whether the setup and operation of several simultaneous, outgoing PPTP connections from hosts in the network are also to be permitted if NAT is activated. The function is disabled by default. If PPTP Passthrough is enabled, the device itself cannot be configured as a tunnel endpoint.
Portforwardings	Shows the number of portforwarding rules configured in Networking->NAT->NAT Configuration .

14.3.2 NAT Configuration

In the **Networking->NAT->NAT Configuration** menu you can exclude data from NAT simply and conveniently as well as translate addresses and ports. For outgoing data traffic you can configure various NAT methods, i.e. you can determine how an external host establishes a connection to an internal host.

14.3.2.1 New

Choose the **New** button to set up NAT.

The **Networking->NAT->NAT Configuration ->New** menu consists of the following fields:

Fields in the menu Basic Parameters

Field	Description
Description	Enter a description for the NAT configuration.
Interface	Select the interface for which NAT is to be configured. Possible values: <ul style="list-style-type: none"> • <i>Any</i> (default value): NAT is configured for all interfaces. • <i><Interface name></i>: Select one of the interfaces from the list.
Type of traffic	Select the type of data traffic for which NAT is to be configured. Possible values: <ul style="list-style-type: none"> • <i>incoming (Destination NAT)</i> (default value): The data traffic that comes from outside. • <i>outgoing (Source NAT)</i>: Outgoing data traffic. • <i>excluding (Without NAT)</i>: Data traffic excluded from NAT.
NAT method	Only for Type of traffic = <i>outgoing (Source NAT)</i> Select the NAT method for outgoing data traffic. The starting point for choosing the NAT method is a NAT scenario in which an "internal" source host has initiated an IP connection to an "external" destination host over the NAT interface, and in which an internally valid source address and internally valid source port are translated to an externally valid source address and an externally valid source port.

Field	Description
	<p>Possible values:</p> <ul style="list-style-type: none"> • <i>full-cone</i> (UDP only): Any given external host may send IP packets via the external address and the external port to the initiating source address and the initial source port. • <i>restricted-cone</i> (UDP only): Like full-cone NAT; as external host, however, only the initial "external" destination host is allowed. • <i>port-restricted-cone</i> (UDP only): Like restricted-cone NAT; however, exclusively data from the initial destination port are allowed. • <i>symmetric</i> (standard value) any protocol: Outbound, an externally valid source address and an externally valid source port are administratively set. Inbound, only response packets within the existing connection are allowed.

In the **NAT Configuration** -> **Specify original traffic** menu, you can configure for which data traffic NAT is to be used.

Fields in the menu **Specify original traffic**

Field	Description
Service	<p>Not for Type of traffic = <i>outgoing (Source NAT)</i> and NAT method = <i>full-cone, restricted-cone</i> or <i>port-restricted-cone</i>.</p> <p>Select one of the preconfigured services.</p> <p>Possible values:</p> <ul style="list-style-type: none"> • <i>User-defined</i> (default value) • <i><service name></i>
Action	<p>Only for Type of traffic = <i>excluding (Without NAT)</i></p> <p>Select which data packets are to be excluded by NAT.</p> <p>Possible values:</p> <ul style="list-style-type: none"> • <i>Exclude</i> (default value): All the data packets that match the following parameters that are to be configured (protocol, source IP address/network mask, destination IP address/net-mask, etc.) are excluded by NAT.

Field	Description
	<ul style="list-style-type: none"> • <i>Do not exclude</i>: All the data packets that do not match the following parameters that are to be configured (protocol, source IP address/network mask, destination IP address/net-mask, etc.) are excluded by NAT.
Protocol	<p>Only for certain services.</p> <p>Not for Type of traffic = <i>outgoing (Source NAT)</i> and NAT method = <i>full-cone, restricted-cone or port-restricted-cone</i>. In this case UDP is automatically defined.</p> <p>Select a protocol. According to the selected Service, different protocols are available.</p> <p>Possible values:</p> <ul style="list-style-type: none"> • <i>Any (default value)</i> • <i>AH</i> • <i>Chaos</i> • <i>EGP</i> • <i>ESP</i> • <i>GGP</i> • <i>GRE</i> • <i>HMP</i> • <i>ICMP</i> • <i>IGMP</i> • <i>IGP</i> • <i>IGRP</i> • <i>IP</i> • <i>IPinIP</i> • <i>IPv6</i> • <i>IPX in IP</i> • <i>ISO-IP</i> • <i>Kryptolan</i> • <i>L2TP</i> • <i>OSPF</i> • <i>PUP</i>

Field	Description
	<ul style="list-style-type: none"> • RDP • RSVP • SKIP • TCP • TLS • UDP • VRRP • XNS-IDP
Source IP Address/Netmask	<p>Only for Type of traffic = <i>incoming (Destination NAT)</i> or <i>excluding (Without NAT)</i></p> <p>Enter the source IP address and corresponding netmask of the original data packets, as the case arises.</p>
Original Destination IP Address/Netmask	<p>Only for Type of traffic = <i>incoming (Destination NAT)</i></p> <p>Enter the destination IP address and corresponding netmask of the original data packets, as the case arises.</p>
Original Destination Port/Range	<p>Only for Type of traffic = <i>incoming (Destination NAT)</i>, Service = <i>user-defined</i> and Protocol = <i>TCP, UDP, TCP/UDP</i></p> <p>Enter the destination port or the destination port range of the original data packets. The default setting <i>-All-</i> means that the port is not specified.</p>
Original Source IP Address/Netmask	<p>Only for Type of traffic = <i>outgoing (Source NAT)</i></p> <p>Enter the source IP address and corresponding netmask of the original data packets, as the case arises.</p>
Original Source Port/Range	<p>Only for Type of traffic = <i>outgoing (Source NAT)</i>, NAT method = <i>symmetric</i>, Service = <i>user-defined</i> and Protocol = <i>TCP, UDP, TCP/UDP</i></p> <p>Enter the source port of the original data packets. The default setting <i>-All-</i> means that the port remains unspecified.</p> <p>If you select <i>Specify port</i> you can specify a single port, if you select <i>Specify port range</i> you can specify a continu-</p>

Field	Description
	ous range of ports which will be a applied for filtering the outgoing data traffic
Source Port/Range	<p>Only for Type of traffic = <i>excluding (Without NAT)</i>, Service = <i>user-defined</i> and Protocol = <i>TCP, UDP, TCP/UDP</i></p> <p>Enter the source port or the source port range of the original data packets. The default setting <i>-All-</i> means that the port remains unspecified.</p>
Destination IP Address/Netmask	<p>Only for Type of traffic = <i>excluding (Without NAT)</i> or <i>outgoing (Source NAT)</i> and NAT method = <i>symmetric</i></p> <p>Enter the destination IP address and corresponding netmask of the original data packets, as the case arises.</p>
Destination Port/Range	<p>Only for Type of traffic = <i>outgoing (Source NAT)</i>, NAT method = <i>symmetric</i>, Service = <i>user-defined</i> and Protocol = <i>TCP, UDP, TCP/UDP</i> or Type of traffic = <i>excluding (Without NAT)</i>, Service = <i>user-defined</i> and Protocol = <i>TCP, UDP, TCP/UDP</i></p> <p>Enter the destination port or the destination port range of the original data packets. The default setting <i>-All-</i> means that the port remains unspecified.</p>

In the **NAT Configuration** -> **Replacement Values** menu you can define, depending on whether you're dealing with inbound or outbound data traffic, new addresses and ports, to which specific addresses and ports from the **NAT Configuration** -> **Specify original traffic** menu can be translated.

Fields in the menu Replacement Values

Field	Description
New Destination IP Address/Netmask	<p>Only for Type of traffic = <i>incoming (Destination NAT)</i></p> <p>Enter the destination IP address and corresponding netmask to which the original destination IP address is to be translated.</p>
New Destination Port	<p>Only for Type of traffic = <i>incoming (Destination NAT)</i>, Service = <i>user-defined</i> and Protocol = <i>TCP, UDP, TCP/UDP</i></p> <p>Leave the destination port as it appears or enter the destination</p>

Field	Description
	<p>port to which the original destination port is to be translated.</p> <p>Select <i>Original</i> to leave the original destination port. If you disable <i>Original</i>, an input field appears and you can enter a new destination port.</p> <p><i>Original</i> is active by default.</p>
New Source IP Address/Netmask	<p>Only for Type of traffic = <i>outgoing (Source NAT)</i> and NAT method = <i>symmetric</i></p> <p>Enter the source IP address to which the original source IP address is to be translated, with corresponding netmask, as the case arises.</p>
New Source Port	<p>Only for Type of traffic = <i>outgoing (Source NAT)</i>, NAT method = <i>symmetric</i>, Service = <i>user-defined</i>, Protocol = <i>TCP, UDP, TCP/UDP</i> and Original Source Port/Range = <i>-All- or Specify port</i></p> <p>Leave the source port as it appears or enter a new source port to which the original source port is to be translated.</p> <p><i>Original</i> leaves the original source port. If you disable <i>Original</i>, an input field appears in which you can enter a new source port. <i>Original</i> is active by default.</p> <p>If you select <i>Specify port range</i> for Original Source Port/Range, you can choose from the following options:</p> <ul style="list-style-type: none"> • <i>Use Original Source Port/Range</i>: The range specified for Original Source Port/Range is not changed, all port numbers are retained. • <i>Use Source Port/Range starting with</i>: There is an input field for you to specify the port number with which to start the port range that replaces the original port range. The count of ports is retained.

14.3.3 NAT - Configuration example

Requirements

- Basic configuration of the gateway

- A working Internet access. For example, **Company Connect** with 8 IP addresses.
- The Ethernet interface **LAN5** is connected to the access router to the internet (IP address $62.10.10.1/29$)
- The IP address $62.10.10.2$ to $62.10.10.6$ are entered on Ethernet interface **LAN5.**

Example scenario

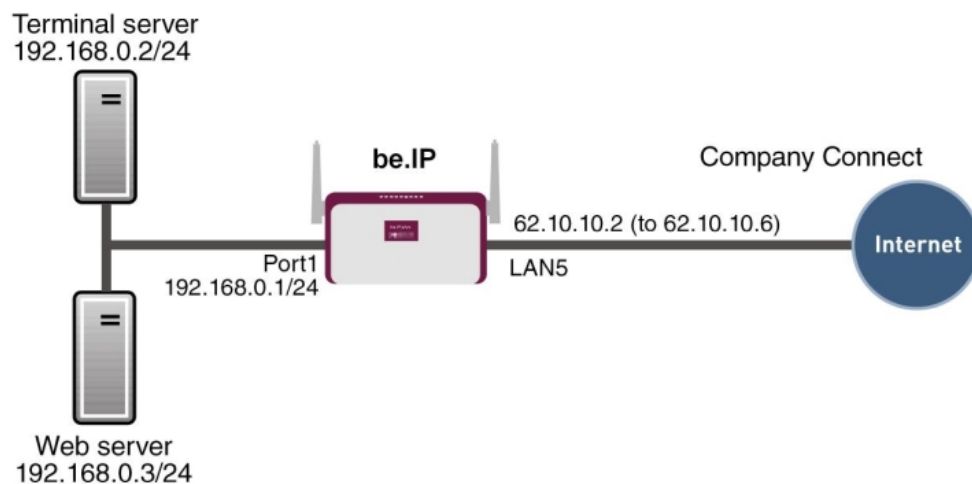

Configuration target

- You configure NAT enables for accessing your gateway over HTTP.
- You also want to access your terminal server and the corporate web server over the Internet.

Overview of Configuration Steps

Enable NAT

Field	Menu	Value
NAT active	Network->NAT->NAT Interfaces	Enabled for LAN_EN5-0
Silent Deny	Network->NAT->NAT Interfaces	Enabled for LAN_EN5-0

NAT enable for the GUI

Field	Menu	Value
Description	Network->NAT->NAT Configuration->New	e.g. GUI

Field	Menu	Value
Interface	Network->NAT->NAT Configuration->New	LAN_EN5-0
Type of traffic	Network->NAT->NAT Configuration->New	incoming (Destination NAT)
Service	Network->NAT->NAT Configuration->New	User-defined
Protocol	Network->NAT->NAT Configuration->New	TCP
Source IP Address/ Netmask	Network->NAT->NAT Configuration->New	Any
Original Destination IP Address/Netmask	Network->NAT->NAT Configuration->New	Host, e.g. 62.10.10.2
Original Destination Port/Range	Network->NAT->NAT Configuration->New	Specify port, 80
New Destination IP Ad- dress/Netmask	Network->NAT->NAT Configuration->New	Host, e.g. 127.0.0.1
New Destination Port	Network->NAT->NAT Configuration->New	Original disabled, 80

Web server

Field	Menu	Value
Description	Network->NAT->NAT Configuration->New	e.g. Webserver
Interface	Network->NAT->NAT Configuration->New	LAN_EN5-0
Type of traffic	Network->NAT->NAT Configuration->New	incoming (Destination NAT)
Service	Network->NAT->NAT Configuration->New	http
Source IP Address/ Netmask	Network->NAT->NAT Configuration->New	Any
Original Destination IP Address/Netmask	Network->NAT->NAT Configuration->New	Host, e.g. 62.10.10.3
New Destination IP Ad- dress/Netmask	Network->NAT->NAT Configuration->New	Host, e.g. 192.168.0.3
New Destination Port	Network->NAT->NAT Configuration->New	Original

Field	Menu	Value
	->New	

Terminal Server

Field	Menu	Value
Description	Network->NAT->NAT Configuration->New	e.g. <i>Terminal-Server</i>
Interface	Network->NAT->NAT Configuration->New	<i>LAN_EN5-0</i>
Type of traffic	Network->NAT->NAT Configuration->New	<i>incoming (Destination NAT)</i>
Service	Network->NAT->NAT Configuration->New	<i>User-defined</i>
Protocol	Network->NAT->NAT Configuration->New	<i>TCP</i>
Source IP Address/Netmask	Network->NAT->NAT Configuration->New	<i>Any</i>
Original Destination IP Address/Netmask	Network->NAT->NAT Configuration->New	<i>Host, e.g. 62.10.10.4</i>
Original Destination Port/Range	Network->NAT->NAT Configuration->New	<i>Specify port, 3389</i>
New Destination IP Address/Netmask	Network->NAT->NAT Configuration->New	<i>Host, e.g. 192.168.0.2</i>
New Destination Port	Network->NAT->NAT Configuration->New	<i>Original</i>

14.4 Load Balancing

The increasing amount of data traffic over the Internet means it is necessary to send data over different interfaces to increase the total bandwidth available. IP load balancing enables the distribution of data traffic within a certain group of interfaces to be controlled.

Specific instructions for configuring load balancing, see [Load balancing - Configuration example](#) on page 198.

14.4.1 Load Balancing Groups

If interfaces are combined to form groups, the data traffic within a group is divided according to the following principles:

- In contrast to Multilink PPP-based solutions, load balancing also functions with accounts with different providers.
- Session-based load balancing is achieved.
- Related (dependent) sessions are always routed over the same interface.
- A decision on distribution is only made for outgoing sessions.

A list of all configured load balancing groups is displayed in the **Networking->Load Balancing->Load Balancing Groups** menu. You can click the  icon next to any list entry to go to an overview of the basic parameters that affect this group.



Note

Note that the interfaces that are combined into a load balancing group must have routes with the same metric. If necessary, go to the **Networking->Routes** menu and check the entries there.

14.4.1.1 New

Choose the **New** button to create additional groups.

The menu **Networking->Load Balancing->Load Balancing Groups->New** consists of the following fields:

Fields in the Basic Parameters menu.

Field	Description
Group Description	Enter the desired description of the interface group.
Distribution Policy	<p>Select the way the data traffic is to be distributed to the interfaces configured for the group.</p> <p>Possible values:</p> <ul style="list-style-type: none"> • <i>Session-Round-Robin</i> (default value): A newly added session is assigned to one of the group interfaces according to the percentage assignment of sessions to the interfaces. The number of sessions is decisive.

Field	Description
	<ul style="list-style-type: none"> • <i>Load-dependent Bandwidth</i>: A newly added session is assigned to one of the group interfaces according to the share of the total data rate handled by the interfaces. The current data rate based on the data traffic is decisive in both the send and receive direction.
Consider	<p>Only for Distribution Policy = <i>Load-dependent Bandwidth</i></p> <p>Choose the direction in which the current data rate is to be considered.</p> <p>Options:</p> <ul style="list-style-type: none"> • <i>Download</i>: Only the data rate in the receive direction is considered. • <i>Upload</i>: Only the data rate in the send direction is considered. <p>By default, the <i>Download</i> and <i>Upload</i> options are disabled.</p>
Distribution Mode	<p>Select the state the interfaces in the group may have if they are to be included in load balancing.</p> <p>Possible values:</p> <ul style="list-style-type: none"> • <i>Always</i> (default value): Also includes idle interfaces. • <i>Only use active interfaces</i>: Only interfaces in the up state are included.

In the **Interface** area, you add interfaces that match the current group context and configure these. You can also delete interfaces.

Use **Add** to create more entries.

Fields in the **Basic Parameters** menu.

Field	Description
Group Description	Shows the description of the interface group.
Distribution Policy	Displays the type of data traffic selected.

Fields in the **Interface Selection for Distribution** menu.

Field	Description
Interface	Select the interfaces that are to belong to the group from the available interfaces.
Distribution Ratio	<p>Enter the percentage of the data traffic to be assigned to an interface.</p> <p>The meaning differs according to the Distribution Ratio employed:</p> <ul style="list-style-type: none"> • For <i>Session-Round-Robin</i> is based on the number of distributed sessions. • For <i>Load-dependent Bandwidth</i>, the data rate is the decisive factor.

The menu **Advanced Settings** consists of the following fields:

Fields in the **Advanced Settings** menu.

Field	Description
Route Selector	<p>The Route Selector parameter is an additional criterion to help define a load balancing group more precisely. Here, routing information is added to the "interface" entry within a load balancing group. The route selector is required in certain scenarios to enable the IP sessions managed by the router to be balanced uniquely for each load balancing group. The following rules apply when using the parameter:</p> <ul style="list-style-type: none"> • If an interface is only assigned to one load balancing group, it is not necessary to configure the route selector. • If an interface is assigned to multiple load balancing groups, configuration of the route selector is essential. • The route selector must be configured identically for all interface entries within a load balancing group. <p>Select the Destination IP Address of the desired route.</p> <p>You can choose between all routes and all extended routes.</p>
Tracking IP Address	You can use the Tracking IP Address parameter to have a particular route monitored.

Field	Description
	<p>The load balancing status of the interface and the status of the routes connected to the interface can be influenced using this parameter. This means that routes can be enabled or disabled irrespective of the interface's operation status. The connection is monitored using the gateway's host surveillance function here. Host surveillance entries must be configured in order to use this function. These can be configured in the Local Services->Surveillance->Hosts menu. Here, it is important that only the host surveillance entries with the action Monitor are taken into account in the context of load balancing. Links between the load balancing function and the host surveillance function are made through the configuration of the Tracking IP Address in the Load Balancing->Load Balancing Groups->Advanced Settings menu. The interface's load balancing status now varies according to the status of the assigned host surveillance entry.</p> <p>Select the IP address for the route to be monitored.</p> <p>You can choose from the IP addresses you have entered in the Local Services->Surveillance->Hosts->New menu under Monitored IP Address and which are monitored with the aid of the Action to be executed field (Action = <i>Monitor</i>).</p>

14.4.2 Special Session Handling

Special Session Handling enables you to route part of the data traffic to your device via a particular interface. This data traffic is excluded from the **Load Balancing** function.

You can use the **Special Session Handling** function with online banking, for example, to ensure that the HTTPS data traffic is sent to a particular link. Since a check is run in online banking to see whether all the data traffic comes from the same source, data transmission using **Load Balancing** might be terminated at times without **Special Session Handling**.

The **Networking->Load Balancing->Special Session Handling** menu displays a list of entries. If you have not configured any entries, the list is empty.

Every entry contains parameters which describe the properties of a data packet in more or less detail. The first data packet which the properties configured here match specifies the route for particular subsequent data packets.

Which data packets are subsequently routed via this route is configured in the **Networking->Load Balancing->Special Session Handling->New->Advanced Settings** menu.

If in the **Networking->Load Balancing->Special Session Handling->New** menu, for example, you select the parameter **Service** = *http (SSL)* (and leave the default value for all the other parameters), the first HTTPS packet specifies the **Destination Address** and the **Destination Port** (i. e. Port 443 with HTTPS) for data packets sent subsequently.

If, under **Frozen Parameters**, for the two parameters **Destination Address** and **Destination Port** you leave the default setting *enabled*, the HTTPS packets with the same source IP address as the first HTTPS packet are routed via port 443 to the same **Destination Address** via the same interface as the first HTTPS packet.

14.4.2.1 Edit or New

Choose the  icon to edit existing entries. Select the **New** button create new entries.

The **Networking->Load Balancing->Special Session Handling->New** menu consists of the following fields:

Fields in the **Basic Parameters** menu.

Field	Description
Admin Status	Select whether the Special Session Handling should be activated. The function is activated by selecting <i>Enabled</i> . The function is enabled by default.
Description	Enter a name for the entry.
Service	Select one of the preconfigured services, if required. The extensive range of services configured ex works includes the following: <ul style="list-style-type: none"> • <i>activity</i> • <i>apple-qt</i> • <i>auth</i> • <i>charge</i> • <i>clients_1</i> • <i>daytime</i> • <i>dhcp</i> • <i>discard</i> <p>The default value is <i>User defined</i>.</p>

Field	Description
Protocol	Select a protocol, if required. The <i>Any</i> option (default value) matches any protocol.
Destination IP Address/Netmask	Enter, if required, the destination IP address and netmask of the data packets. Possible values: <ul style="list-style-type: none"> • <i>Any</i> (default value) • <i>Host</i>: Enter the IP address of the host. • <i>Network</i>: Enter the network address and the related netmask.
Destination Port/Range	Enter, if required, a destination port number or a range of destination port numbers. Possible values: <ul style="list-style-type: none"> • <i>-All-</i> (default value): The destination port is not specified. • <i>Specify port</i>: Enter a destination port. • <i>Specify port range</i>: Enter a destination port range.
Source Interface	If required, select your device's source interface.
Source IP Address/Netmask	Enter, if required, the source IP address and netmask of the data packets. Possible values: <ul style="list-style-type: none"> • <i>Any</i> (default value) • <i>Host</i>: Enter the IP address of the host. • <i>Network</i>: Enter the network address and the related netmask.
Source Port/Range	Enter, if required, a source port number or a range of source port numbers. Possible values: <ul style="list-style-type: none"> • <i>-All-</i> (default value): The destination port is not specified. • <i>Specify port</i>: Enter a destination port. • <i>Specify port range</i>: Enter a destination port range.

Field	Description
Special Handling Timer	<p>Enter the time period during which the specified data packets are to be routed via the route that has been defined.</p> <p>The default value is <i>900</i> seconds.</p>

The menu **Advanced Settings** consists of the following fields:

Fields in the **Advanced Settings** menu.

Field	Description
Frozen Parameters	<p>Specify whether, when data packets are subsequently sent, the two parameters Destination Address and Destination Port must have the same value as the first data packet, i. e. whether the subsequent data packets must be routed via the same Destination Port to the same Destination Address.</p> <p>The two parameters Destination Address and Destination Port are enabled by default.</p> <p>If you leave the default setting <i>Enabled</i> for one or both parameters, the value of the parameter concerned must be the same as in the first data packet with data packets sent subsequently.</p> <p>You can disable one or both parameters if you wish.</p> <p>The Source IP Address parameter must always have the same value in data packets sent subsequently as it did in the first data packet. So it cannot be disabled.</p>

14.4.3 Load balancing - Configuration example

Requirements

- Gateway with the ADSL modem integrated
- An external ADSL modem
- Two independent ADSL Internet connections

Example scenario

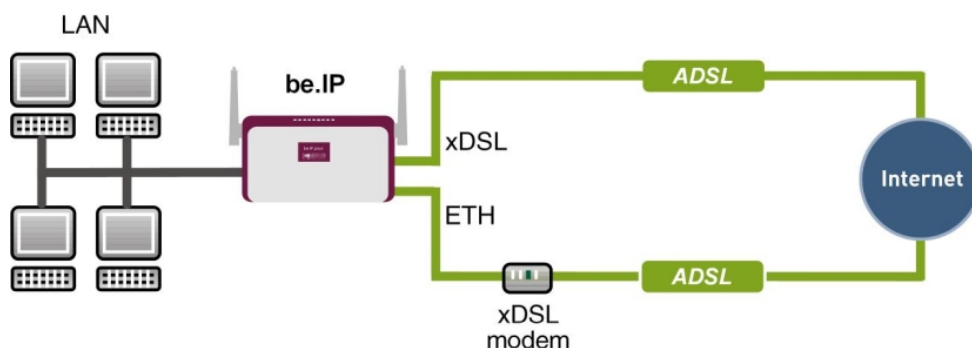

Configuration target

- The data traffic is distributed half and half to the two ADSL lines based on IP sessions.
- We shall then take the example of encrypted HTTP connections (HTTPS) to describe how to effectively avoid any loss of connection that might occur when distributing to different Internet accesses.



Note

When creating the ADSL connections, besides the public IP address, the bintec R3002 also obtains the IP addresses of the DNS servers for resolving the name of the configured Internet provider. Particularly when using different Internet providers, the use of the DSN servers needs to be connection-specific.

The configuration of the DNS servers is automatically created when you create the ADSL connections and can be seen in the menu **Local ServicesDNSDNS Server**.

Overview of Configuration Steps

Set up first Internet connection

Field	Menu	Value
Connection Type	Assistants->Internet Access->Internet Connections->New	Internal ADSL Modem
Description	Assistants->Internet Access->Internet Connections->New->Next	e.g. ADSL-1
Type	Assistants->Internet Access->Internet Connections->New->Next	User-defined via PPP over Ethernet (PPPoE)
Login Name	Assistants->Internet Access->Internet Connections->New->Next	e.g. feste_ip@provider.

Field	Menu	Value
		<i>de</i>
Password	Assistants->Internet Access->Internet Connections->New->Next	e.g. <i>test12345</i>

**Note**

The message you get when you create the second ADSL connection may be ignored. The IP load distribution avoids routing conflicts due to multiple standard routes!

Set up the second Internet connection

Field	Menu	Value
Connection Type	Assistants->Internet Access->Internet Connections->New	<i>External xDSL Mo-dem</i>
Description	Assistants->Internet Access->Internet Connections->New->Next	e.g. <i>ADSL-2</i>
Physical Ethernet Port	Assistants->Internet Access->Internet Connections->New->Next	e.g. <i>ETH5</i>
Type	Assistants->Internet Access->Internet Connections->New->Next	<i>User-defined</i>
Login Name	Assistants->Internet Access->Internet Connections->New->Next	e.g. <i>#0001@t-online.de</i>
Password	Assistants->Internet Access->Internet Connections->New->Next	e.g. <i>test12345</i>

Create a load balancing group

Field	Menu	Value
Group Description	Network->Load Balancing->Load Balancing Groups->New	e.g. <i>Internet Access</i>
Distribution Policy	Network->Load Balancing->Load Balancing Groups->New	<i>Session-Round-Robin</i>
Distribution Mode	Network->Load Balancing->Load Balancing Groups->New	<i>Always</i>
Interface	Network->Load Balancing->Load Balancing Groups->New->Add	<i>WAN_ADSL-1</i>
Distribution Ratio	Network->Load Balancing->Load Balancing Groups->New->Add	<i>50</i>
Interface	Network->Load Balancing->Load Balancing Groups->New->Add	<i>WAN_ADSL-2</i>

Field	Menu	Value
	ancing Groups->New->Add	
Distribution Ratio	Network->Load Balancing->Load Balancing Groups->New->Add	50

Special Session Handling

Field	Menu	Value
Description	Network->Load Balancing->Special Session Handling->New	e.g. <i>HTTPS</i>
Service	Network->Load Balancing->Special Session Handling->New	<i>http (SSL)</i>
Special Handling Timer	Network->Load Balancing->Special Session Handling->New	900 seconds

14.5 QoS

QoS (Quality of Service) makes it possible to distribute the available bandwidths effectively and intelligently. Certain applications can be given preference and bandwidth reserved for them. This is an advantage, especially for time-critical applications such as VoIP.

The QoS configuration consists of three parts:

- Creating IP filters
- Classifying data
- Prioritising data

14.5.1 IPv4/IPv6 Filter

In the **Networking->IPv4/IPv6 Filter->QoS Filter** menu IP filters are configured.

The list also displays any configured entries from **Networking->Access Rules->Rule Chains**.

14.5.1.1 New

Choose the **New** button to define more IP filters.

The **Networking->IPv4/IPv6 Filter->QoS Filter->New** menu consists of the following fields:

Fields in the Basic Parameters menu.

Field	Description
Description	Enter the name of the filter.
Service	<p>Select one of the preconfigured services. The extensive range of services configured ex works includes the following:</p> <ul style="list-style-type: none"> • <i>activity</i> • <i>apple-qt</i> • <i>auth</i> • <i>charge</i> • <i>clients_1</i> • <i>daytime</i> • <i>dhcp</i> • <i>discard</i> <p>The default value is <i>User defined</i>.</p>
Protocol	<p>Select a protocol.</p> <p>The <i>Any</i> option (default value) matches any protocol.</p>
Type	<p>Only for Protocol = <i>ICMP</i></p> <p>Select the type.</p> <p>Possible values: <i>Any, Echo reply, Destination unreachable, Source quench, Redirect, Echo, Time exceeded, Timestamp, Timestamp reply</i>.</p> <p>See RFC 792.</p> <p>The default value is <i>Any</i>.</p>
Connection State	<p>With Protocol = <i>TCP</i>, you can define a filter that takes the status of the TCP connections into account.</p> <p>Possible values:</p> <ul style="list-style-type: none"> • <i>Established</i>: All TCP packets that would not open any new TCP connection on routing over the gateway match the filter. • <i>Any</i> (default value): All TCP packets match the filter.
Destination IPv4 Address/Netmask	Enter the destination IPv4 address of the data packets and the corresponding netmask.

Field	Description
	<p>Possible values:</p> <ul style="list-style-type: none"> • <i>Any</i> (default value): The destination IP address/netmask are not specified. • <i>Host</i>: Enter the destination IP address of the host. • <i>Network</i>: Enter the destination network address and the corresponding netmask.
Destination IPv6 Address/Length	<p>Enter the destination IPv6 address of the data packets and the prefix length.</p> <p>Possible values:</p> <ul style="list-style-type: none"> • <i>Any</i> (default value): The destination IP address/length are not specified. • <i>Host</i>: Enter the destination IP address of the host. • <i>Network</i>: Enter the destination network address and the prefix length.
Destination Port/Range	<p>Only for Protocol = <i>TCP</i>, <i>UDP</i> or <i>TCP/UDP</i></p> <p>Enter a destination port number or a range of destination port numbers.</p> <p>Possible values:</p> <ul style="list-style-type: none"> • <i>-All-</i> (default value): The destination port is not specified. • <i>Specify port</i>: Enter a destination port. • <i>Specify port range</i>: Enter a destination port range.
Source IPv4 Address/Netmask	<p>Enter the source IPv4 address of the data packets and the corresponding netmask.</p> <p>Possible values:</p> <ul style="list-style-type: none"> • <i>Any</i> (default value): The source IP address/netmask are not specified. • <i>Host</i>: Enter the source IP address of the host. • <i>Network</i>: Enter the source network address and the corresponding netmask.
Source IPv6 Address/Length	<p>Enter the source IPv6 address of the data packets and the prefix length.</p> <p>Possible values:</p>

Field	Description
	<ul style="list-style-type: none"> • <i>Any</i> (default value): The source IP address/length are not specified. • <i>Host</i>: Enter the source IP address of the host. • <i>Network</i>: Enter the source network address and the prefix length.
Source Port/Range	<p>Only for Protocol = <i>TCP</i>, <i>UDP</i> or <i>TCP/UDP</i></p> <p>Enter a source port number or a range of source port numbers.</p> <p>Possible values:</p> <ul style="list-style-type: none"> • <i>-All-</i> (default value): The source port is not specified. • <i>Specify port</i>: Enter a source port. • <i>Specify port range</i>: Enter a source port range.
DSCP/TOS Filter (Layer 3)	<p>Select the Type of Service (TOS).</p> <p>Possible values:</p> <ul style="list-style-type: none"> • <i>Ignore</i> (default value): The type of service is ignored. • <i>DSCP Binary Value</i>: Differentiated Services Code Point according to RFC 3260 is used to signal the priority of IP packets (indicated in binary format, 6 bit). • <i>DSCP Decimal Value</i>: Differentiated Services Code Point according to RFC 3260 is used to signal the priority of IP packets (indicated in decimal format). • <i>DSCP Hexadecimal Value</i>: Differentiated Services Code Point according to RFC 3260 is used to signal the priority of IP packets (indicated in hexadecimal format). • <i>TOS Binary Value</i>: The TOS value is specified in binary format, e.g. 00111111. • <i>TOS Decimal Value</i>: The TOS value is specified in decimal format, e.g. 63. • <i>TOS Hexadecimal Value</i>: The TOS value is specified in hexadecimal format, e.g. 3F.
COS Filter (802.1p/Layer 2)	<p>Enter the service class of the IP packets (Class of Service, CoS).</p> <p>Value range 0 to 7.</p>

Field	Description
	The default value is <i>0</i> .
	The default value is <i>Ignore</i> .

14.5.2 QoS Classification

The data traffic is classified in the **Networking->QoS->QoS Classification** menu, i.e. the data traffic is associated using class IDs of various classes. To do this, create class plans for classifying IP packets based on pre-defined IP filters. Each class plan is associated to at least one interface via its first filter.

14.5.2.1 New

Choose the **New** button to create additional data classes.

The **Networking->QoS->QoS Classification->New** menu consists of the following fields:

Fields in the Basic Parameters menu.

Field	Description
Class map	Choose the class plan you want to create or edit. Possible values: <ul style="list-style-type: none"> • <i>New</i> (default value): You can create a new class plan with this setting. • <i><Name of class plan></i>: Shows a class plan that has already been created, which you can select and edit. You can add new filters.
Description	Only for Class map = <i>New</i> Enter the name of the class plan.
Filter	Select an IP filter. If the class plan is new, select the filter to be set at the first point of the class plan. If the class plan already exists, select the filter to be attached to the class plan. To select a filter, at least one filter must be configured in the Networking->QoS->QoS Filter menu.

Field	Description
Direction	<p>Select the direction of the data packets to be classified.</p> <p>Possible values:</p> <ul style="list-style-type: none"> • <i>Incoming</i>: Incoming data packets are assigned to the class (Class ID) that is then to be defined. • <i>Outgoing</i> (default value): Outgoing data packets are assigned to the class (Class ID) that is then to be defined. • <i>Both</i>: Incoming and outgoing data packets are assigned to the class (Class ID) that is then to be defined.
High Priority Class	<p>Enable or disable the high priority class. If the high priority class is active, the data packets are associated with the class with the highest priority and priority 0 is set automatically.</p> <p>The function is enabled with <i>Enabled</i>.</p> <p>The function is disabled by default.</p>
Class ID	<p>Only for High Priority Class not active.</p> <p>Choose a number which assigns the data packets to a class.</p> <div data-bbox="539 947 1316 1101" style="border: 1px solid gray; background-color: #f0f0f0; padding: 5px; margin: 10px 0;"> <p> Note</p> <p>The class ID is a label to assign data packets to specific classes. (The class ID does not define the priority.)</p> </div> <p>Possible values are whole numbers between <i>1</i> and <i>254</i>.</p>
Set DSCP/Traffic Class Filter (Layer 3)	<p>Here you can set or change the DSCP/TOS value of the IP data packets, based on the class (Class ID) that has been defined.</p> <p>Possible values:</p> <ul style="list-style-type: none"> • <i>Preserve</i> (default value): The DSCP/TOS value of the IP data packets remains unchanged. • <i>DSCP Binary Value</i>: Differentiated Services Code Point according to RFC 3260 is used to signal the priority of IP packets (indicated in binary format). • <i>DSCP Decimal Value</i>: Differentiated Services Code Point according to RFC 3260 is used to signal the priority of IP

Field	Description
	<p>packets (indicated in decimal format).</p> <ul style="list-style-type: none"> • <i>DSCP Hexadecimal Value</i>: Differentiated Services Code Point according to RFC 3260 is used to signal the priority of IP packets (indicated in hexadecimal format). • <i>TOS Binary Value</i>: The TOS value is specified in binary format, e.g. 00111111. • <i>TOS Decimal Value</i>: The TOS value is specified in decimal format, e.g. 63. • <i>TOS Hexadecimal Value</i>: The TOS value is specified in hexadecimal format, e.g. 3F.
Set COS value (802.1p/Layer 2)	<p>In the header of the Ethernet packets filtered by the selected filter, you can here set/change the service class (Layer 2 priority).</p> <p>Possible values are whole numbers between 0 and 7.</p> <p>The default value is <i>Preserve</i>.</p>
Interfaces	<p>Only for Class map = <i>New</i></p> <p>When creating a new class plan, select the interfaces to which you want to link the class plan. A class plan can be assigned to multiple interfaces.</p>

14.5.3 QoS Interfaces/Policies

In the **Networking->QoS->QoS Interfaces/Policies** menu, you set prioritisation of data.



Note

Data can only be prioritized in the outgoing direction.

Packets in the high-priority class always take priority over data with class IDs 1 - 254.

It is possible to assign or guarantee each queue and thus each data class a certain part of the total bandwidth of the interface. In addition, you can optimise the transmission of voice data (real time data).

Depending on the respective interface, a queue is created automatically for each class, but only for data traffic classified as outgoing and for data traffic classified in both directions. A priority is assigned to these automatic queues. The value of the priority is equal to the

value of the class ID. You can change the default priority of a queue. If you add new queues, you can also use classes in other class plans via the class ID.

14.5.3.1 New

Choose the **New** button to create additional prioritisations.

The **Networking->QoS->QoS Interfaces/Policies->New** menu consists of the following fields:

Fields in the Basic Parameters menu.

Field	Description
Interface	Select the interface for which QoS is to be configured.
Prioritisation Algorithm	<p>Select the algorithm according to which the queues are to be processed. This activates and deactivates QoS on the selected interface.</p> <p>Possible values:</p> <ul style="list-style-type: none"> • <i>Priority Queueing</i>: QoS is activated on the interface. The available bandwidth is distributed strictly according to the queue priority. • <i>Weighted Round Robin</i>: QoS is activated on the interface. The available bandwidth is distributed according to the weighting (weight) of the queue. Exception: High-priority packets are always handled with priority. • <i>Weighted Fair Queueing</i>: QoS is activated on the interface. The available bandwidth is distributed as “fairly” as possible among the (automatically detected) traffic flows in a queue. Exception: High-priority packets are always handled with priority. • <i>Disabled</i> (default value): QoS is deactivated on the interface. The existing configuration is not deleted, but can be activated again if required.
Traffic shaping	<p>Activate or deactivate data rate limiting in the send direction.</p> <p>The function is enabled with <i>Enabled</i>.</p> <p>The function is disabled by default.</p>
Maximum Upload	Only for Traffic shaping = enabled.

Field	Description
Speed	<p>Enter a maximum data rate for the selected interface in the send direction in kbit per second.</p> <p>Possible values are <i>0</i> to <i>1000000</i>.</p> <p>The default value is <i>0</i>, i.e. no limits are set, the selected interface can occupy its maximum bandwidth.</p>
Protocol Header Size below Layer 3	<p>Only for Traffic shaping = enabled.</p> <p>Choose the interface type to include the size of the respective overheads of a datagram when calculating the bandwidth.</p> <p>Possible values:</p> <ul style="list-style-type: none"> • <i>User defined</i>: Value in byte. <p>Possible values are <i>0</i> to <i>100</i>.</p> <ul style="list-style-type: none"> • <i>Undefined (Protocol Header Offset=0)</i> (default value) <p>Can only be selected for Ethernet interfaces</p> <ul style="list-style-type: none"> • <i>Ethernet</i> • <i>Ethernet and VLAN</i> • <i>PPP over Ethernet</i> • <i>PPP over Ethernet and VLAN</i> <p>Can only be selected for IPSec interfaces:</p> <ul style="list-style-type: none"> • <i>IPSec over Ethernet</i> • <i>IPSec over Ethernet and VLAN</i> • <i>IPSec via PPP over Ethernet</i> • <i>IPSec via PPPoE and VLAN</i>
Encryption Method	<p>Only if an IPSec Peers is selected as Interface, Traffic shaping is <i>Active</i> and Protocol Header Size below Layer 3 is not <i>Undefiniert (Protocol Header Offset=0)</i>.</p> <p>Select the encryption method used for the IPSec connection. The encryption algorithm determines the length of the block cipher which is taken into account during bandwidth calculation.</p> <p>Possible values:</p>

Field	Description
	<ul style="list-style-type: none"> • <i>DES, 3DES, Blowfish, Cast</i> - (cipher block size = 64 Bit) • <i>AES128, AES192, AES256, Twofish</i> - (cipher block size = 128 Bit)
Real Time Jitter Control	<p>Only for Traffic shaping = enabled</p> <p>Real Time Jitter Control optimises latency when forwarding real time datagrams. The function ensures that large data packets are fragmented according to the available upload bandwidth.</p> <p>Real Time Jitter Control is useful for small upload bandwidths (< 800 kbps).</p> <p>Activate or deactivate Real Time Jitter Control.</p> <p>The function is enabled with <i>Enabled</i>.</p> <p>The function is disabled by default.</p>
Control Mode	<p>Only for Real Time Jitter Control = enabled.</p> <p>Select the mode for optimising voice transmission.</p> <p>Possible values:</p> <ul style="list-style-type: none"> • <i>All RTP Streams</i>: All RTP streams are optimised. The function activates the RTP stream detection mechanism for the automatic detection of RTP streams. In this mode, the Real Time Jitter Control is activated as soon as an RTP stream has been detected. • <i>Inactive</i>: Voice data transmission is not optimised. • <i>Controlled RTP Streams only</i>: This mode is used if either the VoIP Application Layer Gateway (ALG) or the VoIP Media Gateway (MGW) is active. Real Time Jitter Control is activated by the control instances ALG or MGW. • <i>Always</i>: Real Time Jitter Control is always active, even if no real time data is routed.
Queues/Policies	<p>Configure the desired QoS queues.</p> <p>For each class created from the class plan, which is associated with the selected interface, a queue is generated automatically and displayed here (only for data traffic classified as outgoing</p>

Field	Description
	<p>and for data traffic classified as moving in both directions).</p> <p>Add new entries with Add. The Edit Queue/Policy menu opens.</p> <p>By creating a QoS policy a DEFAULT entry with the lowest priority 255 is automatically created.</p>

The menu **Edit Queue/Policy** consists of the following fields:

Fields in the **Edit Queue/Policy** menu.

Field	Description
Description	Enter the name of the queue/policy.
Outbound Interface	Shows the interface for which the QoS queues are being configured.
Prioritisation queue	<p>Select the queue priority type.</p> <p>Possible values:</p> <ul style="list-style-type: none"> • <i>Class Based</i> (default value): Queue for data classified as “normal”. • <i>High Priority</i>: Queue for data classified as “high priority”. • <i>Default</i>: Queue for data that has not been classified or data of a class for which no queue has been configured.
Class ID	<p>Only for Prioritisation queue = <i>Class Based</i></p> <p>Select the QoS packet class to which this queue is to apply.</p> <p>To do this, at least one class ID must be given in the Networking->QoS->QoS Classification menu.</p>
Priority	<p>Only for Prioritisation queue = <i>Class Based</i></p> <p>Choose the priority of the queue. Possible values are 1 (high priority) to 254 (low priority).</p> <p>The default value is 1.</p>
Weight	<p>Only for Prioritisation Algorithm = <i>Weighted Round Robin</i> or <i>Weighted Fair Queueing</i></p>

Field	Description
	<p>Choose the priority of the queue. Possible values are <i>1</i> to <i>254</i>.</p> <p>The default value is <i>1</i>.</p>
RTT Mode (Realtime Traffic Mode)	<p>Active or deactivate the real time transmission of the data.</p> <p>The function is enabled with <i>Enabled</i>.</p> <p>The function is disabled by default.</p> <p>RTT mode should be activated for QoS classes in which real time data has priority. This mode improves latency when forwarding real time datagrams.</p> <p>It is possible to configure multiple queues when RTT mode is enabled. Queues with enabled RTT mode must always have a higher priority than queues with disabled RTT mode.</p>
Traffic Shaping	<p>Activate or deactivate data rate (=Traffic Shaping) limiting in the send direction.</p> <p>The data rate limit applies to the selected queue. (This is not the limit that can be defined on the interface.)</p> <p>The function is enabled with <i>Enabled</i>.</p> <p>The function is disabled by default.</p>
Maximum Upload Speed	<p>Only for Traffic Shaping = enabled.</p> <p>Enter a maximum data rate for the queue in kbits.</p> <p>Possible values are <i>0</i> to <i>1000000</i>.</p> <p>The default value is <i>0</i>.</p>
Overbooking allowed	<p>Only for Traffic Shaping = enabled.</p> <p>Enable or disable the function. The function controls the bandwidth limit.</p> <p>If Overbooking allowed is activated, the bandwidth limit set for this queue can be exceeded, as long as free bandwidth exists on the interface.</p> <p>If Overbooking allowed is deactivated, the queue can never</p>

Field	Description
	<p>occupy bandwidth beyond the bandwidth limit that has been set.</p> <p>The function is enabled with <i>Enabled</i>.</p> <p>The function is disabled by default.</p>
Burst size	<p>Only for Traffic Shaping = enabled.</p> <p>Enter the maximum number of bytes that may still be transmitted temporarily when the data rate permitted for this queue has been reached.</p> <p>Possible values are 0 to 64000.</p> <p>The default value is 0.</p>

The menu **Advanced Settings** consists of the following fields:

Fields in the **Advanced Settings** menu.

Field	Description
Dropping Algorithm	<p>Choose the procedure for rejecting packets in the QoS queue, if the maximum size of the queue is exceeded.</p> <p>Possible values:</p> <ul style="list-style-type: none"> • <i>Tail Drop</i> (default value): The newest packet received is dropped. • <i>Head Drop</i>: The oldest packet in the queue is dropped. • <i>Random Drop</i>: A randomly selected packet is dropped from the queue.
Congestion Avoidance (RED)	<p>Enable or disable preventative deletion of data packets.</p> <p>Packets which have a data size of between Min. queue size and Max. queue size are preventively dropped to prevent queue overflow (RED=Random Early Detection). This procedure ensures a smaller long-term queue size for TCP-based data traffic, so that traffic bursts can also usually be transmitted without large packet losses.</p> <p>The function is activated with <i>Enabled</i>.</p> <p>The function is disabled by default.</p>

Field	Description
Min. queue size	<p>Enter the lower threshold value for the process Congestion Avoidance (RED) in bytes.</p> <p>Possible values are <i>0</i> to <i>262143</i>.</p> <p>The default value is <i>0</i>.</p>
Max. queue size	<p>Enter the upper threshold value for the process Congestion Avoidance (RED) in bytes.</p> <p>Possible values are <i>0</i> to <i>262143</i>.</p> <p>The default value is <i>16384</i>.</p>

14.6 Access Rules

Accesses to data and functions are restricted with access lists (which user gets to use which services and files).

You define filters for IP packets in order to allow or block access from or to the various hosts in connected networks. This enables you to prevent undesired connections being set up via the gateway. Access lists define the type of IP traffic the gateway is to accept or deny. The access decision is based on information contained in the IP packets, e.g.:

- source and/or destination IP address
- packet protocol
- source and/or destination port (port ranges are supported)

Access lists are an effective means if, for example, sites with LANs interconnected over a bintec elmeg gateway wish to deny all incoming FTP requests or only allow Telnet sessions between certain hosts.

Access filters in the gateway are based on the combination of filters and actions for filter rules (= rules) and the linking of these rules to form rule chains. They act on the incoming data packets to allow or deny access to the gateway for certain data.

A filter describes a certain part of the IP data traffic based on the source and/or destination IP address, netmask, protocol and source and/or destination port.

You use the rules that you set up in the access lists to tell the gateway what to do with the filtered data packets, i.e. whether it should allow or deny them. You can also define several rules, which you arrange in the form of a chain to obtain a certain sequence.

There are various approaches for the definition of rules and rule chains:

Allow all packets that are not explicitly denied, i.e.:

- Deny all packets that match Filter 1.
- Deny all packets that match Filter 2.
- ...
- Allow the rest.

or

Allow all packets that are explicitly allowed, i.e.:

- Allow all packets that match Filter 1.
- Allow all packets that match Filter 2.
- ...
- Deny the rest.

or

Combination of the two possibilities described above.

A number of separate rule chains can be created. The same filter can also be used in different rule chains.

You can also assign a rule chain individually to each interface.



Caution

Make sure you don't lock yourself out when configuring filters.

If possible, access your gateway for filter configuration over the serial console (not available for all devices) interface or ISDN Login.

14.6.1 Access Filter

This menu is for configuration of access filter. Each filter describes a certain part of the IP traffic and defines, for example, the IP addresses, the protocol, the source port or the destination port.

A list of all access filters is displayed in the **Networking->Access Rules->Access Filter** menu.

14.6.1.1 Edit or New

Choose the  icon to edit existing entries. To configure access filters, select the **New** button.

The **Networking->Access Rules->Access Filter->New** menu consists of the following fields:

Fields in the **Basic Parameters** menu.

Field	Description
Description	Enter a description for the filter.
Service	<p>Select one of the preconfigured services. The extensive range of services configured ex works includes the following:</p> <ul style="list-style-type: none"> • <i>activity</i> • <i>apple-qt</i> • <i>auth</i> • <i>charge</i> • <i>clients_1</i> • <i>daytime</i> • <i>dhcp</i> • <i>discard</i> <p>The default value is <i>User defined</i>.</p>
Protocol	<p>Select a protocol.</p> <p>The <i>Any</i> option (default value) matches any protocol.</p>
Type	<p>Only if Protocol = <i>ICMP</i></p> <p>Possible values:</p> <ul style="list-style-type: none"> • <i>Any</i> • <i>Echo reply</i> • <i>Destination unreachable</i> • <i>Source quench</i> • <i>Redirect</i> • <i>Echo</i> • <i>Time exceeded</i>

Field	Description
	<ul style="list-style-type: none"> • <i>Timestamp</i> • <i>Timestamp reply</i> <p>The default value is <i>Any</i>.</p> <p>See RFC 792.</p>
Connection State	<p>Only if Protocol = <i>TCP</i></p> <p>You can define a filter that takes the status of the TCP connections into account.</p> <p>Possible values:</p> <ul style="list-style-type: none"> • <i>Any</i> (default value): All TCP packets match the filter. • <i>Established</i>: All TCP packets that would not open any new TCP connection on routing over the gateway match the filter.
Destination IPv4 Address/Netmask	<p>Enter the destination IPv4 address of the data packets and the corresponding netmask.</p> <p>Possible values:</p> <ul style="list-style-type: none"> • <i>Any</i> (default value): The destination IP address/netmask are not specified. • <i>Host</i>: Enter the destination IP address of the host. • <i>Network</i>: Enter the destination network address and the corresponding netmask.
Destination IPv6 Address/Length	<p>Enter the destination IPv6 address of the data packets and the prefix length.</p> <p>Possible values:</p> <ul style="list-style-type: none"> • <i>Any</i> (default value): The destination IP address/length are not specified. • <i>Host</i>: Enter the destination IP address of the host. • <i>Network</i>: Enter the destination network address and the prefix length.
Destination Port/Range	<p>Only if Protocol = <i>TCP, UDP</i></p> <p>Enter a destination port number or a range of destination port numbers that matches the filter.</p>

Field	Description
	<p>Possible values:</p> <ul style="list-style-type: none"> • <i>-All-</i> (default value): The filter is valid for all port numbers • <i>Specify port</i>: Enables the entry of a port number. • <i>Specify port range</i>: Enables the entry of a range of port numbers.
Source IPv4 Address/Netmask	<p>Enter the source IPv4 address of the data packets and the corresponding netmask.</p> <p>Possible values:</p> <ul style="list-style-type: none"> • <i>Any</i> (default value): The source IP address/netmask are not specified. • <i>Host</i>: Enter the source IP address of the host. • <i>Network</i>: Enter the source network address and the corresponding netmask.
Source IPv6 Address/Length	<p>Enter the source IPv6 address of the data packets and the prefix length.</p> <p>Possible values:</p> <ul style="list-style-type: none"> • <i>Any</i> (default value): The source IP address/length are not specified. • <i>Host</i>: Enter the source IP address of the host. • <i>Network</i>: Enter the source network address and the prefix length.
Source Port/Range	<p>Only if Protocol = <i>TCP, UDP</i></p> <p>Enter a source port number or the range of source port numbers.</p> <p>Possible values:</p> <ul style="list-style-type: none"> • <i>-All-</i> (default value): The filter is valid for all port numbers • <i>Specify port</i>: Enables the entry of a port number. • <i>Specify port range</i>: Enables the entry of a range of port numbers.
DSCP/TOS Filter (Layer 3)	<p>Select the Type of Service (TOS).</p> <p>Possible values:</p>

Field	Description
	<ul style="list-style-type: none"> • <i>Ignore</i> (default value): The type of service is ignored. • <i>DSCP Binary Value</i>: Differentiated Services Code Point according to RFC 3260 is used to signal the priority of IP packets (indicated in binary format, 6 bit). • <i>DSCP Decimal Value</i>: Differentiated Services Code Point according to RFC 3260 is used to signal the priority of IP packets (indicated in decimal format). • <i>DSCP Hexadecimal Value</i>: Differentiated Services Code Point according to RFC 3260 is used to signal the priority of IP packets (indicated in hexadecimal format). • <i>TOS Binary Value</i>: The TOS value is specified in binary format, e.g. 00111111. • <i>TOS Decimal Value</i>: The TOS value is specified in decimal format, e.g. 63. • <i>TOS Hexadecimal Value</i>: The TOS value is specified in hexadecimal format, e.g. 3F.
COS Filter (802.1p/Layer 2)	<p>Enter the service class of the IP packets (Class of Service, CoS).</p> <p>Possible values are whole numbers between 0 and 7.</p> <p>The default value is <i>Ignore</i>.</p>

14.6.2 Rule Chains

Rules for IP filters are configured in the **Rule Chains** menu. These can be created separately or incorporated in rule chains.

In the **Networking->Access Rules->Rule Chains** menu, all created filter rules are listed.

14.6.2.1 Edit or New

Choose the  icon to edit existing entries. To configure access lists, select the **New** button.

The **Networking->Access Rules->Rule Chains->New** menu consists of the following fields:

Fields in the Basic Parameters menu.

Field	Description
Rule Chain	<p>Select whether to create a new rule chain or to edit an existing one.</p> <p>Possible values:</p> <ul style="list-style-type: none"> • <i>New</i> (default value): You can create a new rule chain with this setting. • <i><Name of the rule chain></i>: Select an already existing rule chain, and thus add another rule to it.
Description	Enter the name of the rule chain.
Access Filter	<p>Select an IP filter.</p> <p>If the rule chain is new, select the filter to be set at the first point of the rule chain.</p> <p>If the rule chain already exists, select the filter to be attached to the rule chain.</p>
Action	<p>Define the action to be taken for a filtered data packet.</p> <p>Possible values:</p> <ul style="list-style-type: none"> • <i>Allow if filter matches</i> (default value): Allow packet if it matches the filter. • <i>Allow if filter does not match</i>: Allow packet if it does not match the filter. • <i>Deny if filter matches</i>: Deny packet if it matches the filter. • <i>Deny if filter does not match</i>: Deny packet if it does not match the filter. • <i>Ignore</i>: Use next rule.

To set the rules of a rule chain in a different order select the  button in the list menu for the entry to be shifted. A dialog box opens, in which you can decide under **Move** whether the entry *below* (default value) or *above* another rule of this rule chain is to be shifted.

14.6.3 Interface Assignment

In this menu, the configured rule chains are assigned to the individual interfaces and the gateway's behavior is defined for denying IP packets.

A list of all configured interface assignments is displayed in the **Networking->Access Rules->Interface Assignment** menu.

14.6.3.1 Edit or New

Choose the  icon to edit existing entries. Choose the **New** button to configure additional assignments.

The **Networking->Access Rules->Interface Assignment->New** menu consists of the following fields:

Fields in the **Basic Parameters** menu.

Field	Description
Interface	Select the interface for which a configured rule chain is to be assigned.
Rule Chain	Select a rule chain.
Silent Deny	<p>Define whether the sender is to be informed if an IP packet is denied.</p> <ul style="list-style-type: none"> • <i>Enabled</i> (default value): The sender is not informed. • <i>Disabled</i>: The sender receives an ICMP message.
Reporting Method	<p>Define whether a syslog message is to be generated if a packet is denied.</p> <p>Possible values:</p> <ul style="list-style-type: none"> • <i>No report</i>: No syslog message. • <i>Info</i> (default value): A syslog message is generated with the protocol number, source IP address and source port number. • <i>Dump</i>: A syslog message is generated with the contents of the first 64 bytes of the denied packet.

Chapter 15 Multicast

What is multicasting?

Many new communication technologies are based on communication from one sender to several recipients. Therefore, modern telecommunication systems such as voice over IP or video and audio streaming (e.g. IPTV or Webradio) focus on reducing data traffic, e.g. by offering TriplePlay (voice, video, data). Multicast is a cost-effective solution for effective use of bandwidth because the sender of the data packet, which can be received by several recipients, only needs to send the packet once. The packet is sent to a virtual address defined as a multicast group. Interested recipients log in to these groups.

Other areas of use

One classic area in which multicast is used is for conferences (audio/video) with several recipients. The most well-known are probably the Mbone Multimedia Audio Tool (VAT), Video Conferencing Tool (VIC) and Whiteboard (WB). VAT can be used to hold audio conferences. All subscribers are displayed in a window and the speaker(s) are indicated by a black box. Other areas of use are of particular interest to companies. Here, multicasting makes it possible to synchronise the databases of several servers, which is valuable for multinationals or even companies with just a few locations.

Address range for multicast

For, IPv4 the IP addresses 224.0.0.0 to 239.255.255.255 (224.0.0.0/4) are reserved for multicast in the class D network. An IP address from this range represents a multicast group to which several recipients can log in. The multicast router then forwards the required packets to all subnets with logged in recipients.

Multicast basics

Multicast is connectionless, which means that any trouble-shooting or flow control needs to be guaranteed at application level.

At transport level, UDP is used almost exclusively, as, in contrast to TCP, it is not based on a point-to-point connection.

At IP level, the main difference is therefore that the destination address does not address a

dedicated host, but rather a group, i.e. during the routing of multicast packets, the decisive factor is whether a recipient is in a logged-in subnet.

In the local network, all hosts are required to accept all multicast packets. For Ethernet or FDD, this is based on MAC mapping, where the group address is encoded into the destination MAC address. For routing between several networks, the routers first need to make themselves known to all potential recipients in the subnet. This is achieved by means of Membership Management protocols such as IGMP for IPv4 and MLP for IPv6.

Membership Management protocol

In IPv4, IGMP (Internet Group Management Protocol) is a protocol that hosts can use to provide the router with multicast membership information. IP addresses of the class D address range are used for addressing. An IP address in this class represents a group. A sender (e.g. Internet radio) sends data to this group. The addresses (IP) of the various senders within a group are called the source (addresses). Several senders (with different IP addresses) can therefore transmit to the same multicast group, leading to a 1-to-n relationship between groups and source addresses. This information is forwarded to the router by means of reports. In the case of incoming multicast data traffic, a router can use this information to decide whether a host in its subnet wants to receive it. Your device supports the current version IGMP V3, which is upwardly compatible, which means that both V3 and V1/V2 hosts can be managed.

Your device supports the following multicast mechanisms:

- Forwarding: This relates to static forwarding, i.e. incoming data traffic for a group is passed in all cases. This is a useful option if multicast data traffic is to be permanently passed.
- IGMP: IGMP is used to gather information about the potential recipients in a subnet. In the case of a hop, incoming multicast data traffic can thus be selected.



Tip

With multicast, the focus is on excluding data traffic from unwanted multicast groups. Note that if forwarding is combined with IGMP, the packets can be forwarded to the groups specified in the forwarding request.

15.1 General

15.1.1 General

In the **Multicast->General->General** menu you can disable or enable the multicast function.

The menu consists of the following fields:

Fields in the Basic Settings menu.

Field	Description
Multicast Routing	<p>Select whether Multicast Routing should be used.</p> <p>The function is enabled with <i>Enabled</i>.</p> <p>The function is disabled by default.</p>

15.2 IGMP

IGMP (Internet Group Management Protocol, see RFC 3376) is used to signal the information about group (membership) in a subnet. As a result, only the packets explicitly wanted by a host enter the subnet.

Special mechanisms ensure that the requirements of the individual clients are taken into consideration. At the moment there are three versions of IGMP (V1 - V3); most current systems use V3, and less often V2.

Two packet types play a central role in IGMP: queries and reports.

Queries are only transmitted from a router. If several IGMP routers exist in a network, the router with the lowest IP address is the "querier". We differentiate here between a general query (sent to 224.0.0.1), a group-specific query (sent to a group address) and the group-and-source-specific query (sent to a specific group address). Reports are only sent by hosts to respond to queries.

15.2.1 IGMP

In this menu, you configure the interfaces on which IGMP is to be enabled.

15.2.1.1 Edit or New

Choose the  icon to edit existing entries. Choose the **New** button to configure IGMP on other interfaces.

The **Multicast->IGMP->IGMP->New** menu consists of the following fields:

Fields in the IGMP Settings menu.

Field	Description
Interface	Select the interface on which IGMP is to be enabled, i.e. queries are sent and responses are accepted.
Query Interval	Enter the interval in seconds in which IGMP queries are to be sent. Possible values are <i>0 to 600</i> . The default value is <i>125</i> .
Maximum Response Time	For the sending of queries, enter the time interval in seconds within which hosts must respond. The hosts randomly select a time delay from this interval before sending the response. This spreads the load in networks with several hosts, improving performance. Possible values are <i>0,0 to 25,0</i> . The default value is <i>10,0</i> .
Robustness	Select the multiplier for controlling the timer values. A higher value can e.g. compensate for packet loss in a network susceptible to loss. If the value is too high, however, the time between logging off and stopping of the data traffic can be increased (leave latency). Possible values are <i>2 to 8</i> . The default value is <i>2</i> .
Last Member Query Interval	Define the time after a query for which the router waits for an answer. If you shorten the interval, it will be more quickly detected that the last member has left a group so that no more packets for this group should be forwarded to this interface. Possible values are <i>0,0 to 25,0</i> . The default value is <i>1,0</i> .

Field	Description
IGMP State Limit	Limit the number of reports/queries per second for the selected interface.
Mode	Specify whether the interface defined here only works in host mode or in both host mode and routing mode. Possible values: <ul style="list-style-type: none"> • <i>Routing</i> (default value): The interface is operated in Routing mode. • <i>Host</i>: The interface is only operated in host mode.

IGMP Proxy

IGMP Proxy enables you to simulate several locally connected interfaces as a subnet to an adjacent router. Queries coming in to the IGMP Proxy interface are forwarded to the local subnets. Local reports are forwarded on the IPGM Proxy interface.

The menu **Advanced Settings** consists of the following fields:

Fields in the **Advanced Settings** menu.

Field	Description
IGMP Proxy	Select whether your device is to forward the hosts' IGMP messages in the subnet via its defined Proxy Interface .
Proxy Interface	Only for IGMP Proxy = enabled Select the interface on your device via which queries are to be received and collected.
Fallback Proxy Interface 1	Only for IGMP Proxy = enabled Select the fallback interface 1 on your device via which queries are to be received and collected. This interface will be used if the proxy function cannot be carried out on the Proxy Interface .
Fallback Proxy Interface 2	Only for IGMP Proxy = enabled Select the fallback interface 2 on your device via which queries are to be received and collected. This interface will be used if the proxy function cannot be carried out on the Fallback Proxy Interface 1 .

15.2.2 Options

In this menu, you can enable and disable IGMP on your system. You can also define whether IGMP is to be used in compatibility mode or only IGMP V3 hosts are to be accepted.

The **Multicast->IGMP->Options** menu consists of the following fields:

Fields in the **Basic Settings** menu.

Field	Description
IGMP Status	<p>Select the IGMP status.</p> <p>Possible values:</p> <ul style="list-style-type: none"> • <i>Auto</i> (default value): Multicast is activated automatically for hosts if the hosts open applications that use multicast. • <i>Up</i>: Multicast is always on. • <i>Down</i>: Multicast is always off.
Mode	<p>Only for IGMP Status = <i>Up</i> or <i>Auto</i></p> <p>Select Multicast Mode.</p> <p>Possible values:</p> <ul style="list-style-type: none"> • <i>Compatibility Mode</i> (default value): The router uses IGMP version 3. If it notices a lower version in the network, it uses the lowest version it could detect. • <i>Version 3 only</i>: Only IGMP version 3 is used.
Maximum Groups	<p>Enter the maximum number of groups to be permitted, both internally and in reports.</p> <p>The default value is <i>64</i>.</p>
Maximum Sources	<p>Enter the maximum number of sources that are specified in version 3 reports and the maximum number of internally managed sources per group.</p> <p>The default value is <i>64</i>.</p>
IGMP State Limit	<p>Enter the maximum permitted total number of incoming queries and messages per second.</p>

Field	Description
	The default value is 0, i.e. the number of IGMP status messages is not limited.

The section **Advanced Settings** allows you to switch IGMP Snooping on or off. IGMP Snooping ensures that multicast traffic is sent only to those clients that have actually required a specific multicast stream.

The function is enabled by default.

15.3 Forwarding

15.3.1 Forwarding

In this menu, you specify which multicast groups are always passed between the interfaces of your device.

15.3.1.1 New

Choose the **New** button to create forwarding rules for new multicast groups.

The **Multicast->Forwarding->Forwarding->New** menu consists of the following fields:

Fields in the **Basic Parameters** menu.

Field	Description
All Multicast Groups	Select whether all multicast groups, i.e. the complete multicast address range 224.0.0.0/4, are to be forwarded from the defined Source Interface to the defined Destination Interface . To do this, check <i>Enabled</i> Disable the option if you only want to forward one defined multicast group to a particular interface. The option is deactivated by default.
Multicast Group Address	Only for All Multicast Groups = not active. Enter here the address of the multicast group you want to forward from a defined Source Interface to a defined Destination Interface .
Source Interface	Select the interface on your device to which the selected multic-

Field	Description
	ast group is sent.
Destination Interface	Select the interface on your device to which the selected multic-ast group is to be forwarded.

Chapter 16 WAN

This menu offers various options for configuring accesses or connections from your LAN to the WAN. You can also optimise voice transmission here for telephone calls over the Internet.

16.1 Internet + Dialup

In this menu, you can set up Internet access or dialup connections.

In addition, you can create address pools for the dynamic assignment of IP addresses.

To enable your device to set up connections to networks or hosts outside your LAN, you must configure the partners you want to connect to on your device. This applies to outgoing connections (your device dials its WAN partner) and incoming connections (a remote partner dials the number of your device).

If you want to set up Internet access, you must set up a connection to your Internet Service Provider (ISP). For broadband Internet access, your device provides the PPP-over-Ethernet (PPPoE), PPP-over-PPTP and PPP-over-ATM (PPPoA) protocols. You can also configure Internet access over ISDN (if supported by you device) .



Note

Note your provider's instructions.

Dialin connections over ISDN are used to establish a connection to networks or hosts outside your LANs.

All the entered connections are displayed in a list, which contains the **Description**, the **User Name**, the **Authentication** and the current **Status**.

The **Status** field can have the following values:

Possible values for Status

Field	Description
	connected
	not connected (dialup connection); connection setup possible
	not connected (e.g. because of an error during setup of an outgoing connection, a renewed attempt is only possible after a

Field	Description
	specified number of seconds)
⊗	administratively set to down (deactivated); connection setup not possible

16.1.1 PPPoE

A list of all PPToE interfaces is displayed in the **WAN->Internet + Dialup->PPPoE** menu.

PPP over Ethernet (PPPoE) is the use of the Point-to-Point Protocol (PPP) network protocol over an Ethernet connection. Today, PPPoE is used for ADSL connections in Germany. In Austria, the Point To Point Tunnelling Protocol (PPTP) was originally used for ADSL access. However, PPPoE is now offered here too by some providers.

16.1.1.1 New

Choose the **New** button to set up new PPPoE interfaces.

The menu **WAN->Internet + Dialup->PPPoE->New** consists of the following fields:

Fields in the Basic Parameters menu.

Field	Description
Description	Enter a name to uniquely identify the PPPoE partner. The first character in this field must not be a number No special characters or umlauts must be used.
PPPoE Mode	<p>Select whether you want to use a standard Internet connection over PPPoE (<i>Standard</i>) or your Internet access is to be set up over several interfaces (<i>Multilink</i>). If you choose <i>Multilink</i>, you can connect several DSL connections from a provider over PPP as a static bundle in order to obtain more bandwidth. Each of these DSL connections should use a separate Ethernet connection for this. At the moment, many providers are still in the process of preparing the PPPoE Multilink function.</p> <p>For PPPoE Multilink, we recommend using your device's Ethernet switch in Split-Port mode and to use a separate Ethernet interface e.g. <i>en1-1</i>, <i>en1-2</i> for each PPPoE connection.</p> <p>If you also want to use an external modem for PPPoE Multilink, you must run your device's Ethernet switch in Split-Port mode.</p>
PPPoE Ethernet Inter-	Only for PPPoE Mode = <i>Standard</i>

Field	Description
face	<p>Select the Ethernet interface specified for a standard PPPoE connection.</p> <p>If you want to use an external DSL modem, select the Ethernet port to which the modem is connected.</p> <p>When using the internal DSL modem, select here the EthoA interface configured in WAN->ATM->Profiles->New.</p> <p>Select <i>Automatic</i> in order to enable the automatic VDSL/ADSL mode. In this mode, the interface for the Internet connection is selected automatically. Note that there has to be an interface entry in the ATM menu. This is not required for a VDSL connection.</p>
PPPoE Interfaces for Multilink	<p>Only for PPPoE Mode = <i>Multilink</i></p> <p>Select the interfaces you want to use for your Internet connection. Click the Add button to create new entries.</p>
User Name	Enter the user name.
Password	Enter the password.
VLAN	Certain Internet service providers require a VLAN-ID. Activate this function to be able to enter a value under VLAN ID .
VLAN ID	<p>Only if VLAN is enabled.</p> <p>Enter the VLAN-ID that you received from your provider.</p>
Always on	<p>Select whether the interface should always be activated.</p> <p>The function is enabled with <i>Enabled</i>.</p> <p>The function is disabled by default.</p> <p>Only activate this option if you have Internet access with a flat-rate charge.</p>
Connection Idle Timeout	<p>Only if Always on is disabled.</p> <p>Enter the idle time in seconds for static short hold. The static short hold setting determines how many seconds should pass between sending the last traffic data packet and clearing the</p>

Field	Description
	<p>connection.</p> <p>Possible values are 0 to 3600 (seconds). 0 deactivates the short hold.</p> <p>The default value is 300.</p> <p>Example: 10 for FTP transmission, 20 for LAN-to-LAN transmission, 90 for Internet connections.</p>

Fields in the IPv4 Settings menu.

Field	Description
Security Policy	<p>Select the security settings to be used with the interface.</p> <p>Possible values:</p> <ul style="list-style-type: none"> • <i>Trusted</i>: All IP packets are allowed through except for those which are explicitly prohibited. • <i>Untrusted</i> (default value): Only those packets are transmitted that can be attributed to a connection that has been initiated from a trusted zone. <p>You can configure exceptions for the selected setting in the Firewall on page 308 menu.</p>
IP Address Mode	<p>Select whether your device is to be assigned a static IP address or whether it should be assigned this dynamically.</p> <p>Possible values:</p> <ul style="list-style-type: none"> • <i>Get IP Address</i> (default value): Your device is dynamically assigned an IP address. • <i>Static</i>: You enter a static IP address.
Default Route	<p>Select whether the route to this connection partner is to be defined as the default route.</p> <p>The function is enabled with <i>Enabled</i>.</p> <p>The function is enabled by default.</p>
Create NAT Policy	<p>Specify whether Network Address Translation (NAT) is to be activated.</p>

Field	Description
	<p>The function is enabled with <i>Enabled</i>.</p> <p>The function is enabled by default.</p>
Local IP Address	<p>Only if IP Address Mode = <i>Static</i></p> <p>Enter the static IP address of the connection partner.</p>
Route Entries	<p>Only if IP Address Mode = <i>Static</i></p> <p>Define other routing entries for this connection partner.</p> <p>Add new entries with Add.</p> <ul style="list-style-type: none"> • <i>Remote IP Address</i>: IP address of the destination host or network. • <i>Netmask</i>: Netmask for Remote IP Address If no entry is made, your device uses a default netmask. • <i>Metric</i>: The lower the value, the higher the priority of the route (range of values 0... 15). The default value is 1.

Fields in the IPv6 Settings menu

Field	Description
IPv6	<p>Select whether the selected PPPoE interface should use Internet Protocol version 6 (IPv6) for data transmission.</p> <p>The function is activated by selecting <i>Enabled</i> .</p> <p>The function is disabled by default.</p>
Security Policy	<p>Select the security settings to be used with the interface.</p> <p>Possible values:</p> <ul style="list-style-type: none"> • <i>Untrusted</i> (default value): Only those packets are transmitted that can be attributed to a connection that has been initiated from a trusted zone. <p>We recommend you use this setting if you want to use IPv6 outside of your LAN.</p> <ul style="list-style-type: none"> • <i>Trusted</i>: All IP packets are allowed through except for those which are explicitly prohibited.

Field	Description
	<p>We recommend you use this setting if you want to use IPv6 on your LAN.</p> <p>You can configure exceptions for the selected setting in the Firewall on page 308 menu.</p>
IPv6 Mode	<p>Only for IPv6 = <i>Enabled</i></p> <p>The selected PPPoE interface is operated in host mode.</p>
Accept Router Advertisement	<p>Only for IPv6 = <i>Enabled</i> and IPv6 Mode = <i>Host</i></p> <p>Select if Router Advertisements are to be received on the selected interface. Router Advertisements are used, e.g., to create the prefix list.</p> <p>The function is activated by selecting <i>Enabled</i> .</p> <p>The function is enabled by default.</p>
DHCP Client	<p>Only for IPv6 = <i>Enabled</i> and IPv6 Mode = <i>Host</i></p> <p>Determine if your device is to act as DHCP client.</p> <p>The function is activated by selecting <i>Enabled</i> .</p> <p>The function is enabled by default.</p>
IPv6 Addresses	<p>Only for IPv6 = <i>Enabled</i></p> <p>You can assign IPv6 Addresses to the selected interface..</p> <p>Add allows you to create one or more address entries.</p> <p>A new windows opens that allows you to specify an IPv6 address consisting of a Link Prefix and a host identifier.</p> <p>If your device operates in host mode (IPv6 Mode = <i>Host</i>, Accept Router Advertisement <i>Enabled</i> and DHCP Client = <i>Enabled</i>), its IPv6 addresses are determined through SLAAC. You need not configure an IPv6 address manually, but you can enter additional addresses if desired.</p> <p>If your device is operating in router mode (IPv6 Mode = <i>Router (Transmit Router Advertisement)</i>, Transmit Router</p>

Field	Description
	Advertisement = <i>Enabled</i> and DHCP Server = <i>Enabled</i>), you need to configure its IPv6 addresses here.

Use **Add** to create more entries.

Fields in the **Link Prefix** menu.

Field	Description
Setup Mode	<p>Select in which way the Link Prefix is to be determined.</p> <p>Possible values:</p> <ul style="list-style-type: none"> • <i>From General Prefix</i> (default value): The Link Prefix is derived from a General Prefix. • <i>Static</i>: You can enter the link prefix.
General Prefix	<p>Only for Setup Mode = <i>From General Prefix</i></p> <p>Select the General Prefix the Link Prefix is to be derived from. You can choose from the General Prefixes available under Network->IPv6 General Prefixes->General Prefix Configuration->New.</p>
Auto Subnet Configuration	<p>Only if Setup Mode = <i>From General Prefix</i> and if a General Prefix has been selected.</p> <p>Select if the subnet is to be created automatically. Automatic subnet creation will use ID 0 for the first subnet, ID 1 for the second, etc.</p> <p>Possible values for the sub net ID are: 0 - 65535.</p> <p>The subnet ID describes the fourth of the four 16 bit fields of a Link Prefix. Upon subnet creation the decimal ID value is converted to a hexadecimal one.</p> <p>The function is activated by selecting <i>Enabled</i>.</p> <p>The function is enabled by default.</p> <p>If the function is disabled, you can define a subnet by entering a Subnet ID.</p>
Subnet ID	<p>Only if Auto Subnet Configuration is not active.</p> <p>Enter a Subnet ID in order to define a subnet. The subnet ID de-</p>

Field	Description
	<p>scribes the fourth of the four 16 bit fields of a Link Prefix.</p> <p>Possible values are <i>0 - 65535</i>.</p> <p>Upon subnet creation the decimal ID value is converted to a hexadecimal one.</p>
Link Prefix	<p>Only for Setup Mode = <i>Static</i></p> <p>You can specify the Link Prefix of an IPv6 address. This prefix must end with <i>::</i>. Its predetermined length is <i>64</i>.</p>

Fields in the **Host Address** menu.

Field	Description
Generation Mode	<p>Determine if the Host Identifier of the IPv6 address is to be automatically derived from the MAC address through EUI-64.</p> <p>The function is activated by selecting <i>Enabled</i>.</p> <p>The function is enabled by default.</p> <p>EUI-64 triggers the following process:</p> <ul style="list-style-type: none"> • The hexadecimal 48 bit MAC address is split into 2 x 24 bit. • <i>FFFF</i> is inserted into the created gap in order to obtain 64 bit. • The hexadecimal notation of the 64 bit is converted to a binary notation. • Bit no. 7 of the first 8 bit field is set to <i>1</i>.
Static Addresses	<p>Independently of the automatic creation described under Generation Mode, you can manually specify the Host Identifier of one or more IPv6 addresses with Add. Its predefined length is <i>64</i>. Start any entry with <i>::</i>.</p>

The menu **Advanced Settings** consists of the following fields:

Fields in the **Advanced Settings** menu.

Field	Description
Block after connection failure for	<p>Enter the wait time in seconds before the device should try again after an attempt to set up a connection has failed. The default value is <i>60</i>.</p>

Field	Description
Maximum Number of Dialup Retries	<p>Enter the number of unsuccessful attempts to setup a connection before the interface is blocked.</p> <p>Possible values are <i>0</i> to <i>100</i>.</p> <p>The default value is <i>5</i>.</p>
Authentication	<p>Select the authentication protocol for this connection partner. Select the authentication specified by your provider.</p> <p>Possible values:</p> <ul style="list-style-type: none"> • <i>PAP</i> (default value): Only run PAP (PPP Password Authentication Protocol); the password is transferred unencrypted. • <i>CHAP</i>: Only run CHAP (PPP Challenge Handshake Authentication Protocol as per RFC 1994); password is transferred encrypted. • <i>PAP/CHAP</i>: Primarily run CHAP, otherwise PAP. • <i>MS-CHAPv1</i>: Only run MS-CHAP version 1 (PPP Microsoft Challenge Handshake Authentication Protocol). • <i>PAP/CHAP/MS-CHAP</i>: Primarily run CHAP, on denial then the authentication protocol required by the connection partner. (MSCHAP version 1 or 2 possible.) • <i>MS-CHAPv2</i>: Run MS-CHAP version 2 only. • <i>None</i>: Some providers use no authentication. In this case, select this option.
DNS Negotiation	<p>Select whether your device receives IP addresses for Primary DNS Server and Secondary DNS Server from the connection partner or sends these to the connection partner.</p> <p>The function is enabled with <i>Enabled</i>.</p> <p>The function is enabled by default.</p>
Prioritize TCP ACK Packets	<p>Select whether the TCP download is to be optimised in the event of intensive TCP upload. This function can be specially applied for asymmetrical bandwidths (ADSL).</p> <p>The function is enabled with <i>Enabled</i>.</p> <p>The function is disabled by default.</p>

Field	Description
LCP Alive Check	<p>Select whether the availability of the remote terminal is to be checked by sending LCP echo requests or replies. This makes it possible to switch to a backup connection more quickly in the event of line faults.</p> <p>The function is enabled with <i>Enabled</i>.</p> <p>The function is enabled by default.</p>

Fields in the IPv4 Advanced Settings menu

Field	Description
MTU	<p>Enter the maximum packet size (Maximum Transfer Unit, MTU) in bytes that is allowed for the connection.</p> <p>With default value <i>Automatic</i>, the value is specified by link control at connection setup.</p> <p>If you disable <i>Automatic</i>, you can enter a value.</p> <p>Possible values are <i>1</i> to <i>8192</i>.</p> <p>The default value is <i>0</i>.</p>

16.1.2 Dual Stack Lite

Dual Stack Lite allows the use of IPv4 connections even if the internet connection at hand is operated via IPv6 only. This is the case if, e.g., you need to continue using IPv4 connections, but your internet service provider assigns IPv6 addresses only due to a shortage of IPv4 addresses.

With DSLite IPv4 packets are "encapsulated" into IPv6 packets. These tunneled IPv4 packets are then sent to the AFTR server (Address Family Transition Router) of your internet service provider where they are "unpacked" and routed into the IPv4 realm of the internet.

A list of all Dual Stack Lite interfaces is displayed in the **WAN->Internet + Dialup->Dual Stack Lite** menu.

16.1.2.1 New

Choose the **New** button to set up additional Dual Stack Lite interfaces.

The menu **WAN->Internet + Dialup->Dual Stack Lite->New** consists of the following

fields:

Fields in the Basic Parameters menu

Field	Description
Description	Assign a name to your Dual Stack Lite connection.
IPv6 Interface	Select the IPv6 interface that is used for the DS Lite connection. This is normally the interface of your internet connection. IPv4 packets sent via this interface are encapsulated into IPv6 packets.
AFTR	Enter the IPv6 address or domain name of your Address Family Transition Router. The provider of your IPv6 internet connection will provide you with this information.
Default Route	Select whether you want to use this connection as the default route. This setting is useful in order to have the complete IPv4 data traffic that is to be sent over the internet be sent over the IPv6 connection. Otherwise, you need to make the corresponding adjustments to your routing. The function is enabled with <i>Enabled</i> . The function is enabled by default.

16.1.3 PPTP

A list of all PPTP interfaces is displayed in the **WAN->Internet + Dialup->PPTP** menu.

In this menu, you configure an Internet connection that uses the Point Tunneling Protocol (PPTP) to set up a connection. This is required in Austria, for example.

16.1.3.1 New

Choose the **New** button to set up new PPTP interfaces.

The menu **WAN->Internet + Dialup->PPTP->New** consists of the following fields:

Fields in the Basic Parameters menu.

Field	Description
Description	Enter a name for uniquely identifying the internet connection. The first character in this field must not be a number No special

Field	Description
	characters or umlauts must be used.
PPTP Ethernet Interface	<p>Select the IP interface over which packets are to be transported to the remote PPTP terminal.</p> <p>If you want to use an external DSL modem, select the Ethernet port to which the modem is connected.</p> <p>When using the internal DSL modem, select here the EthoA interface configured in Physical Interfaces->ATM->Profiles->New, e.g. <i>ethoa50-0</i>.</p>
User Name	Enter the user name.
Password	Enter the password.
Always on	<p>Select whether the interface should always be activated.</p> <p>The function is enabled with <i>Enabled</i>.</p> <p>The function is disabled by default.</p> <p>Only activate this option if you have Internet access with a flat-rate charge.</p>
Connection Idle Timeout	<p>Only if Always on is disabled.</p> <p>Enter the idle interval in seconds. This determines how many seconds should pass between sending the last traffic data packet and clearing the connection.</p> <p>Possible values are <i>0</i> to <i>3600</i> (seconds). <i>0</i> deactivates the timeout.</p> <p>The default value is <i>300</i>.</p> <p>Example: <i>10</i> for FTP transmission, <i>20</i> for LAN-to-LAN transmission, <i>90</i> for Internet connections.</p>

Fields in the IPv4 Settings menu.

Field	Description
Security Policy	<p>Select the security settings to be used with the interface.</p> <p>Possible values:</p>

Field	Description
	<ul style="list-style-type: none"> • <i>Trusted</i>: All IP packets are allowed through except for those which are explicitly prohibited.. • <i>Untrusted</i> (default value): Only those packets are transmitted that can be attributed to a connection that has been initiated from a trusted zone. <p>You can configure exceptions for the selected setting in the Firewall on page 308 menu.</p>
IP Address Mode	<p>Select whether your device is to be assigned a static IP address or whether it should be assigned this dynamically.</p> <p>Possible values:</p> <ul style="list-style-type: none"> • <i>Get IP Address</i> (default value): Your device is automatically assigned a temporarily valid IP address from the provider. • <i>Static</i>: You enter a static IP address.
Default Route	<p>Select whether the route to this connection partner is to be defined as the default route.</p> <p>The function is enabled with <i>Enabled</i>.</p> <p>The function is enabled by default.</p>
Create NAT Policy	<p>Specify whether Network Address Translation (NAT) is to be activated.</p> <p>The function is enabled with <i>Enabled</i>.</p> <p>The function is enabled by default.</p>
Local IP Address	<p>Only for IP Address Mode = <i>Static</i></p> <p>Assign an IP address from your LAN to the PPT interface, which is to be used as your device's internal source address.</p>
Route Entries	<p>Only if IP Address Mode = <i>Static</i></p> <p>Define other routing entries for this PPTP partner.</p> <p>Add new entries with Add.</p> <ul style="list-style-type: none"> • <i>Remote IP Address</i>: IP address of the destination host or network.

Field	Description
	<ul style="list-style-type: none"> • <i>Netmask</i>: Netmask for Remote IP Address. If no entry is made, your device uses a default netmask. • <i>Metric</i>: The lower the value, the higher the priority of the route (range of values 0... 15). The default value is 1.

The menu **Advanced Settings** consists of the following fields:

Fields in the **Advanced Settings** menu.

Field	Description
Block after connection failure for	Enter the wait time in seconds before the device should try again after an attempt to set up a connection has failed. The default value is 60.
Maximum Number of Dialup Retries	Enter the number of unsuccessful attempts to setup a connection before the interface is blocked. Possible values are 0 to 100. The default value is 5.
Authentication	Select the authentication protocol for this Internet connection. Select the authentication specified by your provider. Possible values: <ul style="list-style-type: none"> • <i>PAP</i> (default value): Only run PAP (PPP Password Authentication Protocol); the password is transferred unencrypted. • <i>CHAP</i>: Only run CHAP (PPP Challenge Handshake Authentication Protocol as per RFC 1994); password is transferred encrypted. • <i>PAP/CHAP</i>: Primarily run CHAP, otherwise PAP. • <i>MS-CHAPv1</i>: Only run MS-CHAP version 1 (PPP Microsoft Challenge Handshake Authentication Protocol). • <i>PAP/CHAP/MS-CHAP</i>: Primarily run CHAP, on denial then the authentication protocol required by the connection partner. (MSCHAP version 1 or 2 possible.) • <i>MS-CHAPv2</i>: Run MS-CHAP version 2 only. • <i>None</i>: Some providers use no authentication. In this case, select this option.
DNS Negotiation	Select whether your device receives IP addresses for Primary

Field	Description
	<p>DNS Server and Secondary DNS Server from the connection partner or sends these to the connection partner.</p> <p>The function is enabled with <i>Enabled</i>.</p> <p>The function is enabled by default.</p>
Prioritize TCP ACK Packets	<p>Select whether the TCP download is to be optimised in the event of intensive TCP upload. This function can be specially applied for asymmetrical bandwidths (ADSL).</p> <p>The function is enabled with <i>Enabled</i>.</p> <p>The function is disabled by default.</p>
PPTP Address Mode	<p>Displays the address mode. The value cannot be changed.</p> <p>Possible values:</p> <ul style="list-style-type: none"> • <i>Static</i>: The Local PPTP IP Address will be assigned to the selected Ethernet port.
Local PPTP IP Address	<p>Assign the PPTP interface an IP address that is used as the source address.</p> <p>The default value is <i>10.0.0.140</i>.</p>
Remote PPTP IP Address	<p>Enter the IP address of the PPTP partner.</p> <p>The default value is <i>10.0.0.138</i>.</p>
LCP Alive Check	<p>Select whether the availability of the remote terminal is to be checked by sending LCP echo requests or replies. This makes it possible to switch to a backup connection more quickly in the event of line faults.</p> <p>The function is enabled with <i>Enabled</i>.</p> <p>The function is enabled by default.</p>

16.1.4 PPPoA

A list of all PPPoA interfaces is displayed in the **WAN->Internet + Dialup->PPPoA** menu.

In this menu, you configure a xDSL connection used to set up PPPoA connections. With

PPPoA, the connection is configured so that the PPP data flow is transported directly over an ATM network (RFC 2364). This is required by some providers. Note your provider's specifications.

When using the internal DSL modem, a PPPoA interface must be configured with **Client Type = On Demand** for this connection in **WAN->ATM->Profiles->New**.

16.1.4.1 New

Choose the **New** button to set up new PPPoA interfaces.

The menu **WAN->Internet + Dialup->PPPoA->New** consists of the following fields:

Fields in the **Basic Parameters** menu.

Field	Description
Description	Enter a name for uniquely identifying the connection partner. The first character in this field must not be a number. No special characters or umlauts must be used.
ATM PVC	Select an ATM profile created in the ATM->Profiles menu, indicated by the global identifiers VPI and VCI specified by the provider.
User Name	Enter the user name.
Password	Enter the password for the PPPoA connection.
Always on	Select whether the interface should always be activated. The function is enabled with <i>Enabled</i> . The function is disabled by default. Only activate this option if you have Internet access with a flat-rate charge.
Connection Idle Timeout	Only if Always on is disabled. Enter the idle time in seconds for static short hold. The static short hold setting determines how many seconds should pass between sending the last traffic data packet and clearing the connection. Possible values are 0 to 3600 (seconds). 0 deactivates the

Field	Description
	<p>short hold.</p> <p>The default value is <i>300</i>.</p> <p>Example: <i>10</i> for FTP transmission, <i>20</i> for LAN-to-LAN transmission, <i>90</i> for Internet connections.</p>

Fields in the IPv4 Settings menu.

Field	Description
Security Policy	<p>Select the security settings to be used with the interface.</p> <p>Possible values:</p> <ul style="list-style-type: none"> • <i>Trusted</i>: All IP packets are allowed through except for those which are explicitly prohibited.. • <i>Untrusted</i> (default value): Only those packets are transmitted that can be attributed to a connection that has been initiated from a trusted zone. <p>You can configure exceptions for the selected setting in the Firewall on page 308 menu.</p>
IP Address Mode	<p>Choose whether your device has a static IP address or is assigned one dynamically.</p> <p>Possible values:</p> <ul style="list-style-type: none"> • <i>Get IP Address</i> (default value): Your device is dynamically assigned an IP address. • <i>Static</i>: You enter a static IP address.
Default Route	<p>Select whether the route to this connection partner is to be defined as the default route.</p> <p>The function is enabled with <i>Enabled</i>.</p> <p>The function is enabled by default.</p>
Create NAT Policy	<p>Specify whether Network Address Translation (NAT) is to be activated.</p> <p>The function is enabled with <i>Enabled</i>.</p> <p>The function is enabled by default.</p>

Field	Description
Local IP Address	<p>Only for IP Address Mode = <i>Static</i></p> <p>Enter the static IP address you received from your provider.</p>
Route Entries	<p>Only if IP Address Mode = <i>Static</i></p> <p>Define other routing entries for this connection partner.</p> <p>Add new entries with Add.</p> <ul style="list-style-type: none"> • <i>Remote IP Address</i>: IP address of the destination host or network. • <i>Netmask</i>: Netmask for Remote IP Address. If no entry is made, your device uses a default netmask. • <i>Metric</i>: The lower the value, the higher the priority of the route (range of values 0... 15). The default value is 1.

Fields in the IPv6 Settings menu

Field	Description
IPv6	<p>Select whether the selected ATM profile should use Internet Protocol version 6 (IPv6) for data transmission.</p> <p>The function is activated by selecting <i>Enabled</i> .</p> <p>The function is disabled by default.</p>
Security Policy	<p>Select the security settings to be used with the ATM profile.</p> <p>Possible values:</p> <ul style="list-style-type: none"> • <i>Untrusted</i> (default value): Only those packets are transmitted that can be attributed to a connection that has been initiated from a trusted zone. <p>We recommend you use this setting if you want to use IPv6 outside of your LAN.</p> <ul style="list-style-type: none"> • <i>Trusted</i>: All IP packets are allowed through except for those which are explicitly prohibited. <p>We recommend you use this setting if you want to use IPv6 on your LAN.</p> <p>You can configure exceptions for the selected setting in the</p>

Field	Description
	<i>Firewall</i> on page 308 menu.
IPv6 Mode	<p>Only for IPv6 = <i>Enabled</i></p> <p>The selected PPPoE interface is operated in host mode.</p>
Accept Router Advertisement	<p>Only for IPv6 = <i>Enabled</i> and IPv6 Mode = <i>Host</i></p> <p>Determine if Router Advertisements are to be received over this ATM profile. Router Advertisements are used to create the default router list as well as the prefix list.</p> <p>The function is activated by selecting <i>Enabled</i> .</p> <p>The function is enabled by default.</p>
DHCP Client	<p>Only for IPv6 = <i>Enabled</i> and IPv6 Mode = <i>Host</i></p> <p>Determine if your device is to act as DHCP client.</p> <p>The function is activated by selecting <i>Enabled</i> .</p> <p>The function is enabled by default.</p>
IPv6 Addresses	<p>Only for IPv6 = <i>Enabled</i></p> <p>You can assign IPv6 Addresses to the selected interface..</p> <p>Add allows you to create one or more address entries.</p> <p>A new windows opens that allows you to specify an IPv6 address consisting of a Link Prefix and a host identifier.</p> <p>If your device operates in host mode (IPv6 Mode = <i>Host</i>, Accept Router Advertisement <i>Enabled</i> and DHCP Client = <i>Enabled</i>), its IPv6 addresses are determined through SLAAC. You need not configure an IPv6 address manually, but you can enter additional addresses if desired.</p> <p>If your device is operating in router mode (IPv6 Mode = <i>Router (Transmit Router Advertisement)</i>, Transmit Router Advertisement = <i>Enabled</i> and DHCP Server = <i>Enabled</i>), you need to configure its IPv6 addresses here.</p>

Use **Add** to create more entries.

Fields in the Link Prefix menu.

Field	Description
Setup Mode	<p>Select in which way the Link Prefix is to be determined.</p> <p>Possible values:</p> <ul style="list-style-type: none"> • <i>From General Prefix</i> (default value): The Link Prefix is derived from a General Prefix. • <i>Static</i>: You can enter the link prefix.
General Prefix	<p>Only for Setup Mode = <i>From General Prefix</i></p> <p>Select the General Prefix the Link Prefix is to be derived from. You can choose from the General Prefixes available under Network->IPv6 General Prefixes->General Prefix Configuration->New.</p>
Auto Subnet Configuration	<p>Only if Setup Mode = <i>From General Prefix</i> and if a General Prefix has been selected.</p> <p>Select if the subnet is to be created automatically. Automatic subnet creation will use ID 0 for the first subnet, ID 1 for the second, etc.</p> <p>Possible values for the sub net ID are: 0 - 65535.</p> <p>The subnet ID describes the fourth of the four 16 bit fields of a Link Prefix. Upon subnet creation the decimal ID value is converted to a hexadecimal one.</p> <p>The function is activated by selecting <i>Enabled</i>.</p> <p>The function is enabled by default.</p> <p>If the function is disabled, you can define a subnet by entering a Subnet ID.</p>
Subnet ID	<p>Only if Auto Subnet Configuration is not active.</p> <p>Enter a Subnet ID in order to define a subnet. The subnet ID describes the fourth of the four 16 bit fields of a Link Prefix.</p> <p>Possible values are 0 - 65535.</p> <p>Upon subnet creation the decimal ID value is converted to a hexadecimal one.</p>

Field	Description
Link Prefix	<p>Only for Setup Mode = <i>Static</i></p> <p>You can specify the Link Prefix of an IPv6 address. This prefix must end with <code>::</code>. Its predetermined length is <i>64</i>.</p>

Fields in the **Host Address** menu.

Field	Description
Generation Mode	<p>Determine if the Host Identifier of the IPv6 address is to be automatically derived from the MAC address through EUI-64.</p> <p>The function is activated by selecting <i>Enabled</i>.</p> <p>The function is enabled by default.</p> <p>EUI-64 triggers the following process:</p> <ul style="list-style-type: none"> • The hexadecimal 48 bit MAC address is split into 2 x 24 bit. • <i>FFFE</i> is inserted into the created gap in order to obtain 64 bit. • The hexadecimal notation of the 64 bit is converted to a binary notation. • Bit no. 7 of the first 8 bit field is set to <i>1</i>.
Static Addresses	<p>Independently of the automatic creation described under Generation Mode, you can manually specify the Host Identifier of one or more IPv6 addresses with Add. Its predefined length is <i>64</i>. Start any entry with <code>::</code>.</p>

The menu **Advanced Settings** consists of the following fields:

Fields in the **Advanced Settings** menu.

Field	Description
Block after connection failure for	<p>Enter the wait time in seconds before the device should try again after an attempt to set up a connection has failed. The default value is <i>60</i>.</p>
Maximum Number of Dialup Retries	<p>Enter the number of unsuccessful attempts to setup a connection before the interface is blocked.</p> <p>Possible values are <i>0</i> to <i>100</i>.</p> <p>The default value is <i>5</i>.</p>

Field	Description
Authentication	<p>Select the authentication protocol for this Internet connection. Select the authentication specified by your provider.</p> <p>Possible values:</p> <ul style="list-style-type: none"> • <i>PAP</i> (default value): Only run PAP (PPP Password Authentication Protocol); the password is transferred unencrypted. • <i>CHAP</i>: Only run CHAP (PPP Challenge Handshake Authentication Protocol as per RFC 1994); password is transferred encrypted. • <i>PAP/CHAP</i>: Primarily run CHAP, otherwise PAP. • <i>MS-CHAPv1</i>: Only run MS-CHAP version 1 (PPP Microsoft Challenge Handshake Authentication Protocol). • <i>PAP/CHAP/MS-CHAP</i>: Primarily run CHAP, on denial then the authentication protocol required by the connection partner. (MSCHAP version 1 or 2 possible.) • <i>MS-CHAPv2</i>: Run MS-CHAP version 2 only. • <i>None</i>: Some providers use no authentication. In this case, select this option.
DNS Negotiation	<p>Select whether your device receives IP addresses for Primary DNS Server and Secondary DNS Server from the connection partner or sends these to the connection partner.</p> <p>The function is enabled with <i>Enabled</i>.</p> <p>The function is enabled by default.</p>
Prioritize TCP ACK Packets	<p>Select whether the TCP download is to be optimised in the event of intensive TCP upload. This function can be specially applied for asymmetrical bandwidths (ADSL).</p> <p>The function is enabled with <i>Enabled</i>.</p> <p>The function is disabled by default.</p>
LCP Alive Check	<p>Select whether the availability of the remote terminal is to be checked by sending LCP echo requests or replies. This is recommended for leased lines, PPTP and L2TP connections.</p> <p>The function is enabled with <i>Enabled</i>.</p> <p>The function is enabled by default.</p>

16.1.5 IP Pools



Note

Note that the menu **IP Pools** is only available if a port in the menu **Physical Interfaces->ISDN Ports-> ISDN Configuration** is set to external operation (TE mode). A corresponding adapter which is available separately needs to be connected for external operation.

The **IP Pools** menu displays a list of all IP pools.

Your device can operate as a dynamic IP address server for PPP connections. You can use this function by providing one or more pools of IP addresses. These IP addresses can be assigned to dialling-in connection partners for the duration of the connection.

Any host routes entered always have priority over IP addresses from the address pools. This means that, if an incoming call has been authenticated, your device first checks whether a host route is entered in the routing table for this caller. If not, your device can allocate an IP address from an address pool (if available). If address pools have more than one IP address, you cannot specify which connection partner receives which address. The addresses are initially assigned in order. If a new dial-in takes place within an interval of one hour, an attempt is made to allocate the same IP address that was assigned to this partner the previous time.

16.1.5.1 Edit or New

Choose the **New** button to set up new IP address pools. Choose the  icon to edit existing entries.

Fields in the menu **Basic Parameters**

Field	Description
IP Pool Name	Enter any description to uniquely identify the IP pool.
IP Address Range	Enter the first (first field) and last (second field) IP address of the IP address pool.
DNS Server	<p>Primary: Enter the IP address of the DNS server that is to be used, preferably, by clients who draw an address from this pool.</p> <p>Secondary: Optionally, enter the IP address of an alternative DNS server.</p>

16.2 ATM

ATM (Asynchronous Transfer Mode) is a data transmission procedure that was originally designed for broadband ISDN.

ATM is currently used in high-speed networks. You will need ATM, for example, if you want high-speed access to the Internet via the integrated ADSL or SHDSL modem.

In an ATM network, different applications such as speech, video and data, can be transmitted side-by-side in the asynchronous time multiplex procedure. Each transmitter is provided with time sections for transmitting data. With asynchronous transmission, unused time sections of a transmitter are used by another transmitter.

With ATM, the packet switching procedure is connected-based. A virtual connection is used for data transmission that negotiates between the transmitter and recipient or is configured on both sides. This determines the route that the data should take, for example. Multiple virtual connections can be set up over a single physical interface.

The data is transmitted in so-called cells or slots of constant size. Each cell consists of 48 bytes of usage data and 5 bytes of control information. The control information contains, amongst other things, the ATM address which is similar to the Internet address. The ATM address is made up of the Virtual Path Identifier (VPI) and the Virtual Connection Identifier (VCI); this identifies the virtual connection.

Various types of traffic flows are transported over ATM. To take account of the various demands of these traffic flows on the networks, e.g. in terms of cell loss and delay time, suitable values can be defined using the service categories. Uncompressed video data, for example, requires different parameters to time-uncritical data.

In ATM networks Quality of Service (QoS) is available, i.e. the size of various network parameters, such as bit rate, delay and jitter can be guaranteed.

OAM (Operation, Administration and Maintenance) is used to monitor the data transmission in ATM. OAM includes configuration management, error management and performance measurement.

16.2.1 Profiles

A list of all ATM profiles is displayed in the **WAN->ATM->Profiles** menu.

If the connection for your Internet access is set up using the internal modem, the ATM connection parameters must be set for this. An ATM profile combines a set of parameters for a specific provider.



Note

The ATM encapsulations are described in RFCs 1483 and 2684. You will find the RFCs on the relevant pages of the IETF (www.ietf.org/rfc.html).

16.2.1.1 New

Choose the **New** button to set up new ATM profiles.

The menu **WAN->ATM->Profiles->New** consists of the following fields:

Fields in the ATM Profiles Parameter menu.

Field	Description
Provider	Select one of the preconfigured ATM profiles for your provider from the list or manually define the profile using <code>-- User-defined --</code> .
Description	Only for Provider = <code>-- User-defined --</code> Enter the desired description for the connection.
ATM Interface	Only if several ATM interfaces are available, e.g. if several interfaces are separately configured in devices with SHDSL. Select the ATM interface that you wish to use for the connection.
Type	Only for Provider = <code>-- User-defined --</code> Select the protocol for the ATM connection. Possible values: <ul style="list-style-type: none"> • <i>Ethernet over ATM</i> (default value): Ethernet over ATM (EthoA) is used for the ATM connection (Permanent Virtual Circuit, PVC). • <i>Routed Protocols over ATM</i>: Routed Protocols over ATM (RPoA) is used for the ATM connection (Permanent Virtual Circuit, PVC). • <i>PPP over ATM</i>: PPP over ATM (PPPoA) is used for the ATM connection (Permanent Virtual Circuit, PVC).

Field	Description
Virtual Path Identifier (VPI)	<p>Only for Provider = <i>-- User-defined --</i></p> <p>Enter the VPI value of the ATM connection. The VPI is the identification number of the virtual path to be used. Note your provider's instructions.</p> <p>Possible values are <i>0</i> to <i>255</i>.</p> <p>The default value is <i>8</i>.</p>
Virtual Channel Identifier (VCI)	<p>Only for Provider = <i>-- User-defined --</i></p> <p>Enter the VCI value of the ATM connection. The VCI is the identification number of the virtual channel. A virtual channel is the logical connection for the transport of ATM cells between two or more points. Note your provider's instructions.</p> <p>Possible values are <i>32</i> to <i>65535</i>.</p> <p>The default value is <i>32</i>.</p>
Encapsulation	<p>Only for Provider = <i>-- User-defined --</i></p> <p>Select the encapsulation to be used. Note your provider's instructions.</p> <p>Possible values (in accordance with RFC 2684):</p> <ul style="list-style-type: none"> • <i>LLC Bridged no FCS</i> (Default value for Ethernet over ATM): Is only displayed for Type = <i>Ethernet over ATM</i>. Bridged Ethernet with LLC/SNAP encapsulation without Frame Check Sequence (checksums). • <i>LLC Bridged FCS</i>: only displayed for Type = <i>Ethernet over ATM</i>. Bridged Ethernet with LLC/SNAP encapsulation with Frame Check Sequence (checksums). • <i>Non ISO</i> (default value for Routed Protocols over ATM): Is only displayed for Type = <i>Routed Protocols over ATM</i>. Encapsulation with LLC/SNAP header, suitable for IP routing. • <i>LLC</i>: only displayed for Type = <i>PPP over ATM</i>. Encapsulation with LLC header.

Field	Description
	<ul style="list-style-type: none"> • <i>VC Multiplexing</i> (default value for PPP over ATM): Bridged Ethernet without additional encapsulation (Null Encapsulation) with Frame Check Sequence (checksums).

Fields in menu Ethernet over ATM Settings (appears only for Type = Ethernet over ATM)

Field	Description
Default Ethernet for PPPoE Interfaces	<p>Only for Type = <i>Ethernet over ATM</i></p> <p>Select whether this Ethernet-over-ATM interface is to be used for all PPPoE connections</p> <p>The function is enabled with <i>Enabled</i>.</p> <p>The function is disabled by default.</p>
Address Mode	<p>Only for Type = <i>Ethernet over ATM</i></p> <p>Select how an IP address is to be assigned to the interface.</p> <p>Possible values:</p> <ul style="list-style-type: none"> • <i>Static</i> (default value): The interface is assigned a static IP address in IP Address / Netmask. • <i>DHCP</i>: An IP address is assigned to the interface dynamically via DHCP.
IP Address/Netmask	<p>Only for Address Mode = <i>Static</i></p> <p>Enter the IP addresses (IP Address) and the corresponding netmasks (Netmask) of the ATM interfaces. Add new entries with Add.</p>
MAC Address	<p>Enter a MAC address for the internal router interface of ATM connection, e.g. <i>00:a0:f9:06:bf:03</i>. An entry is only required in special cases.</p> <p>For Internet connections, it is sufficient to select the option Use built-in (default setting). An address is used which is derived from the MAC address of the <i>en1-0</i>.</p>
DHCP MAC Address	<p>Only for Address Mode = <i>DHCP</i></p> <p>Enter the MAC address of the internal router interface of ATM</p>

Field	Description
	<p>connection, e.g. <code>00:e1:f9:06:bf:03</code>.</p> <p>If your provider has assigned you a MAC address for DHCP, enter this here.</p> <p>You can also select the Use built-in option (default setting) An address is used which is derived from the MAC address of the <code>en1-0</code>.</p>
DHCP Hostname	<p>Only for Address Mode = <i>DHCP</i></p> <p>If necessary, enter the host name registered with the provider to be used by your device for DHCP requests.</p> <p>The maximum length of the entry is 45 characters.</p>

Fields in menu **Routed Protocols over ATM Settings** (appears only for Type = **Routed Protocols over ATM**)

Field	Description
IP Address/Netmask	<p>Enter the IP addresses (IP Address) and the corresponding netmasks (Netmask) of the ATM interface. Add new entries with Add.</p>
Prioritize TCP ACK Packets	<p>Select whether the TCP download is to be optimised in the event of intensive TCP upload. This function can be specially applied for asymmetrical bandwidths (ADSL).</p> <p>The function is enabled with <i>Enabled</i>.</p> <p>The function is disabled by default.</p>

Field in menu **PPP over ATM Settings** (appears only for Type = **PPP over ATM**)

Field	Description
Client Type	<p>Select whether the PPPoA connection is to be set up permanently or on demand.</p> <p>Possible values:</p> <ul style="list-style-type: none"> <i>On Demand</i> (default value): The PPPoA is only set up on demand, e.g. for Internet access. <p>You'll find additional information on PPP over ATM under</p>

Field	Description
	PPPoA on page 244.

16.2.2 Service Categories

In the **WAN->ATM->Service Categories** menu is displayed a list of already configured ATM connections (PVC, Permanent Virtual Circuit) to which specific data traffic parameters were assigned.

Your device supports QoS (Quality of Service) for ATM interfaces.



Caution

ATM QoS should only be used if your provider specifies a list of data traffic parameters (traffic contract).

The configuration of ATM QoS requires extensive knowledge of ATM technology and the way the bintec elmeg devices function. An incorrect configuration can cause considerable disruption during operation. If applicable, save the original configuration on your PC.

16.2.2.1 New

Choose the **New** button to create additional categories.

The menu **WAN->ATM->Service Categories->New** consists of the following fields:

Fields in the Basic Parameters menu.

Field	Description
Virtual Channel Connection (VCC)	Select the already configured ATM connection (displayed by the combination of VPI and VCI) for which the service category is to be defined.
ATM Service Category	<p>Select how the data traffic of the ATM connection is to be controlled.</p> <p>A priority is implicitly assigned when you select the ATM service category: from CBR (highest priority) through VBR.1 /VBR.3 to VBR (lowest priority).</p> <p>Possible settings:</p> <ul style="list-style-type: none"> <i>Unspecified Bit Rate (UBR)</i> (default value): No spe-

Field	Description
	<p>cific data rate is guaranteed for the connection. The Peak Cell Rate (PCR) specifies the limit above which data is discarded. This category is suitable for non-critical applications.</p> <ul style="list-style-type: none"> • <i>Constant Bit Rate (CBR): (Constant Bit Rate)</i> The connection is assigned a guaranteed data rate determined by the Peak Cell Rate (PCR). This category is suitable for critical (real-time) applications that require a guaranteed data rate. • <i>Variable Bit Rate V.1 (VBR.1):</i> A guaranteed data rate is assigned to the connection - Sustained Cell Rate (SCR). This may be exceeded by the volume configured in Maximum Burst Size (MBS). Any additional ATM traffic is discarded. The Peak Cell Rate (PCR) constitutes the maximum possible data rate. This category is suitable for non-critical applications with burst data traffic. • <i>Variable Bit Rate V.3 (VBR.3):</i> A guaranteed data rate is assigned to the connection - Sustained Cell Rate (SCR). This may be exceeded by the volume configured in Maximum Burst Size (MBS). Additional ATM traffic is marked and handled with low priority based on the utilisation of the destination network, i.e. is discarded if necessary. The Peak Cell Rate (PCR) constitutes the maximum possible data rate. This category is suitable for critical applications with burst data traffic.
Peak Cell Rate (PCR)	<p>Enter a value for the maximum data rate in bits per second.</p> <p>Possible values: 0 to 10000000.</p> <p>The default value is 0.</p>
Sustained Cell Rate (SCR)	<p>Only for ATM Service Category = <i>Variable Bit Rate V.1 (VBR.1)</i> or <i>Variable Bit Rate V.3 (VBR.3)</i></p> <p>Enter a value for the minimum available, guaranteed data rate in bits per second.</p> <p>Possible values: 0 to 10000000.</p> <p>The default value is 0.</p>
Maximum Burst Size (MBS)	<p>Only for ATM Service Category = <i>Variable Bit Rate V.1 (VBR.1)</i> or <i>Variable Bit Rate V.3 (VBR.3)</i></p>

Field	Description
	<p>Enter a value for the maximum number of bits per second by which the PCR can be exceeded briefly.</p> <p>Possible values: 0 to 100000.</p> <p>The default value is 0.</p>

16.2.3 OAM Controlling

OAM is a service for monitoring ATM connections. A total of five hierarchies (flow level F1 to F5) are defined for OAM information flow. The most important information flows for an ATM connection are F4 and F5. The F4 information flow concerns the virtual path (VP) and the F5 information flow the virtual channel (VC). The VP is defined by the VPI value, the VC by VPI and VCI.



Note

Generally, monitoring is not carried out by the terminal but is initiated by the ISP. Your device then only needs to react correctly to the signals received. This is ensured without a specific OAM configuration for both flow level 4 and flow level 5.

Two mechanisms are available for monitoring the ATM connection: Loopback Tests and OAM Continuity Check (OAM CC). These can be configured independently of each other.



Caution

The configuration of OAM requires extensive knowledge of ATM technology and the way the bintec elmeg devices functions. An incorrect configuration can cause considerable disruption during operation. If applicable, save the original configuration on your PC.

In the **WAN->ATM->OAM Controlling** menu, a list of all monitored OAM flow levels is displayed.

16.2.3.1 New

Choose the **New** button to set up monitoring for other flow levels.

The menu **WAN->ATM->OAM Controlling->New** consists of the following fields:

Fields in the OAM Flow Configuration menu.

Field	Description
OAM Flow Level	Select the OAM flow level to be monitored. Possible values: <ul style="list-style-type: none"> • <i>F5</i>: (virtual channel level) The OAM settings are used for the virtual channel (default value). • <i>F4</i> : (virtual path level) The OAM settings are used on the virtual path.
Virtual Channel Connection (VCC)	Only for OAM Flow Level = <i>F5</i> Select the already configured ATM connection to be monitored (displayed by the combination of VPI and VCI).
Virtual Path Connection (VPC)	Only for OAM Flow Level = <i>F4</i> Select the already configured virtual path connection to be monitored (displayed by the VPI).

Fields in the Loopback menu.

Field	Description
Loopback End-to-End	Select whether you activate the loopback test for the connection between the endpoints of the VCC or VPC. The function is enabled with <i>Enabled</i> . The function is disabled by default.
End-to-End Send Interval	Only if Loopback End-to-End is enabled. Enter the time in seconds after which a loopback cell is to be sent. Possible values are <i>0</i> to <i>999</i> . The default value is <i>5</i> .
End-to-End Pending Requests	Only if Loopback End-to-End is enabled. Enter the number of directly consecutive loopback cells that may fail to materialise before the connection is regarded as interrupted ("down"). Possible values are <i>1</i> to <i>99</i> .

Field	Description
	The default value is <i>5</i> .
Loopback Segment	<p>Select whether you want to activate the loopback test for the segment connection (segment = connection of the local endpoint to the next connection point) of the VCC or VPC.</p> <p>The function is enabled with <i>Enabled</i>.</p> <p>The function is disabled by default.</p>
Segment Send Interval	<p>Only if Loopback Segment is enabled.</p> <p>Enter the time in seconds after which a loopback cell is sent.</p> <p>Possible values are <i>0</i> to <i>999</i>.</p> <p>The default value is <i>5</i>.</p>
Segment Pending Requests	<p>Only if Loopback Segment is enabled.</p> <p>Enter the number of directly consecutive loopback cells that may fail to materialise before the connection is regarded as interrupted ("down").</p> <p>Possible values are <i>1</i> to <i>99</i>.</p> <p>The default value is <i>5</i>.</p>

Fields in the **CC Activation** menu.

Field	Description
Continuity Check (CC) End-to-End	<p>Select whether you activate the OAM-CC test for the connection between the endpoints of the VCC or VPC.</p> <p>Possible values:</p> <ul style="list-style-type: none"> • <i>Passive</i> (default value): OAM CC requests are responded to after CC negotiation (CC activation negotiation). • <i>Active</i>: OAM CC requests are sent after CC negotiation (CC activation negotiation). • <i>Both</i>: OAM CC requests are sent and answered after CC negotiation (CC activation negotiation). • <i>No negotiation</i>: Depending on the setting in the Direction field, OAM CC requests are either sent and/or responded to.

Field	Description
	<p>There is no CC negotiation.</p> <ul style="list-style-type: none"> • <i>Passive</i>: The function is disabled. <p>Also select whether the test cells of the OAM CC are to be sent or received.</p> <p>Possible values:</p> <ul style="list-style-type: none"> • <i>Both</i> (default value): CC data is both received and generated. • <i>Sink</i>: CC data is received. • <i>Source</i>: CC data is generated.
<p>Continuity Check (CC) Segment</p>	<p>Select whether you want to activate the OAM-CC test for the segment connection (segment = connection of the local endpoint to the next connection point) of the VCC or VPC.</p> <p>Possible values:</p> <ul style="list-style-type: none"> • <i>Passive</i> (default value): OAM CC requests are responded to after CC negotiation (CC activation negotiation). • <i>Active</i>: OAM CC requests are sent after CC negotiation (CC activation negotiation). • <i>Both</i>: OAM CC requests are sent and answered after CC negotiation (CC activation negotiation). • <i>No negotiation</i>: Depending on the setting in the Direction field, OAM CC requests are either sent and/or responded to. There is no CC negotiation. • <i>None</i>: The function is disabled. <p>Also select whether the test cells of the OAM CC are to be sent or received.</p> <p>Possible settings:</p> <ul style="list-style-type: none"> • <i>Both</i> (default value): CC data is both received and generated. • <i>Sink</i>: CC data is received. • <i>Source</i>: CC data is generated.

16.3 Real Time Jitter Control

When telephoning over the Internet, voice data packets normally have the highest priority. Nevertheless, if the upstream bandwidth is low, noticeable delays in voice transmission can occur when other packets are routed at the same time.

The real time jitter control function solves this problem. So that the "line" is not blocked for too long for the voice data packets, the size of the other packets can be reduced, if required, during a telephone call.

16.3.1 Controlled Interfaces

In the **WAN->Real Time Jitter Control->Controlled Interfaces** a list of functions is displayed for which the Real Time Jitter Control function is configured.

16.3.1.1 New

Click the **New** button to optimise voice transmission for other interfaces.

The menu **WAN->Real Time Jitter Control->Controlled Interfaces->New** consists of the following fields:

Fields in the Basic Settings menu.

Field	Description
Interface	Define for which interfaces voice transmission is to be optimised.
Control Mode	Select the mode for the optimisation. Possible values: <ul style="list-style-type: none"> • <i>Controlled RTP Streams only</i> (default value): By means of the data routed via the media gateway, the system detects voice data traffic and optimises the voice transmission. • <i>All RTP Streams</i>: All RTP streams are optimised. • <i>Inactive</i>: Voice data transmission is not optimised. • <i>Always</i>: Voice data transmission is always optimised.
Maximum Upload Speed	Enter the maximum available upstream bandwidth in kbp/s for the selected interface.

Chapter 17 VPN

A connection that uses the Internet as a "transport medium" but is not publicly accessible is referred to as a VPN (Virtual Private Network). Only authorised users have access to such a VPN, which is seemingly also referred to as a VPN tunnel. Normally the data transported over a VPN is encrypted.

A VPN allows field staff or staff working from home offices to access data on the company's network. Subsidiaries can also connect to head office over VPN.

Various protocols are available for creating a VPN tunnel, e.g. IPSec or PPTP.

The connection partner is authenticated with a password, using preshared keys or certificates.

With IPSec the data is encrypted using AES or 3DES, for example; with PPTP, you can use MPPE.

17.1 IPSec

IPSec enables secure connections to be set up between two locations (VPN). This enables sensitive business data to be transferred via an unsecure medium such as the Internet. The devices used function here as the endpoints of the VPN tunnel. IPSec involves a number of Internet Engineering Task Force (IETF) standards, which specify mechanisms for the protection and authentication of IP packets. IPSec offers mechanisms for encrypting and decrypting the data transferred in the IP packets. The IPSec implementation can also be smoothly integrated in a Public Key Infrastructure (PKI, see [Certificates](#) on page 72). IPSec implementation achieves this firstly by using the Authentication Header (AH) protocol and Encapsulated Security Payload (ESP) protocol and secondly through the use of cryptographic key administration mechanisms like the Internet Key Exchange (IKE) protocol.

Additional IPv4 Traffic Filter

bintec elmeg gateways support two different methods of setting up IPSec connections:

- a method based on policies and
- a method based on routing.

The policy-based method uses data traffic filters to negotiate the IPSec phase 2 SAs. This allows for a very "fine-grained" filter to be applied to the IP packet, even at the level of the protocol and the port.

The routing-based method offers various advantages over the policy-based method, e.g., NAT/PAT within a tunnel, IPSec in combination with routing protocols and the creation of VPN backup scenarios. With the routing-based method, the configured or dynamically learned routes are used to negotiate the IPSec phase 2 SAs. Although this method does simplify many configurations, problems may also be caused by competing routes or the "coarser" filtering of data traffic.

The **Additional IPv4 Traffic Filter** parameter fixes this problem. You can apply a "finer" filter, i.e. you can enter the source IP address or the source port.

If an IP packet does not match the defined **Additional IPv4 Traffic Filter**, it is rejected. If an IP packet meets the requirements in an **Additional IPv4 Traffic Filter**, IPSec phase 2 negotiation begins and data traffic is transferred over the tunnel.



Note

The parameter **Additional IPv4 Traffic Filter** is exclusively relevant for the initiator of the IPSec connection, it is only used for outgoing traffic.



Note

Please note that the phase 2 policies must match on both of the IPSec tunnel endpoints.

17.1.1 IPSec Peers

An endpoint of a communication is defined as peer in a computer network. Each peer offers its services and uses the services of other peers.

A list of all configured IPSec Peers is sorted by priority displayed in the **VPN->IPSec->IPSec Peers** menu.

Peer Monitoring

The menu for monitoring a peer is called by selecting the  button for the peer in the peer list. See *Values in the IPSec Tunnels list* on page 421.

17.1.1.1 New

Choose the **New** button to set up more IPSec peers.

The menu **VPN->IPSec->IPSec Peers->New** consists of the following fields:

Fields in the menu Peer Parameters

Field	Description
Administrative Status	<p>Select the status to which you wish to set the peer after saving the peer configuration.</p> <p>Possible values:</p> <ul style="list-style-type: none"> • <i>Up</i> (default value): The peer is available for setting up a tunnel immediately after saving the configuration. • <i>Down</i>: The peer is initially not available after the configuration has been saved.
Description	<p>Enter a description of the peer that identifies it.</p> <p>The maximum length of the entry is 255 characters.</p>
Peer Address	<p>Select the IP Version. You can choose if IPv4 or IPv6 is to be preferred or if only one IP version is to be permitted.</p> <div data-bbox="539 894 1315 1048" style="background-color: #e0e0e0; padding: 5px; margin: 10px 0;"> <p> Note</p> <p>This selection is only relevant if an IP address is entered as host name.</p> </div> <p>Possible values:</p> <ul style="list-style-type: none"> • <i>IPv4 Preferred</i> • <i>IPv6 Preferred</i> • <i>IPv4 Only</i> • <i>IPv6 Only</i> <p>Enter the public IP address of the peer or a resolvable host name.</p> <p>This entry can be omitted in certain configurations, but in that case your device cannot initiate an IPSec connection.</p>
Peer ID	<p>Select the ID type and enter the peer ID.</p> <p>This entry is not necessary in certain configurations.</p>

Field	Description
	<p>The maximum length of the entry is 255 characters.</p> <p>Possible ID types:</p> <ul style="list-style-type: none"> • <i>Fully Qualified Domain Name (FQDN)</i>: Any string • <i>E-mail Address</i> • <i>IPV4 Address</i> • <i>ASN.1-DN (Distinguished Name)</i> • <i>Key ID</i>: Any string <p>On the peer device, this ID corresponds to the Local ID Value.</p>
Internet Key Exchange	<p>Select the version of the Internet Exchange Protocol to be used.</p> <p>Possible values:</p> <ul style="list-style-type: none"> • <i>IKEv1</i> (default value): Internet Key Exchange Protocol Version 1 • <i>IKEv2</i>: Internet Kex Exchange Protocol Version 2
Authentication Method	<p>Only for Internet Key Exchange = IKEv2</p> <p>Select the authentication method.</p> <p>Possible values:</p> <ul style="list-style-type: none"> • <i>Preshared Keys</i> (default value): If you do not use certificates for the authentication, you can select Preshared Keys. These are configured during peer configuration in the IPSec Peers. The preshared key is the shared password. • <i>RSA Signature</i>: Phase 1 key calculations are authenticated using the RSA algorithm.
Local ID Type	<p>Only for Internet Key Exchange = IKEv2</p> <p>Select the local ID type.</p> <p>Possible ID types:</p> <ul style="list-style-type: none"> • <i>Fully Qualified Domain Name (FQDN)</i> • <i>E-mail Address</i> • <i>IPV4 Address</i> • <i>ASN.1-DN (Distinguished Name)</i>

Field	Description
	<ul style="list-style-type: none"> • <i>Key ID</i>: Any string
Local ID	<p>Only for Internet Key Exchange = <i>IKEv2</i></p> <p>Enter the ID of your device.</p> <p>For Authentication Method = <i>DSA Signature</i> or <i>RSA Signature</i> the option Use Subject Name from certificate is displayed.</p> <p>When you enable the option Use Subject Name from certificate, the subject name indicated in the certificate is used.</p>
Preshared Key	<p>Enter the password agreed with the peer.</p> <p>The maximum length of the entry is 50 characters. All characters are possible except for <i>0x</i> at the start of the entry.</p>
IP Version of the tunneled Networks	<p>Select if IPv4, IPv6 or both versions are allowed for the VPN tunnel.</p> <p>Possible values:</p> <ul style="list-style-type: none"> • <i>IPv4</i> • <i>IPv6</i> • <i>IPv4 and IPv6</i>

Fields in the menu IPv4 Interface Routes

Field	Description
Security Policy	<p>Select the security settings to be used with the interface.</p> <p>Possible values:</p> <ul style="list-style-type: none"> • <i>Trusted</i>: All IP packets are allowed through except for those which are explicitly prohibited. • <i>Untrusted</i> (default value): Only those packets are transmitted that can be attributed to a connection that has been initiated from a trusted zone. <p>You can configure exceptions for the selected setting in the Firewall on page 308 menu.</p>

Field	Description
IP Address Assignment	<p>Select the configuration mode of the interface.</p> <p>Possible values:</p> <ul style="list-style-type: none"> • <i>Static</i> (default value): Enter a static IP address. • <i>IKE Config Mode Client</i>: Select this option if your gateway receives an IP address from the server as IPsec client. • <i>IKE Config Mode Server</i>: Select this option if your gateway assigns an IP address as server for connecting clients. This is taken from the selected IP Assignment Pool.
Config Mode	<p>Only where IP Address Assignment = <i>IKE Config Mode Server</i> or <i>IKE Config Mode Client</i></p> <p>Possible values:</p> <ul style="list-style-type: none"> • <i>Pull</i> (default value): The client requests the IP address and the gateway answers the request. • <i>Push</i>: The gateway suggests an IP address to the client and the client must either accept or reject this. <p>This value must be identical for both sides of the tunnel.</p>
IP Assignment Pool	<p>Only if IP Address Assignment = <i>IKE Config Mode Server</i></p> <p>Select an IP pool configured in the VPN->IPsec->IP Pools menu. If an IP pool has not been configured here yet, the message <i>Not yet defined</i> appears in this field.</p>
Default Route	<p>Only for IP Address Assignment = <i>Static</i> or <i>IKE Config Mode Client</i></p> <p>Select whether the route to this IPsec peer is to be defined as the default route.</p> <p>The function is enabled with <i>Enabled</i>.</p> <p>The function is disabled by default.</p>
Local IP Address	<p>Only for IP Address Assignment = <i>Static</i> or <i>IKE Config Mode Server</i></p> <p>Enter the WAN IP address of your IPsec tunnel. This can be the</p>

Field	Description
	same IP address as the address configured on your router as the LAN IP address.
Metric	<p>Only for IP Address Assignment = <i>Static</i> or <i>IKE Config Mode Client</i> and Default Route = <i>Enabled</i></p> <p>Select the priority of the route.</p> <p>The lower the value, the higher the priority of the route.</p> <p>Value range from 0 to 15. The default value is 1.</p>
Route Entries	<p>Only for IP Address Assignment = <i>Static</i> or <i>IKE Config Mode Client</i></p> <p>Define routing entries for this connection partner.</p> <ul style="list-style-type: none"> • <i>Remote IP Address</i>: IP address of the destination host or LAN. • <i>Netmask</i>: Netmask for <i>Remote IP Address</i>. • <i>Metric</i>: The lower the value, the higher the priority of the route (possible values 0..15). The default value is 1.

Fields in the menu **Additional IPv4 Traffic Filter**

Field	Description
Additional IPv4 Traffic Filter	<p>Only for Internet Key Exchange = <i>IKEv1</i></p> <p>Use Add to create a new filter.</p>

Fields in the **IPv6 Interface Routes** menu

Field	Description
Security Policy	<p>Select the security settings to be used with the interface..</p> <p>Possible values:</p> <ul style="list-style-type: none"> • <i>Untrusted</i>: IP packets are only allowed through if the connection has been initiated from "inside". <p>We recommend you use this setting if you want to use IPv6 outside of your LAN.</p> <ul style="list-style-type: none"> • <i>Trusted</i> (default value): All IP packets are allowed through except for those which are explicitly prohibited.

Field	Description
	<p>We recommend you use this setting if you want to use IPv6 on your LAN.</p> <p>You can configure exceptions for the selected setting in the Firewall on page 308 menu.</p>
Local IPv6 Network	<p>Select a network. You can choose from the Link Prefixes available under LAN->IP Configuration->Interfaces->New.</p> <p>Enter the Local IPv6 address and the corresponding prefix length. The default prefix length is /64. This prefix must end with ::.</p>
Remote IPv6 Network	<p>Add a new prefix. Enter the address of the other tunnel endpoint. The default prefix Length is 64 and the default Priority is 1. The lower the value entered for Priority, the higher the priority of the route.</p>

Additional data traffic filters

bintec elmeg Gateways support two different methods for establishing IPsec connections:

- a method based on policies and
- a method based on routing.

The policy-based method uses data traffic filters to negotiate the IPsec phase 2 SAs. This enables the filtering of the IP packets to be very "fine grained" down to protocol and port level.

The routing-based method offers various advantages over the policy-based method, e.g., NAT/PAT within a tunnel, IPsec in combination with routing protocols and the creation of VPN backup scenarios. With the routing-based method, the configured or dynamically learned routes are used to negotiate the IPsec phase 2 SAs. While it is true that this method simplifies many configurations, at the same time there can be problems due to competing routes or the "coarser" filtering of the data traffic.

The **Additional IPv4 Traffic Filter** parameter fixes this problem. You can filter more "finely", i. e. you can, e. g., specify the source IP address or the source port. If there is a **Additional IPv4 Traffic Filter** configured, it is used to negotiate the IPsec phase 2 SAs; the route only determines which data traffic is to be routed.

If an IP packet does not match the defined **Additional IPv4 Traffic Filter** it is discarded.

If an IP packet meets the requirements in an **Additional IPv4 Traffic Filter**, IPsec phase 2

negotiation begins and data traffic is transferred over the tunnel.



Note

The parameter **Additional IPv4 Traffic Filter** is only relevant to the initiator of the IPsec connection, it only applies to outgoing data traffic.



Note

Please note that the phase 2 policies must be configured identically on both of the IPsec tunnel endpoints.

Add new entries with **Add**.

Fields in the menu **Basic Parameters**

Field	Description
Description	Enter a description for the filter.
Protocol	Select a protocol. The <i>Any</i> option (default value) matches all protocols.
Source IP Address/Netmask	Enter, if required, the source IP address and netmask of the data packets. Possible values: <ul style="list-style-type: none"> • <i>Any</i> • <i>Host</i>: Enter the IP address of the host. • <i>Network</i> (default value): Enter the network address and the related netmask.
Source Port	Only for Protocol = <i>TCP</i> or <i>UDP</i> Enter the source port of the data packets. The default setting - <i>All</i> (= -1) means that the port remains unspecified.
Destination IP Address/Netmask	Enter the destination IP address and corresponding netmask of the data packets.
Destination Port	Only for Protocol = <i>TCP</i> or <i>UDP</i>

Field	Description
	Enter the destination port of the data packets. The default setting <i>-All-</i> (= -1) means that the port remains unspecified.

The menu **Advanced Settings** consists of the following fields:

Fields in the menu **Advanced IPSec Options**

Field	Description
Phase-1 Profile	<p>Select a profile for Phase 1. Besides user-defined profiles, pre-defined profiles are available.</p> <p>Possible values:</p> <ul style="list-style-type: none"> • <i>None (use default profile)</i>: Uses the profile marked as standard in VPN->IPSec->Phase-1 Profiles • <i>Multi-Proposal</i>: Uses a special profile which contains the proposals for Phase 1 3DES/MD5, AES/MD5 and Blowfish/MD5 regardless of the proposal selection in menu VPN->IPSec->Phase-1 Profiles. • <i><Profilname></i>: Uses a profile configured in menu VPN->IPSec->Phase-1 Profiles for Phase 1.
Phase-2 Profile	<p>Select a profile for Phase 2. Besides user-defined profiles, pre-defined profiles are available.</p> <p>Possible values:</p> <ul style="list-style-type: none"> • <i>None (use default profile)</i>: Uses the profile marked as standard in VPN->IPSec->Phase-2 Profiles • <i>Multi-Proposal</i>: Uses a special profile which contains the proposals for Phase 2 3DES/MD5, AES-128/MD5 and Blowfish/MD5 regardless of the proposal selection in menu VPN->IPSec->Phase-2 Profiles. • <i><Profilname></i>: Uses a profile configured in menu VPN->IPSec->Phase-2 Profiles for Phase 2.
XAUTH Profile	<p>Select a profile created in VPN->IPSec->XAUTH Profiles if you wish to use this IPSec peer XAuth for authentication.</p> <p>If XAuth is used together with IKE Config Mode, the transactions for XAuth are carried out before the transactions for IKE Config Mode.</p>

Field	Description
Number of Admitted Connections	<p>Choose how many users can connect using this peer profile.</p> <p>Possible values:</p> <ul style="list-style-type: none"> • <i>One User</i> (default value): Only one peer can be connected with the data defined in this profile. • <i>Multiple Users</i>: Several peers can be connected with the data defined in this profile. The peer entry is duplicated for each connection request with the data defined in this profile. <p>The configuration of the dynamic peer must not have a Peer ID or a Per IP Address. Clients connecting to the gateway, however, must have a Local ID configured, since this ID is used to distinguish the IPSec tunnels created by dynamic peers. Find information on how to configure this ID type for your IPSec client in its respective documentation.</p> <p>The resulting peer would not apply to all incoming tunnel requests and needs to be moved to the end of the IPSec peer list. Otherwise, all subsequent peers in the list would inactive.</p>
Start Mode	<p>Select how the peer is to be switched to the active state.</p> <p>Possible values:</p> <ul style="list-style-type: none"> • <i>On Demand</i> (default value): The peer is switched to the active state by a trigger. • <i>Always up</i>: The peer is always active.
Backup Peer	<p>Only for peers using IKEv2.</p> <p>If a peer has been configured for the Start Mode <i>Always up</i>, you can select another, already configured peer as a backup option. If the current peer becomes inactive, e.g. because of an outage of the central VPN dial-in node, the backup peer can initiate a connection to a backup VPN dial-in node. If the primary dial-in node becomes available again, the connection is seamlessly switched back.</p> <p>This solution requires that the routing for the peers has to be configured in a way that a connection to the remote site is actually possible via either of them. Moreover, the routing metric for the backup peer should be lesser than for the primary peer. This ensures that the tunnel is switched back to the primary peer as</p>

Field	Description
	soon as its connection is available again.
Delay until returning to primary peer	If in a fallback case the primary peer is coming up again, it may be desirable to delay the use of the primary peer and thus the reset of the secondary peer. This option defines the intended delay time.

Fields in the menu **Advanced IP Options**

Field	Description
Public Interface	Specify the public (or WAN) interface that this peer is to use to connect to its VPN partner. If you select <i>Chosen by Routing</i> , the decision as to via which interface the data traffic is routed is made based on the current routing table. If you select an interface, the interface is used taking into consideration the setting under Public Interface Mode .
Public Interface Mode	<p>Only when an interface is selected for Public Interface.</p> <p>Specify how strictly the setting is handled.</p> <p>Possible values:</p> <ul style="list-style-type: none"> • <i>Force</i>: Only the selected interface is used, independently from the priorities in the current routing table. • <i>Preferred</i>: The priorities in the current routing table will be used. Only if several equivalent routes are available, the route via the selected interface will be applied.
Public Source IPv4 Address	<p>If you are operating more than one Internet connection in parallel, here you can specify the public IP address that is to be used as the source address for the peer's data traffic. Select whether the Public Source IPv4 Address is to be enabled.</p> <p>The function is enabled with <i>Enabled</i>.</p> <p>In the input field, enter the public IP address that is to be used as the sender address.</p> <p>The function is disabled by default.</p>
Public Source IPv6 Address	If you are operating more than one Internet connection in parallel, here you can specify the public IP address that is to be used as the source address for the peer's data traffic. Select whether

Field	Description
	<p>the Public Source IPv6 Address is to be enabled.</p> <p>The function is enabled with <i>Enabled</i>.</p> <p>In the input field, enter the public IP address that is to be used as the sender address.</p> <p>The function is disabled by default.</p>
IPv4 Back Route Verify	<p>Select whether a check on the back route should be activated for the interface to the connection partner.</p> <p>The function is enabled with <i>Enabled</i>.</p> <p>The function is disabled by default.</p>
MobiKE	<p>Only for peers with IKEv2.</p> <p>MobiKE In cases of changing public IP addresses, enables only these addresses to be updated in the SAs without the SAs themselves having to be renegotiated.</p> <p>The function is enabled by default.</p> <p>Note that MobiKE requires a current IPsec client, e. g. the current Windows 7 or Windows 8 client or the latest version of the bintec elmeg IPsec client.</p>
IPv4 Proxy ARP	<p>Select whether your device is to respond to ARP requests from its own LAN on behalf of the specific connection partner.</p> <p>Possible values:</p> <ul style="list-style-type: none"> • <i>Inactive</i> (default value): Deactivates Proxy ARP for this IPsec peer. • <i>Up or Dormant</i>: Your device only responds to an ARP request if the status of the connection to the IPsec peer is <i>Up</i> (active) or <i>Dormant</i> (dormant). In the case of <i>Dormant</i>, your device only responds to the ARP request; the connection is not set up until someone actually wants to use the route. • <i>Up only</i>: Your device responds to an ARP request only if the status of the connection to the IPsec peer is <i>Up</i> (active), i.e. a connection already exists to the IPsec peer.

Field	Description
CA Certificates	<p>Only available if certificates are in use on the device.</p> <p>If you enable the Trust the following CA certificates option, you can select CA certificates that are accepted for this profile.</p> <p>This option can only be configured if certificates are loaded.</p>

IPSec Callback

bintec elmeg devices support the DynDNS service to enable hosts without fixed IP addresses to obtain a secure connection over the Internet. This service enables a peer to be identified using a host name that can be resolved by DNS. You do not need to configure the IP address of the peer.

The DynDNS service does not signal whether a peer is actually online and cannot cause a peer to set up an Internet connection to enable an IPSec tunnel over the Internet. This possibility is created with IPSec callback: Using a direct ISDN call to a peer, you can signal that you are online and waiting for the peer to set up an IPSec tunnel over the Internet. If the called peer currently has no connection to the Internet, the ISDN call causes a connection to be set up. This ISDN call costs nothing (depending on country), as it does not have to be accepted by your device. The identification of the caller from his or her ISDN number is enough information to initiate setting up a tunnel.

To set up this service, you must first configure a call number for IPSec callback on the passive side in the **Physical Interfaces->ISDN Ports->MSN Configuration->New** menu. The value *IPSec* is available for this purpose in the field **Service**. This entry ensures that incoming calls for this number are routed to the IPSec service.

If callback is active, the peer is caused to initiate setting up an IPSec tunnel by an ISDN call as soon as this tunnel is required. If callback is set to passive, setting up a tunnel to the peer is always initiated if an ISDN call is received on the relevant number (**MSN** in menu **Physical Interfaces->ISDN Ports->MSN Configuration->New** for **Service** *IPSec*). This ensures that both peers are reachable and that the connection can be set up over the Internet. The only case in which callback is not executed is if SAs (Security Associations) already exist, i.e. the tunnel to the peer already exists.



Note

If a tunnel is to be set up to a peer, the interface over which the tunnel is to be implemented is activated first by the IPSec Daemon. If IPSec with DynDNS is configured on the local device, the own IP address is propagated first and then the ISDN call is sent to the remote device. This ensures that the remote device can actually reach the local device if it initiates the tunnel setup.

Transfer of IP Address over ISDN

Transferring the IP address of a device over ISDN (in the D channel and/or B channel) opens up new possibilities for the configuration of IPsec VPNs. This enables restrictions that occur in IPsec configuration with dynamic IP addresses to be avoided.



Note

To be able to use IP address transmission via ISDN, you will need a free additional license.

You can obtain this license from your sales partner or from our support.

Before System Software Release 7.1.4, IPsec ISDN callback only supported tunnel setup if the current IP address of the initiator could be determined by indirect means (e.g. via DynDNS). However, DynDNS has serious disadvantages, such as the latency until the IP address is actually updated in the database. This can mean that the IP address propagated via DynDNS is not correct. This problem is avoided by transferring the IP address over ISDN. This type of transfer of dynamic IP addresses also enables the more secure ID Protect mode (main mode) to be used for tunnel setup.

Method of operation: Various modes are available for transferring your own IP address to the peer: The address can be transferred free in the D channel or in the B channel, but here the call must be accepted by the remote station and therefore incurs costs. If a peer whose IP address has been assigned dynamically wants to arrange for another peer to set up an IPsec tunnel, it can transfer its own IP address as per the settings described in [Fields in the menu IPv4 IPsec Callback](#) on page 280. Not all transfer modes are supported by all telephone companies. If you are not sure, automatic selection by the device can be used to ensure that all the available possibilities can be used.



Note

The callback configuration should be the same on the two devices so that your device is able to identify the IP address information from the called peer.

The following roles are possible:

- One side takes on the active role, the other the passive role.
- Both sides can take on both roles (both).

The IP address transfer and the start of IKE phase 1 negotiation take place in the following steps:

- (1) Peer A (the callback initiator) sets up a connection to the Internet in order to be assigned a dynamic IP address and be reachable for peer B over the Internet.
- (2) Your device creates a token with a limited validity and saves it together with the current IP address in the MIB entry belonging to peer B.
- (3) Your device sends the initial ISDN call to peer B, which transfers the IP address of peer A and the token as per the callback configuration.
- (4) Peer B extracts the IP address of peer A and the token from the ISDN call and assigns them to peer A based on the calling party number configured (the ISDN number used by peer A to send the initial call to peer B).
- (5) The IPsec Daemon at peer B's device can use the transferred IP address to initiate phase 1 negotiation with peer A. Here the token is returned to peer A in part of the payload in IKE negotiation.
- (6) Peer A is now able to compare the token returned by peer B with the entries in the MIB and so identify the peer without knowing its IP address.

As peer A and peer B can now mutually identify each other, negotiations can also be conducted in the ID Protect mode using preshared keys.



Note

In some countries (e.g. Switzerland), the call in the D channel can also incur costs. An incorrect configuration at the called side can mean that the called side opens the B channel the calling side incurs costs.

The following options are only available on devices with an ISDN connection:

Fields in the menu IPv4 IPsec Callback

Field	Description
Mode	<p>Select the Callback Mode.</p> <p>Possible values:</p> <ul style="list-style-type: none"> • <i>Inactive</i> (default value): IPsec callback is deactivated. The local device neither reacts to incoming ISDN calls nor initiates ISDN calls to the remote device. • <i>Passive</i>: The local device only reacts to incoming ISDN calls and, if necessary, initiates setting up an IPsec tunnel to the peer. No ISDN calls are sent to the remote device to cause this to set up an IPsec tunnel. • <i>Active</i>: The local device sends an ISDN call to the remote device to cause this to set up an IPsec tunnel. The device

Field	Description
	<p>does not react to incoming ISDN calls.</p> <ul style="list-style-type: none"> • <i>Both</i>: Your device can react to incoming ISDN calls and send ISDN calls to the remote device. The setting up of an IPSec tunnel is executed (after an incoming ISDN call) and initiated (by an outgoing ISDN call).
Incoming Phone Number	<p>Only for Mode = <i>Passive</i> or <i>Both</i></p> <p>Enter the ISDN number from which the remote device calls the local device (calling party number). Wildcards may also be used.</p>
Outgoing Phone Number	<p>Only for Mode = <i>Active</i> or <i>Both</i></p> <p>Enter the ISDN number with which the local device calls the remote device calls (called party number). Wildcards may also be used.</p>
Transfer own IP address over ISDN/GSM	<p>Select whether the IP address of your own device is to be transferred over ISDN for IPSec callback.</p> <p>The function is enabled with <i>Enabled</i>.</p> <p>The function is disabled by default.</p>
Transfer Mode	<p>Only for Transfer own IP address over ISDN/GSM = enabled</p> <p>Select the mode in which your device is to attempt to transfer its IP address to the peer.</p> <p>Possible values:</p> <ul style="list-style-type: none"> • <i>Autodetect best mode</i>: Your device automatically determines the most favourable mode. It first tries all D channel modes before switching to the B channel. (Costs are incurred for using the B channel.) • <i>Autodetect only D Channel Modes</i>: Your device automatically determines the most favourable D channel mode. The use of the B channel is excluded. • <i>Use specific D Channel Mode</i>: Your device tries to transfer the IP address in the mode set in the Mode field. • <i>Try specific D Channel Mode, fall back to B Channel</i>: Your device tries to transfer the IP address in the

Field	Description
	<p>mode set in the Mode field. If this does not succeed, the IP address is transferred in the B channel. (This incurs costs.)</p> <ul style="list-style-type: none"> • <i>Use only B Channel Mode</i>: Your device transfers the IP address in the B channel. This incurs costs.
D Channel Mode	<p>Only for Transfer Mode = <i>Use specific D Channel Mode</i> or <i>Try specific D Channel Mode, fall back to B Channel</i></p> <p>Select the D channel mode in which your device tries to transfer the IP address.</p> <p>Possible values:</p> <ul style="list-style-type: none"> • <i>LLC</i> (default value): The IP address is transferred in the "LLC information elements" of the D channel. • <i>SUBADDR</i>: The IP address is transferred in the subaddress "information elements" of the D channel. • <i>LLC and SUBADDR</i>: The IP address is transferred in both the "LLC" and "subaddress information elements".

17.1.2 Phase-1 Profiles

A list of all configured tunnel profiles is displayed in the **VPN->IPSec->Phase-1 Profiles** menu.

In the **Default** column, you can mark the profile to be used as the default profile.

17.1.2.1 New

Choose the **Create new IKEv1 Profile** or **Create new IKEv2 Profile** button to create additional profiles.

The menu **VPN->IPSec->Phase-1 Profiles->Create new IKEv1 Profile** consists of the following fields:

Fields in the Phase-1 (IKE) Parameters / Phase-1 (IKEv2) Parameters menu.

Field	Description
Description	Enter a description that uniquely defines the type of rule.
Proposals	In this field, you can select any combination of encryption and

Field	Description
	<p>message hash algorithms for IKE phase 1 on your device. The combination of six encryption algorithms and four message hash algorithms gives 24 possible values in this field. At least one proposal must exist. Therefore the first line of the table cannot be deactivated.</p> <p>Encryption algorithms (Encryption):</p> <ul style="list-style-type: none"> • <i>3DES</i>: 3DES is an extension of the DES algorithm with an effective key length of 112 bits, which is rated as secure. It is the slowest algorithm currently supported. • <i>Twofish</i>: Twofish was a final candidate for the AES (Advanced Encryption Standard). It is rated as just as secure as Rijndael (AES), but is slower. • <i>Blowfish</i>: Blowfish is a very secure and fast algorithm. Twofish can be regarded as the successor to Blowfish. • <i>CAST</i>: CAST is also a very secure algorithm, marginally slower than Blowfish, but faster than 3DES. • <i>DES</i>: DES is an older encryption algorithm, which is rated as weak due to its small effective length of 56 bits. • <i>AES</i> (default value): Rijndael has been nominated as AES due to its fast key setup, low memory requirements, high level of security against attacks and general speed. The partner's AES key length is used here. If this has also selected the parameter <i>AES</i> , a key length of 128 bits is used. • <i>AES-128</i>: Rijndael has been nominated as AES due to its fast key setup, low memory requirements, high level of security against attacks and general speed. Here, it is used with a key length of 128 bits. • <i>AES-192</i>: Rijndael has been nominated as AES due to its fast key setup, low memory requirements, high level of security against attacks and general speed. Here, it is used with a key length of 192 bits. • <i>AES-256</i>: Rijndael has been nominated as AES due to its fast key setup, low memory requirements, high level of security against attacks and general speed. Here, it is used with a key length of 256 bits. <p>Hash algorithms (Authentication):</p> <ul style="list-style-type: none"> • <i>MD5</i>: MD5 (Message Digest #5) is an older hash algorithm. It

Field	Description
	<p>is used with a 96 bit digest length for IPSec.</p> <ul style="list-style-type: none"> • <i>SHA1</i> (default value): SHA1 (Secure Hash Algorithm #1) is a hash algorithm developed by NSA (United States National Security Association). It is rated as secure, but is slower than MD5. It is used with a 96 bit digest length for IPSec. • <i>RipeMD 160</i>: RipeMD 160 is a 160 bit hash algorithm. It is used as a secure replacement for MD5 and RipeMD. • <i>Tiger192</i>: Tiger 192 is a relatively new and very fast algorithm. • <i>SHA2-256</i>: SH2 (Secure Hash Algorithmus #2) is a hash algorithm which has been designed to supersede SHA 1. It can be used with hash lengths of 256, 384 or 512 bits. • <i>SHA2-384</i>: SHA-2 with 384 bit hash length. • <i>SHA2-512</i>: SHA-2 with 512 bit hash length. <p>Depending on the hardware of your device some options may not be available.</p> <p>Please note that the quality of the algorithms is subject to relative aspects and may change due to mathematical or cryptographic developments.</p>
DH Group	<p>The Diffie-Hellman group defines the parameter set used as the basis for the key calculation during phase 1. "MODP" as supported by bintec elmeg devices stands for "modular exponentiation".</p> <p>The following groups with their corresponding bit values are available:</p> <ul style="list-style-type: none"> • <i>1 (768 Bit)</i> • <i>2 (1024 Bit)</i> • <i>5 (1536 Bit)</i> • <i>14 (2048 Bit)</i> • <i>15 (3072 Bit)</i> • <i>16 (4096 Bit)</i> <p>Depending on the hardware of your device some options may not be available.</p>
Lifetime	Create a lifetime for phase 1 keys.

Field	Description
	<p>The following options are available for defining the Lifetime:</p> <ul style="list-style-type: none"> • Input in Seconds: Enter the lifetime for phase 1 key in seconds. The value can be a whole number from 0 to 2147483647. The default value is <i>14400</i>, which means the key must be renewed once four hours have elapsed. • Input in kBytes: Enter the lifetime for phase 1 keys as amount of data processed in kBytes. The value can be a whole number from 0 to 2147483647. The default value is <i>0</i>, which means that the number of transmitted kBytes is irrelevant.
Authentication Method	<p>Only for Phase-1 (IKE) Parameters</p> <p>Select the authentication method.</p> <p>Possible values:</p> <ul style="list-style-type: none"> • <i>Preshared Keys</i> (default value): If you do not use certificates for the authentication, you can select Preshared Keys. These are configured during peer configuration in the VPN->IPSec->IPSec Peers. The preshared key is the shared password. • <i>DSA Signature</i>: Phase 1 key calculations are authenticated using the DSA algorithm. • <i>RSA Signature</i>: Phase 1 key calculations are authenticated using the RSA algorithm. • <i>RSA Encryption</i>: In RSA encryption the ID payload is also encrypted for additional security.
Local Certificate	<p>Only for Phase-1 (IKE) Parameters</p> <p>Only for Authentication Method = <i>DSA Signature</i>, <i>RSA Signature</i> or <i>RSA Encryption</i></p> <p>This field enables you to select one of your own certificates for authentication. It shows the index number of this certificate and the name under which it is saved. This field is only shown for authentication settings based on certificates and indicates that a certificate is essential.</p>
Mode	<p>Only for Phase-1 (IKE) Parameters</p> <p>Select the phase 1 mode.</p>

Field	Description
	<p>Possible values:</p> <ul style="list-style-type: none"> • <i>Aggressive</i> (default value): The Aggressive Mode is necessary if one of the peers does not have a static IP address and preshared keys are used for authentication. It requires only three messages to configure a secure channel. • <i>Main Mode (ID Protect)</i>: This mode (also designated Main Mode) requires six messages for a Diffie-Hellman key calculation and thus for configuring a secure channel, over which the IPSec SAs can be negotiated. A condition is that both peers have static IP addresses if preshared keys are used for authentication. <p>Also define whether the selected mode is used exclusively (Strict), or the peer can also propose another mode.</p>
<p>Local ID Type</p>	<p>Only for Phase-1 (IKE) Parameters</p> <p>Select the local ID type.</p> <p>Possible values:</p> <ul style="list-style-type: none"> • <i>Fully Qualified Domain Name (FQDN)</i> • <i>E-mail Address</i> • <i>IPV4 Address</i> • <i>ASN.1-DN (Distinguished Name)</i> • <i>Key ID</i>
<p>Local ID Value</p>	<p>Only for Phase-1 (IKE) Parameters</p> <p>Enter the ID of your device.</p> <p>For Authentication Method = <i>DSA Signature</i> or <i>RSA Signature</i> the option Use Subject Name from certificate is displayed.</p> <p>When you enable the option Use Subject Name from certificate, the subject name indicated in the certificate is used.</p>

Alive Check

During communication between two IPSec peers, one of the peers may become unavailable, e.g. due to routing problems or a reboot. However, this can only be detected when

the end of the lifetime of the security connection is reached. Up until this point the data packets are lost. These are various methods of performing an alive check to prevent this happening. In the **Alive Check** field you can specify whether a method should be used to check the availability of a peer.

Two methods are available: Heartbeats and Dead Peer Detection.

The menu **Advanced Settings** consists of the following fields:

Fields in the **Advanced Settings** menu.

Field	Description
Alive Check	<p>Only for Phase-1 (IKE) Parameters</p> <p>Select the method to be used to check the functionality of the IPsec connection.</p> <p>In addition to the default method Dead Peer Detection (DPD), the (proprietary) Heartbeat method is implemented. This sends and receives signals every 5 seconds, depending on the configuration. If these signals are not received after 20 seconds, the SA is discarded as invalid.</p> <p>Possible values:</p> <ul style="list-style-type: none"> • <i>Autodetect</i> (default value): Your device detects and uses the mode supported by the remote terminal. • <i>Inactive</i>: Your device sends and expects no heartbeat. Set this option if you use devices from other manufacturers. • <i>Heartbeats (Expect only)</i>: Your device expects a heartbeat from the peer but does not send one itself. • <i>Heartbeats (Send only)</i>: Your device expects no heartbeat from the peer, but sends one itself. • <i>Heartbeats (Send &Expect)</i>: Your device expects a heartbeat from the peer and sends one itself. • <i>Dead Peer Detection</i>: Use DPD (dead peer detection) in accordance with RFC 3706. DPD uses a request-reply protocol to check the availability of the remote terminal and can be configured independently on both sides. This option only checks the availability of the peer if data is to be sent to it. • <i>Dead Peer Detection (Idle)</i>: Use DPD (dead peer detection) in accordance with RFC 3706. DPD uses a request-reply protocol to check the availability of the remote terminal and can be configured independently on both sides. This op-

Field	Description
	<p>tion is used to carry out a check at certain intervals depending on forthcoming data transfers.</p> <div data-bbox="541 286 1315 543" style="border: 1px solid gray; background-color: #f0f0f0; padding: 10px;"> <p> Note</p> <p>As the two methods of accessibility testing use different procedures, it is not recommended to use them in combination in Phase 1 and Phase 2. In Phase 2 only heartbeats are supported, so they should be deactivated if Dead Peer Detection is required in Phase 1.</p> </div> <p>Only for Phase-1 (IKEv2) Parameters</p> <p>Enable or disable alive check.</p> <p>The function is enabled by default.</p>
Block Time	<p>Define how long a peer is blocked for tunnel setups after a phase 1 tunnel setup has failed. This only affects locally initiated setup attempts.</p> <p>Possible values are <i>-1</i> to <i>86400</i> (seconds); <i>-1</i> means the value in the default profile is used and <i>0</i> means that the peer is never blocked.</p> <p>The default value is <i>30</i>. If a peer has been configured in "always up" mode, there is an implicit minimum block time of 15 seconds which is applied independently from the configured value.</p>
NAT Traversal	<p>NAT Traversal (NAT-T) also enables IPSec tunnels to be opened via one or more devices on which network address translation (NAT) is activated.</p> <p>Without NAT-T, incompatibilities may arise between IPSec and NAT (see RFC 3715, section 2). These primarily prevent the setup of an IPSec tunnel from a host within a LANs and behind a NAT device to another host or device. NAT-T enables these kinds of tunnels without conflicts with NAT device, activated NAT is automatically detected by the IPSec Daemon and NAT-T is used.</p> <p>Only for <i>IKEv1 profiles</i></p>

Field	Description
	<p>Possible values:</p> <ul style="list-style-type: none"> • <i>Enabled</i> (default value): NAT Traversal is enabled. • <i>Disabled</i>: NAT Traversal is disabled. • <i>Force</i>: The device always behaves as it would if NAT were in use. <p>Only for <i>IKEv2 profiles</i></p> <p>The function is enabled with <i>Enabled</i>.</p> <p>The function is enabled by default.</p>
CA Certificates	<p>Only for Phase-1 (IKE) Parameters</p> <p>Only for Authentication Method = <i>DSA Signature, RSA Signature</i> or <i>RSA Encryption</i></p> <p>If you enable the Trust the following CA certificates option, you can select up to three CA certificates that are accepted for this profile.</p> <p>This option can only be configured if certificates are loaded.</p>

17.1.3 Phase-2 Profiles

You can define profiles for phase 2 of the tunnel setup just as for phase 1.

In the **VPN->IPSec->Phase-2 Profiles** menu, a list of all configured IPSec phase 2 profiles is displayed.

In the **Default** column, you can mark the profile to be used as the default profile.

17.1.3.1 New

Choose the **New** button to create additional profiles.

The menu **VPN->IPSec->Phase-2 Profiles->New** consists of the following fields:

Fields in the Phase-2 (IPSEC) Parameters menu.

Field	Description
Description	Enter a description that uniquely identifies the profile.

Field	Description
	The maximum length of the entry is 255 characters.
Proposals	<p>In this field, you can select any combination of encryption and message hash algorithms for IKE phase 2 on your default. The combination of six encryption algorithms and two message hash algorithms gives 12 possible values in this field.</p> <p>Encryption algorithms (Encryption):</p> <ul style="list-style-type: none"> • <i>3DES</i>: 3DES is an extension of the DES algorithm with an effective key length of 112 bits, which is rated as secure. It is the slowest algorithm currently supported. • <i>-- ALL --</i>: All options can be used. • <i>AES</i> (default value): Rijndael has been nominated as AES due to its fast key setup, low memory requirements, high level of security against attacks and general speed. The partner's AES key length is used here. If this has also selected the parameter <i>AES</i> , a key length of 128 bits is used. • <i>AES-128</i>: Rijndael has been nominated as AES due to its fast key setup, low memory requirements, high level of security against attacks and general speed. Here, it is used with a key length of 128 bits. • <i>AES-192</i>: Rijndael has been nominated as AES due to its fast key setup, low memory requirements, high level of security against attacks and general speed. Here, it is used with a key length of 192 bits. • <i>AES-256</i>: Rijndael has been nominated as AES due to its fast key setup, low memory requirements, high level of security against attacks and general speed. Here, it is used with a key length of 256 bits. • <i>Twofish</i>: Twofish was a final candidate for the AES (Advanced Encryption Standard). It is rated as just as secure as Rijndael (AES), but is slower. • <i>Blowfish</i>: Blowfish is a very secure and fast algorithm. Twofish can be regarded as the successor to Blowfish. • <i>CAST</i>: CAST is also a very secure algorithm, marginally slower than Blowfish, but faster than 3DES. • <i>DES</i>: DES is an older encryption algorithm, which is rated as weak due to its small effective length of 56 bits.

Field	Description
	<p>Hash algorithms (Authentication):</p> <ul style="list-style-type: none"> • <i>MD5</i>: MD5 (Message Digest #5) is an older hash algorithm. It is used with a 96 bit digest length for IPSec. • <i>-- ALL --</i>: All options can be used. • <i>SHA1</i> (default value): SHA1 (Secure Hash Algorithm #1) is a hash algorithm developed by NSA (United States National Security Association). It is rated as secure, but is slower than MD5. It is used with a 96 bit digest length for IPSec. • <i>SHA2-256</i>: SH2 (Secure Hash Algorithmus #2) is a hash algorithm which has been designed to supersede SHA 1. It can be used with hash lengths of 256, 384 or 512 bits. • <i>SHA2-384</i>: SHA-2 with 384 bit hash length. • <i>SHA2-512</i>: SHA-2 with 512 bit hash length. <p>Note that RipeMD 160 and Tiger 192 are not available for message hashing in phase 2.</p> <p>Depending on the hardware of your device some options may not be available.</p>
Use PFS Group	<p>As PFS (Perfect Forward Secrecy) requires another Diffie-Hellman key calculation to create new encryption material, you must select the exponentiation features. If you enable PFS (<i>Enabled</i>), the options are the same as for the configuration of DH Group in the VPN->IPSec->Phase-1 Profiles menu. PFS is used to protect the keys of a renewed phase 2 SA, even if the keys of the phase 1 SA have become known.</p> <p>The following groups with their corresponding bit values are available:</p> <ul style="list-style-type: none"> • <i>1 (768 Bit)</i> • <i>2 (1024 Bit)</i> • <i>5 (1536 Bit)</i> • <i>14 (2048 Bit)</i> • <i>15 (3072 Bit)</i> • <i>16 (4096 Bit)</i> <p>Depending on the hardware of your device some options may not be available.</p>

Field	Description
Lifetime	<p>Define how the lifetime is defined that will expire before phase 2 SAs need to be renewed.</p> <p>The new SAs are negotiated shortly before expiry of the current SAs. As for RFC 2407, the default value is eight hours, which means the key must be renewed once eight hours have elapsed.</p> <p>The following options are available for defining the Lifetime:</p> <ul style="list-style-type: none"> • Input in Seconds: Enter the lifetime for phase 2 key in seconds. The value can be a whole number from 0 to 2147483647. The default value is 7200. • Input in kBytes: Enter the lifetime for phase 2 keys as amount of data processed in kBytes. The value can be a whole number from 0 to 2147483647. The default value is 0. <p>Rekey after: Specify the percentage in the course of the lifetime at which the phase 2 keys are to be regenerated.</p> <p>The percentage entered is applied to both the lifetime in seconds and the lifetime in kBytes.</p> <p>The default value is 80 %.</p>

The menu **Advanced Settings** consists of the following fields:

Fields in the **Advanced Settings** menu.

Field	Description
IP Compression	<p>Select whether compression is to be activated before data encryption. If data is compressed effectively, this can result in higher performance and a lower volume of data to be transferred. In the case of fast lines or data that cannot be compressed, you are advised against using this option as the performance can be significantly affected by the increased effort during compression.</p> <p>The function is enabled with <i>Enabled</i>.</p> <p>The function is disabled by default.</p>
Alive Check	<p>Select whether and how IPSec heartbeats are used.</p> <p>A bintec elmeg IPSec heartbeat is implemented to determine</p>

Field	Description
	<p>whether or not a Security Association (SA) is still valid. This function sends and receives signals every 5 seconds, depending on the configuration. If these signals are not received after 20 seconds, the SA is discarded as invalid.</p> <p>Possible values:</p> <ul style="list-style-type: none"> • <i>Autodetect</i> (default value): Automatic detection of whether the remote terminal is a bintec elmeg device. If it is, <i>Heartbeats (Send & Expect)</i> (for a remote terminal with bintec elmeg) or <i>Inactive</i> (for a remote terminal without bintec elmeg) is set. • <i>Inactive</i>: Your device sends and expects no heartbeat. Set this option if you use devices from other manufacturers. • <i>Heartbeats (Expect only)</i>: Your device expects a heartbeat from the peer but does not send one itself. • <i>Heartbeats (Send only)</i>: Your device expects no heartbeat from the peer, but sends one itself. • <i>Heartbeats (Send & Expect)</i>: Your device expects a heartbeat from the peer and sends one itself. <div data-bbox="539 927 1315 1248" style="border: 1px solid #ccc; padding: 10px; margin-top: 10px;"> <p> Note</p> <p>In Phase 1 and Phase 2, your device supports different methods of accessibility testing: In Phase 1, dead peer detection and heartbeats, in Phase 2 only heartbeats. Since the two methods of accessibility testing use different procedures, it is not recommended to combine them in Phase 1 and Phase 2. Heartbeats should therefore be deactivated in Phase 2 if Dead Peer Detection is required in Phase 1.</p> </div>
Propagate PMTU	<p>Select whether the PMTU (Path Maximum Transfer Unit) is to be propagated during phase 2.</p> <p>The function is enabled with <i>Enabled</i>.</p> <p>The function is enabled by default.</p>

17.1.4 XAUTH Profiles

In the **XAUTH Profiles** menu a list of all XAUTH profiles is displayed.

Extended Authentication for IPsec (XAuth) is an additional authentication method for IPsec tunnel users.

The gateway can take on two different roles when using XAuth as it can act as a server or as a client:

- As a server the gateway requires a proof of authorisation.
- As a client the gateway provides proof of authorisation.

In server mode, multiple users can obtain authentication via XAuth, e.g. users of Apple iPhones. Multiple users can dial-in either one after another or simultaneously via a so-called multi peer. Authorisation is verified either on the basis of a list or via a Radius Server. If using a one time password (OTP), the password check can be carried out by a token server (e.g. SecOVID from Kobil), which is installed behind the Radius Server.

If a company's headquarters is connected to several branches via IPsec, several peers can be configured, for example, one peer for each branch. A password is assigned to each peer, i.e. each branch. Besides this authentication method per branch, XAuth offers an additional method for logging in individually and independently from a user's location via a private password. A specific user can then use the IPsec tunnel across various peers. This is useful, for example, if an employee works alternately in different branches and if he needs to have individual access to the tunnel.

All users are assigned the same password in a so-called multi peer, i.e. a group password. Here, XAuth offers an individual authentication method to the user, too. If in a branch, for example, multiple users have access to a tunnel via a multi peer, it may have an advantage for users with different tasks that each of them uses a private password.

XAuth is carried out once IPsec IKE (Phase 1) has been completed successfully and before IKE (Phase 2) begins.

If XAuth is used together with IKE Config Mode, the transactions for XAuth are carried out before the transactions for IKE Config Mode.

17.1.4.1 New

Choose the **New** button to create additional profiles.

The **VPN->IPsec->XAUTH Profiles->New** menu consists of the following fields:

Fields in the Basic Parameters menu.

Field	Description
Description	<p>Enter a description for this XAuth profile.</p> <p>You can create up to 10 XAuth profiles with Role = <i>Server</i> and Mode = <i>Local</i> or Role = <i>Client</i> settings (see below).</p>
Role	<p>Select the role of the gateway for XAuth authentication.</p> <p>Possible values:</p> <ul style="list-style-type: none"> • <i>Server</i> (default value): The gateway requires a proof of authorisation. • <i>Client</i>: The gateway provides proof of authorisation.
Mode	<p>Only for Role = <i>Server</i></p> <p>Select how authentication is carried out.</p> <p>Possible values:</p> <ul style="list-style-type: none"> • <i>RADIUS</i> (default value): Authentication is carried out via a Radius server. It is configured in the System Management->Remote Authentication->RADIUS menu and selected in the RADIUS Server Group ID field. • <i>Local</i>: Authentication is carried out via a local list.
Name	<p>Only for Role = <i>Client</i></p> <p>Enter the authentication name of the client.</p>
Password	<p>Only for Role = <i>Client</i></p> <p>Enter the authentication password.</p>
RADIUS Server Group ID	<p>Only for Role = <i>Server</i></p> <p>Select the desired list in System Management->Remote Authentication->RADIUS configured RADIUS group.</p>
Users	<p>Only for Role = <i>Server</i> and Mode = <i>Local</i></p> <p>If your gateway is configured as an XAuth server, the clients can be authenticated via a locally configured user list. Define the members of the user group of this XAUTH profile here by entering the authentication name of the client (Name) and the</p>

Field	Description
	authentication password (Password). Add new members with Add .
	There is no limitation for users per XAuth profile.

17.1.5 IP Pools

In the **IP Pools** menu a list of all IP pools for your configured IPsec connections is displayed.

If for an IPsec peer you have set **IP Address Assignment** *IKE Config Mode Server*, you must define the IP pools here from which the IP addresses are assigned.

17.1.5.1 Edit or New

Choose the **New** button to set up new IP address pools. Choose the  icon to edit existing entries.

Fields in the menu **Basic Parameters**

Field	Description
IP Pool Name	Enter any description to uniquely identify the IP pool.
IP Address Range	Enter the first (first field) and last (second field) IP address of the IP address pool.
DNS Server	<p>Primary: Enter the IP address of the DNS server that is to be used, preferably, by clients who draw an address from this pool.</p> <p>Secondary: Optionally, enter the IP address of an alternative DNS server.</p>

17.1.6 Options

The menu **VPN->IPSec->Options** consists of the following fields:

Fields in the **Global Options** menu.

Field	Description
Enable IPsec	<p>Select whether you want to activate IPsec.</p> <p>The function is enabled with <i>Enabled</i>.</p>

Field	Description
	The function is active as soon as an IPSec Peer is configured.
Delete complete IPSec configuration	<p>If you click the  icon, delete the complete IPSec configuration of your device.</p> <p>This cancels all settings made during the IPSec configuration. Once the configuration is deleted, you can start with a completely new IPSec configuration.</p> <p>You can only delete the configuration if Enable IPSec = not activated.</p>
IPSec Debug Level	<p>Select the priority of the syslog messages of the IPSec subsystem to be recorded internally.</p> <p>Possible values:</p> <ul style="list-style-type: none"> • <i>Emergency</i> (highest priority) • <i>Alert</i> • <i>Critical</i> • <i>Error</i> • <i>Warning</i> • <i>Notice</i> • <i>Information</i> • <i>Debug</i> (default value, lowest priority) <p>Syslog messages are only recorded internally if they have a higher or identical priority to that indicated, i.e. all messages generated are recorded at syslog level "debug".</p>

The **Advanced Settings** menu is for adapting certain functions and features to the special requirements of your environment, i.e. mostly interoperability flags are set. The default values are globally valid and enable your system to work correctly to other bintec elmeg devices, so that you only need to change these values if the remote terminal is a third-party product or you know special settings are necessary. These may be needed, for example, if the remote end operates with older IPSec implementations.

The menu **Advanced Settings** consists of the following fields:

Fields in the Advanced Settings menu.

Field	Description
IPSec over TCP	<p>Determine whether IPSec over TCP is to be used.</p> <p>IPSec over TCP is based on NCP pathfinder technology. This technology insures that data traffic (IKE, ESP, AH) between peers is integrated into a pseudo HTTPS session.</p> <p>The function is enabled with <i>Enabled</i>.</p> <p>The function is disabled by default.</p>
Send Initial Contact Message	<p>Select whether IKE Initial Contact messages are to be sent during IKE (phase 1) if no SAs with a peer exist.</p> <p>The function is enabled with <i>Enabled</i>.</p> <p>The function is enabled by default.</p>
Sync SAs with ISP interface state	<p>Select whether all SAs are to be deleted whose data traffic was routed via an interface on which the status has changed from <i>Up</i> to <i>Down</i>, <i>Dormant</i> or <i>Blocked</i>.</p> <p>The function is enabled with <i>Enabled</i>.</p> <p>The function is disabled by default.</p>
Use Zero Cookies	<p>Select whether zeroed ISAKMP Cookies are to be sent.</p> <p>These are equivalent to the SPI (Security Parameter Index) in IKE proposals; as they are redundant, they are normally set to the value of the negotiation currently in progress. Alternatively, your device can use zeroes for all values of the cookie. In this case, select <i>Enabled</i>.</p>
Zero Cookie Size	<p>Only for Use Zero Cookies = enabled.</p> <p>Enter the length in bytes of the zeroed SPI used in IKE proposals.</p> <p>The default value is <i>32</i>.</p>
Dynamic RADIUS Authentication	<p>Select whether RADIUS authentication is to be activated via IPSec.</p> <p>The function is enabled with <i>Enabled</i>.</p>

Field	Description
	The function is disabled by default.

Fields in the PKI Handling Options menu.

Field	Description
Ignore Certificate Request Payloads	<p>Select whether certificate requests received from the remote end during IKE (phase 1) are to be ignored.</p> <p>The function is enabled with <i>Enabled</i>.</p> <p>The function is disabled by default.</p>
Send Certificate Request Payloads	<p>Select whether certificate requests are to be sent during IKE (phase 1).</p> <p>The function is enabled with <i>Enabled</i>.</p> <p>The function is enabled by default.</p>
Send Certificate Chains	<p>Select whether complete certificate chains are to be sent during IKE (phase 1).</p> <p>The function is enabled with <i>Enabled</i>.</p> <p>The function is enabled by default.</p> <p>Deactivate this function if you do not wish to send the peer the certificates of all levels (from your level to the CA level).</p>
Send CRLs	<p>Select whether CRLs are to be sent during IKE (phase 1).</p> <p>The function is enabled with <i>Enabled</i>.</p> <p>The function is disabled by default.</p>
Send Key Hash Payloads	<p>Select whether key hash payloads are to be sent during IKE (phase 1).</p> <p>In the default setting, the public key hash of the remote end is sent together with the other authentication data. Only applies for RSA encryption. Activate this function with <i>Enabled</i> to suppress this behaviour.</p>

17.2 be.IP Secure Client

Here you can download the current Secure IPsec Client software for free.

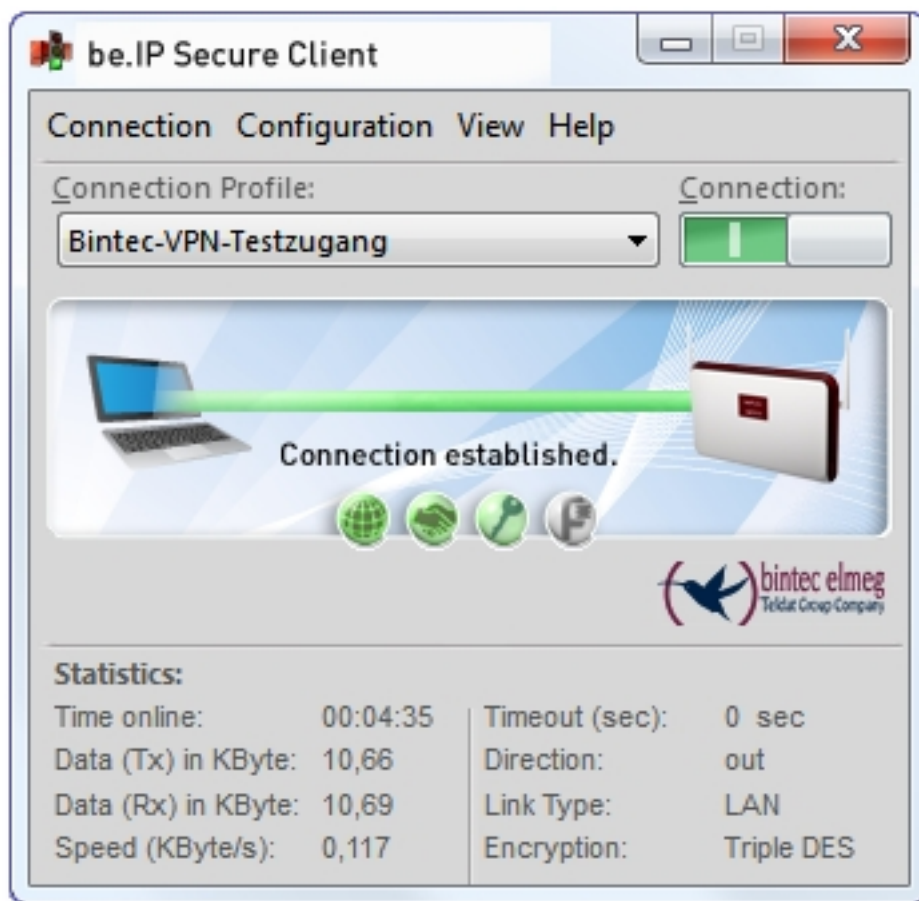

17.3 LISP Light

The Locator/ID Separation Protocol (LISP) provides a new kind of addressing nodes for a more efficient structuring of the internet.

A large number of reasons warrants the introduction of LIPS, the main one being the quickly increasing number of mobile devices accessing the internet as well as local networks. Having to change the complete IP address for every change of location is inefficient and lets routing tables grow out of proportion quickly and unnecessarily.

LISP employs the concept of separating the notion of identity and location of a device inside the network: A Routing Locator (RLOC) specifies the location of a device, and an Endpoint Identifier (EID) specifies its identity. A mapping system connects both parameters.

When using traditional IP-addressing, identity and location are linked to each other by the IP address. If a device receives a new IP address via DHCP - as is the rule especially in mobile computing -, the new IP address is completely unrelated to the previous one, i.e., not only the location has changed, but the complete combination of location+identity has been replaced. As a result, all routes to the previous address and to the device have to be replaced, as well.

From the perspective of LISP addressing, the internet can be seen as structured as follows: The internet is broken into a public realm, the Internet Core, and into private, LISP-enabled networks, LISP sites, which are connected to the Internet Core. The interfaces between both are operated by LISP routers working as Ingress or Egress Tunnel routers (ITR or ETR, respectively). Ingress Tunnel Routers provide entrance to the Internet Core and Egress Tunnel Routers provide entrance to the local network (i.e. an exit from the Internet Core). Both services can be offered by the same device, however:

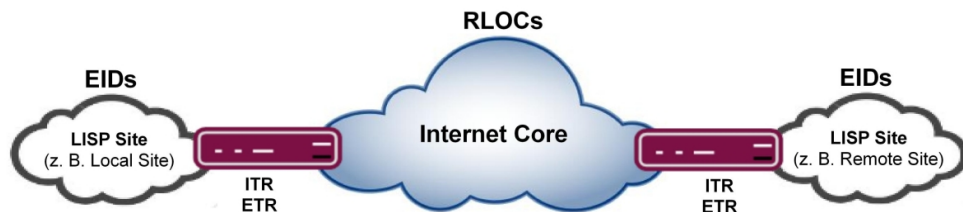

The parameters Routing Locator (RLOC) and Endpoint Identifier (EID) are - practically - a pair of "common" IPv4 or IPv6 addresses. (IPv6 is currently not supported by LISP Light.) The Routing Locator (RLOC) determines the routing via a public, globally routable IP address to a LISP Site, i.e. to a location within the Internet where an Egress Router provides access to a LISP-enabled network. The Endpoint Identifier (EID) is used to address a specific device inside of the LISP Site with a private address. This private address has to be unique across all interconnected LISP Sites, but does not have to be globally unique.

If an IP packet has to be routed from one LISP Site to another one, e.g. from a Local to a Remote Site, the corresponding RLOC-EID pair has to be known. Map Server and Map Resolver provide this information. A Map Server learns RLOC-EID entries from Egress Tunnel Routers and stores them inside of a database. A Map Resolver receives map requests from Ingress Tunnel Routers and queries the RLOC-EID entries in the database.

When routing an IP packet, the Ingress Tunnel Router adds additional information to the packet that already contains the EID (the private sender and destination address) inside the so-called "inner" header: The IP packet receives an additional header, the so-called "outer" header, which contains the RLOC consisting of the public sender and destination address. When the IP packet has arrived at the destination LISP Site through by means of

the RLOC, the Egress Tunnel Router unwraps it. Using the EID information the packet is then transmitted to the final recipient.

LISP Light means that only a subset of the LISP specification from RFC 6830 has been implemented in order to provide the core routing functions.

17.3.1 Router (ITR/ETR)

The menu **VPN->LISP Light->Router (ITR/ETR)** displays a list of all Egress Tunnel Routers (ETR, top card) and of all Ingress Tunnel Routers (ITR, bottom card). Your device operates as Egress Tunnel Router as well as as Ingress Tunnel Router.

17.3.1.1 Add Egress Tunnel Router

Here you carry out the configuration of the Egress Tunnel Router role. For a standard LISP configuration you have to configure at least one Map Server.

The device propagates its own IP address to the Map Server(s) in order to signal that it can receive data packets and via which RLOC it can be accessed as ETR.

An Egress Tunnel Router (ETR) propagates EID-RLOC entries for "its" LISP Sites and receives LISP data, unwraps them and sends them to the devices specified in the EID.

The menu **VPN->LISP Light->Router (ITR/ETR)->Add Egress Tunnel Router** consists of the following fields:

Fields in the menu Map Server

Field	Description
Map Server IP Address	Specify the IP address of the Map Server that is to receive the Map Request messages.
Key type (HMAC Algorithm)	<p>Messages sent to the Map Server can be signed. Here you can select the signing algorithm.</p> <p>Possible values:</p> <ul style="list-style-type: none"> • <i>HMAC-SHA1-96</i> • <i>HMAC-SHA2-256-128</i> • <i>None</i> <p><i>None</i> deactivates message signing.</p>
Authentication key	The Authentication key must also be known to the Map Server in order for it to verify message authenticity.

The menu **Advanced Settings** consists of the following fields:

Fields in the menu Advanced Settings

Field	Description
Map-Register time period (in sec.)	Configure the time to pass between two register messages sent to the Map Server in seconds. The default value is <i>60</i> .
HMAC truncation	The message signature can be written to the data packet either complete (HMAC truncation <i>None</i>) or in truncated (HMAC truncation <i>Enabled</i>). HMAC truncation <i>None</i> is the default setting.

17.3.1.2 Add Ingress Tunnel Router

Here you carry out the configuration of the Ingress Tunnel Router role. For a standard LIPS configuration you must configure at least one Map Resolver.

An Ingress Tunnel Router (ITR) discovers EID-RLOC pairs and stores them in its mapping cache. For discovery it sends map requests to a Map Resolver.

An Ingress Tunnel Router wraps the data packets into the inner and outer header and sends them to the adequate LISP site using the address contained in the RLOC.

The menu **VPN->LISP Light->Router (ITR/ETR)->Add Ingress Tunnel Router** consist of the following fields:

Fields in the menu Map Resolvers

Field	Description
Map Resolver IP Address	Specify the IP address of the Map Resolver that is to answer Map Requests of the ITR. In order to maintain reliability, more than one Map Resolver can be specified.

The menu **Advanced Settings** consists of the following fields:

Fields in the menu Advanced Settings

Field	Description
Map-Request minimum	Specify the minimum time (in seconds) that is to pass between

Field	Description
time period (in sec.)	two requests for the same EID to the same Map Resolver. This settings is to avoid Map Resolver overload. The default value is one second.
Max. Number of pending Map-Requests	Specify how many consequent Map Requests may remain unanswered before switching to the next Map Resolver. This settings determines data loss tolerance. The default value is 2.
Max. Delay before switching to the next Map-Resolver	Specify the time (in seconds) that may pass without an answer to a Map Request before switching to the next Map Resolver. This setting determines network latency tolerance. The default value is 3.

17.3.2 Local/Remote-Sites

LISP-enabled networks are called LIPS Sites. A Local Site is the sum of all IP addresses (EIDs) that belong to the local network and can be reached without a tunnel. Remote Sites are address spaces that can only be reached through a tunnel.

The menu **VPN->LISP Light->Local/Remote-Sites** displays a list of all established LISP Sites, separated into Local Sites (top card) and Remote Sites (bottom card).

17.3.2.1 Add Local Site

Here you can configure Local Sites.

The menu **VPN->LISP Light->Local/Remote-Sites->Add Local Sites** consist of the following fields:

Fields in the menu Local Site

Field	Description
Instance ID	You can select a LISP Instance if you have created one in the menu VPN->LISP Light->EID Prefix Segregation (LISP Instances)->Add Instance . If you keep the default setting <i>Not defined</i> , a default instance is used.

Field	Description
EID prefix (IP address) / Length	Specify the IP prefix of the Endpoint Identifier (EID). Use a LAN address from your network.
Route Locator (RLOC) IP address	In order for the remote tunnel router to know at which IP address your device can be reached, a globally routable IP address (RLOC of the ETR role) is automatically determined and displayed.

The menu **Advanced Settings** consists of the following fields:

Fields in the menu **Advanced Settings**

Field	Description
Interface binding	Selecting an interface is optional. If the same EID is used for multiple interfaces, one of the interfaces can be assigned here.
Database Record TTL (in min.)	Designates the cache entry life time (in minutes) reported to the Map Server. The default value is <i>60</i> minutes.
Exclude EID prefix from tree	If you intend to use a continuous address range, keep the default setting <i>auto</i> . You can remove a sub range from an already created address range. For this, create individual entries with the <i>negative</i> setting.

17.3.2.2 Add Remote Site

Here you can configure Remote Sites.

The menu **VPN->LISP Light->Local/Remote-Sites->Add Remote Site** consists of the following fields:

Fields in the menu **Remote Site**

Field	Description
ID	You can select a LISP Instance if you have created one in the menu VPN->LISP Light->EID Prefix Segregation (LISP Instances)->Add Instance . If you keep the default setting <i>Not defined</i> , a default instance is used.

Field	Description
EID prefix (IP address) / Length	Specify the address range that can be reached through a tunnel.

17.3.3 EID Prefix Segregation (LISP Instances)

The menu **VPN->LISP Light->EID Prefix Segregation (LISP Instances)** displays a list of all configured LIPS Instances.



Note

If you intend to operate only a single network, you do not need to create any instances. In this case a default instance is used.

If you intend to operate multiple separated networks (optionally with overlapping address ranges), you need to create an instance for each network.

17.3.3.1 Add Instance

Here you can configure LISP Instances.

The menu **VPN->LISP Light->EID Prefix Segregation (LISP Instances)->Add Instance** consists of the following fields:

Fields in the menu LISP Instance

Field	Description
Description	Choose a name for the instance in order to distinguish it from other instances more easily.
Instance ID	For the first instance you configure you can keep the default value 0. For all further instances specify a unique integer value. For each instance a virtual interface is created.

The menu **Advanced Settings** consists of the following fields:

Fields in the menu Advanced Settings

Field	Description
Proxy-ETR-RLOC	If required, specify the IP address of a Proxy-ETR all IOP packets are tunneled to for which the Map Resolver answers with

Field	Description
	"forward-native".
LISP interface MTU	<p>Specify the maximum packet size (Maximum Transfer Unit, MTU) in bytes that can be used for the connection between the virtual LISP interfaces.</p> <p>The default value is <i>1444</i>.</p>
Maximum number of cached EID/RLOC entries per ins	<p>Specify the maximum number of EID/RLOC entries in the cache.</p> <p>The default value <i>100</i>.</p>
Maximum number of RLOC addresses per cached EID	<p>Specify the maximum number of RLOC entries in the cache.</p> <p>The default value is <i>10</i>.</p>
Default TTL of cached EID/RLOC entry (in minutes)	<p>Normally, the server provides a value for the TTL (time to live). Here you can specify a value for the case that the server does not provide one (Default TTL Mode = <i>Fallback</i>) or the server-provided value is to be ignored (Default TTL Mode = <i>Fixed</i>).</p>
Default TTL Mode	<p>Here you can select the default TTL mode.</p> <p>Possible values:</p> <ul style="list-style-type: none"> • <i>Fallback</i> (default value): The server does not provide a TTL value. The value specified for Default TTL of cached EID/RLOC entry (in minutes) is used. • <i>Fixed</i>: The value provided by the server is ignored. the value specified for Default TTL of cached EID/RLOC entry (in minutes) is used.

Chapter 18 Firewall

The Stateful Inspection Firewall (SIF) provided for bintec elmeg gateways is a powerful security feature.

The SIF with dynamic packet filtering has a decisive advantage over static packet filtering: The decision whether or not to send a packet cannot be made solely on the basis of source and destination addresses or ports but also using dynamic packet filtering based on the state of the connection to a partner.

This means packets that belong to an already active connection can also be forwarded. The SIF also accepts packets that belong to an "affiliated connection". The negotiation of an FTP connection takes place over port 21, for example, but the actual data exchange can take place over a completely different port.

SIF and other security features

The Stateful Inspection Firewall fits into the existing security architecture of bintec elmeg. The configuration work for the SIF is comparatively straightforward with systems like Network Address Translation (NAT) and IP Access Lists (IPAL).

As SIF, NAT and IPAL are active in the system simultaneously, attention must be given to possible interaction: If any packet is rejected by one of the security instances, this is done immediately. This is irrelevant whether another instance would accept it or not. Your need for security features should therefore be accurately analysed.

The essential difference between SIF and NAT/IPAL is that the rules for the SIF are generally applied globally, i.e. not restricted to one interface.

In principle, the same filter criteria are applied to the data traffic as those used in NAT and IPAL:

- Source and destination address of the packet (with an associated netmask)
- Service (preconfigured, e.g. Echo, FTP, HTTP)
- Protocol
- Port number(s)

To illustrate the differences in packet filtering, a list of the individual security instances and their method of operation is given below.

NAT

One of the basic functions of NAT is the translation of the local IP addresses of your LAN into the global IP addresses you are assigned by your ISP and vice versa. All connections initiated externally are first blocked, i.e. every packet your device cannot assign to an existing connection is rejected. This means that a connection can only be set up from inside to outside. Without explicit permission, NAT rejects every access from the WAN to the LAN.

IP Access Lists

Here, packets are allowed or rejected exclusively on the basis of the criteria listed above, i.e. the state of the connection is not considered (except for **Services** = *TCP*).

SIF

The SIF sorts out all packets that are not explicitly or implicitly allowed. The result can be a "deny", in which case no error message is sent to the sender of the rejected packet, or a "reject", where the sender is informed of the packet rejection.

The incoming packets are processed as follows:

- The SIF first checks if an incoming packet can be assigned to an existing connection. If so, it is forwarded. If the packet cannot be assigned to an existing connection, a check is made to see if a suitable connection is expected (e.g. as affiliated connection of an existing connection). If so, the packet is also accepted.
- If the packet cannot be assigned to any existing or expected connection, the SIF filter rules are applied: If a deny rule matches the packet, the packet is discarded without sending an error message to the sender of the packet; if a reject rule matches, the packet is discarded and an ICMP Host Unreachable message sent to the sender of the packet. The packet is only forwarded if an accept rule matches.
- All packets without matching rules are rejected without sending an error message to the sender when all the existing rules have been checked (=default behaviour).

Specific instructions for the configuration of Stateful Inspection Firewall (SIF), see the end of the chapter [Configuration](#) on page 322.

18.1 Policies

18.1.1 IPv4 Filter Rules

The default behaviour with **Action** = *Access* consists of two implicit filter rules: If an incoming packet can be assigned to an existing connection and if a suitable connection is expected (e.g. such as an affiliated connection of an existing connection), the packet is allowed.

The sequence of filter rules in the list is relevant: The filter rules are applied to each packet in succession until a rule matches. If overlapping occurs, i.e. more than one filter rule matches a packet, only the first rule is executed. This means that if the first rule denies a packet, whereas a later rule allows it, the packet is rejected. A deny rule also has no effect if a relevant packet has previously been allowed by another filter rule.

The security concept is based on the assumption that an infrastructure consists of trusted and untrusted zones. The security policies *Trusted* and *Untrusted* describe this assumption. They define the filter rules **Trusted Interfaces** and **Untrusted Interfaces** which are created by default and cannot be deleted.

If you use the **Security Policy** *Trusted*, all data packets are accepted. You can create additional filter rules that discard specific packets. In the same way, you can allow specific packets when using the *Untrusted* policy.

A list of all configured filter rules is displayed in the **Firewall->Policies+IPv4 Filter Rules** menu.

Using the  button in the line **Trusted Interfaces**, you can determine which interfaces are **Trusted**. A new window opens with an interface list. You can mark individual interfaces as trusted.

You can use the  button to insert another policy above the list entry. The configuration menu for creating a new policy opens.

You can use the  button to move the list entry. A dialog box opens, in which you can select the position to which the policy is to be moved.

18.1.1.1 New



Note

Informationen on the selection of Trusted Interfaces can be found here: [IPv4 Filter Rules](#) on page 310.

Choose the **New** button to create additional parameters.

The menu **Firewall->Policies+IPv4 Filter Rules->New** consists of the following fields:

Fields in the **Basic Parameters** menu.

Field	Description
Source	<p>Select one of the preconfigured aliases for the source of the packet.</p> <p>In the list, all WAN/LAN interfaces, interface groups (see Firewall->Interfaces->Groups), addresses (see Firewall->Addresses->Address List) and address groups (see Firewall->Addresses->Groups) are available.</p> <p>The value <i>Any</i> means that neither the source interface nor the source address is checked.</p>
Destination	<p>Select one of the preconfigured aliases for the destination of the packet.</p> <p>In the list, all WAN/LAN interfaces, interface groups (see Firewall->Interfaces->Groups), addresses (see Firewall->Addresses->Address List) and address groups (see Firewall->Addresses->Groups).</p> <p>The value <i>Any</i> means that neither the destination interface nor the destination address is checked.</p>
Service	<p>Select one of the preconfigured services to which the packet to be filtered must be assigned.</p> <p>The extensive range of services configured ex works includes the following:</p> <ul style="list-style-type: none"> • <i>ftp</i> • <i>telnet</i> • <i>smtp</i> • <i>dns</i> • <i>http</i> • <i>nntp</i> • <i>Internet</i> • <i>Netmeeting</i> <p>Additional services are created in Firewall->Services->Service List.</p>

Field	Description
	In addition, the service groups configured in Firewall->Services->Groups can be selected.
Action	<p>Select the action to be applied to a filtered packet.</p> <p>Possible values:</p> <ul style="list-style-type: none"> • <i>Access</i> (default value): The packets are forwarded on the basis of the entries. • <i>Deny</i>: The packets are rejected. • <i>Reject</i>: The packets are rejected. An error message is issued to the sender of the packet.

18.1.2 IPv6 Filter Rules

The default behaviour with **Action** = *Access* consists of two implicit filter rules: If an incoming packet can be assigned to an existing connection and if a suitable connection is expected (e.g. such as an affiliated connection of an existing connection), the packet is allowed.

The sequence of filter rules in the list is relevant: The filter rules are applied to each packet in succession until a rule matches. If overlapping occurs, i.e. more than one filter rule matches a packet, only the first rule is executed. This means that if the first rule denies a packet, whereas a later rule allows it, the packet is rejected. A deny rule also has no effect if a relevant packet has previously been allowed by another filter rule.

The security concept is based on the assumption that an infrastructure consists of trusted and untrusted zones. The security policies *Trusted* and *Untrusted* describe this assumption. They define the filter rules **Trusted Interfaces** and **Untrusted Interfaces** which are created by default and cannot be deleted.

If you use the **Security Policy** *Trusted*, all data packets are accepted. You can create additional filter rules that discard specific packets. In the same way, you can allow specific packets when using the *Untrusted* policy.

A list of all configured filter rules is displayed in the **Firewall->Policies->IPv6 Filter Rules** menu.

Using the  button in the line **Trusted Interfaces**, you can determine which interfaces are **Trusted**. A new window opens with an interface list. You can mark individual interfaces as trusted.

You can use the  button to insert another policy above the list entry. The configuration

menu for creating a new policy opens.

You can use the  button to move the list entry. A dialog box opens, in which you can select the position to which the policy is to be moved.

18.1.2.1 New

Choose the **New** button to create additional parameters.

The menu **Firewall->Policies->IPv6 Filter Rules->New** consists of the following fields:

Fields in the **Basic Parameters** menu

Field	Description
Source	<p>Select one of the preconfigured aliases for the source of the packet.</p> <p>In the list, all WAN/LAN interfaces, interface groups (see Firewall->Interfaces->IPv6 Groups), addresses (see Firewall->Addresses->Address List) and address groups (see Firewall->Addresses->Groups) are available for selection for IPv6.</p>
Destination	<p>Select one of the preconfigured aliases for the destination of the packet.</p> <p>In the list, all WAN/LAN interfaces, interface groups (see Firewall->Interfaces->IPv6 Groups), addresses (see Firewall->Addresses->Address List) and address groups (see Firewall->Addresses->Groups) are available for selection for IPv6.</p>
Service	<p>Select one of the preconfigured services to which the packet to be filtered must be assigned.</p> <p>The extensive range of services configured ex works includes the following:</p> <ul style="list-style-type: none"> • <i>ftp</i> • <i>telnet</i> • <i>smtp</i> • <i>dns</i> • <i>http</i> • <i>nntp</i> <p>Additional services are created in Firewall->Services->Service List.</p>

Field	Description
	In addition, the service groups configured in Firewall->Services->Groups can be selected.
Action	Select the action to be applied to a filtered packet. Possible values: <ul style="list-style-type: none"> • <i>Access</i> (default value): The packets are forwarded on the basis of the entries.. • <i>Deny</i>: The packets are rejected. • <i>Reject</i>: The packets are rejected. An error message is issued to the sender of the packet.

18.1.3 Options

In this menu, you can disable or enable the IPv4 firewall and can log its activities. In addition, you can define after how many seconds of inactivity a session shall be ended.



Note

The IPv6 firewall is always active and cannot be disabled.

The menu **Firewall->Policies->Options** consists of the following fields:

Fields in the Global Firewall Options menu

Field	Description
IPv4 Firewall Status	Enable or disable the IPv4 firewall function. The function is enabled with <i>Enabled</i> The function is enabled by default.
Logged Actions	Select the firewall syslog level. The messages are output together with messages from other subsystems. Possible values: <ul style="list-style-type: none"> • <i>All</i> (default value): All firewall activities are displayed. • <i>Deny</i>: Only reject and deny events are shown, see "Action". • <i>Accept</i>: Only accept events are shown.

Field	Description
	<ul style="list-style-type: none"> <i>None</i>: Syslog messages are not generated.
IPv4 Full Filtering	<p>With TCP sessions, the SIF first verifies if a session has been established completely and correctly. Incomplete sessions will be blocked. The filtering itself is carried out in a second step. The default setting IPv4 Full Filtering has been designed to meet this "standard" case.</p> <p>If - in a two-way communication - one traffic direction is sent through the router, but the counter direction takes a different route, the session is interpreted as "incomplete" by the SIF, and the data traffic of this connection will be blocked by the router.</p> <p>In order to allow the data traffic of such "incomplete" sessions in the special case of identical source and destination interface you have to disable IPv4 Full Filtering. SIF rules for this data traffic will be ignored.</p>
STUN Handler	<p>Enable this option if you intend to allow network devices (esp. SIP clients) to use STUN in order to identify the network address translation mode and the public IP address. The firewall creates temporary rules that allow RTP data traffic for SIP phone calls.</p>
Port STUN server	<p>Only for STUN Handler= Enabled</p> <p>Enter the number of the port to be used for the connection to the STUN server.</p> <p>The default value is 3478. A 5 digit sequence is possible.</p>

Fields in the **Session Timer** menu.

Field	Description
UDP Inactivity	<p>Enter the inactivity time after which a UDP session is to be regarded as expired (in seconds).</p> <p>Possible values are <i>30</i> to <i>86400</i>.</p> <p>The default value is <i>180</i>.</p>
TCP Inactivity	<p>Enter the inactivity time after which a TCP session is to be regarded as expired (in seconds).</p> <p>Possible values are <i>30</i> to <i>86400</i>.</p>

Field	Description
	The default value is <i>3600</i> .
PPTP Inactivity	Enter the inactivity time after which a PPTP session is to be regarded as expired (in seconds). Possible values are <i>30</i> to <i>86400</i> . The default value is <i>86400</i> .
Other Inactivity	Enter the inactivity time after which a session of another type is to be regarded as expired (in seconds). Possible values are <i>30</i> to <i>86400</i> . The default value is <i>30</i> .

Fields in the **Factory Reset Firewall**

Field	Description
Factory Reset Firewall	Click Reset to reset the firewall to factory defaults.

18.2 Interfaces

18.2.1 IPv4 Groups

A list of all configured IPv4 interface routes is displayed in the **Firewall->Interfaces->IPv4 Groups** menu.

You can group together the interfaces of your device. This makes it easier to configure firewall rules.

18.2.1.1 New

Choose the **New** button to set up new IPv4 interface groups.

The menu **Firewall->Interfaces->IPv4 Groups->New** consists of the following fields:

Fields in the **Basic Parameters** menu.

Field	Description
Description	Enter the desired description of the IPv4 interface group.

Field	Description
Members	Select the members of the group from the available interfaces. To do this, activate the field in the Selection column.

18.2.2 IPv6 Groups

A list of all configured IPv6 interface routes is displayed in the **Firewall->Interfaces+IPv6 Groups** menu.

You can group together the IPv6 interfaces of your device. This makes it easier to configure firewall rules.

18.2.2.1 New

Choose the **New** button to set up new IPv6 interface groups.

The menu **Firewall->Interfaces->IPv6 Groups->New** consists of the following fields

Fields in the Basic Parameters menu.

Field	Description
Description	Enter the desired description of the IPv6 interface group.
Members	Select the members of the group from the available interfaces. To do this, activate the field in the Selection column.

18.3 Addresses

18.3.1 Address List

A list of all configured addresses is displayed in the **Firewall->Addresses->Address List** menu.

18.3.1.1 New

Choose the **New** button to create additional addresses.

The menu **Firewall->Addresses->Address List->New** consists of the following fields:

Fields in the Basic Parameters menu.

Field	Description
Description	Enter the desired description of the address.
IPv4	Allows configuration of IPv4 address lists. The function is enabled with <i>Enabled</i> . The function is enabled by default.
Address Type	Only for IPv4 = <i>Enabled</i> Select the type of address you want to specify. Possible values: <ul style="list-style-type: none"> • <i>Address / Subnet</i> (default value): Enter an IP address with subnet mask. • <i>Address Range</i>: Enter an IP address range with a start and end address.
Address / Subnet	Only for IPv4 = <i>Enabled</i> and Address Type = <i>Address / Subnet</i> Enter the IP address of the host or a network address and the related netmask. The default value is <i>0.0.0.0</i> .
IPv6	Allows configuration of IPv6 address lists. The function is enabled with <i>Enabled</i> . The function is disabled by default.
Address / Prefix	Only for IPv6 = <i>Enabled</i> Enter IPv6 address and the related prefix.

18.3.2 Groups

A list of all configured address groups is displayed in the **Firewall->Addresses->Groups** menu.

You can group together addresses. This makes it easier to configure firewall rules.

18.3.2.1 New

Choose the **New** button to set up additional address groups.

The menu **Firewall->Addresses->Groups->New** consists of the following fields:



Fields in the Basic Parameters menu.

Field	Description
Description	Enter the desired description of the address group.
IP Version	Select the IP version used. Possible values: <ul style="list-style-type: none"> • <i>IPv4</i> • <i>IPv6</i> <i>IPv4</i> is selected by default.
Selection	Select the members of the group from the available Addresses . To do this, activate the Fields in the Selection column.

18.4 Services

18.4.1 Service List

In the **Firewall->Services->Service List** menu, a list of all available services is displayed.

Choose the  icon to edit existing entries. You can delete existing entries with the icon .



Note

Service is also removed from NAT service list! Recreation possible only by factory reset.

18.4.1.1 New

Choose the **New** button to set up additional services.

The menu **Firewall->Services->Service List->New** consists of the following fields:

Fields in the Basic Parameters menu.

Field	Description
Description	Enter an alias for the service you want to configure.
Protocol	Select the protocol on which the service is to be based. The most important protocols are available for selection.
Destination Port Range	<p>Only for Protocol = <i>TCP</i>, <i>UDP/TCP</i> or <i>UDP</i></p> <p>In the first field, enter the destination port via which the service is to run.</p> <p>If a port number range is specified, in the second field enter the last port of the port range. By default the field does not contain an entry. If a value is displayed, this means that the previously specified port number is verified. If a port range is to be checked, enter the upper limit here.</p> <p>Possible values are 1 to 65535.</p>
Source Port Range	<p>Only for Protocol = <i>TCP</i>, <i>UDP/TCP</i> or <i>UDP</i></p> <p>In the first field, enter the source port to be checked, if applicable.</p> <p>If a port number range is specified, in the second field enter the last port of the port range. By default the field does not contain an entry. If a value is displayed, this means that the previously specified port number is verified. If a port range is to be checked, enter the upper limit here.</p> <p>Possible values are 1 to 65535.</p>
Type	<p>Only for Protocol = <i>ICMP</i></p> <p>The Type field shows the class of ICMP messages, the Code field specifies the type of message in greater detail.</p> <p>Possible values:</p> <ul style="list-style-type: none"> • <i>Any</i> (default value) • <i>Echo Reply</i> • <i>Destination unreachable</i> • <i>Source Quench</i>

Field	Description
	<ul style="list-style-type: none"> • <i>Redirect</i> • <i>Echo</i> • <i>Time Exceeded</i> • <i>Parameter Problem</i> • <i>Timestamp</i> • <i>Timestamp Reply</i> • <i>Information Request</i> • <i>Information Reply</i> • <i>Address Mask Request</i> • <i>Address Mask Reply</i>
Code	<p>Selection options for the ICMP codes are only available for Type = <i>Destination unreachable</i></p> <p>Possible values:</p> <ul style="list-style-type: none"> • <i>Any (default value)</i> • <i>Net Unreachable</i> • <i>Host Unreachable</i> • <i>Protocol Unreachable</i> • <i>Port Unreachable</i> • <i>Fragmentation Needed</i> • <i>Communication with Destination Network is Administratively Prohibited</i> • <i>Communication with Destination Host is Administratively Prohibited</i>

18.4.2 Groups

A list of all configured service groups is displayed in the **Firewall->Services->Groups** menu.

You can group together services. This makes it easier to configure firewall rules.

18.4.2.1 New

Choose the **New** button to set up additional service groups.

The menu **Firewall->Services->Groups->New** consists of the following fields:

Fields in the **Basic Parameters** menu.

Field	Description
Description	Enter the desired description of the service group.
Members	Select the members of the group from the available service aliases. To do this, activate the Fields in the Selection column.

18.5 Configuration

18.5.1 SIF - Configuration example

Requirements

- Internet connection
- Your LAN must be connected to one of ports 1, 2, 3 or 4 on the gateway.

Example scenario

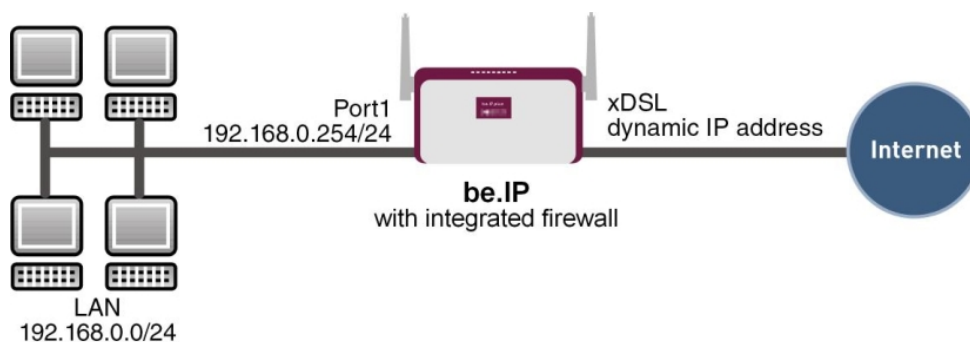

Configuration target

- Only certain Internet services are to be available for the staff of a company (HTTP, HTTPS, FTP, DNS).
- The gateway should operate as a DNS proxy, which means that the clients use the gateway as a DNS server.
- Only the system administrator and the director should be able to establish an HTTP and a Telnet connection to the gateway.

- The director must be able to use all services in the Internet..
- All other data traffic will be blocked.



Important

An incorrect configuration of the firewall can significantly disrupt the functionality of the gateway or drop the connections.

The usual principle for firewalls also applies: Everything that is not explicitly allowed is prohibited.

This means accurate planning of the filter rules and filter rule chain is necessary to ensure correct operation.

Overview of Configuration Steps

Aliases for IP addresses and network address

Field	Menu	Value
Description	Firewall-> Addresses ->Address List-> New	e.g. <i>Administrator</i>
Address Type	Firewall ->Addresses-> Address List ->New	<i>Address / Subnet</i>
Address / Subnet	Firewall-> Addresses ->Address List-> New	e.g. <i>192.168.0.2</i> with <i>255.255.255.255</i>
Description	Firewall-> Addresses ->Address List ->New	e.g. <i>Director</i>
Address Type	Firewall-> Addresses ->Address List-> New	<i>Address / Subnet</i>
Address / Subnet	Firewall ->Addresses-> Address List ->New	e.g. <i>192.168.0.3</i> with <i>255.255.255.255</i>
Description	Firewall-> Addresses ->Address List-> New	e.g. <i>be.IP</i>
Address Type	Firewall-> Addresses ->Address List ->New	<i>Address / Subnet</i>
Address / Subnet	Firewall-> Addresses ->Address List-> New	e.g. <i>192.168.0.254</i> with <i>255.255.255.255</i>
Description	Firewall ->Addresses-> Address List ->New	e.g. <i>Network Internal</i>

Field	Menu	Value
Address Type	Firewall-> Addresses ->Address List-> New	Address / Subnet
Address / Subnet	Firewall-> Addresses ->Address List ->New	e.g. 192.168.0.0 with 255.255.255.0

Address groups

Field	Menu	Value
Description	Gro Firewall->Addresses->ups->New	e.g. be.IP
IP Version	Gro Firewall->Addresses->ups->New	IPv4
Selection	Gro Firewall->Addresses->ups->New	e.g. Administrator and Director

Service Sets

Field	Menu	Value
Description	Group Ne Firewall->Services->s->w	e.g. Internet Ports
Members	Group Ne Firewall->Services->s->w	e.g. http, http (SSL) and ftp
Description	Group Ne Firewall->Services->s->w	e.g. Administration Ports
Members	Group Ne Firewall->Services->s->w	e.g. http and telnet

Filter rules 1: Manage Gateway (System administrator)

Field	Menu	Value
Source Location	Firewall ->Policies ->IPv4 Filter Rules-> New	be.IP
Destination	Firewall-> Policies ->IPv4 Filter Rules-> New	be.IP

Field	Menu	Value
Service	Firewall ->Policies ->IPv4 Filter Rules-> New	<i>Administration Ports</i>
Action	Firewall-> Policies ->IPv4 Filter Rules-> New	<i>Access</i>

Filter rules 2: Use gateway as DNS proxy

Field	Menu	Value
Source Location	Firewall ->Policies->IPv4 Filter Rules-> New	<i>LOCAL</i>
Destination	Firewall-> Policies-> IPv4 Filter Rules-> New	<i>ANY</i>
Service	Firewall ->Policies->IPv4 Filter Rules-> New	<i>dns</i>
Action	Firewall-> Policies-> IPv4 Filter Rules-> New	<i>Access</i>
Source Location	Firewall ->Policies->IPv4 Filter Rules-> New	<i>Netzwerk_Intern</i>
Destination	Firewall-> Policies-> IPv4 Filter Rules-> New	<i>be.IP</i>
Service	Firewall ->Policies->IPv4 Filter Rules-> New	<i>dns</i>
Action	Firewall-> Policies-> IPv4 Filter Rules-> New	<i>Access</i>

Filter rules 3: Deny access from outside to the Gateway

Field	Menu	Value
Source Location	Firewall ->Policies->IPv4 Filter Rules-> New	<i>ANY</i>
Destination	Firewall-> Policies-> IPv4 Filter Rules-> New	<i>be.IP</i>
Service	Firewall ->Policies->IPv4 Filter Rules-> New	<i>any</i>
Action	Firewall-> Policies-> IPv4 Filter Rules-> New	<i>Deny</i>

Filter rules 4: Allow access to all services on the Internet (Director)

Field	Menu	Value
Source Location	Firewall ->Policies->IPv4	<i>Director</i>

Field	Menu	Value
	Filter Rules-> New	
Destination	Firewall-> Policies-> IPv4 Filter Rules-> New	<i>ANY</i>
Service	Firewall ->Policie s->IPv4 Filter Rules-> New	<i>any</i>
Action	Firewall-> Policies-> IPv4 Filter Rules-> New	<i>Access</i>

Filter rules 5: Allow access to the Internet (Staff)

Field	Menu	Value
Source Location	Firewall ->Policie s->IPv4 Filter Rules-> New	<i>Network_Internal</i>
Destination	Firewall-> Policies-> IPv4 Filter Rules-> New	<i>ANY</i>
Service	Firewall ->Policie s->IPv4 Filter Rules-> New	<i>Internet Ports</i>
Action	Firewall-> Policies-> IPv4 Filter Rules-> New	<i>Access</i>

Chapter 19 Local Services

This menu offers services for the following application areas:

- Name resolution (DNS)
- Configuration via web browser (HTTPS)
- Locating of dynamic IP addresses using a DynDNS provider
- Configuration of gateway as a DHCP server (assignment of IP addresses)
- Assignment of incoming and outgoing data and voice calls to authorised users (CAPI server)
- Automation of tasks according to schedule (scheduling)
- Alive checks for hosts or interfaces, ping tests
- Realtime video/audio conferences (Messenger services, universal plug & play)
- Provision of public Internet accesses (hotspot).
- Start network devices that are switched off via an integrated network card (Wake-On-LAN)
- Data traffic of a specific interface (Trace Interface)

19.1 DNS

Each device in a TCP/IP network is usually located by its IP address. Because host names are often used in networks to reach different devices, it is necessary for the associated IP address to be known. This task can be performed by a DNS server, which resolves the host names into IP addresses. Alternatively, name resolution can also take place over the HOSTS file, which is available on all PCs.

Your device offers the following options for name resolution:

- DNS Proxy, for forwarding DNS requests sent to your device to a suitable DNS server. This also includes specific forwarding of defined domains (Forwarded Domains).
- DNS cache, for saving the positive and negative results of DNS requests.
- Static entries (static hosts), to manually define or prevent assignments of IP addresses to names.
- DNS monitoring (statistics), to provide an overview of DNS requests on your device.

Name server

Under **Local Services->DNS->DNS Servers->New** you enter the IP addresses of name servers that are queried if your device cannot answer requests itself or by forwarding entries. Global name servers and name servers that are attached to an interface can both be entered.

Your device can also receive the name servers attached to an interface dynamically via PPP or DHCP and transfer them dynamically if necessary.

Strategy for name resolution on your device

A DNS request is handled by your device as follows:

- (1) If possible, the request is answered directly from the static or dynamic cache with IP address or negative response.
- (2) Otherwise, if a suitable forwarding entry exists, the relevant DNS server is asked, depending on the configuration of the Internet or dialin connections, if necessary by setting up a WAN connection at extra cost. If the DNS server can resolve the name, the information is forwarded and a dynamic entry created in the cache.
- (3) Otherwise, if name servers have been entered, taking into account the priority configured and if the relevant interface status is "up", the primary DNS server is queried and then the secondary DNS server. If one of the DNS servers can resolve the name, the information is forwarded and a dynamic entry created in the cache.
- (4) Otherwise, if a suitable Internet or dialin connection is selected as the standard interface, the relevant DNS server is asked, depending on the configuration of the Internet or dialin connections, if necessary by setting up a WAN connection at extra cost. If one of the DNS servers can resolve the name, the information is forwarded and a dynamic entry created in the cache.
- (5) Otherwise, if overwriting the addresses of the global name servers is allowed in the **WAN->Internet + Dialup** menu (**Interface Mode** = *Dynamic*), a connection is set up – if necessary at extra cost – to the first Internet or dialin connection configured to enable DNS server addresses to be requested from DNS servers (**DNS Negotiation** = *Enabled*), if this has not been already attempted. When the name servers have been negotiated successfully, these name servers are then available for more queries.
- (6) Otherwise the initial request is answered with a server error.

If one of the DNS servers answers with `non-existent domain`, the initial request is immediately answered accordingly and a corresponding negative entry is made in the DNS cache of your device.

19.1.1 Global Settings

The menu **Local Services->DNS->Global Settings** consists of the following fields:

Fields in the Basic Parameters menu

Field	Description
Domain Name	Enter the standard domain name of your device.
WINS Server	Enter the IP address of the first and, if necessary, alternative global Windows Internet Name Server (=WINS) or NetBIOS Name Server (=NBNS).
Primary	
Secondary	

The menu **Advanced Settings** consists of the following fields:

Fields in the Advanced Settings menu

Field	Description
Positive Cache	<p>Select whether the positive dynamic cache is to be activated, i.e. successfully resolved names and IP addresses are to be stored in the cache.</p> <p>The function is activated by selecting <i>Enabled</i>.</p> <p>The function is enabled by default.</p>
Negative Cache	<p>Select whether the negative dynamic cache is to be activated, i.e. whether queried names for which a DNS server has sent a negative response are stored as negative entries in the cache.</p> <p>The function is activated by selecting <i>Enabled</i>.</p> <p>The function is enabled by default.</p>
Cache Size	<p>Enter the maximum total number of static and dynamic entries.</p> <p>Once this value is reached, the dynamic entry not requested for the longest period of time is deleted when a new entry is added. Cache Size is reduced by the user, dynamic entries are deleted if necessary. Statistical entries are not deleted. Cache Size cannot be set to lower than the current number of static entries.</p> <p>Possible values: <i>0.. 1000</i>.</p> <p>The default value is <i>100</i>.</p>
Maximum TTL for Positive Cache Entries	Enter the value to which the TTL is to be set for a positive dynamic DNS entry in the cache if its TTL is <i>0</i> or its TTL exceeds

Field	Description
	<p>the value for Maximum TTL for Positive Cache Entries.</p> <p>The default value is <i>86400</i>.</p>
Maximum TTL for Negative Cache Entries	<p>Enter the value set to which the TTL is to be set in the case of a negative dynamic entry in the cache.</p> <p>The default value is <i>86400</i>.</p>
Fallback interface to get DNS server	<p>Select the interface to which a connection is set up for name server negotiation if other name resolution attempts were not successful.</p> <p>The default value is <i>Automatic</i>, i.e. a one-time connection is set up to the first suitable connection partner configured in the system.</p>

Fields in the IP address to use for DNS/WINS server assignment menu

Field	Description
As DHCP Server	<p>Select which name server addresses are sent to the DHCP client if your device is used as DHCP server.</p> <p>Possible values:</p> <ul style="list-style-type: none"> • <i>None</i>: No name server address is sent. • <i>Own IP Address</i> (default value): The address of your device is transferred as the name server address. • <i>DNS Setting</i>: The addresses of the global name servers entered on your device are sent.
As IPCP Server	<p>Select which name server addresses are to be transmitted by your device in the event of dynamic server name negotiation if your device is used as the IPCP server for PPP connections.</p> <p>Possible values:</p> <ul style="list-style-type: none"> • <i>None</i>: No name server address is sent. • <i>Own IP Address</i>: The address of your device is transferred as the name server address. • <i>DNS Setting</i> (default value): The addresses of the global name servers entered on your device are sent.

19.1.2 DNS Servers

A list of all configured DNS servers is displayed in the **Local Services->DNS->DNS Servers** menu.

19.1.2.1 Edit or New

Choose the  icon to edit existing entries. Select the **New** button to set up additional DNS servers.

Here you can configure both global DNS servers and DNS servers that are to be assigned to a particular interface.

Configuring a DNS server for a particular interface can be useful, for example, if accounts with different providers have been set up via different interfaces and load balancing is being used.

The **Local Services->DNS->DNS Servers->New** menu consists of the following fields:

Fields in the **Basic Parameters** menu.

Field	Description
Admin Status	Select whether the DNS server should be enabled. The function is activated by selecting <i>Enabled</i> . The function is enabled by default.
Description	Enter a description for DNS server.
Priority	Assign a priority to the DNS server. You can assign more than one pair of DNS servers (Primary DNS Server and Secondary DNS Server) to an interface (i. e. for example, to an Ethernet port or a PPPoE WAN partner) or to multiple interfaces. The pair with the highest priority is used if the interface is "up". Possible values from 0 (highest priority) to 9 (lowest priority). The default value is 5.
Interface Mode	Select whether the IP addresses of name servers for resolving the names of Internet addresses are to be obtained automatically or whether up to two fixed DNS server addresses are to be

Field	Description
	<p>entered, depending on the priority.</p> <p>Possible values:</p> <ul style="list-style-type: none"> • <i>Static</i> • <i>Dynamic</i> (default value)
Interface	<p>Select the interface to which the DNS server pair is to be assigned.</p> <p>The selected interface is relevant for outgoing DNS requests. This interface is used for DNS requests directed at the router or generated by the router itself.</p> <p>For Interface Mode = <i>Static</i></p> <p>A DNS server is configured for all interfaces with the <i>Any</i> setting.</p>
IP Version	<p>Select the IP version used.</p> <p>Possible values:</p> <ul style="list-style-type: none"> • <i>IPv4</i> • <i>IPv6</i> <p><i>IPv4</i> is selected by default.</p>
Primary IPv4 DNS Server	<p>Only if Interface Mode = <i>Static</i></p> <p>Enter the IPv4 address of the first name server for Internet address name resolution.</p>
Secondary IPv4 DNS Server	<p>Only if Interface Mode = <i>Static</i></p> <p>Optionally, enter the IPv4 address of an alternative name server.</p>
Primary IPv6 DNS Server	<p>Only if Interface Mode = <i>Static</i></p> <p>Enter the IPv6 address of the first name server for Internet address name resolution.</p>
Secondary IPv6 DNS Server	<p>Only if Interface Mode = <i>Static</i></p>

Field	Description
	Optionally, enter the IPv6 address of an alternative name server.

19.1.3 Static Hosts

A list of all configured static hosts is displayed in the **Local Services->DNS->Static Hosts** menu.

19.1.3.1 New

Choose the **New** button to set up new static hosts.

The menu **Local Services->DNS->Static Hosts->New** consists of the following fields:

Fields in the Basic Parameters menu.

Field	Description
Default Domain	Here, the domain is displayed that you have specified in the menu DNS->Global Settings as Domain Name.
DNS Hostname	<p>Enter the host name to which the IP Address defined in this menu is to be assigned if a positive response is sent upon a DNS request. If a negative response is sent upon a DNS request, no address is specified.</p> <p>The entry can also start with the wildcard *, e.g. *.bintec-elmeg.com.</p> <p>If you specify a simple name (e.g. <i>router</i>), it is expanded by the Default Domain to form a complete DNS name (Fully Qualified Domain Name, FQDN). If you enter a name with the structure of a FQDN (i.e. character sequences separated by "."), the entry is interpreted as a FQDN and is not expanded. The closing "." which is mandatory for a complete FQDN is automatically appended if required.</p> <p>Entries with spaces are not allowed.</p>
Response	<p>In this entry, select the type of response to DNS requests.</p> <p>Possible values:</p> <ul style="list-style-type: none"> • <i>Negative</i>: A DNS request for DNS Hostname gets a negative response.

Field	Description
	<ul style="list-style-type: none"> • <i>Positive</i> (default value): A DNS request for DNS Hostname is answered with the related IP Address. • <i>None</i>: A DNS request is ignored; no answer is given.
IPv4 Address	<p>Only if Response = <i>Positive</i></p> <p>Enter the IPv4 address assigned to DNS Hostname.</p>
IPv6 Address	<p>Only if Response = <i>Positive</i></p> <p>Enter the IPv6 address assigned to DNS Hostname.</p>

19.1.4 Domain Forwarding

In the **Local Services->DNS->Domain Forwarding** menu, a list of all configured forwardings for defined domains is displayed.

19.1.4.1 New

Choose the **New** button to set up additional forwardings.

The menu **Local Services->DNS->Domain Forwarding->New** consists of the following fields:

Fields in the Forwarding Parameters menu.

Field	Description
Forward	<p>Select whether requests for a host or domain are to be forwarded.</p> <p>Possible values:</p> <ul style="list-style-type: none"> • <i>Host</i> (default value) • <i>Domain</i>
Host	<p>Only for Forward = <i>Host</i></p> <p>Enter the name of the host for which requests are to be forwarded.</p> <p>If you enter a name without a ".", the entry is supplemented with the name supplied by the value specified in Local Services->DNS->Global Settings for Domain Name as soon</p>

Field	Description
	as you confirm with OK .
Domain	<p>Only for Forward = <i>Domain</i></p> <p>Enter the name of the domain for which requests are to be forwarded.</p> <p>The entry can start with the wildcard "*", e.g. "*.bintec-elmeg.com".</p> <p>If you enter a name without a leading wildcard "*" a leading wildcard "*" is supplemented as soon as you confirm with OK.</p>
Forward to	<p>Select if matching DNS requests are to be forwarded to the DNS server of an Interface or to a manually specified DNS Server.</p> <p>Possible values:</p> <ul style="list-style-type: none"> • <i>Interface</i> (default value): Requests are forwarded to the DNS server assigned to either an automatically selected or to a user-selected interface. • <i>DNS Server</i>: Requests are forwarded to the specified DNS Server.
Destination Interface	<p>Only for Forward to = <i>Interface</i></p> <p>Select the interface that has the DNS server assigned which is to receive the DNS requests.</p>
Source Interface	<p>Here you can select the DNS request source interface for domain forwarding. This option is available for forwarding to an interface as well as to specific DNS servers. It allows you to send DNS requests from different network segments to different DNS servers. For example, you can forward the requests from your guest network to a webfilter DNS and deny access to undesired content.</p>
Primary DNS Server (IPv4/IPv6)	<p>Only for Forward to = <i>DNS Server</i></p> <p>Enter the IPv4/IPv6 address of the primary DNS server.</p>
Secondary DNS Server (IPv4/IPv6)	<p>Only for Forward to = <i>DNS Server</i></p> <p>Enter the IPv4/IPv6 address of the secondary DNS server.</p>

19.1.5 Dynamic Hosts

In the menu **Local Services->DNS->Dynamic Hosts**, you can find relevant information on dynamic DNS entries.

19.1.6 Cache

In the **Local Services->DNS->Cache** menu, a list of all available cache entries is displayed.

You can select individual entries using the checkbox in the corresponding line, or select them all using the **Select all** button.

A dynamic entry can be converted to a static entry by marking the entry and confirming with **Make static**. This corresponding entry disappears from the list and is displayed in the list in the **Static Hosts** menu. The TTL is transferred.

19.1.7 Statistics

In the **Local Services->DNS->Statistics** menu, the following statistical values are displayed:

Fields in the DNS Statistics menu.

Field	Description
Received DNS Packets	Shows the number of received DNS packets addressed direct to your device, including the response packets for forwarded requests.
Invalid DNS Packets	Shows the number of invalid DNS packets received and addressed direct to your device.
DNS Requests	Shows the number of valid DNS requests received and addressed direct to your device.
Cache Hits	Shows the number of requests that were answered with static or dynamic entries from the cache.
Forwarded Requests	Shows the number of requests forwarded to other name servers.
Cache Hitrate (%)	Indicates the number of Cache Hits pro DNS request in percentage.
Successfully Answered Queries	Shows the number of successfully answered requests (positive and negative).
Server Failures	Shows the number of requests that were not answered by any

Field	Description
	name server (either positively or negatively).

19.2 HTTPS

You can operate the user interface of your device from any PC with an up-to-date Web browser via an HTTPS connection.

HTTPS (HyperText Transfer Protocol Secure) is the procedure used to establish an encrypted and authenticated connection by SSL between the browser used for configuration and the device.

19.2.1 HTTPS Server

In the **Local Services->HTTPS->HTTPS Server** menu, configure the parameters of the backed up configuration connection via HTTPS.

The menu consists of the following fields:

Fields in the HTTPS Parameters menu.

Field	Description
HTTPS TCP Port	<p>Enter the port via which the HTTPS connection is to be established.</p> <p>Possible values are 0 to 65535.</p> <p>The default value is 443.</p>
Local Certificate	<p>Select a certificate that you want to use for the HTTPS connection.</p> <p>Possible values:</p> <ul style="list-style-type: none"> • <i>Internal</i> (default value): Select this option if you want to use the certificate built into the device. • <i><Certificate name></i>: Under System Management->Certificates->Certificate List select entered certificate.

19.3 DynDNS Client

The use of dynamic IP addresses has the disadvantage that a host in the network can no longer be found once its IP address has changed. DynDNS ensures that your device can still be reached after a change to the IP address.

The following configuration steps are necessary:

- Registration of a host name at a DynDNS provider
- Configuration of your device

Registration

The registration of a host name means that you define an individual user name for the DynDNS service, e.g. *dyn_client*. The service providers offer various domain names for this, so that a unique host name results for your device, e.g. *dyn_client.provider.com*. The DynDNS provider relieves you of the task of answering all DNS requests concerning the host *dyn_client.provider.com* with the dynamic IP address of your device.

To ensure that the provider always knows the current IP address of your device, your device contacts the provider when setting up a new connection and propagates its present IP address.

19.3.1 DynDNS Update

In the **Local Services->DynDNS Client->DynDNS Update** menu, a list of all configured DynDNS registrations for updating is displayed

19.3.1.1 New

Choose the **New** button to set up further DynDNS registrations to be updated.

The menu **Local Services->DynDNS Client->DynDNS Update->New** consists of the following fields:

Fields in the Basic Parameters menu.

Field	Description
Host Name	Enter the complete host name exactly as registered with the DynDNS provider.

Field	Description
Interface	Select the WAN interface the IP address of which is to be propagated over the DynDNS service (e.g. the interface of the Internet Service Provider).
User Name	Enter the user name as registered with the DynDNS provider.
Password	Enter the password as registered with the DynDNS provider.
Provider	<p>Select the DynDNS provider with which the specified data are registered.</p> <p>A choice of DynDNS providers is already available, and the protocols they use are supported.</p> <p>Other DynDNS providers can be configured in the Local Services->DynDNS Client->DynDNS Provider menu.</p> <p>The default value is <i>DynDNS</i>.</p>
Enable update	<p>Select whether the DynDNS entry configured here is to be activated and the current IP address of the selected interface is to be sent to the provider .</p> <p>The function is activated by selecting <i>Enabled</i>.</p> <p>The function is disabled by default.</p>
HTTPS/SSL	<p>This option is only available if the selected DynDNS provider supports SSL. If required, you can create a new provider supporting this option in the menu Local Services->DynDNS Client->DynDNS Provider.</p> <p>Enable this option in order to create an SSL-encrypted connection between your device and your DynDNS provider.</p> <p>Choosing <i>Enabled</i> activates the option.</p> <p>It is not enabled per default.</p>
Certificate checking	Enable this function in order to verify the SSL certificate of the sever.
IP Version	This option is only available if your selected DynDNS provider provides server addresses for both IP versions. Select the IP version of the address you intend to update with your DynDNS

Field	Description
	<p>provider.</p> <p>Possible values:</p> <p>IPv4</p> <p>IPv6.</p> <p>In order to update the IPv4 as well as the Pv6 address of an interface, create two entries with otherwise identical settings. Inquire with your service provider if they support multiple updates!</p>

The menu **Advanced Settings** consists of the following fields:

Fields in the **Advanced Settings** menu.

Field	Description
Mail Exchanger (MX)	<p>Enter the full host name of a mail server to which e-mails are to be forwarded if the host currently configured is not to receive mail.</p> <p>Ask your provider about this forwarding service and make sure e-mails can be received from the host entered as MX.</p>
Wildcard	<p>Select whether forwarding of all subdomains of the Host Name is to be enabled for the current IP address of the Interface (advanced name resolution).</p> <p>The function is activated by selecting <i>Enabled</i>.</p> <p>The function is disabled by default.</p>

19.3.2 DynDNS Provider

A list of all configured DynDNS providers is displayed in the **Local Services->DynDNS Client->DynDNS Provider** menu.

19.3.2.1 New

Choose the **New** button to set up new DynDNS providers.

The menu **Local Services->DynDNS Client->DynDNS Provider->New** consists of the following fields:

Fields in the Basic Parameters menu.

Field	Description
Provider Name	Enter a name for this entry.
Server	Enter the host name or IP address of the server on which the provider's DynDNS service runs.
Update Path	Enter the path on the provider's server that contains the script for managing the IP address of your device. Ask your provider for the path to be used.
Port	Enter the port at which your device is to reach your provider's server. Ask your provider for the relevant port. The default value is <i>80</i> .
Protocol	Select one of the protocols implemented. Information on which protocol to use can be found in your provider's documentation. Possible values: <ul style="list-style-type: none"> • <i>DynDNS</i> (default value) • <i>Static DynDNS</i> • <i>ODS</i> • <i>HN</i> • <i>DYNS</i> • <i>GnuDIP-HTML</i> • <i>GnuDIP-TCP</i> • <i>Custom DynDNS</i> • <i>DnsExit</i> • <i>dyndnss</i> • <i>dyndns2</i>
Update Interval	Enter the minimum time (in seconds) that your device must wait before it is allowed to propagate its current IP address to the DynDNS provider again. The default value is <i>300</i> seconds.

Field	Description
IPv6 server	Specify the host name or IPv6 address of the DynDNS provider if you intend to update an IPv6 address.
Supports SSL	Enable support of SSL for securing data traffic between your device and the DynDNS provider. The option is disabled per default.
Homepage	Here you can specify a web address that will take you to the page of the provider.

19.4 DHCP Server

You can configure your device as a DHCP (Dynamic Host Configuration Protocol) server.

Your device and each PC in your LAN requires its own IP address. One option for allocating IP addresses in your LAN is the Dynamic Host Configuration Protocol (DHCP). If you configure your device as a DHCP server, the device automatically assigns IP addresses to requesting PCs in the LAN from a predefined IP address pool.

If a client requires an IP address for the first time, it sends a DHCP request (with its MAC address) to the available DHCP server as a network broadcast.* The client then receives its IP address from bintec elmeg (as part of a brief exchange).

You therefore do not need to allocate fixed IP addresses to PCs, which reduces the amount of configuration work in your network. To do this, you set up a pool of IP addresses, from which your device assigns IP addresses to hosts in the LAN for a defined period of time. A DHCP server also transfers the addresses of the domain name server entered statically or by PPP negotiation (DNS), NetBIOS name server (WINS) and default gateway.

For specific instructions how to use your device as a DHCP server, DHCP client or DHCP relay agent, see the end of the chapter [DHCP - Configuration example](#) on page 349.

19.4.1 IP Pool Configuration

The **Local Services->DHCP Server->IP Pool Configuration** menu displays a list of all the configured IP pools. This list is global and also displays pools configured in other menus.

19.4.1.1 Edit or New

Choose the **New** button to set up new IP address pools. Choose the  icon to edit existing entries.

Fields in the menu **Basic Parameters**

Field	Description
IP Pool Name	Enter any description to uniquely identify the IP pool.
IP Address Range	Enter the first (first field) and last (second field) IP address of the IP address pool.
DNS Server	<p>Primary: Enter the IP address of the DNS server that is to be used, preferably, by clients who draw an address from this pool.</p> <p>Secondary: Optionally, enter the IP address of an alternative DNS server.</p>

19.4.2 DHCP Configuration

To activate your device as a DHCP server, you must first define IP address pools from which the IP addresses are distributed to the requesting clients.

A list of all configured DHCP pools is displayed in the **Local Services->DHCP Server->DHCP Configuration** menu.

In the list, for each entry, you have the possibility under **Status** of enabling or disabling the configured DHCP pools.



Note

In the ex works state the DHCP pool is preconfigured with the IP addresses 192.168.0.10 to 192.168.0.49 and is used if there is no other DHCP server available in the network.

19.4.2.1 Edit or New

Choose the **New** button to set up new DHCP pools. Choose the  icon to edit existing entries.

The **Local Services->DHCP Server->DHCP Configuration->New** menu consists of the

following fields:

Fields in the menu **Basic Parameters**

Field	Description
Interface	<p>Select the interface over which the addresses defined in IP Pool Name are to be assigned to DHCP clients.</p> <p>When a DHCP request is received over this Interface, one of the addresses from the address pool is assigned.</p>
IP Pool Name	Select an IP pool name configured in the Local Services->DHCP Server->IP Pool Configuration menu.
Pool Usage	<p>Select if the DHCP pool is to be used for requests from clients in a network directly connected to an Ethernet interface, or if it is to be used for DHCP requests from a remote network that are sent to your device via a DHCP relay station.</p> <p>In the second case, it is possible to use an IP address pool for the remote network.</p> <p>Possible values:</p> <ul style="list-style-type: none"> • <i>Local</i> (default value): The DHCP pool is only used for DHCP requests from a network directly connected to an Ethernet interface. • <i>Relay</i>: The DHCP pool is only used for DHCP requests forwarded from remote networks. • <i>Local/Relay</i>: The DHCP pool can be used for both kinds of requests.
Description	Enter any description to uniquely identify the DHCP pool.

The menu **Advanced Settings** consists of the following fields:

Fields in the menu **Advanced Settings**

Field	Description
Gateway	<p>Select which IP address is to be transferred to the DHCP client as gateway.</p> <p>Possible values:</p> <ul style="list-style-type: none"> • <i>Use router as gateway</i> (default value): Here, the IP address defined for the Interface is transferred.

Field	Description
	<ul style="list-style-type: none"> • <i>No gateway</i>: No IP address is sent. • <i>Specify</i>: Enter the corresponding IP address.
Lease Time	<p>Enter the length of time (in minutes) for which an address from the pool is to be assigned to a host.</p> <p>After the Lease Time expires, the address can be reassigned by the server.</p> <p>The default value is <i>120</i>.</p>
DHCP Options	<p>Specify which additional data is forwarded to the DHCP client.</p> <p>Possible values for Option:</p> <ul style="list-style-type: none"> • <i>Time Server</i> (default value): Enter the IP address of the time server to be sent to the client. • <i>DNS Server</i>: Enter the IP address of the DNS server to be sent to the client. • <i>DNS Domain Name</i>: Enter the DNS domain to be sent to the client. • <i>WINS/NBNS Server</i>: Enter the IP address of the WINS/NBNS server to be sent to the client. • <i>WINS/NBT Node Type</i>: Select the type of the WINS/NBT node to be sent to the client. • <i>TFTP Server</i>: Enter the IP address of the TFTP server to be sent to the client. • <i>CAPWAP Controller</i>: Enter the IP address of the CAPWAP controller to be sent to the client. • <i>URL (provisioning server)</i>: This option enables you to send a client any URL. <p>Use this option to send querying IP1x0 telephones the URL of the provisioning server if the telephones are to be provisioned automatically. The URL then needs to take the form <i>http://<IP address of the provisioning server>/eg_prov</i>.</p> <p>Multiple entries are possible. Add additional entries with the Add button.</p>

Vendor Specific Information (DHCP Option 43)

The options for a **Vendor String** or a vendor-specific group of DHCP options (**Vendor Group**) enable you to transmit any manufacturer-specific information or configuration parameters to DHCP clients. You can also define entire groups of DHCP options to be transmitted.



Note

For some products settings have already been predefined in this section. These are required for the seamless integration of telephones or LTE access routers and should not be changed or deleted.

Choose the  icon to edit an existing entry or one of the **Add** buttons to add an entry. In the popup menu, you configure manufacturer-specific settings in the DHCP server for specific telephones, for example.

Fields in the Basic Parameters menu for vendor strings

Field	Description
Select vendor	Here, you can select for which manufacturer specific values shall be transmitted for the DHCP server. Possible values: <ul style="list-style-type: none"> • <i>Other</i> (default value) • <i>-bintec-</i>
APN	Only für Select vendor = <i>-bintec-</i> Enter the Access Point Namen (APN) of the SIM card.
PIN	Only für Select vendor = <i>-bintec-</i> Enter the PIN of the SIM card.
Vendor Description	Only für Select vendor = <i>Other</i> Type in the name of the manufacturer for which you want to transfer specific DHCP server settings.
Vendor ID	Only für Select vendor = <i>Other</i> To identify the device, enter the manufacturer ID.

Field	Description
Vendor Option String	Only für Select vendor = <i>Other</i> Enter the manufacturer specific configuration parameters.

Fields in the Basic Parameters menu for vendor groups

Field	Description
Select vendor	Here, you can select for which manufacturer specific values shall be transmitted for the DHCP server. Possible values: <ul style="list-style-type: none"> • <i>Siemens</i> (default value) • <i>Other</i>
Provisioning Server	Only für Select vendor = <i>Siemens</i> Enter which manufacturer value shall be transmitted. For the setting Select vendor = <i>Siemens</i> , the default value <i>sdlp</i> is displayed. You can complete the IP address of the desired server.
Vendor Description	Only für Select vendor = <i>Other</i> Type in the name of the manufacturer for which you want to transfer specific DHCP server settings.
Vendor ID	Only für Select vendor = <i>Other</i> To identify the device, enter the manufacturer ID.
Custom DHCP Options	Only für Select vendor = <i>Other</i> Use Add to add more entries. You can add custom DHCP options.

19.4.3 IP/MAC Binding

The **Local Services->DHCP Server->IP/MAC Binding** menu displays a list of all clients that received an IP address from your device via DHCP.

You can allocate an IP address from a defined IP address pool to specific MAC addresses.

You can do this by selecting the **Static Binding** option in the list to convert a list entry as a fixed binding, or you manually create a fixed IP/MAC binding by configuring this in the **New** sub-menu.



Note

You can only create new static IP/MAC bindings if IP address ranges were configured in **Local Services->DHCP Server->IP Pool Configuration**, and in the **Local Services->DHCP Server->DHCP Configuration** menu a valid IP Pool is assigned to the DHCP server.

19.4.3.1 New

Choose the **New** button to set up new IP/MAC bindings.

The menu **Local Services->DHCP Server->IP/MAC Binding->New** consists of the following fields:

Fields in the **Basic Parameters** menu.

Field	Description
Description	Enter the name of the host to which the MAC Address the IP Address is to be bound. A character string of up to 256 characters is possible.
IP Address	Enter the IP address to be assigned to the MAC address specified in MAC Address is to be assigned.
MAC Address	Enter the MAC address to which the IP address specified in IP Address is to be assigned.

19.4.4 DHCP Relay Settings

If your device for the local network does not distribute any IP addresses to the clients by DHCP, it can still forward the DHCP requests on behalf of the local network to a remote DHCP server. The DHCP server then assigns the your device an IP address from its pool, which in turn sends this to the client in the local network.

The menu **Local Services->DHCP Server->DHCP Relay Settings** consists of the following fields:

Fields in the Basic Parameters menu.

Field	Description
Primary DHCP Server	Enter the IP address of a server to which BootP or DHCP requests are to be forwarded. The default value is 0.0.0.0.
Secondary DHCP Server	Enter the IP address of an alternative BootP or DHCP server. The default value is 0.0.0.0.

19.4.5 DHCP - Configuration example**Requirements**

- An optional DHCP server

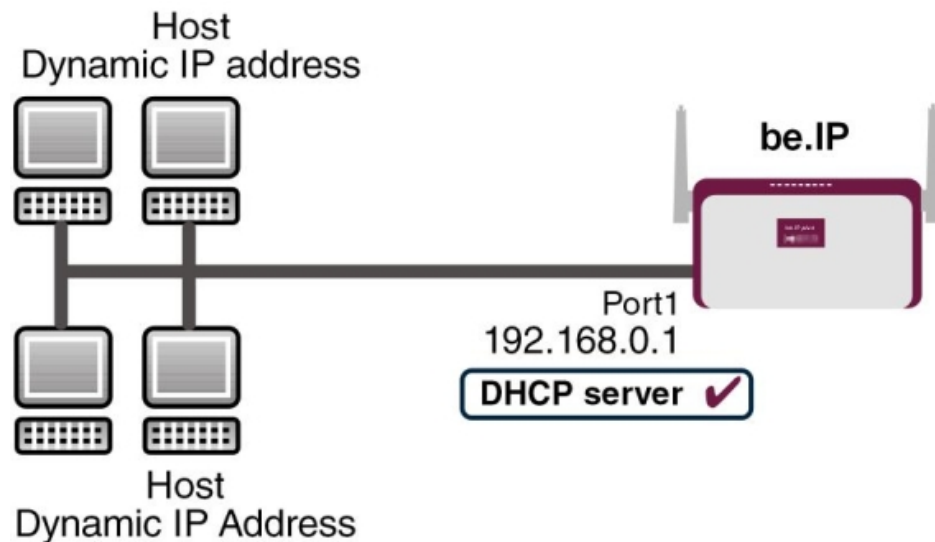
Example scenaria

Example scenario as DHCP Server

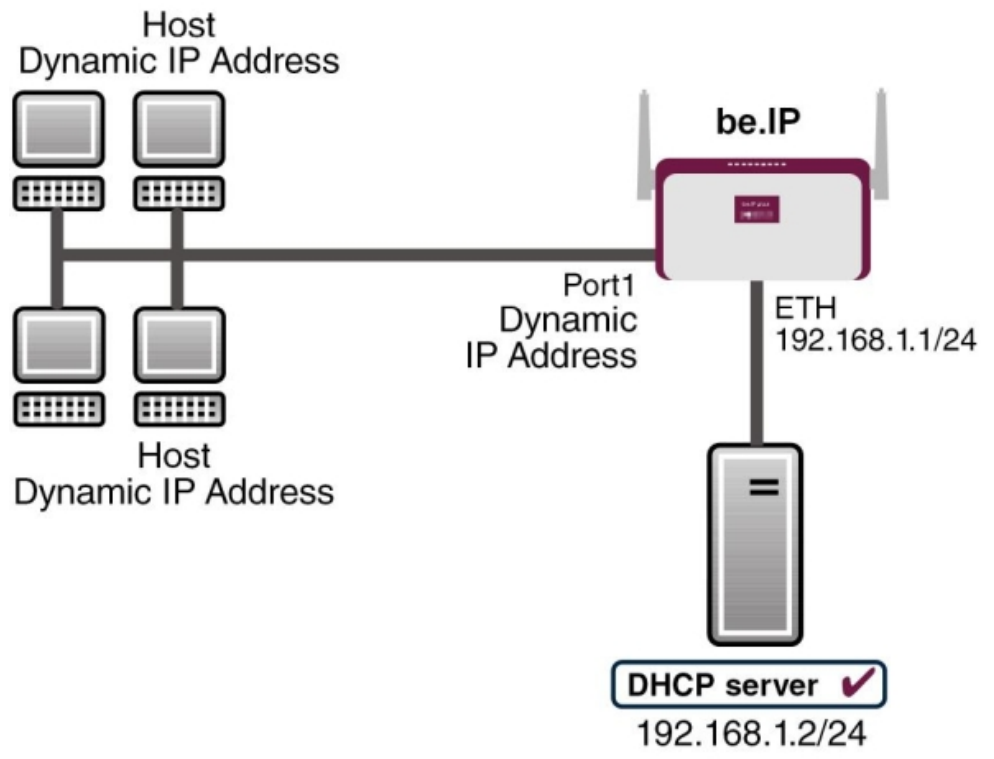

Example scenario as DHCP Client

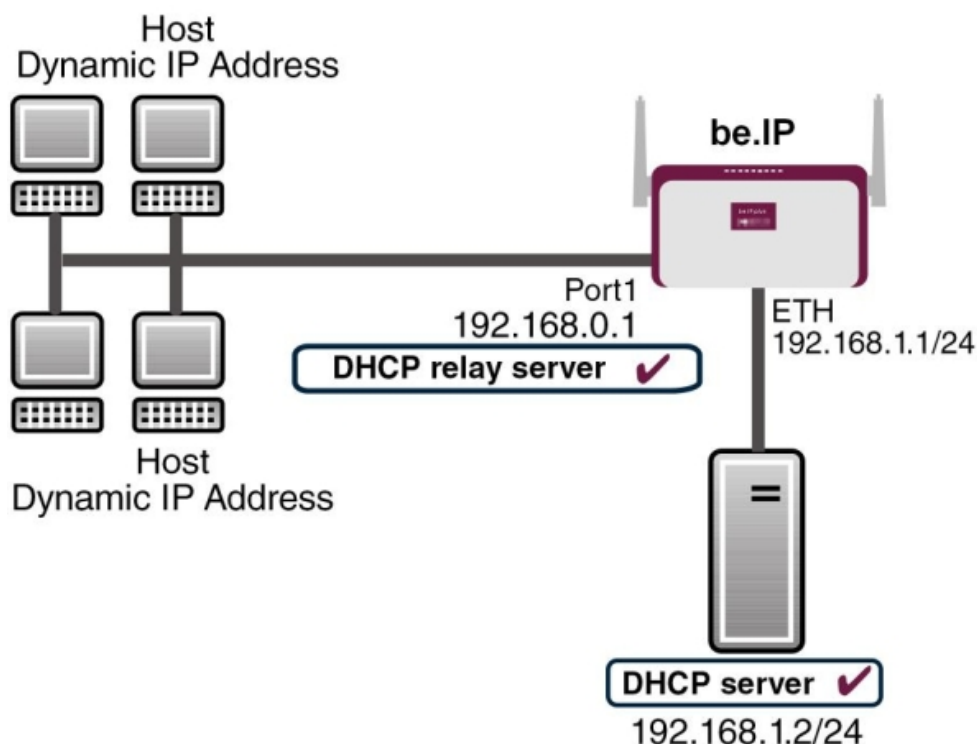

Example scenario as DHCP Relay Server

Configuration target

You can use your device as a DHCP server, DHCP client or DHCP relay agent.



Overview of Configuration Steps

DHCP Server

Field	Menu	Value
IP Pool Name	Local Services->DHCP Server->IP Pool Configuration->New	e.g. <i>IP-Pool-1</i>
IP Address Range	Local Services->DHCP Server->IP Pool Configuration->New	e.g. <i>192.168.0.2</i> and <i>192.168.0.10</i>
Interface	Local Services->DHCP Server->DHCP Configuration->New	e.g. <i>en1-0</i>
IP Pool Name	Local Services->DHCP Server->DHCP Configuration->New	<i>IP-Pool-1</i>
Pool Usage	Local Services->DHCP Server->DHCP Configuration->New	<i>Local</i>

Field	Menu	Value
Gateway	Local Services->DHCP Server->DHCP Configuration->New->Advanced Settings	Use Router as Gateway
Lease Time	Local Services->DHCP Server->DHCP Configuration->New->Advanced Settings	e.g. 120
IP address to use for DNS/WINS server assignment	Local Services->DNS->Global Settings->Advanced Settings	e.g. Own IP address

DHCP Client

Field	Menu	Value
Address Mode	LAN->IP Configuration->Interfaces-><en1-4>-> 	DHCP
DHCP MAC Address (optional)	LAN->IP Configuration->Interfaces-><en1-4> ->  ->Advanced Settings	MAC address for a specific DHCP server

DHCP Relay Server

Field	Menu	Value
Primary DHCP Server	Local Services->DHCP Server->DHCP Relay Settings	e.g. 192.168.1.2
Secondary DHCP Server (optional)	Local Services->DHCP Server->DHCP Relay Settings	if one exists

19.5 DHCPv6 Server

You can operate your device as a DHCPv6 server. The DHCPv6 server can either assign IP addresses as well as DHCPv6 options or DHCPv6 options only without any addresses. These parameters are collected in a so called "Option Set". An option set can be linked to an interface (see **Local Services->DHCPv6 Server->DHCPv6 Server->New**), or it can be configured globally (see **Local Services->DHCPv6 Server->DHCPv6 Global Options->New**). DHCP options can, e.g., contain information about DNS or time servers.



Note

An IPv6 address pool is created by assigning an IPv6 Link Prefix (a subnet with a length of /64) to a DHCPv6 option set. The definition of a separate set of IP addresses like, e.g. fc00:1:2:3::1..fc00:1:2:3::100, is - in contrast with IPv4 - not specified for IPv6.

The following requirements must be met for the configuration of an IPV6 address pool:

- (a) IPv6 has to be activated for the respective interface.
- (b) An IPv6 Link Prefix (subnet) with a length of /64 has to be configured for the respective interface. An IPv6 link prefix can be defined in either of two ways:
 - The IPv6 Link Prefix is derived from a General IPv6 Prefix (a prefix with a length of, e.g., /56 or /48). In this case, the General IPv6 Prefix has to be configured in the menu **Networking->IPv6 General Prefixes->General Prefix Configuration**.
 - The IPv6 Link Prefix with a length of /64 is manually configured for the respective interface and is not derived from a General IPv6 Prefix.
- (c) The **DHCP Server** option has to be enabled for the interface.

Moreover, the following settings are recommended:

- The options **Preferred Lifetime** and **Valid Lifetime** should be set to values higher than the value configured for the option **Router Lifetime**.

With a **Router Lifetime** of 600 seconds a **Preferred Lifetime** of, e.g., 900 seconds and a **Valid Lifetime** of 1800 seconds are reasonable settings.

- The option **DHCP Mode** should be enabled.

In order to make the settings mentioned above, go to the menu **LAN->IP Configuration->Interfaces**. Choose the intended interface with the  icon. Activate IPv6 and set the **IPv6 Mode** to *Router (Transmit Router Advertisement)*. In the field **IPv6-Adressen**, click **Add** and configure the Link Prefix. Confirm your configuration with **Accept**. The configuration of the recommended settings is then carried out in the following menus:

- **Router Lifetime:** LAN->IP Configuration->Interfaces->New->Advanced Settings->Advanced IPv6 Settings
- **Preferred Lifetime** and **Valid Lifetime:** LAN->IP Configuration->Interfaces->New->Basic IPv6 Parameters->Add->Advanced

19.5.1 DHCPv6 Server

Here you can create interface-related address pools and define DHCP options inside of an DHCP Option Set.

19.5.1.1 Edit or New

Use the **New** button in order to create an Option Set. Use the  icon in order to edit an existing entry.

The menu consists of the following fields:

Fields in the menu Basic Parameters

Field	Description
Name	Enter a name for the Option Set.
Interface	<p>Select the IPv6 interface the Option Set is assigned to.</p> <p>You can choose from interfaces with the following configuration:</p> <ul style="list-style-type: none"> • IPv6 is enabled. • The option DHCP Server is enabled. <p>In the ex works state, IPv6 is disabled for all interfaces. If the intended interface is not offered for selection, configure it according to the requirements detailed in the introduction of this section. Configuration is done on the menu LAN->IP Configuration->Interfaces.</p>
Address assignment	<p>The definition of an IPv6 address pools is carried out by assigning an IPv6 Link Prefix (subnet with a length of /64) to a DHCPv6 Option Set. The IPv6 address pool always comprises the complete 64 Bit address space of the selected IPv6 Link Prefix. Address assignment is random.</p> <p>Use Add to assign one or more IPv6 Link Prefixes to the IPv6 Option Set.</p>



Note

Note that only such IPv6 Link Prefixes are available for selection that are assigned to the selected interface.

Fields in the menu **Server Options**

Field	Description
DNS domains search list	Use Add to create a list of domain names which is queried by the client during name resolution (DHCPv6 Option 24 "Domain Search List"). Domain names will be transmitted to the clients in the order defined by the list.

The menu **Advanced Settings** consists of the following fields:

Fields in the menu **Advanced Server Options**

Field	Description
DNS Server	<p>Here you can configure the DNS servers that are propagated by DHCPv6. (DHCPv6 Option 23 "DNS Recursive Name Server").</p> <p>Per default, the global DNS server of the system are propagated. (Global DNS servers are configured by the field DNS Propagation in the menu LAN->IP Configuration->Interfaces->  ->Advanced Settings if IPv6 = Enabled.)</p> <p>You can also manually specify DNS servers and have them propagated to the clients. To do this disable the option Use RA or Global Fallback DNS Server and create the desired DNS server entries using Add.</p>
SNTP Server	Here you can configure the time servers to be propagated by DHCPv6 (DHCPv6 Option 31 "Simple Network Time Protocol Server"). Use Add to create the desired time server entries.

19.5.2 DHCPv6 Global Options

In this menu, you can configure those DHCPv6 options which are globally valid for the DHCPv6 server. An option that has been configured here will be propagated if there is no more specific definition is available (e.g., no interface- or vendor-ID-specific definition).

The menu consist of the following fields:

Fields in the menu **Basic Parameters**

Field	Description
DNS domains search list	Use Add to create a list of domain names which is queried by the client during name resolution (DHCPv6 Option 24 "Domain Search List"). Domain names will be transmitted to the clients in

Field	Description
	the order defined by the list. The domain name (e.g. dev.bintec.de.) must end with a dot (.).

The menu **Advanced Settings** consist of the following fields:

Fields in the menu **Server preference**

Field	Description
Server preference	<p>The DHCPv6 advertisements sent by the DHCPv6 server to the clients may contain the DHCPv6 option 7 "Preference".</p> <p>Possible values are <code>0 . . . 255</code>.</p> <p>In a network with multiple DHCPv6 servers this option controls which server takes the highest priority. If a client receives DHCPv6 advertisements with different priorities from different servers, it will usually accept the parameters from the highest priority server. The client can, however, also accept DHCPv6 advertisements with a lower priority if the set of parameters in the advertisement provides more of the options requested by the client.</p> <p>A value of <code>0</code> means "not specified" (lowest priority), <code>255</code> denotes the highest priority.</p>

Fields in the menu **Advanced Server Fallback Options**

Field	Description
DNS Server	<p>Here you can configure the DNS servers that are propagated by DHCPv6. (DHCPv6 Option 23 "DNS Recursive Name Server").</p> <p>Per default, the global DNS server of the system are propagated. (Global DNS servers are configured by the field DNS Propagation in the menu LAN->IP Configuration->Interfaces->  ->Advanced Settings if IPv6 = Enabled.)</p> <p>You can also manually specify DNS servers and have them propagated to the clients. To do this disable the option Use RA or Global Fallback DNS Server and create the desired DNS server entries using Add.</p>
SNTP Server	<p>Here you can configure the time servers to be propagated by DHCPv6 (DHCPv6 Option 31 "Simple Network Time Protocol Server"). Use Add to create the desired time server entries.</p>

19.5.3 Stateful Clients

Here you see an entry for each Stateful Client that has contacted the server and has been assigned an IPv6 address.

19.5.4 Stateful Clients Configuration

During a stateful configuration of IPv6 clients not only the DHCP options, but also the IPv6 prefix is transmitted to the client.

19.5.4.1 Edit or New

Use **New** to create entries for Stateful Clients. Normally, you do not have to create any entries. Use  in order to edit existing entries. You should check each automatically created entry once to verify the settings and adjust them if required.

The menu consists of the following fields.

Fields in the menu Basic Parameters

Field	Description
DUID	<p>Clients use the DUID field (DHCP Unique Identifier) in order to identify themselves and request an IP address from the DHCPv6 server.</p> <p>If you create an entry using New you can specify the DUID as a 16 - 20 digit HEX number. You can enter them using a "-" (minus) as separator (Windows style), or you can enter them in a single block (Linux style).</p>
Accept Client FQDN	<p>If Accept Client FQDN is enabled, the client is entered into the cache of the Domain Name Server with the parameter FQDN (Fully Qualified Domain Name).</p>
Administrative FQDNs	<p>With Add, you can specify an FQDN (Fully Qualified Domain Name) - even for automatically created entries.</p>
Static Interface Identifier	<p>The field Static Interface Identifier is the host portion of the IPv6 address, i.e., the last 64 Bit of the IP address. This prefix must start with ::.</p>

19.6 CAPI Server

You can use the CAPI Server function to assign user names and passwords to users of the CAPI applications on your device. This makes sure that only authorised users can receive incoming calls and make outgoing calls via CAPI.

The CAPI service allows connection of incoming and outgoing data and voice calls to communications applications on hosts in the LAN that access the Remote CAPI interface of your device. This enables, for example, hosts connected to your device to receive and send faxes.



Note

All incoming calls to the CAPI are offered to all registered and "eavesdropping" CAPI applications in the LAN.

In the ex works state, a user with the user name *default* and no password is entered for the CAPI subsystem.

Once you've created your intended users with password, you should delete the *default* user without password.

19.6.1 User

A list of all configured CAPI users is displayed in the **Local Services->CAPI Server->User** menu.

19.6.1.1 New

Choose the **New** button to set up new CAPI users.

The menu **Local Services->CAPI Server->User->New** consists of the following fields:

Fields in the Basic Parameters menu.

Field	Description
User Name	Enter the user name for which access to the CAPI service is to be allowed or denied.
Password	Enter the password which the user User Name shall use for identification to gain access to the CAPI service.

Field	Description
Access	<p>Select whether access to the CAPI service is to be permitted or denied for the user.</p> <p>The function is activated by selecting <i>Enabled</i>.</p> <p>The function is enabled by default.</p>

19.6.2 Options

The menu **Local Services->CAPI Server->Options** consists of the following fields:

Fields in the Basic Parameters menu.

Field	Description
Enable server	<p>Select whether your device is to be enabled as a CAPI server.</p> <p>The function is activated by selecting <i>Enabled</i>.</p> <p>The function is enabled by default.</p>
Faxheader	<p>Select whether the fax header should be printed at the top of outgoing faxes.</p> <p>The function is activated by selecting <i>Enabled</i>.</p> <p>The function is disabled by default.</p>
CAPI Server TCP Port	<p>The field can only be edited if Enable server is enabled.</p> <p>Enter the TCP port number for remote CAPI connections.</p> <p>The default value is <i>2662</i>.</p>

19.7 Scheduling

Your device has an event scheduler which enables certain standard actions (activation or deactivation of interfaces, for example) to be carried out. In addition, every existing MIB variable can be configured with any value.

You configure the desired **Actions** and define the triggers controlling the date and other conditions of the **Actions**. A trigger may be a single event or a sequence of events collected in an **Event List**. For a single event, create an **Event List** containing only one element.

It is possible to trigger operations on a time-controlled basis. What's more, the status or accessibility of interfaces, or their data traffic can lead to performance of the configured operations, as also the validity of licenses. Here again, it is possible to configure every MIB variable with any value as initiator.

Activate the **Schedule Interval** option under **Options** to put the event scheduler into operation. The system uses this time interval to check if at least one event has occurred. This triggers the configured action.

Specific instructions for configuring Time-controlled Tasks (Scheduling), see the end of the chapter [Configuration example - Time-controlled Tasks \(Scheduling\)](#) on page 377.



Caution

The configuration of actions that are not available as defaults requires extensive knowledge of the method of operation of bintec elmeg gateways. An incorrect configuration can cause considerable disruption during operation. If applicable, save the original configuration on your PC.



Note

To run the event scheduler, the date configured on your device must be 1.1.2000 or later.

19.7.1 Trigger

All configured event lists are displayed in the **Local Services->Scheduling->Trigger** menu. Each event list contains at least one event intended to trigger a configured action.

19.7.1.1 New

Choose the **New** button to create additional event lists.

The menu **Local Services->Scheduling->Trigger->New** consists of the following fields:

Fields in the **Basic Parameters** menu

Field	Description
Event List	You can create a new event list with <i>New</i> (default value). You give this list a name with Description . You use the remaining parameters to create the first event in the list.

Field	Description
	<p>If you want to add to an existing event list, select the event list you want and add at least one more event to it.</p> <p>You can use event lists to create complex conditions for initiating an action. The events are processed in the same order in which they are created in the list.</p>
4Description	<p>Only for Event List <i>New</i></p> <p>Enter your chosen designation for the Event List.</p>
Event Type	<p>Select the type of initiator.</p> <p>Possible values:</p> <ul style="list-style-type: none"> • <i>Time</i> (default value): The operations configured and assigned in Actions are initiated at specific points in time. • <i>MIB/SNMP</i>: The operations configured and assigned in Actions are initiated when the defined MIB variables assumes the assigned values. • <i>Interface Status</i>: Operations configured and assigned in Actions are initiated, when the defined interfaces take on a specified status. • <i>Interface Traffic</i>: Operations configured and assigned in Actions are initiated when the data traffic on the specified interfaces falls below or exceeds the defined value. • <i>Ping Test</i>: Operations configured and assigned in Actions are initiated when the specified IP address is / is not accessible. • <i>Certificate Lifetime</i>: Operations configured and assigned in Actions are initiated when the defined period of validity is reached. • <i>Function Button</i>: The option <i>Function Button</i> determines that pushing the function button on the device can serve as a trigger for any configured action. Pushing the button for approx. one second (but less than three seconds) sets the button status to <i>Active</i>, pushing it for more than three seconds sets it to <i>Inactive</i>. Actions depending on the state of the button are then carried out after the next cyclical query determined by the Schedule Interval. In this way, e.g., a WLAN interface can be activated when the button is pushed

Field	Description
	for a second. Pushing the button for more than three seconds deactivates the interface again.
Monitored Variable	<p>Only for Event Type <i>MIB/SNMP</i></p> <p>Select the MIB variable whose defined value is to be configured as initiator. First, select the System in which the MIB variable is saved, then the MIB Table and finally the MIB Variable itself. Only the MIB tables and MIB variables present in the respective area are displayed.</p>
Compare Condition	<p>Only for Event Type <i>MIB/SNMP</i></p> <p>Select whether the MIB variable <i>Greater</i> (default value), <i>Equal</i>, <i>Less</i>, <i>Not Equal</i> must have the value given in <i>Compare Value</i> or must lie within <i>Range</i> to initiate the operation.</p>
Compare Value	<p>Only for Event Type <i>MIB/SNMP</i></p> <p>Enter the value of the MIB variable.</p>
Index Variables	<p>Only for Event Type <i>MIB/SNMP</i></p> <p>If required, select MIB variables to uniquely identify a specific data set in a MIB Table, e.g. <i>ConnIfIndex</i>. The combination of Index Variable (normally an index variable labelled by a *) and Index Value creates the unique identification of a specific table entry.</p> <p>Create additional Index Variables with Add.</p>
Monitored Interface	<p>Only for Event Type <i>Interface Status</i> and <i>Interface Traffic</i></p> <p>Select the interface whose defined status or data traffic shall initiate an event.</p>
Interface Status	<p>Only for Event Type <i>Interface Status</i></p> <p>Select the status that the interface must have in order to initiate the intended operation.</p> <p>Possible values:</p> <ul style="list-style-type: none"> • <i>Up</i> (default value): The function is enabled.

Field	Description
	<ul style="list-style-type: none"> • <i>Down</i>: The interface is disabled.
Traffic Direction	<p>Only for Event Type <i>Interface Traffic</i></p> <p>Select the direction of the data traffic whose values should be monitored as initiating an operation.</p> <p>Possible values:</p> <ul style="list-style-type: none"> • <i>RX</i> (default value): Incoming data traffic is monitored. • <i>TX</i>: Outgoing data traffic is monitored.
Interface Traffic Condition	<p>Only for Event Type <i>Interface Traffic</i></p> <p>Select whether the value for data traffic must be <i>Greater</i> (default value) or <i>Less</i> the value specified in <i>Transferred Traffic</i> in order to initiate the operation.</p>
Transferred Traffic	<p>Only for Event Type <i>Interface Traffic</i></p> <p>Enter the desired value in kBytes for the data traffic to serve as comparison.</p> <p>The default value is <i>0</i>.</p>
Destination IP Address	<p>Only for Event Type <i>Ping Test</i></p> <p>Enter the IP address whose accessibility is to be checked.</p>
Source IP Address	<p>Only for Event Type <i>Ping Test</i></p> <p>Enter an IP address to be used as sender address for the ping test.</p> <p>Possible values:</p> <ul style="list-style-type: none"> • <i>Automatic</i> (default value): The IP address of the interface over which the ping is sent is automatically entered as sender address. • <i>Specific</i>: Enter the desired IP address in the input field.
Status	<p>Only for Event Type <i>Ping Test</i></p> <p>Select whether Destination IP Address <i>Reacheable</i> must be (default value) or <i>Unreacheable</i> in order to initiate the opera-</p>

Field	Description
	tion.
Interval	<p>Only for Event Type <i>Ping Test</i></p> <p>Enter the time in Seconds after which a ping must be resent.</p> <p>The default value is <i>60</i> seconds.</p>
Trials	<p>Only for Event Type <i>Ping Test</i></p> <p>Enter the number of ping tests to be performed.</p> <p>The default value is <i>3</i>.</p>
Monitored Certificate	<p>Only for Event Type <i>Certificate Lifetime</i></p> <p>Select the certificate whose validity should be checked.</p>
Remaining Validity	<p>Only for Event Type <i>Certificate Lifetime</i></p> <p>Indicate the remaining validity of the certificate in percentage.</p>
Function Button Status	<p>Only for Event Type <i>Function Button</i>.</p> <p>When creating the trigger the dropdown selection Function Button Status allows you to choose which status of the function button activates or deactivates the trigger. If you set the status to <i>On</i>, the trigger becomes active if the status of the function button is <i>Active</i>, and inactive, if the state of the function button is <i>Inactive</i>. If your set it to <i>Off</i>, the trigger becomes active if the state of the function button is <i>Inactive</i>, and inactive if the state of the function button is <i>Active</i>. The current state is checked cyclically at the configured schedule interval.</p>

Fields in the **Select time interval** menu

Field	Description
Time Condition	<p>Only for Event Type = <i>Time</i></p> <p>First select the type of time entry in Condition Type.</p> <p>Possible values:</p> <ul style="list-style-type: none"> • <i>Weekday</i>: Select a weekday in Condition Settings. • <i>Periods</i> (default value): In Condition Settings, select a par-

Field	Description
	<p>particular period.</p> <ul style="list-style-type: none"> • <i>Day of Month</i>: Select a specific day of the month in Condition Settings. <p>Possible values for Condition Settings in Condition Type = Weekday:</p> <p><i>Monday</i> (default value) ... <i>Sunday</i>.</p> <p>Possible values for Condition Settings in Condition Type = Periods:</p> <ul style="list-style-type: none"> • <i>Daily</i>: The initiator becomes active daily (default value). • <i>Monday - Friday</i>: The initiator becomes active daily from Monday to Friday. • <i>Monday - Saturday</i>: The initiator becomes active daily from Monday to Saturday. • <i>Saturday - Sunday</i>: The initiator becomes active on Saturdays and Sundays. <p>Possible values for Condition Settings in Condition Type = Day of Month:</p> <p><i>1 ... 31</i>.</p>
Start Time	Enter the time from which the initiator is to be activated. Activation is carried on the next scheduling interval. the default value of this interval is 55 seconds.
Stop Time	Enter the time from which the initiator is to be deactivated. Deactivation is carried on the next scheduling interval. If you do not enter a Stop Time or set a Stop Time = Start Time , the initiator is activated, and deactivated after 10 seconds.

19.7.2 Actions

In the **Local Services->Scheduling->Actions** menu is displayed a list of all operations to be initiated by events or event chains configured in **Local Services->Scheduling->Trigger**.

19.7.2.1 New

Choose the **New** button to configure additional operations.

The menu **Local Services->Scheduling->Actions->New** consists of the following fields:

Fields in the menu **Basic Parameters**

Field	Description
Description	Enter your chosen designation for the action.
Command Type	<p>Select the desired action.</p> <p>Possible values:</p> <ul style="list-style-type: none"> • <i>Reboot</i> (default value): Your device is rebooted. • <i>MIB/SNMP</i>: The desired value is entered for a MIB variable. • <i>Interface Status</i>: The status of an interface is modified. • <i>Wlan Status</i>: Only for devices with a wireless LAN. The status of a WLAN-SSID is modified. • <i>Software Update</i>: A software update is initiated. • <i>Configuration Management</i>: A configuration file is loaded onto your device or backed up by your device. • <i>Ping Test</i>: Accessibility of an IP address is checked. • <i>Certificate Management</i>: A certificate is to be renewed, deleted or entered. • <i>5 GHz WLAN Bandscan</i>: Only for devices with a wireless LAN. A scan of the 5 GHz frequency band is performed. • <i>5.8 GHz WLAN Bandscan</i>: Only for devices with a wireless LAN. A scan of the 5.8 GHz frequency range is performed. • <i>WLC: New Neighbor Scan</i>: Only for devices with a WLAN controller. A Neighbor Scan is initiated by the WLAN network controlled by the WLAN controller. • <i>WLC: VSS State</i>: Only for devices with a WLAN controller. The status of a wireless network is modified. • <i>WLAN: Operation Mode</i>: The operating mode of a WLAN radio module is modified.
Event List	Select the event list you want which has been created in Local Services->Scheduling->Trigger .

Field	Description
Event List Condition	<p>For the selected chains of events, select how many of the configured events must occur for the operation to be initiated.</p> <p>Possible values:</p> <ul style="list-style-type: none"> • <i>All</i> (default value): The operation is initiated if all events occur. • <i>One</i>: The operation is initiated if a single event occurs. • <i>None</i>: The operation is triggered if no event occurs. • <i>One not</i>: The operation is triggered if one of the events does not occur.
Reboot device after	<p>Only if Command Type = <i>Reboot</i></p> <p>Enter the timespan in seconds that must elapse after occurrence of the event until the device is restarted.</p> <p>The default value is <i>60</i> seconds.</p>
MIB/SNMP Variable to add/edit	<p>Only if Command Type = <i>MIB/SNMP</i></p> <p>Select the MIB table in which the MIB variable whose value shall be changed is saved. First, select the System, then the MIB Table. Only the MIB tables present in the respective area are displayed.</p>
Command Mode	<p>Only if Command Type = <i>MIB/SNMP</i></p> <p>Select how the MIB entry is to be manipulated.</p> <p>Possible settings:</p> <ul style="list-style-type: none"> • <i>Change existing entry</i> (default value): An existing entry shall be modified. • <i>Create new MIB entry</i>: A new entry shall be created.
Index Variables	<p>Only if Command Type = <i>MIB/SNMP</i></p> <p>Where required, select MIB variables to uniquely identify a specific data set in MIB Table, e.g. <i>ConnIfIndex</i>. The unique identification of a particular table entry is derived from the combination of Index Variable (usually an index variable which is flagged with *) and Index Value.</p>

Field	Description
	Use Index Variables to create more entries with Add .
Trigger Status	<p>Only if Command Type = <i>MIB/SNMP</i></p> <p>Select what status the event must have in order to modify the MIB variable as defined.</p> <p>Possible values:</p> <ul style="list-style-type: none"> • <i>Active</i> (default value): The value of the MIB variable is modified if the initiator is active. • <i>Inactive</i>: The value of the MIB variable is modified if the initiator is inactive. • <i>Both</i>: The value of the MIB variable is differentially modified if the initiator status changes.
MIB Variables	<p>Only if Command Type = <i>MIB/SNMP</i></p> <p>Select the MIB variable whose value is to be configured as dependent upon initiator status.</p> <p>If the initiator is active (Trigger Status <i>Active</i>), the MIB variable is described with the value entered in Active Value.</p> <p>If the initiator is inactive (Trigger Status <i>Inactive</i>), the MIB variable is described with the value entered in Inactive Value.</p> <p>If the MIB variable is to be modified, depending on whether the initiator is active or inactive (Trigger Status <i>Both</i>), it is described with an active initiator with the value entered in Active Value and with an inactive initiator with the value in Inactive Value.</p> <p>Use Add to create more entries.</p>
Interface	<p>Only if Command Type = <i>Interface Status</i></p> <p>Select the interface whose status should be changed.</p>
Set interface status	<p>Only if Command Type = <i>Interface Status</i></p> <p>Select the status to be set for the interface.</p> <p>Possible values:</p>

Field	Description
	<ul style="list-style-type: none"> • <i>Up</i> (default value) • <i>Down</i> • <i>Reset</i>
Local WLAN SSID	<p>Only if Command Type = <i>Wlan Status</i></p> <p>Select the desired wireless network whose status shall be changed.</p>
Set status	<p>Only if Command Type = <i>Wlan Status</i> or <i>WLC: VSS State</i></p> <p>Select the status for the wireless network.</p> <p>Possible values:</p> <ul style="list-style-type: none"> • <i>Activate</i> (default value) • <i>Deactivate</i>
Source Location	<p>Only if Command Type = <i>Software Update</i></p> <p>Select the source for the software update.</p> <p>Possible values:</p> <ul style="list-style-type: none"> • <i>Current Software from Update Server</i> (default value): The latest software will be downloaded from the update server. • <i>HTTP Server</i>: The latest software will be downloaded from an HTTP server that you define in <i>Server URL</i>. • <i>HTTPS Server</i>: The latest software will be downloaded from an HTTPS server that you define in <i>Server URL</i>. • <i>TFTP Server</i>: The latest software will be downloaded from an TFTP server that you define in <i>Server URL</i>.
Server URL	<p>Where Command Type = <i>Software Update</i> if Source Location not <i>Current Software from Update Server</i></p> <p>Enter the URL of the server from which the desired software version is to be retrieved.</p> <p>Where Command Type = <i>Configuration Management</i> with Action = <i>Import configuration</i> or <i>Export configuration</i></p>

Field	Description
	<p>Enter the URL of the server from which a configuration file is to be retrieved, or on which the configuration file is to be backed up.</p>
File Name	<p>For Command Type = <i>Software Update</i></p> <p>Enter the file name of the software version.</p> <p>Where Command Type = <i>Certificate Management</i> with Action = <i>Import certificate</i></p> <p>Enter the file name of the certificate file.</p>
Action	<p>For Command Type = <i>Configuration Management</i></p> <p>Select which operation is to be performed on a configuration file.</p> <p>Possible values:</p> <ul style="list-style-type: none"> • <i>Import configuration</i> (default value) • <i>Export configuration</i> • <i>Rename configuration</i> • <i>Delete configuration</i> • <i>Copy configuration</i> <p>For Command Type = <i>Certificate Management</i></p> <p>Select which operation you wish to perform on a certificate file.</p> <p>Possible values:</p> <ul style="list-style-type: none"> • <i>Import certificate</i> (default value) • <i>Delete certificate</i> • <i>SCEP</i>
Protocol	<p>Only for Command Type = <i>Certificate Management</i> and <i>Configuration Management</i> if Action = <i>Import configuration</i></p> <p>Select the protocol for the data transfer.</p> <p>Possible values:</p>

Field	Description
	<ul style="list-style-type: none"> • <i>HTTP</i> (default value) • <i>HTTPS</i> • <i>TFTP</i>
CSV File Format	<p>Only where Command Type = <i>Configuration Management</i> and Action = <i>Import configuration</i> or <i>Export configuration</i></p> <p>Select whether the file is to be sent in the CSV format.</p> <p>The CSV format can easily be read and modified. In addition, you can view the corresponding file clearly using Microsoft Excel for example.</p> <p>The function is enabled by default.</p>
Remote File Name	<p>Only if Command Type = <i>Configuration Management</i></p> <p>For Action = <i>Import configuration</i></p> <p>Enter the name of the file under which it is saved on the server from which it is to be retrieved.</p> <p>For Action = <i>Export configuration</i></p> <p>Enter the file name under which it should be saved on the server.</p>
Local File Name	<p>Only where Command Type = <i>Configuration Management</i> and Action = <i>Import configuration</i>, <i>Rename configuration</i> or <i>Copy configuration</i></p> <p>At import, renaming or copying enter a name for the configuration file under which to save it locally on the device.</p>
File Name in Flash	<p>Where Command Type = <i>Configuration Management</i> and Action = <i>Export configuration</i></p> <p>Select the file to be exported.</p> <p>Where Command Type = <i>Configuration Management</i> and Action = <i>Rename configuration</i></p> <p>Select the file to be renamed.</p>

Field	Description
	<p>Where Command Type = <i>Configuration Management</i> and Action = <i>Delete configuration</i></p> <p>Select the file to be deleted.</p> <p>Where Command Type = <i>Configuration Management</i> and Action = <i>Copy configuration</i></p> <p>Select the file to be copied.</p>
Configuration contains certificates/keys	<p>Only where Command Type = <i>Configuration Management</i> and Action = <i>Import configuration</i> or <i>Export configuration</i></p> <p>Select whether the certificates and keys contained in the configuration are to be imported or exported.</p> <p>The function is disabled by default.</p>
Encrypt configuration	<p>Only where Command Type = <i>Configuration Management</i> and Action = <i>Import configuration</i> or <i>Export configuration</i></p> <p>Define whether the data of the selected Action are to be encrypted..</p> <p>The function is disabled by default.</p>
Reboot after execution	<p>Only if Command Type = <i>Configuration Management</i></p> <p>Select whether your device should restart after the intended Action.</p> <p>The function is disabled by default.</p>
Version Check	<p>Only where Command Type = <i>Configuration Management</i> and Action = <i>Import configuration</i></p> <p>Select whether, when importing a configuration file, to check on the server for the presence of a more current version of the already loaded configuration. If not, the file import is interrupted.</p> <p>The function is disabled by default.</p>
Destination IP Address	<p>Only if Command Type = <i>Ping Test</i></p>

Field	Description
	Enter the IP address whose accessibility is to be checked.
Source IP Address	<p>Only if Command Type = <i>Ping Test</i></p> <p>Enter an IP address to be used as sender address for the ping test.</p> <p>Possible values:</p> <ul style="list-style-type: none"> • <i>Automatic</i> (default value): The IP address of the interface over which the ping is sent is automatically entered as sender address. • <i>Specific</i>: Enter the desired IP address in the input field.
Interval	<p>Only if Command Type = <i>Ping Test</i></p> <p>Enter the time in Seconds after which a ping must be resent.</p> <p>The default value is <i>1</i> second.</p>
Count	<p>Only if Command Type = <i>Ping Test</i></p> <p>Enter the number of ping tests to be performed.</p> <p>The default value is <i>3</i>.</p>
Server Address	<p>Only where Command Type = <i>Certificate Management</i> and Action = <i>Import certificate</i></p> <p>Enter the URL of the server from which a certificate file is to be retrieved.</p>
Local Certificate Description	<p>Where Command Type = <i>Certificate Management</i> and Action = <i>Import certificate</i></p> <p>Enter a description for the certificate under which to save it on the device.</p> <p>Where Command Type = <i>Certificate Management</i> and Action = <i>Delete certificate</i></p> <p>Select the certificate to be deleted.</p>
Password for protected Certificate	<p>Only where Command Type = <i>Certificate Management</i> and Action = <i>Import certificate</i></p>

Field	Description
	<p>Select whether to use a secure certificate requiring a password and enter it into the entry field.</p> <p>The function is disabled by default.</p>
Overwrite similar certificate	<p>Only where Command Type = <i>Certificate Management</i> and Action = <i>Import certificate</i></p> <p>Select whether to overwrite a certificate already present on the your device with the new one.</p> <p>The function is disabled by default.</p>
Write certificate in configuration	<p>Only where Command Type = <i>Certificate Management</i> and Action = <i>Import certificate</i></p> <p>Select whether to integrate the certificate in a configuration file; and if so, select the desired configuration file.</p> <p>The function is disabled by default.</p>
Certificate Request Description	<p>Only where Command Type = <i>Certificate Management</i> and Action = <i>SCEP</i></p> <p>Enter a description under which the SCEP certificate on your device is to be saved.</p>
URL SCEP Server URL	<p>Only where Command Type = <i>Certificate Management</i> and Action = <i>SCEP</i></p> <p>Enter the URL of the SCEP server, e.g. <i>https://scep.bintec-elmeg.com:8080/scep/scep.dll</i></p> <p>Your CA administrator can provide you with the necessary data.</p>
Subject Name	<p>Only where Command Type = <i>Certificate Management</i> and Action = <i>SCEP</i></p> <p>Enter a subject name with attributes.</p> <p>Example: <i>"CN=VPNServer, DC=mydomain, DC=com, c=DE"</i></p>
CA Name	<p>Only where Command Type = <i>Certificate Management</i> and Action = <i>SCEP</i></p>

Field	Description
	<p>Enter the name of the CA certificate of the certification authority (CA) from which you wish to request your certificate, e.g. <i>cawindows</i>. Your CA administrator can provide you with the necessary data.</p>
Password	<p>Only where Command Type = <i>Certificate Management</i> and Action = <i>SCEP</i></p> <p>To obtain certificates, you may need a password from the certification authority. Enter the password you received from the certification authority here.</p>
Key Size	<p>Only where Command Type = <i>Certificate Management</i> and Action = <i>SCEP</i></p> <p>Select the length of the key to be created. Possible values are <i>1024</i> (default value), <i>2048</i> and <i>4096</i>.</p>
Autosave Mode	<p>Only where Command Type = <i>Certificate Management</i> and Action = <i>SCEP</i></p> <p>Select whether your device automatically stores the various steps of the enrolment internally. This is an advantage if enrolment cannot be concluded immediately. If the status has not been saved, the incomplete registration cannot be completed. As soon as the enrolment is completed and the certificate has been downloaded from the CA server, it is automatically saved in the device configuration.</p> <p>The function is enabled by default.</p>
Use CRL	<p>Only where Command Type = <i>Certificate Management</i> and Action = <i>SCEP</i></p> <p>Define the extent to which certificate revocation lists (CRLs) are to be included in the validation of certificates issued by the owner of this certificate.</p> <p>Possible values:</p> <ul style="list-style-type: none"> • <i>Auto</i> (default value): In case there is an entry for a CDP, CRL distribution point this should be evaluated in addition to the CRLs globally configured in the device. • <i>Yes</i>: CRLs are always checked.

Field	Description
	<ul style="list-style-type: none"> <i>No</i>: No checking of CRLs.
Select radio	<p>Only where Command Type = <i>5 GHz WLAN Bandscan</i>, <i>5.8 GHz WLAN Bandscan</i> or <i>WLAN: Operation Mode</i></p> <p>Select the WLAN module on which to perform the frequency band scan.</p>
WLC SSID	<p>Only where Command Type = <i>WLC: VSS State</i></p> <p>Select the wireless network administered over the WLAN controller whose status should be changed.</p>
Operation Mode (Active)	<p>Only where Command Type = <i>WLAN: Operation Mode</i></p> <p>Select the required operating mode for the selected radio module if it currently has the status <i>Active</i>. You may select from any of the operating modes that your device supports. So the choice may vary from device to device.</p>
Operation Mode (Inactive)	<p>Only where Command Type = <i>WLAN: Operation Mode</i></p> <p>Select the required operating mode for the selected radio module if it currently has the status <i>Down</i>. You may select from any of the operating modes that your device supports. So the choice may vary from device to device.</p>

19.7.3 Options

You configure the schedule interval in the **Local Services->Scheduling->Options** menu.

The menu consists of the following fields:

Fields in the Scheduling Options menu

Field	Description
Schedule Interval	<p>Select whether the schedule interval is to be enabled.</p> <p>Enter the interval in seconds after which the system checks whether events have occurred.</p> <p>Possible values are <i>0</i> to <i>65535</i>.</p>

Field	Description
	The value <code>300</code> is recommended (5 minute accuracy).

19.7.4 Configuration example - Time-controlled Tasks (Scheduling)

Requirements

- Basic configuration of the gateway.

Example scenario

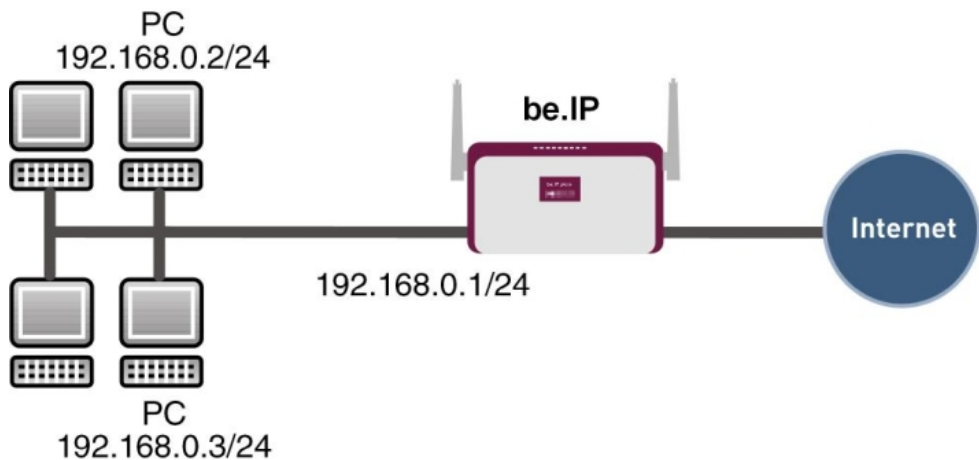

Example scenario Time-controlled Tasks

Configuration target

- You want to reboot your gateway automatically overnight.
- The WLAN interface is to be suspended at the weekend.
- In addition, the configuration is to be backed up automatically once a month on a TFTP server.

Overview of Configuration Steps

Daily reboot

Field	Menu	Value
Event List	Local Services -> Scheduling -> Trigger -> New	<i>New</i>
Description	Local Services -> Scheduling -> Trigger -> New	e.g. <i>Trigger Reboot</i>
Event Type	Local Services -> Scheduling -> Trigger -> New	<i>Time</i>
Time Condition	Local Services -> Scheduling -> Trigger -> New	Condition Type = <i>Periods</i> , Condition Settings = <i>Daily</i>
Start Time	Local Services -> Scheduling -> Trigger -> New	Hour <i>02</i> Minute <i>00</i>
Description	Local Services -> Scheduling -> Actions -> New	e.g. <i>Reboot the devicet</i>
Command Type	Local Services -> Scheduling -> Actions -> New	<i>Reboot</i>
Event List	Local Services -> Scheduling -> Actions -> New	<i>Trigger Reboot</i>
Event List Condition	Local Services -> Scheduling -> Actions -> New	<i>All</i>
Reboot device after	Local Services -> Scheduling -> Actions -> New	e.g. <i>60</i> Seconds
Schedule Interval	Local Services -> Scheduling -> Options	<i>Enabled, 55 sec</i>

Suspending the WLAN interface

Field	Menu	Value
Event List	Local Services -> Scheduling -> Trigger -> New	<i>New</i>
Description	Local Services -> Scheduling -> Trigger -> New	e.g. <i>Trigger switch off WLAN interface</i>
Event Type	Local Services -> Scheduling -> Trigger -> New	<i>Time</i>
Time Condition	Local Services -> Scheduling -> Trigger -> New	Condition Type = <i>Periods</i> , Condition Settings = <i>Saturday - Sunday</i>
Start Time	Local Services -> Scheduling -> Trigger -> New	Hour <i>00</i> Minute <i>00</i>

Field	Menu	Value
Stop Time	Local Services -> Scheduling -> Trigger -> New	Hour 23 Minute 59
Description	Local Services -> Scheduling -> Actions -> New	e.g. <i>Switch off WLAN interface</i>
Command Type	Local Services -> Scheduling -> Actions -> New	<i>Interface Status</i>
Event List	Local Services -> Scheduling -> Actions -> New	<i>Trigger switch off WLAN interface</i>
Event List Condition	Local Services -> Scheduling -> Actions -> New	<i>All</i>
Interface	Local Services -> Scheduling -> Actions -> New	e.g. <i>vss1-0</i>
Set interface status	Local Services -> Scheduling -> Actions -> New	<i>Down</i>
Schedule Interval	Local Services -> Scheduling -> Options	<i>Enabled, 55 sec</i>

Monthly configuration backup

Field	Menu	Value
Event List	Local Services -> Scheduling -> Trigger -> New	<i>New</i>
Description	Local Services -> Scheduling -> Trigger -> New	e.g. <i>Trigger configuration backup</i>
Event Type	Local Services -> Scheduling -> Trigger -> New	<i>Time</i>
Time Condition	Local Services -> Scheduling -> Trigger -> New	Condition Type = <i>Day of Month</i> , Condition Settings = <i>1</i>
Start Time	Local Services -> Scheduling -> Trigger -> New	Hour <i>03</i> Minute <i>00</i>
Description	Local Services -> Scheduling -> Actions -> New	Configuration backup
Command Type	Local Services -> Scheduling -> Actions -> New	Configuration Management
Event List	Local Services -> Scheduling -> Actions -> New	Trigger configuration backup
Event List Condition	Local Services -> Scheduling ->	All

Field	Menu	Value
	Actions -> New	
Action	Local Services -> Scheduling -> Actions -> New	Export configuration
Server URL	Local Services -> Scheduling -> Actions -> New	e.g. <i>tftp://192.168.2.5</i>
CSV File Format	Local Services -> Scheduling -> Actions -> New	<i>Enabled</i>
Remote File Name	Local Services -> Scheduling -> Actions -> New	e.g. <i>monthly-backup.cf</i>
File Name in Flash	Local Services -> Scheduling -> Actions -> New	<i>boot</i>
Configuration contains certificates/keys	Local Services -> Scheduling -> Actions -> New	<i>Enabled</i>
Schedule Interval	Local Services -> Scheduling -> Options	<i>Enabled, 55 sec</i>

19.8 Surveillance

In this menu, you can configure an automatic availability check for hosts or interfaces and automatic ping tests.

You can monitor temperature with devices from the **bintec WI** series.



Note

This function cannot be configured on your device for connections that are authenticated via a RADIUS server.

19.8.1 Hosts

A list of all monitored hosts is displayed in the **Local Services->Surveillance->Hosts** menu.

19.8.1.1 Edit or New

Choose the  icon to edit existing entries. Choose the **New** button to create additional monitoring tasks.

The menu **Local Services->Surveillance->Hosts->New** consists of the following fields:

Fields in the Host Parameters menu

Field	Description
Group ID	<p>If the availability of a group of hosts or the default gateway is to be monitored by your device, select an ID for the group or the default gateway.</p> <p>The group IDs are automatically created from <i>0</i> to <i>255</i>. If an entry has not yet been created, a new group is created using the <i>New ID</i> option. If entries have been created, you can select one from the list of created groups.</p> <p>Each host to be monitored must be assigned to a group.</p> <p>The operation configured for the select Interface is only executed if no group member can be reached.</p>

Fields in the Trigger menu.

Field	Description
Monitored IP Address	<p>Enter the IP address of the host to be monitored.</p> <p>Possible values:</p> <ul style="list-style-type: none"> • <i>Default Gateway</i> (default value): The default gateway is monitored. • <i>Specific</i>: Enter the IP address of the host to be monitored manually in the adjacent input field.
Source IP Address	<p>Select how the IP address is to be determined that your device uses as the source address of the packet sent to the host to be monitored.</p> <p>Possible values:</p> <ul style="list-style-type: none"> • <i>Automatic</i> (default value): The IP address is determined automatically. • <i>Specific</i>: Enter the IP address in the adjacent input field.
Interval	<p>Enter the time interval (in seconds) to be used for checking the availability of hosts.</p> <p>Possible values are <i>1</i> to <i>65536</i>.</p>

Field	Description
	<p>The default value is <i>10</i>.</p> <p>Within a group, the smallest Interval of the group members is used.</p>
Successful Trials	<p>Specify how many pings need to be answered for the host to be regarded as accessible.</p> <p>You can use this setting to specify, for example, when a host is deemed to be accessible once more, and used again, instead of a backup device.</p> <p>Possible values are <i>1</i> to <i>65536</i>.</p> <p>The default value is <i>3</i>.</p>
Unsuccessful Trials	<p>Specify how many pings need to be unanswered for the host to be regarded as inaccessible.</p> <p>You can use this setting to specify, for example, when a host is deemed to be inaccessible, and that a backup device should be used.</p> <p>Possible values are <i>1</i> to <i>65536</i>.</p> <p>The default value is <i>3</i>.</p>
Action to be performed	<p>Not for Action = <i>Monitor</i>.</p> <p>Select which Action should be executed, when the Host is regarded as inaccessible. For most actions, you select an Interface to which the Action relates.</p> <p>All IP interfaces can be selected.</p> <p>For each interface, select whether it is to be enabled (<i>Enable</i>), disabled (<i>Disable</i> default value), reset (<i>Reset</i>), or the connection reestablished (<i>Redial</i>).</p> <p>The Actions <i>Enable</i> and <i>Disable</i> are also cancelled if the hosts is regarded as accessible again.</p> <p>With Action = <i>Monitor</i> you can monitor the IP address that is specified under Monitored IP Address. This information can be used for other functions, such as the Tracking IP Address</p>

Field	Description
	used in IP Load Balancing.

19.8.2 Interfaces

A list of all monitored hosts is displayed in the **Local Services->Surveillance->Interfaces** menu.

19.8.2.1 Edit or New

Choose the  icon to edit existing entries. Choose the **New** button to set up monitoring for other interfaces.

The menu **Local Services->Surveillance->Interfaces->New** consists of the following fields:

Fields in the **Basic Parameters** menu.

Field	Description
Monitored Interface	Select the interface on your device that is to be monitored.
Trigger	Select the state or state transition of Monitored Interface that is to trigger a particular Interface Action . Possible values: <ul style="list-style-type: none"> • <i>Interface goes up</i> (default value) • <i>Interface goes down</i>
Interface Action	Select the action that is to follow the state or state transition defined in Trigger . The action is applied to the Interface(s) selected in Interface . Possible values: <ul style="list-style-type: none"> • <i>Enable</i> (default value): Activation of interface(s) • <i>Disable</i>: Deactivation of interface(s)
Interface	Select the interface(s) for which the action defined in Interface is to be performed. You can choose all physical and virtual interfaces as well as options <i>All PPP Interfaces</i> and <i>All IPSec Interfaces</i> .

19.8.3 Ping Generator

In the **Local Services->Surveillance->Ping Generator** menu, a list of all configured, automatically generated pings is displayed.

19.8.3.1 Edit or New

Choose the  icon to edit existing entries. Choose the **New** button to create additional pings.

The menu **Local Services->Surveillance->Ping Generator->New** consists of the following fields:

Fields in the **Basic Parameters** menu.

Field	Description
Destination IP Address	Enter the IP address to which the ping is automatically sent.
Source IP Address	Enter the source IP address of the outgoing ICMP echo request packets. Possible values: <ul style="list-style-type: none"> • <i>Automatic</i>: The IP address is determined automatically. • <i>Specific</i> (default value): Enter the IP address in the adjacent input field e.g. to test a particular extended route.
Interval	Enter the interval in seconds during which the ping is sent to the address specified in Remote IP Address . Possible values are <i>1</i> to <i>65536</i> . The default value is <i>10</i> .
Trials	Enter the number of ping tests to be performed. The default value is <i>3</i> .

19.9 UPnP

Universal Plug and Play (UPnP) makes it possible to use current messenger services (e.g. real time video/audio conferencing) as peer-to-peer communication where one of the peers lies behind a NAT-enabled gateway.

UPnP enables (mostly) Windows-based operating systems to take control of other devices with UPnP functionality on the local network. These include gateways, access points and print servers. No special device drivers are needed as known common protocols are used, such as TCP/IP, HTTP and XML.

Your gateway makes it possible to use the subsystem of the Internet Gateway Device (IGD) from the UPnP function range.

In a network behind a NAT-enabled gateway, the UPnP-configured computers act as LAN UPnP clients. To do this, the UPnP function on the PC must be enabled.

The pre-configured port used for UPnP communication between LAN UPnP clients and the gateway is *5678*. The LAN UPnP client acts as a so-called service control point, i.e. it recognizes and controls the UPnP devices on the network.

The ports assigned dynamically by, for example, MSN Messenger, lie in the range from *5004* to *65535*. The ports are released internally to the gateway on demand, i.e. when an audio/video transfer is started in Messenger. When the application is closed, the ports are immediately closed again.

The peer-to-peer-communication is initiated via public SIP servers with only the information from the two clients being forwarded. The clients then communicate directly with one another.

For further information about UPnP, see www.upnp.org.

19.9.1 Interfaces

In this menu, you configure the UPnP settings individually for each interface of your gateway.

You can determine whether UPnP requests from clients are accepted by each interface (for requests from the local network) and/or whether the interface can be controlled via UPnP requests.

The menu **Local Services->UPnP->Interfaces** consists of the following fields:

Fields in the Interfaces menu.

Field	Description
Interface	Shows the name of the interface for which the UPnP settings are to be made. The entry cannot be changed.
Answer to client request	Determine whether UPnP requests from clients are to be answered via the particular interface (from the local network).

Field	Description
	<p>The function is enabled with <i>Enabled</i>.</p> <p>The function is disabled by default.</p>
Interface is UPnP controlled	<p>Determine whether the NAT configuration of this interface is controlled by UPnP.</p> <p>The function is enabled with <i>Enabled</i>.</p> <p>The function is disabled by default.</p>

19.9.2 General

In this menu, you make the basic UPnP settings.

The **Local Services->UPnP->General** menu consists of the following fields:

Fields in the General menu.

Field	Description
UPnP Status	<p>Decide how the gateway processes UPnP requests from the LAN.</p> <p>The function is enabled with <i>Enabled</i>. The gateway proceeds with UPnP releases in accordance with the parameters contained in the request from the LAN UPnP client, independently of the IP address of the requesting LAN UPnP client.</p> <p>The function is disabled by default. The gateway rejects UPnP requests, NAT releases are not made.</p>
UPnP TCP Port	<p>Enter the number of the port on which the gateway listens for UPnP requests.</p> <p>The possible values are <i>1</i> to <i>65535</i>, the default value is <i>5678</i>.</p>

19.10 HotSpot Gateway



Important

The Hotspot Gateway must not be operated with IPv6 enabled, since IPv6 data traffic is not registered by the Hotspot Gateway and, therefore, cannot be controlled.

The **HotSpot Solution** allows provision of public Internet accesses (using WLAN or wired Ethernet). The solution is adapted to setup of smaller and larger Hotspot solutions for cafes, hotels, companies, communal residences, campgrounds, etc.

The **HotSpot Solution** consists of a bintec elmegbintec elmeg gateway installed onsite (with its own WLAN access point or additional connected WLAN device or wired LAN) and of the Hotspot server, centrally located at a computing centre. The operator account is administered on the server via an administration terminal (e.g., a hotel reception PC); this includes functions such as registration entry, generating tickets, statistical analysis, etc.

Login sequence at the Hotspot server

- When a new user connects with the Hotspot, he/she is automatically assigned an IP address via DHCP.
- As soon as he attempts to access any Internet site with a browser, the user is redirected to the home/login page.
- After the user has entered the registration data (user/password), these are sent to the central RADIUS server (Hotspot server) as RADIUS registration.
- Following successful registration, the gateway opens Internet access.
- For each user, the gateway sends regular additional information to the RADIUS server for recording accounting data.
- When the ticket expires, the user is automatically logged off and again redirected to the home/login page.

Requirements

To operate a Hotspot, the customer requires:

- a bintec elmegbintec elmeg device as hotspot gateway with active Internet access and configured hotspot server entries for login and accounting (see menu **System Management->Remote Authentication->RADIUS->New** with **Group Description** *default group 0*)

- bintec elmeg bintec elmeg Hotspot hosting (article number 5510000198)
- Access data
- Documentation
- Software licensing

Please note that you must first activate the licence.

Go to www.bintec-elmeg.com then **Service/Support** -> **Services** -> **Online Services**.

- Enter the required data (please note the relevant explanations on the license sheet), and follow the instructions of the online licensing.

- You then receive the Hotspot server's login data.



Note

Activation may require 2-3 business days.

Access data for gateway configuration

RADIUS Server IP	62.245.165.180
RADIUS Server Password	Set by bintec elmeg GmbH
Domain	Individually set for customers by customer/dealer
Walled Garden Network	Individually set for customers by customer/dealer
Walled Garden Server URL	Individually set for customers by customer/dealer
Terms & Conditions URL	Individually set for customers by customer/dealer

Access data for configuration of the Hotspot server

Admin URL	https://hotspot.bintec-elmeg.com/
Username	Individually set by bintec elmeg
Password	Individually set by bintec elmeg



Note

Also refer to the WLAN Hotspot Workshop that is available to download from www.bintec-elmeg.com

19.10.1 HotSpot Gateway

In the **HotSpot Gateway** menu, you can configure the bintec elmeg gateway installed onsite for the **Hotspot Solution**.

A list of all configured hotspot networks is displayed in the **Local Services->HotSpot Gateway->HotSpot Gateway** menu.

You can use the **Enabled** option to enable or disable the corresponding entry.

19.10.1.1 Edit or New

You configure the hotspot networks in the **Local Services->HotSpot Gateway->HotSpot Gateway->**  menu. Choose the **New** button to set up additional Hotspot networks.

The **Local Services->HotSpot Gateway->HotSpot Gateway->**  menu consists of the following fields:

Fields in the menu Basic Parameters

Field	Description
Interface	Choose the interface to which the Hotspot LAN or WLAN is connected. When operating over LAN, enter the Ethernet interface here (e. g. en1-0). If operating over WLAN, the WLAN interface to which the access point is connected must be selected.
	<div style="border: 1px solid gray; padding: 10px; background-color: #f0f0f0;">  <p>Caution</p> <p>For security reasons you cannot configure your device over an interface that is configured for the Hotspot. Therefore take care when selecting the interface you want to use for the Hotspot.</p> <p>If you select the interface over which the current configuration session is running, the current connection will be lost. You must then log in again over a reachable interface that is not configured for the Hotspot to configure your device.</p> </div>
Domain at the HotSpot Server	Enter the domain name that you used when setting up the HotSpot server for this customer. The domain name is required so that the Hotspot server can distinguish between the different clients (customers).

Field	Description
Walled Garden	<p>Enable this function if you want to define a limited and free area of websites (intranet).</p> <p>The function is not activated by default.</p>
Walled Network / Net-mask	<p>Only if Walled Garden is enabled.</p> <p>Enter the network address of the Walled Network and the corresponding Netmask of the intranet server.</p> <p>For the address range resulting from Walled Network / Net-mask, clients require no authentication.</p> <p>Example: Enter 192.168.0.0 / 255.255.255.0, if all IP addresses from 192.168.0.0 to 19.168.0.255 are free. Enter 192.168.0.1 / 255.255.255.255, if only the IP address 192.168.0.1 is free.</p>
Walled Garden URL	<p>Only if Walled Garden is enabled.</p> <p>Enter the Walled Garden URL of the intranet server. Freely accessible websites must be reachable over this address.</p>
Terms &Conditions	<p>Only if Walled Garden is enabled.</p> <p>In the Terms &Conditions input field, enter the address of the general terms and conditions on the intranet server, or public server, e.g., http://www.webserver.de/agb.htm. The page must lie within the address range of the walled garden network.</p>
Additional freely accessible Domain Names	<p>Only if Walled Garden is enabled.</p> <p>Add further URLs or IP addresses with Add. The web pages can be accessed via these additional freely accessible addresses.</p>
Post Login URL	<p>Here you can specify the URL a user is redirected to after logging in to the Hotspot Solution.</p>
Language for login window	<p>Here you can choose the language for the start/login page.</p> <p>The following languages are supported: <i>English, Deutsch, Italiano, Français, Español, Português</i> and <i>Nederlands</i>.</p>

Field	Description
	The language can be changed on the start/login page at any time.

The menu **Advanced Settings** consists of the following fields:

Fields in the menu **Advanced Settings**

Field	Description
Ticket Type	<p>Select the ticket type.</p> <p>Possible values:</p> <ul style="list-style-type: none"> • <i>Voucher</i>: Only the user name must be entered. Define a default password in the input field. • <i>Username/Password</i> (default value): User name and password must be entered.
Allowed HotSpot Client	<p>Here you can define which type of users can log in to the Hot-spot.</p> <p>Possible values:</p> <ul style="list-style-type: none"> • <i>All</i>: All clients are approved. • <i>DHCP Client</i>: Prevents users who have not received an IP address from DHCP from logging in.
Devices per ticket	Enter the maximum number of devices per ticket.
Login Frameset	<p>Enable or disable the login window.</p> <p>The login window on the HTML homepage consists of two frames.</p> <p>When the function is enabled, the login form displays on the left-hand side.</p> <p>When the function is disabled, only the website with information, advertising and/or links to freely accessible websites is displayed.</p> <p>The function is enabled by default.</p>
Pop-Up window for status indication	Specify whether the device uses pop-up windows to display the status.

Field	Description
	The function is enabled by default.
Default Idle Timeout	<p>Enable or disable the Default Idle Timeout. If a hotspot user does not trigger any data traffic for a configurable length of time, they are logged out of the hotspot.</p> <p>The function is enabled by default.</p> <p>The default value is <i>600</i> seconds.</p>

19.10.2 Options

In the **Local Services->HotSpot Gateway->Options** menu, general settings are performed for the hotspot.

The menu consists of the following fields:

Fields in the **Basic Parameters** menu.

Field	Description
Host for multiple locations	If several locations (branches) are set up on the Hotspot server, enter the value of the NAS identifier (RADIUS server parameter) that has been registered for this location on the Hotspot server.

19.11 Wake-On-LAN

With the function **Wake-On-LAN** you can start network devices that are switched off via an integrated network card. The network card also needs a power supply, even when the computer is switched off. You can use filters and rule chains to define the conditions that need to be met to send the so-called magic packet, and select the interfaces that are to be monitored for the defined rule chains. Configuring the filters and rule chains is largely like configuring filters and rule chains in the menu **Access Rules**.

19.11.1 Wake-On-LAN Filter

The menu **Local Services->Wake-On-LAN->Wake-On-LAN Filter** displays a list of all the WOL filters that have been configured.

19.11.1.1 Edit or New

Choose the  icon to edit existing entries. Choose the **New** button to enter additional filters.

The **Local Services->Wake-On-LAN->Wake-On-LAN Filter->New** menu consists of the following fields:

Fields in the menu Basic Parameters

Field	Description
Description	Enter the name of the filter.
Service	<p>Select one of the preconfigured services. The extensive range of services configured ex works includes the following:</p> <ul style="list-style-type: none"> • <i>activity</i> • <i>apple-qt</i> • <i>auth</i> • <i>charge</i> • <i>clients_1</i> • <i>daytime</i> • <i>dhcp</i> • <i>discard</i> <p>The default value is <i>Any</i>.</p>
Protocol	<p>Select a protocol.</p> <p>The option <i>Any</i> (default value) matches any protocol.</p>
Type	<p>Only for Protocol = <i>ICMP</i></p> <p>Select the type.</p> <p>Possible values: <i>Any, Echo reply, Destination unreachable, Source quench, Redirect, Echo, Time exceeded, Timestamp, Timestamp reply.</i></p> <p>See RFC 792.</p> <p>The default value is <i>Any</i>.</p>

Field	Description
Connection State	<p>With Protocol = <i>TCP</i>, you can define a filter that takes the status of the TCP connections into account.</p> <p>Possible values:</p> <ul style="list-style-type: none"> • <i>Established</i>: All TCP packets that would not open any new TCP connection on routing over the gateway match the filter. • <i>Any</i> (default value): All TCP packets match the filter.
Destination IPv4 Address/Netmask	<p>Enter the destination IPv4 address of the data packets and the corresponding netmask.</p> <p>Possible values:</p> <ul style="list-style-type: none"> • <i>Any</i> (default value): The destination IP address/netmask are not specified. • <i>Host</i>: Enter the destination IP address of the host. • <i>Network</i>: Enter the destination network address and the corresponding netmask.
Destination IPv6 Address/Length	<p>Enter the destination IPv6 address of the data packets and the prefix length.</p> <p>Possible values:</p> <ul style="list-style-type: none"> • <i>Any</i> (default value): The destination IP address/length are not specified. • <i>Host</i>: Enter the destination IP address of the host. • <i>Network</i>: Enter the destination network address and the prefix length.
Destination Port/Range	<p>Only for Protocol = <i>TCP</i>, <i>UDP</i> or <i>TCP/UDP</i></p> <p>Enter a destination port number or a range of destination port numbers.</p> <p>Possible values:</p> <ul style="list-style-type: none"> • <i>-All-</i> (default value): The destination port is not specified. • <i>Specify port</i>: Enter a destination port. • <i>Specify port range</i>: Enter a destination port range.
Source IPv4 Address/Netmask	<p>Enter the source IPv4 address of the data packets and the corresponding netmask.</p>

Field	Description
	<p>Possible values:</p> <ul style="list-style-type: none"> • <i>Any</i> (default value): The source IP address/netmask are not specified. • <i>Host</i>: Enter the source IP address of the host. • <i>Network</i>: Enter the source network address and the corresponding netmask.
Source IPv6 Address/ Length	<p>Enter the source IPv6 address of the data packets and the prefix length.</p> <p>Possible values:</p> <ul style="list-style-type: none"> • <i>Any</i> (default value): The source IP address/length are not specified. • <i>Host</i>: Enter the source IP address of the host. • <i>Network</i>: Enter the source network address and the prefix length.
Source Port/Range	<p>Only for Protocol = <i>TCP</i>, <i>UDP</i> or <i>TCP/UDP</i></p> <p>Enter a source port number or a range of source port numbers.</p> <p>Possible values:</p> <ul style="list-style-type: none"> • <i>-All-</i> (default value): The source port is not specified. • <i>Specify port</i>: Enter a source port. • <i>Specify port range</i>: Enter a source port range.
DSCP/TOS Filter (Layer 3)	<p>Select the Type of Service (TOS).</p> <p>Possible values:</p> <ul style="list-style-type: none"> • <i>Ignore</i> (default value): The type of service is ignored. • <i>DSCP Binary Value</i>: Differentiated Services Code Point according to RFC 3260 is used to signal the priority of IP packets (indicated in binary format, 6 bit). • <i>DSCP Decimal Value</i>: Differentiated Services Code Point according to RFC 3260 is used to signal the priority of IP packets (indicated in decimal format). • <i>DSCP Hexadecimal Value</i>: Differentiated Services Code Point according to RFC 3260 is used to signal the priority of IP packets (indicated in hexadecimal format).

Field	Description
	<ul style="list-style-type: none"> • <i>TOS Binary Value</i>: The TOS value is specified in binary format, e.g. 00111111. • <i>TOS Decimal Value</i>: The TOS value is specified in decimal format, e.g. 63. • <i>TOS Hexadecimal Value</i>: The TOS value is specified in hexadecimal format, e.g. 3F.
COS Filter (802.1p/Layer 2)	<p>Enter the service class of the IP packets (Class of Service, CoS).</p> <p>Value range 0 to 7.</p> <p>The default value is 0.</p> <p>The default value is <i>Ignore</i>.</p>

19.11.2 WOL Rules

The menu **Local Services->Wake-On-LAN->WOL Rules** displays a list of all the WOL rules that have been configured.

19.11.2.1 Edit or New

Choose the  icon to edit existing entries. Choose the **New** button to enter additional rules.

The **Local Services->Wake-On-LAN->WOL Rules->New** menu consists of the following fields:

Fields in the menu Basic Parameters

Field	Description
Wake-On-LAN Rule Chain	<p>Select whether to create a new rule chain or to edit an existing one.</p> <p>Possible values:</p> <ul style="list-style-type: none"> • <i>New</i> (default value): You can create a new rule chain with this setting. • <i><Name of the rule chain></i>: Shows a rule chain that has already been created, which you can select and edit.
Description	Only where Wake-On-LAN Rule Chain = <i>New</i>

Field	Description
	Enter the name of the rule chain.
Wake-On-LAN Filter	<p>Select a WOL filter.</p> <p>If the rule chain is new, select the filter to be set at the first point of the rule chain.</p> <p>If the rule chain already exists, select the filter to be attached to the rule chain.</p> <p>To select a filter, at least one filter must be configured in the Local Services->Wake-On-LAN->WOL Rules menu.</p>
Action	<p>Define the action to be taken for a filtered data packet.</p> <p>Possible values:</p> <ul style="list-style-type: none"> • <i>Invoke WOL if filter matches</i>: Run WOL if the filter matches. • <i>Invoke if filter does not match</i>: Run WOL if the filter does not match. • <i>Deny WOL if filter matches</i>: Do not run WOL if the filter matches. • <i>Deny WOL if filter does not match</i>: Do not run WOL if the filter does not match. • <i>Ignore rule and skip to next rule</i>: This rule is ignored and the next one in the chain is examined.
Type	Select whether the Wake on LAN magic packet is to be sent as a UDP packet or as an Ethernet frame via the interface specified in Send WOL packet over Interface .
Send WOL packet over Interface	Select the interface which is to be used to send the Wake on LAN magic packet.
Target MAC-Address	<p>Only where Action = <i>Invoke WOL if filter matches</i> and <i>Invoke if filter does not match</i></p> <p>Enter the MAC address of the network device that is to be enabled using WOL.</p>
Password	Only where Action = <i>Invoke WOL if filter matches</i> and <i>Invoke if filter does not match</i>

Field	Description
	If the network device that is to be enabled supports the "SecureOn" function, enter the corresponding password for this device here. The device is only enabled if the MAC address and password are correct.

19.11.3 Interface Assignment

In this menu, the configured rule chains are assigned to individual interfaces which are then monitored for these rule chains.

A list of all configured interface assignments is displayed in the **Local Services->Wake-On-LAN->Interface Assignment** menu.

19.11.3.1 Edit or New

Choose the  icon to edit existing entries. Choose the **New** button to create other entries.

The **Local Services->Wake-On-LAN->Interface Assignment->New** menu consists of the following fields:

Fields in the menu Basic Parameters

Field	Description
Interface	Select the interface for which a configured rule chain is to be assigned.
Rule Chain	Select a rule chain.

19.12 Trace Interface

The menu **Trace Interface** allows recording the data traffic of a specific interface and allows you to save the recording as a PCAP file once the process has been stopped.

19.12.1 Trace Interface

Fields in the Trace Settings menu

Field	Description
Interface Selection	Select the interface the data traffic of which is to be recorded.
Trace Mode	Here you can choose the layers on which the data traffic of the selected interface is to be recorded. Available choices are: <ul style="list-style-type: none">• <i>Layer 2</i>• <i>PPP</i>• <i>Layer 3</i>• <i>IP</i>

As soon as you start the recording with the **START** button, a window informs you about the recording. During recording you can leave the menu and use the GUI as usual. Once you stop the recording with the **STOP** button, information on the created file is displayed and you can either delete or save it as a PCAP file.

19.12.2 Trace VoIP/SIP

The menu **Trace VoIP/SIP** allows you to capture VoIP/SIP messages at various levels and save them to a text file on your computer. You can choose from the following capture levels, a description what information is written to the file is provided depending on your selection:

- **State information:** The device writes the current state of the VoIP/SIP subsystem to a file you can then download.
- **Events:** The device continuously writes VoIP/SIP information to the capture buffer as soon as you click the Start button. Once you click the Stop button, you are presented with the download option.
- **SIP:** The device continuously writes all SIP messages (only) to the capture buffer as soon as you click the Start button. Once you click the Stop button, you are presented with the download option.

Chapter 20 Maintenance

This menu provides you with numerous functions for maintaining your device. It firstly provides a menu for testing availability within the network. You can manage your system configuration files. If more recent system software is available, you can use this menu to install it. If you need other languages for the configuration interface, you can import these. You can also trigger a system reboot in this menu.

20.1 Log out Users

It can happen that an incompletely terminated configuration session affects functions of the configuration interface. In this case, all active configurations can be checked and - if applicable - terminated.

20.1.1 Log out Users

In this menu, you are presented with a list of all active configuration sessions.

Fields in the menu Log out Users

Field	Description
Class	Displays the class the signed-on user belongs to.
User	Displays the user name.
Remote IP Address	Displays the IP address from which the connection has been established. This may be the address of a PC, but it may also be the address of an intermediate router.
Expires	Displays when the connection will be automatically terminated by the device.
Log out immediately	If you activate the check box, this user will be disconnected from the system when you click Logout .

20.1.1.1 Logout Options

After you have confirmed your selection of connections to be terminated with **Logout** you can choose if any configuration related to the connections is to be saved before the user is actually disconnected, and in which way.

20.2 Diagnostics

In the **Maintenance->Diagnostics** menu, you can test the availability of individual hosts, the resolution of domain names and certain routes.

20.2.1 Ping Test

You can use the ping test to check whether a certain host in the LAN or an internet address can be reached.

Fields in the Ping Test menu

Field	Description
Test Ping Mode	Select the IP version to be used for the ping test. Possible values: <ul style="list-style-type: none"> • <i>IPv4</i> • <i>IPv6</i>
Test Ping Address	Enter the IP address to be tested.
Use Interface	Only for Test Ping Mode = <i>IPv6</i> For link local addresses select the interface to be used for the ping test. <i>Default</i> can be used for global addresses.

Pressing the **Go** button starts the ping test. The **Output** field displays the ping test messages.

20.2.2 DNS Test

The DNS test is used to check whether the domain name of a particular host is correctly resolved. The **Output** field displays the DSN test messages. The ping test is launched by entering the domain name to be tested in **DNS Address** and clicking the **Go** button.

20.2.3 Traceroute Test

You use the traceroute test to display the route to a particular address (IP address or domain name), if this can be reached.

Fields in the Traceroute Test menu

Field	Description
Traceroute Mode	Select the IP version to be used for the Traceroute test. Possible values: <ul style="list-style-type: none"> • <i>IPv4</i> • <i>IPv6</i>
Traceroute Address	Enter the IP address to be tested.

Pressing the **Go** button starts the Traceroute test. The **Output** field displays the traceroute test messages.

20.3 Software & Configuration

You can use this menu to manage the software version of your device, your configuration files and the language of the **GUI**.

20.3.1 Options

Your device contains the version of the system software available at the time of production. More recent versions may have since been released. You may therefore need to carry out a software update.

Every new system software includes new features, better performance and any necessary bugfixes from the previous version. You can find the current system software at www.bintec-elmeg.com. The current documentation is also available here.



Important

If you want to update your software, make sure you consider the corresponding release notes. These describe the changes implemented in the new system software.

The result of an interrupted update (e.g. power failure during the update) could be that your gateway no longer boots. Do not turn your device off during the update.

An update of BOOTmonitor and/or Logic is recommended in a few cases. In this case, the release notes refer expressly to this fact. Only update BOOTmonitor or Logic if bintec elmeg GmbH explicitly recommends this.

Flash

Your device saves its configuration in configuration files in the flash EEPROM (Electrically Erasable Programmable Read Only Memory). The data even remains stored in the flash when your device is switched off.

RAM

The current configuration and all changes you set on your device during operation are stored in the working memory (RAM). The contents of the RAM are lost if the device is switched off. So if you modify your configuration and want to keep these changes for the next time you start your device, you must save the modified configuration in the flash memory before switching off: The **Save configuration** button over the navigation area of the **GUI**. This configuration is then saved in the flash in a file with the name *boot*. When you start your device, the *boot* configuration file is used by default.

Actions

The files in the flash memory can be copied, moved, erased and newly created. It is also possible to transfer configuration files between your device and a host via HTTP.

Configuration file format

The file format of the configuration file allows encryption and ensures compatibility when restoring the configuration on the gateway in various system software versions. This is a CSV format, which can be read and modified easily. In addition, you can view the corresponding file clearly using Microsoft Excel for example. The administrator can store encrypted backup files for the configuration. When the configuration is sent by e-mail (e.g for support purposes) confidential configuration data can be protected fully if required. You can save or import files with the actions "Export configuration", "Export configuration with status information" and "Load configuration". If you want to save a configuration file with the action "Export configuration" or "Export configuration with status information", you can choose whether the configuration file is saved encrypted or without encryption.



Caution

If you have saved a configuration file in an old format via the SNMP shell with the `put` command, there is no guarantee that it can be reloaded to the device. As a result, the old format is no longer recommended.

The **Maintenance->Software & Configuration->Options** menu consists of the following fields:

Fields in the **Currently Installed Software** menu.

Field	Description
BOSS	Shows the current software version loaded on your device.
System Logic	Shows the current system logic loaded on your device.
xDSL Logic	Shows the current version of the xDSL logic loaded on your device.

Fields in the **Software and Configuration Options** menu.

Field	Description
Action	<p>Select the action you wish to execute.</p> <p>After each task, a window is displayed showing the other steps that are required.</p> <p>Possible values:</p> <ul style="list-style-type: none"> • <i>No Action</i> (default value): • <i>Export configuration</i>: The configuration file Current File Name in Flash is transferred to your local host. If you click the Go button, a dialog box is displayed, in which you can select the storage location on your PC and enter the desired file name. • <i>Import configuration</i>: Under Filename select a configuration file you want to import. Please note: Click Go to first load the file under the name <i>boot</i> in the flash memory for the device. You must restart the device to enable it. <p>Please note: The files to be imported must be in CSV format!</p> <ul style="list-style-type: none"> • <i>Copy configuration</i>: The configuration file in the Source File Name field is saved as Destination File Name.

Field	Description
	<ul style="list-style-type: none"> • <i>Delete configuration</i>: The configuration in the Select file field is deleted. • <i>Rename configuration</i>: The configuration file in the Select file field is renamed to New File Name. • <i>Restore backup configuration</i>: Only if, under Save configuration with the setting <i>Save configuration and back up previous boot configuration</i> the current configuration was saved as boot configuration and the previous boot configuration was also archived. You can load back the archived boot configuration. • <i>Delete software/firmware</i>: The file in the Select file field is deleted. • <i>Import language</i>: You can import additional language versions of the GUI into your device. You can download the files to your PC from the download area at www.bintec-elmeg.com and from there import them to your device • <i>Update system software</i>: You can launch an update of the system software, the xDSL logic and the BOOTmonitor. • <i>Export configuration with state information</i>: The active configuration from the RAM is transferred to your local host. If you click the Go button, a dialog box is displayed, in which you can select the storage location on your PC and enter the desired file name. <p>The following options require that an MMC/SD card is inserted (if supported by your device) or that your device is equipped with an additional internal storage.</p> <ul style="list-style-type: none"> • <i>Import Voice Mail Wave Files</i>: In file name, select the <i>vms_wavfiles.zip</i> file that you wish to import. • <i>Import Additional Files (to usb storage)</i>: You can upload additional files to the USB memory. Choose which file to load under File Name • <i>Format MMC/SD Card</i>: Occasionally, the additional internal Flash memory has to be formatted. All stored data are deleted.
Current File Name in Flash	For Action = <i>Export configuration</i>

Field	Description
	Select the configuration file to be exported.
Include certificates and keys	<p>For Action = <i>Export configuration, Export configuration with state information</i></p> <p>Define whether the selected Action should also be applied for certificates and keys.</p> <p>The function is activated by selecting <i>Enabled</i>.</p> <p>The function is enabled by default.</p>
Configuration Encryption	<p>Only for Action = <i>Import configuration, Export configuration, Export configuration with state information</i>. Define whether the data of the selected Action are to be encrypted.</p> <p>The function is activated by selecting <i>Enabled</i>.</p> <p>The function is disabled by default.</p> <p>If the function is enabled, you can enter the Password in the text field.</p>
Filename	<p>Only for Action = <i>Import configuration, Import language Update system software</i>.</p> <p>Enter the path and name of the file or select the file with Browse... via the explorer/finder.</p>
Source File Name	<p>Only for Action = <i>Copy configuration</i></p> <p>Select the source file to be copied.</p>
Destination File Name	<p>Only for Action = <i>Copy configuration</i></p> <p>Enter the name of the copy.</p>
Select file	<p>Only for Action = <i>Rename configuration, Delete configuration</i> or <i>Delete software/firmware</i></p> <p>Select the file or configuration to be renamed or deleted.</p>
New File Name	<p>Only for Action = <i>Rename configuration</i></p>

Field	Description
	Enter the new name of the configuration file.
Source Location	<p>Only for Action = <i>Update system software</i></p> <p>Select the source of the update.</p> <p>Possible values:</p> <ul style="list-style-type: none"> • <i>Local File</i> (default value): The system software file is stored locally on your PC. • <i>HTTP Server</i>: The file is stored on a remote server specified in the URL. • <i>Current Software from Update Server</i>: The file is on the official update server.
URL	<p>Only for Source Location = <i>HTTP Server</i></p> <p>Enter the URL of the update server from which the system software file is loaded.</p>

In the **Advanced Settings** menu, the version of the currently installed system flash files will be displayed.

20.4 Reboot

20.4.1 System Reboot

In this menu, you can trigger an immediate reboot of your device. Once your system has restarted, you must call the **GUI** again and log in.

Pay attention to the LEDs on your device. For information on the meaning of the LEDs, see the **Technical Data** chapter of the manual.



Note

Before a reboot, make sure you confirm your configuration changes by clicking the **Save configuration** button, so that these are not lost when you reboot.

If you wish to restart your device, click the **OK** button. The device will reboot.

20.5 Factory Reset

In the menu **Maintenance->Factory Reset**, you can reset your device to the ex works state without having to have physical access to it.

Chapter 21 External Reporting

In this system menu, you define what system protocol messages are saved on which computers, and whether the system administrator should receive an e-mail for certain events. Information on IP data traffic can also be saved--depending on the individual interfaces. In addition, SNMP traps can be sent to specific hosts in case of error.

21.1 Syslog

Events in various subsystems of your device (e.g. PPP) are logged in the form of syslog messages (system logging messages). The number of messages visible depends on the level set (eight steps from *Emergency* over *Information* to *Debug*).

In addition to the data logged internally on your device, all information can and should be transmitted to one or more external PCs for storage and processing, e.g. to the system administrator's PC. The syslog messages saved internally on your device are lost when you reboot.



Warning

Make sure you only pass syslog messages to a safe computer. Check the data regularly and ensure that there is always enough spare capacity available on the hard disk of your PC.

Syslog Daemon

All Unix operating systems support the recording of syslog messages. For Windows PCs, the Syslog Daemon included in the **DIME Tools** can record the data and distribute to various files depending on the contents (can be called in the download area at www.bintec-elmeg.com).

21.1.1 Syslog Servers

Configure your device as a syslog server so that defined system messages can be sent to suitable hosts in the LAN.

In this menu, you define which messages are sent to which hosts and with which conditions.

A list of all configured system log servers displayed in the **External Reporting->Syslog->Syslog Servers** menu.

21.1.1.1 New

Select the **New** button to set up additional syslog servers.

The menu **External Reporting->Syslog->Syslog Servers->New** consists of the following fields:

Fields in the Basic Parameters menu.

Field	Description
IP Address	Enter the IP address of the host to which syslog messages are passed.
Level	<p>Select the priority of the syslog messages that are to be sent to the host.</p> <p>Possible values:</p> <ul style="list-style-type: none"> • <i>Emergency</i> (highest priority) • <i>Alert</i> • <i>Critical</i> • <i>Error</i> • <i>Warning</i> • <i>Notice</i> • <i>Information</i> (default value) • <i>Debug</i> (lowest priority) <p>Syslog messages are only sent to the host if they have a higher or identical priority to that indicated, i.e. at syslog level <i>Debug</i> all messages generated are forwarded to the host.</p>
Facility	<p>Enter the syslog facility on the host.</p> <p>This is only required if the Log Host is a Unix computer.</p> <p>Possible values: <i>local0</i> - 7</p> <p>.</p> <p>The default value is <i>local0</i>.</p>

Field	Description
Timestamp	<p>Select the format of the time stamp in the syslog.</p> <p>Possible values:</p> <ul style="list-style-type: none"> • <i>None</i> (default value): No system time indicated. • <i>Time</i>: System time without date. • <i>Date &Time</i>: System time with date.
Protocol	<p>Select the protocol for the transfer of syslog messages. Note that the syslog server must support the protocol.</p> <p>Possible values:</p> <ul style="list-style-type: none"> • <i>UDP</i> (default value) • <i>TCP</i>
Type of Messages	<p>Select the message type.</p> <p>Possible values:</p> <ul style="list-style-type: none"> • <i>System &Accounting</i> (default value) • <i>System</i> • <i>Accounting</i>

21.2 IP Accounting

In modern networks, information about the type and number of data packets sent and received over the network connections is often collected for commercial reasons. This information is extremely important for Internet Service Providers that bill their customers by data volume.

However, there are also non-commercial reasons for detailed network accounting. If, for example, you manage a server that provides different kinds of network services, it is useful for you to know how much data is generated by the individual services.

Your device contains the IP Accounting function, which enables you to collect a lot of useful information about the IP network traffic (each individual IP session).

21.2.1 Interfaces

In this menu, you can configure the IP Accounting function individually for each interface.

In the **External Reporting->IP Accounting->Interfaces** menu, a list of all interfaces configured on your device is shown. For each entry, you can activate IP Accounting by setting the checkmark. In the **IP Accounting** column, you do not need to click each entry individually. Using the options **Select all** or **Deselect all** you can enable or disable the IP accounting function for all interfaces simultaneously.

21.2.2 Options

In this menu, you configure general settings for IP Accounting.

```
Log Format
INET: %d %t %a %c %i:%r/%f -> %l:%R/%
```

In the **External Reporting->IP Accounting->Options** menu, you can define the **Log Format** of the IP accounting messages. The messages can contain character strings in any order, sequences separated by a slash, e.g. `\t` or `\n` or defined tags.

Possible format tags:

Format tags for IP Accounting messages

Field	Description
%d	Date of the session start in the format DD.MM.YY
%t	Time of the session start in the format HH:MM:SS
%a	Duration of the session in seconds
%c	Protocol
%i	Source IP Address
%r	Source Port
%f	Source interface index
%l	Destination IP Address
%R	Destination Port
%F	Destination interface index
%p	Packets sent
%o	Octets sent
%P	Packets received

Field	Description
%O	Octets received
%s	Serial number for accounting message
%%	%

By default, the following format instructions are entered in the **Log Format** field: *INET:*

```
%d%t%a%c%i:%r/%f -> %I:%R/%F%p%O%P%O[%s]
```

21.3 Alert Service

It was previously possible to send syslog messages from the router to any syslog host. Depending on the configuration, e-mail alerts are sent to the administrator as soon as relevant syslog messages appear.

21.3.1 Alert Recipient

A list of Syslog messages is displayed in the **Alert Recipient** menu.

21.3.1.1 New

Select the **New** to create additional alert recipients.

The menu **External Reporting->Alert Service->Alert Recipient->New** consists of the following fields:

Fields in the Add / Edit Alert Recipient menu.

Field	Description
Alert Service	<p>Displays the alert service. You can select an alert service for devices with UMTS.</p> <p>Possible values:</p> <ul style="list-style-type: none"> • E-mail • SMS
Recipient	Enter the recipient's e-mail address. The entry is limited to 40 characters.
Message Compression	Select whether the text in the alert E-mail is to be shortened. The e-mail then contains the syslog message only once plus the number of relevant events.

Field	Description
	<p>Enable or disable the field.</p> <p>The function is enabled by default.</p>
Subject	<p>You can enter a subject.</p>
Event	<p>This feature is available only for devices with Wireless LAN Controller.</p> <p>Select the event to trigger an email notification.</p> <p>Possible values:</p> <ul style="list-style-type: none"> • <i>Syslog contains string</i> (default value): A Syslog message includes a specific string. • <i>New Neighbor AP found</i>: A new adjacent AP has been found. • <i>New Rogue AP found</i>: A new Rogue AP has been found, i.e. an AP using an SSID of its own network, yet is not a component of this network. • <i>New AP (WTP) found</i>: A new unconfigured AP has reported to the WLAN. • <i>Managed AP offline</i>: A managed AP is no longer accessible.
Matching String	<p>You must enter a "Matching String". This must occur in a syslog message as a necessary condition for triggering an alert.</p> <p>The entry is limited to 55 characters. Bear in mind that without the use of wildcards (e.g. "*"), only those strings that correspond exactly to the entry fulfil the condition. The "Matching String" entered therefore usually contains wildcards. To be informed of all syslog messages of the selected level, just enter "*".</p>
Severity	<p>Select the severity level which the string configured in the Matching String field must reach to trigger an e-mail alert.</p> <p>Possible values:</p> <p><i>Emergency</i> (default value), <i>Alert</i>, <i>Critical</i>, <i>Error</i>, <i>Warning</i>, <i>Notice</i>, <i>Information</i>, <i>Debug</i></p>
Monitored Subsystems	<p>Select the subsystems to be monitored.</p>

Field	Description
	Add new subsystems with Add .
Message Timeout	<p>Enter how long the router must wait after a relevant event before it is forced to send the alert mail.</p> <p>Possible values are <i>0</i> to <i>86400</i>. The value <i>0</i> disables the timeout. The default value is <i>60</i>.</p>
Number of Messages	<p>Enter the number of syslog messages that must be reached before an E-mail can be sent for this case. If timeout is configured, the mail is sent when this expires, even if the number of messages has not been reached.</p> <p>Possible values are <i>0</i> to <i>99</i>; the default value is <i>1</i>.</p>

21.3.2 Alert Settings

The menu **External Reporting->Alert Service->Alert Settings** consists of the following fields:

Fields in the Basic Parameters menu.

Field	Description
Alert Service	<p>Select whether the alert service is to be enabled for the interface.</p> <p>The function is enabled with <i>Enabled</i>.</p> <p>The function is enabled by default.</p>
Maximum E-mails per Minute	Limit the number of outgoing mails per minute. Possible values are <i>1</i> to <i>15</i> , the default value is <i>6</i> .

Fields in the E-mail Parameters menu.

Field	Description
Sender E-mail Address	Enter the mail address to be entered in the sender field of the E-mail.
SMTP Server	<p>Enter the address (IP address or valid DNS name) of the mail server to be used for sending the mails.</p> <p>The entry is limited to 40 characters.</p>

Field	Description
SMTP Port	Encryption of e-mails (SSL / TLS). The field SMTP Port is per default preset to <i>25</i> and SSL Encryption is enabled.
SMTP Authentication	Authentication expected by the SMTP server. Possible values: <ul style="list-style-type: none"> • <i>None</i> (default value): The server accepts and send emails without further authentication. • <i>ESMTP</i>: The server only accepts e-mails if the router logs in with the correct user name and password. • <i>SMTP after POP</i>: The server requires that e-mails are called via POP3 by the sending IP with the correct POP3 user name and password before sending an e-mail.
User Name	Only if SMTP Authentication = <i>ESMTP</i> or <i>SMTP after POP</i> Enter the user name for the POP3 or SMTP server.
Password	Only if SMTP Authentication = <i>ESMTP</i> or <i>SMTP after POP</i> Enter the password of this user.
POP3 Server	Only if SMTP Authentication = <i>SMTP after POP</i> Enter the address of the server from which the e-mails are to be retrieved.
POP3 Timeout	Only if SMTP Authentication = <i>SMTP after POP</i> Enter how long the router must wait after the POP3 call before it is forced to send the alert mail. The default value is <i>600</i> seconds.

Fields in the **SMS Parameters** menu (for devices with UMTS only)

Field	Description
SMS Device	You can receive notification of system alerts in text messages. Select the device to be used to send the text message.
Maximum SMS per Day	Limit the maximum number of SMS sent during a single day.

Field	Description
	<p>Activating <i>No Limitation</i> allows any number of SMS to be sent.</p> <p>The default value is 10 SMS per day.</p> <p>Note: Entering a value of <i>0</i> is equivalent to activating <i>No Limitation</i>.</p>

21.4 SNMP

SNMP (Simple Network Management Protocol) is a protocol from the IP protocol family for transporting management information about network components.

Every SNMP management system contains an MIB. SNMP can be used to configure, control and administrate various network components from one system. Such an SNMP tool is included on your device: the Configuration Manager. As SNMP is a standard protocol, you can use any other SNMP managers, e.g. HPOpenView.

For more information on the SNMP versions, see the relevant RFCs and drafts:

- SNMP V. 1: RFC 1157
- SNMP V. 2c: RFC 1901 - 1908
- SNMP V. 3: RFC 3410 - 3418

21.4.1 SNMP Trap Options

In the event of errors, a message - known as a trap packet - is sent unrequested to monitor the system.

In the **External Reporting->SNMP->SNMP Trap Options** menu, you can configure the sending of traps.

The menu consists of the following fields:

Fields in the Basic Parameters menu.

Field	Description
SNMP Trap Broadcasting	<p>Select whether the transfer of SNMP traps is to be activated.</p> <p>Your device then sends SNMP traps to the LAN's broadcast address.</p> <p>The function is activated by selecting <i>Enabled</i>.</p>

Field	Description
	The function is disabled by default.
SNMP Trap UDP Port	<p>Only if SNMP Trap Broadcasting is enabled.</p> <p>Enter the number of the UDP port to which your device is to send SNMP traps.</p> <p>Any whole number is possible.</p> <p>The default value is <i>162</i>.</p>
SNMP Trap Community	<p>Only if SNMP Trap Broadcasting is enabled.</p> <p>Enter a new SNMP code. This must be sent by the SNMP Manager with every SNMP request so that this is accepted by your device.</p> <p>A character string of between <i>0</i> and <i>255</i> characters is possible.</p> <p>The default value is <i>SNMP Trap</i>.</p>

21.4.2 SNMP Trap Hosts

In this menu, you specify the IP addresses to which your device is to send the SNMP traps.

In the **External Reporting->SNMP->SNMP Trap Hosts** menu, a list of all configured SNMP trap hosts is displayed.

21.4.2.1 New

Select the **New** button to create additional SNMP trap hosts.

The menu **External Reporting->SNMP->SNMP Trap Hosts->New** consists of the following fields:

Fields in the Basic Parameters menu.

Field	Description
IP Address	Enter the IP address of the SNMP trap host.

21.5 SIA

21.5.1 SIA

In the menu **External Reporting->SIA->SIA**, you can create and download a file that provides extensive support information about the status of your device like, e.g., the current configuration, available memory, uptime etc.

Chapter 22 Monitoring

This menu contains information that enable you to locate problems in your network and monitor activities, e.g. at your device's WAN interface.

22.1 Internal Log

22.1.1 System Messages

In the **Monitoring->Internal Log->System Messages** menu, a list of all internally stored system messages is displayed. Above the table you will find the configured values for the **Maximum Number of Syslog Entries** and **Maximum Message Level of Syslog Entries** fields. These values can be changed in the **System Management->Global Settings->System** menu.

Values in the System Messages list

Field	Description
No.	Displays the serial number of the system message.
Date	Displays the date of the record.
Time	Displays the time of the record.
Level	Displays the hierarchy level of the message.
Subsystem	Displays which subsystem of the device generated the message.
Message	Displays the message text.

22.2 IPsec



22.2.1 IPsec Tunnels

A list of all configured IPsec tunnel providers is displayed in the **Monitoring->IPsec->IPsec Tunnels** menu.

Values in the IPsec Tunnels list

Field	Description
Description	Displays the name of the IPsec tunnel.
Remote IP	Displays the IP address of the remote IPsec Peers.

Field	Description
Remote Networks	Displays the currently negotiated subnets of the remote terminal.
Security Algorithm	Displays the encryption algorithm of the IPSec tunnel.
Status	Displays the operating status of the IPSec tunnel.
Action	Enables you to change the status of the IPSec tunnel as displayed.
Details	Opens a detailed statistics window.

You change the status of the IPSec tunnel by clicking the  button or the  button in the **Action** column.

By clicking the  button, you display detailed statistics on the IPSec connection.

Values in the IPSec Tunnels list

Field	Description
Description	Shows the description of the peer.
Local IP Address	Shows the WAN IP address of your device.
Remote IP Address	Shows the WAN IP address of the connection partner.
Local ID	Shows the ID of your device for this IPSec tunnel.
Remote ID	Shows the ID of the peer.
Negotiation Type	Shows the exchange type.
Authentication Method	Shows the authentication method.
MTU	Shows the current MTU (Maximum Transfer Unit).
Alive Check	Shows the method for checking that the peer is reachable.
NAT Detection	Displays the NAT detection method.
Local Port	Shows the local port.
Remote Port	Shows the remote port.
Packets	Shows the total number of incoming and outgoing packets.
Bytes	Shows the total number of incoming and outgoing bytes.
Errors	Shows the total number of errors.
IKE (Phase-1) SAs (x)	The parameters of the IKE (Phase 1) SAs are displayed here.
Role / Algorithm / Lifetime remaining / Status	
IPSec (Phase-2) SAs	Shows the parameters of the IPSec (Phase 2) SAs.

Field	Description
(x)	
Role / Algorithm / Lifetime remaining / Status	
Messages	The system messages for this IPsec tunnel are displayed here.

22.2.2 IPsec Statistics

In the **Monitoring->IPsec->IPsec Statistics** menu, statistical values for all IPsec connections are displayed.

The menu consists of the following fields:

Fields in the licenses menu

Field	Description
IPsec Tunnels	Shows the IPsec licenses currently in use (In Use) and the maximum number of licenses usable (Maximum).

Fields in the Peers menu

Field	Description
Status	Displays the number of IPsec tunnels by their current status. <ul style="list-style-type: none"> • Up: Currently active IPsec tunnels. • Going up: IPsec tunnels currently in the tunnel setup phase. • Blocked: IPsec tunnels that are blocked. • Dormant: Currently inactive IPsec tunnels. • Configured: Configured IPsec tunnels.

Fields in the SAs menu.

Field	Description
IKE (Phase-1)	Shows the number of active phase 1 SAs (Established) from the total number of phase 1 SAs (Total).
IPsec (Phase-2)	Shows the number of active phase 2 SAs (Established) from the total number of phase 2 SAs (Total).

Fields in the Packet Statistics menu.

Field	Description
Total	Shows the number of all processed incoming (In) or outgoing (Out) packets.



Field	Description
Passed	Shows the number of incoming (In) or outgoing (Out) packets forwarded in plain text.
Dropped	Shows the number of all rejected incoming (In) or outgoing (Out) packets.
Encrypted	Shows the number of all incoming (In) or outgoing (Out) packets protected by IPSec.
Errors	Shows the number of incoming (In) or outgoing (Out) packets for which processing led to errors.

22.3 Interfaces

22.3.1 Statistics

In the **Monitoring->Interfaces->Statistics** menu, current values and activities of all device interfaces are displayed.

With the filter bar, you can select whether to display **Transfer Totals** or **Transfer Throughput**. The values per second are shown on the **Transfer Throughput** display.

Change the status of the interface by clicking the  or the  button in the **Action** column.

Values in the Statistics list

Field	Description
No.	Shows the serial number of the interface.
Description	Displays the name of the interface.
Type	Displays the interface text.
Tx Packets	Shows the total number of packets sent.
Tx Bytes	Displays the total number of octets sent.
Tx Errors	Shows the total number of errors sent.
Rx Packets	Shows the total number of packets received.
Rx Bytes	Displays the total number of bytes received.
Rx Errors	Shows the total number of errors received.
Status	Shows the operating status of the selected interface.
Unchanged for	Shows the length of time for which the operating status of the interface has not changed.
Action	Enables you to change the status of the interface as displayed.

Click the  button to display the statistical data for the individual interfaces in detail.

Values in the **Statistics** list

Field	Description
Description	Displays the name of the interface.
MAC Address	Displays the MAC address.
IP Address / Netmask	Shows the IP address and the netmask.
NAT	Indicates if NAT is activated for this interface.
Tx Packets	Shows the total number of packets sent.
Tx Bytes	Displays the total number of octets sent.
Rx Packets	Shows the total number of packets received.
Rx Bytes	Displays the total number of bytes received.

Fields in the **TCP Connections** menu

Field	Description
Status	Displays the status of an active TCP connection.
Local Address	Displays the local IP address of the interface for an active TCP connection.
Local Port	Displays the local port of the IP address for an active TCP connection.
Remote Address	Displays the IP address to which an active TCP connection exists.
Remote Port	Displays the port to which an active TCP connection exists.

22.3.2 Network Status

The menu **Monitoring->Interfaces->Network Status** provides an overview of all IP interfaces currently configured on the device. You can find information on the status of an interface as well as on relevant parameters like its IPv4 and/or IPv6 IP address, the MAC address of the interface and the currently valid MTU.

22.4 Bridges

22.4.1 br<x>

In the **Monitoring->Bridges->br<x>** menu, the current values of the configured bridges are shown.

Values in the br<x> list

Field	Description
MAC Address	Shows the MAC addresses of the associated bridge.
Port	Shows the port on which the bridge is active.

22.5 HotSpot Gateway

22.5.1 HotSpot Gateway

A list of all linked hotspot users is displayed in the **Monitoring->HotSpot Gateway->HotSpot Gateway** menu.

Values in the HotSpot Gateway list

Field	Description
User Name	Displays the user's name.
IP Address	Shows the IP address of the user.
Physical Address	Shows the physical address of the user.
Logon	Displays the time of the notification.
Interface	Shows the interface used.

22.6 QoS

In the **Monitoring->QoS** menu, statistics are displayed for interfaces on which QoS has been configured.

22.6.1 QoS

A list of all interfaces for which QoS was configured is displayed in the **Monitoring->QoS->QoS** menu.

Values in the QoS list

Field	Description
Interface	Shows the interface for which QoS has been configured.
QoS Queue	Shows the QoS queue, which has been configured for this inter-

Field	Description
	face.
Send	Shows the number of sent packets with the corresponding packet class.
Dropped	Shows the number of rejected packets with the corresponding packet class in case of overloading.
Queued	Shows the number of waiting packets with the corresponding packet class in case of overloading.

Chapter 23 User Access

The system administrator can set up an individual configuration access interface for the users. You, the user, can thus display your most important personal settings and individually customise some of these.

To log in to the configuration interface with your assigned access data, enter your **User Name** and **Password** in the login window.

After successful login, the **Status** page is displayed. It includes an overview of your most important settings.

In the **Phonebook** menu, you can access the **System Phonebook** and create, edit as well as delete entries in a user-specific telephone book.

In the **Call Data Records** menu, you get a detailed overview of the calls you have conducted and accepted.

The **Settings** menu contains an overview of current settings of performance features **Direct Call**, **Call Forwarding** and **Parallel Ringing**. You can individually customise these here. In addition, you can view general settings and customise access and contact data.

23.1 Status

The **User Access->Status** menu displays the most important settings performed for you by the system administrator.

The menu consists of the following fields:

Values in the User Data list

Field	Description
Name, First Name	Displays the configured surname and name, if applicable, of your user.
Description	Displays the configured additional description for your user.

Values in the Internal Numbers & Communication Cost list

Field	Description
<Internal Number>	Displays the connection charges for the internal numbers assigned to your user.

Values in the Further Settings list

Field	Description
Current Class of Service	Displays the name of the authorisation class to which your user is assigned.
Dialling Authorization	<p>Displays the dial permission for your telephones. This derives from the setting for the corresponding user class.</p> <p>Possible values:</p> <ul style="list-style-type: none"> • <i>International</i>: The telephones have unrestricted dialling authorisations and can initiate all connections. • <i>National</i>: The telephones can initiate all calls except international calls. If a number starts with the code for international dialling, the number cannot be dialled. • <i>Incoming</i>: The telephones can receive incoming external calls, but cannot initiate any external calls. Internal calls are possible. • <i>Region</i>: The telephones cannot make any national or international calls. For this dial permission, 10 exception numbers allowing national or international dialling can be configured. An exception number can consist of complete call numbers or sections thereof (e. g. the first numerals). • <i>Local</i>: The telephones can make local calls. National and international calls are not possible. • <i>Internal</i>: The telephones do not have authorisation for incoming or outgoing external calls. Only internal telephone calls are possible.
Allow manual trunk group selection	<p>Indicates whether your user is assigned to an authorisation class for which manual bundle assignment is allowed. If so, authorised bundles or external connections are displayed.</p> <p>Besides general exchange access, a telephone can also selectively use a bundle. Here an external connection is initiated with the corresponding code for the target assignment of the bundle and not by dialling the dialling code.</p> <p>To be able to perform a selective bundle assignment, the authorisation class must possess the appropriate authorisation. The authorisation can also include bundles that the authorisation class can otherwise not assign. If a telephone does not pos-</p>

Field	Description
	<p>cess the authorisation for selective bundle assignment, or if the selected bundle is in use, the busy tone is heard after dialling the code. If Automatic Outside Line is set up for an authorisation class, users of this authorisation class must press the star key before selective bundle assignment, then initiate external dialling with the code for bundle assignment.</p>
Pick-up Group	<p>Displays the number of the group in which calls may be picked up.</p>

23.2 Phonebook

In the **Phonebook** menu, telephone book entries are displayed separately according to **System Phonebook** and **User Phonebook**. In **User Phonebook** the user can create, modify or delete up to 50 own entries. These entries can only be viewed by the respective user. These entries are updated via the **GUI**.

23.2.1 System Phonebook

In the **System Phonebook**, entries of the overall system created by the administrators are displayed. You cannot modify these.

Values in the System telephone book list

Field	Description
Description	<p>Displays the subscriber's description. The System Phonebook is sorted according to these entries.</p>
Phone Number	<p>Displays the telephone number.</p>
Speed Dial Number	<p>Displays the speed-dial number.</p>
Call Through	<p>Indicates whether the telephone number for the Call Through function is activated.</p>

23.2.2 User Phonebook

In the **User Phonebook**, your user entries are displayed. You can add, edit or delete entries.

23.2.2.1 Edit or New

Choose the  icon to edit existing entries. Select the **New** button to create new entries.

The menu **User Access->Phonebook->User Phonebook->New** consists of the following fields:

Fields in the Phonebook Entry menu.

Field	Description
Description	Enter a description for the entry. Sorting in User Phonebook follows the initial letters of the entry.
Phone Number	Enter the telephone number (internal or external).

23.3 Call Data Records

The **Call Data Records** menu displays your user's incoming and outgoing connections recorded to date.

23.3.1 Outgoing

The **Call Data Records->Outgoing** menu consists of the following fields:

Values in the Outgoing list

Field	Description
Date	Displays the connection date.
Time	Displays the time at call start.
Duration	Displays the duration of the connection.
User	Displays the user who called.
Int. No.	Displays the user's internal number.
Called Number	Displays the dialled number.
Project Code	Displays the call project number, if any.
Interface	Displays the interface over which the external connection was

Field	Description
	routed.
Costs	Displays the connection charge, but only if the provider transmits the corresponding data.

23.3.2 Incoming

The **Call Data Records->Incoming** menu consists of the following fields:

Values in the Incoming list

Field	Description
Date	Displays the connection date.
Time	Displays the time at call start.
Duration	Displays the duration of the connection.
User	Displays the user who was called.
Int. No.	Displays the user's internal number.
External Number	Displays the caller's number.
Project Code	Displays the call project number, if any.
Interface	Displays the interface over which the connection from outside was routed.

23.4 Call List

The menu **Applications->Call List** lists details of incoming and outgoing calls. Which kind of calls and how many of them are included can be specified in the submenu **General**.

23.4.1 Incoming

The **Applications->Call List->Incoming** menu contains information that permits the monitoring of incoming activities.

The menu consists of the following fields:

Fields in the Incoming menu

Field	Description
Date	Displays the connection date.
Time	Displays the time at call start.
Type	Displays the type of the connection.
Int. No.	Displays the user's internal number.
Caller Number	Displays the caller's number.
Trunk Number	Displays the port number.
Interface	Displays the interface over which the connection from outside was routed.
Delete	You can use the Select all and Deselect all buttons for all the devices displayed.

23.4.2 Outgoing

The **Applications->Call List->Outgoing** menu contains information that permits the monitoring of outgoing activities.

The menu consists of the following fields:

Fields in the Outgoing menu

Field	Description
Date	Displays the connection date.
Time	Displays the time at call start.
Type	Displays the type of the connection.
User	Displays the user who was called.
Int. No.	Displays the user's internal number.
Called Number	Displays the caller's number.
Trunk Number	Displays the port number.

Field	Description
Interface	Displays the interface over which the connection from outside was routed.
Delete	You can use the Select all and Deselect all buttons for all the devices displayed.

23.5 Settings

In the **Settings** menu, you can perform personal settings to performance features direct call, call forwarding (CF), parallel call and do not disturb, as well as customise general settings.

23.5.1 Feature Settings

In the **Settings->Feature Settings** menu, the settings for performance features direct call, call forwarding (CF), parallel call and do not disturb can be customised.

23.5.1.1 Call Forwarding

In the **Settings->Feature Settings->Call Forwarding** menu, you configure forwarding of incoming calls to your internal number onto the entered destination number.

You are temporarily away from your office, but don't want to miss a call. With call forwarding to another number, e.g. your mobile, you can receive your calls even when you are not at your desk. You can forward calls on your number to any call number. It can occur *Immediately*, *On no reply* or *On Busy*. Call forwarding *On no reply* and *On Busy* can exist concurrently. If you are not near your telephone, for example, the call is forwarded to another number (e.g. your mobile phone) after a short period. If you are making a call at your desk, other caller may receive the busy signal. You can forward these callers e.g. to a colleague or the secretary by using call forwarding on busy.

Calls can be forwarded to internal subscriber numbers, internal team numbers or external numbers. When the number to which calls shall be forwarded is entered, the system automatically checks whether it's an internal or external number.

To continue with configuring, click the  symbol.

Select the  button to go to the **IP1x0** telephone user interface administrator page. This is described in the telephone user guide!

The **Settings->Feature Settings->Call Forwarding** menu consists of the following fields:

Fields in the Call Forwarding menu.

Field	Description
Active Function	Select whether to enable the call forwarding (CF) function for your telephone. The function is enabled with <i>Enabled</i> The function is disabled by default.
Type	Select when incoming calls shall be forwarded to the specified internal number. Possible values: <ul style="list-style-type: none"> • <i>Immediately</i> • <i>On Busy</i> • <i>On no reply</i> (default value) • <i>On busy / On no reply</i>
Destination on no Reply	Enter the number to which incoming calls shall be forwarded after time.
Destination on Busy	Enter the number to which incoming calls shall be forwarded on busy.
Destination immediately	Enter the number to which incoming calls shall be forwarded immediately.

23.5.1.2 Parallel Ringing

In the **Settings->Feature Settings->Parallel Ringing** menu, you configure which calls should be signalled to your terminal.

The menu consists of the following fields:

Fields in the Parallel Ringing menu.

Field	Description
Active Function	Select whether to enable the parallel call function for your telephone. The function is enabled with <i>Enabled</i> The function is disabled by default.

Field	Description
External Number	Under <i>Individual Number</i> enter the external telephone number to which a call should be signalled in parallel. If a mobile number and a call number are configured for personal use, these are displayed in <i>Configured Home Number</i> or <i>Configured Mobile Number</i> and can be selected.

23.5.1.3 Direct Call

You wish to install your telephone in such a way that connection to a specific call number is set up even without entry of the number (e. g. emergency phone). You are not at home. However, there is someone at home who needs to be able to reach you quickly and easily by telephone if necessary (e. g. children or grandparents). If you have set up the Direct Call function for your telephone, the telephone receiver only needs to be picked up. After a time period without further entries set in configuration, the system automatically dials the configured direct call number.

If you do not dial within the specified period from picking up the receiver, automatic dialling is initiated.

The **Settings->Feature Settings->Direct Call** menu consists of the following fields:

Fields in the Direct Call menu.

Field	Description
Active Function	Select whether to enable the direct call function for your telephone. The function is enabled with <i>Enabled</i> The function is disabled by default.
Number	Select which number to use for direct call. Possible values: <ul style="list-style-type: none"> • <i>Preconfigured Number</i>: Select the desired number for which to set up direct call from the dropdown list. • <i>Individual Number</i>: Enter the desired number for which to set up direct call into the input field.

23.5.1.4 Do not Disturb

You can use the "station guarding" (do not disturb) feature to configure which calls will be signalled to your terminal.

The **Settings->Feature Settings->Do not Disturb** menu consists of the following fields:

Fields in the menu Do not Disturb

Field	Description
Active Function	<p>Select whether to enable the "station guarding" function for your telephone.</p> <p>The function is enabled with <i>Enabled</i>.</p> <p>The function is disabled by default.</p>
Do not Disturb	<p>With the station guarding feature, you can enable call signalling to your terminal. Analogue terminals use system code numbers for this.</p> <p>Select the calls for which you wish to use the feature.</p> <p>Possible values:</p> <ul style="list-style-type: none"> • <i>Internal Calls not signaled</i> • <i>External Calls not signaled</i> • <i>No Calls signaled</i>

23.5.1.5 Log on / Log off

With system telephones, it is only possible to log out of a team using the **Log on / Log off** function key. The team administrator must run this function manually if standard telephones are used.

The **Settings->Feature Settings->Log on / Log off** menu consists of the following fields:

Fields in the menu Log on / Log off

Field	Description
Description	Shows which teams the user belongs to.
Status	Select whether the team member shall be logged in or out of the team.

Field	Description
	The function is activated by selecting <i>Logged on</i> .
	The function is enabled by default.

23.5.2 General Settings

Your user's most important settings are listed in the **Settings->General Settings** menu. Personal access data (configuration password, IP phone password) as well as mobile and home office numbers can be customised.

The menu consists of the following fields:

Fields in the User Data menu.

Field	Description
Name	Displays your user's name.
Description	Displays the additional description for your user.
Login Name	Displays your user name for login to the user configuration interface.
Password for HTML Configuration Access	If you wish to change your password for access to the user configuration interface, enter a new password here. To check, you can display the password in plain text by clicking the Show option.
Password for IP Phone Registration	If you wish to change your password for IP telephone login, enter a new password here. To check, you can display the password in plain text by clicking the Show option.
PIN for Phone Access	If you wish to change the PIN for your personal voicebox, enter a new PIN here. To check, you can display the password in plain text by clicking the Show option.
Mobile Number	Here, you can enter the mobile number under which you can be reached.
Home Office Number	Here, you can enter the home office number under which you can be reached.
Busy on busy	Indicates whether performance feature Busy on Busy is enabled

Field	Description
	<p>for the currently selected user.</p> <p>If a subscriber for whom multiple telephone numbers have been configured makes a call, you can decide whether additional calls for this user shall be signalled. If "Busy on Busy" is set for this user, other callers get an Engaged signal if the user is calling on one of her numbers.</p> <p>The function is activated by selecting <i>Enabled</i>.</p> <p>The function is disabled by default.</p>

Fields in the **Status Information** menu.

Field	Description
Extension Numbers	Displays the internal numbers assigned to you.
Current Class of Service	Displays the authorisation class to which you're currently assigned.
Dialling Authorization	Displays your dial permission.
Allow manual trunk group selection	Displays whether you're allowed to assign additional bundles to outside lines and, if so, which.
Pick-up Group	Displays the number of the group in which calls may be picked up.

Glossary

2G	See GSM.
3DES	See DES.
3G	See UMTS.
4G	See LTE.
802.11	The 802.11 norm describes wireless LAN (WLAN). There are a variety of amendments: 802.11a: Gross data transfer rates: 54 Mbit/s, frequency band: 5 GHz, 802.11b/g: Gross data transfer rates: 11 Mbit/s, frequency band: 2.4 GHz, 802.11g: Gross data transfer rates: 54 Mbit/s, frequency band: 2.4 GHz, 802.11n: Gross data transfer rates: 600 Mbit/s, frequency band: 2.4 GHz (optional: 5 GHz)
A-subscriber	The A-subscriber is the caller.
a/b interface	An a/b interface is used to connect an analogue terminal. In the case of an ISDN terminal (terminal adapter) with a/b interface, a connected analogue terminal is enabled to use the supported ISDN performance features.
Access client	Client mode is an operating mode of a wireless access point (AP) in which the latter behaves like a wireless adapter vis-a-vis the higher level AP. With an AP run in client mode, individual computers or entire sub-networks can be connected to higher level networks.
Access point	An access point (AP) is a device for wirelessly connecting clients (computers). The AP thus serves to create a wireless network (WLAN) and connect that WLAN to a wired Ethernet network (bridging).
Accounting	Accounting refers to the recording of connection data, e.g. date, time, connection duration, charging information and number of data packets transferred.
Activity monitor	The activity monitor is used to oversee the status of physical and virtual device interfaces.
Ad-hoc network	In an ad-hoc network, individual clients connect to an independent wireless LAN via a wireless adapter. Ad-hoc networks work independently, with no access point on a peer-to-peer basis. The ad-hoc mode is also referred to as IBSS (Independent Basic Service Set)

mode and is useful in very small networks, e. g. when linking two notebooks with no access point.

ADSL	Asymmetric digital subscriber line. See DSL.
AES	Advanced Encryption Standard (AES, Rijndael) is an encryption method (see Cipher). AES uses a fixed block length of 128 bits. The key length is 128, 192 or 256 bits. AES is a very fast and secure algorithm.
Agent	The call centre agent is a member of a call centre.
Aggressive mode	When an IPSec connection is being established, aggressive mode is used to implement a phase 1 exchange. Aggressive mode offers no identity protection for negotiating nodes, since they have to transmit their identity before they can establish a secure channel. See also Main mode.
AH	The authentication header (AH) is used with IPSec to ensure the authenticity and integrity of the packets transmitted and to authenticate the sender.
Analogue	Analogue signals are used to transmit data. They are more susceptible to errors than digital signals.
Analogue terminals	Terminals that transmit voice and other information analogously, e.g. telephones, fax machines, answering machines and modems. Performance features can only be used with terminals that dial using the MFC dialling method and that have an R or flash key.
Annex A	Annex A is a DSL variant which occurs in connection with analogue telephone connections, e. g. in France.
Annex B	Annex B is a DSL variant which occurs in connection with ISDN, e. g. in Germany.
Annex J	Annex J is a DSL variant purely for data transmission, with no voice data (unbundled connection). Annex J is an extension of specification G.992. These DSL connections require no splitter and have a greater range and faster transmission speed.
Annex L	Annex L is an extension of Annex A. The range is increased at the expense of the data transmission rate.
Annex M	Annex M is an extension of Annex A. The upstream is increased at the expense of the downstream.

Announcement	The announcement is a performance feature. The announcement function enables a connection to be established to other phones which is automatically accepted by the subscribers called. The caller speaks and those called hear the announcement. If one of those called lifts the receiver, a normal connection is established.
ANSI T1.413	ANSI T1.413 is an ADSL variant.
Answering machine	Analogue answering machines are configured as an analogue terminal and selected via the terminal type. The PABX voice mail system is used as the answering machine.
ARP	The Address Resolution Protocol (ARP) supplies the associated MAC addresses to IPv4 addresses. The information required is shared between the network nodes, stored in the device's cache, and deleted again after the ARP lifetime has expired. For IPv6 this functionality is provided by the Neighbor Discovery Protocol (NDP).
ARS	The PABX uses Automatic Route Selection (ARS) to determine the ideal route to the called party, depending on the provider, service, QoS, ...
ATM	Asynchronous Transfer Mode (ATM) is a data transmission technology in which the data traffic is coded in small packets – called cells or slots – with a fixed length and is transmitted via asynchronous time multiplexing.
Authentication	Check on the user's identify.
Authorisation	Based on their identity (authentication), the user can access certain services and resources.
Authorisation class	See CoS.
Automatic callback on busy (CCBS)	Callback on busy is a performance feature. If the connection of the subscriber called is engaged, a callback can be requested. When the called subscriber's phone call ends, the caller is phoned and automatically connected to the called subscriber.
Automatic callback on no reply (CCBS)	Callback on no reply is a performance feature. If the called subscriber fails to take the call, a callback can be requested. When the called subscriber ends a call, the caller is phoned and automatically connected to the called subscriber.
Automatic outside line	Automatic outside line enables the phone number of an external party to be dialled (without entering a code).

Automatic redialling	If the connection of the called party is engaged, an automatic redial can be initiated. This notifies the caller as soon as the line is free.
Automatic Route Selection	Automatic route selection can be used to route calls whatever the number (zone) dialled, via specified providers or bundles.
AUX	AUX is a signal input for external devices, e. g. analogue or GSM modems.
B channel	See Basic Rate Interface and Primary Rate Interface.
B channel	See B channel.
B subscriber	The B subscriber is the called party.
Back Route Verify	If a Back Route Verify is activated for an interface, incoming data packets are only accepted over this interface if outgoing response packets are routed over the same interface.
Backbone area	The core area of a network which connects all the sub-networks (areas) with one another is known as the backbone.
Basic Rate Interface	The Basic Rate Interface is a network connection to the ISDN. This type of connection is often abbreviated to BRI. A basic rate interface includes two basic channels (B channels) each with 64 kbps and one control and signalling channel (D channel) with 16 kbps. There are two operating modes for the Basic Rate Interface: Point-to-point ISDN and Point-to-multipoint The Primary Rate Interface (PRI) is used with larger installations.
Beacon	The central access point sends beacons to create a wireless LAN in infrastructure mode. These messages contain the network name (SSID), a list of the supported transmission rates and the type of encryption.
Bit	A binary digit (bit) is the smallest unit of data in computing technology. Signals are represented in the logical states "0" and "1".
Black / White List	Entries in the Black List are blocked, entries in the White List are allowed through. (Example: Any telephone number beginning with 01234 is blocked in the Black List. The number 01234987 can nonetheless be approved in the White List.)
Blowfish	Blowfish is an encryption method (see Cipher). Blowfish uses a fixed block length of 64 bits. The key length can be between 32 and 448 bits.

BootP	The Bootstrap Protocol (BootP) is used to automatically issue an IP address.
Bps	Bits per second. A unit of measure for the transmission rate.
BRI	See Basic Rate Interface
Bridge	A bridge is a network component for connecting the same types of network at Level 2 of the OSI model. Data packets are transmitted using MAC addresses. The use of bridges divides up the network and reduces the load.
Broadcast	In a broadcast, data packets are sent from one point to all the subscribers in a network, e. g. if the recipient is not yet known. Examples of this are the ARP and DHCP protocols. The communication is via broadcast addresses: MAC networks: FF:FF:FF:FF:FF:FF, IPv4 networks: 255.255.255.255, IPv6 networks: ff00::/8
Broker	Brokering makes it possible to switch between two subscribers without the waiting subscriber being able to hear the other conversation.
BRRP	BRRP is an implementation of the Virtual Router Redundancy Protocol (VRRP). The aim of the method is to compensate for the failure of the default gateway. Multiple routers are combined to form one virtual router. If one of these routers falls over, the others are able to replace it.
Bundle	The external connections of a PABX can be grouped into bundles.
Busy On Busy	If Busy on Busy is enabled, anyone who calls an engaged subscriber hears the engaged tone. Call waiting or call forwarding to a team are not possible.
CA	Certificate Authority. See Certificate.
Cache	The device temporarily stores data used in name resolution in the cache. See also ARP.
Call allocation	With call allocation, calls coming into the PBX are assigned to particular numbers or applications (remote access, ISDN login, ...).
Call centre	A call centre provides support, shares information and sells over the telephone.
Call deflection	Call deflection (CD) is a performance feature. A call can be forward-

ded without it having been taken.

- Call deflection (CD)** See Call forwarding.
- Call forwarding** Call forwarding is a performance feature. When call forwarding (CF) is used, incoming calls can be routed to another, internal or external, phone number. The call can be forwarded in the telephone system or the switchboard, or by the SIP provider.
- Call pickup** See pickup
- Call Through** Call Through refers to dialling into the system via an external connection and the system putting the call through to a different external connection. This can reduce call costs.
- Call variant** The call variant specifies which terminals a call is signalled to. The calendar can be used to control the individual call variants on a time basis.
- Call waiting** Call waiting is a performance feature. Another caller is signalled during a phone call.
- Call waiting protection** When call waiting protection is enabled, other callers are not signalled on the terminal. The caller hears the engaged tone.
- Callback on Busy** See Automatic callback on busy (CCBS)
- Callback on no reply** See Automatic callback on no reply (CCBS)
- Called party number** The number of the party being phoned.
- Caller list** On system telephones, missed calls are saved in a caller list. To achieve this, calling line identification presentation (CLIP) needs to be enabled.
- Calling party number** The number of the calling terminal.
- CAPI** The Common ISDN Application Programming Interface (CAPI) is a programming interface for ISDN. It enables application programs to access ISDN hardware from a PC. See also TAPI.
- CAPWAP** Control And Provisioning of Wireless Access Points Protocol (CAPWAP) is used to have wireless access points (slaves) monitored by a WLAN controller (master). It uses UDP port 5246 for monitoring and 5247 to send data.
- CAST** CAST is an encryption method (see Cipher). CAST uses a fixed

block length of 64 bits. The key length can be between 40 and 128 bits. Alternative names are CAST-128 and CAST5.

Certificate	A certificate identifies a person, an institution, a device or an application. A public key certificate is a digital certificate and it creates a connection between the identity and a public key. Certificates with public keys are issued by a certification authority (CA). Certificates that can no longer be trusted may be revoked using certificate revocation lists (CRLs)
CFB	Call Forwarding Busy (CFB) is a performance feature. CFB forwards callers to a different connection if the connection of the party called is engaged.
CFNR	Call Forwarding No Reply (CFNR) is a performance feature. CFNR forwards callers to a different connection if the call is not taken.
Channel	A wireless channel is a frequency band used for wireless LAN. Devices that send on adjacent channels disrupt one another.
Channel bundling	When channels are bundled, the B channels in an ISDN connection are combined to increase data throughput.
CHAP	The Challenge Handshake Authentication Protocol (CHAP) is an authentication protocol for PPP connections. As well as the standard CHAP, Microsoft also has the variants MS-CHAPv1 and MS-CHAPv2. You dial into a network via PPP and you authenticate yourself with a username and password. The username and password are transmitted encrypted. See also PAP.
Cipher	A block cipher is an encryption algorithm. In this encryption method, a data block of a fixed size (normally 64 bit) is rewritten to a block of the same size using a so-called key. The longer the key, the more secure the algorithm.
CLID	Calling Line Identification (CLID), also known as Caller ID, is used for authentication. A caller is identified by means of his or her ISDN extension number before the connection is established.
Client	A client uses the services provided by a server. Clients are usually workstations.
CLIP	See Display caller number (CLIP / CLIR).
CLIP no Screening	See also Display caller number (CLIP / CLIR). With CLIP no Screening, as well as the normal caller number, another number is also sent, e. g. the number of the switchboard or a service number. The

	normal number can also be suppressed using CLIP, so that the party called only sees the other number.
CLIP off Hook	See Display caller number (CLIP / CLIR).
CLIR	See Display caller number (CLIP / CLIR).
Code procedure	A sequence (code procedure) (consisting of 0 - 9, *, # and R) can be entered on the telephone keypad in order to access the PBX's functions.
COLP	See Display called party number (COLP / COLR).
COLP no Screening	See also Display called party number (COLP / COLR). With COLP no Screening, as well as the normal caller number, another number is also sent, e. g. the number of the switchboard or a service number. The normal number can also be suppressed using COLP, so that the party called only sees the other number.
COLR	See Display called party number (COLP / COLR).
Conference call	With a conference call, multiple internal subscribers can speak to one another on the phone at the same time.
Configuration	The configuration refers to all of a device's settings. It is stored internally, in MIB tables. This data can be backed up, loaded and deleted externally. The configuration is edited using the HTTP(S) user interface, an SNMP client or connected telephones.
CoS	The term Class of Service (CoS) means different things depending on the area in which it is applied. In telecommunications CoS refers to the permission class assigned to the user. The permission class defines the user's rights, e. g. exchange access right, features that can be used, access to applications, ... In network technology CoS refers to the classification of certain services as per IEEE 802.1p. CoS enables priorities to be set in a targeted way, while Quality of Service (QoS) is used to set up explicit bandwidth guarantees or restrictions. Data packets are classified using a DSCP (Differentiated Services Code Point) value.
CRC	Cyclic Redundancy Check (CRC) is a method of detecting errors in the data transmission.
CRL	See Certificate.
D channel	See Basic Rate Interface and Primary Rate Interface.

Daemon	A daemon refers to a program that runs in the background and provides certain services.
Data compression	Data compression is a method of reducing the data volume transmitted. See STAC and MPPC.
Datagram	A datagram is a self-contained data entity with user and control data. It generally stands for the terms data frame, data packet and data segment.
DCN	DCN stands for data communication network.
DDI	DDI stands for Direct Dial In. See Point-to-point ISDN access and Direct dial-in (VoIP).
Dead Peer Detection	In IPSec, Dead Peer Detection is used to identify IKE peers that can no longer be accessed.
DECT	Digital Enhanced Cordless Telecommunications (DECT) is a standard for cordless telephones and wireless PABX systems.
Default gateway	All the data traffic which is not intended for one's own network is sent to the default gateway (default router).
Default route	See Standard route
Default route	The default route is used when no other suitable route is available.
Default router	See Default gateway.
Diffie-Hellman	Diffie-Hellman is a public key algorithm for negotiating and establishing keys. Because data is neither encrypted nor signed, the method is only secure if the connecting partners authenticate themselves using other mechanisms such as RSA and DSA.
Denial-Of-Service Attack	In a Denial-Of-Service Attack (DoS), a network component is flooded with queries so that it becomes totally overloaded. As a result, the system or a particular service can no longer function.
DES	The Data Encryption Standard (DES) is an encryption method (see Cipher). DES uses a fixed block length of 64 bits. The key length is 56 bits. Triple DES or 3DES is based on using DES three times (three different, independent keys).
DHCP	The Dynamic Host Configuration Protocol (DHCP) allows IP addresses to be assigned dynamically. A DHCP server allocates each client in a network an IP address from a defined address pool. The

clients need to be configured accordingly.

Dial preparation	Dial preparation describes the entering of the telephone number before initiating the call, e. g. by lifting the receiver.
Dialling control	See Black / White List.
Dialup connection	When required, a dialup connection is established by dialling a phone number, in contrast to a fixed connection (see Leased line) which is permanently enabled.
Digital	Digital signals are used to transmit data. They are less susceptible to errors than analogue signals.
DIME	Desktop Internetworking Management Environment (DIME) is used to configure and monitor gateways.
Direct call	If the direct call function is set up, the user merely has to lift the telephone receiver to, after a short wait, automatically get a connection to a particular phone number.
Direct dial exception	See Point-to-point ISDN access and Direct dial-in (VoIP).
Direct dial-in (VoIP)	Direct dial-in is a VoIP connection that is also known as point-to-point. It is used to connect a PBX. A main phone number and a number block are issued. Each of the numbers in the number block is called a direct dial exception. (Example: Main number 1234, number block: 1 - 99, numbers of the individual extensions: 1234-1, 1234-2, 1234-3, ...)
Direct dialling range	See number block in Point-to-point ISDN access and Direct dial-in (VoIP)
DISA	DISA - Direct Inward System Access A call, after it has been taken by the PBX, is automatically forwarded after a code has been entered. In the PBX, this code is assigned to an internal telephone number.
Display called party number (COLP / COLR).	Connected Line Identification Presentation (COLP) is used to send the phone number of the called party (B phone number) to the caller. Connected Line Identification Restriction (COLR) is used to suppress the transmission of the phone number of the called party to the caller.
Display caller number (CLIP / CLIR).	Calling Line Identification Presentation (CLIP) is used to send the caller's phone number (A phone number) to the called party. CLIP off Hook sends the phone number of the caller waiting. Calling Line

	Identification Restriction (CLIR) is used to suppress the transmission of the phone number of the caller to the called party.
DNS	The Domain Name System (DNS) is used to convert the domain name (e. g. www.example.org) to an IP address (name resolution).
Do not disturb	See Station guarding.
Domain	A domain is a contiguous sub-set of the DNS (e. g. example.org).
Door intercom	A door intercom is mounted on entrances, and may be part of a PBX.
Downstream	The gateway receives the data from a higher-level network and forwards it to its connected network.
DSA	The Digital Signature Algorithm (DSA) is used to create digital signatures and encrypt data packets. Signatures can be used to verify changes made to the information in the data packet. DSA is used for public-key cryptography (IPSec). See also RSA. Key generation is quicker with DSA than with RSA, but key processing is slower.
DSCP	Data packets can be marked with a Differentiated Services Code-point (DSCP). DSCP values classify data packets in such a way that important packets can be routed through the network more quickly. See also QoS.
DSL modem	See Modem.
DSP	A digital signal processor (DSP) converts analogue, ISDN and VoIP signals to one another. So, e. g., analogue terminals can also be used on an SIP connection.
DSS1	Digital Subscriber Signalling System No. 1 (DSS1) is a signalling protocol for the D channel in the ISDN. It is also known as Euro ISDN.
DTIM	A Delivery Traffic Indication Message informs the clients that multicast or broadcast data is available at the access point.
DTMF	See Multifrequency code dialling method.
DTMF Inband / Outband	See also Multifrequency code dialling method. With inband, the DTMF signal is transmitted in the voice band (G.711) With outband, the DTMF signal is transmitted as specified in RFC 2833.
Dynamic IP address	In contrast to a static IP address, a dynamic IP address is assigned

	temporarily by DHCP. Network components such as the web server or printer usually have static IP address, while clients such as notebooks or workstations usually have dynamic IP addresses.
DynDNS	A DynDNS provider can be used to link a domain name with a dynamically changing IP address.
Encapsulation	Encapsulation of data packets is a particular protocol to transmit the data packets in a network. See also VPN.
Encryption	Refers to the encryption of data, e.g. using MPPE.
Engaged when busy	See Busy on Busy.
ESP	Encapsulating Security Payload (ESP) is a protocol for IPSec. It uses protocol number 50 and supports data encryption and authentication.
Ethernet	Ethernet is a specification for cable data networks. Ethernet works on the first and second layer of the OSI model.
Euro ISDN	Standard ISDN in Europe, based on the DSS1 signalling protocol.
Eurofile transfer	Eurofile transfer (EFT) is a protocol for sharing files over ISDN.
Exchange access right	The telephone system distinguishes between the following exchange access rights: Unlimited: Any international, national or internal connection is permitted. National long-distance calls: Only domestic connections may be established - i. e. dialling any number that begins with 0 but not with 00. Incoming external calls can be received without restrictions. Locality: Only connections to the same area code may be established. So the number may not begin with a 0. Incoming external calls can be received without restrictions. Incoming: Only connections to other terminals in the telephone system may be established. Incoming external calls can be received without restrictions. Internal: Only connections within the telephone system are permitted.
Extension	In PBX systems, an extension refers to the terminal connected to the system.
Extension number	See Point-to-point ISDN access and Direct dial-in (VoIP).
Extension number block	See Point-to-point ISDN access and Direct dial-in (VoIP).
Extension numbers	See Extension number block in Point-to-point ISDN access.

range**Fax**

Fax is used to send text, graphics and documents over the phone network. A distinction is drawn between Group 3 fax machines for the analogue network (transmission rate: 9.6 or 14,4 kbit/s) and Group 4 fax machines for ISDN (transmission rate: 64 kbit/s). To connect Group 3 fax machines to ISDN, a terminal adapter or a suitable PBX is required.

Filter

A filter comprises a number of criteria (e.g. protocol, port number, source and destination address). If these criteria match a data packet, the data packet can be subjected to a particular action (forward, reject, ...). This creates a filter rule.

Filter rule

A rule that defines which data packets should or should not be transmitted by the gateway.

Firmware

The firmware (system software) is programming code that is permanently embedded in the device. It provides the device's functions.

Flash key

The flash key on a telephone is the R button. The key interrupts the line briefly to start certain functions such as inquiries.

Follow-me

Follow-me is a performance feature. This function can be used to route incoming calls from a different extension to one's own terminal.

Fragmentation

If the overall length of the data packet is greater than the Maximum Transmission Unit (MTU) of the network interface, the data packet has to be broken down into multiple physical data blocks using IP fragmentation. The reverse process is known as reassembly.

Frame

A data frame is an information unit (Protocol Data Unit) in the data link layer in the OSI model.

Frame relay

Frame relay is a data transmission technology and upgrade of X.25 (smaller packets, less error checking). Frame relay is primarily used for GSM networks.

FTP

The File Transfer Protocol (FTP) regulates data transmission in IP networks. It regulates the exchange between FTP server and client.

Full-duplex

With full-duplex, data can be sent and received simultaneously over a line.

Function keys

Function keys are special keys on system telephones which can be assigned phone numbers or functions.

FXO	Foreign Exchange Office (FXO) refers to the connection to the analogue terminal. See also FXS.
FXS	Foreign Exchange Station (FXS) refers to the analogue connection to the connection socket or PBX. See also FXO.
G.711	G.711 is an audio codec. Audio signals from the frequency range between 300 Hz and 3400 Hz are passed with a sampling rate of 8 kHz. At a data transmission rate of 64 kbit/s, the codec achieves excellent voice quality (MOS value: 4.4). The A-law quantisation method is used in Europe, and the μ -law method in the USA.
G.722	G.722 is an audio codec. Audio signals from the frequency range between 50 Hz and 7000 Hz are passed with a sampling rate of 16 kHz. At a data transmission rate of 64 kbit/s, the codec achieves outstanding voice quality (MOS value: 4.5).
G.726	G.726 is an audio codec. Audio signals from the frequency range between 200 Hz and 3400 Hz are passed with a sampling rate of 8 kHz. The codec achieves an acceptable voice quality. MOS value: 3.7 (16 kbit/s), 3.8 (24 kbit/s), 3.9 (32 kbit/s), 4.2 (40 kbit/s). There are two different coding methods: I.366 and X.420
G.729	G.729 is an audio codec. Audio signals from the frequency range between 300 Hz and 2400 Hz are passed with a sampling rate of 16 kHz. At a data transmission rate of 8 kbit/s, the codec achieves an acceptable voice quality (MOS value: 3.9).
G.991.1	Data transmission recommendation for HDSL.
G.991.2	Data transmission recommendation for SHDSL.
G.992.1	Data transmission recommendation for ADSL. There are two country-specific versions: G.992.1 Annex A and G.992.1 Annex B. Data transfer rates: 12 Mbit/s (downstream), 1.3 Mbit/s (upstream)
G.992.2	Data transmission recommendation for ADSL (G.LITE / ADSL-Lite). There are two versions: G.992.2 Annex A and G.992.2 Annex B. Data transfer rates: 12 Mbit/s (downstream), 1.3 Mbit/s (upstream)
G.992.3	Data transmission recommendation for xDSL2. There are three variants: G.992.3 Annex A/B (G.DMT to ADSL2) with data transmission rates of 12 Mbit/s in the downstream and 1.0 Mbit/s in the upstream, G.992.3 Annex L (RE-ADSL2) with data transmission rates of 5 Mbit/s in the downstream and 0.8 Mbit/s in the upstream and G.992.3 Annex M (ADSL2) with data transmission rates of 12 Mbit/s

in the downstream and 2.5 Mbit/s in the upstream.

- G.992.4** Data transmission recommendation for ADSL2 with Annex A/B. Data transmission rates: 12 Mbit/s (downstream), 1.0 Mbit/s (upstream)
- G.992.5** Data transmission recommendation for xDSL2+. There are three variants: G.992.5 Annex A/B (ADSL2+) with data transmission rates of 25 Mbit/s in the downstream and 1.0 Mbit/s in the upstream, G.992.5 Annex L (RE-ADSL2+) with data transmission rates of 25 Mbit/s in the downstream and 1.0 Mbit/s in the upstream and G.992.5 Annex M (ADSL2+) with data transmission rates of 25 Mbit/s in the downstream and 3.5 Mbit/s in the upstream.
- G.993.1** Data transmission recommendation for VDSL. Data transmission rates: 52 Mbit/s (downstream), 16 Mbit/s (upstream)
- G.993.2** Data transmission recommendation for VDSL2. Data transmission rates: 200 Mbit/s (downstream), 200 Mbit/s (upstream)
- G.DMT** See F.992.1.
- G.Lite** See F.992.2.
- G.SHDSL** See G.991.2.
- Gateway** The gateway is a network component for connecting different types of network.
- GPRS** General Packet Radio Service (GPRS) is the name for the packet-oriented service for transmitting data in GSM networks.
- GRE** Generic Routing Encapsulation (GRE) is a network protocol for encapsulating other protocols so that they can be transported via the Internet Protocol (IP) in the form of a tunnel (VPN). GRE uses protocol number 47.
- GSM** The Global System for Mobile Communications (GSM), also known as 2G, is a mobile communications standard. It achieves, along with GPRS, a specified max. data transmission rate of 171.2 kbit/s.
- Half-duplex** With half-duplex, data can only be sent and received back-to-back over a line.
- Hands-free calling** With hands-free calling, calls can be made without lifting the receiver. Other people in the room can participate in the conversation using a microphone and loudspeakers.

Hash	To ensure data integrity, the information needs to be protected from unauthorised manipulation while it is being transmitted. To ensure that this happens, every item of communication received has to match the information originally sent. Therefore erratic mathematical value functions (hash functions) are used to calculate checksums (hash values). These are encrypted and sent as a digital signature with the message. The recipient, in turn, checks the signature before opening the packet. If the signature and, thus, the content of the data packet has changed, the packet is discarded. The hash algorithms used most frequently are Message Digest Version 5 (MD5) and Secure Hash Algorithm (SHA1).
HDSL	High Data Rate Digital Subscriber Line. See DSL.
Heartbeat	A network's subscribers use heartbeats to signal that they are ready to receive.
Hold	A telephone call is put on hold without breaking the connection (inquiry/brokering). A distinction is drawn between holding the connection in the PBX (holding in the system) and holding in the switchboard or by the SIP provider.
Hold for enquiry	With hold for enquiry, the phone call with the first party is held while one conducts a second call.
Hop	Hop is the term for the connection from one network node to the next.
Host	A host is a computer system that provides its services to the network.
Host name	The domain name of a host. See DNS.
Host route	A host route is the name for the route to a single host.
Hotspot	A hotspot is a public internet access point via WLAN or wired Ethernet.
HSDPA	High Speed Downlink Packet Access (HSDPA, 3.5G, 3G+ or UMTS broadband) is a data transmission method in the UMTS mobile communications standard.
HTTP	The HyperText Transfer Protocol (HTTP) is a protocol for transmitting HTML pages (web pages) between server and client. By default it uses port 80.
HTTPS	The HyperText Transfer Protocol Secure (HTTPS) is a protocol

which protects against eavesdropping when transmitting HTML pages (web pages) between server and client. HTTPS is schematically identical to HTTP. SSL / TLS is used for additional data encryption. The standard port for HTTPS connections is 443.

Hyperchannel	With a hyperchannel, multiple subscribers have access to the transmission medium. A subscriber can only transmit their data if no other subscriber is using the medium. A hyperchannel network is mainly used for short-range operation with top data rates.
IAE	IAE refers to the standard socket (ISDN connection unit) to which ISDN terminals are connected.
ICMP	The Internet Control Message Protocol (ICMP) is used to exchange information and error messages over IPv4. The version ICMPv6 exists for IPv6.
IGMP	The Internet Group Management Protocol (IGMP) is used in IPv4 networks to organise multicast groups.
IKE	The Internet Key Exchange Protocol (IKE) is used for automatic key management with IPsec connections. The IKE process runs in two phases. During phase 1, the IKE subscribers authenticate themselves to one another and establish a secure channel. In phase 2, the two IPsec subscribers negotiate the SAs. There are two versions of the IKE mechanism.
Infrastructure network	In an infrastructure network the individual terminals (clients) form a wireless LAN via a central access point. This central access point may also be an agent in other networks.
Internal call tone	The internal call tone on a PBX is used to differentiate between internal and external calls.
Internal telephone numbers	Internal phone numbers are used for calls within the PBX.
IP	The Internet Protocol (IP) is a network protocol and it is the basis for the Internet. It works on the network layer of the OSI model. The TCP and UDP protocols are based on IP. There are two versions, Internet Protocol version 4 (IPv4) and Internet Protocol version 6 (IPv6).
IP address	IP addresses are used to navigate in an IP network, to unambiguously identify the source and destination. IPv4 addresses consist of 32 bits, IPv6 addresses of 128 bits. So, with IPv4 2 ³² , i.e.

4.294.967.296 addresses can be represented, with IPv6 2128 = 340.282.366.920.938.463.463.374.607.431.768.211.456 addresses. Dotted decimal notation, e. g. 192.168.0.250, is used for IPv4. Hexadecimal notation, e. g. 2001:db8:85a3::8a2e:370:7344, is used for IPv6. See also netmask.

IPCP	The Internet Protocol Control Protocol (IPCP) is used, in a similar way to DHCP, to configure a host with an IP address, gateway and DNS server, when a PPP network connection is being used. With the extension Robust Header Compression over PPP, the header can be compressed for faster data transmission. Similarly, in IPv6 networks, the functionality is provided by the Internet Protocol version 6 Control Protocol (IPV6CP).
IPSec	IPSec (Internet Protocol Security) is a network protocol for encapsulating other protocols so that they can be transported via the Internet Protocol (IP) in the form of a tunnel (VPN). The protocol number for IPSec depends on the protocol used. The Authentication Header (AH) uses protocol number 51, while the Encapsulating Security Payload (ESP) uses number 50.
IPv6	See IP.
ISDN	Integrated Services Digital Network (ISDN) is a data transmission standard that includes telephony, fax and data transmission. There are two ISDN connection variants: Basic Rate Interface and Primary Rate Interface.
ISDN address	The ISDN address of an ISDN device comprises an ISDN number followed by other numbers that relate to the specific terminal.
ISDN login	The ISDN login is used to remotely configure the device via SNMP. To do so, it needs to have a configured ISDN or wireless connection.
ISDN number	The ISDN number is the network address of the ISDN interface.
ISDN router	See Router.
ISDN-BRI	See BRI.
ISDN-Internal/External	Alternative name for the So bus.
ISDN-PRI	See PRI.
ISP	Internet Service Providers (ISPs) supply technical services for using

the Internet.

ITU	The International Telecommunication Union (ITU) coordinates the setting up and operating of telecommunications networks and services.
Keepalive	Keepalive packets are used to check that the communication partner can be contacted.
Keepalive	Keepalive is a mechanism for maintaining the network connection and for checking that the communication partner can be reached. Specific packets are usually sent to the network for this purpose.
Keypad	The keypad protocol (network direct) is used to access and manage performance features provided by the switchboard.
L2TP	The Layer 2 Tunneling Protocol (L2TP) is a network protocol for encapsulating other protocols so that they can be transported via the Internet Protocol (IP) in the form of a tunnel (VPN). By default, L2TP uses protocol number 1701. The architecture in an L2TP network consists of an L2TP access concentrator (LAC) which may also be permanently integrated into the client, and the L2TP network server (LNS). The LAC establishes the connections to the LNS and manages them. The authorisation is regulated using a network access server (NAS), which can be implemented in the LAC or LNS. The LNS is responsible for routing and controlling the packets received from the LAC. The user data itself is exchanged unencrypted, while control messages for maintaining the accessibility of the tunnel endpoints are transmitted securely.
LAC	See L2TP.
LAN	A Local Area Network (LAN) refers to a network that is geographically very limited and normally spans one building or a company head office.
Layer	A layer refers to a layer in the OSI model.
LCP	The Link Control Protocol (LCP) is used in PPP connections to automatically negotiate encapsulation, process limits for varying packet sizes, authenticate the connection partner, determine faulty links, identify connection faults and terminate the connection.
LDAP	The Lightweight Directory Access Protocol (LDAP) regulates the communication between a client and the directory server. LDAP is used for sharing and updating directories, e. g. a phone book.

Lease time	The lease time refers to the validity period of a dynamic IP address that a client has been given by a DHCP server.
Leased line	See Leased line
Leased line	A leased line is a permanent connection of two communication partners via telecommunications network.
Line access authorisation	See Exchange access right.
LLC	The Link Layer Control (LLC) regulates the media allocation at MAC level.
LNS	See L2TP.
Load balancing	With load balancing, data is sent via different interfaces in order to increase the overall bandwidth available. In contrast to Multilink, load balancing also functions with accounts with different providers.
Loopback	In a loopback switch the sender and recipient are identical.
LTE	Long Term Evolution (LTE), also known as 4G, is a mobile communications standard with a standardised maximum data transmission rate of 300 Mbit/s.
MAC address	The Media Access Control address (MAC address) is the hardware address of the network adapter and is used to identify the device at the hardware level.
Main Mode	When establishing an IPSec connection, main mode is used to implement a phase 1 exchange by setting up a secure channel. See also Aggressive mode.
Man-in-the-Middle attack	In a Man-in-the-Middle attack, the attacker is physically or logically between the two communication partners and so is able to view, and even manipulate, the data traffic.
MD5	Message Digest Algorithm 5 (MD5) is a hash function that generates a 128 bit hash value (checksum). See also Hash.
Media gateway	A media gateway converts the network type of digital voice, audio or image information. For example, the signals from an ISDN network can be converted to an IP network.
Metric	The metric is a measure for the properties of the route. The fastest route has the lowest metric (costs). Simplified, this is connecting

with the smallest number of node points (routers).

MFC	See Multifrequency code dialling method.
MFV	See Multifrequency code dialling method.
MIB	The Management Information Base (MIB) describes the data that can be queried or modified via a network management protocol (e. g. SNMP). The MIB is a database that describes all the devices and functions in the network.
MLP	The Multicast Listener Discovery (MLD) is used in IPv6 networks to organise multicast groups.
Mobile subscriber	If the mobile subscriber is enabled, an external telephone, e. g. a mobile phone can be called in parallel (parallel calling). The system's functions, e. g. callback, can also be used externally. For these functions, the external telephone's star key is interpreted as the R key.
Modem	A modem is an electronic device that converts digital signals to frequency signals in order to distribute data in a wired or wireless network.
MOH	See Music on hold.
MPDU	The MAC Protocol Data Unit (MPDU) refers to a data packet, including management frames and fragmented MSDUs, exchanged wirelessly.
MPPC	Microsoft Point-to-Point Compression (MPPC) is a method of data compression.
MPPE	Microsoft Point-To-Point Encryption (MPPE) is used to encrypt data transmitted via PPP. It was developed by Microsoft and Cisco and specified as RFC 3078.
MS-CHAP	The Microsoft Challenge Handshake Authentication Protocol (MS-CHAP) is a method of authentication. MS-CHAPv1 is intended for authenticating DCN connections and is largely the same as the standard CHAP. MS-CHAPv2 is an authentication method for PPTP connections (VPN).
MSDU	A MAC Service Data Unit (MSDU) is a data packet that is exchanged at LLC level.
MSN	See Multiple subscriber number

MSS	The Maximum Segment Size (MSS) defines the maximum number of bytes that can be used as user data in a TCP segment. The MSS must be smaller than the Maximum Transmission Unit (MTU) to avoid fragmenting the IP packets.
MSS clamping	MSS clamping reduces the Maximum Segment Size (MSS) in order to connect networks with different Maximum Transmission Units (MTU).
MTU	The Maximum Transmission Unit (MTU) is the largest possible data unit that can be transmitted over a physical line.
Multicast	With a multicast, data packets are sent from one point to particular subscribers in a network. In IPv4 this is controlled via the address range 224.0.0.0 to 239.255.255.255 and the IGMP protocol, while in IPv6 it is controlled by ff00::/8 addresses and ICMPv6.
Multifrequency code dialling method	The multifrequency code dialling method, also known as tone dialling, MFV, MFC and DTMF, is a signalling method for automatic telephone routing. Key inputs are represented by overlaid, sinusoidal signals. See also Pulse dialling.
Multilink	With multilink, multiple interfaces (PPP, PPPoE, ...) are combined into a single virtual connection in order to increase the total bandwidth available.
Multiple subscriber number	Multiple subscriber numbers are the individual phone numbers in the ISDN point-to-multipoint connection.
Music on Hold	The term Music On Hold (MOH) refers to automated announcements or hold music on the PBX.
Music on hold	See Music on hold.
MWI	The Message Waiting Indicator (MWI) signals that a new message is available.
NAPT	Network Address Port Translation (NAPT) is another term for PAT. See PAT.
NAT	Network Address Translation (NAT) is used to replace the source and destination IP addresses of a data packet with others. This enables different networks to be connected to one another. See also PAT.
NBNS	Like DNS, NetBIOS Name Service (NBSN) is used in centralised name resolution. See also WINS and DNS.

Netmask	With IPv4 in connection with the IP address, the netmask, also network mask and subnet mask, defines the network by dividing the IP address into network and device parts and thus determining which addresses need to be routed. Example of a netmask: 255.255.255.0. With IPv6 one refers to prefix length.
Network address	A network address is the address of the network as a whole. The network mask and prefix length divide the IP address into the network address and host address (device address). Example of a network address: 192.168.0.250/24
Network direct	See Keypad.
Network route	The network route refers to the route to a particular network.
Network termination	Network termination (NT) refers to a connection or operating type. A terminal is given access to a communication network at the NT interface (connection socket). The connector is called a TAE with an analogue connection, an NTBA with the basic ISDN connection, and NTPMGF with the ISDN Primary Rate Interface. In the NT operation, the gateway is connected to the PABX's external S0 and is an external exchange connection for it. See also TE.
NT	See Network termination.
NTBA	See Network termination.
NTP	The Network Time Protocol (NTP) is used to synchronise the time of day.
NTPMGF	See Network termination.
OAM	OAM is a service for monitoring ATM connections.
Open hold for enquiry	With open hold for enquiry, a call is put on hold and either party can then resume it once more.
OSI model	The OSI model divides the flow of communication between the physical medium and the user level into layers. The requirements at each layer are met by relevant protocols.
OSPF	OSPF is a dynamic routing protocol which is usually used in larger network installations as an alternative to RIP.
PABX	Private Automatic Branch Exchange (PABX) is another expression for a telephone system.

PABX	PABX is another term for a telephone system.
PAP	The Password Authentication Protocol (PAP) is an authentication method for connections via PPP. Unlike with CHAP, the username and password are not sent encrypted.
Parallel call	See Mobile subscriber.
Park	When a call is parked, the connection is held even if the receiver of the terminal involved is replaced or the cable connection is cut off.
PAT	Port and Address Translation (NAT) is used to replace the source and destination IP addresses and source and destination ports of a data packet with others. This enables different networks to be connected to one another. See also NAT.
PBX	Private Branch Exchange (PABX) is another expression for a telephone system.
PDM	See Pulse dialling
Peer	A peer is the endpoint of a communication in the network.
Phase 1/2	See IKE.
Pick-up	With pick-up, calls can be received using code procedures on an internal terminal that is not part of active call allocation.
PIM	The Protocol Independent Multicast (PIM) enables the dynamic routing of multicast packets on the Internet.
PIN	A personal identification number (PIN) can be used to authenticate oneself on the device so that one can use the device's functions.
Ping	Ping is a diagnostic tool that can be used to check whether a particular host in an IP network can be contacted. A measurement is taken of the time interval between sending a data packet (ICMP(v6) echo request packet) and receiving a response packet sent back immediately. This enables the connection quality to be determined.
PKCS	The Public-Key Cryptography Standards (PKCS) are standards for public key cryptography. The PKCS are designed for binary and ASCII data and are compatible with the X.509 standard. The public standards are PKCS #1, #3, #5, #7, #8, #9, #10, #11, #12 and #15. PKCS #10 describes the syntax for certification inquiries.
PKI	A public key infrastructure (PKI) is used to issue, distribute and veri-

fy digital certificates for an encryption procedure.

PMTU	The Path MTU (PMTU) describes the maximum packet size that can be transmitted along the entire connection route without needing to be fragmented.
Point-to-multipoint	Point-to-multipoint connection is an ISDNB connection. It is used to connect ISDN terminals. Multiple subscriber numbers (MSNs) are provided. See also Point-to-point ISDN access
Point-to-multipoint	See Single phone number (VoIP).
Point-to-point	See Point-to-point ISDN access and Direct dial-in (VoIP).
Point-to-point connection number:	See Point-to-point ISDN access
Point-to-point ISDN access	Point-to-point ISDN access refers to an ISDN connection that is also called point-to-point. It is used to connect a PBX. A point-to-point number and a number block are issued. Each of the numbers in the number block is called a direct dial exception. (Example: Point-to-point connection number: 1234, number block: 1 - 99, numbers of the individual extensions: 1234-1, 1234-2, 1234-3, ...) See also Point-to-multipoint connection.
Pool	An address pool is a collection of IP addresses that can be assigned to the connected clients, e. g. by DHCP.
POP3	The Post Office Protocol Version 3 (POP3) is a transmission protocol which controls how a client accesses emails from an email server.
Port	The port number is used to decide the service (telnet, FTP, ...) to which an incoming data packet should be sent.
POTS	Plain Old Telephone System (POTS) refers to the analogue telephone network.
PPP	The Point-to-Point Protocol (PPP) is a standardised technology for setting up a direct connection between the network nodes via dial-up lines.
PPPoA	The Point-to-Point-over-ATM Protocol (PPPoA) enables PPP data packets to be transported directly over an ATM network.
PPPoE	The Point-to-Point-over-Ethernet Protocol (PPPoE) enables PPP data packets to be transported directly over an Ethernet network.

PPTP	The Point-to-Point Tunneling Protocol (PPTP) is a network protocol for encapsulating other protocols so that they can be transported via the Internet Protocol (IP) in the form of a tunnel (VPN). PPTP uses protocol number 1723. The PPTP architecture is divided into two logical systems. The PPTP Access Concentrator (PAC) and the PPTP Network Server (PNS). The PAC is usually integrated into the Windows client. It establishes the connection to the PNS and manages it. The PNS is responsible for routing and controlling the packets received by the PNS.
Pre-shared key	A pre-shared key (PSK) is a key for an encryption procedure. The parties shared the key's value beforehand.
Prefix	See Network address
Prefix delegation	In IPv6 networks, prefix delegation is used to assign the network address (prefix) to the router.
Prefix length	See netmask.
PRI	See Primary Rate Interface.
Primary Rate Interface	The Primary Rate Interface is a network connection to the ISDN. This type of connection is often also called a PRI or S2Minterface. A Primary Rate Interface offers 30 user channels (B channels), each with 64 kbits/s, in Europe and 23 in the USA, one control channel (D channel) with 64 kbits/s and one synchronisation channel with 64 kbits/s in Europe and 8 64 kbits/s in the USA. See also Basic Rate Interface.
Proposal	When an IPsec connection is being established, the initiator of the connection makes proposals with relation to the authentication and encryption methods to be used.
Protocol	Protocols regulate the flow of a data communication on different levels of the OSI model. Protocols control addressing, coding, authentication, formatting, etc. Examples: Ethernet, IP, TCP, HTTP
Proxy	A proxy is a network component. The proxy is an agent. It routes a query from the source with its own IP address to the destination.
Pulse dialling	Pulse dialling is a signalling method for automated telephone routing. Key inputs are represented by a defined number of dc pulses. See also Multifrequency code dialling method (MF).
PVID	The Port VLAN Identifier (PVID) is the standard VLAN ID for the port concerned. A packet that reaches this port without a VLAN tag is as-

signed this ID.

Q-SIG	Q-Interface Signalling Protocol (Q-SIG) is an ISDN-based signalling protocol for linking PABX systems.
QoS	Quality of Service (QoS) describes the properties of the communication service. It is defined using bandwidth, delay, packet losses and jitter. To transmit time-critical data packets for VoIP or video streaming as quickly as possible, QoS is used to sort all the data packets into groups and forward them on in the network either more quickly or slowly, depending on their priority.
Queue	The data packets accumulate in a queue before they are sent.
RADIUS	Remote Authentication Dial-In User Service (RADIUS) is a client-server protocol for authenticating, authorising and accounting for users with dial-in connections. The RADIUS server authenticates the client, e. g. by checking the username and password. See also TACACS+.
RE-ADSL2	See G.992.5.
Real Time Jitter Control	Real Time Jitter Control is used, where necessary, to reduce the size of data packets during a telephone conversation so that voice packets are not blocked.
Registrar	The SIP server (registrar) needs to be used in case the subscribers to a VoIP call are not using static IP addresses. The SIP server registers the clients' IP addresses and sends this data to the SIP proxy, which connects the calls. The SIP proxy and SIP registrar are usually identical.
Reject / reject function	When a phone number that has not been set up in the telephone system is dialled, or if the connection of the party called is engaged, or the party called does not take the call, the reject function determines how to proceed with the call. The call can be routed to a different destination or discarded.
Repeater	A repeater is a device that strengthens electric or optical signals and thus increases the range of the network.
Reset	This returns the device to its unconfigured state.
RFC	A Request For Comments (RFC) is a document that describes the standards and guidelines for the Internet.
Rijndael	See AES.

RIP	The Routing Information Protocol (RIP) is a routing protocol. It is restricted to small networks. See also OSPF.
RipeMD 160	RACE Integrity Primitives Evaluation Message Digest (RipeMD 160) is a hash function that generates a 160 bit hash value (checksum). See also Hash.
RJ45	RJ45 refers to a jack or connector with a maximum of eight wires to the digital terminals' connection.
Roaming	With roaming, a client moves through a WLAN logging on and off at different access points in the same network.
Room monitoring	Room monitoring is a performance feature. One can listen in to the sounds in a room.
Router	A router is a network component for connecting different types of network at the network layer of the OSI model. Data packets are transmitted using IP addresses. Routing tables are used to identify the best routes through the network. In order to keep the routing tables up to date, the routers exchange information via routing protocols (e.g. OSPF, RIP).
Router advertisement	Router advertisements are messages that the router sends to the network. They announce the presence of the router in the network. Router announcements are also used to issue prefixes, organise the autoconfiguration and specify the standard router.
Routing	Routing refers to the identifying of routes for sending messages.
RSA	The RSA algorithm (named after its inventors, Rivest, Shamir and Adleman) is used to create digital signatures and encrypt data packets. The signature can be used to verify changes made to the information in the data packet. RSA is used for public-key cryptography (IPSec). See also DSA. Key generation is slower with RSA than with DSA, but key processing is faster.
RTP	The Real-Time Transport Protocol (RTP) is used to transmit audio and video data (streams) via IP-based networks.
RTS threshold	Once the number of frames in the data packet exceeds the RTS threshold, a connection check (RTS/CTS handshake) is run before a data packet is sent.
RTSP	The Real-Time Streaming Protocol (RTSP) controls the transmission of audio and video data (streams) via IP-based networks. While the Real-Time Transport Protocol (RTP) is used to transmit user

data, the main function of RTSP lies in controlling the data streams.

Rule chain	A rule chain contains a combination of different filter rules. A filter rule selects part of the data traffic based on particular features, e. g. the source IP address, and applies an action, e. g. block, on this part.
S0 bus	The S0 bus is an interface for the ISDN Basic Rate Interface, and links multiple ISDN terminals to the NTBA. The bus is implemented by a four-wire circuit. See also UP0.
S2M interface	See Primary Rate Interface.
SA	So-called security associations (SA) receive information about the measures to secure the communication connection. One SA, at least, is a prerequisite for establishing a secure connection. An SA receives the subscriber's IP address, the authentication protocol used, the encryption algorithm used, the security parameter index (SPI), the selector and the period of validity.
SAD	All the parameters that are set while configuring IPsec are stored in the router in the form of databases. These are the Security Policy Database (SPD) and the Security Association Database (SAD). The SAD receives information about every security connection. That is, which encryption algorithms, keys, protocols, session numbers or periods of validity are to be used. For an outgoing connection, an SPD entry displays an SAD entry. In this way, the SPD can specify which SA is to be used for a particular packet. With an incoming connection, the SAD is addressed in order to specify how the packet is to be processed.
SCEP	The Simple Certificate Enrollment Protocol (SCEP) is used to manage digital certificates.
Scheduling	Scheduling refers to the planning of tasks. Particular actions (e. g. deactivating an interface) are triggered by events (e. g. time or changing a MIB variable).
Serial interface	The serial interface is used to exchange data between computers and peripheral devices. It can be used to configure the device or to transmit data via an IP infrastructure (Serial over IP).
Server	A server offers services used by clients.
SFP	Small Form-factor Pluggable (SFP) is a plug-in connector that was developed for extremely fast Ethernet.

SHA1	Secure Hash Algorithm version 1 (SHA1) is a hash function that generates a 160 bit hash value (checksum). See also Hash.
SHDSL	Symmetrical High-bit-rate Digital Subscriber Line. See DSL.
Shell	The shell is an input interface (e. g. command line or graphic user interface) between computer and user.
Short hold	The short hold is the defined amount of time after which a network connection is automatically cleared if no more data is transmitted.
SIF	With a Stateful Inspection Firewall (SIF), the routing of a data packet is not determined only by source and destination addresses but also using dynamic packet filtering based on the connection status.
Simplex operation	Simplex operation is a performance feature. Simplex operations are used to take a call automatically and switch the speaker function on. If the called party lifts the receiver, a normal voice connection is established.
Single phone number (VoIP)	Single phone number access is a VoIP connection that is also known as a point-to-multipoint connection. It is used to connect VoIP terminals. Multiple subscriber numbers (MSNs) are provided. See also Direct dial-in (VoIP)
SIP	The Session Initiation Protocol is a network protocol for setting up a communication session between two or more subscribers. The protocol is used for IP telephony (VoIP).
SIP provider	A SIP provider does the switching between a SIP connection and other analogue, ISDN and VoIP connections.
SMTP	The Simple Mail Transfer Protocol (SMTP) is used to exchange emails.
SNMP	The Simple Network Management Protocol (SNMP) is used to configure, control and monitor different network components (e. g. routers, servers, etc.) from a single, central system. The network component settings that can be changed are stored in a database – the Management Information Base (MIB). SNMP uses UDP. The network component receives requests to port 161 while the managing system receives confirmation messages (TRAPs) at port 162.
SNTP	The Simple Network Time Protocol (SNTP) is used to transmit the time and to synchronise the server and client.
Softkey	A softkey refers to a key whose function is determined by the asso-

ciated screen display.

Spatial streams	Spatial streams are data streams that are sent out at the same time on the same frequency in the wireless LAN. The transmission rate is multiplied as a result.
SPD	All the parameters that are set while configuring IPsec are stored in the router in the form of databases. These are the Security Policy Database (SPD) and the Security Association Database (SAD). The Security Policy Database lists the forms of data traffic that are to be secured. Factors such as the source and destination address of the data packet are used to do this.
Speaker function	With the speaker function, the people present in the room can listen in to the telephone call.
Speed dial number	A speed dial index (000...999) is assigned to every number in the phone book. This speed dial index can be used to dial instead of the long phone number.
Splitter	A broadband access unit, commonly known as a splitter, is used to split signals that come via a subscriber loop into data and telephone lines.
SRTP	The Secure Real-Time Transport Protocol (SRTP) is the variant of the Real-Time Transport Protocol (RTP) that is encrypted using AES.
SSH	Secure Shell (SSH) is a network protocol that can be used to establish an encrypted connection to a device's shell.
SSID	The Service Set Identifier (SSID) defines a wireless network that is based on IEEE 802.11. The SSID is the network name of the wireless LAN. All the access points and clients that belong to the same network use the same SSID. The SSID string can be up to 32 characters long and is placed, unencrypted, in front of all packets. A client uses SSID ANY to contact all the accessible access points. The user is then shown all the available WLANs and he can select the appropriate network. If an access point is used for different networks, each wireless network is given a separate MSSID (Multi Service Set Identifier).
SSL	Secure Sockets Layer (SSL) is a protocol for data encryption. Since version 3.1, the new term Transport Layer Security (TLS) has been used. SSL is mainly used for HTTPS to encrypt the data transmission between web server and web browser.

STAC	STAC is used to reduce the data volume transmitted (data compression).
Static IP Address	In contrast to a dynamic IP address, the static IP address is assigned permanently by the user. Network components such as the web server or printer usually have static IP address, while clients such as notebooks or workstations usually have dynamic IP addresses.
Station guarding	When station guarding is enabled, acoustic call signalling is switched off. This function is also known as Do not disturb.
STUN Server	Simple Traversal of User Datagram Protocol (UDP) Through Network Address Translators (NATs). A STUN server enables VoIP devices behind an active NAT to access the network.
Sub-addressing	As well as the ISDN telephone number, a sub-address can also be sent when establishing the connection. This sub-address can transmit any additional information. It can be used, e. g., to systematically address multiple ISDN terminals that can be reached under one telephone number, or to open particular programs on a PC.
Subnet	A sub-network in an IP network is known as a subnet. A subnet is defined like a normal network, via an IP address and (sub-)netmask (IPv4) and prefix length (IPv6). Example: 192.168.1.250/24 (192.168.1.250/255.255.255.0, 256 possible IP addresses) is a subnet of 192.168.1.250/16 (192.168.1.250/255.255.0.0, 65536 possible IP addresses).
Suppress telephone number	See Display caller number (CLIP / CLIR) and Display called party number (COLP / COLR).
Switch	A switch is a network component that connects individual network segments to one another. On the one hand, a switch can be operated as a bridge to the data link layer in the OSI model. Unlike the bridge, however, a switch has more than one input and output. On the other hand, the switch can be operated as a gateway to the network layer in the OSI model. The device comparable to the switch in the physical layer is known as the hub.
Switch contact	A telephone can be used to switch a device connected to the switch contact, e. g. a door opener, on and off.
SWYX	SwyxWare is a software-based communication solution for VoIP.
Syslog	The syslog protocol is used to transmit status messages in an IP

network. In this way, different network components can be monitored from a single, central system. Syslog messages are sent as unencrypted text messages over the UDP port 514.

System telephone	A system telephone has multiple function and special keys and can use the performance features of a PBX.
T.38	T.38 or Fax over IP (FoIP) refers to fax transmission via an IP network.
TA	See Terminal adapter
TACACS+	The Terminal Access Controller Access Control System Plus (TACACS+) is a client-server protocol for authenticating, authorising and accounting for users. The TACACS+ server authenticates the client by checking, e. g., the username and password. In contrast to the UDP-based RADIUS protocol, TACACS+ uses TCP on port 49 and transmits the entire communication encrypted.
TAPI	The Telephony Applications Programming Interface (TAPI) is a programming interface for ISDN. It enables application programs to access ISDN hardware from a PC. See also CAPI.
TCP	The Transmission Control Protocol (TCP) is a connection-oriented protocol. It works on the transport layer of the OSI model. With a connection-oriented protocol, a logical connection is established before transmission and maintained. This enables data to be transmitted reliably. Nonetheless, control information is constantly being sent alongside the actual data packets. This causes the data volume sent to increase. See also UDP.
TCP-ACK packet	An ACK (acknowledgement) signal is used when transmitting data to confirm the receipt or the processing of data or commands. TCP uses ACK signals for communication.
TCU	See Network termination. A distinction is drawn between F-coded connectors for telephones and N-coded connectors for fax machines, modems and answering machines.
TE	Terminal equipment (TE) refers to a connection or operating type. The TE connector is a terminal's connector. In TE operation, the gateway is connected to the PABX's internal S0 and thus constitutes an ISDN terminal. See also NT.
TEI	Under ISDN protocol DSS1, the Terminal Endpoint Identifier (TEI) is an identifier for terminals.

Telefax	See Fax.
Telnet	Telecommunication Network (Telnet) is a network protocol. It enables communication with another, remote device in the network, e. g. PCs, routers, etc.
Terminal adapter	A terminal adapter (TA) can be used to connect terminals to an interface on which they cannot be operated directly, e. g. analogue terminals to an ISDN connection.
TFTP	The Trivial File Transfer Protocol (TFTP) regulates the transmission of files. Compared with FTP, there is no option to display data, issue permissions or authenticate users.
Three-party conference	The three-party conference is a performance feature. Three subscribers can speak to one another on the phone simultaneously.
Tiger 192	Tiger 192 is a hash function that generates a 192 bit hash value (checksum). See also Hash.
Time service	The Time protocol is used to synchronise the date and time. The protocol uses port 37 via TCP and UDP.
Time slot	A time slot is a period of time which is permanently assigned within a transmission frame, and is usually equivalent to one transmission channel.
TLS	See SSL.
Tone dialling	See Multifrequency code dialling method.
TOS	Type of Service (TOS) is a field in the header of IP data packets. It specifies the priority of the data packet. See also QoS.
Traceroute	Traceroute is used to determine which routers will be used to route data packets to the queried destination host.
Trigger	This refers to a trigger impulse.
Triple DES	See DES.
Trunk	A trunk consists of bundled connections or transmission channels. See also Bundle.
TTL	The Time to live (TTL) is the configured period of validity of a data packet. With the Internet Protocol (IP), TTL specifies how many hops a data packet may pass. The maximum value is 255 hops. The

	<p>TTL is reduced by 1 with each hop. If a data packet has not yet reached its destination when its TTL expires, it is discarded.</p>
Twofish	<p>Twofish is an encryption method (see Cipher). Twofish uses a fixed block length of 128 bits. The key length is 128, 192 or 256 bits.</p>
U-ADSL	<p>Universal Asymmetric Digital Subscriber Line (UADSL) is a DSL variant. It was developed as ANSI T1.413 and standardised as G.992.2. U-ADSL enables different communication technologies to be used in parallel, e. g. ISDN and POTS, and does not require a splitter.</p>
UDP	<p>The User Datagram Protocol (UDP) is a connectionless protocol. It works on the transport layer of the OSI model. With a connectionless protocol, no control is integrated for delivering the packet. The control must take place in the application layer. Conversely, UDP is faster than connection-oriented protocols.</p>
ULA	<p>Unique Local Addresses (ULA) are IPv6 addresses that are not routed. They can be used in private networks (e. g. a LAN). ULAs begin with the prefix fd.</p>
UMTS	<p>The Universal Mobile Telecommunications System (UMTS), also known as 3G, is a mobile communications standard with a specified max. data transmission rate of 384 kbit/s and 21 Mbit/s in association with HSPA+.</p>
Unicast	<p>With Unicast, data packets are transmitted from a sender to a single recipient.</p>
UP0	<p>The UP0 connection is an interface for the ISDN Basic Rate Interface, and links one ISDN terminal to the NTBA. The connection is implemented via a two-wire circuit, and offers a greater range than the S0 bus.</p>
UPnP	<p>Universal Plug and Play (UPnP) is used to control devices (audio devices, routers, printers, etc.) from any manufacturer via an IP-based network.</p>
Upstream	<p>The gateway forwards the data from its own network.</p>
URL	<p>A Uniform Resource Locator (URL) identifies a file's storage location. Example: http://www.example.org/index.htm (Internet website)</p>
UUS	<p>With User to User Signalling (USS), text messages can be exchanged with other subscribers.</p>

V.110	V.110 describes a method of aligning bitstreams with 0.6, 1.2, 2.4, 2.8, 7.2, 9.6, 12, 14.4, 19.2 and 38.4 kbit/s with the ISDN bitstream of 64 kbit/s.
VDSL	Very High Speed Digital Subscriber Line. See DSL.
VID	See VLAN.
VLAN	A network can be divided up into one or more logical sub-networks—so-called Virtual Local Area Networks (VLAN) – by the network components no longer forwarding the data packet of a defined sub-network to other sub-networks. Each VLAN is assigned a unique number, This number is called a VLAN ID (VID) and assigned to the data packets in the VLAN tag.
Voice mailbox	A voice mailbox is a user's personal answering machine in a voice-mail system.
Voicemail system	A voicemail system enables voice messages to be stored, accessed and forwarded, like an answering machine, but with more options.
VoIP	Voice over IP (VoIP), also known as IP telephony, refers to the transmitting of voice via an IP network. The telephone is connected and disconnected using signalling protocols, e. g. SIP.
VPN	A virtual private network (VPN) is used to transport private data packets through a public network. The data is separated from the publicly accessible data by being encapsulated in new protocols so that they can be routed to the intended recipient. In this context, one also refers to a tunnel that is established between the private networks of the two connected parties. VPN protocols are IPSec, PPTP, L2TP and GRE.
VSS	The Virtual Service Set (VSS) refers to a prefix for wireless LAN interfaces.
Walled garden	In the context of hotspots, a walled garden refers to the area of the website which is available to users free of charge and without logging in.
WAN	A Wide Area Network (WAN) refers to a network that is spread over a large geographic area. Global WAN networks provide access to the Internet.
WDS	The Wireless Distribution System (WDS) is used to establish a wireless connection between access points.

Web server	A web server provides HTML documents (web pages).
WEP	Wired Equivalent Privacy (WEP) is an encryption protocol for WLANs. The key length is 40 or 104 bits.
WINS	The Windows Internet Name Service (WINS) is a translation of the NetBIOS over TCP/IP network protocol by Microsoft. Like DNS, WINS is used for centralised name resolution. See also DNS.
WLAN	Wireless Local Area Network (Wireless LAN, WLAN) refers to a local wireless network based on the 802.11 standard.
WMM	Wi-Fi Multimedia (WMM) prioritises the data packets from different applications, thus improving the transmission of voice, music and video data in WLAN networks. To do this, WMM provides quality-of-service features (QoS) for IEEE 802.11-based networks.
WPA	Wi-Fi-Protected Access (WPA) is an encryption protocol for WLANs. WPA uses dynamic keys that are based on the Temporal Key Integrity Protocol (TKIP).
WPA 2	Wi-Fi Protected Access (WPA) is an encryption protocol for WLANs. WPA 2 uses AES.
WPA Enterprise	With WPA 1 / 2, WPA Enterprise enables subscribers to be authenticated using the Extensible Authentication Protocol (EAP). After successful authentication, the server transfers a shared key to the client and the access point for data transfer in the WLAN.
WPA-PSK	With WPA 1 / 2, WPA-PSK enables subscribers to be authenticated using pre-shared keys. The access point and the client use the same string for the key calculation in the WLAN. This string needs to be configured by the users.
X.25	X.25 is a standardised series of protocols for wide area networks (WANs) via the telephone network.
X.31	The X.31 standard describes the connecting of ISDN and X.25 systems. It is a standard for connecting card terminals.
X.500	The X.500 standard describes the setting up of a directory service. See also LDAP.
X.509	The X.509 standard describes the generating of certificates for a public key infrastructure (PKI).
X.75	X.75 is a standardised series of protocols for ISDN networks with a

transmission rate of 64 kbit/s.

XAuth

XAUTH (Extended Authentication) is used to add further authentication mechanisms to IKE. After a successful phase 1 authentication, the user can be separately identified again. The identifying is done using the username and password, PAP, CHAP or hardware-based systems.

Zone

A zone refers to a phone number or numbers that begin with the same sequence.

Index

- Interface 62
- 2,4 GHz band rate profile 161
- 5 GHz band rate profile 161
- Accept Client FQDN 357
- Accept Router Advertisement 122 ,
234 , 247
- Access 358
- Access Configuration 90
- Access Control 159
- Access Filter 219
- Access Type 86
- Action 184 , 219 , 311 , 313 , 366 ,
396
- Action to be performed 381
- Active Function 434 , 434 , 435 , 436
- Active Radio Profile 146
- Active Radio Profile 143
- Additional freely accessible Domain
Names 389
- Additional IPv4 Traffic Filter 271 , 273
- Address assignment 354
- Address / Prefix 317
- Address / Subnet 317
- Address Mode 121 , 256
- Address Range 317
- Address Type 317
- Addresses 101
- Admin Status 196
- Administrative FQDNs 357
- Administrative Status 267 , 331
- Advertise 124
- AFTR 240
- Airtime fairness 149
- Alert Service 413
- Alive Check 70 , 287 , 292
- All Multicast Groups 228
- Allowed Addresses 159
- Allowed HotSpot Client 391
- Always on 231 , 240 , 245
- APN 346
- Assigned Wireless Network (VSS)
143 , 146
- ATM Interface 254
- ATM PVC 245
- ATM Service Category 258
- Authentication 237 , 243 , 250
- Authentication ID 90
- Authentication Method 267 , 282
- Authentication Type 68
- Auto Subnet Configuration 124 , 236 ,
249
- Autonomous Flag 126
- Autosave Mode 79 , 366
- Bandwidth 149
- Based on Ethernet Interface 120
- Beacon Period 150
- Blacklist blocktime 159
- Block after connection failure for 237 ,
243 , 250
- Block Time 287
- Burst size 211
- CA Certificate 75
- CA Certificates 287
- CA Name 366
- Call Forwarding extern (SIP 302) 94
- Call Hold inside the PBX system 94
- CAPWAP Encryption 146
- Certificate is CA Certificate 73
- Certificate Request Description 75 ,
366
- Certificate Revocation List (CRL)
Checking 73
- Channel 146
- Channel Plan 150
- Class ID 205 , 211
- Class map 205
- Client Band select 157
- Client Type 257
- Code 320
- Codec Profiles 94 , 100
- Codec Proposal Sequence 104
- Command Mode 366
- Command Type 366
- Common Name 77
- Compare Condition 360

- Compare Value 360
- Config Mode 269
- Configuration contains certificates/keys 366
- Congestion Avoidance (RED) 213
- Connected clients 163
- Connection Idle Timeout 231 , 240 , 245
- Connection State 201 , 216 , 393
- Consider 192
- Continuity Check (CC) End-to-End 262
- Continuity Check (CC) Segment 262
- Control Mode 208 , 264
- COS Filter (802.1p/Layer 2) 201 , 216 , 393
- Count 366
- Country 77
- Create Default Route 127
- Create NAT Policy 233 , 241 , 246
- CSV File Format 366
- Custom 77
- Custom DHCP Options 347
- Cyclic Background Scanning 149
- D Channel Mode 280
- Deactivate number suppression 94
- Default Ethernet for PPPoE Interfaces 256
- Default Idle Timeout 391
- Default Route 240
- Default Route 233 , 241 , 246 , 269
- Default User Password 68
- Delete SIP bindings after Restart 94
- Description 73 , 81 , 90 , 101 , 104 , 143 , 146 , 148 , 173 , 176 , 183 , 196 , 201 , 205 , 211 , 216 , 219 , 231 , 240 , 240 , 245 , 254 , 267 , 273 , 282 , 289 , 294 , 316 , 317 , 317 , 319 , 320 , 322 , 331 , 344 , 348 , 360 , 366 , 393 , 396 , 430 , 436
- Destination 311 , 313
- Destination immediately 434
- Destination Port/Range 184 , 196 , 201 , 216 , 393
- Destination Address / Length 176
- Destination Interface 334
- Destination Interface 176 , 228
- Destination IP Address/Netmask 172 , 184 , 196 , 273
- Destination IP Address 360 , 366 , 384
- Destination IPv4 Address/Netmask 201 , 216 , 393
- Destination IPv6 Address/Length 201 , 216 , 393
- Destination on Busy 434
- Destination on no Reply 434
- Destination Port 173 , 273
- Destination Port Range 320
- Device 146
- Devices per ticket 391
- DH Group 282
- DHCP Broadcast Flag 127
- DHCP Client 122
- DHCP Client 234 , 247
- DHCP Hostname 127 , 256
- DHCP MAC Address 127 , 256
- DHCP Mode 128
- DHCP Options 344
- DHCP Server 122 , 139
- Dial End Monitoring Time 94
- Direction 205
- Distribution Policy 192 , 193
- Distribution Mode 192
- Distribution Ratio 193
- DNS domains search list 355
- DNS Hostname 333
- DNS Negotiation 237 , 243 , 250
- DNS Propagation 128
- DNS Server 252 , 296 , 343 , 355
- Do not Disturb 436
- Domain 334
- Domain / Realm 90
- Domain at the HotSpot Server 389
- Downstream Bandwidth Limitation 101
- Dropping Algorithm 213

- DSCP / TOS Value 173
- DSCP Settings for rtp Traffic 103
- DSCP/Traffic Class Filter (Layer 3)
 - 201 , 216 , 393
- DTIM Period 150
- DTMF 104
- DUID 357
- Dynamic blacklisting 159
- E-mail 77
- EAP Preauthentication 154
- Early media support 94
- Enable update 338
- Enabled number 111
- Encapsulation 254
- Encrypt configuration 366
- Encryption Method 208
- End-to-End Pending Requests 261
- End-to-End Send Interval 261
- Entry active 68
- Event 413
- Event List 360 , 366
- Event List Condition 366
- Event Type 360
- External Number 434
- External Filename 79 , 80
- Facility 410
- Failed attempts per Time 159
- File Encoding 79 , 80
- File Name 366
- File Name in Flash 366
- Filter 205
- Force certificate to be trusted 73
- Forward 334
- Forward to 334
- Fragmentation Threshold 150
- From Domain 94
- From Interface 180
- Frozen Parameters 198
- Function Button Status 360
- G.711 aLaw 104
- G.711 uLaw 104
- G.722 104
- G.726 (16 kbit/s) 104
- G.726 (24 kbit/s) 104
- G.726 (32 kbit/s) 104
- G.726 (40 kbit/s) 104
- G.726 Codec settings 104
- G.729 104
- Gateway 344
- Gateway Address 176
- Gateway IP Address 172
- General Prefix 124 , 236 , 249
- General Prefix active 180
- Generate international phone number
 - 94
- Generate national subscriber number
 - 94
- Generate Private Key 75
- Generation Mode 125 , 237 , 250
- Global CLIP no Screening Number 91
- Grace time 161
- Group Description 68 , 192 , 193
- Group ID 381
- High Priority Class 205
- Host 334
- Host Name 338
- IGMP Proxy 226
- IGMP Snooping 154
- IGMP State Limit 225
- Incoming Phone Number 280
- Index Variables 360 , 366
- Inhibited number 111
- Interface 59 , 59 , 170 , 183 , 193 ,
 - 208 , 221 , 225 , 264 , 331 , 338 ,
 - 344 , 354 , 366 , 383 , 389 , 398
- Interface Action 383
- Interface Mode 120 , 331
- Interface Status 360
- Interface Traffic Condition 360
- Interfaces 101 , 205
- Internal Number 109
- Internet Key Exchange 267
- Interval 360 , 366 , 381 , 384
- Intra-cell Repeating 154
- IP Version of the tunneled Networks
 - 267
- IP Address 256 , 257 , 348 , 410 , 418
- IP Address Assignment 269

- IP Address / Netmask 121 , 143
- IP Address Mode 233 , 241 , 246
- IP Address Range 139 , 252 , 296 , 343
- IP Address/Netmask 139
- IP Assignment Pool 269
- IP Compression 292
- IP Pool Name 252 , 296 , 343 , 344
- IP Version 319
- IP Version 331
- IPv4 317
- IPv4 Address 333
- IPv4 Back Route Verify 276
- IPv4 Proxy ARP 276
- IPv6 122 , 234 , 247 , 317
- IPv6 Address 333
- IPv6 Addresses 122
- IPv6 Interface 240
- IPv6 Mode 122 , 234 , 247
- Key Size 366
- Language for login window 389
- Last Member Query Interval 225
- Layer 4 Protocol 173
- LCP Alive Check 237 , 243 , 250
- LDAP URL Path 81
- Lease Time 344
- Level 410
- Licence Key 54
- Licence Serial Number 54
- Lifetime 282 , 289
- Link Prefix 124 , 236 , 249
- Local Certificate 282
- Local Certificate Description 79 , 80 , 366
- Local File Name 366
- Local ID 267
- Local ID Type 267 , 282
- Local ID Value 282
- Local IP Address 172 , 233 , 241 , 246 , 269
- Local IPv6 Network 271
- Local PPTP IP Address 243
- Local WLAN SSID 366
- Locality 77
- Location 94 , 143 , 146
- Login Frameset 391
- Long Retry Limit 150
- Loopback End-to-End 261
- Loopback Segment 261
- MAC Address 120 , 143 , 256 , 348
- Mail Exchanger (MX) 340
- Matching String 413
- Max. number of clients - hard limit 157
- Max. number of clients - soft limit 157
- Max. queue size 213
- Max. Transmission Rate 150
- Maximum Burst Size (MBS) 258
- Maximum Downstream Bandwidth 101
- Maximum Number of Dialup Retries 237 , 243 , 250
- Maximum Response Time 225
- Maximum Upload Speed 208 , 211 , 264
- Maximum Upstream Bandwidth 101
- Members 316 , 317 , 322
- Message Compression 413
- Message Timeout 413
- Metric 172 , 176 , 269
- MIB Variables 366
- MIB/SNMP Variable to add/edit 366
- Min. queue size 213
- MobIKE 276
- Mode 75 , 173 , 225 , 280 , 282 , 294
- Monitored Interface 360
- Monitored Subsystems 413
- Monitored Variable 360
- Monitored Certificate 360
- Monitored Interface 383
- Monitored IP Address 381
- MTU 239
- Multicast Group Address 228
- Name 146 , 180 , 294 , 354
- NAT method 183
- NAT Traversal 287
- Netmask 256 , 257
- Network Name (SSID) 154

- New Destination IP Address/Netmask 187
- New Destination Port 187
- New Source IP Address/Netmask 187
- New Source Port 187
- Number 435
- Number of allowed simultaneous Calls 94
- Number of Admitted Connections 274
- Number of Messages 413
- Number of Spatial Streams 149
- OAM Flow Level 261
- On Link Flag 126
- Operating Mode 143
- Operation Band 148
- Operation Mode 146 , 148
- Organization 77
- Organizational Unit 77
- Original Destination Port/Range 184
- Original Destination IP Address/Netmask 184
- Original Source Port/Range 184
- Original Source IP Address/Netmask 184
- Outbound Interface 211
- Outgoing Signalisation 91
- Outgoing Phone Number 280
- Overbooking allowed 211
- Overwrite similar certificate 366
- Parent Location 101
- Password 75 , 79 , 80 , 90 , 231 , 240 , 245 , 294 , 338 , 358 , 366 , 396
- Password for protected Certificate 366
- PBX coupling 94
- Peak Cell Rate (PCR) 258
- Peer Address 267
- Peer ID 267
- Phase-1 Profile 274
- Phase-2 Profile 274
- Phone Number 430
- PIN 346
- Policy 70
- Pool Usage 344
- Pop-Up window for status indication 391
- Port 341
- Port STUN server 93
- Post Login URL 389
- PPPoE Ethernet Interface 231
- PPPoE Interfaces for Multilink 231
- PPPoE Mode 231
- PPTP Address Mode 243
- PPTP Ethernet Interface 240
- Preferred Lifetime 126
- Preshared Key 154 , 267
- Primary DNS Server DNS-Server (IPv4/IPv6) 334
- Primary IPv4 DNS Server 331
- Primary IPv6 DNS Server 331
- Prioritisation Algorithm 208
- Prioritize TCP ACK Packets 237 , 243 , 250 , 257
- Priority 68 , 211 , 331
- Priority Queueing 211
- Propagate PMTU 292
- Proposals 282 , 289
- Protocol 184 , 196 , 201 , 216 , 273 , 320 , 341 , 366 , 393 , 410
- Protocol Header Size below Layer 3 208
- Provider 254 , 338
- Provider Name 341
- Provider Status 90
- Provider without Registration 94
- Provisioning Server 347
- Proxy 93
- Proxy ARP 127
- Proxy Interface 226
- Proxy Port 93
- Public Interface 276
- Public Interface Mode 276
- Public Source IPv4 Address 276
- Public Source IPv6 Address 276
- Query Interval 225
- Queues/Policies 208
- RA Encrypt Certificate 75
- RA Sign Certificate 75

- RADIUS Dialout 70
- RADIUS Secret 68
- Radius Server 154
- RADIUS Server Group ID 294
- Real Time Jitter Control 208
- Reboot after execution 366
- Reboot device after 366
- Recipient 413
- Registrar 92
- Registrar Port 92
- Registration Timer 93
- Remaining Validity 360
- Remote File Name 366
- Remote IPv6 Network 271
- Remote PPTP IP Address 243
- Reporting Method 221
- Response 333
- Retries 70
- Robustness 225
- Role 294
- Route Active 176
- Route Class 170
- Route Entries 233 , 241 , 246 , 269
- Route Selector 194
- Route Type 170 , 176
- Router Preference 128
- Router Lifetime 128
- RSSI threshold 161
- RTS Threshold 150
- RTT Mode (Realtime Traffic Mode)
211
- Rule Chain 219 , 221 , 398
- Rx Shaping 160
- SCEP URL 75
- Secondary DNS Server (IPv4/IPv6)
334
- Secondary IPv4 DNS Server 331
- Secondary IPv6 DNS Server 331
- Security Mode 154
- Security Policy 121 , 122 , 233 , 234 ,
241 , 246 , 247 , 269 , 271
- Segment Pending Requests 261
- Segment Send Interval 261
- Select radio 366
- Select vendor 346 , 347
- Selection 319
- Send WOL packet over Interface 396
- Server 341
- Server Address 366
- Server IP Address 68
- Server Timeout 70
- Server URL 366
- Service 184 , 196 , 201 , 216 , 311 ,
313 , 393
- Set COS value (802.1p/Layer 2) 205
- Set DSCP/Traffic Class Filter (Layer 3)
205
- Set interface status 366
- Set status 366
- Setup Mode 124 , 236 , 249
- Severity 413
- Short Guard Interval 150
- Short Retry Limit 150
- Signal fixed out number 91
- Signal remote caller number 91
- Silent Deny 221
- SNTP Server 355
- Source 311 , 313
- Source Address / Length 176
- Source Interface 173 , 196 , 228 , 334
- Source IP Address/Netmask 173 ,
184 , 196 , 273
- Source IP Address 360 , 366 , 381 ,
384
- Source IPv4 Address/Netmask 201 ,
216 , 393
- Source IPv6 Address/Length 201 ,
216 , 393
- Source Location 366
- Source Port 173 , 273
- Source Port Range 320
- Source Port/Range 184 , 196 , 201 ,
216 , 393
- Special Handling Timer 196
- SRTP 100
- Start Mode 274
- Start Time 364
- State/Province 77

- Static Addresses 125 , 237 , 250
- Static Interface Identifier 357
- Status 360 , 436
- Stop Time 364
- STUN server 93
- Subject 413
- Subject Name 366
- Subnet ID 124 , 236 , 249
- Substitution of International Prefix with "+" 94
- Substitution of Incoming Number Prefix 94
- Successful Trials 381
- Summary 77
- Sustained Cell Rate (SCR) 258
- T.38 FAX support 94
- Target MAC-Address 396
- Target Number "Immediate" 109
- Target Number "On busy" 109
- Target Number "On no reply" 109
- TCP-MSS Clamping 127
- Terms & Conditions 389
- Throughput 163
- Throughput/client 164
- Ticket Type 391
- Time Condition 364
- Timestamp 410
- Tracking IP Address 194
- Traffic Shaping 211
- Traffic Direction 360
- Traffic shaping 208
- Transfer Mode 280
- Transfer own IP address over ISDN/GSM 280
- Transferred Traffic 360
- Transmit Key 154
- Transmit Power 146
- Transparent MAC Address 59
- Transport Protocol 92 , 93
- Trials 360 , 384
- Trigger 383
- Trigger Status 366
- Tx Shaping 160
- Type 101 , 180 , 201 , 216 , 254 , 320 , 393 , 396 , 434
- Type of Call Forwarding 109
- Type of Messages 410
- Type of traffic 183
- U-APSD 154
- UDP Port 70
- Unsuccessful Trials 381
- Update Interval 341
- Update Path 341
- Upstream Bandwidth Limitation 101
- Upstreaming Device with NAT 94
- URL SCEP Server URL 366
- Use CRL 366
- Use PFS Group 289
- Used Channel 146
- Used Prefix / Length 180
- User Defined Channel Plan 150
- User Name 90 , 231 , 240 , 245 , 338 , 358
- Users 294
- Valid Lifetime 126
- Vendor Description 346 , 347
- Vendor ID 346 , 347
- Vendor Mode 68
- Vendor Option String 346
- Vendor Specific Information (DHCP Option 43) 344
- Version Check 366
- Video 100
- Virtual Channel Connection (VCC) 258 , 261
- Virtual Channel Identifier (VCI) 254
- Virtual Path Connection (VPC) 261
- Virtual Path Identifier (VPI) 254
- VLAN 160 , 231
- VLAN ID 120 , 139 , 160 , 231
- VLAN Identifier 131
- VLAN Members 131
- VLAN Name 131
- Wake-On-LAN Filter 396
- Wake-On-LAN Rule Chain 396
- Walled Garden 389
- Walled Garden URL 389
- Weight 211

- Wildcard 340
- Wildcard MAC Address 59
- Wildcard Mode 59
- Wireless Mode 149
- WLC SSID 366
- WPA Cipher 154
- WPA Mode 154
- WPA2 Cipher 154
- Write certificate in configuration 366
- XAUTH Profile 274
- AP LED mode 140
- AP location 140
- ACCESS_ACCEPT 67
- ACCESS_REJECT 67
- ACCESS_REQUEST 67
- ACCOUNTING_START 67
- ACCOUNTING_STOP 67
- Action 168 , 404 , 420 , 423
- Alarm Input 43
- Alert Service 415
- Alive Check 421
- Allow manual trunk group selection 438
- Answer to client request 385
- AP discovered 162
- AP managed 162
- AP offline 162
- As DHCP Server 330
- As IPCP Server 330
- Assign project codes 55
- Attacked Access Point 167
- Authentication for PPP Dialin 72
- Authentication Method 421
- Back Route Verify 179
- BOSS 404
- Busy on busy 437
- Bytes 421
- Cache Hitrate (%) 336
- Cache Hits 336
- Cache Size 329
- Call Forwarding 433
- Call Forwarding (CFNR) 50
- Call Through 429
- Called Number 112 , 430
- Called Number 116 , 432
- Caller Number 115 , 431
- CAPI Server TCP Port 359
- Certificate Request 75
- Charge Information (S0 / Upn Extension) 42
- Charge Rate Factor 42
- Class 400
- Client Registration Timer 106
- Client Subscription Timer 106
- Compression 64
- Configuration Interface 58
- Configuration Encryption 404
- Confirm Admin Password 44
- Connected clients/VSS 162
- Contact 38
- Costs 112 , 430
- Country Profile 41
- CPU usage [%] 162
- Currency 42
- Current Class of Service 438
- Current File Name in Flash 404
- Current Local Time 47
- Date 112 , 113 , 115 , 116 , 420 , 430 , 431 , 431 , 432
- Default Behavior 101
- default MSN 85
- Delete 115 , 116 , 167 , 177 , 431 , 432
- Delete call data records 115
- Delete complete IPsec configuration 296
- Delete the complete WLAN Controller configuration 140
- Description 420 , 421 , 423 , 424 , 429 , 437
- Destination File Name 404
- Destination IP Address 177
- Details 420
- DHCP Server 140
- Dialling Authorization 438
- Direct Call 50 , 435
- Discovered 144
- DNS domains search list 355

- DNS Requests 336
- DNS Server 356
- Do not Disturb 436
- Domain Name 329
- Done 168
- Doorcom Signalling 43
- Drop non-members 131
- Drop untagged frames 131
- Dropped 422 , 425
- DSCP Settings for sip Traffic 106
- Duration 112 , 113 , 430 , 431
- Dynamic RADIUS Authentication 297
- ECDSA Key Status 63
- ED25519 Key Status 63
- Enable IPsec 296
- Enable server 359
- Enable VLAN 132
- Encrypted 422
- Encryption Algorithms 63
- Error 168
- Errors 421 , 422
- Expires 400
- Explicit Call Transfer 51
- Export call data records 115
- Extended Route 177
- Extension Numbers 438
- Extension Rerouting 43
- External Door Connections 50
- External Number 113 , 431
- Factory Reset Firewall 316
- Fallback interface to get DNS server 329
- Faxheader 359
- Filename 404
- First seen 167
- First Timeserver 48
- Forwarded Requests 336
- Function 85
- Gateway 177
- Global Rerouting 43 , 43
- Hashing Algorithms 63
- Home Office Number 437
- Host for multiple locations 392
- HTTPS TCP Port 337
- IGMP State Limit 227
- IGMP Status 227
- Ignore Certificate Request Payloads 299
- IKE (Phase-1) 422
- IKE (Phase-1) SAs 421
- Image already exists. 168
- Include certificates and keys 404
- Initializing 144
- Int. No. 112 , 113 , 115 , 116 , 430 , 431 , 431 , 432
- Interconnect external calls 40
- Interface 112 , 113 , 115 , 116 , 131 , 140 , 177 , 178 , 179 , 385 , 425 , 425 , 430 , 431 , 431 , 432
- Interface Selection 399
- Interface Description 58
- Interface is UPnP controlled 385
- Internal Time Server 48
- International Prefix / Country Code 41
- Invalid DNS Packets 336
- IP Address 425
- IP Address / Netmask 424
- IP Address Range 140
- IPsec (Phase-2) 422
- IPsec (Phase-2) SAs 421
- IPsec Debug Level 296
- IPsec over TCP 297
- IPsec Tunnels 422
- IPv4 Firewall Status 314
- IPv4 Full Filtering 314
- ISDN Timeserver 48
- Last seen 167
- Level 420
- Line Access Digit 55
- Local Address 424
- Local Certificate 107 , 337
- Local ID 421
- Local IP Address 421
- Local Port 421 , 424
- Location 38
- Log Format 412
- Log on / Log off 436
- Log out immediately 400

- Logged Actions 314
- Logging Level 64
- Login Grace Time 64
- Login Name 437
- Logon 425
- Logout Options 400
- Loopback active 182
- MAC Address 424 , 425
- Managed 144
- Max Call List entries for System Calls 117
- Max Call List entries per User 117
- Maximum Message Level of Syslog Entries 38
- Maximum E-mails per Minute 415
- Maximum Groups 227
- Maximum Number of Accounting Log Entries 38
- Maximum number of concurrent connections 62
- Maximum Number of Syslog Entries 38
- Maximum Sources 227
- Maximum TTL for Negative Cache Entries 329
- Maximum TTL for Positive Cache Entries 329
- Memory usage [%] 162
- Message 420
- Messages 421
- Metric 177 , 178
- Mobile Number 437
- Mode 179 , 227
- Mode / Bridge Group 58
- MTU 421
- Multicast Routing 224
- Name 85 , 437
- NAT 424
- NAT active 182
- NAT Detection 421
- National Prefix / City Code 41
- Negative Cache 329
- Negotiation Type 421
- Netmask 177
- Network Name (SSID) 167
- New File Name 404
- No License Available 144
- No. 179 , 420 , 423
- Offline 144
- Other Inactivity 315
- Overview 163
- Packets 421
- Parallel Ringing 434
- Passed 422
- Password 415
- Password for HTML Configuration Access 437
- Password for IP Phone Registration 437
- Phone Number 429
- Physical Address 425
- Pick-up (Extension) 55
- Pick-up Group 55 , 438
- PIN for Phone Access 437
- PIN1 45
- PIN2 45
- POP3 Timeout 415
- POP3 Server 415
- Port 182 , 425
- Port STUN server 314
- Positive Cache 329
- PPTP Inactivity 315
- PPTP Passthrough 182
- Primary DHCP Server 349
- Privacy Number Truncation 114
- Project Code 112 , 113 , 430 , 431
- Protocol 177 , 178
- PVID 131
- QoS Queue 425
- Queued 425
- Received DNS Packets 336
- Record calls 117
- Record connected calls 117
- Region 140
- Remote Access (e.g. Follow me, Room Monitoring) 45
- Remote Address 424
- Remote ID 421

- Remote IP 420
- Remote IP Address 400
- Remote IP Address 421
- Remote Networks 420
- Remote Port 421 , 424
- Rerouting of Incoming Distribution 43
- Rerouting to Number 40
- Restore Default Settings 61
- Rogue Client MAC Address 167
- Route 178
- Route Type 177
- RSA Key Status 63
- RTP Port 106
- Running 168
- Rx Bytes 423 , 424
- Rx Errors 423
- Rx Packets 423 , 424
- Save incoming calls 114
- Save outgoing calls 114
- Schedule Interval 376
- Second Timeserver 48
- Secondary DHCP Server 349
- Security Algorithm 420
- Select file 404
- Send 425
- Send Certificate Chains 299
- Send Certificate Request Payloads 299
- Send CRLs 299
- Send Initial Contact Message 297
- Send Key Hash Payloads 299
- Sender E-mail Address 415
- Server preference 356
- Server Failures 336
- Set Date 48
- Set Time 48
- Show Manufacturer Names 38
- Show passwords and keys in clear text 46
- Signal 164
- Signal dBm 167
- Silent Deny 182
- SIP Port 106
- SMS Device 416
- SMTP Authentication 415
- SMTP Port 415
- SMTP Server 415
- SNMP Listen UDP Port 66
- SNMP multicast discovery 66
- SNMP Read Community 46
- SNMP Trap Broadcasting 417
- SNMP Trap Community 417
- SNMP Trap UDP Port 417
- SNMP Version 66
- SNMP Write Community 46
- SNTP Server 356
- Source File Name 404
- Source Location 168 , 404
- Speed Dial 55
- Speed Dial Number 429
- SSH Port 62
- SSH service active 62
- SSID 167
- Static Blacklist 167
- Status 85 , 140 , 420 , 422 , 423 , 424
- STUN Handler 314
- Subsystem 420
- Successfully Answered Queries 336
- Sync SAs with ISP interface state 297
- System Admin Password 44
- System Logic 404
- System Name 38
- System Parking (Open Enquiry) 51 , 55
- TCP Inactivity 315
- TCP Keepalives 64
- Team Signalling 43
- Test Ping Address 401
- Test Ping Mode 401
- Third Timeserver 48
- Throughput 164
- Time 112 , 113 , 115 , 116 , 420 , 430 , 431 , 431 , 432
- Time Update Interval 48
- Time Update Policy 48
- Time Zone 47
- Total 422
- Trace Mode 399

- Traceroute Address 402
- Traceroute Mode 402
- Transfer call data records via Serial 2
114
- Transfer Signalling 40
- Transfer to busy extension 40 , 51
- Trunk Group Selection 55
- Trunk Number 115 , 116 , 431 , 432
- Tx Bytes 423 , 424
- Tx Errors 423
- Tx Packets 423 , 424
- Type 115 , 116 , 423 , 431 , 432
- Type of attack 167
- UDP Inactivity 315
- Unchanged for 423
- UPnP Status 386
- UPnP TCP Port 386
- URL 168 , 404
- Use Interface 401
- Use Zero Cookies 297
- User 112 , 113 , 115 , 116 , 400 , 430
, 431
- User Name 415 , 425
- Web Access Password 114
- Web Access Username 114
- WINS Server 329
- WLAN Controller: VSS throughput
162
- xDSL Logic 404
- Zero Cookie Size 297
- Access Points 163
- Access Points 144
- AP Autoprofile 143
- Access Filter 215
- Access Type 36
- Actions 365
- Active Clients 164
- Active IPsec Tunnels 36
- Active Sessions (SIF, RTP, etc...) 36
- Address List 317
- Administration 132
- Alert Recipient 413
- Alert Settings 415
- Allow manual trunk group selection
428
- BOSS Version 36
- Cache 336
- Call Forwarding 108
- Certificate List 73
- Certificate Servers 81
- Client Management 165
- Codec Profiles 103
- Controlled Interfaces 264
- CPU Usage 36
- CRLs 80
- Current Class of Service 428
- Date 47
- Description 36 , 427
- DHCP Configuration 343
- DHCP Relay Settings 348
- DHCPv6 Global Options 355
- DHCPv6 Server 354
- Dial Control 110
- Dialling Authorization 428
- DNS Servers 331
- DNS Test 401
- Domain Forwarding 334
- Dynamic Hosts 336
- DynDNS Provider 340
- DynDNS Update 338
- Feature Settings 433
- Firmware Maintenance 168
- General 113 , 117 , 140 , 386
- General Prefix Configuration 180
- General Settings 437
- Global Settings 328
- Groups 316 , 318 , 321
- Hosts 380
- HotSpot Gateway 389
- HTTP 61
- HTTPS 61
- HTTPS Server 337
- Incoming 113 , 115 , 431 , 431
- Interface Assignment 220 , 398
- Interfaces 58 , 118 , 383 , 385 , 411
- IP Pool Configuration 342
- IP Pools 252 , 296
- IP/MAC Binding 347

IPSec Peers 266
 IPSec Statistics 422
 IPSec Tunnels 420
 IPv4 Filter Rules 310
 IPv4 Route Configuration 170
 IPv4 Routing Table 177
 IPv4/IPv6 Filter 201
 IPv6 Route Configuration 175
 IPv6 Routing Table 178
 ISDN Internal 85
 ISDN Login 61
 Last configuration stored 36
 Load Balancing Groups 192
 Log out Users 400
 Memory Card 36
 Memory Usage 36
 Name, First Name 427
 NAT Configuration 183
 NAT Interfaces 182
 Neighbor APs 165
 Network Status 424
 Night Mode Status 36
 No. 36
 OAM Controlling 260
 Options 72 , 179 , 227 , 296 , 314 ,
 359 , 376 , 392 , 402 , 412
 Outgoing 112 , 116 , 430 , 432
 Passwords 44
 Phase-1 Profiles 282
 Phase-2 Profiles 289
 Pick-up Group 428
 Ping 61
 Ping Generator 384
 Ping Test 401
 Port Configuration 131
 PPPoA 244
 PPPoE 231
 PPTP 240
 Profiles 253
 QoS Classification 205
 QoS Interfaces/Policies 207
 Radio Profiles 148
 RADIUS 67
 Registrar 36
 Rogue APs 166
 Rogue Clients 167
 Rule Chains 219
 Serial Number 36
 Service Categories 258
 Service List 319
 SIP Provider 90
 SNMP 61 , 65
 SNMP Trap Hosts 418
 SNMP Trap Options 417
 Special Session Handling 195
 SSH 61 , 62
 Stateful Clients 357
 Static Hosts 333
 Statistics 336 , 423
 Status 36
 Sync Interface 87
 Syslog Servers 409
 System 38
 System Date 36
 System Licences 53
 System Messages 420
 System Phonebook 429
 System Reboot 407
 Telnet 61
 Time 47
 Timer 50
 Traceroute Test 402
 Trigger 360
 Uptime 36
 User 358
 User Phonebook 429
 VLANs 131
 Wake-On-LAN Filter 392
 Wireless Networks (VSS) 153 , 165
 WLAN Controller 162
 WOL Rules 396
 XAUTH Profiles 294
 AP configuration 144
 Access Codes 55
 Access Rules 214
 Additional IPv4 Traffic Filter 265
 Addresses 317
 Administrative Access 61

- Alert Service 413
- ATM 253
- Bridges 424
- Call Data Records 112 , 430
- Call List 115 , 431
- CAPI Server 358
- Certificates 72
- Controller Configuration 140
- DHCP Server 342
- DHCPv6 Server 352
- Diagnostics 401
- DNS 327
- DynDNS Client 338
- Factory Reset 408
- Forwarding 228
- General 223
- Global Settings 37
- HotSpot Gateway 387 , 425
- HTTPS 337
- IGMP 224
- Interface Mode / Bridge Groups 56
- Interfaces 316 , 423
- Internal Log 420
- Internet + Dialup 230
- IP Accounting 411
- IP Configuration 118
- IPSec 265 , 420
- IPv6 General Prefixes 180
- ISDN Ports 84
- Load Balancing 191
- Log out Users 400
- Maintenance 168
- Monitoring 162
- NAT 181
- Neighbor Monitoring 165
- Outgoing Services 108
- Phonebook 429
- Policies 309
- QoS 201 , 425
- Real Time Jitter Control 264
- Reboot 407
- Remote Authentication 66
- Routes 170
- Scheduling 359
- Services 319
- Settings 90 , 433
- SIA 418
- SNMP 417
- Software & Configuration 402
- Surveillance 380
- Syslog 409
- Trace Interface 398
- UPnP 384
- VLAN 130
- Wake-On-LAN 392
- Applications 112
- Call Routing 108
- External Reporting 409
- Firewall 308
- LAN 118
- Local Services 327
- Maintenance 400
- User Access 427
- VoIP 90
- Wireless LAN Controller 133
- DHCP-Client (Configuration example) 349
- DHCP-Relay-Server (Configuration example) 349
- DHCP-Server (Configuration example) 349
- NAT (Configuration example) 188
- SIF (Configuration example) 322
- #
- #1#2, #3 78
- <
- <Internal Number> 427
- A**
- Access via LAN 23
- Assistants 34
- Authentication key 302
- Autosave Configuration 38
- B**

- Base Network (SSID) 154
- Basic configuration 15
- C**
- Called Name 112
- Caller Name 113
- Configuration 23
- Configuration example - DHCP-Client 349
- Configuration example - DHCP-Relay-Server 349
- Configuration example - DHCP-Server 349
- Configuration example - Load balancing 198
- Configuration example - NAT 188
- Configuration example - Scheduling 377
- Configuration example - SIF 322
- Configuration example - Time-controlled Tasks 377
- Configured Speed / Mode 83
- Current Speed / Mode 83
- D**
- Database Record TTL (in min.) 305
- Default TTL in minutes of cached EID/RLOC entry 306
- Default Ttl Mode 306
- Description 306
- Description - Connection Information - Link 37
- Downstream 88
- Drilling template 10
- DSL Chipset 87
- DSL Configuration 87
- DSL Line Profile 89
- DSL Mode 88
- DSL Modem 87
- DSP Channels 36
- E**
- EID prefix (IP address) / Length 304
- Ethernet Ports 82
- Ethernet Interface Selection 83
- Exclude EID prefix from tree 305
- F**
- Flow Control 83
- Function button 360
- G**
- Gathering configuration data 16
- H**
- HMAC truncation 303 , 303
- Homepage 341
- HTTP/HTTPS 23
- HTTPS/SSL 338
- I**
- Instance-ID 304 , 306
- Interface - Connection Information - Link 37
- Interface binding 305
- Internal ISDN connection 10
- IP address 16
- IP Version 338
- K**
- Key type (HMAC Algorithm) 302
- L**
- LISP interface MTU 306
- Load balancing (Configuration example) 198
- M**
- Map Resolver IP Address 303
- Map Server IP Address 302
- Map-Register time period (in sec.) 303 , 303
- Map-Resolver IP Address 305

- Maximum number of cached EID/RLOC entries per ins 306
 - Maximum number of RLOC addresses per cached EID 306
 - Maximum Upstream Bandwidth 88
 - MediaSec 100
 - Monitoring 420
 - Multicast 222
- N**
- Netmask 16
 - Network setting 19
 - Networking 170
- O**
- Open configuration interface 24
 - Operating elements 24
 - Operation Mode (Active) 366
 - Operation Mode (Inactive) 366
- P**
- Physical Connection 87
 - Physical Interfaces 82
 - Pin Assignments 11
 - Port Configuration 83
 - Preparations 15
 - Proxy-ETR-RLOC 306
- R**
- Radio1 164
 - Reset 8
 - Reset button 10
 - Route Locator (RLOC) IP address 304
- S**
- Scheduling (Configuration example) 377
 - Server IPv6 341
 - Setting up a PC 17
 - SIP Header Field: FROM Display 94
 - SIP Header Field: FROM User 94
 - SIP Header Field: P-Asserted 94
 - SIP Header Field: P-Preferred 94
 - SNR Margin 88
 - Software updates 21
 - Status 35
 - Support 9
 - Supports SSL 341
 - Switch Port 83
 - System Management 35
 - System requirements 15
 - Systemsoftware 15
- T**
- Time-controlled Tasks (Configuration example) 377
 - Transmit Shaping 88
- U**
- Upstream 88
 - User access 20
- V**
- VPN 265
- W**
- Wall mounting 10
 - Walled Network / Netmask 389
 - WAN 230
 - WEP Key 1-4 154
 - Wizard for network setting 19