

THE
JOURNAL OF BOTANY
BRITISH AND FOREIGN

EDITED BY

A. B. RENDLE, D.Sc., F.R.S., F.L.S.
KEEPER, DEPARTMENT OF BOTANY, BRITISH MUSEUM (NAT. HIST.).

VOL. LXV.

LONDON
TAYLOR AND FRANCIS
RED LION COURT, FLEET STREET
1927.

CONTENTS.

ARTICLES :—	Page
A New Species of <i>Diclidocarya</i> Reid from the Senftenberg Brown-Coal. By E. M. REID. (With Plate)	1
Miscellanea Bryologica X. By H. N. DIXON	5
Lichens from Spitsbergen and Bear Island. By R. PAULSON	12
The Genus <i>Argostemma</i> . By H. N. RIDLEY	25
Notes on the British Pansies. By E. DRABBLE.....	42, 167, 213
The Grampian Mts. of Victoria and their Flora. By E. ASHBY	53
William Bartram and the Genus <i>Asimina</i> in North America. By A. W. EXELL	65
The Flora of Asturias. By Rev. T. STEPHENSON	70
Notes on the Genus <i>Carex</i> of the 'London Catalogue,' 11 Ed. By ARTHUR BENNETT	74
The Flora of Simla. By L. V. LESTER-GARLAND	97
Diatoms from Tientsin, North China. (With Text-figure.) By B. W. SKVORTZOW	102
Lichenological Notes.—II. By W. WATSON	109
Notes on <i>Potamogeton</i> . By ARTHUR BENNETT	113
Notes on <i>Orobanche</i> . By C. E. SALMON	117
A Counterfeit Collection of Mexican Plants	118
<i>Callithamnion scopulorum</i> C. Ag. (With Text-figures.) By M. A. WESTBROOK	129
The <i>Melampyrum</i> Species of East Asia. By R. v. Soó	138
The Irish " <i>Spiranthes Romanzoffiana</i> ." By A. J. WILMOTT	145
Myrphid Visitors to Certain Flowers. By E. and H. DRABBLE	149
<i>Callithamnion purpuriferum</i> J. G. Ag. (With Text-figures.) By M. A. WESTBROOK	161
Recent Lichens from Arctic Regions. By R. PAULSON	171
Notes on the Genus <i>Hemiandra</i> R. Br. By O. H. SARGENT	174
The Nomenclature of the Group <i>Salvia Verbenaca</i> L. By H. W. PUGSLEY	185
A List of <i>Cyanophyceæ</i> from North Manchuria. By B. W. SKVORTZOW ..	195
On some <i>Algæ</i> from Sorai Lake, Sumatra. By B. W. SKVORTZOW	198
North-Eastern Union of Scientific Societies. By A. B. RENDLE	199
<i>Arctostobus</i> Lippert. A Genus of <i>Mycetozoa</i> Revived. By G. LISTER ..	202
What is <i>Sempervivum tortuosum</i> ? By R. LLOYD PRÆGER.....	209
Notes on Jamaica Plants. <i>Acanthaceæ</i> . By S. MOORE	219

ARTICLES (<i>continued</i>):—	Page
Unusual Leaf-Forms in <i>Helianthus annuus</i> L. (With Text-figures.) By B. F. BARNES	222
<i>Tunica</i> Mert. et Koch. By T. A. SPRAGUE.....	225
New <i>Rubiaceæ</i> collected by Mr. L. J. Brass in British New Guinea. By S. MOORE	241, 265
Freshwater Algae and Phytoplankton of the Lakes and Rivers of the Zaisan District, Altai Mountains, Siberia. (With Text-figures.) By B. W. SKVORTZOW.....	249
Gilbert Islands Mosses. By H. N. DIXON	254
Plants collected during the British Arctic Expedition, 1925. By J. W. S. MARR	272
<i>Michelia kinsopa</i> and <i>M. doltsopa</i> Buch.-Ham. (<i>Magnoliaceæ</i>). By J. E. DANDY	277
Note on Two Species of Loureiro's <i>Flora cochinchinensis</i> . By S. MOORE and G. TANDY	279
The British Association at Leeds. By A. B. RENDLE	282
Collecting in Spain from a Motor-Car. By A. J. WILMOTT	297
The Floral Mechanism of <i>Catasetum macrocarpum</i> Rich. (<i>C. tridentatum</i> Hook.). By B. J. BEDELL	304
Eighth International Horticultural Congress, 1927. By A. B. RENDLE	318
Notes on the Shrubby Species of <i>Hypericum</i> of Tropical Africa, Madag- ascar, and the Mascarenes. By R. D'O. GOOD. (Plate 582.)	329
On some Indian <i>Charophyta</i> . By J. GROVES and G. O. ALLEN	335
An Enumeration of the Species of <i>Polygala</i> in Angola. By A. W. EXELL	339
Two New <i>Mesembryanthemæ</i> . By N. E. BROWN	348
The Fertilisation of <i>Ophrys fusca</i> . By M. J. GODFERY	350

SHORT ARTICLES:—

<i>Cerefolium</i> Haller. By T. A. SPRAGUE	15
New Variety of <i>Mercurialis perennis</i> L. By S. K. MUKERJI	56
Fifth International Botanical Congress, 1930	128
Two Papuan Species of <i>Ardisia</i> . By C. T. WHITE	248

NOTES FROM THE BRITISH MUSEUM HERBARIUM:—

Two New Species of <i>Acanthaceæ</i> . By S. MOORE	13
Notes on Ashanti Plants. By S. MOORE	14

SHORT NOTES:—

<i>Alibertia</i> or <i>Cordia</i> . By T. A. SPRAGUE	16
<i>Oleuria</i> v. <i>Shavia</i> . By J. M. BLACK	17
Citation of Species described by Wawra and Peyritsch. By A. W. EXELL	18
Association of Special Libraries and Information Bureaux	58
Arquivos de Botanica do Estado de S. Paulo	58
Drying Shrubby Specimens. By A. H. WOLLEY-DOD	84
Chromosome Number and Individuality in the Genus <i>Crepis</i> . By E. G. BAKER	84

SHORT NOTES (*continued*):—

	Page
<i>Charesia</i> : a recently described Genus of <i>Caryophyllaceæ</i> from the Central Caucasus. By A. W. EXELL	152
The Statistical Comparison of Floras. By R. D'O. GOOD	230
A Variety of <i>Spirodela polyrrhiza</i> Linn. By J. GORDON DALGLIESH... ..	319
<i>Bartsia viscosa</i> Linn. in Kent. By F. J. HANBURY	319
Ayrshire Notes. By D. A. BOYD	319
Lizard Orchis. By C. C. LACAITA	320
<i>Salvia controversa</i> Ten. By C. C. LACAITA	320
Primula Hybrids. By H. W. PUGSLEY	351
<i>Carex dioica</i> f. <i>isogyna</i> . By A. BENNETT	351
New Records for Sphagna in Scotland. By W. R. SHERRIN	352
Classification of Plants on the Basis of Parasitism. By E. G. B.	352

ABSTRACTS AND NOTES OF PAPERS OF INTEREST TO STUDENTS
OF THE BRITISH FLORA. By C. E. SALMON, E. G. BAKER,
and Miss D. POWELL

78, 153, 178, 228, 257, 288

OBITUARIES

57, 80, 118, 151, 176, 203, 229, 258, 314

See Index, under heading 'Obituaries,' for alphabetical arrangement of subjects.

REVIEWS ... 18, 59, 84, 121, 156, 180, 204, 231, 260, 289, 321, 354

See Index, under heading 'Reviews,' for authors and titles of books.

BOOK-NOTES, NEWS, ETC. 21, 63, 92, 125,
158, 182, 208, 238, 263, 294, 323, 358

CORRESPONDENCE

SUPPLEMENT:—

Mr. John Gossweiler's Portuguese West African Plants (*continued*).
By A. W. EXELL, R. D'O. GOOD, Miss S. GREVES, and Mr. S.
MOORE.

CONTRIBUTORS TO THIS VOLUME.

- ALLEN, G. O.
 ARDACH, J.
 ARDUBY, E., F.L.S.
 BAKER, E. G., F.L.S.
 BARNES, B. F., B.Sc., F.L.S.
 BEDELL, B. J., B.Sc.
 BENNETT, ARTHUR, A.L.S.
 BLACK, J. M.
 BOYD, D. A.
 BROWN, N. E., A.L.S.
 DALGLISH, J. GORDON, F.L.S.
 DANDY, J. E., B.A., F.L.S.
 DIXON, H. N., M.A., F.L.S.
 DRABBLE, E., D.Sc., F.L.S.
 DRABBLE, H.
 EARLE, A. W., M.A., F.L.S.
 FUPPSCH, F. E., D.Sc., F.L.S.
 GEPPE, A., M.A., F.L.S.
 GODFREY, Col. M. J., F.L.S.
 GOOD, R. D'O., M.A., F.L.S.
 GUEVES, Miss S., M.Sc.
 GIFFITHS, B. M., D.Sc., F.L.S.
 GROVES, JAMES, F.L.S.
 HANBURY, E. J., F.L.S.
 HILL, T. G., F.L.S.
 HUTCHINSON, J., F.L.S.
 JACKSON, B. D. (the late),
 F.L.S.
 LACAITA, C. C., M.A., F.L.S.
- LESTER-GARLAND, L. V., M.A.,
 F.L.S.
 LISTER, Miss G., F.L.S.
 MARR, J. W. S.
 MOORE, S., B.Sc., F.L.S.
 MUKERJI, S. K., M.Sc., F.L.S.
 NICHOLSON, W. E., F.L.S.
 PAULSON, R., F.L.S.
 POWELL, Miss D., M.Sc., F.L.S.
 PRAEGER, R. LLOYD, D.Sc.
 PUGSLEY, H. W., B.A., F.L.S.
 RAMSBOTTOM, J., M.A., F.L.S.
 REID, Mrs. E. M., F.L.S.
 RENDLE, A. B., F.R.S.
 RIDLEY, H. N., C.M.G., F.R.S.
 SALMON, C. E., F.L.S.
 SARGENT, O. H.
 SHERRIN, W. R., A.L.S.
 SKVORTZOW, B. W.
 SMITH, Miss A. LORRAIN, F.L.S.
 SOÓ, Dr. R. v.
 SPRAGUE, T. A., B.Sc., F.L.S.
 STEPHENSON, Rev. T., D.D.
 TANDY, G., B.A., F.L.S.
 WATSON, W., D.Sc., A.L.S.
 WESTBROOK, M.A., M.Sc.
 WHITE, C. T., F.L.S.
 WILMOTT, A. J., B.A., F.L.S.
 WOLLEY-DOD, Lt.-Col. A. H.

LIST OF PLATES.

580. <i>Dididocarya</i> Reid	Facing p. 1
581. <i>Annona pigmea</i> and <i>A. incana</i> W. Bartr.	„ p. 65
582. Under sides of leaves of species of <i>Hypericum</i> from Tropical Africa, etc.	„ p. 329

CORRECTIONS.

- P. 17, line 22, for "Colville" read "Coville."
P. 158, line 16 from bottom, add name "By HANS ANDRÉ."
P. 158, lines 17 & 18 from bottom, Subtitle should read "*Nebst versuch einer
charakterologischen Analyse pflanzlicher Lebensfunktionen.*"
P. 254, line 5 from top, for "*gracilis*" read "*gracile*" and in Fig. 4 on
preceding page
P. 319, line 14 from bottom, for "T." read "J."

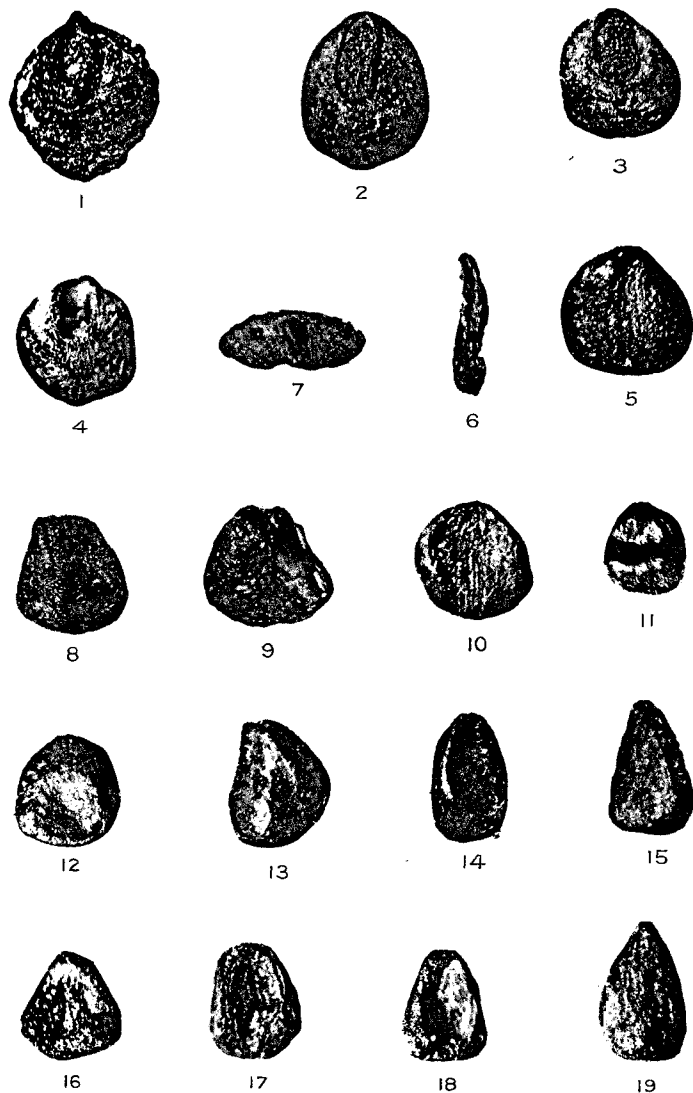

Photo. M. E. J. Chandler.

DICLIDOCARYA Reid.

THE
JOURNAL OF BOTANY
BRITISH AND FOREIGN.

A NEW SPECIES OF *DICLIDOCARYA* REID FROM
THE SENFTENBERG BROWN-COAL.

By E. M. REID, B.Sc., F.L.S., F.G.S.

(PLATE 580.)

I RECEIVED this summer (1926) a collection of small seeds for determination from Dr. P. Menzel, of Dresden. Dr. Menzel writes: "Dieselben treten in einer begrenzten Schicht von Kauscha im Senftenberger Braunkohlenrevier (Miocän) in grosser Menge auf; sie wurden zumeist beim Ausschwemmen des tonigen, mit vielen Pflanzenresten (Holzresten, meist dünnen zackigen, Blättern von *Fagus attenuata* Goepp., Früchten des *Carpolithes Wetzleri* [*Spirematospermum Wetzleri* Chand. (Zingiberaceæ) (Chandler, 1925, 17, pl. i. fig. 8)], *Nyssa*, und vielen schilffartigen Blattresten) durch setzten Materiales gewonnen; zuweilen lagen sie dicht gedrängt neben einander."

The seeds proved to belong to two species of *Diclidocarya* Reid, one an undescribed species, the other, *D. globosa* E. M. Reid. At present we are without any knowledge of what the relationship of this genus may be.

A species was figured, but without description, as an unknown seed from the Pliocene clay of Tegelen, by C. and E. M. Reid (1907, pl. iii. fig. 124). Later (Reid, 1908, 589-90), seeds found at Raevels, in Belgium, were described, but not named. These belonged to the species afterwards described as *D. globosa* E. M. Reid. In 1915 the same species was figured and described from Reuver on the West Prussian Border, when it was compared with the genus *Stocksia* (Reid, 1915, 112, pl. xi. fig. 18). In 1920 the present writer discovered a second species, evidently belonging to the same genus, in the Mio-Pliocene of Pont-de-Gail* (1920, 80-82, pl. iv. figs. 23-25). As the living genus to which the fossils belong, if there be such, could not be discovered, it was necessary to institute a new

* M. P. Marty informs me that this deposit is now regarded by some geologists as of Miocene age, although others regard it as Lower Pliocene. He himself regards it as Mio-Pliocene.

generic name, *Diclidocarya* being chosen as having reference to the peculiar valve of germination. In 1923 the species *D. globosa*, which had previously been known only from the Pliocene strata of Belgium and the Netherlands, was discovered at Pont-de-Gail. It was then named and described, and a suggestion was made that the genus was probably aquatic, a suggestion based on its association only with aquatic plants at Raevels, and on its great abundance in the strata at Pont-de-Gail (1920, 82). It will be seen that the occurrence in the Senftenberger brown-coal, as described by Dr. Menzel, bears out that suggestion. It is possibly owing to its aquatic habitat that its living relationship cannot be traced, as the seeds of aquatic plants, being difficult to obtain, are sometimes not well known.

The following is the description of the genus as given in 1920 and emended in 1923 (p. 352) by the substitution of *anatropæ* for *campylotropæ*:—*Nucula parvæ subglobosæ vel subpyramidales, anatropæ, parte inter geminandum valvatim delapsa ventrali obovata apice micropylæ affini; parietes indurati, crassi, cellululis aeriferis in pariete dorsali; integumenta tria; seminis-locus haud altus.*

In describing this "seed" we are met at the outset by the great difficulty that we do not know whether it is a true seed or a fruit. Hitherto we have described it as a seed, and shall continue to do so in the present paper, although the other possibility must be borne in mind.

With the discovery of the new Senftenberg species, fresh information has come to light which enables us to make a slight development on the former description. In the first place, the form of the seed need be neither sub-globose nor sub-pyramidal; the Senftenberg seed is flattened dorsi-ventrally. In the second, the tegmen has now been found and will be described under *D. Menzelii*. In the third, one specimen of *D. Menzelii* shows a thick coat not hitherto seen—at least, not in its entirety. This closely envelops the seed, but is distinct from it (Pl. 580. fig. 1). With the knowledge of this coat, we have been able to recognize remains of it on other specimens of *D. Menzelii*, also of *D. gibbosa* and *D. globosa*. When completely worn down, it seems to be represented by a thin resinous-looking film (the thin dark shining external coat of previous descriptions). It is in this form that the remains of it most frequently occur.

If, then, the nuts be truly seeds, this coat must be the pericarp; the thick hard coat with air-cells in its interior and the thin inner coat together forming the testa. The fruit would then appear to have been a dry apocarpous fruit.

Continuing the description as though the nut were a seed: the hilum is undoubtedly adjacent to the micropyle, being seen very clearly on *D. gibbosa* and *D. globosa* as a scar at the base of the dorsal surface. It is not clearly seen on *D. Menzelii* except in the specimen showing the pericarp. The chalaza is at the end opposite to the micropyle (on the "seed" itself, not on the valve); the embryo is therefore pendulous. In the specimen of the tegmen photographed, the micropylar cap is seen attached at the upper end, the other end being ragged where it broke away from the chalaza.

If ever the true botanical position of this genus be found, it will then be possible to determine definitely whether the nut be a seed or an endocarp. If it should prove to be an endocarp, then the fruit would seem to have been one with a gynobasic style; the hilum of the present description would then be interpreted as the receptacular attachment; the raphe as the funicle; the inner thin coat would alone form the testa; and the seed would have to be interpreted as pendulous, inverted, and orthotropous.

In order to make the study of these nuts easier, we treated the Senftenberg specimens, also those from Pont-de-Gail, with nitric acid (HNO_3) and potassium chlorate (KClO_3). A very few nuts suffered in the process, but by far the greater number were unharmed. It certainly makes the structure more easy to see, and we feel inclined to adopt the treatment, using it with great caution, as a secondary treatment after fruits and seeds have been isolated from the matrix by boiling with soda.

Diclidocarya Menzelii, sp. nov. (Pl. 580. figs. 1-7.)

Diagnosis. Nucula rotunda vel ovalis, 2.5-1.3 mm. long., 2.4-1.1 mm. lat., dorsi-ventraliter compressa, in latere quoque valde inflata, valvula germinationis parva ovalis.

Description. The "nut" is either round or oval when not distorted, and flattened dorsi-ventrally. The lateral protuberances, formed by a great development of air-cells within the hard coat, are very conspicuous. Between them on the dorsal side lies a broad groove which shows longitudinal striations, and appears to have carried the raphe, as it leads from the region of attachment (seen in fig. 5) to the external chalaza. On the ventral side of the nut at the base is a conspicuous oval germination valve or plug, which is smaller in proportion to the size of the nut in this species than in *D. globosa* and *D. gibbosa*. The micropyle is clearly associated with this valve, and can be seen at its extremity passing to the interior of the seed through a little cap (figs. 2, 3). This little cap is formed on the external side by the whole wall of the valve, but on the internal side (that is, the side towards the cavity) by the lining of the seed-cavity only. There is a distinct tendency for it to break away from the rest of the valve. The thin inner lining of the cavity is striate longitudinally. The tegmen in this species is frequently preserved; it is thin, but must have been tough, and is formed of very large flat polygonal cells, elongate longitudinally and with slightly sinuous walls (fig. 6). The micropylar end of the figured specimen is perfect, the chalazal end is torn where it broke from the chalaza.

DICLIDOCARYA GLOBOSA E. M. Reid, var. ? (Pl. 580. figs. 16-19.)

The fruits of *D. globosa* from the Senftenberg brown-coal are not very typical of the species as described or illustrated from Tegelen, Hoovels, Reuver, and Pont-de-Gail, the four localities from which it has been recorded. From these deposits the greater number of

specimens were globose, although some tended to be narrower and more angular (figs. 14, 15). The narrow form was regarded as due to distortion resulting from mutual compression, as, except for this difference, there was no distinction between the two forms. It may be that its occurrence in the brown-coal unaccompanied by the globose form marks a variety, but in view of its occurrence in other localities intermingled with, and grading into, the globose form, we hesitate to describe it as such.

D. globosa ranges in time from the Miocene of the brown-coal through the Mio-Pliocene of Pont-de-Gail, the Lower Pliocene of Reuver, to the Middle Pliocene of Tegelen.

BIBLIOGRAPHY.

- CHANDLER, M. E. J. 1925. "The Upper Eocene Flora of Hordle, Hants." Mem. Paleontogr. Soc. 1925, i. 1-32, pl. iv.
 REID, C. and E. M. 1907. "The Fossil Flora of Tegelen-sur-Meuse, near Venloo, in the Province of Limburg." Verhandl. k. Akad. Wetensch. Amsterdam (Tweede Sectie), Deel xiii. no. 6, 1907.
 ——. 1908. "Détermination de l'âge des argiles à brique de Tegelen, Reuver, Ryckevorsel et Raevens." Bull. Soc. Belge de géol. xxi. 583-590.
 ——. 1915. "The Pliocene Floras of the Dutch-Prussian Border." Meded. v. Rijksopsporing van Delfstoppen." No. 6, The Hague.
 REID, E. M. 1920. "Recherches sur quelques Graines Pliocènes du Pont-de-Gail (Cantal)." Bull. Soc. géol. de Fr. ser. 4, xx. 48-87.
 ——. 1923. "Nouvelles recherches sur les graines du Pliocène inférieur du Pont-de-Gail (Cantal)." Bull. Soc. géol. de Fr. ser. 4, xxiii. 308-355.

EXPLANATION OF PLATE 580.

In order to show the germination-valve of these nuts as clearly as possible, they are all inverted in the figures, so that micropyle and hilum are at the top of the figures.

Figs. 1-7. *Diclidocarya Menzelii*, sp. nov.

- Fig. 1. Ventral face with valve in place and thick outer coat visible around the margin. (This specimen has unfortunately been lost.) $\times 12$.
 Figs. 2, 3. Ventral faces of two nuts, to show variation in size; valves in place. At the apex of the valve the little cap can be seen. $\times 12$.
 Fig. 4. Ventral face with valve removed. $\times 12$.
 Fig. 5. Dorsal face showing median groove; the hilum is at the top, the external chalaza at the bottom of the figure. $\times 12$.
 Fig. 6. Tegmen removed from the nut. $\times 15$.
 Fig. 7. Section to show lateral protuberances. The ventral face is at the top. $\times 15$.
 Figs. 8, 9. *Diclidocarya gibbosa* Reid, $\times 12$. Specimens from Pont-de-Gail; 8 with, 9 without, valve.

Fig. 10-19. *Diclidocarya globosa* Reid, $\times 12$.

- Fig. 10. From Reuver, ventral face, valve in place.
 Figs. 11, 12. From Tegelen, 11 (distorted) ventral, 12 dorsal, face.
 Figs. 13-15. From Raevens, showing variation in form.
 Figs. 16-19. From brown-coal, showing variation in form. 18 is without the valve.

MISCELLANEA BRYOLOGICA.—X.

By H. N. DIXON, M.A., F.L.S.)

(Continued from Journ. Bot. 1924, p. 236.)

THE GENUS THIEMEA C. M.

IN Journ. Bot. lx. 104 (1922), I described a new genus of mosses, *Beddomiella*, with a single species, *B. funarioides* Dixon. Unfortunately, this must be suppressed. I was not then aware that C. Mueller had created a genus *Thiemia*, which was published in 1881, and has since then almost passed into oblivion. It was founded in Bot. Centralbl. vii. 343, on a moss from Yomah, Pegu, collected by Kurz, and bearing the MS. name in Hampe's herbarium of *Funaria saxicola*. This I find to be identical with my *Beddomiella funarioides*. C. Mueller placed it in Funariaceæ, remarking on its anomalous character, resembling vegetatively a *Leptotrichum*, with Funarioid fruit.

E. S. Salmon has fully discussed the position of this moss, and figured it in Journ. Bot. xl. 273 sqq. t. 440 (1902), and finally sinks it in *Wilsoniella* as *W. Hampeana* (C. M.). The peristome is, indeed, that of *Wilsoniella*, except that the teeth show a more or less decided tendency to curve or to be spirally twisted (no quite perfect peristome has as yet been seen). But the extremely lax, almost Funarioid areolation, the broader leaves, and especially the curious, quite Funarioid form of the capsule, remove it very markedly from the remaining species of *Wilsoniella*, and, while retaining it close to that genus, I am of opinion that it should maintain generic rank. The fact that it has been referred to three families (Funariaceæ, Pottiaceæ, and Dicranaceæ) is, in itself, a testimony to its anomalous character. The synonymy is as follows:—

- THIEMEA HAMPEANA* C. M. in Bot. Centralbl. vii. 346 (1881).
 Syn. *Wilsoniella Hampeana* (C. M.) Salmon in Journ. Bot. xl. 275, t. 440, figs. 1-8 (1902).
Beddomiella funarioides Dixon in Journ. Bot. lx. 104, t. 564, fig. 2 (1922).
Funaria saxicola Hampe MS., Jaeg. Adumbr. ii. 697 (1877-78).
Wilsoniella saxicola Paris Ind. ed. 2 (1906).

LEPTODONTIUM SQUARROSUM (Hook.) Par.

To the already long synonymy of this plant I am unfortunately able to add several more names, for two of which I am myself responsible. These are:

- Zygodon Simii* Dixon in Trans. Roy. Soc. S. Afr. viii. 198 (1900).
Holomitrium Maclennani Dixon in Smithson. Miscell. Colls. vol. 72, no. 3, p. 2 (1920).

A specimen from Dzomba, Zambesi, 6000-7000 ft., leg. Sir John Kirk, which has received a MS. name in Herb. Kew., also belongs here.

Holomitrium Hildebrandtii C. M. in Hildebrandt, Mousses de Madag. No. 2099, has already been referred here by Cardot as var. *Hildebrandtii*, differing from the type, however, by only the faintest of characters.

Holomitrium serratum (Schimp.) C. M., from Mexico, also belongs here; and I have very little doubt that *Zygodon Sullivantii* C. M., from North Carolina, is the same thing.

The explanation of this rather appalling casualty list lies to a considerable extent in the fact that it has scarcely been recognized how greatly developed the perichætium may be in *L. squarrosum*. The perichætial leaves are generally described as similar to the stem-leaves, but longer, and convolute at the base, and in many cases this quite adequately describes them, the perichætium being conspicuous, but not in any way striking, measuring about 3-4 mm. in length, and bearing but a very small proportion to the length of the seta (1.5-2 cm.). In other cases, however, the inner perichætial bracts become greatly extended, convolute, smooth, and membranous, as much as 1 cm. in length, and then reaching midway up the seta or even higher. The perichætium is then exactly like that of *Holomitrium*, and the capsule and vegetative structure lend themselves readily to the deception.

HYPNUM MICROCLADUM.

Two distinct plants have been described under this name, viz. :—

H. microcladum Tayl. in London Journ. Bot. v. 64 (1846), from the Andes of Quito.

H. microcladum Doz. & Molk. in Ann. Sc. Nat. 1844, 308, from Borneo &c.

Jaeger, Adumbr. ii., places Taylor's South American moss under *Rhaphidostegium* (p. 476), and Dozy and Molkenboer's Asiatic species under *Trichosteleum* (p. 487).

Paris (Index, Ed. ii.) follows this arrangement, but erroneously cites *Trichosteleum microcladum* Jaeg. p. 487 for both plants.

Unhappily, however, Dozy and Molkenboer's species from Borneo, Celebes, and New Guinea is not a *Trichosteleum*, but is also a *Rhaphidostegium*, and must stand as *R. microcladum* (Doz. & Molk.) Broth. *R. microcladum* (Tayl.) Jaeg. is therefore antedated by this, and is untenable; and C. Mueller's name for it (Syn. ii. 392) will stand, as *R. esmeraldicum* (C. M.) Broth.

R. microcladum (Doz. & Molk.) Broth. occurs in herb. Mitten from "Micronesia, E. Bailey." I have it also from two localities in the Malay Peninsula, in continental Asia.

BARBULA ALBICUSPIS Mitt.

Mitten described this in the Musci Ind. Or. (Journ. Linn. Soc. (Bot.) iii., Suppl. 35), from sterile specimens, coll. Hooker, Donkia Pass, Sikkim, alt. 18,000 ft. Having occasion to examine this, I was struck with the resemblance to *Grimmia apocarpa* var. *gracilis* (*G. gracilis* Schleich.) in the colour and habit, the roughened back of

the nerve, and the hyaline tips of the leaves. A closer examination made it quite certain that the suspicion was justified, as an immature perichætium was detected, quite characteristic of the *Grimmia*, having moderately long, toothed hair-points. On my first examination of the plant I felt some doubt, as the lower leaf-cells were almost without the sinuosity characteristic of the *Grimmia*, though otherwise agreeing exactly; the cells of the perichætial leaves, however, showed the normal sinuosity, and left no doubt whatever of the identity. The upper leaf-cells are rather markedly papillose, as is described by Loeske for some forms of this *Grimmia*. *B. albicuspis* Mitt. must, therefore, become a synonym of *G. gracilis* Schleich.

MOSSSES OF HARVEY'S 'THESAURUS CAPENSIS,' VOL. I. (1859).

This work appears to have been overlooked by most bryological writers (Jaeger, Paris, Brotherus, C. Mueller). On pages 63, 64, Mitten has described one new species of *Ephemerum* (*E. diversifolium*) and three of *Entosthodon* (*E. clavatus*, *E. urceolatus*, and (p. 64) *E. cavifolius*). These are figured on plate 100.

In view of the rather large number of species of *Funaria* (*Entosthodon*) described since this work, it is rather surprising that only one of them, at most, appears synonymous with any of Mitten's three species, but this seems happily to be the case.

E. cavifolius has exceedingly concave leaves with very short points, unmarginated; peristome 0; and appears to me a very distinct species. I have it from Kirstenbosch, coll. Pillans (No. 4750).

E. clavatus Mitt. is described as allied to *E. curvipes* C. M., but with a more clavate capsule, and apparently gymnostomous. It is possible that *E. campylopodioides* C. M. (Hedwigia, xxxviii. 60, 1400) may be the same thing, though Mitten describes his *E. clavatus* as "nervo sub apice evanido," while C. Mueller's species has "nervo cruminiusculo purpureo in aristam brevem acutatam excedente."

Finally, *E. urceolatus* Mitt. is described as like *E. Rottleri* Molkenboer., but smaller, leaves acuminate (in *E. Rottleri* piliferous), capsule when deperculate urceolate.

ANOMOBRYUM ROBUSTUM.

I described an African species as *A. robustum*, sp. nov., in Smithson. Misc. Colls. 72, no. 3, p. 7 (1920), t. i. fig. 4. I was not then aware of *A. robustum* Broth. in Herzog, "Bryophyten meiner zweiten Reise durch Bolivia," in Bibl. Bot. Heft. 87, p. 83 (1916). This, of course, antedates my publication, and Brotherus, therefore, in Engler, Die natürlich. Pflanzenfam., Musci, ed. ii. 372 (1924), has altered the name of the African moss to *A. Maclellanani*.

EURHYNCHIUM REMOTIFOLIUM Jaeg.

In both the *Flora of New Zealand* (ii. 108) and the *Handbook of the New Zealand Flora* (p. 477) the New Zealand plant is referred to the S. American *Hypnum remotifolium* Grev., without any ques-

tion being raised, Mitten's *H. asperipes* being given as a synonym. Mitten apparently acquiesced in this reduction, as the New Zealand moss appears in his herbarium as "*Eurhynchium remotifolium*—*H. asperipes* Mitt.," and in another case simply as "*Hypnum remotifolium*."

I have carefully examined the original specimens of *H. remotifolium*, gathered by Jameson on Pichincha, and I have no doubt that, though closely allied, it is not the New Zealand plant. Wilson based his determination almost entirely on a barren plant of Sinclair's, which certainly agrees very closely with the S. American species; but then Sinclair's plant is almost certainly *Rhynchostegium tenuifolium* (Hedw.), a moss which in vegetative characters is extremely like the *Eurhynchium*. The other New Zealand plant which Wilson had under observation was one of Knight's, which in both Hooker's and Wilson's herbaria is without fruit, and which is, I think, also certainly *R. tenuifolium*.

The S. American plant is aptly described by Wilson as resembling very closely the European *E. speciosum*, both in leaf-structure and in the synoecious inflorescence. The New Zealand moss is autoicous, the nerve is shorter, the acumen longer and finer, the cells wider, the seta shorter (under 2 cm., while in the S. American plant it is over 2 cm., often 2.5 cm.), the perichætal leaves with longer, more coarsely toothed acumen. The habit also is very different; the New Zealand plant being much more rigid, with dense foliage, the leaves very rigidly divergent all round the stem, something as in *Eurhynchium striatum* and *E. striatulum*. In fact, if the distinction of the genera *Eurhynchium* and *Oxyrrhynchium* be maintained, the S. American *H. remotifolium* would undoubtedly belong to *Oxyrrhynchium*, while *H. asperipes* Mitt. would, I think, quite properly find its place in *Eurhynchium*.

It is remarkable that both Greville and Schwaegrichen describe the seta of Jameson's plant as smooth, since it is certainly rough in all the specimens available. Wilson, moreover, in the Kew copy of Schwaegrichen, Suppl. ii. t. 200, has a MS. note "an orig. sp. from Dr. Greville to W. W. has the seta rough! (W. W., Aug. 1847)." Mitten in the Musci Austr.-Amer. correctly describes it as "ubique scaberrimo."

Paris, in the Index, ed. ii., has got the synonymy into an almost inextricable muddle. This is primarily due to C. Mueller (Syn. ii. 490), who has entirely confused two distinct plants—the S. American *H. remotifolium* Grev. (*Eurhynchium*) and the Indian *Leskea remotifolia* Hook., which is a *Thuidium*. He there describes an Indian *Thuidium*, but as if it were the S. American plant described by Greville. He doubts whether Schwaegrichen's figure (t. 200) belongs to the *Thuidium*—not unnaturally, since Schwaegrichen's figure actually does represent the S. American *Eurhynchium*, as it purports to do! And then C. Mueller adds to the confusion by adding a note to the effect that Schwaegrichen's plant was "ex speciminibus Hookerianis, n. el. Montagne acceptis," whereas Schwaegrichen makes no mention whatever of either Hooker or Montagne! (It seems probable that he

is here quoting a letter from Schwaegrichen, enclosing both *H. remotifolium* Grev. and *L. remotifolia* Hook., and that C. Mueller had confused the two.)

Under *Eurhynchium remotifolium* Paris has created a "*H. remotifolium* Grev. MSS.," for the New Zealand plant, to account for its appearing in the Fl. N.Z. as *H. remotifolium* Grev., failing to recognize that Hooker and Wilson were simply citing the S. American plant, with which they believed the New Zealand moss to be identical. This was quite natural in Paris, since he accepted C. Mueller's citation of Greville's species as the *Thuidium*.

A further stage in the confusion is reached when C. Mueller (Syn. ii. 251) makes *Leskea remotifolia* Hook. a synonym of the Indian *Hypnum* (*Eurh.*) *scabrisetum* Schwaegr. (Suppl. iii. pt. ii. t. 281); and this has vitiated Paris's reference under *Eurh. scabrisetum* (Grev.) and *Thuidium remotifolium*.

Eurhynchium remotifolium (Grev.) having been absorbed (by C. Mueller) into *Thuidium*, it became necessary to obtain another name for the S. American moss, and this was found in *H. clinocarpum* Tayl., the next earliest of a rather long list of names at one time or another bestowed upon this species, and the S. American species will be found in Paris, Index, Ed. ii., under the name *Eurhynchium clinocarpum* (Tayl.) Par.

The more important items of the synonymy may be abbreviated as under:

EURHYNCHIMUM ASPERIPES (Mitt.) Dixon, comb. nov.

Syn. *Hypnum asperipes* Mitt. in Journ. Linn. Soc. (Bot.) iv. 85 (1859); and Fl. Tasm. ii. 209 (1860).

Hypnum remotifolium H. f. & W., Fl. N.Z. ii. 108, and Handb. N.Z. Fl. 477 (nec *H. remotifolium* Grev.).

Distribution. New Zealand, Tasmania.

EURHYNCHIMUM REMOTIFOLIUM (Grev.) Jaeg. Adumbr. ii. 422, p. p.

Syn. *Hypnum remotifolium* Grev. in Mem. Wern. Soc. Edinb. v. 483 (1824); Schwaegr. Suppl. ii. pt. ii. t. 200; Mitt. Musc. Austr.-Amer. in Journ. Linn. Soc. (Bot.) xii. 556.

H. Regnellii Hampe in C. M. Syn. ii. 447 (*vide* Mitten, *loc. cit.*).
Distribution. Amer. Mer. occ. et or.

EURHYNCHIMUM SCABRISSETUM (Schwaegr.) Par. Ind. 447.

Syn. *Hypnum scabrisetum* Schwaegr. Suppl. iii. pt. ii. t. 281 (1829-30); C. M. Syn. ii. 250; Mitt. Musc. Ind. Or. in Journ. Linn. Soc. (Bot.) iii., Suppl. 80. (Non *Leskea remotifolia* Hook. MS.; nec *Thuidium remotifolium* Jaeg.)

Distribution. India Or. bor.

LESKEA REMOTIFOLIA Hook. MS.

It will be seen from the above that *Leskea remotifolia* Hook. is left in a state of suspended animation. Is it, or is it not, a published species? Hooker never described it. Schwaegrichen never described

it. C. Mueller might be held to have had it before him when he wrote the description in Syn. ii. 490. But it seems unreasonable to hold that the publication of an Indian species of *Thuidium*, *Leskea remotifolia* Hook. MS., could be validly based on an imperfect diagnosis in the *Synopsis*, where C. Mueller had no intention of describing a new species at all, but supposed he was only re-describing a S. American species of Greville which was actually a *Eurhynchium*!

Moreover, who is to say what Hooker's *L. remotifolia* actually was? Mitten might be presumed to know, as he dealt with it in the Musc. Ind. Or. as if it were an already published and well-known species—used, indeed, by him as the basis of comparison for one or two of his new species. Now Mitten cites for it (*op. cit.* in Journ. Linn. Soc. (Bot.) iii., Suppl. (1859), 135): "In Nepal, Wallich! In Assam superiore, Griff." Clearly, the former alone would be Hooker's type. But "*Leskea remotifolia* Hook., Nepal, Wallich, H. 1971" in herb. Hooker, at Kew, is the only specimen, and this has a smooth seta; and that Mitten understood it so is clear from his note (*op. cit.* 134) on *L. contortula*, where the seta of *L. remotifolia* is by implication referred to as *smooth*. Now, C. Mueller's plant (Syn. ii. 490) clearly had a rough seta, since he describes the species as "*H. involventi* simillimum" without further reference to the smoothness or otherwise of the seta. (It may be added that in Hooker's herbarium on the same sheet as Wallich's plant is a further specimen "H. 1037, Sikkim, 4800 ft.," purporting to be the same thing, but actually a *Eurhynchium* with a rough seta, viz., *E. scabrisetum* (Schwaegr.); and if a part of this were sent to Schwaegrichen as *L. remotifolia* Hook. MS., it might to some extent explain the confused synonymy of C. Mueller (Syn. ii. 251) referred to above.)

C. Mueller's "*H. remotifolium* Grev.," then, whatever it may have been, cannot be the same thing as Hooker's 1971, Nepal, Wallich; and its description, therefore, cannot be looked upon, in any circumstances, as the publication of *Thuidium remotifolium*.

Wallich's plant, H. 1971 referred to above, considered by Mitten as the type of *L. remotifolia* Hook., with elongate smooth seta, has an erect or suberect, cylindrical, straight or only slightly curved capsule, with straight rostrate lid, a rather unusual feature in the subgenus *Thuidiella*, and it is also accompanied by a rather distinct type of vegetation. It is, in fact, quite recognizable as *T. squarrosulum* Ren. & Card., closely allied to *T. Haplohymenium* (Harv.) Jaeg., from which it differs in having the inner perichætal leaves not ciliate.

Thuidium remotifolium (Hook.) Jaeg. is therefore a *nomen nudum*, and this much vexed name *remotifolium* may be quite cheerfully dropped in favour of the validly published name.

The correct name will be:

Thuidium squarrosulum Ren. & Card. in Bull. Soc. roy. Belg. xxxviii. 31 (1899).

Syn. *Leskea remotifolia* Hook. MS. ined.

Thuidium remotifolium Jaeg. Adumbr. ii. 740; *nomen nudum*.

Non *Hypnum remotifolium* Grev.; nec *H. remotifolium* C. M. Syn. ii. 490.

LESKEA LONGIROSTRIS Schwaegr. Suppl. iv. pt. ii. t. 290 (1830).

This little-known Indian plant is placed by Paris, following Jaeger, under *Homalothecium*, with a query; Brotherus states that it is unknown to him. C. Mueller omits all reference to it from the *Synopsis*.

I have examined an original in Hooker's herb. at Kew, "*Leskea longirostris* Schwaegr. Suppl. t. 290 (from Herb. Arnott); Nepal." Its position is somewhat problematic, but it is in no case a *Homalothecium*. I think it may be referred to *Stereophyllum*—at any rate, in the wider sense. It is a fairly robust plant, with sub-homomallous leaves, fully 2 mm. long, ovate, shortly and acutely acuminate, with single nerve reaching to about mid-leaf, narrow linear upper cells, and numerous, quadrate, lax (Entodontoid), pellucid, alar cells. The perichætal leaves are erect, not highly differentiated; seta 1.5 cm., pale; capsule erect, elliptic-oblong, pale orange-brown, about 2 mm. long without lid; the lid conical with a rather fine, curved, shortly rostrate beak; about half the capsule length. Spores small. Peristome double; the outer of rather small, narrow teeth, pale, striolate below, above papillose. Endostome (imperfect) showing a fairly elevated basal membrane and remains of narrow, linear, not highly developed processes (Schwaegrichen figures it with narrow rimose processes, and no cilia). Exothecium cells lax, wide, and rather thin-walled.

Stereophyllum chionostomoides Broth., n. sp. (ined.), Kumaon, Gollan, No. 1806, in herb. E. Levier, is identical with Schwaegrichen's species.

The position of the plant is difficult to decide. The genus *Stereophyllum* as earlier understood has been split up by Fleischer and Brotherus into several smaller genera, one of which—*Juratzkæa*—has been removed by Fleischer to Fabroniaceæ. In some respects the present species comes near to *Juratzkæa*, but the rostrate lid is against it, and it is better, perhaps, retained in *Stereophyllum*, in spite of the erect symmetrical capsule. The genera *Schwetschkea*, *Juratzkæa*, and *Stereophyllum* seem to form a rather closely connected series, and even some species of *Rhynchostegiella* (e.g. *R. humillima* (Mitt.) Broth., and still more an ined. species I have from Mussooree) run them very close.

Whether placed in *Juratzkæa* or *Stereophyllum*, Schwaegrichen's name must be retained. In the latter case it would stand as *Stereophyllum longirostre* (Schwaegr.) Dixon, comb. nov.

Leskea longirostris Schwaegr. must not be confused with *L. longirostris* Brid., which is a Central American *Rhaphidostegium*.

LICHENS FROM SPITSBERGEN AND BEAR ISLAND.

BY ROBERT PAULSON, F.L.S.

A LIST of the lichens collected during the 1921 Oxford University Spitsbergen Expedition was published in 1923*.

Since then the 1923 Merton College (Oxford) Expedition and the 1924 Oxford University Arctic Expedition have brought much additional lichen-material from Spitsbergen, especially from the north, including a part of North-East Land, which has added considerably to the number of species and varieties hitherto known. When the whole of the material has been worked through, it is proposed to publish a supplementary list or lists.

In his recently published account† of the lichens from Bear Island, Dr. Bernt Lyngé, of the Oslo Botanical Museum, criticises some of my determinations of Bear Island specimens in the Oxford 1923 list.

On page 4 of his Introduction, he states, "I have not seen their [the collectors'] lichens myself. . . . Their *Cladonia furcata* var. *spinosa*, *Cl. rangiformis* and *Alectoria bicolor* are interesting, if correctly determined. The last-mentioned plant does not grow north of the Dovre Mountains in Norway [approximately 62° 0' N. lat.] and *Cl. rangiformis* has never been collected north of Lofoten" [68° 0' N. lat.].

Must we, therefore, henceforth assume that no *Cladonia*, collected north of Lofoten (in Bear Island, for instance), can possibly be *C. rangiformis*?

As to *Cladonia furcata*, although it is not included in Dr. Lyngé's list of "Lichens from Spitsbergen."‡ or in "Lichens from Bear Island," I still maintain that this plant was collected in the latter place (1921) from at least two localities.

Alectoria bicolor is recorded by Dr. W. L. Lindsay§ among the lichens collected by Robert Brown (of Campster) in West Greenland, at Jakobshaven and Junarkok, the latter locality having a latitude of 70° 36' N. He had sufficient material, so it appears, to be able to assume that *Al. jubata* may pass through *Al. bicolor* into *Al. ochroleuca*.

E. Stizenberger||, gives Greenland as a habitat, and R. Heber Howe writes concerning this lichen: "Distribution: Boreale."

All the above stations are considerably north of the Dovre Mountains, and consequently the climate is decidedly arctic.

* Paulson, Robert, "Spitsbergen Lichens," Journ. Bot. Ixi. 77-81.

† Lyngé, Bernt, *Lichens from Bear Island (Bjørnøya)*, Oslo, 1926, 4-5.

‡ Lyngé, Bernt, *Lichens from Spitsbergen*, Kristiania, 1924.

§ Lindsay, W. L., "Observations on the Lichens collected by R. Brown in West Greenland," Journ. Linn. Soc. xxviii. 305-369 (1871).

|| Stizenberger, E., *Alectorienarten und ihre geographische Verbreitung*, Annalen des k. k. Naturhistorischen Hofmuseums, vii. Heft 3, Wien, (1892).

Again, Dr. Lyngé states (p. 4): "Their *Cladonia gracilis* is supposed to be *Cladonia elongata*, so common in the Arctic." But he appears to have forgotten that he himself did not recognise *Cl. elongata* as a species for more than a year after the Oxford list was published, for in *Lichens of Spitsbergen*, 1924, 9, he cites: "*Cladonia gracilis* (L.) Willd. var. *elongata* (Jacq.) Hoffm." Two years afterwards he records the variety as having specific rank, but *Cl. gracilis* is still represented according to his own lists, 1924 and 1926, in the var. *chordalis*. The specimen I received from Spitsbergen was certainly recognised as approaching *elongata* standard, but I preferred to classify it under the specific name.

It was after considerable deliberation and discussion that I came to the conclusion that a lichen from Bear Island, collected 1923, must be *Cladonia foliaceae*, though Dr. Lyngé regards this as "absolutely impossible."

Dr. Lyngé also questions *Lecanora galactina* subsp. *dispersa* of my list, suggesting that it should be compared with *Lecanora Nordenskiöldii* or *L. torrida*.

These two species I have not seen, but on reading the descriptions I still adhere to my original determination. My lichen differs in well-recognised characters—e. g., *L. torrida* has black apothecia, while in *L. galactina* and its allies the apothecia are brown. The microscopical characters also leave no room for doubt.

NOTES FROM THE BRITISH MUSEUM HERBARIUM.

TWO NEW SPECIES OF ACANTHACEÆ.

BY S. MOORE.

Ruellia Lowei, sp. nov. *Herba* infrapalmaris; *caule* abbreviato robusto dense fulvo-villoso-tomentoso; *foliis* paucis subrosulatis anguste oblongo-obovatis obtusis obtusissimisve basi in petiolum brevem attenuatis undulatis supra scabridis subtus in nervis necnon margine sparsim strigilloso-pilosis; *inflorescentia* scaposa scapis folia plene excedentibus solitariis vel perpaucis inferne nudis erectis pilosis; *floribus* subsessilibus in axillis oppositis solitariis vel binis; *bracteis* bracteolisque oblongis breviter acuminatis uti calyx minute puberulis; *calycis* segmentis bracteolis longioribus lineari-lanceolatis acuminatis; *corollæ* tubo leviter curvato sursum dilatato inferne minute puberulo limbi lobis inter se subæqualibus suborbicularibus tubo brevioribus; *staminibus* didynamis juxta medium tubum insertis; *pollinis* granis poris 2 donatis exino delicatissime faviformi-insculpto; *ovario* glabro in stylum puberulum desinente.

Hab. Tonkin, Col des Nuages; *Willoughby P. Lowe*.

Whole plant in flower barely 15 cm. high. Root not seen. Stem 3 mm. thick and about 1 cm. long. Leaves three pairs, drying greyish-green darker above, up to 6 × 2.8 cm., but often smaller and some only 2.5 × 1.5 cm.; petioles up to 1 cm., though often shorter, pilose-villosulous. Flowering scapes up to 14 cm. long, naked for the lower

8 cm. Flowers in the opposite axils, the lower pairs 1.5-2 cm. apart, the upper to the number of four closer together. Bracts 5.5 mm., bracteoles 1 mm., calyx 6 mm. long. Corolla apparently white; the tube about 2 cm. long, when dry 1 mm. wide in lower half, expanded to 4 mm. above; lobes about 7 mm. long. Ovary barely 3.5 mm., style 2.3 cm. long. Capsule 18-20 mm. long, about 20-seeded; ripe seeds oblong, greenish, microscopically hairy, 2 mm. long.

An elegant plant easily recognized by its scapose habit.

Dicliptera (§ *Platystegiæ*) **Whitmeei**, sp. nov. *Herba* ramosa, ramis quadrangularibus brunneo-pubescentibus; *foliis* petiolatis oblongo-ovatis acutis vel acutiusculis utrinque puberulis; *spiculis* breviter pedicellatis 1-2-floris (flore secundo dum adsit sterili) in axillis superioribus aggregatis; *pedicellis* pubescentibus bractea subulata onustis; *bracteis* spicularum (paris inter se inæqualibus) ovatis vel ovato-oblongis brevissime acuminatis mucronulatis basi rotundatis ima basi breviter angustatis pag. utraque minute pubescentibus; *bracteolis* linearibus calyce brevioribus; *calycis* segmentis lineari-lanceolatis acutis ciliatis; *corollæ* tubo sursum dilatato puberulo labio antico oblongo-obovato 3-dentato postico ovato obscure retuso æquilongis; *staminibus* exsertis antherarum loculis contiguis.

Hab. Lifu, Loyalty Islands; *Whitmeei*.

Leaves up to 3.5 × 2.2 cm., drying dark above green below; petioles at most 1.5 cm. long, pubescent. Pedicels of the spicules ± 2 mm. long; larger bracts about 12 × 7 mm., smaller 10 × 6 mm.; bracteoles 3 mm., calyx 4 mm. long. Tube of corolla 5 mm. long, below 1.25 mm. above 2.5 mm. broad; the lips 8 mm. long. Ovary 1 mm., style 10.5 mm. long. Capsule pubescent, 5 mm. long, its narrowed base 1.5 mm. long. Seeds orbicular, puberulous, barely 2 mm. across.

Affinity with the New Caledonian *D. pubescens* Juss., known from it on sight by the shape of the spicular bracts.

NOTES ON ASHANTI PLANTS.

A small collection by Mr. A. E. Kitson in the Kintampo district, Gold Coast, made in the present year and presented by him to the Museum, contains the following items:—

Polygala Baikiei Chodat. It is of interest to record another locality for this rather rare species, hitherto, except for one somewhat doubtful specimen from Sierra Leone, collected only in Nigeria.—A. W. EXELL.

Monotes Kerstingii Gilg. This is an extension of the recorded range of this species, which was originally described from Togoland and has since been collected in the Cameroons.—A. W. EXELL.

Aspilia Kitsonii S. Moore, sp. nov. *Herba* verisimiliter annua, pauciramosa; ramis tenuibus scabriusculis distanter foliosis; *foliis* subsessilibus trinerviis lineari-lanceolatis acutis basi obtusis margine remote subobscure denticulatis utrinque scabridis; *capitulis* parvis

ad apicem ramorum perpaucis pedunculis gracilibus scabriusculis sæpe oblongatis insidentibus; *involucri* campanulati 4-serialis phyllis oblongis extimis abbreviatis omnibus obtusis inferne tenuiter coriaceis apertæ herbaceis margine rigide ciliatis intimis fere glabris; *ligulis* illis circa 8 exsertis oblongo-obovatis apice perspicue bifidis lobis obtusis; *achæniis* oblongis pilis sericeis appressis inspersis pappo appulsi-inciso setis destituto coronatis.

Hab. Ashanti, Kintampo District, 1926; *Kitson*.

Leaves 3-6 cm. long by 5-9 mm. broad, when dry dark above grey below. Peduncles up to 7.5 cm. long, but usually shorter and none only 2 cm. Involucres 6.5 × 6 mm.; outer leaves 2.5 mm., middle ones 3-5 mm., inner 6 mm. long. Receptacular paleæ narrowly ovate-oblong, obtusely acute, near the top microscopically serrulate, membranaceous, 5 mm. long. Limb of ligules 7 × 3 mm. Achenes 5 × 1.5 mm.

Judging from the description this must be near *A. Bussei* Muschl., which has narrow leaves and small heads; but the leaves are said to be serrate, the involucre leaves broad ("latæ"), and the obovoid achenes crowned by a pappus with a 2 mm. long seta.

In addition to the above, the following of Mr. Kitson's collecting are worthy of notice as members of the Gold Coast flora, *Octodon antosum* Hiern and *Acrocephalus lagoensis* Bak.—S. MOORE.

CEREFOLIUM HALLER.

BY T. A. SPRAGUE, B.Sc., F.L.S.

THE generic name *Chærefolium* has been ascribed to Haller (1768) by Schinz and Thellung (Vierteljahrsschr. Nat. Ges. Zürich, llii. 552, 1909), who have adopted it in place of *Anthriscus* Hoffm. (1814). The object of the present note is to show that the name adopted in 1768 by Haller for the Chervil and its congeners was *Cerefolium*, and that the spelling *Chærefolium* was due to an oversight on his part. *Chærefolium* appeared as the name of the genus in question in Haller's *Historia*, i. 327 (1768), followed by the synonyms *Chærophyllum* Tourn. and *Scandicis* spec. Linn. But none of Haller's three species bears the name *Chærefolium*: the first is named *Chærophyllum foliis glabris, triplicato pinnatis, lobulis obtusis*, the second is *Cerefolium foliis acute dentatis, triplicato pinnatis, glabris, nervis hirsutis*, and the third is *Cerefolium foliis hirsutis, peltatis cordatis, seminibus obscure striatis*. Thus Haller used three different names for the genus on pp. 327, 328. Reference to his "Tabula Classium et Generum" (p. lxi) shows that he there adopted *Chærophyllum*; in the index (iii. 193), however, he kept up *Cerefolium*, treating *Chærophyllum* as a synonym. *Chærefolium* is not even mentioned in the index. Which, then, of the three names *Chærefolium*, *Chærophyllum*, and *Cerefolium* did Haller intend to adopt? Reference to his *Nomenclator*, 69 (1769), shows that it was

Cerrefolium, under which all three species bear diagnostic phrases. The confusion in names evidently arose from Haller having changed his mind during the preparation of his *Historia*. He had formerly adopted the name *Chærophyllum* (Enum. Stirp. Helv. i. 452, 1742), and this name appeared in the "Tabula Classium et Generum" in the early part of the first volume of the *Historia*. The index, which is at the end of vol. iii., represents his final views before publication, and in it he adopted *Cerrefolium*. The generic name and the three species (i. 327, 328) were doubtless originally under *Chærophyllum*. Haller presumably altered the second and third species to *Cerrefolium*, forgot to alter the first, and by an oversight converted the name at the head of the genus into *Chærefolium* instead of *Cerrefolium*. It follows that, under International Rules, *Cerrefolium* Haller (not *Chærefolium* Haller, as suggested by Schinz and Thellung) will replace *Anthriscus* Hoffm. (1814), unless the latter name is conserved. The principal references and synonymy of *Cerrefolium* are appended.

CERREFOLIUM [Riv. Pl. Pentapet. 11, 30, tt. 43, 44 (1699); Rupp. Fl. Jen. 269 (1718); ed. Hall. 283 (1745)], Haller Hist. i. 327 (lapsu *Chærefolium*), 328 (1768), et l. c. iii. 193 (1768); Haller, *Nomenclator*, 69 (1769); Besser, Prim. Fl. Galic. i. 218 (1809); S. F. Gray, Nat. Arr. Brit. Pl. ii. 501 (1821); Besser, Enum. Pl. Volhyn. 44 (1822); Link, Handb. i. 351 (1829); Rupr. Fl. Ingr. i. 469 (1860); G. Beck, Fl. Nied.-Österr. ii. Abt. 1, 631 (1892); Druce, Fl. Berksh. 243 (1897); Britton & Brown, Ill. Fl. ed. 2, ii. 629 (1913).

Anthriscus Hoffm. Gen. Umbell. pp. xxiii, 38 (1814); Endl. Gen. 786 (1839); Benth. & Hook. f. Gen. Pl. i. 899 (1867); Engler & Prantl, Nat. Pflanzenfam. iii. Abt. 8, 152 (1898).

Chærophyllum Adans. Fam. ii. 96 (1763), non Linn.

SHORT NOTES.

ALIBERTIA OR *CORDIERA*.—The Rubiaceous genera *Cordia* and *Alibertia* were published simultaneously by A. Richard in Mém. Soc. Hist. Nat. Par. vol. v. (1830), the former on p. 222, t. 20, and the latter on p. 234, t. 21. They are now regarded as being congeneric. Under International Rules, Art. 46, the first author who united them had the option as to which of the names should be adopted, and his choice cannot be modified by subsequent authors. Grisebach, Fl. Brit. W. Ind. 319 (1860) accepted the generic name *Cordia* for *C. triflora* A. Rich., but at that date apparently did not suspect that *Cordia* and *Alibertia* were congeneric. On p. 710 (1864) in his "Corrections," however, the following entry occurs:—"Page 319. *Cordia*; cancel Richard's erroneous character of the fruit: for *Alibertia* (berry many-seeded) and *Thielodoxa* (berry 'few-seeded') will prove its congeners." He made no statement on p. 710 as to which of the three generic names should be adopted, but in the Index, p. 714, *Alibertia* is

stated to be a synonym of *Cordia*, which might suggest that Grisebach intended to adopt the latter name. But there is no evidence that Grisebach was responsible for the compilation of the Index, and in any case the entry may mean merely that *Cordia* and *Alibertia* were regarded by him as being synonymous. That this is the correct interpretation is evident from the fact that in the following year Grisebach kept up both *Alibertia edulis* and *Cordia triflora* in his Geog. Verbreit. Pfl. Westind. 39, 45 (1865). Obviously he had not decided which name should be adopted for the genus. In 1866 he still retained *Alibertia edulis* and described a new species *A. jacquinioides* (Cat. Pl. Cub. 123).

The first authors who united *Cordia* and *Alibertia*, and definitely chose one of the names, were Benth. & Hook. f. (Gen. Pl. ii. 81, 1873), who decided in favour of *Alibertia*, which is accordingly the correct name for the genus under International Rules. This is fortunate, since *Alibertia* is much better known than *Cordia*, having been adopted in Engler & Prantl (Pflanzenfam.) and Martius (*Flora Brasiliensis*). Under the American Code, Canon 13, which recognizes "priority of position," *Cordia* is the accepted name of the genus, since it appeared on an earlier page than *Alibertia*.—T. A. SPRAGUE.

OLEARIA V. *SHAWIA*.—In the July number of the *Journal*, 193-4, Dr. F. V. Colville, of the United States National Herbarium, Washington, writes in favour of retaining the generic name *Shawia* in place of *Olearia*, his principal argument being that the *Century Dictionary*, in its edition of 1909-11, prefers *Shawia*. I find, however, that in the same edition a well-known grass is called *Capriola Dactylon* instead of *Cynodon Dactylon*, although in 1905 the International Botanical Congress of Vienna placed *Capriola* in the list of *nomina rejicienda* and *Cynodon* among the *nomina conservanda*. Many other names in the same dictionary show that its botanical editor is seeking to maintain a Kuntzean nomenclature and is in revolt against the International Rules. This being so, it is clear that even if Australian botanists are successful in getting *Olearia* conserved by some future congress, and in preventing confusion in that large genus by retaining its well-known name instead of changing to an older but utterly unknown name, the *Century Dictionary* will still go on using the appellation *Shawia*, unless its botanical editor alters his views on nomenclature. I therefore decline to regard the *Century Dictionary* as anything more than the mouth-piece of a section—although it may be a large section—of United States botanists. It certainly does not represent general American opinion, because I believe that Canada and Latin America follow the International Rules, as do also many botanists within the United States. Thus Professors B. L. Robinson and M. L. Fernald, both of Harvard and editors of Gray's *New Manual of Botany*, 7th edition, state in their preface:—"The editors have scrupulously endeavoured to bring the nomenclature of the *Manual* into accord with the Vienna agreement, in order that American botanical nomenclature may be free, as speedily as possible, from peculiarity or provincialism and assume the form

JOURNAL OF BOTANY.—VOL. 65. [JANUARY, 1927.] c

which has received international sanction."—J. M. BLACK, Hon. Secretary of the Committee on Australian Botanical Nomenclature.

CITATION OF SPECIES DESCRIBED BY WAWRA AND PEYRITSCH.—The new species described in Wawra and Peyr., *Sertum benquense* in Sitz. Akad. Wiss. Wien. Math. Nat. xxxviii. (1860) 555–586 were all described by either one or the other of these two authors. The Polypetalæ were by Wawra, unless otherwise stated at the beginning of the family, while the Gamopetalæ, Apetalæ, and Monocotyledons were by Peyritsch.

Six species were wrongly cited in the Kew Index and the errors have been repeated in many subsequent works. The necessary corrections are as follows:—

Acacia reficiens Wawra, non Wawra & Peyr.
Cucumis sagittatus Peyr., non Wawra & Peyr.
Gossypium anomalum Wawra, non Wawra & Peyr.
Grewia cyclopetala Wawra, non Wawra & Peyr.
Tribulus exrucians Wawra, non Wawra & Peyr.
Triumfetta benquensis Wawra, non Wawra & Peyr.

A. W. EXELL.

REVIEWS.

Aims and Methods in the Study of Vegetation. Edited by A. G. TANSLEY, M.A., F.R.S., and T. F. CHIPP, M.C., Ph.D. Demy 8vo; pp. xvi, 383; 62 figs. British Empire Vegetation Committee and Crown Agents for the Colonies: London, 1926. Price 12s. 6d. (post free).

THIS volume is the outcome of a resolution passed at the Imperial Botanical Conference in 1924. One of the subjects considered at the Conference was the need for a survey of the vegetation of the British Empire, and a resolution was passed by which a Committee was appointed to promote this object. The 'Aims and Methods' is presented as the first fruits of the Committee's activity, the two editors being respectively its acting Chairman and Secretary. To quote the preface, "The actual work of exploring, recording, and investigating the vegetation of different parts of the Empire can, of course, only be carried out by a multitude of different workers . . . resident in the different countries." "Though much work of this kind has been done, a great deal remains, and the object of this book is to put into the hands of workers in vegetation in all parts of the British Empire something that will be useful, . . . and to give those who may become workers some idea of the aims, opportunities, and methods of work that lie before them."

The Committee has shown considerable promptitude in the production of the book, which, but for the unfortunate accident which destroyed the copies on the eve of its publication, would have appeared several months ago. Some expression of this rapidity of production is found in the constitution of the volume. The first and slightly larger "half" forms Part I., and is a general introduction to the systematic study of vegetation, including an explanation of the

forms and units employed, a description of the methods used, and a consideration of the various factors involved, namely climatic and physiographic, edaphic (soil), and biotic (animals and man). It forms an eminently useful handbook, and reflects the knowledge and experience of the senior editor. The last chapter of Part I. deals with the lower plants, which require special methods of study. Mr. J. Ramsbottom supplies interesting sections on the parts played in vegetation, respectively, by Fungi and Lichens, and Mr. A. D. Cotton contributes a few pages on sea-weeds—a wide and attractive field of exploration, of which our knowledge is comparatively scanty.

The remaining portion of the volume is of a different nature. It does not follow any considered plan, but consists "of a number of chapters by expert workers in the field overseas, whose assistance the editors have been fortunate to enlist." These chapters, which add much to the value and interest of the book, will serve two purposes. They will, as the editors suggest, enable the student to learn, at first hand, the views of some of the most successful workers in the Empire as to the equipment and methods of work which they have found most useful in the field, and also serve to emphasise the fact that any serious study of the vegetation of a given area must be undertaken by experienced workers on the spot—the method which is so often adopted, of necessity, in floristic works, of compilation in a herbarium and library will not be suitable for the ecological monograph.

The special chapters are subdivided into Part II. Regional and Part III. Types of Vegetation. The former includes chapters, respectively, by T. F. Chipp on aims and methods of study in tropical countries, with special reference to West Africa, and by Dr. L. Dudley Stamp, formerly of Rangoon University, on special aspects of vegetation survey in the tropics, and short chapters by Prof. J. W. Bews, Prof. T. G. B. Osborn, and Dr. Leonard Cockayne, born of their experience in South Africa, South Australia, and New Zealand, respectively. In Part III. Prof. R. S. Troup, Prof. Bews, and Dr. Howe (of Toronto) and Cockayne deal with forest-problems in India, South Africa, Canada, and New Zealand, Prof. Bews and Dr. Cockayne with grasslands (South Africa and New Zealand) and sand-dunes (New Zealand); and Dr. H. H. Allan contributes notes on the study of the open communities of high mountain areas in New Zealand. Several of these chapters are helpfully illustrated with original photographic reproductions.

In order to supply the book at as low a price as possible, it is being distributed through voluntary agents in different parts of the Empire. Among these are The Secretary, Forestry Commission of New South Wales, Sydney; Dr. M. O. Malte, Victoria Memorial Museum, Ottawa; Dr. W. Burns, Agricultural College, Poona, Bombay Presidency; F. Eyles, Dept. of Agriculture, Salisbury, Rhodesia; Dr. Pole Evans, Dept. of Agriculture, Pretoria; and W. G. Freeman, Director of Agriculture, Port of Spain, Trinidad. It may also be obtained from the Crown Agents for the Colonies, 4 Millbank, London, S.W., or Dr. T. F. Chipp, 199 Kew Road, Kew, Surrey.

The Aspergilli. By CHARLES THOM and MARGARET B. CHURCH. pp. ix, 272, tt. iv., text-figures. 6" x 9". London: Baillière, Tindall & Cox. Baltimore: Williams & Wilkins. Price 22s. 6d.

ASPERGILLUS is one of the most difficult genera with which a mycologist has to deal, and the difficulties are more obvious because its species are common on all kinds of organic matter, and with *Penicillium* and *Mucor* are the most frequent contaminations encountered in culture work. Certain species are used in industry—*A. niger* for the production of citric acid and in the manufacture of pyrogallic acid from oak-galls; *A. flavus-oryzæ* and *A. Wentii* for fermenting soy beans to produce soy sauce; and enzymes of commercial value are furnished by *A. Okazakii* and *A. Oryzæ*. Further, *A. fumigatus* causes a disease in birds, especially in captivity. It is obvious, therefore, that proper identification of species of *Aspergillus* is a matter of considerable importance. Anyone, however, who has attempted this knows that it is a matter of extreme difficulty and immense uncertainty; and literature is littered with new species which often are merely obvious admissions of failure to recognise the form under discussion. Mycologists will therefore welcome the present book. Professor Charles Thom and his associate, Margaret B. Church, of the Bureau of Chemistry, U.S. Dept. of Agriculture, are well-known for their previous studies in *Penicillium* and *Aspergillus*; and we understand that a similar monograph of *Penicillium* is in preparation.

The first 90 pages deal with general matters. The genus is first defined morphologically. The name *Eurotium* (perfect stage) is discarded because few of the species are known to produce perithecia; this is directly opposed to the International Rules of Nomenclature as they read at present, but it would have been unsound to assume that all species of *Aspergillus* are conidial stages of *Eurotium* spp. The genus *Sterigmatocystis* is not upheld, nor is Langeron's *Diplostephanus*, recently proposed for the perithecial stage of these forms. *Aspergillopsis* Speg. (*Rhopalocystis* Grove) for brown-coloured forms is not upheld, nor is *Aspergillopsis* Sopp. for the *A. ustus* series. For a study of the genus, pure culture-methods are absolutely necessary. Details are given, therefore, of culture media and methods of study, the morphological characters, the colour of the parts, the colour and nature of the colony, and the basis of description and classification. One chapter is devoted to physiological and biochemical studies. Two chapters of more general interest deal with the fermentative activities of different species and their uses in industry, and the significance of certain species in human and animal disease. There is a great deal of information summarized in these chapters, far too much for an attempt to be made to detail it here.

The second part of the volume "The Nomenclature of the *Aspergilli*" opens with a couple of group keys, the first primarily based on colour, the second an abbreviation of a synoptical key which occupies thirty pages at the end of the book. The species are treated in eleven groups. The species, which have been accepted and studied by the authors are given with historical and morphological

detail; others which are regarded as forms or synonyms, or which have not been seen, are commented on usually quite fully. While, perhaps, the treatment is not the one usual in systematic work, and consequently is at first somewhat difficult to follow, there can be no doubt that the authors have done a very great deal to straighten out the tangle into which the specific limits and the nomenclature in this genus have inevitably fallen. These chapters or sections are followed by one on species probably *Aspergilli*, but without sufficient data for grouping—over thirty of them,—and one giving species of other genera described as *Aspergilli*, and other species probably of other genera, but not identified. After the full synoptical key mentioned above is a list of accepted species, those grown in culture by the authors and other species "probably valid as representing forms which may be re-discovered and cultured," forty-seven of the first and nineteen of the others. There are over nine pages of references and a full index. There are four plates of photomicrographs and fourteen text-figures. The book is one which would be found useful in all biological laboratories. J. R.

BOOK-NOTES, NEWS, ETC.

LINNEAN SOCIETY.—At the General Meeting on November 18, Miss E. R. Saunders read a paper on "The Origin of the Double Stock."

It appears to have been first mentioned by Dodoens (1568), who describes it as being very rare, because it is of the larger sort which begins to flower in the early spring, and also as being found in gardens. It was first figured (so far as we know) by Lobel (1581), who represents it as similar to the Double Stock of to-day in being fully double and absolutely sterile. Further information as to its origin we have none. In these circumstances a plant which appeared in the present season in an F₂ family from the cross pure-breeding glabrous single cream ♀ x double-throwing glabrous white ♂ is of considerable interest, for the normal single and fully double condition were here exhibited in the same individual. The cross was made in 1923 and the resulting seeds sown the same autumn. The F₁ plants, which were purple and hoary, flowered in 1924. The seeds from one of these plants were not sown until the spring of 1926, when they yielded 179 hoary and 100 glabrous, of which 214 were single and 58 double. One of the hoary single-flowered plants produced six primary lateral axes in addition to the main axis. The flowers on the main axis were all typical singles, except three. So also were those on the first, second, third, and fifth lateral axes. The three flowers mentioned above on the main axis and those on the fourth lateral branch were uniform and peculiar. The calyx and corolla were normal, but the stamens were represented by petaloid structures. The gynæcium differed from the ordinary siliqua in being either 3- or 4-valved; in many cases it became ruptured in the flowering stage, revealing within a second set of petaloid structures and a second ovary. This intermediate type of flower had not previously been met with in the cultures which have now been carried out for nearly thirty years. The sixth branch produced fully double flowers indistinguishable from those borne by the ordinary double-flowered plant. We thus

have proof that the fully double condition may arise from the normal by a single step. It is therefore possible that the mutation which is here seen in only one branch of a plant may at some time have occurred throughout a whole individual, and so have given rise at one step to the double-flowered type.

Miss W. A. Chesters read a paper on "The Vascular Supply of the Bracts of some Species of *Anemone*."

A detailed study of the vascular system of the bract-node of the species of the *Anemone* shows that in types exhibiting a large leafy involucre the vascular system of the peduncle is dominated by that of the involucre. In species like *A. Hepatica*, in which the involucre closely approximates to a calyx, the incoming bundles take a less prominent part in the formation of the vascular ring of the axis. The resemblance between the course of the bract-bundles of *A. Hepatica* and the sepal bundles of *Ranunculus Ficaria* is very striking.

The vascular supply of the bracts of *Eranthis hyemalis* resembles that of *A. nemorosa* in all essentials, suggesting that the modifications shown in the vascular system of *A. Hepatica* and *A. angulosa* are correlated with the reduction of the involucral leaves rather than with the difference in position.

The vascular anatomy of the bracts and the bract-node of these species of *Anemone* appears to support the view of the homology of the involucre of *A. Hepatica* and the calyx of *Ranunculus Ficaria*.

The President, Dr. A. B. Rendle, gave an account of the International Congress of Plant Sciences (Fourth International Botanical Congress) held at Cornell University, Ithaca, N.Y., U.S.A., from August 16-23 last. Special reference was made to the efficiency of the general organization and of the local arrangements, and to the convenience of a definite centre such as was afforded by the Cornell University. Also to the friendly spirit which pervaded the meeting. Some account was also given of the Western excursion arranged by Dr. George Fuller of Chicago, which followed the meeting. A fuller account of the Congress appeared in the November and December numbers of the *Journal of Botany*.

At the meeting on December 2, Dr. Malte Oscar Malte, Chief Botanist, National Herbarium, Ottawa, and Dr. Theodore George Bentley Osborn, Professor of Botany, University of Adelaide, South Australia, were elected Fellows.

Mr. J. Ramsbottom exhibited a clump of seventeen mushrooms which were joined together at the base of the stem. They had been forwarded by Mr. L. M. Curtis, of Holbeach, Lincolnshire, having been found in a pasture there. A lantern-slide was also shown in which a mushroom bore three other full-grown mushrooms on the cap. The speaker suggested that such abnormalities were of little or no significance.

Mr. Ramsbottom also gave an account of the Society of Amateur Botanists, founded in 1860, which was a development of evening botanical classes and country rambles conducted by the late M. C. Cooke. It was planned for excursions, interchange of specimens, communication of papers, and the establishment of a library, herbarium, and museum. Cooke was the first and only President. Excursions were held on

alternate Saturdays, and meetings on alternate Wednesdays. At one time the Society numbered about fifty, and among the members and those who attended the meetings were James Britten, Thiselton-Dyer, W. W. Newbould, Berthold Seemann, Worthington G. Smith, and Henry Trimen. Some of the papers read at the meetings were published in the *Journal of Botany* or in the ephemeral *Botanists' Chronicle*. The meetings were held first at the Metropolitan Club, Edgware Road, and then over the shop in Piccadilly of Robert Hardwicke, the publisher of natural history works. The foundation of 'Hardwicke's Science Gossip' was described, and the manner in which a letter in the first volume (1865) from W. Gibson, suggesting an association of amateur microscopists, "something on the plan of the Society of Amateur Botanists," led to the formation of the Quekett Microscopical Club. The new club enrolled 155 members in its first year. Excursions were carried out as with the Society of Amateur Botanists, many of whose members joined the new club. The Society languished and may be said to have been killed by the Quekett.

Mr. C. E. Salmon exhibited and commented on "Some interesting British Plants."

Vicia angustifolia Linn. var. *lutescens* Corbière, found on sea-cliffs in Cornwall, was at first thought to be *V. lutea*. Later, pods were seen which were finely pubescent, not coarsely hairy as in *V. lutea*, and also of a different type.

Alchemilla connivens Buser.—This is rather a small plant with decumbent stems, with a very graceful and beautiful habit, and may be known by its very fine and acute leaf-toothing, the deeply-cut and widely-separated lobes of the stem-leaves, and the remarkable shining silky veins on the under surface of the foliage. It grows at high elevations in Scotland and was seen first at Dalnaspidal, Perthshire, at about 2500 ft. elevation. It might be passed over as small *A. acutidens*.

Alchemilla tenuis Buser.—This was found on the Sow of Atholl and at a low elevation near Aviemore. It is a medium-sized slender plant, with rather narrow and acute toothing to the leaves, which are obviously hairy on both sides; the stipules are purple at the base; the stems are decumbent-ascending, the flowers small in sparsely-flowered corymbs. The only British species with which this may be confused is *A. minor* Huds. var. *filiaculis* Buser, but that has larger flowers, the leaf-toothing is different, and it lacks the purple stipules and the feature of heteropody.

Alchemilla Salmoniana Jaquet.—This was discovered in Cumberland at a height of about 2000 ft. The whole plant had a remarkable dark bluish-green tint, the stems were hairy below and glabrous above, with the branches forming a very acute angle with the axis, the leaves were hairy on both sides (more so above), and whilst the earlier petioles were very sparsely hairy, the later ones were strongly so. The flowers were large in small compact corymbs, and the fruiting sepals quite erect. It was recently described in this *Journal* (1926, 280).

Myosotis brevifolia Salmon.—This new species of *Myosotis*, found in marshes in the Cross Fell district, was described and figured in the *Journal of Botany*, 1926, 289, pl. 579.

LINNEAN SOCIETY LIBRARY.—The question of increasing the facilities afforded to the Fellows for consulting the Society's Library has been repeatedly considered. While it has not yet been found practicable to keep the Rooms open during the evening without an increase in the Staff, which the finances of the Society will not at present permit, the announcement recently circulated indicates a distinct improvement. The Library will now remain open from 10 A.M. to 5 P.M. every day throughout the year, except on Sundays, Good Friday and the following Saturday, Christmas Day, and Bank Holidays. Hitherto the Library has been closed on Saturday afternoons, for some days at Christmas and Easter and during the month of August. The new arrangement will not entail any additional expenditure or increase in the times of attendance of individual members of the Staff, but has been made possible by an adjustment of duty. It will be remembered that in recent years separate reading and writing rooms have been provided for the convenience of the Fellows.

THE BOTANIST'S CHRISTMAS.

LET *Ilex Aquifolium* grace the hall,

Brightening the scene with his gay scarlet drupe—
Not berry, please! I've often told you all

None but a chuckle-headed nincompoop
Would so miscall the fruit. Annoying, very,
That people can't distinguish drupe from berry.

The stiff, waved leaves of *Ilex* are supplied
With prickly teeth. You have observed them? Good!

Though true botanic lore you may deride,
I somehow thought it probable you would,
Remember, too, the Aquifoliaceæ

In many ways approach the Celastraceæ.

Now take some *Hedera Helix*, if you please.

His unarmed leaf and tough and pliant stem
Enable you to handle him with ease.

His flowers—no doubt you never noticed them—
Are quite the last a-growing and a-blowing,
Although I own they make but little showing.

And last, hang up the *Viscum album*, too—

A highly interesting parasite.

Beneath its greenish yellow foliage you

Shall kiss the maids, as is most just and right.

A pleasing custom—very early British

Which even makes a botanist feel skittish.

TOUCHSTONE.

(Reproduced by permission from the *Morning Post*, Dec. 21, 1926.)

A LIMITED number of copies of the *Index to "Bibliographical Notes" in the 'Journal of Botany,' 1893-1924*, printed in the October number of the *Journal*, are available for distribution. Application should be made to the Editor, British Museum (Natural History), Cromwell Road, London, S.W. 7.

THE GENUS ARGOSTEMMA.

By H. N. RIDLEY, C.M.G., F.R.S.

THE genus *Argostemma* consists of a large number of small, usually succulent, herbaceous plants of the family Rubiaceæ. They are rarely over a foot tall, and, though mostly erect, are not rarely creeping. The leaves are sometimes in equal pairs, but more commonly one of the pair is reduced to a sessile rounded lamina very much smaller than the full-sized leaf opposite it. The flowers are few and borne on a terminal peduncle, star-like and pure white, except one species (*A. nultans*), which is, especially in bud, flushed with violet. The stamens in one section have the oblong anthers as long as the filaments; in the other, the anthers form a cone, being adnate together, linear, opening by a pore at the top and much longer than the short bent filaments. The capsule is soft, dehiscent at the top, and the seeds appear to be usually dispersed by rainwash.

The plants inhabit the dark forests of India and the Malay region, one only occurring in West Africa, and are usually very conspicuous from their bright, white, starry flowers.

The first species were described by Dr. Wallich, from India, in Roxburgh's *Flora Indica*, ii. 324. All these belonged to a section characteristic of the Indian mountains and scantily descending into the Malay Peninsula. They are distinguished by their few fleshy leaves at the top of a succulent stem, and the stamens free from each other, and with filaments longer in proportion to the oblong anthers than in the other section, while in some species the dehiscence is said to be lateral, not by a terminal pore.

Reinwardt, in *Sylloge Ratisb.* ii. 10 (1828), four years later founded a genus *Pomangium* for the Malay species, which differ from Wallich's type-specimen in having an elongate leafy stem with numerous pairs of leaves scattered over it, and the anthers long and narrowed to the tip, and connate in a cone much longer than the very short filaments, and always opening with a terminal pore.

These plants form the largest part of the genus, and, though almost absent from the Indian region, are numerous in the Malay Peninsula and Archipelago, so far east as the Philippines and New Guinea. It might be advisable to separate these two groups of plants into distinct genera, but, as there are a few species which are intermediate between the two, I retain at present Reinwardt's *Pomangium* for a section of the genus, the typical *Argostemmas* being those of the Indian region.

Distribution. The first section, *Eu-argostemma*, is almost confined to India, with one species in West Africa, and one or two through Burma and Siam to the Malay Peninsula, and one Himalayan one ranges as far as China. There are about 22 species. The second section *Pomangium* contains about 95 known species, of which 80 are confined to the Malay Peninsula, Sumatra, Java, and Borneo; one species reaches India, and a few occur in Siam. Beyond Java to the East they get scarcer and smaller, two (as yet undescribed) are

recorded from Celebes, one from Timor, about eight from New Guinea, and four from the Philippines.

The species, as a rule, are rather local, only one or two being at all widely distributed, which is usually the case in plants which have no great facilities for dispersal.

I have separated some of the species which have formerly been described under *Argostemma*, but which clearly are generically distinct, under the new generic name of *Argostemmella*.

§.1. EU-ARGOSTEMMA.

Leaves usually few, one to four or five at the top of an unbranched succulent stem. Anthers free from each other, not forming a beaked cone, opening by a terminal pore or short slit at the top, except in *A. pumilum* and *Kurzii*, in which the anthers dehisce longitudinally.

Leaf one only developed, the second stipuloid (Heterophyllæ):—

A. humile Benn. Pl. Jav. Rar. 95. Penang.

A. monophyllum Ridl. Khasiya.

A. Kurzii Clarke in Hook. fil. Fl. Br. Ind. ii. 45. Martaban.

Leaves two, equal or subequal (Homophyllæ):—

A. pictum Wall. in Roxb. Fl. Ind. ii. 328. Burma, Malay Peninsula.

A. Korthalsi Miq. Fl. Ind. Bat. ii. 165 (not seen). Java.

A. neurocalyx Miq. Mus. Lugd. Bat. Bot. iv. 229 (not seen). Java.

Leaves more than two developed (Homophyllæ):—

A. sarmentosum Wall. in Roxb. Fl. Ind. ii. 334. N. India.

A. tavoyanum Wall. Benn. Pl. Jav. Rar. 94. Burma.

A. courtallense Arn. in Ann. Nat. Hist. iii. 22. W. & S. India.

A. verticillatum Wall. in Roxb. Fl. Ind. ii. 325. India to Siam, China.

A. khasianum Clarke in Hook. fil. Fl. Br. Ind. iii. 43. N. India.

A. succulentum Ridl. Burma.

A. Parishii Hook. fil. Fl. Br. Ind. iii. 44. Burma.

A. soneriloides Kurz in Journ. As. Soc. Beng. xii. (ii.) 310. Andamans.

A. inæquilaterum Benn. Pl. Jav. Rar. 96 (*A. acuminatum* King in Journ. As. Soc. Beng. xxiii. (2) 143). Malay Peninsula.

A. diversifolium Ridl. in Journ. Roy. As. Soc. Str. Br. Ivii. 52. Malay Peninsula.

A. pumilum Benn. Pl. Jav. Rar. 95. West Africa, India.

A. enerve Ridl. Borneo.

A. inæquale Benn. Sumatra.

Leaves numerous on a slender stem, unequal:—

A. Lobbia Hook. fil. Fl. Br. Ind. ii. 44. Burma.

ARGOSTEMMA HUMILE Bennett, Pl. Jav. Rar. 95.

Herba pusilla 5 cm. alta, *foliis* 1-2-paribus valde inæqualibus, majore lanceolato acuto, basi angustato, subtus pallido, nervis 5-paribus inarcuantibus, 4-5 cm. longo, 1 cm. lato, petiolo brevissimo vel sub-

nullo; folio minore lanceolato sessili 5 mm. longo; *stipulis* ovatis parvis; *pedunculo* gracili 2 cm. longo; *floribus* umbellatis 8 parvis; *pedicellis* 6 mm. longis puberulis; *bracteis* lanceolatis 5 mm. longis; *calyce* parvo campanulato, lobis multo longioribus lanceolatis 2 mm. longis; *corolla* alba lobis lanceolatis acuminatis 6 mm. longis; *staminibus* 4 liberis corollæ brevioribus, filamentis gracilibus; antheris subæquilongis cylindricis superne attenuatis.

Hab. Penang (*W. Jack* in herb. Wall. 8391).

This species, which has never been collected again, is only very incompletely described by Bennett, and has been confused with the Indian *A. monophyllum* Ridl. by Hooker in the *Flora of British India*. As it belongs to the typically Indian section, I should have thought it had been wrongly localised, but with the specimens in Wallich's herbarium is a label believed to be in Jack's handwriting.

Sonerilæ species novissima, foliis lanceolatis. The enclosed are ripe capsules which may probably grow if sown," evidently sent by the collector.

A. monophyllum, sp. nov. *A. humile* Hook. fil. Flor. Brit. Ind. iii. 44 (not of Bennett).

Species parvula, *A. humili* approximata sed folio evoluto singulo, ovato sæpe lato, basi rotundato rarissime angustato.

Herba glabra tubere parvo, *caule* 2-4 cm. alta, *foliis* stipuloideis 1-2-paribus ovatis acutis sessilibus 3-5 mm. longis; folio evoluto uno ovato acuminato, basi rotundato, sessili rarius ovato-lanceolato, nervis indistinctis tenuibus 4- vel 5-paribus, 2-12 cm. longo, 8-40 mm. lato, folio opposito minore ovato acuminato 5 mm. longo; *pedunculo* 1-6 5 cm. longo, crassiusculo vel gracili; *umbella* 3-14-flora; *bracteis* ovatis acutis 5 mm.-1 cm. longis foliaceis, pedicellis 5 mm.-1 cm. longis pubescentibus; *calyce* campanulato, lobis majusculis ovatis acutis; *corolla* 1 cm. lata, lobis lanceolatis acuminatis; *staminibus* liberis corollæ brevioribus, filamentis brevibus; antheris longioribus cylindricis acuminatis obtusis; *stilo* longiore filiforme, stigmate globoso minimo.

Hab. India, Khasiya, 4000 ft. alt. (*Hooker, Griffith*); Assam, North Cachar, Haflong, 2500 feet (*Craib*).

Hooker referred this plant to the *A. humile* Benn., of Penang, from which it seems to me abundantly distinct. In the typical form the large leaf is ovate rounded at the base, but specimens occur with lanceolate leaves somewhat acuminate at base.

A. PICTUM Wall. in Roxb. Fl. Ind. (*Ed. Carey*) ii. 227.

Originally described from Penang plants. It has also been collected in Moulmein by Lobb and in Siam, Gorge below Ban Kaw (*Herr*) (*A. plumbeum* Craib in *Kew Bulletin*, 1916, 263).

A. bifolium, sp. nov.

Species *A. picta* diversa foliis acuminatis, pedicellis longioribus, corollæ lobis angustis acuminatis.

Herba, *caule* brevissimo; *foliis* 2 subinæqualibus sessilibus ovatis acuminatis obtusis glabris, pilis brevibus sparsis superne exceptis,

uno 8 cm. longo, 1 cm. lato, altero 4 cm. longo; *pedunculo* 6 cm. longo; *bracteis* anguste lanceolatis; *pedicellis* gracilibus 8 mm. longis; *floribus* 13; *calyce* campanulato, lobis oblongis obtusis; *corolla* 5 mm. longa lobis lanceolato-linearibus; *staminibus* linearibus conniventibus, in columna elliptica majuscula breviter rostrata; filamentis brevibus.

Hab. Perak, Maxwell's Hill (*Ridley* in *Herb. Kew.*).

This certainly resembles *A. pictum* Wall. in habit, but the leaves are more narrowed to a point, the pedicels longer, and the corolla-lobes are quite narrow and acuminate instead of being short and rounded, and the stamen-column much larger and elliptic. The leaves are quite sessile and rounded at the base, not shortly petiolate as in *A. pictum*.

A. INÆQUILATERUM Benn. Pl. Jav. Rar. 96, collected in Penang, is identical with *A. acuminatum* King, who appears to have overlooked Bennett's description.

A. succulentum, sp. nov.

A. verticillato Hook. fil. affinis, sed multo major, partibus omnino majoribus, foliis æqualibus petiolatis, pedicellis longioribus et crassioribus.

Herba glabra succulenta; *caule* 20 cm. alta; *foliis* 4 terminalibus subverticillatis ovato-lanceolatis acuminatis acutis, basibus cuneatis, nervis 5-paribus, 11 cm. longis, 4 cm. latis; petiolis 1 cm. longis; *stipulis* lanceolatis 3 mm. longis; *pedunculis* 2, validulis, 2 cm. longis; *floribus* 11, subumbellatis; *bracteis* stipuliformibus; *pedicellis* 1 cm. longis; *calyce* campanulato, lobis ovatis-triangularibus acutis 1 mm. longis; *corollæ* lobis ovatis 5 mm. longa; *staminibus* filamentis brevibus; antheris oblongis obtusis liberis.

Hab. Burma, Moulmein (*Parish*, 126), in *Herb. Kew.* Limestone rocks. Whole plant succulent as a balsam.

This plant was referred by Hooker to *A. verticillatum*, but differs in its larger size, its petiolate leaves, all equal in size, and stouter pedicels; the flowers are also much larger.

A. PUMILUM Benn. Pl. Jav. Rar. 95. West Africa, Sierra Leone; Nigeria, Oban (*Talbot*).

To this African species Hooker referred plants collected in Khasiya, and some collected in the Lahore Hills (*Wallich*, 8394 B). I have compared the African and Indian plants carefully, and can see no character by which they can be specifically separated. The Indian plants have more fleshy leaves, and the flowers are smaller, otherwise I see no difference between them. A plant labelled *A. africanum* Schlechter, 15793, differs in its thinner leaves and tall slender cymes with long pedicels. It was collected in the Cameroons, and is probably only a variety of *pumilum*.

A. enerve, sp. nov.

Species nullo ejus sectionis valde affinis, staminibus liberis oblongis obtusis; foliis 2-3-paribus haud verticillatis.

Herba debilis glabra 10 cm. alta, basi breviter repente; *foliis* 4-5 oblongis ovatis vel oblongo-lanceolatis obtusis, basibus subacutis, herbaceis nerviis æqualibus 2-5 cm. latis, petiolis 3 mm. ad 10 mm. longis; *stipulis* ovato-lanceolatis; *pedunculo* gracili 3-4 cm. longo; *floribus* umbellatis 4-5; *bracteis* ovato-lanceolatis 2 mm. longis; *pedicellis* gracilibus 9 mm. longis; *calyce* campanulato, lobis ovatis acutis 1 mm. longis; *corollæ* lobis lanceolato-ovatis acutis 3 mm. longis; *staminibus* 5 corollæ paullo brevioribus liberis, filamentis brevibus complanatis rectis, antheris longioribus oblongis obtusis; *stilo* vix longiore, stigmatate pulviniformi.

Hab. Borneo, Sarawak (Bureau of Science, Manila, 1227, native collector).

This is a weak herb with two or three pairs of leaves, glabrous, the flowers small with separate oblong stamens. In habit it somewhat resembles *A. riparium* Ridl., but it belongs to the *Eu-argostemma* section, with free stamens. The specimens are poor, and there is no locality given nor collector's name.

A. INÆQUALE Benn. Pl. Jav. Rar. i. 94; Miq. Fl. Ind. Bat. ii.

Herba repens debilis, carnosula 6 cm. longa; *foliis* subæqualibus similibus ovatis, basibus rotundatis, nerviis viridibus, fascia albicante in medio paginæ superioris, subtus pallidis, majore 3 cm. longo, 1 cm. lato, minore 2 cm. longo, 1 cm. lato, petiolis 2 mm. longis; *stipulis* parvis obtusis; *pedunculo* gracili 2 cm. longo; *bracteis* minutis lanceolatis; *pedicello* 1 cm. longo puberulo, flore singulo parvo; *calyce* 4 mm. longo, lobis ovatis; *corolla* 6 mm. lata, lobis ovatis; *staminibus* liberis, filamentis brevibus, antheris cylindricis obtusis minute rostratis, corollæ subæquilongis.

Hab. Sumatra (*Horsfield*, *Curtis*).

Miquel, whose figure is apparently a sketch of the type, shows the leaves sessile and with distinct nerves, but in the specimens in *Herb. Mus. Brit.* and at *Kew* the nerves are quite invisible and the petiole is quite distinct. *Curtis*'s specimen is flowerless, but appears to be this. He describes it on the ticket as a very soft dwarf plant generally found in company with *Anæctochilus*. No definite locality for the plant is given by either collector, and it has not been rediscovered.

§ 2. POMANGIUM Reinwardt.

(Syll. Pl. Nov. Soc. Bot. Ratisbon, ii. 10 (1828) as genus.)

This section is characteristic by its cone of stamens, the anthers connate and the ending in a beak opening by a terminal pore, the filaments very short and curved, rarely connate.

This group appears to be quite absent from the Indian region. Species occur in Siam, Annam, and Hainan. They are abundant in the Malay Peninsula and islands to New Guinea and the Philippines, and are about 100 in number. Some of the species have been very inadequately described by Miquel and others. The old descriptions by Bennett in Pl. Jav. Rar. are very incomplete; but, fortunately, the types are in the Natural History Museum. Where the descrip-

tions are insufficient and I have seen types, I have added descriptions of these. Most of the species have, however, been very fairly well described, and it is unnecessary to redescribe them.

The section is best separated by the foliage. In one subsection the leaves are in pairs equal in size or nearly so, distinctly petiolate and similar in shape (*Homophyllæ*). In the other the alternate leaf in each pair is reduced to a stipule-like ovate or lanceolate sessile organ (*Heterophyllæ*). I have not been able to find in the large series of living or dried specimens which I have seen any intermediate stage between the fully developed petiolate leaf and the stipuliform sessile leaf, though it is not uncommon to find in a homophyllous species that the alternate leaves are distinctly smaller, sometimes but half the size of the others opposite to them; but in such cases the smaller leaf is of the same shape as the larger one, and is distinctly petiolate. In one species, *A. borragineum* Bl., common in Java and Sumatra, which has typically homophyllous foliage, I found a number of plants from one locality in Sumatra, all of which were identical in other respects with the common form, but were heterophyllous. In some cases also we have two species very closely allied and very similar in most respects to each other, but one is homophyllous and the other heterophyllous—such are *A. montanum* Bl. of Java, homophyllous, and *A. leve* Benn. (*A. macrosepalum* Miq.) of Sumatra, which is heterophyllous.

It is so convenient for the purposes of identification and arrangement to keep the species sorted into these two sections that I continue to do so in this paper.

The heterophyllous species are the most abundant, especially in the Malay Peninsula, where the forests are most dense and dark.

I give below descriptions and notes on little-known species of this section.

Section 2. POMANGIUM. Stamens connate in a cone.

1. Verticillatæ. Leaves few, in a terminal whorl, subequal or equal.

A. rostratum Wall. in Roxb. Fl. Ind. ii. 327. India.
A. stellatum Craib in Kew Bull. 1911, 387. Siam.
A. Neesianum Walp. in Ann. Act. Acad. Nat. Cur. xix. 349. Philippines.
A. timorense Benn. Pl. Jav. Rar. 95. Timor.

2. Eupomangieæ. Leaves scattered on the stem, numerous. Cochinchina, Hainan, Malay region to Philippines and Papua.

A. Homophyllæ. Leaves equal in the pairs. Species numerous.
 B. Heterophyllæ. Leaves unequal, one of each pair sessile, dissimilar, stipuliform.

1. Monophylleæ. Succulent tuberous herbs with one large ovate or lanceolate leaf, the other small stipuliform.

A. unifolium Benn. Pl. Jav. Rar. 94. Malay Peninsula.
A. unifolioides King in Journ. As. Soc. Beng. lxxii (2) 148. Malay Peninsula.

A. tenue Ridl. in Journ. F.M.S. Mus. vi. 39. Malay Peninsula.

A. begoniaceum Miq. in Fl. Ind. Bat. ii. 348. Java. (I have not seen this, and it is not perfectly described.)

2. Polyphyllæ. Leaves numerous, scattered. Species numerous.

A. Homophyllæ.

A. MONTANUM Bl. in DC. Prod. iv. 418; Benn. Pl. Jav. Rar. 92, 192.

Herba erecta, 20 cm. alta, caule hirta; foliis subæqualibus ovatis breviter acuminatis basibus rotundatis vel breviter attenuatis superne sparse hirtis, subtus pallidioribus nervis subtus elevatis 5-paribus hirtis; petiolis 1-2 cm. longis, gracilibus hirtis; stipulis oblongo-ovatis 4 mm. longis; floribus majusculis 3-5 vel pluribus; pedunculo pubro, 2 cm. longo; bracteis ovatis ad basin vel ad dimidium; pedicellis 5 mm. longis hirtis, bracteolis parvis linearibus; calyce campanulato longe hirta, lobis latis ovatis; corollæ lobis 1 cm. longis lanceolatis acuminatis; staminum columna brevior, antheris oblongis dilatis abrupte rostro terminatis; capsula hirta campanulata lobis ovatis.

Hab. Java (*Lobb*), Banyumas (*Horsfield*).

var. *minor*, var. nov. Planta minor 28 cm. alta; sepalis acutioribus.

Hab. Sumatra, Gunong Merapi (*Bunne Meyer*, 4869); Korinchi, Atola dras (*Robinson*).

ARGOSTEMMA STELLARE, nom. nov. *A. stellatum* Ridl. in Journ. Mul. Br. Roy. As. Soc. 67 (not of Craib).

Hab. Sumatra, Berastagi (*Ridley*, *Holtum*); Sibolga langit by the Potani river, Berastagi (*Larzing*).

This species is allied to *A. montanum* Bl., but differs in the lanceolate narrower leaves, quite glabrous, and pustulate beneath with very faint nerves. The stipules are large and ovate. Flowers large and showy. Calyx hairy with lanceolate subacute lobes. Corolla 2.2 cm. across, the lobes ovate-lanceolate with several nerves. Stamens with oblong anthers gradually, not abruptly, tapering into the beak.

A. PEDUNCULOSUM Miq. Fl. Ind. Bat. ii. 349. I have seen no specimen of this plant, which was collected near Tobah in Salindong, Sumatra, by Junghuhn. This is, I presume, Lake Tobah, which is at no great distance from Berastagi. The description differs from that of *A. stellare* in the short petioles, obovate or subobovate elliptic veinless leaves, one or two inches long, and corolla-lobes broadly ovate. Miquel, however, says it is near *A. subinæquale*.

A. FULVUM Zoll. & Mor. Verzeich. 1845, 61.

Herba caule valido succulento hirta; foliis æqualibus lanceolato-oblongis obtuse acuminatis basibus attenuatis superne glabris, subtus nervis 13-paribus elevatis cum reticulationibus hirtis 6 cm. longis 1.4 cm. latis; petiolis crassis 4 mm. longis; stipulis ovatis acutis 4 mm. longis; pedunculo hirta 3 cm. longo; bracteis 2 anguste linearibus 4 mm. longis, 2 latis; ramis 2 trifloris; bracteolis ovatis;

pedicellis 1 cm. longis, in fructu 1.5 cm. longis; *calyce* obovato hirto, lobis ovatis acutis; *corollæ* lobis lanceolatis acuminatis 1 cm. longis, 3 mm. latis; *staminum* filamentis longiusculis corollæ lobis multo brevioribus.

Hab. Java (*De Vriese*). In sylvis primævis prope Gunong Bonkak (*Zoll.*, 1902).

A single specimen from De Vriese in Herb. Kew. Very distinct from *A. montanum* in the oblong leaves on very short petioles, branched inflorescence of 2 three-flowered cymes, longer filaments, and elliptic anthers; this I suppose to be Zollinger's *A. fulvum*, as, though the leaves are hardly subverticillate as he describes them, they are distinctly oblong acute narrowed at the base, and more hairy in typical *A. montanum*.

A. BORRAGINEUM Bl. in DC. Prodr. iv. 417. *A. javanicum* Warb. lt. Coburg. i. 117, t. 39 D.

Herba hirta 2 vel 3 cm. ad 30 cm. alta; *foliis* ovatis vel oblongis æqualibus, basibus angustatis superne sparse hirsutis, costa hirsutiore subtus glabrescentibus, costa nervisque 7-paribus hirsutis 5-10 cm. longis, 2-3.5 cm. latis; *petiolis* 5 mm. to 6 cm. longis dense pubescentibus; *stipulis* oblongis ovatis 3-5 mm. longis; *pedunculo* 1-2.5 cm. longo hirto; *ramis* 1-2 bracteis lanceolatis acutis minutis; *floribus* 2-10; *pedicellis* hirtis 5 mm. ad 1.5 mm. in fructu; *calyce* hirto obconico, lobis ovatis acutis; *corollæ* lobis lanceolatis acuminatis 5 mm. longis; *staminibus* connatis attenuatis brevioribus; *capsula* campanulata 4-5 mm. longa hirtula.

Hab. Java (*Horsfield*) (*Zollinger*, 1810). Chibandong, Kosala Bantam at 1700 feet, large form 30 cm. tall (*Forbes*, 425); Preanger, Puchak-chaching at 5000 ft. (*Forbes*, 1047a); Mt. Gede, terrestrial and epiphytic; Papandayan Woods (dwarf forms) and Mt. Salak (tall form) (*Ridley*); Preanger (*Koorders*); Woods of Tankuban-prau (*Warburg*).

The plant varies very much in size from 6 to 30 cm. tall. The biggest specimen I have seen is in Horsfield's collection. This has also much larger leaves than the small forms, and with longer petioles. The flowers are about the same size in all. In the small forms there is a tendency to reduction in the size of one leaf in each pair, but they are always similar in shape and petioled.

var. *padangense*, var. nov.

Herba 15 cm. alta ramosa; *foliis* ovatis æqualibus vel subinæqualibus, omnibus ovatis petiolatis; *floribus* plantæ typicæ sed lobis corollæ brevioribus ovato-lanceolatis acutis; *capsulis* majoribus 5 mm. longis et latis.

Hab. Sumatra, Padang, Mount Singalan (*Beccari*, 36); Merapi at 1100 metres (*Bunnemeyer*, 4869).

The dwarf forms of the Javanese plant occasionally show an inequality of the leaves, but in them and the var. *padangense* both leaves are similar and pedicelled, the larger size of the capsule and shorter and broader corolla-lobes, however, distinguish this local variety.

var. *breviflorum*, var. nov.

Herba var. *padangensi* similis, sed lobis corollæ brevibus 3 mm. longis, subobtusis, *capsulis* parvis ut in forma *javanica*.

Hab. Sumatra, Berastagi (*Ridley*).

var. *heterophyllum*, var. nov.

Habit of *A. borragineum* Bl., the small form, but the leaves are unequal.

Herba 15 cm. alta; *foliis* majoribus ovatis vel oblongo-oblanco-ellipticis basibus angustatis paullo inæqualibus, nervis 7 paribus subtus ovatis hirtis, superne costa hirta excepta glabris, 3 cm. longis 1.5 cm. latis; *petiolis* 2 mm. longis; *foliis* minoribus oblongis 5 mm. longis ovatis; *stipulis* similibus; *cymis* 5-6-floris; *pedunculo* 1 cm. longo; *pedicellis* 3 mm. longis hirtis; *calycis* lobis lanceolatis hirsutis; *corollæ* lobis late lanceolatis acuminatis 5 mm. longis; *staminibus* ut in *A. borragineo*.

Hab. Sumatra, Korinchi, Barong baru no. 3; Tapan (*Robinson* and *Kloss* in Herb. Mus. Brit.).

This is exactly like the dwarf form of *A. borragineum* from Gede and Papandayan, but with one of each pair of leaves stipuloid.

A. nutans King, var. *borneense*, var. nov.

Herba, caule rugoso; *foliis* oblongo-ellipticis apicibus rotundatis superne dense pustulatis, subtus dense breviter hirtis, nervis utrinque ovatis hirtisque 9-10-paribus; 8 cm. longis, 4 cm. latis; *petiolis* subrectis 3 cm. longis; *stipulis* triangularibus acutis 5 mm. longis glabris; *pedunculis* 3.5-5 cm. longis; *cymis* umbellatis multifloris 1 cm. longis et latis hirtis; *floribus* ut in typo.

Hab. Borneo, Gunong Temabok, 7000 feet alt. (*Moulton*, 6653, in Herb. Kew.).

In some respects this suggests a form of *A. borragineum* Bl., but it seems more closely allied to *A. nutans* King of the Malay Peninsula.

A. multinervium, sp. nov.

Species *A. corymboso* Ridl. affinis sed foliis lanceolatis basi attenuatis, pedicellis brevioribus, floribus minoribus.

Herba, caule erecto 15 cm. alto vel elatiore, deciduo hirto ad basin, superne hirto; *foliis* æqualibus elliptico-latis acuminatis basibus pedicellatis attenuatis sæpe inæquilateris, nervis 15 paribus subtus hirtis, superne sparse hirtis, subtus dense hirtis, vel glabrescentibus, 10-15 cm. longis, 4-5 cm. latis; *petiolis* gracilibus 3 cm. longis; *stipulis* oblongis truncatis, vel cum cuspe parvo, glabrescentibus; *petiolis* hirtis 5 mm. longis; *pedunculo* 6 cm. longo hirto; *bracteis* oblongo-lanceolatis cuspidatis deflexis; *floribus* plurimis in cymis 2 congestis, racemosis; *pedicellis* 5 mm. longis dense hirtis; *calyce* campanulato 3 mm. longo, lobis parvis ovato-triangularibus subtus dense hirtis; *corollæ* lobis extus hirtis lanceolatis; *staminum* filamentis incrassata lageniformi; *stilo* longiore, stigmatibus globosis.

Hab. Sumatra, Gunong Sibayak, Bandar baru (*Nur*, 7312); Berastagi (*E. M. Burkill*).

This is undoubtedly near *A. corymbosum* Ridl., but has lanceolate leaves long-narrowed at base, shorter pedicels, and smaller flowers. It differs mainly from *A. Teysmannianum* in its numerous nerves and its flowers not simply umbellate.

A. riparium, sp. nov.

Species nullo affinis; foliis iis *A. oblongi* King similibus sed æqualibus, ubi *A. nutante* King differt petiolis multo longioribus, foliis subtus pallidis.

Herba repens ascendens 15 cm. alta, *caule* glabro succulento; *foliis* æqualibus oblongo-ovatis subacutis basibus rotundatis vel brevissime attenuatis membranaceis subtus glaucescentibus, nervis 4-paribus cum costa subtus hirtulis 4-6 cm. longis 2-3-5 cm. latis; petiolis 1 cm. longis hirtulis; *stipulis* oblongis glabris; *pedunculo* 3-5 cm. longo, pubescente; *bracteis* lineari-lanceolatis 2 mm. longis; *pedicellis* (in fructu) 7-12, umbellatis hirtis 1-2 cm. longis; *calyce* campanulato hirtio lobis triangulari-ovatis acutis brevibus; *corolla* *staminibus* que non visis; *capsula* 3 mm. longa campanulata hirta.

Hab. Sumatra, Siak, banks of the Sungai Kelantan (Ridley, 8966, in Herb. Kew.).

This has the foliage and general habit of *A. oblongum* King, but the leaves are similar in size and shape.

A. SUBINÆQUALE Benn. Pl. Jav. Rar. 95; Miq. Fl. Ind. Bat. ii. pl. xxxi. 13.

Herba, *caule* 18-30 cm. alto, basi tubere parvo globoso; *foliis* subæqualibus similibus omnibus petiolatis, ad basin caulis delapsis ovato-ellipticis vel ovatis, superne glabris vel sparse hirtis, subtus nervis 12-paribus hirsutioribus, majoribus 5-11 cm. longis, 3-5 cm. latis, cum petiolis 2 cm. longis; minoribus 3 cm. longis, 2 cm. latis cum petiolis brevioribus; *stipulis* ovatis; *pedunculo* 2 cm. longo, in fructu 4 cm. longo glabro; *pedicellis* ad 5. cum calyce hirsutis; *calycis* lobis parvis ovatis tubo æquilongis; *corollæ* lobis lanceolatis acutis 1.5 cm. longis; *staminum* columna ad basin dilatata, superne angustata lageniformi, *corollæ* brevioris.

Hab. Sumatra (*Horsfield* in Herb. Mus. Brit.).

The leaves of this above are nearly equal in size. The plant has been very incompletely described, and appears to be rare, as it has not been collected again.

A. TEYSMANNIANUM Miq. Fl. Ind. Bat. ii. 349.

Herba erecta subglabra 15-30 cm. alta, superne hirta; *foliis* tenuibus oblanceolato-oblongis vel late lanceolatis subacutis vel obtusis, subtus pallidis, basibus acuminatis subæqualibus, nervis 7-paribus subtus hirtis; foliis vetustis glabris, 10 cm. longis, 4-5 cm. latis; petiolis 4-6 cm. longis; *stipulis* oblongis denticulatis marginibus hirtis mox glabris 5 mm. longis; *pedunculo* 2-6 cm. longo, hirtio; *bracteis* oblongis obtusis marginibus hirtis; *pedicellis* hirtis 1-2 cm. longis; *floribus* 7-8 umbellatis; *calyce* brevi campanulato hirtio, lobis ovatis hirtis (maturis glabris); *corollæ* lobis extus hirtis

1 mm. longis late lanceolatis acuminatis; staminibus antheris oblongis breviter rostratis.

Hab. Sumatra, Padang district, Gunong Talang, Laras Talang. (*Wimmer*, 5258); Lubu Alang (*Teymann*).

I conclude this is the plant Miquel described, as it agrees pretty well with his description of *Teymann's* plant, which, however, was very incomplete. It is so named also by Bakhuisen.

A. Hullettii, sp. nov.

Species *A. Teysmanniano* Miq. affinis, foliis lanceolatis floribus minoribus differt.

Herba glabra vel parce hirsuta ascendens 15-20 cm. alta; *foliis* æqualibus lanceolatis vel ellipticis acuminatis vel cuspidatis basi paulatim attenuatis; nervis 8-paribus vix elevatis, 10-11 cm. longis, 1-1.5 cm. latis; petiolis 2 cm. longis; *stipulis* lineari-lanceolatis 1 cm. longis; *pedunculo* gracili 2 cm. longo; *floribus* ad 14 deflexis hirtis; *pedicellis* 4 mm. longis pubescentibus; *alabastris* acuminatis; *calycis* lobis ovatis acutis brevibus; *corolla* 4 mm. longa lobis lanceolatis acutis; *staminibus* connatis in andrœcio cylindricis, brevioribus.

Hab. Sarawak, Matang, 2000 feet alt. (*Hullett*, *Haviland*).

This is distinct in its pendent flowers and broad equal leaves. A plant from the Lawas River, collected by Burbidge, which is more condensed, with shorter petioles, very inconspicuous nerves, and peduncle 5 cm. long, seems to be a form of it.

A. velutinum, sp. nov.

Species *A. muscicola* Ridl. affinis sed majore, foliis latioribus hirtioribus floribus pluribus minoribus.

Herba reptans 11 cm. longa, dense velutina; *foliis* in paribus æqualibus herbaceis lanceolatis acute acuminatis subtus papillois; nervis 8-paribus subtus dense pilis multo-cellularibus tectis, sparsius superne et subtus pilosis 4-6 cm. longis 1-2.5 cm. latis; petiolis 1 cm. longis pilosis; *stipulis* oblongis obtusis glabris 2 mm. longis; *pedunculis* gracilibus erectis pubescentibus 2 in axillis superne 3 cm. longis, in fructu 5 cm. longis; *bracteis* 2 vel 3 linearibus curvis vel patentibus glabrescentibus 2-5 mm. longis; ramis 1 vel 2; *cymis* trifloris; *bracteolis* linearibus perparvis; *pedicellis* 3 mm. longis; *calyce* campanulato pubescente 3 mm. longo, lobis ovato-lanceolatis apiculatis; *corollæ* tubo brevissimo, lobis lanceolatis acuminatis extus pubescentibus; *staminibus* antheris connatis acuminatis paulo brevioribus, filamentis brevissimis; *capsulis* campanulatis pubescentibus 5 mm. longis; *pedicellis* 1 cm. longis.

Hab. Borneo, Sarawak, Serapi, 2800 feet alt. (*Haviland*, 684); Matang (Ridley, 12304); Mount Marus, Upper Baram on rocks (*Moulton*, 165); Herb. Kew.

The leaves are in life velvety deep green. This is most nearly allied to *A. muscicola* Ridl., but has much broader leaves, and the whole plant is more hairy: the flowers are also smaller.

A. parvulum, sp. nov.

Species *musnicolæ* Ridl. affinis, sed glabra foliis distincte petiolatis, floribus minoribus.

Herba parva 5 cm. alta, puberula; *foliis* æqualibus lanceolatis basi cuneatis glabris; *nervis* 5-paribus tenuibus inconspicuis, 3 cm. longis, 1.5 mm. latis; *petiolis* gracilibus 3 mm. longis; *stipulis* linearibus-oblongis obtusis 3 mm. longis; *pedunculo* gracili 1 cm. longo; *bracteis* lanceolatis brevibus; *pedicellis* 3 gracilibus 5 mm. longis; *calyce* brevi-campanulato, lobis ovatis; *corolla* 1 cm. lata, lobis lanceolatis acuminatis angustis; *staminibus* connatis, antheris oblongis rostratis, corollæ brevioribus.

Hab. Borneo, Sarawak, Upper Baram, at 5000 feet (*Moulton*, 6726).

A very small species allied to *A. musnicola* and *A. bryophilum* Val. of New Guinea. The specimen is a poor one, but it seems to be distinct from anything I have seen.

A. Moultonii, sp. nov.

Species parva reptans, foliis ovatis cordatis æqualibus, floribus parvis, nullo affinis.

Herba reptans ascendens 10 cm. longa velutina; *foliis* in paribus remotis æqualibus velutinis ovatis subacutis vel obtusis, basi cordatis vel rotundatis; *nervis* 7-paribus subtus latis, pubescentibus, 2 cm. longis atque latis; *petiolis* .5-1 cm. longis velutinis; *stipulis* oblongis obtusis 5 mm. longis; *pedunculo* gracili 3-6.5 cm. longo puberulo; *floribus* 3-5 parvis umbellatis; *bracteis* ovatis 3 mm. longis; *pedicellis* 5 mm. longis pubescentibus; *calyce* campanulato pubescente, lobis ovatis tubo ferme æquantibus, 3 mm. longis; *corollæ* lobis anguste lanceolatis, 5 mm. longis; *staminibus* in cono lanceolato connatis ferme petalis æquilongis.

Hab. Borneo, Upper Baram, Gunong Semapok, at 3000-4000 feet alt. (*Moulton*, 6695, 6999, in Herb. Kew.).

var. *hirta*, var. nov. Foliis majoribus 3 cm. longis 2.5 cm. latis in utraque pagina dense hirtis, pedunculo et calyce hirtis. Same locality (*Moulton*, 6654, in Herb. Kew.).

This does not seem to be clearly allied to any species, except perhaps *A. velutinum* Ridl., but its rounded cordate velvety leaves are very distinct.

B. Heterophyllæ.

A. LANCEOLARIUM, comb. nov. *A. lanceolatum* Val. Ic. Bogor, t. 388, not of Ridley.

This is well described and figured in Valetton's plate. It occurs in Borneo, at Kuching in Sarawak, and on the road from Kuching to Matang in thick forest (*Ridley*, 16329), and was collected originally by Teysmann in West Borneo and at Mt. Damus by Hallier. It is remarkably woody for the genus, and the short white corolla-lobes are reflexed. It is nearly allied to *A. ophirense* Maing., which has a very much larger corymb of much larger flowers. *A. ophirense*

Maing., occurs in Borneo at Penkulu Ampat, Sarawak River (*Haviland*, 84), apparently quite identical with the Mount Ophir plant.

A. LONGIFOLIUM Benn. Pl. Jav. Rar. 97.

This appears to be absolutely identical with *A. spinulosum* (H. Clarke), which is abundant in the mountains of Selangor and Perak. Clarke's type-specimen is labelled "Singapore, Lobb," and is rather smaller than the common form in all parts. Being a mountain-plant it could not have been collected in Singapore, but possibly came from Penang. Bennett's type of *A. longifolium* was collected in Sumatra by Horsfield, and is in Herb. Mus. Brit.

A. squalens, sp. nov.

Herba *A. ophirense* affinis, sed hirta et foliis dense scabridis, nervis plurioribus.

Herba 30 cm. alta, caule hirta; *foliis* pluribus inæqualibus majoribus oblongo-lanceolatis acutis basi angustatis subobtusis nervis inæquilateris superne dense pustulatis costa et nervis elevatis subtus pallidis pustulatis; *nervis* 12-13-paribus elevatis cum costa approxime hirtis, 6-10 cm. longis, 2 cm. latis; *petiolis* 3 mm. longis minoribus; *foliis* minoribus ovatis sessilibus pustulatis 5 mm. longis; *stipulis* lanceolatis-ovatis acutis 5 mm. longis; *pedunculis* 2 in axillis supremis 4 cm. longis; *bracteis* 2, in medio lanceolatis acuminatis; *floribus* paucis 2; *pedicellis* 1 cm. longis; *bracteolis* 1 mm. longis anguste linearibus acuminatis; *calyce* obovoideo lobis parvis dentiformibus; *corolla* et *staminibus* non visis.

Hab. Sumatra, Padang, Ayer Mancior at 360 metres alt. (*Becardi*, 608, in Herb. Kew.).

This is allied to *A. ophirense* Maing., but is hairy with closely approximated hairs, more numerous nerves, and the leaves densely scabrid with minute pustules.

A. SARAWAKENSE W. W. Sm. in Notes Roy. Bot. Gard. Edin. vol. 318 (1915).

The description and specimens quoted for this species by the author seem to me to cover two species. Haviland's Sarawak plants No. 1613, 2953, and Haviland and Hose 3408, form the type of *A. Havilandii* Ridl., which antedates Smith's species by three years.

The specimen Haviland No. 689, the first number quoted by Smith, however, seems to me to be quite distinct specifically, though undoubtedly closely allied; for this plant I propose the name *A. psychotroides*. It differs from *A. Havilandii* in the very much larger leaves which are usually not white beneath, the larger flowers on a much larger and stouter head, and the accrescent calyx-lobes, which are deflected in fruit over the calyx-tube and nearly quite cover it. The slender woody stem covered with a pale bark, so characteristic of *A. Havilandii*, is represented in *A. psychotroides* by a stout stem covered by a smooth black bark. The curious paleaceous fibres in the mouth of the capsule appear to be the same in both.

A. psychotroides, sp. nov.

Species *A. Havilandii* Ridl. proxima, sed major, foliis late lanceolatis, floribus majoribus.

Suffruticosa, caule lignoso valido erecto superne puberulo cortice nigricante 30 cm. alto; *foliis* inæqualibus pluribus; majoribus lanceolatis acuminatis basibus attenuatis subtus pallidis superne glabris, costa nervisque 10-11-paribus crassiusculis subtus hirtis 10-13 cm. longis, 3.5-4 cm. latis; petiolis 4-5 mm. longis puberulis; foliis minoribus oblongo-ovatis latis, 8 mm. longis; *stipulis* lanceolatis cuspidato-acuminatis 6 mm. longis; *cymis* corymbosis, ramis crassis 2 ad 4 multifloris 4 cm. longis, 3 cm. latis, pubescentibus; *pedicellis* in racemis 1 cm. longis pubescentibus; *bracteis* linearibus vel lanceolatis acutis; *calyce* pubescente, lobis ovatis rotundatis deflexis 3 mm. longis, 2 mm. latis; *corollæ* lobis lanceolatis acuminatis minoribus; *staminibus* conniventibus in cono ovoideo obtuso vix rostrato, corollæ brevioribus; *stigmatibus* globosis; *capsula* campanulata 4 mm. longa, lobis 4 mm. longis, 3 mm. latis, patentibus reflexis rotundatis.

Hab. Borneo (*Lobb, Lowe*); Sarawak, Kuching (*Haviland, 668, 689, 2960*); Herb. Kew.

A. LÆVIGATUM Benn. Pl. Jav. Rar. 96.

Herba succulenta, parce ramosa caule breviter dense hirta, pilis ascendentibus adpressis 8-12 cm. longa; *foliis* inæqualibus carnosissimis, majoribus lineari-oblongis paulo adversus apicem angustatis, basibus inæquilateris rotundatis glabris et lævibus pilis paucis in apice et costa exceptis, nervis valde inconspicuis 5-paribus, 5 cm. longis, 1.5 cm. latis, petiolis 2 mm. longis hirtis; foliis minoribus sessilibus ovatis acutis sessilibus ferme 5 mm. longis; *stipulis* similibus; *pedunculis* 2 cm. longis glabris; *bracteis* lanceolatis subacutis; *floribus* 1-2; *pedicellis* hirtis; *calyce* campanulato ovatis 2 mm. longis; *corollæ* lobis lanceolatis 1 cm. longis, 2 mm. latis; *staminibus* connatis gradatim attenuatis; *capsula* 5 mm. longa et lata hirta, lobis ovatis acutis pedicello 1 cm. longo.

Hab. Java, Mount Karang (*Horsfield* in Herb. Mus. Brit.).

This plant, remarkable for the rough adpressed hairs on the stem, has not been met with again, nor ever adequately described.

A. invalidum, sp. nov.

Species *A. unifloro* Bl. affinis at debilis foliis tenuibus lanceolatis basibus inæquilateribus floribus majoribus, lobis corollæ lanceolatis.

Herba debilis ascendens; caule hirta; *foliis* inæqualibus majoribus membranaceis lanceolatis acuminatis, basibus obtusis inæquilateris glabris, costa subtus excepta hirtula, 5.5 cm. longis, 2 cm. latis; nervis tenuibus 9-paribus; petiolis 3-5 mm. longis; foliis minoribus ovatis acutis 5 mm. longis; *stipulis* similibus minoribus; *pedunculo* 1.5 cm. longo, glabro; *pedicellis* 2-3 hirtis 7 mm. longis; *calyce* campanulato hirta, lobis brevibus ovatis cuspidatis; *corolla* 1 cm. lata lobis lanceolatis acuminatis cuspidatis; *staminum* columna cylindrica acuminata æquilonga vel longiore.

Hab. Sumatra, Melintang at 1200 metres (*Bünnemeyer, 4310*); Nibolungit, Bukit Pasang (*Nur, Burkill, 7244* in part.); Herb. Kew.

Undoubtedly allied to *A. uniflorum* Bl., to which it has been attributed by the Dutch botanists, but a much weaker plant with thin lanceolate leaves, larger and unequal at base, and two or three flowers which are larger and with longer lanceolate corolla-lobes.

A. uniflorum is confined to Java.

A. longistipula, sp. nov.

Species *A. elatostemmati* Hook. fil. affinis, sed foliis lanceolatis acutis.

Erutex, caule validulo lignoso simplici vel ramoso 16 cm. alto repente; *foliis* inæqualibus pluribus lanceolatis acuminatis versus basem angustatis, marginibus minute serrulatis, basibus inæquilateris, nervis 12-paribus subtus cum nervulis elevatis hirtis, superne subglabris vel pilis paucis longis in costa nervisque munitis, 6 cm. longis, 1.5-2 cm. latis; petiolis 2 mm. longis; foliis minoribus ovato-lanceolatis, vel lanceolatis acutis, marginibus hirtis 1 cm. longis; *stipulis* lanceolatis acutis marginibus hirtis 1.5 cm. longis, 4 mm. latis; *floribus* 2 vel 3 in pedicellis hirtis 1.5 cm. longis, in fructu 1 cm. longis; *pedunculo* 1.5-2 cm. longo, hirta; *bracteis* linearibus acuminatis 2 mm. longis; *calyce* campanulato, lobis angustissimis linearibus; *corollæ* lobis linearibus-lanceolatis acuminatis angustis 1 cm. longis; *staminum* columna elongata cylindrica acuminata, corollæ ferme æquilonga; *capsula* obovoidea 5 mm. longa scabrida-hirta.

Hab. Forests, Johor, Ulu Madik near Gunong Belumut (*Holttum, 10057*); Negri Sembilan, Gunong Angsi (*Winkler 1775, Nur 11680*).

Allied to *A. elatostemma*, but the leaves are lanceolate acuminate, the stipules large and lanceolate, the calyx-lobes longer and acute, the corolla-lobe longer and narrower.

A. Motleyi, sp. nov.

Species *A. elatostemmati* Hook. fil. affinis foliis tenuioribus glabris nervis subtus elevatis, flore singulo.

Herba repens 20 cm. longa caule hirta; *foliis* inæqualibus in paribus remotis, majoribus oblongo-ovatis obtusis, basibus inæqualiter lobis glabris subtus pallidis, nervis tenuibus 4-paribus inter se approximatis; 2.3-2.6 cm. longis, 1.5 cm. latis; petiolis 5 mm. longis hirtis; foliis minoribus ovatis acutis sessilibus 5 mm. longis; *stipulis* similibus minoribus; *pedunculo* hirta unifloro 1 cm. longo; *bracteis* lanceolatis parvis; *pedicello* hirta 1 cm. longo; *calyce* parvo hirta, lobis ovatis obtusis 2 mm. longis; *corollæ* 5 mm. longæ lobis late lanceolatis sub acutis hirtis; *staminibus* subæquilongis.

Hab. Borneo, Bangarmassing (*Motley, 1174*, in Herb. Kew.).

A. densifolium, sp. nov.

Species *A. nervoso* Ridl. affinis, sed foliis multo minoribus nec nervosis, floribus multo minoribus.

Herba, caula ascendente 8-10 cm. alta pubescente hirta; *foliis* approximatis inæqualibus majoribus oblongo-lanceolatis, basibus rotundatis inæquilatoris, superne glabris nervis 15-paribus pubescentehirtis subtus, 5.5 cm. longis, 1.75 cm. latis; petiolis 3 mm. longis hirtis; *foliis* minoribus oblongo-ovatis glabris; *stipulis* ovatis 3-5 mm. longis; *pedunculo* 2 cm. longo glabro; *bracteis* lanceolatis acutis 5 mm. longis glabris; *cymis* 3 patentibus; *pedicellis* gracilibus 5 mm. longis; *calyce* brevi, lobis angustis lanceolatis; *corolla* 1.2 cm. lata, lobis anguste lanceolatis acuminatis; *staminibus* paullo longioribus obtuse acuminatis.

Hab. Borneo, Sarawak at Puak (*Ridley*, 12448, in Herb. Kew.).

var. *latifolia*, var. nov. *Foliis* dense congestis latioribus 11 cm. longis, 3.5 cm. latis, oblanceolatis; capsulis 3 mm. longis infundibuliformibus lobis brevibus acutis.

Hab. Borneo, British North Borneo, Bongaya (*Ridley*).

This I take to be a form of the preceding species with larger and denser foliage. The general structure of the leaves is the same, the nervation quite similar, the nerves and secondary nervules being quite prominent beneath.

The species seems to be of the affinity of *A. elatostemma* and its allies, but is more erect with more crowded leaves.

A. annamiticum, sp. nov.

Species *A. involucrato* Hemsl. affinis, sepalis brevibus distincta.

Herba repens ascendens 15 cm. alta; *foliis* inæqualibus, majoribus oblongo-lanceolatis breviter acuminatis vel acutis basibus attenuatis subinæquilatoris superne sparse hirtis subtus dense molliter hirtis, nervis gracilibus 10 paribus 4-6 cm. longis, 1.5-2 cm. latis; petiolis 5 mm. longis hirtis; *foliis* minoribus ovatis sessilibus 5 mm. longis; *pedunculis* pallide hirtis 1.5 cm. longis raro ramosis; *floribus* 5-7; *pedicellis* 5 mm. longis pallide hirtis; *bracteis* parvis hirtis; *calyce* hirtio lobis parvis lineari-oblongis; *corollæ* lobis lanceolatis acuminatis obtusis 5 mm. longis; *staminibus* connatis, cylindricis petala superantibus; *capsula* campanulata 4 mm. lata, lobis ovatis hirtis.

Hab. Annam, Dalat, Langbian (*Kloss*). White, stamens yellow. Near *A. involucrato* Hemsl., but the calyx-lobes are short.

A. hirtellum, sp. nov.

Species *A. parvifolio* Benn. affinis foliis utrinque hirsutis basibus inæquilateribus floribus minoribus.

Herba rigidula hirsuta 10 cm. alta, *foliis* inæqualibus, majoribus ovato-ellipticis acutis, basibus obtusis inæquilateribus dense utrinque hirsuta, marginibus ciliatis nervis inconspicuis 6-paribus; 2 cm. longis, 1 cm. latis; petiolis 2 mm. longis, hirtis; *foliis* minoribus ovatis acutis hirtis marginibus longius hirtis; *floribus* 2 in pedicellis 5 mm. longis hirtis; *calyce* brevi hirtio, lobis angustis lanceolato-linearibus acuminatis; *corolla* 2 cm. lata, lobis angustis lanceolatis acuminatis; *staminum* columna cylindrica lanceolata.

Hab. Sumatra, Agam, Brani ad 950 metres alt. (*Bünnemeyer*, 3338, in Herb. Kew.).

Allied to *A. parvifolium* Benn., to which Bakhuisen refers it, but the leaves are closer-set, densely hairy all over, not glaucous beneath, nerves very slender, base of leaf inequilateral, flowers 2 smaller. The specimens above quoted are stiff with almost woody stem, no. 3121 of the same collection from nearly the same locality, has very weak, slender stems and smaller and more flaccid leaves. It is flowerless, and I take it to be the same species in a young state.

A. rupestre, sp. nov.

Species erecta foliis inæqualibus *A. salicifolio* Ridl. affinis, foliis lanceolatis angustis floribus multo minoribus diversa.

Herba erecta, *caule* hirtio 10 cm. alta; *foliis* majoribus anguste lanceolatis subacutis, basibus attenuatis glabris marginibus denticulatis attenuatis spinulosis, subtus glaucis, nervis inervis, costa latiuscula superne elevata, 2.5-2.75 cm. longis, 6 mm. latis; petiolis 3 mm. longis; *foliis* minoribus lanceolato-ovatis glabris 3 mm. longis; *stipulis* trilobis minoribus; *pedunculo* singulo erecto glabro 1-2 cm. longo; *bracteis* 4 verticillatis lanceolatis 1 mm. longis in medio pedunculi; *bracteis* similibus; *pedicellis* 5 mm. longis; *floribus* 1-3; *calyce* campanulato glabro lobis brevibus triangularibus acutis; *corollæ* lobis lanceolatis acuminatis 5 mm. longis; *staminibus* connatis, antheris gradatim acuminatis, corollæ paullo brevioribus; *capsula* campanulata 5 mm. longa.

Hab. Borneo, Sarawak, on the hill near Matang growing on the rock (*Haviland*, 1031, in Herb. Kew.).

This is quite after the style of *A. salicifolium* Ridl., but is smaller with lanceolate leaves narrowed to the base and denticulate edges. The flowers are fewer, usually solitary, and slightly larger.

ARGOSTEMMELLA Ridl., gen. nov.

Herbæ parvæ, habitu *Argostemmatiss*, foliis in paribus inæqualibus oblongis vel ovatis, uno majore altero minore stipuliformi; floribus terminalibus paucis subsessilibus vel pedicellatis parvis albis; sepalis 5 lanceolatis; corolla campanulata 5-loba; staminibus 5 liberis brevioribus, filamentis brevibus linearibus, antheris oblongis obtusis longitudo-lineariter dehiscentibus.

Species 2, Borneo.

A. GRACILIS Ridl. (*Argostemma gracile* Stapf).

This is well described and figured by Stapf in Trans. Linn. Soc. iv. (ser. 2) 168, pl. xii. D. 10-12. In habit it much resembles *Argostemma parvifolium* Bl., and still more *A. quadripetalum* (*quadripetalatum* Elmer). It was first collected on Mount Kinabalu by Haviland, and has been since obtained by Moulton on Gunong Temabok, Upper Baram Valley, at 4000 feet alt.

A. BRACHYANTHERA Ridl. *Argostemma brachyanthera* Stapf, *loc. cit.*

This has more the habit of *Argostemma uniflorum* Bl., as Stapf (*loc. cit.*) states.

It is only known from Kinabalu (*Haviland*).

NOTES ON THE BRITISH PANSIES.

THE *TRICOLOR*-SERIES.

BY ERIC DRABBLE.

THE *tricolor*-series of British pansies includes all the large-flowered annual plants. They were distributed by M. Rouy (Fl. de France, iii.) amongst his *saxatilis* and *arvensis* series, but this resulted in what appears to me to be an unnatural separation of clearly related plants. Thus, *V. contempta* finds a far more natural position with *V. Lejeunei* and *V. Lloydii* than with perennials like *V. lepida*, while *V. alpestris* so closely resembles *V. variata* that it seems better to place it in the *tricolor* set, in spite of its apparent power of becoming perennial, than to group it with those plants characterized by the possession of long well-developed slender perennating branches, and where *alpestris* is placed there also must *monticola* go.

The most ready means of distinguishing the *tricolor* plants from the *arvensis*-series lies in the size of the flowers. How far the differences in the form of the stigma and the direction of the stigmatic orifice (Wittrock, *Viola Studier* L., Act. Hort. Berg. ii. No. 1, 1897) and the presence of a stigmatic lip (Wittrock, *loc. cit.*; Clausen, Studies in the Collective Species *Viola tricolor* L., Bot. Tidsskr. xxxvii. 1922) are of general diagnostic value I have not yet determined, but already sufficient evidence has been gathered to suggest that the character of the pollen magazine—*horreolus pollinis clausus, apertus, semiclausus*—used by Wittrock and Clausen and the presence or absence of dark pigment spots on the style below the stigma are not of primary importance. To these characters I shall return on another occasion. Clausen's chromosomal researches promise to be of very great interest, but hitherto they have not gone far enough to be of general applicability. All that is attempted in this paper is to identify and describe those plants which appear to be distinguishable in Great Britain. Only incidentally is passing reference made to their inter-relationships. That is a matter for lengthier treatment elsewhere.

Again, I have to record my gratitude for the help I have received when consulting the plants in the herbaria at the British Museum, Kew, and the Imperial College of Science, South Kensington. The Collections at the last-named Institution are referred to throughout as Herb. Imperial College.

VIOLA CONTEMPTA.

Jordan, Pugillus, 24 (1852); Boreau, Fl. du Centre, ed. 3, ii. 81 (1857).

Plant annual. *Stem* simple erect or with ascending or erect branches from the base, not caespitose. *Leaves* finely pubescent or nearly glabrous; lowest leaves ovate subcordate, very obtuse crenate; intermediate lanceolate obtuse or subacute, upper narrowly lanceolate or linear-lanceolate acute deeply crenate-dentate. *Stipules* pinnately

lobed with oblong or linear-oblong lateral lobes; mid-lobe with a few crenations, broad obtuse and foliaceous in the lower stipules, narrow acute in the upper. *Peduncles* generally twice to three times as long as the leaves, slightly spreading in flower, widely in fruit. *Sepals* lanceolate. *Petals* longer than the sepals, whitish or pale yellow, the upper sometimes tinged with blue.

A plant of cultivated land, usually of tall and robust habit. Readily known by its lanceolate leaves, pinnatifid stipules, and pale flowers.

Hortic. Herb. Mus. Brit.:—*Viola contempta* Jord., de Mt. Pilar (Loire). *Colui*, 1852; *Alexis Jordan*, 1853.

Viola contempta Jord.! C. Martin, Pl. des Env. de Lyon, 1851, Champs près à Mt. Pilar (Loire), 19 juill., agrees exactly with Jordan's sheet. The description of *contempta* was published by Jordan in 1852, while Martin's sheet is dated 1851, and there can be little doubt that Jordan himself named Martin's specimens.

W. Becker, *Viol. Exsicc. v. Lief.* 1903, no. 125 a, *V. alpestris* (DC.) Wittrock, f. *typica* et *versicolor* W. Becker, Fl. Helvetica; in agris et hortis 1000 m.; legit Prof. F. O. Wolf, is *contempta*. The specimens I possess of Becker's *Viol. Exsicc. vi. Lief.* 1905, no. 149, *V. arvensis* Murr. Fl. Hungarica, legit S. Kupçok, seem to be the same; the blue spot on the upper petals in these specimens may occur also in English plants, e.g., in certain Somerset specimens; in these some flowers have a very definite and well-marked blue patch, while others are only slightly tinged with blue. Indeed, Jordan wrote (*Pugillus*, p. 25): "petalis . . . superioribus subalbidiis passim apice vel in totum pallidè cœrulescentibus."

Magnier's *Flora Select. exsicc.* 2114, *V. alpestris* Jordan, Haute Savoie, 1889, in my herbarium is *V. contempta*.

VIOLA LLOYDII.

Jordan ap. Boreau, Fl. du Centre, ed. 3, ii. 80 (1857); Lloyd et Foucaud, Fl. Ouest de Fr. ed. 4, 48 (1886); Drabble in Journ. Bot., Suppl. 1909, 7; F. N. Williams, Prodr. Fl. Brit. pt. 10 (1912).

Plate:—Drabble, Journ. R. Hort. Soc. xxxv. part ii. 1910, figs. 53 & 54.

Plant annual. *Stem* upright with branches spreading from the base, not caespitose. *Leaves* crenate, obtuse (except sometimes the uppermost), lowest oval or subcordate, intermediate and upper oblong-lanceolate, generally longer than the internodes. *Stipules* pinnately or digitately lobed, the lateral lobes broadly linear-oblong, the mid-lobe lanceolate-oblong entire or slightly crenate. *Peduncles* upright in flower, somewhat spreading in fruit. *Sepals* lanceolate acute ("obliques, lanceolés acuminés"—Boreau, p. 80); sepaline appendages large. *Corolla* longer than the sepals, the upper petals violet or blue, the lateral and lowest generally paler; sometimes all the petals are purple or blue or more rarely all yellow.

A plant of cultivated or broken waste land. Usually very densely leafy, with the leaves longer than the internodes.

Excise. Herb. Imperial College:—*V. Lloydii* Jord. in Herb. Dôseglise. (This plant was grown from seed sent to Déséglise by Jordan himself.)

Herb. Mus. Brit.:—*V. Lloydii* Jord. Wild in garden, Nantes, June 1892. Herb. J. Lloyd.

V. Lloydii Jord. Société Dauphinoise pour l'échange des plantes françaises, no. 2777, in Herb. De Candolle is typical *Lloydii*. I have to thank the late M. C. de Candolle for a beautiful photograph of this specimen.

V. Provostii Boreau, Fl. du Centre, ed. 3, ii. 82, seems to be a yellow-flowered *Lloydii* of vigorous growth and with unusually long peduncles. It is described by Boreau as an obtuse-leaved annual. The sheet in Herb. Kew. labelled "*Viola Provostii* Boreau, 18 mai, 1856," from Boreau himself agrees with this description, but that in Herb. Mus. Brit. labelled "*V. Provostii* Boreau" by Gaston Genevier from Vendée is a broad-leaved and very long-peduncled yellow-flowered "*lepida*" plant with well-developed typical slender woody perennating branches. Evidently there has been some confusion in the use of the name *Provostii*, and this subject will be re-opened when *lepida* is being considered. The true *Provostii* takes its place under *Lloydii*.

VIOLA LLOYDII Jord. var. INSIGNIS.

Drabble in Journ. Bot., Suppl. 1909, 7.

This plant differs from typical *Lloydii* in its very large flowers, which may be as much as 45 mm. in length from back to front, with petals much longer than the sepals, violet or blue in colour, the lateral and lower generally paler than the upper. In habit it is taller and usually less branched, the leaves are broader, more deeply crenate, very obtuse, and usually shorter than the internodes. It is a well-marked variety, and not merely a luxuriant state of *Lloydii*.

Viola orcadensis, sp. nov.

Herba annua, caule erecto, unico vel cum paucibus ramis, non-cæspitose; foliis infimis ovatis vel ovato-cordatis, intermediis superioribusque ellipticis; stipulis digitatis vel pinnatifidis, lacinia media integra, multo longiore quam laciniis lateralibus; pedunculis longis erectis; floribus speciosis cœruleis; calcare crasso non incurvato, appendicibus sepalorum longiore.

Hab. Orkney and Shetland Islands and Sutherland. Type in Herb. Mus. Brit. (ex Herb. E. Drabble).

Plant annual. *Stem* upright, rather stout, sparsely clothed with short hairs, simple or slightly branched at the base, not cæspitose. *Leaves* roundly crenate, lowest ovate or ovate-cordate; intermediate and upper elliptic. *Stipules* digitate or with the lateral lobes carried up in a pinnate manner; mid-lobe non-foliaceous, broadly oblong or oblong-spathulate, entire, obtuse, much longer than the short lateral lobes, of which there are usually four on the outer and one on the inner side. *Peduncles* long, often as long as or longer than the stem,

upright in flower, spreading a little in fruit. *Flowers* large, an inch or more in length and $\frac{3}{4}$ in. in breadth. *Sepals* broadly triangular lanceolate acute. *Petals* broad and overlapping, blue, the lowest paler with yellow base; spur very stout, straight, longer than the sepaline appendages.

Occurs freely in the Orkney and Shetland Islands, and also in Sutherland. Specimens were sent by W. R. Linton to the Bot. Ex. Club with the following note (Rep. Ex. Club, 1887):—" *V. tricolor* L., var.—Orkney Isles, August 1886. A remarkable and distinct variety occurring in arable land, which is characterized by its large deep blue flowers, and perhaps differentiated in other ways from ordinary *tricolor*."

I received from W. H. Beeby and from E. S. Marshall specimens of this plant. Beeby's specimens were accompanied by notes which read thus: "Baltisound, Unst, Shetland, W. H. Beeby, 26.7.1886. On stony ground (serpentine gravels) to a great extent overgrown with large patches of rough grass, heather, etc. Among other plants occurring were such things as *Polygala*, *Euphrasia*, *Gnaphalium sylvaticum*, *Hutrychium Lunaria*, etc., etc.; with various *Junci*, *Carices*, etc., and *Narthecium*, on the wet stony parts. Alt. 50–100 ft., just above the cult. zones"; and "Shetland. N. shore of Sullom Voe. Growing under the low sea-bank. *Lapsana* (casual) occurred with it. The seeds may have been brought down by a small burn which flows across the habitat of the *Viola*."

Its nearest relative would seem to be *V. Lloydii*, but it is distinguished by the different form and texture of the leaves, which have a peculiar, almost greasy, appearance in the dry state. The spur is longer than that of *Lloydii*, and the sepaline appendages are smaller. Though difficult to characterize adequately on paper, it is a very distinct plant.

VIOLA LEJEUNEI.

Jordan, Pugillus, 27 (1852).

Plant annual. *Stem* simple erect or with several branches ascending from the base, non-cæspitose. *Leaves* crenate, the lowest ovate-obtuse, intermediate lanceolate acute or subacute, upper narrowly lanceolate acute. *Stipules* digitate, mid-lobe narrowly linear-oblong entire or with very few crenations, lateral lobes much smaller and shorter, linear acute. *Peduncles* erect in flower, slightly spreading in fruit. *Sepals* linear-lanceolate acute; sepaline appendages rather small. *Petals* longer than the sepals, blue or pale yellow with the upper ones tinged with blue. (Jordan, Pugillus, 27, writes: "foliis . . . inferioribus ovatis vel lanceolatis acutiusculis," but his own specimens in Herb. Mus. Brit. have obtuse lower leaves.)

A plant of cultivated ground. It is readily distinguished from *V. Lloydii* by the following characters:—In *Lejeunei* the leaves are acute, the mid-lobe of the stipule is narrow and entire, the sepals are very narrowly linear-lanceolate acute, and the sepaline appendages are small. In *Lloydii* the leaves are obtuse, except sometimes the uppermost, the mid-lobe of the stipule is broader and often somewhat

crenate, the sepals are broader ("elliptiques, lanceolés acuminés," Boreau, 80), the appendages are larger, and the whole plant is generally more densely leafy.

Hesicc. Herb. Mus. Brit.:—*V. Lejeunei* Jord., de Verviers (Belgique), Colui, 1851; *Alexis Jordan*, 1853.

V. Lejeunei Jord., de Verviers (Belgique), Cult. 1859. Ex. Herb. A. Jordan, 1864. This is the original locality (Jordan, *Pugillus*, 27).

A plant in Herb. Imp. College, labelled "*V. Lejeunei* Jord., Cult. hort. Andegavensis, Boreau," has more rounded leaves and broader mid-lobe of the stipule, but seems to be correctly named.

In August 1925, plants were gathered by Col. H. H. Johnston at Stromness, Mainland, Orkney, and sent to the Bot. Ex. Club labelled "*Viola tricolor* Linn. subspecies *genuina* Wittrock, var. *færoënsis* (W. Becker) C. H. Ostenfeld, in *Botany of the Færøes*, pt. iii. 856 (1908) (*vide* C. H. Ostenfeld, 7th September, 1925)." With this is a note from Ostenfeld: "A little darker in the petals than the type, otherwise agreeing well with it." The specimen submitted to me seems to be indistinguishable from *V. Lejeunei*. Moreover, I received from W. H. Beeby a specimen gathered in the Færøes labelled "Plantæ færoënsis a Museo botanico Hauniensi distributæ:—*Viola tricolor* L., Insula Stionis, 2.8.1897, legit J. Hartz et C. Ostenfeld." In a note sent to me with this plant, Beeby wrote: "Becker named it *V. tricolor* subsp. *færoënsis* Becker." This is clearly what Becker meant by *færoënsis*, and the description in Ostenfeld's *Botany of the Færøes*, part 3, 856, fits it exactly. It runs thus: "Folia ovato-rotundata, plane crenata, ad apicem obtusissima, partim submarginata, ad basin in petiolum breviorum abrupte vel subabrupte angustata. Stipulæ lyrato-incisæ, lacinia terminalis lata obtusa, lacinia laterales breves oblongæ, obtusiusculæ, introrsum 1-2, extrorsum 3-4. Sepala late lanceolata." Ostenfeld continues: "To this description Mr. Becker adds the following note:—'The form in question is characterized by its broad-ovate leaves, by the stipules pinnatifid to a smaller degree than the main form (coming near to the stipules of *Viola cornuta*).'" He then goes on: "In my list (*l. c.* p. 80) I had named the form *V. tricolor* L. sp. *genuina* Wittrock, forma, and had mentioned that it is perennial. I should now like to name it *V. tricolor* L. subsp. *genuina* Wittrock var. *færoënsis* (Becker) . . ."

This plant is quite different from that so named for Col. H. H. Johnston and sent to me from the Exchange Club. I have never seen British specimens of *færoënsis*. Evidently there has been some confusion here. It is possibly an instance of the unnatural results obtained by the use of those characters employed by Wittrock in his classification of the pansies, to which detailed consideration will be given in a future communication. It may be well to state that Col. Johnston's plant does not seem to be identical with that described by me above as *V. orcadensis*, but only one sheet of his series was submitted to me.

VIOLA VECTENSIS.

F. N. Williams, Prodr. Fl. Brit. 10, 1912 (pro var.).

Plant annual. *Stem* short, 3-8 cm., densely pubescent, upright, simple, or with few spreading branches from the base, little or not at all cespitose. *Leaves* longer than the internodes, crenate, densely hispid, lowest leaves round or cordate, the others ovate, very obtuse except the uppermost, which may be subacute. *Stipules* densely hairy, pinnately lobed, mid-lobe somewhat foliaceous with few crenations, lateral lobes linear or linear-oblong, arising chiefly near the base. *Peduncles* about twice as long as the leaves, upright in flower, prouding slightly in fruit. *Sepals* narrow, triangular-lanceolate acuminate with small appendages. *Petals* much longer than the sepals, overlapping, yellow, the upper often tinged with violet. *Spur* a little longer than the sepaline appendages.

This is a small, very hairy plant, sufficiently characterized in the description given above. It requires further study, and hitherto I have not cultivated it. I hope to be able to give attention to it this year in the living state. The plant was collected by C. E. Palmer outside Steyne Wood, Bembridge, Isle of Wight, in June 1900, and distributed through the Botanical Exchange Club with the following note:—"Prof. B. von Borbás, of Buda Pest, to whom I submitted specimens of this plant, has determined it to be *V. banatica* Kitaib. in Roemer & Schultz's Syst. v. 382, non Reich. 'Icon.'"

Prof. v. Borbás seems to have made a strange error in thus naming the Isle of Wight plant. *V. banatica* Kit. is described as follows in Roemer & Schultz's Syst. v. 382 (1818):—" *V. banatica* Kitaib.; caule angulate decumbenti-difuso, foliis inferioribus cordatis, superioribus ovato-oblongis, dentato-crenatis, stipulis runcinato-pinnatifidis, corollis calycem glabrum vix excedentibus. Intermedia quasi tricolorum inter et arvensis β . . . \odot " Apart from the statement "corollis calycem glabrum vix excedentibus," there is nothing here to include the Bembridge plant, though the description is too meagre to render any identification secure. But reference to the specimen labelled "*V. banatica* Kit. in F. Schultz's Herb. norm. nov. ser. cent. 27, no. 2611," which is undoubtedly authentic, shows at once that it is not the Isle of Wight plant. When well grown it seems to be a large yellow-flowered plant with the general habit of *V. Lloydii*. (To avoid any future doubt or confusion, it may be mentioned that Borbás is right in stating that *V. banatica* Kit., of Reichenbach's Icones Fl. Germ. et Helvet. vol. iii. no. 4517, is incorrectly named. It is neither *banatica* nor *vectensis*.) Quite certainly, then, the name *banatica* was wrongly applied to our plant, which seems to have been without a name until F. N. Williams called it var. *vectensis* in his *Prodromus*, 10, 1912.

Hesicc. Herb. Mus. Brit.:—*V.* —. Barren field outside Steyne Wood, Bembridge, Isle of Wight, 6th June, 1900.—C. E. Palmer (Ex. Club British Isles).

VIOLA VARIATA.

Jordan, Prodr. 26, 1852; Drabble in Journ. Bot., Suppl. 1909, 7 & 8.

Plates:—Drabble, Journ. R. Hort. Soc. xxxv. pt. ii. figs. 55 & 62 (1910); Smith's Eng. Bot. 1287; Wittrock, Viola Studier I., pl. i. figs. 21 & 22 (as *V. tricolor* (L.) f. *typica*), and pl. iii. fig. 34 (as f. *versicolor*).

Plant annual. *Stems* slightly hairy, much branched; branches spreading from the base, caespitose. *Leaves* more or less hairy, lower leaves long-petioled, subcordate-rotund, very obtuse, crenulate; intermediate ovate obtuse; uppermost sometimes acute and narrower. *Stipules* with pinnately arranged linear-oblong lateral lobes and broader usually foliaceous somewhat crenate very obtuse mid-lobe. *Peduncles* nearly erect. *Sepals* linear-lanceolate acuminate. *Petals* overlapping, brightly coloured, the upper ones usually purple or blue, the lateral and lower ones paler, sometimes yellow or almost white. *Spur* as long as, or a little longer than, the sepaline appendages.

Readily recognized by its caespitose habit, obtuse leaves, pinnatifid stipules, which are similar in form to those of *V. ruralis* Jord., though smaller, and its brightly coloured flowers, which vary considerably in size. The flower somewhat resembles that of *V. Lloydii*, but is generally wider in proportion to its length.

Exsicc. Herb. Mus. Brit.:—*V. variata* Jord., Billot, Fl. Gall. et Germ. no. 2625.

V. variata Jord.!, Cult. 1860. Ex herb. Al. Jordan, 1864.

V. variata Jord.!, Lyon; A. Jordan, 1853. Ex herb. Al. Jordan.

Herb. Kew.:—*V. variata* Jord., Billot, Fl. Gall. et Germ. n. 2625.

Herb. Imperial College:—*V. variata* Jord., Billot, Fl. Gall. et Germ. no. 2625.

All the plants cited above have rather small and pale flowers, but that plants with larger and more brightly-coloured flowers were well known to Jordan is evident from his description (*Pugillus*, p. 26):—"petalis calyce majoribus, superioribus . . . pulcherrimè et intensè violaceis subvelutinis rarissime pallidis, lateralibus cæruleo-violaceis . . . inferiore obovato cæruleo-violaceo . . ." There can be no doubt, therefore, that Jordan regarded plants with larger flowers than those shown in his specimens in Herb. Mus. Brit. as coming within his species *V. variata*. In this he was certainly right; I have found all intermediates in this country between the smaller and larger flowered plants. Many specimens from the north of Scotland have very large flowers, and are less branched than in the typical plant; indeed, flowering may take place before the main stem branches at all, and apparently the plant may then die away without any caespitose development. Such plants agree exactly with *V. tricolor* f. *typica* Witt., *Flora Suecica*, F. Henriksson, 1.6.1925, in Herb. Mus. Brit., which is certainly early-flowering *V. variata* Jord. But such specimens are connected by all intermediates with those of typically caespitose habit, and are clearly pædogenic. Large flowers are generally associated with northern pansies and those of high altitudes. Even the typically very small-flowered *V. derelicta* becomes much larger-flowered in N. Scotland.

As indicated above, *V. variata* Jordan comprises part of Wittrock's *V. tricolor* L. *genuina*; f. *typica* (Viol. Stud. I., 56, pl. i. fig. 22) and f. *versicolor* (p. 58 and pl. iii. fig. 34) are certainly *variata*.

VIOLA VARIATA Jordan var. SULPHUREA.

Drabble, Journ. Bot., Suppl. 1909, 8.

Plate:—Wittrock, Viola Studier I., pl. ii. figs. 31 & 32 (as *V. tricolor* L. f. *lutescens*).

Differs from *variata* in its yellow flowers, its generally coarser growth, larger leaves, and broader stipules. In general, I have refrained from giving names to mere "colour varieties." But in this instance the plant is of so striking an appearance, while seeming also to differ constantly in other features, that a name is clearly demanded. It comes perfectly true in cultivation, and in certain districts is the predominant pansy of cultivated land. On the Continent it has quite undoubtedly been confused with *alpestris*, to which it bears a great resemblance. It can be distinguished, however, by its much harder habit, larger leaves and stipules, and by the broader sepals and the larger sepaline appendages which are as long as the stout peduncular spur. Occasionally the flowers may be entirely whitish-yellow or the upper petals may be tinged with blue or violet, as is shown in Wittrock's Viola Studier I., pl. ii. figs. 29 & 30 (as *V. tricolor* L. f. *albida*); most usually they are of a rich yellow throughout.

Comparison with *V. luteola* Jord. (cultivated by Déséglise from seed sent by Jordan himself) in Herb. Imperial College would have made me suspect that these two plants were the same, were it not that Jordan (*Pugillus*, p. 28) states that *luteola* is perennial, which *sulphurea* certainly is not. *V. luteola* Jord.!, Maladetta, Tyr. centr., Cult. 1859, ex herb. Al. Jordan, 1864, and *V. luteola* Jord.!, Maladetta, Cult. 1852, A. Jordan, 1853, both in Herb. Mus. Brit., are similar, and certainly do not show any sign of being perennial. Still, in face of Jordan's express statement, it would be unwise to unite the two.

VIOLA CANTIANA.

Drabble, in Journ. Bot., Suppl. 1909, 7.

Plate:—Drabble, in Journ. R. Hort. Soc. xxxv. pt. 2, 1910, figs. 56 & 63.

A Latin diagnosis follows, as none was published in 1909:—

Viola annua, caulibus diffusis, caespitosis; foliis hispidulis, parvis, lateralibus rotundato-ovatis obtusissimis, intermediis superioribusque lanceolatis, obtusis vel subacutis; stipulis parvis, lacinia media spatulata; pedunculis longis, gracilibus, erectis; sepalis angustis; petalis multo longioribus quam sepalis, splendide coloratis, cæruleo-luteo tinctis; calcaribus appendices breves calycis parum superante.

Hab. Cantia, Anglia. Type in Herb. Drabble.

Plant annual, 15-24 cm. in height, caespitose, with many spreading or ascending shortly hispidulous slender branches from the base; stem how straight with long internodes. *Leaves* crenate, shortly hispid or hispidulous, lowest rotund-ovate very obtuse, intermediate and upper lanceolate obtuse or subacute; all the leaves small, 1-1.5 cm.

long. *Stipules* small, pinnatifid, lateral lobes oblong-linear or linear arising from a broad base, the mid-lobe spatulate with few (2-4) crenations. *Peduncles* long, slender, upright. *Sepals* narrow, linear-lanceolate acuminate, appendages short. *Petals* much longer than the sepals, upper petals blue, lateral and lowest yellow with blue margins, lower petal umbilicate with a broad squarely truncate end. *Spur* a little longer than the sepaline appendages.

The slender stems, caespitose habit, small hispidulous leaves and stipules, relatively long internodes and sharp and definite colouring of the petals, render this plant easy to recognize. It is, indeed, one of the most clearly defined of all our pansies. So far I have only met with it in three localities.

F. N. Williams's statement (*Prodromus*, 10, 1912) that he was unable to distinguish *cantiana* from *variata* is surprising, as he certainly had never seen a specimen of *cantiana* named by me.

There remain two plants which may most naturally be considered here, namely, *V. alpestris* Jord. and *V. monticola* Jord.

Of the set in which he places *V. alpestris*, Jordan writes (Obs. ii. 31, 32):—Ces espèces ne sont, pour ainsi dire, ni annuelles, ni bis-annuelles, ni vivaces. En effet, elles fleurissent ordinairement dès la première année de leur existence, et si elles vivent plus d'une année, leur racine n'en a pas moins l'aspect d'une racine annuelle et ne ressemble en rien à une rhizome qui vit et se développe sous terre chaque année. Elle donne naissance, vers son collet, à un grand nombre de bourgeons dont le développement est peu inégal, ce qui donne à la plante une aspect très-cespiteux surtout quand elle croît isolée. Lorsqu'une ou plusieurs tiges meurent et se dessèchent, elles sont immédiatement remplacées par d'autres, jusqu'à ce que la racine soit épuisée, ce qui arrive ordinairement après la seconde année." That *alpestris* may become perennial, however, seems clear from examination of the specimen in Déséglise's Herbarium at the Imperial College of Science, cited below, and the same seems to be true for *monticola*. That Jordan intentionally distinguished these plants from the set with perennating branches is evident from Obs. p. 37, where he writes: "Le *V. saxatilis* Schmidt paraît assez voisin des espèces que je viens de signaler, mais il en est certainement très-distinct. . . ." Schmidt, *Flora Bohemica*, cent. 3, p. 60, described *saxatilis* as perennial, and Jordan says (p. 37) that: "s'il est réellement vivace, comme le dit Schmidt, je crois que c'est bien à tort qu'on l'a rapproché du *V. tricolor*." There is no reason whatever to doubt that Schmidt was correct, and on this ground Jordan says that *saxatilis* ought to be placed in the group to which *V. sudetica* Willd. belongs. It is clearly most natural, therefore, to place *V. alpestris* Jord. with the *tricolor* plants, and not with the set with well-developed twiggy perennating branches. It follows from what has just been said that M. Rouy (Fl. de France, iii. 41) was mistaken in making *V. alpestris* Jord. synonymous with *V. saxatilis* Schmidt. Jordan (Obs. ii. 37) quite definitely states that they are distinct.

VIOLA ALPESTRIS.

Jordan, Observ. ii. 32-34 (1846); DC. Prodr. i. 303, 1824 (as *V. tricolor* L. γ *alpestris*); Grenier et Godron, Fl. de France, i. 184, 1848; Boreau, Fl. du Centre, ed. 3, ii. 83-84, 1857; Drabble in Journ. Bot., Suppl. 9, 1909.

Plate:—Drabble in Journ. R. Hort. Soc. xxxv. pt. ii. figs. 57 & 64 (1910).

Stem much branched, caespitose, branches diffuse, spreading below, then ascending. *Leaves* more or less downy, $\frac{1}{4}$ — $\frac{1}{3}$ as long as the internodes, crenate, obtuse; lowest leaves cordate-oblong obtuse, intermediate oval-oblong narrowed into the petiole, upper narrower. *Stipules* of the lower leaves with oval obtuse crenate stalked mid-lobe and narrow linear lateral lobes arising near the base, those of the upper leaves with a spatulate entire or subentire mid-lobe and short linear-oblong lateral lobes arising successively from near the base in a condensed pinnate manner. *Peduncles* long slender. *Sepals* narrowly lanceolate acuminate. *Petals* longer than the sepals, pale yellow, sometimes touched with purple. *Spur* slender, longer than the short sepaline appendages.

There has been much confusion between *alpestris* and *variata* var. *sulphurea*, but the two plants may be distinguished readily, as pointed out above (p. 49).

Herb. Mus. Brit.:—*Viola alpestris* Jord., Villar de Beauport (Hte. Savoie), 28 mai, 1858, *legit ipse*.

V. alpestris Jord., Champs montueux, Conflans, Hte. Savoie, *legit* Perrier, 20 mai, 1854.

V. tricolor L. var. *alpestris* Jord. Near Lac Tanex, Valais, 11 vi. 1896, R. P. M. (ex herb. R. P. Murray).

Herb. Imperial College:—*V. alpestris* Jord., à sommet du Columbar, vii. 79 in Déséglise's herbarium.

Herb. Kew.:—*V. tricolor* γ *alpestris* DC. Prodr. i. 303, n. 81, Chaîne du Breson, en Savoie (Seringe's sheet). This is rather stout *alpestris*.

V. tricolor L. var. *alpestris*, 6.6.79. Sur Branson, Valais, communicated to Sir Joseph Hooker by L. Favrat and W. Barbey.

Our British plants agree exactly with specimens named *alpestris* in my own herbarium from Brison (Htes. Alpes, ex herb. Ch. Arnaud); from Nürnberg (*legit* Carl Semler, Fl. Bavarica); and from Weinberg (*legit* C. Scholz, Fl. Sudet. Occid.).

Jordan regarded his *V. alpestris* as equivalent to *V. tricolor* var. *alpestris* DC. The plant from Seringe's herbarium in Herb. Mus. Brit. labelled "*V. tricolor* γ *alpestris* DC." is evidently rather stout, large-flowered *alpestris*, and this seems to confirm Jordan's opinion.

Many specimens have clearly been wrongly referred to *V. alpestris* Jord. The comparatively small stature (1-2 dec., Boreau, ed. 3, ii. 83), the obtuse leaves (Jordan, Obs. ii. 33; Grenier et Godron, Fl. de France, i. 184; Boreau, 83), and the form of the stipules, which Jordan says resemble those of *V. gracilescens**, serve to rule out

* It must be noted that Jordan is here referring to his species *V. gracilescens* (Obs. ii. 20, 21, and pl. 2 B), which I have given reasons (Journ. Bot. 1926, 268) for referring to *V. ruralis* and not to *V. tricolor* L. var. *gracilescens* DC.

many plants in Continental sets. As an instance may be mentioned the plant thus named from Haute Savoie, 1889, in Magnier's Fl. select. exsicc. no. 2114, in my own herbarium, which is an acute-leaved plant, and appears to be *V. contempta* Jordan.

VIOLA MONTICOLA.

Jordan, Obs. ii. 37 (1846); Becker, *Viola Europææ*, Beihefte z. Bot. Centralbl. xxvi. 343 (1909).

Plant annual or biennial, probably sometimes perennial. *Stems* somewhat caespitose at the base, branches spreading below, then ascending, downy, often with several short slender non-flowering branches. *Leaves* downy, dark green, crenate; lower leaves and those of the short non-flowering branches ovate or cordate obtuse, intermediate ovate-lanceolate acute or subacute, upper narrower, acute. *Stipules* of the lower leaves very small, palmate, the mid-lobe scarcely exceeding the lateral lobes in length and breadth and resembling them in form, stipules of the upper leaves often larger, palmate, with the mid-lobe entire, oblong, and broader and longer than the lateral lobes. *Peduncles* erect in flower, spreading in fruit. *Sepals* triangular-lanceolate or linear. *Petals* longer than the sepals, generally very pale yellow or yellowish white, the lower petal deeper yellow; sometimes the whole corolla is suffused with blue. *Spur* slender, generally longer than the sepaline appendages.

This plant certainly appears to be capable of becoming perennial. Jordan describes it as annual, while Becker says it is perennial, and there is little doubt that Jordan and Becker were dealing with the same plant. It is readily recognized by its very small palmate stipules, particularly those of the lower leaves, and by its caespitose habit and deep green leaves.

Exsicc. Herb. Mus. Brit.:—*V. monticola* Jord., Billot, Fl. Gall. et Germ. no. 2222.

V. monticola Jord., de Bagnères de Luchon, Pyrénées. *Colin*, 1851; *Alexis Jordan*, 1853.

V. monticola Jord., juin 1869, Héas, Hautes Pyrénées (Bordère). This is rather broad-leaved and the upper petals are tipped with blue.

Herb. Kew.:—*V. monticola* (Jord.), juin, Vallée de Lys, 1862, Herb. de M. Fourcade, Bagnères de Luchon.

V. monticola Vallée de Lys, June, Herb. Churchillianum proprium. This is rather broad-leaved, but otherwise typical.

Herb. Imperial College:—*V. monticola* Jord., Herb. Bordère, Héas, juin 1873. The leaves of this specimen are unusually large, but the small round-leaved flowerless shoots are present.

Our British plants agree well with those so named by Jordan in Herb. Mus. Brit. The latter are, however, cultivated specimens, and stouter and more fleshy than the wild ones. This seems to have led to some confusion, certain collectors having erroneously referred specimens of *V. variata* var. *sulphurea* to *monticola*. A careful examination shows that Jordan's cultivated plants, though approaching *sulphurea* in habit, retain the characteristic stipules and other distinguishing features of *monticola*. Jordan may have drawn up

his description from cultivated specimens; if so, this might account for his statement that the spur is not longer than the sepaline appendages, for in cultivation these appendages do tend to become more luxuriant. In our wild plants they are generally shorter than the spur. The specimens from Vallée de Lys in Herb. Kew., cited above, and Billot's specimen no. 2222 in Herb. Mus. Brit., agree exactly with our British plants. Rouy & Foucaud (Fl. de France, iii. 14) made *V. tricolor* v. *bella* Grenier & Godron (Fl. de France, i. 144), synonymous with *V. monticola* Jord. I am unable to follow them in this, as, according to Grenier and Godron, *bella* differs from *monticola* in the stems being "raides et dressés." This is borne out by a specimen in my own herbarium labelled "*V. tricolor* L. var. *bella* Godr. et Gren., Breslau, juli 1884, R. v. Uechtritz," which closely resembles *monticola*, but differs in just those characters of the stem mentioned by Grenier and Godron.

THE GRAMPIAN MOUNTAINS OF VICTORIA, AUSTRALIA,
AND THEIR FLORA.

By EDWIN ASHBY, F.L.S., &c.

THE range is situated in Western Victoria about meridian 147° 30", and between 37th and 38th parallel. The northern extremity at Mt. Zero is due north of the southern extremity at Mt. Sturgeon, but the Range is bent westward with Mt. William (1830 ft.) as the centre of the bend and the wings trending north-west and south-west respectively. The total length of the range is 60 miles, and the greatest breadth is about 30 miles. The rocks are sandstone with quartzite and intrusive rocks in a few places. It differs from any other range of mountains I have ever visited in Australia. One deduced from general appearance that its elevation was due to a fault, one side, the eastern, being continuously precipitous, the original elevation of this wall, judging from the height of Mt. William (1830 ft.) and Mt. Rosea (3095 ft.), having been fully 4000 ft., the western slope being gradual. I now find that Professor Sir Edgeworth David in the *Federal Handbook of Australia*, 1914 (pp. 258-66), ascribes the uplift as due to folding, the formation being almost entirely sedimentary sandstones, perhaps Devonian or Lower Carboniferous. He suggests its correlation with the Mansfield Shales in which fossil *Lepidodendron australe* occurs; but as no fossil indications have up to the present been met with in the Grampians, the true age of its sandstones must remain uncertain.

This elevated mass has during the ages been cut into narrow valleys running more or less north and south, the ridges between rising above the floor of the valleys one to two thousand feet; the upper portion of these walls forms a sheer cliff for several hundred feet, the actual summits often being immense blocks of detached sandstone weighing hundreds of tons each, and apparently waiting for the first earth-tremor to send them hurtling down into the valley-bottoms.

Lateral streams have in some parts cut narrow gorges crosswise; but for these one would have great difficulty in getting out of the main north and south valleys.

As comparatively little damage has been done by fires, one of the chief factors in the destruction of fauna and flora in Australia, the Bush is mostly undamaged by the intrusion of Man, and the soil, except in the bottoms, is too poor for agriculture. The whole range, except for alienated blocks, has been declared a faunal reserve.

The range is an ecological islet rising abruptly out of hundreds of miles of undulating plains. Westward the nearest ranges on anything near the same altitude are the Mt. Lofty Ranges close to Adelaide, and eastward the great Dividing Range and the Cape Otway Hills.

The isolated position of this range adds greatly to its botanical interest, its flora being the meeting-place of east and west. Here the beautiful *Boronia pinnata* Sm., which is such a favourite near Sydney, growing there almost down to sea-level (in fact, at Port Stephens, 130 miles still further north, I gathered it at sea-level), only occurs at the top of the mountains at an altitude of 2000 ft.; and whereas in New South Wales it is a dwarf shrub of about 2 ft. 6 in., in the Grampians it reaches over 6 ft. high, though it seems quite local, only occurring on some summits.

The handsome crimson or perhaps orange-red *Grevillea oleoides* Sieb., which is in New South Wales a dwarf shrub with linear foliage, re-occurs in the Grampians on the summits of the range called "The Eastern Wall," and there has a larger and broader leaf as compared with the specimens from the northern state. Another species, *G. rosmarinifolia* A. Cunn., which is in New South Wales a large bush (the example growing in my own garden is 7-8 ft. high and 2 ft. wide), re-occurs in the Grampians as a quite small shrub about 2 ft. high: it is rare there, being only recorded from Mounts William and Rosea at an altitude of over 2000 ft. For each of the foregoing the Grampians are the extreme western limit of range, and each species shows some specialization.

For some plants, as *Astroloma conostephioides* F. Muell., which is quite a common shrub and one of the most showy in my own neighbourhood of Blackwood in South Australia, the Grampians form the extreme eastern limit of their range. The charming Blue Tinsel Lily, *Calcectasia cyanea* R. Br., which is common in many parts of Western Australia and has only one record, from Robe, in South Australia, here recurs in considerable numbers, although local. Another Liliaceous plant, *Borya nitida* Labill., which is recorded in botanical works as confined to Western Australia, re-occurs in the Grampians; the plants were not in flower at the time of my visit, but some brought back last November are looking well in my garden and now coming into flower. It is interesting to note that only two members of the genus *Borya* are recorded as Australian, the one now referred to from W. Australia and *B. septentrionalis* F. Muell. from Queensland.

Mr. J. W. Audas, the Keeper of the National Herbarium of Victoria, gave me a list of 15 species of plants endemic to the

Grampians. Papilionaceous shrubs are richly represented in this range, the showy genus *Pultenaea* being represented by 17 species; of these, four are endemic, notably the Rosy Bush-Pea (*P. subalpina* Druce), better known as *P. rosea* F. Muell., it having given its name to the second highest mountain, Mt. Rosea. On the summit or just below the summit of this mountain are hundreds of bushes of this showy species, four or more feet high, which only here and there had any open flowers at the time of our visit, but a week or so later would have been a sheet of rose-coloured blossoms set off with exceptional charm by the dark green tinged with bluish white of the foliage. This patch is situated where a mountain-stream takes its rise. This beautiful shrub only occurs at this spot and at a similar spot on the still more lofty Mt. William, a few examples tailing out down the banks of the little stream before referred to. *P. Luehmanni* Maid., the Thready Bush-Pea, is another peculiarly Grampian plant: although only about eighteen inches high, it is very graceful, numberless slender branches starting from the root-stock as well as bifurcating later, and each branchlet is surmounted with bunches of old-gold-coloured flowers; this species is confined to peaty and swampy ground. The two other members of this genus endemic to the range are *P. Benthami* F. Muell., which was not in flower at the time of my visit, but when out is very showy, and *P. costata* Williamson, also not in flower, except an odd piece or two during our stay. Then, again, the showy *Bauera sessiliflora* F. Muell., endemic to the Grampians, is a most distinct species and quite the most handsome of the genus.

The following is the list as supplied by Mr. Audas of species endemic to the limited area under review:—

- DILLENIACEÆ. *Hibbertia humifusa* F. Muell.
 RHAMNACEÆ. *Trymalium Daltoni* F. Muell.
 LEGUMINOSÆ. *Pultenaea subalpina* Druce (*P. rosea* F. Muell.), *P. costata* Williamson, *P. Benthami* F. Muell., *P. Luehmanni* Maid.
 MYRTACEÆ. *Calythrix Sullivanii* F. Muell., *Eucalyptus alpina* Lindl.
 MAXIFRAGACEÆ. *Bauera sessiliflora* F. Muell.
 COMPOSITEÆ. *Olearia speciosa* Hutchins.
 MYLIDIACEÆ. *Stylidium soboliferum* F. Muell.
 SPACRIDACEÆ. *Leucopogon thymifolius* Lindl.
 LABIATEÆ. *Prostanthera debilis* F. Muell.
 PROTEACEÆ. *Grevillea Williamsoni* F. Muell.
 ORCHIDACEÆ. *Caladenia iridescens* E. S. Rogers.

[Specimens of most of the above are included in a small collection from the Grampian Mts. which Mr. Ashby has sent to the British Museum.—A. B. R.]

NEW VARIETY OF *MERCURIALIS PERENNIS* L.

By S. K. MUKERJI, M.Sc., F.L.S.

Mercurialis perennis L., var. *Salisburyana*, var. nov.; a forma typica *foliis* profunde dentato-serratis saturate viridibus hispidioribus, *petiolis* saepius brevioribus, *stylis* brevioribus crassioribus ascendentibus differt.

Habitat. Damp shady localities in a *Quercus-Fraxinetum* coppice at Staplehurst (Kent).

The plants generally occur on dark loamy or clayey soil in small clumps, either forming pure crops or growing in association with other herbaceous undergrowth such as *Scilla*, *Primula*, *Ficaria*, and *Anemone*.

In the fresh condition this variety recalls *Urtica dioica*, to which it bears a striking resemblance in its external characters, especially those of the leaf, and may perhaps for this reason have been overlooked. So far I have not been able to find it in any other woods in other parts of this country.

The tap-root bears abundant secondary rootlets that are of two types—branched and unbranched. The average rooting depth is less than that of the type, extending mostly to about 20 cm. or less.

In the type the height of the stem ranges from 20–60 cm., while in the variety it seldom exceeds 45 cm. The characters of the rhizome are the same as in the type.

The leaves are ovate, ovate-oblong, or ovate-lanceolate, with usually an acuminate leaf-tip. Fully-grown leaves above the middle of the stem very commonly measure 8 cm. in length by 3 cm. in breadth, although any length from 5–10 cm. may occur. The leaves are thinner in texture than those of the type and are more hispid, having a fine silky-shining pubescence on the veinlets. They are darker green than in the type. But their most conspicuous feature is the deeply-serrated leaf-margin, by which the new variety is at once distinguished in the field. The leaf-teeth are triangular or ovate-triangular, with an upwardly-curved apiculus surmounted by a hydathode. The lower margin of the teeth in the middle region of a fully-grown leaf is 3–5 mm. long, while the upper margin is 1–2.5 mm. The petiole is generally shorter and more slender than in the type. It is 3–9 mm. long, with an average length of about 5 mm.

The flowers are as in the type, except that the styles are usually shorter, thicker, and ascending rather than spreading. Pollination is both anemophilous and entomophilous. Flies and bees have been observed to bring about pollination. The ripe fruits burst open and eject the seeds to a distance of about 4 metres. In this respect it practically agrees with the type except that the range is slightly greater. Size and other characters of the seed agree with the type.

The variety is named in honour of Dr. E. J. Salisbury, of University College.

In conclusion, I wish to thank the authorities at the Herbaria at the British Museum and Kew for facilities and help.

OBITUARIES.

MISS MATILDA SMITH, A.L.S.
(1854–1926).

We regret to have to record the death of Miss Matilda Smith, which took place at 49 Gloucester Road, Kew, on December 29th, in her 73rd year (she was born on July 30th, 1854); she had been in failing health for some time.

Miss Smith was well known in the botanical world as artist at the Royal Gardens, Kew, where she had worked for more than forty years. Her introduction to botanical work is described in the *Journal of the Kew Guild* for 1916, where there is also a good portrait. In 1878 Sir Joseph Hooker was trying to find a successor to the late Mr. W. H. Fitch, as artist for the *Botanical Magazine*. Knowing that his cousin, Miss Smith, was fond of drawing plants, although she had no knowledge of Botany, Sir Joseph made arrangements for her to draw under his tuition. It was a difficult task for anyone to follow on after Mr. Fitch, whose excellent drawings are well known to all botanists, but Miss Smith rapidly became skilful, and her first drawings appeared in vol. 104 of the *Botanical Magazine* (1878). In 1881 Miss Smith was appointed artist and lithographer to *Hooker's Icones*, beginning at Plate 1354. It was not until April 1898 that she was definitely appointed Artist on the Staff of the Kew Herbarium.

In addition to the work in the *Botanical Magazine* and *Hooker's Icones*, she made drawings for Sir George Watt's *Cotton Plants*; Mr. Harry Johnston's *Liberia*; Collett's *Flora Simlensis*; T. F. Cheeseman's *Illustrations of New Zealand Plants*; Bayley Balfour's *Flora of Socotra*; Aitchison's *Botany of Afghanistan*; and Dr. O. Stapf's *Icones of India*. Her work is represented in the *Journal of Botany* by two plates—one illustrating Mr. Hesketh Prichard's "Patagonian Plants," which she drew, and the other Mr. C. E. Salmon's "Notes on *Limonium*," which she lithographed—Plates 465 and 466 (1904).

The work of botanical artists is generally straightforward, and it is only very occasionally, as in the case of *Actinotinus sinensis* Oliver, figured in *Hooker's Icones*, tab. 1740, that there is any attempt at trickery in the plants sent to them. In this instance one of Dr. Henry's Chinese collectors had artfully inserted an inflorescence of a *Tiburnum* into the terminal bud of *Æsculus chinensis*.

High tribute has been paid to Miss Smith's skill. Collett speaks of her "beautiful and characteristic illustrations." Cheeseman, in his Preface to the *Illustrations of the New Zealand Flora*, says: "Miss Smith's capabilities are widely known among botanists, but these plates will enhance her already well-earned reputation." On her retirement from her post at Kew in July 1921, the *Kew Bulletin* wrote: "The devotion to duty which has marked Miss Smith's tenure of her post has placed Kew under an obligation it is not easy to measure."

In 1916 she was elected President of the Kew Guild; and in 1921 her conspicuous services to Botany were recognized by her election to the Associateship of the Linnean Society. Quite recently she was

awarded the Veitchian Medal by the Council of the Royal Horticultural Society for outstanding work in connection with Horticulture.

Miss Smith was also actively interested in parochial work at Kew. She was a prominent Church worker, a Lady Guardian, and, latterly, editor of the Parish Magazine.

She leaves a record of a hard-working, useful life, and her excellent drawings will long continue to help others in their work. She was constantly associated with some of the most prominent botanists in the country; and leaves behind her a great number of friends to grieve for her passing. Many of these friends attended a Memorial Service held at Kew Church on New Year's Day, which preceded the interment in Richmond Cemetery. The genus *Smithiella* (Urticaceae) was named in her honour by Mr. S. T. Dunn (Kew Bull. 1920, 210).

E. G. BAKER.

WE have also regretfully to record the death, on December 2nd last, of Dr. R. W. Phillips, Emeritus Professor of Botany, University College of North Wales. We hope to give an appreciation of his work in our next issue.

SHORT NOTES.

ASSOCIATION OF SPECIAL LIBRARIES AND INFORMATION BUREAUX.—Sir Richard Gregory, Editor of *Nature*, has issued the following statement on behalf of the Council of the Association:—As a result of successful conferences which have been held annually for the past three years, the Association of Special Libraries and Information Bureaux has been formed and is now in process of incorporation. The Council cordially invites the support of all organizations and bodies, commercial houses, industrial concerns, etc., which attach adequate importance to the collection, treatment, and dissemination of information relevant to their work.

The new body will act as a channel through which the inquiring member may be put into direct touch with the source of information required. With the generous assistance of the Carnegie Trust, the Association has in preparation a Directory of sources of specialized information in the British Isles; a copy of this will be sent free to each member, as soon as available. In addition, it is hoped to establish, by co-operation between interested parties, unified policies with respect to abstracting, cataloguing, indexing, filing, etc.

Membership is open to all interested bodies, and a small subscription of £2 2s. per annum has been fixed. Further details will be furnished by the Secretary, 38 Bloomsbury Square, London, W.C. 1.

ARCHIVOS DE BOTANICA DO ESTADO DE S. PAULO.—Under this name is continued the series of publications initiated under the title *Anexos dos Memorias do Instituto de Butantan, Secção de Botanica*, the first volume of which has already appeared. The change of title is due to the transference of the Botanical Section from the Instituto de Butantan to the Museu Paulista. Vol. i. fasc. 2 contains an important contribution to our knowledge of the Brazilian Moss-flora by Prof. Th. Herzog, of Munich, based mainly on collections from the States of S. Paulo and Minas Geraes.

REVIEWS.

Genetical and Cytological Investigations on Viola tricolor L. and V. arvensis Murr. By Dr. J. CLAUSEN, Genetic Laboratory, Copenhagen. Pp. 1-156, pl. 2 (coloured). [Separate from *Hereditas*, vol. viii. 1926. Lund.]

In this work the author has counted 20,000 individuals of 28 ~~crossings~~ and examined 1400 cytological preparations. The great range of flower-colour so well known to students of this difficult group is explained as due to ten genes which he has found by Mendelian analysis, some of them polymeric. *V. arvensis* is the more dominant. When all basal genes are absent the flower is pure white or, if it has the gene for yellow, partly yellow. The presence of other genes may add velvety red, then velvety violet; three more remove the velvety appearance; another can turn the flower full yellow, and yet another completes the typical yellowish-white flower of *V. arvensis*. The small flower of *V. arvensis* is due to the presence of an additional gene inhibiting the development of large flower. The style spot, sometimes used as a specific difference between the two, is affected by many genes, three distinct ones connected with its presence and others which inhibit it. As a result complicated inheritance is found in segregation.

Viola tricolor has 13 chromosomes, while *V. arvensis* has 17, and hybrids produce many peculiar forms owing to variations in the behaviour of unpaired chromosomes. Some aberration occurred in crosses between different *V. arvensis* varieties as a result of faulty conjugation of chromosomes.

It is possible to segregate new constant types from the inter-specific crosses, and one type is named *Viola hyperchromatica*. In addition there occurs segregation in races where the chromosome number is constant.

V. arvensis and *V. tricolor* are regarded as distinct species on grounds of distribution (both topographical and ecological), chromosome numbers, and their behaviour on crossing.

There is general discussion of the phylogeny of chromosome numbers, segregation of species characters, reasons why species remain pure in nature, and so on; but, from a taxonomic point of view, the interest in the paper lies in the facts concerning the complicated inheritance of flower colour and size, and in the fact of the relation of chromosome numbers between the two species. It appears to be the latter fact, with the irregularities consequent upon crossing, which produces the chaos of forms observed by systematists. Whether it will be possible to work out a nomenclature satisfactory to systematists and a method of identifying the genetic relations of the forms from morphological examination only, must be left for further study of the genetics and cytology of the numerous forms in other parts of Europe.

The print, paper, plates, and English are excellent, the last being by Mr. W. Worster from the author's Danish.—A. J. WILMOTT.

The Natural History of the Oxford District. Edited by JAMES J. WALKER, R.N., Hon. M.A., F.L.S. Sm. 8vo, pp. viii, 336. University Press, Oxford, 1926. Price 10s. net.

THE recent meeting of the British Association suggested the compilation of this summary for the use of members, but it is hoped that the work may be of some permanent value and service to members of the University who are interested in biological studies as well as to naturalists generally. The volume comprises a series of chapters by well-qualified authorities on the various departments of Natural History, beginning with an interesting account of the Physiography of the region by H. O. Beckett, Director of the Oxford School of Geography, followed by shorter chapters on Climate and Early and Modern Settlement. Dr. G. C. Druce is responsible for the Botanical Section, entitled "The Botany of the Upper Thames"—that is, the area included in H. C. Watson's botanical division of that name, comprising Oxfordshire with Bucks and Berks. It is an area to which Dr. Druce has devoted many years of study, and on the flora of which he is the recognized authority. His contribution to the present volume, occupying about fifty pages, is an eminently readable sketch of the various types of vegetation which occur in the district, with their constituent flora. Dr. Druce also gives a brief account of the History of Botany in Oxford, whose Botanic Garden, the oldest surviving in Britain, was founded in 1621, and with which have been associated Bobart, Robert Morison, Dillenius, and Sibthorp.

The volume concludes with an account, by Dr. R. T. Gunther, of the old Ashmolean Museum and the collection of early scientific instruments formed by Dr. Lewis Evans and given by him to the University which have recently been arranged by Dr. Gunther in the upper storey of the building.

Plant Nutrition and Crop Production. By E. J. RUSSELL. Pp. ix and 115; 21 plates, 37 text-figures. University of California Press, Berkeley, California, 1926. Price 12s. 6d.

THE Hitchcock Lectureship was founded in the University of California by the late Charles M. Hitchcock for the provision of public lectures on popular and scientific subjects. The present volume embodies the Hitchcock Lectures for 1924, and in them Sir John Russell has given an admirable survey of our knowledge of the nutrition of the plant and the production of crops from the agricultural point of view. On the present occasion it is appropriate to give a general idea of the author's theme: briefly the work of the earlier workers is given—van Helmont, Woodward, Priestley, de Saussure, Boussingault, Liebig, Lawes, Gilbert, and others. This historical summary leads to the consideration of artificial manures and the various results following their application. Details are given which indicate "that the soil, the climate, and the plant must be regarded as an interlocking system," and although no increase in crop yield may follow the application of artificial manures, other advantages may obtain; the hastening of the maturation of the barley fruit, for instance, by the use of phosphate may obviate much loss by the action of the gout-fly.

The author next considers the attempts of Mitscherlich and others to find a mathematical expression for the growth of the plant. But the factors involved are so numerous—many even have yet to be formulated—that the results of such attempts are unsatisfying. A comparison is there made of the action of farmyard and of artificial manures; this naturally leads to a consideration of the decay of plant-tissues and so to the microbiology of the soil. Finally, the structure and composition of the soil are described.

The result is an eminently readable account written in clear language, relief being given by apt quotations, which can be understood by educated folk whether they be scientists or not: and when the mass of relevant literature is considered, this is no mean achievement.

Here and there are found remarks, the truth and significance of which are not always realized. "The past has been rich in the joys and thrills of discovery; but it has taught this lesson: that discoveries in applied science inevitably follow advances in pure science." Too many of our universities and colleges are ill-found for the work to be done in pure science. Again, "No scientific investigation is complete until its results can be expressed quantitatively." Further, in commenting on Warington's failure to find and isolate the nitrate-producing organism of the soil and the success of Winogradsky, Sir John says: "The result is a warning against the over-organization of research; an official group working with official methods might have laboured for years without success."

To us it is a pleasure to be able strongly to recommend the book: it will be found an excellent introduction to an all-important subject.

T. G. HILL.

Naturalist's Guide to the Americas. Prepared by the Committee on the Preservation of Natural Conditions of the Ecological Society of America. Assembled and edited by VICTOR E. SHELFORD. 8vo, pp. xv, 761, frontispiece and 16 text-figs. Baillière, Tindall & Co., London; Williams & Wilkins Co., Baltimore, 1926. Price 45s. net.

THE origin and purpose of this encyclopædic work are explained, in his preface, by the editor, who is Chairman of the Committee responsible for the preparation of the volume. The Ecological Society of America, with about 500 members, "includes a larger proportion of persons interested in the preservation of natural conditions for research in pure science and for educational work than any other of our national scientific societies." In attacking the problem of securing the preservation of natural areas the Committee felt the lack of definite guides. The organization which produced the *Naturalist's Guide* includes about seventy-five members, and its efforts are directed towards the preservation of natural areas with original flora and fauna and the maintenance of the natural biotic balance in existing preserves. The Committee aimed to have two members in each State (and Province of Canada) who should (1) supply information relative to natural areas &c. in their territory, and (2) undertake to interest

one local organization concerned with pure science in the preservation of natural areas. Other members were engaged in writing reports &c., and in propaganda work. The work of the numerous contributors, extending over seven years, passed through the hands of seven Associate-editors, and was finally prepared for publication by Forrest Shreve, of the Desert Laboratory of the Carnegie Institution.

The book, which is closely but clearly printed in double columns to the page, contains six sections.

Section I. is a brief Introduction by V. E. Shelford, emphasizing the importance of the study of habitats and the relations of organisms to them, and the necessity of the preservation of natural areas for the solution of the problems which will arise.

Section II. (pp. 6-53), entitled "Uses, Values, and Management of Natural Areas," deals with Artistic and Literary, and Scientific and Practical Uses and Values, Forces making for the Destruction or Preservation of Natural Areas, Interest and Management, Administration of Wild Life in State and National Parks, and the Duty of Scientific Men in Conservation.

Section III. (pp. 55-81), Original Biota of the Americas North of the Amazon, is a briefly descriptive list of the large ecological areas as regards the general character of the vegetation and the mammal- and bird-life.

Section IV., Natural Areas and Regions, occupies the greater part of the volume (pp. 83-720). The primary object is "to locate natural areas so as to make them available to Naturalists." The territory covered is divided into three sections: (1) Northern tundra and ice-covered regions and Northern coniferous forests; (2) Temperate America; (3) Tropical America, including the areas between the Southern United States and the Amazon River.

Under (1) are included Greenland (north-west and Danish), the American Arctic Archipelago, Labrador, Newfoundland, the Mackenzie Watershed, and Alaska. In each case are described the geology and physiography, climate, and the biota (plant and animal life), and information is given as to routes of travel.

The second section, which includes Southern Canada and the United States, gives more detail. A general account describes the original character of the territory; general physiographic features are described and geographic and local plant and animal communities briefly outlined. The original biotic conditions are then contrasted with the present modified condition. Specific descriptions of natural areas follow. All preserved areas and areas available for study, in natural condition, preserved areas in a semi-natural condition, such as forest-preserves, bird and game sanctuaries, and second-growth areas undergoing succession are included. A general grouping is adopted, namely:—A, chiefly comprises forest, including the Canadian provinces, the Pacific United States, and their National forests; B, chiefly Deciduous Forest—the eastern and east-central United States (in part); C, Deciduous Forest, South-eastern Coniferous Forest and large Swamp Areas—the Atlantic States from New Jersey to Florida and the south-eastern Central States; D, chiefly Oak-grove Savanna

Illinois, Iowa, Missouri, and Oklahoma; E, chiefly Grassland or Steppe; and F, chiefly Desert and Semi-Desert.

The accounts of the areas included in Section (3)—Mexico and Central America, Northern South America, and the Atlantic and Pacific Islands—are necessarily less detailed, and vary according to the information available. Here, as elsewhere in the volume, a guide to further information is supplied by local bibliographies, which might sometimes be more extensive. Thus Dr. Britton's useful bibliography on Porto Rico contrasts with the inadequate one on Jamaica, of two entries only, one of which is Goose (*sic*) Philip Henry, *Naturalist's Sojourn in Jamaica*; we have heard of a *Flora of Jamaica*, which, though incomplete, might be of some assistance.

Section V. is a List of Organizations interested in the preservation of Natural Conditions; and Section VI. comprises two indexes—namely, index of scientific and common names of birds, and index of authors and localities.

BOOK-NOTES, NEWS, ETC.

LINNEAN SOCIETY.—At the meeting on January 6, 1927, the President announced a vacancy in the List of Associates caused by the death of Miss Matilda Smith. The vacancy will not be filled until the end of the session in order to give Overseas Fellows an opportunity of nominating candidates.

The President (Dr. A. B. Rendle) showed a series of lantern-slides illustrating some of the early botanical collections from North and Central America contained in the Sloane Herbarium at the British Museum. These included a small collection of mosses and liverworts from Virginia by the Rev. William Clark (1729), and one of flowering plants from the same collector arranged in months according to the time of flowering; a collection by Joseph Lord from Carolina (1704) containing good specimens with neatly-written descriptive labels; extensive collections in Carolina and Virginia in 1710 and 1711 by John Lawson, Surveyor-General of North Carolina from 1701-11, who met his death in an expedition against the Indians in the latter year (many of the specimens bear Lawson's original labels with date, locality, and other information, and references to his book *New Voyage to Carolina* (1709)); examples from James Petiver's *Hortus Botanicus Americanus*, which was purchased by Sloane and forms part of his Herbarium—among these are specimens sent from the Scots settlement in Darien by Archibald Stewart, Surgeon (1699); and collections from Maryland by the Rev. Hugh Jones (died 1701), a resident in Calvert County, Maryland, and by William Vernon and Dr. J. Kreig, who made a joint expedition to Maryland (1698) and brought home a large number of plants which were catalogued by John Ray, some of whose annotations are preserved with the specimens; they were later named by Dr. Solander, in whose manuscripts are descriptions of the novelties. Photographs were also shown illustrating a collection by William Bartram (1739-1823) and containing specimens of the plants mentioned in his *Travels through North and South Carolina, Georgia, &c.* (1791).

Mr. Cecil Norman gave an account of a paper on the Pimpinellas of Tropical Africa. This genus of Umbellifere is well represented in Tropical Africa by about 25 species. It occurs in all parts of the tropical region, usually in open country at an elevation of not less than about 3000 ft., and it ascends as high as 10,000 ft. on the mountains.

With one exception all the species belong to the sub-genus *Eu-pimpinella*, and both sections of the sub-genus, viz., *Tragoselinum* and *Tragium*, are well represented. Again, with one exception, all the species are perennials or biennials, the exception being a delicate little annual from Eritrea. They are nearly always found growing amongst grasses in open country—there are frequent references to this on the collectors' tickets—they do not seem to occur in country that is at all densely wooded.

So far as it is possible to form an opinion, it seems that the species are restricted in range for the most part, the exceptions to this being *P. oreophila*, *P. Buchananii*, *P. simensis*, and, perhaps, *P. Volkensii*, which are very widely dispersed. Only one species seems to occur in Tropical and South Africa, and that is the common *P. caffra*, which reappears unexpectedly in Abyssinia.

Mr. Wilmott gave an account of his expedition to the Sierra Nevada of Spain with Mr. T. A. Loft-house last June. Lantern-slides showed the arid nature of the vegetation at both ends of the range, trees being almost absent except by the streams and in gorges. At the west end an ascent was made to over 9000 ft. towards the Veleta, which rises to about 11,000 ft. The snow was more abundant than usual and the season very backward, but many interesting plants were gathered. Ascents were also made to the Dornajo, a lower limestone ridge, from which Boissier described many new species gathered during his visit in 1837. Many of these were gathered on this excursion along the path followed by Boissier, including the rare *Convolvulus nitidus* from the summit of the ridge. The last hours of the descent into Guejar in the gorge of the River Genil was extremely steep but through open woodland. The journey to the eastern end was by *Correos motor-bus* via Lanjaron, Berja, and Laujar, and specimens were gathered at each of these places. Minas de Beires, a mining hamlet some 3000 ft. above Beires, was reached by mules, and a fortnight was spent at the manager's bungalow (5760 ft.) overlooking the Mediterranean near Almeria. This area seemed botanically unexplored, and many interesting plants were collected, many within a stone's throw of the bungalow. Ascending to the crest of the Sierra Nevada, a zone of *Erinacea pungens* occurs between 6000 and 7000 ft. and one of the spiny *Astragalus nevadensis* near the crest. The deep gorge of the River Ohanes contained several species not previously recorded so far south, e.g. *Pinguicula grandiflora*. Altogether nearly 3000 gatherings were made during the five weeks, and some long series of critical species were brought back to the Natural History Museum. A grant from the Trustees of the British Museum enabled Mr. Wilmott to undertake the expedition and to take advantage of the hospitality offered by Mr. Loft-house's friend at the mines.



ANNONA PIGMEA W. Bartr., upper figure.
ANNONA INCANA W. Bartr., lower figure.

WILLIAM BARTRAM AND THE GENUS *ASIMINA*
IN NORTH AMERICA.

BY A. W. EXELL, M.A., F.L.S.

(PLATE 581.)

AN examination, which Dr. Rendle asked me to undertake, of some specimens in the British Museum Herbarium, sent by William Bartram from the south-eastern United States towards the end of the eighteenth century, has raised several points of interest on the nomenclature of some species of *Asimina*, which were described by Bartram in his *Travels through North and South Carolina, Georgia, East and West Florida, etc.* (1791).

ANNONA PIGMEA Bartram.

William Bartram (*Travels*, 171) states: "... and I observed here in plenty the very dwarf decumbent *Annona*, with narrow leaves, and various flowers already noticed at Alatamaha (*Annona pigmea*).” This refers to a description on p. 18 of the same work, which reads as follows:—"In similar situations, and commonly a near neighbour to this new *Kalmia*, is seen a very curious species of *Annona*. It is a very dwarf, the stems seldom extending from the earth more than a foot or eighteen inches, and are weak and almost decumbent. The leaves are long, extremely narrow almost lineal. However, small as they are, they retain the figure common to the species, that is lanciolate, broadest at the upper end, and attenuating down to the petiole, which is very short; their leaves stand alternately, nearly erect, forming two series, or wings, on the arcuated stems. The flowers both in size and colour resemble those of the *Antrilobe**, and are single from the axillæ of the leaves on incurved pedunculi, nodding downwards. I never saw the fruit.” In the British Museum Herbarium are two specimens collected by Bartram which are undoubtedly the species here described. The one specimen is No. 22 in a small collection made by William Bartram entitled "Specimens of Trees Shrubs & Plants collected in Carolina Florida & Georgia 1773.4.5.6 with notes and observations." With the specimen is the following MS. description:—"Anona. This is undoubtedly the most diminutive Tribe of the Anona, the stems seldom extend above 12 or 15 inches, for the most part simple or undivided into limbs or branches; a many decumbent stems arise from one root or source diverging every way from the centre which bend down arch wise their extremities almost touching the earth. The leaves are extremely narrow almost linear. From their bosoms almost the whole length of the stem is produced a single nutant moderately large dull purple Flower; some are yellow, some red, and others almost white and they have an agreeable scent; I never saw the fruit. This curious shrub is an inhabitant of the hard sandy level humid Plains of Ft. Florida. Lat. 30." There can be no doubt that this specimen

* Probably *An. triloba*.

is the *Annona pigmea* described in the *Travels*. The other specimen, which is identical, was No. 2 in another booklet of William Bartram's collection, entitled "Book 1 Et. Florida No. 51. Plants." There is a drawing in Herb. Mus. Brit., among a collection of William Bartram's drawings made during his travels, numbered Tab. XVII. Fig. 2 (see fig.), corresponding to this plant, and at the beginning of the drawings and bound in with them is the following description of the drawing mentioned above:—"2 Anonm. Tab. XVII. Fig. 2. The flower & fruits much like the preceding species*, the petals are long narrow of a pale purple, the button containing the essential parts of fructification is large of a deep purple, as is the inside of the bottom of each Petala. The leaves long & extremely narrow. There rises a number of very slender stalks from a root inclining towards the Earth, which produce a great number of large pendant sweet Flowers fluttering in the wind."

Facing p. 17 in Bartram's *Travels* is a figure named ANONA PYGMEA, which has been the cause of the confusion which has later arisen as to the identity of *Annona pigmea* Bartram. The figure has leaves oblong to oblanceolate, and flowers with petals under 3 cm. long. It corresponds neither with the two specimens in Herb. Mus. Brit. collected by Bartram, nor with the descriptions on pp. 18 and 171 in Bartram's *Travels*, nor with Bartram's drawing in Herb. Mus. Brit.

Annona pigmea Bartram having been established as the species with long, very narrow leaves and large flowers, it remains to trace out its further history. The name was apparently first taken up by Willdenow (Sp. Pl. ed. 4, ii. (1800) 1268), but from his description and in particular from the words "Corolla campanulata magnitudine *A. squamosæ* . . ." it is evident that Willdenow was describing the small-flowered species with oblanceolate leaves figured by Bartram, and not the very narrow-leaved larger-flowered species which has been identified as *Annona pigmea* Bartram. Willdenow's citation can thus be dismissed as *Annona pigmea* Willd., non Bartram, nomen abortivum. Michaux (Flora Boreali-Americana (1803) 330) gives *Orchidocarpum pygmæum*, quoting as synonym *Annona pygmæa* Bartr. Trav. The description is insufficient to determine to what extent he went by Bartram's erroneous figure and to what extent he relied on the description in the text, but it seems likely that ". . . foliis prælonga lanceolatis cuneatisve . . ." is taken both from Bartram's description "The leaves are long, extremely narrow almost lineal" and from the figure in which the leaves are cuneate. The importance of this citation is not great, and it seems best to regard *Orchidocarpum pygmæum* Michx. as a name referring in part to one species and in part to the other. Persoon (Syn. Plant (1805) 95) quotes *Anon. pygmæa* Willd. p. 1268, Bartr. (*sic*) Trav. t. I. as a synonym for his *Porcellia pygmæa*. The description "fol. lanceolatis longissimis glabris . . ." tends to show that he was referring to the true *Annona pygmæa* Bartram. Dunal (Mon. de la Fam. des Anonacées (1813) 84) transfers the species, correctly, to the genus

* *Annona incana* Bartram.

Asimina, and his figure and description undoubtedly refer to the species originally described and collected by Bartram. The name therefore stands as *Asimina pygmæa* (Bartram) Dunal.

Asa Gray (Coulter Bot. Gaz. ii. (1886) 164) considering the broader-leaved smaller-flowered species figured in Bartram to be *Annona pygmæa* Bartram, and stating ". . . the figure and description both unequivocal" in spite of the fact that the description ". . . leaves long and extremely narrow" could never apply to the figure, redescribed the real *Annona pygmæa* Bartram as *Asimina angustifolia*. This must now be reduced to a synonym of *Asimina pygmæa* (Bartram) Dunal.

It now remains to find the correct name for the smaller-flowered broader-leaved species. It is proposed to call this *Asimina secundiflora* Shuttlew., a name which has up to the present been quoted only in synonymy. How this species came to be figured in Bartram's *Travels* instead of the plant which he had described, preserved, and drawn is difficult to conjecture; but it may be pointed out that the account of the travels was not published until 1791, while the journey actually took place in 1773-6.

ANNONA INCANA Bartram.

In Bartram's *Travels*, 171, is the following description:—"Of the low shrubs many were new to me and of a very pleasing appearance, particularly a species of Annona (*Annona incarna*, floribus grandioribus paniculatis;) this grows three, four or five feet high, the leaves somewhat cuneiform or broad lanciolate, attenuating down to the petiole, of a pale or light green colour, covered with a pubescence or short fine down; the flowers very large, perfectly white and sweet scented, many connected together on large loose panicles or spikes; the fruit of the size and form of a small cucumber, the skin or exterior surface somewhat rimose or scabrous, containing a yellow pulp of the consistence of a hard custard, and very delicious, wholesome food. This seems a variety, if not the same that I first remarked, growing on the Alatomaha near Fort Barrington, Charlotta and many other places in Georgia and East Florida. . . ." The word *incarna* is obviously a misprint or orthographical error for *incana*, the latter being the spelling which occurs in the synopsis of the contents of the chapters of the book, p. v of the introduction, the name referring of course to the "pubescence or fine down." The reference to the former collection at Alatomaha occurs on p. 18, *loc. cit.*:—"As soon as I had lost sight of the river, ascending some sand-hills, I observed a new and most beautiful species of Annona, having clusters of large white fragrant flowers. . . ." The two specimens corresponding to these two collections made by Bartram are in Herb. Mus. Brit. The one specimen was No. 23 in the book of Specimens of Trees Shrubs & Plants, already mentioned, and with it is the following MS. description:—"No. 23 Anona. This fine flowering shrub is like wise stoloniferous, sending upwards a many divergent stems from the same source, rising 5, 7 feet high, dividing alternately into several branches, which subdivide again, which terminate with

very showy panicles or clusters of very large snow white flowers, of an agreeable sent, these flowers are succeeded by large oblong or kidney form berries, or fruits, the skin or rind of which are scabrous & contain several large compressed seed immerst in a soft yellowish delicious pulp somewhat of the consistence and Taste of a hard custard. They are eaten by the Indians & other Inhabitants: the White people call them Custard apples; I have frequently eat of this delicious fruit & found them nourishing and inocent.—It is an inhabitant of the barren Sandhills; & near the high banks of Rivers. So. Georgia & Et. Florida. Lat. 28, 29, 30, 31."

The other specimen was No. 1. in Book 1. Et. Florida. Both specimens have now been laid into the general collection in Herb. Mus. Brit.

There is also among William Bartram's drawings in Herb. Mus. Brit. a drawing of this species numbered Tab. XVII. Fig. 1 (see fig.), and with the following MS. description:—"No. 1. Papaw apple Anona Tab. XVII. Fig. 1. This elegant Shrub grows 8 or 10 feet high, the leaves of a light green colour. Flowers large & white produced in clusters. Fruits when ripe is large of an oblong form the pulp soft & yellow of an agreeable fragrance well tasted, and are commonly eaten."

There can be no doubt that this species, of which the two specimens are in Herb. Mus. Brit. in good condition, was adequately published as *Annona incana* Bartram. Once more confusion has arisen owing to the fact that in Bartram's *Travels*, opp. p. 20, there is a plate, this time correctly figuring the species in question, but with the name *Anona grandiflora*. This plate is not an engraving of Bartram's drawing in Herb. Mus. Brit., nor, apparently, an adaptation from it. As the name *Annona grandiflora* was in any case already occupied (*Annona grandiflora* Lam., Ins. Mascar.; Madag.), this species must now be called *Asimina incana* (Bartram). Dunal (Mon. Fam. Anonac. (1813) 84) first transferred the species to the genus *Asimina*, and it was known as *Asimina grandiflora* (Bartram) Dunal until Nash (Bull. Torr. Bot. Club, xxiii. (1896) 239) pointed out that this name was invalid owing to the earlier *Annona grandiflora* Lam., and proposed the name *Asimina obovata* (Willd.) as the oldest one available, ignoring, however, that the species had been originally described by Bartram as *Annona incana*, although it was figured as *Anona grandiflora*.

It seems desirable to reprint, with the necessary corrections, the useful key to the genus *Asimina* given by Small (Fl. S.E. Unit. Stat. (1903) 447), including at the same time various alterations in nomenclature made by Robinson (Syn. Fl. N. Amer. i. pt. 1 (1895-7) Suppl. 464) which seem to have been overlooked, and a new species recently described by Small.

I. Perianth trimerous.

- A. Flowers terminal, or from the axils of the leaves of the season, appearing after the leaves.
 a. Flowers axillary (except rare cases in No. 1), long-pedicelled; leaf-blades long and narrow, linear or oblanceolate.

- Mature outer petals 3.5 cm. long or longer, white or yellowish-white at maturity..... 1. *A. pygmaea*.
 Mature outer petals 3 cm. long or shorter, deep purplish-black at maturity.
 Petals oblanceolate or narrowly obovate, the outer 2-3 cm. long [flora.]
 Petals oblong, all nearly alike, 6-8 mm. long 2. *A. secundiflora*.
 3. *A. Rugelii*.
 b. Flowers terminal, sessile or nearly so; leaf-blades short and broad, obovate or oval..... 4. *A. incana*.
 B. Flowers from the axils of the deciduous leaves of the preceding season, appearing before the leaves.
 a. Leaves leathery; leaf-blades reticulated; flowers yellowish-white, 1 or 2 in an axil.
 Young leaves densely tomentose on both surfaces; mature outer petals 4-5 cm. long 5. *A. speciosa*.
 Young leaves sparingly tomentose, the upper surface soon glabrous; mature outer petals 2.5-4 cm. long. 6. *A. reticulata*.
 b. Leaves membranous, blades not reticulated; flowers purple, solitary in the axils.
 A shrub mostly less than 1.5 m. tall; mature outer petals 1 cm. long or shorter; fruit 3-4 cm. long ... 7. *A. parviflora*.
 A shrub or tree 3-12 m. tall; mature outer petals 2 cm. long or longer; fruit 7-16 cm. long 8. *A. triloba*.
 II. Perianth tetramerous..... 9. *A. tetramera*.

1. ASIMINA PYGMÆA (Bartram) Dunal. *Annona pigmea* Bartram (*Travels*, 171); *Orchidocarpum pygmæum* Michx. pro parte; *Porcelia pygmæa* Pers.; *Asimina angustifolia* A. Gray; non *Anona pygmea* Bartram (*Travels*, tab. opp. p. 17); nec *Asimina pygmæa* A. Gray.

2. *Asimina secundiflora* Shuttlew. nom. nov. *Anona pygmea* Bartram (*Travels*, tab. opp. p. 17); *Orchidocarpum pygmæum* Michx. pro parte; *Asimina pygmæa* A. Gray. Type-specimen:—Rugel No. 10 in Herb. Shuttleworth, in Herb. Mus. Brit., in pine-woods near Jacksonville and Smyrna, E. Florida, April-May, 1848.

3. ASIMINA RUGELII Robinson. *Asimina reticulata* Shuttlew.

4. *Asimina incana* (Bartram), comb. nov. *Annona incana* Bartram (*Travels*, 171); *Anona grandiflora* Bartram (*Travels*, tab. opp. p. 20); *Annona obovata* Willd.; *Asimina obovata* Nash. Type-specimens:—Bartram No. 23 in Specimens of Trees Shrubs & Plants; Bartram No. 1 in Book 1. Et. Florida. Both in Herb. Mus. Brit.

5. ASIMINA SPECIOSA Nash. *Asimina grandiflora* (Michx.) A. Gray.

6. ASIMINA RETICULATA Chapman. *Asimina cuneata* Shuttlew.; non *Asimina reticulata* Shuttlew.

7. ASIMINA PARVIFLORA (Michx.) Dunal. *Orchidocarpum parviflorum* Michx.

8. ASIMINA TRILOBA (L.) Dunal. *Annona triloba* L.

9. *ASIMINA TETRAMERA* Small. I have not seen any material of this interesting new species collected near the estuary of the St. Lucie River, Florida, and described in *Torrey*, xxvi. 56 (1926).

... EXPLANATION OF PLATE 581.

The Plate is a photographic reproduction of William Bartram's original drawings in the Department of Botany, British Museum (Nat. Hist.): the reproduction is half the original size. The upper figure is *Annona pigmea* Bartram; the lower is *Annona incana* Bartram.

THE FLORA OF ASTURIAS.

By THE REV. T. STEPHENSON, D.D.

THE Pyrenees are continued due west along the North of Spain by the long line of the Cantabrian Mountains, which run from about thirty to fifty miles from the northern coast, widening into a number of small ranges in Galicia. At the same time lesser ranges run roughly parallel with the coast, very near to the sea. The result is that all along this narrow belt, with the Bay of Biscay to the north and the mountains to the south, there is a moist and comparatively cool climate, very different from that of the rest of Spain. In fact, both flora and climate are very much like those of England, and most of the common English plants are common here also.

During most of June last, by the favour of a grant from the Royal Society, I was able to explore a good deal of Eastern Asturias, which is one great tangle of mountains, pierced by river-gorges of surpassing beauty. At about five miles from the coast, and something over twenty miles long, runs the perfectly saw-edged Sierra de Cuera, whose highest points are a little over four thousand feet in height. South and slightly west of this, and about eighteen miles from the coast, is the magnificent *massif* of the Picos de Europa, of which several summits are above eight thousand feet in height. The most striking of them, the Naranco de Bulnes, rises in a steep and picturesque cone, somewhat resembling the Matterhorn.

In this region the rock-strata are twisted and contorted in the most extraordinary way. The oldest rock is white Ordovician sandstone, which alternates with other formations in narrow belts and curves, roughly parallel with the coast. The main bulk both of the Sierra de Cuera and the Picos de Europa consists of Dinantian limestone of Permian age*. This runs out in a series of low cliffs along the coast; and the great bulk of the plants found were on this limestone. Above the limestone are a good many enclaves belonging

* "On pourrait donc dire de toutes ces sierras de l'Orient des Asturies, qu'elles sont comme les ondes pétrifiées du dynamisme permien qui eut un foyer convulsif dans les proximités des Monts Cantabres" (XIV^e Congrès International de Géologie, Madrid, 1926. Los Asturias, p. 87). At the same time, the main upheaval was, no doubt, in some post-Eocene period.

to the coal-measures. On the lowest level there is a long strip of Upper Cretaceous clay, also parallel with the coast, very narrow in the east, but widening considerably about Oviedo. Great numbers of Marsh Orchids were found along this belt; but otherwise the limestone flora was far more interesting.

On the lower slopes of one of the great buttresses of the Picos de Europa, and lying north-west of them, Covadonga provides a unique centre for exploration, and here most of my work was done. Memorable as the place where the Christian reconquest of Spain began, the Sacred Cave and chapel attract many pilgrims. The fine basilica, built on an outstanding mass of limestone over two hundred feet high, gives distinction to an incomparable situation. There is a first-rate hotel, and every facility for those of many interests, whether for fishing, hunting and mountain-climbing, or for the geologist and botanist. The place ought to be better known in England. To reach it overland involves a complicated journey; but it is only about six hours' journey from Santander, at which port some of the great liners from England call. About Covadonga the slopes are often densely wooded, the commonest trees being Chestnut (*Castanea*), Alder, Cherry, Ash, Beech, Sycamore, Plane, Firs (not in any quantity), and various kinds of Oak. Smaller trees include Hawthorn, Hazel, Holly, Elder, much Dwarf Elder, Privet, Laurel, and Euonymus. On the lower levels there are a great many Chestnuts, but all I saw had a rather gnarled and stunted growth, reminding one of the English oaks. In late June the children were feasting on the delicious black cherries. Eucalyptus, of two or three sorts, is planted a good deal, for timber, and grows freely and well. Poplars are kept regularly stripped, except for a wisp at the top, and the young branches fed to cattle. The hillsides are steep and the valleys narrow, so that there are not many large fields, and the limestone outcrops divide the slopes naturally into terraces. Wherever possible the smallest patches are cultivated, the crops being chiefly of hay and maize. In early June the women and girls were everywhere hoeing the maize: in the wildest and most unexpected places one would find them at work. In these fields *Oxalis violacea* is a very persistent weed, sometimes covering the whole ground. Apple-trees also do well, and this is a great cider country.

On the limestone escarpments and terraces north of the Sella, at Villanueva, along with many common British plants, there was great plenty of a fine red form of *Anthyllis Vulneraria*, with *Sideritis hysopifolia* and *Teucrium pyrenaicum*. This last, with its compact habit and pretty rosettes of white and lilac flowers, would be an attractive plant for rock-gardens. These three species were also found at Llanes, by the sea, the *Anthyllis* being much shorter and of a very dark red. Other species noted were *Campanula Erinus* and *Ulciorrhinum origanifolium*, both of which are widely distributed.

Orchids were plentiful—*Serapias cordigera* in great abundance, *S. lingua*, *Ophrys apifera*, *Anacamptis pyramidalis*, and *Gymnadenia conopsea*. In the valley were a great many of the Spanish Marsh Orchis, *Orchis Durandii* B. & R., growing with

quite typical *O. elodes*: there were a few hybrids. Near Cangas de Onis were *Campanula patula* and *Lythrum acutangulum*, both fairly widespread.

Around Covadonga there is a great wealth of species. *Helleborus foetidus*, with some *H. viridis*, grows in amazing quantities to at least 3000 feet. In the meadows is a fine form of *Aquilegia vulgaris*. On the rocks, *Arabis alpina*, *A. Turrita*, *Nocca Auerswaldii*, *Petrocoptis Lagascae*, *Saxifraga Geum*, *Linaria faucicola*, *L. triornithophora*, and *Antirrhinum Huetii*, a handsome cream-coloured form found in all the river-gorges. *Lithospermum prostratum* is everywhere, and was seen all along the railway in the North of Spain. *Erinus alpinus* about Covadonga is of the typical tomentose, and much the prettier, form. At about 2000 feet it is replaced by the var. *glabratus*. Other plants are *Sisymbrium austriacum*, *Erysimum ochroleucum*, *Linum viscosum*, all widely distributed; *Orobanchis niger*, *O. montanus*, *Eryngium Bourgati*, very handsome with its white-veined leaves, and also found by the sea; *Astrantia major*, most plentiful; *Asperula aristata*, *Centranthus Calcitrapa*, *Dabeocia polifolia*, *Pinctosoricum officinale*, *Scrophularia Scorodonia*, *Pinquicula grandiflora*, *Lamium maculatum* near farm-houses; *Prunella grandiflora* almost everywhere; *Lilium Martagon* and *L. pyrenaicum*. *Laserpitium latifolium* was one of the very few Umbelliferae in fruit in June. *Hieracia*, except *H. pilosella*, were conspicuous by their absence.

Of the Orchids, *Ophrys apifera* was growing perched on tiny ledges of the rock-face. On the grassy slopes on the south side of the valley was *Orchis Fuchsii*, exactly like the taller British form. It was abundant for about a mile, but I saw it nowhere else. There were also *O. Durandii*, *Platanthora bifolia*, but not *P. chlorantha*, as far as I saw; *Ophrys scolopax*, not plentiful, but widely distributed; *Listera ovata* and *Epipactis palustris*. The growth upon the upland meadows is nothing like as lush and varied as amongst the Alps, but the orchids are a wonderful sight. There are countless thousands of *Orchis elodes*, of the slender form familiar on English heaths, with *Serapias cordigera*, *Anacamptis pyramidalis*, and *Gymnadenia conopsea*. Yet, though individuals are so numerous, I did not light upon a single hybrid, except of *Orchis Durandii* with *O. elodes*.

Higher up, towards the little lakes Enol and Encina, which are about 3200 feet above sea-level, a few of the mountain-plants were *Potentilla frigida*, *Reseda glauca*, *Alchemilla alpina*, *Genista hispanica*, *Saxifraga aizoon*, *Valeriana montana*, *Senecio spathulifolius*, *Globularia nudicaulis*, and *Gentiana acaulis*, whose flowers were over. Close to the lakes there is a manganese mine, worked by a British company. The ore is washed before being sent down in cradles to Covadonga, a few hundred feet below, on the margin of a swampy hollow called Comeya, no doubt once a lake. Here was found, growing with quantities of *Caltha palustris* and *Polygonum Bistorta*, a good-sized colony of *Orchis incarnata* with purple flowers, the plants being of the average height of 2 dm. This was the only

place where this species was seen, and it appears to be very rare south of the Pyrenees. Here also was growing a belated flower of the charming *Narcissus Bulbocodium*. I was told that the Narcissi near the lakes are very fine in spring, many growing in situations where they never get a ray of direct sunlight.

In the gorge of the Sella, south of Cangas de Onis, the following plants were noted:—*Thalictrum saxatile*, *Dianthus monspessulanus*, *Saxifraga canaliculata*, which also grows near the lakes; *Anarrhinum bellidifolium*, *Prunella laciniata*, *Euphorbia verrucosa*, and *Smilax asper*. This last is widespread, and had green berries in June.

In the splendid gorge of the Cares, towards Camarmeña, were the following:—*Iberis Tenoreana*, *Veronica Teucrium*, and *Digitalis parviflora*, of a dull brown colour, about the ugliest flower I ever saw. Here also is a *Crepis*, which awaits description by Mr. C. C. Lacaita, who found it a year ago. It also grows on the coast of Llanes. In a very wild part of the mountains were some luxuriant plants of *Solanum nigrum*, looking, I thought, very much out of place.

The last few days were spent at Llanes, by the sea. Here the coast consists of a series of low limestone cliffs, cut into by many small bays and coves, whose sands are generally covered at high water. Familiar British sea-plants were found, such as *Glaucium luteum*, *Eryngium maritimum*, *Euphorbia portlandica*, and *Armeria maritima*, a form with very pale flowers. At one spot there were plenty of *Ononis reclinata* and *Linaria supina*, a very pretty form, well worth cultivating. The only Orchid was *Serapias cordigera*. More inland were *Malva silvestris*, *Campanula glomerata*, *Erica vagans*, *E. ciliaris*, *Euphorbia pilosa*, and *E. angulata*.

The ferns about Covadonga are very plentiful, and as Spain as a whole has a great many non-British species, I anticipated making the acquaintance of some new forms: however, I saw nothing that is not British. Here is the list: *Adiantum Capillus-Veneris*, rather plentiful in rock-clefts; *Pteris aquilina*, abundant; *Blechnum spicant*, *Asplenium adiantum-nigrum*, *A. marinum*, at Llanes; *A. Trichomanes*, very abundant and attaining the length of nearly 4 dm.; *A. ruta-muraria*, *Athyrium Filix-femina*, *Phyllitis Scolopendrium*, plentiful; *Cystopteris fragilis*, scarce; *Polystichum aculeatum*, *P. angulare*, very abundant; *Lastrea montana*, *L. Filix-mas*, not very common; *L. rigida*, one plant; *L. aristata*, one plant; *Polypodium vulgare*, plentiful; and *Phegopteris Robertiana*, abundant on high levels. Of grasses and sedges I made no collection, but I saw very little that is not British.

The most interesting plant of the region, perhaps, is *Petrocoptis Lagascae* Wk. The genus is Pyrenean. Its forms are *P. pyrenaica* A. Br., (a) *gallica* Wk. and (b) *hispanica* Wk., and *P. Lagascae* Wk. *P. Lagascae* grows on the mountains of Asturias and Leon. These forms are fully described and figured by Willkomm, *Icones et Descriptiones Plantarum Novarum* . . . præcipue Hispaniæ, vols. i., ii., Lipsiæ, 1852-1861. It should be noted that in the plate of *P. Lagascae* the leaves are coloured a bright blue! The genus is near to *Silene*, but with entire, cuneate petals, with a long limb, and rather long, narrow,

tongue-shaped processes at the top of the limb. *P. Lagaſcæ* has flowers at least twice as large as those of *P. pyrenaica*, about 15 mm. across, varying in colour from bright pink to pure white. The leaves are narrow-spathulate, with long petioles and a fine point, in colour green or glaucous, rather coriaceous, and drying often to pink or violet tints. The habit varies a good deal according to the situation, from compact tufts of about 1.5 dm. in diameter to straggling sprays of 3 dm. or more. The stems are furnished with small, opposite, oval-lanceolate leaves. The plant grows in crevices of the limestone, and the smooth, somewhat reniform seeds are furnished with a white feathery tuft, evidently to prevent rolling away from the tiny cracks in which they lodge. The forms with compact habit and bright pink flowers would grace any rock-garden, and should be very easy to grow. The plant is plentiful at Covadonga, and is to be found in the gorges of the Sella and Cares.

My chief objective was concerned with the Marsh Orchids. These were most abundant, but, apart from the one little colony of *O. incarnata* at Comeya, all of one sort, *Orchis Durandii*. It belongs to the *O. sesquipedalis* group, and is very near to the type, which was described from the Charente region in a paper in Journ. Bot., April 1925 (p. 93). Amongst the hills it grows in damp places up to about 2000 feet, often, but by no means always, associated with *O. elodes*. The average height is about 3 dm. It grows by the Sella to its mouth at Ribadesella, and I saw it and examined it as far west as Oviedo, growing in damp meadows in great numbers. I hope after next season's flowering to write a detailed note upon the form, about which there are a good many points that are not easily cleared up.

Upon the whole, I was surprised *not* to find a trace of some of the orchids which are plentiful in Southern France, especially as the district is a limestone area. I saw nothing of *Orchis laxiflora*, *O. palustris*, or *O. militaris*, *Ophrys aranifera*, *O. arachnites*, *Cephalanthera longifolia*, *C. rubra*, or *Himantoglossum hircinum*, nearly all of which are plentiful in the Charante region in Southern France.

I am greatly indebted to Mr. A. J. Wilmott for identifying most of the plants named above.

NOTES ON THE GENUS *CAREX* OF THE 'LONDON CATALOGUE,' II Ed.

By ARTHUR BENNETT, A.L.S.

THE genus in Great Britain has species that, considering their southern range in Europe, are unique.

C. AQUATILIS Wuhl. is unknown elsewhere south of 59° N. lat. Yet in Ireland it occurs at the head of Lough Caragh, Kerry (*R. W. Scully*), at 52° 10' N. lat. And these Kerry specimens have the colour of the basal portion just as in *C. kattedgensis* Fr., deep

blackish-brown shading off into reddish-brown—so different from the green of the Limerick specimens. I have tried several times to separate these southern forms from the boreal, but can find no valid reason for so doing; certainly the Kerry specimens are very regular in the arrangement of the fruits and glumes. *C. kattedgensis* Fr. reaches its southern limit in the Beuly Frith in 57° 30' N. lat. In Europe it is not recorded south of 59° N. lat. Why this should be I cannot suggest, unless they were carried south during Glacial Periods. A peculiar extension the reverse way, namely northwards, is found in *Orithimum maritimum*; there are in Europe no records north of 51° N. lat. But on the cliffs of Mangustra, north of the island of Eileen Moloch, on the west side of Lewis, Outer Hebrides, it occurs at 58° 5' N. lat.

C. DIVISA L. A closely-allied species, sometimes regarded as a variety of this—i. e., *C. setifolia* Godr. * (*C. chaetophylla* Steud.),—has been recorded, but usually with some doubt; but C. B. Clarke thought the Seaford, Sussex, specimens rightly named.

C. VULPINA L. var. *LITORALIS* Nolte. This having been named by Kukenthal, I thought there must be some real difference from the typical form; but the name should be erased. Looking it up in Prahl's Fl. Schlesv.-Holstein, I found he simply says "eine kleine Form." To have a series of small forms would increase our list to no useful purpose.

C. ELONGATA L. var. *UMBROSA* Kneuch. This is a woodland form. found in Suffolk and Norfolk.

C. AQUATILIS Wuhl. The first mention of this as a British species under the name *aquatilis* was in Hooker's Brit. Fl. ed. 3, 404 (1835). He there says of the Clova plant: "This Dr. Greville has ascertained, on comparison with a Lapland specimen from Dr. Fries, to be identical with the *C. aquatilis* of Wahlenberg." Yet in the 5th ed., 427 (1842), he remarks: "Dr. Boott is led to doubt if this really be the *C. aquatilis* of Wahlenberg." It was first gathered in Scotland about 1824 by W. J. Hooker, W. S. Burchell, and R. K. Greville. I have one of the original specimens gathered by Dr. Greville, and others by Dr. Wright in 1831.

C. AQUATILIS × *GOODENOVII*. Specimens gathered by E. S. Marshall were confirmed by Kukenthal.

C. GOODENOVII × *RIGIDA* (*concolor*). This has been found in several places in the Highlands. *C. Goodenovii* ascends to 3250 ft. (*Macvicar*), and *C. rigida* descends in Sutherland to 1400 ft.

A very interesting and critical plant from "Swamp near White Water (c. 2300 ft.), Clova, Forfar, 1904. E. S. Marshall" is

* There are two other species so named: *C. setifolia* Kunze (Chili); *C. setifolia* Dewey (U.S.A.).

named by Kükenthal "*C. Goodenovii* × *rigida* forma super-rigida, and is a very critical plant." In appearance it is very like *C. hibernica* (*C. Hudsonii* × *aquatilis* A. Benn), on a small scale. Mr. Marshall calls it "a charming little sedge."

C. GOODENOVII Gay var. *TORNATA* (Fr. Mant. 3, 154, 1842, sub *vulgaris*). I do not think the description has been given in any British book, namely "densissime cuspidata, crassa, rigida, foliis latis planis, spicis spissis."

There are some varieties of *Goodenovii* that are not listed that may be mentioned here: "v. *bulbosa* Meinhäuser, Fl. Ingrica, 409 (1878), v. *pumila* A. et G. Syn. ii. 2, 1898?" Marshy spot near shore, Fairlie, Ayr (1896), A. Somerville. This is exactly analogous to *C. glauca* γ. *bulbosa* Drejer, Symb. Curicol. t. vi. 20 (1844), where Drejer quotes as syns. "*C. bulbosa* Vahl herb., *C. trinervis* Thomas, ad *C. trinervis* accedens." This Fairlie plant is a very odd one with the spikes agglomerated, the female ones very thick and closely packed; the fruits are subrotund. Another plant from the "Western side of Great Cumbrae, v.c. 100 (1899), A. Somerville" strongly simulates *C. rigida*, with very long styles, female spikes 5 cm. × 5 mm., glumes black with a faint green centre. Yet another, "Frimley, Surrey (1898), E. S. Marshall," named "var. *juncella*," has female spikes 4 cm. × 2.5 mm. and male spikes the same. Even the male spike is symmetrically arranged, a rare thing in *C. Goodenovii*.

C. RIGIDA Good in Trans. Linn. Soc. ii. 193 (1794). Mr. Fernald, of the Gray Herbarium, U.S.A., in his *Persistence of Plants in Unglaciated Areas of Boreal America*, p. 267 (1925), uses the name *C. concolor* R. Br. in Supp. App. Parry's Voyage, 218 (1823), for *C. rigida*. And it seems he is right, since *C. rigida* Schrank. Baier. Fl. 290 (1789) is the valid name for *C. firma* Host. Gram. i. 56 (1801).

C. INTERMEDIA Mieg. Richter, in his Pl. Europ. t. 150 (1890), places this under *C. vulgaris* Fr., with which it has no affinity. The late Mr. C. B. Clarke and I looked up Miegervillo's specimens at Kew, and there is no doubt it is the same as Mr. Marshall's specimens, and a form of *panicca*, towards *vaginata*; it was so named by a continental botanist.

C. CAPILLARIS L. Blytt, in his Norges Fl. i. 244 (1861), has a var. *major*, and some of our specimens accord with it.

C. DISCOLOR Nyl. Spic. Fl. Fenn. iii. 12 (1866). *C. epigejos* Fries (non Laest.). Laestadius described his plant in Act. Holm, 339 (1822), as *C. aquatilis* β. *epigejos*. Fries described his species in Bot. Not. 105 (1843), and added a note on it at p. 120 (1845). He again did so in Summa Veg. Scand. 233 (1846), where he quotes Nylander as remarking "In vivo comparata *C. aquatilis* eximie differt." Fries quotes, "p. 105," this is an error, the correct reference being Nyl.

Spicileg. Pl. Fenn. Cent. Alt. p. 23, no. 52. Fries also quotes under his *epigejos* "*C. aquatilis* Hooker, Brit. Fl. 4, 336." The date of this ed. is 1838. This is curious, because it evidently came from the region where Dr. White gathered his specimens of *discolor*.

C. FULVA × *LEPIDOCARPA* = *C. Lentzii* A. et G. Syn. ii. 2, 206 (1903).

C. FULVA × *EDERI* = *C. Appeliana* Zahn in Österr. bot. Zeitschr. xl. 364 (1890).

C. FULVA × *FLAVA* = *C. xanthocarpa* Degl. in Lois. Fl. Gall. ii. 299 (1807).

C. FLAVA × *EDERI* = *C. alsatica* Zahn, loc. cit. 363.

C. FLAVA × *SAXATILIS* = *C. Marshallii* A. Benn.

C. RIPARIA × *VESICARIA* = *C. Osomadensis* Simonkai, Enum. Pl. Transs. 556 (1886).

C. INFLATA Huds. Under this I placed as a variety *C. utriculata* Boott, which is the Irish plant I wrongly referred to *C. rhyrachophysa* Meyer, and which is neither var. *robusta* Sonder, var. *elatior* Blytt, nor var. *latifolia* Asch.; these are merely forms of *inflata*. In 1886, Bailey (Proc. Am. Acad. p. 67) regarded this as a var. of *riparia*. But in 1889, in "Studies of the Types of *Carex*," p. 59 (Mem. Torr. Bot. Club, i.), he accepted it as a species. Kükenthal named the Irish plant, and it certainly stands apart from the other varieties of *C. inflata*.

C. SAXATILIS L. var. *GLOMERATA* Ewing. It seems that Mr. Ewing was right in separating this. It has quite the look of small specimens of *C. atrata* L., and grows in Scotland on Ben Lawers, Craig Mhor, Glen Lochay, and Beinn Heagsarnich.

LIST OF RELEVANT PAPERS.

- BENNETT, A. Notes on British Plants. *Carex*. Journ. Bot. 1897, 244, 259.
 MARSHALL, E. S. Notes on some British Sedges. *Ibid.* 1898, 73.
 SALMON, C. E. *Carex* Notes. *Ibid.* 1906, 224.
 BENNETT, A. The Genus *Carex* in Britain. Trans. Bot. Soc. Edinb. 1910, 77.
 BENNETT, A. *Carex aquatilis* and its Scottish Forms. *Ibid.* 86.
 DRUCE, G. C. Critical Remarks upon the Cyperaceae-Caricoideae as treated in *Das Pflanzenreich* by G. Kükenthal. Ann. Scott. Nat. Hist. 1910, 46.
 BENNETT, A. Notes on the Review of Kükenthal's *Carex*. *Ibid.* 111.
 BENNETT, A. Notes on British Carices. Trans. Bot. Soc. Edinb. 1925, 127.

NOTES ON PAPERS OF INTEREST TO STUDENTS OF THE BRITISH FLORA.

THE DISTRIBUTION OF CERTAIN MEMBERS OF THE BRITISH FLORA. III. (*Annals of Botany*, xl. (1926)).—Mr. J. R. Matthews makes a third contribution to this study. The previous contributions dealt with (I.) "Plants restricted to England and Wales" (*Ann. Bot.* 1923); (II.) "Plants restricted to Scotland, England, and Wales" (*Ann. Bot.* 1924). The first part of the present paper deals with "Irish and Anglo-Irish Plants," while the latter part contains a general discussion of the data brought forward in all three papers and the conclusions arrived at from the study of them.

The distribution of the Irish and Anglo-Irish Plants is presented cartographically along the lines adopted in the two previous papers. It is pointed out that the Hibernian plants, which form a small but puzzling group, are, with a few exceptions, outlying members of a South European stock, which, taken as a whole, forms a well-defined element in the flora of Britain—an element that has been fully described by Dr. Stapf. A map shows that these members, although absent from England, are connected with their main continental area by a series of progressive steps. The mass distribution of the Anglo-Irish group, numbering 68 species, indicates a general prevalence in France and South Europe. In England the south and south-east counties show the greatest density, while in Ireland the distribution is rather uneven. The range of the rarer species of this group points to a close connection between South-East Ireland and South-West England.

In the general discussion which follows, the conclusion arrived at is that, excluding the arctic and boreal elements, the British flora is the resultant of numerous invasions from the mainland, coming from different directions. These invasions may be traced clearly in the several distribution maps present in these papers. Five invasions are defined which have shared in the building of our flora over a long period subsequent to the time of maximum glaciation. These invasions should be envisaged as a whole, as one migration merges into another and so tends to obscure the working of the "Age and Area" principle. The invasions reaching the South-West of England and Ireland are regarded as the beginning of the re-immigration process, but they merge into later invasions from the south-east. The preponderance of the Central European element in our flora is accounted for by a prolonged invasion from the south-east becoming the dominant one.—D. POWELL.

MR. MAGNUS SPENCE'S HERBARIUM.—We are indebted to Col. H. H. Johnston for a reprint from *The Orcadian* of July 8th, 1926, giving an account of the presentation of the above Herbarium to the Orkney Natural History Society by Mrs. Work, of Kirkwall, a daughter of the late Mr. Spence.

The Herbarium, which now finds a home in the Stromness Museum, is a valuable acquisition, containing 406 different species of flowering

plants and higher cryptogams. These form 71 per cent. of the 572 species recorded in Mr. Magnus Spence's *Flora Orcadensis*, published in 1914; but the *Flora Orcadensis* contains several species erroneously or doubtfully recorded by various botanists from Orkney. Mr. Spence's Herbarium also contains specimens of several species which are not included in the Flora; and some of these are new records.

The Herbarium is enriched by valuable notes on many of the sheets by Mr. Arthur Bennett and other experts, and has been arranged by Col. H. H. Johnston, C.B.

A short appreciation of Mr. Spence's work will be found in the *Journal of Botany*, 1919, the year of his death (p. 293). A notice of his *Flora Orcadensis* appeared in the *Journal* in 1914 (p. 222).

ADDITIONS TO THE FLORA OF ORKNEY (*Trans. Bot. Soc. Edinb.* xxix. (part 3) 297-307 (1926)).—This paper forms a continuation of eight papers by Col. H. H. Johnston on additions to the Flora of Orkney not recorded in the second edition of Watson's *Topographical Botany*. Among the additions are:—

Rosa omissa Desegl., var. b. *Sherardi* Wolley-Dod, forma *submollis* Wolley-Dod—between Lee Craig and Stanger Head, Flotta.

Hieracium silvaticum Gouan var. i. *subtenuis* W. R. Linton—Trowie Glen, Hoy.

The following segregates of *Taraxacum officinale* Wiggers:—Group V. *Spectabilia*—*T. faeroense* Dahl. forma *angustifolia* Dahl.; *T. nevosum* Dahl. forma *crocatum* Dahl. Group VI. *Vulgaria*—*T. cyanolepis* Dahl. *T. hamatifrons* Dahl., n. sp., *T. tanylepioides* Dahl., n. sp., and *T. orcadense* Dahl., n. sp.

Carduus palustris Linn. var. b. *ferox* Druce—Naversdale, Orphir, Mainland. *Potamogeton perfoliatus* Linn. var. *rotundifolius* Wallr.—Loch of Saintear, Westray. *P. heterophyllus* Schreb. var. *paucifolius* (Opiz)—Loch of Harray, Sandwick. *P. nitens* Weber var. *d. curvifolius* (Hartm.)—Loch of Rango, Sandwick. *Sclerochloa maritima* Lindl., subvar. *subcaespitosa* Druce—west side of Aith Hope, Hoy.

There are also the following Cryptogams:—*Chara muscosa* Groves & Bullock-Webster—Loch of Rango, and, in the same Loch, *C. contraria* Kützing, *C. aspera* Willd., and *C. desmacantha* Groves & Bullock-Webster.

In the same issue of this Journal are "Notes on Fife and Kinross Roses," by Mr. J. R. Matthews (219-225), and by the same writer a "Note on the Flora of Salisbury Crags" (226-229), which includes a list of the species recorded thence in the 18th Century.—C. E. S. & E. G. B.

THE GENUS *HIERACIUM*.—Students of this genus will find much of interest in K. H. Zahn and H. Romieux's article on "*Hieracium nouveaux de Suisse et de France*" in *Bull. Soc. Bot. Genève*, xviii. fasc. i. 145-155, Jan.-June 1926.—C. E. S. & E. G. B.

OBITUARIES.

REGINALD W. PHILLIPS

(1854-1926).

ON the 2nd of December last there died at Leominster one who had done a great deal for the higher education in Wales, and particularly for the study of Botany. The late Professor Phillips was born at Talgarth, in Breconshire, on October 15th, 1854. At that time the facilities offered to Welsh children for obtaining higher education were few, and so expensive as to be quite out of the reach of all but the well-to-do. For this reason one finds that many who subsequently became leaders of thought in Wales had, like Phillips, to start their scholastic careers by serving apprenticeships as pupil teachers in elementary schools. During 1873-4 Phillips took the course of training at the Bangor Normal College, where his natural abilities soon placed him at the top of his class. Though at that time the range and standard of work in many of the subjects was less than that in the County Schools to-day, the record of the "Old Normal College" in respect of notable men turned out by it is remarkable. Though Phillips had a leaning towards natural history while still at school, his subsequent specialization in botany was determined by the teaching of the Vice-Principal, Mr. John Price. The course was an exceedingly elementary one, just sufficient to pass the old "Science and Art" examinations; and at that time the teacher's knowledge of it was slight. There was a belief among the students that Mr. Price's enthusiasm was of recent birth, and that his studies marched only a few chapters of the text-book in advance of our own. It is, however, an undoubted fact, paradoxical though it may seem, that the fruitfulness of the teaching, measured in terms of enthusiasm, and after-college interest in the subject was proportionately greater than that of the far more extensive and thorough training now given in the Welsh University Colleges! At one time the three Chairs of Botany in the Welsh University (Swansea College had not been established then) were filled by three ex-schoolmasters, who had commenced their botanical studies at the Normal College. Other old students of the College who remained schoolmasters retained their affection for botany; of these, Mr. D. A. Jones, M.Sc., of Harlech, a recognized authority on Bryophyta and Lichens, is an example.

After obtaining the certificate at Christmas 1874, Phillips was appointed headmaster of an elementary school at Ferndale. He remained here but a short time, as he was invited to return to his old College as tutor. After doing excellent work in this capacity, he resigned in 1881, and entered St. John's College, Cambridge. He studied botany under Dr. S. H. Vines, and graduated with first class honours in the Natural Sciences Tripos in 1884. He also obtained the London B.Sc. degree.

In 1884 he was appointed as one of the small band of young and enthusiastic teachers that laid the foundation of the subsequent success of the newly established University College at Bangor. It is

sad to think that only two of these pioneers remain—Sir Harry Reichel and Prof. Rhys Roberts, the first Greek Professor of the College. At first, Phillips had charge of both branches of Biology; but at an early date these were separated, and he was made Professor of Botany. Several of the young professors, Phillips among them, established at various centres extra-mural courses. Those in botany were remarkably successful: the lectures were so lucid and interesting, and the printed syllabuses so filled with well-arranged information, that increased attention was paid to the subject; and, in addition, as a direct result of this slight contact with University Studies, many young people were attracted to the College itself.

During the early years of the College, it suffered much from the lack of an efficient system of secondary education in Wales, science, in particular, being more handicapped than the classics. As a consequence, most of the departments had to hold matriculation classes in addition to the ordinary Degree Courses. This continued until the establishment of County Schools, as the result of the passing of the Intermediate Education Act in 1889. Even after this event, it took some time to render the new schools efficient enough to allow of matriculation work in the Colleges to be dispensed with. Before this Phillips had become interested in the educational enterprise of the late Mr. Cadwaladr Davies, the first Registrar of the College, who had taken a leading part in the establishment of the North Wales Scholarship Association. Afterwards, when the Secondary Schools were started, Phillips served for years as the Chairman of the Local Governing Body. At the same time he was co-opted as member of the Merionethshire Education Committee. At first the Welsh Colleges prepared their students for passing the external examinations of the London University. The serious disadvantages resulting from this complete separation of teaching and examining were not removed until 1894, when the Welsh University was established. In all the arduous consultative and administrative work entailed by this change Phillips took a prominent and useful part.

While thus active in promoting Welsh education generally, he carried on his botanical studies. He made himself familiar with the flora of the College area, but became specially interested in the marine flora of Carnarvon and Anglesey. In the laboratory he specialized on the morphology of the Red Seaweeds, and during the years 1895-7 there appeared in the *Annals of Botany* a series of valuable studies in the "Development of the Cystocarp" in the two groups, the Rhodomelaceæ and the Rhodymeniales. He also contributed the article on "Algæ" to the 10th and 11th editions of the *Encyclopædia Britannica*. In 1898 he obtained his London D.Sc.

After this, he became more and more engrossed with administrative work; to these preoccupations were added his work as magistrate and, during the war, as chairman of the local Tribunal. The unfortunate result of all this was that he had no opportunities left to carry on his research work.

The tragic loss of his son by drowning, and later his wife,
JOURNAL OF BOTANY.—VOL. 65. [MARCH, 1927.] u

affected his health, and he began to suffer from heart trouble and, still later, from the disease to which he finally succumbed. In October 1922 he resigned his Chair at the College, but his successor, Prof. Thoday, gave him facilities for working in his old laboratory, and, though interrupted by recurring attacks of illness, he returned with almost youthful ardour to his early researches. The principal papers published by him at this period were: "On the Structure of *Spyridia filamentosa*," *Annals of Botany*, xxxviii. 1924; "The Ceramidium of *Polysiphonia*, *New Phyt.* xxiii. 1924; "On Vascular Pseudopodia in *Callithamnion* sp.," *Revue Algolog.*; "On the Genera *Phyllophora*, *Gymnogongrus*, and *Ahnfeldtia*, and their Parasites," *New Phyt.* xxiv. 1926; and "On the Form of the Protoplast in Cells of the Genus *Ceramium* and those of *Dasya coccinea*," *New Phyt.* xxv. 1926.

The spinal trouble which had overtaken him began to paralyse his lower limbs, and he was taken to London to undergo an operation. This proved unsuccessful, and he died at his brother-in-law's house in Leominster on his way back to Bangor. It is pathetic to think that almost to the very last he looked forward to a return to his favourite studies. A room was reserved for him in the New College Buildings, to which the Botany Department had just removed, and he planned to have himself conveyed there each day in a Bath chair.

Professor Phillips was a born teacher. He was a fluent and lucid lecturer, and he possessed the interest and conviction that impress and inspire listeners. In the field his alertness and enthusiasm—and, above all, the intellectual enterprise of his mind—made him an ideal companion. Some of the writer's pleasantest memories will be of tramps with him among the hills and crags of Snowdonia or along the seashores of North Wales. However fatigued our bodies happened to be, though we might be hungry and wet and foot-sore, Phillips's mind remained active. His observation would still be keen, his enthusiasm unabated, and his mind still showed activity and ingenuity in pursuing possible explanations of facts and phenomena. All this fills one with regret that his researches suffered such a long interruption. If Welsh education gained much through his activities on its behalf, the loss to botanical research was much greater.—
J. LLOYD WILLIAMS.

I met Phillips in the St. John's Chemistry Laboratory in 1884; he took Chemistry as his second subject for his Tripos. During the summer of that year he did some work on transpiration with Francis Darwin. Between 1900 and 1904 he was in London from time to time as external examiner in Botany in London University. He attended some of the British Association meetings, including the one in South Africa in 1905, where he gave the opening paper at Cape Town, "On the Recent Advances in our Knowledge of Seaweeds." He joined the Linnean Society in 1890. The list of papers which follows has been compiled by Mr. J. Ardagh, of the Department of Botany.— A. B. R.

- On the Transpiration-stream in Cut Branches [with Francis Darwin]. *Proc. Camb. Philos. Soc.* v. 330-67 (1886).
 Notes on the Flora of Breconshire. *Journ. Bot.* xxx. 354-5 (1892).
 List of Plants collected by Members of the Botanical Excursion Class, University College of North Wales. 8vo. Bangor, (1894).
 On the Development of the Cystocarp in Rhodomelaceae. *Annals of Botany*, ix. 289-305 (1895); x. 185-204 (1896).
 Note on *Saccorhiza bulbosa* J. G. Ag. and *Ataria esculenta* Grev. *Ibid.* x. 96-7 (1896).
 On the Development of the Cystocarp in Rhodymeniales. *Ibid.* xi. 347-68 (1897); xii. 173-202 (1898).
 The Form of the Protoplasmic Body in certain Floridæ. *Ibid.* xii. 569 (1898), *Brit. Assoc. Rept.* 1898, 1044.
 "Algae" in the *Encyclopædia Britannica*, ed. 10 (1902) and ed. 11 (1910).
 On the more recent Advances in our Knowledge of Seaweeds. *Brit. Assoc. Rept.* 1905, 585 (Abstract).
 Note on the Duration of the Prothallia of *Lastrea Filix-mas* Presl. *Annals of Botany*, xxxiii. 265-6 (1919).
 The Ceramidium of *Polysiphonia*. *New Phytol.* xxiii. 142-49 (1924).
 On the Structure of *Spyridia filamentosa* (Wulf.) Haw. and the Affinities of the Genus. *Annals of Botany*, xxxviii. 547-61.
 On the Origin of the Cystocarp in the Genus *Gracilaria*. *Ibid.* xxxix. 787-803 (1925).
 On Vascular Pseudopodia in *Callithamnion* sp. *Rev. Algolog.* ii. 14-18 (1925).
 On the Genera *Phyllophora*, *Gymnogongrus*, and *Ahnfeldtia* and their Parasites. *New Phytol.* xxiv. 241-55 (1925).
 On the Form of the Protoplast in Cells of the Genus *Ceramium* and those of *Dasya coccinea*. *Ibid.* xxv. 277-93 (1926).

JOSEPH JACKSON LISTER, F.R.S.

(1857-1927).

MR. J. J. LISTER, who died at Grantchester, Cambridge, on February 5th, was the son of Arthur Lister, the distinguished student of the Mycetozoa, and nephew of Lord Lister. He was educated at St. John's, Cambridge, and became a Fellow of his College. His life was spent in Cambridge, where his work in zoology gained for him the Fellowship of the Royal Society in 1900. His article on the Mycetozoa in the 11th Edition of the *Encyclopædia Britannica*, based largely on his father's work, brings him within the fringe of botany, and a further claim to our recognition may be found in his botanical work on Christmas Island, which he visited as naturalist on board H.M.S. 'Egeria' in 1888. In a report on his botanical collections, by Mr. W. B. Hemsley, in the *Journal of the Linnean Society* (xxv. 1890) a fern, *Acrostichum Listeri* Baker, and an orchid, *Phreatia Listeri* Rolfe, are named in his honour. He became a Fellow of the Linnean Society in 1906.

SHORT NOTES.

DRYING SHRUBBY SPECIMENS.—Many herbarium specimens of shrubby subjects, and especially thorny ones, are liable to damage their mounts as well as those of adjacent specimens from the stubby or thorny projections on their stems. I find that in most cases if such projections be removed no harm is done to the specimen, and it will lie more satisfactorily in the herbarium. Some collectors, quite rightly, remove whole branchlets, but unless these are cut off quite flush with the stem, the stub ends are most objectionable. I have heard it argued that these should be left in order to show the habit of the specimen, but I doubt there being much in this, and if the trimming be done with judgment no harm should arise. Prickles can easily be broken off or cut off if they project unduly from the specimen, and small ones can be crushed down. These protuberances are especially objectionable if the specimen is to be sent by post, necessitating an undue amount of packing-paper to prevent damage. I have in mind especially Roses, which I can assert are in no wise spoilt as specimens by such trimming or removal of projecting prickles. There are, of course, some shrubs, the growth of which is so tortuous and rugged, or the fruits so large and hard, that no treatment will flatten them, but most British plants are quite amenable to it.—A. H. WOLLEY-DOD.

CHROMOSOME NUMBER AND INDIVIDUALITY IN THE GENUS *CREPIS*.—E. B. Babcock and Margaret M. Lesley (*University of California, Publications in Agricultural Sciences*, ii. No. 11, 315-41) deal with the chromosomes and taxonomic relationship in the genus *Crepis*. They give a table showing Hoffmann's key to the sections of the genus, based principally on the pappus bristles and beak of the fruit, and also a tentative classification of twenty-one species, based on the number and length of the chromosomes. They state that, taxonomically considered, the genus *Crepis*, as it stands at present, is a heterogeneous assemblage of distinct but related groups of species. Similarity of chromosome size seems a better criterion of relationship than number alone, although closely related species usually have the same number of chromosomes. Most of the cytological heterogeneity is confined to Hoffmann's sections *Eucrepis* and *Cantonina*. There are good figures of the fruits of many species.—E. G. B.

REVIEWS.

Vascular Plants from Novaya Zemlya. By B. LYNGE.
Large 8vo, pp. 1 151, pls. i. xlvii. Brøgger: Kristiania, 1924.

THIS is no. 13 of the *Reports of the Scientific Results of the Norwegian Expedition to Novaya Zemlya, 1921*, published by the Videnskaps-selskapet i Kristiania. Although the title-page is dated 1923, the back of p. 151 reads "Printed, Jan. 23rd, 1924," so it can scarcely have been published earlier. Having had occasion to work

at the flora of Spitsbergen, I can thoroughly appreciate the great usefulness of the present work, which brings together the results of all previous work on the flora of Novaya Zemlya. I wish that something similar could be done for Spitsbergen, which, by the way, is wrongly spelt in the work under review. It is a Dutch name, and there can be no justification of a German transliteration in English, in which language the work is written.

The first 12 pages contain a short historical account of botanical exploration in Novaya Zemlya and a short summary of essential details concerning the present expedition, of which a full account is given in Report no. 1. Pp. 13-127 consist of a list of species and varieties of vascular cryptogams and phanerogams known to occur. The distribution is indicated fully, and is supplemented by the 120 maps on pls. i.-xx., to which means of illustration the shape of the country lends itself. But, in addition, the work is full of interesting botanical notes, based on observations made by the author. These include details of ecology, time of flowering, pollination, and dispersal, as well as critical notes bearing on taxonomy.

The *Salices* have been determined by Johs. Lid, and include seven species and numerous hybrids. In Spitsbergen there are only two species. The genus *Taraxacum* is by J. Holmboe, who records five species, of which *T. Nova Zemliae* is new. This name should have a hyphen: [the international rules do not permit such trinominals. The genus *Poa*, so difficult in the arctic regions, is by C. A. Lindman, who recognizes four indigenous species with many forms and hybrids. Lindman's views on the frequent occurrence of vivipary are rather novel, and are as follows:—"In Novaya Zemlya the phenomenon of viviparous inflorescences is very common for the genus *Poa*. Although we do not know what reasons there are for such a revolution in the life of a species, we cannot omit to presume that it is specially provoked by the sterility, a debilitation in some way (or a destruction) of the sexual organs. There is a sufficient reason for this conclusion in the fact that a viviparous individual of an Arctic *Poa* generally differs from its species, becoming distinctly intermediate with regard to its floral organs, or often to its vegetative ones too, like a cross-breed between two certain species. I therefore think it inevitable, on meeting with viviparous Arctic *Poa*, to regard them as cross-breeds; the classification, then, must be an attempt to determine their parents, *i. e.*, the components of the hybrid combination." I think that there can be little doubt that the condition of vivipary should be sought for in a high degree of atmospheric humidity rather than in this way. In the very wet summer of 1924 I received considerable numbers of viviparous specimens of grasses, and also saw *Scirpus caespitosus* viviparous. Junci are commonly viviparous when hanging over close to or below the surface of water. In the Spitsbergen specimens of Arctic *Poa* which I have examined, there is also much vivipary, but, although the floral parts are considerably modified in this way and the task of determination is made very difficult, I do not see the intergrading mentioned by Lindman, and doubt that experimental investigation, which should not be difficult if living material were procured,

will support the hybridization hypothesis. Such experimental work is much required to settle the facts concerning the relations of this difficult genus, which is also affected by the frequent heavy manuring of the places where they grow.

A summarized list of the vegetation, preceded by additional records and followed by a good bibliography and index, complete the text. The plates, other than maps, illustrate rare or new species, plants *in situ*, scenery, and the Arctic *Poa*. The book is very well produced in all ways.

A few notes based on my own work on Spitsbergen plants may be appended. In the first place, many species occur in Novaya Zemlya which do not reach Spitsbergen, such as, e. g., *Rumex arifolius*, *Ranunculus acer*, *R. auricomus*, and *R. reptans*, *Thalictrum alpinum*, *Arabis petræa*, etc., these all being less arctic species which may here reach their farthest north. The *Cardamine* is identified as var. *dentata* (Schultes); this var. is (see Kerner, Fl. Austro-hung. exsicc. 886) one of the southern forms of the species, and the Novaya Zemlya plant is not likely to be that. The separation of *Cochlearia* into two forms I think very satisfactory, except that they are probably two species which hybridize and produce intermediate and peculiar forms in much the same way as the British species do. *C. grœnlandica* grown from seed in a greenhouse remains a tiny rosette about half an inch across for a year without any attempt to flower. *C. arctica* remains small and does not become large like *C. officinalis*. Certainly we have nothing approaching *C. grœnlandica* in the British Isles, although it has been recorded. There is nothing to indicate what the author means by *Draba alpina* var. *glacialis* (Adams) Kjellm. *Draba glacialis* Adams has been much debated, and, so far as I am aware, is a *nomen dubium*. It is a pity that throughout no references are given which would precise the meaning of the names used. It is only in these difficult cases that one can realize that the mere citation of an author's name cannot give precision. In Spitsbergen material I found plenty of *D. alpina* and its var. *oblongata*, but did not require another varietal name. One should not be expected to hunt through all Kjellman's papers until the reference is found—it should be given to save such waste of time. *Chrysosplenium tetrandrum* seems either distinct from *C. alternifolium* or not worth distinguishing as a var., for the number of stamens is not constantly four. Possibly culture would settle the matter, as also that of the validity of *Dryas octopetala* var. *minor*, which is stated to be differentiated from the type in many features and to be the only form in Novaya Zemlya. If this be so, it should prove to be a distinct species, or at least subspecies. It is good to have the *differentiæ* of some arctic critical plants set out—e. g., *Potentilla*. Many of the old records in such cases are wrong for lack of a work where the *differentiæ* can be readily found. It is to be regretted that the *Flora Arctica* started by Ostenfeld and Gelert was never finished. I wish that the author had similarly set out the *differentiæ* of *Luzula confusa* and *L. arctica*; most of these given in the books seem to break down when applied to Spitsbergen specimens, though I under-

stand that the two species are very distinct when seen growing. The long account of *Catabrosa algida* and *C. concinna* does not help me to settle the names of the Spitsbergen material at the British Museum. I have seen all forms of intergrading between the two species, and either they hybridize much or are merely forms of a single variable species. Field-study by one well versed in the problem might settle the matter. *Deschampsia alpina* is distinguished specifically from *D. cœspitosa*; British botanists require to re-investigate their so-called var. *alpina*. References to where the *differentiæ* of the *Puccinellia* species are to be found accurately set forth would also have been useful. In fact, the chief criticism of the work is that without references the specimens are not completely identified, the reference required being that where one may find the connotation of the name used.

A. J. WILMOTT.

The Student's Handbook of British Hepatics. By SYMERS M. MACVICAR, with Illustrations by H. G. JAMESON. Second Edition, Revised and Enlarged. 8vo, pp. xxix, 464. Sumfield, Eastbourne. Wheldon and Wesley, London, 1926. Price 24s.

THE first edition of this useful work has been out of print for some little time, and all students of the British hepatics will welcome the appearance of the Second Edition, which has been fully brought up to date. The first edition considerably enlarged the small band of students of this very interesting group of plants, which, since the days when W. J. Hooker published his *British Jungermanniæ* in 1816, has been rather neglected in this country. The neglect is a little difficult to account for in view of the great interest which the plants undoubtedly have, and the fact that they exhibit a much greater degree of endemism than any other group of British plants. Until the appearance of the first edition there was no illustrated work dealing with hepatics in an efficient manner within the reach of students of moderate means. The introduction has been revised, and a Glossary, prepared by Mr. D. A. Jones and illustrated by a special plate and references to the illustrations in the body of the book, has been added; this will be of service to many beginners.

No less than twenty species new to the British list since the first edition are figured and described. A few of these are due to the elevation to specific rank of forms recognized in the first edition, but the greater number are species which have long been recognized on the Continent, and a substantial proportion of them comes from the south-west of England.

In the genus *Riccia* the name *R. Beyrichiana* Hampe takes the place of *R. Lescuriana* Aust., in accordance with the laws of priority. *R. commutata* Jack is added to the British list, and *R. Huebeneriana* Lindenb. takes the place of *R. pseudo-Frostii* Schiffn., the latter being reduced to a synonym.

In the genus *Fossombronina* there are three additional species, *F. Loitlesbergeri* Schiffn., *F. Husnoti* Corb. var. *anglica* Nich., and *F. Crozalsii* Corb.

Marsupella apiculata Schiffn., the presence of which in Britain was suggested in the first edition, is added for Scotland, and two new genera, *Southbya nigrella* (De Not.) Spr., and *Gongylanthus ericetorum* (Raddi) Nees for the west of England. The interesting genus *Anastrophyllum* has a new species, *A. Jørgensenii* Schiffn.

In the genus *Lophozia*, two segregates of *L. ventricosa* (Dicks.) Dum., namely, *L. longiflora* (Nees) Schiffn. and *L. confertifolia* Schiffn., both referred to as likely to occur in Britain in the first edition, take their place as British plants. In the large genus *Cephalozia*, *C. macrantha* Kaal. & Nich., following the opinion of K. Mueller, is, I think rightly, reduced to a variety of *C. pleniceps* Aust.; and *C. compacta* Warnst. figures as a British plant as a variety of *C. connivens* (Dicks.) Lindb.

It is perhaps in the puzzling genus *Cephalozia* that the most striking alterations and additions have been made. The detailed work of M. Douin on the Cephaloziales has received critical consideration, and several modifications of the treatment in the first edition appear. M. Douin's proposed new genera are treated as subgenera, and five out of six genera are recognized in Britain, including *C. dentata*, which should be placed in *Evansia*. *C. Hampeana* (Nees) Schiffn. and *C. rubella* (Nees) Warnst. take the place of *C. bifida* Lindb. A few of the species recognized in the first edition are reduced to the rank of varieties and several new varieties are dealt with, besides *C. Nicholsonii* Douin & Schiffn., *C. calyculata* (Dur. & Mont.) K. Müll., and *C. dentata*, which are added to the British list. Some questions may be raised as to the validity of *C. Nicholsonii*, but a fair case for its provisional acceptance is made out.

Odontoschisma elongatum (Lindb.) Evans, treated as a variety of *O. denudatum* (Nees) Dum. in the first edition, is elevated to specific rank. *Lepidozia sylvatica* Evans is added to the genus *Lepidozia* and given a wide distribution in Britain.

Dr. A. W. Evans's treatment of the genus *Herberta* is accepted, and our British representation is divided into *H. adunca* (Dicks.) Gray and *H. Hutchinsiae* (Gotts.) Evans. Students will have no difficulty in distinguishing the two species with the aid of this book.

Diplophyllum gymnostomophilum Kaal. is added to the genus *Diplophyllum*, from Scotland, and there are two additions to the genus *Scapania*: *S. Degenii* K. Müll., which takes the place of *S. irrigua* var. *alpina* Bryhn of the first edition and *S. scandica* (Arn. & Buch). On the other hand, *S. rosacea* (Corda) Dum. is dropped as a British plant.

An improved type of paper brings out the excellent drawings of Mr. H. G. Jameson, which are such a marked feature of the work, rather better than in the first edition; and in spite of its greater length the present edition weighs somewhat less than the first edition, which on the physical side was rather a heavy work.

W. E. NICHOLSON.

RECENT FLORISTIC WORKS.

- (1) *Floræ Siamensis Enumeratio. A List of the Plants known from Siam, with Records of their Occurrence.* By W. G. CRAIB, M.A., F.L.S. Svo, Part I., pp. 1-198, with map (1925); Part II., pp. 199-358 (1926). Published under the auspices of the Siam Society, Bangkok. Price 12s. 10d. each part.

IN 1904-5 the late Mr. F. N. Williams published a list of the plants known from Siam (Bull. Herb. Boissier, ser. 2, iv.-v.); his list included mainly plants from the southern parts, but at that time no area of the country had been fully explored. Since then large areas of North Siam have been collected over, and also several areas in the South, and the knowledge of the flora has been greatly enlarged by the work of Dr. A. F. G. Kerr, who has explored nearly all the provinces. Mr. H. N. Ridley and Dr. Hosseus have also visited the country and published lists of definite areas.

In the present volume Prof. Craib aims to collect into one list the scattered records of previous papers, supplemented by more recent work. The arrangement followed as to sequence of families and genera is that of Bentham and Hooker's *Genera Plantarum*. Under each species references are given to the original publication of the combination and of the trivial name; also to Indian and Malayan floristic works; plants recorded or those seen by the writer are cited, and where the species is not endemic an indication of its general distribution is given. Special attention has been paid to the citation of local names, for which Dr. Kerr, who supplies a chapter on local plant-names, is responsible. Some new varieties and combinations are included, but the new species are in course of description in Prof. Craib's series of "Contributions to the Flora of Siam" in the *Kew Bulletin*, to which references are given. It is unfortunate that sometimes the printing of the "Flora" gets ahead of the *Bulletin*, giving rise to citations such as "Kew Bull." or "Kew Bull. 1926, p. ." A preferable mode of citation would be "Kew Bull. 1925 [or 1926] ined."

Part I. deals with the polypetalous Dicotyledons from Ranunculaceæ to the end of Anacardiaceæ; the Polypetalæ should be completed in a third part which will close Vol. I.

The text is well arranged and clearly printed, and the book when completed will form a useful addition to available Indian and Malayan floras.

- (2) *An Enumeration of Philippine Flowering Plants.* Vol. IV. By ELMER D. MERRILL. Svo, pp. 515, with 6 maps. Bureau of Science, Manila, 1926.

THE present volume marks the conclusion of Dr. Merrill's work on the Flora of the Philippine Islands, to the study of which he has devoted many years. The publication of the *Enumeration* began in 1922, and the systematic portion was completed with Vol. III. (1923).

Vol. I. includes the Gymnosperms and Monocotyledons, and Vols. II. and III. include the Dicotyledons. Vol. IV. is a development of the introductory matter, which it was originally intended should be issued as a part of Vol. I., and includes also a general index. This Introductory Volume is of considerable value and of general interest. It contains chapters dealing with the situation, climate, and geology of the islands, the peoples, and local names; and also a discussion of the Philippine alphabet (contributed by Mr. E. E. Schneider). Then follow an historical sketch of Philippine botany and sections on the general ecology of plants and animals and the biologic subdivisions. Dr. Merrill then deals at some length with floristic relationships with surrounding regions, and gives also a brief review of the corresponding faunistic alliances. His conclusions express the overwhelmingly Malaysian character of the flora of the Philippines, which in the Cretaceous period formed part of the great Asiatic-Australian continent. Archipelagic conditions obtained in the late Cretaceous, since which the Philippines have remained essentially insular, although at times connected to the south-west with Borneo and to the south with Celebes and the Moluccas. Connections with Formosa were broken in the early Tertiary.

An extensive bibliography is followed by some pages of corrections and additions to the previous volumes. The two general indexes occupy just half the volume. The first includes local names of families, genera, and species.

- (3) *Flora of South Australia*. By J. M. BLACK. Part III. Meliaceae-Scrophulariaceae. With Illustrations by the Author. 8vo, pp. 359-514. Adelaide: Rogers, 1926. Price 5s.

WE congratulate Mr. Black on the progress of this work, the two earlier parts of which have been reviewed in the *Journal of Botany* (1923, p. 27, and 1925, p. 27). The scope and character of the present issue conform with that of the previous parts, and bear evidence of the same careful work and detailed knowledge of the flora. We note that the first family Molinaceae is referred by its number, 65 A, to its proper position after Rutaceae towards the end of the previous part. The families then follow in the Englerian sequence from Callitrichaceae 69 to Scrophulariaceae 100. Part IV., which is announced as in course of preparation, should complete the volume. A useful innovation as compared with the previous Parts is the utilization of the inside of the back cover for a list of the families included in the Part.

Pflanzen als Gesteinsbildner. By JULIUS PIA. 8vo, pp. viii, 355, tt. 166. Borntraeger. Berlin, 1926. Price 19.50 M.

THIS very attractive volume appeals both to the geologist and botanist. A considerable proportion of the sedimentary rocks which comprise the earth's crust owes its origin to plant or animal life.

The author, who is associated with the Vienna Natural History Museum, has given an account of the work of the plants in this respect, treating each group in succession from the Fission Fungi and Algæ upwards to the Cormophytes. Under each group the form and general structure of the organisms concerned are described in some detail, illustrated by good clear text-figures; their method of working as potential rock-formers is explained, and, finally, their position as factors in geology. References to relative literature are included at the end of the various sections.

Under the Fission Fungi the work of the sulphur-bacteria, iron-bacteria, and chalk-separating bacteria are considered. The Fission Algæ (Schizophyceae or Cyanophyceae) fall into two sections, the Chalk and the Siliceous. The former are seen in operation to-day in the cushion-forming *Rivularia* or the travertine-formation at the Mammoth Hot Springs in Yellowstone Park. The fossil genus *Cryptozoon* of the Cambrian of the Eastern United States is compared with these. The siliceous or senter-forming Algæ are also remarkably well represented in action to-day in the Yellowstone hot-spring area. The diatoms are the most important rock-makers of the more highly organized unicellular Algæ. The multicellular Algæ include members of the Green, Brown, and Red series. The Dasycladaceae (Siphoneae Verticillatae), the structure of several of which is described in some detail, have left monuments of their work in the Dolomites. The Codiaceae (for instance, *Halimeda*) are important reef-formers. The Charophyta are also included here. The Rhodophyceae (Corallinaceae) are the most conspicuous chalk-builders of the present day.

The six sections devoted to the cellular plants occupy the first half of the book; the second half deals with the Cormophytes as rock-builders, and, except for a few pages on some aquatic mosses and flowering-plants which separate chalk, is occupied with coal and its formation. The important extinct genera of the Coal-measures are described in some detail. Finally, the present-day vegetation of marsh- and moor-land is described as an agent in peat-formation at the present day.

The book supplies a well-arranged general account of an interesting subject. The helpful illustrations include photographs of the vegetation as well as figures of plant form and structure.

Elementary Botany: an Introduction to the Study of Plant Life. By W. WATSON, D.Sc. 8vo, cloth, pp. viii, 368. With 225 text-illustrations. Arnold's, London, 1926. Price not stated.

IT is generally admitted that to write a satisfactory elementary text-book on any subject is a very difficult task. Since the value of such a book depends largely on the method of arrangement and presentation, it is the experienced teacher who is most likely to succeed. For this reason at least, *Elementary Botany*, by Dr. Watson, Biology Master, Taunton School, deserves careful attention.

The general *facies* of the book is attractive, but it must be confessed that further acquaintance ends in disappointment. There is little originality of treatment, and the arrangement of the subject-matter leaves something to be desired. Most teachers of Botany have their own views as to how the subject should be taught, and there is little doubt that, associated with the personality of the teacher and as an accompaniment to an established scheme of practical work, the book may be of value. In this respect it fulfils much of what is claimed for it, but beyond this it is unlikely to go.

There are many ways in which the subject can be introduced to the student, depending greatly on the age of the latter, but it is a general axiom that the introduction should be made through the most widespread and fundamental phenomena in the plant kingdom. These are undoubtedly physiological rather than morphological, and the greatest defect of Dr. Watson's book is the inadequate treatment of the physiological side and the lack of correlation between form and function. It is true that a wide series of experiments is included, but these are uninspired and quite insufficiently explained.

As regards arrangement several undesirable features are noticeable. There is a tendency to use terms which are not explained until some pages later, and it is also difficult to find any careful system of subject sequence. It is not easy to know why the chapters on the Phanerogams and Cryptogams respectively should be separated by those on such general subjects as Mendelism, Evolution, and Ecology, or why the chapter on the Gymnosperms should be sandwiched between one on the Ferns and one on the Mosses. Nomenclature is not always satisfactory, as, for example, in the use of the word "egg" to denote the fertilized ovum when the term "zygote" is specially intended to prevent such ambiguous designation.

The book is well-produced and the author is to be congratulated on the illustrations, which are mostly very clear original line-drawings.

R. D'O. G.

BOOK-NOTES, NEWS, ETC.

FIFTH INTERNATIONAL BOTANICAL CONGRESS.—A large meeting of British botanists was held, by permission, at the Rooms of the Linnean Society on Thursday afternoon, January 27th, to initiate arrangements for the Fifth International Botanical Congress. Dr. A. B. Rendle, who presided, reported that the invitation to meet in this country extended by the British botanists had been accepted by the delegates attending the Fourth Congress, held at Ithaca, U.S.A., in August last. London had originally been selected as the place of meeting, but, in response to an expression of feeling both in America and this country that Oxford or Cambridge would be a more suitable home for the Congress, the question of locality was discussed and it was agreed that the Executive Committee should enquire into the possibilities of one or other of the two University towns.

The scope of the Congress was then discussed, and it was agreed

to confine the programme to pure botany—applied sciences (such as Agronomy, Forestry, and Horticulture) would not be included.

An Executive Committee was elected as follows:—Sir David Prain, Professors Dame Helen Gwynne-Vaughan, A. C. Seward, A. G. Tansley, V. H. Blackman, W. Stiles, Neilson Jones, Dr. A. W. Hill, Dr. A. B. Rendle, and Mr. F. T. Brooks.

LINNEAN SOCIETY.—At the General Meeting on January 27th, Professor R. R. Gates gave an account, illustrated with a large series of lantern-slides, of the Tundra Vegetation of Russian Lapland.

The observations were made while on a visit to the plant-breeding station at Khibiny, in Russian Lapland, north of the Arctic Circle, in lat. 67° 44' N. Khibiny is on Lake Ymandra, and is partly surrounded by mountains which reach a height of nearly 4000 feet. The summer season lasts from the middle of June to the end of August; most of the plants bloom twice, June and August. In February the lowest temperature is about -36° 4 F., while in June—the warmest month—the mid-temperature is 53° 6 F. and the maximum 86° F. There is very little rain from May to August, but the winds are very strong and have a marked effect on the vegetation.

This country was heavily glaciated; the only trees are *Pinus sylvestris* var. *lapponica*, *Picea obovata*, *Betula pubescens*, and *B. verrucosa*; the conifers form extensive more or less open forests and the flowering plants number only 300-400 species. The bulk of them are plants named by Linnæus, and many of them are rarities in our own flora, being found, if at all, chiefly in the Highlands of Scotland or the North of England.

Lake Ymandra was formerly much larger than now, and former levels can be easily traced in ascending the slopes of the mountains. The lower slopes are chiefly composed of morainic material, which has been much shifted by streams in the post-glacial period. In ascending a peak 1500 feet high one finds on the lower levels the trees mentioned, together with *Betula nana* on the moors, becoming commoner as we ascend. The undergrowth consists of *Vaccinium* spp., *Arctostaphylos Uva-ursi* (replaced by *A. alpinum* higher up), *Ledum palustre*, *Calluna vulgaris*, *Epilobium angustifolium*, and *Rubus saxatilis*. Quantities of spring mosses, *Hylocomium splendens*, *Hypnum Schreberi*, *Polytrichum*, and *Sphagnum* give character to these slopes.

At the second level the trees are more scattered, while at the third level, 100 metres above the Lake, the spruces are covered with lichens, especially *Alectoria jubata*, *Usnea barbata*, and *Evernia prunastri*. Cladonias now become more common on the ground and *Empetrum nigrum* is more abundant at higher levels. Here also are such plants as *Juniperus communis*, *Linnæa borealis*, *Geranium pratense*, and *Sorbus Aucuparia*.

Ascending further, we pass the tree-line. The rocks are large, cleaved, and faulted blocks of nepheline syenite partly covered with vegetation. In pools caused by the faulting are colonies of *Eriophorum polystachyon* and *E. vaginatum*, while the smaller *E. alpinum* occurs at lower levels. Fringing the pools are dwarf willows and

such plants as *Taraxacum* and *Pinguicula vulgaris* and *P. alpina*. On these wind-swept slopes many of the plants are much reduced in size. *Loiseleuria procumbens* is here, as well as *Tofieldia alpina*—*T. borealis* occurring at low levels. *Picea* and *Juniperus* are reduced to Krumholz forms creeping over the rocks. The most typical plants at these higher levels are *Arctostaphylos alpinus*, *Betula nana*, *Juniperus nana*, and mats of reduced *Vaccinium* and *Andromeda polifolia*. This is typical rock tundra. Several species of *Cladonia* are abundant, and several Carices, of which over twenty species occur in this region, are characteristic of the higher levels, forming large yellowish patches on the hills, which can be recognized at a distance. *Silene acaulis* occurs here as well as by the lakeside, which is over 400 feet above sea-level. At the summit the few scattered plants included *Linnaea borealis*, *Dryas octopetala*, and *Juncus* sp., while on the highest peaks are found *Oxytropis campestris* and *Saxifraga oppositifolia*. Farther north, on the Murmansk coast, this mountain vegetation comes down to sea-level.

In the sand along the lake-shore were polsters of *Silene acaulis* and *Diapensia lapponica*, as well as *Papaver radicum* var. *lapponicum* with large yellow flowers, *Empetrum nigrum*, *Calluna vulgaris*, *Arctostaphylos Uva-ursi*, *Oxytropis campestris*, and *Saxifraga aizoides*. All except the last, which characteristically borders pools in the sand, have largely-developed root-systems.

Along the river Lutnermajoki, which flows into Lake Ymandra, are found such mesophytes as *Geum rivale*, *Maianthemum bifolium*, *Trollius europæus*, *Tussilago Farfara*, *Trientalis europæus*, and *Equisetum sylvaticum*. The small birches, alders, and willows (*S. alba*) here are cut to make "tree hay" for the cattle and sheep. Other plants commonly found at the lower levels in this district include *Parnassia palustris*, *Comarum palustre*, *Spiræa Ulmaria*, *Allium Schænoprasum*, *Silene inflata*, *Lonicera cærulea*, and *Rosa acicularis*—a new most northerly record for *Rosa*, this species being known in Alaska, but from a lower latitude.

At the Meeting on February 3rd, Dr. G. Claridge Druce exhibited several interesting British plants. These included the following:—*Botrychium rutaceum* (Sw.) from Kincardineshire, from a gathering by T. R. Sim in 1876, in the herbarium of the late Rev. H. E. Fox. There is also a specimen in Herb. Mus. Brit. from Ayrshire (1887) by Mr. Whitwell. Sim's specimen is the earliest evidence of its occurrence as a British plant.

Senecio erraticus Bertoloni, from the New Forest, Hants, where it was detected by Mr. Colin Trapnell in 1923. The exhibitor visited the Hampshire locality in 1926 and found *erraticus* growing with *Jacobæa* and *aquaticus*. Puzzling intermediate forms occurred. *S. aquaticus* var. *ornatus* Druce, from the Shetland Isles, was also shown.

A new species of *Taraxacum* from Oxford and Tenby was shown which has recently (B. E. C. 1926 incl.) been described by Dahlstedt from specimens sent by the exhibitor. The Tenby one grew in damp

spots in sand-dunes. It resembles *T. anglicum* and some other *palustris* species of the section, but it belongs to the group *vulgaria*, and has remained constant in cultivation for several years. Another large flowered form of the *vulgaria* group from Western Ross-shire and Oxford, Dahlstedt has described as *T. sublucescens*. The number of British Dandelions is now brought up to 83.

Orchis prætermissa Druce. The original specimens were shown as well as an example which Mr. B. S. Ogle of Steeple Aston succeeded in growing from seed and flowering, and also a seedling from the second generation which flowered this year in Oxfordshire, an unique example of a British Orchid being grown from seed for two generations. The progeny in essential features are identical with the grandparents. The species hybridises with *O. maculata*, *O. Fuchsii*, and *O. incarnata*. It is widely distributed through Britain and Ireland, but in the north usually is represented by var. *pulchella* Druce. *O. prætermissa* is found in France, Belgium, and Holland.

Dr. A. W. Hill, F.R.S., gave an account, illustrated by lantern-slides, of some of the characteristic trees of Western America, seen during his visit in August last. These included the Monterey Cypress (*Cupressus macrocarpa*), the *Sequoia gigantea* in the Yosemite Valley, and the magnificent Redwood forests further north.

Prof. C. E. Moss gave a précis of a paper on the Potamogetons of South Africa, and referred especially to the wide distribution of some of the species. He also commented on the wide distribution generally of the aquatic and marsh species as contrasted with the striking peculiarity exhibited by the dry land flora of South Africa.

BRITISH MYCOLOGICAL SOCIETY.—Vol. XI. of the Transactions of this Society is completed by the issue (Dec. 1926) of Parts III. and IV.; Parts I. and II. were published in August. A photograph of the late W. N. Cheeseman forms a frontispiece to the volume, and illustrates an appreciation of his work by Mr. J. Ramsbottom. Mr. Cheeseman was President of the Society at the time of his death (Nov. 1925). Among the numerous articles are Mr. Ramsbottom's Presidential Address (1925) on "The Taxonomy of Fungi" (a useful review of the subject), reports of work done on the forays at Tintern and Dublin respectively, and continuations of Dr. Petch's "Studies in Entomogenous Fungi." Miss Lorrain Smith writes on "Lichen Dyes," and describes a new family of lichens, Cryptotheciaceæ, which she regards as primitive, from material in the herbarium of the late Dr. Stirton; the two genera *Cryptothecia* and *Stirtonia* include six species, mainly Indian. A new species of *Urophlyctis* (*U. Potteri*) producing galls on the stem of *Lotus corniculatus* is described by Mr. A. W. Bartlett from a single locality in Northumberland. The papers are well illustrated, and there are two beautiful coloured plates of species of *Lepiota* from drawings by E. A. and V. Rea. We note that the Society now numbers 357 ordinary members.

NATURAL HISTORY MAGAZINE.—Under this title the Trustees of the British Museum are issuing a periodical to represent the Departments of the Natural History Branch at South Kensington. The

Magazine is neatly and clearly printed in a crown octavo, and the first number (January 1927) contains 32 pages—the price is One Shilling. In a brief Introduction the Director, Sir Sidney Harmer, explains the purport of the new periodical, which will enable the Trustees to acknowledge their indebtedness to donors who have contributed to the Museum. "It is proposed to issue the periodical quarterly, and include in it accounts, illustrated if necessary, of subjects which may appear to be of general interest." Dr. G. F. Herbert Smith contributes a short account of the Museum building, illustrated with a view of the front aspect. Then follow nine articles by various members of the Staff. The botanical article, by R. D'O. Good, is a description of *Rafflesia*: the largest known flower, the original specimens of which, sent to Sir Joseph Banks by Sir Stamford Raffles from Sumatra in 1818, and described and figured by Robert Brown, first Keeper of the Department of Botany, are preserved in the Museum. Excellent specimens recently presented to the Museum are exhibited in the Botanical Gallery. Some good illustrations accompany the article. An appreciation of the late William Fawcett, one of the first Assistants to work in the new building, is accompanied by an excellent photograph. Botanists will also be interested in Mr. G. J. Arrow's account of the Bark-beetles or Shot-hole borers, the makers of the fern-leaf-like patterns seen when loose bark is stripped from the trunk of a dying elm or ash; a large collection of these has recently been acquired. To the same family belongs the Ambrosia-beetle, also tree-inhabiting, which lives on a fungus cultivated by them upon the walls of their chambers.

ARCHIVES DE BOTANIQUE, A NEW BOTANICAL PERIODICAL.—This new medium of publication is issued by Prof. René Viguier, of the Faculty of Sciences, Caen. It will comprise two portions: (1) A monthly Bulletin of 8 to 32 pages and (2) Memoirs, each separately paged and appearing at indefinite intervals. The first issue "Bulletin Mensuel No. 1," Janvier 1927, consists of 16 pages, and contains descriptions of two new species of *Pedicularis* from Yunnan, and of a new *Calothrix*, an account of the Hypericum of the Section Spachium from Madagascar, and a review of Schlechter's *Orchidaceæ Perrierianæ*. Among the items of news the late William Fawcett is erroneously described as Assistant-Director of the Royal Botanic Gardens, Kew. The death is also announced of Hilaire Ricome (1867–1926), Professor of Botany at the Faculty of Sciences at Poitiers since 1920, and the author of papers on plant physiology and anatomy.

AMONG the candidates recommended by the President and Council for election into the Royal Society, botany is represented by Professor Abercrombie Anstruther Lawson, of Sydney University, N.S.W.

MR. A. G. TANSLEY, F.R.S., Lecturer in Botany at Cambridge University, has been appointed to the Sherardian Professorship in Botany at Oxford University in succession to Sir Frederick Keeble, F.R.S., who is resigning.

THE FLORA OF SIMLA.

BY L. V. LESTER-GARLAND, M.A., F.L.S.

HAVING recently had occasion to make frequent use of Sir H. Collett's excellent *Flora Simlensis*, I was led to investigate and tabulate the geographical distribution of the species therein contained, to see what light it threw upon the composition of the Flora of the southern flank of the Himalaya. It proved to be a laborious undertaking, but the results were interesting and to some extent unexpected. In the Introduction which he contributed to the book, W. B. Hemsley took the trouble to draw out a rather elaborate comparison of the Flora of Simla with that of the British Isles. His results have a certain superficial and restricted interest—for instance, it is interesting to an ordinary intelligent Englishman to realise that a large number of our commonest plants are also constituents of the vegetation of the Temperate Himalaya. But such a comparison is of little or no value to a scientific student of botanical geography, who is concerned with the sources of a given flora and its relation not to some other isolated flora arbitrarily selected, but to the flora of the whole world, of which it forms a part.

There is another point suggested by a perusal of Hemsley's Introduction which needs to be noticed. He proceeds upon the assumption that the presence of a given species or genus in each of two separate areas proves that there is a connection between them. In a broad sense this is true: they do possess so much in common. But this does not take us very far. In the case of widely-distributed plants it takes us a very little way. The whole area of distribution of each species or genus has to be considered before it is possible to say whether its presence in both districts is a proof of real affinity—for instance, Hemsley quotes the remark from Thomson's *Western Himalaya and Tibet*: "The more common shrubby forms of the vegetation of the temperate zone are *Salix*, *Rosa*, *Rubus*, *Lonicera*, *Viburnum*, *Berberis* (as well as *Indigofera* and *Prinsepia*)—all except the two last quite European." But this does not really prove any connection with Europe, for these genera are not specially European, but extend over most of Asia and much further. The Himalayan species might be, and as a matter of fact are, more nearly related to Asiatic forms which range east into China than with those of Europe. To get any adequate scientific idea of the relation of two floras, it is not enough merely to compare the two lists (whether of species or genera). It is necessary to ascertain whether the existence of a given species in both is only due to the fact that both districts fall within a larger area over which the species ranges, or whether a special bond of connection is established by the fact that the species is peculiar to or characteristic of both.

The area covered by the *Flora Simlensis* is small—approximately that of the county of Sussex. On the other hand, the vertical range is considerable, roughly from 2000 to 10,000 ft. It extends from the sub-tropical zone at the base of the chain through the whole of

the temperate belt to the fringe of the sub-alpine. The alpine zone is not reached, but we have a more or less complete section of the vegetation of this part of the Himalaya up to that point. Simla itself lies "on the watershed of the two great river-systems of the Ganges and the Indus" at an altitude of about 7200 ft. The rainfall for the year is given as 70 inches, 52 of which fall between June and September, but there is much less in the north of the district. Snow falls from December to March. The mean annual temperature is 54°-86, the recorded extremes being 26°-6 and 86°. January is the coldest month, with a mean temperature of 40°-6, and June is the hottest, with a mean of 67°-1.

The total number of species, excluding a few cultivated or doubtful plants, is just over 1300. It is divisible into the following groups:—

1. Plants belonging to the general flora of Europe and Asia.	
(a) Low-level plants	194
(b) Silvestral plants	42
	— 236
2. Arctic-Alpine	11
3. Mediterranean	21
4. Plants belonging to the general flora of India	424
5. Plants ranging east into Burmah and China and not found in the plains of India	122
6. Endemic in the Himalaya.....	499
	—
	1313

I. THE TEMPERATE EUR-ASIAN ELEMENT.—Two features of this group are noticeable, its size and its composition. When the vast extent of mountainous country which separates India from the low-level districts of Europe and Asia is considered, it is surprising to find so many Eur-Asian species, most of them very common and ordinary plants, on the south side of the Himalaya. And, further, it might have been expected that a large proportion of the identical species would consist of silvestral plants which might be presumed to have found their way along the mountain ranges. But the fact is just the opposite. Of the 236 species, only about 42 are silvestral, and the only trees or shrubs are *Taxus baccata*, *Juniperus communis*, *Berberis vulgaris*, *Buxus sempervirens*, two Willows, *Hedera Helix*, *Philadelphus coronarius*, *Daphne oleoides*, *Pirus Aucuparia*, *Prunus Padus*, *Ribes nigrum*, *Ribes rubrum*—13 in all. There are none of the forest trees, unless the Yew is counted as such. The conclusion seems to be that the mountain-masses have acted as a very effective barrier even to the silvestral plants, and that most of the plants under consideration have reached India, when they have not been introduced by man, by creeping round their flanks from the Orient. Of the 194 low-level plants, 73 are wide-spread weeds or plants which, without being actual weeds of cultivation, are found to follow closely human occupation of the soil. Another 38 are water-plants or plants of wet places, such as are disseminated by birds, and often have a very wide area of distribution. The remaining 83 have

presumably reached India in the normal course of distribution either by turning the flanks of the mountain-masses or perhaps in some cases by penetrating the valleys. At all events, after the most liberal deduction from the total on the score of human agency, there remain enough to prove that the Eurasian flora has natural outliers on the south side of the Himalaya. Of this same total of 194, 36 possess what may be called a cosmopolitan constitution, and are found more or less all over India; another 33 are fairly common in North India. The rest must be regarded as being unable to stand the heat of the plains.

II. THE ARCTIC-ALPINE ELEMENT.—Under this head are included only those plants which belong to the general frigid flora of Europe and Asia. Endemic Himalayan sub-alpine species, of which a considerable number is found in the Simla district, are included in Group 6. The highest spot is Hatugarrh (10,456 ft.), and this is the only place where the vegetation is even sub-alpine. The group, therefore, is a very small one, but there are about eleven downward stragglers from the highest zone, most of which have a very wide range. Four of them—*Viola biflora*, *Potentilla Sibbaldi*, *Phleum alpinum*, and *Leontopodium alpinum*—extend right across the more or less continuous mountain-masses from the Atlantic to the Pacific, from the Pyrenees to China, and are also found in the Arctic. Two more, *Lloydia serotina* and *Galium triflorum*, range from the Alps to China and also to the Arctic, but are not known from the Pyrenees. *Arabis alpina* and *Salix hastata* extend from the Pyrenees to the Himalaya, but apparently not further east, and are also Arctic. *Thlaspi alpestre* occurs from the Pyrenees to the Himalaya, but does not reach the Arctic. *Silene tenuis* and *Osmorrhiza Claytoni* (?) are apparently true high northern species—Arctic and Subarctic.

III. THE MEDITERRANEAN ELEMENT.—In this small group are included only those plants which are peculiar to the Mediterranean Region (in the widest sense of the term), on the principle already stated. They alone prove a direct connection. There are, of course, other plants which are well known in that region, but which extend beyond it, and have probably reached the foot of the Himalaya as part of the general Indian flora from the plains. As thus limited, the group is a very small one. Of the 21 plants which it contains, eight are widely distributed in the region—*Capparis spinosa* (as the form *C. leucophylla* DC.), *Trigonella polycerata*, *T. corniculata*, *Lathyrus inconspicuus*, *Celtis australis*, *Asphodelus tenuifolius*, *Erianthus Ravennæ*, *Andropogon Gryllus*. The following twelve are restricted to the Eastern portion:—*Argyrolobium roseum*, *Morina persica* (closely allied to *M. græca*), *Withania coagulans*, *Veronica biloba*, *Leptorrhados Benthamiana*, *Micromeria biflora*, *Corylus Colurna*, *Rpipactis consimilis*, *Pennisetum orientale*, *Juglans regia* (native from the Caucasus to India, with a variety in China), *Gagea persica*, (*t. reticulata*). To these must be added *Cedrus Libani* var. *Deodara*.

Even if it is regarded as an endemic Himalayan *species*, the presence of the genus establishes a connection, for the only other two forms are exclusively Mediterranean.

There is then a slight, but definite, direct connection between this small district in the Himalaya and the Mediterranean Region. The connection becomes more clearly marked as you proceed from Simla north-westwards towards Afghanistan, where the floras of the Orient and of the Himalaya, of Tibet, and the steppes of South Asia all find a meeting-place.

IV. PLANTS BELONGING TO THE GENERAL FLORA OF THE INDIAN PENINSULA.—These number about 424, nearly one-third of the total. For our present purpose they may be divided into the following groups:—(a) Species which are found all over India (277). These include a large number of widely spread tropical plants—mostly confined to the Old World, but some of them almost cosmopolitan in the tropics, and a number of species endemic in India. The bulwark of the Himalaya, facing the sun and forming an effective screen on the north and north-east, provides a sheltered strip of country which allows tropical and sub-tropical species to reach a considerably higher elevation than they could have reached in a more-exposed situation. It will be remembered that the lower limit of our district is about 2000 ft. Many of these plants mount a good deal beyond that. The vegetation of the two great river-plains of the Indus and the Ganges, which encircles the base of the outer ranges, splashes up, as it were against them or penetrates the valleys, so that the warm and temperate floras come into actual contact at a certain level. (b) Plants found in hilly districts all over India (55). (c) There is a small group of nine plants which are found at Simla, and only reappear in the Nilghiris or other hills in the south. Such gaps in an area of distribution are, of course, not uncommon. (d) Plants found in Northern India only (50). A few of these are endemic in North India. Many of them extend out into Burmah and China. There is no trace of the flora of the great desert region which reaches from Southern Morocco to the plains of the Indus. The rainfall, no doubt, is too high for extreme xerophytic types. (e) There are some 33 species whose distribution is so arbitrary or doubtful that it is difficult to class them.

V. This group consists of plants which do not belong to the general flora of the Indian Peninsula and are not found in the plains, but which are derived from the floras of countries further east—Burmah, China, Siam, etc. These form a considerable section; they are present in increasing numbers as you get further east, and thin out towards the north-west. In Engler's "Sketch of the Floral Kingdoms and Floral Regions of the Earth," which forms an appendix to the Eighth Edition of the *Syllabus der Pflanzenfamilien*, the temperate Himalaya forms part of a province which stretches eastward into Yunnan, Sz-tschwan, Schensi, Hupoh, and Kansu, and is included in the temperate *East Asian Region*, forming a long

narrow strip from west to east. At first sight this seems unexpected, but our analysis of the flora of this small district of Simla lends it support, as far as it goes. I have already drawn attention to the paucity of European and West Asiatic silvestral types. Chinese types are far more frequent. The temperate vegetation of the south side of the Himalaya has far less affinity with that of the north and north-west side of the great mountain-masses than with that of the hill-districts further east.

VI. PLANTS WHICH ARE ENDEMIC IN THE HIMALAYA.—These form the largest group, approximately 38 per cent. of the whole. Among them are species belonging to each of the three great zones—the sub-alpine, the temperate, and the sub-tropical. The majority are temperate types, as would be expected, but there is a considerable number of modified sub-tropical or even tropical types. The following sub-tropical or warm-temperate genera have endemic species in this district:—*Arisæma* (5), *Strobilanthes* (4); *Indigofera*, *Lespedeza*, *Desmodium*, *Rhynchosia*, *Plectranthus*, *Andropogon* (3 each); *Meliosma*, *Atylosia*, *Flemingia*, *Chirita*, *Litsea*, *Pilea*, *Elatostemma*, *Roscoea*, *Cautleya*, *Pennisetum*, *Arundinaria* (2 each); *Schizandra*, *Stephania*, *Grewia*, *Cedrela*, *Zizyphus*, *Sabia*, *Crotalaria*, *Smithia*, *Uraria*, *Albizzia*, *Oldenlandia*, *Randia*, *Marsdenia*, *Tylophora*, *Hoya*, *Ceropegia*, *Vandellia*, *Dissandra*, *Dædalacanthus*, *Justicia*, *Cinnamomum*, *Balanophora*, *Phyllanthus*, *Curcuma*, *Hedy-chium*, *Sauromatum*, *Typhonium*, *Remusatia*, *Gonatanthus*, *Isachne*, *Pollinia*, *Ischæmum*, *Aristida*, *Anthistiria*, *Tripogon* (one each). This makes a total of 74 species, of which 20 belong to the Leguminosæ. All the Araceæ are endemic with the exception of *Arisæma flavum*, which reaches Afghanistan and Arabia. The presence of six species belonging to so thoroughly tropical a family as the Zingiberaceæ is remarkable. Nor are they confined to the lower elevations. *Roscoea alpina*, according to Royle, is found as high as 9000 feet on hills which in the winter are covered with snow. To the foregoing list of species must be added the two monotypic genera *Platystemma* (Gesneraceæ) and *Herpetospermum* (Cucurbitaceæ), which are equally suggestive of hot climates. All these facts taken together indicate a remarkable invasion of the temperate zone by specialized forms of tropical or sub-tropical types. But at Simla, as Hemsley remarks, there is no trace of the epiphytic and rock orchids which are common further east, *e. g.*, in Sikkim, between 5000 and 6000 feet, and sometimes reach 8000 feet. Their absence is, no doubt, to be accounted for by the fact that Simla is a good deal further north than Sikkim, and has a much drier and colder climate.

Three other endemic Himalayan genera, but of the temperate type, are found at Simla:—*Craniotome* (Labiata—monotypic), *Roylea* (Labiata—monotypic and Western Himalaya only), and *Vicatia* (Umbellifera, with 3 species). The genera with the largest number of endemic species are almost exclusively temperate or cosmopolitan. They are: *Impatiens* (10), *Nepeta* (9), *Polygonum* (8), *Swertia* and *Habenaria* (7), *Clematis* and *Carex* (6), *Astra-*

galus, *Potentilla*, *Lonicera*, *Senecio* and *Arisæma* (5), and *Euonymus*, *Acer*, *Rubus*, *Saxifraga*, *Sedum*, *Epilobium*, *Viburnum*, *Galium*, *Anaphalis*, *Saussurea*, *Lactuca*, *Lysimachia*, *Gentiana*, *Pedicularis*, *Strobilanthes*, and *Scutellaria*, with 4 each.

The number of arborescent or shrubby species is large; Hemsley enumerates 137 which may be called trees, and this total would be considerably increased if woody climbers and small shrubs were taken into account. This was to be expected in what is so largely a forest region.

Of the total of 499, some 113 seem to be confined to the Western Himalaya.

From this analysis two facts of special interest emerge:

(1) Quite a considerable number of *low-level* Eur-Asian species have succeeded, partly with human assistance, in rounding the great mountain-masses on the west and north-west, and established themselves as components of a flora which is derived mainly from the south and the east; while the paucity of the silvestral species indicates that the mountains have proved an effective barrier on the north to the direct passage of Eur-Asian plants.

(2) Under the shelter of the great range there is a zone in which sub-tropical plants penetrate in an unusual manner into the midst of a temperate flora, and many specialized forms of sub-tropical types have been developed which must be adapted to existence in a colder climate. What delicate modifications in their constitution have achieved this is beyond our present knowledge. We only know that in many cases they are reflected in modifications of their outward structure which are sufficiently marked to justify us in regarding them as different species, or even genera, from those which exist on the plains.

DIATOMS FROM TIENTSIN, NORTH CHINA.

By B. W. SKVORTZOV.

(From the Sungari River Biological Station of the Manchuria Research Society, Harbin.)

In a previous note, "On the Phytoplankton from the Ponds of Tientsin" (*Journal of the North China Branch of the Royal Asiatic Society*, liii. 1922), I gave some account of the freshwater algae gathered by me on March 17, 1919, in the ponds of the Russian Garden and near the brick-kilns in Tientsin. Diatoms discovered in the last pond have only lately been investigated, a list being given below. This list contains the names of 52 forms, 17 of which belong to the brackish and marine water species, the others to freshwater varieties. In this note three new species, eleven varieties, and two new forms have been described.

CYCLOTELLA MENECHINIANA Kütz.

Very rare, seen only twice.—Ubiquitous.

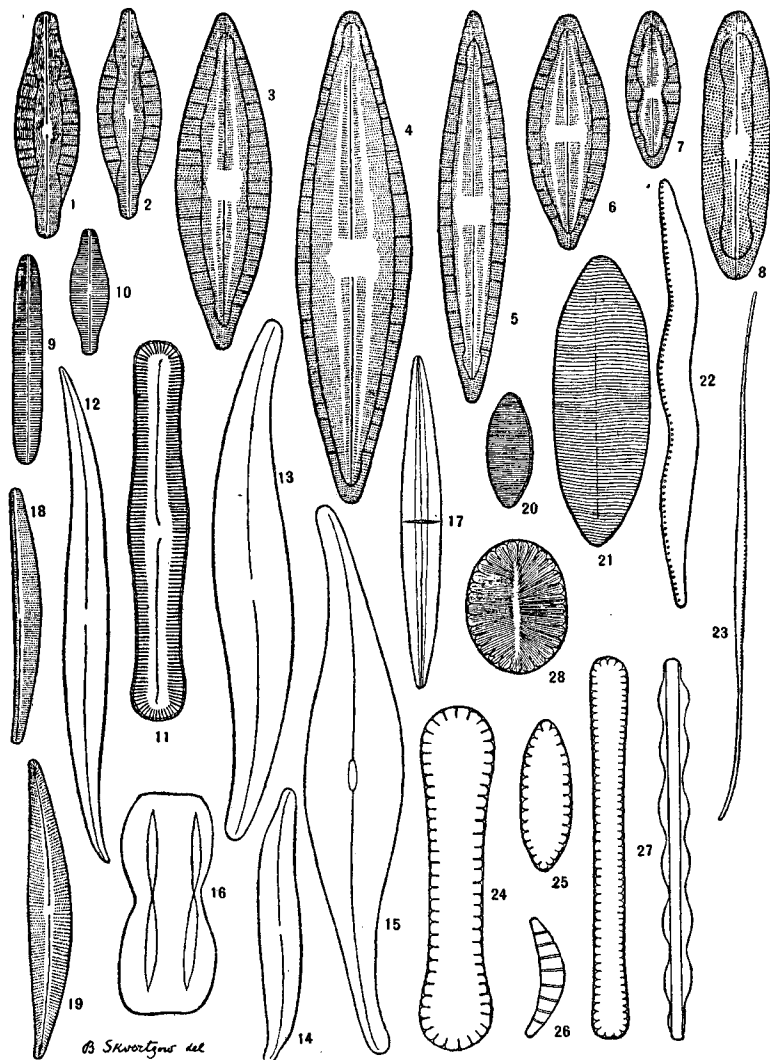

- 1, 2. *Mastogloia Smithii* Thwaites. 3, 4, 6. *M. Braunii* Grun.; 5, var. *sinensis*, var. nov. 7. *M. pumila* Grunow var. *sinensis*, var. nov. 8. *M. Grevillei* W. Sm. var. *sinica*, var. nov. 9. *Navicula tientsinensis*, sp. nov. 10. *Navicula gregaria* Donk. 11. *Pinnularia acrosphaeria* Bréb. var. *laevis* Cleve. 12. *Pleurosigma elongatum* Sm. 13. *P. Spenceri* Sm. var. *sinensis*, var. nov.; 14, var. *tientsinensis*, var. nov. 15. *P. Parkeri* Harrison. 16. *Amphiprora medulica* Peragallo var. *sinensis*, var. nov. 17. *Tropidoneis maxima* Greg. var. *sinensis*, var. nov. 18. *Amphora angusta* (Greg.) Cleve var. *sinensis*, var. nov. 19. *Cymbella gracilis* Rabenh. 20. *Tryblionella debilis* Arnott & Rylands var. *sinensis*, var. nov. 21. *T. Hantzschiana* var. *levidensis* Grunow forma *sinensis*, f. nova. 22. *Nitzschia sigma* W. Sm. var. *serpentina*, var. nov. 23. *N. rigida* Kütz. var. *sinensis*, var. nov. 24. *Surirella tientsinensis*, sp. nov. 25. *S. angusta* W. Smith. 26. *Rhopalodia gibberula* (Kütz.) O. Müll. 27. *Cymatopleura sinensis*, sp. nov. 28. *Surirella ovalis* Bréb. var. *minuta* (Bréb.) V. H. forma *tientsinensis*, f. nova. ×450.

MELOSIRA ISLANDICA O. Müll. var. *HELVETICA* O. Müll.; Jahrb. Wissensch. Bot. xliii. 67, t. i. figs. 8-11.

Valve, l. 0.0408, b. 0.0042 mm.—Rare.

SYNEDRA ULNA Ehrenb. var. *SPLENDENS* (Kütz.) V. Heurck, t. xxxviii. fig. 2.

Valve linear: l. 0.170, b. 0.006 mm. Striæ 9 in 0.01 mm.—Ubiquitous.

S. ACUS Kütz.; V. Heurck, t. xxxix. fig. 4.

Valve, l. 0.170 mm., b. 0.004 mm. Striæ 15 in 0.01 mm.—Ubiquitous.

MASTOGLIOIA SMITHII Thwaites. (Figs. 1, 2.)

Cleve, Syn. ii. 152; V. Heurck, Syn. 70, t. iv. fig. 13; Pant. ii. 41, t. vii. fig. 136.

Valve lanceolate, more or less rostrate: l. 0.034-0.0374 mm., b. 0.011 mm. Loculi 0.5-7.5 in 0.01 mm. Striæ 18-20 in 0.01 mm.—Widely distributed in brackish water.

M. BRAUNII Grun. (Figs. 3, 4, 6.)

Cleve, Syn. ii. 158; Peragallo, i. t. vi. figs. 7, 8, 9.

Valve elliptic-lanceolate: l. 0.0425-0.0918, b. 0.0153-0.0221 mm. Striæ 18 in 0.01 mm. Loculi 5-5.5 in 0.01.—Widely distributed in brackish water.

Var. *sinensis*, var. nov. (Fig. 5.)

Valvula elongato-lanceolata, 0.085 long., 0.017 mm. lat. Loculi 4.5 in 0.01 mm., spinulo terminati. Striæ 18 in 0.01 mm.

M. pumila Grunow var. *sinensis*, var. nov. (Fig. 7.)

Valvula elliptico-lanceolata, 0.272-0.029 long., 0.009-0.010 mm. lat. *Nodus centralis* magnus, quadratus lyriformis. Loculi 5-5.5 in 0.01 mm. Striæ 22-24 in 0.01 mm., parallelæ, versus partes ultimas radiatæ, tenuiter punctatæ.

M. pumila Grun. is found in slightly brackish water in the Baltic and in Hawaii.

M. Grevillei W. Sm. var. *sinica*, var. nov. (Fig. 8.)

Valvula linearis cuneato-obtusa, 0.0408-1.0476 long., 0.0102-0.012 mm. lat. Loculi 6 in 0.01 mm. Striæ 15-17 in 0.01 mm.—Brackish water.

DIPLONEIS ELLIPTICA Kütz.; Cleve, Syn. i. 92.

Valve elliptical, with broad and rounded ends: l. 0.0527-0.003, b. 0.017-0.023 mm. Striæ 8 to 8.5 in 0.001 mm.—Widely distributed.

NAVICULA CUSPIDATA Kütz. forma *CRATICULARIS* F. Heribaud, Diat. d'Auv. 107, t. iv. fig. 15.

Valve lanceolate: l. 0.1003, b. 0.0272 mm.—The type is ubiquitous.

Var. *AMBIGUA* Ehrenb.; Cleve, Syn. i. 110.

Valve, l. 0.068, b. 0.019 mm. Striæ 18 in 0.01 mm.—Recorded from most parts of the world.

Navicula tientsinensis, sp. nov. (Fig. 9.)

Valvula angusta linearis marginibus parallelis basi et apice rotundata, 0.4 mm. long., 0.0052 mm. lat. *Area axialis* angusta. Striæ 18 in 0.01 mm., parallelæ. Lineæ longitudinales simplices.

N. GREGARIA Donk. (Fig. 10.)

Brit. Diat. 43, t. vi. fig. 13; V. Heurck, Syn. 85, t. viii. figs. 12-15.

Valve lanceolate with rostrate-capitate end: l. 0.023, b. 0.0068 mm. Striæ 15 in 0.01 mm.—In brackish water in Europe, S. Africa, and Argentina.

N. CRYPTOCEPHALA Kütz.; V. Heurck, Syn. 84, t. vii. figs. 1, 5; Cleve, Syn. ii. 14.

Valve lanceolate with rostrate-capitate ends: l. 0.0221-0.0374, b. 0.005-0.0085 mm. Striæ 14-15 in 0.01 mm.—Ubiquitous.

PINNULARIA ACROSPHÆRIA Bréb. var. *LEVIS* Cleve. (Fig. 11.)

Cleve, Syn. ii. 86; Schm. Atl. xliii. fig. 18.

Valve linear, gibbous in the middle and at the ends: l. 0.085, b. 0.012. Striæ 12 in 0.01 mm. Area smooth.—New Zealand and Australia.

P. MAJOR (Kütz.) var. *GENUINA* Rabenh.; Mayer, Bacill. Regensb. Gewäss. 212.

Valve linear, gibbous in the middle and at the ends: l. 0.114, b. 0.022. Striæ 8 in 0.01 mm.—Ubiquitous.

PLEUROSIGMA ELONGATUM Sm. (Fig. 12.)

Peragallo, Monogr. 7, t. iii. figs. 5-8.

Valve long pointed at the ends: l. 0.204, b. 0.019 mm. Striæ 18 in 0.01 mm.—Brackish water in many parts of Europe and Asia.

P. SPENCERI Sm. var. *SMITHII* Grun.; Peragallo, Monogr. 22, t. viii. figs. 21, 23.

Valve, l. 0.102, b. 0.014 mm. Striæ 24 in 0.01 mm.

Var. *tientsinensis*, var. nov. (Fig. 14.)

Valvula sigmoidea ad extremitates subobtusè rotundatas angustata, utrinque excavata: 0.102 mm. long., 0.0153 mm. lat. Striæ longitudinales 24 in 0.01 mm., striæ transversales 27 in 0.01 mm.

Var. *sinensis*, var. nov. (Fig. 13.)

Valvula sigmoidea, ad extremitates subacutatas angustata: 0.2 mm. long., 0.029 mm. lat. Striæ longitud. 15-17 in 0.01 mm., striæ transvers. 12 in 0.01 mm.

P. PARKERI Harrison. (Fig. 15.)

Peragallo, Monogr. 25, t. viii. fig. 33.

Valve lanceolate sigmoid; ends produced obtuse: l. 0.125-0.0139,

b. 0.0221 mm. Transverse striæ 21, longitudinal 22 in 0.01 mm.—
Fresh and brackish water in Europe.

Amphora angusta (Greg.) Cleve var. *sinensis*, var. nov. (Fig. 18.)
Valvula angusta lanceolata: 0.0425 mm. long., 0.0055 mm. lat.
Striæ 18 in 0.01 mm.

This variety seems to be akin to var. *Eulensteini* Grun. (see
Schm. Atl. xxv. fig. 1).

Tropidoneis maxima Greg. var. *sinensis*, var. nov. (Fig. 17.)
Valvula 0.0663 mm. long., 0.009 mm. lat. Striæ transversales
18 in 0.01 mm., punctulatae.

T. maxima Greg. and its varieties occur in marine water.

AMPHIPORORA PALUDOSA W. Sm. Brit. Diat. i. 44, t. xxxi.
fig. 269; Cleve, Syn. i. 14.

Frustule membranaceus: l. 0.0425-0.0646 mm., b. 0.0187-
0.0357 mm. Striæ 18 in 0.01 mm.—In brackish water, Europe,
West Indies.

A. medulica Peragallo var. *sinensis*, var. nov. (Fig. 16.)

Frustulum membranaceum basi et apice rotundatum, 0.0993 mm.
long., 0.0221 mm. lat. Linea mediana sigmoidea. Striæ 18-19 in
0.01 mm.

A. medulica Per. (Diat. mar. France, 185, t. xxxviii. fig. 21)
is known from Medoc.

CYMBELLA CISTULA Homp.; V. Heurck, Syn. 64, t. ii. figs. 12-13.

Valve boat-shaped with obtuse ends: l. 0.074, b. 0.017 mm.
Striæ 8-9 in 0.01 mm. Widely distributed in fresh and slightly
brackish water.

Var. *MACULATA* Kütz.; V. Heurck, Syn. 64, t. ii. fig. 16.

Valve, l. 0.034, b. 0.0102 mm. Striæ 11-12 in 0.01 mm.—
Widely distributed in fresh water.

C. GRACILIS Rabenh. (Fig. 19.)

Rabh. Süßwass. Diat. t. x. fig. 1; Cleve, Syn. i. 169.

Valve narrow with acute ends: l. 0.0544, b. 0.001 mm. Striæ
12 in 0.01 mm. Frequent in fresh water, especially in alpine regions.

RIOPALODIA GIBBA (Ehrenb.) O. Müll.

Valve, l. 0.0980, b. 0.017 mm.—Widely distributed.

R. VENTRICOSA (Grun.) O. Müll.

Valve, l. 0.0612, b. 0.011 mm.

R. GIBBERULA (Kütz.) O. Müll. (Fig. 26.)

Valve, l. 0.0255, b. 0.0068 mm. Costæ 4 in 0.01 mm.—Widely
distributed.

Nitzschia rigida Kütz. var. *sinensis*, var. nov. (Fig. 23.)

Valvula linearis sigmoidea, 0.192 mm. long., 0.0062 mm. lat.
Costæ 6.5 in 0.01 mm. Striæ 15 in 0.01 mm.

N. ACUMINATA Sm.; V. Heurck, Syn. 173, t. lviii. figs. 16, 17;
Peragallo, Diat. mar. France, 271, t. lxx. figs. 18-21.

Valve, l. 0.0646-0.0918, b. 0.0085-0.012 mm. Striæ 15-16 in
0.01 mm.—Known in salt waters.

N. HUNGARICA var. LINEARIS Grunow; V. Heurck, Syn. t. lviii.
figs. 23, 25.

Valve, l. 0.125, b. 0.0085 mm. Costæ 6 in 0.01 mm.

N. SIGMA W. Sm.; V. Heurck, Syn. 179, t. lxxv. figs. 7 & 8.

Valve sigmoid, lanceolate: l. 0.0697-0.085, b. 0.006-0.007 mm.
Costæ 9-10 in 0.01 mm. Puncta 24-25 in 0.01 mm.—Widely
distributed.

Var. *serpentina*, var. nov. (Fig. 22.)

Valvula 0.0986 mm. long., 0.0068 mm. lat. Costæ 9-10 in
0.01 mm. Puncta 24 in 0.01 mm.

TRYBLIONELLA HANTZSCHIANA var. VICTORIE Grun.; V. Heurck,
Syn. t. lvii. fig. 14.

Valve, l. 0.048, b. 0.022 mm. Striæ 12 in 0.01 mm.—Frequent.

Var. LEVIDENSIS (Smith) Grunow forma SINENSIS, forma nova.
(Fig. 21.)

Valve lanceolate, acute: l. 0.068, b. 0.0204 mm. Striæ 18 in
0.01 mm.—Frequent.

T. debilis Arnott & Rylands var. *sinensis*, var. nov. (Fig. 20.)

Valvula parva, acuta, 0.011 mm. long., 0.0076 mm. lat. Striæ
exiguæ, 15 in 0.01 mm.

HANTZSCHIA AMPHIOXYS (Kütz.) Grun. var. XEROPHILA Grun.
Diat. Franz-Jos.-Land, 99.

Valve, l. 0.0408, b. 0.0068 mm. Striæ 20 in 0.01 mm.

Surirella tientsinensis, sp. nov. (Fig. 24.)

Valvula lineari-oblonga panduriformis, apice et basi late rotun-
data: 0.0646 mm long., in medio 0.0102 lat., in extremitatibus
0.0136 mm. lat. Costæ 6 in 0.01 mm.

S. APICULATA Hustedt, Beitr. Algenfl. Bremen, 310, t. iii.
fig. 23.

Valve linear, pointed at the ends: l. 0.053, b. 0.013 mm. Costæ
7 in 0.01 mm.

S. ANGUSTA W. Smith, Brit. Diat. i. 34, t. xxxi. fig. 260.
(Fig. 25.)

Valve linear, subelliptical and pointed at the ends: l. 0.255,
b. 0.0068 mm. Costæ 7 in 0.01 mm.—Widely distributed.

S. OVALIS Bréb. var. MINUTA (Bréb.) V. Heurck forma TYPICA Mayer, Bacil. Regensburg. Gewas. 335, t. xix. fig. 15.

Valve, l. 0.0221, b. 0.0085 mm. Costæ 6 in 0.01 mm.—Widely distributed.

Var. MINUTA (Bréb.) V. Heurck forma ÆQUALIS V. Heurck, t. lxxiii. fig. 8.

Valve, l. 0.0306–0.0425, b. 0.0204–0.272 mm. Costæ 4–6 in 0.01 mm. Puncta 18 in 0.01 mm.

Var. MINUTA (Bréb.) V. Heurck forma TIENTSINENSIS forma nova. (Fig. 28.)

Valve broad oval-shaped with rounded ends: l. 0.024, b. 0.017 mm. Costæ 4.5 in 0.01 mm. Puncta 18 in 0.01 mm.

S. SPLENDIDA (Ehrenb.) Kütz. var. GENUINA Mayer; V. Heurck, t. lxxii. fig. 4.

Valve, l. 0.144, b. 0.046 mm.—Widely distributed.

CYMATOPLEURA SOLEA (Bréb.) W. Smith var. GENUINA Kirchner; Mayer, Bacill. Regensburg. 316, t. xiv. figs. 12, 13, 18 (1913).

Valve linear-oblong, with subelliptical ends: l. 0.074–0.140, b. in the middle 0.015–0.020, at the ends 0.027 mm. Costæ 7 in 0.01 mm.—Widely distributed.

Var. GENUINA Kirchner forma MINUTA Mayer, *op. cit.* 317, t. xvii. fig. 2 a.

Valve small, little contracted in the middle and rounded in the ends: l. 0.0527–0.0578, b. 0.0153–0.017 mm. Costæ 7–7.5 in 0.01 mm. One form resembles *Cymatopleura pygmaea*, Pant. Bal. t. ii. fig. 285.

Var. SUBCONTRACTA O. Müll.; Schmidt, Atlas, t. 245; Mayer, *loc. cit.* fig. 3.

Valve very little contracted in the middle: l. 0.0918, b. 0.011. Costæ 6.5 in 0.01 mm.

C. sinensis, sp. nov. (Fig. 27.)

Valvula linearis apice et basi rotundata: 0.0527–0.0745 mm. long., 0.0051 mm. lat. Costæ 5–6 in 0.01 mm.; undulationes 5–6.

BIBLIOGRAPHY.

- CLEVE, P. T. "The Diatoms of Finland." Acta Soc. Fl. et Fauna Fenn., Helsingfors, viii. 68 (1891).
- . "Synopsis of the Naviculoid Diatoms." Svenska Vet.-Akad. Handl. xxvi., xxvii. Stockholm, 1894–95.
- et A. GRUNOW. "Beiträge zur Kenntniss der arctischen Diatomeen." *Ibid.* xvii. No. 2, 1880.
- "Diatomeentafeln, zusammengestellt für einige Freunde." New York, 1888.
- DIPPEL, L. "Diatomeen der Rhein-Mainebene." Braunschweig, 1904.
- GRUNOW, A. "Die Diatomeen von Franz-Josephs-Lands." Denkschr. k. k. Akad. Wiss. Wien, xlvi. 53 (1884).
- VON HEURCK. "Synopsis des Diatomées de Belgique." Anvers, 1880–81.
- MAYER, A. "Die Bacillariaceen der Regensburger Gewässer." Bericht. Naturvereins in Regensburg, 1913.

MEISTER, FR. "Kieselalgen der Schweiz." Bern, 1912.

MÜLLER, O. "Pleomorphismus, Auxosporen und Dauersporen bei *Melosira* Arten." Jahrb. Wiss. Bot. xliii. (1906).

PANTOCSEK, J. "Beiträge zur Kenntnis der fossilen Bacillarien Ungarns," i.–iii. Berlin, 1886–91.

PERAGALLO, H. & M. "Diatomées marines de France." Grez-sur-Loing, 1897–1908.

SCHMIDT, A. "Atlas der Diatomaceenkunde." Leipzig, 1874–

SKVORTZOW, B. W. "On the Phytoplankton from the Ponds of Tientsin." Journ. North China Branch, Royal Asiatic Society, liii. (1922).

[I am indebted to Prof. F. E. Fritsch for assistance in preparing this paper for the press.—ED.]

LICHENOLOGICAL NOTES.—II.

By W. WATSON, D.Sc.

IN the last lot of lichenological notes given in this *Journal* for May 1925 (p. 130), two new species were recorded and described. It is of interest to note that, in both cases, the plants described have been found in additional localities. *Clathroporina calcarea* was found by Mr. Knight and myself on calcareous rocks near Symond's Yat (Coldwell Rocks, v.c. 34) in August 1925. The colour of the thallus is variable: in deep shade its normal reddish tint is entirely lost and, as is so common in shade-plants, a greenish tint appears. A specimen collected in Sept. 1926 by Dr. Lloyd Praeger from calcareous rocks on the Hill of Usinach, West Meath, Ireland, has been recently sent to me by Miss Knowles. *Stenocybe bryophila* was collected by Mr. D. A. Jones at Ceunant Mawr, v.c. 49. It was on hepatics, but in this case the hepatics were on a tree and not on a rock, as in the original specimen from Cwm-y-glo.

In the following notes, species and varieties not previously recorded for the British Isles are indicated by asterisks. The botanical vice-counties are indicated by their numbers:—

THERMUTIS VELUTINA (Ach.) Th. Fr. On rock, Harlech, v.c. 48 (*D. A. Jones*).

PHYSMA CHALAZANODES (Nyl.) A. L. Sm. On soil-cap of wall with *Pottia lanceolata* C. M. Dodhill, near Taunton; on wall-top, Sherford, near Taunton, v.c. 5; Bishop's Cleeve, near Cheltenham, v.c. 33 (*H. H. Knight*).

P. POLYANTHES (Bernh.) Arn. (*Collema myriococcum* Ach.). (growing among mosses on north side of wall, near Cheltenham, v.c. 33 (*H. H. Knight*); among mosses, soil-cap of wall, Buckden, v.c. 64 (*T. Hebdén*).

COLLEMA GLAUDESCENS Hoffm. Usually occurs on clayey soil, and is found in this normal habitat at Stoke St. Mary, v.c. 5, and

Somerton, v.c. 6. Its occurrence on sandy soil has been previously noted ("New, Rare, or Critical Lichens," Journ. Bot. 1917, 109). It is present on the damp sand at Blakeney Point in both v.c. 27 & 28.

C. CERANOIDES (Boit.) Nyl. is a fairly characteristic lichen of the sand-dune flora, especially when the sand is carpeted by such mosses as *Tortula ruraliformis* Dixon. It occurs in such situations at Lelant, Hayle, and Carbis Bay (v.c. 1), Braunton (v.c. 4), Minehead (v.c. 5), and Blakeney (v.c. 27 & 28). At Yr Ogof, Beddgelert (v.c. 49), it occurs with *Ephebe lanata* Wain. at an altitude of 2000 ft. The plants from Beddgelert, Braunton, and Carbis Bay belong to the state with smaller lobes, which has been distinguished as form *crisatulum* Nyl.

COLLEMA CHEILEUM Ach. The form NUDUM (Schaer.), with a better-developed thallus which is devoid of granules, occurs on the ground at Wrington, v.c. 6, and among mosses on rocks at Harlech, v.c. 48. At Sawrey and Hawkshead, v.c. 69, it occurs on a wall.

Form *GRANIFORME Ach. is an extreme development in an opposite direction, the granules being so numerous that the normal thallus is almost obliterated. It has been noted at Clatworthy and Taunton v.c. 5, Wincanton v.c. 6 Cheltenham v.c. 33, and is probably widely distributed, though its granular appearance causes it to be mistaken in the field for other collemaid or leptogiid species.

Form *DISPERSUM mihi. Thallus in small graniferous dark patches, 1-2 mm. in diameter, scattered over the rock, irregularly rounded, sterile; normal thalline lobes almost entirely obliterated; medullary layer with close texture; algal chains of few cells, seldom moniliform, reaction with iodine uncertain but often red. On shaded portions of old mortar and limestone of the ruins of an old house at Curland, near Taunton, v.c. 5, Dec. 1921. Bouly de Lesdain considers it to be the juvenile state of a *Collema*, but it has been noticed in the same state for five years. It has a close resemblance to form *monocarpon* Cromb., but is without apothecia, and the normal structure of the thallus is often entirely lost. It probably owes its condition to its damp shaded habitat.

Form *SUBCHEILEUM (Harm.) has the close texture of the type, but there is no red coloration with iodine. Limestone wall near Taunton (5).

C. MULTIFIDUM var. GYROSUM (Ach.) A. L. Sm. On the side of a limestone road, Rushup Edge, v.c. 57.

SYNECHOBLASTUS POLYCARPUS (Schaer.) D. T. & S. On stone roof, Dowderwell, near Cheltenham, v.c. 33 (*H. H. Knight*).

S. LAUREI (Flot.) Krb. In a specimen which was collected by Mr. Hebden at Buckden, v.c. 64, the spores are obtuse and seem quite distinct from those of *S. polycarpus*. Mr. Knight informs me that he found it in the Ingleton district (v.c. 64) in May 1925.

S. NIGRESCENS (Huds.) Anzi. The var. **furfuraceus* (Schaer.) with the lobes densely isidiose-granulose is not uncommon. I have noticed it at Paignton (3), Staple (5), and Othery (6). So far as my observations go, it is always sterile, and the granules often follow the lines of the plications. Its reaction with iodine is somewhat inconstant.

LEPTOGIUM MICROPHYLLUM (Ach.) Leight. On base of beech tree, Trevaylor, near Penzance, v.c. 1. Form *saxicolum* Rip. On calcareous rock, Wells, v.c. 6.

L. BIATORINUM (Nyl.) Leight. Near Cheltenham, v.c. 33 (*H. H. Knight*).

L. CRETACEUM (Sm.) Nyl. Wall-top, Sheepscombe, near Cheltenham, v.c. 33 (*H. H. K.*); on calcareous rocks, Coldwell Rocks, v.c. 34.

L. MINUTISSIMUM (Flk.) Fr. On banks, Cushuish, Hawkridge, and Broomfield, near Taunton, v.c. 5; on the ground, Cleeve Hill and Combe, v.c. 6 (with a *Didymospheria* parasitic on the lobes); on tree, Cleeve Hill, near Cheltenham, v.c. 33 (*Knight*); on the ground, Dolgelly and Barmouth, v.c. 48.

Harmand (in Lich. de France) includes *minutissimum* as a form under *L. tenuissimum*, and also gives a form *intermedium* with thalline characters intermediate between those of the type and its form *minutissimum*. Both typical *L. tenuissimum* and *minutissimum* are found near Cheltenham, but another plant sent to me by Mr. Knight from a railway-cutting at Gotherington in the same district had shorter and broader lobes than typical *L. tenuissimum*, and was more suggestive of a deeply-cut *L. minutissimum*. This plant corresponds to the one named by Harmand *L. tenuissimum* form *intermedium*. I prefer to place it as *L. minutissimum* form **intermedium*, as it seems to be nearer to *minutissimum* than to *tenuissimum* and as both of these plants are given specific value by British lichenologists.

*L. GRANULIFORME Harm. Another specimen sent from the same railway-cutting agrees with this species. Its spores are 4-5-septate, become divided longitudinally, and eventually are many-chambered. The lobules are too small for *L. minutissimum*, but less erect than in *L. pusillum*, and the spores of the latter are described as having 3-4 transverse divisions only. Harmand's description is as follows:—"Thalle noir, très peu brunâtre, composé de granulations serées par groupes arrondis ou irréguliers de 3 à 6 millim. de diamètre. Apothécies d'abord très petites, à disque concave, brun-rougeâtre foncé, puis planes, plus grandes atteignant 0.7 millim. en diamètre, et paraissant bordées par les granulations du thalle, spores ovoïdes-ellipsoïdes, 0.32-36 x 0.11-16 mm., à 5-6 cloisons transversales, et, à la fin, divisées en un grand nombre de petites logettes."

L. PUSILLUM Nyl. Wall-top, Woodmancote, v.c. 33 (*H. H. K.*); on clay in Mulgrave Wood, v.c. 62 (*T. Hebden*); on ground, Harlech, v.c. 48. The Woodmancote plant has spores in which a fifth transverse septum is sometimes present, but its lobules are erect and less irregular than in the Gotherington plant named *L. granuliforme*.

**L. BYSSINUM* (Krb.) Zw. has a thallus resembling that of *Pannaria nebulosa*. So far as vegetative characters go, a sterile plant from limestone mud collected by Mr. Hebden at Wicken Crag, Keighley, v.c. 63, agrees quite well.

L. RUGINOSUM (Duf.) Nyl. Llechwedd du Mawr, near Harlech, v.c. 48 (*D. A. Jones*). Harmand describes this plant as *L. chloromelum*, and gives *Collema ruginosum* Duf. as a synonym. As *L. chloromelum* has a subsmooth thallus and Harmand's description gives the thallus as "fortement rugueux," it is evident that he refers to the strongly-wrinkled *L. ruginosum*.

STICTINA DUFOUREI (Del.) Nyl. Prenteg, N. Wales (*D. A. Jones*). I also have a specimen in my herbarium from W. Cantyre (101), collected by W. West in 1909.

**LOBARIA LINITA* (Ach.) Harm. On mossy earth and shaded rocks of mountainous districts. The thallus is smaller, more orbicular, and less reticulated than in *L. pulmonaria*. The lobes are also relatively broader and rounded, and the apothecia are more scattered. It occurs in abundance in some places (*e.g.*, Grimsel) on the Alps, but appears to be rare in our mountainous districts. Harlech and Talsarnau, v.c. 48 (*D. A. Jones*). Mr. Hebden has sent me a specimen collected by H. L. Livens at Tanybwlech, v.c. 48.

SOLORNA SPONGIOSA (Sm.) Carroll. Near Cheltenham, v.c. 33 (*H. H. K.*); Keighley, v.c. 63 (*T. Hebden*).

NEPHROMIUM LUSITANICUM var. *HIRBERNICUM* Nyl. Becky Falls, v.c. 3; Kenmore, v.c. 88 (*A. Wilson*, 1913).

PELTIGERA CANINA form **SUBNITENS* Harm. Exford, v.c. 5. This is merely a state in which the tomentum disappears from the upper surface, except at the margin.

P. RUFESCENS var. *PRETEXTATA* (Flk.) Nyl. has been elevated to the rank of a species by Zopf, and this view has been adopted by Du Rietz, Lynge, and others. It is a common plant in many parts of the British Isles and, from my field-observations, does not deserve a status higher than a varietal one. Wherever suitable conditions of moisture (or shade) exist this plant may occur. It is often associated with *Leptogium lacerum* and, in humid districts, may be commoner than the type.

P. POLYDACTYLA form *COLLINA* (Ach.) Nyl. Withypool, v.c. 5; Berrow, v.c. 6; Pevensey, v.c. 14.

CALICIUM PUSILLUM Flk. Combe St. Nicholas, v.c. 5.

STENOCYBE TRAJECTA Nyl. Talsarnau and Cwm Bychan (*D. A. J.*).

RAMALINA POLYMORPHA Abh. On shingle, Blue Anchor (5) and Chesil Beach (9).

R. CUSPIDATA form *MINOR* Nyl. is a small state which is common on our coasts.

USNEA BARBATA Web. (*U. dasypoga* Nyl.). Exton and Porlock (5); Bradley Wood (6 and 8).

U. HIRTA form **ARENICOLA* mihi. Differs from the type in its small size and in its habitat. On sand-dunes, Dawlish Warren (3) and Braunton (4).

CETRARIA ACULEATA var. **ALPINA* Schaer. forms cushions similar to those of var. *hispida* (Light.) Cromb., but the laciniae are flatter. Cader and Mynydd Moel (48), Glyder Fawr (49). The thallus is also somewhat larger than in *hispida*.

PLATYSMA ULOPHYLLUM (Ach.) Nyl. *Cetraria chlorophylla* (Humb.) Wain. On stumps, Tyndrum (88); on boulder, Cwm Bychan (48). Mr. Knight also records it from v.c. 42.

P. GLAUCUM var. *FALLAX* (Web.) Ach. Becky Falls (3); Quantocks (5); Penselwood (6). Var. **fuscum* Flot., with a browner thallus than the type and with the edges soredate, occurs on pales at Tyndrum, v.c. 88.

EVERNIA PEUNASTRI form **NANA* Lamy. is a distinctive form, owing to the thalline lobes being short, narrow, and crowded. It occurs on shingle at Blue Anchor (5). Var. *STICTOCERA* Hook. On fixed dune, Blakeney (27 & 28).

NOTES ON *POTAMOGETON*.

BY ARTHUR BENNETT, A.L.S.

IN the third edition of Hooker's *Student's Flora* in 1884, it is remarked of the genus: "Species about 50." In 1907, Ascherson and Graebner in *Das Pflanzenreich* name 87 species. At the present date we are supposed to have 140. How many of these will eventually be retained, it is difficult to say. One difficulty is that the types of 42 species are only in the Scandinavian herbaria. Of these I possess 22 secondary types—that is, I either have specimens from the author, or by names, numbers, &c., I have identified them.

I propose to make some remarks on various species, and I shall be very grateful for criticism, &c.

Hagström (Crit. Res. on the Potamogetons, 1916, 129) has divided *P. javanicus* Hassk. into four species, and at p. 133 seems to

doubt whether he has gone far enough. I quite agree with him, and now wish to add another species to the group, and probably a second one, but of the latter my material is poor; there may be better under Faurie's number in other herbaria.

Potamogeton subfuscus, sp. nov. *Caulis* humilis filiformis, ramosus vel simplicior. *Folia* natantia subacuta, 2 cm. longa, 5 mm. lata, 5-nervia; folia submersa filiformia, ligula 5-7 mm. longa. *Turris* 9 mm. long. acutus. *Pedunculus* æqualis, 15-18 mm. longus. *Spicæ* 2-3 verticillatæ. *Fructus* 2 mm. long., 1.5 mm. lat.; margine ventrali rotundatus, carina alata, margine dorsali rectus umbone semi-centrali. *Stylus* erectus 0.50 mm., semi-centralis.

Hab. (1) Japan, Etangs et fosses D'Ateita, Sept. 6, 1894, Faurie, No. 13778; (2) Nippon, aqua Utaza, July 1904 (Faurie), No. 5702; (3) Yezo, in ripis flum. Yshutze, July 1905 (Faurie), No. 7189.

No. 1 is named "*javanicus*" by A. & G. in *Das Pflanzenreich*, 164 (1907); and No. 3 is named "*limosellifolius*" Maxim. (165, l. c.), and this is so far right, in that the two are mixed. The second is a plant with the habit and aspect of *javanicus*, but blackish brown, with smaller and more elongated leaves, and the first quite different from *P. tenuicaulis* Muell., more approaching *P. Midukimo* Makina, and as minor differences the flowers are always in whorls of 2 or 3, not continuous, as in *javanicus*.

The second species is "Faurie's No. 2007, 27.7.1898, Isle of Sado, Japan."

This is certainly a new species with fruit quite different from that of any other Japanese species, or of *javanicus*, being entirely without carina, teeth, or umbo, but better material must be awaited before it can be described.

Some of the specimens of *P. tenuicaulis* Muell., *P. javanicus* Hassk., *P. parvifolia* Buch., are by no means settled. Hagström remarks that "the fig. of the fruit of *javanicus* given by A. & G., l. c. p. 47, f. 14 a, seems to represent the Madagascar plant." To me it represents no species of the section, certainly entirely different from the fruit of *P. tenuicaulis* Muell. I consider that *P. parvifolia* Buch., is the same as Hildebrandt's No. 4066 from Madagascar (Imerina), and not the same as Mueller's *tenuicaulis*, although up till now so considered by Dr. Schinz and myself. Hagström does not seem to have seen any Australian specimens of Mueller's.

With regard to the original specimens of *javanicus* Hassk., Mr. Merrill wrote me from Manila, Philippine Islands, that he considered he had determined Loureiro's *Hydrogeton heterophyllum* Fl. Cochinch. 244 (1790) (*P. octandrum* Poir. Ency. Meth. Supp. 4, 534 (1816)), to be the same as *javanicus*. In the British Museum Herbarium there is a specimen from Loureiro named "*Hydrogeton heterophyllum* Lour. Coch. 244."

In the Vienna Herbarium are specimens from "Dr. Knider,

Batavia, named" *P. octandrus* ex herb. Reichenbach, with the note: "Lecta à Dr. Knider pr. Batavia mihi communicata ab. amo. Schinoff, 1830 in Mayo, non *octandrum* Lam. Enc. 12, 534, 1816."

These specimens are *P. javanicus* Hassk. as generally accepted, but I have never been able to see a specimen named by Hasskarl. (If Steudel was right, Mr. Merrill may be so.) I have always understood that Hasskarl had seen a specimen of *P. tenuicaulis* Muell. from Trinity Bay, Queensland (17° S. lat. 146° E. long.), and accepted it as his *javanicus* (*fide* Dr. Schinz).

Of the species of the genus published of late years, *P. tenuinervis* Camus (in Lecomte's *Notulæ Syst.* i. 88 (1909)), Japan, Savatier, No. 3473, Herb. Paris, is the most puzzling. The figure looks like a young *P. Maackianus* A. Benn., as, with the exception of *P. Robinsii* and *P. crispus*, I know of no species of the genus with such a serrated leaf-margin. It is curious that from the same place there is a specimen named "*P. crispus* L. v. *serrulatus* Schrad" in the Kew Herbarium from the "Science College, Imp. Univ. Japan," and that is *P. Maackianus*!

P. NITENS Web. in North America.

A few years before he died, Mr. Morong, of Mass., U.S.A., wrote me that Dr. Tiselius, of Stockholm, had named specimens from Wenham Pond, Mass. (*Faxon*), as *P. nitens*. He then sent me a series, and there was no doubt that it was Weber's plant. In fact, one specimen was identical with specimens from the Kiel Herbarium, sent me by Dr. Reinke in 1892. Hagström remarks at p. 231 of his *Crit. Res. Pot.* (1916): "*P. nitens* seems to be a rare plant in N. America, which should be looked for. Robinson and Fernald do not mention it in Gray's *New Manual* of 1908."

I have specimens sent me by Morong (except the Sault Ste. Marie ones) from:

1. Millboro, Del., 15.6.85 (*A. Comans*);
2. Wenham, Mass., 13.9.80 and 86 (*C. E. Faxon*);
3. Nantucket, Mass., 5.9.82 (*T. Morong*);
4. Sault Ste. Marie, Mich., 4.8.81 (*E. J. Hill*);
- 5 and 6. v. *occidentalis* A. & G. Navy Islands, Ont., Canada (*W. Scott*), 1887. Queenstown, Ont., No. 184 (*W. Scott*) 1897 (*ex Macoun*).

These two last seem to be a hybrid between *P. perfoliatus* v. *Richardsonii* A. Benn. and *P. heterophyllum* Schreb. The Sault Ste. Marie specimens exactly accord with specimens from Kerry Island (*Dr. Scully*) and Elevenes, Norway (lat. 63° 35' N.) *Johnson*.

P. CRISPUS L. It is curious that the Rev. T. Morong, in his *N. American Natadaceæ* (1893) 37, in a note remarks: "That none of the old authors name this as N. American." Somehow he overlooked that Pursh (Fl. Am. Sept. 120 (1814)) gives it from "Canada to Virginia," and marks it "v. v." as having seen a living specimen. That he was right as to the species is shown by his

reference to "Fl. Dan. t. 927," and Curtis, "Fl. Lond. 5, t. 15." Yet up to 1893 there was no specimen of it from U.S.A. in the Kew Herbarium. Now it is on record from nine States and the District of Columbia.

P. PERFOLIATUS L. The late Mr. Fryer, after a careful study of specimens from all parts of the world, considered that the major part of the named varieties were mere forms. In European Floras 47 varieties are named and described. Probably seven-tenths of these are local conditions of growth. Yet it is curious to see the stability of the species in Japan, where the variation is very small, and the colour dark, so different from European specimens. Still, in Europe there are two varieties which, if gathered in Brazil, would probably be claimed as species. One from the Florentine Herbarium, gathered by Parlatore in Lago d'Alserio in Lombardy 1874, is remarkable. Its leaves are 2.3 cm. x 2.15 cm., crenulated on the margin, and with the veins very prominent; the internodes are only 1 cm. long, and all the upper leaves are overlapping. The other, gathered by Caspary in "Lake Ostritz, Prussia, 1886," is 7 dm. long, and along the whole length the leaves overlap; nothing can be seen of a stem. The leaves are very thick, and the whole habit quite unlike any other specimens.

I do not think in British books there is any mention of Hagström's division of *P. Cooperi* Fryer. He divides them as follows:—
a. *serrulatus* f. *eu-Cooperi*. Leicestershire!, Salop!, M.-W. York!, Notts!

f. *Jacksonii*. Chester!, Cambridge!.

f. *scoticus*. Stirling, Scot.!

And I add to these:—

f. *hibernicus*, Irish Nat. 243 (1896). Co. Down!, Co. Antrim!.

This hybrid has also been named *P. cymotoides* A. & G. Syn. Mitt.-Eur. Fl. 337 (1897), and *P. cymbifolia* Fischer in Mitt. Bayer. Bot. Ges. 1904, 366.

P. OBTUSIFOLIUS M. & K. This species is usually described as having 3-veined leaves, but in specimens from the Methyl River, 57° N. lat., Canada (*L. M. Macoun*), it is 5-veined. Fieber, in Die Pot. Böhm. (1838) t. iii. f. 19, figures it with 3-5-7-veined leaves.

P. ASCHERSONII A. Benn. This Chilian and S. American species is recorded by Hagström from "Sable Island, Canada, and Newfoundland." This Sable Island plant I described as *P. pusillus* L. var. *capitatus* in Journ. Bot. 1901, 202. I then noticed its likeness to *Aschersonii*, but it is very remarkable that a S. American species should reappear in British N. America. But accepting it as such, specimens from "Ontario, Canada, *Macoun*, No. 22203," and from "Dover, Maine, U.S.A., 1894, *W. L. Fernald*," must be so named, but I do not wholly accept them.

NOTES ON *OROBANCHE*.

By C. E. SALMON, F.L.S.

DR. G. BECK VON MANNAGETTA has recently determined several examples of *Orobanche* for me, and amongst his determinations I find two varieties, both from Jersey, which have not been, so far, I believe, reported from that island.

1. *O. PURPUREA* Jacq., var. *a. TAPEINA* G. Beck. Wall-tops, Jersey, 1871 (*F. Piquet*). This is described by Beck (Mon. *Orobanche*, 124, 1890) as follows:—"Flores parvi, summo 18 mm. longi, plurimum intense violacei; calycis dentes tubo suo breviores. Spica laxa, pauciflora. Scapus sæpe gracilis, tenuis, summo 17 cm. altus."

The form of *purpurea* which Beck designates as *β. typica* (of which he saw examples from Quenvais, Jersey, coll. J. D. Gray, 1894) is separated by the following characters:—Flores magnitudine intermediæ, anthesi circa 2-2.5 cm. longi; dilute in limbo intensius colorati. Calycis dentes tubo suo breviores, sæpe subtriangulares. Spica multiflora solum in parte superiore anthesi conferta deinde semper laxiflora.

O. MINOR Sutton var. *CONCOLOR* Duby. St. Ouen's Bay, Jersey, 1883 (*Dr. H. F. Parsons*).

The main features separating this from *minor* are as follows:—Stem thickened at the base, and, like the whole plant, straw-sulphur in colour, abundantly scaly. Spike cylindrical, lax-flowered. Bracts ovate-lanceolate, a little shorter than the corolla and, like the calyx, glandular-pilose. Corolla straw-sulphur in colour, tubular-campanulate, externally glandular-pilose; its dorsal line curved from the base, almost straight in the middle, sloping downwards to the upper lip. Filaments pilose below, above, like the style, glabrous or sparingly glandular-pilose. Stigma yellow.

Duby originally described this plant in Bot. Gall. ed. 2, i. 350 (1828), and Beck amplified the diagnosis.

Beck noted that in these Jersey specimens the filaments were more hairy than in normal *concolor*, and observed that they could not come under var. *flavescens* Reuter (as Dr. Parsons had labelled them), on account of the yellow stigma.

In view of Mr. Pugsley's note in this *Journal* for 1926, p. 18, respecting *O. amethystea* Thuill., I was glad to find that Beck confirmed plants named thus, which I had gathered in E. Kent in 1890 and Dorsetshire in 1921. The former he noted varied "corollis minus genuflexis et filamentis in basi copiosius pilosis," the latter he considered typical.

O. amethystea may thus, I think, safely remain in the *London Catalogue* as the British species upon the authority of the monographer of the genus. When gathering the Dorset specimens I was able, at the same time, to collect undoubted *O. minor* not far away, and thus had the advantage of comparing them in the fresh condition and noting their differences.

OBITUARY.

JOHN NUGENT FITCH

(1840-1927).

THE well-known botanic artist, John Nugent Fitch, died of acute bronchitis on the 11th January last, and was buried at East Finchley. He was born at Glasgow on the 24th October, 1840, and had therefore reached his 86th year. His uncle, Walter Hood Fitch (1817-92), had been trained by Sir William Hooker, becoming an extremely fine botanic artist who foreshortened and posed leaves in a singularly natural manner, even from dried specimens. The younger Fitch worked under his uncle's supervision till about 1876, when his name began to appear to many plates in the 'Transactions' and 'Journals' of the Linnean Society. It was in the year just mentioned that he produced a striking proof of his lithographic ability. The French artist Riocreux had drawn *Cincho Calisaya* var. *macrocarpa* for Howard's *Quinology of the East Indian Plantations*, the author intending to have it engraved in Paris under the eye of the artist, but Fitch begged to be allowed to show what he could do by lithography, and, leave being given, he produced the fine folio plate which closes the volume. Much of his work was putting the drawings of others on to the stone; thus, when in 1878 he began to work for the *Botanical Magazine*, his share was to lithograph drawings, at first made by Lady Thiselton-Dyer, who was succeeded by the late Miss Matilda Smith; in all, nearly 2500 plates were lithographed by the younger Fitch for that serial. He also illustrated the eleven quarto volumes of Warner's *Orohid Album*, 1882-96. In 1920, in consequence of an illness, he lost the use of his fingers, thus ending his artistic career. He was elected F.L.S. in 1877. A few years before his death he was awarded a Civil List pension.—B. D. JACKSON.

A COUNTERFEIT COLLECTION OF MEXICAN PLANTS.

WE are indebted to Mr. Paul C. Standley, of the U.S. National Museum, for a reprint of an article from *Science* (Feb. 4, 1927), in which he exposes a serious attempt at deception on the part of a European dealer in herbarium specimens. As it is in the interest of workers that the details should be widely known amongst botanists, we quote freely from Mr. Standley's article:—

A few years ago the U.S. National Museum received a large collection of plants made in Mexico by Brother (†) Arsène from the neighbourhood of Puebla and Morelia, where he was teaching in the schools of the Christian Brothers. He was assisted by other members of the same Order, some of whom collected in other districts. The duplicates, comprising several thousand specimens, were distributed to other herbaria in the United States. Brother Arsène also sent a very large number of specimens to France which were disposed of by

Brother Héribaud in the interests of the Order; a large proportion of these were consigned to one or more continental dealers in herbarium material. Mr. Standley goes on to say:—

"The plants distributed by Brother Héribaud were properly labelled, and so far as is known none of the specimens actually collected by Brother Arsène and his associates was ever distributed with an incorrect label.

"Mexican plants are in much demand by herbaria, and apparently the supply was not equal to the demand, consequently at least one of the dealers devised a unique scheme for satisfying those who wished Mexican plants. I am informed that one lot of plants purchased by the Gray Herbarium and purporting to have been collected in Mexico by one of the Christian Brothers (Brother Adole) consisted in part of species known otherwise only from Brazil*!

"The first and only experience that I have had personally with fictitiously labelled plants of this collection was in preparing for mounting specimens of the Buchtien Herbarium, which was acquired several years ago by the National Museum. This herbarium contained several thousand specimens purporting to have been collected in Mexico by Brother Arsène and other members of the Christian Brothers, which had been received by Buchtien in exchange for Bolivian plants. To one acquainted with the flora of Mexico, examination of this 'Mexican' collection was dumbfounding.

"Many of the plants labelled as coming from Mexico were species of well-known range, of which it could be stated with all confidence that they did not occur in Mexico. Some were from the eastern United States, some from California, others from the West Indies, and some even of Old World origin.

"In looking over several thousand of these plants, it was possible gradually to form some idea of their true nature and source. The results were highly interesting, but the explanation is so complicated that it may be difficult to state it lucidly.

"In his desire to have for sale material which he could append to Brother Arsène's genuine collections, some dealer evidently had made use of miscellaneous collections remaining upon his hands, the demand for which had been exhausted. Some of these were from Mexico, others from the United States, and still others from Asia and Australia. All such specimens were now supplied with characteristic and uniform labels, 5¼ by 3¼ inches, bearing in heavy type the heading 'Plantæ Mexicanæ'; the word Mexico, followed by 'Puebla:' and 'Morelia:;' and 'Coll: Nicholas, Arsène.'

"The dealer who created these false specimens possessed no high degree of ingenuity, else it would not be so easy to expose his system. In some instances the Buchtien Herbarium contained two specimens of a given rare species lying in a single cover, one being improperly labelled as collected in Mexico by Arsène, the other a correctly labelled specimen of the collection from which the 'Arsène' specimen had

* [I can confirm this, as Dr. Robinson showed me several instances when I visited the Gray Herbarium in September last.—Ed.]

been fabricated. Anyone experienced in the preparation and handling of herbarium specimens will understand how easy it was to recognise the fact that the apparently unrelated specimens had a common origin, since they were alike in every detail of size, shape, discoloration, etc., and in those intangible but quickly perceptible characters which mark all the specimens of a series of one species that have been collected and dried by one collector upon a certain date.

"For instance, part of a specimen of *Arctostaphylos canescens* Eastwood, collected on Mount Tamalpais, California, had been ticketed as collected by Arsène at Rincón. Among the United States collections from which these supposed Mexican collections were segregated are C. F. Baker's 'Plants of the Pacific Coast' and his plants of Cuba; plants of the Southeastern States distributed by the Biltmore Herbarium; and various collections distributed by G. L. Fisher.

"The distributor of these plants was not content with ascribing specimens wrongly to Brother Arsène, but his ingenuity was equal to the creation of a new and fictitious collector, Herrera. This is a common Spanish family name, but I have no hesitation in asserting that this particular Herrera never existed.

"'Herrera's' collections were manufactured from those of Pringle. In many instances the type collections of Pringle's new species were thus divided. Here, too, only the name of the species was invariably retained. The date of collection is sometimes earlier and sometimes later than Pringle's. The locality is usually the same, but often the altitude (given in feet on Pringle's labels and in metres on those of 'Herrera') has been altered.

"There are probably other complications that have escaped me, but those mentioned are sufficient to indicate their general nature. The facts of the case are such that no one understanding them can doubt that the labels were falsified with the intent to deceive. I know of no other instance in which similar deceit has been practised in the distribution of herbarium specimens, and fortunately so, since such deception can result only in chaos. Some of these wrongly labelled collections have reached the United States. Here the result is likely to be bad enough, although in most cases an American botanist will at least question the new records of distribution introduced. In Europe, where knowledge of American geography is naturally less intimate, the results are likely to be extremely unfortunate. Certainly students of 'discontinuous distribution' will find much to interest them in the study of these collections. The thousands of specimens included in the Buchtien Herbarium comprise only a small portion of the collection distributed with these worse than misleading labels, for thousands of others were distributed to the larger herbaria of Europe and America.

"It is with the hope of warning European botanists as to errors lurking in the labels of the (spurious) Arsène collections and to prevent erroneous records of distribution, which, if printed, will persist for many years, that this article has been prepared. For the benefit of European workers, the following summary of the matter may prove helpful:—

"Extreme care is necessary in the citation of specimens of plants supposed to have been collected in Mexico by Brothers Arsène, Nicolás, Adole, and Abbon (and perhaps others). If the labels are multi-graphed and in script, there is no reason to doubt their authenticity. Labels ($1\frac{1}{2}$ by 4 inches) issued at the U.S. National Herbarium and headed 'Plants of Mexico,' with printed locality, also are authentic. Beware of large ($5\frac{1}{4}$ by $3\frac{1}{4}$ inches) labels, surrounded by a black frame, with the heading 'Plantae Mexicanae,' and bearing two names of collectors, Arsène and Nicolás, one or both of which are deleted with pen and ink. Plants with such labels are almost certainly false. Either they were not collected in Mexico, or else they were collected by Pringle at another date and locality than that specified. It is best to destroy all plants bearing such labels. All labels of this type bearing the name 'Herrera' as collector are fictitious and should be disregarded.

"In closing, I cannot state in too strong terms that no blame for this condition of affairs attaches to Brother Arsène; rather, he has been made the victim of an unfortunate conspiracy, if such it may be termed. No more conscientious or industrious collector has ever worked in Mexico, and he has contributed in a very large measure to our knowledge of the Mexican flora."

REVIEWS.

An Outline of Plant Geography. By DOUGLAS HOUGHTON CAMPBELL. 8vo, pp. ix, 392. With 52 plates and 101 figs. Macmillan's: London, 1926. Price 17s. net.

PROF. CAMPBELL has had enviable chances of observing at first hand the vegetation of many parts of the world. The specimens, notes, sketches, and photographs accumulated during these journeys, extending over a period of more than thirty years, have served as the basis of the present volume. These personal data have been supplemented by the free use of standard general works—as those of Drude and Schimper,—descriptive floras, and especially Engler's series of monographs, *Die Vegetation der Erde*. The author apologises for his intrusion into a realm of botany in which he cannot claim to be an expert with the suggestion that one who is, in a way, an amateur, may be more likely to appreciate the more salient features of a flora than the specialist in some particular group.

An introductory chapter gives a brief account of plant-succession and existing factors in distribution, and this is followed by one on climatic zones. The remaining seven chapters deal with the vegetation of the world classed under four headings: (1) The North Temperate Zone with three chapters, Eurasia and North Africa, Atlantic and Central United States and Canada, and the Rocky Mountains and Pacific Slope; (2) the Palæotropics; (3) the Neotropical Regions; (4) the South Temperate Zone.

The illustrations are an important feature of the book. They

include excellent photos of characteristic vegetation in many parts of the world, and the author expresses his indebtedness to colleagues and others for their use.

As regards the subject-matter, it is, of course, easy to be critical. To give a satisfactory outline of plant geography within the compass of a small volume calls for the combined expert knowledge of the geologist, the geographer, and the botanist with a working acquaintance with the floras of the different parts of the Earth and the factors of plant distribution. And such an one would probably have approached the subject from a different standpoint than that adopted by Prof. Campbell. Within the limitations which he admits in his Preface, the author has given a readable account of the vegetation in many parts of the world, and the reader will be able to form an idea of its great variety and of some of its characteristic features. The sections dealing with small areas are of unequal value; that on the British Islands is one of the poorest.

If Prof. Campbell had sought the help of a friend familiar with floristic work to read through the proofs he would probably have avoided various errors in citation of species which somewhat mar the generally pleasing appearance of the text.

Forest, Steppe, and Tundra: Studies in Animal Environment.

By MAUD D. HAVILAND (Mrs. H. H. BRINDLEY). 8vo, pp. 218. With 7 text-diagrams, 8 plates, and folding map. University Press: Cambridge, 1926. Price 12s. 6d. net.

THOUGH, as the title suggests, the book is primarily zoological in character, the botanist and nature-lover generally will peruse it with interest. The author's purpose is to trace a relation between the animal and its environment, and from the first she was confronted by the difficulty of defining formations and associations for the animal world on similar lines to those used by plant-ecologists. The plant is fixed, and can only meet change in environment by structural and physiological changes in itself. The animal is mobile and, within limits, can change its environment by moving elsewhere. However, the main types of land-environment, Woodland, Grassland, and Desert, represent conceptions for the zoologist in relation to which animal adaptation may be studied.

The preparation for the work consisted of an expedition to the cold desert tundras of Siberia, followed by war service in south-west Russia. The contrast of tundra and steppe, their analogies and differences, suggested the present studies, and the preparation for the trilogy of Woodland, Grassland, and Desert was completed by a trip to the tropical jungle of British Guiana.

In a somewhat lengthy introduction (pp. 1-32) the author discusses the factors of morphological and physiological adaptation, and the equipment necessary for the study of bionomics. The main subject-matter falls under four headings: Part I. The Rain-forest

(pp. 37-117); Part II. The Steppe (119-148); Part III. The Tundra (149-196); Part IV. The Taiga (197-210). The last-named is the flat marshy coniferous subarctic forest which in Siberia stretches from the Pacific Ocean to the Ural Mountains, some 3600 miles long by 800 miles wide. The sketch of the country and its environmental conditions is based on a short journey made by the author through the Yenisei Taiga in 1914.

The book is well written, and the chapters teem with interest on the plant and animal life of the areas under consideration. The plates are mainly well-selected photographic reproductions of typical scenery, and the map illustrates the distribution of forest, steppe, and tundra in Asia.

Kryptogamenflora für Anfänger. IV. Die Algen, Abteil. 1. By G. LINDAU; 2nd Edition by HANS MELCHIOR. 8vo, pp. viii & 314. Springer: Berlin, 1926. Price R.M. 20.40.

THIS volume, which deals only with the Myxophyceæ, Flagellata, Peridinieæ, and Bacillariales, is intended to afford a beginner a concise introduction to the systematic study of the freshwater and marine representatives of these classes. The course that has been followed in its compilation is, however, not altogether clear, for, whilst a large proportion of the forms included are common and of wide distribution, a considerable number are rare and hitherto only recorded from a few localities. There is a risk that a beginner may be deluded into supposing that this book includes all the forms he is likely to encounter, and that this may encourage him to attempt to fit whatever he finds into the compass of one or other of the described species. In view of the slight, and often somewhat elusive, differences that are employed in specific distinction among the Protophyta, this is a real danger. There can be no doubt that, for the serious worker in the realm of the Algæ, a primary acquaintance with genera and species that are of abundant occurrence is quite essential, and it would probably have been better if the present volume had been restricted to such. Subsequent progress with the help of standard works is not too difficult, and in this connection the list of literature on pp. 36, 37 should be most useful. One misses, however, a reference to West's *British Freshwater Algæ*, perhaps one of the most valuable books for the beginner in algology that has yet been published.

The introductory section gives useful hints on occurrence and investigation of Algæ, but omits instructions as to the methods of measuring the latter. The subsequent general description of the four groups dealt with is admirable in most ways, but too little stress is laid on internal structure, so that a novice might obtain the impression that outward form was all important. The systematic portion, which occupies the greater part of the volume, is clear, the diagnoses, though concise, are in general adequate, and the numerous tables for determination of genera and species are well constructed. The volume is provided with sixteen plates comprising nearly 500 separate figures,

the majority of which are adequate for the recognition of the form they depict. The more abundant illustration that would be desirable from the standpoint of the beginner was, no doubt, ruled out by considerations of cost.

The grouping of all the Flagellata as one class is a somewhat antiquated attitude, and the few points mentioned in the introductory section with respect to their relation to other classes of Protophyta are not always in line with the present-day point of view.

F. E. FRITSCH.

Die Pilze Mitteleuropas. Band I. Die Rohrlinge (Boletaceæ).
By FRANZ KALLENBACH. Parts 1 and 2. W. Klinkhardt,
Leipzig, 1926-7. M. 4.

THIS atlas, which promises to be the most complete that has so far been attempted, is appearing under the auspices of Der Deutschen Gesellschaft für Pilzkunde and other societies, and is edited by Professors Kniep, Claussen, and Bass. The intention is to issue two coloured and two other plates with four pages of text every two or three months. The first two parts are to hand. The plates are three-colour processes and, without margin, measure $11\frac{1}{2}$ in. \times $8\frac{1}{4}$ in. Plate I. shows specimens of *Boletus satanus* in various stages of development; Plate II. *Boletus satanus*, *B. rhodoxanthus*, *B. erythropus*, *B. luridus*, and *B. miniatoporus*; Plate III. a series of *B. rhodoxanthus*; and Plate IV. of *Boletus impolitus*. The uncoloured plates (Plates X. and XI.) are mainly photographs showing pore-surfaces, habit, and the like. Text dealing only with *Boletus satanus* is published at present, and indicates the detail with which the individual species are to be treated; in all there are twelve drawings, two photographs, fifteen small anatomical drawings, and practically four pages of text dealing with this fungus.

The plates are very good, and every mycologist will hope that the work will be carried on until complete; already the iconograph of *Boletus* is much enriched. The reason for departing from the time-honoured custom of beginning Icones with *Amanita* is that originally the intention was to supplement Rickon's Blatterpilze (Agaricaceæ).

J. R.

WE have received the following from Dr. W. Watson, whose *Elementary Botany* was reviewed in our last number (p. 91):—

The reviewer of my *Elementary Botany* states that "there is little originality of treatment," and then proceeds to criticise a number of things in which it departs from stereotyped methods.

He does not understand why the chapter on Gymnosperms is postponed till the Ferns have been considered, apparently preferring to keep the two chapters in taxonomic sequence. This is undoubtedly the right method if an ascending series is used but, when a descending series is employed, the consideration of the Gymnosperms before the

Ferns causes difficulty in making the reproductive processes of the former intelligible to the student.

The insertion of chapters on Mendelism, Evolution, and Ecology between the chapters dealing with the Phanerogams and the Cryptogams is in general accordance with the introduction of these subjects to the student.

The "use of the word 'egg' to designate the fertilized ovum" causes so little ambiguity in a botanical work that the use of a familiar word with three letters seems preferable to the use of an unfamiliar term with six.

As my personal bias is physiological, I am quite willing to agree with the reviewer that an introduction to plant-life should largely depend on physiological phenomena. This view may, after all, be a biased one which requires some correction; the average boy not only likes to see how plants do their work, but also likes to look at the workers. Correlation between structure and function is better shown by a close association of morphology and physiology which may be so intimately blended that the correlation is not obtrusive.

That the "wide series of experiments" is a minimum and not a maximum quantity is evident if page 7 is read. Their insufficient explanation is intentional: an experiment is a direct question set to the plant, and the student should read the answer for himself. If the explanation involves giving the answer, my experience teaches me that some students neglect the experiments or do them in a perfunctory manner.

The value of the book depends, as the reviewer states, on the "personality of the teacher" and "on an established scheme of practical work." Without such accompaniments, especially the latter, I do not know any method whereby a sound knowledge of botany can be obtained.—W. WATSON.

BOOK-NOTES, NEWS, ETC.

LINNEAN SOCIETY.—At the General Meeting on Feb. 17, Miss Eleanor Vachell gave an account, illustrated with coloured lantern-slides, of an unusual specimen of *Anagallis*.

The plant was noticed in a newly constructed public park at Coldknap, Barry, Glamorgan, in July 1926, in a flower-border about to be weeded, growing amongst a large colony of normal plants of *A. arvensis*. It had eleven stems—seven bearing scarlet flowers and four bearing blue flowers. Two types, *A. arvensis* Linn. and *A. fœmina* Mill., were apparently represented on the same plant, *i. e.*:—

Seven Stems.—Corolla-segments scarlet, edge even, fringed with numerous glandular hairs, calyx two-thirds as long as corolla.

Four Stems.—Corolla-segments blue, edge denticulate, with very few glandular hairs, calyx as long as corolla.

The root appeared normal, no fusion of two roots being visible.

The interest of the specimen is that the characteristic features of two species (as usually recognized) are represented, but remain distinct. No parti-coloured flowers suggested hybrid origin: it appears rather that one portion of the plant may have reverted. The capsules on the seven stems bearing scarlet flowers were considerably in advance of those on the four stems bearing blue flowers. All the leaves were like those of *A. arvensis*.

The President read the following letter from the Rev. Canon F. W. Galpin:—"With reference to Miss Vachell's interesting exhibit, I should like to state that, in the year 1924, a great quantity of *Anagallis fœmina*, together with an abundance of the common *A. arvensis*, was growing in a field near Rivenhall Place, Witham. My neighbour, Mrs. Bradhurst, who lives at The Place, and is a good field-botanist, observed a plant on which three stems bore red flowers and one stem blue. She transferred the plant to her garden, as the field was shortly coming under cultivation again; there I saw it, but unfortunately all the flowers had dropped. I am glad, however, that her find, which was somewhat doubted at the time, has now received ample corroboration. I may add that, after a prolonged search, I failed to find any similar specimen; nor did I observe any parti-colour hybridization between the two types."

Dr. Stapf suggested that Miss Vachell's plant was an instance of somatic segregation. He referred to Hoffman's experiments at Giessen and to Professor Weiss's, which showed a high constancy of colour and reluctance to cross. He paralleled the case of *A. arvensis* and *A. fœmina* by reference to *A. Monelli* (blue) and *A. collina* (red), which in their native areas are colour-constant. They are, however, to all appearance the parents of our garden pimpernels, of which seven colour-forms were known by 1839. He suggested that these two species should be subjected to genotic experiment, which might throw much light on the problem of our smaller wild pimpernels.

Mr. R. J. Chittenden referred to other examples, such as *Primula sinensis* and *Matthiola incana*, in which several characters are affected by a sport. The sport in these cases is due probably to somatic non-disjunction. The sporting *Anagallis* may be heterozygous for the various *fœmina* characters shown by the sport, and the *fœmina* characters being linked, the elimination of the homologous *arvensis* chromosome at a somatic cell-division would give a chimera of the type shown.

Mr. C. Leonard Huskins (Visitor) remarked that phenomena similar to the one described by Miss Vachell were known in wheat. Plants had been found bearing both *Triticum vulgare* heads and heads of the speltoid type, *i. e.* similar to *T. Spelta*. Heads had also been found which were *vulgare* on one side and speltoid on the other. There was considerable evidence that this change was due to chromosomal aberration. In species which had arisen by hybridization and subsequent polyploidy, it would seem that only a slight irregularity in cell-division was needed to upset the balance and permit the appearance of characters belonging to one of the original parental or other related species.

Mr. W. B. Turrill urged that further genetical experiments should be made with the blue and scarlet British pimpernels. He stated that there were other blue forms besides that usually recognized as *Anagallis fœmina* Mill., and certainly one in Great Britain, which had the corolla characteristics of *A. arvensis* except that the colour was blue.

At the meeting on March 3, Mr. E. G. Baker exhibited a fruit of *Cordyla africana* Lour.

The genus *Cordyla* is an anomalous genus of Leguminosæ, generally placed in the tribe Swartzieæ. The fruit somewhat resembles a Mango externally, hence the name "Wild Mango," and has several seeds with large fleshy cotyledons embedded in pulp. The flowers are apetalous. There are numerous perigynous stamens, and the ovary is on a long gynophore. *Calycandra pinnata* Rich., which is synonymous, was placed in the Capparidææ. The timber is valuable, especially for making pianos.

Mr. T. A. Sprague exhibited a series of photographs (taken in Virginia, U.S.A., by Dr. W. J. Humphreys) of ice-ribbons on *Cunila origanoides* Britton.

The photographs represent ribbons of ice which are formed on the dead stems of *Cunila origanoides*, a perennial Labiate which grows on dry hills in the eastern United States. The ribbons are formed, not by external deposition, but by the exudation of water from the stem. According to Coblenz, the water rises in the vessels of the wood. The ribbons begin as a vertical row of hair-like ice crystals, which are soon bound together by a connecting web of ice. A fringe of ice is thus formed which gradually grows out into a ribbon. The ribbons are as thick as a table-knife, $\frac{1}{2}$ -2 inches broad, and may be 6 or 7 inches long. From one to five (but usually two) ribbons may arise from the same stem. Similar formations have been observed on thistles and on species of *Pluchea*, *Heliotropium*, and *Helianthemum*. The process appears to be a purely physical one.

Mr. H. N. Ridley mentioned that Foerste, in the *Botanical Gazette*, had stated that the achenes of *Ambrosia trifida* in winter emit from the beak strands of ice, $1\frac{1}{2}$ -3 inches long, and the achenes are dispersed by wind, especially when they freeze to leaves or sticks that are blown away.

Mr. A. J. Wilmott gave an account of the Irish *Spiranthes*; a paper by him on this subject will appear in our next number.

THE J. E. GRIFFITH HERBARIUM, ETC.—The botanical collections made by Mr. J. E. Griffith, of Bangor, have recently been acquired by the Department of Botany of the National Museum of Wales. The plant collections, which formed the basis of Mr. Griffith's *Flora of Anglesea and Carnarvonshire*, comprise flowering plants, ferns, bryophytes, marine algæ, and lichens, amounting in all to more than 5000 specimens. A large proportion of the specimens were collected by Mr. Griffith himself, and among the rest are a small number col-

lected by Rev. Hugh Davies, author of *Welsh Botany* (the bulk of whose collections were acquired by the Department of Botany, British Museum, over thirty years ago). There are also ten volumes of botanical books which belonged to Hugh Davies, including Sowerby's *English Fungi*, one volume of which was dedicated to the Welsh botanist, a volume of Hugh Davies botanical MS., and a number of autograph letters from famous botanists of the late 18th century. Two copies of a route across Snowdon, the first almost certainly in Hudson's hand-writing, the second headed "My rout (*sic*) with Mr. Hudson" and signed "Hugh Davies," afford sufficient proof that William Hudson visited North Wales, a fact which has hitherto been in doubt (*cf.* Rees, Journ. Linn. Society, xlvii, 288 (1926).—H. A. HYDE.

In the *Journal of the Indian Botanical Society for December, 1926* (vol. v. no. 3), N. K. Tiwary, of the Benares Hindu University, describes the pillaging of the nectar from flowers of the Leguminous plant, *Sesbania grandiflora*, by several species of birds. The nectar is secreted by glands on the inside of the united bases of nine stamens, and the arrangement of the surrounding organs leaves only two small approaches from above to the nectar. The bird-robbers seem to have found out the exact position of the nectar, and peck holes at the spot on the outside of the calyx-tube with great precision. Further, only those buds are attacked which are sufficiently developed to secrete nectar.

The same author describes the phenomenon of polyembryony in six species of *Eugenia*, which show very different degrees of the condition. In *E. Sumbolana* several embryos may arise parthenogenetically or apogamously from different parts of the ovule. The question of the origin and significance of polyembryony is discussed, and the writer finds reason to agree with Ernst that it is the expression of the hybrid origin of the plants. The author has also compiled a list of species, systematically arranged, in which polyembryony has been recorded, indicating that its occurrence has not hitherto been reported in the Myrtales.

FIFTH INTERNATIONAL BOTANICAL CONGRESS, 1930.

THE first meeting of the Executive Committee was held, by permission, at the rooms of the Linnean Society on February 25th, 1927. Professor A. C. Seward, F.R.S., was appointed Chairman, Dr. A. B. Rendle, F.R.S., Treasurer, and Mr. F. T. Brooks and Dr. T. F. Chipp Joint Secretaries.

It was decided to hold the Congress in Cambridge, probably beginning on the 15th August. It was also decided to organise the Congress in the following seven sections:—Morphology (including Anatomy), Taxonomy and Nomenclature, Plant Geography and Ecology, Palaeobotany, Genetics and Cytology, Physiology, and Mycology and Plant Pathology.

CALLITHAMNION SCOPULORUM C. Ag.

By M. A. WESTBROOK, M.Sc.

CALLITHAMNION SCOPULORUM, C. A. Ag. Spec. Alg. ii. 166 (1828); J. G. Ag. Alg. Medit. 73 (1842); Kütz. Spec. Alg. 644 (1849); J. G. Ag. Spec. Alg. ii. 47 (1851); Kütz. Tab. Phyc. xi. 70*f-h* (1862); Ardissonne, Phyc. Medit. i. 61 (1883); Hauck, Meeresalgen, i. 79 (1883).

C. roseum var. *tenuis* Lyngb. Tent. Hydr. Dan. 126 (1819).

C. hirtellum Zanard. Callith. 37 (1846); Icon. Phyc. Adriat. 82 A (1860).

C. pusillum Schousb. in Bornet, Alg. Schousb. 328 (1892).

This Red Seaweed is widely distributed on rock-surfaces in the littoral zone from the Faroës Islands in the north to the southern shores of the Mediterranean. Specimens have been found on various substrata, usually non-living, as indicated by its specific name, though Killian (1914) describes it as growing profusely on *Corallina*, and Jonsson (1912) found it on *Gigartina* sp., *Cystoclonium purpurascens*, and *Cladophora rupestris*. The composition of the rock-surface seems to be of little importance to the plant, for it was gathered in flourishing condition from such varied substances as chalk, sandstone, and granite.

It forms a well-marked but inconspicuous association on steep, moderately exposed rock-surfaces, either alone or accompanied by a mixed collection of smaller algæ or else under the shelter of larger forms such as *Fucus vesiculosus*. The dominant factor determining its presence or absence seems to be the amount of light to which it is exposed during the period of uncovering. For instance, on a boulder under observation on the beach at Shanklin it attained its greatest development in July 1925, on the side facing the north-west, where also was the thickest growth of *Fucus vesiculosus*. Small patches, usually covered by other algæ, were found on the north-east, but it was practically absent from the rest. At Guernsey (April 1925) it was growing in the ridges lining rather narrow gullies of rock, which were left uncovered about two hours after high tide. It was here only a little below the *Pelvetia*-zone and was accompanied by *Catenella Opuntia*. On a chalk-face at the top of the beach at Broadstairs *C. scopulorum* was found (May 1925), together with the following:—*Catenella Opuntia*; *Spermothamnion repens* var. *roseolum*; *Rhodochorton floridulum*; *Ceramium flabelligerum* (dwarf); *Polysiphonia nigrescens* (dwarf); *Enteromorpha compressa* (dwarf); *Chaetomorpha* sp.; *Ectocarpus* sp.; *Isthmoplea sphaerophora*; *Fucus vesiculosus* (dwarf).

The species is constantly found with the outer wall covered with a thick growth of fine filaments, whose components are too small to be seen clearly, but appear to be bacteria or Cyanophyceæ. *Chantrelia secundata* (?) was found on material from Salcombe (April 1926); the *Callithamnion* was almost covered by its dense growth,

and sporelings were to be found even all over the sporangia (fig. 6). Their basal pseudoparenchymatous disc did not penetrate the wall of the host. Material from polluted waters was invested with diatoms of various kinds (*Limnophora* etc.), attached singly by gelatinous stalks.

HABIT.

Specimens form close, deep purple tufts, the individual plants generally only reaching a height of 5-1 cm. and often being less, though luxuriant ones from shady crevices may be as much as 3-4 cm. high. They are thus far from conspicuous. The plant is attached to the substratum both by down-growing intramatrical filaments, which later break through the wall of the axile cell, and by elongated branches which emerge singly from the base of the dorsal face of a branch of the first order (fig. 3). These latter have been figured by Børgesen (1902) and also by Nägeli (1861) as "rhizoids." They interweave with the basal portions of the other algæ present, e. g., the creeping parts of *Calenella Opuntia* and the rhizoidal branches of *Rhodochorton floridulum*. The long lower branches and their rhizoids may become detached from the parent plant and propagate it, as do the runners and stolons of higher plants.

The main axis is composed of a single row of cells, generally not

EXPLANATION OF FIGURES (p. 131).

(The original magnifications are given; the figures have been reduced by about two-thirds.)

- Fig. 1. Apex of tetrasporic plant, with pinnae arranged alternately, all in one plane. $\times 115$.
 Fig. 2. Apex of tetrasporic plant with unusually long lateral pinnae, giving a corymbose appearance to the apex. $\times 115$.
 Fig. 3. Filament from the base of plant, with branched "rhizoids." $\times 115$.
 Fig. 4. Tetrasporic branch showing wound-reaction; at *a* and *b* are broken cells, while from either side filaments are growing which will re-establish continuity. "Starch" was present in the shaded cells. $\times 370$.
 Fig. 5. Regeneration of the tetrasporangium. $\times 785$.
 Fig. 6. Filament with sporangia of *Chytridium* epiphytic. A dehiscent sporangium is seen, opening by a "lid" and with remains of the mesochiton inside. $\times 785$.
 Fig. 7. Filament with a short branch growing up into the cavity of a dehiscent sporangium. $\times 585$.
 Fig. 8. Vertical section of sporangium showing tetrahedral cleavage; the thickness of the wall is exaggerated. $\times 585$.
 Fig. 9. Filament-cell bearing young procarp. $\times 785$. *tr*=trichogyne; *cpg*=carpogonium; *amc*=auxiliary mother-cell.
 Fig. 10. Same, with trichogyne developed. $\times 785$.
 Fig. 11. Procarp ready for fertilization. $\times 490$. *ac*=auxiliary cell; *bc*=basal cell.
 Fig. 12. Germinating carpospore with two shoot-cells and a rhizoid. $\times 1200$.
 Fig. 13. Portion of female plant bearing cystocarp with two gonimolobes. $\times 230$.
 Fig. 14. Portion of male plant showing position of development of antheridial groups. $\times 230$.
 Fig. 15. Young antheridial group with stages in the development of antheridia. $\times 1400$.

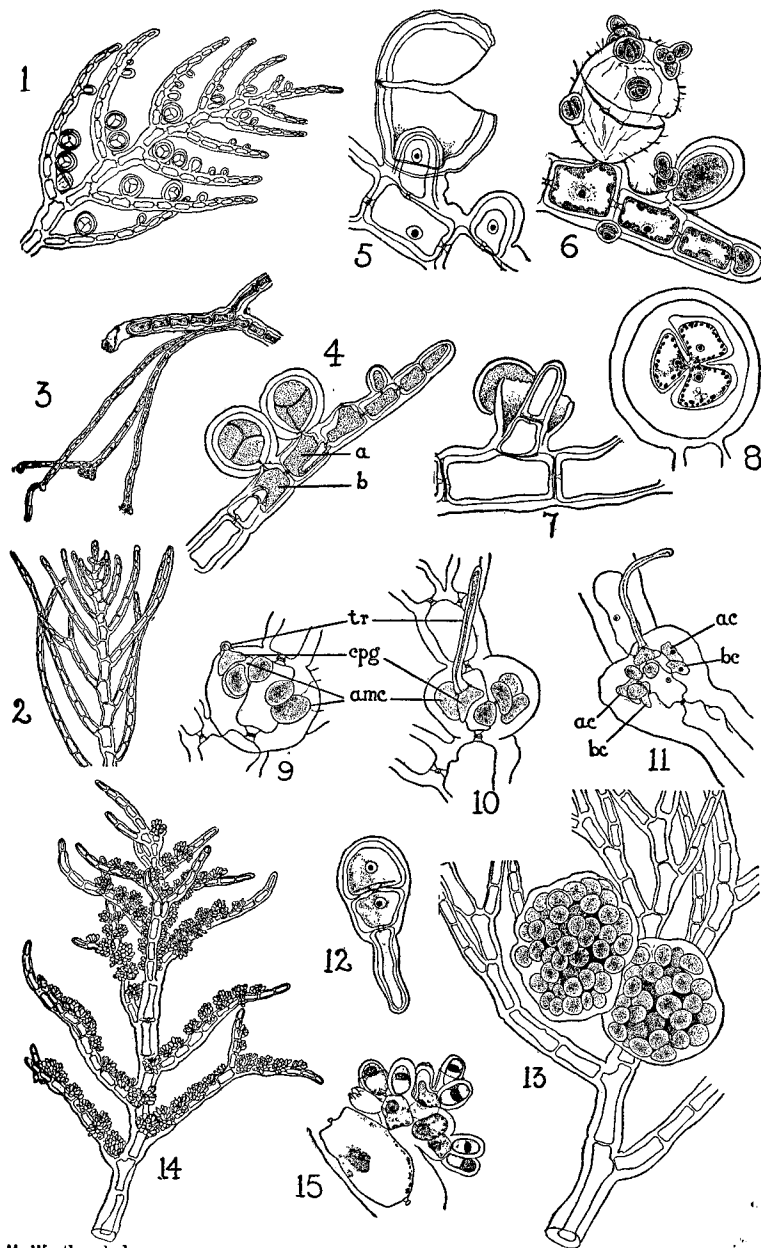

M. Westbrook d.

Callithamnion scopulorum C. Ag.

(For Explanation of Figures, see p 130.)

at all zigzag. It is usually stated (Nägeli, Börgesen, Cotton) that cortication is absent; this, however, is not true of the basal portions of vigorous plants. Here cortical filaments emerge from the basal cell of a branch of the first order and grow downward in the outer layer of the wall of the axile cell. They are, however, very inconspicuously developed in comparison with such species as *C. tetragonum* and *C. Hookeri*.

The thickness of the basal cells varies from 80–100 μ , higher up they are from 60–80 μ , tapering at the apex to about 14 μ . They are from $1\frac{1}{2}$ to 5 times as long as broad. As a rule, each cell of the axis bears one branch—all these lying in one plane. At the base of the plant the branches are all strongly divaricating; they emerge at an angle of about 80°, and are then recurved downwards, bearing at most one or two pinnæ. Higher up the branches are given off at an angle of about 45°, and may themselves be similarly provided with pinnæ of the second order. Tripinnate fronds are occasionally encountered in vigorous specimens. In the typical form the branches are not so strongly developed as the main axis, and do not overtop it; the outline of the shoot is then roughly triangular (fig. 1). In some plants which were found in spring and which seemed to be in active growth, the frond had not the usual feathery appearance and it was seen that the pinnæ was much elongated, so that the apex had a corymbose outline (fig. 2). Tetrasporangia were very sparsely developed on these branches, but lower down the pinnæ were typical.

In all stages the cells are uninucleate, the central nucleus measuring about 7 μ in diameter; there are numerous ribbon-like or variously branched chromatophores. The cell-contents include crystalloids of an angular outline, staining black with Haidenhein's hæmatoxylin, and numerous grains of Floridean starch, turning red-brown with iodine in potassium iodide or with Schultze's solution. In the reproductive stage the vegetative cells often contain no insoluble reserves, all going to the tetraspores or carpospores, but sometimes in such material a succession of cells will stain deep brown with iodine, and so present a marked contrast to the others. Closer examination generally shows that the starch-containing cells have been cut off from their neighbours by a wound, involving the splitting of a cell or perhaps only the severance of a pit-connection. In these cases it will be found that the cells on either side of the break, or just above and below it, put out thin filaments, which grow up and down and establish communication with an undamaged cell (fig. 4). A similar development has been noted in the cœnocytes of *Griffithsia Bornetiana* (Lewis, 1909) and *G. corallina* (Janczewski, 1876) and in *Monospora pedicellata* (Tobler, 1903); the reaction serves to show the physiological importance of the delicate pit-connections.

The cell-wall is composed of two layers, averaging 4 μ in thickness. The outer is apparently resistant, and is frequently covered with minute epiphytes. Treatment with acid shows that the inner layer is not homogeneous, but there are several lamellæ, these being somewhat more conspicuous at the ends of the cells. As to the chemical composition of the wall, it is clear that it does not, as reported by

P'anini (1924), consist solely of cellulose. Iodine in potassium iodide followed by strong H_2SO_4 caused the inner layer to turn bright blue, but the outer, though much swollen, was not coloured at all. Similar swelling was effected by dilute acetic acid; this was mainly confined to small parts of the wall, which thus bulged outwards, especially just above the cross-wall separating the cell from that next below it. This recalls the observation recorded by Wurdack (1923) for the outer wall of filaments of *Edogonium irregulare*, nor in this case could the substance be further identified. After 24 hours in warm ammonium oxalate (1% aq.) filaments of *C. scopulorum* were little altered in appearance, but the cellulose reaction was more easily given by the inner layer. Treatment for 24 hours with a solution of cuprammonium hydrate caused swelling of the cell-walls; filaments were then washed in water and placed in dilute acetic acid. By this means the cellulose should have been dissolved away, but, though the layers were obviously more diffuse, the tough outer wall forbade it to pass out except where there was a cut end. The outer layer was deeply stained by ruthenium red, suggesting that its nature is partly pectic.

In some stages hairs were found, though they were not developed to such a conspicuous extent as, for instance, in *C. Brodiaei* or *C. corymbosum*. They were found in spring on male, female, and tetrasporic plants, though they were best developed by the female plants, where superficially they are very like trichogynes. They are of the type usual in *Callithamnion* (Rosenvinge, 1921)—that is, they are hyaline, unicellular, and terminal on a cell with which they are united by a delicate pit-connection. On an average, their thickness was about 7 μ , while the length varied from 80–160 μ , exceptionally being as long as 530 μ . Apparently lateral hairs were sometimes seen; these have developed terminally, but been pushed aside by a lateral outgrowth from the mother-cell. Later on the hairs fall off or are perhaps eaten. Their function remains obscure: they are considered to form a protection against injurious illumination or else to offer increased surface for respiratory exchange and absorption of gases and salts in solution. The latter explanation seems inadequate in the case of forms such as *Callithamnion* and *Chantransia*, where the cells are freely exposed to the surrounding medium. It was noted that at Broadstairs, in May, where *C. scopulorum* was found with hyaline hairs, the latter were profusely developed by other algae in rock-pools or faces (e. g., *Ceramium flabelligerum*, *C. strictum*, *C. botryocarpum*, *Cystoclonium purpurascens*, *Lomentaria articulata*, etc.), while in *Polysiphonia nigrescens* and *Laurencia pinnatifida* trichoblasts, though quite different in origin, were similarly being produced actively.

TETRASPORIC PLANTS.

The tetrasporangia are sessile on the upper faces of pinnæ of the first and second and occasionally of the third order. Usually they are regularly developed in acropetal succession, one from each cell of the branch, beginning from the base (fig. 1). The position and

development recall *C. polyspermum*, but on the basal branches and in plants which have been growing in a tangle of other vegetation the tetrasporangia are scattered, sometimes being produced terminally on a short pinna or emerging from the dorsal face of a branch. In no case was more than one sporangium borne by a branch-cell.

The sporangial initial is somewhat clavate, and contains a single nucleus with a large nucleolus and inconspicuous linin network. The cytoplasm is dense and chromatophores can hardly be distinguished. At first there is no Floridean starch, but later on grains appear round the nucleus, and before the first division they are present in quantity. The details of the reduction division have not been observed; the spores are arranged regularly in the tetrahedral fashion (fig. 8). The ripe tetrasporangium is almost spherical, averaging $70\ \mu$ in length by $65\ \mu$ in diameter. As in the case of the vegetative cells, the wall of the tetrasporangium is two-layered, these two being continuous with those of the filament. Their nature seems, however, to be slightly altered, for the inner will only give a cellulose reaction after treatment with ammonium oxalate. In the ripe sporangium the portion of the wall surrounding the spores seems to be differentiated as a third layer, just as in the oogonia of *Fucus*. At maturity the protoplasmic connection between the spores is severed, and they come slightly apart, being somewhat angular on account of the confined space. Dehiscence takes place by means of a transverse split in the wall about halfway round the sporangium and extending about halfway round it. A kind of lid is thus formed, having a hinge at one side (fig. 6). Through the opening the spores push out, becoming elongated and compressed in the process. As soon as they are free they enlarge and become spherical and the closely-packed starch-grains become more diffused, thus making the plastids more clearly visible. Careful observation will show that the innermost layer of the sporangial wall still surrounds the four spores, but it is very soon dissolved away and the members of the quartet separate. Within the empty sporangium are the remains of the second wall-layer; it is attached at the base to the pit-connection with the mother-cell, standing up in the cavity, somewhat collapsed and with a ragged opening at the top (fig. 6). It is not known how far the discharge is influenced by external conditions; it was once effected by leaving filaments overnight in a damp box and then placing them in sea-water.

The dehiscence seems to follow the same course in other species of *Callithamnion*—e. g., *C. byssoides* and *C. tetragonum*. Thuret (1878) figures the sporangium of *C. corymbosum* opening by a lid; in this species Rosenvinge (1923) once watched the spores escaping: the two top ones squeezed out together, followed by the others separately. He figures "lids" also for *C. Brodiaei*, *C. roseum*, and *C. Furcellariae*. The remains of the second wall-layer do not seem to have been noticed in these or in other cases, but can generally be seen if recently emptied sporangia are carefully examined.

In some members of the Florideæ, often apparently primitive forms, such as *Chantransia*, *Galaxaura*, *Rhodochorton*, the sporangium mother-cell behaves in the same way as does the antheridial

mother-cell—that is, it can produce a new sporangium in the place of an old one, the second one growing up into the empty cavity. This may be repeated several times, as is evinced by the number of old walls left standing within each other. It is not known as a normal occurrence in *Callithamnion*, and does not seem to have been recorded abnormally either (Thuret's *C. elegans*=*Plumaria*). In one plant of *C. scopulorum* there were found a few examples of this regeneration of the sporangium, a secondary one being formed (fig. 5). In another case it was not a sporangium, but a short branch which was produced (fig. 7).

FEMALE PLANTS.

The procarys are always borne by an intercalary cell, in some cases as many as three successive ones may become fertile. The appearance of the plants is somewhat altered, since the lateral branches are very vigorous and may attain the same or even a greater length than the main axis. There is thus the simulation of dichotomous branching, and, since the laterals do not all emerge in one plane, there is a spiral arrangement much recalling that described in detail by Rosenvinge (1920) for *C. corymbosum*.

The fertile axial cell first cuts off, right and left, two large cells with conspicuous nuclei, which form the auxiliary mother-cells. One of them also acts as the "Tragzelle" and produces the carpogonial branch (fig. 9). This is four-celled as usual in the genus, the component cells being arranged across the axis in a characteristic zigzag fashion. The carpogonium seems rather transparent and devoid of contents; the trichogyne arises as a small projection which forces its way through the thick wall of the procary (fig. 9). It then lengthens considerably, becoming from 75 – $160\ \mu$ long, generally straight (fig. 10), but sometimes bent (fig. 11). Spermatia may be seen attached to it. After fertilization, which is presumed to take place, the trichogyne is cut off by an ingrowth of the wall, the auxiliary cells having been produced previously by a transverse division in each of the mother-cells (fig. 11). The subsequent developments are the same as in other species—e. g., *C. corymbosum* (Oltmanns, 1898), *C. Furcellariae* (Kylin, 1922). Two large gonimolobes are finally formed (fig. 13), on an average, $165\ \mu$ in diameter, $195\ \mu$ long; a small lobe is often to be found at the base of each, produced by a second division of the auxiliary cell as has been described for several other species of *Callithamnion*. The carpospores are about 30 – $35\ \mu$ in diameter; they have a conspicuous nucleus and numerous discoid plastids as in the tetraspore. Germination takes place as usual in the Ceramiaceæ to form first a rhizoid cell with scanty contents and a shoot initial cell, which continues to divide by transverse walls (fig. 12). Later stages have been figured by Killian (1914): the primary rhizoid degenerates, and is replaced by secondary ones, while the apical cell divides actively and cuts off lateral branches.

MALE PLANTS.

Antheridial plants were, as is not uncommonly the case in the Florideæ, smaller than the typical female and tetrasporic plants, not reaching a height of more than 5 – 1 cm. This is no doubt because of

the cessation of branching in a fertile plant, following on the early production of antheridia. The laterals are not always in the same plane, they do not emerge at a greater angle than usual (*i. e.*, about 40°), but are afterwards somewhat divaricating (fig. 14). The antheridial groups are produced in the same position as the tetrasporangia, but more than one is generally found on each filament-cell; they form short branched axes whose components early function as antheridial mother-cells (fig. 15). Finally, each cell gives about three bushy groups, which fuse and partially encircle the axis; the production of antheridia may also extend to the main axis.

The antheridial mother-cells are either axile cells of the antheridial groups or are special cells cut off from these; they are slightly pigmented and uninucleate. Each produces from 2-4 primary antheridia (fig. 15), the usual number being 3. They arise as protoplasmic protuberances, surrounded on the exterior by the wall of the mother-cell. They enlarge to about 5μ in length, and each receives a nucleus, but little else in the way of contents, and is then abstricted from the mother-cell. As in the vegetative cells, the wall shows two distinct layers; the escape of the spermatium is effected by the splitting of the wall at the apex; the contents, having severed their connection with the mother-cell, are then discharged. Fresh material was not examined at this stage, so that it cannot be said whether the spermatium is walled or not. In mounted preparations free spermatia seemed to be surrounded by a thin wall, but this may be only the inner layer of the antheridium-wall, having been forced out together with the protoplasmic contents by pressure on the cover-glass. That this walled appearance was abnormal was suggested by the fact that, occasionally, within the empty antheridium could be seen, just as in the sporangium, the collapsed remains of the inner wall-layer.

Usually three antheridia are produced in succession beneath the apex of the mother-cell, and may be seen in different stages of development (fig. 15). Secondary antheridia are generally formed within the empty primary ones, and occasionally signs have been seen of an even greater fertility of the mother-cell. There was, however, no such general production of tertiary antheridia as has been recorded for *Callithamnion brachiatum* (Grubb, 1925), nor was the development of secondary antheridia as clearly seen as in this species.

PERIODICITY OF REPRODUCTION.

The times and places at which *C. scopulorum* has been found fertile are here combined with the results of previous workers (De Toni, 1924):—

Male.

Broadstairs..... May.

Female.

Broadstairs..... May.
 Faroës Islands (*Börgeesen*)..... June.
 Balearic Islands (*Rodriguez*)..... September.
 Plymouth..... April.

Tetrasporic.

Balearic Islands (*Rodriguez*)..... May, June, October.
 Faroës Islands (*Börgeesen*)..... April-August.
 Iceland (*Jónson*)..... May-July.
 Norway (*Foslie*)..... August-September.
 Sweden (*Kylin*)..... August.
 France (N.) (*Chemin*)..... April-August.
 England (*Traill*)..... June-July.
 Shanklin..... February, July.
 Broadstairs..... April, May.
 Plymouth..... April, June, July.
 Salcombe..... April.

In England reproduction seems to be confined mainly to the late spring and early summer; there is no evidence as to the plant's behaviour during the winter months. At Plymouth in midsummer no sexual plants could be found, while the only representatives of the species were faded or otherwise unhealthy-looking plants with sporadic sporangia. It may be that the tetraspores produced in summer do not proceed far with germination until the next spring; the high mortality one may presume likely would then explain the comparative rarity of sexual plants; carpospores would develop under more favourable conditions of light and temperature, and so produce a good crop of tetrasporic plants. However, the great disproportion in numbers between sexual and asexual generations makes one suspect that the latter may be able to reproduce itself.

Part of the material for this investigation was collected while utilizing a grant from the Dixon Fund: for this latter grateful acknowledgments are made.

BIBLIOGRAPHY.

- AGARDH, C. A. (1828). 'Species Algarum, &c.' Vol. ii. Lund.
 AGARDH, J. G. (1842). 'Algæ Maris Mediterranei et Adriatici.' Paris.
 —. (1851). 'Species Algarum.' Vol. ii. 1. Lund.
 —. (1876). 'Epicrisis Systematis Floridearum.' Lund.
 ARDISSONE, F. (1883). "Phycologia Mediterranea.—I." Mem. Soc. Crittog. Ital. i. Varese.
 BÖRGESEN, F. (1902). "The Botany of the Færoës.—II. Marine Algæ." Copenhagen and Christiania.
 BORNET, E., and THURET, G. (1878). 'Études Phycologiques.' Paris.
 COTTON, A. D. (1912). "Clare Island Survey.—15. Marine Algæ." Proc. Roy. Irish Acad. xxxi.
 DE TONI, G. B. (1924). 'Sylloge Algarum.—VI. Florideæ.' Sectio V. Padua.
 GRUBB, V. M. (1925). "The Male Organs of the Florideæ." Journ. Linn. Soc. (Bot.) xlvii.
 HAUCK, F. (1883). "Die Meeresalgen Deutschlands und Oesterreichs." Rabenhorst's 'Kryptogamen Flora.' Leipzig.
 JANCZEWSKI, E. (1876). "Notes sur la Développement du Cystocarpe dans les Floridées." Mém. Soc. Nat. de Cherbourg, xx.
 JÓNSON, H. (1912). "The Marine Algal Vegetation of Iceland.—I. Rhodophyceæ." Bot. Tidskr. xxiv. Copenhagen.
 KILLIAN, K. (1914). "Über die Entwicklung einiger Florideen." Zeitschrift f. Bot. vi.
 KYLIN, H. (1922). "Studien über die Entwicklungsgeschichte der Florideen." Kgl. Svensk. Vetensk.-Akad. Handl. lxxiii.

- LEWIS, I. F. (1909.) "The Life-History of *Griffithsia Bornetiana*." Ann. Bot. xxiii.
- NÄGELI, C. (1861.) "Beiträge zur Morphologie und Systematik der Ceramiaeen." Sitz.-Ber. K. Bayerisch. Akad. Wiss. München, i.
- OLTMANN, F. (1898.) "Zur Entwicklungsgeschichte der Florideen." Bot. Zeitung, lvi.
- PANINI, F. (1924.) "Osservazioni sulla sostanza fondamentali nella membrana cellulare di diversi algue." Atti R. Ist. Veneto Sci. Lett. ed Arti, lxxxiv.
- ROSENVINGE, L. K. (1911.) "Remarks on the Hyaline Unicellular Hairs of the Florideae." Biolog. Arbejder. Tilegnede Eug. Warming.
- (1920.) "On the Spiral Arrangement of the Branches in some *Callithamnionia*." K. Dansk. Vidensk. Selsk. ii.
- (1923.) "The Marine Algæ of Denmark.—II." K. Dansk Vidensk. Selsk. Skrifter, 7 Raekke, Naturvidensk. og Mathem. Afd. vii. 3. Copenhagen.
- TOBLER, F. (1903.) "Ueber Vernarbung und Wundreiz an Algenzellen." Ber. Deutsch. Bot. Gesell. xxi.
- WURDACK, M. E. (1923.) "The Chemical Composition of the Walls of certain Algæ." Ohio Journ. of Science, xxiii.

THE *MELAMPYRUM* SPECIES OF EAST ASIA.

BY DR. RALPH V. SOÓ
(Budapest).

AMONG the semi-parasitic Scrophulariaceæ-Rhinanthoideæ the genus *Melampyrum* has played an important part both in the systematic work of the last few years and in work on the Theory of Descent. Since Prof. v. Wettstein pointed out the phenomenon of season-dimorphism in the Plant Kingdom, and extended the conception to many *Melampyrum* species, many attempts have been made, partly by the Wettstein school, partly by the opponents of season-dimorphism to explain the affinities and evolutionary relationships of the polymorphic species of this genus. My own work has been the comparison and unification of the conclusions arrived at by Wettstein, the revision of the Middle and S.E. European material in particular, and a monographical review of all the species and forms, paying especial attention to their distribution. I have made, moreover, an attempt to give a satisfactory explanation of the origin of season-dimorphic strains in general.

The papers by Karl Ronniger (1910, 1917, 1918, 1924) and the monograph of the genus *Melampyrum* by Gustav Beauverd (1916) were the starting-point for my investigations. Both my observations in the field, spreading over several years, and the extensive herbarium material through which I have worked have convinced me that season-dimorphic and pseudo-season-dimorphic (more briefly and more correctly pseudo-polymorphic) pure lines (strains, races) exist, and that their systematic significance cannot be neglected, although the theories concerning their origin are difficult to understand.

The pseudo-season-polymorphic races have originated from the populations of the original genotypically varying forms through the selective working of the sociological factors, especially those of the habitat, as hereditary biotypes (œcotypes) with an apparently phyletic potentiality. (For more details, see my Monograph in Rep. Spec. Nov. Berlin, xxiii. (1926), xxiv. (1927), and Math. Naturw. Anzeiger der Ungarischen Akademie, xliii. 320-331 (1926).)

SYSTEM.

Sectio I. *Spicata* Wettst., Ronn. (1918), (1924).

Subsectio 1. *Arvensia* Soó in Jávorka Magyar Fl. 1006 (*arvensis* Ronn.).

Lower lip flat, bent upwards at the edges, involute (concave), with three very small teeth (scarcely 1 mm. long) crowded closely together at the tip. Corolla-throat entirely closed. Capsule dehiscing bilaterally, in *M. chlorostachyum* only by the anterior side (according to Beauverd). Bracts flattened.

Subsectio 2. *Barbata* Ronn.

Lower lip convex, sharply revolute at the edges; tip with three stout teeth 1 mm. long or longer, and not crowded together. Corolla-throat somewhat opened. Capsule bilaterally dehiscent. Bracts flattened.

Subsectio 3. *Carinata* Beauv.

Bracts grooved, pectinately toothed. Spikes quadrangular. Calyx-teeth unequal. Capsule only dehiscing anteriorly.

Sectio II. *Laxiflora* Wettst., Ronn. (1924).

Subsectio 1. *Nemorosa* Soó, l. c. 1007.

Bracts usually coloured. Flowers over 12 mm. long, yellow (a. Series *Eu-nemorosa*) or reddish, relatively rose-coloured (b. Series *Rosea*). Corolla-throat open or closed. Capsule bilaterally dehiscent.

Subsectio 2. *Silvatica* Soó, l. c. 1010.

Bracts green. Flowers up to 12 mm. long, yellow or white. Corolla-throat widely open. Capsule bilaterally dehiscent.

Subsectio 3. *Pratensis* Soó, l. c. 1009.

Bracts green. Flowers (with exception of *M. lineare*) more than 15 mm. long. Corolla-throat almost closed. Capsule unilaterally dehiscent.

Synopsis of Sections and Species.

I. *Spicata* Wettst.

- | | |
|--------------------------------|---|
| 1. <i>Arvensia</i> Ronn. | 1. <i>M. ciliatum</i> Boiss. & Heldr. |
| | 2. <i>M. arvensis</i> L. |
| | 3. <i>M. elatius</i> Reut. |
| | 4. <i>M. caucasicum</i> Bunge. |
| 2. <i>Barbata</i> Ronn. | 5. <i>M. chlorostachyum</i> (Hohenacker) Beauv. |
| | 6. <i>M. barbatum</i> W. & K. |
| | 7. <i>M. variegatum</i> Huter, Porta, & Rigo. |
| | 8. <i>M. fimbriatum</i> Vandas. |
| 3. <i>Carinata</i> Beauv. | 9. <i>M. cristatum</i> L. |

II. *Laxiflora* Wettst.1. *Nemorosa* Soó.

- A. *Eu-nemorosa* Soó ...
10. *M. nemorosum* L.
 11. *M. Degenianum* Soó.
 12. *M. velebiticum* Borb.
 13. *M. italicum* Soó.
 14. *M. vaulense* (Ronn.) Soó.
 15. *M. catalaunicum* Freyn.
 16. *M. subalpinum* Juratzka.
 17. *M. fallax* Čelak.
 18. *M. polonicum* (Beauv.) Soó.
 19. *M. bhariense* Kern.
 20. *M. Hoermanniarum* Maly.
 21. *M. Dörfleri* Ronn.
 22. *M. trichocalycinum* Vandas.
 23. *M. herculeoticum* Boiss. & Orph.
 24. *M. scardicum* Wettst.
 25. *M. indicum* Hook. f. & Thoms.
 26. *M. laxum* Miq.
 27. *M. roseum* Maxim.
 28. *M. selaceum* (Maxim.) Nakai.
 29. *M. aristatum* (Beauv.) Soó.
 30. *M. Henryanum* (Beauv.) Soó.
 31. *M. japonicum* (Fr. & Sav.) Soó.
 32. *M. Klebelsbergianum*, sp. nov.
M. latifolium et *ovalifolium* Nakai.
- B. *Rosea* Soó
33. *M. silvaticum* L.
 34. *M. saxosum* Baumgt.
 35. *M. pratense* L.
 36. *M. lineare* Lam.
 37. *M. stenophyllum* Boiss.
M. Guinieri (*M. silv.* ssp.) Beauv.
- Mihi ignotæ.....
2. *Silvatica* Soó
3. *Pratensis* Soó
- Species vel forma dubia...

Summary of the Phylogenetic Characters and the
Distribution of the Groups.

1. *Arvensia*. A West Asiatic (Caucasus, Armenia, Asia Minor) and South European group: *M. arvensis* only is found in the rest of Europe as an immigrant of later times, as has occurred with many species which have accompanied agriculture from its eastern sources (see Soó in Oesterr. Bot. Zeitschr. 1922— ueber *Consolida orientalis*).

Constituents of the Southern Eurasian flora. Centre of development, the Caucasus, especially in the neighbourhood of the Black Sea.

2. *Barbata*. Western Balkan Peninsula and Italy (Adriatic region), Donau region; elsewhere only adventitious. Constituents of the West-Pontic (Illyrian-Hungarian) flora. Centre of development, the Dinaric Alps.

3. *Carinata*. Constituents of the Eurosiberian flora; richest development of forms in Central Europe (Alps, Carpathians).

4. *Nemorosa-Eu-nemorosa*. The yellow-flowered species are members of the European flora, the most variable group, segregated into many micro-species which have independent distributions, but are linked together at their boundaries by transition forms. Their richest development is in the Alps (South-west, Eastern, and Dinaric

Alps) and Carpathians, especially characteristic of the region in brackets. Constituents of the Central European and West-Pontic-Balkan floras. Centre of development, the Alps.

The *Rosea* spp. are the *Melampyrum* species of East Asia, and are also segregated into micro-species.

5. *Silvatica*. *M. silvaticum* is a montane species of Eurosiberia. Centre of development undoubtedly the Alps and the Carpathians, where *M. saxosum* was derived from it a long time ago.

6. *Pratensis*. *M. pratense* is also Eurosiberian, very variable in the Alps, and is accompanied, moreover, in nearly all mountain-systems where it occurs by endemic forms. *M. lineare* is the only species in North America.

When I visited the various London Botanical Institutions in October 1926, I took the opportunity to examine the types of *Melampyrum* in the Linnean Herbarium and the East Asiatic material of this genus in the British Museum Herbarium and the Kew Herbarium. The discovery of a fine new species rewarded my efforts. This is here described under the name *M. Klebelsbergianum*, in honour of Count Dr. K. Klebelsberg, the Hungarian Kultusminister, whose kindness has made possible my recent journey. For further information on the systematic, phylogenetic, and phyto-geographical relationships, on the races of *Melampyrum* and their significance, and a critical account of season-polymorphism, as well as descriptions and distribution of all the species and forms, see my systematic monograph of the genus *Melampyrum* (Fedde, Rep. Spec. Nov. Berlin, xxiii. (1926)).

CONSPECTUS FORMARUM MELAMPYRI GENERIS ASIATICARUM
(Sect. *Rosea* Soó).

1. *M. INDICUM* Hook. f. & Thoms. Kew Journal, ix. 276 (1857).

Caulis ramosus, internodiis multis, abbreviatis, rami arcuati. *Folia* anguste lanceolata, 5-8 mm. lata, utrinque attenuata, intercalaria 5-10-paria. *Inflorescentiæ* initium ad nodum 16-30 situm. *Bracteæ* inferiores ovato-lanceolatae, superiores basi hastato-dentatae virides. *Calyx* tubo 3 mm. longo, puberulo, costis pilis sparsis multicellularibus præditus, dentes triangulari-lanceolati, acuti, tubo breviores. *Corolla* circa 15 mm. longa, purpurea, in sicco cærulescens. *Antheræ* 3 mm. longæ; *ovarium* 1.5-2 mm.; *capsula* glabra 8-10 mm.; *semina* 5-6 mm. longæ.

Flowering viii.-ix. In dry thickets, Eastern India.

Vidi:—(*Hooker & Thomson!*) Khasia: Shillong, Madplang (Clarke).

2. *M. LAXUM* Miquel, Prodr. Flor. Japon. (1865) 55. Ann. Mus. Bot. Lugd. ii. 123.

Syn.: *M. laxum* subsp. *laxum* Beauv. Mon. Melamp. (1916) 541.

Var. *genuinum* Beauv. l. c. 561; *M. arcuatum* Nakai! in Tok. Bot. Mag. (1909) 5 & 6.

Caulis ramosus, internodiis numerosis, non abbreviatis, rami

arcuati vel patentis, rarius suberecti. *Folia* 10–25 mm. lata, late vel ovato lanceolata, intercalaria 0–2 paria. *Inflorescentiæ* initium ad nodum 6–12 situm. *Bracteæ* ovatae, integerrimæ vel ± hastato-pectinatae, superiores parvæ. *Calyx* tubo 3 mm. longo, glabrescenti vel puberulo, dentes breves, 1.5 mm. longi, ± ovati, obtusi, exaristati. *Corolla* circa 15–20 mm. longa, rosea vel pallide purpurea. *Capsula* pilosa.

Flowering viii.–ix. In thickets and forests, Japan.

Vidi:—Japan: (*Miquel*); Nagasaki-Sinabura (*Maximowicz* f. *nikkoense*); Koyasan (*Faurie*, 69); Sado (*Faurie*, 2271); Togakushi (*Faurie*, 2269); Shirakuzure (*Takeda*); Mayasan, Mayabara (*Bisset*); Kurotoyama Komagataka (*Takeda* v. *arcuatum*); Nikko (*Yatabe* f. *nikkoense*).

Formæ: f. *nikkoense* Beauv. Mon. du genre Melamp. in Mem. Soc. Hist. Nat. Genève, 1916, 541, pro var. *Folia* circa 15 mm. lata (Apud typum usque 10 mm. lata, parva)—f. *platyphyllum* Beauv. l. c. 542, pro var. *Folia* 20–28 mm. lata, bracteæ magis dentatæ.

Var. *arcuatum* (Nakai, l. c. pro sp.) Soó, comb. nov. *Folia* circa 15 mm. lata, lanceolata; *rami* arcuati; *corolla* minor, 10–15 mm. longa, sæpe albida.

In my Monograph I referred *M. arcuatum* tentatively to Sect. *Silvatica* following Beauverd; but the plants collected by Takeda, which I saw in the London Herbaria identified as *M. arcuatum*, only represent a form of *M. laxum*. *M. arcuatum* is therefore not a Japanese endemic as I stated (l. c. p. 167).

3. *M. ROSEUM* Maxim. Prim. Flor. Amur, 210 (1859).

Syn.: *M. jedoense* Miquel, Ann. Mus. Bot. Lugd. ii. (1865) 122; *M. roseum* ssp. *eu-roseum* Beauv. Mon. Melamp. 546; var. *typicum* Franch. & Sav. Enum. Pl. Jap. ii. 461 (1875). *M. arvense* et *M. pratense* Auct. Japon. p.p.; *M. roseum* Forb. & Hemsl. Ind. Flor. Sin. ii. 226 p.p.

Caulis ramosus, internodia numerosa, brevina vel ± elongata, rami arcuati vel suberecti. *Folia* 12–15 mm. lata, lanceolata, intercalaria 0–2 paria. *Inflorescentiæ* initium ad nodum 5–10 situm. *Bracteæ* inferiores ovato-lanceolatae, integræ, superiores basi hastato-dentatæ vel dentibus curvatis præditæ. *Calyx* tubo 3–4 mm. longo, puberulo, costis scabris vel longo ciliatis (cfr. var. *hirsutum*) dentes triangulari-lanceolati, acuti, porrecti vel subfalcati, tubum subæquantés. *Corolla* 15–20 mm. longa, rosea. *Capsula* hispida, basi ± glabrescens.

Flowering vii.–viii. In thickets and forests. Eastern Siberia (Amur), Manchuria, Northern China, Corea, Japan (in the last three places only the subspecies).

Vidi:—Siberia: Kumari at Talu (*Komarov*, 1407); Blagojetschenk (*Karo* ap. *Dörfler*, 65); at Lake Hanka (*Bohnhof*, *Prezwalski*, partly f. *Beauverdi*); at Amur (*Radde*). Manchuria: (*Wilford*, partly f. *Beauverdi*); Sungari, Tschingau Uiril (*Komarov*); Ussuri (*Maximowicz*, f. *Beauverdi*).

Formæ: f. *Beauverdi* Soó, f. nov. (var. *setaceum* f. *latifolium* Beauv. l. c. 547, certe non Nakai). *Folia* 5–8 mm. lata.

Subsp. *hirsutum* Soó, comb. nov. (var. *hirsutum* Beauv. l. c. 548). *Calyx* nervis pilis multicellularibus longis pilosis.

Vidi:—Manchuria (*Radde*). Corea: (*Faurie*, 450); Mt. Nainpiang (*Faurie*, 449); Tschunampo (*Faurie*, 789); Inchön (*Gottsche*); Corea Archipelago (*Oldham*, 646); Tschusima Island (*Gottsche*). Japan: (*Rein*); Simabura (*Maximowicz*). China: Shantung, Mt. Tschien (*Faber*); Tschifu (*Faber*); Mt. Lushan, near Kiaoutschau (*Krug*); Cape Yatan (*Zimmermann*, 426, 446); Kiangshi (*Schindler*, 364); Kiaukiang (*Forbes*, *M. Dubois*, *Reymond*); Shensi and Kansu: Si-kui-tzui-san, Lim-san-huo, Tai-pa-san, Hua-san, In-kia-po (*Giraldi*, 5507, 5508, 5510, 6079).

4. *M. SETACEUM* Nakai in Tokio Bot. Mag. 1909, 9.

Syn.: *M. roseum* var. *setaceum* Maxim. ap. Palibine Cons. Fl. Corea, ii. 22 (1900). Beauv. Mon. Melamp. 547. *M. setaceum* v. *genuinum* Nakai, l. c. f. *genuinum* Beauv. l. c. 547. ? *M. ciliare* Miquel, Ann. Mus. Bot. Lugd. ii. 122 (1865). *M. roseum* v. *ciliare* Nakai, l. c.

Præcedenti similis, sed differt *foliis* linearibus vel lineari-lanceolatis, 2–8 mm. latis; *bracteis* hastato-dentatis, dentibus setaceis, curvatis; *calycis* dentibus longe aristatis, tubo duplo longioribus tubum corollæ subæquantibus.

Flowering viii.–ix. In thickets and forests of Manchuria, Corea, and Japan.

Vidi:—Manchuria: Mukden-Kirin (*James*). Corea: Seoul (*Gottsche*, *Kalinowski*); Mt. Nam-shan (*Faurie*, 447); Mt. Kongshan (*Wilson*); Kang-kai (*Millo*).

Formæ: f. *latifolium* Nakai, l. c. *Folia* 5–8 mm. (ad typum 2–3 mm.) lata. f. *congestum* Nakai, Tok. Bot. Mag. 1917, 107. *Planta* densissime ramosa, congesta.

5. *M. ARISTATUM* Soó, comb. nov.

Syn.: *M. laxum* ssp. *aristatum* var. *aristatum* Beauv. Mon. Melamp. 542. *M. roseum* var. *aristatum* Beauv. l. c. 548. Beauverd has described the same plant as new twice, as a ssp. of *M. laxum* (although it has villous capsules) and as a var. of *M. roseum*!

Caulis ramosus, internodiis minus numerosis, elongatis, rami arcuati. *Folia* ovato-lanceolata, 20–25 mm. lata, intercalaria 1–3 paria. *Inflorescentiæ* initium ad nodum 6–9 situm. *Bracteæ* hastato-dentatæ. *Calyce* dentibus longe aristatis, linearibus, tubo fere duplo longioribus. *Corolla* rosea, 20 mm. longa. *Capsula* ± hispida.

Flowering viii. In forests on Quelpaert Island, Corea (*Faurie*, 1193, 1928; *Jacquet*, 1171).

6. *M. HENRYANUM* Soó, comb. nov.

Syn.: *M. laxum* ssp. *Henryanum* var. *Henryanum* Beauv. Mon. Melamp. 543 (owing to the villous capsule in no way connected with

M. laxum). *M. roseum* Forb. & Hemsl. Ind. Fl. Sin. ii. 220, p.p.; Diels in Engl. Jahrb. xxix. 569 (1901).

Caulis ramosus, internodiis minus numerosis, elongatis, rami arcuati vel suberecti. *Folia* lanceolata, 10–15 mm. lata, rarius latiora, intercalaria 0–2 paria. *Inflorescentiæ* initium ad nodum 6–10 situm. *Calyx* tubo puberulo, nervis pilis multicellularibus superioribus erectis, inferioribus reversis, ciliatus, dentes triangulari-lanceolati, acuti, exaristati, tubum subæquantés. *Corolla* purpurea, 15–18 mm. longa. *Capsula* ± hispida.

Flowering vii.–viii. In thickets and forests of Middle and Southern China.

Vidi:—Hupeh: Patung, Nanto, Tchang (*Henry*, 4513); West Hupeh (*Wilson*, 1310). Kiangsu: Tschin-kiang (*Kjell Kolchoff*, 241). Sze-tschuan: Muli (*Forrest*, 22,459, "*M. chinense*"). Yunnan: Pin-fa (*Cavalerie*). S.E. Tibet (*Forrest*).

7. *M. Klebelsbergianum* Soó, sp. nov.

Caulis ramosus, internodia numerosa, abbreviata, rami patentes vel subarcuati. *Folia* lanceolata, 15–30 × 4–7 mm. longe petiolata, intercalaria 0–1 paria. *Inflorescentiæ* basis ad nodum 5–7 situm. *Calyx* tubo puberulo, nervis pilis multicellularibus superioribus erectis, inferioribus reversis, ciliatus, dentibus triangulari-lanceolatis, acutis, exaristatis tubo multoties brevioribus. *Corolla* purpureo-violacea, 12–16 mm. longa, fauce peraperta. *Capsula* ± hispida.

Flowering vii.–viii. In thickets, South-west China to Kansu. Yunnan: (*Forrest*, 7049); Tali Range (*Forrest*, 4506); Tsekou (*Manberg*). Kansu: Tong-ting-schan (*Licent*).

8. *M. JAPONICUM* Soó, comb. nov.

Syn.: *M. nemorosum* var. *japonicum* Fr. & Sav. Enum. Pl. Jap. i. (1785) 352. *M. roseum* ssp. *japonicum* Nakai in Tok. Bot. Mag. 1909, 8. *M. roseum* ssp. *japonicum* var. *japonicum* Beauv. Mon. Melamp. 548. f. *purpureum* Beauv. l. c.

Caulis ramosus, internodiis numerosis, brevibus vel ± elongatis, rami arcuati vel suberecti. *Folia* caulina 10–20 mm. lata, intercalaria 0–2 paria. *Inflorescentiæ* initium ad nodum 6–10 situm. *Bractea* inferiores subintegræ, superiores basi ± hastato-dentatæ longe ciliatæ. *Calyx* tubo dense villosus, dentes triangulari-lanceolati, ciliati, acuti, porrecti, tubum subæquantés. *Corolla* 15–20 mm. longa, rosen. *Capsula* hispida (lupe!).

Flowering vii.–viii. In forests and thickets of Corea and Japan.

Vidi:—Corea: Ouen-san (*Faurie*, 448); Japan: (*Rein, Maries*); Tokio (*Dönitz*); Hakodate (*Faurie*, 233); Nasuzan (*Faurie*, 234); Matshusima (*Faurie*); Hushino (*Faurie*, 2314); Koshu, Komugadake (leg. ?); Arima (*Henry*); Tatu (*Takeda*); Twaki (*Makino*); Shinshin (*Tatabe*).

Formæ: f. *leucanthum* Nakai in Tok. Bot. Mag. 1909, 8. *Flores* ± albidæ.

Species mihi non cognitæ.

M. laxum f. *australe*, f. *longitubum*. Nakai in Tok. Bot. Mag. 1909, 10.

M. roseum ssp. *japonicum* var. *sendaiense* Beauv. Mon. Melamp. 548 (an. *M. roseum* typus?).

M. ovalifolium Nakai, l. c. 3, 6 (*M. roseum* ssp. *ovalifolium* var. *ovalifolium* Beauv. l. c. 549).

M. latifolium Nakai, *op. cit.* 1917, 107.

M. obtusifolium Bonati ap. Pampanini in Nuov. Giorn. Bot. Ital. 1910, 713. (*M. laxum* ssp. *laxum* var. *obtusifolium* Beauv. Mon. Melamp. 542. According to the description an interesting species apparently near to *M. Henryanum*.)

[Dr. Soó's paper was communicated in German. For translation and preparation for press, I am indebted to Mr. A. W. Exell, of the Department of Botany, British Museum.—Ed.]

THE IRISH "*SPIRANTHES ROMANZOFFIANA*."

By A. J. WILMOTT, B.A., F.L.S.

WHILE on a visit to Ireland last year, Mr. Francis Druce and I determined to make an attempt to see both the northern and southern plants which had been referred to *Spiranthes Romanzoffiana* Cham., since there had been some suggestions that the two were not identical. The original locality near Berehaven, Co. Cork, had apparently been lost sight of, but another locality had been discovered in Kerry, near Waterville. With the aid of information from Miss Vachell and Mr. Scully, we were fortunately able to see the southern form in flower in both localities. Specimens were preserved in spirit, and one plant was taken fresh to Toome, Armagh, and compared with the northern form which occurs in considerable quantity in many places around the shores of Lough Neagh. We saw about a dozen flowering plants in Co. Cork, six in Kerry, and quite 200 in two localities near Toome, and are of opinion that the two forms are quite distinct. The species in this section of the genus *Spiranthes* are very close, and the two Irish plants seem as distinct from each other as the other species are.

The points of distinction are as follows:—

Southern form: plant shorter (about 9–12 cm.), leaves broader, flat or folded along the midrib, stem-leaves loosely sheathing the stem, the two edges meeting below in a broadly rounded sinus; bracts acute, in shape like an old flat steel pen, not long acuminate; inflorescence dense, the labellum of one flower almost or quite touching the flower below; flowers smaller, shorter, fatter, beautiful glistening white, lip shorter and broader, abruptly constricted towards the middle, attachment "disc" of the (smaller) pollinia narrower, stigmatic surface broader (in the few flowers dissected).

Northern form: plant tall and slender (about 15–30 cm.), leaves

much longer, often actually, and always relatively, much narrower, mostly folded on the midrib and not appearing flat (more or less "tubular," as described by Praeger); stem-leaves more numerous, tightly sheathing the stem with much narrower sinus, the upper ones very narrow and, like the bracts, long acuminate; inflorescence long and lax, the flowers generally not touching; flower greenish white, but appearing creamy white when alongside the southern form, longer, more slender, narrower in front view, with longer narrower more recurved labellum, which is more gradually constricted near the middle.

The history of the southern form is as follows:—

1809 or 1810.—Two specimens found near Berehaven by Mr. James Drummond (cf. Babington, 1844). One of these specimens went to Sir J. E. Smith in 1810, and is now in his herbarium at the Linnean Society in a dissected condition.

1828.—Smith (Eng. Flora, iv. 36) described his specimen as a new species, *Neottia gemmipara*, having waited in vain for a better fresh specimen.

1834.—Sowerby gave a figure in *English Botany* (Suppl. t. 2786) made from Smith's specimen. As Syme says later: "this figure presents no resemblance whatever to the Irish plant."

1840.—Lindley (Gen. & Spec. Orchid. 464), without further material to go on, places it in *Spiranthes* next to *S. Romanzoffiana*, with the note: "That this obscure plant is actually the same as *Spiranthes Romanzoffiana* I cannot absolutely affirm, because I have had no opportunity of examining its flowers. But the resemblance between them is so great that I scarcely entertain a doubt upon the subject."

1840-1845.—It was re-discovered and shown to Babington in 1843, who gave a good description of the plant with a figure (1845, in Trans. Linn. Soc. xix. 261). But he says it differs from *S. Romanzoffiana*, and agrees with *S. cernua* L.

1851.—Reichenbach (Icones Fl. Germ. xiii. t. 125) repeats the bad E. B. S. figure as *S. gemmipara*, and figures in contrast the true *S. Romanzoffiana* from "Unalaska Cham.!"

1857.—Lindley (Journ. Linn. Soc. i. 168), having examined fresh specimens, discusses at length its differences from *S. cernua* and *S. Romanzoffiana* (Reichenbach's figure), and says it is certainly not *S. cernua*, and differs from *S. Romanzoffiana*. He adds that, in his opinion, it is nearer *S. æstivalis* than *S. cernua*. He also objects to Babington's identification on geographical grounds. (The notice of this paper in the *Gardeners' Chronicle* has this latter statement correct, but the review of the *Gardeners' Chronicle* in the *Phytologist*, N. S. ii. 114, makes Lindley say that it is nearer *S. autumnalis* than *S. cernua*.) This opinion of Lindley is interesting to me, since I saw *S. æstivalis* fresh within a few weeks of seeing *S. gemmipara*, and was struck by the similarity, which I should not have been when comparing the northern plant with *S. æstivalis*.

1861.—Hooker (Curtis, Bot. Mag. t. 5277) objects to Lindley's remarks about plant-geography, instancing *Najas flexilis* and *Erio-*

caulon as other American plants in Ireland. He gives a coloured figure from fresh Irish specimens, and says that the figure shows it to be identical with *S. cernua*. He rather inclines to the view that *S. Romanzoffiana* may be identical with *cernua*, and describes in a footnote original specimens of the latter from Chamisso. This figure is of a more robust specimen than any I saw last year, but is very different from the robust specimens of the northern form. It is figured with yellowish flowers, but I think this must have been due to imagination or fading. All the specimens I saw in Cork and Kerry had pure glistening white flowers, and this fits Babington's description well. They soon fade to brownish, and I suspect the colour was never as figured by Hooker.

1866.—Reichenbach (Internat. Congress London, Report, p. 176), in a discussion on a paper by David Moore, states that Moore had sent him a living specimen of the Irish plant, and after a thorough examination he could not agree with all those who since Babington had declared Lindley wrong in separating it from *cernua*. *S. gemmipara* and *cernua* were quite distinct, and he thought *S. gemmipara* was *S. Romanzoffiana*. It is stated that Asa Gray agreed to this determination. From this time on the plant has generally been called *S. Romanzoffiana*.

1869.—Syme (E. B. ed. 3, ix. 117) reproduces Hooker's plate, calls the plant *S. gemmipara* (*cernua* Bab. non Rich.), and cites as synonym "*S. Romanzoffiana* Cham. Rechb. fil., Asa Gray, Man. ed. v."

1873 & 1874.—Two new localities were discovered in Co. Cork (Allin in Journ. Bot. xi. 308; Allin, Flow. Pl. Co. Cork, 77; Editor's note to Praeger's paper in Journ. Bot. 1892, 274).

1892.—Praeger (Journ. Bot. xxx. 272) gives an account of the discovery of the northern plant, and compares it with the southern *gemmipara*.

1921.—Scully (Irish Nat. xxx. 79) records that MacSweeney found not more than four or five specimens in a bog near Waterville, July 30, 1916. I saw six flowering spikes last year.

The northern plant was discovered in Armagh by Mr. Lloyd Praeger in 1892, and an account of the discovery published in the *Journal of Botany* the same year (xxx. 272). He notes the difference in size between the southern *gemmipara* (as described by Babington, the Hooker figure, and Asa Gray's dimensions as given by Syme) and the Armagh plant. It is clear that his Armagh specimens were unusually small (at Toome the average size was greater, and later Kilrea specimens show that the plant also gets larger in Praeger's original locality). The Hooker figure is of a very large plant, and should be compared with the largest specimens of the northern plant, which would be fully double its size. To understand the dimensions given, it should be remembered that Asa Gray's plant referred to is not *S. Romanzoffiana*, but is *S. stricta* (Rydberg) Nelson, which is probably the same as the northern Irish plant. In passing, one may note that Asa Gray did not know these plants well. He identifies the Linnean Herbarium specimen of *Ophrys cernua* Linn. as *S. Romanzoffiana*, whereas it is certainly typical *S. cernua*, as Oakes Ames has subsequently noted on the sheet.

Since 1892 it has been found in places all round Lough Neagh and by some of the tributaries, descending the R. Bann to Coleraine. I have not seen specimens from all the localities, but all I have seen indicate that the northern form is uniform and distinct from *S. gemmipara*. It appears a very close match for the plant widely known in North America as *S. Romanzoffiana*.

But the plant generally known in North America as *S. Romanzoffiana* is not the same as the plant which grows in Alaska, and which was originally described from Unalashka by Chamisso. Rydberg, who knew both plants in the field, distinguished the widespread American plant under the name of *Gyrostachys stricta* (1900: in Mem. N.Y. Bot. Gard. i. 107), and, although many American botanists do not recognize the validity of Rydberg's species, I think it may be because they do not know the plants in the field as Rydberg does. The Alaskan specimens I have seen agree with the figure given in Reichenbach's *Icones Fl. Germ.*, with remarks made by Hooker (1861), and with the description of Rydberg, and are quite distinct from *S. stricta*. They have small flowers, more scarious bracts like those of *S. cernua*, differently shaped basal leaves, and so on.

In 1901 Rydberg again described *Gyrostachys stricta* in Britton's *Manual Fl. N. States and Canada* (p. 299). Mr. Arthur Bennett, seeing this account, suggested to Mr. Praeger (1905, *in litt.*) that the Northern Irish plant was Rydberg's *stricta*, while the southern plant was *S. Romanzoffiana*. I think his suggestion concerning the northern plant may be right: I have, independently, come to this conclusion, and have already stated so at the meeting of the Linnean Society on March 3rd last. The chief difficulty lies in the fact that Rydberg says his *G. stricta* is subglabrous above, in contradistinction to the Alaskan plant, which is densely glandular in the upper part of the scape. All the Irish specimens I have seen are densely glandular—there seems no difference between them in this respect (and both have an equally strong odour recalling that of vanilla). But since some North American specimens of *S. stricta* appear to be as densely glandular as those of the Northern Irish plant, and since Lindley (1857) saw few glands on his specimen from Co. Cork, I do not think this can be regarded as a point of difference between the North American and North Irish plants. Our British plants should therefore be called *S. gemmipara* (Smith) Lindley and *S. stricta* (Rydberg) Nelson, respectively.

Whether *S. gemmipara* be endemic, or whether it may be found in America not yet distinguished from *S. stricta*, must be left an open question. I have seen specimens from the Rocky Mountains which superficially resemble closely the Cork plant. I do not care to offer an opinion on dried material. But Rydberg (1900) says: "The Rocky Mountain plant differs slightly from that of Canada and the North-Eastern United States in being generally somewhat lower, 1-2 dm. high, with shorter spikes and broader basal leaves." This remark might apply to the Cork plant, and, in view of the great similarity between dried specimens of these species, it seems desirable that the American forms be re-examined.

The root-system and method of growth of these plants is well described by Mousley (1924: *Orchid Review*, 357), following a note by Col. Godfrey in the same journal (1922: 261; and see reply 1924). My own observations show that there is no difference in this respect between the two Irish plants, each of them having several tuberous roots when the plant is a very strong one. The roots of the southern plant are, like the rest of the plant, on a smaller scale, but otherwise identical.

SYRPHID VISITORS TO CERTAIN FLOWERS.

BY E. AND H. DRABBLE.

WHILST preparing a paper for the *New Phytologist* on Dipteran visitors to flowers, it was found that the following visits of Syrphids were not recorded in Knuth's *Handbook of Flower Pollination* (English Edition, Oxford, 1906). It may be worth while, therefore, to place them on record. The list is entirely the outcome of our own observations in Derbyshire and North Middlesex during the years 1916-1923.

The Syrphids are a family of cyclorrhaphous Diptera, and are commonly known as "hover-flies." They visit flowers for both nectar and pollen. That they play an important part in pollination is, we think, beyond dispute:—

RANUNCULUS FLAMMULA L.

Leiogaster metallina F., *Chrysogaster hirtella* Lw., *Ch. macquarti* Lw.

RANUNCULUS ACRIS L.

Cheilosia barbata Lw. *Cheilosia impressa* Lw.
Ch. intonsa Lw. *Chrysochlamys cuprea* Scop.
Ch. cynocephala Lw.

RUBUS spp.

<i>Pipizella flavitarsis</i> Mg.	<i>Syrphus lineola</i> Ztt.
<i>Cheilosia variabilis</i> Pz.	<i>S. vitripennis</i> Mg.
<i>Platycheirus manicatus</i> Mg.	<i>S. bifasciatus</i> Mg.
<i>P. peltatus</i> Mg.	<i>S. luniger</i> Mg.
<i>P. scutatus</i> Mg.	<i>S. balteatus</i> Mg.
<i>P. albimanus</i> F.	<i>S. cinetellus</i> Ztt.
<i>P. clypeatus</i> Mg.	<i>S. auricollis</i> Mg.
<i>P. angustatus</i> Ztt.	<i>S. labiatarum</i> Verr.
<i>Melanostoma mellinum</i> L.	<i>Sphaerophoria scripta</i> L.
<i>M. scalare</i> F.	<i>S. menthastris</i> L.
<i>Leucozona leucorum</i> L.	<i>Baccha elongata</i> F.
<i>Catabomba pyrastris</i> L.	<i>Rhingia campestris</i> Mg.
<i>Syrphus albostrigatus</i> Fln.	<i>Eristalis arbustorum</i> L.
<i>S. tricinetus</i> Fln.	<i>Xylota segnis</i> L.
<i>S. lunulatus</i> Mg.	

HERACLEUM SPHONDYLIIUM L.

Cheilosia variabilis Pz.	Platycheirus clypeatus Mg.
Ch. barbata Lw.	Syrphus vittiger Ztt.
Ch. intonsa Lw.	S. grossulariæ Mg.
Ch. albitarsis Mg.	S. vitripennis Mg.
Ch. cynocephala Lw.	S. corollæ F.
Platycheirus manicatus Mg.	S. luniger Mg.
P. peltatus Mg.	S. cinctellus Ztt.
P. scutatus Mg.	S. compositarum Verr.
P. albimanus F.	Sphærophoria scripta L.

CHRYSANTHEMUM LEUCANTHEMUM L.

Cheilosia pulchripes Lw.

TANACETUM VULGARE L.

Cheilosia cyanocephala Lw.

ANTENNARIA MARGARITACEA Br.

Platycheirus scutatus Mg. Syrphus vitripennis Mg.

SENECIO JACOBÆA L.

Platycheirus albimanus F. Sphærophoria scripta L.
Syrphus vitripennis F. Eristalis pertinax Scop.

HIERACIUM BOREALE Fr.

Platycheirus manicatus Mg. Syrphus balteatus Deg.
P. albimanus F. S. cinctellus Ztt.
Catabomba pyrastris L. Sphærophoria scripta L.
Syrphus ribesii L. Eristalis arbustorum L.
S. vitripennis Mg. E. pertinax Scop.
S. luniger Mg. Syritta pipiens L.

TARAXACUM OFFICINALE W.

Platycheirus manicatus Mg. Syrphus vitripennis Mg.
P. albimanus F. S. luniger Mg.
Melanostoma mellinum L. S. balteatus Deg.

SONCHUS ASPER Hill.

Platycheirus manicatus Mg. Melanostoma mellinum L.
P. albimanus F.

LEONTODON AUTUMNALE L.

Platycheirus peltatus Mg. Syrphus luniger Mg.
P. scutatus Mg. S. compositarum Verr.
Syrphus vitripennis Mg. Sphærophoria scripta L.
S. corollæ F. Ascia podagrica F.

CONVOLVULUS ARVENSIS L.

Cheilosia barbata Lw. Platycheirus albimanus F.
Ch. intonsa Lw. Melanostoma mellinum L.
Ch. albitarsis Mg. Syrphus vitripennis Mg.
Ch. cynocephala Lw. Sphærophoria flavicauda Ztt.
Ch. impressa Lw. var. nitidicollis Ztt.
Platycheirus manicatus Mg.

OBITUARY.

CHARLES SPRAGUE SARGENT

(1841-1927).

WE have heard, with much regret, of the death of Professor C. S. Sargent at his home near Boston, on March 22nd last, within a few weeks of his 86th birthday. Sargent's name will always be associated with the Arnold Arboretum, at Jamaica Plain, near Boston, of which he became Director at its foundation in 1872, and to the development of which he devoted the greater part of his life. The history of the Arboretum is briefly described in the handy little Guide prepared by Sargent. It originated in a bequest by Mr. James Arnold, a merchant of New Bedford, in 1868, of \$100,000 to be devoted to the advancement of agriculture or horticulture. The legacy was assigned by the trustees to the President and Fellows of Harvard College to be used to develop and maintain an arboretum, and in March 1872 120 acres were set aside for the purpose, the University undertaking to grow a specimen of every tree and shrub able to support the climate of eastern Massachusetts. "Only a comparatively small part of the trees and shrubs which might be expected to thrive in New England were to be found in any collection when this indenture was made, and the Arboretum has been obliged, therefore, to undertake botanical explorations in many countries. These explorations have enriched the Arboretum, and through it the gardens of the United States and of Europe; and gradually the Arboretum has become an important scientific station for increasing the knowledge of plants and for their multiplication in parks and gardens." Thus Sargent modestly summarizes fifty-five years' work, involving time, energy, and also wealth, in building up the unique collection under his charge. Additions were subsequently made to the area, which now occupies 240 acres of meadow, hill, and valley. By a contract between the University and the City of Boston, the latter agreed to maintain and police a system of carriage-drives and walks, in return for the opening of the Arboretum to the public daily.

In the pursuit of his studies, Sargent visited the forest-areas of the North-American continent, and the report of his survey led to the establishment of the Bureau of Forestry and the setting aside by the Government of the great forest-reserves. His *Silva of North America* (1891-1902), beautifully illustrated by C. E. Faxon, in fourteen quarto volumes, is his most important publication. "*Trees and Shrubs*" (1905-13), edited by Sargent, contained descriptions by himself and other specialists, with plates by Faxon, of new or little-known woody plants of the Northern Hemisphere of special garden, economic, or scientific interest. The garden and herbarium of the Arnold Arboretum supplied much of the material described.

Sargent became interested in the flora of Eastern Asia, and in 1894 published a *Forest Flora of Japan*; and subsequently, in the botanical exploration of Western China, especially with the view of introducing hardy trees and shrubs for cultivation. Mr. E. H.

Wilson's later journeys (1907, 1908, and 1910) to that country were made under the auspices of the Arnold Arboretum, of which he has been for some years past Assistant-Director. *Plantæ Wilsonianæ*, edited by Sargent (1911-17), is an enumeration of the woody plants found by Wilson during these two expeditions.

In 1888 Sargent founded a weekly journal, *Garden and Forest*, which he edited until 1897.

Sargent was born in Boston, Mass., on April 24, 1841, and graduated at Harvard in 1862. He served on the Federal side in the Civil War, after which he travelled in Europe for three years. On his return to America he took up botany, and more especially the study of the native trees and shrubs, and, as already recorded, became associated with the Arboretum in 1872.

Sargent's outstanding contributions to botanical science were recognized in this country, where he had many friends, by his election to the foreign membership of the Linnean Society in 1902.—A. B. R.

SHORT NOTE.

CHARESIA: A RECENTLY DESCRIBED GENUS OF CARYOPHYLLACEÆ FROM THE CENTRAL CAUCASUS.—*Charesia*, a new genus of Caryophyllaceæ, founded on *Silene Akinfjevi* Schmal., has recently been described by E. Busch (*Travaux du Musée Botanique de l'Académie des Sciences de l'U. R. S. S., Leningrad*, xix. 182 (1926)), and it may be useful to publish the following slightly shortened translation of the account of the affinities (published in Russian) to supplement the Latin diagnosis:—Schmalhausen described the species *Silene Akinfjevi* from a fragmentary specimen only. It differs from the genus *Silene* in the unilocular capsule, that of the latter genus being 3-5-locular up to one-third of its height and unilocular above. It differs from the genus *Petrocoma* by having smaller seeds without annular thickenings around the micropyle; it differs from *Melandryum* in having smaller seeds which are slightly flattened laterally, and have 3-4 rows of spines, while the seeds of *Melandryum* are everywhere finely papillate. The seeds of *Charesia* recall those of *Heliosperma*, which, however, have two rows of spines arranged like leaves on a branch, while those of *Charesia* have, as already mentioned, 3-4 rows, the spines becoming smaller towards the micropyle.

Owing to the incompleteness of his material, the original description of *Silene Akinfjevi* Schmal. was not quite accurate. Thus the author states that the calyx is inflated, while actually it is only swollen when the fruit is formed; the calyx-teeth are said to be triangular oblong and somewhat blunt, while they are actually triangular and acute.

The plant is conspicuous for its brilliant green colour; but unfortunately nearly all the specimens were in fruit, and only a few flowering specimens were collected.

There is a good figure with the generic description (*loc. cit.*).—A. W. EXELL.

ABSTRACTS OF PAPERS OF INTEREST TO STUDENTS OF THE BRITISH FLORA.

THE EVENING PRIMROSE IN ENGLAND ("The History of *Oenothera biennis* L., *O. grandiflora* Soland., and *O. Lamarckiana* De Vries, in England," in *Proc. Amer. Soc.* lxx. 349-378 (1926)).—The history of the species of *Oenothera* in this country has been the subject of considerable discussion, and the following extracts from a recent paper by Prof. Bradley Moore Davis, recording the results of his investigations in our British herbaria, will be of interest to British botanists:—

The summer of 1925 afforded a long-awaited opportunity to examine English herbaria for data on the time of appearance and distribution in England of *Oenothera biennis* L., *O. grandiflora* Sol., and *O. Lamarckiana* de Vries. These are species of particular interest to geneticists working with *Oenotheras* who hold widely different opinions on the part that each has played in the development of certain conspicuous *Oenothera* floras of England. The most important problem is that of the time of appearance of *Oenothera Lamarckiana*. Was it present as early as 1806, when Smith described in the *English Botany* a remarkable display of *Oenotheras* on the sand-hills of Lancashire? Or did it appear in England much later, perhaps not much before the date 1860, when Messrs. Carter, of London, offered it to the trade as a cultivated plant, and after this become established as a garden-escape in various localities?

De Vries (1914) and Gates (1915), in their desire to establish the presence of *Lamarckiana* in England close to the time when Lamarck's plants were grown in the gardens of the Muséum d'Histoire Naturelle at Paris about 1796, have unequivocally expressed the opinion that the *Oenothera* flora of 1806 over the sand-hills of Lancashire contained *Lamarckiana*, and that Smith's account and Sowerby's figures of *Oenothera biennis* in *English Botany* (xxii. 1534, 1806) refer to *Lamarckiana*, and not to *biennis* as stated.

"I have never accepted these views, although open-minded with respect to evidence, and I am now prepared to take a positive position against them, holding that the *Oenothera* flora of Lancashire in 1806 was *biennis*, and also that the herbarium of the Muséum d'Histoire Naturelle in Paris contains no material that establishes the existence of *Lamarckiana* as early as 1796, that the plants grown by Lamarck (*Oenothera Lamarckiana* Seringe) were forms of *Oenothera grandiflora* Solander, and that other material of this period, including a specimen of Michaux's, believed by de Vries to be *Lamarckiana* cannot be so identified. I shall reserve a discussion of the herbarium material at Paris for another paper, and at this time only consider evidence in British herbaria bearing on the part that *biennis*, *grandiflora*, and *Lamarckiana*, together with some other large-flowered species, have played in the development of conspicuous *Oenothera* associations of England."

Prof. Davis discusses in considerable detail the various specimens

that he examined at the British Museum, the Linnean Society, Kew, and elsewhere, and his conclusions are summarised as follows:—

The Evening Primrose upon the sand-hills of Lancashire in 1806 was *Enothera biennis* L., and not *Enothera Lamarckiana*, as claimed by de Vries and Gates. This is established by specimens in Smith's herbarium at the Linnean Society of London. From these specimens or similar ones, Sowerby drew the figures which accompany Smith's description of *Enothera biennis* in *English Botany*, 1806.

Material in British herbaria gives a clear history of rather frequent collections of *biennis* from Lancashire, following the interest aroused by Smith's (1806) account in *English Botany*. The plant known to Don (1832) and to Baxter (1839) was also *biennis*. Not until recent years, after 1880, have we any records of *Lamarckiana* in Lancashire, as discussed by Bailey (1907) and Wheldon (1913). Evidence is clear that *biennis* was grown in English gardens for more than a century previous to 1800.

Enothera grandiflora Sol. has never established itself in England, probably because the summers are not sufficiently warm. British herbaria have almost nothing that may safely be identified as *grandiflora*. Certain sheets, incorrectly named, refer to narrow-leaved, large-flowered *Enotheras* with pubescence similar to that of *Lamarckiana*. Sims's "*Enothera grandiflora* B. Pubescent Great-flowered *Enothera*" (1819) was not *grandiflora*, which is almost glabrous, but possibly some associated form such as are known to grow in the southern United States.

Enothera Lamarckiana is now widely cultivated in England, having taken the place of *biennis* in popular favour. It may frequently be seen as a garden-escape. The most extensive wild stands are on the sand-hills of Lancashire. From observations of Bailey (1907), it seems probable that *Lamarckiana* has been in Lancashire since 1880, but there is no herbarium evidence of its presence in this region before Bailey's collections after 1900. The frequent collections of *Enothera* material from Lancashire from 1806 to the time of Bailey's studies present no *Lamarckiana*, only *biennis*.

There is very little herbarium material in England that may safely be identified with *Enothera Lamarckiana*, and none of this is of earlier dates than 1860, at about which time Carter & Co. placed *Lamarckiana* on the market. Of especial interest is the sheet in the Gray Herbarium of Harvard University with material grown by Dr. Asa Gray at Cambridge, Massachusetts, in 1862, from seed sent by Thompson, of Ipswich, England. This sheet is offered as holding the oldest specimens of *Lamarckiana* known, possibly not more than one or two generations removed from the cultures of Messrs. Carter.

It is my belief that de Vries and Gates have failed to present satisfactory evidence for the existence of *Lamarckiana* previous to its presentation by Messrs. Carter about 1860.

There is clear evidence in British herbaria of the introduction into England as early as 1830, and at later dates, of certain narrow-leaved, large-flowered *Enotheras*, with pubescence similar in character to that of *Lamarckiana* and with red papillæ.

With respect to the origin of *Enothera Lamarckiana*, it seems probable that Messrs. Carter, about 1860, obtained their material from some garden of England, or from some garden-escape. It is hardly possible that it could have come from the sand-hills of Lancashire, since the evidence is strong that *Lamarckiana* reached Lancashire much later as a garden-escape. If *Lamarckiana* arose in England, there are permitted many possibilities of its being of hybrid origin, and its parentage might readily have involved *Enothera biennis* and some narrow-leaved, large-flowered *Enothera*, with pubescence similar to that of *Lamarckiana*, that is, some species of *Enothera* among the introductions known to have been grown in English gardens about 1830 and later. The degree of success attained in the synthesis of *Enothera neo-Lamarckiana* from *franciscana* × *biennis* is suggestive of such a possible origin, since *franciscana* is one of those western American species, narrow-leaved, large-flowered, and with pubescence similar in character to that of *Lamarckiana*.

NOTES ON FIFE AND KINROSS ROSES (Trans. Bot. Soc. Edinburgh, xxix. 219–25 (1926)).—J. R. Matthews gives a list of eleven aggregate species and about 40 varieties of roses occurring in Fife and Kinross. The earliest record for these counties was in Lightfoot's *Flora Scotica* in 1777, where *R. villosa* L. is reported as occurring on the coast of Fife. Greville in his *Flora Edinensis* (1824) mentions *R. spinosissima* L. growing on the hills of North Queensferry. Balfour and Sadler (1863) record five species from the county.

The field-observations have chiefly been made along the coast from Inverkeithing to Kirkcaldy and in Kinross-shire. Among the more important plants recorded are the following:—

R. arvensis Huds. var. *ovata* (Lej.). Between Burntisland and Aberdour.

R. spinosissima L. var. *typica* W.-Dod. Plentiful near Tillyrie, Milnathort.

R. canina L. as an aggregate is common; var. *sentiosa* Baker, high-road between Burntisland and Kinghorn; var. *insignis* (Déségl. & Rip.), Blairadam and Gateside; var. *adscita* (Déségl.), Burntisland; var. *verticillacantha* Baker, near Blairadam, very rare.

R. dumetorum Thuill. var. *semiglabra* (Rip.) is more frequent than the type; var. *jactata* (Déségl.), near Inverkeithing; var. *ramealis* (Pug.), Blairadam.

R. glauca Vill. Very common in the north of the vice-county; var. *transiens* (Gren.), Blairadam and Milnathort; var. *subcristata* (Baker). By far the commonest variety.

R. coriifolia Fries. Generally distributed, but not so abundant as *R. glauca*; var. *frutetorum* Chr., Milnathort; var. *Watsoni* (Baker), same locality; var. *subhispidata* W.-Dod. frequent; var. *Bakeri* (Déségl.), several bushes near Milnathort; vars. *subcollina* Chr., *cæsia* (Sm.) and *obovata* (Baker), noted as rare near Milnathort.

R. pomifera Herrm. A rare rose in Britain, but typical *R. pomifera* does occur on the coast of Fife.

R. mollis Sm. Common. The author considers unsatisfactory the segregation into four varieties: *typica* W.-Dod, *glandulosa* W.-Dod, *cærulea* Baker, and *pseudo-rubiginosa* (Lej.).

R. omissa Déségl., with its varieties *typica* Kell., *resinosoides* (Crép.), *Sherardi* Davis, *submollis* (Ley), *uncinata* (Lees), *suberecta* (Ley), and *cinerascens* (Dum.).

R. tomentosa Sm. Not so common as *R. omissa*; the following varieties occur:—*eglandulosa* W.-Dod, *pseudo-cuspidata* (Crep.), and *scabriuscula* Baker.

R. rubiginosa L. fairly frequent.—E. G. B.

REVIEWS.

Enzymes: Properties, Distribution, Methods, and Applications.

By SELMAN A. WAKSMAN and WILBUR C. DAVISON. 8vo, pp. xii, 364, with 10 text-figures. London: Baillière, Tindall, and Cox, 1926. Price 25s. net.

In the preparation of this volume, the endeavour of the authors has been "to collect in as concise form as possible the available information in regard to enzymes, and to indicate the original sources from which more detailed knowledge may be obtained." The subject-matter is divided into four sections which treat respectively of the Properties of Enzymes, the Distribution of Enzymes, Methods for the Preparation and Study of Enzymes, and Practical Applications of Enzyme Activity.

The first section, a general account of enzyme action, is contained within fifty-five pages. Here, we think, the authors have been too concise; the condensation of hundreds of papers into so small a volume often results in strings of facts which, useful though they be to those who require a work of reference, to the student is bewildering without more explanation and elaboration.

The second section, which deals with the distribution of enzymes in the human and animal body, in the plant, and in micro-organisms, is a valuable summary, but, again, we think, suffers from undue conciseness.

The third section, which is concerned with the preparation and purification of enzymes and the measurement of their activity, will certainly prove of great value; it is well arranged, easy of reference, and the instructions are clearly written.

The bibliography, which consists of 78 pages of reference, is a conspicuous feature, and, notwithstanding some omissions of important or useful papers, which omissions are inevitable, will be of the greatest use. The adequate index and detailed table of contents make reference easy. The volume has been carefully prepared for press, and the number of misprints is very few; marigolds (for mangolds) on p. 103 made us pause. One pleasing feature of the book must not be overlooked; it is not uncommon to find that books

"made" in the United States of America are unduly heavy in weight in proportion to their size. This is not the case in the present instance.

We have already indicated our regret for the conciseness of the narrative; but, in judging a book, the intention of the author must not be overlooked. In this case the authors have written for those interested in or investigating enzyme action, rather than for the undergraduate reading for an Honours degree. And in this the authors have done their task well, and have produced a valuable book for the post-graduate worker and teacher.

T. G. HILL.

A Guide to the Orchids of Sikkim. By PAUL BRÜHL, D.Sc. Sm. 8vo, pp. xx, 208. Thacker, Spink, & Co. Calcutta, 1926. Price Rs. 5.

THIS handy booklet is described as a guide to the identification of those species of Orchids found between the Terai and the northern frontier of independent Sikkim, including the Chumbi Valley and British Bhutan. It is written for out-of-door use with the living plant, and for non-botanists so far as possible in ordinary English terms. It is in Key-form: first a Key to the Genera, then to the species, in each case on the dichotomous plan, and leading ultimately to a fairly full description of each species, with indications of locality, altitude, and month of flowering. Most of the characters referred to can be made out by the naked eye without dissection, except for a longitudinal median section through the flower. The species number 453, about 53 per cent. occur also in the Assam region, especially in the Khasia Hills, and 28 per cent. are found also in Nipaul. The text is clear, and the descriptions give the impression of having been carefully prepared. We notice on p. 44 that *Microstylis aphylla* appears twice, the first should be *M. saprophyta*; and several misprints in generic names have "got through" in the Key to the Genera. The author acknowledges his indebtedness to the monumental work by the late Sir George King and Robert Pantling on *The Orchids of the Sikkim-Himalaya*.

It is to be regretted that the manuscript of a complete guide to the flora of the district was lost. The success, which the present little volume deserves, if achieved, may encourage the author to undertake again the larger work.

British Wild Fruits and How to Identify them. By RICHARD MORSE, F.L.S. Sm. 8vo, pp. 64, with full-page plates. Epworth Press. London, 1927. Price 1s. 6d.

THIS little volume contains descriptions in popular language of the plant and the fruit of fifty-six of the more striking fruits of our flora, including one or two introduced plants. The term "fruit" is used in the popular sense—as something more or less soft and fleshy, and usually brightly coloured when ripe. Dry fruits are excluded. Each left-hand page contains descriptions of two subjects, one or both of

which are illustrated on the opposite page by reproductions of photographs by the author or clear line-drawings by Doris Meyer.

It is a tasty little volume, and will be helpful, so far as it goes, to amateurs who do not aspire to the use of a more complete flora.

A Standard Catalogue of English Names of our Wild Flowers, to which are added the Ferns and their Allies. By J. F. RAYNER. 8vo, pp. ii, 56. Gilbert, Southampton; Simpkins, London [1927]. Price 1s. 6d.

THE author of this pamphlet is a keen botanist and an ardent supporter of various societies interested in field-botany in the south of England. He has made a praiseworthy attempt to standardize English names for our British plants. In so doing, he has followed mainly the same plan as was adopted by Bentham in his *Handbook of the British Flora*, taking up a popular name, where such was already in fairly general use, and in other cases selecting an epithet which describes some obvious characteristic of the species, and is frequently also expressed by the trivial portion of the Latin binomial.

The arrangement of families and genera is that of the *London Catalogue*; there is a running number throughout, and the Latin binomial follows the English name, in brackets. Rare and local species are indicated by the letters R. and L., and introduced species by an asterisk.

The Catalogue will be helpful to those who find the Latin binominals an obstacle to the study of our flora.

Ueber Künstliche Blatt- und Blütenmetamorphosen bei der Schneebere (Symph. rac. Michx.) (Nebst versucht einer charakterologischen Analyse pflanzenlicher Lebenspunktionen). (Abhandlungen zur theoretischen Biologie, Heft 25.) 8vo, pp. vii, 125, with 2 coloured plates and 59 text-figs. Borntraeger, Berlin, 1927. Price M. 10.50.

THIS memoir is very wide in its scope and philosophical in its tone. The author's inspiration proceeds from the biological conclusions of Aristoteles, which conclusions he would link up with modern ideas. He attempts a "characterologic analysis" on general grounds, and proceeds to a consideration of this analysis on the experimental facts afforded by his study of *Symphoricarpus racemosus* Michx. There are detailed accounts of the results of systematic removal of the leaves from different parts of a plant, and over one hundred figures showing the resulting leaf- and flower-modifications. Partial and complete phyllody of the calyx can, apparently, be produced at will. This species would seem to offer an enormous amount of material for analysis. Its manifestations might well prove most illuminating when investigated cytologically or bio-chemically.—G. TANDY.

BOOK-NOTES, NEWS, ETC.

LINNEAN SOCIETY.—At the General Meeting on March 17, the President announced a vacancy in the list of Foreign Members of the Society, in consequence of the death of Professor Ludwig Radlkofer.

Mr. E. M. Marsden-Jones and Mr. W. B. Turrill gave an account of an improved herbarium method. Briefly, the process is the sticking-down of the specimens in the living condition. The best results have been obtained with paste, "Gloy" being the best so far tested. A sheet of paper or card is brushed over with a thin layer of the paste, and the specimens placed on this. They are dabbed down and excess of paste is wiped away. The sheet is then placed in a press and considerable pressure applied. After a few days the specimens are dry; they retain their shape, and sometimes their colour, indefinitely. The most useful results are obtained with dissected flowers and inflorescences; all parts of the flower can be shown with upper and lower surfaces visible, and sections can also be stuck down for drying in position. With some plants, ironing through blotting-paper with a hot iron gives excellent results. For taxonomy the need for boiling and dissecting is practically eliminated when series like those shown are available. In such a family as Zingiberaceæ and in such a genus as *Iris*, without a method like this, herbarium work is largely hopeless. In genetical studies it has been found most valuable, not only in making ordinary herbarium specimens of entire plants for future reference, but also in having series showing various floral and other organs on cards. In work on *Geum*, herbarium sheets of the distinct forms resulting from the crossing of the British species were prepared, and on cards complete sets of the petals and calyxes of all plants raised were kept.

The President referred to the specimens of *Iris* flowers prepared by the late Mr. Dykes, and Mr. H. N. Ridley mentioned Mr. Maw's *Crocus* specimens as comparable with the exhibits before the meeting.

Miss F. Haworth gave an account of her investigations into dyes obtained from Lichens, and exhibited a collection of the Lichens used and of materials woven and dyed by herself. There are two kinds of dyes, those needing a mordant (adjective dye) and those which only need boiling (substantive). In the first type, different effects are produced by the use of different mordants, e.g. tin brightens the colour, whereas iron deadens it. Lichens used as dyes by the Highland crofters are called "crottles." Many of them are substantive, but a better effect is secured by mordanting.

Parmelia saxatilis (gathered preferably after a wet day) and *P. omphalodes* are used in the preparation of Harris tweed, and give a characteristic smell to the cloth. *Xanthoria parietina* gives a yellow or orange colour (with potassium bichromate a plum colour); *Parmelia caperata* gives lemon-yellow; *Lobaria pulmonaria* is used by Herefordshire peasants to dye stockings brown. *Usnea barbata* dyes orange. *Lecanora tartarea* gives a red dye.

It may be stated generally that the best results are obtained where numerous soredia are present. The power of producing these plentifully is possibly connected in some way with the dye-yielding property. Rock-lichens give the best dyes, those species with a large

flat thallus rarely producing a permanent dye, though *Peltigera canina* gives a yellow colour with cotton.

Professor F. E. Fritch described, with the aid of a series of lantern-slides, his investigations of the Heath-Association on Hindhead Common.

The purpose of the communication was to explain the diverse character of the vegetation on different parts of the heath and the mode of recovery after fires. Except along the pathways and on newly-burnt ground the vegetation consists almost solely of *Calluna vulgaris*, *Erica cinerea*, *E. Tetralix*, *Vaccinium Myrtillus*, *Pteridium aquilinum*, *Ulex nanus*, *Molinia cærulea*, and *Deschampsia flexuosa*; but the relative grouping of these different species varies considerably with the length of the period that has elapsed since the last fire, with the aspect, and with soil-features. The character of the vegetation in the first years following upon a fire depends upon the size of the growth that was burned, but ultimately it always passes over to a phase in which *Calluna* is completely dominant and more or less completely hides the codominant, but largely prostrate, *Ulex nanus*. On slopes facing south *Erica cinerea* may become a temporary dominant for some years, owing to the dying away of large numbers of the young *Calluna* plants.

An outstanding fact is the stationary character of the vegetation. Fires cause little ultimate change and, after a number of years have elapsed, the heath presents the same appearance and detailed composition as before. Plants like *Pteridium* and *Molinia* may exhibit a limited increase of area in the first years after a fire, but do not advance after the vegetation has closed up.

Dr. E. J. Salisbury called attention to the chief interest of the successions on Hindhead in the contrast they offered to the fire successions on other areas. On the gravel-heaths of Hertfordshire, fires had brought about a marked and permanent increase of Bracken, and indeed some heaths, which were formerly dominated by *Ulex*, had now, owing to repeated fires, become Bracken heaths. The other striking difference was the minor rôle played by grasses in the early stages of the succession after burning at Hindhead, whereas on the Yorkshire "swiddens," on the heaths of Hertfordshire, and elsewhere grasses were an important feature of the early stages, *Holcus lanatus* and *H. mollis* being usually conspicuous species.

APPOINTMENT OF ECONOMIC BOTANIST AT KEW.—Following a grant to the Royal Botanic Gardens of £4000 for five years from the Empire Marketing Board, Mr. Hugh C. Sampson, formerly Director of Agriculture, Madras, has been appointed Economic Botanist at Kew. The object of the new appointment is the development of the economic resources of the Dominions and Colonies with the help of the facilities afforded by Kew.

THE Thirty-second Annual Congress of the South-Eastern Union of Scientific Societies will be held at Hastings, from May 25 to 28, under the presidency of Dr. A. B. Rendle, F.R.S., at the invitation of the Mayor and Corporation and the Hastings and St. Leonard's Natural History Society. Dr. E. J. Salisbury will be president of the Botanical Section.

CALLITHAMNION PURPURIFERUM J. G. Ag.

By M. A. WESTBROOK, M.Sc.

CALLITHAMNION PURPURIFERUM J. G. Ag. Spec. Alg. ii. 59 (1851).

Phlebothamnion purpuriferum Kütz. Spec. Alg. 656 (1849); Tab. Phyc. xii. 11 c-e (1862).

Aristothamnion purpuriferum J. G. Ag. Anal. Alg. ii. 44 (1892).

Pleonosporium ? *purpuriferum* De Toni, Syll. Alg. iv. 1307 (1903).

The plant is only recorded as growing parasitically on other algæ, such as *Gigartina Burmanni*, in the littoral region at and near the Cape of Good Hope, e. g., at Table Bay, Sea Point, Kommetje.

HABIT.

Specimens form close rosy tufts up to six inches high. The main axis, clothed all round with pyramidal clusters of branches, is very distinct, and at the base may be as much as 1 mm. in diameter, the articulations being about the same in length. The branches of the second order are produced one from each axial cell, and are arranged spirally with a divergence of about $\frac{1}{4}$, except at the base of the plant, where they emerge in all directions. At the growing apices the pinnae are introrse and are corymbosely clustered, but as they get older the angle of branching becomes greater, till they are finally strongly divaricating. This gives a characteristic appearance, as does also the fact that the cells are rather short and broad, and at the apex taper suddenly to a sharp point (fig. 10), somewhat as in *Callithamnion tetragonum*.

The axes of the first and second orders are densely corticated by downgrowing intramatrical filaments which arise from the lower cells of their branches. These "rhizoids" spread out fanwise over the central cells and finally produce a compact "cortex" reaching a thickness of as much as 370 μ . The innermost cells are colourless and attenuated, and mostly run longitudinally; the outer ones are larger, more regularly arranged, and contain numerous chromatophores. From these cells emerge numerous short, spine-like, adventitious branchlets, perpendicular to the surface (fig. 1). At the base of the plant the "rhizoids" act as attaching organs; the outermost ones spread over the surface of the host, while the majority of the rest penetrate right into the tissues of the latter and there ramify to some extent. In *Gigartina Burmanni* they reached to about 1 mm. below the surface, but seemed to confine themselves to passing among and between the thick gelatinous cell-walls of the thallus. There were no signs of the "rhizoids" penetrating into *Gigartina* cells or forming pit-connections with them, and so the *Callithamnion* must be regarded as showing only a rather advanced stage of epiphytism.

Hyaline unicellular hairs of the usual Floridean type were often

found terminating the ultimate branches of female plants; morphologically they are similar to the trichogynes, but are longer, averaging $200\ \mu$ and sometimes reaching to $250\ \mu$. They are always terminal in origin, but may be later pushed aside, as in *Callithamnion scopulorum*, by the continued growth of the apical cell.

There are four kinds of reproductive bodies: carpospores, spermatia, tetraspores, and polyspores; the two latter may be found together, but the others are formed on separate plants.

MALE PLANTS.

Antheridial plants have only previously been recorded by Ferrari (1925), who gives a brief description of the male organs, stating that in position and structure they resemble those figured by Buffham (1892) for *Spermothamnion Turneri*. The antheridial groups here are pedicellate catkin-like structures, and, from the material here examined, it would seem that a much better comparison would be with those of *Callithamnion tetragonum* or *C. Brodiaei*, though in these latter they are smaller and more compact.

The antheridial groups are found singly, on the adaxial face of the cells of the ultimate branches (fig. 2), and form more or less hemispherical cushions averaging 70 to $100\ \mu$ in diameter, covered externally with antheridia. The development is as follows:—A uninucleate dome-shaped segment is cut off from the adaxial face of a

EXPLANATION OF FIGURES (p. 163).

(The original magnifications are given; the figures have been reduced by about two-thirds).

- Fig. 1. Cross-section of base of axis, showing large central cell with lamellate wall. The cortex is composed of downgrowing filaments with short spiny branches on the outside. $\times 115$.
- Fig. 2. Ultimate ramuli of male plant seen from ventral face, bearing compact spherical antheridial groups. $\times 170$.
- Fig. 3. Median longitudinal section of filament with three stages in the development of the antheridial groups. $\times 900$.
- Fig. 4. Vertical section of group beginning to produce antheridia. $\times 1400$.
- Fig. 5. Portion of crushed antheridial group. The cell-walls are not shown. $\times 2550$.
- Fig. 6. Apex of female plant with young procarp. $\times 800$. *tr*=trichogyne initial; *cpg*=carpogonium; *amc*=auxiliary mother-cell.
- Fig. 7. After fertilization. The auxiliary cells (*ac*) have formed and the carpogonium has produced a 2-celled sporogenous thread (*sp*); from this on the left a small sporogenous cell (*sc*) has been cut off and is about to fuse with the auxiliary cell. *bc*=basal cell. $\times 800$.
- Fig. 8. Development of the cystocarp. $\times 800$. *c*=central cell of gonimolobe; at *d* a cell is beginning to grow down over the fertile filament-cell.
- Fig. 9. Oblique section of developing cystocarp showing two primary gonimolobes (*p*) and the beginnings of two secondary ones (*s*). $\times 490$. *f*=fertile filament-cell.
- Fig. 10. Filaments seen from ventral face, bearing polysporangia in various stages. $\times 370$.
- Fig. 11. Vertical section of polysporangium initial, showing four of the six nuclei present. $\times 785$.
- Fig. 12. Median section of polysporangium, showing simultaneous cleavage into uninucleate portions, radiately arranged. $\times 785$.

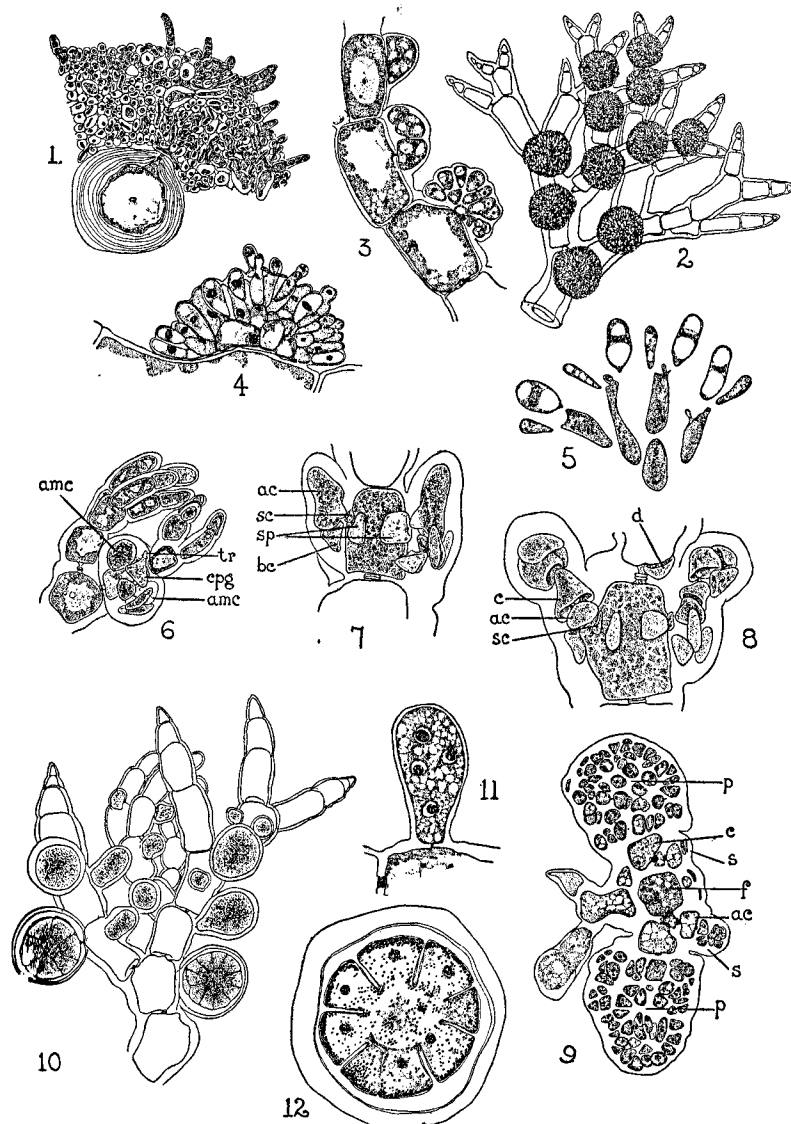

A Westbrook d.

Callithamnion purpuriferum J. G. Ag.

(For Explanation of Figures, see p. 162.)

vegetative cell (these are all multinucleate) near the apex of a short branch (fig. 3). It then divides transversely, and from each cell arise several very short branches; further division of these produces finally a hemispherical complex of crowded compressed branches radiately arranged (fig. 3). The cells are without chromatophores, but have one or more nuclei; the outermost ones are all uninucleate, and act as antheridial mother-cells. The antheridia arise as small protuberances, elongating upwards (fig. 4) and pushing up the limiting layer of the cell-complex. In a young cluster it may be seen that the position of origin is slightly lateral, but later the mother-cells become so compressed and attenuated that the antheridia seem almost terminal (fig. 5). Each produces in succession two to four antheridia (fig. 5); the latter have scanty protoplasmic contents with a central nucleus suspended therein and a vacuole on either side of it. The cell-contents escape by an apical split in the wall and form the spermatium.

There was no sign of the development of secondary antheridia, but the cells are so crowded that empty antheridia are obliterated; increased and continued production of spermatia seems to be effected rather by the formation of new antheridial mother-cells as lateral branches from the old ones (fig. 5). As will be seen from the list of synonyms, the plant is placed by De Toni in the genus *Pleonosporium*. The male organs are known for six species of the latter: *P. Borreri*, *P. Wuellerstorffianum*, *P. dasyoides*, *P. flexuosum*, *P. vancouverianum*, and *P. squarrosom*. In all they are oblong cylindrical structures with antheridial mother-cells arranged round a central axis, the whole often being pedicellate. It is obvious that *C. purpuriferum* does not conform at all to this type, but agrees with the rest of the *Callithamnieæ*, where there are clusters of short branches, varying very much in the degree of compactness, but similarly constructed in the essentials.

FEMALE PLANTS.

The earliest stages in the development of the procarys are found at the tips of the corymbosely-clustered branches. From each side of a filament-cell, as usual multinucleate, and only a few divisions removed from the apex, an auxiliary mother-cell is cut off. As in most *Ceramiales* one of them produces the carpogonial branch, consisting of four cells, arranged across the fertile filament-cell in a characteristic zigzag fashion (fig. 6). The uninucleate carpogonium is transparent and bears a slightly-curved trichogyne, which may reach a length of 140 μ . At this stage spermatia have been seen attached, and fertilization presumably takes place. At the same time the auxiliary mother-cells have elongated, and by a transverse division each forms a basal cell and an auxiliary cell, the latter remaining attached to the filament (fig. 7).

After fertilization the trichogyne disappears and the carpogonium divides by a transverse wall to produce a two-celled sporogenous thread; each of its components cuts off a small crescentic cell (*sc*) towards the neighbouring auxiliary, which puts out a protuberance to meet it (fig. 7). Apparently from this cell a diploid nucleus passes into the auxiliary, but the two do not fuse intimately, since the two

sporogenous cells can be detected considerably later in the development of the gonimoblast (fig. 8). The rather transparent remains of the carpogonial branch-cells can also be seen for some time—they seem to give up their contents to the segmenting carpogonium, for the cells of the sporogenous thread are well filled.

After the fusion process the auxiliary divides transversely, and the larger upper cell produces numerous branching chains of cells (fig. 9), the contents of each of which finally become a carpospore. At a fairly early stage each auxiliary cell again divides (fig. 9) and gives a second gonimolobe cell, which forms another, smaller, bunch of carpospores, slightly below the first.

Fig. 9 shows a transverse section through a developing cystocarp. In the centre is the fertile filament-cell, which is clearly differentiated from the surrounding sterile ones by the large number of deeply-staining nuclei which it contains. On either side are the two auxiliary cells, to each of which is attached the uninucleate central cell of a primary gonimolobe. At the periphery are the collapsed remains of two cells of the carpogonial branch. The cystocarp is naked, but the fertile filament-cell becomes covered to some extent by the downgrowth of a few intramatrical filaments from the cells above. The same can be seen in *C. Brodiaei* and in *C. roseum* (Rosenvinge, 1923), and is perhaps a strengthening device for the cell which has to bear the heavy masses of carpospores.

The two large gonimolobes are in outline either globose or subreniform, and are surrounded by a thick hyaline wall. They average 360 μ in length by 280 μ in diameter. The portion of the filament above the fertile cell does not grow much after fertilization, and so, on superficial examination, the cystocarp appears terminal.

The development closely parallels that in other species of *Callithamnion*, as described by Oltmanns (1898) for *C. corymbosum*, by Kylin (1922) for *C. Furcellariae*, and by Rosenvinge (1923) for several other species. There are minor differences in the prominence of the multinucleate axile cell and its covering by downgrowing filaments, the persistence of the sporogenous cells, and the constant development of two small secondary gonimolobes. This latter is noticed sometimes in *C. Furcellariae* and in *C. Brodiaei*, but here Rosenvinge found that they arise from the central cell of the primary gonimolobes instead of from the auxiliary cell.

There is, apparently, no complete description of the development of the cystocarp in *Pleonosporium*. De Toni (1903) gives as a character of the genus that there is a single gonimoblast divided into numerous rounded gonimolobes, which are produced in succession, while Kylin has described the early stages in *P. squarrosom* and *P. vancouverianum*, where "the procarys is developed from the subterminal cell of a branchlet, the terminal cell being pushed aside. From the subterminal cell a lateral pericentral one is cut off, representing the supporting cell, which will, before the development of the four-celled carpogonial branch, cut off a small sterile cell. The subterminal cell also gives birth to a transversal one, probably representing the mother-cell of a second auxiliary cell" (1925, p. 58). This is clearly quite unlike the events in *Callithamnion*.

POLYSPORES.

Asexual reproduction is effected both by tetraspores and polyspores, but only the latter were found in this material. The sporangia occupy the same position as the antheridial groups (fig. 10), but more than one (1-3) are usually to be found on each filament-cell, the development being in basipetal sequence. The ovoid initial cell is uninucleate, but early becomes multinucleate (fig. 11), stages with 6 nuclei present being most common. It then becomes more spherical, and, when there are a considerable but varying number of nuclei present, cytoplasmic cleavages delimit uninucleate, radiately arranged portions. Since the furrows do not proceed quite to the middle, a central sterile portion is left (fig. 12), as in the polysporangium of *Gonimophyllum Skottsbergii* (Kylin, 1925). The number of spores in the sporangium varies—24 is an average, but there may be as many as 32. Cytological details were not available to determine whether any of the mitoses are reducing, in which case the polysporangium would be homologous with a tetrasporangium. If it were a question of successive divisions and cleavages of the latter, one would expect that the spores would number some power of two, but this is not regularly the case, while the furrowing is a simultaneous process. However, be their origin and cytologic status what it may, the polyspores are morphologically identical with tetraspores and fulfil the same reproductive function.

NOMENCLATURE.

The alga was first described by Kützing (1849) under the generic name *Phlebothamnion*, but the development of the "tetrachocarps" and cystocarps was said to be as in *Callithamnion*, to which genus J. Agardh (1851) removed it. Later, in his detailed analysis of the *Callithamniæ* (1892), which he divided into sixteen sections, he made *C. purpuriferum* the single type of the last genus *Aristothamnion*, saying that "in *Callithamniorum* gente Genus hoc nobilissimum putavi." The antheridia he did not know, but in habit and structure of frond he compared it with *C. Laricini*, though the fruits of the two were seen to be different. This is not to be wondered at, for the latter is now placed in the genus *Pleonosporium*. De Toni (1903) removed *C. purpuriferum* to the same genus and left it in the same position in his later work (1924); probably he was influenced by the characteristic development of polyspores, which are not found in his species of *Callithamnion*. They are, however, not restricted to *Pleonosporium*, but are known for species of *Spermothamnion* and *Composothamnion*, among others. It would seem that, judging from the development of reproductive organs, *C. purpuriferum* is rightly placed in the genus *Callithamnion*, while there is nothing in the vegetative structure which precludes this. So far as it is known, *Pleonosporium* is much nearer to *Monospora*, *Griffithsia*, and *Spermothamnion*.

Material of this alga was collected by Dr. E. M. Delf in South Africa, and thanks are due to her for kind permission to examine it.

BIBLIOGRAPHY.

- AGARDH, J. G. (1851.) 'Species Algarum. Vol. ii. Pars i. Floridearum Pars.' Lund.
 —. (1892.) "Analecta Algologica.—II." Act. Soc. Physiograph. Lundensis, xxviii.
 BUFFHAM, T. H. (1892.) "On the Antheridia etc. of some of the Florideæ." Journ. Quekett Microsc. Club, ser. 2, v.
 DE TONI, G. B. (1903.) 'Sylloge Algarum.—IV. Florideæ.' Sectio 3. Padua.
 —. (1924.) 'Sylloge Algarum.—VI. Florideæ.' Sectio 5. Padua.
 FERRARI, I. (1925.) "Sulla Presenza degli Spermatozoi nel *Pleonosporium purpuriferum*." La Nuova Notarisa. Padua.
 KÜTZING, F. T. (1849.) 'Species Algarum.' Leipzig.
 —. (1862.) 'Tabulæ Phycologicae, xii.'
 KYLIN, H. (1922.) "Studien über die Entwicklungsgeschichte der Florideen." Kgl. Svensk. Vetensk.-Akad. Handl. lxiii. Stockholm.
 —. (1925.) "The Marine Red Algæ in the Vicinity of Friday Harbour, Washington." Lunds Universitets Arsskrift, N. F. Avd. 2, Bd. xxi. Nr. 6. Lund.
 OLTMANN, F. (1898.) "Zur Entwicklungsgeschichte der Florideen." Bot. Zeitung, lvi.
 ROSENZINGE, L. K. (1923.) "The Marine Algæ of Denmark.—III." Kgl. Dansk Vidensk. Selsk. Skrifter. 7 Række. Naturvidensk. og Mathem. Afd. vii. 3. Copenhagen.

NOTES ON THE BRITISH PANSIES.

THE *SAXATILIS*-SERIES.

BY ERIC DRABBLE.

THE *saxatilis*-series of Rouy and Foucaud is based on *V. saxatilis* Schmidt, Fl. Bohemica, iii. 60 (1794), and is made by them to include many plants, which they characterize thus: "Plantes non velues-hérissées, annuelles ou bisannuelles, dépourvues de souche vivaces; stipules nettement pinnatifides à segments latéraux linéaires, fleurs grandes; corolla nettement plus grande que les sépales, mais n'égalant jamais 2-3 fois leur longueur; éperon plus gros [than in *V. Curtisii*], dépassant les appendices du calice" (pp. 40, 41).

In describing the plants of the *saxatilis*-series as annual or biennial, Rouy and Foucaud's Key is misleading. The same branch of the Key leads to *V. Curtisii*, a characteristically perennial plant, and, moreover, the series includes the perennial *V. lepida*. One would be inclined to think that a mere slip had been made, were it not that *V. contempta* Jord., *V. Provostii* Boreau, and *V. Meduanensis* Boreau, all stated in the original descriptions to be annuals, are also included. Schmidt (Fl. Bohemica, iii. 60) described *V. saxatilis* as perennial, and it is better to include in this series perennial plants only. Thus constituted, the *saxatilis*-series consists of plants of perennial habit with large flowers, narrow sepals, spur longer than the papillate appendages, and with the lower parts of the branches long, slender and twiggy, lying just below the surface of the soil or embedded in the surrounding vegetation.

V. saxatilis itself does not seem to be British. It is described by Schmidt (p. 60) as a perennial with large yellow flowers, pinnatifid stipules, and obtuse, roundedly crenate, *entirely glabrous* leaves. Plants that I have seen thus named from Bohemia (Fl. Bohemica borealis; *V. saxatilis* Schmidt var. *lutea* Wiesb. in Herb. C. Bailey) are of the perennial "*Provostii*" type (see below, p. 171), and clearly fall into the *saxatilis*-series as here constituted.

Several members of this Series have been claimed as British, but for the most part they seem to be merely forms of *V. lepida*, which is very abundant in this country.

VIOLA LEPIDA.

Jordan, Pugillus, 28 (1852); *V. tricolor* L. var. *lepida* Nyman, Consp. Fl. Eur. 80 (1878); Drabble in J. Bot., Suppl. 1909, 10; *V. tricolor* (L.) subsp. *stenochila* Wittrock, Viola-Studier, 73, 1897 (excluding var. *depressa*).

Plate:—Drabble in Journ. Roy. Hort. Soc. xxxv. pt. ii. figs. 56 & 65 (1910).

Plant perennial, 6–18 in. or more in height. *Stems* several from the base, slightly pubescent, upright, or procumbent below, then ascending, the lower parts slender and twiggy, usually below the surface of the soil or embedded in the surrounding humus. *Leaves* pubescent, crenate or crenate-dentate, ciliate; the lower ovate-obtuse, sometimes cordate, the intermediate ovate-lanceolate, obtuse or subacute, the upper lanceolate or linear-lanceolate, acute or subacute. *Stipules* hairy and ciliate; the mid-lobe generally entire or narrowly spatulate or oblong, of the lower stipules often subfoliaceous and crenate or crenate-dentate; the lateral lobes narrowly linear-oblong; usually the whole stipule is palmate, but the lateral lobes may be borne pinnately, especially in the lower stipules. *Peduncles* erect or nearly so. *Flowers* brightly coloured, $\frac{2}{3}$ to 1 inch or more in length. *Sepals* narrowly linear-lanceolate or triangular-acuminate. *Petals* much longer than the sepals, usually purple or blue with some suffusion of yellow or white, especially in the lowest one; sometimes the petals are entirely yellow. Spur longer than the rather small sepaline appendages.

Exsicc. Herb. Mus. Brit.:—*V. lepida* Jord. Cult. plant de Belgique. Cult. 1852; and Cult. 1858; ex herb. Alexis Jordan (two sheets).

V. lepida Jord., Billot, Fl. Gall. et Germ. exsicc. no. 2019, Ardennes.

Herb. Imperial College:—*V. lepida* Jord. in Déséglise's herbarium, from Jordan himself.

Herb. Ch. Bailey:—*V. lepida* Jord., Billot, Fl. Gall. et Germ. exsicc. no. 2019, Ardennes.

V. incerta Blocki, Schultz, Herb. norm., nov. ser., cent. 26, no. 2514, Carpathians, Hungary.

V. tricolor L., Becker Viola Exsicc. vi. Lief. 1905, no. 152 (yellow-flowered *lepida*).

V. saxatilis Schmidt, Fl. exsicc. Austro-Hung. Porta, 576 (yellow-flowered *lepida*).

V. tricolor L. fr. *saxatilis*, Fl. Croatica, 6535, ex herb. L. Rossi (yellow-flowered *lepida*).

V. saxatilis Schmidt var. *lutea* Wiesb. Fl. Bohemica borealis, (yellow-flowered *lepida*).

Jordan writes (*Pugillus*, 29): "Hab. in Belgia?" and "Per decem annos colui," but *lepida* has more recently been recorded from Charante Inférieure, Ardennes and Meuse (*Rouy & Foucaud*, iii. 43). Jordan's specimens in Herb. Mus. Brit. and Herb. Imperial College are poor and imperfect, but after examination of these and comparison with his description, there can be no doubt that our British plant is correctly named. Moreover, specimens gathered in July 1860, near the Spittal of Glen Shee, in Perthshire, were submitted to Boreau, who returned this note:—"Videtur *V. lepida* Jord." (Rep. Thirst Bot. Ex. Club, 1862, and Journ. Bot. i. 1863, p. 145). There seems to be no justification for H. C. Watson's reference to *lepida* as an "ambiguity" (*Cybele*, 487, 1870).

V. lepida is widely distributed in Great Britain, especially, but by no means exclusively in the upland districts. It shows considerable variation, but I am quite unable to recognize any constant varieties. All intermediates occur between narrow and broad leaves, and entire, crenate and crenate-dentate mid-stipular lobes. On cultivated land *lepida* may form many ascending or upright branches, produce flowers and die away without becoming perennial or forming twiggy bases. It then sometimes shows considerable resemblance to *V. Lejeunei*, which, however, in my experience is always annual.

The relation of *V. Meduanensis* to *lepida* is a matter to which I have given much attention.

V. Meduanensis Boreau (Fl. du Centre, ed. 3, ii. 80–81, 1857) is stated to be an annual. The following is taken from Boreau's description:—"Tige dressée, les latérales étalées ascendantes, peu rameuses; feuilles obtuses crénelées, les inférieures ovales oblongues, à peine échancrées en cœur à la base, les supérieures ovales; stipules pinnatifides à lobes linéaires oblongs, l'intermédiaire assez semblable aux feuilles, un peu crénelé." This description fits certain British plants which are also closely matched by the following specimens:—Herb. Mus. Brit.: *Viola Meduanensis* Bor., le châtaigneraie, pendée 1875 (ex herb. Lloyd); *V. Meduanensis* Bor., St. Hilaire (*Vendée*), mai 1859, *Legit* Genevier; *V. Meduanensis* Bor., Morbihan, cultivated field, W. of Rochefort-en-terre, *A. J. Wilmott*, 11.8.1925; *V. Meduanensis* Bor. Fl. Gall. et Germ. Exsicc. no. 3707.—Herb. Imperial College:—*V. Meduanensis* Bor., from Boreau himself, in Herb. Déséglise. In all these specimens the internodes are very long in proportion to the leaves, and the lateral lobes of the stipules are exceedingly narrow, but neither of these characters is emphasized by Boreau. It is true he describes the leaves as obtuse, but I have seen authentic specimens thus named with acute leaves, e. g., *Billot*, 3707 and the sheet from Boreau himself in Herb. Déséglise. The peduncles in these specimens vary in length. In some, but not in all,

they are very long, but they do not exceed those of extreme forms of *lepida*. All the specimens mentioned above, if perennial, I should place in *lepida*. This applies also to certain plants in my own herbarium, particularly to some collected by Mr. W. H. Pearsall near Broughton-in-Furness. The Furness specimens show all intermediates between broad-leaved plants without any trace of twiggy bases and very narrow-leaved plants with the twiggy bases well developed. Mr. Pearsall is unable at present to say whether these become perennial or not, but he is keeping them under observation. So far, I can only refer them to *lepida*. If *Meduanensis* be really an annual, it must be kept separate from *lepida*, but I suspect that at least some of the specimens named *Meduanensis* are really *lepida* in its first year.

VIOLA CARPATICA.

Borbás in *Oesterr. Bot. Zeitschr.* xli. 422 (1891); Koch, *Synopsis*, ed. 3, i. 222 (1892); Drabble in *Journ. Bot.* 1909, Suppl. p. 12.

Certain plants gathered by the late J. A. Wheldon in June 1900, at Cockerham Moss, Lancashire, were thus named by Borbás. The authentic specimens that I have examined differ from ordinary *lepida* only in their more luxuriant growth, their longer and larger leaves which are usually rather closely set, giving a very leafy appearance to the plant, and their rather broader sepals. I am quite unable to find any constant features whereby *carpatica* can be separated from *lepida*, and regard it as a mere state of that species.

In addition to Wheldon's specimens in my own herbarium, the following may be cited as possessing the characters on which *carpatica* was founded by Borbás.

Herb. Ch. Bailey:—*V. tricolor* L. var. *alpestris* Gremli, Fl. de Bormio, pieds du Val Federia, Livigno, 2000 m., 1897; legit M. Longa.

V. tricolor L. var. *versicolor* Becker, Fl. Hungarica, Herb. S. Kupçok, Bakahanya, 1903.

Baenitz Herb. Europ., Fl. Prussica orient. Königsberg, 1891.

V. carpatica Borbás is stated in Koch's *Synopsis*, ed. iii. 222, to be *declinata* × *tricolor* a *subalpina*. *V. declinata* Waldst. & Kit. is unknown in this country. Some specimens collected by P. Hilton at Chailey, E. Sussex, in 1906 and 1907, seem to have gone into circulation under this name. Of this Sussex plant, A. O. Hume wrote: "I have no doubt whatsoever myself as to what it is, it belongs, of course, to the *tricolor* group; but it is a clearly distinct species, viz. *Viola declinata* Waldst. & Kit., often confounded with *V. gracilis* Sibth. & Sm., and mixed up with *V. heterophylla* Bertol., but you may, I think, rely upon its being the true *declinata*, which is beautifully figured in Reichenbach, Plate 4515."

The ease with which Hume allowed himself to be convinced is, perhaps, rather disturbing. Waldstein and Kitaibel (Pl. rar. Hung. iii. 248) write: "tota planta exceptis stipularum ciliis glabra lævis," and, quite apart from any other consideration, this rules out the Sussex plant. I possess specimens named *declinata* from Hungary (auf der Alpe Terentin), collected by L. Vagner in 1881, to which this

description does apply, and they are not the same as the Sussex plant, which is *lepida*. Wrongly-based "identifications," such as that just mentioned, have led to much confusion in the pansies. No British plants ought to be identified with named Continental ones without the most careful comparison with authentic specimens as well as with descriptions.

It appears to be quite certain that the Cockerham moss-pansy is not a hybrid involving *declinata*. It must be realized, of course, that Borbás may have been mistaken in his opinion of the origin of his Carpathian plants, for it does not seem to have been based on any experimental evidence. However, it is unnecessary to pursue the matter further, for though extreme forms of the Lancashire plant do look very distinct, they are connected by all intermediates with ordinary *lepida*, and I have no hesitation in placing them under that species.

It is necessary once more to refer to *V. Provostii* Boreau (Fl. du Centre, ed. ii. 82, 1857). Boreau describes it as annual. It seems to be a yellow-flowered *Lloydii*, and, if used at all, the name *Provostii* should be kept for such plants. *V. Provostii* Boreau, Beaucouze, mai 1859, Provost, no. 304 in Herb. Kew., is certainly a first year's plant. On the other hand, the following are clearly yellow-flowered *lepida*: Herb. Mus. Brit.:—*V. Provostii* Boreau, Champs à Plounerin (Côtes du Nord), 25 mai, 1878, Miciol (a broad-leaved yellow-flowered *lepida*); *V. Provostii* Bor. Evrunes, Vendée, 3 mai 1869 and mai 1878, ex herb. Gaston Geneviev (2 sheets).

It appears, then, that *V. carpatica* is merely a luxuriant leafy form of *lepida*, that *V. Meduanensis* may be *lepida* flowering in the first year, and that many of the plants termed *V. Provostii* are yellow-flowered *lepida*, though this name ought to be restricted to yellow-flowered *Lloydii*. Further cultural work is in progress, the results of which will be communicated in due course.

In addition to specimens in the herbaria at the British Museum, Kew, and the Imperial College of Science, South Kensington, I have examined many sheets kindly lent to me some years ago by the late Charles Bailey and now in the Manchester Museum.

RECENT LICHENS FROM ARCTIC REGIONS.

BY ROBERT PAULSON, F.L.S.

A SMALL packet of lichens, collected by Mr. J. W. Marr, during the period he spent as a member of "The British Arctic Expedition" (1925) in Spitsbergen and Franz-Josef-Land, contained material of considerable interest.

The majority of specimens identified are, as might be expected, considering the circumstances under which they were gathered, common to Arctic regions, but among them is a specimen of *Crocynia*, a genus noted from Spitsbergen (for the first time) in the material

collected by C. S. Elton, of the Oxford Spitsbergen Expedition, 1924, and also several small portions of *Lecanora polytropella*.

The localities for lichens collected in Spitsbergen are: Green Harbour and Liefde Bay, including Reindeer Peninsula; for North East Land, Chermiside Island; and for Franz-Josef-Land, Cape Barents.

GREEN HARBOUR, 78° 5' N., 14° 10' E. Visited July 16.

The soil here has been formed by the breaking down of the local Miocene coal-measures, mostly carbonaceous sandstone, with an addition of glacially-transported material of a similar nature.

Cetraria nivalis Ach. and *Lecanora tartarea* var. *frigida* Ach. were abundant.

LIEFDE BAY AND REINDEER PENINSULA, 79° 41' N., 13° 40' E.
Visited July 22, 23.

The land bordering both bay and peninsula is formed of rather fine-grained red-brown sandstone, with some similar slate-green rocks, both containing numerous calcite veins.

The specimens from this area were all collected on low, rather barren ground bordering a small bay. The land was strewn with biggish rocks that were often of a brilliant orange colour, owing to the abundant growth of lichens.

The specimens collected are *Cetraria islandica* Ach., *Xanthoria lychnea* Th. Fr., *Placodium elegans* DC., *P. murorum* var. *pusillum* Flag., *Lecanora polytropica* var. *alpigena* Leight., *L. tartarea* var. *upsaliensis* Nyl., *Crocynia membranacea* Zahlb., and *Stereocaulon alpinum* Laur.

CROCYNIA MEMBRANACEA Zahlb.—Growing over decayed moss. Thallus white, sub-pulverulent or minutely granular, vaguely squamulose at the margin, K+faint yellow. Gonidia in glomerules with a diameter of 20–35 μ ; gonidia free from the glomerules have a diameter of 8–10 μ . Lower hyphæ brown, articulate and anastomosing.

A specimen of this lichen with a sketch of a transverse section of thallus was sent to Dr. Bouly de Lesdain, who has kindly reported "Le *Crocynia* appartient bien à la section Hyphæ inferne colorata. Gonidia protococcoidea."

CAPE BARENTS, FRANZ-JOSEF-LAND, 79° 55' N., 51° 18' E.
Visited August 25.

The Cape consists of a projecting low-lying spit backed by a buttress of dolerite 200 feet high. Huge rounded boulders which appear to be fast embedded in the ice are strewn over the low land. Beyond the buttress stretches the ice-cap, which possibly covers the entire Franz-Josef Archipelago.

As far as could be seen, mosses and lichens comprise the whole flora, the bulk of which was on the top of the buttress. Specimens from the Cape are: *Cetraria nivalis* Ach., *Rinodina exigua* var. *lecideoides* Th. Fr., *Gyrophora arctica* (very abundant), *Stereocaulon alpinum* Laur., *Cladonia degenerans* Flk., and *Solorina crocea* Ach.

RINODINA EXIGUA var. LECIDEOIDES Th. Fr.—This specimen was on a piece of ancient drift picked up on the shore. The wood is coniferous; bordered-pits measure 18–20 μ in diameter.

The thallus is pale to dark grey, but the crowded, black, abundantly fertile apothecia give to the lichen an inky-black appearance. Spore-measurements are 18–22 \times 8–10 μ .

CHEMISIDE ISLAND, NORTH EAST LAND, 80° 57' N., 27° 32' E.
Visited September 21.

This island is formed dominantly of a medium-grained, grey, two-mica granite, which contains large inclusions of mica-schist.

The lichens are *Lecanora polytropella* Nyl., *L. polytropica* var. *alpigena* Leight., *Gyrophora polyphylla* Hook., and *Rhizocarpon geographicum* DC.

LECANORA POLYTROPPELLA Nyl.—This was growing on quite small pieces of disintegrating granite. In outward appearance it closely resembles *Lecanora polytropica*. The thallus is sub-granular, yellow. Apothecia have a diameter up to 1 mm., but the majority of them are smaller; paraphyses slender, crowded, with an epithecium of brown granules. Spores oblong, 9–10 $\mu \times$ 3.5. Hymenial gelatine I+blue permanent. A new record for Spitsbergen.

This lichen, having been preserved in formalin, is not easy to determine, but it appears to be nearer *L. polytropella* than to *L. stenotropa* Nyl.

GYROPHORA POLYPHYLLA Hook.—The specimens are small, monophyllous, the largest being .8 cm. in diameter when moist. The folding of the thallus gives the appearance of a rosette with the edges of the leaf erect. Chermiside specimens are not fertile; they resemble exactly, except in size, a specimen labelled *Gyrophora glabra* Ach. var. *corrugata* Schleicher, Herb. Hookerianum, 1867. See also Th. Fr. Lich. Scand., note on variations, page 165.

Notes on localities, soil, etc., were supplied by the collector. The remarks upon habitat are for the most part abstracted from Mr. Marr's manuscript.

NOTES ON THE GENUS *HEMIANDRA* R. BR.

BY O. H. SARGENT.

In January 1924, during a brief visit to a locality about 14 miles south-west of York, Western Australia, a small colony of shrublets with red tubæform flowers was seen (1). The genus was undoubtedly *Hemiandra**, and at first the plant was thought to be a variety of *H. pungens* R. Br.; but the striking differences in form and colour between the corollas of this and all previously seen varieties of *H. pungens* induced the author to make as complete a study of the whole genus as available material would permit. A collection of *Hemiandra* species from localities well scattered over the south-western portion of the State was carefully examined, and another red-flowered form (3)—unquestionably a distinct species—was discovered, amongst specimens of a var. (?) of *H. pungens*, having been placed there on account of a superficial resemblance. Towards the end of the same year, a third red-flowered form (4) was collected by Mr. C. A. Gardner, of the W.A. Department of Agriculture. Fairly exhaustive study of this material, besides establishing the specific rank of the first-named plant, has led to conclusions of some importance concerning the genus generally:—

- (a) The genus is valid and very natural, readily distinguished from its allies by the *characteristic leaf-form*, varying from almost ovate, through lanceolate to narrow-linear, glabrous, pubescent or hirsute, but *always strongly ribbed longitudinally below, and rigidly pungent-pointed*.
- (b) The character of the calyx sharply divides the genus into two sections, for which the author proposes the names: *Cheilocalyx* (calyx bilabiate: *H. pungens* &c.) and *Asterocalyx* (calyx tubular or campanulate, with a more or less patent 5-lobed limb: *H. incana* Bartl., and two new species).
- (c) The character of the corolla is of specific value.
- (d) The point of insertion of the stamens and their length relative to the corolla-tube are of specific importance.
- (e) Habit and indumentum are characteristic in some species, but not in all.
- (f) As suggested by Bentham (Flora Austr. v. 110) several, if not all, of the "forms" grouped by him under *H. pungens* R. Br., are almost certainly entitled to specific rank. Differences of foliage, and, in some cases, of habit seem constantly associated with more readily described differences of floral structure.

In September 1926, after this paper was sketched out, Mr. Gardner found still another red-flowered species (2), which confirms the conclusions stated above. Descriptions of this and the three other

* A small West Australian genus of Labiate, belonging to the Australian tribe Prostanthereæ.

novelties are offered hereunder with some further remarks upon them. It seems best to delay revision of *H. pungens* till slight doubts concerning some of the "forms" included under that name have been cleared up.

1. *Hemiandra rutilans*, sp. nov. (§ *Cheilocalyx*). *Fruticulus* erectus, caulibus foliis et calycibus subscabro-canescens, vel foliis interdum glabris; *foliis* linearibus vel lineari-oblongatis; *calyce* bilabiato; *corolla* sanguinea subdense pubescente tubo tubæforme limbo vix bilabiato, lobis subæqualibus tubo multo brevioribus integerrimis; *staminibus* quarto infero tubi insertis, antheris longe exsertis.

Hab. "Sand Springs," near York, W.A., Jan. 1924. Herb. Sargent, 1428.

Caulis ad 10 cm. (vel altior?); folia 21 mm. long., 2 mm. lat.; calycis tubus 6 mm., corollæ tubus 21 mm. long.

2. *Hemiandra Gardneri*, sp. nov. (§ *Cheilocalyx*). *Fruticulus* prostratus, caulibus foliis et calycibus cinereis velutinis pilis brevissimis; *foliis* oblongatis aliquanto congestis; *calyce* anguste campanulato limbo bilabiato lobis tribus; *corolla* lateritia tubi dimidio infero cylindrico supero tubæforme limbo distincte bilabiato lobis brevibus æquilongis, posticis rotundis integris ciliolatis, lateralibus oblongis integris vel paucidentatis, lobo anteriore late cuneato apice crasse 6-dentato; *staminibus* apici partis cylindricæ corollæ insertis, antheris breviter exsertis.

Hab. "In arenosis aridis apertis prope Watheroo, W.A.," September 1926. Herb. C. A. Gardner, 1931.

Caulis primarius ultra 40 cm. long.; folia ad 20 × 5 mm.; calycis tubus 5 mm., corollæ tubus 14 mm. long.

3. *Hemiandra rubriflora*, sp. nov. (§ *Asterocalyx*). *Fruticulus* ascendens vel erectus, caulibus foliis et calycibus breviter hirsutis; *foliis* oblongatis costa media triente superiore trifurcata; *calyce* folioso, tubo campanulato quam limbo multo brevior, lobis quinque longe acuminatis; *corolla* rubra tubo cylindrico, limbo bilabiato, labio supero multo longiore quam infero, lobo mediano labii inferioris elliptico-oblongo emarginato, limbi lobis ceteris omnibus oblongis emarginatis alte vel brevissime lobulatis lobulis obtusis; *staminibus* brevissimis in faucem insertis, antheris ellipticis lobis sterilibus fere obsoletis.

Hab. Protheroe, W.A. (coll. *Miss E. Penn.*), October 1916 (?). Herb. Sargent, 1436; also Herb. C. A. Gardner, 2050. "Sand heaths in arid sandy soil nr. White Peak," September 30, 1926 (corolla-lobes minutely dentate). "Flowers dull scarlet." Caulis ad 15 cm.; folia 15 × 6 mm.; calycis tubus 5 mm.; corollæ tubus 8 mm. long.

4. *Hemiandra coccinea*, sp. nov. (§ *Asterocalyx*). *Fruticulus* erectus, caulibus hispidis; *foliis* hispidis oblongatis costa mediana

triente inferiore trifurcata; *calyce* hispido, tubo cylindrico-campanulato, limbo alte in partes quinque spinosas diviso, segmento dorsale ceteris latiore longioreque; *corolla* coccinea tubo cylindrico angusto triente superiore campanulato lato oblique et abrupte explicato, partibus limbi subæqualibus margine integris, labio inferiore breviter bifido leniter crenulato; *staminibus* apici partis cylindricæ corollæ affixis, antheris valde exsertis.

Hab. Sand Plain, nr. Wongan Hills, W.A., December 1924. Herb. Sargent, 1445 (coll. *C. A. Gardner*).

Caulis 12 cm. alt.; folia 13 × 5 mm.; calycis tubus 6 mm., corollæ tubus 18 mm. long.

The corolla of *H. rutilans* closely resembles that of *Microcorys longifolia* Benth. The sterile connective of the posticous anthers is spatulate, that of the anticous subulate. All the plants seen had made only one year's growth after a bush-fire; so height is uncertain. One plant had purplish flowers. *H. Gardneri* is remarkable for its velvety indumentum. *H. rubriflora* is notable for its leafy calyx and strange corolla, the strictly cylindrical tube and larger upper lip being unique in the genus. It shares with *H. coccinea* the character of a branched midrib to the leaf; but the branching is nearer the base in the latter species and nearer the apex in the former. No trace of such branching has yet been found in any other species. Each of the four new species displays characters clearly distinguishing it from any other species of the genus. Apparently each is narrowly restricted in range and in danger of extinction. In form as well as colour the corollas of these novelties are unlike those of previously known species of *Hemiandra*, being suggestive rather of related genera. Thus the genus could be divided into two sections by corolla characters—one with pale flowers of characteristic likeness in shape, almost certainly pollinated by insects, the other with red flowers of more varied form, perhaps pollinated by birds. This division cuts across and is less convenient for systematic purposes than the one founded upon calyx form.

[Specimens of the species described above have been presented by Mr. Sargent to the British Museum Herbarium.—Ed.]

OBITUARIES.

LUDWIG RADLKOEFER

(1829–1927).

ON Feb. 16th last there died at Munich, where he had spent his entire life, a veteran among botanists, Prof. Dr. Ludwig Radlkofer. He was in his 98th year, when unwise participation in a torchlight procession connected with local festivities led to a brief illness terminating in his death. Radlkofer had long withdrawn from active teaching duties, but he retained his Chair and acted as Director of the Botanical Museum of the University to the last. A man of small stature, with only a slight tendency to corpulence, he betrayed by his

upright carriage and elastic step, even in his later years, the excellent constitution that enabled him to live to a ripe old age.

He was born at Munich on Dec. 29th, 1829, graduating as a Doctor of Medicine in that university at the age of 25; he also studied for a short time at Jena. In 1856 he qualified as "Privatdozent" at Munich, became Assistant Professor in 1859, and attained the full rank of "ordentlicher" Professor in 1863. His first published papers were concerned with the fertilization-process in Angiosperms and with protein-crystalloids, but he soon forsook these lines of enquiry for the taxonomic researches that were to constitute his life-work. He became an acknowledged authority on the Sapindaceæ, and to him are due the sections dealing with this family in Martius's *Flora Brasiliensis* and the *Natürliche Pflanzenfamilien*, while he published a monograph of the genus *Serjania* in 1875. He will, however, in all probability be principally known to posterity as a vigorous protagonist of the use of anatomical characters in taxonomy. The value of such characters was expounded in numerous communications, and the full case for the anatomical method stated in a "Fest-rede" ("Ueber die Methode in der botanisch. Systematik, insbesondere die anatom. Methode") in 1883. He laid his views before the British Association in 1868, and again in 1885.

Radlkofer had a most intimate knowledge of the anatomical features of the families of Angiosperms, but he left to his pupil, Hans Solereder, the task of compiling a record of the innumerable data, many of them gleaned by investigators in Radlkofer's own laboratory. From all quarters he was constantly receiving sterile herbarium-specimens for determination, but often a single leaf would suffice him to settle genus or species on the basis of its anatomy. He continued an active worker to the end, a paper dealing with a new genus of Sapindaceæ (*Euchorium*) being published as late as 1925. He was elected a Foreign Member of our Linnean Society in 1897.

F. E. FRITSCH.

FREDERICK WILLIAM PAYNE

(1852–1927).

THE death of Mr. Frederick William Payne on Easter Sunday marked the close of a busy useful life, in which the study of Natural History occupied the leisure. He was educated at the Brighton Grammar School, where he became a teacher at the age of 15, working at the same time for a London University B.A. degree, which he obtained in 1871. In 1873 he was appointed Science Master at the School, and three years later a Junior Master at the City of London School, on the staff of which he continued until 1919, when he retired after 42 years' service. From 1907 till 1917 he acted as Hon. Sec. of the legal sub-committee of the Assistant Masters' Association. For some years all his holidays were devoted to botanical excursions, then he became specially interested in diatoms, his collection of which he arranged according to Van Heurck's system. He kept a record of the number of slides

mounted each year, and his collection at his death contained more than 6000 slides. Mr. Payne had attained very considerable skill in mounting diatoms; by manipulation he was able to show an individual species in several points of view, a great advantage for the student as compared with the ordinary "strewn" slide, in which a given species has to be located among a crowd of others. After his retirement from the City of London School he was a frequent visitor to the Cryptogamic Department of the Natural History Museum until about a year ago, when his health broke down. He was an extremely careful worker. His paper on *Liostephania* and its allies, illustrated by seventy-seven original figures, and published independently, was a useful piece of work, and in his two subsequent papers he was able to correct errors of interpretation by previous workers.

It is to be regretted that the interest in diatoms is at present so restricted, in view of their importance as constituents of plankton, and also as affording trustworthy material for study of variation where they occur in deposits of great thickness and representing considerable passage of time. The diatoms deserve higher consideration than mere objects of great variety and beauty as seen under the microscope. We can ill afford the loss of a careful and devoted worker, in whom some also have missed a helpful and respected, albeit unassuming, friend.

We are indebted to his widow, Mrs. M. Payne, for the facts of his life referred to above.

A list of his papers follows:—

"*Liostephania* and its Allies." With 77 original figures, pp. 30, 4 pls. Wheldon & Wesley, London, 1922.

"*Coscinodiscus blandus* A. Schm. Atlas, pl. 59, fig. 35"; "Nuova Notarisia," ser. 36, 1925, pp. 29-30.

"Notes on Diatoms, No. 3 *." *Distylum trigonum* Bail., *D. inaequale* Bail., *Triceratium (Distylum) Sol H. v. H.*" Journ. Bot. 1925, pp. 256-62, 3 figs.

A. B. R.

ABSTRACTS OF PAPERS OF INTEREST TO STUDENTS OF THE BRITISH FLORA.

QUERCUS SESSILIFLORA IN SUTTON PARK (Proc. Birmingham Nat. Hist. & Phil. Soc. xv. 106 (1926)).—Mr. H. H. Bloomer writes that a recent examination of the oaks of Sutton Park has revealed that *Q. sessiliflora* is to be found there. This is particularly interesting, because, since Bagnall's *Flora of Warwickshire* was published in 1891, it has generally been assumed that *Q. Robur* is the only species in the park, and the nearest place to this locality in which *Q. sessiliflora*, a rare and local species of the county, is recorded, is close to Coleshill. In the older part of Streetly Wood are many large trees, some being *Q. sessiliflora* and some *Q. Robur*. The two

* The two previous papers constitute notes No. 1 and No. 2.

species are found growing close to each other, so that *Q. sessiliflora* cannot be considered a recent introduction.—E. G. B.

RECORDS OF CUMBERLAND *SPHAGNA* (*North-Western Naturalist*, i. 83-84 (1926)).—The gatherings have nearly all been examined by Mr. W. R. Sherrin. Amongst other records we note:—

S. plumulosum Roll. Oulton Moss, near Wigton. Var. *viride* Warnst., Orton Common; var. *purpureum* Warnst., on High Pike, at 1500 feet; var. *versicolor* Warnst., Orton Common, and form *validum* Warnst., edge of Wastwater Lake, foot of Carrock Fell, and in a hollow in the sand-hills just south of Seascale.

S. molle Sull. Kingmore Nature Reserve, near Carlisle.

S. crassicaudum Warnst. var. *diversifolium* Warnst., foot of High Pike; var. *intermedium* Warnst., near form *lancoletum* Warnst., on west side of Corney Fell in South Cumberland.

S. medium Linpr. and its var. *versicolor* Warnst., on Oulton Moss.—E. G. B.

ONOBRYCHIS GENERIS REVISIO CRITICA (*Publications de la Faculté des Sciences de L'Université Masaryk*. Edited by Bohuslav Hostinsky, Parts 1-3, with 9 plates (1925-26)).—Dr. G. Sirjaev has made a critical revision of the genus *Onobrychis*, of which he recognizes 126 species. It is a valuable contribution to our knowledge of the subject, but there is only one species in Britain, formerly known as *O. sativa*, the common sainfoin, now called *O. viciaefolia* Scopoli. This the author regards as introduced in Britain. Various synonyms are given, and numerous good plates are quoted, among these being:—Sturm, *Flora*, v. t. ix.; Jacq. *Fl. Austr.* iv. tab. 352; Beck in Rechb. *Icon. Germ. et Helv.* xxii. t. mmecli. f. 1, 2, 1-15.—E. G. B.

THE SYSTEMATIC VALUE OF THE TRICHOME OF THE HUNGARIAN SPECIES AND HYBRIDS OF *VERBASCUM* (*Botanikai Közlemények*, xxii. 4-15, 2 figures (Buda-Pest, 1925)).—There is, fortunately, a German *résumé* of this interesting paper by Boros Adám on *Verbascum* species and hybrids. The species are grouped into: I. *Simpliciterichomatosa*, and II. *Astrotrichomatosa*. The hybrids are arranged in three subdivisions:—

A. Hybrids between two species of Group I.

B. Hybrids between a species of Group I. and a species of Group II.

C. Hybrids between two species of Group II.

Twenty-three hybrids are mentioned, but we refer only to those with British parents. There are no British representatives of subdivision A. In B we have *V. Blattaria* × *nigrum* (*V. intermedium* Rupr.). In C there are: *V. Lychnitis* × *nigrum* (*V. Schiedeanum* Koch), and *V. nigrum* × *Thapsus* (*V. collinum* Schrad.); the trichome of both of these is figured.—E. G. B.

'THE IRISH NATURALISTS' JOURNAL,' Jan. 1927, i. No. 9, 188, contains an interesting note upon *Serratula tinctoria* by R. A. Phillips (first reported in the same Journal, March 1926), who states

that it is quite native on rocks by edge of River Barrow, near New Ross, Co. Wexford. Not recorded for Ireland in Praeger's *Topographical Botany* or Babington's *Manual of British Botany*, ed. 10.
C. E. S.

REVIEWS.

Catalogue of the Trees and Shrubs at Westonbirt. By A. BRUCE JACKSON, A.L.S. 4to, pp. xii, 206, 2 portraits and 66 pls. University Press, Oxford, 1927. Price £4 4s. 0d. net.

THIS beautifully-produced contribution to the literature of arboriculture is a catalogue of the trees and shrubs in the collection of the late Sir George Lindsay Holford, at Westonbirt, which stands on a plateau of the Cotswolds, 350-400 ft. above sea-level.

The arboretum was founded by Mr. R. S. Holford (1808-1892), who converted an area of about one hundred acres of sandy loam consisting of arable fields sparsely clothed with hedgerow elm, oak, and thorn, into plantations with an almost endless variety of conifers and deciduous trees. The original plan was enlarged by cutting a broad drive through the adjoining woodland of 400 acres, on each side of which were planted rare and interesting trees and shrubs; the work was continued by the son, who inherited his father's taste for planting as well as the power of visualizing the ultimate result of the work. Mr. Jackson remarks that the charm of Westonbirt lies not so much in the number of species represented and in the beauty and symmetry of the individual specimens, as in the skilful manner in which evergreens have been used as a background, so that each plant or plant-group stands in a perfect setting. Sir George Holford succeeded his father in 1892, and for nearly a century tree-planting has gone on at Westonbirt almost uninterruptedly, with the result that the visitor may wander over five hundred acres of arboretum and woodland and find at every few steps a new tree to admire.

The arrangement of the text is alphabetical according to the Latin name of the species, beginning with *Abelia grandiflora* and closing with *Zelkova crenata*. The names adopted are mostly those of the Kew Hand-lists; the English or popular name is added when such is in common use, and occasionally synonyms are quoted; the native home of the plant and references to standard works on trees and shrubs are also given. The position or positions of the plants in the arboretum, pleasure grounds, or wood (Silkwood) are indicated, and notes on size, year of introduction, and other points of interest are added. No estimate is given of the number of species included, but it must be somewhere about eight hundred.

The catalogue will form an interesting record for the period concerned of trees and shrubs in cultivation in the south of England, and the very beautiful plates, reproductions of photographs of individual specimens or groups, add greatly to its value; the authorship of the photographs is not stated, but we understand that they were the work of the late Mr. Malby.

Mr. A. B. Jackson's name as compiler should be a guarantee of careful and critical work; and it is to be regretted that Sir George Holford, to whose help and encouragement the compiler pays tribute, did not live to see the book completed. Sir George was unmarried, and therefore leaves no son to carry on the traditions of this valuable collection, which, we trust, will not be allowed to become derelict.

The Ferns (Filicales) treated comparatively with a View to their Natural Classification. Volume II. *The Eusporangiate and other Relatively Primitive Ferns.* By F. O. BOWER, Sc.D., LL.D., F.R.S. Royal 8vo. Pp. i-v, & 1-344, 1 plate; figs. 310-580, 4 maps and diagram. Cambridge University Press, 1926. Price 30s. net.

THE introduction to this volume is a summary of the contents of Vol. I. (1923), which presented an analytical examination of the criteria of comparison to be used in the investigation of the evolutionary relationships of ferns. The result of that study was that twelve leading characteristics of ferns were selected, and briefly they comprise the following:—external morphology; apical segmentation; structure of frond; vascular system; dermal appendages; position and structure of sorus; indusium; sporangium; spore-output; prothallus; sexual organs; embryology. The variations of these criteria were checked by the fossil record, to settle what is primitive, what is derivative.

In Chapters XVIII.-XXV. of the present volume, the following families are discussed in detail:—Cœnopteridaceæ, Ophioglossaceæ, Marattiaceæ, Osmundaceæ, Schizæaceæ, Marsileaceæ, Gleicheniaceæ, Matoniaceæ. They are then summed up in a general review of the Simplicies (Chapter XXVI.). The Simplicies are characterized by the production of rather large sporangia, which both originate and mature at the same times in the sorus; and the physiological drain of spore-bearing falls simultaneously upon the pinna or upon the whole frond, this being regarded as a simple and primitive condition. The Simplicies include all the living Eusporangiate ferns. The Cœnopteridaceæ are known as fossils only, and are characteristic of the Palæozoic period, one section of them, the Botryopteridæ, being the most primitive ferns as yet recognized, while the Zygopteridæ were more elaborate in their development; and to them are related the Ophioglossaceæ, of which, however, no fossil records have so far been found. The Marattiaceæ probably date back to the Upper Carboniferous and Permian; they are typically Eusporangiate, bearing sporangia in primitive sori (often synangial) on primitive fronds. The Osmundaceæ date from the Permian period, and are held to be the nearest representatives of a central stock, from which many of the Leptosporangiate may have originated. In this family are two ancient genera which prefigure the two lines of evolution followed by the later ferns; *Osmunda* bears its sporangia normally in marginal tassels on narrow pinnae, while *Todea* bears them on the lower surface of expanded pinnae. The equally ancient families of the Schizæaceæ

and the Gleicheniaceæ bear marginal and superficial sori respectively; and to them are related more or less directly the two main sequences of the Leptosporangiate ferns, the Marginales and the Superficiales. The marginal was probably the original position for the sorus for all ferns, whereas the superficial position would seem to have been acquired as a consequence of the broadening of the frond-surface. In some families the superficial position was attained in Palæozoic time, and has remained constant ever since; in others the marginal position has been retained with great constancy. The author insists upon the great importance of this distinction, which characterizes the main lines of parallel progression exhibited by the later ferns.

In Chapters XXVII.-XXXIV. certain families are studied which, while much recalling the Simplices, show more advancement in the sum of their characters, but fall short of the full development found in the Leptosporangiatæ. They hold an intermediate position; and many of them are characterized by having a Gradate sorus, either marginal or superficial; the sporangia are smaller than in the Simplices, the spore-output smaller and spread over a longer period. These families are mostly of Mesozoic types, and indicate the progenitors of the modern Leptosporangiate ferns. They comprise several distinct families which on the sum of their characters range themselves either with the Schizæaceæ (Hymenophyllaceæ, Loxsomaceæ, Dicksoniaceæ) or with the Gleicheniaceæ (Protocyatheaceæ, Cyatheaceæ, Dipteridaceæ). The Plagiogyriaceæ may represent an early offshoot from Osmundaceæ, having points in common with *Todea*. The Dicksoniaceæ are abundantly distinct from the Cyatheaceæ, with which they have been grouped in the past on the score of a dendroid habit.

Some readers may be surprised to find the Marsileaceæ included in the Simplices; but D. H. Campbell's investigations of the family seem to show that it has a real relationship to the Schizæaceæ in structure, though differing so markedly in its heterospory and in its aquatic habit. The early geological history of *Marsilea* is unknown.

Professor Bower has given us in this volume the results of prolonged thought and investigation, which should be of the greatest value to pteridologists and should stimulate students to join in the search for a really natural and satisfactory classification of the Ferns.

The third volume, on which the author is now engaged, will be concerned with the Leptosporangiatæ, and is awaited with much interest.

A. G.

BOOK-NOTES, NEWS, ETC.

LINNEAN SOCIETY OF LONDON.—At the general meeting on April 7th, Professor J. Percival gave an account, illustrated with lantern-slides, of the species and races of wheat and their relationships. Prof. Percival has devoted many years to the study of the literature of the subject as well as to the species and races of wheat which are known at the present day, a very large proportion of which he has cultivated in the experimental grounds of the Department of Agriculture at Reading.

At the meeting on April 28th, Miss M. A. Pocock, who was also elected a Fellow, gave an account of a trip, made by herself and another lady, across Western Africa, passing from the Zambesi through Angola; the scenery and vegetation were illustrated by a number of beautiful lantern-slides. Dr. Hugh Scott gave a narrative, similarly illustrated, of his recent expedition to the highlands of Central Abyssinia. The fauna and flora are of peculiar interest, in that they are those of a large, well-watered, elevated country in the heart of Africa, isolated from surrounding regions by low-lying desert or semi-desert tracts; and that they exhibit a remarkable blend of Palæarctic, Ethiopian, and Oriental elements. The Expedition set out from Addis Ababa, the capital, at over 8000 feet above sea-level, and, by trekking with a mule caravan and camping during many weeks, several very different types of country, lying at elevations between 5500 and 12,000 feet, were visited. These included the primeval forest of Djem-Djem, composed mainly of giant juniper-trees; Mount Zuquála, an extinct volcano with a lake in its crater, and covered with giant heath and other interesting vegetation; the plains southwards to Lake Zwai, a region of dry bush and thorn-scrub; the park-like country, forest, and heath-land of Mount Chillálo; and the Muger Valley, a great chasm more than 2000 feet deep, with precipitous sides. The lantern-slides illustrated the different kinds of country and vegetation (especially the curious mixture of temperate and distinctly African plants frequently met with), as well as some aspects of the human life of Abyssinia.

At the meeting on May 12, the President read a letter from Mr. W. Coldstream, formerly of the Indian Civil Service, giving growth-measurements of several specimens of *Eucalyptus tereticornis* Sm. planted by him in various parts of the Punjab fifty years ago.

The Botanical Secretary exhibited, on behalf of Dr. W. Watson, A.L.S., some abnormal specimens of *Stellaria Holostea* L., from Milverton, W. Somerset. All the flowers were green, and any stamens or carpels present showed leaf-like characters. Many of the flowers consisted merely of sepal-like bodies, with buds in their axils. The three carpels, instead of being joined, were separate, and showed transitions to sepal-like bodies.

The Botanical Secretary also showed several copies of 'The Balkan News' of 1918, the paper published for H.M. Salonica Forces, containing articles on the collection of plants in Macedonia and on the competitions organised for fostering the interest of the troops in the vegetation of that country.

Mr. James Groves read a paper on "Charophyta from Madagascar," in which a number of new species were described from the collections of Mr. T. B. Blow. Mr. Blow gave a brief account of his observations, proving that the alleged larvicidal qualities of the Charophyta were non-existent.

Mr. T. A. Sprague and Mr. V. S. Summerhayes communicated the results of their critical work on the limitations of a genus of Santalaceæ, *Eusanus* R. Br., and showed reason for recognising as of

generic value the two sections into which the genus had previously been divided. The identity of the Juan Fernandez species was also cleared up.

At the Anniversary Meeting on May 24, Sir Sidney F. Harmer K.B.E., F.R.S., was elected President in place of Dr. A. B. Rendle, who retired after four years' service. Dr. E. J. Collins and Miss G. Lister were elected Members of Council in place of retiring Councillors, Mr. E. A. Bunyard and Dr. B. D. Jackson.

In his Presidential Address, Dr. Rendle announced an arrangement which had just been concluded with the Central Library, financed by the Carnegie Trust, by which, in return for a substantial grant of money from the Trust towards its Library, the Society becomes an Outlier branch of the Central Library. Under the arrangement the Central Library has the privilege of borrowing books for the use of its members from the Linnean Society's Library, and in return members of the Society will be able to obtain the use of books from the Central Library, and through it from other societies which have already become outlier branches.

In presenting the Linnean Gold Medal to Dr. Otto Stapf, the President referred to the services of the recipient to botanical science during a period of nearly 50 years, and covering a wide range of botanical subjects. Dr. Stapf had also served the Society as a Councillor, and for seven years as Botanical Secretary.

After the meeting Fellows and their friends dined together at the Criterion Restaurant.

A CORRECTION.—*Sonerila ciliata*. My attention has just been called to the fact that in the *Journal of the Federated Malay States*, x. 92, the species I originally described as *Sonerila alata* has there been printed *S. ciliata* by a printer's error. The characteristic mark of the species is its winged stem, as is noted in the description. The name should stand *Sonerila alata*.—H. N. RIDLEY.

DR. G. CLARIDGE DRUCE, F.R.S.—Students of the British Flora will appreciate the honour done to their branch of science by the election of Dr. Druce to the Fellowship of the Royal Society. They will join with the Editor of this *Journal* in tendering their congratulations to the recipient on this recognition of his yeoman service to British floristic work.

MR. ANTONY GEPP.—Visitors and students who have been associated with the Cryptogamic Section of the Department of Botany, at the Natural History Museum, will hear with regret of the retirement of Mr. Gepp, on reaching the age-limit. Mr. Gepp joined the Staff of the Museum in January 1886, shortly after leaving Cambridge, where he graduated, from St. John's College, in the Natural Sciences Tripos. Students of the Ferns, Mosses, and Seaweeds will gratefully recall help received from Mr. Gepp during his period of service of more than 41 years, and will be glad to know that he is still to be found at the Museum, where he proposes to continue his work on the Ferns.

THE NOMENCLATURE OF THE GROUP
SALVIA VERBENACA L.

By H. W. PUGSLEY, B.A., F.L.S.

In 1908 I wrote in this *Journal* (xli. 97 sq.) a lengthy paper on the plants of this group, reviewing the numerous forms that had been distinguished and describing the peculiar polymorphism of the corolla that occurred in varying degree in all of them. The different ways in which the plants had been grouped was discussed, and the arrangement of the Abbé Coste's *Flore de France* (iii. 102) was adopted, subject, in view of the opinion of Dr. Briquet (*Labiées des Alpes Maritimes*, 490 sq.), to the reduction of Coste's three species, *Salvia clandestina* L., *S. Verbenaca* L., and *S. horminoides* Pourr., to the rank of subspecies. In accordance with this plan the common English clary and the Lizard *S. clandestina* were identified with *S. horminoides* and the Guernsey *S. clandestina* (*S. Marquandii* Druce) with *S. Verbenaca*, under which it was placed as a variety *oblongifolia*.

The following year Dr. Druce contributed a note to this *Journal* (xlvii. 87, 88) objecting to the identification of the common British *Salvia* with *S. horminoides* on the ground that it did not agree with a specimen from Pourret in Herb. Mus. Brit., and contending that his *S. Marquandii* could not be referred to a restricted *S. Verbenaca* or named var. *oblongifolia* Benth. My reply to this note was printed in the pages of the *Journal* immediately following it.

The difficulty of determining the affinities of these *Salvias* from their unequal and sometimes fragmentary representation in herbaria was pointed out in my original paper, as well as the desirability of seeing them growing in their natural habitats. With this in mind, in June 1914, I visited the Guernsey station for *S. Marquandii*, and saw it there in limited quantity. In the spring of 1922, during a holiday in Algeria, I found, *in situ*, the three species of this group recognised in Battandier and Trabut's *Flora* as *S. Verbenaca*, *S. clandestina*, and *S. lanigera*, the two last in several distinct habitats. And a French tour in the spring of 1925 enabled me to find the three species admitted by Coste. In passing from Avignon to the Pyrenees I spent a day at Narbonne to see *S. horminoides* in its classic locality.

In attempting to supplement and modify my paper of 1908, the first form for consideration is the *S. Verbenaca* of Linnæus. This is briefly diagnosed (Sp. Pl. 25 & ed. ii. 35) without description, but with several citations, including two, with figures, from Barrelier and Triumfetti. There are two specimens of *S. Verbenaca* in the Linnean Herbarium, annotated by Linnæus himself; and the species was shown as existing in his herbarium when his earliest list was compiled (1753). These specimens do not disagree with the text of *Species Plantarum*, and clearly resemble the two figures cited there, as already shown (Journ. Bot. xli. 98). They must therefore be regarded as the specific type, although it is clear from the citations

generic value the two sections into which the genus had previously been divided. The identity of the Juanan Fernandez species was also cleared up.

At the Anniversary Meeting on May 24, Sir Sidney F. Harmer K.B.E., F.R.S., was elected President in place of Dr. A. B. Rendle, who retired after four years' service. Dr. E. J. Collins and Miss G. Lister were elected Members of Council in place of retiring Councillors, Mr. E. A. Bunyard and Dr. B. D. Jackson.

In his Presidential Address, Dr. Rendle announced an arrangement which had just been concluded with the Central Library, financed by the Carnegie Trust, by which, in return for a substantial grant of money from the Trust towards its Library, the Society becomes an Outlier branch of the Central Library. Under the arrangement the Central Library has the privilege of borrowing books for the use of its members from the Linnean Society's Library, and in return members of the Society will be able to obtain the use of books from the Central Library, and through it from other societies which have already become outlier branches.

In presenting the Linnean Gold Medal to Dr. Otto Stapf, the President referred to the services of the recipient to botanical science during a period of nearly 50 years, and covering a wide range of botanical subjects. Dr. Stapf had also served the Society as a Councillor, and for seven years as Botanical Secretary.

After the meeting Fellows and their friends dined together at the Criterion Restaurant.

A CORRECTION.—*Sonerila ciliata*. My attention has just been called to the fact that in the *Journal of the Federated Malay States*, x. 92, the species I originally described as *So. Sonerila alata* has there been printed *S. ciliata* by a printer's error. The characteristic mark of the species is its winged stem, as is noted in the description. The name should stand *Sonerila alata*.—H. N. N. RIDLEY.

DR. G. CLARIDGE DRUCE, F.R.S.—Students of the British Flora will appreciate the honour done to their branch of science by the election of Dr. Druce to the Fellowship of the Royal Society. They will join with the Editor of this *Journal* in tendering their congratulations to the recipient on this recognition of his yeoman service to British floristic work.

MR. ANTONY GEPP.—Visitors and students who have been associated with the Cryptogamic Section of the Department of Botany, at the Natural History Museum, will hear with regret of the retirement of Mr. Gepp, on reaching the age-limit. Mr. Gepp joined the Staff of the Museum in January 1886, shortly after leaving Cambridge, where he graduated, from St. John's College, in the Natural Sciences Tripos. Students of the Ferns, Mosses, and Seaweeds will gratefully recall help received from Mr. G. Gepp during his period of service of more than 41 years, and will be glad to know that he is still to be found at the Museum, where he proposes to continue his work on the Ferns.

THE NOMENCLATURE OF THE GROUP *SALVIA VERBENACA* L.

By H. W. PUGSLEY, B.A., F.L.S.

IN 1908 I wrote in this *Journal* (xvi. 97 sq.) a lengthy paper on the plants of this group, reviewing the numerous forms that had been distinguished and describing the peculiar polymorphism of the corolla that occurred in varying degree in all of them. The different ways in which the plants had been grouped were discussed, and the arrangement of the Abbé Coste's *Flore de France* (iii. 102) was adopted, subject, in view of the opinion of Dr. Briquet (*Labies des Alpes Maritimes*, 490 sq.), to the reduction of Coste's three species, *Salvia clandestina* L., *S. Verbenaca* L., and *S. horminoides* Pourr., to the rank of subspecies. In accordance with this plan the common English clary and the Lizard *S. clandestina* were identified with *S. horminoides* and the Guernsey *S. clandestina* (*S. Marquandii* Druce) with *S. Verbenaca*, under which it was placed as a variety *oblongifolia*.

The following year Dr. Druce contributed a note to this *Journal* (xvii. 87, 88) objecting to the identification of the common British *Salvia* with *S. horminoides* on the ground that it did not agree with a specimen from Pourret in Herb. Mus. Brit., and contending that his *S. Marquandii* could not be referred to a restricted *S. Verbenaca* or named var. *oblongifolia* Benth. My reply to this note was printed in the pages of the *Journal* immediately following it.

The difficulty of determining the affinities of these *Salvias* from their unequal and sometimes fragmentary representation in herbaria was pointed out in my original paper, as well as the desirability of seeing them growing in their natural habitats. With this in mind, in June 1914, I visited the Guernsey station for *S. Marquandii*, and saw it there in limited quantity. In the spring of 1922, during a holiday in Algeria, I found, *in situ*, the three species of this group recognised in Battandier and Trabut's *Flora* as *S. Verbenaca*, *S. clandestina*, and *S. lanigera*, the two last in several distinct habitats. And a French tour in the spring of 1925 enabled me to find the three species admitted by Coste. In passing from Avignon to the Pyrenees I spent a day at Narbonne to see *S. horminoides* in its classic locality.

In attempting to supplement and modify my paper of 1908, the first form for consideration is the *S. Verbenaca* of Linnæus. This is briefly diagnosed (Sp. Pl. 25 & ed. ii. 35) without description, but with several citations, including two, with figures, from Barrelier and Triumfetti. There are two specimens of *S. Verbenaca* in the Linnean Herbarium, annotated by Linnæus himself; and the species was shown as existing in his herbarium when his earliest list was compiled (1753). These specimens do not disagree with the text of *Species Plantarum*, and clearly resemble the two figures cited there, as already shown (Journ. Bot. xvi. 98). They must therefore be regarded as the specific type, although it is clear from the citations

JOURNAL OF BOTANY.—VOL. 65. [JULY, 1927.] o

that the name, as understood by Linnæus, really covered other allied forms. Of these specimens, which were both cultivated in the Upsala garden and are of unknown origin, the first bears very small flowers, with relatively fair-sized corollas, and shows no fruiting calyces. It is a slender plant, with narrow, sinuate, and crenate leaves, even the uppermost pair being but little broader. The second specimen, which was first named "*clandestina*" in Linnæus's handwriting and subsequently corrected, shows no flowers but good fruiting calyces of average size, and its narrow leaves are more deeply divided than those of the other. It was evidently collected at a later stage, and it seems possible, in spite of the different foliage, that the two specimens may have been taken from the same plant. The essential features of both are the relatively slender habit, narrow leaves throughout, and lax racemes of flowers. The calyx shows long straight teeth in the lower lip, and is clothed with pilose and glandular hairs. The exact colouring of the corolla in the first specimen is indeterminable, and its apparently intermediate form is of little taxonomic importance in view of the polymorphism of this organ throughout the group.

It is to *S. Verbenaca* L., of which this slender narrow-leaved plant is the type, that Dr. Druce wished (Journ. Bot. xvii. 88) to refer the common British clary, while retaining his *S. Marquandii* as a separate species. The former plant will be dealt with later under *S. horminoides*.

The similarity of *S. Marquandii* to Linnæus's type of *S. Verbenaca* is shown in Journ. Bot. xvi. 148-150, and in the same paper (*l. c.* 98, 142) the reasons for adopting Coste's view of a restricted *S. Verbenaca* agreeing with this type are also set forth. I did not then mention that this view had already been taken in Loret and Barrandon's *Flore de Montpellier*, ed. 2, 382-3 (1886), and still earlier (1870) by E. Timbal-Lagrave in a detailed account of these plants (Mém. Acad. Science de Toulouse, 7e série, ii. 228-241).

S. Verbenaca L., thus restricted, is extremely near to, if not identical with, the blue-flowered form of *S. pallidiflora* St. Amans (Fl. Agenaise, 10 (1821)). The author's description is ambiguous and appears to include two plants, but according to Timbal-Lagrave the chief difference from *S. Verbenaca* lies in the more deeply-cut leaves and larger corollas of *S. pallidiflora*. Timbal-Lagrave also thought the calyx of *S. pallidiflora* to be eglandular, but Jordan and Fourreau (Icones Fl. Eur. ii. 17) show it with glandular hairs (under *Gallitrichum pallidiflorum*) and mention this feature in their text; and stalked glands appear to be sparingly present in dried specimens from the *locus classicus* (Billot, no. 1296). After examining a large number of specimens, I am led to the belief that the development of stalked glands, both on the calyx and the upper part of the stem, is variable throughout the group and largely influenced by environment, although these glands certainly exist in greater abundance on an average in some forms than in others. In 1925, at one spot at Carcassone, I met with a fair quantity of a plant, producing no glandular hairs on the calyx or inflorescence, and

many large concolorous corollas, which would have been named *S. pallidiflora* by Timbal-Lagrave. A little later, at Collioure, to the south of Perpignan, I collected a form with both calyx and inflorescence densely glandular, but otherwise like the Carcassone plant; and at Castel Rousillon another similar form was growing, which differed only in its more deeply divided leaves. The Guernsey plant (*S. Marquandii*), as seen in different years, is also variable in glandular development, but I have seen no entirely eglandular examples.

In my paper of 1908 (*l. c.* 150) *S. Marquandii* is referred, on account of its leaf-cutting, to a var. *oblongifolia* Benth. (of *S. Verbenaca*), which is based on *S. oblongata* Vahl. Of Vahl's plant I have seen no authentic specimen, and it is evident from the further material examined that the Guernsey plant, as well as *S. pallidiflora* at Agen and other French forms, exhibits a considerable range of variation in foliage just as in glandular development. While some cultivated examples of *S. Marquandii* almost exactly match the first sheet of *S. Verbenaca* in the Linnean Herbarium, wild specimens can be found agreeing with *S. pallidiflora* from Agen, as represented by Billot, No. 1296, or with examples of *S. Verbenaca* from Toulouse or from Spain. There appears to be no stable character by which these plants can be separated, and it therefore seems best to regard both *S. pallidiflora* and *S. Marquandii* as forms or states of true *S. Verbenaca* L., varying in leaf-cutting and glandular development, and to drop Bentham's varietal name for the Guernsey plant. A *Salvia* which, though falling under restricted *S. Verbenaca*, seems really to differ from the above-mentioned forms, and is perhaps true *S. oblongata* Vahl, was found in 1925 near Puycedra, across the Spanish frontier.

A feature, seemingly unnoticed hitherto, distinguishing all of these true *Verbenaca*-forms, is the colouring of the flower, which is of a less pure blue than in the other members of the group. This may be seen in the coloured suffusion of the calyx, which is generally of a dull pinkish purple when dried, instead of dark blue, and in the dried corolla, which becomes distinctly violet in hue. This character is equally visible in *S. Verbenaca* from France or Spain, in *S. pallidiflora* from Agen, and in *S. Marquandii* from Guernsey.

The figure of *Gallitrichum pallidiflorum* in Jordan and Fourreau's *Icones* depicts a robust plant of much-branched habit, like the other species of *Gallitrichum*, with foliage more deeply cut than in the specimens of *S. pallidiflora* seen from Agen. It is quite likely that such foliage occurs in this plant, but as all of the forms figured in this work are shown with abundant, uniformly proterandrous corollas, and the polymorphism of this organ has apparently escaped observation, the general accuracy of the descriptions and finely-produced plates cannot be assumed with much confidence.

The geographical distribution of this *S. Verbenaca* L., *sensu stricto*, remains for comment. According to Coste, its range is "tout le bassin méditerranéen," and midi, ouest, centre, and Corsica are given for France. In Herb. Mus. Brit. *S. Verbenaca* is not as well

represented from Italy and Eastern Europe as is *S. multifida*, but there are a number of French examples. It is found near Avignon (Billot, No. 1945). Loret and Barrandon record it as growing about Montpellier, and Timbal-Lagrange states that it is common near Toulouse, whence there are specimens in the National Collection. It is also to be found at Carcassone, Perpignan, Agen, and probably many other localities in the south-west of France, and from its being recorded also for the west and centre of France (*Coste*) it is not surprising that it should extend as far as Guernsey. Spanish material resembling this plant needs careful comparison with *S. verbenacoides* Brotero, but herbarium specimens such as Willkomm, Iter. hisp. sec. 238, Navarre, is typical *S. Verbenaca*, and this was collected in three Spanish localities last year by Mr. Wilmott. It also occurs in the Canaries (Bourgeau, Pl. Canar. No. 550). In Sp. Plant. ed. 1, Linnæus states of *S. Verbenaca* "Habitat in Europæ pascuis," to which "et orientis" is added in the second edition. This addition is perhaps placed inadvertently under *S. Verbenaca* instead of *S. clandestina*, one of Linnæus's sheets of the latter plant, received after 1753, being annotated as from Forskal "ex Arabia," which is not given as a habitat under *S. clandestina*.

Turning to *S. clandestina* L., an interesting question arises as to the correct application of the name. In the *Flora Græca* Sibthorp and Smith describe under it the plant since known as *S. controversa* Ten. or *S. lanigera* Poiret, but Bentham (*Labiatarum Genera*, etc.) referred it to the *S. multifida* of the *Flora Græca*, and has been commonly followed by later authors.

The earliest account of *S. clandestina* appears in Linnæus's handwriting on the interleaving of one of his copies of Sp. Plant. (ed. 1), and this was printed in the second edition (p. 36) with the habitat "Romæ" changed to "In Italia."

The full diagnosis, synonymy, and description are:—

"S. foliis serratis pinnatifidis rugosissimis, spica obtusa, corollis calyce angustioribus.

"Horminum sylvestre, inciso folio, cæsis flore, italicum. Barr. Rar. 24, t. 220.

"Habitat in Italia, ♂.

"Caules tetragoni, obtusi, villosi, adscendentes, spithamæ: ramis supernis sæpius duobus. Folia oblonga, pinnato-sinuata, rugosissima, crenata, obtusa, petiolata, in caule 2. s. 3. paribus. Spica truncata, verticillis remotis. Bracteæ cordatæ, trifloræ. Calyces pilis glutinosis, labio superiore plicato. Corolla violacea, vix calyce duplo longior: labii inferioris medio lobo albo."

And there is a marginal note written by Linnæus in one of his copies: "Folia omnino *S. ceratophyllæ* sed parva: verbo herba *S. Verbenacæ* foliis *S. ceratophyllæ*."

The citation from Barrelier is struck out in pencil in this copy and marked in Sir J. E. Smith's hand "non est (Sibthorp)."

The two specimens of *S. clandestina* in the Linnean Herbarium evidently belong to one species, although the second one (Forskal, ex Arabia) is only in bud. They are both written up by Linnæus

himself, and the name *S. clandestina* is duly included in the third list of his herbarium (1767). The first sheet received "ex horto Gotttingensi" shows a good though small specimen, with well-developed foliage and inflorescence. It has not been disputed, I think, that these two specimens are identical with *S. controversa* Ten.

The explanation of the divergent views of Sibthorp and Smith, and of Bentham, appears to be that the former considered that Linnæus's description agreed with his specimens, and that the Barrelier citation was erroneous, while Bentham thought that the description and citation accorded, and the specimens belonged to a different plant. Smith, in the text of the *Flora Græca*, remarks that Sibthorp had long since pointed out that the Barrelier citation did not refer to the plant of Linnæus, but Bentham (*op. cit.*) does not offer any reason in support of his converse arrangement. He takes up the name of "*S. clandestina* L., Sp. Pl. 36, non ejusdem herb." for the *S. multifida* of Sibthorp and Smith, Fl. Græc. i. 17, and his next species is *S. controversa* Ten. (*S. clandestina* Linn. Herb. non ejusd. Sp. Pl. 36).

A comparison of Linnæus's diagnosis and description of *S. clandestina* with actual specimens of *S. controversa* and *S. multifida* shows, I think, that the plant he was dealing with was the former, which was represented in his herbarium. His account was based on his herbarium material, for while all of its details accord with *S. controversa*, some of them could not possibly be applied to *S. multifida*. The stems of *S. multifida* are not villous, while those of *S. controversa* are so. The oblong pinnate-sinuate foliage is that of *S. controversa* rather than the other, and the term "rugosissima," in contrast to which "læviscula" was inserted in the second edition of Sp. Plant. under *S. Verbenaca*, refers clearly to the specimens of *S. clandestina* in the Linnean Herbarium, in contrast to which the leaves of Linnæus's cultivated examples of *S. Verbenaca* are relatively smooth. The leaves of *S. multifida* are not more rugose than those of *S. Verbenaca*. This rugosity of the foliage is, of course, a variable factor in all of these plants, but it is more generally marked in *S. controversa* than in the other forms, owing probably to the nature of the habitats; and it is conspicuous in Linnæus's own specimens. The "verticillis remotis" of the spikes, too, accords better with *S. controversa*, as does also Linnæus's manuscript comparison with *S. ceratophylla*. The citation of Barrelier (Icon. 220) appears due to Linnæus assuming that this figure represented the *S. clandestina* of his herbarium, which he might easily do, seeing that *S. multifida* was unknown to him.

The habitat given by Linnæus for *S. clandestina*, "Italia," is really correct for both plants, *S. controversa* having been originally described from Calabria. But there is no evidence that this was known to Linnæus. His original manuscript locality was "Romæ," taken no doubt from Barrelier, and this was perhaps extended to "Italia" simply on general grounds. I can find no clue to the source of Linnæus's Gottingen specimen, and, as mentioned above, the locality of the plant from Forskal, "ex orientis," appears to have been placed under *S. Verbenaca* through inadvertence.

From all these considerations it seems clear that the view of Sibthorp and Smith is the more correct one, and that the name *S. clandestina* L. Sp. Pl. ii. 36 (excl. syn.) should be applied to *S. controversa* Ten., the Linnean specimens being regarded as the type. *S. controversa* was identified by Tenore (Syll. Fl. Neap. 18 (1831)) with *S. clandestina* Sibth. & Sm. Fl. Græc. i. 18, tab. 24, excl. syn., non Linn. Sp. Pl.

The geographical range of *S. clandestina*, as thus understood, is more southern and eastern than that of the other members of the group. It is reported to occur on the French Riviera (*Briquet*), and grows in Calabria (*Tenore*), extending eastwards to Cyprus (*Sibthorp*), Egypt and Arabia (*Forsk.*). Battandier and Trabut report it for the Hauts-Plateaux region of Algeria, where I collected it in 1922, both at Batna and Tingad, as well as at Elkantara, on the edge of the desert.

If *S. clandestina* L. is interpreted as above, it remains to deal with the plant to which Bentham referred this name, the *S. multifida* of Sibthorp and Smith. This is described (Prodr. Fl. Græc. 16 (1806)) thus:—

“Foliis cordatis multifidis incisibus glabris, caule folioso simplici, staminibus appendiculatis retusis.

“H. sylvestre inciso folio, cæcio flore, italicum. Barr. 220.

“Ic. Fl. Græc. t. 23.

“In pascuis circa Byzantium.”

The plate of the *Flora Græca* depicts a dwarf plant, with much cut leaves, which resembles the figure cited from Barrelier, but has a calyx essentially different from that obtaining throughout the *Verbenaca*-group. In consequence of this discrepancy, which was noticed by Bentham, it was suggested (Journ. Bot. xlv. 100) that the name *S. multifida* should be set aside as a *nomen ambiguum*. As Sibthorp's specimen from Constantinople, however, possesses the usual calyx of the group, and not that drawn in the plate, it may be supposed that a draughtsman's error has occurred here, and it may perhaps be best, while noting the mistake, to follow Bentham's example in not ignoring the name on this account.

The plant in question appears from the evidence of herbaria to be widely spread and fairly uniform. It is generally of dwarf habit, with the stem clothed with a very short pubescence below and abundantly glandular in the inflorescence. The leaves are usually, but not always, rather broad, and normally deeply sinuate or irregularly incised. The spike is relatively dense, with rather small but strongly pilose and glandular calyx, with the teeth of the lower lip shorter than in *S. Verbenaca*, and large proterandrous corolla of a light blue colour with the lower lip often white.

Salvia multifida Sibth. & Sm., however, is apparently not the earliest valid name for this plant, for *S. verbenacoides* Brotero, Fl. Lusit. i. 17 (1804), seems to be certainly conspecific. Brotero's description of his plant (*vide* Journ. Bot. xlv. 99) is meagre, and states that it is intermediate between *S. clandestina* and *S. Verbenaca*, or a variety of them. It is not clear how Brotero understood these

two names. There is good and uniform material of *S. verbenacoides* in Hb. Mus. Brit., which is probably authentic, *e. g.*:—Fl. Lusit. (Sec. Brot. 2 anno), No. 220, Coimbra; Welwitsch, Iter. Lusit. No. 411, Cacilhas; Fl. Lusit. Exsicc. No. 299, Coimbra; and this seems indistinguishable from *S. multifida*. If this is so, and if, with *S. multifida*, *S. verbenacoides* is held to constitute a distinct species, Brotero's name must be taken up to represent it, being two years earlier than that of Sibthorp and Smith.

Coste gives the range of this plant as the whole Mediterranean basin, and quotes Provence, Languedoc, and Rousillon for France. It is seemingly generally distributed and uniform in the Balkan Peninsula, common in Italy, and also (as *S. verbenacoides*) in Spain and Portugal. It extends too along North Africa, and is said to be common in Algeria. I met with it round Algiers, as well as at Tingad in the Hauts-Plateaux region, where it was growing with *S. clandestina* (*S. controversa*). The Madeiran *S. collina* Lowe also very closely resembles this plant.

In Battandier and Trabut's *Flore d'Algérie*, 688 (1888), *S. clandestina* L., as here understood, is named *S. lanigera* Poir., and *S. controversa* Ten. is taken to represent a rather tall and slender form, with narrow leaves having distant segments, which is nearer to *S. verbenacoides* Brot. This plant, of which there are good specimens in Hb. Mus. Brit., has the facies of a distinct form perhaps endemic in North Africa, which is closely allied to *S. verbenacoides*, but is separable at least as a variety. It is said to be very common in the Algerian coast region.

The first plant to be separated from *Salvia Verbenaca* after *S. clandestina* L. was the *S. horminoides* of Pourret (Mém. Acad. Toulouse, iii. 327 (1788)). This was treated at length in my paper of 1908, and identified (Journ. Bot. xlv. 146-148) with the common British clary, and a further discussion took place a year later (*l. c.* xlvii. 87-91).

Pourret's account runs thus:—

“Caulescens, foliis oblongis, repandis, crenatis: calycibus coloratis: corollæ labiis approximatis, longitudine aequalibus, pistillo incluso ♂. Cette espèce est commune aux environs de Narbonne et tient le milieu entre les *S. Verbenaca* L. et *S. virgata* Jacq.”

In 1788, when this was written, Pourret, being acquainted with the *Species Plantarum* of Linnæus, would identify *S. Verbenaca*, which was only briefly diagnosed, by the figure of Barrelier cited for it (No. 208) or that of Triumfetti. The region in which he botanised produced a plant that agreed with these plates, as well as another that he would probably identify with Barrelier's figure No. 220 and name *S. clandestina*. With a knowledge, therefore, of these two plants, he describes as new a third one, which he says is intermediate between *S. Verbenaca* (the taller of the two) and *S. virgata* Jacq., a much larger and coarser species. *S. horminoides* would thus be a larger plant than either *S. Verbenaca* or *S. clandestina*—a character indicated by Pourret's epithet “caulescens.” Had *S. Verbenaca*, as understood by Pourret, been the larger plant, he would not have

compared *S. horminoides* with *S. virgata*, but would have regarded it as intermediate between *S. Verbenaca* and *S. clandestina*. It must therefore be concluded that *S. horminoides* was the largest plant of the *Verbenaca*-group known to Pourret. As already pointed out (*l. c.* xlv. 142), not only the tall habit, but the spreading leaves, coloured calyx, and closed corolla, all point to a plant resembling the common British one. It is likely that the epithet "*horminoides*" was used by Pourret from the resemblance of his plant not to *S. Horminum* L., but to *Horminum pyrenaicum* L., which, when growing, curiously recalls a dwarf plant of *S. horminoides* with large flowers. This is mentioned by Bubani, and struck me immediately when in 1924 I first saw *Horminum pyrenaicum* growing in the Tyrol.

The view that *S. horminoides* is a relatively large and coarse plant, with dark flowers and mostly cleistogamous corollas, was set forth in detail, before the publication of Coste's work, by E. Timbal-Lagrange, in a paper "Variations des *Salvia pratensis* et *Verbenaca*" in *Mém. Acad. Toulouse*, 7e Série, ii. 241, and it is emphasized in Loret and Barrandon's *Fl. de Montpellier*, ed. 2, 382-3 (1886), where the two species are contrasted thus:—

"*S. Verbenaca* . . . corolle bleu . . . à lèvres plus ou moins inégales, un peu écartées, la supérieure un peu arquée au sommet seulement et dépassant le calice: style ordinairement plus longue que la corolle: feuilles oblongues: tiges grêles, de 2-3 décim.

"*S. horminoides* . . . corolle bleuâtre . . . très courte, à lèvres égales, rapprochées, style souvent incluse; feuilles oblongues-élargies, vertes; tige forte, parfois rougeâtre, de 4-6 décim. . . . floraison très tardive (mai)."

A note follows:—"Pour ce qui est du *S. horminoides* de Pourret, il a été prouvé depuis longtemps que ce n'est nullement celui de Godron et Grenier, et il devrait être rapporté, si on ne l'acceptait pas comme espèce, à celui que nous prenons pour le *S. Verbenaca* de Linné. La texte de l'abbé Pourret et l'habitat indiqué par lui ne laissent aucun doute à cet égard, ainsi que l'ont établi M. Bubani et les botanistes toulousains dont l'opinion est acceptée aujourd'hui par tous ceux qui ont étudié la question."

Bubani (*Fl. Pyrenæa*, i. 393 (1897)), who treats the plants of his district as falling under two species, *S. multifida* (including typical *S. Verbenaca* L.) and *S. verbenæfolia* (*S. horminoides*), remarks that in Pourret's herbarium at Madrid (as also at Paris) the name *S. horminoides* is not consistently used, and that Pourret, after applying it originally to the tall plant, with dark cleistogamous flowers, noted on one of his labels that he thought this plant to be true *S. Verbenaca*, and reversed his name accordingly. The majority of the existing specimens named by Pourret, however, are stated by Bubani to accord with his original account of *S. horminoides*, and the fact that he subsequently expressed a change of opinion on one of his herbarium tickets does not invalidate his earlier published name. Pourret's specimen of *S. horminoides* in *Hb. Mus. Brit.*, to which Dr. Druce drew attention, is fragmentary and cannot be surely identified, and, in view of Bubani's remarks on the *S. horminoides* of

Pourret's herbarium, it cannot be held to be in any sense a specific type. The example from Pourret in Allioni's herbarium, seen by Dr. Briquet, likewise appears to be inadequate, for Dr. Briquet remarks, in describing it, that Pourret probably included both broad- and narrow-leaved forms under his name.

As *S. horminoides* was stated by Pourret to be common around Narbonne, and is recorded as growing on the ramparts there, I devoted a day in May 1925 to a solution of its identity on the spot. Narbonne has extended greatly since Pourret's time, and the old ramparts are mostly pulled down. But one length still exists, converted into a small recreation ground. Here I found one species of *Salvia* growing freely; it was our British form. Just outside the town there are extensive railway-sidings and wastes, where flourished hundreds, perhaps thousands, of plants of this same *Salvia*. It is noteworthy that among this vast number of plants, nearly all of which were in flower, I saw no large proterandrous corollas. The flowers were, as described by Pourret, "*corollæ lobiis approximatis*." After a considerable search, I succeeded in finding on the sidings one solitary individual of another form—a coarse and somewhat abnormal state of true *S. Verbenaca* L. It is thus clear that the common *Salvia* of Narbonne at the present day is our British plant, just as was apparently the case in Pourret's time and half-a-century ago, when Timbal-Lagrange and other French botanists made their investigations. According to Bubani, however, two forms were abundant there in 1846.

In the case of *S. horminoides*, as of *S. Verbenaca*, a form with an extreme type of leaf-cutting was distinguished in my former paper as a variety. This was largely done under the influence of Dr. Briquet, who bases his arrangement of the group almost solely on such leaf-characters. With my present experience, however, I am no longer disposed to place so much reliance on the cutting of the foliage, as intimated above under *S. Verbenaca*. With our British *S. horminoides*, and perhaps with the other forms, the lobing of the earliest root-leaves, such as are seen in winter and early spring, is very much deeper than in the subsequent basal foliage visible at the time of flowering, and some circumspection is needed before depth of lobing can be regarded as a real character. The plate of *Gallitrichum anglicum* Jord. & Fourr., cited under the var. *incisum* in my paper (*l. c.* xlv. 145), shows foliage such as is often seen with ordinary French or British *S. horminoides*, and may be well transferred to the specific type of that plant; and *G. stereocaulon*, from Sicily, as well as *G. maculatum*, appears to be practically identical. These three plants are figured with an eglandular inflorescence, and my Narbonne specimens approach them in this respect, while in Britain the glandular character of the inflorescence is generally well marked. So, in this feature, as in the leaf-cutting, *S. horminoides*, like *S. Verbenaca*, is evidently variable.

The distribution of *S. horminoides*, according to Coste, is "*Europe méridionale*," and includes the midi, ouest, and centre of France. Its appearance in Britain is therefore not surprising. Timbal-Lagrange states that it is very common in south-western France, and in 1925

it was observed at Carcassone and abundantly in many places along the railway thence to Toulouse. It occurs also in Spain (*Sennen*, No. 4209, Barcelona) and extends to Eastern Europe. According to Battandier and Trabut, it is found sparingly in Algeria, where in 1922 I noticed it in one locality (Maison Carrée, near Algiers).

After seeing these plants growing in distant regions and re-examining the material in Hb. Mus. Brit., I am unable to follow Dr. Briquet in treating them all as subspecies which pass imperceptibly into each other. In the Alpes-Maritimes, where a number of forms grow in close proximity, they may appear to run together in this way, perhaps owing to the frequent occurrence of hybrids. But I can see no evidence that this generally happens. The French plants that Coste would have named *S. Verbenaca* L. all appear, so far as herbarium material shows, to belong to one species, in spite of the differences in leaf-cutting and glandular development. And the same plant occurs in Spain, in Guernsey, and elsewhere. Similarly, *S. horminoides*, which in life is easily recognized, is a well-marked plant throughout its range, and, while it frequently grows in company with other members of the group, it seems to be constantly later in coming into flower. The specimens of *S. clandestina* (*S. controversa*) from Cyprus, Arabia, and Algeria, seem also obviously to belong to one distinct species, and were so treated by Bentham; and *S. verbenacoides* (*S. multifida*), which is well represented in Hb. Mus. Brit., especially from the Balkan Peninsula and from Spain, appears to exhibit its characteristic features with complete uniformity. In Algeria all the examples of this plant that I noticed in different stations were readily recognizable as one species, although presenting vegetative variations such as might be expected.

The treatment of this group in Rouy's *Flore de France*, xi. 327-330 (1909), seems to be based on Dr. Briquet's work, but has six leading forms ranked as five subspecies (*S. Verbenaca*, *S. oblongata*, *S. clandestina*, *S. horminoides*, and *S. multifida*) and one race (*S. controversa*). The leaf-form is almost the sole basis of distinction, and the descriptions are incomplete. It is not easy to understand what form is intended for typical *S. Verbenaca* L., or why *Gallitrichum anglicum* and *G. maculatum* are referred to varieties of this rather than to *S. horminoides*.

To sum up, the original *Salvia Verbenaca* of Linnæus (Sp. Pl. 25) may be said to have comprised all of the forms dealt with in this paper. The citation from Hort. Cliff. shows the inclusion of the British plant, and the three figures of Barrelier and Triumfetti indicate that not only the type in the Linnean Herbarium, but *S. verbenacoides* was also included. Linnæus's knowledge of the actual plants was probably confined to the garden form from which the two specimens in his herbarium were taken.

In Sp. Plant. ed. 2, Linnæus introduced his *S. clandestina*, drawing up his description from the specimen in his herbarium received from the garden at Gottingen subsequently to 1753, but erroneously citing Barrelier's Icon. 220 as representing it instead of *S. verbenacoides*, with which he was unacquainted.

In 1788 Pourret, apparently determining Linnæus's *S. Verbenaca* and *S. clandestina* from the two figures of Barrelier, Nos. 208 and 220, described as *S. horminoides* a taller plant, with dark inflorescence and cleistogamous flowers, which he thought differed from both.

Brotero, in 1804, distinguished another form from Portugal, which he considered intermediate between *S. Verbenaca* and *S. clandestina*, under the name of *S. verbenacoides*; and in 1806 a very similar plant from Eastern Europe, apparently conspecific, for which Barrelier's Icon. 220 was again cited, was described by Sibthorp and Smith in the *Flora Græca* as *S. multifida*.

In 1817 Poiret (Encycl. Suppl. v. 49) named *S. lanigera* a plant which seems to be identical with *S. clandestina* L.; and this was again described in 1831 by Tenore (Syll. Fl. Neap. 18) under the name of *S. controversa*.

Finally, in 1821, St. Amans (Fl. Agen. 10) distinguished as *S. pallidiflora* a plant which is shown by authentic specimens to be inseparable from the Linnean type of *S. Verbenaca*, as represented by the specimens in his herbarium; and this plant was again described as *S. Marquandii* by Dr. Druce in Journ. Bot. xlv. 405 (1906).

A LIST OF CYANOPHYCEÆ FROM NORTH MANCHURIA, CHINA.

BY B. W. SKVORTZOW
(Harbin, Manchuria, China).

In the present small note, I give a list of Blue-green Algæ observed in North Manchuria during the last ten years. Some of these Algæ were previously indicated in my paper "Ueber einige Süßwasseralgen aus der Nordmandschurei, im Jahre 1916 gesammelt," Archiv f. Hydrobiol. Bd. xvi. Heft. 3, 1926. This new list contains 47 species and varieties.

CHROOCOCCUS Näg.

C. TURGIDUS (Kütz.) Näg. Frequent in marshes near Harbin and other places. Occurs in Baikal, Kosogol, Tomsk, and Kamtschatka.

C. LIMNETICUS Lemm. In plankton of lakes near Harbin. Occurs in the Altai (Siberia).

Var. SUBSALSUS Lemm. Somewhat rare in plankton. Occurs in Europe.

APHANOCAPSA Näg.

A. GREVILLEI (Hass.) Rabenh. In marshes near Harbin. Occurs in South Asia.

A. THERMALIS Brüg. In marshes in autumn near Harbin. Occurs in hot water in Tapan and Kamtschatka.

APHANOTHECE Näg.

A. GELATINOSA (Nenn.) Lemm. In pools and on surface of the earth near Harbin. Occurs in Europe.

MICROCYSTIS Kütz.

M. FIRMA (Bréb. et Lenorm.) Rabenh. In plankton of lakes near Harbin. Occurs in Europe.

M. FLOS-AQUÆ (Wittr.) Kirch. In lakes near Harbin and other places. Occurs in Siberia and Asia Minor.

M. ÆRUGINOSA Kütz. Somewhat rare near Harbin. Occurs in Asia Minor, China, Kamschatka, and the Tropics.

M. INCERTA Lemm. In pools near Harbin. Occurs in Europe.

GOMPHOSPHERIA Kütz.

G. LACUSTRIS Chodat. In marshes and lakes, frequent. Occurs in Siberia.

G. APONINA Kütz. Very rare, in plankton of lakes near Harbin. Occurs in Asia Minor and Mongolia.

CELOSOPHERIUM Näg.

C. KÜTZINGIANUM Näg. Very frequent in plankton of lakes near Harbin and in other places. Occurs in Siberia, Central Asia, and Asia Minor.

MERISMOPEDIA Meyen.

M. GLAUCA (Ehrenb.) Näg. Very frequent in marshes and lakes. Occurs in Central Asia, Asia Minor, Siberia, Mongolia, China, and Kamschatka.

M. TENUISSIMA Lemm. In plankton of lakes near Harbin. Occurs in Central Asia, Kamschatka.

TETRAPEDIA Reinsch.

T. REINSCIANA Arch. Somewhat rare near Harbin. Occurs in Europe.

OSCILLATORIA Vaucher.

O. LIMOSA Ag. var. LÆTE-ÆRUGINOSA Kütz. In pools. Occurs in Tibet and Siberia (Tomsk).

O. PRINCEPS Vauch. In marshes found among other algæ forming a black floating mass near Harbin. Occurs in Tomsk, Baikal, China, Kamschatka.

O. ANGUINA Bory. Among other algæ in marshes. Occurs in Europe.

O. MOUGEOTII Kütz. In marshes. Occurs in Kamschatka.

O. TENUIS Ag. Very frequent near Harbin on earth. Occurs in Central Asia and Kamschatka.

O. GEMINATA Menegh. In lakes near Harbin. Occurs in Kamschatka.

O. LIMNETICA Lemm. On lakes near Harbin. Occurs in Europe.

O. AGARDHII Gom. Frequent in plankton. Occurs in Asia Minor, Siberia, and Kamschatka.

ARTHROSPIRA Stizen.

A. JENNERI Stiz. In pools. Occurs in Central Asia and Kamschatka.

SPIRULINA Turpin.

S. MAJOR Kütz. Among other algæ. Occurs in Tibet and Kamschatka.

LYNGBYA Ag.

L. LIMNETICA Lemm. Frequent in plankton of lakes. Occurs in the Altai (Siberia).

L. CONTORTA Lemm. In plankton of lakes near Harbin. Occurs in South China and Ceylon.

L. ESTUARIUM (Mert.) Lieb. In marshes and on earth. Occurs in Turkestan and China.

MICROCOLEUS Desmaz.

M. VAGINATUS (Vauch.) Gom. On earth near Harbin. Occurs in Siberia (Tomsk) and China.

NOSTOC Vaucher.

N. LINKIA (Roth) Born. In marshes and earth near Harbin. Occurs in Kamschatka and Tropics.

N. ELLIPSOSPORUM (Desm.) Rabenh. On earth. Occurs in Europe.

N. SPHERICUM Vauch. Somewhat frequent in marshes near Harbin. Occurs in Siberia and Kamschatka.

NODULARIA Mertens.

N. SPUMIGENA Mert. In marshes in Sungari river-valley near Harbin. Occurs in Europe.

N. TURICENSIS (Cram.) Hansg. Rare on water-plants (*Carex* sp.). Occurs in Europe.

ANABÆNA Bory.

A. LEMMERMANNI Richter. Very frequent in lakes. Occurs in Europe, Siberia, and Kamschatka.

A. FLOS-AQUÆ (Lyngb.) Bréb. With the preceding near Harbin. Occurs in Asia Minor, Baikal, and Kamschatka.

Var. GRACILIS Kleb. In lakes.

A. SPIROIDES Kleb. In plankton of lakes near Harbin. Occurs in Asia Minor and Kamschatka.

A. OSCILLARIOIDES Bory var. TENUIS Lemm. In plankton of lakes and pools. Occurs in Asia Minor.

APHANIZOMENON Morren.

A. FLOS-AQUÆ (L.) Ralfs. Very frequent in lakes. Occurs in Asia Minor, Siberia, Kamschatka.

CYLINDROSPERMUM Kütz.

C. LICHENIFORME (Bory) Kütz. In marshes near Harbin. Occurs in Asia.

MICROCHÆTE Thuret.

M. CALOTRICHOIDES Hansg. On earth among *Nostoc*. Occurs in Europe.

RIVULARIA (Roth) Ag.

R. INTERMEDIA Lemm. On water-plants (*Trapa*). Occurs in Kamschatka.

R. PISUM Ag. In marshes. Occurs in Siberia.

R. NATANS (Hedwig) Welwitsch. In marshes near Harbin. Occurs in Kamschatka.

TOLYPOTHRIX Kütz.

T. TENUIS (Kütz.) Johs. In marshes near Harbin. Occurs in Siberia.

ON SOME ALGÆ FROM SOREI LAKE, SUMATRA.

By B. W. SKVORTZOW
(Harbin, China).

THE material in which the following Algæ were found was collected by Baron E. E. Brugen during a visit to the Island of Sumatra in 1907. The collection consisted of a few phytoplankton samples from Sorei Lake. The samples contain a rich zooplankton. The following Algæ were found in this collection:—

GLENODINIUM ARMATUM Lev.

CHROOCOCCUS LIMNETICUS Lemm. var. SUBSALSUM Lemm.

STAUROSTRUM QUADRIFURCATUM Schmidle* var. SUMATRANUM, var. nov. A typo differt membrana punctata et lateribus in parte cellulæ superiore convexis.

Length of cell 61 μ ; breadth with spines 88 μ , without spines 60–62 μ . All the specimens examined were covered with a thick gelatinous sheath.

COSMARIUM GLOBOSUM Bulnh.

GYMNOZYGA MONILIFORMIS Ehrenb.

Cells covered with a gelatinous sheath.

BOTRYOCOCCUS BRAUNII Kütz.

Very abundant.

GEMINELLA MINOR (Näg.) Heering.

GLÆOTILA PLANCTONICA Boloch.

SPIROGYRA sp.

SOUTH-EASTERN UNION OF SCIENTIFIC SOCIETIES.

By A. B. RENDLE, F.R.S.

THE thirty-second Annual Congress of the South-Eastern Union of Scientific Societies was held at Hastings and St. Leonards, May 25–28, under the presidency of Dr. A. B. Rendle, F.R.S. The Masonic Hall, St. Leonards, was the headquarters of the Congress; and there was a very good attendance of members, associates, and delegates from the affiliated societies, who were welcomed by the Mayor of Hastings (Councillor T. S. Dymond, J.P.) and Mr. Anthony Belt as representing the Hastings and St. Leonards Natural History Society.

The presidential address on "The Past and Present Floras of Sussex" included a review of the floras at different ages in the earth's history, as represented by the fossils which have been found in the county. The most important was the Wealden Flora, our knowledge of which was largely gained from the Rufford Collection from the Ecclesbourne and Fairlight beds, as elaborated by Prof. A. C. Seward †. This flora, so far as it is represented by the fossils, consisted of Ferns, Cycads, Bennetites, and Conifers, some of the last of which are allied to the modern *Araucaria*, while others are of doubtful affinity. The relationships of this flora must be sought at the present day in the Southern Hemisphere; its facies suggests a warmer climate than that prevailing in Britain at the present day. Subsequent geological changes were briefly reviewed. The Lower Greensand, which preceded the area of the deep Cretaceous Sea, had

* Schmidle, "Die von Prof. Dr. Volkens und Dr. Stuhlmann in Ostafrika gesammelten Desmidiaceæ," Beiträge zur Flora von Afrika, xvi. in Engl. Bot. Jahrb. liii. 57, fig. 8 (1899).

† *The Wealden Flora*, published by the Trustees of the British Museum, 1894–5).

not proved so rich in fossils in Sussex, but had provided an interesting cone, a species of Pine (*Pinites sussexensis*). A special interest of these beds was the appearance in them of dicotyledonous woods, showing a remarkably well-differentiated structure comparable to dicotyledonous wood of the present day. Advancing to Tertiary times, the Bracklesham Beds in the extreme west of the county provided an interesting item of the Eocene flora in the fruits of *Nipadites Burtini*, found in 1890 on the beach at West Wittering. This genus of Palms, which was represented by a number of species in Eocene times, is very closely allied to the modern monotypic genus *Nipa*, a native of muddy shores and estuaries in further India and Malaya. *Nipadites* and other species found associated with it or in beds of similar age also indicate a climate approaching subtropical conditions. After the glacial epoch, in which conditions in Britain and a great part of Europe resembled those obtaining in Greenland at the present day, our modern flora migrated into Britain by way of the connection which was still maintained with the Continent in the extreme south-east. Since his advent in Britain, man had exerted an increasing influence on the flora by felling the forest, by cultivation and drainage, and by directly or indirectly introducing plants from other countries.

It was highly important that an adequate record of the present-day flora should be preserved, and it was to be regretted that Sussex did not possess a county flora comparable with the up-to-date floras of other counties in the Union. A beginning had been made with Arnold's *Flora of Sussex*, but this was incomplete and not sufficiently critical. It was suggested that the Natural History Societies scattered through the county might become responsible for checking and bringing up to date existing records in the different botanical areas which had already been indicated. It should be possible to find a competent editor to undertake the collation of records and the compilation of a satisfactory *Flora of Sussex*.

The address was illustrated by a series of lantern-slides, which included photographic reproductions of some of the more important fossils from the various ancient floras, and also of their present-day representatives, when such still exist.

At the Meeting of Representatives on the following morning, the President again brought forward the matter of a botanical survey of the County of Sussex for the purpose of the production of a Flora, and suggested that the local Societies in each of the six districts should be responsible for the Survey of their own particular area. This was carried unanimously and referred to the Botanical Section, by which it was later unanimously adopted. The Sectional Committee would in due course meet to consider the matter.

Dr. E. J. Salisbury, President of the Botanical Section, gave an interesting address entitled "The Waning Flora of England." Dr. Salisbury stated that although the number of species that had become extinct in Britain as a whole was small, no less than 293 species of British wild flowers had disappeared or were indisputably diminishing in one or more English counties—that is, some thirteen per cent. of

our total flora. Of this regrettably large total, the majority (namely, 124 species) are plants of damp situations. The level of water in wells in various parts of the country and the behaviour of many small streams shows that the level of the permanent water-table has been falling for some years, so that we are forced to conclude that Britain is tending to become drier, probably owing chiefly to the improved drainage and quicker run-off into the sea. There is some evidence, however, of a widespread rise in level of the land with respect to the sea, which would operate in the same direction. The decrease of many cornfield-weeds is the result of improved methods of screening, whilst not a few plants with conspicuous flowers are becoming exterminated by ruthless picking, which prevents their natural regeneration.

The address was illustrated by an excellent series of lantern-slides—photographic reproductions of the plants referred to, many of which were shown in their native habitats.

Dr. Salisbury's address was followed by a paper by Councillor T. S. Dymond, J.P., "The Weeds of a St. Leonard's Garden." This was a remarkable record of wild plants found in the speaker's garden of $\frac{1}{2}$ acre during the years 1920-26. Forty families of flowering-plants were represented, including 156 species, and there was one fern (*Lastrea Filix-mas*).

Botanical rambles were conducted by Dr. Salisbury—on Thursday to Pevensy Marshes and Bay, and on Friday to Rye Harbour and Camber Sands. The marshes proved a little disappointing, owing to the lateness of the season, but the botanists were rewarded by the sight of the sea-kale (*Crambe maritima*) in full flower on the shore at Pevensy. The rain cleared on Friday afternoon in time to allow two hours of interesting work on the sand-dunes between Rye Harbour and the sea.

The reception by the Mayor and Mayoress on Thursday evening at the new White Rock Pavilion was a pleasant social function; and on Friday evening Mr. E. A. Martin delighted a large audience with a lecture on "The Amenities of the South Downs." A very successful meeting was closed with a lecture by Mr. E. J. Bedford on "Wild Flowers," illustrated by a number of the lecturer's beautiful photographic reproductions in the form of lantern-slides.

During the Congress a Museum had been arranged in a large room at the Headquarters, under the charge of Dr. Norman Ticehurst. The botanical exhibits included a fine collection of British Sphagna, shown by W. R. Sherrin, some rare Sussex plants by C. E. Salmon, a volume of West Kent Hepatics by St. J. Marriott, a collection of Lichens by R. Paulson, photographs of the new Economic Plant Room at Reading Museum by Major Laffan, and local collections of flowering plants arranged by Miss Kaye Smith and others.

Special thanks are due to the Local Executive Committee, with the Mayor (Councillor Dymond) as Chairman, and Mr. W. R. Butterfield and Miss E. M. Clark as Hon. Local Secretaries, for the excellent arrangements for the Congress.

KLEISTOBOLUS LIPPERT, A GENUS OF MYCETOZOA
REVIVED.

By G. LISTER, F.L.S.

KLEISTOBOLUS PUSILLUS was described and illustrated by the late Christian Lippert in a paper entitled "Ueber zwei neue Myxomyceten," published in Verhandlungen der k. k. zool.-bot. Gesellschaft in Wien, xlv. 70, t. iii. figs. 1-12, 1894. The sporangia developed from pale brown plasmodium on fir-wood collected at Hallstatt in the autumn of 1892, and kept under observation for several months in Lippert's laboratory in Vienna. Apparently only a few sporangia appeared, and these were very minute.

In response to my asking for a loan of the type, Prof. F. von Höhnelt sent me in 1911 a mounting of sporangia labelled *Kleistobolus pusillus*, but which proved to be very small specimens of *Licea minima* Fries. Trusting to the mounting being correctly named, I too hastily concluded that *Kleistobolus* was merely an unusually small form of *L. minima*, and gave it as a synonym for the latter species in the second and third editions of Mycetozoa. I realized my mistake when last autumn I received from Dr. J. Jarocki, of the Zoological Department of Warsaw University, a specimen he had collected in July 1926 on fir-wood, in the Tatra Mountains, Poland. This is undoubtedly the true *Kleistobolus pusillus*, and confirms, on the whole, the accuracy of Lippert's description.

The specimen consists of a slip of spruce-wood, over which are scattered numerous minute dark brown sporangia, measuring only 0.06 to 0.1 mm. diam.; they are hardly discernible to the naked eye, and as many as nineteen may be counted on one square millimetre. They are either subglobose or drum-shaped, and are flattened above and below; each is provided with a flat or convex iridescent lid, which often has an upturned rim, and readily separates by a circular fissure from the side-walls of the sporangium. When strongly magnified the inner surface of the hyaline delicately membranous lid is seen to be studded with many bead-like warts, 1.5 to 2 μ diam., loosely scattered towards the middle, and more thickly arranged around the margin. Beside the warts, a few short tubular processes, 5 to 10 μ long by 2 to 3 μ wide, project from the inner side of the lid; these were well illustrated by Lippert, who thought that they represented rudimentary capillitium. Apparently owing to an error in manipulation, he described the sporangia as inverted and adhering to the substratum by their lids: he also stated that the side sporangium walls are double, the outer layer dark and thick, the inner membranous and colourless. In the Polish specimen the walls of the sporangia are composed of a pale brown membrane, clothed externally with deposits of dark refuse matter. Within the free margin is a single row of bead-like warts, similar to those on the lid; they recall the peg-like warts adorning the margins of the sporangial lobes in several species of *Licea*, but are far more regular in shape and distribution. The spores are rich brown in mass, very pale when magnified and smooth,

7 to 8 μ diam.; their walls are marked with thicker areas separated by thinner spaces, which gives them a faceted appearance when dry; in this character and in the spore-contents being rosy in colour, they resemble the spores of *Orcadella*.

Lippert placed *Kleistobolus* in "Perichæaceæ" on account of the short tubular processes attached to the lid which he regarded as rudimentary capillitium, but this would seem a doubtful interpretation. Somewhat similar processes occur sometimes on the inner side of the peridium of *Licea minima*, and may be comparable to the pouch-like projections occasionally developed on the walls of *Tubifera ferruginosa*. From the structure of the sporangium-wall and of the spores, the genus seems to have a strong affinity to both *Orcadella* and *Licea* in the Liceaceæ.

By a slight modification of Lippert's definition, the genus *Kleistobolus* may be defined as follows:—Sporangia scattered, sessile, dark brown, subglobose or drum-shaped, with circular hyaline lids; these are marked on their inner surface with bead-like warts and short tubular projections; lateral walls of one layer, membranous, clothed with refuse deposits; spores pale brown.

I am much indebted to Dr. Jarocki for supplying me with this very interesting specimen, which enables me to correct an error of my own and to give respectful recognition to the accuracy of Lippert's observations.

OBITUARY.

ABERCROMBIE ANSTRUTHER LAWSON

(1874-1927).

THE news of the death of Prof. A. A. Lawson at Sydney on March 26 last, after a short illness, came as a shock to his friends in Great Britain.

Lawson was a Scotsman, and began his botanical training under Prof. F. O. Bower at Glasgow University, but for reasons of health went to California, where he graduated at Berkeley University in 1898 and became Instructor in Botany. He also studied at Chicago and later at Bonn. In 1907 he was appointed Lecturer in Botany at Glasgow University, and worked there until 1912, when he was called to the newly-established Chair in the University of Sydney. The visit of the British Association to Sydney in 1914, with his old chief as President of the Botanical Section, was a great pleasure to him. We found him eagerly anticipating the erection of a new botany school on a site in the beautiful Botanic Gardens, but the war intervened and other causes of delay; the new building was formally opened, shortly before his death, in November 1926. It has been described by a colleague in the Sydney University as "a monument to the zeal, capacity, and artistic sense of Professor Anstruther Lawson."

Lawson had worked at Algæ under Prof. Setchell at Berkeley, but

his published work dealt with Cytology and the gametophyte generation of the Gymnosperms and the Psilotaceæ. The thesis for his degree was on the "Pollen Mother Cells of *Cobaea*," and this was followed by other papers on meiosis. He was a skilled draughtsman, and in his appreciation in *Nature* of his former pupil, Prof. Bower remarks that "few microscopists have combined more effectively than he did refined cytological method with artistic skill."

His residence in Australia gave opportunity for studying at first hand the Psilotaceæ; and latterly he had worked at the remarkable endemic Cycad genus *Bowenia*, an elaborate memoir on which was published in 1926 in the *Transactions of the Royal Society of Edinburgh*. Lawson had been nominated for the Fellowship of the Royal Society, but death came in the interval before election.

A. B. R.

REVIEWS.

A Treatise on the British Freshwater Algæ, in which are included all the Pigmented Protophyta hitherto found in British Freshwater. By the late G. S. WEST. New and Revised Edition, in great part re-written, by F. E. FRITSCH. 8vo, pp. xvi-534, 207 figs. Cambridge Press, 1927. Price 21s. net.

BRITISH workers on freshwater Algæ have long desired a new edition of West's *Treatise*, published in 1904 and long out of print and to a considerable extent out of date; the volume on *Algæ* in the Cambridge Handbooks series, 1916, did not replace the earlier work. The issue of the new edition is an important event, as the treatment of the subject will influence the teaching of algology in this country for some time to come. It is therefore a matter of moment to ascertain how the subject is presented by such an authority as Professor Fritsch.

The book has been almost completely rewritten. It is 162 pages longer, and the print is slightly smaller; 62 new genera are described, and the systematic portions include 13 pages on the Dinophyceæ (Peridinieæ) and 37 pages on the pigmented Flagellata. There are very numerous references to literature, and many carefully drawn-up keys which enable every genus to be identified, and even some of the commoner species.

Professor Fritsch has taken the opportunity to re-cast as well as re-write the book, and the result is practically new work in which the results of the last twenty years of research on the freshwater Algæ are brought together and critically combined into a compact and comprehensive whole. The key-note of Professor Fritsch's treatment is the theory of the polyphyletic Flagellate ancestry of the Algæ, propounded by Bohlin and Luther, and developed later by F. F. Blackman and A. G. Tansley. It is the steady adherence to this guiding principle which unifies the treatment of the subject and makes the work much more than a new edition. In the pursuance of this view, the Algæ are divided into eleven great groups, each of which is

founded primarily on a flagellate form, known or unknown, and secondarily on the type of cell-modification and cell-aggregation. Four of the groups (viz., Chrysophyceæ, Cryptophyceæ, Chloromonadales, Euglenineæ) are wholly flagellate and a fifth (Dinophyceæ) is also too "flagellate" in type to have been included in the former edition. The phenomenon of homoplasy is greatly in evidence, and some of the more novel alterations in West's classification are justified by an appeal to its working. Very rightly, Heterokontæ is taken out of the old Chlorophyceæ and appear as a separate group. West's Phæophyceæ disappears into Heterokontæ, but the familiar sharply-defined groups of Bacillarieæ, Myxophyceæ, etc., remain as before.

The term Chlorophyceæ is abandoned, and Isokontæ takes its place. This appears to the reviewer to be an undesirable change. The green, brown, red, and blue-green Algæ are reasonably natural groups, and it would be a simple matter to add a yellow-green section to them, either under the name Heterokontæ itself or, for the want of a better, under some such title as Crocophyceæ. The term Isokontæ, as used by Professor Fritsch, also includes Stephanokontæ and Isokontæ, and the wholly flagellate main groups are variously isokont and heterokont. Consistency in these matters is impossible, and a conservative attitude towards well-established and reasonably accurate terms is therefore justifiable. The classification by cilia is not used mechanically, and the criterion of each of Professor Fritsch's groups is the aggregate of ciliary character, pigments and pigment-ratios, and types of metabolism. By using the aggregate it is possible to make out a plausible case for the inclusion of Stephanokontæ and Akontæ in the new Isokontæ (pp. 18-25, 220, 224).

Within the Isokontæ, Professor Fritsch attacks the tangled problem of the old Protococcales, and sets matters in order with a mastery born of special acquaintance with these difficult forms. The old name has too many erroneous connotations to permit its retention, and it is therefore replaced by Chlorococcales. The new Protococcales is, however, deprived of Volvocales, which is given equal rank with Chlorococcales and with the remaining five usual groups of the old Chlorophyceæ. The classification of the Chlorococcales will probably meet with general approval, and the discussion on the Chlorococceæ tends to straighten out a very tangled part of the subject.

A novel change is the removal of the Cladophorales from the Siphonales to the Ulothricales. Multinucleation and septation are considered to be secondary features brought about by the increase in size of the cells of the filament, and the Siphonalian habit is considered as only another case of homoplasy. On an aggregate of characters, a reasonable case can be made out for this view, but perhaps it might be better to have raised Cladophorales to group-rank with Ulothricales, and thus have avoided a rather heavy call on the credit of homoplasy.

In the Conjugatæ an important change is made by the separation of the Saccoderm from the Placoderm desmids, and the inclusion of the former with the Zygnemales. Here, again, homoplasy is invoked to explain the similarities between the two groups of desmids.

Pleurococcus is discussed and defined, and placed in the Chætophorales. In the latter group the Chætophoraceæ are divided into Chætophoreæ, Erectæ, and Prostrateæ, in accordance with Professor Fritsch's views on the importance of the projecting and prostrate branch-systems in the possible evolution of the land-plants. *Pleurococcus* is looked upon as a very much reduced prostrate branch-system, and is therefore given hospitality in this group.

Each section of the book is enriched with valuable critical discussions. The judgments made are supported by facts, and references are given to the literature in which the subject is debated. Things have to be classified somehow, and in the absence of contrary evidence there is no better plan than the judicious application of a generally admitted evolutionary theory such as the one Professor Fritsch has so ably used.

It would have been a great convenience if the Introduction had contained a small section on "The Identification of Freshwater Algæ." Genera can be run down with the aid of the many excellent keys provided, but the non-algological botanist finds almost insuperable difficulty in identifying the species. Of course, there are many references to the "Susswasserflora," but it would help considerably if it was mentioned that this German publication, at present in twelve small volumes, edited by Pascher, published by Fischer, Jena, is the only convenient compilation for the identification of species of freshwater Algæ.

The new edition of West is a very notable achievement. Professor Fritsch not only presents a great mass of facts in a compact and orderly form, but he infuses it with life by his attempt to comprehend the multiplicity of algal forms in the framework of the theory of a polyphyletic flagellate ancestry and widely prevalent homoplasy. This view gives plenty of opportunity for argument on details—a result which Professor Fritsch frequently admits,—but these differences of opinion are likely to be fruitful in stimulating further work. The book will be essential as a compendium of knowledge of the freshwater Algæ, the method of recasting should meet with general acceptance, and its critical spirit and fresh view-point will be a stimulus to the study of these lower forms of plant-life.

BENJAMIN MILLARD GRIFFITHS.

A Botanist in the Amazon Valley. An Account of the Flora and Fauna in the Land of Floods. By R. RUGGLES GATES, Ph.D., F.L.S., Professor of Botany, University of London (King's College). 8vo, pp. 203, frontispiece, map, and 10 plates. Witherby: London, 1927. 7s. 6d. net.

PROF. GATES has given a readable and interesting account of six weeks' travel up the Amazon during the months of July, August, and September 1925. The trip was made by ocean-steamer as far as Manaos, nearly 1000 miles into the heart of South America, and thence by river-boat to Teffé, 370 miles up the River Solimoes, as this portion of the stream is called. Professor Gates made good use

of the time. Three thousand feet of film were photographed, chiefly of the different types of vegetation along the river's edge, and in addition nearly 150 photographs were taken—some of these are reproduced in the volume. Extensive collections of fruits, woods, nuts, barks, etc., were made, and a number of living plants, chiefly Orchids and other epiphytes, were brought home in Wardian cases. The book gives an idea of the conditions of travel, especially in the upper reaches of the river, of the places visited *en route*, and of the inhabitants and their manners and customs. It also contains much of the personal detail incidental to books of travel; but the naturalist will appreciate the description of the vegetation and animal-life observed along the banks of this great tropical river-system.

A chapter is devoted to Teffé, a small village on a lake-like expansion of the river, where Bates spent five years between 1850 and 1860. In the *Naturalist on the River Amazon* it is called Ega, and Bates found the locality remarkable for its variety of plants and animals; he collected more than 7000 species of insects, many of which were new to science. The village seems to have diminished in size, though still of great interest to the naturalist.

The great variety of trees, their manner of growth, and the characters of their fruits are conspicuous features of a journey through the almost interminable tropical forest, "the vastest area of jungle in the world"; 200 species of trees may be found in 2½ acres. A chapter is devoted to a brief description of some of the palms and a few other genera. The timber-trees are practically unexploited from the commercial point of view, but the conditions of growth offer many difficulties of exploitation, as the individuals of one species often occur widely separated, and the great wealth of climbers and lianes binds the trees together inextricably. The annual flooding of enormous areas of the Amazon Valley for several months in the year creates conditions in which forest-cutting is impossible. A. B. R.

Allgemeine Pflanzengeographie. By Dr. AUGUST HAYEK. Paper, 8vo, pp. viii, 409, with 5 text-figures and 2 maps. Borntraeger: Berlin, 1926. Price R.M. 20.

THIS book may well be described as a text-book of plant-geography, and contains within its comparatively small compass an enormous collection of data. It is essentially a work of compilation, and provides a very complete summary of the state of present knowledge of the distribution of plants, and for this reason if for no other should find a place in the library of every plant-geographer.

The main body of the book is divided into three parts—ecological plant-geography, phylogenetic plant-geography, and floristic plant-geography,—and is preceded by a short history of the subject and discussion of its aims and objects.

The ecological part of the book is divided into autecology, or the relation of individual plants to their habitat, and synecology, or the study of plant-communities. The first has sections dealing with the

external factors affecting the plant, climatic factors, and vegetation forms. The second has sections on the plant-society, the chief plant-formations, and the vegetation-zones of the world. The phylogenetic part is similarly divided into sections on the origin of species, the distribution and migration of plants, the areas of species, the age of species, and the distributional changes in the course of the earth's history. The floristic part contains a summary of the distribution of all the families of plants and a detailed description of the floral regions of the world.

Two folding maps are provided—one a vegetation map and the other a floral map of the world, the latter in colours. Unfortunately, these maps are loose in a pocket in the cover and, moreover, the projection used is that of Mercator. It is difficult to say why the use of this particular projection has become so widespread—it gives a very misleading and exaggerated representation of much of the world and should certainly not be used for maps of the whole world in any scientific publication. The question of the maps leads to what is perhaps the chief defect of the book—namely, that it is very poorly produced in paper covers with the pages untrimmed. This has been done presumably on the score of economy, but the advantages of a stronger binding and better finish would have been well worth the expense. The book is well indexed, and there is an extensive and valuable bibliography.

R. D'O. G.

BOOK-NOTES, NEWS, ETC.

MR. F. W. PAYNE'S COLLECTION OF DIATOMS.—The collection of fossil Diatoms made by the late Mr. F. W. Payne, a notice of whose work appeared in the last number of the *Journal*, has been purchased by the Trustees of the British Museum. The collection, which is a general one, has been accumulated during the past forty years, and is to a large extent based on the gatherings made by Lawrence Hardman, of Liverpool, between 1855 and 1875. A special feature of the collection is that the specimens are all selected and in many cases mounted in various positions. It is now available for consultation.

PROF. F. O. BOWER, F.R.S.—An appropriate commemoration of his long tenure of the Professorship of Botany at Glasgow University and his services to botanical science generally was the presentation of a portrait of Prof. Bower to the University on June 22nd. The portrait, by Sir William Orpen, R.A., was an expression of appreciation from Prof. Bower's numerous friends.

BRITISH MUSEUM APPOINTMENT.—Mr. James Edgar Dandy, B.A., F.L.S., has been appointed by the Principal Trustees to fill the vacancy in the Department of Botany caused by the retirement of Mr. Antony Gepp. Mr. Dandy was educated at Downing College, Cambridge, and gained a First Class in Part I. (1924) and a Second Class in Part II. (1925) of the Natural Sciences Tripos. Since leaving Cambridge he has worked in the Kew Herbarium as a temporary Assistant. He was elected F.L.S. on May 24th last.

WHAT IS *SEMPERVIVUM TORTUOSUM*?

By R. LLOYD PRAEGER, D.Sc.

SEMPERVIVUM TORTUOSUM Aiton and *S. pygmaeum* C. Sm. are names which occur repeatedly in the literature of Canarian botany during the last hundred years and more—the first representing, according to the stations given, a Teneriffe plant and the second a species from Lanzarote, another island of the Canary group. Under these names two allied but well-differentiated species are frequent in gardens; both of these belong to the section or genus *Aichryson* Webb & Berth., which consists mainly of annual herbs (the two plants mentioned are among the few perennials) with soft, fleshy, mostly hairy stems and leaves, yellow flowers, and deeply toothed hypogynous scales. An enquiry as to the identity of these two plants works out as follows:—

S. tortuosum was described by Aiton in 1789 (Hort. Kew. ed. 1, ii. 148):—"S. foliis obovatis subtus gibbis villosis, nectariis bilobis. Gouty Houseleek. *Nat.* of the Canary Islands. Mr. Francis Masson. *Introd.* 1779." (It may be remarked in passing that Masson, the earliest collector sent out by Kew, was in the Canaries in 1777, not later (see *Journ. Bot.* xxii. 117); but the plant may have been sent to him after his return.) Six years after its publication *S. tortuosum* was figured in the *Bot. Mag.* (t. 296). The source of the specimen drawn is not stated; the figure agrees with Aiton's brief description, to which Curtis refers as his sole source of information concerning the plant. In 1799 Willdenow (*Sp. Pl.* ii. 933) includes the name and Aiton's description in his edition of Linnæus. In the second edition of *Hortus Kewensis* (iii. 173 (1811)) Aiton adds a reference to *Bot. Mag.* 296, thus accepting that figure as representing his plant. In the following year Haworth includes *S. tortuosum* in his *Synopsis Pl. Succ.* (p. 166), calling it "Twisted Houseleek" instead of Aiton's curious name "Gouty Houseleek"; and nine years later, in his *Revisiones* (p. 66), remarks that the plant, as known to him, is more dense and twisted in the branches, and more gibbous and crowded-leaved than in the *Bot. Mag.* figure. But he makes a mistake (*Synopsis*, p. 166) by confounding it with *S. villosum* Aiton, as is evident from his quoting (under *villosum*) Aiton and Willdenow, ascribing the plant to Madeira, and in his *Revisiones* (p. 65) calling it "small shrubby villos" (the italics are mine); *villosum* Aiton is a Madeira annual. The subsequent history of *villosum* Haworth will be given immediately.

This brings us down to 1825, and (except for Haworth's slip about *villosum*) all is easy going and there is only one plant on the stage. But now the trail divides. Among the plants collected by Christian Smith in the Canaries in 1815 was one from the island of Lanzarote which is described by Link in von Buch's *Physikalische Beschreibung der Canarischen Inseln*, 1825 (p. 155) as *Sempervivum pygmaeum* (!) Sm. Webb and Berthelot (1840), the monographers of the islands, did not know it, and merely transfer it to their genus *Aichryson* and

repeat Link's brief description (Phyt. Canar. i. 184). But they actually had the plant before them, and proposed to name it *Aichryson molle* (this is not *Sempervivum molle* Visiani, 1841, an obscure plant from Nubia), as shown by a specimen given alive by Webb to Gay in 1843, now in Herb. Kew. C. Smith's *S. pygmaeum* remained obscure till Bolle re-collected it on Lanzarote about 1890 (Bot. Jahrb. xiv. 240), and R. P. Murray some ten years later (Bornmüller in Bot. Jahrb. xxxiii. 428) when the fables about its being annual, one-flowered, &c., were dissipated. But it remained without adequate description till 1913, when Burchard, finding it on Fuerteventura (for the first time), published it as *A. pulvinatum*, sp. n. (*Fedde Repertorium*, xiii. 57, and Praeger in Trans. Bot. Soc. Edinb. xxix. 214 (1925)). The plant is frequent in European collections, mostly under the name *Sempervivum pygmaeum*; and I have gathered it in its original stations on both Lanzarote and Fuerteventura. What is it? It is clearly the original *S. tortuosum* of Aiton and the Bot. Mag., and of authors down to 1825. Both collected material and garden material agree with all that Aiton and Haworth have to say about it, and with the Bot. Mag. figure.

Meanwhile, Haworth's shrubby *villosum* (*tortuosum* Aiton) was assigned definite stations at Teneriffe in Buch's work—"Baranco de S. Filipe, Villa Orot. Wald unter Agua Mansa." A few years later De Candolle (Prod. iii. 411 (1828)) describes *villosum* Haw. non Aiton and his description accords well with *tortuosum* Aiton (non DC.). He gives Prince Salm-Dyck as authority for its distinctness from *tortuosum* DC. non Ait.—of which more anon. Webb and Berthelot (*l. c.* i. 183) renamed as *Aichryson radicescens* this *villosum* of Haworth, Buch, and De Candolle (non Ait.), ascribing it to Teneriffe, evidently on the authority of Buch's stations; but these stations are erroneous, as will be shown below, and the plant does not appear ever to have been found on Teneriffe. As already suggested by Kuntze and Bornmüller, *A. radicescens* would appear to be certainly *tortuosum* Aiton of Lanzarote and Fuerteventura.

Let us go back again to about 1825. We find that De Candolle figures and describes *S. tortuosum* in *Plantes Grasses* (t. 156), quoting Aiton and Willdenow. But his plant is clearly a different species from Aiton's. It is much larger and laxer, with stalked, thinner, less densely hairy leaves. Madeira is cited as its home; this is altered in *Prodromus* (iii. 411) to Canaries, but it has never since been found in either place. This, and not Aiton's plant, is the *A. tortuosum* described by Webb and Berthelot (*l. c.* i. 184). Their description of it is original and excellent. It makes clear some further differences with Aiton's *tortuosum*—for instance, that the hypogynous scales are usually digitate, not bilobed*. It is presumably taken from garden material, for, as to stations, they merely quote from Buch (I shall refer to this in a moment). This plant, or this and Aiton's combined, is the plant which most subsequent botanists intend when they write

* But, following De Candolle, they quote both Bot. Mag. 296 and Pl. Gr. 156, showing that, like most subsequent authors, they passed the DC. plant as being that of Aiton.

of *tortuosum* Aiton, and it is the *tortuosum* of gardens being still much cultivated. It requires a new name, for which I propose *S. domesticum*, on account of its frequency as a house- and cottage-window plant. If Webb and Berthelot's genus *Aichryson* be deemed valid, the plant will have to stand as *A. domesticum*, since their *A. tortuosum* is (*teste* their description and references) composite, including *tortuosum* Ait., *domesticum* Praeger, and (as will be seen) *Lindleyi* W. & B.

S. domesticum has not been found wild since De Candolle's time (if then?), and, as we have seen, Aiton's *tortuosum* is confined to Lanzarote and Fuerteventura. But several writers—von Buch (Phys. Besch. 166 (1825)), Masferrer (Recuerdos Bot. Tenerife, 57 (1880)), Bornmüller (Bot. Jahrb. xxxiii. 429 (1903))—have recorded *tortuosum* from Teneriffe, and have published definite stations for it. How is this to be explained? I have spent many days searching for either *tortuosum* Aiton or *tortuosum* DC. in the Teneriffe stations quoted by these writers. Neither plant could be found, but a significant point emerged, which furnished the clue to the mystery. In most if not all of the stations in question *S. Lindleyi* W. & B. (*Aeonium Lindleyi* W. & B.) was found in abundance, yet this conspicuous and striking plant is not referred to by any of the authors quoted (except Masferrer, see *infra*). Now *Lindleyi*, like *tortuosum*, is one of the few perennial *Semperviva* with obovate or spatulate hairy leaves and yellow flowers. It is a very different species from *tortuosum*, being an *Aeonium* (not an *Aichryson*), with entire scales &c., and is a much larger, indeed a comparatively massive, plant. But it might be taken for *tortuosum* by anyone working from descriptions and not familiar with the plant; and there is no doubt that it has been. The evidence is convincing, and the history of *Lindleyi* would appear to be as follows:—

In 1815 Christian Smith collected a plant on Teneriffe (above Santa Ursula and at Esperanza) for which he proposed the name *Sempervivum polycarpum*, sp. n. (spec. with label in C. Sm.'s handwriting in Herb. Brit. Mus.!). This specimen is *Lindleyi*. In 1825 C. Smith's plant was published in Buch (*l. c.*) as *tortuosum*; thus started the idea that *tortuosum* is a Teneriffe plant. The stations given are Puerto Orotava gegen S. Ursula, Barranco S. Andrea, Val Igueste (p. 166). *Lindleyi* was named, figured, and described by Webb and Berthelot (*l. c.* 189, tab. 33); they collected it on Teneriffe (where it is endemic and locally abundant) during their exploration of the Canaries in 1820-30*. Kuntze (1891) deals with *Lindleyi* and *tortuosum*, but only makes worse confusion (Rev. Gen. Plant, i. 231). He "lumps" *tortuosum* Aiton and *tortuosum* DC., and divides the product into α *Lindleyi*, β *viscatum*, γ *Goochia*. These last are

* By a strange mischance, they identified it with the plant of Bot. Register 1553, which Lindley misnamed *villosum*. But this plate represents not *Lindleyi* but *spatulatum* Hornem. = *lineolare* Haw. = *barbatum* C. Sm. non W. & B. = *strepsicladum* W. & B. Curiously enough, while Lindley's description otherwise fits *spatulatum*, what he says of the scales fits *Lindleyi*—not *spatulatum*, which has none, nor *villosum*, in which they are palmate.

three species of *Aeonium* which are allied to each other, but all far removed from *tortuosum*. As Bornmüller remarks, such a conclusion could have been reached only by a study of bad herbarium material; he cannot have seen the living plants. Bornmüller himself (1903) collected "*tortuosum*" in several places, but his plant must have been *Lindleyi*; for he puts it among the *Aeonia* with *cruentum* (including *spathulatum*), *caespitosum*, *viscatum*, and *Goochia* as Sectio *Goochia*. Now *Lindleyi* (which he does not mention) certainly belongs to this section, and is, indeed, its only other obvious member; *tortuosum* is far removed from it. Masferrer (1880) under *Lindleyi* merely quotes Webb and Berthelot—"Peñascos secos de la region inferior de Tenerife, W. B." (p. 58): evidently he did not know the plant; but under *tortuosum* he quotes original stations—"Barranco de Castro y en alguna otra parte—Setiembre, 1878; en fl. y fr." (p. 57). It seems clear that he fell into the same error, and that his *tortuosum* was *Lindleyi*. The same applies to Lindinger (Fl. der Kanar. Inseln, in Hamburger Universität Abh. aus dem Gebiet der Auslandskunde, xxi. (1926) 197), who quotes new Teneriffe stations for *tortuosum*, but did not identify *Lindleyi*. Finally, N. E. Brown in Herb. Kew. names as *Lindleyi* several garden specimens of *tortuosum* DC.; he surely never saw *Lindleyi* alive.

In the light of the above remarks, the synonymy of these three plants would appear to be as follows:—

1. SEMPERVIVUM TORTUOSUM Aiton.

Sempervivum tortuosum Aiton, Hort. Kew. (1) ii. 148 (1789); Curtis, Bot. Mag. 296 (1795); Willd. Sp. Pl. ii. 933 (1799); Haworth, Syn. 166 (1812), and Rev. 66 (1821); Hornemann, Hort. Hafniensis, i. 516 (1815); Link, Enum. Berol. ii. 19 (1822); *nec* DC. Pl. Gr. 156, *nec auct. plur. subseq.*

S. villosum (Aiton) Haw. Syn. 166 (1822) and Rev. 65 (1821); Link, Enum. Berol. ii. 19 (1822); *ibid.* in Buch, Phys. Besch. 177 (1825); DC. Prod. iii. 411 (1828); *nec* Aiton, Hort. Kew. (1) ii. 148 (1789) *nec aliorum*.

S. pygmaeum C. Sm. *ex* Link in Buch, Phys. Besch. 155 (1825); Christ in Bot. Jahrb. ix. 161 (1888); Bornmüller in Bot. Jahrb. xxxiii. 428 (1903), *et hort. plur.*

Aichryson pygmaeum (C. Sm.) W. & B. Phyt. Canar. i. 184 (1840); Webb *ex* Christ in Bot. Jahrb. ix. 109 (1888); Bolle in Bot. Jahrb. xiv. 240 (1892); Pitard & Proust, Iles Canar. 188 (1908).

A. radicescens W. & B. l. c. 183 (1840); Webb *ex* Christ in Bot. Jahrb. ix. 109 (1888); Pitard & Proust, l. c. 188 (1908).

Sempervivum radicescens (W. & B.) Lowe, Man. Fl. Madeira, i. 331 (1868); Christ in Bot. Jahrb. ix. 161 (1888).

Aichryson pulvinatum Burchard in Fedde, Repert. xiii. 57 (1913).

Hab. Lanzarote! Fuerteventura! Frequent in botanic gardens under the name *Sempervivum pygmaeum*.

2. SEMPERVIVUM DOMESTICUM Praeger, nom. nov.

Sempervivum tortuosum (Aiton) DC. Pl. Gr. 156 (about 1825) and Prod. iii. 411 (1828); Christ in Bot. Jahrb. ix. 161 (1888), *et*

script. plur. post 1825, et hort. plur.; nec Aiton, Hort. Kew. (1) ii. 148 (1789), *nec script. alior. pre 1825.*

Aichryson tortuosum (Aiton) W. & B. l. c. i. 184 (1840), *quoad descript.*; Webb *ex* Christ in Bot. Jahrb. ix. 109 (1888); Pitard & Proust, l. c. 188 (1908).

Aichryson domesticum Praeger, *supra*, p. 211.

Hab. Madeira (DC. Pl. Gr.); Canaries (*ibid.* *Prodromus*). Not found since in either island group. Frequent in botanic gardens, generally as *S. tortuosum*, and often seen in cottage windows, sometimes in a variegated form.

3. SEMPERVIVUM LINDLEYI W. & B.

S. tortuosum (Aiton) Link in Buch, l. c. 166 (1825); Masferrer, Recuerdos Bot. Tenerife, 57 (1880); Bornmüller in Bot. Jahrb. xxxiii. 429 (1903).

Aeonium Lindleyi W. & B. l. c. i. 189, tab. 33 (1840); Pitard & Proust, l. c. 192 (1908).

Sempervivum Lindleyi W. & B. l. c.

S. tortuosum a. Lindleyi (W. & B.) Kuntze, Revis. Gen. Pl. i. 231 (1891).

Aeonium tortuosum (Aiton) Pitard & Proust, l. c. 190 (1908).

Hab. Teneriffe! locally abundant. Rather rare in cultivation, under several names.

I trust that this detailed statement will lay to rest once for all the uneasy ghost of *Sempervivum tortuosum*. Considering the intricate puzzle in which it has become involved, Aiton showed prophetic genius in selecting its name. The only outstanding point is the question of the origin of De Candolle's plant. Concerning this I have no suggestion to offer at present.

NOTES ON THE BRITISH PANSIES.

THE LUTEA-CURTISII SERIES.

BY ERIC DRABBLE.

VIOLA LUTEA.

Hudson, Fl. Angl. ed. 1, 331, 1762; Smith, Fl. Brit. 248, 1800; De Candolle, Fl. de Fr. v. 619, 1815; *V. lutea* Huds., *a. grandiflora* Koch, Synopsis, ed. 2, 95, 1843; Grenier & Godron, Fl. de Fr. i. 184, 1848; *V. grandiflora* Huds. Fl. Angl. ed. 2, 380, 1778; Grenier & Godron, Fl. de Fr. 185, 1848, p.p.; *V. sudetica* Willd. *a. lutea* DC. Prodr. i. 302, 1824; *V. lutea* Huds. var. *unguiculata* and subvars. *lutea* and *violacea* Rouy & Foucaud, Fl. de Fr. iii. 53, 1896; *V. chrysantha* Schrad., Catal. sem. hort. Götting; Reichenbach, Iconographia Exotica, cent. ii, 5.

Plates:—Smith, Eng. Bot. 721, 1800; Reichb. Icon. Fl. Germ. et Helvet. iii. tab. 23, figs. 4516 & 4519; Drabble, in Journ. Roy. Hort. Soc. xxxv. pt. ii. (1910) fig. 61; Reichb. Icon. Exotica, pl. 114 (as *V. chrysantha* Schrad.).

A perennial plant, branching extensively, with slender, sometimes woody branches which emerge separately and may give the impression that each flowering stem represents a separate plant. The branches arise in a tuft from the root-stock often deeply below the surface of the ground. The subaerial branches vary greatly in height from a few inches to 18 inches or more. The leaves are usually small, the lower obtuse, more or less rounded, the upper generally narrower and sometimes acute. The stipules are digitate with narrow obtuse or acute lateral lobes and longer, generally narrow and entire, sometimes subfoliaceous and more or less crenate mid-lobe. The peduncles are slender and long, and in typical *lutea* they overtop the stem by several inches; each aerial branch bears few flowers, sometimes only one. The sepals are narrowly triangular-linear. The corolla is usually large, $\frac{3}{4}$ in. or less to $1\frac{1}{2}$ in. or more in length. The petals are typically much longer than the sepals, bright yellow, pale cream, blue, purple, or particoloured. The spur is slender, straight or curved, and much longer than the small sepaline appendages.

In recent years the name *V. lutea* has been restricted to the typical yellow-flowered form of the limestone uplands. This form also occurs on sand-hills on certain parts of the coast—a fact to which fuller reference will be made when the distribution of the pansies is being considered.

V. lutea Huds. var. *amœna* Henslow, Cat. Brit. Plants, 3, 1829 (non *V. amœna* T. F. Forster in Symon's Synopsis, 189, 1798); *V. sudetica* Willd. var. *media* DC. Prodr. i. 302, 1824; *V. lutea* Huds. var. *unguiculata* subvar. *violacea* Rouy & Foucard, Fl. de Fr. iii. 53, 1896, is merely a purple- or blue-flowered form of typical *lutea* and is connected with it by many intermediates. Gardner (*Rambles in Braemar*, 18, 1845) gives nine grades of colour-variation between *amœna* and *lutea* proper. The plant termed subvar. *insignis* by E. G. Baker (J. Bot. 1901, 222) from Craig Caillaich in Breadalbane and Ben Lawers is a large-flowered form of *amœna*.

Exsicc. The following are *V. lutea* Huds. (including f. *amœna*):—Herb. Mus. Brit.:—*V. lutea* Huds., Schultz, Herb. norm., no. 1019.

Herb. Kew.:—*V. sudetica* Willd., in *Sudetorum horto Rübezahl* (372), ex herb. Hooker.

Herb. Ch. Bailey:—*V. lutea* var. *grandiflora*, Switzerland, Eyre de Crespigny.

V. grandiflora Vill., Vogese-Rhenarum, Rutgen, 1879.

V. grandiflora Vill., Baenitz, Herb. Europ., Fl. Alsatica, 1883, 1897, and 1899.

V. grandiflora Vill., Lauterbrunnen, Bernese Alps, J. S. Mill.

V. lutea Sm., Schultz, Fl. Gall. et Germ. exsicc. no. 111, Voges.

V. lutea Huds., subsp. *elegans* (Spach, Korschl.), Becker, Viol. exsicc. vii. Lief. 1906, no. 172 (Alsacia).

V. lutea subsp. *elegans* Fl. Alsatica, Emil Haussner, 1891.

V. lutea Huds. subsp. *sudetica* Willd., Becker, Viol. exsicc. vi. Lief. 1905, no. 145 (Silesia).

V. lutea Huds., Riesengebirge, Rehorn, 1881, Pax.

V. lutea Huds., Fl. exsicc. Austro-Hungarica (Bohemia), no. 574.

The following are f. *amœna*:—

Herb. Ch. Bailey:—*V. lutea* Sm., Schultz, Fl. Gall. et Germ. exsicc. no. 111 (*in parte*).

V. grandiflora Vill., Herb. Vogese-Rhenarum, Rutgen, 1879 (*in parte*).

V. grandiflora Vill., Baenitz, Herb. Europ., Fl. Alsatica, 1899 (*in parte*).

V. elegans Spach, Baenitz, Herb. Europ., Fl. Alsatica, Münster, 1883 (*in parte*).

V. lutea Huds. var. *hamulata* J. G. Baker (Ex. Club Rep. 1868) was gathered by J. G. Baker on Richmond Racecourse and on Copperthwaite Moor, and was described as having the root-stock perennial, wide creeping; stems diffuse, much branched at base, slender; lower leaves about $\frac{1}{2}$ in. long with ciliated crenations, upper ovate-bluntish or even lanceolate-acute; stipules with terminal lobe much longer than the others, leafy and toothed, lateral lobes few, two or three on one side, one on the other, linear or subspathulate; sepals lanceolate-acuminate, equalling the petals; corolla $\frac{1}{2}$ in. across, yellow; spur slender, curved upwards, barely $1\frac{1}{2}$ times as long as the subquadrate calycine appendages. Unfortunately, the type-specimen was destroyed by fire in 1864 and the plant does not seem to have been rediscovered.

V. lutea Huds. var. *Murrayi* Drabble (J. Bot., Suppl. 1909, p. 13) was gathered by Mr. Cecil Hay Murray in 1907 at the north end of Loch Muick growing in loose granitic sand with little or no humus and practically in the water, the upper layer of sand alone being unsubmerged. I have seen the same form from the bank of the Spee. It is characterized by its rather stout aerial sympodial runners, in this respect differing greatly from all other forms of *lutea*, but it appears to grade into the type and to be a mere state. Both yellow- and purple-flowered plants occur.

V. sudetica Willd. (*sensu stricto*), Enum. hort. Berol. Suppl. p. 12, 1813; Koch, Synopsis, ed. 2, 93, 1843, is an updrawn form with very large violet (or occasionally yellow) flowers and narrow, strongly unguiculate petals. The following specimens are typical *sudetica*:—

Herb. Kew.:—*V. sudetica* W., Mont Pilat près Lyon, ex herb. Jordan.

V. sudetica Willd., Lozère, juil. 1822, ex herb. Benth.

V. sudetica Willd. (*V. lutea* Huds.), Lozère, 1865, ex herb. J. S. Mill.

Herb. Ch. Bailey:—*V. sudetica* Willd., Magnier, Fl. Select. exsicc. 23 bis (non 23), Puy de Dôme.

V. sudetica Willd., Becker, Viol. exsicc. iii. Lief. 1902, no. 67.

V. lutea Smith var. *grandiflora* Koch, Schultz, Herb. Norm., cent. 11, no. 1019 (*in parte*).

V. elegans Spach, Baenitz, Herb. Europ., Fl. Alsatica, 1883 (*in parte*).

V. polychroma Kerner, Sched. ad Fl. exsicc. Austro-Hungar. ii. 89, no. 575, 1882; *V. saxatilis* var. *polychroma* Borbás in Koch, Syn. Deutsch. Schweiz. Fl., Aufl. 3, 221, 1892. Plate:—Drabble, in J. R. Hort. Soc. xxxv. pt. ii. 1910, figs. 59 & 66.—This is an updrawn state with broad leaves and generally less unguiculate petals than in typical *lutea*. There is considerable variety in the colour of the flower. Plants examined at Eyam, Derbyshire, showed the following range:—(i.) all the petals yellow; (ii.) upper and lateral creamy white, lowest yellow; (iii.) upper blue, lateral creamy white, lowest yellow; (iv.) upper and lateral blue, lowest yellow with blue margin; (v.) upper deep purple, lateral blue, lowest blue with yellow base. The plant grows locally in abundance in the Peak District of Derbyshire amongst long grass. It grades into the ordinary *lutea* of the turf on the upland limestone hills.

The following specimens are *polychroma*:—

Herb. Mus. Brit.:—*V. polychroma* A. Kerner, Fl. exsicc. Austro-Hungar. 575, Salisburgia, Eysn.

V. polychroma A. Kerner; Hayek, Fl. Stiriaca exsicc. 5 Lief. 237, Schladming, Stiria Superior, Maio, 1905, leg. F. v. Hayek.

V. alpestris DC., subsp. *polychroma* A. Kerner; Hayek, Fl. Stiriaca exsicc., 26 Lief. suppl. 1289, Aschbach, leg. A. Klammerth.

V. alpestris Jord., ssp. *polychroma* Kern.; Fl. Bohemiae et Moraviae exsicc., F. Petrak, Mähr-Weissknoben, Lfg. 16, nr. 1504.

Herb. Kew.:—*V. polychroma* A. Kerner, Fl. exsicc. Austro-Hungar. 575, Salisburgia, Eysn.

V. calaminaria Lejeune, Rev. Fl. Spa., ex DC. Prodr. i. 302, 1824; *V. multicaulis* Koch, Synop. 1843; *V. lutea* γ. *multicaulis* Koch, Synop. 76, 1857.—Plate:—Drabble in J. R. Hort. Soc. xxxv. pt. ii. 1910, fig. 58; Schimper, Plant Geography, Engl. ed. 1903, fig. 53. This is an updrawn, narrow-leaved, and usually, though not always, small-flowered state of *lutea*.

The following specimens are *calaminaria*:—

Herb. Mus. Brit.:—*V. lutea* Sm. var. *multicaulis* Koch; Wirtgen, Herb. pl. select. etc., Fasc. v. 172, auf Gelmeiboden, zu Aachen, and ditto, Fasc. viii. 172 bis, auf Gelmeiboden in Indethal.

V. lutea Huds.; *V. calaminaria* Lej. Rev. 49, Herb. Plantes rares ou critiques de Belgique, par Henri van Heurck et A. Martinis, Fasc. vii. no. 312. Pilouses sur le terrain extrait des mines de calamine, Oneux (Liège), 15 et 30 mai 1868. E. Marchal.

(*V. lutea* Sm. var. *multicaulis* Koch, Wirtgen, Herb. pl. select. etc., Fasc. i. 19, Aachen, resembles more closely the ordinary large-flowered broad-leaved *lutea*.)

Herb. Kew.:—*V. calaminaria* Lej., Altenberg bei Aachen, 1858.

Herb. Ch. Bailey:—*V. lutea* Huds.; *V. calaminaria* Lej. Herb. Plantes rares ou critiques de Belgique, par Henri van Heurck et A. Martinis, Fasc. vii. no. 312.

V. lutea Huds. var. *calaminaria* Lejeune; Becker, Viol. exsicc. v. Lief. 1903, no. 119.

V. calaminaria Lej., Baenitz, Herb. Europ., 1885.

V. sudetica Willd., Loire, 1877, Herb. G. Gautier (Narbonne).

The tolerance of zinc in the soil said to be shown by *V. calaminaria* seems to be quite well established. Risse (Sachs, Exp. Physiol. 153, 1865) stated that *Viola tricolor* may take up zinc in considerable quantity from soils rich in this element and that the zinc accumulates particularly in the leaves, where it is probably deposited in the cell-walls in a form which exercises no poisonous effect on the protoplasts. Some writers, however, go much further and claim that the zinc is responsible for the particular characters shown by *V. calaminaria*. Thus Schimper (Plant Physiol. English ed., 93, 1903) states definitely that the presence of calamine (zinc carbonate) "induces hereditary modifications in some plants. . . . The plants thus modified grow in a zinc soil in great numbers and luxuriance and do not overstep its limits." He then goes on to say, "The calamine violet, *Viola calaminaria* Lej. (*V. lutea* var. *multicaulis* Koch) differs from other forms of *Viola lutea* by its rich ramification, its longer stem and its smaller corolla, which, however, varies somewhat in size. In the case of *Thlaspi calaminare* Lej. et Court, the petals are broader than those of the type form and are much longer than the sepals, while the filaments are shorter than the sepals. *The zinc in the soil has induced in the one form an increase, in the other form a decrease in the size of the corolla.*" (The italics are my own.)

For the italicized statement not a particle of evidence is offered, and yet Warming (*Ecology of Plants*, Engl. ed., 56) writes: "The calamine violet (*Viola calaminaria*) is presumably a form that has arisen from *Viola lutea* by the action of zinc in the soil." It is amazing that such unsupported statements should be printed and still more so that they should be quoted by botanists of repute. The matter really seems at present to stand thus:—Risse (Sachs, Exp. Physiol. 153) observed that *Silene inflata* (*S. Cucubalus*) and *Armeria* sp. showed very active growth in a soil rich in zinc. Working with *Viola*, Hoffmann (Bot. Zeit., 1875, 628, and Untersuch. über Variation, 56, 1877) arrived at the conclusion that *V. calaminaria* did not alter when grown in soil free from zinc, nor did cultivation on soil rich in zinc produce any morphological effect on *V. tricolor*. Pfeffer (Physiol. of Plants, Engl. ed., i. 436, 1900) rightly points out that *V. calaminaria* occurs on soils other than those containing zinc. I have myself found it in Derbyshire away from any calamine-containing soils—even on the Millstone Grit, where there are several clumps which have been growing for many years unchanged. Of course, all forms of *lutea* are very rare on the Grit, but the fact that *V. calaminaria* when growing there shows its characteristic features year after year seems to have some bearing on the matter in hand. It is true that Schimper regarded the special characters of *calaminaria* as hereditary modifications induced by calamine. If this be true, the plants which grow off the calamine-containing soils might be descended from a stock which had acquired its peculiarities on such soils, but for this there is no more evidence than for Schimper's

other statements. Indeed, on the available evidence, to invoke the action of zinc as a factor in this case is certainly unwarranted, and *calaminaria* seems to be a form of *lutea* in which zinc is in no way necessarily concerned. For its general vegetative characters the surrounding vegetation is probably largely responsible, while the small size of the flowers—by no means a constant character—is not beyond the range found in other forms of *lutea*.

V. Curtisii Forster in Eng. Bot. Suppl. t. 2693, 1831; *V. Curtisii* Forster *a. genuina* Rouy & Foucaud, Fl. de Fr. iii. 50, 1896; *V. Curtisii* Forster var. *Forsteri* H. C. Watson, Cybele Brit. 487, 1870; *V. tricolor* L., subsp. *Curtisii* Forster, *a. Forsteri* Lond. Cat. ed. 6, 1867; was first recorded from Branton Burrows, Devonshire, and later from sand-hills on the Welsh coast and from many other localities. Later it was called var. *Forsteri* H. C. Watson, Cybele, p. 487. This sand-hill pansy is often somewhat small-flowered and then looks rather distinct, but it merges insensibly and completely into the ordinary large-flowered upland *lutea*. Moreover, cultivated specimens of the Branton Burrows plant and of *lutea* proper seem to me to be indistinguishable, and I have no doubt that *Curtisii* is merely a form of *lutea*. The occurrence in quantity of so characteristic a calcicole as *V. lutea* on sand-hills by the sea is no great matter for surprise. There is a considerable literature dealing with the calcicolous flora of sand-dunes, and Salisbury ("The Soils of Blakeney Point: a Study of Soil Reaction &c.," in Annals of Bot. 1922, 391-432) has shown that dunes in their earlier stages may have a large calcium carbonate content, which diminishes, owing to leaching, as the dune-systems grow older. It is interesting in this connection to note that the *Curtisii*-pansies, formerly abundant on the Wallasey sand-hills, are now quite extinct, the latest record that I have found being 1862.

The extinct narrow-leaved plant of the Wallasey and New Brighton sand-hills was called *V. sabulosa* Bor. by Jordan (*V. sabulosa* Boreau, Bull. Soc. Acad. Angers, 24, no. 6, 305; Dumort, Bull. R. Soc. Belg. vii. 353, 1868; *V. tricolor* λ . *sabulosa* DC. Prodr. i. 304, 1824; *V. Curtisii* Forster γ . *sabulosa* Rouy & Foucaud, Fl. de Fr. iii. 50, 1896), but the narrow-leaved specimens of *Forsteri* from Branton Burrows are indistinguishable from the New Brighton plants, while broader-leaved specimens seem to be identical with plants from the Welsh and Irish coasts. *V. sabulosa* Bor., cult. from seed from Ostende, J. Lloyd, in Herb. Mus. Brit., has much longer and narrower leaves than those of our West Coast plants, while F. N. Williams (Prodr. 10, 591, 1912) found that *V. sabulosa* on the dunes between Knocke and the Dutch frontier did not agree with the British specimens so named. The only British plants that I have seen which approach the true *sabulosa* at all closely are those from the sand-hills, Ross Links, Northumberland, in Herb. Mus. Brit. Whether or not the true *sabulosa* is identical with *V. tricolor* var. *maritima* Schweigger (Marss. Fl. Neu-pommern, 58) I have not yet determined.

V. Pesneau Lloyd & Foucaud, Fl. Ouest. Fr. 48, ed. 4, 1886;

V. tricolor δ . *Pesneau* Lloyd, Fl. Ouest, ed. 3, 43, 1876; *V. Curtisii* Forster β . *Pesneau* Rouy & Foucaud, Fl. de Fr. iii. 50, 1896; *V. Rhotomagensis* Pesneau, Cat. Loire Inf. ed. 2, Suppl. 1841 (*non* Desf. Tabl. Bot. Mus. Hist. Nat., Paris, 153, 1804—here the *Index Kewensis* is in error) is a narrow-leaved generally rather small-flowered form with particoloured or purple flowers. Plants from Mochras, Merioneth, and from St. Anne's, Lancashire, were thus named correctly by Mr. E. G. Baker.

V. Curtisii var. *Mackaii* H. C. Watson, Cybele, 487, is a particoloured form from Portmarnock sand-hills near Dublin, and var. *Syme* Baker, Thirsk Bot. Ex. Club Rep. 8, 1859, a yellow-flowered form from Mullaghmore, Co. Sligo. There seems to be no justification for perpetuating these names.

V. tricolor L. subsp. *ammotropha* Wittrock, Viola Studier I. 66-68, appears to be a *Curtisii* pansy with pale rose-colour (f. *genuina* and f. *ornata*) or purple (f. *violacea*) in some or all of the petals; f. *violacea* is probably identical with *V. Pesneau*.

Long experience of these plants in the field, in cultivation, and in herbaria has convinced me that there is one well-defined species, *V. lutea*, and that *amaena* Henslow (*non* Forster), *Murrayi* Drabble, *audetica* Willd., *polychroma* Kerner, *calaminaria* Lej., *Curtisii* Forster (including *Forsteri* H. C. Wats., *Pesneau* Lloyd, *Mackaii* H. C. Wats., and *Syme* Baker) are merely forms of *lutea*. Some are colour-forms, others are ecads. To name colour-forms seems to me to be undesirable. The naming of ecads may be a convenience, but this paper is concerned only with a systematic consideration of the pansies. Their ecology will be the subject of a future communication.

The writer wishes once more to record his gratitude for the facilities given him for consulting the collections at the British Museum and Kew. He has examined also the pansies in the herbarium of the late Charles Bailey, now in the Manchester Museum.

NOTES ON JAMAICA PLANTS.

(Continued from Journ. Bot. 1926, p. 159.)

ACANTHACEÆ.

By S. MOORE.

In working up the *Acanthaceæ* for the *Flora of Jamaica*, the relative paucity of this family in the West Indies when compared with its lavish representation in South America is apparent, for of the whole number of its genera, above 150, only nine are known as being certainly endemic. Of these, *Ruellia* is largest, with seven species; *Blechnum*, *Anthacanthus*, and *Drejerella* are represented each by three species; while *Salpicantha*, *Dianthera*, and *Psilanthele* have two, and *Lepidagathis* and *Dicliptera* one each. Not one of these genera is confined to Jamaica, and only *Anthacanthus* is exclusively West Indian. This poor list is reinforced to some degree by escapes

from cultivation that have been able to hold their own against the native vegetation. *Thunbergia* with four species, two Indian and two African, heads the list; there are two species of *Strobilanthes* from India, the Madagascar *Barleria lupulina* Lindl. (perhaps, too, the Old-World *B. Prionitis* L.), the Indian *Andrographis paniculata* Nees and *Adhatoda Vasica* Nees, besides *Graptophyllum pictum* Griff. and the handsome Guiana plant *Pachystachys coccinea* Nees. As several more escapes are known to have established themselves in the West Indies, it may be that a careful search will result in some at least of these being found in Jamaica.

RUELLIA.

Browne (*Natural History of Jamaica*, 267-8) mentions three plants under *Ruellia*, one referable certainly to *R. paniculata* L., a second as certainly *R. tuberosa* L., and a third, "the smaller *Ruellia*, with a thick capsule," which can be none other than *R. geminiflora* H. B. K., a conjecture confirmed by the further description "Capsulis crassioribus, foliis oblongis vix petiolatis, floribus solitariis vel geminatis subsessilibus ad alas," which agrees exactly with that species. In the *Flora Jamaicaensis* (Linn. *Amœnitates Academicæ*, v. 380, 1760) we find four citations under *Ruellia*, viz.: *R. Blechnum* (in error for *Blechnum*), now known as *Blechnum Brownei* Juss., *R. paniculata*, *R. clandestina*, a synonym for *tuberosa* and *R. biflora*. It is unfortunate that the question now arising—what is this *R. biflora* of the list?—can be directly answered by reference neither to the Linnean Herbarium nor to the British Museum's Hortus Cliffortianus specimens. In spite of this, the view now to be mentioned, although merely inferential, will, it is hoped, prove conclusive in deciding the question.

R. biflora L. Sp. Pl. 635 (1753), founded on a Carolina plant, is *Dyschoriste oblongifolia* O. Kuntze, and this being very like *D. humistrata* O. Kuntze, Lindau, in Urban's *Symbolæ Antillanæ*, ii. 189, thinks it "highly probable" that the *R. biflora* of the *Flora Jamaicaensis* is really *D. humistrata*, which, unlike its congener in being confined to the American Continent, has been found also in Cuba and San Domingo. But inasmuch as *Dyschoriste* is not known to occur in Jamaica, and Browne's description cited above answers excellently to *R. geminiflora* H. B. K., a well-known Jamaica plant, there is little reason to doubt that the *R. biflora* of the Flor. Jam. is really *R. geminiflora*, and this view is strengthened by the fact that *R. geminiflora* has only four seeds to the capsule, a character of *Dyschoriste*, but not ordinarily of *Ruellia*. Further, as showing how these plants have been confused, there is a British Museum specimen collected by Masson in Jamaica, and named in Solander's handwriting "*Ruellia biflora*," which is without doubt *R. geminiflora*.

SALPIXANTHA.

Under the name *Salpixontha coccinea*, Hooker proposed as the type of a new genus a plant figured in the *Botanical Magazine*, tab. 4158 (1845). There is a mistake in Hooker's description; he

says the calyx is bibracteate at base—meaning, of course, bibracteolate, and omits mention of the bract which, although small, is certainly present. As will be seen directly, this is an important point. Some thirty years afterwards Bentham in *Genera Plantarum*, ii. 1103, merged Hooker's genus in *Geissomeria*; but Lindau in Urban's *Symbolæ Antillanæ*, ii. 205, restored it to its old status, the pollen being markedly different from that of the other genus. In the same volume of the *Genera Plantarum* (p. 1096) Bentham assigned to a new genus, *Neriacanthus*, another Jamaican plant remarkably like *S. coccinea* in general appearance, except that instead of the flowers being in long spikes, the spikes are short, and each flower is subtended by a large instead of a very small bract. In both these there are a number of resemblances. In both the foliage is virtually identical; the flowers are decussately arranged; the front lobe of the corolla is larger than the others; the anthers are one-celled; the pollen is, as Lindau showed, similar, as is the capsule with dark brown, shining, somewhat fleshy valves, and the seeds with relatively broad and weak retinacula. Against these points one can cite only the broader corolla-tube of *Neriacanthus*, and the stamens arising from it above the middle instead of below, as in *Salpixontha*. Another difference might be adduced from the respective descriptions, as Bentham speaks of a staminode in the flower of *Neriacanthus*; but this is an error of observation, for not only has the effort to see this met with no success, but it does not appear in the figure in Hooker's *Icones*, tab. 1200. As for the bracts, large in one case and small in the other, this difference is sometimes seen within the limits of the same genus among the Acanthaceæ, including *Geissomeria* itself. Under the circumstances, there seems no sufficient reason why Bentham's genus should be retained; consequently *Neriacanthus Purdieanus* becomes *SALPIXANTHA PURDIEANA*, comb. nov.

DREJERELLA.

Lindau established his genus *Drejerella* (Urban's *Symb. Antill.* ii. 222) mainly on the pollen, the other characters being those of *Beloperone*. This pollen, he says, is of the kind named "Spangpollen," i. e., the grain is traversed by smooth bands or depressions not reaching the poles. In one case, however, that of *D. nemorosa*, he notices that the bands are almost entirely broken up into nodules (Knötchen), making the pollen very much like that of *Beloperone* except for having 3 pores instead of 2. But these nodular bands are also to be seen in the other species of *Drejerella* examined, although in all these cases, including that of *D. nemorosa*, the nodules are closer together than in the pollen of *Beloperone*. For this reason I have had some doubt about keeping up the genus, although a difference in the shape of the pollen-grains must also be taken into account. But, seeing how *Drejerella* has now passed well into vogue, further disturbance in the nomenclature of these plants seems inadvisable.

The genus must be enlarged by the inclusion of Dr. N. L. Britton's recently described *Beloperone? jamaicensis* (Bull. Torr. Bot. Club, xli. 16), which therefore becomes *DREJERELLA JAMAICENSIS*, comb. nov.

UNUSUAL LEAF-FORMS IN *HELIANTHUS ANNUUS* L.

By B. F. BARNES, B.Sc., F.L.S.

THE lateral branches of the common Sunflower, *Helianthus annuus*, frequently show in their leaves a transition from the broad cordate leaf characteristic of the main stem to a lanceolate form—the cordate leaves appear on the lower part of the branch, the lanceolate ones on the upper part and sometimes on the receptacle of the capitulum.

Late in September 1926, a pinnatifid leaf was noticed, interpolated in a normal series of leaves on a lateral branch (fig. 1). The parent plant was one of a number grown from the same stock of "seed," gathered in 1925 from one capitulum. The other plants were examined, and, although no more pinnatifid leaves were found, several peculiarities were observed. An examination of the specimens of *Helianthus annuus* in the British Museum Herbarium has not brought to light any similar leaves, nor has a reference to such been found in literature.

The large cordate leaves of *Helianthus annuus* show much minor variation, but there is a general agreement in the arrangement of the veins and in the disposition of the lamina about them. A prominent midrib passes directly forward from the petiole to the apex of the leaf. Close to its origin, the midrib gives off a strong lateral branch to each half of the lamina; these secondary veins curve outwards and forwards, and, usually, they can be traced nearly to the apex. They branch in their turn; the most obvious branches proceed towards the margin of the base of the blade, and other and weaker branches, together with similar branches of the midrib, provide the vascular tissues of the central and apical regions of the leaf. The smaller veins anastomose freely throughout the leaf. The margin is bordered by a series of loops, and there seems to be a definite relation between the position and size of the loops and the position and size of the serrations.

The lanceolate leaves are constructed on a similar plan, but there are indications that the two main lateral veins tend to develop less strongly; this is associated with the disappearance of the cordate base and the appearance of a cuneate base. The lamina of the narrow leaves may be considered as representing the central and apical regions of the lamina of the broader leaves.

The abnormal leaves which were found approximate in outline to the lanceolate type, but they agree with the cordate leaves in a tendency to form three main veins. In two leaves the lamina was asymmetrical. In one the left half was almost normal, differing from a similar half of a cordate leaf only in the possession of a wide cuneate base. In the right half the strong lateral vein was present, but it did not bear any large branches on its outer side; the lamina of this half was reduced in size, and its margin was vaguely sinuous, and not serrated. The peculiar features of the abnormal half seem to be clearly related to the absence of lateral branches from the main secondary vein. In the other skew leaf (fig. 2), the right half had

a cuneate base, but was otherwise normal; in the left half the basal lateral vein was feebly developed, and reached little more than half-way along the leaf; the lamina was narrow, and bore two elongated outgrowths on the margin.

*Helianthus annuus* L.

1. Pinnatifid leaf in a normal series on a lateral branch.

In the pinnatifid leaf, which first attracted attention, and in a few other leaves both halves of the lamina were diminished in width, and normal serrations were lacking. This suggests that the peripheral system of minor veins had been lost, and, with them, the capacity to form serrations. The venation of the pinnatifid leaf

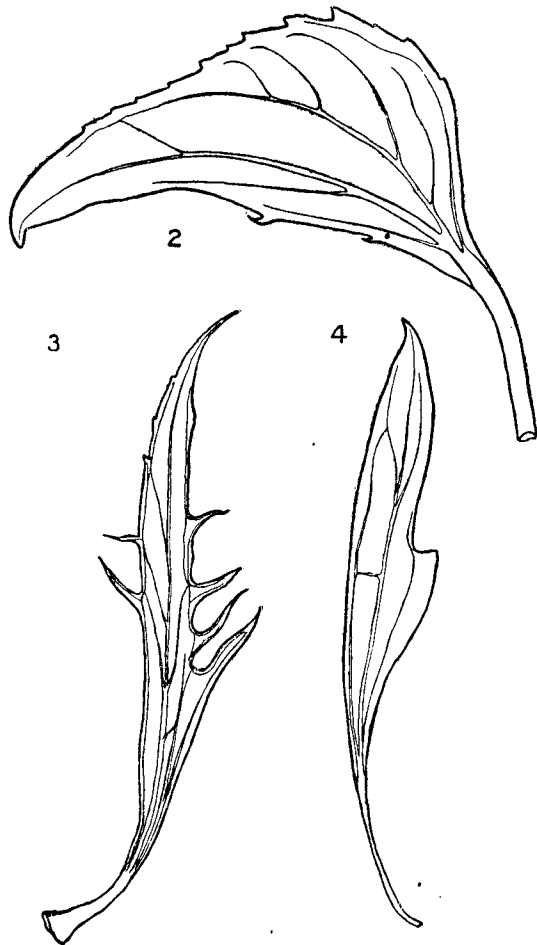

Helianthus annuus L.

2. Skew leaf. 3. Pinnatifid leaf. 4. Elongated leaf.

(fig. 3) was arranged on the same lines as that of a cordate leaf, but the two lateral veins diverged but slightly from the midrib. The right basal vein was moderately developed in proportion to the midrib, and gave off one outwardly-directed branch, which terminated in the most pronounced marginal lobe. Three more strong lobes

stood out on this side. They showed no definite relation to the ends of branch-veins, but into each two veins passed from a system of anastomoses lying just within the margin. On the left side two long outgrowths each received one vein from an anastomosis, and towards the apex three small protuberances were present.

Another elongated leaf (fig. 4) showed three main veins; on the left the vein pursued an evenly curved course, and, in agreement with this, the margin curved evenly. On the right a sudden inward deflection of the vein was accompanied by an abrupt large tooth on the margin. The vascular supply in this leaf was less than in the pinnatifid leaf, and this doubtless accounts for the absence of long outgrowths from the margin.

In structure, and in their position on the branch, these peculiar leaves seem to belong to the cordate type. The abnormalities appear to be due to a reduction in the branching of the main lateral veins, to a decrease in the angle of divergence between the veins, and to a falling off in the production of lamina. In the pinnatifid leaf especially, less lamina was present than it seems possible to explain by the reduction in the venation.

The arrangement of the lamina about three large veins occurs in the stronger leaves of *Bidens tripartita*, but the smaller leaves of this species show little or no trace of such a disposition. Although the pinnatifid leaf bears a superficial resemblance to the similarly cut leaves of *Crepis*, *Centaurea*, and other Compositæ, which do not, like *Bidens*, belong to the Helianthoideæ, these leaves possess a strong midrib, which is not approached in strength by any of the subsidiary veins.

It is possible that the appearance of these unusual leaves in *Helianthus annuus* is to be attributed to their development at the end of the growing season, but against this view is the fact that they were mixed with ordinary leaves. The stock to which the plants belong is variable; it yields syncotyous and tricotyous seedlings, it shows variation in the colours of the disc and ray florets, and the plants differ greatly in their capacity to form lateral branches. It may be that the production of exceptional leaves is merely another expression of instability in this stock.

TUNICA MERT. ET KOCH.

By T. A. SPRAGUE, B.Sc., F.L.S.

THE name *Tunica* is applied at the present day to a genus typified by *T. saxifraga* (L.) Scop., and is usually attributed to Scopoli. Schinz and Thellung (Schinz & Keller, Fl. Schweiz, ed. 4, i. 232, 1923) ascribe it to "Adanson em. Mert. et Koch." As will be shown, both *Tunica* Adans. (1763) and *Tunica* Scop. (1772) are "nomina abortiva," being nomenclatural synonyms of *Dianthus* L. (1753); and the generic name, as nowadays employed, should be attributed to Mortens and Koch.

According to Fuchsius (Hist. 351, 1542), the name *Tunica* or *Herba Tunica* was used by druggists and herbalists in the sixteenth century for the genus *Dianthus*, which Fuchsius called *Betonica altera*. *Tunica* in this sense was adopted by Ruppianus (Fl. Jen. 105, 1718), Dillenius (Hort. Eltham. 400, 1732), Haller (Enum. Helv. 381, 1742; Hist. Helv. i. 391, 1768), Ludwig (Def. 171, 1748), Boehmer (Ludw. Def. ed. 2, 298, 1760), Adanson (Fam. ii. 255, 1763), and Scopoli (Fl. Carniol. ed. 2, i. 298, 1772).

The Pink genus was, however, more generally known during the seventeenth century and the early part of the eighteenth under the name *Caryophyllus*. Mattioli (Comm. Diosc. 578, 1565) included both the Clove tree and the Pinks under *Caryophyllus*; and Caspar Bauhin (Pinax, 207, 1623) restricted *Caryophyllus* to the latter, using the generic name *Caryophyllus aromaticus* for the Clove. *Caryophyllus*, as thus restricted, was adopted by Tournefort (Élém. i. 279, 1694; Inst. i. 329, 1719) and Moench (Meth. 58, 1794).

In 1735 Linnæus (Syst. Nat. ed. 1) used the generic name *Caryophyllus* for the Clove, and replaced *Caryophyllus* Tourn. by *Dianthus* L., which was gradually accepted by other botanists, so that by the close of the eighteenth century *Caryophyllus* Tourn. and *Tunica* Rupp. had become mere synonyms of *Dianthus*.

Towards the end of that century, Moench (Meth. 60, 1794) proposed a new genus, *Imperatia*, to accommodate *Gypsophila saxifraga* L., a species which could be assigned satisfactorily neither to *Gypsophila* nor to *Dianthus*, in which Linnæus at first included it.

Mertens and Koch (Röhling's Deutschl. Fl. ed. 2, iii. 182, 1831) accepted Moench's genus, but were unable to retain the name *Imperatia* Moench (1794), on account of the existence of *Imperata* Cyrill. (1792). Instead of proposing a new generic name, they unfortunately revived the name *Tunica* and, still more unfortunately, ascribed it to "Scopoli (mit Abänderung)." In view of the fact that Scopoli cited Lonitzer (who cited *Herba Tunica* as a synonym of *Flos Caryophyllorum*), Haller, and Adanson as authorities for *Tunica*, and that all his species of *Tunica* were included under *Dianthus* in Sp. Pl. ed. 1, it is evident that Scopoli proposed neither a new generic name nor a new genus; he merely replaced the name *Dianthus* L. (1735) by the prior name *Tunica*; and Mertens and Koch's so-called "emendation" of *Tunica* Scop. consisted in removing all the true and original species (i. e., *Dianthus*), retaining only *T. saxifraga* (L.) Scop.

Tunica Boehm. (Ludw. Def. ed. 2, 298, 1760) was a "nomen abortivum" for *Dianthus* L. (1753), which he cited in synonymy together with *Caryophyllus* Tourn.

Tunica Adans. (Fam. ii. 285, 1763) was accompanied by the references: Lonic., Dill. Elth. t. 298; *Caryophyllus* Tourn. t. 174; *Dianthus* Linn.; *Saponaria* Dill. Elth. t. 276. Thus, like *Tunica* Scop. and *Tunica* Boehm., it was a "nomen abortivum" for *Dianthus* L. (1753), but included also *Gypsophila perfoliata* L.

Under the International Rules a "nomen abortivum" has no status whatsoever, and there is nothing to prevent the same name

being adopted subsequently as a valid name either for the same or for a different group. Hence Mertens and Koch were at liberty to use the name *Tunica* to replace *Imperatia* Moench, and the effective publication of *Tunica* in this sense dates from 1831. But in the very same year Link (Hand. ii. 235) raised *Gypsophila* sect. *Petrorrhagia* Ser. (DC. Prodr. i. 354, 1824) to generic rank, with *P. saxifraga* Ser. ex Link as type-species. Apparently the third volume of Mertens and Koch's edition of Röhling's *Deutschlands Flora* appeared in the first half of the year 1831, since Mertens died on June 19, 1831; but his name appears as a living author on the titlepage, and the writer of a review of the volume (in *Flora, Literatur-ber.* 1831, 145) made no mention of his death, so that not only the volume, but even the review probably appeared not later than June 1831. There appears to be no means, however, of ascertaining in what part of the year 1831 the second volume of Link's *Handbuch* appeared. In such a case the International Rules prescribe that the first author who united *Tunica* Mert. et Koch and *Petrorrhagia* (Ser.) Link, and chose one of these names, must be followed. *Petrorrhagia* appears to have been overlooked from 1831 till 1894, when it was reduced to *Tunica* by B. D. Jackson in *Index Kewensis*, ii. 479. It was not until 1903 that it was revived by Post and Kuntze (Lexik. 427, "1904"). Hence *Tunica* Mert. et Koch should be upheld, with *Petrorrhagia* Link as a synonym. The principal relevant synonymy of *Tunica* and *Dianthus* is given below:—

TUNICA Mert. et Koch in Röhling's Deutschl. Fl. ed. 2, iii. 182 (1831, semestre priore); Koch, Syn. 93 (1836); Fisch. et Mey. Ind. Quart. Sem. Petrop. 48 (1837); A. Braun in *Flora*, 1843, 384; Benth. et Hook. f. Gen. Pl. i. 145 (1862); Pax in Engl. & Prantl. Nat. Pflanzenfam. iii. Abt. 1 B, 76 (1889); non Adans. (1763).

Imperatia Moench, Meth. 61 (1794); non *Imperata* Cyrill. (1792).

Petrorrhagia Link, Handb. ii. 235 (1831); Post et Kuntze, Lexik. 427 (1903); Britton & Brown, Ill. Fl. ed. 2, ii. 72 (1913).

Dianthus sect. *Petrorrhagia* Ser. ex DC. Prodr. i. 354 (1824).

Gypsophila sect. *Petrorrhagia* G. Don, Gen. Syst. i. 383 (1831).

DIANTHUS L. Sp. Pl. 409 (1753); Gen. Pl. ed. 5, 191 (1754).

Tunica [Fuchs. Hist. 351 (1542), pro syn.; Rupp. Fl. Jen. 105 (1718)]; Adans. Fam. ii. 255 (1763); Scop. Fl. Carniol. ed. 2, i. 298 (1772).

Caryophyllus [C. Bauh. Pinax, 207 (1623); Tourn. Inst. i. 329 (1719)]; Moench, Meth. 58 (1794); non L. (1753).

ABSTRACTS OF PAPERS OF INTEREST TO STUDENTS
OF THE BRITISH FLORA.

NOTES FROM 'THE NATURALIST,' 1926, Feb. (p. 53).—The *Ledum* reported in *Journal of Botany*, 1925, 178, from Blackstone Edge, between Rochdale and Halifax, by F. J. Stubbs, has now been definitely determined by A. J. Wilmott as *L. latifolium* and not *palustre*.

April (pp. 107–112). "Additions to the Flora of Cheshire," by N. Woodhead. *Fumaria capreolata* is given as a new County Record, but see *Journ. Bot.* 1913, 50.

May (pp. 145–148). "*Impatiens glandulifera* and other Adventive Plants in Britain," by G. C. Druce.

August (pp. 237–241). "Notes on the Vegetation of Spurn," by J. Grainger. An interesting ecological account of this remarkable peninsula.

September (p. 273). "An Abnormal Specimen of *Cardamine pratensis*," by J. M. Brown. This example possessed flowers which were quite typical, with the exception of the gynœcium. In some cases a stalked bud-like structure occupied the centre of the flower; in others the centre was occupied by a gynophore bearing a pear-shaped structure having the usual external features of the pistil and terminating in a stigma. This "ovary," however, contained an irregular cluster of malformed stamens and not ovules.—C. E. S.

In *The Vasculum*, xiii. 19 (Oct. 1926), R. B. Cooke reports *Wahlenbergia hederacea* from Durham, v.c. 66, a new County Record. The plant was found in plenty near the Bollihope Burn.—C. E. S.

THE HORNWORTS AND THEIR OCCURRENCE IN BRITAIN, BY CECIL SANDWICH (*Annual Report and Proceedings of the Bristol Naturalists' Society*. Fourth Series, vol. vi. part iv. 1926, pp. 303–311, with fig.).—The Ceratophylla, or Hornworts, are totally submerged aquatic flowering weeds. The minute flowers are monœcious and axillary, at separate nodes; the ♂ bear numerous stamens, the ♀ a single ovule. Prof. Glück*, of Heidelberg, has made an intensive study of the leaves of these plants from an anatomical and biological point of view. The Ceratophylla have no roots, but are provided with rhizoid branches, which morphologically represent shoots, and biologically act as roots to anchor the plant on the mud and to nourish it. The rhizoid leaves are much smaller and finer than the ordinary leaves, and are sometimes undivided. The linear segments of the rhizoid leaves bear 3–4 tiny prickles composed of only one cell, while the terminal segments of the ordinary water-leaves are formed differently, having tissue and ending in a sharp tooth or prickle. The phylogenetic position of the Ceratophyllaceæ has for many years provided an embarrassing problem, but the author agrees with its being placed in the Ranales next Cabombaceæ. He states that it may well be one of the very earliest genera of aquatic Angiosperms.

* Glück, H., *Biologische und morphologische Untersuchungen über Wasser und Sumpfgewächse*, 2 Theil, Jena, 1906, pp. 191–203.

In 1753, Linnæus, in the *Species Plantarum*, clearly described two species, founded on *Hortus Cliffortianus*, 446 (1737):—

(1) *Ceratophyllum* foliis dichotomo-bigeminis, fructibus trispinosis, and (2) *C. submersum* foliis dichotomo-trigeminis, fructibus muticis, *Hydroceratophyllum* folio lævi octo cornubus armato, Vaill. act. 1719, Affinis nimium præcedenti ut fere varietas.

Good sheets of these are in Clifford's Herbarium at the Natural History Museum. Vaillant in 1719 divided the two species very simply and clearly:—

(1) *Hydroceratophyllum* folio aspero, quatuor cornubus armato, and (2) *Hydroceratophyllum* folio lævi, octo cornubus armato.

The author summarizes his conclusions as follows:—

There are in Britain two well-defined species of *Ceratophyllum*:

(1) *C. demersum* L. (*oxyacanthum* Cham.). Leaves dark green, stiff, once or twice dichotomously forked, with 2–4 linear segments, which are serrulate or denticulate-spinous; fruit smooth or sometimes pitted, at maturity producing near the base two lateral spines, and at the summit a spine which, with the style, at least equals and usually far surpasses the length of the fruit.

(2) *C. submersum* L. (*muticum* Cham.). Leaves a clear green longer than those of *C. demersum*, thrice dichotomously forked, thus usually with eight very finely serrulate capillary segments; occasionally one of these fails to develop at the final lateral forkings. The fruit is hard and often covered with raised tubercles, which are scarcely visible when the fruit is young; there are no lateral spines near the base, and the style is much shorter than the fruit. The whole plant is softer and more collapsible than *C. demersum*.

The existence in Britain of *apiculatum* Cham., which should be treated as a variety of *C. demersum*, the author considers doubtful.—E. G. B.

OBITUARY.

THE REV. JOHN ROFFEY, M.A.
(1860–1927).

WE regret to have to record the death of the Rev. John Roffey, which occurred on a botanical excursion in Northern Italy. He started on a holiday on June 20th, and on July 1st he went to stay at the Park Hotel at Riva, on Lake Garda. Shortly after his arrival he had a heart attack, from which he did not recover. He was buried locally on July 6th.

Mr. Roffey was well-known to British botanists as our leading authority, in this country, on the difficult and intricate genus *Hieracium*, and was responsible for the list of *Hieracia* in the last edition of the *London Catalogue*, where 247 species or subspecies are indicated as British. In compiling this list, he followed Zahn's monograph perhaps rather too closely, as Zahn's knowledge of our British forms appears not to extend beyond Linton's Set of British *Hieracia* and F. N. Williams's *Prodromus*.

Mr. Roffey was born in 1860 (August 25) and educated at Oxford, where he graduated B.A. in 1884, taking a Third Class in Modern History, and M.A. in 1888. He held curacies at first in the provinces, and later in London, and at the time of his death was a licensed preacher in the diocese of Southwark, where he had been assistant Priest at the church of St. Alphege since September 1926.

Mr. Roffey made numerous botanical excursions both in this country and abroad. It was the writer's good fortune to join him on two occasions in Scotland—once in Perthshire and once at Aviemore, Inverness, where he was temporarily taking duty.

Although a good and critical botanist, he has written very little. His best-known paper appeared in this *Journal* in 1925, and was an explanatory note on the list of *Hieracia* in the Catalogue. He states there that the changed order of the sections may at first seem startling to British botanists, notably the removal of the *Alpina* and *Amplexicaulia* to a place between the *Vulgata* and *Prenanthoidea*, but the strangeness is due to the connecting sections being unrepresented in Britain. He described a species—*H. pseudozetlandicum*, which was the *H. zetlandicum* of the Linton Set of British *Hieracia*. Another noticeable alteration is the adoption of the name *Lachenalii* Gmel. as an earlier name for *sciaphilum*.

Though of a retiring disposition, he was of a kindly nature and ever ready to help in the determination of critical plants. He will be much missed by those of us who had the privilege of knowing him.

E. G. BAKER.

SHORT NOTE.

THE STATISTICAL COMPARISON OF FLORAS.—In the *Japanese Journal of Botany*, vol. ii. 1925, there appeared a long paper by Yushan Kudo on the Flora of Yezo, the most northerly of the larger islands of the Japanese Archipelago. The current (May-June) number of *Torreya* contains a commentary on this paper written by T. D. A. Cockerell, of which one of the most important features is the criticism of Kudo's use of the percentage method of floral comparison. This method is very widely used, but is most fallacious and meaningless, and Cockerell's criticism of it deserves wider publicity. Briefly, the method employed is to express the relationship of one flora to another by a percentage obtained from the number of species common to both. The inadequacy of this expression may be at once shown. Suppose two floras, one having 1000 species and one with 100 species, and with 50 species common to both. This is clearly open to two interpretations depending on the point of view from which it is treated—namely, as a 10 per cent. similarity or a 50 per cent. one. Similarly, suppose one flora contained only 50 species, all of which occurred in the flora containing 1000 species the percentage similarity would be 100, but it can hardly be said that this expresses the relation between the two satisfactorily. The general similarity between floras depends not only on units actually common to the two, but more so on the *degree* of similarity between the other

units. Many other points of interest will occur to readers of this note, but enough has been said to emphasize Cockerell's views. It is only fair to add that while it is easy to condemn the percentage method, it is difficult to invent any more satisfactory yet *simple* numerical comparison, but while, for this reason, percentages are used, their limitations and dangers must be remembered. The statistical comparison occupies only one page in Kudo's paper, and hence its effect upon an otherwise admirable and most valuable paper is very slight indeed.

R. D'O. GOOD.

REVIEWS.

Catalogue of Cainozoic Plants in the Department of Geology, British Museum (Nat. Hist.). Vol. I. The Bembridge Flora. By ELEANOR MARY REID, B.Sc., F.L.S., F.G.S., and MARJORIE ELIZABETH JANE CHANDLER, with a Section on the Charophyta by JAMES GROVES, F.L.S. 8vo, pp. viii, 206, with 20 text-figs. and 12 plates. Trustees of the British Museum, 1926. Price 15s.

IN this interesting contribution to our knowledge of the Cainozoic plants, the authors add one more to the valuable series of publications on European Tertiary floras which we associate with the name of the senior author, collaborating originally with her husband, the late Clement Reid, continuing alone after his death, and later in collaboration with Miss M. E. J. Chandler.

The material which forms the subject of the catalogue was collected by the late J. E. Ely A'Court Smith, who devoted the forty years of his retirement from active service to the study of the fossiliferous outcrop of Bembridge beds, near Gurnard, Isle of Wight. The vicissitudes attending his collection, which found a home, twenty-three years after his death, in the British Museum, are told in the Introduction.

The book consists of two parts:—an Introduction of considerable interest occupying thirty-two pages, and a detailed and critical systematic description of the specimens occupying 140 pages. A list of works quoted and an index complete the volume.

Very little has previously been published on the plants of the Bembridge beds, which are pictured as deposited in a large delta with extensive mud-flats, in an area of depression subject from time to time to changes of level, which controlled the invasion or exclusion of the sea. Remains of stems and leaves are mostly fragmentary. The number of recognizable fruits and seeds is much greater. Those occurring in the greatest number are of land-plants, especially adapted for wind-dispersal, and fruits and seeds of water-plants. An analysis of the flora in relation to its physical character and habitat indicates a large proportion of species with organs specially adapted for wind-carriage, and which could be wind-borne, a slightly larger proportion of aquatic or semi-aquatic species, and a smaller proportion having no special means of transport, neither wind-buoyant or aquatic. The authors make an interesting comparison with the Tertiary floras of

Tegelen, Pont-de-Gail, and Hordle, which have been the subject of previous memoirs, and again emphasize the relation between these Tertiary floras and the living floras of East Asia and North America, tracing the changes which become apparent during the progress of the Tertiary period. Special attention is directed to the relation of the European Tertiary floras to the existing flora of South-West China and Upper Burma, which the work of recent explorers has rendered more obvious.

The detailed study of the species indicates a warm temperate or subtropical climate.

The systematic account comprises 121 species which the authors are able to assign with greater or less certainty to 58 recent or extinct genera. These comprise eight species of *Chara*, two of Filicales (*Acrostichum* and *Azolla*), an *Equisetum*, nine Conifers, twenty Monocotyledons, mainly aquatic, but including three Palms, and an Aroid assigned to the Eastern genus *Epipremnum*, and sixty-six Dicotyledons. A number of undetermined species in various families makes up the total.

The text is elucidated by a wealth of excellent figures, reproductions from the authors' photographs of the actual fossils. Of the twelve plates ten are double-page, and each contains on an average more than twenty figures. The book has been well and clearly printed by Messrs. Clowes; the binding is less satisfactory. A. B. R.

The Genera of South African Flowering Plants. By E. P. PHILLIPS, M.A., D.Sc., F.L.S., Senior Botanist, Department of Agriculture, Union of South Africa. Large 8vo, pp. 702. Government Printers, Cape Town, 1926. Price £1.

THIS volume is issued, by the Department of Agriculture, as Memoir No. 10 of the Botanical Survey of South Africa, the Committee of which entrusted the work of compilation to Dr. Phillips. A second edition of William Harvey's *Genera of South African Plants*—the original was published in 1838—appeared, edited by the late Sir Joseph Hooker, after the author's death in 1868. Though an excellent book, this has long ceased to be representative of the South African Flora, the larger portion of the area now under consideration was sixty years ago botanically unexplored, and considerable additions have also since been made to our knowledge of the flora of the Cape province. Dr. Phillips's book will be welcomed by all interested in the study of the South African flora, and should prove an asset in the advance of that study. In his Preface the author refers to the work as a compilation in the preparation of which he has drawn freely on available sources of information. The only originality claimed for it lies in the keys to the families and genera. The flora of South Africa is too vast and varied for any one worker to claim expert knowledge in every group, and increased knowledge will presumably necessitate certain modifications in future editions of the book. But

Dr. Phillips has, at any rate, the advantage of some years of personal acquaintance with his subject. He acknowledges help received from colleagues and friends in South Africa, especially from Mr. N. S. Pillans, of the Bolus Herbarium, for the account of the Restionaceæ, and also from Mr. N. E. Brown for descriptions of *Mesembrianthemum* and allied genera.

The arrangement of the families is that of Engler's *System*, a synopsis of which is given; and the genera follow that of Dalla Torre and Harms' *Genera Plantarum*, each genus in the text bearing the number assigned to it in that work; this is not definitely stated, and explains the frequent gaps in the running number, by which also the genera are indicated in the Index. In the subdivision of the families the arrangement in the later volumes of the *Flora Capensis* and the *Genera Plantarum* of Bentham and Hooker has been adopted.

The key to the families occupies pp. 8-38; it would have been helpful to have added the number to the name of the family—as having found the family from the key one has to look up the index to find the family in the text; Dr. Phillips is, however, alive to the importance of utilizing page-headings for indicating the family (with its number). The arrangement of the text follows the plan adopted by Harvey; a diagnosis of the family is followed by a key to the genera, and of each genus there is a diagnosis, with notes as to habit, number of species, and distribution. The subject-matter is well arranged and clearly printed. The disadvantages of the use of a stereotyped series of numbers to indicate the genera is shown not only by the numerous gaps in the series but also by the necessity of indicating additions by one or more letters—in the extreme case of *Mesembrianthemum*, which Mr. N. E. Brown has felt compelled to segregate very considerably, the numbers run from 2405 (*Mesembryanthemum* in its restricted sense) through the alphabet and recommence with 2405za. Is anything gained by the use of these numbers?

As Dr. Phillips himself suggests in his Preface, it is perhaps too much to expect, especially in a massed record of facts such as is the present volume, that no mistakes will be detected, and he trusts that any such will be brought to his notice. Use of the book in the herbarium, the study, or the field may reveal points which require emendation or amplification. Some extension of the distribution-area is indicated; thus the genera *Phænohoffmannia*, *Pearsonia*, and *Listia* (pp. 320 & 321) are cited as endemic but occur also in Tropical Africa; and other similar instances might be given. *Sphæralcea* St. Hill., which occurs twice on p. 402, suggests a new authority for the genus. Botanists may appropriately express their gratitude to the author for the extremely useful aid to their work with which he has supplied them by indicating any errors of omission or expression which they may come across. A. B. R.

Manual of Cultivated Trees and Shrubs hardy in North America, exclusive of the Subtropical and warmer Temperate Regions. By ALFRED REHDER. 8vo, pp. xxxvii, 930. Macmillan, New York, 1927. Price 42s. net.

THE object of this volume is to present a systematic and descriptive enumeration of the cultivated trees and shrubs hardy in North America within an area whose southern limit is an isothermal line connecting points which have a mean temperature near the freezing-point in the coldest month. In the East the area coincides almost with that of the manuals of Gray and of Britton; westwards the line runs from Virginia, through Western North Carolina, Northern Georgia and Alabama, Central Arkansas, Central New Mexico, Central Arizona, and then northward through North-eastern California and Oregon to North-western Washington.

The term "trees and shrubs" is used in a wide sense, including not only woody vines, but also suffruticose plants, and in doubtful cases plants only slightly woody have been included. Thus almost exclusively herbaceous families are represented, such as Caryophyllaceæ, by *Silene chlorafolia* Sm., a West Asian species, and Cruciferae by species of *Iberis*, *Æthionema*, and *Alyssum*. The general arrangement of the work is similar to that of the manuals of the native flora of the area, to which therefore it serves as a supplement and companion.

Woody plants known to have been successfully introduced, particularly in more recent times, have found a place in the book, but exigencies of space have necessitated the omission of less known and rarely cultivated varieties and garden forms, and in some large genera as *Salix*, *Crataegus*, *Rubus*, and *Rosa* species of neither economic nor horticultural importance, which occur only in a few special collections, have not been mentioned.

The sequence of the families is that of Engler's *Syllabus*, which again ensures uniformity with modern American manuals. The International Rules have been followed in the nomenclature (with two exceptions referred to below), which also makes for uniformity with other standard works. Intergeneric hybrids are, however, distinguished by the use of special generic names—for instance, the graft hybrid *Cytisus Laburnum* becomes *Laburnocytisus Adamii* Schneid. Another departure from the Rules is the use of the term "var." for any subdivision below the species. The vague citation "Hort." has been avoided, and has been replaced by the name of the author who validated the name by description and publication. Only the more important synonyms are cited; but references are given to illustrations, especially those in the more easily accessible works. In order to give some guide as to the approximate hardness of each species (or variety) the area has been divided into eight climatic zones, which are indicated in a small sketch-map; reference to the zone is given by citation of a number in the description. The descriptions are mainly botanical, space allowing only of very brief notes on the economic and ornamental properties of the plants.

The descriptive matter is preceded by a synopsis of the orders and

families, and an analytical key to the families and aberrant genera. Under each family in the text is a key to the genera, and under each genus a key to the species. The descriptions of the species are condensed by use of abbreviations, which are also used for references to books containing illustrations, indication of distribution, &c. Considerable attention is paid to varieties; and reference is also made in smaller type to closely related species which are not of sufficient importance to merit a description in the ordinary sequence.

As regards the scientific merit of the work, we recognise it as the fruit of long experience in the best-equipped school. The volume is dedicated to the late Charles Sprague Sargent, and was published shortly before the work of the founder and Director of the Arnold Arboretum was ended by death. Dr. Rehder has been associated with the Arboretum for many years, and the present Manual is for him mainly the compression of first-hand information into a small and useable compass. The 1000 pages of text include, besides introductory matter, general keys, a glossary, and an excellent index of 70 pages, descriptions of 468 genera distributed among 112 families. About 2350 species are fully described and represented in the keys, and 2465 varieties are briefly described or indicated. Further, 1265 species and 507 hybrids are briefly described or mentioned in their proper sequence.

In the exigencies of space the type is small and somewhat compressed; but the text is as clear as could be expected under the circumstances. Certainly there is no waste of space.

Dr. Rehder is to be congratulated on the production of a very useful handbook, a valuable addition to the series of manuals dealing with the native and introduced flora of the North American Continent.

A. B. R.

Kinabalu, the Haunted Mountain of Borneo. An Account of its Ascent, its People, Flora, and Fauna. By MAJOR C. M. ENRIQUEZ, F.R.G.S., 2/20 Burma Rifles. 8vo, pp. xx, 199. With map and photographs. Witherby's, London, 1927. Price 10s. 6d. net.

MT. KINABALU is, by repute, familiar ground to botanists. Since its exploration by Sir Hugh Low in the middle of last century, it has been visited by Burbidge, Whitehead, Haviland, Miss Gibbs, and others, and the literature on its flora is extensive, though doubtless by no means complete. The present volume adds but little to our knowledge of the vegetation. The primary object of the journey was to collect butterflies, but a small collection of Mosses was made which includes a new species of *Dicranoloma* and a new variety of *Hypnodendron Copelandi* Broth., hitherto known only from the Philippines. A brief appendix is devoted to the botany, and contains some notes on the general character of the vegetation at different levels. In the body of the work there is also some account of the species of *Nepenthes* (pitcher-plants) (spelt *Napenthes* throughout), found between 4500 and 8500 feet elevation.

The index of butterflies, and in a less degree that of the birds, is more extensive and a number of the former are figured.

The book is an account, in an easy style of writing, of an expedition organized during a two months' leave from military service. It is written in diary form, and gives a general idea of present conditions in British North Borneo, of its native inhabitants, of the character of the remarkable mountain mass, and the difficulties attending its ascent.

It is clearly but somewhat wastefully printed, the subject-matter being spaced in numbered paragraphs, to which, and not to the pages, the entries in the several indexes relate. The binding is rough, and the plates are already escaping from their attachment.

Principles of Plant Growth. An Elementary Botany. By WILFRED W. ROBBINS, Associate Professor of Botany in the College of Agriculture of the University of California. 8vo, pp. viii, 299. With 136 text-figs. Wiley & Sons, New York. Chapman & Hall, London, 1927. Price 11s. net.

PROF. ROBBINS is joint-author of a text-book of General Botany*, which was reviewed in this *Journal* in 1925, p. 309, and many of the text-figures in the present volume have been reproduced from this and other publications by the same author. The author has had considerable experience in connection with the work of the Colorado Agricultural Experiment Station as well as in California, and the purpose of the book is to answer questions which have come to the attention of the writer from farmers and others interested in the growing of plants. With this view the fundamental principles of plant-growth are presented in language as far as possible non-technical, and numerous illustrations are drawn from the practical operations of horticulture and agriculture. Thus the chapter on the seed gives information on the following questions, among others:—What are the conditions necessary for germination? Why is it advisable to compact the soil over the seed after it is planted? What are the so-called "hard-seeds" of alfalfa and other legumes? How can their percentage germination be improved? What determines the depth to which seed can be planted? How long will seeds live? How may germination be hastened? What are the methods for the home testing of seeds? What diseases are carried by seeds, and how can seeds be disinfected? Chapters on water, temperature, and light, as related to plant-life, successfully illustrate fundamental facts of plant physiology in relation to cultural operations; and the same plan is effectively followed throughout.

Though written by an American botanist primarily for American readers, the book will be of interest and helpful to workers in plant-culture in other parts of the world.

* *A Text-Book of General Botany for Colleges and Universities.* By Richard M. Holman and Wilfred W. Robbins, Associate Professors in the University of California, 1924.

Wild Flowers of the Cape. A Floral Year. By A. HANDEL HAMER. With 12 reproductions in colour by ETHEL DRISCOLL, and 79 drawings in black and white by DOROTHY LEVYNS. 4to, pp. 104. Miller, Capetown; Blackwell, Oxford [1927]. Price 21s. net.

"THE almost daily demand from visiting laymen, and the man in the street, for a popular book on our beautiful flora, based on a simple plan, has prompted the preparation of this volume, written in popular language, not overburdened with scientific detail and phraseology"—thus the Publishers' note.

The plan adopted is to describe the flowers appearing in the Cape Peninsula month by month, from July, "the season which answers to the general idea of spring, when the flowers crowd upon us and the greater number of birds build their nests," on through the summer and autumn to the winter months of May and June. "The yearly chain of wonderful wild flowers suffers no interruption in its circle, but in the winter months there is an artistic diminution from its greatest opulence."

The author is Commissioner of "The Wild Flower Protection Association," and the motive of the book is to encourage an intelligent interest in the wild flowers with a view to their protection. An Appendix gives a list of the species, the plucking, uprooting, or damaging of which is prohibited in the Cape Province.

The author is also a naturalist, and the record of each month is a chatty account of the flowers as they grow in the various localities, of points of interest in their habit, pollination, or fruiting, and also of associated bird and animal life. Strict botanical descriptions are not attempted, but features are described which will not be found in a scientific flora. For example, an insistence on the right way to look at a flower to appreciate the relation of its form to its environment or its method of pollination. Thus, *Gladiolus tenellus*, the small brown afrikander, "adopts a through lighting, and one has not seen the flower properly until with the sun above the slope on which it grows (it orientates down slope) one has stooped down and peered into the flower as the sun shines through."

The correlation of figures and text is somewhat unusual. The small black and white sketches are printed in the broad margin of the page without special reference to the accompanying text. Each bears a number, and its name can be found by reference to a key-list of flowers in the beginning of the book. An indication of the reduction in size from the natural object would have been a helpful addition. The twelve plates, beautifully printed in colour, each representing one or more flowers, add conspicuously to the attractiveness of the volume.

It is a book which the visitor to the Cape, if a lover of flowers, will treasure as a delightful reminder of his visit, and "the man in the street," who can afford to possess it, will find his interest in the native flora much increased.

The text, which is remarkably clear, and the production of the book generally, reflect great credit on the printers and publishers, Messrs. Maskew Miller, of Cape Town.

BOOK-NOTES, NEWS, ETC.

THE BOTANICAL DEPARTMENT OF UNIVERSITY COLLEGE.—In connection with the celebrations of the Centenary of the College in June of this year, an interesting pamphlet has been issued, entitled "An Outline of the History of the Botanical Department." The Chair of Botany dates from the foundation of the College in 1827, but during the first fifty years there existed here no department of Botany in the modern sense. The professor, who held his post primarily as an additional source of income, delivered his lectures and departed, and there were no practical facilities for developing the science within the precincts.

During the whole period there have been only three Professors of Botany: John Lindley, 1828–1860; Daniel Oliver, 1860–1888, and his son, F. W. Oliver, 1888, to the present time. William Griffith, known for his work on Indian botany, and William Crawford Williamson, a pioneer in the study of the structure of fossil plants, were pupils of Lindley. His work at the College allowed ample leisure for investigation, writing, and administrative work outside the College. Lindley's *Vegetable Kingdom* was a solid contribution to the development of a natural system of plant classification, and his Introductory books were extensively used. With Hutton he elaborated a *Fossil Flora of Britain*; but his most outstanding work was on the taxonomy of the Orchidaceæ; his *Genera and Species of Orchidaceous Plants* (1840) brought order into the family by supplying a basis for its subdivision.

The work of Daniel Oliver was mainly the building up of the Kew Herbarium and the exposition of the collections in many publications too well known to need mention here. But the pamphlet gives an interesting insight into his work at University College, where for the 28 years of his professorship he lectured at 8 A.M.—this entailing a start from his home at Kew Gardens at 6 A.M. A feature of his lectures was his insistence on practical work in Systematic Botany; every day six specimens were dealt with, a quarter of an hour being taken from the lecture for this purpose.

In 1880, when the University of London imposed a practical test at the various examinations, practical laboratory classes were started under the direction of F. O. Bower. Bower was succeeded in 1882 by D. H. Scott, who also gave advanced lectures during the winter.

The modern development of the Department dates from 1888, when Daniel Oliver was succeeded by his son. More commodious quarters were obtained in the Birkbeck building, hitherto devoted to Applied Chemistry, and in 1909 Botany migrated to the old Physiological Department, where it found accommodation much superior to that which preceded it, but which is now cramped and inadequate.

With the establishment of Botany as a full-time subject full courses for advanced and post-graduate students were instituted, and some account is given of the achievements in the various lines of work. Among the names of the workers are many which are familiar as associated with important additions to knowledge in various branches of the science. The lines of work have varied in the course of time. In the 'eighties and 'nineties morphology and anatomy were predominant,

later anatomy from an evolutionary point of view. This led on to palæobotany, and in the early years of the present century there came a definite trend towards ecology and physiology. A feature of the ecological work has been study in the field, for some years carried out at the Bouche d'Erquy, a Brittany Salt Marsh, and since 1910 at a permanent station at Blakeney Point, Norfolk.

Copies of the pamphlet may be obtained from Mr. F. T. Smith in the Department, price Half-a-crown.

'COUNTRY-SIDE: A QUARTERLY MAGAZINE DEVOTED TO NATURE.'—Number 1 of the New Series of this Magazine for Nature-lovers contains 44 pages of short articles, notes, reviews, &c., which will be of interest to lovers and students of Nature in the British Isles. Many of the contributions are illustrated by photographs and line-blocks. Of special interest is the excellent photograph of Mr. E. Kay Robinson, founder and president of the British Empire Naturalists' Association and originator of *Country-Side*, and an article from his pen describing the regretted break-down in health which incapacitated him last year for further active control of the Union and its Journal. The Journal has been revived under the editorship of Mr. Richard Morse, F.L.S., and Mr. Ray Palmer, F.E.S., F.Z.S. Articles of botanical interest are "The Quest of British Orchids," by C. B. Tahourdin; "Botanizing in Fenland," by J. F. Rayner, an account of a visit to Wicken Fen, now under the charge of the National Trust; "Wild Plants that catch Insects," by J. E. Lousley; and "Some Easily-grown Alpines," by R. J. Skarratt. A classified list of "Nature Records" includes first note of flowering of plants from observers in different countries; there is also a long list of referees. The price of the copy is 9d.

An inset in the Magazine gives a brief statement of the present position of the B. E. N. A., the future of which is shortly to be discussed at a meeting of members. The annual subscription will for the present be a *minimum* of 4s., and each member will receive, in addition to every issue of *Country-Side*, a copy of the *Country-Side Diary*, published in December. Subscriptions should be sent to Mrs. G. B. Thomason, 'Warham,' Glamorgan Road, Hampton Wick, Middlesex.

BRITISH MUSEUM (NATURAL HISTORY).—The issue of additional series of postcards illustrating British Orchids brings up to thirty the number of British species of this family now available in picture-postcard form. Series Nos. 1 and 2 were issued previously; the species now illustrated are as follows:—

Series No. 3. *Orchis purpurea*, *O. ustulata*, *O. maculata*, *Himantoglossum hircinum* (Lizard Orchis), and *Aceras anthropophora*.

Series No. 4. *Gymnadenia conopsea*, *G. alba*, *Cæloglossum niride*, *Platanthera bifolia*, and *P. chlorantha*.

Series No. 5. *Epipactis Helleborine*, *E. atropurpurea*, *E. palustris*, *Cephalanthera latifolia*, and *C. rubra*.

Series No. 6. *Herminium monorchis*, *Spiranthes spiralis*, *S. striata* (Ireland), *Listera ovata*, and *Cypripedium Calceolus*.

With the exception of the *Cypripedium*, the figures are reproduced from Mr. E. G. Bedford's drawings of living plants.

THE IMPERIAL BUREAU OF MYCOLOGY has issued a list of Mycologists resident in the British Empire in 1927. This supersedes the list previously issued, and the Director asks for additions and corrections for incorporation in the next list, which will be issued in due course. The names are arranged alphabetically in groups corresponding to Great Britain and the various overseas dominions. The special interests of each worker are indicated.

Copies of the list may be obtained from the Bureau, Kew, Surrey; price One Shilling.

DEATH OF FATHER OF THE LINNEAN SOCIETY.—By the death, at the age of 91, on July 6, at Penllergaer, Swansea, of Sir John Talbot Dillwyn-Llewelyn, Bart., the Linnean Society of London loses its Fellow of longest standing. Sir John, who was elected on June 16, 1859, had never taken an active part in the affairs of the Society, but was much interested in Horticulture and a keen supporter of the Royal Horticultural Society; he was elected one of the Victorian Medallists of Honour in 1907. A portrait and short biographical notice appears in the *Gardeners' Chronicle*, July 16. The Father of the Linnean Society is now Dr. W. C. McIntosh, F.R.S., Emeritus Professor of Natural History, University of St. Andrews, who joined the Society March 5, 1863, and was awarded the Linnean Medal for investigations in marine zoology in 1924.

AMONG the names of recipients of Civil List Pensions which has recently been published we note that of Professor James Richard Ainsworth Davis, M.A., in recognition of his services in furthering the cause of science and education. Botanists are specially indebted to Prof. Ainsworth Davis for his translation from the German of Dr. Paul Knuth's *Handbook of Flower Pollination*, which was published by the Clarendon Press. Also that of Mrs. Gertrude Eleanor Fitch, in recognition of the services rendered by her husband, the late John Nugent Fitch, the botanical artist, an account of whose work was given in the *Journal* last April (p. 118).

MR. CHARLES H. WRIGHT, A.L.S.—The *Gardeners' Chronicle* for July 16 has a portrait and biographical sketch of Mr. Charles Wright, who has been associated with the Herbarium at the Royal Gardens, Kew, since 1884, first as Assistant, and since 1908 as Assistant Keeper. Mr. Wright's principal charge has been the Petaloid Monocotyledons and Ferns, and he has also rendered important service as Sub-Editor of the *Flora Capensis* and *Flora of Tropical Africa*, to which he has contributed accounts of several families.

THE death is announced, on July 14, at the age of 83, of Mr. CHARLES FORD, I.S.O., formerly (1871–1902) Superintendent of the Botanical and Afforestation Department, Hongkong. Mr. Ford was the author of various Reports on plants of economic interest, and also prepared an Index of Chinese Plants mentioned in the *Journal of Botany* up to the end of 1880 (vols. i.–xviii.), which was published in Hongkong in 1883. He was elected F.L.S. in 1885.

NEW RUBIACEÆ COLLECTED BY MR. L. J. BRASS IN BRITISH NEW GUINEA.

By S. MOORE.

THE services of Mr. L. J. Brass, who had already collected plants in British New Guinea, were recently enlisted by the late Professor Sargent with the object of securing Papuan specimens for the Arnold Arboretum. Mr. C. T. White, F.L.S., Queensland Government Botanist, under whose auspices Mr. Brass has been working, enquired whether it would be convenient for the Rubiaceæ to be worked out at the British Museum, and, Dr. Rendle's answer being favourable, the present paper is the result. While writing it, Dr. Valetton's memoir on Papuan Rubiaceæ, only just finished (Engl. Bot. Jahrb. lx. and lxi.), has been constantly in use. Valuable, however, as that memoir is, the title "Die Rubiaceæ von Papuasien" is somewhat of a misnomer. This title was adopted to be in accord with the series of monographs on the New Guinea flora appearing from time to time in the *Jahrbuch*, and is incorrect only in respect of certain genera, in dealing with which the author confines himself to Mandated Territory species alone. Attention is drawn to this matter because, from neglect of it, the danger is run of species founded on material from British or Dutch New Guinea being re-described as new on specimens from the north-eastern part of the island. Further, it may be remarked that correlation between the presumed species of the three geographical divisions would be an advantage, as it is scarcely possible to name, without some mistakes, a series of specimens from descriptions alone, and the chances are that redundancies occur in the lists from all three.

The collection contains sixty-two numbers referable to fifty-five species: of these, seventeen are only generically nameable, owing to their imperfect state. To these must be added a specimen with only a single flower, and therefore not dissected, of uncertain (possibly new) genus. Nineteen of the remainder are considered to represent new species, while one is a male specimen of *Timonius merokensis* Wernh., of which only the female was previously known.

The types of the species are in the Botanical Department of the British Museum.

NEONAUCLEA Merr. (*Nauclea* auct.).

Of this genus (as *Nauclea*) Valetton cites eight Papuan species. The following is believed to be yet another:—

Neonauclea Brassii, sp. nov. *Arbor* gracilis, glabra, 5–6 m. alt.; *ramulis* tetragonis cinereis; *foliis* obovato-oblongis basi in petiolum brevem latum superne concavum nigrum cuneatum angustatis apice obtusissimis pergamaceis nitidis glabris costis lat. utrinque 8–9 patule aruatis pag. utraque bene visibilibus reticulo laxo parum eminente; *stipulis* oblongis obtusis in sicco nigris; *pedunculo* (uno solum viso) terminali foliis brevioribus bracteolis jam delapsis paululum sub apice

instructo; *capitula* globoso; *ovario* quadrangulati sparsim puberulo ovulis in loculis solitariis; *calycis* parte persistente griseo-pubescente hujus lobis truncatis appendicula inferne superneque attenuata medio conflata griseo-pubescente apice tamen obtusa brunnea glabraque; *corollae* lobis suborbicularibus; *antheris* corollae faucibus insertis apicem tubi attingentibus; *stylo* exserto; *stigmatibus* globoso.

Hab. Sogere, 1500 ft. in marshy places in rain forest, 658.

Branches 4-5 mm. across. Leaves 8-11 × 4.5-7 cm., drying chestnut-colour but paler below. Stipules 7 × 3 mm. Peduncle 4 cm. long. Capitulum (including the protruded styles) nearly 4 cm. in diameter. Ovary about 1 mm. long. Persistent part of calyx 2 mm. long; lobes about 1 mm., appendix 5-6 mm. long. Corolla 9-10 mm. long; lobes 1-1.5 mm. broad. Style protruding from the corolla 5-6 mm.

Apparently near *N. maluensis* (Valeton sub *Nauclea*), from N.E. New Guinea, described as having leaves grey above and red below, and rotundate appendages to the calyx linear at the tip; unfortunately its flowering capitula are unknown; but, in view of the difference in calycine appendages, its flowers are almost certain to show further discrepancies when they come to be examined.

DOLICHOLOBIUM.

Dolicholobium rufflorum, sp. nov. *Arbuscula* gracilis; *ramulis* mox glabris subtortibus cortice sulcato cinereo circumdatis cicatricibus foll. delapsorum signatis; *foliis* obovatis vel obovato-oblanco-latis acuminatis apice acutis obtusisve basi in petiolo rufo-pubescentem angustatis papyraceis utrinque subnitidis in sicco brunneo-viridibus subtu pallidioribus pag. sup. glabris pag. inf. in nervis rufo-pubescentibus costis lat. tenuibus utrinque 11-13 juxta marginem subito arcuatis haud dichotomis pag. utraque eminentibus reticulo sat arcto costulis subrectis percurso; *stipulis* petiolis brevioribus oblongis obtusis appresse rufo-tomentosis; *cyma* terminali subsessili vel pedunculata (pedunculo uti pedicelli elongati rufo-tomentello) 2-3-flora; *florum* ♂ solum cognitorum calyce cupulari dorso rufo-tomentoso ore dense piloso-ciliato; *corollae* 5-merae albæ tubo rufo-tomentello quam lobi oblongi obtusi intus glabri paullo brevioris; *antheris* inclusis sessilibus prope medium tubum affixis; *styli* rudimento parvulo ramis 2 brevibus terminato.

Hab. Hohoro, Vailala River, in open rain-forests on the ridges, 1046.

"Small, slender tree." Leaves mostly 10-18 × 4-7.5 cm., but a few smaller are present; petioles 1-2 cm. long. Stipules soon falling off, about 8 mm. long. Peduncles 4-20 mm. long, when short stout, slender when long. Pedicels 25-30 mm. long. Calyx 2.5 mm. long. Corolla-tube somewhat widened above, 7 mm. long., lobes 10 mm. long. Anthers narrowly linear, 3 mm. long. Style rudiment 2 mm., the arms 1 mm. long, glabrous.

In foliage this is almost a counterpart of *D. Forbesii* Wernh., hitherto the only species known from S.E. Papua; its leaves are thinner (those of *Forbesii* being pergamaceous), and both stipules and

flowers are quite different. Besides *D. Forbesii* Valeton mentions six species as endemic in New Guinea—of these, *ruffiflorum* is nearest *D. rubrum* Schlechter and *D. graciliflorum* Valeton, both shrubs. The chief points about the new plant are the small stipules, the peduncles sometimes much shorter than and, when longest, not longer than some of the petioles, the long, very slender pedicels and the corolla with short tube and lobes only about half as long again.

OLDENLANDIA.

Valeton's clavis differentiates seventeen species natives of Papua. The following is remarkable for its long and narrow leaves and solitary pedunculate flowers:—

Oldenlandia Aparine, sp. nov. *Herba* diffusa fere glabra; *ramulis* prolixis quadrangularibus striatulis in nodis aliquantum tumidis; *foliis* elongatis linearibus vel angustissime lineari-lanceolatis acuminatis basi petioliformi-angustatis papyraceis utrinque scabriusculis in sicco fuscis costa media pag. sup. plana pag. inf. prominente; *stipulis* parvulis a basi lata in lobos lineares inæquilongos desinentibus; *floribus* in axillis solitariis pedunculatis pedunculis tenuibus patulis recurvisve; *ovario* subgloboso; *calycis* scabriusculi lobis 4 ovario paullo longioribus lineari-lanceolatis acuminatis; *corolla* anguste campanulata hujus lobis 4 oblongis obtusis tubum semiaquantibus; *staminibus* corollae ori affixis, antheris breviter exsertis; *capsula* globosa coriacea nitida fere usque basin fissa polysperma.

Hab. In sago swamps, Varsava River, 1017.

Branches 1-2 mm. in diameter; internodes usually 6-8 cm. long. Leaves up to 7.5 cm. long and 4 mm. broad, usually 5-6 cm. × 3 mm. Peduncles 8-20 mm. long. Ovary 1.25 mm., calyx-lobes barely 2 mm. long. Corolla apparently white, 3 mm. long (lobes 1 mm., tube 2 mm.), the tube slightly pilose within. Filaments 1 mm. long, papillose anthers .75 mm. Capsule 3.5 mm. in diameter, crowned by the persistent up to 2.5 mm. long calyx-lobes.

MUSSÆNDA.

Valeton's clavis deals with fourteen Papuan species of this genus: it omits the names of seven, viz., one from the Mandated Territory, *M. procera* Bail. (Queensl. Agric. Journ. iii. 155), four from Dutch and two from British New Guinea. The types of all seven, except *M. procera*, are in the British Museum, and to these are now added the two following:—

Mussænda ornata, sp. nov. *Frutex* scandens vel diffusus; *ramulis* teretibus glabris sparsim minuteque lenticelliferis striatulis novellis fulvo-pubescentibus; *foliis* petiolatis ovatis acuminatis acumine obtuso basi rotundatis vel rotundato-truncatis nitidis membranaceis pag. utraque fere glabris costis lat. utrinque 9-10 aperte arcuatis nequam dichotomis tandem intramarginalem efficientibus omnibus uti reticulum arctum etsi delicatulum sat prominentibus; *stipulis* petiolo brevioribus oblongis obtusis secus lineam elevatam dorsalem

minute puberulis diutule persistentibus; *cymis* (floribus exemptis) quam folia paullo brevioribus harum ramis ascendentibus bis trichotomis uti bractæ subulatæ acuminatæ fulvo-puberulis; *pedicellis* brevibus fulvo-pubescentibus; *ovario* quam pedicellus longiore fulvo-pubescente; *calycis* fere basin usque divisi segmentis foliaceis ovatis acuminatis basi exclusa fere glabris; *segmento foliaceo* late ovato verisimiliter obtuso basi 5-nervo costa centrali bis dichotoma præter nervos puberulos glabro; *corollæ* tubo elongato sursum vix ampliato fulvo-pubescente lobis oblongis acutis dorso puberulis.

Hab. Hewa, Vailala River, in the rain-forests, 1126.

"Climbing or large rambling shrub." Branchlets brown, 2.5-3 mm. across; internodes 4-6 cm. long. Leaves 8-9 × 4.5-6 cm., drying greenish-grey; secondary nerves running almost straight from side-nerve to side-nerve; petioles slender, nearly glabrous, 10 mm. long. Stipules 9 mm. long, dark when dry. Cymes (without the flowers) about 7 × 5 cm. Peduncle 2 cm. long, bearing at top a couple of small foliaceous bracts about 20 × 3 mm. Bracts about 7 mm. long. Primary branches 2.5-3.5 cm., pedicels 2-3 mm. long.

Flowers yellow. Calyx 15 mm. long, the segments 5 mm. broad; petaloid segments white, 10 × 7.5 cm. with a 13 mm. stalk. Corolla-tube 37 mm. long, when dry 1.5 mm. wide in lower part, 2 mm. in the upper; lobes 10 mm. long. Fruit not seen.

The position of this is probably next to *M. æstuarii* K. Schum., described as having smaller elliptical leaves acute at base with only 6-7 pairs of side-nerves, and flowers different in some respects.

M. pluviatilis, sp. nov. *Frutex* amplus, diffusus; *ramulis* sat validis tetragonis glabris striatulis lenticelliferis novellis appresse griseo-sericeis; *foliis* (paris sæpe inæquimagnis) petiolatis ovatis vel late ovato-oblongis breviter acuminatis acumine acuto basi cuneatis raro rotundatis membranaceis supra fere glabris pallideque nitidis subtus in costis minute appresse pubescentibus costis lat. utrinque 9-10 aperte arcuatis haud dichotomis laxè reticulatis costis uti reticulum pag. inf. solummodo bene visis; *stipulis* a basi lata attenuatis fere medium usque bilobis dorso pilis strigillosis appressis instructis lobis subulatis acutis; *cymis* bis trichotomis foliis circiter æquilongis brevipedunculatis paucifloris fere glabris; *bracteis* subulatis appresse strigillosis; *pedicellis* ovario cylindrico plane brevioribus; *calycis* segmentis subulato-filiformibus dorso puberulis segmento foliaceo ovato breviter acuminato basi 7-nervi nervo centrali cito dichotomo; *corollæ* tubo sat elongato sursum aliquanto ampliato fulvo-puberulo lobis abbreviatis ovatis acuminatis; *fructu* oblongo fere glabro calyce persistente coronato.

Hab. Kurandi, Eastern Division, in rain-forest regrowths, 1401.

"Large rambling shrub." Branchlets dark purple-brown, 3-4 mm. across. Leaves in the very early state with a dense clothing on the nerves of white appressed strigillose hairs, 9-14 × 5-7 cm., drying greyish-brown; petioles 15-30 mm. long, of the smaller of a pair 5-7 mm. Stipules 8 mm. long, of which the lobes 3 mm. Inflorescence about 10 × 3-4 cm. Peduncle about 15 mm., bracts 3 mm.,

pedicels 3-4 mm. long. Flowers yellow. Ovary 7 mm., calyx-segments 5-6 mm. long, petaloid segment 7 × 4 cm. in addition to a delicate stalk of nearly 4 cm. Corolla-tube 40 mm. long, when dry 1 mm. wide below, 2.5 mm. above; lobes 6 mm. long. Fruit (apparently not quite ripe) 22 × 4-5 mm.

According to description, this differs from *M. Pullei* Valet., among other features, in bilobed stipules, few-flowered cymes, bracts shorter than the ovaries and subulate (not foliaceous) calyx-lobes.

Another *Mussaenda* specimen, unfortunately without flowers, is No. 649, from Sogere, 1500 ft. It is "a large, rambling shrub in the rain-forest," and agrees exactly with Forbes's Nos. 30 and 207, doubtfully referred, in the absence of flowers (see Journ. Bot. Suppl. 1923, p. 24), to *M. macrantha* Valet.

RANDIA.

Randia suavissima, sp. nov. *Arbuscula* vel *frutex* elatus; *ramulis* tetragonis brunneo-pubescentibus postinde glabris cinereisque; *foliis* magnis subsessilibus obovato-subpanduriformibus cuspidato-acuminatis apice acutis basi obtusis pergamaceis pag. sup. glabris levissimeque nitidis subtus pubescentibus costis lat. utrinque circa 14 sub margine arcuatis pag. utraque eminentibus; *stipulis* diutule persistentibus lanceolatis acutis dorso brunneo-pubescentibus; *floribus* breviter pedicellatis nunc in axillis summis solitariis nunc in cymam ramosam circa 12-floram brevipedunculatam digestis pedunculo pedicellisque sparsim pubescentibus; *bracteis* parvulis ovatis; *ovario* subturbinate glabro; *calycis* tubo anguste campanulato ore ciliato dentibus 5 brevibus acutis instructo intus glanduloso; *corollæ* albæ suaveolentis tubo sat elongato superne dilatato quam lobi inter se paullo inæquales lanceolati acuti longiore; *antheris* sessilibus linearibus faucibus corollæ insertis; *stylo* inclusis puberulo; *stigmatibus* anguste clavato stylo æquilongis; *fructu* fusiformi.

Hab. Ihu, Vailala River, in rain-forests, 967.

"A small tree, 15 ft." Leaves when full-grown about 27 × 10 cm. or somewhat less, drying grey-green, darker above; petioles stout, pubescent, at most 5 mm. long. Inflorescence (in flower) about 10 × 8 cm. Peduncle stout, 6 mm. long; branches of cyme 15-23 mm. long; pedicels 4-6 mm. long. Ovary 4-6 mm. long; calyx-tube 7 mm., its teeth 1 mm. Corolla-tube 3-4 cm. long, 2 mm. wide, enlarged to 5 mm. in upper part; lobes 27 × 7-10 mm. Anthers 10 mm. long, as also are the style and the stigma. Fruit (not yet mature) 4 × 1.5 cm.

This is evidently near *R. insignis* Valet., said to have somewhat differently-shaped leaves, flowers in corymbose racemes on pedicels of 2-4 cm., ovary pilose outside, calyx without the ciliation at the mouth, longer anthers, and exerted stigma.

No. 927 with axillary flowers, has a fruit in one axil, in the opposite a flower. It is "a slender tree or tall bush," the fruit "coloured yellow and green." It is certainly conspecific with No. 967.

GARDENIA.

Gardenia dryadum, sp. nov. *Arbuscula* fere omnino glabra; *ramulis* primo aliquanto compressis mox subteretibus corticeque cinereo striato obductis inferne nudis floriferisque necnon foliorum delapsorum sigillis prominentibus notatis; *foliis* petiolatis late obovatis sursum rotundatis apice emarginatis basin versus gradatim attenuatis chartaceis opacis costis lat. utrinque 7-8 ascendentibus marginem versus arcuatis pag. utraque sat eminentibus pag. inf. in axillis sæpe barbellatis; *stipulis* ovato-oblongis obtusis usque medium connatis; *floribus* 5-meris inter minores in ramulis axillaribus validis maxime abbreviatis pedunculatis pedunculis basi bracteis parvis ovatis stipatis; *ovario* turbinato quam calyx tubulosus ore undulato-denticulato paullo brevior; *corollæ* tubo calycem excedente superne dilatato extus dense sericeo-tomentoso lobis lanceolato-oblongis obtusis tubum æquantibus; *antheris* inclusis; *stilo* incluso glabro; *stigmatibus* fusiformi vertice bifido.

Hab. Loloki River, 1000 ft. alt., 547.

"Small tree, leaves pale green, flowers white." Branchlets soon becoming 4 mm. across. Leaves mostly 12-15 × 8-9.5 cm., drying a dark grey-brown; reticulum virtually invisible to the naked eye; petioles stout, somewhat flattened, 10-15 mm. long. Stipules 10 mm. long. Flower-bearing branches woody, 5-12 mm. long, about 2-4 mm. thick. Bracts concave, 3 mm. long. Pedicels up to 6 mm. long, often shorter. Ovary 3 mm., calyx 5 mm. long. Corolla-tube 10 mm. long, 2-3 mm. wide below, 4.5-5 mm. above; lobes 10 mm. long. Anthers 3.5 mm., style 5 mm., stigma 3 mm. long.

Nearest *G. carstensensis* Wernh. (referred to *Randia* by Valetton), differing from it chiefly in the smaller obovate leaves, the entire (not lobed) calyx, and the more slender tomentose (not minutely grey-hairy) corolla-tube.

TIMONIUS.

Valetton's clavis of this genus concerns only species known from the Mandated Territory; they number 29. The British Museum has 11 Papuan types, of which 7 are from Dutch and 4 from British New Guinea. The following, believed to be new, bring up the number of types to fourteen:—

Timonius whiteanus, sp. nov. *Arbuscula*; *ramulis* inferne nudis cicatricibus foliorum mortuorum notatis prima juventute appresse sericeo-villosulis dein glabris corticeque cinereo multistriato circumdatis; *foliis* petiolatis oblongo-oblancoatis vel elliptico-oblongis breviter acuminatis obtusiusculis basi in petiolum coarctatis tenuiter pergumaceis nitidulis supra glabris subtus præsertim in costis subsparsim appresse sericeo-strigillosis in sicco castaneo-brunneis costis lat. utrinque 8-10 marginis fere tenus ascendentibus pag. inf. prominentibus axillis interdum barbellatis reticulo arcto mediocriter visibili; *stipulis* elongatis triangularibus acuminatis extus appresse sericeis; *floribus* ♀ (♂ ignotis) in axillis solitariis pedunculatis pedunculis compressis sparsim minute sericeis; *ovario* globoso; *calycis* ovario

æquilongi tubo cylindrico lobis 5 brevibus triangularibus obtusis intus sericeis; *corollæ* tubo leviter infundibulari extus dense appresse sericeo-tomentoso lobis 11 oblongis obtusis crassiusculis tubo brevioribus; *stilo* incluso microscopice sericeo quam rami 11 brevior; *drupa* depresso globosa glabra nitida calyce persistente terminata parum succosa pyrenis pluribus radiatim dispositis fere omnino impleta.

Hab. Ihu, Vailala River, on river bank, 1109.

"Compact tree, 12-15 ft." Leaves 7-10 × 3-4 cm.; petioles 10-15 mm. long. Peduncles 1-1.5 cm. long. Calyx-tube 5 mm. long, the lobes about 1 mm. Corolla white; tube 8 mm. long, 2 mm. wide immediately above the slightly enlarged base and 3 mm. in its upper part, lobes 3-4 mm. long. Style 4 mm. long with 7 mm. long branches. Ripe drupe rich brown, crowned by the rigid calyx, 12 × 10 mm., with five slightly protruding angles having a depression between each pair, occupied, except for a very narrow pulpy portion abutting on the exocarpe, by closely-packed radiately-arranged pyrenes, the 18 rays each with four pyrenes.

Timonius sylvestris, sp. nov. *Arbuscula*; *ramulis* ultimis robustis internodio summo compresso minute griseo-sericeo ceteris subteretibus glabris cortice subcinereo sulcato obductis; *foliis* majusculis petiolatis oblongo-obovatis cuspidato-acuminatis apice obtusiusculis basi cuneatis pergumaceis in sicco castaneis pag. inf. castaneo-griseis juvenilibus subtiliter appresse fulvo-sericeis postea pag. sup. glabris nitidisque pag. inf. in nervis pubescentibus vel fere glabris costis lat. utrinque 14-17 apertissime ascendenti-arcuatis usque marginem progradientibus utrinque prominulis reticulo clathrato; *capitulibus* ♂ paucifloris dichotomis pedunculo quam petiolus brevior insidentibus bracteis ovatis intus basi appresse sericeo-villosis involucrentibus; *floribus* 4-meris sessilibus secundis; *calycis* sparsim appresse sericei tubo campanulato; *corollæ* vix pansæ extus dense sericeo-tomentosæ tubo sensim leviter dilatato quam lobi oblongi obtusi longior; *antheris* subsessilibus.

Hab. In rain-forest at Bisiatabu, 1500 ft., 582.

"Small tree, 15 ft., thin grey bark." Leaves 13-19 × 6-10 cm., petioles stout channelled above, finely puberulous, 1.5-3 cm. long. Peduncles compressed, silky or nearly glabrous, 12-15 mm. long. Branches of cymes about 7 mm. long, the bracts apparently about 7 × 5 mm. (none complete seen). Calyx-tube 4 mm., lobes 5-6 mm. long. Corolla-tube 13 mm. long, below 1 mm. wide, under the limb 2 mm.; lobes 8 mm. long. Anthers 7.5 mm. long. Style rudiment silky at base, 8 mm. long. Female plant not seen.

Affinity most probably with *T. grandifolius* Valet., which has still larger leaves obtuse or rotundate at base, and with 20-30 side-nerves and short petioles, much longer peduncles (3-4.5 cm. long), and 5-merous ♂ flowers.

(To be continued.)

TWO PAPUAN SPECIES OF *ARDISIA*.

By C. T. WHITE, F.L.S.

(Government Botanist, Brisbane, Queensland).

Ardisia filipes, sp. nov.

Frutex glaber. *Folia* breviter petiolata; petiolis 2-4 mm. longis; lamina 5-6 mm. longis ca. 4-plo longioribus quam lata, submembranaceis, lanceolatis, ad basim cuneatis ad apicem longe acuminatis; acumine ipso ca. 1 cm. longo; costa media subtus prominentibus; venis vix visibilibus. *Racemi* axillares, foliis multo breviores, 3-4-flori, umbellati; pedunculo ca. 5 mm. longo; pedicellis tenuibus ca. 8 mm. longis. *Flores* albi; calycis lobis 5 triangularibus ca. 0.5 mm. longis; corollæ lobis 5 ad basim brevissime connatis, 2 mm. longis, ovatis, acutis, nigro-punctatis; staminibus sessilibus, antheris triangularibus, acutis, 1.5 mm. longis; ovario ovoideo cum stylo 1.5 mm. longo. *Fructus* mihi non visus (fruit a red berry, $\frac{1}{2}$ in. diam., seed $1\frac{1}{4}$ in. round, C. E. Lane-Poole). *Ardisia* sp., C. E. Lane-Poole, *Forest Resources of Papua and New Guinea*, 131 (Melbourne, 1925).

Hab. Mount Obree, alt. 7400 ft., C. E. Lane-Poole, No. 358.

A shrub with white flowers and red berries; flowering and fruiting January 1923.

I could not find any fruits among Lane-Poole's material preserved in formalin, though they are referred to on the field-label.

About fifteen species of *Ardisia* have been recorded from Papua, and the present one seems to differ markedly from all these in its comparatively small long-acuminate leaves.

ARDISIA VENUSTA S. Moore in Journ. Bot. lii. 292 (1914).
A. Poolei White & Francis ex Lane-Poole, *Forest Resources of Papua and New Guinea*, 131 (Melbourne, 1925).

Hab. Owen Stanley Range, near Laruni, alt. 4000 ft., C. E. Lane-Poole, No. 393.

Small tree or large shrub; flowers red. Flowering February 1923.

The above species was named as new and a description drawn up by Mr. W. D. Francis and myself, but when revising the material it was thought that Mr. Lane-Poole's plant represented *A. venusta* S. Moore. Specimens sent to the British Museum were compared with the type and found to be identical.

FRESHWATER ALGÆ AND PHYTOPLANKTON OF THE LAKES AND RIVERS OF THE ZAISAN DISTRICT, ALTAI MOUNTAINS, SIBERIA.

By B. W. SKVORTZOW

(Harbin, China).

THE Algæ of South Siberia—as well as of the rest of this large country—are rather incompletely known. In the year 1830, Chr. Ehrenberg published an account of some of the Algæ in his "Beiträge zur Kenntniss der Organisation d. Infusorien und ihrer Geograph. Verbreitung, besonders in Sibirien"*; some are also listed in his *Microgeologie*, Leipzig, 1854. The most important contributions to our knowledge of the Freshwater Algæ of this region are of recent date—viz., H. Printz, "Die Chlorophyceen des Südlichen Sibiriens und des Uriankailendes" (Kgl. Norske Videnskab. Selskabs. 1815, No. 4), and B. W. Skvortzow, "Les algues de l'Altai" (Journ. Russ. Bot. Soc. iii. 1918, Petrograd).

Through the kindness of Prof. Werestchagin, of the Zoological Museum of the Russian Academy of Science, I have been enabled to examine some Algæ which were collected in 1905 by A. N. Sedelnikoff in lakes in the Altai Mountains of South Siberia. All the samples were gathered in the environs of Zaisan Lake, the Algæ of which will be dealt with in a separate paper.

The following is a list of the different localities in which the samples were collected:—

1. Plankton of Kamaruch River (3. vii. '05).
2. Plankton of Black Irtsich River (4. vii. '05).
3. Plankton of Topolevka River (4. vii. '05).
4. Plankton of Djarma River (2. vii. '05).
5. Plankton of Karasu Lake.
6. " " " "
7. Algæ collected near Tacibai Village.
8. Algæ collected near Djailubai Village.
9. Plankton of Kockul Lake (3. viii. '05).

The list includes 113 species and varieties, three of which are new to science. The number indicates the locality given above.

FLAGELLATE.

- Dinobryon protuberans* Lemm. 2.
Phacus orbicularis Hübner. 8.
Trachelomonas intermedia Swir. 8.
T. volvocina Ehrenb. 7, 8.
T. Borodiniana Swir. 8.
T. hispida (Perty) Stein. 8.
Peridinium cinctum (Müll.) Ehrenb. 4.

* Phys. Abhandl. K. Akad. Wiss. Berlin, 1830.

- Eudorina elegans* Ehrenb. 9.
Pandorina morum Bory. 4, 9.
Volvox aureus Ehrenb. 1, 6.

CYANOPHYCEÆ.

- Microcystis æruginosa* Kütz. 9.
M. incerta Lemm. 9.
Cælosphærium Kuetzingianum Näg. 9.
Gomphosphæria Naegelianiana (Ungel) Lemm. 9.
Merismopedia elegans A. Br. 1.
Oscillatoria proboscidea Gomont. 8.
Nostoc pruniforme Ag. 1, 9.
Rivularia sp. 9.

DIATOMACEÆ.

- Melosira granulata* Ralfs. 2.
Cyclotella Meneghiniana Kütz. 9.
Tabellaria flocculosa Kütz. 9.
Flagellaria capucina Desm. 7, 8.
F. crotonensis Kitton. 2, 9.
Synedra acus Kütz. 9.
S. capitata Ehrenb. 9.
Asterionella gracillima Heib. 2.
Cocconeis placentula Ehrenb. 1, 9.
C. pediculus Ehrenb. 1, 9.
Navicula cuspidata Kütz. 7.
Pinnularia major Kütz. 9.
Gomphonema geminatum (Lynbg.) Ag. 1.
G. constrictum Ehrenb. var. *subcapitata* Grun. 9.
Epithemia granulata (Ehrenb.) Kütz. 9.
Rhopalodia gibba (Ehrenb.) O. Müll. 9.
R. ventricosa (Grun.) O. Müll. 9.
Cymatopleura Solea W. Sm. 7, 8.
C. elliptica Bréb. var. *hibernica* W. Sm. 9.

CONJUGATE.

- Gonatozygon Kinahani* (Arch.) Rabenh. 1.
G. monotanium De Bary. 1, 4, 8.
G. pilosum Wolle. 1.
Netrium Naegelii (Bréb.) W. et G. West. 1.
Penium margaritaceum Bréb. 8.
Closterium Venus Kütz. 8.
C. moniliferum Ehrenb. 1, 7, 9.
Pleurotanium coronatum (Bréb.) Rabenh. 1.
Euastrum denticulatum (Kirchn.) Gay. 9.
E. Turnerii West. 1.
Micrasterias crux-melitensis (Ehrenb.) Hass. 1.
Cosmarium pygmaeum Arch. 9.
C. subtumidum Nordst. var. *Klebsii* (Gutw.) W. & G. West. 7.

- Cosmarium Meneghinii* Bréb. 8.
C. pachydermum Lund. 8.
C. læve Rabenh. var. *septentrionale* Wille. 8.
C. granatum Bréb. 1, 8, 9; var. *subgranatum* Nordst. 8.
C. punctulatum Bréb. 9.
C. Blyttii Wille. 7, 8, 9.
C. triplicatum Wolle. 1.
C. reniforme (Ralfs) Arch. 9.
C. Turpinii Bréb. 9.
C. Botrytis Menegh. 9.
Xanthidium cristatum Bréb. 1, 4.
Arthrodesmus convergens Ehrenb. 1.
Staurostrum gracile Ralfs. 6, 9.

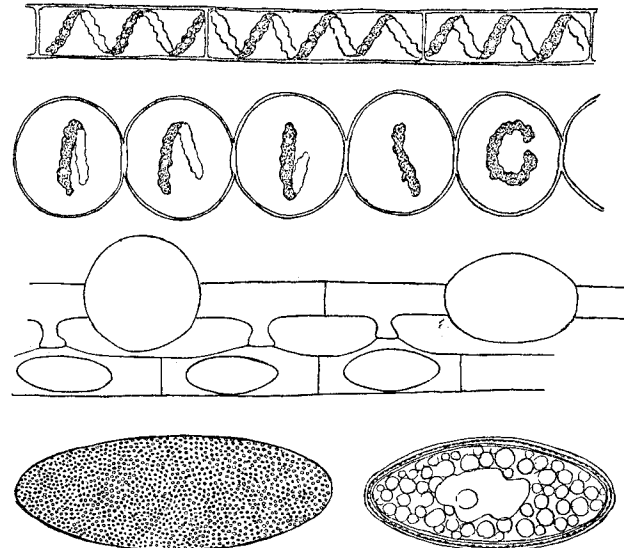
Fig. 1.—*Spirogyra sibirica* Skvortz., sp. nov.

- S. brevispinum* Bréb. 1, 9.
S. paradoxum Meyen. 9.
Desmidium Swartzii Ehrenb. 1, 8.
D. aptogonum Bréb. 1, 4, 8.
D. cylindricum Grev. 1.
Hyalotheca dissiliens (Sm.) Bréb. 1, 4.
Sphærozosma vertebratum Ralfs. 1, 9.
Spondylosium papillatum W. et G. West. 9.
Onychonema læve Nordst. var. *micracanthum* Nordst. 9.
Spirogyra Grevilleana (Hass.) Kütz. 7.
S. flavescens (Hass.) Kütz. 8.
S. maxima (Hass.) Wittr. 1.

Spirogyra sibirica, sp. nov. (Fig. 1.)

S. cellulis vegetativis diam. 2-3-plo longioribus; *chromatophora* singula, dentata vel serrata, anfractibus 1-4; *cellulis fructiferis* tubum copulantem versus solum inflatis; *cellulis sterilibus* in filis fertilibus sæpe valde inflatis et distortis; *zygosporis* ovoideis vel ellipsoideis, aureis, dense scrobiculatis. Diam. fil., 17 μ ; zygosp. 20 \times 32-40 μ .

Filaments 17 μ diam., cells 2-3 times as long. Chromatophore single, dentate or serrate, making 1-4 turns in the cell. Fertile cells swollen only on the side of the conjugation-canal; cells which have failed to conjugate often much swollen and distorted; spore ovoid, ellipsoid, golden colour, covered with pits, 20 μ in diam. and 32-40 μ in length. 8.

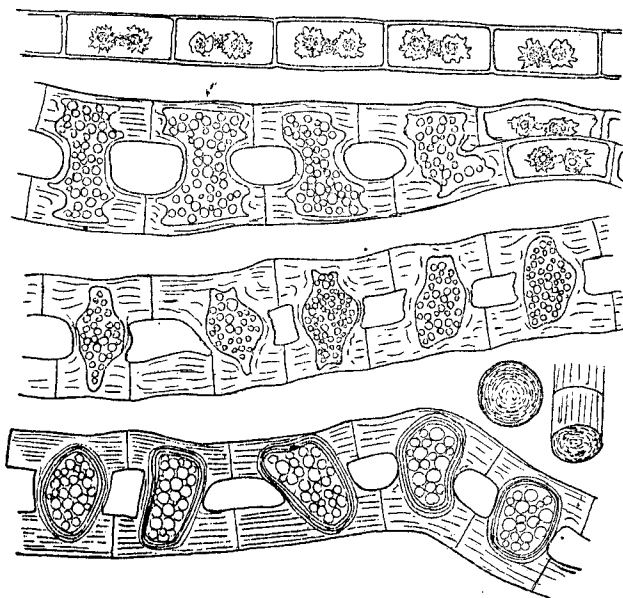

Fig. 2.—*Zygnema pectinatum* var. *conspicuum* (Hass.) Kirchn.

Zygnema pectinatum (Vauch.) Ag. var. *conspicuum* (Hass.) Kirchn. (Fig. 2.)

Membrane at first thin, later with a thick gelatinous sheath. Conjugation scalariform, spores globose or broadly ellipsoid. 7, 8.

Mougeotia quadrangulata Hass. 1.

M. scalaris Hass. 8, 9.

CHLOROPHYCEÆ.

Sphaerocystis Schroeteri Chod. 5, 6

Oocystis lacustris A. Br. 1, 9.

Botryococcus Braunii Kütz. 1, 4, 5, 9.

Kirchneriella lunaris Moeb. 1, 4.

Crucigenia rectangularis Chodat. 9.

Celastrum pulchrum Schmidle. 9.

C. microporum Näg. 9.

Sorastrum spinulosum Näg. var. *crassispinosum* (Reinsch.) Hansg. 8.

Polyedrium minimum A. Br. 9.

P. caudatum (Corda) Lagerh. 9.

P. lobulatum Näg. var. *irregulare* Reinsch. 9.

Scenedesmus bijugatus (Turp.) Kütz. 4; var. *granulatus* Schmidle. 8; var. *seriatus* Chod. 8.

S. acuminatus (Lagerh.) Chod. 8.

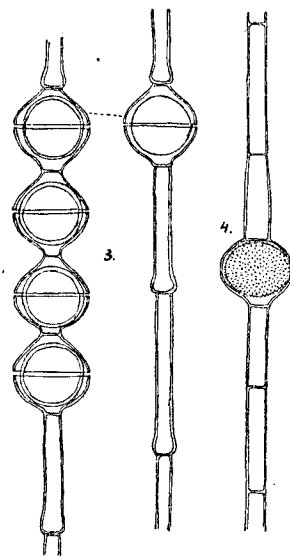

Fig. 3.—*Edogonium longicolle* var. *rotundospora* Skvortz., var. nov.

Fig. 4.—*O. Aster* var. *gracilis* Skvortz., var. nov.

S. arcuatus Lemm. 8.

S. acutiformis Schroet. 8.

S. quadricauda (Turp.) Bréb. 8.

Pediastrum Boryanum (Turp.) Men. f. *genuinum* Kirchn. 9; var. *granulatum* (Kütz.) A. Br. 7, 8, 9.

P. Kawraiskyi Schmidle. 1, 2, 9.

P. tricornutum Borge. 4.

P. tetras (Ehrenb.) Ralfs. 8.

P. duplex Meyen. 2, 8.

P. radiatum Meyen. 8.

P. integrum Näg. 9.

Ankistrodesmus falcatus (Corda) Ralfs. 1, 9.

Ophiocytium capitatum Wolle var. *brevispinum* Lemm. 8.

Stigeoclonium sp. 4.

Schizomeris Leibleinii Kütz. 7, 8.

Edogonium Richterianum Lemm. 8.

O. Aster Witttr. var. *gracilis*, var. nov. (fig. 4), oogoniis et oosporis minoribus quam in forma typica; oosporis spinis parvis obtectis. Lat. oogon. 28 μ , long. 27 μ ; lat. oospor. 24 μ , long. 20 μ .

Oogonia and oospore smaller than in the typical form. Oospore covered with small spines. Oogonia 28 μ diam., 27 μ long., oospore 24 μ diam., 20 μ long.

O. longicolle Nordst. var. *rotundospora*, var. nov. (fig. 3), oogoniis globosis, 20-21 μ lat., 20 μ long.; oosporis 19.5-20 μ lat. Diam. cell. veg. 5-7 μ , 5-7-plo longioribus.

Diam. of vegetative cells 5-7 μ ; cell 5-7 times as long. Oogonia globose 20-21 μ diam., 20 μ long.; oospore 19.5-20 μ diam.

GILBERT ISLANDS MOSSES.

By H. N. DIXON, M.A., F.L.S.

I RECENTLY received from the Rev. G. H. Eastman, Missionary of the London Missionary Society in the Gilbert Is. group, a small collection of mosses, mostly made in November-December 1926. The term "small" is relative. Although the collecting extended over parts of several days and in eight different islands, the number of species only amounted to seven or eight, and yet in all probability the gatherings represent the greater part of the species existing in the group.

The Gilberts are situated on the Equator, and between 170° W. and 180°. They are all coral islands, and all small and low-lying. The vegetation is scanty; coco-nut palms, Pandanus, and Jack-fruit are the only, or almost the only, trees. Woodford in *Geographical Journal* (vi. (1895), 325 sqq.) gives a list of the plants known, which he believes to be nearly complete, and which comprises only 20 species of vascular plants, almost without exception plants of general distribution in tropical oceanic islands and continental seashores. The cellular cryptogams have, I believe, never been studied.

The mosses for the most part follow the general lines of the distribution of the vascular plants. There is one new species; of the rest, four or five have a fairly wide distribution on the shores of the Pacific; the remaining two are only known each from one, or at most two, groups of the Pacific Is. It will be seen, therefore, that this collection makes a very distinct and welcome contribution to our knowledge of the bryophyte flora of the Pacific.

LEUCOBRYACEÆ.

LEUCOPHANES SMARAGDINUM* (Mitt.) Par. (*Octoblepharum smaragdinum* Mitt. in *Bonplandia*, ix. (1861) 366).
Little Makin I., 2 Dec., 1926 (No. 23).

A specimen of this species, with which the present plant agrees exactly, exists in the Kew collection, determined by Mitten, and collected by Powell in the Ellice Is., the group adjacent to the Gilberts, in September 1877.

L. pungens Fleisch., *ined.* (M. Fr. Arch. Ind. et Polynes. no. 405), from Samoa, appears to me identical with *L. smaragdinum*. Mitten's description in *Bonplandia* is very inadequate, and if Fleischer had only seen this it would quite explain his failing to identify his moss with it. Mitten does not include it in his list of Samoan mosses collected by Powell, but an unnamed specimen in his herbarium, "Samoa, Powell," belongs here.

The Gilbert Is. plant grew in large loose tufts of a bright glaucous green above, without fruit.

Distr. Samoa; Ellice Is.; Fiji.

CALYMPERACEÆ.

CALYMPERES TENERUM C. M. On trunks of Jack-fruit trees, Butaritari I., Dec. 1926 (Nos. 15, 17, 18).

Spherical bunches of gemmæ on the tips of the abnormal leaves were very conspicuous.

Distr. India; Malaya; Java; Borneo; New Caledonia; Queensland; Fiji.

CALYMPERES CRASSINERVE (Mitt.) Jaeg. (*Thyridium crassinerve* Mitt., *Syrrophodon crassinervis* Par.) On trunk of tree, Butaritari I., Dec. 1926 (No. 16).

A peculiar species, certainly no *Thyridium*, and probably best placed in *Calymperes* (subgen. *Somphoneuron*). The stems in the dry state are julaceous with the densely-set incurved leaves, the habit being then very much that of *Holomitrium vaginatum*. Abnormal leaves bear heads of propagula, but no fruit has been found. The cells are rather large, 10-13 μ wide, with a single distinct median papilla.

Distr. Samoa.

CALYMPERES DOZYANUM Mitt. Trunk of Jack-fruit tree, Butaritari I., with *C. tenerum* (No. 17 a).

I cannot distinguish this from *C. Dozyanum*, which has not been recorded from the Pacific, but which has a wide distribution in the Malay Archipelago, extending to the Philippines and Ceylon.

POTTIACEÆ.

Hyophila beruensis Dixon, sp. nov.

Humilis. Læte pallide virens. Caulis perbrevis, vix 5 mm. altus; folia rosulata, madida erecto-patentia, sicca involuta, subrigide contorta; late oblongo-spathulata, 1.5-2 mm. longa, .5-.6 mm. lata, apud basin circa .3 mm. lata; apice rotundata, *robuste apiculata*; marginibus omnino planis, integris vel subintegris. Costa apud basin valida, 60-80 μ lata, superne *validiuscula*, in apicem folii per-

currens. Cellulæ obscuriusculæ, in foliis infimis solum claræ, irregulariter hexagonæ, 8–12 μ latæ, lævissimæ, parietibus sat tenuibus; basin versus sensim majores, latiores, ad basin rectangulares, 2 \times 1–3 \times 1, hyalinæ, marginales 2–3 seriebus minores.

Propagula multicellularia irregularia ramosa magna stipitata ad .25 mm. longa axillaria haud numerosa inveniuntur. Cetera ignota.

Hab. Under coco-nut palms on coral sand, Beru, 28 Feb., 1926 (No. 1), type; and June 1926 (No. 5), co-type.

Although sterile, this is, I think, clearly an undescribed species. The leaves are practically entire, occasionally with a very slight irregularity of the margin near apex, but in no way denticulate; the margin is quite plane, the cells rather large for the genus and quite smooth, and the propagula are rather remarkable. They arise from a short axillary thread-like stem, and are at first broadly fusiform or clavate; later they develop branches more or less at right angles to the main axis, but in several planes, so that the complete body is somewhat in the form of a caltrop, the original part usually longer and tapering at base, and the several shorter branches arising from the upper, broader part of this and spreading in a stellate manner from it. A very similar form of brood-body is shown by Limpinricht (*Die Laubmoose Deutschlands &c.* i. 588, fig. 171), particularly the central figure of the three, under *Trichostomum Warnstorffii*. This resemblance is the more interesting, since that species is now referred to *Hyophila* as *H. riparia* (Aust.) Fleisch. The development of the brood-bodies is well shown by Correns (*Vermehrung &c.* pp. 69, 70, figs. 38, 39).

BRYACEÆ.

BRACHYMENIUM INDICUM (Doz. & Molk.) Bry. jav.

Sterile tufts of this were found in nearly all the gatherings:—Beru; Onotoa; Tarawa; Abemama; Little Makin (Nos. 1, 3, 7, 8, 10, 24).

Distr. Java; Amboina; New Caledonia; Fiji.

HYPNACEÆ.

ECTROPOTHECIUM MONUMENTORUM (Dub.) Jaeg.

Maraki I., Nov. 30th, 1926 (No. 9); Tarawa I. (No. 11); Tabiteuea I. (No. 12); Butaritari I. (Nos. 19, 21, 22); Ellice Is., leg. Powell (No. 68), in Herb. Mitten. All growing on coral rock or soil, in low, green, or yellow, dense patches.

I at first supposed this to be an undescribed species, marked by the very short seta and minute capsule, but there can, I think, be very little doubt that the plants—certainly all forms of one species—are identical with the primarily Malayan but rather widespread *E. monumentorum*. They all represent a slightly denser and more compact form than usual, but the general habit, branching, leaf-form and structure, and fruiting characters are similar in every way. Apart from the habit, the very short seta (less than 1 cm.) and small capsule are marked features.

I have a specimen sent from Mitten's herbarium in the New York Bot. Garden (No. 68 cited above), named, by Mitten, with several others, *E. Chamissonis*; none of them, however, appear to belong to that species. *E. Chamissonis* is a rather more robust plant (Fleischer, indeed, places the two species in two different subgenera, *E. Chamissonis* in *Ectropothecium* proper, and *E. monumentorum* in *Electropothecidium*, consisting of smaller species), of looser, more elongate, more regularly pinnate habit, and markedly longer setæ. Fleischer, it is true, and Brotherus give the length of seta in *E. Chamissonis* as 1 cm., but it is definitely stated by the authors of the *Bryologia javanica* to be 1.8 cm., and is so figured by them. Most of the Gilbert Is. plants have only a few old setæ left, but No. 12 has several old capsules (de-operculate) remaining.

Distr. Sumatra; Java; Caroline Is.; Timor; Banca; Philippines; Borneo; Singapore.

A sterile plant from Little Makin I. (No. 26) is probably an *Isopterygium*, but is not in sufficient quantity to be determined.

ABSTRACT OF PAPER OF INTEREST TO STUDENTS OF THE BRITISH FLORA.

NATURAL ORCHID HYBRIDS, BY COL. M. J. GODFERY (*Genetica*, ix. (1927) 19–38, with 6 figures and 1 coloured plate).—This is an interesting account of Orchid hybrids occurring in nature. The first natural hybrid discovered appears to be *Gymnadenia conopsea* \times *Nigritella nigra*, found in the Alps near Grenoble in 1787 and described by Villars under the name of *Orchis suaveolens* (Pl. Dauph. ii. 38, tab. 1, figs. 1–3). It was not till 1830 that another hybrid was recorded under the name *Orchis hybrida* Bonning, growing among its parents, *O. militaris* and *O. purpurea*. In 1841 Weddell found *Aceras anthropophora* \times *O. militaris* in the Forest of Fontainebleau. Among exotic Orchids, \times *Phalænopsis intermedia* was probably the first natural hybrid observed, at any rate in England.

Paragraphs are devoted to (1) hybrids between species of the same genus and (2) hybrids between species of different genera. In the first category are the British marsh-Orchids *Orchis incarnata*, *latifolia*, *prætermissa* and *purpurella*, which hybridize rather freely with *O. maculata* and also to a less extent among themselves. Wherever they grow together, hybrids may usually be found, and in some localities there are so many intermediate forms as to give some plausibility to the theory that they all belong to one polymorphic species. The more probable explanation is that they are the offspring of primary hybrids re-crossed with one or other of the parents.

A list is then given of hybrids between different genera, some of which are figured. Among these are:—*Orchis militaris* \times *Aceras anthropophora*, *Orchis latifolia* \times *Cœloglossum viride*, *Orchis maculata* (*elodes*) \times *Gymnadenia conopsea*, *Gymnadenia conopsea* \times *Cœloglossum viride*.

There are also paragraphs dealing with the effect of pollination on the ovules, transmission of characters, dominance of one or other parent, relation of variation to hybridisation, obstacles to hybridisation, fertilisation of a hybrid by its own pollen, fertilisation by pollen from a similar hybrid, whether hybridism can give rise to a new species, and the establishment of a hybrid by self-fertilisation.

Under the heading "Can Hybridism give rise to a new Species?" the author states that for the evolution of a true breeding race or species from a hybrid, two conditions appear to be essential: (1) the hybrid must be sufficiently abundant to ensure adequately frequent pollination from another specimen of similar parentage; (2) it must be protected from crossing with either parent.—E. G. B.

OBITUARY.

SIR HARRY JOHNSTON, G.C.M.G.

(1858–1927).

APPRECIATION of the work of Henry Hamilton Johnston as one of our great pioneers of Empire on the African Continent has appeared in the public press. The interesting *Story of My Life*, which he published in 1922, gives the reader an insight into the versatility and industry of a man who, trained as an artist in the Royal Academy Schools, devoted the best years of his life, as he himself describes it, "to the acquisition for British control of 400,000 square miles in various parts of Africa."

Johnston was a keen naturalist, a good observer, and could describe what he saw in clear simple language, while his artistic talent and skill in photography added greatly to the value of his descriptive work. In his various books on different parts of Tropical Africa the botanist will find vivid descriptions of landscape and vegetation, sometimes rich in detail; and our systematic knowledge of the plants has been much increased by collections brought home by himself or made under his directions or by his encouragement. An example of the latter was the exploration of Mt. Mlanje, Nyasa-land, by Mr. Alexander Whyte, in 1891, whose collections, described by the British Museum botanists (*Transactions of the Linnean Society*, ser. 2, iv.), yielded many interesting novelties. Johnston was a little impatient with the botanist's "unemotional" descriptions of the plants, with the beauty of which he was familiar in their native haunts—"Botany," he writes, "should be dealt with by a class of sylphs; instead of which its priests are often old and unenthusiastic men. Plod through page after page of botanical description, and where do you find any hint, as a rule, of the matchless beauty they should be describing?" (*British Central Africa*, ed. 3, 211, note). His own descriptions were often informative and helpful to the botanist. See, for instance, his reference to the *Mussaendas*—"The *Mussaendas* furnish much of the beauty of the bush and forest in Western Equatorial Africa. They usually grow as shrubs or

creepers, and either develop large white or scarlet or vivid orange flowers in clusters, or else the actual corolla of the flower remains small, but one of the sepals grows to an exaggerated extent, and becomes like a large leaf of satiny texture. This is either brilliantly white—as if it were cut out of white velvet—or crimson-scarlet, very similar to the *Poinsettias*. The magnificent displays of these crimson *Mussaendas* (*M. erythrophylla*) in the forests of Sierra Leone, Uganda, and the north-east of the Congo Basin are among the most splendid effects I have ever seen in tropical vegetation"—in the chapter on the botany of the Congo in his book *George Grenfell and the Congo* (1908).

In 1882 Johnston joined Lord Mayo's expedition to Southern Angola, where he was much impressed with *Welwitschia*, and in the following year went alone to the Congo, where he met H. M. Stanley. Johnston's description of his journey in his first published book, *The River Congo* (1884), led to his appointment as leader of a scientific expedition to Mt. Kilimanjaro under the auspices of the British Association and the Royal Society, an account of which he published on his return (1886); a list of the plants collected was contributed by Prof. Oliver and Mr. J. G. Baker, of the Royal Gardens, Kew, and a complete enumeration was published later in the *Transactions of the Linnean Society* (1887). It includes the remarkable tree-Senecio, *S. Johnstoni*, which attains a height of 80 feet. Entering the service of the Foreign Office, Johnston was appointed Vice-Consul in the Niger Delta and the Cameroons, where he remained for three years. From 1888 to 1896 his activities were transferred to South Central Africa; the settlement and development of Nyasa-land under a British rule was a result. *British Central Africa* (1897) is an attempt to give some account of a portion of the territories under British influence north of the Zambezi; and *The Uganda Protectorate* (1904) describes the physical features, natural history, and ethnology of a vast area of some 150,000 square miles, over which he presided as Special Commissioner from 1899–1901. In addition to Johnston's own notes and illustrations of the vegetation, lists of the plants known to occur in the area are contributed to each of the above two works by Mr. I. H. Burkill and Mr. C. H. Wright, respectively. While in Uganda he visited the Ruwenzori Range, the botany of which he describes with excellent illustrations of the tree-Senecios and Lobelias and other striking characteristics. He also explored the Semliki Forest, from which he sent home to the British Museum the first complete skin of the Okapi.

Liberia (1906) is an account of the Negro republic which Johnston had visited several times. It is admirably illustrated by his own sketches and photographs of its people, animals and plants, and contains a valuable appendix on the flora by Dr. O. Stapf.

For the latter years of his life his home was in Sussex, where he bought 'St. John's Priory,' near Arundel, an old monastic building; the development of the garden of four acres, he writes, "played a large part in my bodily and mental activities since 1906."

Disappointed in two attempts to enter Parliament, he visited the

United States and the West Indies in 1908 to study the Negro question; the result appeared in a volume entitled *The Negro in the New World*. He had also some success as a novelist; *The Gay Dombey* (1919) was a clever sequel to Dickens's *Dombey and Son*; and was followed by other similar attempts. But the chief literary work of his later years was the study of the Bantu and semi-Bantu languages.

Johnston received many honours and distinctions, including the G.C.M.G. at the close of his African work in 1901, the D.Sc. degree of Cambridge University in 1902, and the Gold Medal of the Royal Geographical Society in 1904.—A. B. R.

REVIEWS.

Conifers, Junipers and Yew: Gymnosperms of British Columbia.

By JOHN DAVIDSON. Pictures specially drawn by IVY ABERCROMBIE. 8vo, pp. xvii, 72, frontispiece and 37 plates, some coloured. Fisher Unwin, London, 1927. Price 21s. net.

THIS is the first volume of a series which it is proposed to issue under the title of *Illustrated Botany of British Columbia*. Mr. Davidson, now Assistant Professor of Botany in the University of British Columbia, was formerly Provincial Botanist, and has had good preparation for the work. The collection of material and data was begun in 1911, when Mr. Davidson inaugurated the Botanical Survey of the Province on behalf of the Government of British Columbia. Since then many thousands of specimens have been collected on exploration trips to various parts of the Province, and notes of observations have been made of studies in the field, herbarium, and botanical garden, where a very good representation of the native plants may be seen growing.

Acknowledgment is made of the help of nearly two hundred correspondents in all parts of British Columbia for their enthusiastic co-operation in sending specimens to aid in determining the distribution of the species; between 4000 and 5000 such specimens have been received annually and have been identified. It is evident, therefore, that the proposed Flora will be a first-hand account of the botany of the Province, and not a mere compilation from existing records. It is proposed to continue the work in subsequent annual volumes, taking next the Monocotyledons and later the Dicotyledons, until all the native flowering-plants have been dealt with. The genera number approximately 480, which, with one coloured plate for each genus, will entail six volumes with about 80 coloured plates to each.

A few pages are devoted to a general account of the characters of the Gymnosperms and of the Coniferales, the only order which is represented in British Columbia; this concludes with a diagram in the form of a key, by which the nine genera of Pinaceae represented in the flora may be recognised. The text contains clear descriptions in English of the naked-eye characters of the genera and species, with notes on their distribution and economic uses. Following

the description of each genus is a useful analytical table of the species, showing at a glance the outstanding characters of each. Variations are also discussed; as, for instance, under Douglas Fir, the extreme forms of which may be mistaken for different species; or the Lodge-pole Pine, *Pinus contorta*, the result of a close study of which species in relation to environment in the coastal area and in the dry-belt and subalpine regions of the interior shows that the so-called var. *Murrayana* is merely an environmental form. Typical specimens of species and variety transplanted into the University Botanical Gardens are after ten years' growth identical in foliage, habit, and rate of growth.

The production of the plates is not satisfactory. These are printed on highly-faced paper, and the coloured examples are often very crude. The black-and-white figures, illustrating mainly the ovulate and pollen-bearing strobilus respectively, and ripe cone and seed, are more helpful, but for the titles of the plates and the indications of the figures it is necessary to turn over a transparent sheet on which the legends are printed. Partly as a result of this the appearance of many of the plates is very unbalanced and the general effect wasteful. The authors will be well advised to reconsider the method of illustration in subsequent volumes.—A. B. R.

Botanical Magazine.—The recently issued number (vol. clii. pt. i.) maintains a high standard of excellence in production. The plates, mainly by Miss L. Snelling, are models of plant illustration, the clear floral dissections being specially helpful. Dr. Stapf's discussion of the species figured, introducing notes as to origin, habitat, &c., adds to the interest of the subject-matter—in the case of *Primula effusa* a useful key is supplied to the *malacoides*-series, of which this species is a member. Under *Anagallis collina* reference is made to the range of colour in the flowers of the pimpernel of gardens, and also familiar to British botanists in our native species, the study of which has led to the recognition of two distinct forms, *A. arvensis* (red) and *A. femina* (blue). *A. collina* is of Moroccan origin, and was discovered near Mogador by R. K. A. Shousboe and described in 1800. It is found over a considerable area in Morocco and is very constant in its scarlet colour. It is a parallel species with *A. Monelli*, the commonest pimpernel of Spain, which is not uncommon in North Africa from West Algeria to Tripoli, and is also remarkably constant in the blue colour of its flowers. The blue- and red-flowered species meet in a few places in Algeria and Tunis, but no natural hybrids have been recorded. The blue-flowered form has been known in cultivation for over 300 years; the species was named by Linnaeus in honour of Jean de Monnel de Bouverix, a physician of Tournay who received seeds from Cadiz and brought the plant to the notice of Clusius about 1602. Dr. Stapf writes that—"Up to the time of the introduction of *A. collina*, *A. Monelli* showed no sign of breaking

away from the normal blue of the flowers; but from the 'twenties of the last century onwards we meet in the horticultural literature with garden varieties which are distinguished by their different colours (Sweet, in the 3rd edition of his *Hortus Britannicus* (1839), has already seven garden forms.) Several of these have since been lost, others were added, with the result that Andrée in 1901 could enumerate not less than nine colour-varieties of the garden pimpernel, some of which appear to be reversions to *A. collina*, some to *A. Morelli*, whilst others are intermediate; of these some were described from the beginning as hybrids. Their parentage was not stated, but it is clear from the appearance of the plants that only *A. Monelli* and *A. collina* could be involved. The scarlet-flowered garden pimpernels differ from field-specimens of *A. collina* only in their more luxuriant growth and their usually annual duration, both being conditions imposed upon them by the gardener."

Habranthus robustus Herbert (tab. 9126) represents the identification of a species which has been in cultivation at Kew since 1895, the origin of which was doubtful. Dr. Stapf has established its identity with the species described by Herbert in 1837. Strangely enough, the origin of this species is also uncertain; it was introduced by a nurseryman in 1827 from Buenos Ayres, but there is no definite evidence of its ever having been found growing there.

We regret to notice that in two cases Dr. Stapf lapses into trinomial nomenclature. The first plant figured is quoted in the text, with a diagnosis, as *Magnolia Sprengeri diva* Stapf. From the discussion it is seen that the author regards this as comparable with the varieties *purpurascens* and *elongata* of Rehder and Wilson; he characterises these by the ambiguous term "type," with the remark that all three occur in the same locality (in Central China), and "there is at present no reason for considering them as more than minor strains and possibly crosses, in an otherwise uniform population." But surely the grade to which an author assigns a plant should be indicated in the citation of the name, and it should not be necessary to hunt through his discussion to find out whether he regards it as a subspecies, variety, form, "minor strain," or cross.

The next figure is of *Cypripedium manchuricum virescens*—the diagnosis is, however, of *Cypripedium manchuricum*, a new name for a species from South-Eastern Siberia which has long been in cultivation, but has been confused with another species, *C. macranthon* Gmelin. No diagnosis is given of a subspecies, variety or form *virescens*, but the author states that the species "is particularly liable to colour-variation," the sepals and petals varying from purple to red, or rose or greenish to white. This being the case, it would be interesting to know what is the colour of the type-specimen of the species.

We regret to have to chronicle this fall from grace, which we trust is only temporary.

The present number is dated on the cover "published August 8th, 1927," but it is described as vol. clii. (1926) part i. The last number issued was dated September 21, 1926, and formed the com-

pletion of vol. cli. (1925). In a standard work such as the *Botanical Magazine*, where new species are described, it seems undesirable that there should be any suggestion of confusion between the year of publication and the year of the volume.—A. B. R.

BOOK-NOTES, NEWS, ETC.

MALAYAN ORCHIDS IN REICHENBACH'S HERBARIUM.—Dr. J. J. Smith, in the *Bulletin de Jardin Botanique de Buitenzorg* (ser. 3, viii. pp. 353-369, June 1927), notes the results of his examination of H. G. Reichenbach's types of Malayan Orchids which have recently become available for study. The results will not enhance Reichenbach's reputation among orchidologists, who will be grateful to Dr. Smith for clearing up the doubts attaching to many of his species owing to inadequacy of description. A large proportion of the names proposed by Reichenbach are reduced to synonyms of species previously described by Blume, Lindley and others; thus of fourteen species of *Dendrobium* only five names are valid. In other cases Reichenbach's names must replace later combinations formed in ignorance of the type-species. Some species still remain doubtful, as the herbarium contained only sketches or fragments insufficient for determination.

FRIEDRICH EHRHART.—A portrait of this 18th century botanist appears in the *Nederlandsch Kruidkundig Archief*, Jaargang 1926, associated with an article of Dr. J. Valckenier Suringar entitled "De botanicus Jakob Friedrich Ehrhart en zijn bezoek aan ons land in 1782." The late Mr. James Britten published in the *Journal of Botany* (1922 and 1923) two articles on Ehrhart's life and work especially bearing upon his *Exsiccata* and his relations with Linnæus.

PHENOLOGICAL OBSERVATIONS IN BOHEMIA.—Under the title "Botanisch-Phænologische Beobachtungen in Böhmen," the Department of Botany, British Museum, has received a series of annual reports from the years 1907 to 1917, prepared by the botanical-phenological section of the Bohemian Gesellschaft für Physiokratie. The reports chronicle the dates of leaf-unfolding, flowering, maturing of fruit and leaf-fall, of a limited number of trees and shrubs in a considerable number (up to fifty) of localities at different altitudes.

HANDBOOK OF THE BRITISH SPHAGNA.—An illustrated handbook to the species and varieties of Sphagna recorded for Great Britain, by Mr. W. R. Sherrin, A.L.S., is in the press and will shortly be published by Messrs. Taylor and Francis.

We offer congratulations to Major T. F. Chipp, M.C., Ph.D., Assistant Director, Royal Botanic Gardens, Kew, who has been awarded the degree of D.Sc. at London University for a thesis entitled *The Gold Coast Forest: a Study in Synecology*.

FIFTH INTERNATIONAL BOTANICAL CONGRESS, CAMBRIDGE, 1930.—Readers of the *Journal* have already been informed as to progress of arrangements for the International Congress. The following notice is now being widely circulated among general scientific and botanical journals:—

At the International Botanical Congress of Plant Sciences (Fourth International Botanical Congress), held at Ithaca, United States, in August 1926, an invitation was conveyed from British Botanists for the Fifth International Botanical Congress to be held in England in 1930. The invitation was accepted by the Botanists assembled at Ithaca, and arrangements are now being made for the Congress to be held at Cambridge about the middle of August 1930.

An Executive Committee has been formed to make arrangements for the Congress, consisting of Dr. F. F. Blackman, Prof. V. H. Blackman, Dr. E. J. Butler, Prof. Sir John Farmer, Prof. F. E. Fritsch, Prof. Dame Helen Gwynne-Vaughan, Dr. A. W. Hill, Prof. W. Neilson Jones, Sir David Prain, Dr. A. B. Rendle (Treasurer), Prof. A. C. Seward (Chairman), Prof. W. Stiles, and Prof. A. G. Tansley.

It has been decided to organise the Congress in the following seven Sections:—Morphology (including Anatomy), Palaeobotany, Plant Geography and Ecology, Taxonomy and Nomenclature, Genetics and Cytology, Physiology, and Mycology and Plant Pathology.

Mr. F. T. Brooks, The Botany School, University of Cambridge, England, and Dr. T. F. Chipp, Royal Botanic Gardens, Kew, England, have been appointed Honorary Secretaries of the Committee, and any communications with regard to the Congress should be addressed to one or other of the Secretaries.

ASSOCIATION OF SPECIAL LIBRARIES AND INFORMATION BUREAUX.—It is expected that some 200 organisations will be represented at the Fourth Conference of the Association of Special Libraries and Information Bureaux which meets at Trinity College, Cambridge, September 23rd–26th. Sir Geoffrey Butler, K.B.E., Senior M.P. for Cambridge University, will deliver the Presidential Address, whilst among the many well-known experts giving papers are Sir Henry Lyons (Director, The Science Museum), Mr. A. E. Overton (Principal, Board of Trade), and Sir Richard Gregory (Editor of *Nature*). The subjects to be discussed at the Conference include such topics as the recent Report of the Public Libraries Committee, co-operation between Libraries, and book-selection in Science and Technology. Sectional meetings will be held on information and statistics in commerce and industry, on patent classification, and on information bureaux questions. The Conference is open to all interested, whether members of the Association or not; a copy of the detailed programme and other particulars can be obtained from the Secretary, ASLIB, 38 Bloomsbury Square, London, W.C.1.

With the assistance of the Carnegie United Kingdom Trustees the Association is publishing in the autumn a Directory of sources of specialised information, edited by Mr. G. F. Barwick, late Keeper of Printed Books at the British Museum. The book is unique in character, inasmuch as it records under thousands of subject-headings the various centres in Great Britain and Ireland to which those in search of specialised information should turn.

NEW RUBIACEÆ COLLECTED BY MR. L. J. BRASS IN BRITISH NEW GUINEA.

By S. MOORE.

(Concluded from p. 247.)

Timonius Brassii, sp. nov. *Arbuscula* novellis stipulis floribusque exemptis glabra; ramulis subteretibus sed superioribus compressis cortice cinereo lenticellis parvulis copiose insperso obductis; foliis obovato-oblongatis breviter acuminatis vertice obtusis basi in petiolum mediocrem angustatis tenuiter pergamaceis nitidis in axillis costarum sæpe breviter barbellatis in sicco castaneo-brunneis costis lat. utrinque 6–7 pag. sup. planis pag. inf. exstantibus reticulo sat arcto sine lente vix aspectibili; stipulis conum angustum acutum sericeum cito deciduum formantibus; floribus ♀ solum visis in axillis solitariis pedunculis compressis petiolos adæquantibus vel paullo superantibus apice articulatis insidentibus; ovario oblongo-obovoideo quam calyx paullo longiore; calycis tubo quam lobi 5 triangulares obtusiusculi brevioris; corollæ tubo calycem duplo excedente extus dense sericeo-tomentoso lobis 9 oblongis obtusis crassiusculis tubum circa semiaquantibus; stylo incluso glabro in ramos 9 inæquilongos lineares abeunte; drupa globosa longitrorsum sulcata calyce persistente instructa sectione transversa pyrenas 14 circa centrum succosum serie unica dispositas proferente.

Hab. Bomgwina River, Eastern Division, 1626.

“Small tree on small grass patches in the rain-forest.” Leaves 6.5–10 × 2.5–3.5 cm.; petioles shallowly channelled, 5–10 mm. long. Stipules 17–20 mm. long. Peduncles 10–15 mm. long. Ovary 5 mm. long. Calyx-tube 2 × 3 mm.; lobes 2.5 mm. long. Corolla white; tube 9 mm. long., very short glabrous base, 2 mm. wide immediately narrowed to 1.25 mm., then suddenly enlarged to 2.5 mm., at the mouth barely 3 mm. wide, lobes 5.5 mm. long. Style stout, 5 mm. long., its longest arms 7 mm. Drupe brown when dry, about 10 mm. across, the central pulpy area only some 3 mm. across; pyrenes arranged close to the surface in unbroken order.

Judging from Valetton's clavis this should be near *T. oblongus*, a species of which only foliage and fruit are known. With apparently similar foliage *T. oblongus* has much shorter stipules (only 5 mm. long); moreover, the fruit is globose-obconic and has about 12 pyrenes.

Conspecific with this is No. 758 collected at Budatobara, with somewhat shorter stipules (13–15 mm.), peduncles 2 cm. long and fruit with 16 pyrenes.

J. MEROKENSIS Wernh. in Journ. Bot. lvi. 130.

Tree, 30 ft. Iawarere, 684.

This is the ♂ plant hitherto unknown; the following details have been noted. *Inflorescence* covered by a tawny tomentum, the sessile flowers usually in 2–3-flowered cymes on peduncles of 7–15 mm. *Bracts* narrowly linear, about 3 mm. long. *Calyx* narrowly campanulate, 5 mm. long, divided about halfway down into 5 somewhat

unequal linear lobes. Corolla (just before opening) 12 mm. long; tube 5 mm. long, 1.25 mm. wide below and barely 2 mm. under the limb. Anthers 5 mm. long.

No. 946 from Ihu, Vailala River, is apparently a new species of *Timonius* with large ovoid fruits 2.5 cm. across. It resembles *T. subcoriacea* Valet. in size of fruit; also from the description in foliage and the remarkable compression of the youngest internodes; but the fruit, besides a difference in shape, has its centre occupied by a star-shaped 7-rayed woody mass containing 9 pyrenes. There being no flowers a detailed description is not offered.

AIOSPERMA.

This genus, remarkable for its curiously-shaped fruit and long pendulous seeds, was described and excellently figured in Lauterbach and K. Schumann's *Fl. deutsch. Schutzgeb. Südsee* (1901). To the two species there described Valeton afterwards added a third, all three being from the Mandated Territory. A fourth species, the first from British New Guinea, is the following:—

Airosperma fusca, sp. nov. *Frutex* tenuis, orgyalis; *ramulis* teretibus primo minutissime tomentellis deinde minute pubescentibus tandem glabris; *foliis* petiolatis ovato-lanceolatis vel lanceolato-obovatis acuminatis apice acutis basi cuneatis membranaceis supra nitidulis subtus in nervis minute appresse puberulis in sicco olivaceo-nigris costis lat. utrinque 8–10 mediocriter perspicuis reticulo laxo nequaquam prominulo; *stipulis* triangularibus acuminatis dorso minute puberulis; *cymis* breviter pedunculatis quam folia multo brevioribus minutissime tomentellis; *bracteis* bracteolisque linearibus parvis; *floribus* breviter pedicellatis; *ovario* late cylindrico; *calycis* minute puberuli lobis linearibus; *corolla* alba "oculo" puniceo; lobis tubo paullo brevioribus; *antheris* subsessilibus; *stylo* tenui glabro; *fructu* ovoideo medio sulcato glabro; *seminibus* spathulatis puberulis.

Hab. Hohoro, Vailala River, 1050.

Leaves 8–27 × 3.5–5.5 cm.; petioles 5–20 mm. long. (of the uppermost leaves only 5 mm.). Stipules 5 mm. long. Peduncles 3 mm. long. Cymes 1.5 × 2 cm.; pedicels 1.5–2 mm. long. Ovary 1.5 × 1.25 mm. Calyx 1.5 mm. l., of which 5 mm. belong to the limb. Corolla still in bud 5 mm. long; tube 3 × 1.3 mm., lobes 2 mm. long. Style 1 mm. long, as long as the slender at the apex, recurved arms. Fruit yellow, 6 mm. long; seeds 5.5 mm. long.

Near *A. psychotrioides* Laut. & K. Schum., described as having differently-shaped leaves which dry a dark yellow-green, stipules only 2 mm. long, shorter calyx-lobes, corolla with tube considerably longer than the limb and a thick style with short thick arms. Moreover, the corollas are said to be greenish.

IXORA.

Nineteen species of *Ixora* are in Valeton's list, all from Dutch New Guinea or the Mandated Territory. *T. argentea* Wernh. from the former is omitted.

Ixora Brassii, sp. nov. *Frutex* glaber circiter metralis vel paululum ultra; *ramulis* gracilibus subteretibus ad nodos tumidis; *foliis* petiolatis oblongo-vel anguste ovato-lanceolatis acuminatis vertice acutis basi obtusis chartaceis in sicco, supra griseo-brunneis pallidissimeque nitidis subtus castaneis costis lat. utrinque circa 8 interjectis aliis vix ejusdem valoris patulis marginem appropinquantibus subito arcuatis uti reticulum laxum pag. inf. visibilibus; *stipulis* —; *floribus* in cymas terminales sessiles congestas paucifloras foliis multo breviores digestis; *ovario* turbinato; *calycis* lobis 4 triangularibus acutis ovario subæquilongis; *corollæ* puniceæ tubo intus sursum pubescente lobis oblongo-lanceolatis acutis; *antheris* subsessilibus; *stylo* breviter exserto piloso; *stigmatis* ramis ascendentibus.

Hab. Owen Stanley Range between Mts. Brown and Clarence, 1509.

Leaves 8–12 × 3—nearly 4 cm.; petioles 6–10 mm. long. Flowering cymes 17 × 20 mm., its flower-bearing branches about 3 mm. long; pedicels 0–1 mm. long. Ovary 1 mm. Corolla-tube 5 mm. long, the lobes 7.5 mm. Anthers 4 mm. long. Style exserted 4 mm. beyond the corolla; its arms 4 mm. long.

Apparently near *I. kaniensis* Valet., which has shorter-stalked leaves, less congested inflorescences, and corollas with shorter tube and lobes three times its length.

Ixora ihuensis, sp. nov. *Frutex* diffusus, glaber, ultraorgyalis; *ramulis* tetragonis (senioribus subteretibus) mox cortice cinereo obductis; *foliis* brevipetiolatis ovato-lanceolatis breviter acuminatis apice basi obtusis pergamaceis in sicco pag. sup. brunneis pag. inf. subcastaneis costis lat. utrinque 9–12 tenuibus pag. utraque (uti reticulum) parum eminentibus; *stipulis* e basi lata setaceis quam petioli brevioribus; *paniculis* longiuscule pedunculatis angustis e ramis paucis patulis brevibus sistentibus; *floribus* sessilibus vel subsessilibus; *ovario* subturbinato quam calyx dentibus 4 acutis brevissimis indutus duplo longiore; *corollæ* albæ tubo lobos late oblongos subtruncatos æquante; *filamentis* crassiusculis quam antheræ fere 4-plo brevioribus; *stylo* exserto piloso.

Hab. In rain forest, Ihu, Vailala River, 997.

"Loosely branched bush 8 ft. high." Leaves 8–13 × 2.5–4.5 cm. Stipules 6 mm. long. Peduncle 6.5 cm. long; inflorescence (without the flowers) nearly 4 cm. long, the branches up to 12 mm. Bracts and bracteoles setaceous, the former 2 mm. long. Pedicels at most only 1 mm. long. Ovary 2 mm., calyx 1 mm. long. Corolla-tube and lobes each 9 mm. long. Filaments 2 mm., anthers 7.5 mm. long. Style-arms ascending, 3 mm. long.

Differs from *I. doreensis* in shape of leaves and stipules, sessile or subsessile flowers, much shorter corolla-tube and other features.

PSYCHOTRIA.

Of this genus, so largely represented in the hylæa regions of both worlds, Valeton, dealing with the Mandated Territory alone, characterises no less than fifty-two species. Besides the three novelties

described below, several of Mr. Brass's specimens are unidentified; but nothing definite can be done with them owing to their imperfect state. The opportunity has been taken to describe, as the type of a new species, a small but good specimen omitted by Dr. Wernham from his memoir in Trans. Linn. Soc., Bot. ix.

Psychotria (Grumilea) Brassii, sp. nov. *Frutex* alte scandens; *caule* subtereti rubiginoso-tomentello; *foliis* breviter petiolatis oblongo-ovatis obtusis basi cordulatis lateve truncatis chartaceis supra præsertim in nervis pubescentibus subtereti præsertim in costa centrali rubiginoso-tomentellis costis lat. utrinque 8-9 (raro modo 7) pag. sup. leviter impressis pag. inf. exstantibus levissime arcuatis tandem nervum marginalem constituentibus reticulo pag. sup. difficile viso; *stipulis* cito delapsis lanceolatis acutis rubiginoso-tomentellis; *panicula* terminali a basi ramosa folia longe excedente laxè multiflora rubiginoso-tomentella; *bracteis* minutis setaceis; *floribus* minimis sessilibus; *fructu* parvo globoso piloso calyce persistente tomentello terminato; *albumine* ruminato.

Hab. Iawarere, 1000 ft., 688.

"A large rain-forest liane." Stems 3-4 mm. across; internodes about 4-5 cm. long. Leaves 6-9 × 3.5-4 cm., drying grey except for the nerves on the underside; petioles tomentellous, 5 mm. long or less. Stipules about 6 mm. long. Inflorescence about 15 × 12 cm.; primary branches ascending, 3.5-4 cm. long, the rest patent, ultimate ± 4 mm. long, each crowned with a tuft of hairs in which nestles a small cyme of 3 or 4 sessile flowers. Bracts 1.5-2 mm. long. Fruit only 1.5 mm. across, slightly ribbed, greyish and marked with glistening white dots; the tufted crowning calyx less than 1 mm. long.

A very distinct species, so much so that description seems justified although the specimen is without flowers. The affinity would seem to be with *P. Whitei* S. Moore, but with many important differences. The only remaining stipules were not well seen, and the description may therefore not be quite accurate.

Psychotria (Grumilea) montensis, sp. nov. *Frutex* metralis, glaber; *ramulis* gracilibus ascendenti-patulis paullo anfractuosis striatulis fuscis; *foliis* lanceolatis vel oblanceolato-oblongis acuminatis acumine obtuso basi in petiolum sat longum angustatis chartaceis costis lat. utrinque 5-6 tenuibus pag. inf. mediocriter visibilibus ascendentibus prope marginem arcuatis et tandem evanidis; *stipulis* parvulis oblongis breviter bitidis cito exutis; *floribus* parvis breviter pedicellatis in thyrsum angustum rariramosum e cymis pedunculatis subdistantibus paucifloris minute bracteatis compositum digestis; *ovario* oblongo calycem 5-dentatum æquante; *corolla* intus in faucibus villosula paullulum ultra medium in lobos 5 ovato-oblongos obtusos divisa; *stylo* subexserto; *drupa* oblongo-ovoidea costis paucis percursa brunnea maculis minutis Incentibus copiose inspersa; *albumine* ruminato.

Hab. Owen Stanley Range between Mts. Brown and Clarence, 1511.

"Bush 3 ft." Leaves 5.5-7 × 2.5-3 cm., faintly shining on the upper side, drying greenish grey above and brown below; petioles slender, 5-10 mm. long. Stipules 3.5 mm. long. Inflorescence about 6 cm. long, the peduncle some 3 cm.; cyme-bearing branchlets 2 ascending pairs 5-10 mm. long, the ultimate cyme with more flowers than the lateral ones; peduncle and branches white. Ovary and calyx each 1 mm. long. Corolla white; tube 1.2 mm., lobes 1.5 mm. long and calyx each 1 mm. long. Corolla white; tube 1.2 mm., lobes 1.5 mm. long.

Fruit 5 × 3 mm. on a stalk of about 2 mm. long.

With much the look of *P. laxiflora* Bl., this differs in the longer-stalked leaves and narrow inflorescence, besides the flower and fruit.

Psychotria (Grumilea) reticulatissima, sp. nov. *Frutex* elatus, glaber; *ramulis* validis cortice fusco cinctis foliorum delapsorum sigillis magnis suborbicularibus notatis; *foliis* majusculis petiolatis late oblongo-oblanceolatis cuspidato-acuminatis obtusiusculis basi cuneatis pergamaceis nitidis in sicco fusco-rufidis costis lat. utrinque 17-19 patulis rectis sub margine ipso arcuatis inæquilaterque dichotomis inde costam intramarginalem anfractuosis inconspicuas sæpe interruptam constituentibus reticulo arcto pag. utraque optime exstante; *stipulis* petiolis brevioribus ovatis rotundatis; *floribus* parvulis sessilibus 4-meris in cymas paucifloras paniculam brevem subsessilem foliis multo brevioribus minute bracteatis sistentes ordinatis; *ovario* subgloboso; *calycis* lobis brevibus rotundatis; *corolla* vix usque medium in lobos deltoideos obtusos divisa; *fructu* globoso-clavato apice nudo leviter ruguloso; *albumine* ruminato.

Hab. Owen Stanley Range, between Mts. Brown and Clarence, 3000-3500 ft., 1484.

"Tall bush." Branchlets up to 6 mm. wide, the leaf-scars, placed at intervals of less than 1 cm., 4 × 4 mm. Leaves 15-22 × 6-7 mm.; petioles somewhat enlarged at base, 1.5-2.5 cm. long. Stipules 7-10 mm. long, black and shining, remaining for a little time. Inflorescence about 2.5 × 2.5 cm.; the stout peduncle about 5 mm. long; lateral branches several, ± 6 mm. long; ultimate branchlets bearing the cymes 2-3 mm. long. Flowers white. Ovary .75 mm., calyx .5 mm. long. Corolla (just before expansion) .2 mm. long; lobes .75 mm. Fruit orange-yellow, few-ribbed if ribbed at all, reddish brown, 4 mm. across, including the 2 mm. stalk 5.5 mm. long.

Known by the large dark reddish leaves with close prominent reticulation coupled with the short inflorescences of rather closely-packed small flowers. There being only a single flower on the specimen, fuller details are not given.

The present opportunity is taken to describe the following:—

Psychotria Wernhamiana, sp. nov. Verisimiliter *frutex*, inflorescentia exclusa glaber; *ramulis* subteretibus ad nodos leviter tumidis cortice rubiginoso minute multistriato-obductis; *foliis* petiolatis ovato-oblongis acuminatis apice obtusis basi obtusissimis vel leviter

rotundatis pergamaceis costis lat. utrinque 10-12 tenuibus pag. utraque sat prominentibus fere rectis sub margine dichotomis reticulo aretissimo oculo nudo vix aspectabili; *floribus* pedicellatis glabris in cymas corymbosas plurifloras ramulos bis trichotomos minutissime rubiginosovelutinos terminantes inflorescentiam pedunculatam foliis æquilongam referentes digestis; *bracteis* inf. linearibus acutis sup. oblongo-ovatis obtusiusculis; *ovario* campanulato calycem 5-dentatum breviter excedente; *corollæ* tubo lato lobis oblongis obtusis æquilongis intus prope basin (ad staminum insertionem) annulo denso pilorum alborum instructo; *filamentis* antheris æquilongis; *styli* ramis oblongis obtusis decoloribus.

Hab. Dutch New Guinea. Foot-hills of Mt. Carstenz, 500 ft. Boden Kloss, Nov.-Dec. 1912.

Leaves 6-7 × 2.5-2.8 cm., drying a greyish red above, redder on the underside, quite glabrous, the very fine reticulum imparting a faintly striolated appearance; petioles 5-10 mm. long. Inflorescence 5.5 × 4.5 cm.; peduncle 2.5 cm. long; primary branches up to 2 cm.; ultimate branchlets 2-3 mm. long. Lower bracts nearly 1 cm. long, the younger up to 2 mm. Pedicels .5-2 mm. long. Flowers white. Ovary 1 mm., calyx .75 mm., corolla-tube 2 mm. and lobes 2 mm. long. Disk fleshy, very prominent. Filaments, anthers and style each 1 mm. long. Fruit not seen.

A very distinct species.

HYDNOPHYTUM.

This well-known myrmecophilous genus occupies a large part of Beccari's classical memoir "Piante ospitrici" (*Malesia*, vol. ii. 1884). Beccari there describes thirty species, fourteen of them from New Guinea or its near neighbourhood, viz., Aru Islands and Jobie (two each), Kei and Admiralty Islands (one each), and eight from the mainland. This eight from the whole island is now increased, as per Valetton's recent memoir, to twenty-six species for the Mandated Territory alone. But except for D'Albertis, who collected on the Fly River, scarcely anything has come from British New Guinea. It is hoped that the three new species here described will be established as valid, although they are admittedly closely allied to others already known.

Hydnophytum amplifolium, sp. nov. *Frutex* epiphyticus, glaber; caules plures, simplices, crassos, e basi inæqualiter tumida emissos procreans; *foliis* magnis obovato-oblancoelatis breviter lateque acuminatis obtusis basi in petiolum quam inflorescentia longiorem coaretatis pergamaceis costis, lat. utrinque 10-11 paribus sæpissime oppositis vel suboppositis cum costa centrali angulum fere rectum efformantibus ad marginem accedentibus dichotomis costamque marginalem late arcuatam constituentibus; *stipulis* —; *floribus* in spicas vix omnino sessiles bis vel ter bifurcatis dense annulatim cicatricosas ordinatis; *bracteis* brevissime cupularibus griseis; *ovario* 2-loculari subgloboso calyce truncato glabro longiore; *corollæ* 4-meræ tubo præterquam basin ipsam glabram intus villosa lobos ovatos obtusos paulo exce-

dente; *staminibus* prope basin tubo insertis filamentis abbreviatis; *styli* ramis anguste spathulatis; *fructu* quadrangulati calyce coronato; *pyrenis* oblongis obtusis.

Hab. Upoia, Vailala River, 200 ft., on rain-forest trees, 1151.

Stems fistular, 6 mm. wide. Leaves 25 × 8.5 cm., drying grey; petioles nearly 3 cm. long. Peduncle appressed to the branch, very broad, 3-4 mm. long; branches almost 3 mm. across. Ovary 1 mm., calyx .25 mm. long. Corolla white, when just about to open 3.5 mm. long, of which the tube claims 2 mm. Stamens inserted 1 mm. from the corolla-base; filaments .4 mm., anthers nearly 2 mm. long. Fruit 5 × 2 mm. Pyrenes flattened, about .5 mm. across.

This is close to *H. normale*, *radicans*, *Albertisii*, and *Keiense*, all of Beccari, and figured in *Malesia*, ii. tabs. xxix.-xxxi. The distinguishing points are the broad leaves, the almost sessile doubly or trebly bifurcate inflorescences, the corolla villous all over inside except at the very base, the stamens inserted low down on the corolla-tube, and the spathulate style-arms.

Hydnophytum Brassii, sp. nov. *Frutex* epiphyticus glaber; caule pauciramoso sat elato crasso aliquanto compresso ad nodos cicatricibus orbicularibus notatos tumido in sicco fusco-griseo; *foliis* subsessilibus ovatis (raro ovato-oblongis) obtusissimis basi rotundatis crassiusculo-pergamaceis sub lente rugulosis costis lat. utrinque 2-3 fere evanidis; *florum* pulvinis parvis axillaribus sessilibus dense cicatricosis paucifloris; *ovario* subgloboso; *calyce* truncato glabro; *corollæ* tubo cylindrico ima basi dilatato in faucibus (nequaquam alibi) villosa lobis 4 ovato-oblongis obtusis tubum vix æquantibus ima basi exclusa glabris; *staminibus* corollæ ori insertis filamentis brevibus complanatis antheris oblongis breviter exsertis; *drupa* ovoidea apice umbonata; *pyrenis* ovoideis a vertice truncato appendicem tenuem proferentibus.

Hab. Keura, Gulf division, 1200.

"Large epiphyte on beech trees." Stem (of the only specimen seen) nearly 4 dm. long and 5-7 mm. thick, with a branch almost at right angles 7.5 mm. long. Leaves mostly about 5 × 3.5 cm., rarely up to 7.5 × 5.5 cm., drying grey-green, the older ones shining chiefly on the upper side; petioles thick and fleshy, at most 3 mm. long. Flower-bearing pulvini about 5 × 8 mm. Flowers white. Calyx .5 mm. long. Corolla (just before opening) 5.5 mm. long; tube 3 mm. long and 1 mm. wide at base; lobes 2.5 mm. long. Filaments .5 mm., anthers 2 mm. long. Style 3 mm. long, the narrowly oblong arms 1 mm. long. Drupe 5 × 3.5 mm. Pyrenes 4 mm. long, excluding the very narrow 1 mm. long apex.

Foliage much like that of *H. loranthifolium* Becc., which has leaves with visible side-nerves, corolla-lobes villous on the inner face, broader drupes, and pyrenes ending in a very short point.

Hydnophytum camporum, sp. nov. *Frutex* epiphyticus, glaber caules breves e basi complanata carnosus a formicis excavata gignens; *foliis* subsessilibus obovatis vel obovato-oblancoelatis obtusis vel

obtusissimis basi longiuscule cuneatis carnosis costis lat. utrinque 5 recte ascendentibus nisi ob pustulas difficile visis vel omnino abditis; *floribus* in pulvinis axillaribus sessilibus plurifloris cicatricibus dense cinctis sitis; *bracteis* breviter cupularibus microscopicè purpureo-piliferis; *ovario* subgloboso fere omnino glabro; *calyce* abbreviato truncato glabro; *corolla* vix usque medium in lobos 4 oblongos obtusos sparsissime piliferos divisa tubo superne leviter ampliata intus in faucibus villosa; *staminibus* corollæ ori insertis antheris sessilibus oblongis subexsertis; *styli* ramis linearibus; *fructu* lageniformi glabro; *pyrenis* ovatis sursum subito caudatis.

Hab. Bisiatabu, 1500 ft., epiphytic on savannah trees, 605.

Stems fleshy, drying brown, 3 dm. long, 5 mm. across, bearing leaves at distances of 4-7 cm., strongly nodular from the presence of exhausted pulvini, which measure about 6 × 10 mm. Leaves 8-9 × 4-4.5 cm., widest above the middle; surface finely rugulose under the lens, drying green; petioles broad, fleshy, flat above, about 5 mm. long. Bracts less than 1 mm. across. Ovary (with calyx) 1.5 × 1 mm., calyx alone .5 mm. deep. Corolla 6 mm. long, of which the tube, 1 mm. wide in its upper part, takes 4 mm. Style 4 mm. long, its arms 1 mm. Fruit 7 mm. long, in the lower part 3 mm., in the "neck" 2 mm. wide. Pyrenes 6.5 mm. long, of which nearly 2 mm. belong to the narrow portion, and 3 mm. wide (the narrow part .3 mm. wide).

This is certainly close to *H. cuneatum* Valet. from the Mandated Territory, which, judging from the description, has narrower leaves, dark when dry, larger flowers (8-10 mm. long) with longer corolla-lobes densely hairy halfway up, and smaller pyrenes (only 4-4.5 mm.) with a shorter narrowed portion.

PLANTS COLLECTED DURING THE BRITISH ARCTIC EXPEDITION, 1925.

By JAMES W. S. MARR.

THE plants listed below were collected between June and September in Spitsbergen and Franz Josef Land. Since the chief work of the Expedition was Hydrographical, Botanical work was limited to observations at certain isolated localities on land. In addition, some Algæ were collected from dredgings and tow-nettings in the adjoining seas.

Through the kindness of Mr. A. D. Cotton, Keeper of the Kew Herbarium, the material was sorted out and referred to the various authorities. The work of identification was carried out by the following:—

Mr. A. R. Horwood, Kew (Phanerogams); Mr. H. N. Dixon (Mosses); Miss M. M. Duke, Kew (Algæ); Mme M. Lemoine, Paris (Lithothamnion); Mr. R. Paulson (Lichens)*. The writer

* An account of the Lichens by Mr. Paulson has already appeared in the *Journal* (pp. 171-173).

wishes to acknowledge his indebtedness and to offer his best thanks for this work. He is further indebted to the geologist of the party, Mr. Charles B. Bisset, for the collection of plants from Cape Barents, and for the geological information throughout.

Collections were made at Green Harbour, King's Bay, and Liefde Bay, Spitsbergen; Cape Barents, Northbrook Island, Franz Josef Land; and at Chermiside Island, North-East Land. Lists of the several groups have been drawn up, together with a few explanatory notes and points of interest, and brief geological notes are added which may serve to give some idea of the nature of the soil of the localities visited. The Algæ from tow-nettings and dredge are dealt with separately in a final paragraph.

I. GREEN HARBOUR, July 16th.

78° 5' N., 14° 10' E.

The plants were collected on the low ground, at the height of some fifty feet above sea-level, a little to the south of the mining town of Barentsberg. The soil has been formed by the breaking-down of the local Miocene coal measures—mostly carbonaceous sandstones, with an addition of glacially-transported material roughly of a similar nature. Raised beaches were noted to a height roughly of 250 feet above sea-level.

Phanerogams.

Ranunculaceæ: *Ranunculus nivalis* L., *R. sulphureus* Sol.

Papaveraceæ: *Papaver radicum* Rottb.

Cruciferae: *Draba alpina* L., *D. oblongata* Smrft., *Cochlearia fenestrata* R. Br.

Caryophyllaceæ: *Silene acaulis* L. All the specimens are in the condition of *S. exscapa* All., which Rohrbach does not regard as distinct. *Cerastium alpinum* L., *Stellaria longipes* Goldie.

Rosaceæ: *Dryas octopetala* L.

Saxifragaceæ: *Saxifraga cæspitosa* L., *S. oppositifolia* L.

Polygonaceæ: *Oxyria digyna* (Linn.) Hill.

Salicaceæ: *Salix polaris* Whltnbg.

II. KING'S BAY, July 19th.

78° 56' N., 12° 3' E.

The geology of the country in the neighbourhood of the King's Bay settlement is complex, and the land bordering the sea is composed of heterogeneous material from the moraines of numerous glaciers. The commonest material is carbonaceous sandstone or claystone, possibly derived from the local coal measures.

A solitary flowering plant was collected here at sea-level: *Cerastium Regelii* Ostenf.

III. LIEFDE BAY, July 22nd and 23rd.

79° 41' N., 13° 40' E.

The land bordering the bay, together with Reindeer Peninsula, is formed of rather fine-grained, red-brown sandstone with some similar

slate-green rock, both containing narrow calcite veins. Morainic and raised beach deposits consist almost entirely of this material, with the exception of numerous large erratic boulders of coarse gneissose granite. The surface of Reindeer Peninsula is covered with the characteristic sub-Arctic stone Polygons.

Flowering plants and lichens were collected from two separate localities here: (1) Reindeer Peninsula; (2) a small raised beach, strewn with large erratic boulders, bordering a little bay called Mushroom Harbour. The flora of both localities was strikingly less rich than that of Green Harbour.

(1) Reindeer Peninsula.

Phanerogams.

Cruciferae: *Cochlearia fenestrata* R. Br. var. *prostrata* Malm. This plant is probably a prostrate form of the same species as that collected at Green Harbour.

Saxifragaceae: *Saxifraga flagellaris* (Sternb.) R. Br., *S. cernua* L.

Juncaceae: *Luzula confusa* Lindb.

Gramineae: *Alopecurus alpinus* Sm., *Poa arctica* R. Br., *Glyceria angustata* (R. Br.) Fr., *G. Vahliana* (Liebm.) Fr.

Altitudes supra S. M.: *S. flagellaris*, 50 ft.; Juncaceae and Gramineae, 200-300 ft.; *Cochlearia*, 300 ft.; *S. cernua*, 400 ft.

(2) Raised Beach.

The collections were made roughly at sea-level.

Phanerogams.

Cruciferae: *Draba alpina* L.

Caryophyllaceae: *Silene acaulis* L. The specimen is in the condition of *S. exscapa* All.

Saxifragaceae: *Saxifraga oppositifolia* L. This specimen differs from the Green Harbour one in its trailing habit.

IV. CAPE BARENTS, NORTHBROOK ISLAND, FRANZ JOSEF LAND, August 25th.

79° 55' N., 50° 18' E.

Geology: Cape Barents is a buttress of dark basaltic rock projecting from the ice-cap of Northbrook Island. There is a boulder beach at its base reaching to 50 ft. above sea-level. The rock is an olivine tholeiite with marked columnar jointing, and weathers with a grey crust. A few pebbles of sandstone and quartzite were noted on the boulder beach. The rock is rich in easily soluble iron.

A large concourse of birds was observed—Fulmar Petrels, Arctic Terns, Ivory Gulls, Kittiwakes, Skua Gulls, Glaucous Gulls, Snow-Buntings, Purple Sandpipers, and Guillemots—and portions of the higher parts of the cliff were much discoloured by their droppings. Thus a soil resulting from the weathering of the rock would, at the least, have no lack of nitrates or iron and would afford a sure support

for the persisting Arctic flora which is ever striving to gain a foothold in the face of most adverse conditions.

As far as could be seen in the short time available, the flora consisted solely of mosses and lichens growing mainly on the summit of the buttress. There three species of moss were found, besides a hepatic:—

Camptothecium nitens Schimp., *Webera cucullata* Schimp., *Polytrichum alpinum* L. var. *septentrionale* (Sw.).

They were densely packed, growing in crevices where they had collected a substantial vegetable soil.

Patches of green and red Algal stains were observed in the hard snow on the boulder beach. The red colour is due to the Alga, *Sphaerella nivalis*, which is mentioned by Dr. Bruce (*Polar Exploration*) as thriving well in snow washed by water flowing from bird cliffs rich in nitrogenous material.

A piece of old driftwood picked up on the 50-ft. raised beach, a quarter of a mile inland, was found to be coniferous, and was probably a pine carried by the Polar Current from the Siberian mainland. Such driftwood is of interest as affording a possible means of dispersal of plants and animals, or their resting-stages, to these far distant and isolated islands (C. S. Elton, *The Dispersal of Insects to Spitsbergen*).

V. CHERMSIDE ISLAND, NORTH-EAST LAND, September 21st.

80° 57' N., 27° 32' E.

The island is formed, for the most part, of a medium-grained grey, two-mica granite which contains large inclusions of mica-schist, pegmatite, graphic granite, and orthoclase felspar. Quartz veins are common. Boulders of augen gneiss were observed on the beach at the point where the landing was made.

The part visited was a low, flat, boulder-strewn, raised beach, backed to the S.W. by gently-sloping ground, covered with dirty névé, from which tiny streams trickled and became dissipated in puddles on the beach. The S.W. side was thus rather exposed. To the West and South (roughly) were steep scree slopes, and the shore to the N.E., if anything, was sheltered by neighbouring high islands.

The offshore water may be influenced to some extent by the dying-out stages of the Gulf Current, for several large jelly-fish, measuring a foot across, were observed floating on the surface. These were thought to be Atlantic types.

There was a scanty flora here—sparse grass and a few mosses and lichens—and, for the rest, the neighbouring scree slopes were dotted here and there with patches of yellow-green moss. One Phanerogam only, other than the grasses, was seen, but the season was late and the observations of the most cursory nature.

On the beach the mosses predominated, and of these the following were noted:—

Webera nutans Hedw. forma, *Rhacomitrium canescens* Brid., *Hypnum stramineum* Dicks., *Aulacomnium turgidum* Schwaeagr.

The lichen, *Cetraria nivalis* Ach., was found sparingly on the ground, the others on the boulders and small pebbles.

The boulder lichens appeared to be growing generally on the N.E. side of the rock. I know nothing of the prevailing winds here, but it is conceivable that the lichens favoured the sheltered side (see above) in preference to that where they might be exposed to bitter winds from the permanent ice-cap of North-East Land. This is mere conjecture, as there was little time for careful examination, and one could but roughly estimate directions.

Algæ: Green slime was noted in the freshwater puddles on the beach, but the specimens were lost. *Chætopteris plumosa* (Lyngb.) Kütz. was abundant on the shore boulders, and fragments of a species of *Erythrotrichia* were found on microscopic examination.

VI. NOTE ON ALGÆ FROM DREDGINGS, TOW-NETS, &c.

1. In Mushroom Harbour, Liefde Bay, a dense tangle of *Chætormorpha melagonium* (Web. & Mohr.) Kütz. f. *typica* was brought up by an anchor. This weed is abundant all over the floor of the bay in the shallower water. It grows in close clumps separated by small grey-green patches of sand, and to one at the masthead the appearance presented, in four or five fathoms of water, is that of a mosaic. It gives a ready indication of shoaling, although one is at first liable to mistake it for rocks. It shelters a host of small Amphipods, Molluscs, etc.

2. At Cape Barents dredging was carried out in 13 fathoms as we lay at anchor, and the following Algæ were collected:—

Monostroma sp., probably *M. Grevillei* Wittr.; *Laminaria* sp., too young for identification; *Dichlora viridis* Grev.; *Polysiphonia arctica* J. Ag.

A bottom deposit yielded blue mud with dolerite pebbles.

3. An interesting tow-net haul was made on August 30th in British Channel, Franz Joseph Land, 80° 13' N., 51° 34' E. The surface-water had been observed to be very dirty, and the net was choked in every mesh with a slimy green-brown substance which had a sickly, horrible smell as of rotting seaweed. Countless Diatoms were found in it, but it bulked largely of minute particles of indeterminate Algal débris. It is difficult to account for its presence in such vast quantity, unless it had drifted together under the influence of some local eddy. There must be many such eddies in the Franz Josef Archipelago.

4. 80° 22' N., 30° 4' E., September 15th, 14 fms. Bottom: Hard ground with blue mud and diorite pebbles.

The position is a bank some seven miles north of Gilles Island. A notable feature here was the presence of huge *Laminarias* in great quantity. The dredge used was so heavy that it could scarcely be hove up, the tangle of weed trailing for many yards behind in the water. The bottom pebbles were richly encrusted with brilliant pink coralline Algæ (*Lithothamnion*). The following were also noted:—

Alaria sp., probably *A. esculenta* Grev.; *Phycodrys rubens*

Batrrs. (*Delesseria sinuosa* Lamour.) (this specimen had a very marked odour of iodine); *Dichlora viridis* Grev.

5. 80° 51' N., 29° 30' E., September 19th, 16–20 fms. Bottom: Rock and pebbles.

Kallymenia rosacea J. Ag., *Lithothamnion fœcundum* Kjellm., *L. læve* Rosenv., *L. glaciale* Kjellm. (very young). These three species were encrusting angular pebbles.

A large tube-inhabiting Polychæte was noted having the tentacular end effectively masked, whether by chance or not, by a tuft of a delicate brown Alga. Specimens of these Polychætes are now awaiting examination in the Royal Scottish Museum at the hands of Mr. A. C. Stephen.

MICHELIA KISOPA AND M. DOLTSOPA BUCH.-HAM. (MAGNOLIACEÆ).

By J. E. DANDY, B.A., F.L.S.

MICHELIA KISOPA Buch.-Ham. and *M. doltsope* Buch.-Ham. were both originally described by de Candolle in 1818 on the same page of his *Systema** from specimens collected in Eastern Nepal by Hamilton (formerly Buchanan). In the case of each species the type-specimen was definitely cited, and stated to be in the Lambertian Herbarium. They were included in the portion of Lambert's herbarium purchased for the British Museum, and are now in the British Museum Herbarium. They have apparently not been examined by recent workers upon Indian botany, and since 1824 botanists have accepted the conception of the two species held by Wallich, who interpreted them by describing and figuring two plants † which he supposed to be the same as those described by de Candolle. Wallich, although he considered de Candolle's descriptions to be unsatisfactory ‡, based his interpretations entirely upon them, and was satisfied that his conclusions were correct. Examination of Hamilton's plants now shows that whereas Wallich was correct in his interpretation of *M. kisopa*, he was wrong in the case of *M. doltsope*, and his error unfortunately necessitates the substitution of the latter name for one which has been in general use for a century.

The type-specimen of *M. kisopa* § proves to be identical with the plant || described and figured ¶ as that species by Wallich, and subsequently accepted as *M. kisopa* by Hooker and Thompson and all other authors in works on Indian botany.

In the case of *M. doltsope*, however, Hamilton's type** is not the same as the plant †† described and figured as *M. doltsope* ‡‡ by

* DC. Syst. i. 448 (1818).

† Wall. Tent. Fl. Nepal. Illustr. 7–8, tt. 3–4 (1824). ‡ L. c. 1.

§ This bears in Hamilton's handwriting the label: "*Michelia Kisopa*. Narain hetty. 22nd Oct. 1802."

¶ Wallich, n. 970. ¶ Wall. Tent. Fl. Nepal. Illustr. 8, t. 4 (1824).

** His label reads: "*Michelia Doltsope*. Narain hetty. 9th Feb. 1803."

†† Wallich, n. 971. ‡‡ L. c. 7, t. 3.

Wallich, but is identical with the latter's *Magnolia excelsa*, described and figured in the same work*, and later transferred by Blume to *Michelia*. De Candolle's description of *M. doltsopa* fits *M. excelsa* exactly, except that the leaves are described as glabrous. This must have been an error on de Candolle's part, for the leaves of his type possess the rufous indumentum of the lower surface so characteristic of *M. excelsa*. The mis-statement probably helped to confuse Wallich and later botanists, and cause them in the absence of the type to hesitate to identify *M. doltsopa* with *M. excelsa*. The plant actually described and figured by Wallich as *M. doltsopa* had glaucescent almost glabrous leaves, thus conforming with de Candolle's description; but Blume pointed out that it did not agree as regards the flowers, and proposed for it the new name *M. latifolia*†. Subsequently Hooker and Thomson recognised that Wallich's plant was no more than a form of *M. champaca* L., and these authors‡, being dissatisfied with de Candolle's description of *M. doltsopa*, in the absence of the type, accepted Wallich's interpretation and included the name as a synonym of *M. champaca*§. Wallich was deterred from associating his *Magnolia excelsa* with *Michelia doltsopa* by his belief that the former was confined to a single station and did not occur at the locality where Hamilton found *M. doltsopa*||.

Michelia doltsopa must therefore replace *M. excelsa* as the name for a species which is now known to be widely distributed, extending from Eastern Nepal to Yunnan¶. It embraces *Michelia manipurensis* Watt, the type of which is an excellent match of Wallich's type of *Magnolia excelsa*, and which cannot be retained as a distinct species. Some specimens of *M. doltsopa* approach very closely the more robust examples of *M. floribunda* Finet & Gagnep., and the ranges of the two species overlap in Upper Burma and Western Yunnan. Forrest has collected both on the Shweli-Salween divide, and it is not improbable that in this region the two species interbreed.

Lambert's herbarium was seen by D. Don in compiling his *Prodromus Floræ Nepalensis*, and he included under *M. doltsopa*** in addition to the type, two other specimens, both collected by Hamilton and labelled by him as that species. One of these is identical with the type, but the other †† differs considerably. It possesses the leaves of *M. doltsopa*, but without the rufous indumentum, while the flowers resemble those of *M. champaca* in the narrower perianth-segments and slender grey-tomentose peduncle. The stipular scar is confined to the base of the petiole as in *M. doltsopa*, whereas in *M. champaca* it extends almost to the top. Consideration of these and other characters leads to the conclusion that this specimen is a

* L. c. 5, t. 2. The type-specimen is Wallich, n. 6494.

† Bl. Fl. Jav., Magnol. 14 (1828).

‡ Hook. f. & Thoms. Fl. Ind. i. 80 (1855).

§ Wall. Tent. Fl. Nepal. Illustr. 2 (1824).

¶ L. c. 79.

|| The plant from Northern Siam, enumerated as *M. manipurensis* by Craib (Fl. Siam. Enum. 27), is better referred to *M. floribunda*.

** D. Don, Prodr. Fl. Nepal. 226 (1825).

†† Bearing the label: "*Michelia Doltsopa* of the Nawars. The best timber tree in Nepal. Wood odorous."

natural hybrid of *M. champaca* and *M. doltsopa*, which occur together in Eastern Nepal.

The synonymy of *M. doltsopa* is as follows:—

Michelia doltsopa Buch.-Ham. ex DC. Syst. i. 448 (1818).

Magnolia excelsa Wall. Tent. Fl. Nepal. Illustr. 5, t. 2 (1824).

Michelia excelsa Bl. ex Wall. Numer. List, 220, n. 6494 (1832)*.

Sampacca excelsa O. Ktze. Revis. Gen. Pl. i. 6 (1891).

Michelia manipurensis Watt ex Brandis, Ind. Trees, 8 (1906).

NOTES ON TWO SPECIES OF LOUREIRO'S FLORA COCHINCHINENSIS.

BY S. MOORE AND G. TANDY.

[MR. S. MOORE has recently published a list of determinations of Loureiro's plants now in the Department of Botany of the British Museum. As the collection had for many years been distributed through the herbarium, it was almost inevitable that a few should be overlooked. The two following are cases in point.—ED. JOURN. BOT.]

BEMBIX LOUR.

BY S. MOORE.

Among the botanical puzzles bequeathed to his successors by the Rev. Father João de Loureiro *Bembix* occupies a prominent position. Described under the name *Bembix tectoria* †, it has defied, in the absence of a specimen, the penetration of all who have sought to assign the plant a definite position in the Natural System. Referred by its describer to the DECANDRIA, TRIGYNIA, it is said to have an inferior 3-partite calyx; 5 petals; 10 stamens, alternately long and short, seated on the base of the petals, and an ovate ovary with 3 oblong-turbinate bisulcate styles terminating each in a vertically compressed emarginate stigma. Of scandent habit, it has large hard "cuneiform" entire leaves and flowers in small subterminal racemes, and bears small ovate berries doubtfully trilobular. Seeds were not seen.

Adrien de Jussieu ‡ seems to have been the first to suggest a position for the plant. He placed it with doubt at the end of *Malpighiaceae*, and nothing better was suggested by Endlicher §, Meisner ||, Lindley ¶, Bentham & Hooker ** and Baillon ††: the

* This combination is generally attributed to Bl. Fl. Jav., Magnol. 8 (1828), but although Blume there suggested the transference, he did not actually make the combination, which first appeared in Wallich's list.

† Fl. Cochinch. 282. Use of the leaves to protect boats, houses, &c., from weather-effects suggested the trivial name.

‡ Vide Walp. Rep. v. 357. § Gen. Plant. 1064.

|| Plant. vasc. Gen. ii. 347. ¶ Veg. King. 390.

** Gen. Plant. i. 251. Planta—"Cochinchinensis nobis incognita et quoad allmitates valde dubia."

†† Dict. de Bot. i. 400; Hist. de Plantes, v. 445, n.

latter pointed to the trimerous calyx as being at variance with that of other *Malpighiaceæ*, though otherwise the supposed affinity might be allowed to pass. The most recent notice is that of Mr. Merrill, who writes*: "A genus of uncertain status, by some authors tentatively referred to the *Malpighiaceæ*, where I do not think it can possibly belong. From the indicated uses of the leaves for thatching houses it should eventually be located if field-work be undertaken in the vicinity of Hue with this end in view."

Loureiro's specimen has recently come to light, and, although the material is very imperfect, only fragmentary indeed, there is no doubt as to the genus of the plant Loureiro had before him when describing his *Bembix*: a single glance is, in fact, enough to show it to have been what was years afterwards named *Ancistrocladus* †. Had the writer wished to defeat enquiry, he could have achieved his purpose in no surer way than by remaining silent on the very point that enables one to name the genus on sight—namely, the peculiar hooks upon the branches, which are one of its most characteristic features!

The material consists of four small scraps each about 10 cm. in length, and each with one or two strong recurved hooks. One fragment has the lower part (probably about half) of three leaves pseudoverticillate at the end of the branch, as is so frequently the case in this genus. The leaves dry dark brown, are very coriaceous and prominently reticulate on either face: in shape they seem to be oblong or ovate-oblong, and are narrowed into a very short and broad petiole; the longest fragment measures about 9 × 3 cm. The hooks, it should be added, are found upon the smaller branches alone. There are no signs of inflorescence, neither has a flower been preserved nor a fruit. The native name is given as "Lá trung cuôn."

We owe to Gagnepain ‡ an account of *Ancistrocladus* as represented in Cochinchina. His clavis embraces four species, but for our purpose two of the four are at once thrown out on account of the structure of their stigmas. The two remaining, *A. cochinchinensis* Gagnep. and *A. extensus* Wall., Gagnepain distinguishes primarily on their anthers, and here, as we have no flowers, we are in an unsatisfactory position. Moreover, the two are so similar in general appearance that it is not possible to decide which of them is certainly what we are in search of, if indeed what we want may not be a third species undetected since Loureiro's time. Some help is afforded by the Annamese name for *A. cochinchinensis*, which, according to Gagnepain, is "Trang quang," *i. e.* one very like Loureiro's mentioned above, whereas he gives no native equivalent for *A. extensus*. Another of the four species is known as "Giay trung quòn," a name still more like Loureiro's; but the claims of this (*A. Wallichii*) have already been rejected. On the whole, there is reasonable ground for concluding that *Bembix tectoria* and *Ancistrocladus cochinchinensis* may be names for the same plant. According to Gagnepain the stem

* Comment. Loureiro's Fl. Cochinchin. fol. 574 (typescr. in Herb. Mus. Brit.).

† Wall. Cat. n. 1052.

‡ Lecomte, Fl. Gen. l'Ind.-Chine, i. 394.

of *A. cochinchinensis* is used for the staves of barrels; nothing is said of its leaves as furnishing material for thatching.

How did Loureiro come to describe the calyx as tripartite, and, having overlooked two of the flower's five sepals, how could he have missed them when they had grown out into five large foliar organs surrounding the fruit? It is perhaps possible that the mistake as regards the flowering calyx may have been the printer's, and that all or some of the sepals may have fallen away from the fruit examined: the suggested trilobularity of the fruit was perhaps caused by his taking the intrusions of the testa into the albumen to be septa of a three-celled fruit. And if these suppositions be thought too far-fetched to be credible, cursory perusal of a former memoir* should suffice to show that Loureiro made mistakes still more serious than those brought to light here.

Published in 1790, *Bembix* has nearly half-a-century's priority over *Ancistrocladus* (1832), which will doubtless be included in the next list of *nomina conservanda*.

CYCAS INERMIS LOUR.

BY G. TANDY.

THIS name has been commonly interpreted as a synonym of *C. revoluta* L.—a not unnatural conclusion in view of the fact that Loureiro says: "Differ. spec. Cyc. frondibus pinnatis: stipitibus inermibus." The leaf-specimen from him in Herb. Mus. Brit. is certainly not *C. revoluta* L., but bears considerable resemblance to *C. circinalis* Linn. and *C. Rumphii* Miq.

Merrill (*An Interpretation of Rumphius's Herbarium Amboinense*, p. 74) says of *C. Rumphii*: "Possibly more than one species is represented by the plants figured and described by Rumphius, but more abundant material and a critical study of all the Indo-Malayan forms allied to *Cycas circinalis* will be necessary definitely to settle this point." If it be shown that *C. Rumphii* and *C. inermis* are synonymous, then *C. inermis* has the priority and must be accepted as the valid name.

There is another specimen in the Herb. Mus. Brit. collected by E. H. Wilson from a plant cultivated at Kinting (Veitch Collectn., No. 5420) which seems to make it desirable to keep up both names for the time being. The leaf agrees very well with Loureiro's plant, and the sterile part of the sporophyll is deeply cut, which puts the plant out of the *C. circinalis* group (*cf.* Pilger in *Naturl. Pflanzenf.* 2 Aufl. 13 Band, p. 74) and brings it near to *C. Micholitzii* Dyer, which, from the figure, may well be a form of *C. inermis*. Apparently Dyer did not see Loureiro's plant, since he says, when citing *C. inermis* as a synonym of *C. revoluta* (Ind. Flor. Sin. ii. 55): "*C. inermis* only differs in its unarmed petioles."

However, pending the critical examination mentioned above, it will be well to make no change in nomenclature beyond retaining *Cycas inermis* Lour. for the South-eastern Asiatic species.

* Journ. Bot. lxiii. 245. The name *Eystanthes* on pp. 254 and 255 should be corrected to *Eystathes*.

THE BRITISH ASSOCIATION AT LEEDS

(August 31-September 7).

THE Meeting at Leeds will be remembered as one of the most interesting and successful in recent years. At the time of the Inaugural Address nearly 2500 members had registered, and, though the next morning we were introduced to a Leeds mist, the sun broke through, and we were favoured with days of bright warm sunshine eminently favourable for excursions and garden parties.

Sir Arthur Keith's Presidential Address, entitled "Darwin's Theory of Man's Descent as it stands to-day," was an historical account of the development of Darwinism as bearing on the origin of Man, and a vigorous defence of the theory. Newspaper reports and wireless have given it so wide a publicity that it is unnecessary to make more than a passing reference here.

The President emphasised some points of general interest in phylogeny. He indicated that the process of evolution has been infinitely more complex than was suspected in Darwin's time. Man's descent has not been in a straight line, but investigation has shown that in remote times the world was peopled, though sparsely, with races showing an even greater diversity than those of to-day, and that already a process of replacement was at work. To unravel Man's pedigree we have to thread our way, not along the links of a chain, but through the meshes of a complicated network. It is amongst a welter of extinct fossil forms that we have to trace the zigzag line of Man's descent.

Again, evolution has not proceeded in an orderly manner. In some extinct races while one part of the body has moved forwards another part has lagged behind. We must be prepared for discordances of evolution.

We have been able to trace Man backwards to the close of the Pliocene, and in the great anthropoids which lived in Himalayan jungles and contemporary jungles of Europe during Middle and later Miocene times discoveries still to be made may reveal the ancestral forms of human teeth.

We have to consider not only the materials for Man's history, and place them, so far as our scanty information allows, in the order of their sequence, but to seek out the biological processes and controlling influences which have shaped the evolutionary histories of Man and ape. When we have discovered the machinery of development and of growth we shall also know the machinery of Evolution, for they are the same. The discovery of hormones and the progress of experimental embryology have opened up vistas for the student of Evolution undreamt of by Darwin.

Thanks to Professor Priestley's good offices, the Botanical Section was conveniently and comfortably housed in the school-rooms of Trinity Congregational Church, which provided not only a large lecture-hall, but also commodious Committee- and common-rooms. The section was very well attended. Past presidents were well repre-

sented by Dr. Scott, Prof. Bower, Prof. Seward, Dr. Wager, Miss Saunders, and others; and among the Visitors were our old friend Dr. Lotsy, Dr. Svedelius, from Gothenberg, and Dr. Gager, of the Brooklyn Botanical Garden, and Mr. Hazen, from the United States. The Sectional photograph must have provided a record for the number of participants, and the operator was puzzled to find room for the many young people in the foreground of the picture.—A. B. R.

Prof. Fritsch's Presidential Address was entitled "Some Aspects of the Present-day Investigation of Protophyta."

The address falls into three main divisions. The first and largest is occupied with a consideration of "Parallel Evolution among Protophyta." The freshwater Algæ are considered as "representing the most elementary types of plant-life to which we are likely to have access." A strong plea is made, therefore, for increased facilities for their investigation. In reviewing the progress of our knowledge of the Protophyta during the last thirty years, Professor Fritsch points out the great number of "points of parallel" existing between the Isokontæ ("all true Green Algæ") and the Heterokontæ—groups, nevertheless, sharply delimited. "It is now clear that in *all* the classes of pigmented Protophyta an analogous evolutionary sequence has been followed, but that the features associated with what may be called 'algal organisation' have appeared, if at all, at different points in the sequence in the diverse classes. It is no longer feasible to separate the Algæ from the holophytic Flagellata as distinct groups of Protophyta. There is reason to believe that every series of holophytic Flagellates could potentially have acquired algal characteristics, although on the present evidence some have failed to do so." Here are adduced Pascher's Chrysophycæ, where, though many points of parallel are still observable, the majority of forms have remained algal. The remaining classes are not considered in detail, but it is stated that "in all the nine classes mentioned evolution has progressed along similar lines, and in many cases has led to the production of analogous forms of plant-body. Thus, the motile unicellular individual, the motile colony, the palmelloid type, the dendroid colony, the chlorococcoid type, the simple and the branched filament, the siphonous type, and others are all to be found in two or more of these classes. In five of them, moreover, the stage of the branched filament has been reached." It is, however, considered "probable that all the nine classes represent as many evolutionary series of uncertain origin."

Proceeding to the consideration of the Relation of the Protophyta to the Higher Plants, Prof. Fritsch discounts any suggestion that the freshwater Algæ are "starvation forms," and prefers to regard "the filamentous forms in the different classes as the end-points of an up-grade development." Further, the hypothesis of direct derivation of land-flora from forms belonging to the Phæophycæ or the Rhodophycæ is rejected, since the only Algæ possessing the same metabolism as terrestrial plants are to be found in the Isokontæ. "It seems to me that there is every reason to suppose that,

approximately at the level of morphological differentiation and stature reached by the Isokontæ of the present day, the terrestrial habit was adopted in the remote past, the more highly elaborated Green Alga became a land-plant, the early forms of which are perhaps yet to be disclosed by palæontological research. The facts of relative development of the three large algal classes just considered appear to indicate that the first land-plants were probably forms of small stature, although not necessarily quite as simple as the most advanced Isokontæ known to us at the present day. . . . On the little available evidence it seems possible that oogamy may have been undeveloped or incipient in the first land-plants. If one recognises among Phæo-phyceæ and Rhodophyceæ many features of anatomy, life-history, etc., that recall the characteristics of land-plants, I can see in that only a confirmation of the belief that environment has little to do with the broad evolution of the plant-organism, and that these features are a natural outcome of the evolutionary trend in the Vegetable Kingdom, and not any positive evidence for the view that they must necessarily have originated in a marine environment." It is considered possible, in view of the conditions described for *Pylaiella*, that an analogous condition of homologous alternation of generations may be found in the Chætophorales, and it is important that investigation be made as to the complete restriction to asexual reproduction of particular filaments of any Green Alga.

On the subject of investigation Prof. Fritsch offers a warning in the matter of "pure culture" work, and suggests that such work must always be regarded as ancillary to the direct observation of the Alga in nature. This desirable object may be attained only by the provision of an adequate Experimental Station in suitable country where the town-botanist may observe Algæ in fresh water.—G. TANDY.

Dr. Fritsch also contributed a paper on the systematic position of the genus *Sphæroplea*, which has usually been regarded as a septate member of the Siphonales, but investigation of the species, which are well represented in South Africa, indicates an affinity with the Ulotrichales on the grounds both of vegetative and reproductive characteristics. Other papers on Algæ dealt with the cytology of *Callithamnion*, by W. T. Mathias, the cytology and development of *Asparogopsis*, by Prof. N. E. Svedelius, and the structure and reproduction of *Bifurcaria tuberculata*, a British species, by Miss E. M. E. Rees; the other two species of this genus are South African. Mr. Malins Smith described the results of five years' observations on the Algæ of a small sphagnum bog, including records of temperature and hydrogen-ion concentration of the water, and periodical observations of weather conditions and of the flow of the water and also chemical analyses of the water. His results shed light upon the specific composition of the algal flora, the relative abundance and interdependence of the chief groups and the periodicity of the various species.

A group of papers on the Fungi included an account by Dame Helen Gwynne-Vaughan and Mrs. H. S. Williamson on the effect of light and heat in inducing germination of the ascospores of *Lachnea*,

and Mr. B. Barnes described the production of a number of colour and form variants from the normal by exposing the spores of *Eurotium herbariorum* to high temperatures for a short time before sowing. Some of these variants retained their peculiar characters through a number of transfers.

Perithecial development in *Nectria mammoidea* and the occurrence of *Monascus* on desiccated coco-nut were described by Mr. A. E. S. McIntosh and Mr. James Stirling respectively.

Phloem-necrosis and Starch-accumulation as concomitants of leaf-roll disease of Potato were discussed by Dr. T. Whitehead.

Mr. J. Walton reviewed the position of our knowledge of palæozoic Bryophyta. There are only two trustworthy records of fossil mosses of this age, both from the upper carboniferous of France. The speaker had previously described several liverworts from the upper and middle coal-measures of this country, to which he now adds some new types indicating that there were present in Palæozoic times liverworts with (a) differentiation into axis and leaves, (b) thaloid form with lobed margin, (c) simple dichotomously-branched thallus, and (d) thaloid form with highly-differentiated vascular strand. Prof. Bower traced the evolutionary changes occurring in the superficial sorus of ferns; and Prof. McLean Thompson the progress of sterility in the androecium of the Lecythidean Myrtles, which has been transformed progressively into massive and sterile tissue partly glandular and partly petaloid. The latter part is marked by pronounced cellular gigantism, the presence of which is in some way connected with stamen sterility. Dr. A. S. Foster described the result of an investigation of the nodal anatomy of the bud-scales of 130 species of woody Dicotyledons; he finds a very close parallelism between the nodes of the bud-scale and foliage-leaf respectively, and suggests that bud-scales probably represent "the original ontogenetic modifications of foliage-leaf primordia with subsequent evolutionary specialisation."

A group of papers on plant-physiology included descriptions of observations on the influence of Ultra-violet Radiation on the structure and growth of plants by Miss M. Martin and Miss A. Westbrook.

A discussion on the Carpel was opened by Miss E. R. Saunders, who restated her view that two carpellary types have originated in the course of evolution, the valve or hollow type, which never bears more than a single row of ovules on each margin, and the solid type, in which from one to several rows of ovules may be borne on either side of the midrib. When two types of carpel are present in the ovary, one only as a rule is fertile. The stigmatic function may be restricted to one or other type, or may be performed by both. The speaker claimed that the view advanced afforded a satisfactory explanation of the occurrence of the commissural stigma, the solitary terminal carpel, supernumerary styles and stigmas, free central placentation and other difficulties in the interpretation of the floral structure. The chief arguments were adduced from the number and position of the stigmas and the supply of vascular tissue to the pistil, the occurrence of two

rings of bundles to supply the carpels being regarded as evidence of the existence of two whorls. On this view the number of carpels is frequently double that generally recognised, 10 instead of 5 in many families of Dicotyledons, and 6 instead of 3 in Liliaceæ and other Monocotyledons. The legume of the pea was regarded as bicarpellary, though Miss Saunders admitted the existence of a simple carpel in Ranunculaceæ. Illustrations were described from the Cruciferae, the ovary of which is assumed to consist of a pair of sterile valvular and a pair of fertile solid carpels, Papaveraceæ, and Rosaceæ, but it was claimed that the polymorphic condition occurs throughout the whole range of Dicotyledons and Monocotyledons.

In the discussion which followed, Dr. Hamshaw Thomas emphasized the importance of anatomical evidence and, in general, was in agreement with Miss Saunders. He suggested that the ovary of the fossil genus *Caytonia*, where the ovules were borne in two rows near the midrib of the structure, might be more helpful in elucidating the morphology of Angiosperms than the open megasporophyll of *Cycas*.

Dr. Rendle expressed appreciation of Miss Saunders's contribution to the study of the flower, but feared that her interpretation of the carpel raised more difficulties than it solved. It implied a discontinuity in the development of the parts of the flower; while sepals, petals, and stamens were simple leaf-structures, the pistil involved the pairing of two different types. It seemed unreasonable to regard the follicle in the Ranunculaceæ as formed from a simple carpel and the pod of the Leguminosæ as derived from two, valve and solid respectively. He saw no insuperable difficulty in imagining a terminal leaf, even if that were necessary to explain a simple carpel like that of the pea. A stigma was merely a receptive surface which might have originally been generally distributed on the top of the carpel and become in course of evolution restricted for supply purposes to the area above either sutural or commissural bundles. Branched stigmas were not uncommon, and an increase in number of branches would not necessarily indicate a similar increase in number of carpels. Miss Saunders had laid considerable stress on the existence of a second whorl of three stigmas in the liliaceous genus *Aphyllanthes* as evidence of the existence of a second whorl of carpels; the speaker suggested that we might equally regard the coronal outgrowth of the corolla in many petaloid Monocotyledons as representing a second whorl of petals. He thought the number of vascular bundles an uncertain guide to the number of the carpels.

Mr. J. Parkin emphatically upheld the monocarpellary character of the pea-pod, and referred to some unpublished work by Dr. A. J. Eames, of Cornell University, which, while supporting the view of a 4-carpellary pistil in Cruciferae, was antagonistic to the assumption of two kinds of carpels. He also suggested a simple explanation of the commissural stigma in Papaveraceæ.

Dr. Scott found great difficulty in accepting the assumption of two kinds of carpels which he regarded as a serious break in the continuity of the development of the parts of the flower; he thought the evidence based on the number of vascular bundles untrustworthy—

it must be borne in mind that the development of the seed demanded a much increased flow of nourishment.

Prof. McClean Thompson insisted on the importance of a study of the flower from the physiological standpoint, and regarded vascular structure as of secondary importance, a pronouncement which called forth a strong protest from Miss Saunders.

There were also two joint discussions with other sections. The Control of Plant Diseases was discussed with the Section Agriculture, Mrs. N. L. Alcock and Dr. W. B. Brierley opening with papers dealing more especially with the success of measures adopted in the past, the present administration of control and the factors essential for its success, the question of research, and the popularisation and application of knowledge. The Climates of the Past was the subject of a discussion in which the botanists, geologists, and cosmical physicists joined; the opener was Prof. A. C. Seward.

During the meeting Prof. J. P. Lotsy gave several demonstrations of the Natural Hybrids which he had recently studied in New Zealand and South Africa. Selecting two well-marked species which remained constant over their own special area of distribution, he was able to study their behaviour where the two met and could cross. A series of hybrids occurred, sometimes showing a remarkable range of leaf-form between those of the two parents, and in some cases resembling forms which had been previously regarded as species. Among the instances that were illustrated were species of *Nothofagus* and *Coprosma* in New Zealand, and of *Cotyledon*, and succulent *Euphorbia* in South Africa. Dr. Lotsy suggested that under conditions of isolation the hybrids thus produced might persist as new species. The demonstration was illustrated by a large and beautiful series of drawings and photographs.

On Saturday the botanists visited Bolton Woods under the leadership of Dr. Wager, walking along the Wharfe from the beautiful old Priory to Barden Towers, lunching midway by the Strid. On Sunday more open country was visited, the day being devoted to an excursion to Malham Cove and Tarn. A short outing to Bramham Woods was arranged for Thursday afternoon, and on Friday the botanists met in the grounds of Weetwood Hall, an estate recently acquired by the University for hostel and playing-fields. The usual Sectional Dinner took place at the Metropole Hotel on Monday evening.

An account of the activities of the Botanical Section would be incomplete without grateful reference to the work of the efficient local Secretary, Miss L. I. Scott.

Botany was also honoured by the inclusion of Prof. F. O. Bower, F.R.S., the retiring President of the Section, among the recipients of Honorary Degrees at the University; Prof. Bower received the degree of D.Sc.—A. B. R.

ABSTRACTS OF PAPERS OF INTEREST TO BRITISH
BOTANISTS.

DIE DACTYLORCHISGRUPPE DER OPHRYDINEEN. By A. Fuchs and H. Ziegenspeck (*Botanisches Archiv*, Bd. xix. Heft 3-4 (Aug. 1927), with 73 figs.).—This paper should be carefully studied by students of the *Dactylorchis* group of the *Ophrydineae*. It contains valuable anatomical and taxonomic information on various members of the group, and there are numerous drawings illustrating the structure of certain organs, more particularly of *Orchis latifolia*, *O. incarnata*, and *O. maculata*; also a bibliography of recent literature dealing with the group.

The principal results of the purely systematic investigation are that the authors consider that in the Mediterranean region and Europe there exist, excluding *Orchis sambucina* and *O. iberica*, only three species: *Orchis latifolia*, *O. maculata*, and *O. incarnata*. A very detailed clavis of the forms and hybrids between these species is given.

Each of the species shows a great variety of forms, and is divided into a very large number of geographical races and individual forms. It is possible to distinguish more or less distinctly hereditary races and small races. The locality also has an essential influence on this very plastic young group. It may be that it directly produces certain forms (Plastotype), or that it, out of the abundance of forms, selects certain types (Genotypes). The most fixed type, *Orchis maculata*, occupies the widest area. Next comes, according to number and area, *Orchis incarnata*. *Orchis latifolia* occupies the smallest area and has the greatest abundance of forms which are not yet fixed.

Where the habitats of the different species meet, there originate a very large number of hybrid forms, which may even outnumber the pure species. Especially where closely-limited districts become isolated, as may happen where a moor becomes smaller, there originate real local "endemisms." As a consequence of the existing heteroploidy and irregular nuclear divisions acting with sterility and differential viability of the segregated forms, these local endemisms may be succeeded by permanent forms.—E. G. B.

LIZARD ORCHIS.—In the *Proceedings of the South London Entomological and Natural History Society* (1926-27, pp. 41-44, with tab.) Mr. E. Step gives an account of the appearance or re-appearance of the Lizard Orchis in Surrey. It is a plant of Central and Southern Europe, extending to North Africa, but it appears to be rarely abundant. In early Floras it used to be recorded as "Kent and Surrey, very rare," and Kent was doubtless its real home. Its somewhat doubtful Surrey station appears to have been Box Hill. Ray says that the Lizard Orchis was first noticed as a British plant by Dr. Bowles, who found it between Dartford and Crayford. During the present century its appearances have been comparatively and increasingly frequent. It early made an appearance in the Wye

district of Kent, and then, in 1907, it appeared in West Sussex. In 1911, Mr. Bedford found it in the Cuckmere district of Sussex, and since then it has occurred in many places, even as far west as East Gloucestershire, but mostly in Kent.

In 1924 some school-children discovered a small colony of the plant on the North Downs, near Dorking. In 1926 the clump produced eleven spikes, but some plant-extermiator found the spot and left only one spike, which luckily happened to be somewhat apart from the rest and hidden in long grass.—E. G. B.

SPARTINA TOWNSENDII H. & J. Groves.—The recent issue of the *Botanical Magazine* (clii. Part I. Tab. 9125) contains a very good figure, by Miss Snelling, and a description, by Dr. O. Stapf, of this plant. Dr. Stapf states that the ascertained history of this grass, so remarkable for its mysterious origin and its marvellous spreading, goes back to 1870, when a specimen of it was collected on the fore-shore at Hythe on the western side of Southampton Water. More of it was collected in the same locality during the next ten years by the brothers Henry and James Groves, who in 1881 described it as *Spartina Townsendii**. Two years later it was recorded two miles north of Hythe, in 1887 from the mud-flats near Southampton, in 1893 from Yarmouth and the Newtown River, Isle of Wight, and in 1895 from the Medina River in the same island. By 1907 many thousands of acres became covered with the grass, and even the Channel was no barrier to the advance of the vigorous newcomer. In 1905 small colonies of it were recorded from the estuary of the River Vire on the east coast of the Cherbourg peninsula.

As to the origin of the grass, Dr. Stapf is inclined to agree that Foucaud's suggestion is still the most plausible explanation—that it is a hybrid between *S. alterniflora* and *S. stricta*.—E. G. B.

REVIEWS.

Flora of West Tropical Africa. By J. HUTCHINSON, F.L.S., and J. M. DALZIEL, M.D., B.Sc., F.L.S. Vol. i. pt. 1. 8vo, pp. x, 246; with sketch-map and 108 text-figs. Crown Agents for the Colonies, London, 1927. Price 8s. 6d.

As Sir Joseph Hooker's *Flora of British India* rendered possible the preparation of a series of floras of more restricted areas, such as Cooke's *Flora of Bombay*, Duthie's *Flora of the Gangetic Plains*, and Gamble's *Flora of Madras*, so the *Flora of Tropical Africa* is to be the parent of a number of regional floras, the inception of the first of which we now welcome. West Tropical Africa, as represented by Mr. Hutchinson's and Dr. Dalziel's *Flora*, comprises the British West African Colonies of the Gambia, Sierra Leone, the Gold Coast, and Nigeria, including the British sphere of the Cameroons and the

* A description with plate by the Messrs. Grove will be found in the *Journal of Botany*, 1882, p. 1.

adjacent French and Portuguese possessions, which, as indicated by a sketch-map, cover French and Portuguese Guinea and the large area of the French Soudan up to the Tropic of Cancer on the north: the whole area is approximately $2\frac{1}{2}$ million square miles, or $1\frac{1}{2}$ the area of British India. The combination of authors is a happy one; Mr. Hutchinson has served a long apprenticeship in systematic work in the Kew Herbarium, and Dr. Dalziel brings to the task great knowledge of the vegetation in the field gained during his years of service in West Africa. The authors have also had the advantage of Dr. F. T. Chipp's experience of forest vegetation in the Gold Coast, and he is wholly or partly responsible for the elaboration of some groups, such as Annonaceæ, *Rinorea* (in Violaceæ), and others. A feature, which has already been successfully introduced in other Floras, is the use of illustrations—a typical species is figured under each genus. These text-figures, which are mainly the work of Mr. W. E. Trevithick, are a helpful addition.

The arrangement follows the modification of Hallier's System, recently elaborated by Mr. Hutchinson, and the present instalment of the *Flora* includes families 1 to 70, namely Cycadaceæ, represented by one species of *Encephalartos*, and Gnetaceæ, represented by a species of *Gnetum*, in Gymnosperms, and the families of Archichlamydeous Dicotyledons from Annonaceæ to Tiliaceæ. The *Flora* is to be completed in four parts. The number of species recorded is estimated at about 5000, a smaller total than in some other tropical areas of similar extent, owing mainly to the general uniformity of the area, which, apart from the Cameroons Mountain and Fernando Po, includes comparatively few mountain-ranges.

A *résumé* is given of the work of botanical exploration in the various provinces, also a bibliography of works dealing mainly with West African botany, and a glossary, with some illustrations, of botanical terms. The systematic enumeration is preceded by an artificial key to the families represented.

An important feature of the systematic enumeration is the adoption of elaborate keys for the determination of the genera and species. Little or nothing is added of description under the species, but reference is given to the *Flora of Tropical Africa* and a few works dealing specially with the area, and only such synonyms are cited as are additional to those in the parent *Flora*, to which the present is supplementary and complementary. Distribution within the area, and generally, is indicated, and a limited number of specimens are cited.

The only adverse criticism we have to make concerns the typography. Except for the prefatory correspondence, the gist of which might have been got into a page or so, there is certainly no waste of space, and it is to be feared that the worker will find the very small type under the individual species rather trying. A whole page of it, as, for instance, under *Rinorea* (p. 95), makes one quail!
—A. B. R.

Principles of Soil Microbiology. By SELMAN A. WAKSMAN. 8vo, pp. xxviii, 897; with 19 plates and 77 text-figures. London: Baillière, Tindall & Cox, 1927. Price 45s. net.

ALTHOUGH it has been known for very many years that organisms occur in great numbers in the soil, it was not realised until quite recently that many of them have their home and carry out their life-histories there. There is still a tendency amongst botanists to view the soil from a purely physical and chemical standpoint, even sometimes almost as if it might be given a formula—plus earthworms. Chiefly through the pioneer work of Beijerinck and of Winogradsky (to whom the volume under review is appropriately dedicated, and whose photographs are included) the abundance and importance of bacteria in the soil was first recognised, but within recent years evidence has accumulated to show that protozoa, nematodes, rotifers, algæ, and fungi occur there in quantity and apparently play an important role in soil-processes. S. A. Waksman, Professor of Soil Microbiology at Rutgers University, has been one of the most active investigators in this line of work. The present volume is a tribute to his energy and to his wide knowledge of soil microbiology, and in the advance of our knowledge this volume will take its place as a landmark and as a standard work. It is the first of its kind and will probably be the last, for as most workers on the subject have already specialised on the different aspects of it to become soil mycologists, soil protozoologists, and so on, the various groups will each receive monographic treatment. It is well the effort has been made, and made successfully, for the discussion of the interrelated soil-processes is sure to prove a stimulus to further work. The soil is a very complex medium under very complex environmental conditions, and the different types of organisms inhabiting it have activities which may be supplementary or antagonistic; the resultant phenomena of the sum total of their activities are important, and it is fortunate therefore to have the whole subject treated by one worker, though this naturally entails a little unevenness.

The book is divided into four sections: A. Occurrence and differentiation of micro-organisms in the soil. B. Isolation, identification, and cultivation. C. Chemical activities. D. Soil microbiological processes and soil fertility. The first section occupies 48 pages, and its detail may be judged from the fact that there are 121 references as foot-notes. Section B begins with a concise account of bacteria and of their general activities. Chapters are devoted to autotrophic bacteria—those capable of obtaining their carbon from the carbon-dioxide of the atmosphere and their oxygen from inorganic substances, including those capable of oxidising simple nitrogen compounds, or sulphur and its inorganic compounds; iron, hydrogen, and methane bacteria—a peculiar and important group; to bacteria fixing atmospheric nitrogen, best known as occurring in the root-nodules of Leguminosæ, though they are neither confined to this family nor to the roots, for they appear on the leaves of *Pavetta* and other Rubiaceæ, and Myrsinaceæ, and are said to be carried through the seed, into which they penetrate while the plant is still alive—the

amount of fixed nitrogen is so large that in India *Pavetta* is used as a green manure; heterotrophic aerobic bacteria requiring combined nitrogen; anaerobic bacteria; bacteria reducing nitrates and sulphates; bacteria capable of decomposing celluloses and other complex carbohydrates and hydrocarbons; bacteria decomposing urea, etc. Occurrence, isolation, classification, and physiology are all considered. Other chapters in this section deal in the same way with algæ, fungi, *Actinomyces*, protozoa and fauna other than protozoa. Perhaps the occurrence of a definite algal flora is the most surprising at first sight. In the soil, algæ and autotrophic bacteria are the only micro-organisms which can synthesize organic from inorganic matter; autotrophic bacteria obtain energy chemosynthetically, using inorganic substances as a source of energy, algæ photosynthetically, using the energy of sunlight. It is common knowledge that algæ are universally distributed on the surface of the soil wherever there is light and moisture, but they also live below the surface, not exposed to the rays of the sun and under more uniform temperature and moisture conditions. The occurrence of algæ and diatoms in the soil was referred to by Ehrenberg, but only within the last fifteen years or so has their general occurrence been realised and the fact that they actively grow and play a definite part in soil-transformation. Some algæ can utilize organic materials and may thus develop in complete absence of light, leading a heterotrophic existence; the chlorophyll under these conditions may be lost or retained, which is a matter which so far has not received attention from mycologists interested in the origin of fungi. Fungi are now amongst the best known of soil-organisms, and Professor Waksman has contributed largely to our knowledge of the species and of their physiology and of the related *Actinomyces*, which he regards as physiologically differentiated from fungi. Fungi occur in enormous numbers, and *Mucor*, *Penicillium*, and other well-known genera appear to have soil as their chief habitat. They are concerned in cellulose fermentation, decomposition of nitrogen compounds, and altogether are, if not equal in importance to Bacteria, at least a good second. Mycorrhizas are also considered here, but not in my opinion adequately, and the perennating mycelium of Basidiomycetes warrants more extended notice. Protozoa, the most abundant group of animals, have a chapter devoted to them, and the rotifers, nematodes, annelids, worms, insects, and other non-protozoan fauna are considered in the final chapter of this section.

The rest of the volume, more than half, is devoted to a consideration of the chemical activities of the micro-organisms and of their effects on soil-fertility. Here there is of necessity some repetition of facts stated in the previous section; but as the point of view is different, the various activities are correlated to give as complete a picture as is at present possible of the result of the welter of life in the cosmos of the soil. The transformation of organic matter, the availability of the mineral elements, the fixation and transformation of organic matter, and the best means of the preservation of the nitrogen already in the soil are a few of the processes which depend largely on the activities of micro-organisms

and which control the growth of cultivated plants. Further, parasitic fungi often carry out the saprophytic part of their life-histories in the soil, and even such a well-known parasite as *Phytophthora* can live saprophytically in soil for a considerable period. To understand the chemical processes taking place in the soil as the result of the activities of micro-organisms, to find out the conditions of their occurrence and relative frequency, and to apply methods of modifying the soil-population and its activities are problems facing the soil microbiologist. It should be clearly understood that though most of the investigations have been carried out on cultivated soils, we have the same groups of micro-organisms at work in all soils.

The book is well printed and, in spite of its size, attractive in appearance and easy to handle. There are some matters in the book which might be criticised, but to labour these would indicate a lack of perspective. The book is extremely valuable as showing the present state of our knowledge and lines along which research is proceeding, and everyone whose interest in plants does not stop at soil-level will find information and inspiration in its well-documented pages.

J. RAMSBOTTOM.

The Field-Club Flora of the Lothians. Edited by ISA H. MARTIN, M.A., F.L.S. Small 8vo, pp. viii, 142; with folding map, frontispiece, 2 plates, and illustrated glossary. Blackwoods: Edinburgh, 1927. Price not stated.

THIS very handy little volume has been issued by the Botanical Committee of the Edinburgh Natural History Society in the hope that it may be of use to younger students and amateurs who are interested in the field botany of the Lothians. It is a list of the flowering plants and ferns following the nomenclature and sequence of the tenth edition of the *London Catalogue*, with indications of their habitat and localities within the area. The English names, which follow the botanical binomials, bear no suggestion of local lore, being in fact the more or less satisfactory names familiar in British Floras. In addition to the Catalogue there are seven "ecological lists"—that is, lists of plants found in special localities, such as Arthur's Seat and Craggs, illustrating hill plants; other lists are illustrative of loch plants, moor plants, riverside plants, &c. A feature of the booklet is the illustrated glossary, which is added in the hope that it may help the student when consulting larger floras. The text is well arranged and clearly printed, but the illustrations in the glossary are not so well produced.

Die Laubmoose Europas. Band iv. Lief. i. *Ergänzungsband.* *Andreaeales-Bryales*, von WILH. MÖNKEMEYER. 8vo, pp. x, 256; 51 figs. Akademische Verlagsgesellschaft: Leipzig, 1927. Price M. 21.

LIMPRICHT'S *Laubmoose* (1890-1904) constitutes Band iv. of Rabenhorst's *Kryptogamen-Flora von Deutschland, Osterreich und der Schweiz*, and is still the most authoritative work on the mosses of Europe. But since its publication bryological science has advanced

in many details, and Herr Mönkemeyer has found enough material to fill a supplementary volume.

In his Introduction he gives an account of the germination, structure, and reproduction of mosses, and of the sporogonium; discusses variability of form, influence of habitat and substratum, adaptations of xerophytic mosses and saprophytes, the geographical distribution of mosses in Germany, together with their Alpine and Mediterranean affinities, very rare species, fossil forms; and supplies a classified bibliography of moss literature.

In the systematic part Herr Mönkemeyer has deviated from the older plan followed by Limpricht of dividing the cleistocarpous mosses off from the stegocarpous, and has adopted the modern natural method of distributing the cleistocarpous forms among the groups to which they are allied. With slight variations he employs the classification elaborated by V. F. Brotherus in Engler's *Die Natürlichen Pflanzenfamilien*. He devotes some fifty pages to his general keys for the determination of genera and species—artificial keys which appear to be extremely helpful as being founded upon easily-observed characters; and as he holds that neither keys nor descriptions are of real value unless backed up with illustrations, he gives abundant references to the figures in the text. It would seem that any moss with a marked habit or structural peculiarity can, with the help of these keys, be quickly placed in its appropriate artificial group, and then traced to its proper genus and species. The descriptions of the genera and species are short and concise; subspecies are treated as varieties, and varieties are lowered to the rank of forms. In each family attention is called to the allied genera of the world which are not found within the European limits. Under each genus a careful key to the species is provided; but in his introduction the author warns us that he has been unable to cope with the genus *Bryum* in this way; it contains as many as 300 European species which defied all his efforts to reduce them to the analytical order of a key; he has therefore restricted this key to the species of Middle Europe. However, the genus *Bryum* is not included in the present part of the book, which breaks off abruptly in *Anæctangium*, and possibly will require two more parts for completion.

We have here a sound and helpful work which has been carefully thought out, the outcome of many years of devoted study and mature reflection.

A. G.

BOOK-NOTES, NEWS, ETC.

A NEW PRITZEL.—The Royal Horticultural Society is to be congratulated on the approaching completion of a work of the first importance to botanists and horticulturists—an emended and enlarged edition continued up to the end of the year 1920 of Pritzel's *Iconum Botanicarum Index*. The story of the inception and conduct of the work is given in the circular issued by the Oxford University Press, the publishers of the new *Iconum Botanicarum Index Londinensis*, which has been prepared at the Royal Botanic Gardens, Kew, under the auspices of the Royal Horticultural Society, with Dr. Otto Stapf, F.R.S., as Editor.

In 1855, Georg August Pritzel, Archivarius and Librarian of the Prussian Academy of Sciences in Berlin, published his first edition of the *Iconum Botanicarum Index*, and in 1866 he issued a supplementary list of references up to the end of the year 1865. These two volumes, which contain over 107,000 references to illustrations of Flowering Plants and Ferns, have remained till now the standard Alphabetical Register or book of reference to the illustrations of plants which have appeared in botanical, horticultural, and other publications.

Owing to the enormous development in the facility of reproducing illustrations and the vast number of new plant figures which have been published since the appearance of Pritzel's supplementary volume, the Royal Horticultural Society of London considered it was desirable to attempt to prepare a continuation of this great index of plant illustrations. The Council of the Society, on the advice of their Scientific and Horticultural Committees, decided in 1917 to undertake the revision and continuation of Pritzel's Index, and the work was then set in hand.

The Director of the Royal Botanic Gardens, Kew, placed accommodation at the disposal of the Society as well as the use of the Kew Library, and permitted the manuscript supplement of the Pritzel Index, which has been continued at Kew, to be typed for the revision. He also permitted the Keeper of the Herbarium to act as Editor of the undertaking. The task is now nearing completion, and the first portion is ready for the press.

The new edition, which will also include the references in the original Index, will contain 450,000 references to illustrations of Flowering Plants, Ferns, and Fern Allies published in botanical, horticultural, and other works and journals between the years 1753 and 1920 (inclusive). Further it is proposed to issue periodic supplements at intervals, the first being already in preparation.

The following principles have been adopted in connexion with the revision:—

All botanical plates and figures are cited as they are given in the respective publications, and no attempt has been made to correct the name of a plant which may now be known under some other name. Obvious errors, other than taxonomic, have, however, been corrected.

References to figures of some of the more important hybrids have been included, but illustrations of the numberless garden varieties and forms of cultivated plants are not registered. Thus the basis of selection has been:

All plates and drawings, whether reproduced from photographs or not, are included, if accompanied by a scientific botanical name.

All reproductions of sufficient botanical, horticultural, scientific, artistic, or historical value are included; but purely anatomical or teratological figures are not registered.

Attention has been paid to "habit" figures, more particularly in the case of trees, and to analyses or any part-illustrations which depict differential characters essential for the determination of species, and for such figures special symbols or abbreviations are employed.

Not only has the original Pritzel Index with its Supplement and

the Kew Manuscript Supplement been typed out in card catalogue form for the purpose of preparing the present revision, but all the relevant literature in the libraries at Kew, the British Museum (Natural History), and elsewhere has been examined and the necessary entries have been made. In addition, very valuable assistance has been given by Botanists on the Continent of Europe and in the United States, and references to a very large number of figures, not readily available in this country, have been added, which will render the citations in the new Index almost complete.

The edition will be strictly limited. The work will appear in six volumes, in which the matter will be arranged in three columns, as in the *Index Kewensis*, in order to reduce as far as possible the size of the volumes. The volumes will be bound in cloth so as to range with *Index Kewensis*.

It is proposed to produce two volumes in each of the years 1928, 1929, 1930.

The subscription price has been arranged on the basis of either (1) a lump sum of £25, payable in advance of publication, or (2) a subscriber's payment, £9 for the first two volumes and £4 10s. for each of the volumes iii. to vi. The price to non-subscribers on publication will be not less than £5 per volume.

NEWS has come of the death of Professor Bruce Fink, one of America's leading lichenologists, who carried on the succession from Tuckerman. He died suddenly on July 10th while at work in his laboratory at Miami University, Ohio. Fink's volume, *Lichens of Minnesota*, was published in 1910, and is the work by which he is best known in Britain. He was also a pioneer in the difficult study of lichen ecology.—A. L. S.

CHARLES DARWIN'S HOME TO BE PRESERVED.—At the close of his Presidential Address to the British Association at Leeds, Sir Arthur Keith announced that the Council of the Association were considering the purchase of Darwin's house, Downe, Kent; he appealed to the members present to help save the estate from the hands of the builders in order that house and grounds might be preserved as a memorial of the great Naturalist, in a condition as near as possible to that in which he had left them. In response to the appeal, Dr. George Buxton Brown at once generously offered to become wholly responsible for the purchase. The house has in recent years been used as a school.

THE booklet on *Edible and Poisonous Fungi*, issued by the Ministry of Agriculture and Fisheries, contains twenty-five coloured plates, each faced by a description of the fungus, its properties, and an indication of its habitat. Edible species include, besides the common and horse-mushrooms, fourteen other species; and nine poisonous or suspicious species are figured and described. The "Foreword" emphasises the importance of establishing the identity of a fungus before it is eaten, and the danger of relying on rule-of-thumb methods to distinguish poisonous from edible species. The booklet can be bought at the office of the Ministry, 10 Whitehall Place, London, S.W. 1, S/Cloth Boards 3s., Quarter Boards 2s. 6d.

COLLECTING IN SPAIN FROM A MOTOR-CAR.

By A. J. WILMOTT, B.A., F.L.S.

MY opportunity of making this tour arose from Mr. Lacaita's desire for a companion on a trip he had planned: the Trustees of the British Museum gave the necessary leave and also a grant towards expenses. In ten weeks we travelled 4600 miles by car, the route being:—Havre to Bayonne, across the Pyrenees by the Pass of Roland, down past Roncesvalles to Pamplona, Logroño, Soria, Aranjuez, through the Sierra Morena gorge of Despeñaperros to Linares, Guadix, Granada, Jaen, Cazorra, to Jaen again and then Cordoba, Seville, Badajoz, Guadalupe, Sierra de Gredos, Cistierna, Covadonga, and back through San Sebastian and Dax to Havre.

Collecting from a motor is a very different form of collecting from that undertaken last year in the Sierra Nevada. Then, settled at a base, repeated day excursions made it possible to attempt a thorough collection, although the richness and diversity of the flora, together with the rapid seasonal changes in that country, made a really complete collection even then out of the question. This year it was a case of skimming the cream from a large number of different habitats. With eyes on the alert for anything fresh, we travel at our full speed. We slow down for anything suspicious—we satisfy our suspicions and pass on or stop as the case deserves. If we stop, we generally find that with one fresh plant are others, and the halt may extend to a half-hour or more of hurried gathering and searching. We immediately lay our haul into papers, and then go on ten, fifteen, twenty miles, find a new collecting-ground with fresh plants, and collect again. To stop for everything would mean that we could not cover the necessary ground, but, although a few plants were certainly missed, there were very few that we did not see again on slowing down. But the Spanish flora is so rich and varied that, collecting in this way with relatively few stops during a journey of 100 miles, we obtained as much material as we could deal with in the evenings, and required an occasional quiet day for drying and clearing the presses. In normal sunny weather most plants will dry in three days. Twelve wire presses and airing-boards were just sufficient to deal with the maximum amount of specimens which were drying at one and the same time. Slow dryers (such as Orchids, Saxifrages, and many others) were kept apart. On the top of the car our presses were well sunned in a strong wind.

The bulk of the collection is not of new plants, but of "critical" plants—of groups that are known to be difficult, specimens of which are always valuable. The more one knows which groups are "critical" and what taxonomic problems are waiting to be solved, the more valuable the collection formed will be.

In passing, one may say that the Spanish roads, as a whole, are quite good for motoring, while the French national roads are execrable.

Our diversions consisted of excursions into mountain ranges—the ascent on a mule or donkey, the descent on foot if possible.

JOURNAL OF BOTANY.—VOL. 65. [NOVEMBER, 1927.] Y

The plants have not yet been worked out, but a few notes may be of interest, while a sketch of the trip will indicate what material may be found at the Museum when the collection has been dealt with.

Crossing the Pyrenees (May 24), the zone of Beech above that of Chestnut made fine forest, which extended to the top of the pass. At the top it was beginning to dwarf, and could be seen on the neighbouring ridges ascending gullies nearly to the crest. The plants of the grassland on the crest were not very interesting; there was fine *Lathræa clandestina* under the beeches. In the descent to Pamplona we entered the more arid "open" associations which practically cover Spain. Not until we reached the northern side of the Sierra de Gredos on the way back did we again see a "green" country such as we know in England. South of Pamplona we met a real natural flower-garden on the rocky slope of a little hill: Helianthemums, *Thalictrum tuberosum*, and a galaxy of other species almost sufficient in themselves for a day's collecting. At Logroño the good weather deserted us, and we crossed the mountain-ridge to Soria in driving mist and icy wind. A few interesting plants (*Linaria nivea*, a mountain-pansy, etc.) were collected; but it was a disappointment not to obtain a good collection from this interesting district: the valley of the Rio Iregua on the north side (much *Quercus Toza* woodland) looked a fine country for collecting. A collection from the dry hills of Castile was made in the afternoon at Soria—Thymes, Salvias, Helianthemums, Linarias, and perhaps fifty other species growing on a single hillock. These open associations are very interesting. One realises the dulness of the relative poverty of the British flora and of "closed" associations in general.

From Soria to Guadalajara we passed through a long stretch of open *Quercus Toza* woodland where all the trees are small, whether naturally or from recent or continual cutting of the older trees I do not know—again a different flora. A pine forest provided another change, with some British species such as *Polygala vulgaris* and *Orchis "mascula"* (almost certainly not the same as the British one). Farther on *Hedysarum humile* made glorious patches of colour on the dry hills.

Going on to Aranjuez we collected on the dry gypsaceous hills, from which so many species have been described. The most interesting was the enormous *Reseda suffruticosa*, which reaches five feet in height. *Asphodelus cerasiferus* with its large fruits is quite easily distinguishable from *A. microcarpus* when seen alive. On the way to Valdepeñas we obtained *Onosma (hispanicum?)*, which was one of our special desiderata: this genus in Spain seems very local and restricted. One hill-side was scattered with the very local *Acanthyllis armata*, whose inflated calyces look curiously like gooseberries (the legumes are entirely enclosed): of this plant we only saw a single other specimen (near Guadix) during our tour.

Passing southwards (June 2) we come to the Sierra Morena and the end of the plateau of Castile. It is curious to find oneself at the top of a mountain range after many days' journey over relatively level ground. It is true that the plain of Castile is not level—rather

is it several levels. One journey's miles over a flat area bounded by distant mountains, and then suddenly the road runs steeply downhill and the vista opens into another plain some distance below. What was the plain now becomes the bounding hills. But at the Sierra Morena one suddenly runs down a gorge into the massif of the Sierra Morena, which is, as it were, a huge southern buttress of the 3-4000 ft. high central plateau. We were in a hurry to reach Linares, and only stopped to see some of the special Sierra Morena species—e. g., *Jastone mariana*, *Digitalis mariana*, and others. A short afternoon storm gave us hours of extra work by wetting our presses. Near Linares I first gathered the remarkable *Echium pomponium*, like an enormous candle six feet high, sometimes branched—three sheets are necessary for a proper exhibition of a single specimen. The giant wayside *Onopordon* is also troublesome to collect.

The road to Guadix took us through fine and relatively unknown mountain country—more time could profitably be spent in it. Bedmar is a village perched under mountain rocks, where we found the *Echium granatense*, which we were going to Guadix to hunt. The country near Guadix is curious—the clay soil has been eroded into gulleys, leaving conical teeth or toothed ridges up to the higher level plain. Near Guadix these are dense, and a gypsy village there is mostly housed in dug-outs in these conical hillocks. The bare dry soil and gulleys suggest Arabia rather than Spain.

The road to Granada is very bad and very picturesque. I was able to collect several Sierra Nevada species of which I wanted further material. Being delayed at Granada by repairs to the car, we returned to these mountains, and also spent a day in the gorge near Dilar, visited long before by Boissier. A visit to the Sierra Elvira, where Lange obtained his single specimen of *Herniaria brevistipulata*, did not provide this rarity—this small dry range is low and seems of no particular interest.

The road from Granada to Jaen runs over several ranges, which are presumably the reason why the direct railway has not been made; motor-buses supply the deficiency—indeed, motor-bus routes are abundant in Spain. Here we were glad to meet *Onosma* again. A hurried dash in the evening to the rocks above Jaen yielded the rare *Linaria lilacina* and other interesting plants, especially *Campanula decumbens*, which we had failed to find in its original habitats near Aranjuez.

After a rest to empty our presses we went to Cazorla, a village on the fringe of the large mountain massif explored by Reverchon from the opposite western side. We had two good days on the Sierra de Cazorla, obtaining a number of interesting plants. The beautiful deep rose *Viola cazortensis* was a fine sight on some of the rocks—it has a slender spur nearly an inch long; its nearest relative grows in Greece. The *Pinguicula vallisneriifolia* was found by a waterfall above the village, hanging in long lines from fluted ridges on the rocks under dripping water. Its long light green leaves and pale blue flowers were a beautiful sight.

The Sierra de Cazorla, like so many other Spanish Sierras, rise

suddenly and steeply almost straight out of the plain, and the views from the crest are superb. In one direction, looking down a steep gorge, the massif of the Majina is seen, miles away, rising straight from the other side of the plain. In the other direction, from a different crest, rise and fall something like fifty miles of mountains. The descent into the pine-clad valley is steep: we have far to go in these limestone hills before we come to the water necessary for lunch, and without good guides we should certainly call them waterless, as does Hervier. But the most astonishing thing was the extreme freshness of the vegetation in this range after many days of travel in a parched country. An acre or two of green grazing high up was a relief to the eyes. Among interesting plants found was *Convolvulus nitidus*, which excited us, as we thought that it was only known from the Dornajo (Sierra Nevada); it was, however, collected by Reverchon.

Our planned two-day excursion to the Barranco Valentin had to fall through, since the second of the days would be Feste Corpus, the great religious festival of the year, when the guides would not go. To wait would leave the car six days exposed to blazing sun, as there was no available shed to serve as garage! A bad chill caught by Mr. Lacaita forced the decision to return to Jaen, where we dealt with the great mass of material which two days' collecting had provided. Running west to Cordoba we found that the *Echium granatense* and *E. pomponium* extended until we had passed out of the province of Jaen. *Daucus maximus* was sometimes in masses by the roadside. That day (June 18th) we ran into really hot weather, and saw an interesting dust whirlwind which struck the car as it passed along the road. Before going on to Seville we spent a hot morning on the Sierra Morena foot-hills to look for a *Dianthus*, which we obtained. The drive to Seville was hot: summer heat, not due for two weeks, had already burnt up the vegetation—our yesterday's plants on the roof of the car were dried out and shrivelled in the day's sun.

From Seville we went to Jerez de los Caballeros, where are the ruins of a fortress of the Knights Templars. On the way we crossed the western end of the Sierra Morena, which have here spread out into a series of lower hills. Much of them is covered by a park-like woodland, which is sometimes composed of *Quercus Suber*, and sometimes of *Quercus Ballota* (the edible acorn, here used for food). No doubt, the spring flora of bulbs is beautiful, but when we passed almost everything was burnt up. The summer-flowering *Asphodelus aestivus* was seen, and seen frequently throughout Estremadura. This wooded country continued until near Badajoz, when we descended to the river-valley; from there to Merida, and, until we came near the Sierra de Guadalupe, we were passing through a great wheat-growing area. From time to time we passed huge piles of wheat at the open threshing-places where they thresh by driving horses over the spread wheat.

From this plain low Sierras rise, as usual suddenly, at intervals. When we reached the Sierra de Guadalupe, the vegetation immu-

diately became fresher, and some of the gorges were as beautiful woodland as anything we saw in Spain. After the dulness of Estremadura it was most delightful.

At Guadalupe we enjoyed the hospitality of the Monastery, where is housed the most famous "Virgen" in Spain. Gorgeous tapestries, vestments, and other treasures, presented by all the Kings of Spain for centuries, are to be seen, and a series of large paintings by Zurbaran. The situation of the Monastery in the heart of the mountains is very fine. The rocky summit of the ridge (*Quercus Toza* scrub nearly reaches the ridge) was visited and the *Jasione*, which we specially wanted, found in flower, though not in profusion. As usual, many plants not previously seen were met with. A hurried walk to Mirabel yielded flowers of an interesting (new?) *Serratula*, which Mr. Lacaita had previously found there in bud only. The curious acaulescent *Centaurea toletana* was also a pleasant surprise. The vegetation in the dense woodland of some of the valleys was very luxuriant, including *Quercus lusitanica*, *Arbutus Unedo*, etc. *Sarothamnus eriocarpus* with its snow-white roundish pods is locally abundant on the hill-sides. But the higher levels are covered with miles of *Cistus ladaniferus*, which is very dull and is troublesome to ride through—fortunately, it was not at its gum-exuding period. Alternating or mixed with the *Cistus* are species of bushy *Erica*.

The next day we crossed the rest of the Sierra de Guadalupe, obtaining another interesting *Jasione*. From the summit we could just see the snows of the Sierra de Gredos in the distance across the plain (which proved to be plains, as in Castile). Crossing this we found the little-known *Echium polycaulon* all along the south side of Gredos from Candeleza to Arenas de San Pedro. The Sierra de Gredos again rise sharply out of the plain to about 8000 ft., the lower slopes being covered with beautiful Pine forest (ground flora of Bracken and other plants), but we had no time to explore them.

From Arenas de San Pedro the new road to Avila ascends the steep face of the Sierra by a series of zig-zags—the old paved road, still used by mule trains, would be too steep for motors. At the top of the pass (Puerto del Pico) we meet *Cystisus purgans*, which (June 28) colours the upper northern slopes of Gredos with gold. *Genista cinerea* (?) and *G. anglica* are also in abundance. Before descending to Hoyos del Espino, where we stayed for the ascent of Gredos, we visited the Pine wood near Hoyo Casero (according to the local people's spelling, wrongly called Hoyo Quesero in all the botanical books), where Graells found the curious *Leuzea rhaeniticoides*. This plant was plentiful there, but has not been found elsewhere; we did not find it in the pine-woods near Hoyos del Espino. Near it we made a large collection; the flora was rich in species we did not see again—a fine *Nepeta*, *Pulsatilla alpina* in fruit, and many others. The north side of Gredos is a green country, where many British species were again met with; it was the first green country we had seen for a long time. Near Hoyos del Espino we found such British plants as *Eriophorum*, *Wahlenbergia*, *Viola*

"*palustris*" (probably *V. Juressi*). The day we ascended Gredos the weather broke. After much rain and icy wind we reached the Spanish Alpine Club's "Refugio" and had an hour's collecting in the evening between rains. Our guide and his son made us extremely comfortable in spite of the weather, which was unheard of for that time of the year (a week later two shepherds and 200 sheep died of cold there—in July!). The next day was just as bad—we had a couple of hours' collecting around the hut. This provided many of the special Gredos flora—*Reseda gredensis* (a curious plant of rocky slopes), the fine *Genista Barnadesii*, and others. Fortunately our men had provisions for a third day, and we decided to stay on, being rewarded by a gloriously fine day, on which we ascended to the Laguna finely situated in a hollow surrounded by the highest peaks. On this granite range *Linaria alpina* replaced the *Linaria "melanantha"* (or allies) met with on many other ranges. The *Antirrhinum* left unnamed by Leresche and Levier was collected with difficulty—it prefers niches in perpendicular rock-faces, but our boy guide was an excellent rock-scrambler. *Narcissus rupicolus* was still in flower at that altitude above the snow-patches. We descended by way of the King's refugio situated on the crest, whence on fine days the Sierra de Guadalupe can be seen across the plain.

After two days spent drying plants and collecting near Hoyos del Espino, we made for the Asturias (July 5th). The intervening country was mainly dull and dried up—some of it very dull. The fine walled town of Avila was an interesting sight. Just before reaching Sahagun a change in the vegetation marked the limit of the effect of the Atlantic damp air (Bay of Biscay)—*Centaurea Scabiosa* being seen again, and as a common plant. We were running into almost unbotanised country, and near Cistierna collected many plants on a hill-side. But the bad weather settled in, and, although we managed to collect several rarities (*Campanula acutangula*, *Pimpinella siifolia*, a little-known *Matthiola*, *Petrocoptis*, etc.) near Riaño, it was only in dashes from the car between rains. The fine Puerto de Ponton was crossed (July 8th) in rain. At Covadonga (July 8th–21st) the weather continued bad—we had three fine days, by luck these were the three we selected for excursions.

Fine intervals enabled us to make short excursions: one morning we went to the gorge of the Cares and obtained several interesting plants, visiting the original station for Mr. Lacaita's *Crepis asturica* on the way. The scenery of these very narrow gorges is wonderful. The vegetation near Coradonga was very luxuriant—as much so as in the west of Ireland, although the unusually wet season may have had something to do with this. Such plants as *Erica Mackaiiana* (seen more abundantly further west at Leitriegos), *Arbutus*, *Saxifraga umbrosa* (very like the Irish form) increased the similarity. The beautiful *Linaria faucicola* was in plenty. *Petrocoptis Lagascae*, both pink and white, large-flowered and small-flowered, with glaucous foliage or green, made an interesting study.

Drying plants was only possible through the kindness of the hotel-

staff, which gave us the run of the "blanchador," where we dried our papers (and ourselves!) at the red-hot iron-heating stove. The Puerto de Ponton was revisited: the clouds descended, but we fortunately met a herdsman who piloted us to heights where we could obtain interesting plants and who regaled us in his hut with a horn of fresh warm milk. The road up to this pass runs through a gorge until recently impassable—the road is a feat of engineering, running at times through tunnels cut through the rock, and at other times cut in the side of the precipice sheer above the water. Earlier in the year the flower-covering of the rocks is very fine—*Saxifraga canaliculata* makes large snowy-white patches.

We made an excursion through dense sea-fog and cloud to Leitriegos in the country first well collected in by Durieu. This hamlet of twenty houses is at the top of the pass close to the Pico de Aroas. Local hospitality enabled us to spend the night, and we had a beautiful sunny morning on the peak. *Eryngium Duriei* was found in bud, *Armeria Duriei*, *Pyrethrum anomalum*, and a crowd of interesting plants. In the rivulet below was *Myosotis stolonifera*, which, when not stoloniferous (!), looked very like *M. repens*. By 2 P.M. the clouds had ascended again and enveloped us; we were told that no day in the year passed without the hamlet being enveloped by clouds. From the Pico in the morning we may have seen the Picos de Europa to the east—if we did, it was the only time we saw them clear during our visit to the Asturias.

Our visit to the Picos themselves was on the third fine day—a very steep hour's ascent by motor to the Lago Enol, and then an ascent to the foot of the Peña Santa. The flora was relatively uninteresting, except for a few rarities discovered by Leresche and Levier. *Campanula acutangula* was abundant, but almost without flower. *Pimpinella siifolia* was frequent—we saw it also near Covadonga and above the Puerto de Ponton. A single flower of *Aquilegia discolor* was found, and was not discolorous! A gully full of snow was ascended until it became certain that the pall of cloud was not going to rise—*Ranunculus Sequieri* was in flower at the highest point we reached. We descended to the Lago Enol, having had two glimpses of some of the Picos, one in the morning and one as we left, but not a peep at the highest one. So we had to leave them, and the bad weather continued till we reached the Landes again. The journey home through France was botanically uneventful.

In this account it has not been possible to mention more than a few interesting plants. A more detailed account must be postponed till a later date.

THE FLORAL MECHANISM OF *CATASETUM*
MACROCARPUM RICH. (*C. tridentatum* Hook.).

By B. J. BEDELL, B.Sc.

CATASETUM is peculiar among orchids in having a violently explosive mechanism to eject its pollinia. The rostellum is projected upwards into two tentacles (called "Antennæ" by Darwin in his *Fertilization of Orchids*)*. Immediately upon an antenna being touched, the anther enclosing the two pollinia, the pedicel, and viscid disc are shot out from the flower. In *C. macrocarpum*. (fig. 1) one antenna (a_1 , fig. 2) is curved forwards and towards the centre of the flower, so that its tip lies just inside the apex of the labellum, while the other (a_2 , fig. 2) is curved in a sideways direction and lies in contact with the base of the labellum.

The present paper deals with:—

- Part I.—The Mechanics of the Ejection of the Pollinia.
Part II.—The Sensitiveness of the Antennæ.

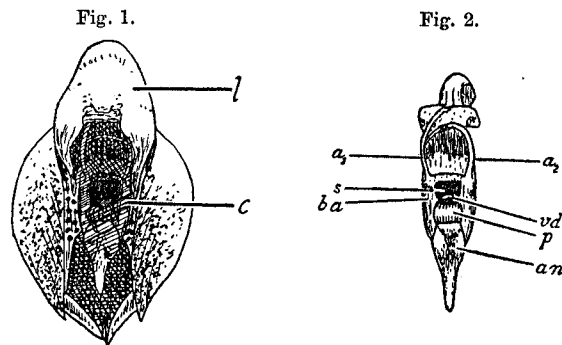

Fig. 1.—The flower of *Catasetum macrocarpum* Rich. *l*, labellum; *c*, column. About two-thirds nat. size.

Fig. 2.—The column. *an*, anther; *p*, pedicel; *vd*, back of viscid disc; *s*, stigmatic cavity; a_1 , projecting antenna; a_2 , inwardly-curving antenna; *ba*, side of column forming base of antennæ.

Part I.—THE MECHANICS OF THE EJECTION OF THE POLLINIA.

Imagine a piece of rubber tubing about three times as long as its diameter, split longitudinally, and with one of its ends pinched together. Such a tube if opened out would be square at one end and terminate in a hollow point at the other. The pedicel (figs. 2, 3, & 8) when flattened out resembles this, except that what corresponds to the square end is tapered and produced to form the viscid disc (*vd*, figs. 2 & 8), and to the other end the pollinia are attached to

* On the Various Contrivances by which Orchids are fertilized by Insects. London, 1862.

each side of the boat-shaped point (*pl*, fig. 3). If the rubber tube while opened out were made to fit over a spherical knob, it would constantly tend to spring away from it, owing to its tendency to close and assume the form of a straight tube. The pedicel in the flower closely fits over the hump (*h*, figs. 4 & 8). The hollow pointed end sheathes the point of the hump, while the viscid disc end is held in place by its being joined at its sides to the tissue of the column—which is also the base of the antennæ (*ba*, fig. 2). When an antenna is touched these junctions rupture, allowing the pedicel to straighten and the viscid disc to swing out. Only when the pedicel is nearly straight can its sheathing pointed end slip off the point of the hump. The pedicel is then set free, and the momentum acquired by the heavy viscid disc during its swing is imparted to the pollinia and to the anther (*an*, fig. 2), which continues to enclose them (the slender joint by which the lower tip of the anther is attached to the filament (*f*, figs. 3, 4, & 8) becoming broken). It was assumed by Darwin that the tendency of the pedicel to straighten was the sole motive force for the ejection (*vide* his "Whalebone Analogy" in the

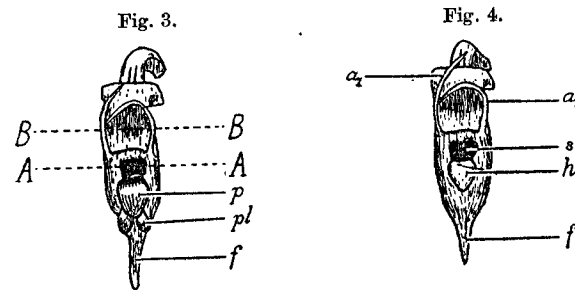

Fig. 3.—The column, showing the anther removed. *p*, pedicel; *pl*, pollinium; *f*, filament; *AA*, line about which column was cut in Experiment I.; *BB*, line about which column was cut in Experiment IV.

Fig. 4.—The column, showing anther and pedicel removed. *h*, hump; *s*, stigmatic cavity; a_1 , projecting antenna, a_2 , inwardly-curving antenna; *f*, filament.

Fertilization of Orchids). It was thought by the present writer that possibly this was not the only source of energy, and that perhaps the pedicel came to be in a state of longitudinal tension as the flower became mature—the hollow pointed end being stretched over the point of the hump and the other end being held by the tissue of the column. Upon this junction being ruptured the pedicel would at once contract longitudinally, and, since the hollow pointed end is kept fixed, the viscid disc would acquire momentum. Accordingly, three experiments were carried out:—

Experiment I.—To measure the potential energy that the pedicel possesses if ejection of the pollinia and their attachments is due alone to the straightening of the pedicel.

Experiment II.—To measure the energy that is required to eject the pollinia and their attachments to a distance which can be measured.

Experiment III.—To find out whether the pedicel was in a state of longitudinal tension.

Experiment I.—To measure the potential energy that the pedicel possesses if ejection of the pollinia and their attachments is due alone to the straightening of the pedicel.

The petals, including the labellum, were removed with a safety-razor blade from a flower. The anther was next pulled off, so that the flower presented the appearance shown in fig. 3. The column was then cut in two about the line *AA*, fig. 3. Great care was exercised in doing this, so as not to cause explosion of the pedicel. Only part of the weight of the razor-blade was allowed to press on the column, and V-shaped nicks were made until the sides were severed. Next, the back of the column was cut off, so that the remaining part could rest flat on its back upon a microscopic slide. When the back of the column was cut off, it was found that the viscid disc was not in contact with anything, contrary to Darwin's assertion in which he says that it is kept moist by being embedded against the back of the column—"The whole surface of the disc is kept damp before ejection, by resting close against the roof of the stigmatic chamber" (Darwin's *Fertilization of Orchids*). Moreover, the present writer has sectionised young buds and found in them that the disc is at no time in contact with anything. Doubtless, since the Orchid is open for only two days, the disc does not have time to dry or possibly the cement differs from that found in other orchids.

The remaining part of the column was placed on a slide (fig. 5) and held in place by two blocks of hard paraffin-wax (*b*, in fig. 5) cemented to the slide and by a piece of cotton thread tied round the slide and over the filament. A bar made from a safety-razor blade and having a paper scale stuck on it was weighed (weight 0.793 gm.) and placed so that one end rested on the back of the viscid disc and the other on the slide under a piece of paper stuck on it to keep this end of the bar in place (figs. 6 & 8). The slide was then placed on a level glass slab, a spherometer was placed over it and adjusted so that its point came just into contact with the end of the bar resting on the back of the viscid disc (fig. 7). The spherometer reading was taken and found to be 0.515 cms. The point of the spherometer was then screwed down, to depress the bar and sever the connection between the viscid disc and the column. The reading of the spherometer was then brought back to 0.515 cms., the straightening action of the pedicel keeping the bar in contact with the point of the spherometer. The latter was next screwed up a little. A suitable balance weight next was placed on the bar, in such a position that when the spherometer point was depressed to give the original reading of 0.515 cms. and raised a little again the bar did not rise (fig. 8). The downward vertical force of the end of the bar now balances the lifting-force exerted by the back of the viscid disc due to the

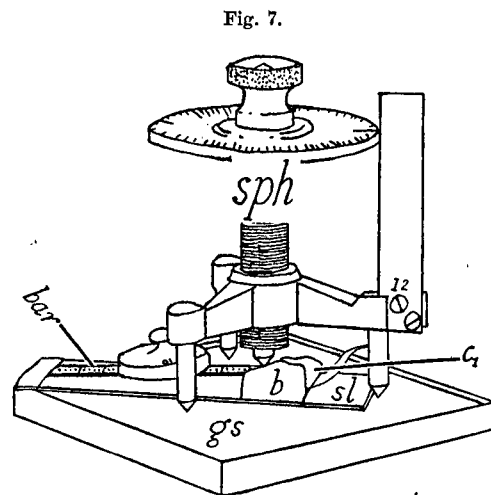
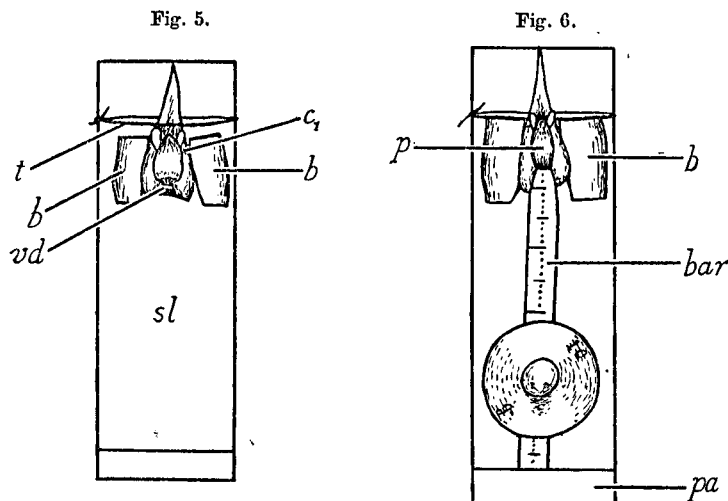

Fig. 5.—Showing how lower half of column (*c₁*) is clamped to the slide (*sl*) by the blocks of wax (*b*, *b*) and by the cotton thread (*t*). *vd*, back of viscid disc.

Fig. 6.—Showing bar and weight in position for Experiment I. *pa*, paper stuck to slide to keep *bar* in position; *b*, block of wax; *p*, pedicel.

Fig. 7.—Showing apparatus set up for Experiment I. *sph*, spherometer; *gs*, glass slab; *sl*, microscopic slide; *b*, block of wax; *c₁*, lower half of column; *bar*, graduated bar resting on back of viscid disc and on slide.

straightening action of the pedicel at the spherometer reading of 0.515 cms., *i. e.*, when the viscid disc is in the same relative position as it is in the flower, before its connection with the sides of the column is broken. This force may be calculated—let it be represented by R dynes (fig. 8). The weight of the bar, 0.793 gm., acts at its middle point. The balance weight exerts a force of W gms. weight at a distance d cms. from its middle point to the lower end of the bar.

Thus, by taking moments about the lower end of the bar, we get:

$$R \times 5.34 = \left(0.793 \times \frac{5.34}{2} + Wd \right) g,$$

where 5.34 is the length of the bar and g is the acceleration due to gravity. From which R may be calculated in dynes— W , d , and g being known.

In the experiment the distance d_1 cms. from the lower rim of the balance weight to the lower end of the bar was actually recorded, and the radius r cms. of the weight added to it, giving d ; $d = d_1 + r$,

where r for a 10 gm. weight = 0.98 cms.

“ “ 5 “ = 0.83 “
 “ “ 2 “ = 0.68 “

R was calculated for many spherometer readings (see Table I.) until the pedicel had become sufficiently straight for its hollow pointed end to slip off the point of the hump.

TABLE I.

W gms. wt.	d_1 cms.	R dynes.	Spherometer reading in cms.
10	2.0	5865	.515
10	1.0	4027	.585
5	3.0	3907	.600
10	2.0	5865	.630
10	1.5	4946	.690
10	1.0	4027	.660
5	2.5	3448	.680
5	2.0	2988	.680
5	1.5	2524	.690
5	1.0	2070	.720
5	0.5	1612	.775
2	3.0	1742	.780
2	2.0	1374	.800
2	2.5	1558	.830
2	3.0	1742	.850
2	2.5	1558	.885
2	2.0	1374	.900
2	1.0	1007	.920
2	1.0	1007	.950

In the Graph (fig. 9) the values of R as ordinates are plotted against the displacements as given by the spherometer readings, and the comparatively smooth curve obtained. The area shaded in the figure gives, in ergs, the work performed by the pedicel in straightening from its natural condition to the point at which ejection takes

place. This area is found to represent 1225 ergs, and is the potential energy available by the plant for the ejection of the pollinia and their attachments due to the straightening of the pedicel.

Fig. 8.

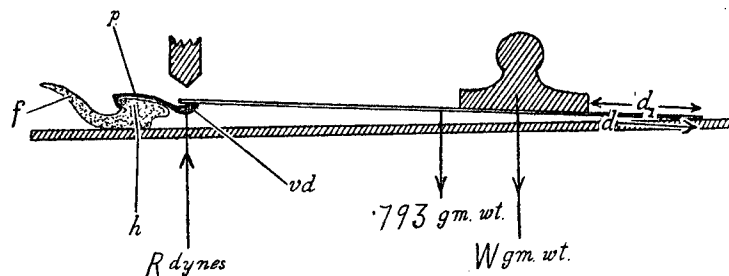

Fig. 9.

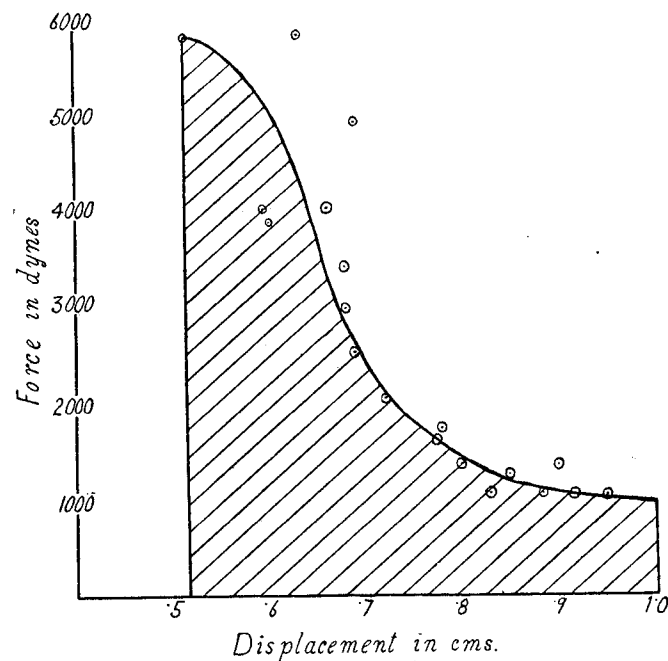

Fig. 8.—A diagram showing the forces made use of in Experiment. h , hump; p , pedicel; vd , viscid disc; f , filament. (The drawing of the section of the flower must not be taken as accurate.)

Fig. 9.—Graph, shaded area giving work done in ergs by the pedicel's straightening.

Experiment II.—To measure the energy that is required to eject the pollinia and their attachments to a distance which can be measured.

A flower with petals removed was held firmly by the ovary in a clamp on a retort-stand at a height h cms. (fig. 10) above a level surface. A piece of paper was placed flat on the surface where it was expected that the viscid disc would fall. The Orchid was brought into focus on the screen of a Reflex camera, so that the horizontal line on the screen, which had been adjusted level, passed through the image of the pedicel. The Orchid was "fired" by Mr. T. F. Farrell, a pupil of the author's, while the latter observed the trajectory through the camera. The angles α (fig. 10) were estimated by the author and by Mr. T. F. Farrell. Our estimations closely coincided. The range s was measured in centimetres, and the mass (m gms.) of pollinia and attachments was taken; in the cases of flowers V. and VI. by cutting out a small piece of paper upon which the viscid disc had stuck, weighing the whole in a weighing-bottle and deducting the

Fig. 10.

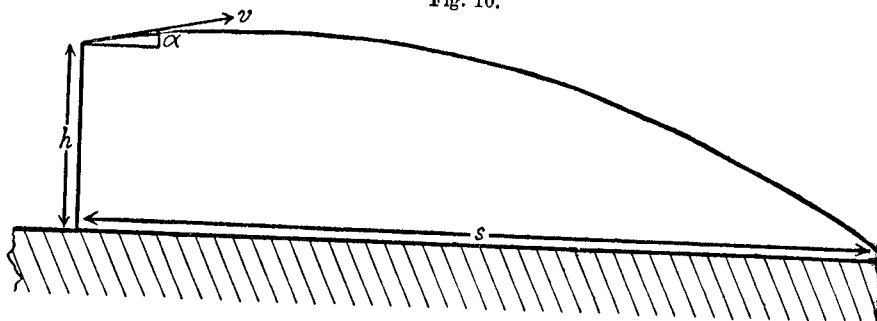

Trajectory of the pollinia and attachments.

weight of the bottle and of an equal area of the same kind of paper, so that all the cement of the disc was included in the final weight. In flowers III. and IV. this precaution was not taken. In flower III. the pollinia carried the anther, but in flowers IV., V., and VI. the anther was removed before the ejection. Also in flower III. α was not observed, but only guessed to be 0° .

By means of the formula,

$$v = \sqrt{\frac{gs^2}{2h \cos^2 \alpha + s \sin 2\alpha}}$$

(where g is the acceleration due to gravity), v , the velocity of projection of the pollinia and attachments, was found; and hence the kinetic energy in ergs, just after ejection:

$$\text{Kinetic Energy} = \frac{1}{2}mv^2.$$

TABLE II.

Flower.	s cms.	h cms.	m gms.	α° .	v cms./sec.	K.E. ergs.
III.	33.5	27.0	0.13	0° ?	142.8	1325
IV.	58.0	26.5	0.050	-9	312.7	2444
V.	81.5	27.5	0.058	+15	266.1	2053
VI.	51.0	29.5	0.058	-10	253.3	1861

s =range, h =height, m =mass of pollinia and attachments, α° =angle of elevation (+) or angle of depression (-), v =initial velocity, K.E.=kinetic energy.

The value for the kinetic energy found in the case of flower III. does not fall very well into line with the values found in flowers IV., V., and VI., due doubtless to the following reasons:—

(i.) The angle α was not observed, but only afterwards guessed to be 0° .

(ii.) This was the only flower in which the anther was not removed from the pollinia before ejection, and some energy must have been wasted in breaking the connection between the anther and filament, and also in imparting momentum to the anther.

From a consideration of the above experiments, it will be seen that in the case of one flower the energy available, due to the straightening action of the pedicel, was only 1225 ergs, whilst in the cases of four other flowers the energy needed for ejection was very considerably greater than this. This would mean, if there were no considerable variations in flowers and if the results were reliable, that the efficiency was over 100 per cent.—which is absurd. There are apparently three ways of accounting for this discrepancy:—

(i.) That the measurements were not sufficiently accurate.

The only data obtained which were not measured with instruments were the values for the angle α (Experiment II.). It is possible to estimate an angle with the method described above fairly accurately; if, however, the true value for α differed from the estimated angle by as much as 5° in the case, say, of flower V., the values of the kinetic energy would not differ from the kinetic energy given above by more than 274 ergs—and it is unlikely that an error as great as 5° was made.

(ii.) That the flower used in Experiment I. was unusual in giving such a low value for the energy available.

It was unfortunate that this experiment was only performed upon one flower. However, at the time that the experiment was devised most of the plants in the neighbourhood had finished flowering, and it must be understood that cutting through the bases of the antennae without causing explosion of the pollinia is a delicate operation and entails the wasting of many flowers. The flowers do not seem to vary much in other qualities—for instance, the weight of the pollinia pedicel and viscid disc is quite constant. And the individual flowers are so exactly proportioned that the prominent antenna is always almost touching the inside of the dome of the labellum.

(iii.) That some other source of energy also is available besides that due to the tendency of the pedicel to straighten.

It was thought that possibly the pedicel was in a state of longitudinal tension, and upon its viscid disc end being released it would at once cause the viscid disc to acquire momentum. This suggested mechanism is the same kind as that of a catapult, except that in the latter two elastic bands are employed instead of one. (The efficiency of a catapult may be fairly high; it was found to be as great as 76 per cent.) Accordingly, Experiment III. was conducted.

Experiment III.—To find out whether the pedicel was in a state of longitudinal tension.

Two short lengths of hair were stuck with glycerine jelly to the pedicel before its ejection, about 2 inch apart. The column was placed under a microscope on a slide and the hairs drawn on a piece of paper by means of a drawing eyepiece. The pedicel was carefully removed and the hairs drawn again by means of the microscope set up as before.

The hairs were found to be the same distance apart, subject to errors in technique—that is, there is very little contraction of the pedicel, if any, after removal from the hump. This result would seem to negative the suggestion that the pedicel was in a state of tension in the flower. However, it may be that it takes a large stress to produce a small strain, and that the experiment was not sufficiently accurate to indicate any strain. The negative result of this experiment, therefore, need not necessarily disprove the supposition that the pedicel is under tension in the flower.

Another possible source of energy lies in the possibility of the hump over which the pedicel is stretched being compressed, prior to the rupture of the junction of viscid disc and column. This source of energy has only just occurred to the writer and has not been investigated.

Part II.—THE SENSITIVENESS OF THE ANTENNÆ.

When the projecting antenna is touched, even very lightly, the junctions between the back of the viscid disc and the sides of the column (which form also the bases of the antennæ) are broken, liberating the pedicel. The stimulus of the touch (i.) is evidently transmitted to these junctions, (ii.) when it is transmitted thither it causes the junctions to rupture. A junction must be quite substantial, considering that it holds the pedicel from straightening and possibly from contracting; however, we are, here, only concerned with the transmission of the stimulus.

Darwin assumes that the stimulus is transmitted by a kind of nerve. He says in his *Fertilization of Orchids* (speaking of *C. tridentatum*): "Considering the above several facts, we may infer that it must be some molecular change which is conveyed along the antennæ, causing the membrane round the discs to rupture." Against this theory we have the following considerations:—

(i.) The sides of the column forming the bases of the antennæ

have been cut through without rupturing the junction between viscid disc and column or the ejection of the pollinia and attachments; yet the junction still retains its power of rupturing upon being lightly pressed.

(ii.) Experiment IV.—The column was cut through about the line *BB* (fig. 3) so that the antennæ were still attached, and the anther and pollinia and filament removed to reduce weight. The remaining part of the column was suspended by the projecting antenna being lightly held by forceps fixed in a retort-stand clamp (fig. 11). It was found that the antenna could be bent in any direction (in the figure it is shown bent over by a 1 gm. balance

Fig. 11.

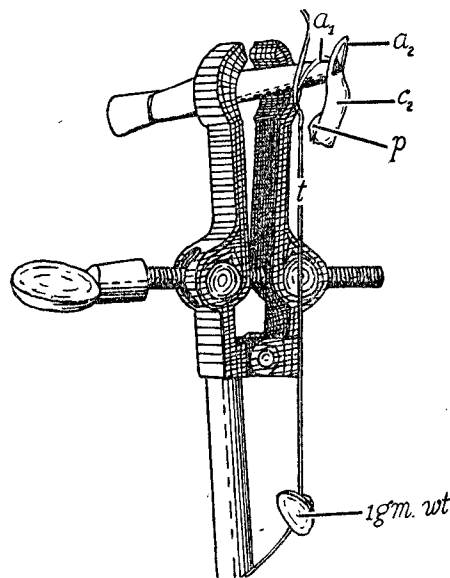

Showing upper part of column (*c*₂) suspended by the projecting antenna (*a*₁), which is held by forceps fixed in a retort-stand clamp and bent over by the tension in the cotton thread (*t*) attached to its tip produced by the 1 gm. wt. *a*₂, inwardly-curving antenna; *p*, still unexploded pedicel.

weight) without ejection of the pedicel, but upon the column being lightly moved while in this position ejection took place.

It seems that the stimulus is conveyed by the purely mechanical movement of the antenna, which, being very stiff, actually moves the tissues surrounding the junction between the viscid disc and the base of the antenna, causing it to rupture. In the flower all the parts are very firm, owing to turgescence, and the junction of viscid disc to column is kept rigidly fixed. If, then, the tip of an antenna is moved

JOURNAL OF BOTANY.—VOL. 65. [NOVEMBER, 1927.] z

its base will also move, provided that the antenna is stiff enough, and will exert a lever action on the junction. If, on the other hand, as in Experiment IV., the base of the antenna itself is clamped, no amount of movement of its tip will be conveyed to the junction of viscid disc with the sides of the column. Also a flower may be shaken considerably, as Darwin says, without explosion; but in this case the antenna will not be appreciably moved relative to the rest of the flower, since it is very light. It may be here remarked that when the back of the column was cut away, so that the inwardly-curving antenna was not in contact with anything, it was just as sensitive as the projecting antenna. This fact could hardly be explained if the sensitiveness relied on some kind of "molecular change." Darwin, in his *Fertilization of Orchids*, and speaking of the antennæ of *C. tridentatum*, says, "both are sensitive, but apparently the one which is coiled within the middle of the labellum is the more sensitive of the two."

SUMMARY.

(1) There is some doubt as to the validity of the view held by Darwin that the straightening of the pedicel is sufficient to cause ejection of the pollinia and attachments to the distance observed.

(2) The stimulus of touching the antenna is transmitted mechanically, contrary to the view held by Darwin.

(3) The inwardly-curving antenna would be as sensitive as the other if it was not in contact with the column.

(4) The viscid disc is not kept moist by being in contact with the back of the stigmatic chamber, as held by Darwin, for it is always free from it.

OBITUARIES.

BENJAMIN DAYDON JACKSON
(1846-1927).

THE news of the death of Dr. Jackson will have come as a surprise and shock to his many friends. On his way home on Saturday, October 1, he was knocked down by a motor-car in crossing the Buckingham Palace Road. For a few days the reports from Westminster Hospital, where he was taken after the accident, were hopeful, but, in spite of his vigorous constitution, the shock to the system had been too great and he passed away on the afternoon of October 13.

The story of Jackson's life is intimately associated with that of the Linnean Society, which he served devotedly for forty-seven years, twenty-two (1880-1902) as Botanical Secretary, then as General Secretary from 1902-26, and since May 1926 as Curator of the Linnean Collections.

Jackson was born in Stockwell and educated at private schools, and for some years followed a business career. His name was familiar to me when a boy, as he was for some time Secretary of a Society with which my father was associated. His interests in British Botany

brought him into touch with the botanists at the British Museum and Kew, and there are specimens collected by him in the herbaria of both these institutions. The Department of Botany in those days, still housed at Bloomsbury in proximity to the British Museum Library, would appeal strongly to Jackson's bibliographical instincts. His certificate as a candidate for the Fellowship of the Linnean Society was signed by John J. Bennett and William Carruthers, respectively Keeper and Assistant of the Department of Botany; he was elected in 1868 in his twenty-second year. In 1869 he joined the recently-founded Quekett Club. Mr. James Groves informs me that he and his brother Henry made Jackson's acquaintance at the South London Microscopical and Natural History Club in 1874, where they were almost the only field-botanists, though even at that time Jackson's interests were more in the literature of botany than in botany itself.

His "Sketch of the Life of William Sherard," printed in the *Journal of Botany* in 1874, was the first of a long series of biographical essays, many of which appeared among the obituary notices year by year in the *Proceedings of the Linnean Society*, and one of George Bentham, in the *English Men of Science Series* (1906); his English edition of T. M. Fries's *Life of Linnæus* was published in 1923. His capacity for editing and annotating found early expression in the reproduction of two Sixteenth Century tracts, John Gerard's *Catalogue of Plants cultivated in his Garden in the Years 1596-9* and William Turner's *Libellus de re herbario novus* (1538), published in 1876 and 1877 respectively. In each case Jackson added the modern names of the plants and a life of the author. His first important work of reference was the *Guide to the Literature of Botany* (1881), a classified selection of the literature of the subject, which after nearly fifty years is still a valuable handbook; this was followed (1882) by a *Vegetable Technology: a Contribution towards a Bibliography of Economic Botany*. In the next year he started work on the *Kew Index*—this, his greatest contribution to botanical science, was his chief work until its completion in 1895. In the preparation of the first Supplement (published in Brussels, 1901-6) he co-operated with the late Dr. Th. Durand. The *Glossary of Botanical Terms*, issued in 1900, with second and third editions in 1905 and 1916, is, after the *Kew Index*, probably the most widely used book of botanical reference.

As has been indicated, Jackson's genius was literary rather than scientific, but in his younger days he contributed occasional botanical notes to this *Journal*: such are "*Lotus angustissimus* L. in Kent" (*Journ. Bot.* 1875, 335), a record of an observation made on a botanical trip with the late W. W. Newbould, and "*Notes on Hibiscus palustris* L. and certain Allied Species," and "*On the Occurrence of Single Florets on the Rootstock of Catananche lutea*" in the *Journal of the Linnean Society* (xix. 1882).

In 1880 Jackson was elected Botanical Secretary, and began his official association with the Linnean Society. As Botanical Secretary, an honorary post, Jackson seems to have taken a large share in the

administrative work of the Society, and, apart from the time spent at Kew on the *Index*, to have made his working home there. I do not know when he established himself at the desk (his own property) in the corner of the reading-room, but one generally found him at the Society's rooms when consulting the library or the Linnean herbarium, and naturally turned to him for help or advice; and so long as I can remember (from 1888 onwards) he always read the Minutes at the meetings and seemed, generally, to "run" the Society.

The permanent staff had not been altogether satisfactory for some years, and when in 1902 the Assistant Secretary resigned Jackson's offer to take the position of senior member of the salaried staff was gladly accepted by the Council, and he became General Secretary, retaining at the same time his seat on the Council, a condition which he himself imposed. From then onwards until recent years Jackson took the main responsibility for the arrangement of the meetings, and the production of the Society's *Journal* and *Transactions*—matters which should fall within the province of the two honorary secretaries,—as well as the other duties incident to the management of a scientific society with 700 members. It has not been an easy task during the last few years gradually to lighten the burden which it was unfair to impose on a man, however vigorous and willing, who had long fulfilled the appointed tale of years. I am sure that even at eighty he was convinced of his ability to carry on, and, though his friends and Fellow-members combined to make the break as easy as possible, it was a trying experience when, at the Anniversary Meeting in 1926, he read the Minutes for the last time, and at the presentation of his portrait to the Society received the cordial appreciation of his long and devoted service voiced by some of his former colleagues. To enable him to continue to serve the Society, he was at the same meeting appointed Curator of the Linnean Collections, in which capacity he would still be responsible for the herbarium, books, manuscripts, and other objects closely associated with Linnaeus. He settled down to work with the prospect, it was hoped, of some years more of helpful association with the Society—a hope which to our regret and loss has not been realised. His last important work for the Society was the preparation of the new edition of the *Catalogue of Books and Pamphlets in the Library*, issued in 1925.

I doubt whether man ever found a more congenial occupation than did Jackson in his association with the Linnean Society. His capacity for secretarial work and organization, his genius for bibliographical research, and, it must be added, his aptitude for giving help and advice in matters within his ken, all found a natural outlet. His upright commanding figure, courteous manner, and ready welcome will be a lasting memory, not only for Fellows, but for the many visitors from overseas who came to consult the library or herbarium.

Another manifestation of his helpfulness was in connection with local Natural History and other Societies. He was one of the earliest members of the Quekett Club, an honorary member of the Essex Field Club, a past-president of the Herts Natural History Society—he edited the second edition of Pryor's *Flora of Hertfordshire*

(1887); while his address on "Notable Trees and Old Gardens of London" was a feature of the meeting of the South-Eastern Union of Scientific Societies in London in 1917—to mention only a few of them.

Throughout the scientific world he was recognised as the authority on matters connected with Linnaeus, and especially in Sweden, where he was the most honoured guest at the bi-centenary celebrations of the birth of the great Naturalist in 1907, receiving the honorary Ph.D. and A.M. of Upsala University and the Order of Knighthood of the Polar Star.

A representative gathering of his friends and former colleagues met at the Golder's Green Crematorium, on October 19, to pay their last respects to his memory and to express their sympathy with his widow.—A. B. RENDLE.

REV. W. E. TAYLOR, M.A.

WILLIAM ERNEST TAYLOR, who died suddenly at Bath on Sunday, October 2, at the age of 71, was for sixteen years (1880–1896) a missionary (C.M.S.) in East Equatorial Africa. He was my contemporary at Oxford, where he was a scholar at Hertford College, and was induced to collect plants in the districts in which he laboured in Africa.

From 1882–1888 he sent nearly 2000 specimens to the British Museum, mainly from the Mombassa, Giriyama, and Uyui districts. Many of these were new to science, and were described by Dr. Rendle ("New Plants from East Equatorial Africa," in *Journ. Linn. Soc.* 1896) and myself (*Journ. Bot.* 1886). Others have been taken up by Mr. S. Moore in his *Alabastra* in this *Journal*, and in the *Flora of Tropical Africa*. He remained in the service of the C.M.S. in Africa till 1904, first at Cairo and later in the Soudan. Returning to England he held in succession several curacies and livings, and at the time of his death was Rector of Halton Holgate, Lines. He was the author of various works and translations in the Swahili language, mainly of a religious character.—H. N. RIDLEY.

ST. JOHN MARRIOTT.

It is with much regret that we record the death at a comparatively early age of St. John Marriott, who succumbed from the shock of an otherwise successful operation on October 7. Marriott was a keen field-naturalist, well known in the Woolwich area and to members of the South-Eastern Union of Scientific Societies, at the meetings of which he was a familiar figure. In 1925 he published a small handbook entitled *British Woodlands, as illustrated by Lessness Abbey Woods*, a general survey of the flora and fauna of an interesting and ancient woodland area on the outskirts of Woolwich, the continued existence of which is threatened. Marriott was specially interested in the bryophytes, and contributed some "Notes on the Bryophyta of Essex" to the handbook issued in connection with the South-Eastern Union's Meeting at Chelmsford in 1926.—A. B. R.

EIGHTH INTERNATIONAL HORTICULTURAL CONGRESS.

Vienna, September 19-25, 1927.

THE Eighth International Horticultural Congress was arranged by the Horticultural Society of Austria, in Vienna, which thus commemorated the centenary of its foundation. It was held under the auspices of the Federal President, Dr. Michael Hainisch, and under the presidency of several Federal Ministers and the Mayor of the city. Prof. Richard Wettstein was Chairman of the Committee, and Dr. Arthur Bretschneider the Secretary General. The Royal Horticultural Society was represented by Mr. F. J. Chittenden, Director of Wisley, Mr. G. W. Leak, Member of Council, and Dr. A. B. Rendle, the Society's Botanist; Mr. H. V. Taylor (Commissioner of Horticulture) represented the British Government. The Meetings of Congress took place in the University, where the members were welcomed by the Minister of Agriculture and Forestry and Prof. Wettstein. The subject of the opening meeting was "International Agreement on the Introduction of a uniform Horticultural Nomenclature and precise Rules for the Naming of Novelties." Dr. V. Suringar (Holland) referred to the difficulties attending the application of the Rules of Botanical Nomenclature as codified at Vienna (1905) and Brussels (1910), especially with regard to names of genera and species which were used in varying senses in horticulture; he also criticized the American "Standardized Plant Names" as unscientific, and suggested the consideration of popular names in Esperanto. A great need was the preparation of standard lists of species. The last point was emphasized by Dr. Camillo Schneider, of Berlin, who deplored the lack of horticultural monographs on important groups of plants. Dr. Tanaka (Japan) proposed that Latin names for horticultural species should be valid, the word "Hort." followed by "ex" being introduced before the name of the authority. Dr. Rendle suggested that the rules for Horticultural Nomenclature drawn up by the Brussels International Congress in 1910 should form a basis of discussion, and that the plan adopted by the botanists at Ithaca in 1926 might with advantage be adopted by the horticulturists—namely, the appointment of a commission to receive suggested emendations and additions to these rules and prepare material for discussion at the next Congress which will meet in London in 1930 shortly before the Botanical Congress. Resolutions dealing with points of special interest to horticulture might then be passed on to the botanists for consideration and, if deemed advisable, incorporation in the Code of Botanical Rules. As an outcome of the discussion, an international committee was appointed, which should summarize the views of the different countries interested and report to the London Congress in 1930. Similar committees were appointed to consider other subjects raised at the Congress—namely, a scheme for a uniform system of description of colour in flowers, certification of plants, fruit-growing research, interchange of plants between educational institutions, and others.

The afternoons of the week were devoted to excursions, including visits to the famous gardens and palace at Schönbrunn, the Botanic Gardens (where among other objects the fine specimen of *Ginkgo* was admired), the extensive gardens of Mr. Rothschild on the Hohe Warte (whence fine views of the city, the Danube, and the Wiener-Wald were obtained), various public gardens, and the health resort of Baden. Pleasant social functions were supplied by an evening reception by the Minister of Agriculture, tea in the wonderful Rathhaus Hall with the Burgomaster, and a similar function with the Federal President. Fortunately, the visit of the Congress to the beautiful city and its surroundings was favoured by fine summer weather for most of the week.—A. B. R.

SHORT NOTES.

A VARIETY OF *SPIRODELA POLYRRHIZA* Linn.—There is a variety of *Spirodela polyrrhiza* so strikingly different in coloration from the normal form that it has been considered well to put it on record; it is perhaps as worthy of varietal rank as, for instance, *Nymphæa alba* var. *rubra* Lönnroth. The form was noticed this year in the ditches round Lewes, never being found among the thick masses of the normal condition of the plant, but scattered here and there in restricted areas, and always in association with *Hydrocharis morsus-ranae* Linn.

Description of the Frond.—Deeply suffused and mottled with rich carmine-red on upper surface; underside deep carmine, the roots being tinged with the same colour. That these specimens are not an immature condition is shown by the fact that they were noticed up to late in August and the first days of September. Moreover, winter buds had developed on some of the shoots, these also being of a deep carmine-red. The colour is very evanescent, herbarium material being quite inadequate, dried specimens fading to a dull green. The writer hopes to have an accurate water-colour sketch made from the living plant.—T. GORDON DALGLIESH.

BARTSIA VISCOSA Linn. IN KENT.—A few days ago the Honourable Mr. Justice G. J. Talbot sent me a specimen of the above gathered in a rough pasture near Cowden. This I believe to be the first record of the occurrence of this species in Kent. There were many other specimens of the plant in the same field. The finder would prefer not to give any more detailed information as to its exact locality.—FREDERICK J. HANBURY.

AYRSHIRE NOTES.—On 24th September, when visiting Cairntable (1944 ft.), I obtained specimens of *Tetraplodon mnioides* B. & S., with capsules, which were growing on a portion of a decaying carcass of sheep. I am not aware that this moss has previously been recorded for v.c. 75. Among the microfungi observed were *Thecopsora Galii* De Toni on *Galium saxatile*, *Milesina Blechni* Syd. on *Blechnum*

Spicant, and *Gibbera Vaccinii* Fr. on *Vaccinium Vitis-Idæa*. Near the summit of the mountain, and also at a much lower height, during the descent towards Muirkirk, numerous plants of *Empetrum nigrum* had their stem surrounded by a shining black stroma of *Melasmia Empetri* Magn., while *Phæangella Empetri* Boud. occurred on the dead leaves.—D. A. BOYD.

LIZARD ORCHIS.—Referring to the note in the October number (p. 288), this species, according to my experience, only occurs sporadically in Southern Europe, but is extremely plentiful in Western France, where I have seen it in many thousands by the roadsides in the Limousin, Berry, Touraine, and Orléanais in the latter half of June.—C. C. LACAITA.

SALVIA CONTROVERSA Ten.—As there has been frequent misunderstanding and consequent confusion in the use of the name *Salvia controversa*, a note in a form easily accessible to English botanists may be of use.

In the fourth Appendix (1823) to the *Floræ Neapolitanæ Prodromus*, p. 4, Tenore refers to *Salvia ceratophylloides*, var. B.: "floribus parvis, corollis albis," a garden plant, which he calls "in hortis obvia," citing two synonyms which need not here be quoted, as Tenore afterwards withdrew them, and with a note of interrogation "Sibth. Fl. Græc. tab. 24."

Then in the *Sylloge* (1831), p. 18, he raises this variety to a species with the following diagnosis:—" *S. controversa*; foliis pinnatifido-linearibus serratis rugosissimis revolutis, caulibus foliosis corollis calycibus hirsutissimis muticis triplo longioribus, galea stricta subfalcata, filamentorum appendicibus filiformibus elongatis," and with the synonym *S. ceratophylloides* B. Ten. Fl. Neap. Prodr. Ap. iv. p. 4, excluding the synonyms, except Fl. Gr. tab. 24; and on p. 20 he further says: "*Salvia controversa* Ten., *S. clandestina* S. et S. Fl. Gr. tab. 24, excl. synonymis, non Linn. Sp. Pl., an *S. clandestina* Linn. Herb. (?), an *S. laciniata* Link Enum. alt. i. p. 16?"

From the description and the resemblance, as it appeared to the author, with Fl. Gr. tab. 24, there can be little doubt that Tenore meant to describe and give a name, which would be free from ambiguity, to a plant that he knew in cultivation, and which in all probability was *S. lanigera* Poir., of the existence of which name Tenore seems to have been unaware. Poiret's name, published in 1817, has fourteen years' precedence of Tenore's. Bentham, therefore, had no justification for using the latter in preference to that of Poiret, which he quotes as a synonym in *Labiatarum Gen. et Spec.* In this evil course he has unfortunately been followed by many subsequent authors, particularly by the French.

A further perplexity has been introduced by Tenore's quoting in the *Sylloge*, loc. cit.: "in pascuis siccis Calabriae, Monteleone," as a habitat for his *S. controversa*, implying that his description is that of an Italian plant, in which case *S. controversa* could not be synonymous with *S. lanigera*, because it is quite certain that *lanigera*

does not grow in Italy, and that the Calabrian plant quoted by Tenore is only a very deeply lacinate form of *S. multifida* S. et S. (*S. clandestina* L. sec. Bentham). So that if Tenore really meant *lanigera* by his name *controversa*, his determination of the Monteleone plant was erroneous. This has been very clearly pointed out by Caruel in Parl. Fl. Ital. vi. p. 261. Speaking of the figure in Fl. Gr. tab. 24, he says: "whether this is the true *S. clandestina* Linn., or should go under the other name of *S. lanigera* Poir., it certainly cannot pass, as Bentham and others have thought, under the name of *S. controversa* Ten., which must be referred to our form" (i. e., *S. Verbenaca* β *australis* = *S. multifida* S. et S.). This view has been reiterated by Briquet, Lab. Alp. Mar. p. 521: "M. Caruel a rendu attentif au fait que le *S. controversa* Ten. n'était autre que la forme à feuilles étroites et disséquées du *S. Verbenaca* et non pas, comme l'ont cru Bentham et Boissier, la plante de Grèce à laquelle Poiret a imposé le nom de *S. lanigera*. La description de Tenore est, comme beaucoup de celles de cet auteur, suffisamment mal faite pour pouvoir s'appliquer à peu près aussi bien aux deux formes, mais le vrai *S. lanigera* (*S. controversa* auct., non Ten.) ne croît pas en Italie."

To conclude, it seems to me that Caruel and Briquet are wrong; that Tenore did describe the garden form of *S. lanigera* and apply to it the name *controversa*, which, however, was still-born, as it arrived fourteen years too late, and therefore should never be used, except when quoted in the synonymy of *S. lanigera*. Furthermore, it is clear that Tenore wrongly referred the Calabrian *Salvia* to his species *controversa*.—C. C. LACAITA.

REVIEWS.

The Flora of Buckinghamshire: with Biographical Notices of those who have contributed to its Botany during the last Three Centuries. By GEORGE CLARIDGE DRUCE, M.A., D.Sc., &c. 8vo, pp. cxxvii, 437, with 3 plates and map. Buncle, Arboath, 1926. Price 25s.

"*The Flora of Buckinghamshire* completes the Flora of the Upper Thames, which I have been privileged to compile, and in doing so I have been enabled to visit every parish of this pleasant area"—thus the author records the completion of a series of valuable county Floras, and at the same time emphasizes the close personal touch with his subject, which is so marked a characteristic of his work on British botany.

The Introduction is a lengthy one, occupying 127 pages. A general account of the area is followed by a sketch of the geology of the county, with notes of the plants characteristic of the various formations. The botanical districts, five in number, are based upon the river-drainage, and include those of the Ouse, the Ouzel, the

Thame, the Thames, and the Colne and the Chess. The number of adventitious species in the Colne district is very large, owing chiefly to the contiguity of the metropolitan area, the chief factor being the great quantity of street-sweepings and house-refuse brought from the urban area in barges and deposited on the banks of the canal or in adjacent brick-yards. The most prominent alien by the streams in this district is *Impatiens biflora*, and the yellow *Mimulus* is also abundant.

The most interesting species of the county are *Carum Bulbocastanum*, limited to the chalk area of Bucks, Herts, Beds, and Cambridgeshire; *Danaa cornubiense* (Bucks, Devon, and Cornwall), *Orchis militaris* (figured on the frontispiece), *Cyperus fuscus*, and *Buxus sempervirens*. The paucity of lacustrine species is a characteristic of the flora.

About 1200 well-established species have been recorded for Buckinghamshire and the six adjacent counties, and of these 1010 have been found in Bucks.

Forty pages of the Introduction are occupied by the "botanologia" of the county, biographical notices of those who have contributed to our knowledge of its botany, from Matthias de l'Obel, born 1538 (not 1838, as stated), whose citation of *Nymphaea lutea minor* &c. may be the first reference to a Buckinghamshire plant, to the author himself, who has acceded to the wish of friends and put on record some personal details. The story of his life and of his relations with the county extending over seventy years is an interesting tale of difficulties surmounted in the pursuit of the study of nature, and no one will grudge the few pages given to its recital. Ten pages are devoted to John Hill (also plate ii.), though his additions to the flora of the county are comparatively few; true, he was buried at Denham, but the somewhat lengthy account of his life and of his relations with his contemporaries is a vigorous vindication of his claim for citation as the author of names of some of our British genera, a subject in which Dr. Druce has shown considerable interest.

The Countess of Aylesford (1760-1832) is the subject of the remaining plate (iii.). Her large collection of paintings of plants is now in the possession of the Earl of Dartmouth. They include over 120 of Bucks plants, painted at Denham, nearly 100 of which are the first evidence of their occurrence in the county.

The summary of Buckinghamshire plants includes 1027 species of flowering plants, ferns, and charophytes, 88 of which are regarded as denizens or colonists. There are, in addition, 335 alien species, 56 hybrids, and 519 varieties and named forms, yielding a grand total of 1937.

In the arrangement of the systematic portion the ordinal and generic sequence of Bentham & Hooker's *Genera Plantarum* is followed (except that the Coniferae are placed after the Angiosperms), though not necessarily with the same limitations; the sequence of species follows that of the author's list of British plants. The names adopted for some of the more important families will be unfamiliar to

many students of the British flora; such are Brassicaceae (Cruciferae), Amniaceae (Umbelliferae, which, however, is retained in the plan of the flora on p. cxxi), and Asteraceae (Compositae). Dr. Druce quotes the popular names of the species, but wisely avoids mere translations of the scientific name; a few synonyms are also cited. The "grade of citizenship" (native, denizen, &c.) and the nature of the habitat are given, and also the earliest record for the plant in the county. Then follow notes on the distribution of the plant in the county, arranged under the various districts, and in neighbouring counties. Critical notes are frequently included, which are sometimes, as in the case of the Elms and Orchids, of general interest. Dr. Druce does not, so far as we have been able to ascertain, definitely declare his allegiance to any code of nomenclature, though he claims the support of the "Vienna Actes" in his vindication of Sir John Hill. But, on the other hand, he uses *Juncoides* for *Luzula*, indicating that he does not accept the list of *nomina conservanda*. And the half-suggestion of a new binominal for the English Elm (p. 103) may cause trouble in the future.

The critical student will find much of interest and, doubtless, some matter for criticism in the volume, but every student of British botany will welcome the completion of the series of Floras dealing with the Thames valley, a series which has set a high standard of excellence for future compilers of county floras.

PRINTZ, H. *Chlorophyceae (nebst Conjugatae, Heterocontae und Charophyta)*, in A. ENGLER, *Die natürlichen Pflanzenfamilien*, 2nd edit. vol. iii. pp. iv and 463, with 366 figures in the text. Engelmann, Leipzig, 1927. Price: 41 Marks bound, 35 Marks unbound.

THE volume entitled "Chlorophyceae" in the new edition of the *Natürliche Pflanzenfamilien* is more than double the size of that issued in 1897, and Printz is to be congratulated on the amount of careful and detailed work he has put into it. Such a survey is very welcome at the present juncture, in view of the many new genera of Green Algæ that have been established in this century, many of them described in relatively inaccessible periodicals. From this point of view the citation of the place of description of each genus and the numerous excellent illustrations are very valuable features of the new edition. The bibliography given under each family is exhaustive, and the descriptive matter clear and up to date. In the account of conjugation in Zygnemataceae (p. 366) one misses, however, any mention (saving the literature citations) of the recent work of Lloyd and Czurda.

Within the compass of a brief review it is impossible to deal with many minor points of criticism, and I propose to confine myself to a discussion of the broader classification. Unlike Wille, Printz accepts

the class Heterokontæ, but otherwise he retains much the same grouping as was adopted by the former in the supplement to the first edition, published in 1909. The Chlorophyceæ are subdivided into Euchlorophyceæ, Conjugatæ, Heterokontæ, and Charophyta. The implication that the Heterokontæ are but a separate branch of a common group is unfortunate, since all the evidence indicates that there is no relationship whatsoever between them and the remaining Green Algæ. In the phylogenetic scheme on p. 26 Euchlorophyceæ and Heterokontæ are similarly shown as lines originating from a common group "Flagellata." There is no reason to suppose, however, that the flagellate ancestors of the Green and Yellow-green Algæ originated from a common stock. Everything points to a polyphyletic origin of the different classes of Protophyta. It is, indeed, to be deprecated (although the fault probably lies with the general editor) that Green Algæ and Heterokontæ are included in one volume, with the exclusion of other groups of holophytic Protophyta, since the juxtaposition implies a relationship for which there is no warrant, whilst the divorce of Heterokontæ from groups such as the Chrysophyceæ, with which there are some indications of affinity, is unfortunate.

In Printz's scheme of classification the Conjugatæ are given equal status with the other three groups; in this respect he follows Wille, Oltmanns, and others. There can be no doubt, however, that they are not a separate group, and that they are at least as closely allied to the Euchlorophyceæ as are the Siphonales and other sets of forms included in the former.

Turning to the Euchlorophyceæ, these are grouped into Protococcales, Chætophorales, Siphonocladiales, and Siphonales. All the non-filamentous forms are thus classed in one group, which is of course permissible, although the name Protococcales would best be abandoned. In my opinion, however, it is useful to separate the unicellular non-motile type represented by *Chlorococcum*, *Chlorella*, and a host of colonial forms from the motile Volvocales and their immediate derivatives. The detailed classification of the Protococcales follows closely on the lines adopted by Wille in the 1909 supplement. So many differences of opinion exist with reference to the grouping of these forms that criticism is perhaps hardly warranted, but the inclusion of the bulk of the non-motile types in two families, Oocystaceæ and Cœlastraceæ, hardly makes for clearness of perspective with reference to these difficult forms. Printz (p. 21) remarks that too much stress has been laid on morphological features in the classification of the Green Algæ, but it appears to the writer that in the types under discussion the diverse modes of colony-formation constitute at the present time the only satisfactory basis for an orderly classification.

All the filamentous forms, apart from the cœnocyctic types, are embraced in the Chætophorales, a designation taken over from Wille, but rather an unsatisfactory one for so wide a group, and, moreover, one that other authorities have given a different connotation. It may be

doubted, too, whether it is justifiable to regard all the filamentous Green Algæ as members of one group. The writer is also of the opinion that there are no satisfactory grounds for maintaining the Siphonocladiales which include a heterogeneous assemblage of forms, in part probably closely related to the Siphonales and in part cœnocyctic members of Ulotrichales (Printz's *Chætophorales*) (cf. Printz's own remarks on pp. 257, 275).

The classification of Heterokontæ does not differ very materially from that proposed by Pascher and adopted by most recent authorities.

F. E. FRITSCH.

Die Pilze Mitteleuropas. Bd. I. *Die Rohrlinge (Boletaceæ).* By F. KALLENBACH. Lief. 3 and 4, pp. 5-24, tt. 6. Fol. Leipzig: Werner Klinkhardt, 1927. Price M. 10.

WITH these two fascicles the great work being published by the German Mycological Society and others begins to take shape and give an idea of its completed form. The two parts contain four coloured and two uncoloured plates and twenty pages of text. The coloured plates reach the same high standard as those of the previous part and depict *Boletus pseudosulphureus* Kallenb., *B. pulverulentus* Opat., *B. rimosus* Vent., and *B. erythropus* Pers., non Fr.; the other plates show photographs of five species and microscopic details of four. The first-named species was described by Kallenbach four years ago from deciduous woods. *B. rimosus* is the same species as *B. nigrescens* Roze & Rich. *B. erythropus* Pers., non Fr., raises a point which has never been properly considered in mycological nomenclature: it is easy to make a rule ignoring names prior to Fries, but monographers, in particular, object to doing this when it leads to a changing over of names together with a confusion of diagnoses. The matter is made worse by drawings having to serve more or less as types. The impossibility of identifying fleshy fungi without plenty of experience in the field will be understood by anyone who glances over some of the plates, and may help to disabuse the minds of some old-fashioned laboratory workers that there is nothing but man-made difficulty in the study of these forms. The fulness of the text has necessitated twenty-four pages for the description of seven species, much of it in small type.—J. R.

An Introduction to Structural Botany. Part I. *Flowering Plants.* Eleventh Edition. By DUKINFELD HENRY SCOTT and F. T. BROOKS. 8vo, pp. viii, 301, with 117 text-figs. and a glossary. Blacks: London, 1927. Price 5s.

SIR JOSEPH HOOKER once referred to a little shilling primer on Botany, which he prepared for an excellent series issued by Messrs Macmillan, as his most successful piece of work—from a certain point

of view. Dr. Scott may perhaps regard his *Introduction to Botany* in the same light—there can be no doubt that it is the most widely read of his many contributions to botanical literature.

The first edition appeared in 1894, and was very favourably reviewed in this *Journal* by the late George Murray (1894, p. 217). The book met a need for a clear exposition of the elementary principles of plant structure and function by reference to species familiar and easily accessible to all students. The Wall-flower, the White Lily, and the Spruce Fir were successively studied in detail, as illustrative of the structure and life-history of a typical Dicotyledon, Monocotyledon, and Gymnosperm, respectively. A chapter on general physiology dealt with the main facts of nutrition, respiration, and other manifestations of life in the flowering plant.

The author had repeatedly revised the book for successive editions, the tenth of which appeared in 1920, but has now thought it advisable to call in the aid of a younger man with recent experience in general botanical teaching. The co-operation of Mr. F. T. Brooks, University Lecturer in Botany at Cambridge, has been secured, and he has revised and brought up to date the present edition. The chief changes have been made in the chapter on "Outlines of Physiology," to which two entirely new sections on Growth and Movement of Plant Organs have been added, thus completing the general survey of the mode of life of a typical flowering plant. It is interesting to note that Mr. Brooks has no further information on the causes of the ascent of water in the wood, "as to which we are still very much in the dark" (1894, p. 227; 1927, p. 229), the position being identical in the two editions.

BOOK-NOTES, NEWS, ETC.

LINNEAN SOCIETY.—The Annual Dinner was held at the Criterion Restaurant on Thursday, October 20. The President, Sir Sydney Harmer, K.B.E., presided, and among the guests of the Fellows were Lt.-Col. Uggla, Attaché of the Swedish Embassy, and Madame Uggla. The dinner was followed by a reception by the President in the Rooms of the Society at Burlington House. Mr. E. A. Bunyard gave a short lecture on some of the more striking features of the flora of the Cape Province, photographed by him during his recent visit, and a number of exhibits were displayed in the library.

THE BRITISH BRYOLOGICAL SOCIETY held its Annual Meeting and Excursion at Brecon, August 12 to 19, 1927, under the Presidency of the Rev. C. H. Binstead, M.A., F.L.S. About thirty members and friends were present. The weather conditions were somewhat adverse; owing to the heavy rainfall the Usk and the mountain-streams were so swollen that the riparian bryophytes were submerged and the waterfalls so overbrimming that the rocks were unapproachable in places. In spite of this, some good work was done, and several records were added to the County Flora.

The Brecon Beacons were visited twice; there was some excellent ground on the fine cliffs and crags of Craig Cerig Gleisiad, where ravens and buzzards circled round the cliff-tops. Heavy rain unfortunately curtailed the visit to Sennybridge and the Usk valley. A fine drive across high moorland led the way into the delightful wooded cwm of the Hepste, but the excess of water in the streams and falls made the visit somewhat tantalizing.

The results of interest are noted below; new records for v.c. 42 are starred. Mosses:—*Sphagnum recurvum* var. *robustum**, *S. cuspidatum* var. *falcatum** and *plumulosum**, *S. inundatum* var. *diversifolium**, *S. auriculatum* var. *canovirescens** and *ovatum* f. *intortum**, *S. aquatile* var. *remotum**, *sanguinale**, and *pauperatum**. *Oligotrichum hercynicum* c.fr., *Polytrichum alpinum*, *Dicranella secunda**, *Fissidens Curnowii**, *Grimmia torquata*, *Pottia intermedia**, *Barbula rubella* var. *dentata**, *B. ferruginescens*, *B. recurvifolia**, *Weisia calcarea**, *Webera cruda*, *W. proligera**, *Bryum atropurpureum* var. *gracilentum**, *B. Mildeanum*, *Plagiothecium pulchellum*, *Orthothecium intricatum*, *Hypnum cupressiforme* var. *mamillatum**, *H. stramineum*, *H. sarmentosum*. Hepatics:—*Riccia sorocarpa**, *R. Beyrichiana**, *R. Crozalsii**, *Aneura multifida**, *Pellia Fabbroniana* var. *lorea*, *Blasia pusilla**, *Marsupella ustulata*, *Alicularia scalaris* var. *procerior**, *Eucalyx obovatus*, *Aplozia sphaerocarpa**, *Lophozia Muelleri**, *L. heterocolpa** (new to Wales), *L. birenata**, *L. excisa*, *L. attenuata**, *Bazzania triangularis**, *Scapania aspera** (Crickhowell).

At the Annual Meeting the Officers were elected, and the work on the revision of the 'Hepatic Census Catalogue' was discussed; many counties require to be examined in detail before a new edition can be issued. North-Eastern Ireland was chosen for next year's Excursion: date, August 29 to September 4, 1928.—E. ARMITAGE.

BRITISH ASSOCIATION COMMITTEE ON BIOLOGICAL MEASUREMENTS, 1927.—Contributors of papers involving extensive numerical observations are requested to consult the recommendations of this Committee, obtainable from the British Association, Burlington House, W. 1. Price 6d.

Arrangements have been made whereby original data, too extensive for complete publication, may be deposited at the British Museum (Natural History) or with the Royal Society of Edinburgh, and so be made available for future workers. Authors desirous of depositing data, whether zoological or botanical, in this manner should communicate with either the Keeper of Zoology, Natural History Museum, S.W. 7; or the General Secretary, The Royal Society of Edinburgh, 22 George Street, Edinburgh, enclosing full bibliographic reference to the publication in which the results are summarised.

CHAROPHYTA INDICA.—Under this title, Mr. G. O. Allen is issuing a series of Indian Charophytes; Fascicle 1 of which, containing nos. 1-14, has recently appeared. The specimens are excellent

and beautifully mounted in the same style as that adopted by Mr. James Groves and Canon Bullock-Webster for their series of British and Irish species. The two new species are included in fascicle 1. Unfortunately, some notes by Messrs. Groves and Allen, including descriptions of the two novelties, are unavoidably held over until the next number of the *Journal*.

CORRESPONDENCE.

To the Editor of the 'Journal of Botany.'

DEAR SIR,

In the review of the *Flora of West Tropical Africa*, published in your issue for October, p. 290, it is stated that "The arrangement follows the modification of Hallier's system recently elaborated by Mr. Hutchinson. . . ."

I should like to point out that the system elaborated in my recent book cannot by any means be called a modification of Hallier's work. It is true that the first few orders are arranged somewhat similarly, but there the resemblance between the two systems ends. When I began a serious study of the phylogeny of flowering plants in 1919, I was advised by Dr. Stapf to "look up Hallier, as some of his suggestions might be helpful." So far as I remember, I soon gave up the attempt to follow his many unorthodox views on relationships. I realised that the elaboration of a new and evolutionary system must be the result of an independent examination of the actual plants themselves, and in consequence I spent much of my leisure time for several years in the examination of the species of all those families which appeared to be primitive. Some of the results of those studies have appeared from time to time in the *Kew Bulletin* and in my recent book.

If, in the review, the arrangement had been called a modification of the De Candolle System as elaborated by Bentham and Hooker, and as recommended by Bessey in America and by the brilliant researches of Newell Arber and Parkin in this country, little exception could have been taken to the statement. For it was mainly the works of the three last-named that inspired me to take up the task.

Royal Botanic Gardens,
Kew, Surrey.

Yours faithfully,
J. HUTCHINSON.

[We gladly print Mr. Hutchinson's letter, and regret that he should have found a "fly in the ointment" of a very favourable notice of his book. Hans Hallier was a pioneer in the attempt to arrange the families of the Dicotyledons phylogenetically, and, though there are resemblances, we admit that there are considerable differences between his system and that of Mr. Hutchinson's. But is it a less generous use of the term to regard the latter as a *modification* of the De Candolle System as elaborated by Bentham and Hooker?—
ED. JOURN. BOT.]

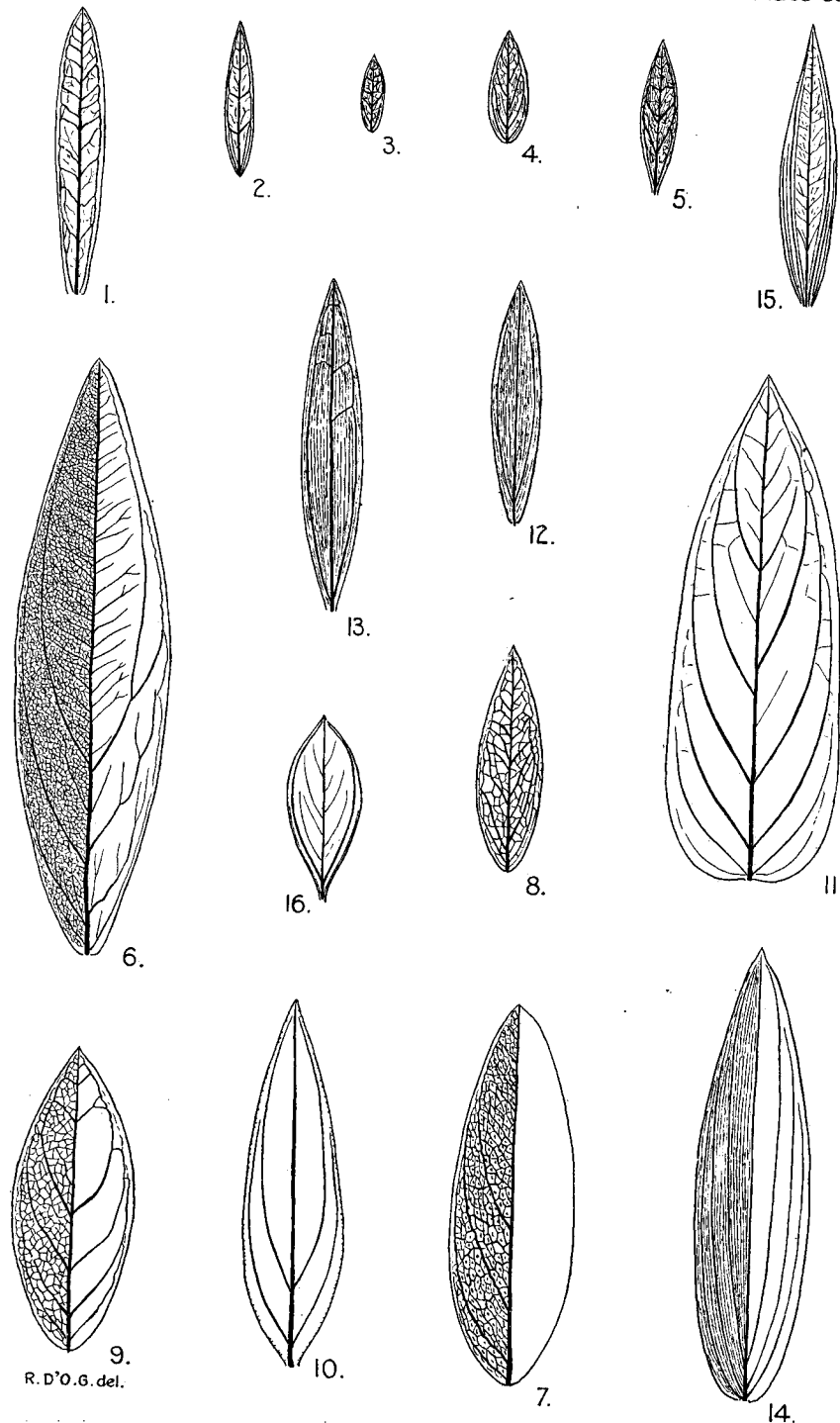

UNDER SIDES OF LEAVES OF SPECIES OF *HYPERICUM* FROM TROPICAL AFRICA, &C.

1. *H. lanceolatum*. 2. *H. angustifolium*. 3, 4, 5. *H. leucoptychodes*. 6. *H. Roeperianum*.
 7. *H. Schimperii*. 8. *H. gnidiaefolium*. 9. *H. Conrauanum*. 10. *H. Quartinianum*.
 11. *H. ulugurense*. 12, 13. *H. keniense*. 14. *H. Bequaertii*. 15. *H. mysorense*.
 16. *H. socotranum*. All natural size.

NOTES ON THE SHRUBBY SPECIES OF *HYPERICUM*
 OF TROPICAL AFRICA, MADAGASCAR, AND THE
 MASCARENES.

By R. D'O. GOOD, M.A., F.L.S.

(PLATE 582.)

A RECENT attempt to identify accurately certain specimens of shrubby, large-flowered *Hypericum* collected on Ruwenzori revealed the fact that the taxonomy of this small group of plants was in a very confused state. In order to reduce this confusion as much as possible, a careful investigation of the various types concerned and an examination of all the material in Herb. Kew. and in Herb. Mus. Brit. was made, and the results are given below. The primary object was to provide notes, which would assist in the accurate determination of species in the most convenient way pending the detailed taxonomic revision of the species. Such a work would involve the examination and comparison of an enormous series of specimens before the true inter-relationships could be determined, and would also need a very considerable knowledge of the living plants in the field. Until such a work is undertaken, it is hoped that the notes given below may be of practical value in segregating the specimens.

The following shrubby, large-flowered species of *Hypericum* have been described from the region under consideration:—

- H. lanceolatum* Lamarck, *Encyclopédie Méthodique*, iv. 145, c. 1797.
H. angustifolium Lamarck, " " " "
H. leucoptychodes Steud. ex Richard, *Tent. Flora Abyss. i.* 96, 1847.
H. Roeperianum Schimp. in " " " "
H. Quartinianum A. Rich. " " " "
H. Schimperii Hochst ex " " " "
H. gnidiaefolium A. Rich. " " " "
H. keniense Schweinf. in von Hoehnel, zum Rudolph See, Append. 15, 1892.
H. ulugurense Engl. in Engl. Bot. Jahrb. xxviii. 434, 1900.
H. riparium Chev. in Bull. Soc. Bot. Fr. liv. Mem. viii. 8, 1907.
H. Conrauanum Engl. in Engl. Bot. Jahrb. xl. 555, 1908. [1920.
H. Bequaertii De Wild. in Rev. Zool. Afr. viii., Suppl. Bot. 5,
H. ruwenzoriense De Wild. " " "

Part of the confusion in the identification of the species has been due to the inclusion of *H. lanceolatum* in the *Flora of Tropical Africa* and the treatment there of *H. angustifolium* and *H. leucoptychodes* as synonyms of it. The result has been that almost every subsequently collected specimen from Tropical Africa has, at some time or other, been named *lanceolatum*, a name which, as will be seen later, is not applicable to plants from the Continent. Another cause of confusion has been the use of floral characters as a primary criterion in separating the species. Such characters do not appear to be very constant, and also in most specimens are difficult to make

out and often are quite unrecognisable. There seems little doubt that the best characters for a primary classification are those of leaf-features, and particularly of venation as seen on the underside of the leaf. It is these characters which are made the basis of the clavis given at the end of these notes. This clavis is based upon the type-specimens. All the species described are included, although there is little doubt that some of them can scarcely be maintained. Until a detailed revision is made, it is most convenient to keep up all the species and to name individual specimens according to the type-specimen which they most closely resemble.

The following are notes on the chief characters of the different species, and lists of determinations. References are made to the Plate (no. 582), which illustrates the undersides of characteristic leaves of the type-specimens or of specimens compared with the type:—

H. LANCEOLATUM Lamarck. (Pl. 582, fig. 1)

Leaves of medium size, about 4 cm. long by 6–7 mm. broad, linear-spathulate acute; venation regularly pinnate, lateral veins rather widely spaced, arcuate; tertiary venation inconspicuous or apparently absent. Flowers large, solitary, more than 5 cm. in diameter; styles joined almost to the tip.

Isle of Bourbon: Commerson, Richard, Balfour. *Comoros*: Humblot, 1581.

H. ANGUSTIFOLIUM Lamarck. (Pl. 582, fig. 2.)

Leaves small, about 2 cm. long by 4 mm. broad, linear-lanceolate acute; venation regularly pinnate, lateral veins very few arcuate, tertiary irregular slightly conspicuous. Flowers large, about 5 cm. in diameter, solitary terminal; styles free in the upper half or two-thirds.

Isle of Bourbon: Commerson.

This species is very like the next, and intermediates tend to connect the two. On the other hand, the types of the two species are quite different in leaf, and the flowers of the above species are larger. On these and on geographical considerations it seems better to keep the two apart for the present.

H. LEUCOPTYCHODES Steudel. (Pl. 582, figs. 3, 4, 5.)

Leaves small, rather variable in size, but between 1 and 2 cm. long and 3–5 mm. broad, lanceolate acute; venation regularly but sparsely pinnate; the tertiary venation somewhat conspicuous and often having the effect of small striæ. Nearly all the veins are pellucid (translucent when seen by transmitted light), and this forms the most important feature of the species. Flowers usually smaller than 5 cm. in diameter and the styles joined to above the middle.

Abyssinia: Schimper, 340, 834, 906, 1177, 1784; Russell, 5; Roth, 176; Heudner, 1443; Wellby, s.n. *Eritræa*: Pappi, 225. *Nyasaland*: Whyte, 164; Buchanan, 36, 121; Sharpe, 6, 172; Cameron, 5; Cunningham, 7; Johnston, s.n. *Kenya Colony*: Elliott, 172; Powell, 153; Baker, 333; Fries, 696; Battiscombe,

731, 702; Thomson, s.n.; Jackson, s.n. *Uganda*: Fyffe, 14; Scott Elliot, 8338, 8385. *Tanganyika Territory*: Maber, 138; New, s.n.; Johnston, 180. *Nigeria and Cameroons*: Dalziel, 8330; Dunlap, 187; Mann, 1199, 2179; Preuss, 637; Kalbreyer, 112; Bates, 830; Talbot, s.n. *Fernando Po*: Mann, 294. *Belgian Congo*: Kässner, 3225. *Transvaal*: Burt Davy, 442, 2808; Wilms, 138; Schlechter, 3942; Rogers, 11,483; Nelson, 504; Rehmann, 6335; Hutchins, 9; McLea, 3035; Atherstone, s.n. *Griqualand East*: Tyson, 3044. *Natal*: Wood, 1995. *Madagascar*: Hilsenberg and Bojer, s.n. (styles almost united).

Occurs over a wide range of altitude, 4–12,000 ft. This species is the *H. lanceolatum* of Oliver in *Flora of Tropical Africa*, Hutchinson and Dalziel in *Flora of West Tropical Africa*, and of Burt Davy in *Flowering Plants and Ferns of the Transvaal and Swaziland*.

H. ROEPERIANUM Schimper. (Pl. 582, fig. 6.)

Leaves very large, averaging 8 by 2 cm., lanceolate acute; venation irregularly pinnate, laterals of the lower half of the leaf few, but very strong and ascending nearly to the top of the leaf, those of the upper half much closer, but less strong and nearly at right angles to the midrib; tertiary venation very finely and closely reticulated and prominent on the under surface. The leaves are usually paler beneath. Styles united almost to the tip.

Abyssinia: Schimper, 866 (type); Heudner, 1441. *Uganda*: Maitland, 1259; Scott Elliot, 6569, 6908. *Kenya Colony*: Powell, 86; Fries, 418; Battiscombe, 1128; Dowson, 649; Elliott, 174; Mearns, 1362; Cholmley, s.n.; Gregory, s.n.; Johnston, s.n.; Whyte, s.n. *Tanganyika Territory*: Johnston, s.n.; Buchwald, 4a. *Portuguese East Africa*: Honey, 682; Bryce, s.n. *Rhodesia*: Mundy, 2734; Eyles, 795; Swynnerton, 681, M 81, 6091; Teague, 214. *Angola*: Welwitsch, 1055.

Varies considerably in foliage according to age. Old leaves are coriaceous and the venation prominent, younger leaves are thin, and the venation, though very conspicuous, is not prominent.

H. RIPARIUM Chevalier.

Leaves very similar in venation to the younger leaves of the preceding species. Styles completely united to the tip.

This species is very like forms of the last, and can hardly be considered specifically distinct. Its geography, on the other hand, is quite different, and its occurrence in the highlands so far west is of great interest.

French Guinea: Chevalier, 13460.

H. SCHIMPERI Hochst. (Pl. 582, fig. 7.)

Leaves rather large, elliptic-lanceolate, slightly broader below the middle, subacute, dark on the upper side, much paler beneath; venation almost regularly pinnate, laterals few; tertiary venation reticulate, the meshes large and generally punctate. The venation is equally conspicuous and prominent on both leaf-surfaces. Styles united to the tip.

Abyssinia: Schimper, 132, 782, 1160; Quartin Dillon and Petit (type); Heudner, 1442.

Also probably very closely related to *H. Roeperianum*, but the foliage in its typical condition is quite distinct, the two important features of difference being the venation raised on both surfaces and punctate meshes of the tertiary reticulation.

H. GNIDIÆFOLIUM A. Richard. (Pl. 582, fig. 8.)

Leaves of medium size, about 3 by 1 cm.; venation almost regularly pinnate, laterals few; tertiary venation reticulate, meshes large but not punctate, venation conspicuous. Styles free in the upper quarter.

Abyssinia: Dillon and Petit, from Oudjerate, and ex Hb. Tranqueville.

This species looks very like a small and young-leaved specimen of the preceding, but the styles are free above. The general leaf-size is characteristic also.

H. CONRAUANUM Engler. (Pl. 582, fig. 9.)

Leaves rather large, about 4-5 cm. long by 1.5 cm. broad; venation rather irregularly pinnate; tertiary reticulation large and conspicuous, but neither prominent nor punctate. Styles united to the tip.

Cameroons: Conrau, 28.

This species is very near *H. riparium* Chev., and, like that species, comes from Western Tropical Africa. They are probably both western forms of *H. Roeperianum*.

H. QUARTINIANUM A. Richard. (Pl. 582, fig. 10.)

Leaves large, about 8-10 by 3 cm., rather narrow-lanceolate acute; venation very characteristic, apparently consisting only of two or three pairs of laterals in the lower half of the leaf; tertiary venation and upper laterals apparently entirely absent. Edge of leaf black, punctate. Underside of leaf somewhat glaucous. Styles united to the tip.

Abyssinia: Dillon and Petit, Choa; Schimper, 61, 1393; Heudner, 1439; Wellby, s.n.; Massey, 24. *Nyasaland*: Whyte, s.n.; Stolz, 221; McClounie, 143; Thomson, s.n.; Johnson, s.n. *Tanganyika Territory*: Whyte, s.n.; Battiscombe, s.n. *Kenya Colony*: Dowson, 647.

The venation is quite sufficient to distinguish this species (on the upper surface of leaf it appears to be parallel). The flowers are usually very large.

H. ULUGURENSE Engler. (Pl. 582, fig. 11.)

Leaves very large, up to 7 by 2.5 cm., sessile oblong-lanceolate acute, slightly broader towards the base, truncate or slightly subcordate; venation almost regularly pinnate, except quite near the leaf-tip where the laterals are smaller, main laterals in about 6 pairs; tertiary venation scarcely visible, not reticulate. Styles united at the tip.

Tanganyika Territory: Stuhlmann, 9247; Brebner, 443; Prittwitz u. Gaffron, 114.

The venation combined with the sessile leaves, broadest at the base, is characteristic of the species. In these respects it resembles certain Asiatic species. The flowers are very large.

H. KENIENSE Schweinfurth. (Pl. 582, figs. 12, 13.)

Leaves of medium size, 3-4 cm. long by 7 mm. broad, narrowly lanceolate acute; venation parallel, all the veins running nearly the whole length of the leaf, numerous and parallel, one pair of laterals more conspicuous than the rest, cross-veins very rare, and no trace of reticulation. Flowers large, the stamens about half as long as the petals.

H. BEQUAERTII De Wildeman. (Pl. 582, fig. 14.)

Leaves often very large and with at least one pair of more prominent laterals, but otherwise indistinguishable from those of the preceding. Flowers large, reddish-orange, stamens two-thirds as long as the petals.

H. RUWENZORIENSE De Wildeman.

Leaves usually small and indistinguishable from those of the above two species. Flowers not so large, yellow.

I have grouped these three species together here because they are, in their parallel venation, entirely distinct from any of the others mentioned, and also because they are only distinguishable by flower colour and other slight floral characters. I have also combined the citations below because they can rarely be distinguished in the dried state.

H. Bequaertii and *H. ruwenzoriense* represent the two species of Ruwenzori which collectors all agree are distinct, although the flower colour is the most conspicuous difference between them. *H. Bequaertii* differs, as stated, from *H. keniense* in the proportions of the stamens and petals, but this can hardly be considered a very satisfactory criterion, and it seems questionable if De Wildeman's species can stand.

Ruwenzori Mts.: Dawe, 560; Scott Elliot, 7989, 7986, 8107; Doggett, s.n.; Godman, 321, 314; Humphreys, 512; Wollaston, s.n. *Mt. Elgon*: Snowden, 436. *Aberdare Mts.*: James, s.n. *Mt. Kenya*: Hutchins, 379; Mearns, 1405; Mackinder, s.n. *Mt. Kilimandjaro*: Johnston, 180; Volkens, 1486 a.

For convenience in identification the foregoing diagnostic notes are here combined into a short dichotomous key:—

A. Leaves pinnately and reticulately veined.

B. Leaves not more than 2 cm. long, lanceolate or linear.

Flowers 5 cm. in diameter, plant from the
Isle of Bourbon *H. angustifolium* Lam.
Flowers usually smaller, leaves with pellucid
veins *H. leucoptychodes* Steud.

- BB. Leaves more than 2 cm. long.
 C. Leaves linear-spathulate, regularly pinnately veined *H. lanceolatum* Lam.
 CC. Leaves lanceolate or narrow oblong, irregularly pinnate, the lower laterals stronger than the upper.
 D. Tertiary venation reticulate and conspicuous.
 Reticulation prominent and meshes very small *H. Roeperianum* Schimp.
 Reticulation larger, conspicuous, but not prominent.
 Leaves about 5 cm. long.
 Meshes of tertiary venation punctate *H. Schimperii* Hochst.
 Meshes of tertiary venation not punctate [*Conrauanum* Engl.
H. riparium Chev.; *H.*
 Leaves about 3 cm. long; venation not punctate *H. gnidiæfolium* A. Rich.
 DD. Reticulation apparently completely absent.
 Conspicuous venation reduced to two or three pairs of laterals in the lower part of the leaf *H. Quartinianum* A. Rich.
 All lateral veins conspicuous; leaves subcordate below *H. ulugurense* Engl.
 AA. Leaves with parallel venation. [De Wild.
 Flowers yellow *H. ruwenzoriense*
 Flowers reddish-orange
 Stamens half the length of the petals *H. keniense* Schwfth.
 Stamens two-thirds the length of the petals. *H. Bequaertii* De Wild.

This is a convenient opportunity to clear up some little confusion that exists regarding the Socotran species of *Hypericum*. In Bayley Balfour's *Botany of Socotra* four species are cited—namely, *H. scopulorum* Balf. fil., *H. tortuosum* Balf. fil., *H. mysorensense* Heyne, and *H. lanceolatum* Lam. The first and second of these are endemic species, and may be dismissed at once because they are small and numerous-flowered, plants belonging to the section *Arthrophylla*. The third citation is of considerable interest because *H. mysorensense* is otherwise an Indian species (see map in Hutchinson's *Families of Flowering Plants*). A comparison of the Socotran plant with Heyne's type-specimen in Herb. Kew. shows that, although the former is perhaps narrower in the leaf and has a more conspicuous venation, the two certainly belong to the same species. The venation of *H. mysorensense* is extremely characteristic, being a combination of pinnate and parallel arrangement (see Plate 582, fig. 16).

The fourth citation is incorrect, and the plant so-called, Bayley Balfour, 246, appears to represent a species hitherto unrecognized. It is therefore described and named here.

***Hypericum socotranum*, sp. nov. (Pl. 582, fig. 17.)**

Frutex glaber ramosus, ramis teretibus brunneo-griseis irregulariter striatis; *foliis* parvis, obovato-lanceolatis acutis submucronatis basi cuneatis, infra glaucis, venis lateralibus inæqualiter pinnatis,

pare infimo conspicuo ad apicem laminæ adscendente, reliquis inconspicuis patentibus; *floribus* solitariis terminalibus breviter pedicellatis; *sepalis* oblongis lanceolatis subacutis quam staminibus paulo brevioribus; *petalis* oblique anguste-spathulatis quam staminibus duplo longioribus; *stylis* 5 tote liberis cum ovario stamina excedentibus.

Hab. Socotra: on the higher rocky parts of the hills, in flower February and March, Bayley Balfour, 246.

Leaves 2–2.5 cm. by 8–10 mm., *sepals* 7–8 mm. by 3 mm., *petals* about 1.8 cm. long, *stamens* about 9 mm. long, and *ovary* and *styles* 11–12 mm. long.

This species differs from *H. lanceolatum* Lam., with which it has been confused, in the leaf-size, leaf-shape, venation, flower-size, and in the free styles. Its nearest affinity is with *H. leucoptychodes* Steud., the widely-distributed mainland species, but it is quite different in leaf-shape and venation.

In conclusion, I wish to express my indebtedness to the Directors of the Herbaria at Berlin and Paris for the loan of type and other specimens.

ON SOME INDIAN CHAROPHYTA.

BY JAMES GROVES AND G. O. ALLEN.

THE following notes relate to some charophytes collected by G. O. A. in the United Provinces, specimens of which are being issued in a first fasciculus entitled *Charophyta Indica*. The plants were all, with the exception of no. 12, collected in the immediate neighbourhood of Saharanpur, and were obtained by wading in one to two feet of water, in shallow ponds of the type that dry up, largely or entirely, in the hot weather. No. 12 was collected in rather deeper water at Dehra Dun, an adjoining district. Saharanpur District lies at the head of the great Gangetic Plain, and is at the very western border of Clarke's Sub-sub-area 6, the specimens being obtained about 40–50 miles south of the Himalayan foot-hills. The climate is somewhat less hot than the eastern portion of the United Provinces, the temperature seldom exceeding 105° in a normal year. The average rainfall is about 39 inches.

So far as concerns the number of species, the cold season (Nov.–Feb.) is the period when charophytes are most abundant, though luxuriant growth is perhaps a more characteristic feature of the rainy season (mid-June–Sept.) plants—e. g., *Nitella acuminata*, *N. furcata*, and *Chara brachyypus*. June and July are practically blank months, but by August several are to be found, and others commence in November. Amongst the factors bearing on the times of appearance of the different species, one of the chief may be the increase in the amount of sunlight that can penetrate to the bottom of the charophyte-zone in the cold weather. It is around the margin that most of these plants are to be found. In the rainy season, in many small

ponds this area is occupied by a dense growth of grasses and rushes etc., and further out by a number of floating-leaved plants, while at this season submerged plants, such as *Ceratophyllum*, are particularly abundant. By the time the cold season has set in, this vegetation has mostly disappeared, aided largely no doubt by the shrinking in size of the patches of water, with the result that around the margin the water is clear and the bottom is soft mud. Conditions do not alter much during the cold season, except for occasional rain about Christmas time. By the commencement of the hot season small ponds have dried up, and, of the few remaining localities, many have been quite spoilt by the activities of village pigs and the constant watering of cows and water-buffaloes. By the middle of April hardly a species remains except *C. Braunii*, which is to be found as late as June.

The numbers given below are those of the specimens in the fasciculus.

1. *NITELLA MIRABILIS* (Nordstedt MS.) J. Groves. ♂ & ♀.

Collected 19th Dec., 1926. Fairly common, growing in clumps by itself in open water near the margin, on very soft mud. Found in the middle of the cold season only. The young male heads were enveloped in a dense mucous cloud. This remarkable species, with its numerous clustered and stalked oogonia and antheridia, is at present known only from the United Provinces (Gonda and Saharanpur) and Southern China (Yunnan).

2. *N. ACUMINATA* Braun.

Collected Aug. and Sept. 1926. Abundant in the rainy season, especially around rice-fields, and in small open spaces protected by rushes. A medium to rather large form of this widely-distributed species, which occurs in the tropical and subtropical regions of both hemispheres.

3. *N. DISPERSA* Braun.

Collected 14th Nov., 1926. A rather lax form, but a considerably stouter, and a capitate form also occur. In most of the sets there are specimens of both sexes, but in a few the male only could be included. Uncommon, occurring in the early to middle cold season and preferring soft mud. An interesting species, so far apparently only known to occur also in Bombay and Assam. An unusual feature is the occasional presence of a long cylindrical end-cell to a dactyl, in place of the usual conical one. The two types of end-cell, the conical and \pm cylindrical, here present on the same plant, usually serve as a good character to divide the arthroductylous homœoclemous *Nitellas* into two apparently natural groups, for which the names *Conoteles* and *Allantoteles* are suggested. The Saharanpur plant also exhibits the peculiarity of being to a very small degree submonœcious, inasmuch as single antheridia have occasionally been detected on female, and single oogonia on male, individuals.

4. *N. AXILLARIS* Braun.

Collected Sept.-Oct. 1926. It occurred very sparingly, in the

rains only, amongst dense masses of *N. acuminata*. The first record of this species from the mainland of Asia, but it occurs (var. *javanica* Braun) in Java, and, if we include *N. sublucens* T. F. Allen, which seems almost identical, in Japan. In the Western Hemisphere it is recorded from N., Centr., and S. America and the West Indies.

5. *N. flagellifera*, sp. nov.

Arthroductyla homœoclema conoteles flabellata gymnocephala plerumque macroductyla monœcia.

Ramuli verticillorum 6, ter-furcati, ad nodum primum frequenter, et etiam sæpe ad nodum secundum, flagellum ramo normali simile, gerentes. Dactyli normaliter bicellulati, cellula inferior ad extremitatem leviter fastigata, cellula ultima angusta conica. Oogonia solitaria. Oospora aurantiaca; membrana angulariter et imperfecte reticulata.

Stem moderately stout (diam. c. 500 μ). Branchlets 6, three times forked, the rays divergent, producing very frequently at the first, and often also (on the central ray) at the second node a vigorous fertile shoot. Primary rays of the upper whorls usually more, and of the lower usually less, than half the length of the branchlet, secondary rays 6 (one central), tertiary almost always 4 (some not again forked), quaternary 3-4. Dactyls normally 2-celled, lower cell tapering slightly at the distal end, upper cell narrow-conical acute, \rightarrow c. 190 μ long, c. 40-45 μ broad at the base.

Monœcious. Gametangia at the second and third nodes. Oogonia solitary, c. 475 μ long (excl. cor.), 400 μ broad; coronula c. 75 μ broad, 50 μ high, the upper cell elongated. Oospore dull orange-yellow, c. 325 μ long, 275 μ broad, 200 μ thick, showing about 7 narrowly-flanged firm ridges, terminating in a short crest; membrane angularly and somewhat imperfectly reticulate. Antheridium c. 250 μ in diam.

Hab. Saharanpur, U.P.; Nov. 28, 1926. Found plentifully in one pond only in the early cold season.

A medium-sized plant, with the internodes not much longer than the branchlets, the latter being often much elongated ($>$ 8 cm.), growing in broadly-spreading tufts, the whole outline forming half an ellipse. Akin to *N. oligospira*, but the final node frequently fertile, and the dactyls, with the exception of a very occasional one-celled individual, not much abbreviated. The outstanding character, the production of short branches, frequently at the first and often also (on the central ray) at the second branchlet-node, gives the plant a very distinctive appearance. The presence of a small shoot at the first branchlet-node is recorded by Braun as occurring in a form of *N. microcarpa* from Surinam (Fragm. p. 71, fig. 78), but in the present plant the proliferous character is much more pronounced. Possibly on a revision of the rather ill-defined species, *N. oligospira*, this and the following may be found reducible to varietal rank; in the meanwhile, it seems safer to treat them as species. Neither appears to produce the uniformly short divergent clusters of dactyls characteristic of the *Brachyductyla*, under which section Braun placed *N. oligospira*.

6. *N. patula*, sp. nov.

Arthroductyla homœoclema conoteles flabellata gymnocephala plerumque macroductyla monœcia.

Ramuli verticillorum 6, ter- et sæpe partim quater-furcata. Dactyli fere semper bicellulati, sed raro uno abbreviato unicellulato; cellula inferior ad extremitatem leviter fastigata, cellula ultima angusta conica. Oogonia solitaria. Oospora dilute-brunnea; membrana subtiliter et regulariter granulata.

Stem moderately stout (diam. c. 500 μ). Branchlets normally 6, 3 and often 4 times forked, the rays divergent; primary rays less than half the length of the branchlets, secondary 6-7, tertiary and quaternary 3-4, quinary 2-3. Dactyls normally 2-celled, but occasionally at the fourth forking one 1-celled, short and narrow, resembling the upper cell of the others; lower cell tapering slightly at the distal end, upper cell narrow-conical acute, \rightarrow c. 125 μ long, 40 μ broad at base.

Monœcious. Gametangia produced together at second and third nodes. Oogonia solitary, c. 525 μ long (excl. cor.), 475 μ broad; coronula persistent, c. 75 μ broad, 45 μ high, the upper cell elongated. Oospore light warm brown, c. 375 μ long, 350 μ broad, 200 μ thick, showing about 7 low thin ridges; membrane finely and evenly granular. Antheridium diam. \rightarrow c. 275 μ .

Hab. Saharanpur, U.P.; Oct. 12. Dense masses in splendid condition in the open middle portion of a small rush-surrounded pond which was drying up rapidly between the rainy and cold seasons.

A rather large plant, resembling *N. furcata* in habit, through the divergence of the branchlet-rays; also allied to *N. oligospira*, but with few abbreviated dactyls and with a granulate oospore-membrane; differs from *N. mucronata* in the absence of 3-celled dactyls, the shape of the apex of the lower cell and of the end-cell, as well as in the colour of the oospore and the decoration of its membrane.

7. *N. FURCATA* Agardh (*N. Rowburghii* Braun; *N. polyglochin* Braun (*sensu strictiore*)).

Collected Sept.-Oct. 1926. It occurs plentifully during the rains in the same sort of habitat as *N. acuminata*, and grows to a good length when the depth of the water admits of it. Found in different parts of India, Ceylon, the Malay Archipelago, Philippine Islands, Madagascar, and Northern Australia.

8. *CHARA CORALLINA* Willd.

Collected 2nd Jan., 1927, growing in clumps in open shallow water. This handsome vigorous species is widely distributed in India, and occurs also in Ceylon, Sumatra, Philippine Islands, and Mauritius.

9. *C. BRAUNII* Gmel. (*C. coronata* Braun).

Collected 12th April, 1926. A very common cold-weather species, not infrequently growing in large patches, and extending right through the hot weather. The specimens represent rather a slender form. It is almost world-wide in its distribution.

10. *C. ERYTHROGYNA* Griff. (*C. Griffithii* Braun).

Collected 19th Sept., 1926. Fairly common in the rains and until the end of December. A rare species, recorded only from a few localities in district 6, and from Cochin China and Java. Perhaps hardly separable from *C. Thwaitesii* Braun, found in Ceylon. A confusion has arisen as to the spelling of the name, Braun having cited it as "*erythrogona*."

11. *C. HYDROPHYTYS* Reichenb.

Collected 23rd Sept., 1926. Only found on this one occasion, and lasting for about ten days, on the very shallow, quickly drying-up margin of the pond, mainly growing by itself in small, scattered, spreading clumps, but here and there mixed up with *C. zeylanica*, which it much resembled. The bottom was hard gritty soil, an unusual place for a charophyte. This species is almost confined to the tropical regions of both hemispheres.

The production of an upward-growing cortex only from the lowest free branchlet-node links this species with the small group "Gymnopodes" of the Diplostephanae, the members of which also belong to the warmer regions.

12. *C. FRAGILIS* Desv.

Collected 10th May, 1926. Well-grown plants of a typical form, in some 3-4 feet of water, occurring throughout the cold and hot seasons. Probably the most widely distributed of all the Charophyta.

13. *C. BRACHYPUS* Braun.

Collected 3rd Oct., 1926. A rather slender form. Fairly common in the rainy and early cold seasons, occurring often in dense masses, and partial to a firm soil. Recorded from scattered localities in tropical and subtropical regions of the Eastern Hemisphere.

14. *C. ZEYLANICA* Willd.

Collected Oct. 1926. Fairly common between the rainy and cold seasons. In its many forms or varieties the most widespread of the tropical and subtropical charas. The present plant is a very clean neat form, with short branchlets and spine-cells and with the lowest branchlet-node fertile.

AN ENUMERATION OF THE SPECIES OF *POLYGALA*
IN ANGOLA.

BY A. W. EXELL, M.A., F.L.S.

SINCE working out the species of *Polygala* collected by Mr. J. Gossweiler in Portuguese West Africa (Journ. Bot. 1926, Suppl. Polypetalæ, 21 *et seq.*) I have been able to study authentic material of all the species so far recorded from that part of Africa. The

identification of species in this genus is often difficult, and a key to the Angolan species may therefore be useful, though, as material of many of these is very scanty, further collecting will doubtless reveal errors in the ideas here expressed. I hope to publish similar keys to the species from other regions of Africa at some future date, and I would point out that further material from Africa for comparison and identification would be gratefully received at the Museum.

Of the 31 species recognized in Angola, 17 are, according to present records of distribution, endemic to the region; one only, *P. erioptera*, extends outside Africa through Arabia to India; three, *P. myriantha*, *P. albida*, and *P. arenaria*, are fairly widespread in Tropical Africa; one only, *P. acicularis*, extends up the west coast of Africa as far as Nigeria; three, *P. seminuda*, *P. Schinziana*, and *P. kalaxariensis*, extend towards the desert regions of S.W. Africa, the latter occurring also in Rhodesia; five more extend eastwards into Rhodesia, two of them as far as Nyasaland and two southwards into the Transvaal; one species, *P. macrostigma*, has so far only been recorded from the north of Angola and from Katanga.

No attempt has been made to deal with varieties of the species in question, for, in view of the considerable range of structure met with in the commoner species of which we have considerable material, it seems unsafe to try to distinguish varieties from forms due to varying habitat until an adequate amount of material has been collected.

The specimens quoted are in the British Museum Herbarium unless otherwise stated.

I have to thank the Director of the Royal Gardens, Kew, and Dr. De Wildeman, of the Botanic Garden, Brussels, for the loan of specimens, and Dr. Mildbraed, of Berlin, and the Director of the Gray Herbarium for specimens and assistance.

I. Sepals all free.

1. Flowers in lateral racemes (never in terminal racemes).
 - Leaves elliptical to narrowly elliptical; wings usually exceeding 4 mm.
 - Wings suborbicular, concealing the ripe capsule. 1. *P. filifera*.
 - Wings obliquely oblanceolate or obovate, narrower than the ripe capsule. 2. *P. myrtilloopsis*.
 - Leaves clavate to narrowly oblong; wings not exceeding 4 mm. 3. *P. erioptera*.
2. Flowers in terminal racemes (occasionally also with lateral racemes or with solitary axillary flowers as well).
 - Flowers large, wings exceeding 8 mm.
 - Flowers purple or red 4. *P. Gomesiana*.
 - Flowers white or yellow 5. *P. macrostigma*.
 - Flowers with wings not exceeding 7 mm.
 - Posterior sepal much exceeding the two anterior ones. 6. *P. myriantha*.
 - Posterior sepal not larger than the two anterior ones.
 - Seeds glochidiate 7. *P. africana*.
 - Seeds sericeous, not glochidiate.
 - (1) Leaves filiform; racemes elongated.
 - Dwarf plant 4-8 cm. in height 8. *P. Pearsonii*.

- Plant not dwarf, exceeding 12 cm. in height.
 - Flowers 2 mm. (-3 mm.) long 9. *P. spicata*.
 - Mature flowers always exceeding 3 mm.
 - Wings with conspicuous median vein 10. *P. seminuda*.
 - Wings not as above.
 - Pedicels of mature flowers at least 3 mm. long 11. *P. angolensis*.
 - Pedicels not exceeding 2 mm.
 - Wings exceeding 5 mm.
 - Upper petals notched at the apex; bracts coloured 12. *P. Guerkei*.
 - Upper petals notched at one side; bracts not coloured 13. *P. nambalensis*.
 - Wings 4 mm. long 14. *P. paludicola*.
 - (2) Leaves not filiform; flowers in crowded racemes which are often sub-capitate.
 - Mature flowers 5-7 mm. long.
 - Branching racemose 15. *P. albida*.
 - Branching cymose, becoming monopodial 16. *P. arenaria*.
 - Mature flowers 2-4 mm. long.
 - Leaves puberulous or pilosulose 16. *P. arenaria*.
 - Leaves glabrous.
 - Seeds subglobose, usually with tawny-brown silky hairs 17. *P. Welwitschii*.
 - Seeds cylindrical, with white silky hairs 18. *P. lepidota*.
- #### II. Two anterior sepals joined.
1. Eight fertile stamens.
 - Leaves obovate to oblanceolate 19. *P. Schinziana*.
 - Leaves subulate to narrowly linear.
 - Leaves fasciculate 20. *P. acicularis*.
 - Leaves not fasciculate.
 - Mature flowers 6 mm. long or longer.
 - Leaves rigid, infl. glabrous 21. *P. viminalis*.
 - Leaves lax, infl. pubescent 22. *P. laxifolia*.
 - Mature flowers 5 mm. long or shorter.
 - Leaves few, almost subulate, up to 1 mm. broad; ripe seeds ovoid 23. *P. rivularis*.
 - Leaves well-developed, up to 2 mm. broad; ripe seeds cylindrical 24. *P. Antunesii*.
 - 2. Six fertile stamens and 2 sterile filaments.
 - Young stems pubescent 25. *P. kalaxariensis*.
 - Young stems glabrous.
 - Leaves oblanceolate.
 - Flowers 8-12 mm. long, in crowded heads 26. *P. robusta*.
 - Flowers 7-8 mm. long, not crowded 27. *P. Poggei*.
 - Leaves linear or clavate.
 - Flowers usually exceeding 8 mm. (up to 10 mm.); leaves distinctly clavate 28. *P. Baumii*.
 - Flowers not exceeding 8 mm.; leaves linear or subulate.
 - Plant tall, slender, fastigiate 29. *P. nematophylla*.
 - Plant suffruticose, caespitose, or ericoid.
 - Pedicels shorter than the flowers 30. *P. arenicola*.
 - Pedicels often longer than the flowers 31. *P. huillensis*.

1. *P. FILIFERA* Chodat in Engl. Jahrb. xviii. 315 (1912). *Antunes*, 337 (Herb. Berlin); *Welwitsch*, 1028; *Pearson*, 2418 (Herb. Kew.).

Welwitsch, 1028, was referred by Chodat (Bull. Herb. Boiss. Sér. 1, iv. 902 (1896)) to *P. Fischeri* Gürke. Both this specimen and *Pearson*, 2418, have much longer and stouter inflorescences than the type of *P. filifera*, but this would be explainable if the type-specimen were a young, poorly-developed plant.

Hab. In open thickets (*Welw.*).

Distr. Angola, Nyasaland, and Rhodesia.

2. *P. MYRTILLOPSIS* Welw. ex Oliv. in Fl. Trop. Afr. i. 130 (1868). *Welwitsch*, 1029.

A very rare species, which, to my knowledge, has only been collected once, near Lopollo, Huilla. Some confusion has arisen owing to the misidentification of *Welwitsch*, 1024, actually *P. viminalis* Gürke, as this species. Chodat considers that the affinity is with *P. asbestina* Burch., and there is also a very close resemblance to *P. serpentaria* Eckl. & Zeyh. from South Africa.

Hab. On sandy hills covered with thickets (*Welw.*).

Distr. Angola.

3. *P. ERIOPTERA* DC. in Prodr. i. 326 (1824). *Welwitsch*, 992, 1000, 1003; *Gossweiler*, 303, 783, 783 B; *Pearson*, 2401 (Herb. Kew.).

An extremely variable species of which Chodat has described a number of varieties, one of which, var. *angolensis*, includes the Angola specimens. As very similar forms have been collected in India, it is doubtful whether the varietal characters are constant. The species seems to accommodate itself, with considerable change of habit, to a wide range of habitat.

Hab. On grassy hills and stony places and in neglected, once cultivated areas.

Distr. Throughout Tropical Africa, Arabia, Persia, and India.

4. *P. GOMESTANA* Welw. ex Oliv. in Fl. Trop. Afr. i. 126 (1868). *Welwitsch*, 1032; *Berthelot*, 17; *Gossweiler*, 2435, 2567; *Baum*, 371; *Pearson*, 2214 (Herb. Kew.); *Capello*, 25 (Herb. Lisbon).

Hab. In swampy situations and along watercourses (*Gossw.*).

Distr. Angola.

5. *P. MACROSTIGMA* Chodat in Engl. Jahrb. xviii. 319 (1912). *P. splendens* Exell in Journ. Bot. lxiv. Suppl. Polypetalæ, 22 (1926). *Gossweiler*, 8470.

Distr. Angola and Katanga.

6. *P. MYRIANTHA* Chodat in Engl. Jahrb. xviii. 321 (1912). *Gossweiler*, 2470, 3114.

Chodat (*loc. cit.*) has pointed out the affinity of this species with *P. oligophylla* DC. from Nepal. *P. myriantha* is smaller and more profusely branched; it has also smaller flowers.

Hab. In open woods and grasslands, where it is greatly liked by cattle, which eat off the shoots (*Gossw.*).

Distr. So far recorded from the Cameroons, Angola, Uganda, Nyasaland, and Rhodesia.

7. *P. AFRICANA* Chodat in Mém. Soc. Phys. Genève, xxxi. no. 2, p. 168 (1893). *Welwitsch*, 1009, 1010, 1021; *Gossweiler*, 3242.

Hab. In short grass (*Welw.*).

Distr. Angola, Rhodesia and Transvaal.

8. *Polygala Pearsonii*, sp. nov. *Herba* annua nana ramosa; *foliis* brevissime petiolatis, filiformibus vel anguste linearibus appresse pubescentibus; *floribus* breviter pedicellatis, pedicello quam flos brevior, in racemos elongatos multifloros dispositis; *alis* oblique obovatis glabris; *sepalis* liberis obovatis glabris; *carina* cristata, crista parva paucilobata; *staminibus* 8; *capsula* obovata alata glabra; *seminibus* conicis longe sericeis.

Hab. In the sand among grasses and *Welwitschias* between Mossamedes and the River Coroca, South Angola, *H. H. W. Pearson*, 2200 (holotype, Herb. Kew.), 2187 (Herb. Kew.).

Plant a dwarf with pink flowers, reaching the height of about 7 cm.; *leaves* 8-20 by 1 mm.; *inflorescences* up to 3 cm. long; *pedicels* 1.5 mm. long; *wings* 3 by 2.5 mm.; *sepals* 1.4 by .8 mm.; *capsule* 4 by 3 mm.; *seed* 2 by 1 mm.

Probably most nearly related to *P. leptophylla* Burch. from South Africa and to *P. erubescens* E. Mey. ex Chodat. It is a much smaller plant than the former, and from the latter, of which I have seen no authentic specimen, it apparently differs in having seeds with long silky hairs.

Distr. South Angola.

9. *P. SPICATA* Chodat in Mém. Soc. Phys. Genève, xxxi. n. 2, p. 221 (1893). *P. Schlechteri* Schinz in Vierteljahrsschr. Nat. Ges. Zürich, lv. 237 (1910). *Welwitsch*, 1027; *Gossweiler*, 2148, 2783 p.p., 3265; *Baum*, 315.

Very closely related to the Brazilian species *P. tenuis* DC.

Hab. An annual marsh-herb in wet meadows (*Gossw.*).

Distr. Angola and Transvaal. No doubt, this species will be found to occur also in Rhodesia, but I have no record of it from there.

10. *P. SEMINUDA* Harv. Fl. Cap. i. 86 (1859). *Gossweiler*, 71.

I have referred this specimen to *P. seminuda* with some hesitation. It is certainly very close, but further material may show it to be distinct. Chodat (Mon. Polyg. 399 (1893)) identifies *P. seminuda* with *P. hottentotta* Presl., but there can be no doubt that they are distinct. *Gossweiler* states that the flowers of his specimen were sweetly scented.

Hab. In ravines of bare sandy hills (*Gossw.*).

Distr. Angola and Namaqualand.

11. *P. ANGOLENSIS* Chodat in Engl. Jahrb. xviii. 318 (1912). *P. sparsiflora* Oliv. var. β in Fl. Trop. Afr. i. 128 (1868). *Welwitsch*, 1018; *Dekindt*, 255 (Herb. Berlin); *Capello*, 126 (Herb. Lisbon).

This is closely related to the preceding species. Chodat (*loc. cit.*) points out the differences and compares it also with *P. ukirensis* Gürke. It can be most readily distinguished from the latter species by the appressed hairs of the peduncles, those of *P. ukirensis* having distinctly patent hairs.

Hab. In damp meadows (*Dekindt, Welw.*).
Distr. Angola.

12. *P. GUERKEI* Chodat in Engl. Jahrb. xviii. 318 (1912).
P. psammophila Gürke in Baum-Warburg Kunene-Sambesi Exped. 279 (1903). *Baum*, 817, 871.

Chodat (*loc. cit.*) gives an account of the affinities.

Hab. In grass on sand-hills (*Baum*).
Distr. Angola.

13. *P. NAMBALENSIS* Gürke in Baum-Warburg Kunene-Sambesi Exped. 276 (1903). *Baum*, 244 (Herb. Berlin); *Gossweiler*, 2794, 3354.

Closely allied to the preceding species, to which I wrongly referred the two specimens collected by Gossweiler (Journ. Bot. lxiv. Suppl. Polypetalæ, 21 (1926)). In this species the carina is bent more sharply at right angles and the upper petals are notched at one side just below the apex, while in *P. Guerkei* the upper petals are apically emarginate. Chodat (Engl. Jahrb. xviii. 318 (1912)) has corrected various mistakes in the original description and pointed out the true affinity.

Hab. On sand-hills (*Baum*); in damp meadows (*Gossw.*).
Distr. Angola.

14. *P. PALUDICOLA* Gürke in Baum-Warburg Kunene-Sambesi Exped. 279 (1903). *Baum*, 373, 373 A; *Gossweiler*, 2783 p.p., 3150, 3260; *M. A. Pocock*, 316 (Herb. Bolus).

Chodat (Engl. Jahrb. xviii. 317 (1912)) discusses the affinity of this species.

Hab. An annual weedy herblet growing in marshes (*Gossw.*); in marshy grasslands besides rivers (*M. A. Pocock*).

15. *P. ALBIDA* Schinz in Verh. Bot. Ver. Brand. xxix. 53 (1888).
P. Livingstoniana Chodat in Mém. Soc. Phys. Genève, xxxi. no. 2, p. 339 (1893); *P. Stanleyana* Chodat, *loc. cit.* 340; *P. modesta* Gürke in Engl. Jahrb. ix. Beibl. 47, 35 (1895). *Welwitsch*, 998, 999, 1011, 1016, 1017, 1025, 993 p. p. (Herb. Kew.); *Gossweiler*, 3459; *Capello*, 142 (Herb. Lisbon); *Pearson*, 2049 (Herb. Kew.); *H. H. Johnston*, s.n. (Herb. Kew.); *Mr. & Mrs. Monteiro*, s.n. (Herb. Kew.); *Wellman*, s.n. (Herb. Kew.).

Hab. In wooded meadows (*Welw.*).

Distr. Widely distributed in Tropical Africa.

16. *P. ARENARIA* Willd. Sp. Pl. iii. 880 (1803). *P. Chodatiana* Hiern in Cat. Welw. Afr. Pl. i. 45 (1900), non A. W. Bennett; *Welwitsch*, 993, 1001, 1002.

P. Chodatiana Hiern is merely a poorly-developed specimen of

this species. The method of branching is very characteristic, and readily distinguishes the species from the nearly allied *P. albida* Schinz. The main stem ends in an inflorescence, and one, two, or three lateral branches carry on the growth, the process being repeated several times, so that the plant has a straggling habit.

Hab. In short grass in wooded pastures (*Welw.*).

Distr. Western Tropical Africa, Uganda, and Bahr-el-Ghazal region.

17. *P. WELWITSCHII* Chodat in Mém. Soc. Phys. Genève, xxxi. no. 2, p. 221 (1893). *Welwitsch*, 993 p.p. (Herb. Kew.), 1007, 1008, 1012, 1013, 1014, 1015.

Chodat (Mon. Polyg. 341 (1893)) has described two varieties, var. α *linearifolia* and var. β *ovatifolia*, but the specimens here cited show every transition between the two leaf-forms. The method of branching is often very similar to that of the preceding species, but the flowers are smaller and the leaves glabrous, while those of *P. arenaria* are puberulous or pilosulose.

Hab. On grassy hills and in damp pastures (*Welw.*).

Distr. Angola.

18. *P. LEPIDOTA* Welw. ex Exell in Journ. Bot. lxiv. Suppl. Polypetalæ, 22 (1926). *P. Welwitschii* var. *linearifolia* Chodat *vide* Hiern in Cat. Welw. Afr. Pl. i. 45 (1900). *Welwitsch*, 1026; *Gossweiler*, 4059, 4203 A.

Allied to *P. Welwitschii*, but more dwarf and less branched; resembling *P. pygmaea* Gürke of the Central African Lake District in habit, but with a longer narrower aril.

Hab. In sub-humid pastures (*Welw.*); in woods (*Gossw.*).

Distr. Angola and Rhodesia.

19. *P. SCHINZIANA* Chodat in Mém. Soc. Phys. Genève, xxxi. no. 2, p. 364 (1893). *P. benquellensis* Gürke in Baum-Warburg Kunene-Sambesi Exped. 277 (1903); *Baum*, 554.

Hab. At the edges of woods (*Baum*).

Distr. Angola and Ambola.

20. *P. ACICULARIS* Oliv. in Fl. Trop. Afr. i. 132 (1863), non S. Wats. *Mr. & Mrs. Monteiro*, s.n. (Herb. Kew.).
Distr. Nigeria, Cameroons, Congo, Angola, and Nile Lands.

21. *P. VIMINALIS* Gürke in Pflanzenwelt Ost-Afr. C. 234 (1895). *Welwitsch*, 1019, 1020, 1024; *Gossweiler*, 1475, 4230; *Baum*, 138, 874; *Pearson*, 2414 (Herb. Kew.).

Hab. In dry grasslands, sandy woods, and grassy hills (*Welw.*).

Distr. Angola, Nyasaland, and Tanganyika Territory.

22. *Polygala laxifolia*, sp. nov. *P. rarifolia* DC. forma *fida* Hiern in Cat. Welw. Afr. Pl. i. 47 (1900). *Herba* vel *suffruticosa* ramulis primo dense pubescentibus demum glabris; *foliis*

linearibus vel anguste linearibus laxis glabris apice mucronulatis; floribus in racemos terminales bracteatos, bracteis filiformibus pubescentibus, dispositis; alis late ellipticis apice rotundatis pubescentibus; sepalis duobus inferioribus usque ad apicem connatis pubescentibus; petalis superioribus oblongis apice truncatis basi cuneatis glabris; carina cristata, crista paucilobata; antheris 8; ovario oblongo, apice emarginato, puberulo.

Hab. In stony woods between Lopollo and Ferrão da Sola, Huilla, Welwitsch, 1023.

Leaves 3-5 cm. by 1-3 mm.; inflorescences 9-12 cm. long; pedicels up to 4 mm. long; bracts 2-2.5 mm. long; wings 7 by 4 mm.; upper petals 8 by 3 mm.; carina 8 by 3 mm.

This species is very near to *P. viminalis* Gürke, but can be distinguished by the pubescent inflorescences and the broader laxer leaves.

Distr. Angola.

23. *P. RIVULARIS* Gürke in Baum-Warburg Kunene-Sambesi Exped. 278 (1903). *P. rarifolia* DC. var. *melanophleba* Welw. ex Oliv. in Fl. Trop. Afr. i. 133 (1868). Welwitsch, 1022; Gossweiler, 2529, 3351, 3992; Baum, 595, 911.

Hab. In marshes (Baum); in damp pastures (Welw.); in marshes and damp meadows (Gossw.).

Distr. Angola.

24. *P. ANTUNESII* Gürke in Engl. Jahrb. xxxii. 131 (1902). Antunes, 167 (Herb. Berlin); Gossweiler, 3601; H. H. Johnston, s.n. (Herb. Kew.).

A suffruticose undershrub, woody at the base; laxly branched; sepals lurid yellow with orange-red veins; petals cream-white throughout (Gossw.). Near *P. rigens* DC., but easily distinguishable by the seeds, which have short patent hairs, while those of *P. rigens* are sericeous.

Hab. In short thickets (Gossw.).

Distr. Angola.

25. *P. KALAXARIENSIS* Schinz in Verhandl. Bot. Vereins Prov. Brand. xxix. 52 (1888). *P. kubangensis* Gürke in Baum-Warburg Kunene-Sambesi Exped. 275 (1903). *P. Dekindtii* Gürke in Engl. Jahrb. xxxii. 131 (1902). Welwitsch, 1031; Gossweiler, 2548, 3123, 3356, 3884, 3897, 4107; Baum, 287; Dekindt, 242 (Herb. Berlin).

Hab. In sandy woods (Welw.); in short shrub-grown pasturage, marshes, and thickets (Gossw.); in sandy places (Baum).

Distr. Angola, Rhodesia and S.W. Africa.

26. *P. ROBUSTA* Gürke in Baum-Warburg Kunene-Sambesi Exped. 274 (1903). Gossweiler, 2851, 4106; Baum, 704.

The two varieties described by Gürke, var. *cærulea* and var. *rubra*, seem merely to be flower-colour varieties such as are met with in a number of species of this genus.

Hab. In sandy places among shrubs (Baum); in shrubby pasturage (Gossw.).

Distr. Angola.

27. *P. POGGEEI* Gürke in Engl. Jahrb. xiv. 309 (1891). Pogge, 29 (Herb. Berlin).

Distr. Angola.

28. *P. BAUMII* Gürke in Baum-Warburg Kunene-Sambesi Exped. 276 (1903). *P. congestiflora* Johnston in Contrib. Gray Herb. 1924, 37. Gossweiler, 2600, 2750, 2890, 3734; Baum, 815; Anita G. Curtis, 419 (Herb. Gray).

An annual or perennial herblet with the habit of an undershrub, branched from the base; branches spreading, ascending, often supported by neighbouring shrubs; calyx light green; petals greenish; carina with blue fringed margin at the apex (Gossw.).

Hab. In sandy places amongst grass (Baum); in thickets and shrub-grown pasturage (Gossw.).

Distr. Angola.

29. *P. NEMATOPHYLLA* Exell in Journ. Bot. lxiv., Suppl., Polypetalæ, 23 (1926). Gossweiler, 2155, 2782, 2795, 3352, 3353, 4037; M. A. Pocock, 901 (Herb. Bolus).

Stems sulcate, striate; leaves ascending; sepals white, purplish-veined; petals violet-blue, deeply fringed along the margin (Gossw.).

Hab. In thickets, open woods, wet pasturage, and shrub-grown pasturage (Gossw.).

Distr. Angola.

30. *P. ARENICOLA* Gürke in Baum-Warburg Kunene-Sambesi Exped. 273 (1903). Baum, 301; Gossweiler, 3698, 4034, 4115; M. A. Pocock, 466 (Herb. Bolus).

The Gossweiler specimens were described as var. *angustifolia* Exell in Journ. Bot. xlv., Suppl., Polypetalæ, 23 (1926), but more material may show that the narrowness of the leaves, compared with those of the type, is not a distinct varietal character.

Hab. In sandy places on a hill (Baum); in herb-grown thickets (Gossw.); in woodlands (M. A. Pocock).

Distr. Angola.

31. *P. HUILLENSIS* Welw. ex Oliv. in Fl. Trop. Afr. i. 133 (1868). Welwitsch 1030; Gossweiler, 2146.

A many-headed perennial with woody rootstock; leafy shoots much branched from the base, ascending; total height five inches; flowers indigo-blue.

Hab. In sandy and stony pastures (Welw.); skirting marshy meadows (Gossw.).

Distr. Angola.

TWO NEW MESEMBRYANTHEMÆ.

BY N. E. BROWN, A.L.S.

IMITARIA N. E. Br. (genus novum). Planta ad *Conophytum* et *Lithopem* consimilis. *Calycis* tubus elongatus, superne inæqualiter 6-lobus. *Petala* numerosa, inferne in tubum connata. *Staminodia* plurima, filiformia, apice recurvata. *Stamina* 18-20, biseriata, inferiora inclusa, superiora exserta. *Stylus* elongatus, filiformis; stigmata 6, minuta. *Ovarium* inferum, 6-loculare; ovula in solum loculorum inserta. *Capsula* parva, 6-valvata; valvarum carinis contiguus centralibus alato-marginatis, loculis alis membranaceis tectis; semina compresso-ovoidea, levia. Species 1.

Perennial, succulent, stemless, resembling *Lithops* and *Conophytum* in appearance, each growth being an obconic body with a transverse fissure across its top. Flowers solitary, terminal, partly included in the body of the growth. Calyx with a compressed tube above the ovary, 6-lobed at the top. Petals numerous, in 3-4 series, united into a tube below. Stamines many, at the mouth of the corolla-tube, linear-filiform. Stamens in two series, arising from the corolla-tube, the lower included, the upper with the anthers exserted from the tube. Style elongated, included within the corolla-tube, with 6 minute stigmas at its apex. Ovary inferior, 6-celled, placentas on the floor of the cells. Capsule subhemispherical, 5-angled and flattish at the top, with 6 valves and cells; valves with the expanding keels contiguous, forming a stout central keel, with membranous marginal wings that are united in pairs between the valves; cells somewhat flatly roofed with membranous cell-wings, without a tubercle at the opening. Seeds compressed-ovoid, pointed at one end, smooth.

A monotypic genus, native of South Africa, intermediate between *Conophytum* and *Gibbaeum*, and probably of hybrid origin between those two genera, which also occur in its vicinity. I place it next to *Conophytum*, from which it differs by its unequally 6-lobed calyx, and by the cells of the capsule being roofed with membranous cell-wings.

The name is derived from the Latin, *imito*, to imitate, on account of the manner in which the plant imitates the genera *Lithops* and *Conophytum*, as well as the stones it grows among.

I. Muirii N. E. Br. *Corpuscula* carnosa, 6-10 lin. alta, 5-8 lin. lata et 4-7½ lin. crassa, obconica, breviter biloba, loborum apice convexa, minute velutino-puberula. *Calycis* tubus 1½ lin. longus, corpusculo inclusus, lobis longioribus 1½ lin. longis et 1 lin. latis. *Corolla* 7-8 lin. diametro, rosea, tubo 2½-3 lin. longo. *Stylus* 2 lin. longus, lutescens; stigmata vix ¼ lin. longa. *Capsula* 2 lin. diametro.

Plant consisting of a single growth or of 2-8 growths in a clump. Each growth 6-10 lines high, 5-8 lines broad, and 4-7½ lines thick, with the fissure 1½-2 lines deep, dividing the top into two convex lobes; substance soft and pulpy, smooth, velvety puberulous to the touch, being microscopically puberulous with minute forked hairs,

dull greyish-green or brownish in nature, becoming green under cultivation. Calyx-tube 1½ line long, included in the body of the growth; the two lateral lobes 1 line long, fleshy and keeled, the other four about 1½ line long and 1 line broad, flat, with broad membranous margins. Corolla-tube 2½-3 lines long; petals in 3-4 series, spreading horizontally upon the top of the growth, overlapping, about 3-4 lines long and ½-¾ line broad, but only dried flowers seen, linear, obtuse, of "a lovely rose-pink, a little paler at the base," according to Dr. Muir. Stamines about 1½ line long, erect, with recurved tips, linear-filiform, acute, apparently whitish or pink. Stamens 18-20; anthers yellow. Style about 2 lines long, attaining to the top of the lower series of anthers, rather stout, yellowish; stigmas less than ¼ line long. Capsule 2 lines in diameter when closed; valves pallid within, and the expanding keels honey-coloured. Seeds rather less than ½ line long, brown.

South Africa: on a hill in the Klein Karoo, *Muir*, 4021!

For this very distinct and pretty little plant I am indebted to its discoverer, Dr. J. Muir, who informs me that it is difficult to detect in its native locality.

Faucaria albidens N. E. Br. *F. felinae* Hill affinis. *Folia* conferta, 9-15 lin. longa, 6-8 lin. lata et 3-4 lin. crassa, ambitu lanceolata, acuta, marginibus 2-4-dentatis, dentibus validis 1-2 lin. longis albidis. *Flores* eis *F. felinae* similes, circa 1½ pollicem diametro, luteæ.

Plant about 2 inches high, with crowded growths. Leaves spreading, 9-15 lines long, 6-8 lines broad and 3-4 lines thick at the middle, somewhat lanceolate in outline, acute, flat on the face, with 2-4 marginal teeth on each side, convex on the back and slightly keeled at the apex; teeth short and stout, 1-2 lines long, with white horny margins and points, and the apical part of the keel also with a horny white margin; surface smooth, glabrous, dark green, shining, pellucid-dotted. Flowers sessile. Calyx subequally 5-lobed nearly down to its union with the ovary, glabrous, green; lobes about 4 lines long and nearly 2 lines broad, oblong, obtuse, some with membranous margins. Corolla about 1½ inch in diameter; petals numerous, in 2-3 series, about 10 lines long and ½ line broad, linear, obtuse, yellow. Stamens 3-3½ lines long, yellow. No glands. Stigmas 5, ascending-spreading and exceeding the stamens, 4½-5 lines long, filiform, yellowish. Ovary slightly concave around the base of the stigmas at the top, 5-celled.

South Africa. Locality unknown; brought from South Africa to Wembley Exhibition by Mr. F. Frith in 1924.

Described from a living plant given to me by Mr. C. D. O'Donoghue, with whom it flowered in September 1927. It differs from all others of this genus by the short stout white teeth on the leaves.

THE FERTILISATION OF *OPHRYS FUSCA* LINK.

BY COLONEL M. J. GODFERY, F.L.S.

WITH reference to the description of the visits of *Andrena trimmerana* and of *A. nigro-anea* to *Ophrys fusca* at Hyères in April 1924 (Journ. Bot. 1925, p. 38), although I watched the same plants almost daily in 1925 and 1926 I saw nothing visit them.

In 1927, however, Mr. M. Gordon told my wife on the 4th April that bees were busy with *O. fusca* in our orchid-bed in the garden of the Hôtel Continental, Hyères. She went there and saw a small bee with two pairs of pollinia on the end of his abdomen visit two flowers of *O. fusca*, and withdraw a further pair from each. He then had eight pollinia in all, and was so weighted that he appeared to be down at the stern, as she expressed it. In each case he alighted on the lip of the flower, facing inwards, but immediately turned round and plunged the end of his abdomen into the cavity at the base of the lip, working it about vigorously. She knelt down with her face quite close to the flower, but he took no notice of her. Having no net, she watched him till he flew away. Later Mr. Gordon saw another bee carrying two pairs of pollinia visit *O. fusca*. It was an extremely warm calm day, which no doubt explained the unusual activity of these insects. The next day I watched the flowers, but nothing came to them, but on April 6th about 1 P.M., when it was warm and sunny, I saw a small rather long slender bee bearing a small bunch of pollinia enter a flower of *O. fusca*. I gently enclosed him in a glass-bottomed pill-box, and he was very active, seeking some way of escape. The bunch of pollinia appeared to hamper his movements, and he tried hard to drag them off with his hind legs, but without success. I then cut off two fresh flowers of *O. fusca*, and put them into the box with him. Almost immediately he went to one of them, turned round, so as to face outwards, and thrust the end of his abdomen into the basal cavity of the lip, so that the bunch of pollinia disappeared from sight. He engaged in very active movements, thrusting his abdomen about, and changing the position of his feet on the lip, as if to get a firmer hold. I watched him through a low-power lens, and he appeared to be in a state of wild excitement. This went on for quite an appreciable time, after which he came off the flower with an additional pair of pollinia, and rested for a while, quite still. Then he rubbed his head with his fore legs and began to move about again, soon stopping and trying to scrape off the pollinia. Presently he came across the second flower and at once went through the same movements, thrusting the end of his abdomen into the cavity at the base of the lip, working it vigorously about, dancing a Charleston on the lip, and finally emerging with yet another pair of pollinia. The vigour with which he used the bunch of bright yellow pollinia, as if he were trying to sweep out the basal cavity of the lip with a tiny broom, was surprising. It could not fail to place a great deal of pollen on the stigma, which is just behind the cavity—indeed, the pollinia became so messed up and broken that it would have been difficult to count their numbers.

The question has been raised in certain Continental papers (*e.g.*

Bull. des Naturalistes de Mons, 1925, p. 81) whether visits to a flower of *Ophrys* satisfy the eager instincts of the insects concerned. The observations described above appear to suggest that such visits increased rather than diminished their ardour. It came as a surprise that an insect already bearing two pairs of pollinia should visit three flowers in quick succession.

SHORT NOTES.

PRIMULA-HYBRIDS.—In a paper by Mr. Miller Christy on "*Primula vulgaris* var. *caulescens*" (*New Phytologist*, xxii. 233-239 (1923)), it is observed that while the hybrid *P. veris* × *vulgaris* is usually found but sparingly in British localities where the parent species grow in proximity, yet in Northumberland and Durham it is locally abundant. Mr. Christy regards this local abundance as noteworthy, and I think that most British botanists have met with the hybrid only as more or less isolated individual plants. In France, according to Rouy (Fl. Fr. x. 204), *P. veris* × *vulgaris* is found "Çà et là avec les parents, assez fréquent."

It may be worth recording that at Menaggio, on Lake Como, where both *P. veris* × *P. vulgaris* were growing and flowering together most abundantly in the second week of last April in the hilly meadows above the town, the hybrid between them, varying greatly in inflorescence and flower, was everywhere to be seen, and in many spots was almost as common as the parents, the three forms often occurring together in the greatest profusion. The primrose here favours the meadows in preference to the adjoining woods.

It is a curious coincidence that these two species should hybridise with this unusual freedom in the remote districts near the northern and southern extremities of their geographical range, and the explanation in both cases appears to be their simultaneous flowering owing to local climatic conditions.

The abundance of primroses about the Italian lakes generally is remarkable, and around Lugano they grow in greater profusion than I have ever seen elsewhere. The oxslip (*P. elatior*), which is so common in Switzerland, appears to be absent about the lakes on the south side of the Alps.—H. W. PUGSLEY.

CAREX DIOICA L. forma *ISOGYNA*. Kukenthal (1909) in *Pflanzenreich*, IV. 20, 79.—*C. dioica** *isogyna* Angström in Fries, *Mant.* iii. 135 (1842); *Herb. Norm. Succ.* 15, No. 86; *C. dioica* L. var. *isogyna* Hart. *Hand. Sk. Fl.* ed. 4 (1843).

Springfield. Unst. Shetland, 29.7.86. *W. H. Beeby*, No. 739.

The form is distinguished from typical *dioica* by the male and female flowers being on one and the same plant.

Looking through specimens of *C. dioica* to see if any had been passed over, I came across the specimen noted above—the only British specimen I have seen.—A. BENNETT.

NEW RECORDS FOR SPHAGNA IN SCOTLAND.—Opportunity has been granted me to examine a small set of Sphagna, collected by J. Sims (1878–9) at Strachan, in Kincardineshire, and now in the British Museum Herbarium. Of the forty-five specimens, twenty are new records for the county, which proves how much the Sphagna have been neglected in Scotland—in Aberdeenshire, for instance, the southern district is only poorly represented, while for the north (v.c. 93) not a specimen is recorded in the *Census Catalogue of British Mosses*. An asterisk denotes whether it is the species or the variety that is new.

Sphagnum fimbriatum Wils. var. **validius* Card., Dalbro; *S. Girgensohnii* Russ. var. **microcephalum* Warnst., Meal Manoch; *S. *fuscum* v. Klinggr., Meal Manoch; *S. *rubellum* Wils., Dalbro; *S. *plumulosum* Roll., Linn of Dye; *S. compactum* var. **imbricatum* Warnst., Koerloak; *S. *squarrosus* var. *subsquarrosus* Russ., Meal Manoch; *S. teres* var. **imbricatum* Warnst., Dalbrake; *S. teres* var. **subteres* Lindb., Blackhall; *S. *amblyphyllum* var. *mesophyllum* Warnst., Linn of Dye; *S. *recurvum* var. *majus* Angstr., Den of Garon; *S. *cuspidatum* var. *falcatum* Russ.; *S. cuspidatum* var. **submersum* Schimp., Dalbrake; *S. *inundatum* var. *eurycladum* Sherrin, Glen of Dye; *S. inundatum* var. **diversifolium* Warnst., Meal Manoch; *S. *auriculatum* Schimp., Powlair; *S. *crassycladum* Warnst., Gellan Bog; *S. crassycladum* var. **magnifolium* Warnst., Glen of Dye; *S. papillosum* var. **normale* Warnst., Dalbro; *S. *subbicolor* Hampe, Linn of Dye.

There was also a specimen of *S. *medium* Limpr., Powlair, Birso, Aberdeenshire, v.c. 92, a new record for that county.—W. R. SHERRIN.

CLASSIFICATION OF PLANTS ON THE BASIS OF PARASITISM (*American Journal of Botany*, xiv. pp. 481–486 (1927).—Mr. P. A. Young states that the rapidly-expanding field of plant parasitology demands a system of classification of parasites, and suggests the following. Plants are classified into the following main groups:—

A, Non-parasitic organisms; B, Commensals; C, Xenoparasites; D, Reciprocal parasites; E, Facultative parasites; F, Facultative saprophytes; G, Facultative autophytes; H, Partial parasites; I, Obligate parasites.

A. NON-PARASITIC ORGANISMS include: (a) Autotrophic plants—green plants which carry on photosynthesis and are not attached to other plants.

(b) Insectivorous plants.

(c) Obligate saprophytes. Most species of the following groups are now believed to be obligate saprophytes:—*Myxogastrales*, *Monoblepharis*, *Hypoxylon*, *Clavaria*, *Thelephora*, *Agaricus*, *Boletus*, the *Lycoperdales*, and some *Bacteria*.

(d) Epiphytes, such as *Tillandsia*, *Platyserium*, etc.

(e) Non-parasitic non-pathogenic internal organisms. *Anabaena* normally forms colonies in special cavities in the leaves of *Azolla*.

B. COMMENSALS. (a) Lichen-algæ.

(b) Saprophytic phanerogams with ectotrophic mycorrhizas, such as *Monotropa* and *Sarcodes*.

C. XENOPARASITES. Green plants which may become artificially parasitic—for instance, MacDougal and Cannon induced *Cissus* and *Agave* to grow and produce roots in *Opuntia*.

D. RECIPROCAL PARASITES. (a) Tubercle-forming bacteria in legume roots, and (b) Certain endotrophic mycorrhizal fungi—*e. g.*, *Phoma* in *Calluna*.

E. FACULTATIVE PARASITES. (a) Artificial parasites. Some natural saprophytes, such as physiological forms of *Alternaria tenuis*, cause cellular diseases of seedlings inoculated in test-tubes.

(b) Wood-rotting facultative parasites: *Nectria cinnabarina*, *Xylaria*, etc.

(c) Facultative wound-parasites. Those attacking living ripe fruits, tubers, and fleshy roots in which the metabolic activity is low. Wound-parasites of field-crops and soil-inhabiting parasites.

(d) Tracheal plant pathogens. *Fusarium niveum* and *Pseudomonas campestris* live in tracheæ which are dead syncytes.

(e) Parasitic lichens.

(f) Ectotrophic mycorrhizal fungi.

(g) Parasites which kill host-cells before entering them.

(h) Callosiparasites. Fungi which induce their hosts to form callosities on the cell-walls: *Macrosporium* etc.

F. FACULTATIVE SAPROPHYTES are parasites which sometimes secure the food from dead organic matter.

(a) Trotoparasites is a new term referring to organisms which turn from parasites into saprophytes: *Venturia inæqualis* etc.

(b) Natural parasites. *Ustilago* produces abundant mycelia and sporidia in culture.

(c) Artificial saprophytes. Natural obligate parasites which are artificial saprophytes to the extent that they can grow artificially on such media as agar, broth, etc.: *Septoria*, *Taphrina*.

G. FACULTATIVE AUTOPHYTES are parasites which sometimes live autotrophically.

Semiparasitic green Phanerogams which have roots in the soil and can live without attachment to their hosts for indefinite periods of time: *Comandra umbellata* etc.

H. PARTIAL PARASITES are green phanerogams which secure part of their food-materials through haustoria in the aerial branches of their host. Autotrophic mistletoes: *Viscum* and *Phoradendron*.

I. OBLIGATE PARASITES are organisms which secure their food only from living matter.

(a) Parasitic phanerogams containing little or no chlorophyll. Vegetative stems or long flower-stalks may be present (*Cuscuta*, *Orobancha*, etc.), or vegetative organs may be reduced to haustoria (*Rafflesia*, *Pilostyles*, etc.).

(b) Mycotropophytes, a new term referring to parasites exhibiting metamorphosis in which important stages in the life-cycles develop without the use of external food. The promycelia of *Puccinia graminis*.

(c) Totoparasites are fungi which produce both perfect and imperfect spore-forms on mycelia attached to the living hosts: *Albugo*, *Plasmopara*.

(d) Parasites which live only in one species of host: *Physoderma*, *Peronospora*, etc.

(e) Heteroecious fungi: *Sclerotinia heteroica*.

(f) Obligate parasites with highly specialised food-relationship. Such are:—Fungi not known on artificial media: *Synchytrium*, *Peronospora*, etc. Those that grow well in the most vigorous hosts: *Bremia*, *Erysiphe*, etc. Physiological forms of some Pucciniaceæ which grow well only in certain varieties of hosts.

(g) Non-pathogenic parasites such as the *Lolium* fungus which does not apparently injure its host.—E. G. B.

REVIEWS.

The Quantitative Method in Biology. By the late JULIUS MACLEOD, Dr. Nat. Sc., Professor of Botany in the University of Ghent. Edit. 2. 8vo, pp. viii, 228. Manchester: University Press. London: Longmans, 1927. Price 15s. net.

THE paramount difficulty which all those concerned with taxonomies have to face is that the unit with which they have chiefly to work is indefinable and there is no criterion by which it can be recognised. For this reason alone any attempt to reduce the study of taxonomy to a more exact science deserves very careful consideration and attention. Such an attempt is made in the book under review.

The author opens by giving his views as to the nature and constitution of a biological species. He believes that every species has a definite and peculiar chemical constitution and that the notion of species must be a chemical notion. On this assumption it follows, as he says, "that the so-called characteristics of each species are the product of reactions, in which there intervene, on the one hand, the external causes which affect the individuals during their development, and, on the other hand, the living substance of the species under consideration." It therefore appears that were our methods more perfect it would be possible to found a rational classification of plants and animals based upon differences of chemical constitution. Unfortunately, it is at present possible to express differences in observable characters only. Is it possible to obtain an exact conception of species from these observable characters—namely, by a numerical expression of their values and relationships? The remainder of Prof. Macleod's book is devoted to the explanation of a suggested method by which this may be done.

A careful study of any extensive series of individuals shows that they can be segregated into groups of various sizes according to their more obvious features. A further examination of the members of any one such group shows that they resemble one another and differ from other groups in varying ways and intensity. Some of the features

distinguishing the members of any one group will be found to be of very much greater fundamental importance in determining the general make-up of the group than others. What and which these characters are can only be discovered by very careful study of the variation within the group concerned.

These fundamental characters Prof. Macleod calls *primordia*, and he maintains that by studying their nature and by making careful measurements of a large number it is possible to obtain mean values which will be peculiar to the group of individuals in question only. In other words, that each species can be expressed by a numerical expression peculiar to itself—at any rate, as regards some of its characters. He considerably elaborates the conception of *primordia*, and recognises several distinct kinds and values. Most of the book is devoted to this and to examples, and only a small concluding part is devoted to the practical application of the method.

The desirability of some such quantitative means of species definition, if it could be made in any way a practical one, would doubtless be admitted by all taxonomists, but it cannot be said that Prof. Macleod's provides a practical procedure. In the first place, it is necessary as a preliminary to examine and measure a very large series of individuals, and this alone limits the application of the method just where it might be of most use. As a general rule, the more specimens available the easier becomes their classification. Secondly, it provides no key as to what may and what may not be considered a species. It certainly permits the segregation of individuals into a number of groups according to the measure of various somewhat arbitrary characters, but this is putting the cart before the horse, and to call such groups species is to increase rather than diminish the purely artificial specific conception. The phenomena of heredity and variation in the organic world are so complex and manifold that it seems scarcely possible that they can ever be classified and disentangled solely by mathematical means.

On the other hand, the book contains very much of value. It is a repository of interesting facts about variation, and the huge amount of accurate and detailed personal observation on which the work is based has thrown considerable light on variation in general, and it is in the accumulation of such records in ever-increasing quantity that the best hope of solving the species problem lies. Finally, the book fulfils the double purpose of showing both the possibilities and the limitations of the quantitative method applied to systematic biology.

R. D'O. GOOD.

Plant Autographs and their Revelations. By Sir JAGADIS CHUNDER BOSE, F.R.S. 8vo, pp. xiv, 231. With portrait of the author, and 120 text-illustrations. Longmans: London, 1927. Price 7s. 6d.

THE author has achieved a wide reputation for his experimental investigation of plant-life and its various manifestations from the starting-point of a physicist. In his writings on different phases of

plant-physiology, Sir Jagadis has met with some adverse criticism from expert plant-physiologists, due in part to his inadequate appreciation of the facts of plant-anatomy, the intimate relation of which to the functions of the plant and its organs must be recognised—see, for instance, Mr. T. G. Hill's recent review of his *Nervous Mechanism of Plants* in this *Journal* (1926, 251).

It is thirty years since, as a student of electrical phenomena, Prof. Bose demonstrated certain remarkable responses of metallic filaments, suggestive of fatigue, sickness, and death, which found a parallel in similar responses of animal muscle and plant tissues. These phenomena were demonstrated by highly sensitive self-recording instruments, in the devising of which Sir Jagadis has throughout his investigations shown great skill and ingenuity.

The present volume is a summary of his researches in plant-physiology written for the general reader with as few technicalities as possible. And while the conclusions based on the investigations may not always meet with the unqualified approval of the botanist, he will at the same time find much of interest in this somewhat popular and easily-written exposition of some of the phenomena of plant-life and its response to various external stimuli. The ingenious devices for demonstrating and recording the results of experiment will also call for admiration.

The author has done useful work in demonstrating the general continuity of life in the plant and animal. It is unnecessary to repeat the criticism of some of the results; one of the most striking of these is the location of the "heart" of the plant in the outer layers of the cortex, in the propulsive action of which the author finds the force necessary to raise the transpiration-current in the stem of a tree. In his insistence on a "vital force," whatever that may be, the author probably comes nearer the explanation of this elusive phenomenon than have some of his predecessors.

The explanation of the behaviour of the praying palm of Faridpore, which, by its timely death, almost providentially gave the opportunity for a control experiment, supplies an excellent popular demonstration of the relation between temperature variation and plant-movement. The solution of the mystery of the Weeping Mango-tree in the Calcutta suburbs afforded a physiological explanation of an apparently supernatural phenomenon.

The text is divided into twenty-seven subject-chapters, and in an Appendix the author expounds the ideal which has governed his work and the foundation of the Institute which bears his name in Calcutta—namely, the advancement of knowledge, for its own sake and the widest possible civic and public diffusion of it.

Magnolias. By J. G. MILLAIS. With illustrations by R. MILLAIS and from photographs. Longmans: London, 1927. Price 32s.

THE author writes as an expert on Magnolias in cultivation, and to the increasing number of garden-lovers who share his interest in this beautiful genus the book will be welcomed as bringing together what is known of the species. The cultural notes embodying the

experience of the writer will be especially helpful. Mr. Millais laments the lack of interest which has hitherto been shown in Magnolias—the gardener who loves shrubs and wishes for abundant flowers at all seasons from February to October, must give first claim to Magnolias even in preference to Rhododendrons and Roses. England in April should be as lovely as Japan in cherry time if gardeners would only put in the common Magnolias that are offered to them.

Mr. Millais has had the help of botanist and collector in the preparation of his book. Mr. George Forrest supplies a chapter (III.) on "Magnolias of Yunnan," and Prof. W. Wright Smith has given generous assistance regarding the new Asiatic species. Mr. J. E. Dandy, whose name is carelessly printed throughout as Dendy, has elaborated a key to the species, forty-five in number (Chapter IV.). Unfortunately, the printer has bungled, and the key is useless; it is not a key. Reference may, however, be made to the *Journal of the Royal Horticultural Society* (lii. pt. 2, 260), where Mr. Dandy has published it in a slightly modified and useable form.

Mr. Millais contributes a preliminary chapter, "Magnoliaceæ," dealing in a general way with the Magnolias and their cultivation. His opening statement that "the Magnolias are amongst the most ancient shrubs and trees in the world, dating back to the earliest arrival of plant-life" is a little startling, and antedates even the estimate assigned to Mr. Hutchinson, who "regards *M. pterocarpa* as a type almost as ancient as the *Ginko (sic)*" On p. 11 we are informed that "the Magnolia is a protogenitus plant, which means that the stigma matures before the stamens." However, we can take no exception to the opening statement of his second chapter: "We must not be ungrateful for Life, though the lot of many is hard"; after which we follow the author through very devious ways for a few pages till we find ourselves in his garden near Horsham, where Magnolias flower from March 1 until Nov. 10.

The greater part of the volume, p. 54 to end, is occupied with an "Alphabetical List of Magnolias" in two chapters, the first a list of species and synonyms, with references under the former to place of publication and to published figures, and the second (pp. 75-251) a descriptive account of the species, varieties, and hybrids, with notes on geographical distribution and cultivation. Mr. Dandy has supplied botanical descriptions for those species which the author was unable to study from living specimens, and Mr. E. H. Wilson also contributes notes on some of his own discoveries. Botanists will be grateful for these chapters, as at present there is no monograph of the family. But here, again, we note the lack of the guiding hand. Two species, *M. taliensis* and *M. tsarongensis*, are treated in full in the alphabetical sequence as species, though the former is admittedly a young condition of *M. Nicholsiana*, and the latter a synonym of *M. globosa*, both of which have previously been fully described. It would seem that the author neglected to consult his botanical helpers in the matter of proof-reading.

The beautiful illustrations add greatly to the value of the book (but for reference purposes they should have been numbered); the

majority are reproductions of photographs showing the habit of the plants or the character of foliage and flower; a few are in collotype. Four reproductions of delicate sketches by R. Millais call for special mention. The plate of *M. stellata*, facing p. 214, is mis-named *M. salicifolia*.—A. B. R.

BOOK-NOTES, NEWS, ETC.

LINNEAN SOCIETY OF LONDON.—At the General Meeting on November 3, the President, Sir Sidney F. Harmer, K.B.E., F.R.S., moved the following Resolution, which was passed in silence, all standing:—

"That the Fellows of the Linnean Society of London in General Meeting assembled desire to express their sorrow on hearing of the death of Dr. B. DAYDON JACKSON, who had been a Member of the Council from 1880-1902, General Secretary from 1902-1926, Vice-President 1926-27, and Curator of the Linnean Collections from 1926. During his long period of office Dr. Jackson had given the most competent and devoted service to the Society and he had lost no opportunity of advancing its interests in every possible way."

Twenty certificates of recommendation for election to Fellowship were read.

Dr. R. W. T. Gunther exhibited a collection of rotographs of unpublished letters of John Ray, the exhibition being supplemented by a volume—lent by the Royal Society—containing some original letters.

The former were written by Ray to the antiquary, John Aubrey, and to the Keeper of the Ashmolean Museum, Edvard Lhwyd, between 1676 and 1703. They therefore cover an important part of Ray's life, and are supplemental to the letters edited for the Ray Society by Dr. Edwin Lankester in 1848, when they do not appear to have been available for study.

It is now proposed to print them *in extenso* as an extra volume in the Ray Society's Series, together with Ray's letters to the Secretaries of the Royal Society, and with those portions of his other letters previously omitted.

Mr. T. A. Sprague gave an account, illustrated by lantern-slides, of Brunfels as a botanist, together with a brief sketch of his life. A study has been made of all the plants illustrated in his Herbal. His interest in plants seems to have been chiefly confined to their medicinal properties, on which his classification was largely based, with the result that some of his "genera" were highly artificial. "*Scrophularia*," for example, included the species now known as *Scrophularia nodosa*, *Sedum Telephium* and *Ranunculus Ficaria*, belonging to three different natural families.

His use of the terms "male" and "female" sometimes indicated differences in flower-colour between two plants which were otherwise more or less similar, the deeper colour in the following order—red, blue, yellow, white—being "male," and the paler colour "female": thus the yellow water-lily was *Nenufar mas*, and the white one *Nenufar foemina*. The term "female" in other cases indicated a spurious kind or an abnormality.

It is frequently difficult to correlate the illustrations with the names given in the text, which often consists almost exclusively of extracts from classical or mediæval authors. A certain amount of additional information, such as particulars of flower-colour, is sometimes given in the German edition, and this is often helpful in determining the species. The Herbal derives its importance from the fact that it contains the first recognisable illustrations of many of the Linnean species, of which indeed they may often be regarded as the historic types.

Mr. S. K. Mukerji gave an account, illustrated with lantern-slides, of his investigations of the Biological Relations of *Mercurialis perennis* L.)

A detailed study has been made of plants from various parts of England, together with experimental cultures and herbarium specimens. A new variety of *M. perennis* was found in Kent.

The geographical distribution of all the species of the genus has been worked out. The known range of *M. perennis* has been considerably extended, and the discontinuity in distribution of the genus is more apparent than real.

Seed output is low in *M. perennis* compared with many other woodland species, and only about 10 per cent. of the seeds formed in England are germinable. The root-system shows branched and unbranched roots, both infected with fungi, particularly the former. Depth of penetration depends on the soil-type, water-content, soil-reaction, and other edaphic factors. Shallow rooting is associated with very high water-content, and the lower the acidity the deeper the penetration.

An intergradation of sex has been observed, and the sporadic occurrence of male or hermaphrodite flowers on female plants has been recorded. Pollination is partly entomophilous but mainly anemophilous. The fruit explosively ejects the seeds to a distance of about 4 metres.

M. perennis occurs in soils with water-content ranging from 10 to 80 per cent., the optimum growth being attained between 40 and 55 per cent. High water-content ameliorates the effect of acidity.

M. perennis shows no correlation between dry weight and the total carbonate-content of the soil, and it is apparently not a true calcicole but an oxyphobe. It shows decided preference for soils with a high organic content. The nitrate-content of the soil does not markedly influence growth, but low nitrate-content retards or may even suppress flowering. Light-intensity distinctly affects the distribution and growth of individuals of the different sexes separately, and it is suggested that light-intensity may determine the sex of a plant under certain conditions.

At the General Meeting on November 17, Mr. N. E. Brown gave a short account of the botanical work of Carl Pehr Thunberg (1743-1828), a pupil of Linnæus, who collected at the Cape, in Java, and in Japan. Mr. Brown communicated the results of his study of the South African species of Iridaceæ in Thunberg's Herbarium, now at Upsala; he found that examination of the types of Thunberg, Linnæus, and other earlier workers, and their comparison with later

collections necessitated some revision of more recent work on the South African Flora.

Mr. A. W. Exell showed some presumed hybrids of *Cotoneaster frigida* Wall. which had arisen in Messrs. Waterer's nurseries at Bagshot. Suggestions were made as to their parentage, and specimens of the presumed parents were shown.

In the discussion which followed, the question was raised as to the possible effects of cultivation in inducing variation, which might perhaps simulate the result of hybridizing.

By the death, at the age of 70, of Dr. Wilhem Ludvig Johannsen, Professor of Plant Physiology in the University and Director of the Plant Physiological Laboratory in Copenhagen, the Linnean Society loses one of its Foreign Members. Professor Johannsen was elected in May 1926. He was well known for his work on problems of heredity, and especially for his demonstration of pure lines in flowering plants.

BOTANY OF THE MALAY PENINSULA.—The *Gardeners' Bulletin, Straits Settlements* for August contains a list of the botanical collectors who have worked in the Peninsula, with their collecting-places, drawn up by Mr. I. H. Burkill, formerly Director of the Singapore Botanic Gardens. Mr. Burkill also gives an exhaustive review of the work that has, so far, been done on the plant-geography of the Peninsula.

UNIVERSITY OF CALIFORNIA PUBLICATIONS IN BOTANY.—Recently-issued parts include a continuation of Mr. N. L. Gardner's descriptions of "New Rhodophyceæ from the Pacific Coast of North America," Parts iv. & v. (vol. xiii. Nos. 18 & 19), mainly new species of *Antithamnion* and *Callithamnion*; and, by the same author, an account of a collection of Myxophyceæ made by Prof. H. H. Chung in the province of Fukien, China (vol. xiv. No. 1)—nineteen genera and fifty-six species and varieties are recorded, of which thirteen species and five varieties are new to science. Mabel L. Ruttle and W. P. Fraser contribute a remarkably well-illustrated account of their work on Crown-rust of Oats—*A Cytological Study of Puccinia coronata on Banner and Cowra 35 Oats* (vol. xiv. No. 2).

DECAPITALIZATION OF SPECIFIC NAMES.—The *Botanical Gazette* announces that, commencing with the September issue, it "will abandon the use of capitals for all specific names, thus meeting the wishes of an increasing number of contributors, and following the practice of *Biological Abstracts* and most biological journals."

One advantage of a Code of Rules is that by observing them the individual worker or writer is often relieved of the onus of deciding on one or other of alternative courses, and of the necessity of meeting the, often varied, wishes of contributors and others. Following the general practice of botanical journals, the *Journal of Botany* will continue to observe Recommendation X. of the Vienna-Brussels Code—specific names begin with a small letter except those which are taken from names of persons or from generic names.

INDEX.

For Classified Articles, see—Obituaries; Reviews. New genera, species, and varieties, and new names are distinguished by an asterisk.

For Supplements see end of Index.

- Abstracts of Papers of Interest to Students of the British Flora, 153, 178, 228, 257, 288.
- Acanthaceæ, Two New Species of, 13.
- Airosperma fusca *, 266.
- Algæ from Sumatra, 198.
- Alibertia or Cordiera, 16.
- Allen, G. O., see Groves, J., and Allen, G. O.
- Altai Mts., Siberia, Freshwater Algæ from, 249.
- Amateur Botanists, Society of, 22.
- America, Early Collections from N. and Central, 63.
- America, Trees of Western, 95.
- Amphiprora medulica var. sinensis *, 106.
- Amphora angusta var. sinensis *, 106.
- Anagallis Scarlet- and blue-flowered, 125.
- Angola, Species of Polygala from, 339.
- Annona incana, 67; pigmea, 65.
- Anomobryum Maclennani, 7; robustum, 7.
- Archives de Botanique, noticed, 96.
- Archivos de Botanica S. Paulo, noticed, 58.
- Arctic Regions, Lichens from, 171.
- Ardagh, J., Bibliography of R. W. Phillips, 82.
- Ardisia, Two Papuan Species of, 248.
- Argostemma, The Genus, 25, 33.
- Argostemma annamaticum *, 40; bifolium *, 27; borragineum var. breviflorum *, 33, var. padangense * 32, var. heterophyllum *, 33; densifolium *, 39, var. latifolia *, 40; enerve *, 28; hirtellum *, 40; Hullettjii *, 35; invalidum *, 38; lanceolarium *, 36; longistipula *, 39; monophyllum *, 27; Motleyi *, 39; Moultonii *, 36, var. hirta *, 36; multinervium *, 33; nutans var. borneense *, 33; parvulum *, 36; psychotroides *, 38; riparium *, 34; rupestre *, 41; squalens * 37; stellare *, 31; succulentum *, 28; velutinum *, 35.
- Argostemella *, 41.
- Ashanti Plants, 14.
- Ashby, E., Grampian Mts. of Victoria and their Flora, 53.
- Asia, Melampyrum Species of Eastern, 138.
- Asimina in North America, W. Bartram and, 65.
- Asimina incana *, 69; secundiflora, nom. nov., 69.
- Aspilia Kitsonii *, 14.
- Asturias, Flora of, 70.
- Ayrshire Notes, 319.
- Babcock, E. B., and Lesley, M. M., Chromosome Number and Individuality in Crepis (abstr.), 84.
- Baker, E. G.: Matilda Smith (obit.), 57; Babcock and Lesley's "Chromosome Number and Individuality in Crepis" (abstr.), 84; Cordyla africana shown, 127; Papers of Interest to Students of the British Flora, 78, 153, 178, 229, 257, 288; Rev. J. Roffey (obit.), 229; Classification of Plants on the Basis of Parasitism, (abstr.) 352.
- Barbula albicuspis, 6.
- Barnes, B. F., Unusual Leaf-forms in Helianthus annuus, 222.
- Bartram, W., and the Genus Asimina, 65.
- Bartsia viscosa in Kent, 319.
- Bear Island Lichens, 12.
- Beck von Mannagetta, G., Determinations of Orobanchæ, 117.
- Bedell, B. J., Floral Mechanism of Cataseta macrocarpum, 304.

- Bembix Lour., 279.
 Bennett, A.: Notes on the Carex of the 'London Catalogue,' 74; Notes on Potamogeton, 113; Carex dioica L. forma isogyna, 351.
 Biological Measurements British Assoc. Committee, 327.
 Black, J. M., Olearia v. Shawia, 17.
 Bohemia, Phenological Observations in (abstr.), 263.
 Botanical Congress, Fifth International, 92, 128, 264.
 'Botanical Magazine,' noticed, 261.
 Botanists' Christmas, The, 24.
 Bower, F. O., Presentation of Portrait to, 208.
 Boyd, D. A., Ayrshire Notes, 319.
 Brass, L. J., New Rubiaceae collected in British New Guinea, 241, 265.
 British Arctic Expedition (1925), 171; Plants, 272.
 British Association at Leeds, 282.
 British Association Committee on Biological Measurements, 327.
 British Bryological Society, Annual Meeting, 326.
 British Museum (Nat. Hist.): 'Natural History Magazine,' noticed, 95; Notes from Herbarium, 13; Payne Collection of Diatoms, 208; Postcards of Orchids, 239.
 British Mycological Society, Trans., 95.
 British New Guinea, Rubiaceae from, 241.
 British Pansies, Notes on, 42, 167, 213.
 British Plants, Some Interesting, exhibited, 23, 94.
 British Sphagna, Handbook of, announced, 263.
 Brown, N. E., Two New Mesembryanthemae, 348.
 Brunfels, 358.
 Callithamnion purpuriferum (text-figs.), 161; scopulorum (text-figs.), 129.
 Carex dioica forma isogyna, 351.
 Carex of the 'London Catalogue,' Notes on, 74.
 Cataseta macrocarpum, Floral Mechanism of, 304.
 Caucasus, Charesia from Central, 152.
 Cerefolium, 15, 16.
 Charesia from Central Caucasus, 152.
 Charophyta from Madagascar, 183; Indian, 335.
 Charophyta Indica (Allen), noticed, 327.
 Chipp, T. F., awarded D.Sc., 263.
 Christmas, The Botanists', 24.
 Chromosome Number and Individuality in Crepis (abstr.), 84.
 Classification of Plants on the Basis of Parasitism, 352.
 Coldstream, W. A., Growth-measurements of Eucalyptus tereticornis (abstr.), 183.
 Cordyla africana, shown, 127.
 Cotoneaster frigida hybrids shown, 360.
 Counterfeit Collection of Mexican Plants, 118.
 'Country-Side,' noticed, 239.
 Crepis, Chromosome Number and Individuality in (abstr.), 84.
 Cumberland Sphagna (abstr.), 179.
 Cyanophyceae from N. Manchuria, 195.
 Cycas inermis Lour., 281.
 Dactylorhizengruppe der Ophrydineen (abstr.), 288.
 Dalgleish, J. Gordon, A Variety of Spirodela polyrrhiza, 319.
 Dandy, J. E.: appointed to Dept. of Botany, 208; Michelia kisopa and M. doltsopa, 277.
 Darwin, C., his house to be preserved, 296.
 Davies, Hugh, 128.
 Davis, J. R. Ainsworth, placed on Civil Pension List, 240.
 Decapitalization of Specific Names, 360.
 Diatoms from Tientsin, 102.
 Dielidocarya Menzliei *, 3.
 Dieliptera Whitmeei *, 14.
 Dixon, H. N.: Miscellanea Bryologica X., 5; Gilbert Island Mosses, 254; Mosses of British Arctic Expedition, 272.
 Dolicholobium rufflorum *, 242.
 Double Stock, Origin of, 21.
 Drabble, E., Notes on the British Pansies, 42, 167, 213.
 Drabble, E. and H., Syrphid Visitors to Certain Flowers, 149.
 Drejerella, 221.
 Druce, G. C.: Interesting British Plants, shown, 94; elected F.R.S., 184.

- Drying Shrubby Specimens, 84.
 Duke, Miss M. M., Algae of British Arctic Expedition, 272.
 Dyes, Lichen, 159.
 Economic Botanist at Kew, 160.
 "Edible and Poisonous Fungi" noticed, 296.
 Ehrhart, F., portrait of, 263.
 Eighth International Horticultural Congress (1927), 318.
 Eucalyptus tereticornis, Growth-measurements of, 183.
 Eurhynchium asperipes *, 9; remotifolium *, 7.
 Exell, A. W.: Notes from British Museum Herbarium, 14; Citation of Species described by Wawra and Peyritsch, 18; W. Bartram and the Genus Asimina in N. America, 65; Soó's "Melampyrum Species" (transl.), 145; Charesia from Central Caucasus (transl.), 152; Enumeration of the Species of Polygala in Angola, 339; Cotoneaster frigida hybrids shown, 360.
 Faucaria albidens *, 349.
 Fertilisation of Ophrys fusca, 350.
 Fife and Kinross Roses (abstr.), 155.
 Fifth International Botanical Congress, 92, 128, 264.
 Floras, Statistical Comparison of, 230.
 Fritsch, F. E.: help acknowledged, 109; Lindau and Melchior's 'Kryptogamenflora,' iv. (rev.), 123; Heath-Association on Hindhead Common (abstr.), 160; L. Radlkofer (obit.), 176; Printz's 'Chlorophyceae' (rev.), 325.
 Galpin, Rev. Canon F., 126.
 Gardenia dryadum *, 246.
 Gates, R. R., Tundra Vegetation of Russian Lapland (abstr.), 93.
 Gepp, A.: Bower's 'The Ferns,' vol. ii. (rev.), 181; retires from British Museum, 184; Mönkemeyer's 'Die Laubmoose Europas,' iv. pt. 1 (rev.), 293.
 Gilbert Island Mosses, 254.
 Godfrey, M. J., the Fertilisation of Ophrys fusca Link, 350.
 Good, R. D'O.: Watson's 'Elementary Botany' (rev.), 91; Hayek's 'Allgemeine Pflanzengeographie' (rev.), 207; Statistical Comparison of Floras, 230; Notes on the Shrubby Species of Hypericum of Tropical Africa, Madagascar, and the Mascarenes, 329; Macleod's Quantitative Method in Biology (rev.), 354.
 Grampian Mts., Victoria, Flora of, 53.
 Griffith, J. E., Herbarium etc. of, 127.
 Griffiths, B. M., West and Fritsch's 'British Freshwater Algae' (rev.), 204.
 Gunther, R. T., Unpublished letters of Ray shown, 358.
 Groves, J., Charophyta from Madagascar, 183.
 Groves, J., and Allen, G. O., On some Indian Charophyta, 335.
 Hanbury, F. J., Bartsia viscosa in Kent, 319.
 Harner, Sir S. F., elected Pres. Linn. Soc., 184.
 Harvey's 'Thesaurus Capensis,' Mosses of, 7.
 Haworth, Miss F., Lichen Dyes (abstr.), 159.
 Helianthus annuus, Unusual leaf forms of, 222.
 Hemiandra, Notes on, 174.
 Hemiandra coccinea *, 175; Gardneri *, 175; rubriflora *, 175; rutilans *, 175.
 Herbarium Method, An Improved, 159.
 "Herrera," fictitious collector, 120.
 Hill, A. W., Trees of Western America (abstr.), 95.
 Hill, T. G., Russell's 'Plant Nutrition and Crop Production' (rev.), 60; Waksman and Davison's 'Enzymes' (rev.), 156.
 Hindhead Common, Heath-Association on (abstr.), 160.
 Hornworts in Britain (abstr.), 228.
 Horticultural Congress, Eighth International, 318.
 Horwood, A. R., Phanerogams of British Arctic Expedition, 272.
 Hudson, W., in Wales, 128.
 Hungarian Species and Hybrids of Verbascum (abstr.), 179.
 Hutchinson, J., Reply to Review of his 'Flora of West Tropical Africa,' 328.

INDEX

- Hydnophytum amplifolium *, 270; Brassii *, 271; camporum *, 271.
 Hyophila beruensis *, 255.
 Hypericum, Shrubby Species of, from Tropical Africa etc., 329.
 Hypericum socotranum *, 334.
 Hypnum microcladum, 6.
- Ice-ribbons on *Cunila origanoides*, photos shown, 127.
 Imitaria, New Genus, 348; *I. Muirii* *, 348.
 Indian Charophyta, 335.
 Individuality and Chromosome Number in *Crepis* (abstr.), 84.
 International Congress of Plant Sciences at Ithaca, 22.
 'Irish Naturalists' Journal,' noticed, 179.
Ixora Brassii *, 267; *ihuensis* *, 267.
- Jackson, B. D. (the late), J. N. Fitch (obit.), 118.
 Jamaica Plants, Notes on, 219.
 'Journal of Indian Botanical Society,' noticed, 64.
- Kent, *Bartsia viscosa* in, 319.
 Kew, Economic Botanist appointed, 160.
 Kinross Roses (abstr.), 155.
 Kitson, A. E., Ashanti Plants, 14.
 Kleistobolus, A Genus of Mycetozoa revived, 202.
- Lacaita, C. C.: *Salvia controversa*, 320; Lizard Orchis, 320.
 Lawson, A. A., recommended for Royal Society, 96.
Leptodontium squarrosum, 5.
Leskea remotifolia Hook., 9.
 Lesley, M. M., see Babcock, E. B., and Lesley, M. M.
 Lester-Garland, L. V., Flora of Simla, 97.
 Lichen Dyes (abstr.), 159.
 Lichenological Notes, II., 109.
 Lichens from Arctic Regions, 171.
 Lichens from Spitsbergen and Bear Island, 12.
- Linnean Society: Anniversary Meeting, 184; Annual Dinner, 326; Death of "Father" of, 240; General Meetings, 21, 22, 63, 93, 94, 125, 127, 159, 182, 183, 358; award of Gold Medal, 184; Library, 24, 184 (Carnegie Trust).
 Lister, Miss G., *Kleistobolus*, A Genus of Mycetozoa revived, 202.
 Lizard Orchis, 320.
 'London Catalogue,' Ed. 11, *Carex* of, 74.
 Loureiro's 'Flora Cochinchinensis,' Notes on Two Species of, 279.
 Lyngbe, Bernt, 12, 13.
- Madagascar, Charophyta, 183; *Hypericum* from, 329.
 Malay Peninsula, Botany of, 360.
 Malayan Orchids in Reichenbach's Herbarium, 263.
 Marr, J. W. S.: Arctic Lichens collected by, 171; Plants collected during British Arctic Expedition (1925), 272.
 Marsden-Jones, E. M., and Turrill, W. B., Improved Herbarium Method (abstr.), 159.
 Mascarenes, *Hypericum* from, 329.
Mastogloia Grevillei var. *sinica* *, 104; *pumila* var. *sinensis* *, 104.
 Matthews, J. R., Distribution of Certain Members of the British Flora (abstr.), 78.
Melampyrum species of East Asia, 138.
Melampyrum aristatum *, 143; *Henryanum* *, 143; *japonicum* *, 144; *Klebsbergianum* *, 144.
Mercurialis perennis var. *Salisburyana* *, 56.
 Merton College Expedition (1923), 12.
 Mesembryanthemae, Two New, 348.
 Mexican Plants, Counterfeit Collection of, 118.
Michelia doltsopa and *M. kisopa*, 277.
Miscellanea Bryologica, X., 5.
 Moore, S. Le M.: Notes from the British Museum Herbarium, 13; Notes on Jamaica Plants, 219; New Rubiaceae collected by L. J. Brass in British New Guinea, 241, 265; *Bombix*, 279.
 Moss, C. E., Potamogetons of South Africa (abstr.), 95.
 Mosses from Gilbert Island, 254.

INDEX

- Mosses of Harvey's 'Thesaurus Capensis,' 7.
 Mukerji, S. K., New Variety of *Mercurialis perennis*, 56.
Mussaenda ornata *, 243; *pluviatilis* *, 244.
 'Mycologists Resident in British Empire,' noticed, 240.
 'Natural History Magazine,' noticed, 95.
 Natural Orchid Hybrids (abstr.), 257.
 'Naturalist,' noticed, 228.
Navicula tientsinensis *, 105.
Neonauclaea Brassii *, 241.
 Nicholson, W. E., Macvicar and Jameson's 'Students' Handbook of British Hepatics' (rev.), 87.
Nitella flagellifera *, 337; *patula* *, 338.
Nitzschia rigida var. *sinensis* *, 107; *sigma* var. *serpentina* *, 107.
 Norman, C., *Pimpinellas* of Tropical Africa (abstr.), 64.
 Notes on Papers of Interest to Students of British Flora, 78.
- OBITUARIES:—
 Dillwyn-Llewelyn, Sir J. T., Bart., 240.
 Fink, Bruce, 296.
 Fitch, J. N., 118.
 Ford, C., 240.
 Jackson, B. D., 314.
 Johannsen, W. L., 360.
 Johnston, Sir H., 258.
 Lawson, A. A., 203.
 Lister, J. J., 83.
 Marriott, St. John, 317.
 Payne, F. W., 177.
 Phillips, R. W., 58, 80.
 Radlkofer, L., 159, 176.
 Roffey, Rev. J., 229.
 Sargent, C. S., 151.
 Smith, Matilda, 57.
 Taylor, Rev. W. E., 317.
- Cedogonium Aster* var. *gracile* *, 253 (text-fig.), 254.
Oenothera biennis, *O. grandiflora*, and *O. Lamarckiana* in England (abstr.), 153.
Oldenlandia Aparine *, 243.
Olearia v. Shawia, 17.
 'Onobrychis Generis Revisio Critica' (abstr.), 179.
- Ophrys fusca* Link, Fertilization of 350.
 Orchid Hybrids, Natural, 257.
 Orchis, Lizard, 288.
 Orkney, Additions to Flora of (abstr.), 79.
 Orobanche, Notes on, 117. *See*, Oxford University Arctic Expedition (1924), 12; Spitsbergen Expedition (1921), 12.
- Pansies, Notes on British, 42, 167, 213.
 Parasitism, Classification of Plants on basis of, 352.
 Paulson, R.: Lichens from Spitsbergen and Bear Island, 12; Recent Lichens from Arctic Regions, 171.
 Payne, F. W., Diatom Collection purchased by Brit. Mus. (N.H.), 208.
 Percival, J., Species and Races of Wheat (abstr.), 182.
 Peyritsch, see Wawra and Peyritsch.
Pleurosigma Spenceri var. *sinensis* *, 105; var. *tientsinensis* *, 105.
 Pocock, Miss M. A., Western Africa (abstr.), 183.
Polygala, Angola species of, 339.
Polygala Baikiei, 14; *laxifolia* *, 345; *Pearsonii* *, 343.
 Potamogeton, Notes on, 113.
Potamogeton subfuscus *, 114.
 Potamogetons of South Africa (abstr.), 95.
 Powell, Miss D., Matthews, Distribution of Certain Members of the British Flora (abstr.), 78.
 Praeger, R. Lloyd, What is *Semprevivum tortuosum*?, 209.
 Primula Hybrids, 351.
 Pritzel's 'Iconum,' Announcement of New Edition, 294.
Psychotria Brassii *, 268; *montensis* *, 268; *reticulatissima* *, 269; *Wernhamiana* *, 269.
 Pugsley, H. W.: Nomenclature of the Group *Salvia Verbenaca*, 185; Primula Hybrids, 351.
- Quercus sessiliflora* in Sutton Park (abstr.), 178.
- Ramsbottom, J.: Thom and Church's 'The Aspergilli' (rev.), 20; Kallenbach's 'Die Pilze Mitteleuropas,'

INDEX

- Bd. i. (rev.), 124, 325; Waksman's 'Principles of Soil Microbiology' (rev.), 291.
- Randia suavisima* *, 245.
- Ray, J., Unpublished Letters of, 358.
- Reichenbach's Herbarium, Malayan Orchids in, 263.
- Reid, Mrs. E. M., New *Diclidocarya* from the Senftenberg Brown Coal, 1.
- Rendle, A. B.: Early Collections from North and Central America (abstr.), 63; R. W. Phillips (obit.), 80; C. S. Sargent (obit.), 151; F. W. Payne (obit.), 177; retires from Presidency of Linn. Soc., 184; South-Eastern Union of Sci. Soc. Thirty-second Annual Congress, 199; A. A. Lawson (obit.), 203; Gates's 'Botanist in the Amazon Valley' (rev.), 206; Reid and Chandler's 'Catalogue of Cainozoic Plants in Brit. Mus. (N.H.)' (rev.) 231; Phillips's 'Genera of South African Flowering Plants' (rev.), 232; Rehder's 'Manual of Cultivated Trees and Shrubs' (rev.), 234; Sir H. Johnston (obit.), 258; Davidson's 'Conifers, Junipers, and Yew' (rev.), 260; 'Botanical Magazine,' 261; British Association at Leeds, 282; Hutchinson and Dalziel's 'Flora of West Tropical Africa' (rev.), 289; B. D. Jackson (obit.), 314; St. John Marriott (obit.), 317; Millais's *Magnolias* (rev.), 356.
- REVIEWS:—
- André, H., Ueber Künstliche Blatt- und Blütenmetamorphosen bei der Schneebeere, 158.
- Black, J. M., Flora of South Australia, Pt. iii., 90.
- Bose, Sir J. G., Plant Autographs, 355.
- Bower, F. O., The Ferns, vol. ii., 181.
- Brindley, Mrs. H., see Haviland, M. D.
- Brooks, F. T., see Scott, D. H., and Brooks, F. T.
- Brühl, P., Orchids of Sikkim, 157.
- Campbell, D. H., Outline of Plant Geography, 121.
- Ochandler, M. J., see Reid, E. M., and Chandler, M. J.
- Church, M. B., see Thom, C., and Church, M. B.

REVIEWS (cont.):—

- Clausen, J., Genetical and Cytological Investigations on *Viola tricolor* and *V. arvensis*, 59.
- Craib, W. G., *Flora Siamensis Enumeratio*, 89.
- Dalziel, J. M., see Hutchinson, G., and Dalziel, J. M.
- Davidson, J., Conifers, Junipers, and Yew, 260.
- Davison, W. C., see Waksman, S. A., and Davison, W. C.
- Druce, G. C., Flora of Buckinghamshire, 321.
- Enriquez, C. M., Kinabalu, 235.
- Fritsch, F. E., and West, G. S., see West, G. S., and Fritsch, F. E.
- Gates, R. R., A Botanist in the Amazon Valley, 206.
- Hamer, H. H., Wild Flowers of the Cape, 237.
- Haviland, M. D., Forest, Steppe, and Tundra, 122.
- Hutchinson, J., and Dalziel, J. M., Flora of West Tropical Africa, vol. i. pt. 1, 289, 328 (reply).
- Jackson, A. B., Trees and Shrubs of Westobirt, 180.
- Jameson, Rev. H. G., see Macvicar S., and Jameson, H. G.
- Kallenbach, F., Die Pilze Mitteleuropas, Bd. i., 124, 325.
- Lindau, G., and Melchior, H., Kryptogamenflora für Anfänger, iv., 123.
- Lynge, B., Vascular Plants from Novaya Zemlya, 84.
- Macleod, J., Quantitative Method in Biology, 354.
- Macvicar, S., and Jameson, H. G., Students' Handbook of British Hepatics, 87.
- Martin, I. H., Field-Club Flora of the Lothians, 293.
- Melchior, H., see Lindau, G., and Melchior, H.
- Merrill, E. D., Enumeration of Philippine Flowering Plants, vol. iv., 89.
- Millais, J. G., *Magnolias*, 356.
- Monkemeyer, W., Die Laubmoose Europas, iv. Lief. 1, 293.
- Morse, R., British Wild Fruits, 157.

INDEX

REVIEWS (cont.):—

- Phillips, E. P., Genera of S. African Flowering Plants, 232.
- Pia, J., Pflanzen als Gesteinsbildner, 90.
- Printz, H., Chlorophyceae (Engler-, Die Nat. Pflanzenfam.), 323.
- Rayner, J. F., Standard Catalogue of English Names of Wild Flowers, 158.
- Rehder, A., Manual of Cultivated Trees and Shrubs, 234.
- Reid, E. M., and Chandler, E. J., Catalogue of Cainozoic Plants in British Museum (Nat. Hist.), 231.
- Robbins, W. F., Principles of Plant Growth, 236.
- Russell, E. J., Plant Nutrition and Crop Production, 60.
- Scott, D. H., and Brooks, F. T., Introduction to Structural Botany, 325.
- Shelford, V. E., Naturalists' Guide to the Americas, 61.
- Tansley, A. G., Aims and Methods in the Study of Vegetation, 18.
- Thom, C., and Church, M. B., The Aspergilli, 20.
- Waksman, S. A., Principles of Soil Microbiology, 291.
- Waksman, S. A., and Davison, W. C., Enzymes, 156.
- Walker, J. J., The Natural History of the Oxford District, 60.
- Watson, W., Elementary Botany, 91, 124 (reply).
- West, G. S., and Fritsch, F. E., The British Freshwater Algae, 204.
- Ridley, H. N.: The Genus *Argostemma*, 25; *Sonerila ciliata* (alata), correction, 184; Rev. W. E. Taylor (obit.), 317.
- Romieux, H., see Zahn and Romieux.
- Ruellia, 220; Lowei *, 13.
- Salmon, C. E.: Some Interesting British Plants (abst.), 23; Abstracts of Papers of Interest to Students of British Flora, 78, 179, 228; Notes on *Orobancha*, 117.
- Salpicantha, 220.
- Salvia controversa, 320.
- Salvia Verbenaca Group, Nomenclature of, 185.

- Sargent, O. H., Notes on the Genus *Hemiandra*, 174.
- Scotland, New Records for *Sphagna* from, 352.
- Sempervivum domesticum* *, 212; *tormentosum*, 209.
- Shawia, 17.
- Sherrin, W. R., New Records for *Sphagna* in Scotland, 352.
- Shrubby Species of *Hypericum* from Tropical Africa etc., 329.
- Simla, Flora of, 97.
- Skvortzow, B. W.: Diatoms from Tientsin, 102; Cyanophyceae from North Manchuria, 195; Algae from Sorei Lake, Sumatra, 198; Freshwater Algae and Phytoplankton of Altai Mts., 249.
- Smith, Miss A. L., Bruce Fink (obit.), 296.
- Society of Amateur Botanists, mentioned, 22.
- Sonerila ciliata* (alata), correction, 184.
- Soó, R. v., *Melampyrum* Species of E. Asia, 138.
- South Africa, Potamogetons of (abstr.), 95.
- South-Eastern Union of Sci. Soc. Thirty-second Annual Congress, 160, 199.
- Spain, Collecting in, from a Motor-car, 297.
- Spartina Townsendii* (abstr.), 289.
- Special Libraries Association, 58, 264.
- Spence, Magnus, Herbarium of, 78.
- Sphagna* in Scotland, New Records, 352.
- Spiranthes Romanzoffiana*, Irish, 145.
- Spirodela polyrrhiza* var., 319.
- Spirogyra sibirica* * (text-fig.), 250, 251.
- Spitsbergen Lichens, 12.
- Sprague, T. A.: *Cerefolium*, 15; *Alibertia* or *Cordia*, 16; Photos of Ice-ribbons shown, 127; *Tunica*, 225; *Brunfels* as a Botanist (abstr.), 358.
- Sprague, T. A., and Summerhayes, V. S., *Fusanus* (abstr.), 183.
- Standley, P. C., see Counterfeit Mexican Plants.
- Stapf, O., Linnean Gold Medal awarded to, 184.
- Statistical Comparison of Floras, 230.

INDEX

- Stephenson, Rev. T., Flora of Asturias, 70.
 Stock, Origin of Double, 21.
 Sumatra Algae, 198.
 Summerhayes, V. S., see Sprague, T. A., and Summerhayes, V. S.
 Sureirella tientsinensis *, 107.
 Surrey, Lizard Orchis in (abstr.), 288.
 Syrphid Visitors to Certain Flowers, 149.
- Tandy, G.: André's 'Ueber Künstliche Blatt- und Blütenmetamorphosen bei der Schneebeere' (rev.), 158; *Cycas inermis* Lour., 281.
 Tansley, A. G., appointed Sherardian Professor in Botany, Oxford, 96.
 'Thesaurus Capensis,' Mosses of, 7.
 Thiemea, The Genus, 5.
 Tientsin, Diatoms from, 102.
 Timonius Brassii *, 265; *sylvestris* *, 247; *Whiteanus* *, 246.
 "Touchstone," The Botanists' Christmas, 24.
 Tropical Africa, Hypericum from, 329.
Tropidoneis maxima var. *sinensis* *, 106.
Tryblionella debilis var. *sinensis* *, 107.
 Tundra Vegetation of Russian Lapland (abstr.), 93.
 Tunica, 225.
 Turrill, W. B., see Marsden-Jones, E. M., and Turrill, W. B., 159.
 University College Botany Dept., 238.
- University of California, Botany Publications, 360.
- Vachell, Miss E., 145; scarlet- and blue-flowered *Anagallis* (abstr.), 125.
 Verbascum, Hungarian Species and Hybrids of, 179.
Viola orcadensis *, 44; *tricolor*, 42.
- Watson, W.: Lichenological Notes, II., 109; reply to review of his 'Elementary Botany,' 124.
 Wawra and Peyritsch, Citation of species described by, 18.
 Westbrook, M. A.: *Callithamnion scopulorum* (text-figs.), 129; *Callithamnion purpuriferum* (text-figs.), 161.
 Western America, Trees of (abstr.), 95.
 Wheat, Species and Races of (abstr.), 182.
 White, C. T., Two Papuan Species of *Ardisia*, 248.
 Wilmott, A. J.: Clausen's 'Genetical and Cytological Investigations on Viola' (rev.), 59; Expedition to Sierra Nevada, Spain, 64; Lynges's 'Vascular Plants of Novaya Zemlya' (rev.), 84; The Irish "Spiranthes Romanzoffiana," 145; Collecting in Spain from a Motor-car, 297.
 Wolley-Dod, A. H., Drying Shrubby Specimens, 84.
 Wright, C. H., 240.
- Zahn and Romieux's 'Hieracium nouveaux de Suisse et de France' (abstr.), 79.

SUPPLEMENT.

- Mr. John Gossweiler's Portuguese West African Plants.
 Dicotyledones, Part I.—Polypetalæ, A. W. Exell, 25-80.
- Dicotyledones, Part II.—Gamo-petalæ, R. D'O. Good, 41-43, 68, 69; Compositæ, S. Moore, 43-68; Sapotacæ, S. Greves, 70.

1500 66
 2

Printed by TAYLOR and FRANCIS, Red Lion Court, Fleet Street.

MR. JOHN GOSSWEILER'S PLANTS FROM ANGOLA AND PORTUGUESE CONGO.

DICOTYLEDONES.

Part II.—GAMOPETALÆ.

By R. D'O. GOOD, M.A., F.L.S.

RUBIACEÆ.

SARCOCEPHALUS ESCULENTUS Afzel. ANGOLA: Vale do Zondo, Cazengo, 8918. P. CONGO: Buco Zau, 7143 *a*, *b* and *c*, 8099; Subluali, Mayumbe, 8042; between Tema and Janguila, Bembe, 7411; Hombe, Mayumbe, 7909; Sumba, Peco, 8962; Nkanda, Mbaku, Mayumbe, 9004 *a* and *b*. Native name "N'Gulo." Valuable for its fruit and good yellow timber, which becomes orange with age.

No. 8214 has leaves more than 30 cm. long and fruits 20 cm. in diameter. The collector suggests this is a distinct species, but the material is insufficient to show this.—Western Tropical Africa.

ADINA MICROCEPHALA Hiern. ANGOLA: Granja de S. Luiz, N'Dalalondo, Cazengo, fl. Oct., 5991.—Angola, Nyasaland, S. Rhodesia, Transvaal, Nile Land and Madagascar.

MITRAGYNA MACROPHYLLA Hiern. P. CONGO: N'Zanza, Potigan forest, Mayumbe, 7769; Sumba, Peco, 8653, 8679.—Western Tropical Africa, Congo, Uganda, Niam Niam Land.

UNCARIA AFRICANA G. Don. ANGOLA: Castende, Cuzana, fl. Oct., 8447. P. CONGO: skirting the gallery woods at Quibanga, near Forte Nije, 7338; Congo Yala, s. n.—Western Tropical Africa, Congo, Uganda.

HYMENODICTYON KURRIA Hochst. ANGOLA: at 1750 m. on Serra Ferreira de Amaral, 2858; fruit only, without locality, 8876; occurs also at Caconda.—Widespread in Tropical Africa.

CORYNANTHE PANICULATA Welw. P. CONGO: Sera, Subluali, Mayumbe, 8030; Muanda stream, Congo, 8541, fl. and fr. March, 8627; Sumba, Peco, fl. Feb., 8797; Nkanda, Mbaku, Mayumbe, 9012. Native name "Saia." Very durable timber.—Angola.

Pausinystalia mayumbensis R. Good, sp. nov. *Arbor* gracilis ramosa, ramis teretibus glabris; *foliis* longe petiolatis ovalibus ellipticis vel oblanceolatis basi cuneatis apice longe obtuseque acuminatis, subcoriaceis utrinque glabris, in sicco brunneis supra nitidis; *floribus*