

A COMPREHENSIVE TREATISE ON
INORGANIC AND THEORETICAL CHEMISTRY

VOLUME III

Cu, Ag, Au, Ca, Sr, Ba

BY THE SAME AUTHOR

A COMPREHENSIVE TREATISE ON
INORGANIC AND THEORETICAL CHEMISTRY

In Sixteen Volumes. With Diagrams.

- Vol. I. H, O.
- Vol. II. F, Cl, Br, I, Li, Na, K, Rb, Cs.
- Vol. III. Cu, Ag, Au, Ca, Sr, Ba.
- Vol. IV. Ra and Ac Families, Be, Mg, Zn, Cd, Hg.
- Vol. V. B, Al, Ga, In, Tl, Sc, Ce, and Rare Earth
Metals, C (Part I).
- Vol. VI. C (Part II), Si, Silicates.
- Vol. VII. Ti, Zr, Hf, Th, Ge, Sn, Pb, Inert Gases.
- Vol. VIII. N, P.
- Vol. IX. As, Sb, Bi, V, Cb, Ta.
- Vol. X. S, Se.
- Vol. XI. Te, Cr, Mo, W.
- Vol. XII. U, Mn, Ma, and Re, Fe (Part I).
- Vol. XIII. Fe (Part II).
- Vol. XIV. Fe (Part III), Co.
- Vol. XV. Ni, Ru, Rh, Pd, Os, Ir.
- Vol. XVI. Pt. and General Index, completing the work.

MELLOR'S MODERN INORGANIC CHEMISTRY.

Revised and Edited by G. D. PARKES, M.A., D.Phil., in
collaboration with J. W. MELLOR, D.Sc., F.R.S.
With numerous Illustrations.

A COMPREHENSIVE TREATISE ON
INORGANIC
AND THEORETICAL
CHEMISTRY

BY
J. W. MELLOR, D.Sc., F.R.S.

VOLUME III

WITH 158 DIAGRAMS



LONGMANS, GREEN AND CO.
LONDON • NEW YORK • TORONTO

LONGMANS, GREEN AND CO. LTD.
OF PATERNOSTER ROW

43 ALBERT DRIVE, LONDON, S.W.19
NICOL ROAD, BOMBAY

17 CHITTARANJAN AVENUE, CALCUTTA
36A MOUNT ROAD, MADRAS

LONGMANS, GREEN AND CO.

55 FIFTH AVENUE, NEW YORK 3

LONGMANS, GREEN AND CO.

215 VICTORIA STREET, TORONTO 1

NEW IMPRESSION . . . September 1946

Ministry of Agriculture, Fisheries and Forestry
Veterinary Laboratory Library

Class No. BE1
MEL
LR 57/5
No.

127

WELLCOME INSTITUTE LIBRARY	
Coll.	WelMCMac
Coll.	
No.	65

CODE NUMBER : 95253

All rights reserved

Printed in Great Britain by William Clowes & Sons, Limited, Beccles

PREFACE

I HAVE been very pleased with the general reception which the first two volumes have received. The present volume includes copper, silver, gold, and the alkaline earths. The radium and actinium families will appear at the beginning of Volume IV. The history of the atomic theory in the first volume carried the evolution of the atom concept up to, and prepared the way for, the introduction of the developments which followed the interest awakened by the discovery of the X-rays and radioactivity. This subject is also included in the chapters associated with radium.

STOKE-ON-TRENT,
November, 1922.

CONTENTS

CHAPTER XXI

COPPER

- § 1. The History of Copper (1); § 2. The Occurrence of Copper (5); § 3. The Separation of Copper from its Compounds (10); § 4. The Extraction of Copper (21); § 5. The Physical Properties of Copper (33); § 6. The Chemical Properties of Copper (69); § 7. The Atomic Weight of Copper (110); § 8. Alleged Allotropic Forms of Copper (113); § 9. The Copper Suboxides (116); § 10. Cupric Oxide (131); § 11. The Hydrated and Colloidal Cupric Oxides (142); § 12. Higher Copper Oxides (147); § 13. Cupric Ammino-oxides (151); § 14. Copper Fluorides (154); § 15. Copper Chlorides—Cuprous Chloride (157); § 16. Cupric Chloride (169); § 17. Complex Salts of Cupric Chloride (182); § 18. Cuprous Bromide (192); § 19. Cupric Bromide (196); § 20. Cuprous Iodide (201); § 21. Cupric Iodide and the Copper Polyiodides (206); § 22. Cuprous Sulphide (210); § 23. Cupric Sulphide (220); § 24. Cuprous Sulphate (231); § 25. Cupric Sulphate (234); § 26. Cupric Ammino-Sulphates. Double Cupric Sulphates (251); § 27. The Basic Cupric Sulphates (261); § 28. Copper Carbonates (267); § 29. Copper Nitrates (280); § 30. Copper Phosphates (287).

CHAPTER XXII

SILVER

- § 1. The History of Gold and Silver (295); § 2. The Occurrence and Distribution of Silver (298); § 3. The Extraction of Silver from its Ores (301); § 4. The Desilverization of Lead (310); § 5. The Purification of Silver; and the Separation of the Metal from its Compounds (314); § 6. The Physical Properties of Silver (321); § 7. The Chemical Properties of Silver (342); § 8. The Atomic Weight and Valency of Silver (363); § 9. Silver Suboxide, or Silver Quadrantoxide, or Silver Tetroxide (368); § 10. Silver Oxide (371); § 11. Silver Hydroxide and Silver Ammino-Hydroxide (380); § 12. Silver Dioxide; or Silver Peroxide (383); § 13. Silver Fluoride (386); § 14. Silver Chloride (390); § 15. Action of Light on Silver Halides (408); § 16. Silver Bromide (418); § 17. Silver Iodide (426); § 18. Silver Sulphide (438); § 19. Silver Sulphate (450); § 20. Silver Carbonate (456); § 21. Silver Nitrate (459); § 22. Silver Ammino-nitrates; Double or Complex Nitrates (477); § 23. Silver Peroxynitrate and Peroxy-sulphate (482); § 24. Silver Phosphates (485).

CHAPTER XXIII

GOLD

- § 1. The Occurrence and Distribution of Gold (491); § 2. The Mining and Extraction of Gold—Amalgamation Process (495); § 3. The Chlorination and Cyanide Processes for the Extraction of Gold (499); § 4. The Purification and Refining of Gold (507); § 5. The Physical Properties of Gold (509); § 6. The Chemical Properties of Gold (525); § 7. The Atomic Weight of Gold (535); § 8. The Flocculation and Deflocculation of Colloidal Solutions (536); § 9. The Preparation of Colloidal Solutions (551); § 10. Colloidal Gold, Silver, and Copper (554); § 11. Purple of Cassius, and Ruby Glass (564); § 12. Allotropic Modifications of Gold and Silver (568); § 13. Alloys of Gold, Silver, and Copper (571); § 14. The Oxides and Hydroxides of Gold (577); § 15. Gold Fluoride (585); § 16. Gold Chlorides (586); § 17. Gold Bromides (605); § 18. Gold Iodides (608); § 19. The Sulphides of Gold (610); § 20. Gold Sulphates (615); § 21. The Gold Nitrates (615); § 22. The Family Relationship of Copper, Silver, and Gold (617).

CHAPTER XXIV

THE ALKALINE EARTHS

- § 1. The History of Calcium, Strontium, and Barium (619); § 2. The Occurrence of the Alkaline Earths (622); § 3. The Preparation of the Metals of the Alkaline Earths (626); § 4. The Properties of Calcium, Strontium, and Barium (631); § 5. The Atomic Weights of Calcium, Strontium, and Barium (616); § 6. The Hydrides of the Alkaline Earths (649); § 7. The Preparation of the Oxides of Calcium, Strontium, and Barium (652); § 8. The Properties of the Oxides of Calcium, Strontium, and Barium (660); § 9. The Higher Oxides of Calcium, Strontium, and Barium (666); § 10. The Hydroxides of Calcium, Strontium, and Barium (673); § 11. Calcium, Strontium, and Barium Fluorides (688); § 12. Calcium, Strontium, and Barium Chlorides (697); § 13. Calcium, Strontium, and Barium Bromides (725); § 14. Calcium, Strontium, and Barium Iodides (734); § 15. Calcium, Strontium, and Barium Sulphides (740); § 16. The Sulphates of the Alkaline Earths (760); § 17. The Dehydration and Rehydration of Gypsum. Plaster of Paris (767); § 18. The Solubility of the Sulphates of the Alkaline Earths (777); § 19. The Properties of the Sulphates of the Alkaline Earths (792); § 20. The Complex Sulphates of the Alkalies and Alkaline Earths (804); § 21. The Occurrence and Preparation of Carbonates of the Alkaline Earths (814); § 22. The Solubility of the Carbonates of the Alkaline Earths (824); § 23. The Properties of the Carbonates of the Alkaline Earths (833); § 24. Nitrates of the Alkaline Earths (849); § 25. The Normal Phosphates of the Alkaline Earths (864); § 26. Hydrophosphates of the Alkaline Earths (880); § 27. Dihydrophosphates of the Alkaline Earths (886); § 28. Pyrophosphates of the Alkaline Earths (891); § 29. Metaphosphates of the Alkaline Earths (893); § 30. Complex Phosphates of the Alkaline Earths (896); § 31. Some Relations between Calcium, Strontium, and Barium (907).

ABBREVIATIONS

aq.	= aqueous
atm.	= atmospheric or atmosphere(s)
at. vol.	= atomic volume(s)
at. wt.	= atomic weight(s)
T° or °K	= absolute degrees of temperature
b.p.	= boiling point(s)
θ°	= centigrade degrees of temperature
coeff.	= coefficient
conc.	= concentrated or concentration
dil.	= dilute
eq.	= equivalent(s)
f.p.	= freezing point(s)
m.p.	= melting point(s)
mol(s)	= $\begin{cases} \text{gram-molecule(s)} \\ \text{gram-molecular} \end{cases}$
mol(s)	= $\begin{cases} \text{molecule(s)} \\ \text{molecular} \end{cases}$
mol. ht.	= molecular heat(s)
mol. vol.	= molecular volume(s)
mol. wt.	= molecular weight(s)
press.	= pressure(s)
sat.	= saturated
soln.	= solution(s)
sp. gr.	= specific gravity (gravities)
sp. ht.	= specific heat(s)
sp. vol.	= specific volume(s)
temp.	= temperature(s)
vap.	= vapour

The use of **triangular diagrams** for representing the properties of three-component systems was suggested by G. C. Stokes (*Proc. Roy. Soc.*, 49. 174, 1891). The method was immediately taken up in many directions and it has proved of great value. With practice it becomes as useful for representing the properties of ternary mixtures as squared paper is for binary mixtures. The principle of triangular diagrams is based on the fact that in an equilateral triangle the sum of the perpendicular distances of any point from the three sides is a constant. Given any three substances *A*, *B*, and *C*, the composition of any possible combination of these can be represented by a point in, or on the triangle. The apices of the

ABBREVIATIONS

triangle represent the single components *A*, *B*, and *C*, the sides of the triangle represent binary mixtures of *A* and *B*, *B* and *C*, or *C* and *A*; and points within the triangle ternary mixture. The compositions of the mixtures can be represented in percentages, or referred to unity, 10, etc. In Fig. 1, pure *A* will be represented by a point at the apex marked *A*. If 100 be the

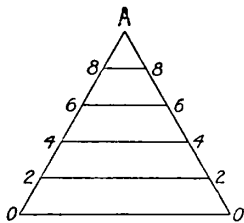

FIG. 1.

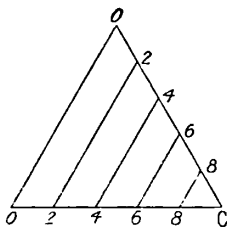

FIG. 2.

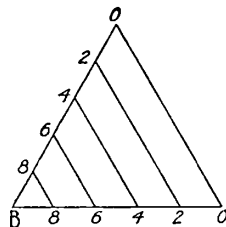

FIG. 3.

standard of reference, the point *A* represents 100 per cent. of *A* and nothing else; mixtures containing 80 per cent. of *A* are represented by a point on the line 88, 60 per cent. of *A* by a point on the line 66, etc. Similarly with *B* and *C*—Figs. 3 and 2 respectively. Combine Figs. 1, 2, and 3 into one diagram by superposition, and Fig. 4 results. Any point in this

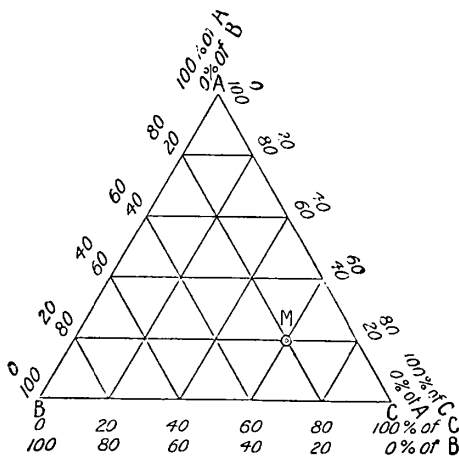

FIG. 4.—Standard Reference. Triangle.

diagram, Fig. 4, thus represents a ternary mixture. For instance, the point *M* represents a mixture containing 20 per cent. of *A*, 20 per cent. of *B*, and 60 per cent. of *C*.

CHAPTER XXI

COPPER

§ 1. The History of Copper

COPPER was one of the earliest metals discovered by man, and this long before the histories of ancient peoples were inscribed on papyri, or engraved on stone pillars; Genesis (4. 22) states that Tubal-cain—3870 B.C.—was an artificer in brass, although there is some uncertainty whether the original term means copper or bronze. The translators of the Bible did not understand the distinction these terms bear in metallurgy, and they were used synonymously—the translations “brass is molten out of stone” (*Job*, 28. 2) and “out of the hills thou mayest dig brass” (*Deut.*, 8. 9), obviously refer to the metal or ore of copper, and not to brass. There is, indeed, nothing to show that what is now understood as brass was known in scriptural times, for zinc, an essential constituent of that alloy, was discovered at a much later period. Bronze, the copper-tin alloy, was known. A button, bead, and piece of wire, all made of copper, are reputed to have been found in the tomb of one of the earlier kings of Egypt—4400 B.C. Excavations among the remains of the ancient Phœnician, Babylonian, Assyrian, and Egyptian civilizations have furnished a multitude of copper and bronze relics—the latter usually containing from 10 to 14 per cent. of tin. The ancient bronze ornaments contain various proportions of copper and tin, and a few show the presence of lead, or of lead and iron. Bronze objects dating back to 3000 B.C. are known.¹ The numbers indicated in Table I represent analyses of some old bronzes:

TABLE I.—ANALYSES OF ANCIENT BRONZES.

Bronze.	Date.	Copper.	Tin.	Lead.	Iron.	Arsenic.	Antimony.	Cobalt or Nickel.
Nineveh cup . . .	1000 B.C.	80·84	18·37	0·43	0·16	—	—	1·22
Greek vase . . .	330 B.C.	81·76	10·07	5·25	0·15	—	—	—
Statuette of Osiris .	300 B.C.	76·83	11·33	11·70	tr	0·11	0·13	—
Assyrian figure . .	(?)	85·07	5·33	8·48	0·75	—	—	—

A rod found at Mèdûm in Egypt is claimed to be the earliest specimen of bronze, and it is reputed to date from 3700 B.C. It contains 9·1 per cent. of tin, 89·8 per cent. of copper, and a little arsenic. According to M. Berthelot,² some of the old Egyptian relics formerly thought to be bronze, are made of copper, and in Mesopotamia, about 4000 B.C., virtually pure copper was worked, and statuettes dating from about 2600 B.C., consisting of copper or of copper with small amounts of tin, have been found—*e.g.* the bronze statuette of Gude. Analyses of certain relics of the Mycænæan age—that is, the period described in the poems of Hesiod and Homer, perhaps 1000 B.C.—show that they consisted largely of copper unalloyed with tin,³ as illustrated in Table II. It is stated in the *Iliad*, that Achilles' shield was made of tin, gold, silver, and *chalcos*, which latter may have been copper, but more probably bronze. We are also told that at the Battle of Marathon, 490 B.C., the Persians were armed with bronze swords and spears, and the Greek victors are said to have been more pleased with these captured implements of war than they were with any

of their other prizes. According to J. G. Wilkinson, the early bronze tools found in the *débris* of the ancient peoples, show that the bronze they employed was superior for the manufacture of cutting tools, to the bronze produced at the present day.

TABLE II.—ANALYSES OF SO-CALLED ANCIENT BRONZES.

Copper.	Date.	Copper.	Tin.	Lead.	Iron.	Bismuth.	Arsenic.	Cobalt and Nickel.
Egyptian dagger .	4500 B.C.	99.53	nil	tr	0.08	nil	—	nil
Egyptian knife .	1500 B.C.	96.65	0.03	0.63	1.18	0.44	0.81	0.26
Nails (Mycenæan) .	1000 B.C.	99.53	—	0.27	0.20	—	—	—

It has been said that the Chinese book, *Shoo-King*, about 2500 B.C., mentions copper, and later records show that the kings Yu and Chun, who reigned about 2200 B.C., caused nine bronze vases to be cast, and maps of the nine provinces of the Empire to be engraved upon them. However, but little is known of archæological exploration in China because the examination of ancient burial sites is prohibited by the Government, and opposed by the people. M. Chikashigé has analyzed some ancient Chinese and Korean bronze objects, coins, etc. He said that brass articles are not so antique as bronze, and that the former date from the beginning of the Sung dynasty, about the tenth century.

The Sanscrit word *ayas*, the Latin *æs*, the Gothic *aiz*, the German *erz*, and the English *ore*, are all of Aryan origin, and have been taken to show that the Aryans were acquainted with either copper or bronze. The terms were afterwards used to denote copper, brass, or bronze.⁴ Even so late as Pliny (c. 75 A.D.), these three substances were confused by the one term. From philological and archæological reasons, it is probable that the primitive Aryans had not reached the Iron Age; and there is no Aryan word for tin, an essential constituent of bronze, for the Greek *κασσίτερος* is said to be derived from the Assyrian *kasazitirra*, which in turn comes from the Accadian *id-kasdura*. Consequently, it is thought that *ayas*, *æs*, or *aiz* is primitive, and originally meant copper. The Greeks, who were among the most advanced of the Aryan nations, seem to have been ignorant of copper when visited by the early Phœnician traders. The Greek term *χαλκός* for copper or bronze is not of Aryan origin. Just as the Latin *æs cuprium*—the origin of the term cuprium or copper—is derived from the name of Cyprus, having been originally *æs cyprium* (that is, Cyprian copper or bronze), so the Greek *χαλκός* may be derived from the name of the town Chalcis in Eubœa. In confirmation of the suggestion of the philologists, that a Copper Age preceded that of bronze, some of the oldest relics (celts, etc.) now collected in various museums are of copper, not bronze.⁵ These celts are usually chisel-shaped like the celts of the Stone Age. Archæological discoveries in India, Austria, Hungary, France, Italy, and Spain have shown that a Copper Age, about 4000 B.C., came intermediate between the Stone and Bronze Ages. In Britain, however, this is not the case, because the evidence shows that bronze was the first metal known in this island, and that it was introduced by traders from Gaul. In America, too, utensils have been discovered in ancient mounds showing that a prehistoric race prior to the Indians must have been acquainted with copper.⁶ A. Helps says that at the time of the Spanish conquest of Peru, copper was considered to be far more valuable than gold or silver. E. Nordenskiöld⁷ has discussed the Copper and Bronze Ages in South America; and J. E. Reynolds in North America. According to W. Gowland,⁸ there is no evidence of a Copper Age in Japan, but in the early centuries of our era, the Japanese had acquired a skill in the preparation and working of copper far in advance of that attained by any race until many centuries after the beginning of the Iron Age, or even in Roman times.

According to Diodorus (c. 30 B.C.), the Nubian and Ethiopian mines kept Egypt

so plentifully supplied with copper at the time of the Pharaohs that this metal or bronze was used in making domestic furniture, chariots, swords, arrow tips, etc. According to M. Berthelot,⁹ the oldest known copper mine associated with the smelting of copper occurs in the Sinai Peninsula,¹⁰ and workings there have been traced back to 4300 B.C. The remains of a copper foundry dating back to 1300 B.C. have been found at *Tel-el-Sifr* (South Chaldea). The island of Cyprus seems to have produced copper from about 3000 B.C., and its copper mines passed successively under the dominion of the Egyptians, Assyrians, Phœnicians, Greeks, Persians, and the Romans.

The bronze objects found in Cyprus have from 2 to 4 per cent. of tin, but no tin has been found on the island. W. Gowland¹¹ believes that the early bronze was obtained by smelting stanniferous copper ores, and although this might possibly have been the case in Western Europe, the absence of tin in the copper mines of Asia Minor, Egypt, and India, does not support this view, but rather indicates that the ancient bronzes were made from tin and copper mined or smelted independently. The remains of Roman mines in Egypt, Cyprus, Central Europe, the Spanish Peninsula, and Britain show evidence of the roasting and smelting of sulphide ores. A comparison of C. N. Otin's analyses of various prehistoric articles of copper, and of copper-tin from Rumania, with analyses of various Roman vessels, showed that the Rumanian articles were made from local ores, and that they could smelt copper almost as well as the Romans. In Germany, copper mining began at Rammelsberg (Harz) about 968 A.D., and at Hettstedt in the Mansfeld district (Harz) about 1199. Although the Romans obtained copper from Anglesey during their occupation of Britain, very little copper was mined in England in the Middle Ages. In 1694, copper was imported from Sweden for British coinage, since the Cornish copper was considered of little value. In 1564, Queen Elizabeth granted mining concessions to T. Thurland and D. Hochstetter, who formed companies for mining copper, and German miners worked at Coniston (near Keswick), St. Just (Cornwall), Neath (Wales), Ecton (Staffordshire), and elsewhere. The dates¹² of the opening of smelteries in Wales are Neath (1584), Melincrethyn (1695), Tailbach (1727), Swansea (1717), Penclawdd (1800), Llanelly (1805), Loaghor (1809), Hafod (1810), Cwmavan (1837), and Pembrey (1846). Copper was mined in Connecticut in America in 1709, and later in New Jersey, Pennsylvania, Montana, California, etc. Native copper was discovered in Lake Superior about 1840, but copper mining was not established there until about 1850.

The remains of primitive smelting furnaces show that the copper ore was probably placed on charcoal in shallow pits in the ground, and rude copper cakes 8 to 10 inches in diameter were obtained during the cooling of the metal at the bottom of the pit. Egyptian pictures also show furnaces worked (with forced draught) first by blowpipe (perhaps about 2000 B.C.), and later by bellows (about 1500 B.C.). There are references to copper in Plato's *Timæus* (c. 360 B.C.), in Aristotle's *Generation and Corruption* (c. 350 B.C.), in the spurious work *On Marvels*, and in numerous other early writings. In the third century B.C., Theophrastus, in his *Περὶ Πυρρός* (c. 315 B.C.), first described green and blue copper minerals; and in his *De materia medica* (c. 75 A.D.), Dioscorides used the Latinized Greek terms *chalcitis*, *misgy*, *sory*, and *melanteria*—*chalcitis* appears to have referred to a partially weathered copper pyrite; and *melanteria* to copper sulphate; while *sory* was a blackish stone impregnated with both copper and iron sulphates; and *misgy* appears to have been a yellow earth likewise impregnated with the sulphate. Pliny, in his *Historia naturalis* (c. 77 A.D.), gave the same list as Dioscorides, but he seems to have been somewhat confused between chrysocolla and chalcitis. Dioscorides also described a furnace for the smelting of copper.

In the latter half of the eleventh century, Rugerus or Theophilus¹³ gave a description of copper smelting and refining:

The ore employed is of a green colour and mixed with lead. A pile of ore is burned after the manner of lime, whereby the colour is not changed, but the stone loses its hardness

whereby it can be broken up. Coals are placed in the furnace, then the bruised and roasted ore, again coal, and ore anew until the furnace is charged. The bellows are then applied, and when the stone has commenced to liquify, the lead flows out through some small cavities, and the copper remains within. When this has been blown on for a very long time, and cooled, it is taken out; and another charge is again placed in the furnace after the same order.

Theophilus also described the construction of the furnace. In 1540, V. Biringuccio outlined the process of roasting, smelting, and pole-refining employed in Saxony; and fourteen years later, G. Agricola gave a description of various copper ores, and of the roasting, smelting, liquation, and refining of copper, which showed clearly the methods employed in the sixteenth century.

The alchemists of the Middle Ages symbolized copper by the looking-glass of Venus—*vide* 1. 1, 1 and 8. The deposition of copper which occurs when a piece of iron is immersed in a soln. of copper salt was cited by Paracelsus, in his tract *De tinctura physicorum* (c. 1520), as a proof of the transmutation of iron into copper, and G. W. Wedel (1715) and J. A. Stiller (1685) seem to have held similar views, although J. B. van Helmont (c. 1640) rightly surmised that the copper already existed in the soln., for he stated that when a metal is dissolved in an acid it is not essentially changed, for it can be recovered from the solvent. This hypothesis was established by R. Boyle about 1675,¹⁴ when he showed that this solvent permits the copper to be precipitated in order to take up the precipitating metal iron or zinc.

REFERENCES.

- ¹ H. Garland, *Journ. Inst. Metals*, 10. 339, 1913; M. Busch, *Zeit. angew. Chem.*, 27. 512, 1914; J. Napier, *Manufacturing Arts in Ancient Times*, Paisley, 1879; J. G. Wilkinson, *Manners and Customs of the Ancient Egyptians*, London, 1878.
- ² M. Berthelot, *Ann. Chim. Phys.*, (6), 12. 136, 1887; (6), 17. 607, 1889; M. Berthelot and C. E. Ruelle, *Collection des anciens alchimistes grecs*, Paris, 1888; M. Much, *Die Kupferzeit in Europa*, Wien, 1886; W. M. Flight, *Journ. Chem. Soc.*, 41. 134, 1882; E. O. von Lippmann, *Entstehung und Ausbreitung der Alchemie*, Berlin, 537, 549, 1919; G. W. Mullins, *Metal Ind.*, 19. 521, 1921.
- ³ B. H. Brough, *The Nature and Yield of Metalliferous Deposits*, London, 1900; W. Gowland, *Journ. Inst. Metals*, 7. 23, 1912; H. Garland, *ib.*, 10. 329, 1913; M. Chikashigé, *Journ. Chem. Soc.*, 117. 917, 1920.
- ⁴ O. Schrader, *Sprachvergleichung und Urgeschichte*, Jena, 1907.
- ⁵ J. Evans, *The Ancient Stone and Bronze Implements, Weapons, and Ornaments of Great Britain and Ireland*, London, 1881.
- ⁶ J. W. Foster and J. D. Whitney, *Report on the Geology and Stratigraphy of Lake Superior*, Washington, 1851; C. Henrich, *Trans. Amer. Inst. Min. Eng.*, 25. 175, 1895; A. F. Wendt, *ib.*, 15. 25, 1887; A. Helps, *The Spanish Conquest of America*, London, 3. 535, 1857.
- ⁷ E. Nordenskiöld, *The Copper and Bronze Ages in South America*, Göteborg, 1921; J. E. Reynolds, *Canadian Journ.*, 1. 330, 1856.
- ⁸ W. Gowland, *Trans. Japan Soc.*, 13. 20, 1915.
- ⁹ M. Berthelot, *Ann. Chim. Phys.*, (7), 11. 47, 433, 1897.
- ¹⁰ F. Petric, *Researches in Sinai*, London, 1906.
- ¹¹ W. Gowland, *Journ. Inst. Metals*, 7. 23, 1912; C. N. Otin, *Bull. Acad. Roumaine*, 1. 297, 1913.
- ¹² J. Percy, *Historical Notes on Copper Smelting in Great Britain*, London, 1861; G. Francis, *The Smelting of Copper in the Swansea District of South Wales from the time of Elizabeth to the Present Day*, Swansea, 1867; London, 1881; H. C. H. Carpenter, *On Progress in the Metallurgy of Copper*, London, 1918.
- ¹³ R. Hendrie, *An Essay on the Various Arts, in Three Books by Theophilus also called Rugerus, Priest and Monk*, London, 1847; V. Biringuccio, *De la pirotechnica*, Venice, 1540; G. Agricola, *De re metallica*, Basil, 1556.
- ¹⁴ R. Boyle, *The Origin of Fluidity and Firmness*, London, 1661; *Treatise on the Mechanical Causes of Chemical Precipitation*, London, 1675; G. W. Wedel, *Compendium chymicæ theoreticæ et practicæ*, Jenæ, 1715; J. M. Stiller, *Chemischer Natur Spiegel*, Hannover, 1685; J. B. van Helmont, *Ortus medicinae*, Lugduni Batavorum, 1656.

§2. The Occurrence of Copper

An *ore* is a metalliferous mineral or aggregate of metalliferous minerals, mixed with more or less gangue, and contains a metal (or metals) which has found a recognized application in the industries, and which occurs naturally in sufficient abundance to be of commercial importance. The *gangue* is the matrix of minerals associated with the mineral containing the metal to be extracted. The nature and character of the gangue usually determines the details of the ore-dressing and metallurgical treatment to which the ore is subjected in the extraction of the metal.¹

Copper ores are rather widely distributed, and are found in nearly every country. The occurrence of copper is considered by T. Carnelley² to agree with its position in the periodic table. The chief deposits are indicated on the map, Fig. 1. The copper minerals are far more numerous and represent a wider range of composition

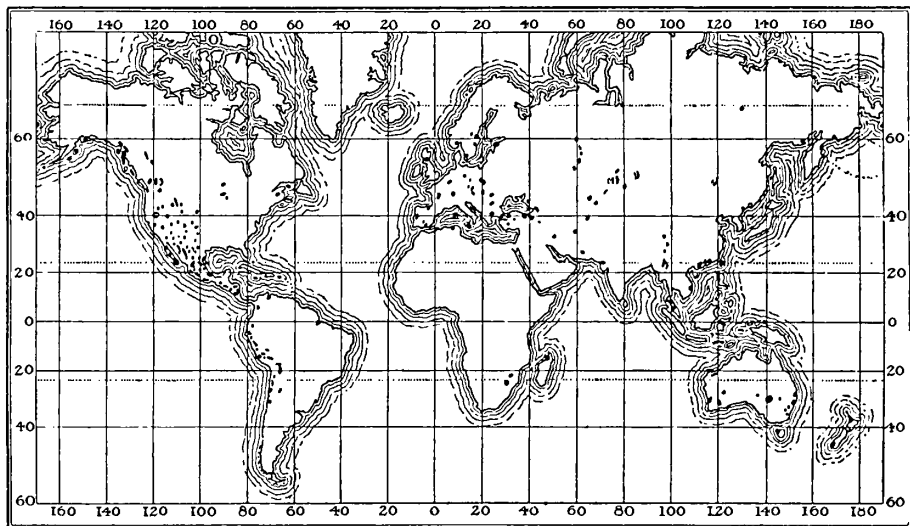

FIG. 1.—The Geographical Distribution of the Chief Deposits of Copper Ores.

than those of silver, to be afterwards described. The oxidized ores of copper are very numerous, those of silver are virtually non-existent. Copper occurs as metal, in various forms of sulphide, arsenide, antimonide, halides, etc., and also oxidized, as oxide, silicate, sulphate, phosphate, arsenate, carbonate, nitrate, oxychloride, etc.

The United States of America is the largest producer, and the deposits are mainly about the Rocky Mountains and Sierra Nevada; about Lake Superior; and about the Atlantic coast beds—Michigan, Montana, Arizona, California, Utah, Colorado, and Tennessee. The Anaconda mine (Butte, Montana) is said to have been the most productive on record; it is famous for its veins of rich secondary sulphides. The Arizona ores are low-grade porphyries; the Michigan ores are unique deposits of the native metal; the Utah ore is an altered siliceous porphyry containing small grains of copper minerals distributed throughout the mass. The Tennessee deposits are pyritically smelted and the flue gases are used in the manufacture of sulphuric acid. There are important deposits in Mexico, Canada—Sudbury and British Columbia—and Newfoundland. Chile is stated to have probably two thousand mines regularly or intermittently worked. The average yield of each is not stated. The mine at Chuquicamata is very rich, yielding the oxidized mineral, brochantite, $\text{CuSO}_4 \cdot 3\text{Cu}(\text{OH})_2$, etc. The deposits were worked by the aborigines before the Spanish conquest. Smaller deposits occur in Peru, Bolivia, Argentina, and Venezuela.

Many of the copper mines of Europe have been worked since the days preceding the Roman Empire; several of the old mines are exhausted; others abandoned because unprofitable. Some of the mines most productive to-day are the oldest. The most important mines in Europe occur in the district about Huelva, extending into Spain and

Portugal, where the Rio Tinto Co. alone produced 30,000 tons in 1890. These mines were worked many centuries by the Romans. The German deposits are mainly located about Mansfeld (Rhenish Prussia); they have been worked continuously for a thousand years, and are estimated to have an equally long life ahead of them. The more important Russian deposits occur in the Urals. In Great Britain, the mines of Cornwall have been worked for a long time, but the yield is not very large; there are also deposits at Alderley Edge (Cheshire), Anglesey, etc. In Ireland, copper ore is mined in Cork, Tipperary, and Wicklow. Many districts in Africa have important deposits of copper. Some have been worked by the natives for centuries. There are mines in Rhodesia, Cape Colony, Congo Free State, etc. The mines of Namaqualand are the most important. There are large deposits of copper in Asia, but they are mainly undeveloped. The mines in Japan are, perhaps, the most important to-day. China has produced copper from shallow pits for thousands of years, but the Chinese mines are quite undeveloped. India has many ancient mines worked in the early centuries, but now mainly idle. The Siberian deposits are undeveloped. In Australasia, there are important mines in New South Wales, Tasmania, and South Australia; the mines in Queensland and Western Australia are not so important.

According to W. H. Weed,³ the World's smelter production in 1920 was :

Metric Tons.		Metric Tons.	
United States of America	548,418	Cuba	6,485
Chile	94,531	Sweden	3,500
Japan	65,554	Norway	1,400
Mexico	50,480	Australasia	1,000
Canada	35,500	Austria-Hungary	1,000
South Africa	32,230	Argentina
Peru	31,276	British Isles
Spain and Portugal	25,000	Italy
Germany	17,255	Russia
Bolivia	9,900		

A *metric ton* or *tonne* represents 1000 kilograms or 2205 lbs. ; a *short ton* or *net ton* is 2000 lbs. ; and a *long ton* or *gross ton* is 2240 lbs. The world's output of copper in metric tons was :

	1880	1890	1900	1910	1913	1917
	156,400	274,065	491,435	877,494	1,002,284	1,435,721
Highest price	£72 10	£61 12 6	£78 7 6	£62 1 3	£77 2 6	£140
Lowest price	£57 0	£46 10 0	£70 15 0	£32 15 0	£61 15 0	£110

The average price in 1801–1810 was £160 per ton ; this had fallen to £88 per ton in 1841–1850, and with small fluctuations down to £55 per ton in 1900. There was an abnormally large demand for copper created by the war, and the price soared to £153 per ton in 1916. The World's output in 1920 was 949,015 metric tons, or 1,044,299 short tons ; and the price ranged from £70 to £122 5s. per ton.

The minerals forming copper ores are usually associated with a variety of other metallic minerals and earths as gangue. The ores of most industrial importance, and most frequently encountered in mining operations, are, in alphabetical order : azurite, bornite, chalcocite, chalcantite, chalcopyrite, ehrysocolla, eovellite, cuprite, enargite, famatinite, malachite, pyrite, tenorite, and tetrahedrite. Others are of less economic value. The ores are generally classified as native copper ores ; sulphide ores ; and oxidized ores. Small quantities of **native copper** occur in many districts, but large quantities occur in the Lake Superior region, North Michigan. A mass reported to weigh 420 tons was found in the Minnesota mine in 1857. Native copper is usually fairly pure, but it may contain small amounts of silver and bismuth. It has a red colour and crystallizes in the cubic system ; the crystals are often twinned to form elongated spear-shaped aggregates. The native copper is considered⁴ to be a mineral of secondary origin, and to have been deposited from soln., or formed by the reduction of some solid compound. Pseudomorphs after the oxide, cuprite, and azurite are well known. The soln. have been formed mainly by the oxidation of pyritic ores. R. Pumpelly,⁵ G. Fernekes, and R. D. Irving suggest that cases occur where the reducing agent was some compound of iron—oxide or silicate. H. N. Stokes found hornblende and siderite can precipitate the

metal from a soln. of copper sulphate, and he showed that other ferruginous minerals can act in a similar manner under suitable conditions. H. C. Biddle studied the reducing action of carbon dioxide under press.; and A. Gautier, that of superheated steam, $\text{Cu}_2\text{S} + 2\text{H}_2\text{O} = 2\text{Cu} + \text{SO}_2 + 2\text{H}_2$; while H. de Sénarmont, R. Beck, E. Haworth and J. Bennett, and E. J. Schmitz have shown that organic matter found in bones, wood, shales, etc., can effect the reduction.

Among the native sulphide ores is chalcocite, also called *redruthite*, *vitreous copper*, or *copper glance*. In the ideal case, this mineral approaches cuprous sulphide, Cu_2S , with 79.8 per cent. of metal. It crystallizes in the rhombic system, and has a greyish-black colour often with a bluish or greenish tarnish. The sp. gr. ranges from 5.5 to 5.8, and the hardness from 2.5 to 3.0. It is soluble in hot nitric acid, leaving a deposit of sulphur. The corresponding cupric sulphide, CuS , is a rarer mineral called *covellite*, or *indigo copper*, or *blue copper*, on account of its deep blue colour. It occurs in microscopic crystals belonging to the hexagonal system. There is also *chalcantite* or *cyanosite*, blue copper sulphate, $\text{CuSO}_4 \cdot 5\text{H}_2\text{O}$, which occurs in deposits, and as incrustations which are oxidation products of minerals containing copper sulphide. There are also some basic sulphates, *brochantite*, $\text{CuSO}_4 \cdot 3\text{Cu}(\text{OH})_2$, *langite*, $\text{CuSO}_4 \cdot 3\text{Cu}(\text{OH})_2 \cdot 2\text{H}_2\text{O}$, and *woodwardite*. These basic salts are probably mixtures. *Chalcopyrite*, also called *copper pyrites*, *towanite*, and *yellow copper ore*, is the most abundant of all the copper ores. In the ideal case, it approximates to CuFeS_2 , or $\text{Cu}_2\text{S} \cdot \text{Fe}_2\text{S}_3$, with 34 per cent. of copper; but there are sometimes so many impurities present that the ore contains but 2 per cent. of the metal in question; even with this small amount, the ores can be profitably smelted under favourable conditions. In some places auriferous chalcopyrite is worked as an ore of gold. Another variety is called *bornite*, *erubescite*, *variegated copper ore*, *purple copper ore*, *horseflesh ore*, or *peacock ore*. This mineral appears to be related to chalcopyrite much as *marcasite* is related to *pyrite*, but there are differences of opinion as to the composition of the ideal mineral: Cu_3FeS_3 is sometimes given. B. J. Harrington⁶ gives Cu_5FeS_4 . There are also *chalmersite*, CuFe_2S_3 ; and *cubanite*, CuFe_2S_4 , to be included among the rarer copper-iron sulphides; *carrollite*, $\text{CuS} \cdot \text{Co}_2\text{S}_3$, is also rare. The colour of chalcopyrite is brass or bronze-yellow, sometimes with a bluish iridescence produced by the thin film formed by the tarnishing of the surface; *bornite* has a bronze colour, and tarnishes much more readily than chalcopyrite—the corresponding iridescent effects are sometimes very pretty. Chalcopyrite crystallizes in the tetragonal system, and the tetrahedral crystals so closely resemble octohedra that they were once thought to belong to the cubic system. A variety of chalcopyrite occurring in botryoidal masses is called *blistered copper ore*. *Bornite* belongs to the cubic system. Some varieties of *marcasite* and *pyrite* contain up to 5 per cent. or even more copper. The arsenides: *domeykite*, Cu_3As , and a variety with cobalt and nickel as well as copper is called *mohawkite* or *adgonite*, Cu_4As ; and *whitneyite* or *darurnite*, Cu_9As ; the antimonide: *horsfordite*, Cu_8Sb ; the selenides: *berzelianite*, Cu_2Se ; *umangite*, Cu_3Se_2 ; *zorgite*, $(\text{Cu}, \text{Pb})\text{Se}$, and a variety with copper, silver, and thallium, called *crookesite*; the telluride: *richardite*, Cu_4Te_3 , have been reported. *Enargite* or *luzonite* is a mixed copper and arsenic sulphide in some cases approximating $3\text{Cu}_2\text{S} \cdot \text{As}_2\text{S}_5$, or Cu_3AsS_4 , analogous with the isomorphous *famatinitite*, $3\text{Cu}_2\text{S} \cdot \text{Sb}_2\text{S}_5$, or Cu_3SbS_4 , while *tennantite* corresponds sometimes with $3\text{Cu}_2\text{S} \cdot \text{As}_2\text{S}_3$ or with $\text{Cu}_3\text{As}_2\text{S}_7$; and *tetrahedrite*, $3\text{Cu}_2\text{S} \cdot \text{Sb}_2\text{S}_3$, or else $\text{Cu}_3\text{Sb}_2\text{S}_7$. *Enargite* is the source of the arsenic in Manila copper. *Tetrahedrite* is also called *fahlerz*, *fahl ore*, or *grey copper ore*, and it can be regarded as cuprous sulphide with more or less copper replaced by iron, zinc, and mercury and mixed with arsenic or antimony sulphide. Gold and silver are also usually present. It is an iron-black or steel-grey mineral occurring in tetrahedral crystals belonging to the cubic system. It is rarely worked for copper alone on account of the difficulty of eliminating arsenic. In addition to these sulpho salts, there are *chalcostibnite*, CuSbS_3 ; *empletite*, CuBiS_2 ; *stylopyrite*, Cu_3SbS_3 ; *wittichenite*, Cu_3BiS_3 ; *aikenite*, CuPbBiS_3 ; *klaprotholite*, $\text{Cu}_6\text{Bi}_4\text{S}_9$; *epigenite*, $\text{Cu}_7\text{As}_2\text{S}_{12}$; *cuprobismuthite*, $\text{Cu}_6\text{Bi}_3\text{S}_{15}$; *sulvanite*, Cu_3VS_4 . The copper in these minerals is sometimes replaced by other metals—silver, mercury, lead, zinc, thallium, etc.—and the arsenic, antimony, and bismuth may replace one another.

The oxidized ores, like the basic copper sulphates indicated above, usually occur as decomposition products of sulphide ores, and they occur in the upper part of a seam associated with iron oxide, while the sulphide ore is lower down. They do not occur on an extensive scale, and they are not such important sources of copper as the sulphide ores. *Cuprite*, also called *red oxide of copper* or *ruby ore*, in the ideal case approximates to cuprous oxide, Cu_2O , with 88.8 per cent. of copper. It has a red colour, and crystallizes in octahedra and cubes belonging to the cubic system. *Tenorite*, *melaconite*, or *black oxide of copper*, occurs massive in a few localities. In the ideal case, it corresponds with cupric oxide, CuO , containing 79.85 per cent. of copper. *Green carbonate of copper*, or *malachite*, occurs in green masses or incrustations, and when pure corresponds with $\text{CuCO}_3 \cdot \text{Cu}(\text{OH})_2$, with 57.33 per cent. of copper; the less common *blue carbonate of copper*, also called *azurite*, occurs in blue or greenish-blue masses approximating in the ideal case to $2\text{CuCO}_3 \cdot \text{Cu}(\text{OH})_2$,

with 55.3 per cent. of copper. Both carbonates occur in monoclinic crystals. **Dioptase** is a green copper silicate, and is rather scarce. In the ideal case, it corresponds with $\text{CuSiO}_3 \cdot 2\text{H}_2\text{O}$. It occurs in rhombohedral crystals. The more common hydrate, $\text{CuSiO}_3 \cdot 2\text{H}_2\text{O}$, is called **chrysocolla**, and $\text{CuSiO}_3 \cdot 3\text{H}_2\text{O}$, **asperolithite**. Chrysocolla is also green, but it does not occur in crystals. The silicates **shattuckite**, $\text{CuH}_2\text{Si}_2\text{O}_7$, and **planchéite**, $\text{Cu}_6\text{H}_4\text{Si}_5\text{O}_{18}$, are rare. **Atacamite** is a copper oxychloride, $\text{CuCl}_2 \cdot 3\text{CuO} \cdot 3\text{H}_2\text{O}$, or $\text{CuCl}_2 \cdot 3\text{Cu}(\text{OH})_2$, approximating to 59 per cent. of copper. It crystallizes in the rhombic system, and occurs massive in Chile and Bolivia. There are several copper arsenates and phosphates which occur as minerals, but they are of no importance as sources of copper. **Olivenite**, $3\text{CuO} \cdot \text{As}_2\text{O}_5 \cdot \text{Cu}(\text{OH})_2$, occurs in olive-green prisms belonging to the rhombic system; the fibrous aggregates of acicular crystals are called wood copper; it may also occur massive in various shades of green, yellow, or brown. The so-called **lironite** corresponds with $8\text{CuO} \cdot \text{As}_2\text{O}_5$, and **clinoclare** with $6\text{CuO} \cdot \text{As}_2\text{O}_5 \cdot 3\text{H}_2\text{O}$. The hydrated phosphate, **libethenite**, $4\text{CuO} \cdot \text{P}_2\text{O}_5 \cdot \text{H}_2\text{O}$, is olive green; **phosphocheilite**, $6\text{CuO} \cdot \text{P}_2\text{O}_5 \cdot 3\text{H}_2\text{O}$, varies in colour from emerald green to almost black. The uranophosphate, **chalcolithite**, $\text{CuO} \cdot 2\text{UO}_3 \cdot \text{P}_2\text{O}_5$, is known; and there is also the tungstate, **cuprotungstite**, CuWO_4 .

According to C. C. Hutchins,⁷ spectroscopic observations indicate that copper is present in the sun, and it has also been found by A. Ward, G. S. Jamieson, W. N. Hartley, and E. E. Howell in meteorites. In the latter case, E. Cohen has reported up to 0.3 per cent. of copper. This metal has also been detected in numerous rocks, and in soils.⁸ For example, F. W. Clarke and G. Steiger observed on the average, in oceanic clays, and river silt, 0.0130 per cent. of cupric oxide, and J. D. Robertson found 0.0040 to 0.00880 per cent. in some American limestones. Sea and many mineral waters contain traces of copper.⁹ The metal has been found in the ashes of seaweeds. Copper also occurs in numerous plants.¹⁰ This was recognized as early as 1814 by J. F. John. It is also particularly noticeable in plants grown in cupriferous soils. The metal has also been found in different organs of animals; for example, L. van Itallie and J. J. van Eck found copper a normal constituent of the human liver—3.8 to 30.0 mgrm. per kilo. of liver. It was reported by A. H. Church in the blood of herbivora.¹¹ According to A. H. Church, it occurs in the complex compound *turacine*, $\text{C}_{32}\text{H}_{81}\text{Cu}_2\text{N}_9\text{O}_{32}$, as a red pigment colouring the plumage of the turacou. W. C. Rose and M. Bodansky found copper in various coelenterata, mollusca, crustaceæ, elasmobranchii, and teleostomi. R. A. Muttkowsky found the metal in many insects and arthropoda—snails, slugs, garter-snakes, centipedes, spiders, etc. R. S. Hiltner and H. J. Wichmann found 0.12 to 0.362 grms.—or an average of 0.80 grm. per kgrm.—of copper per kilogram in oysters of Atlantic waters. R. A. Muttkowsky believed that copper forms the nucleus of a respiratory protein in mollusca and crustaceæ; and in arthropoda, as a nucleus of hæmocyamine. The copper found in plants is due to mechanical storage, and plays no active rôle in the physiology of the plant. It appears also that a very pale blue cupriferous hæmocyamine can play the same rôle in the blood of certain crustaceæ and arthropoda that ferruginous hæmoglobin plays in the red blood of animals.

A. Duflos showed that copper may contaminate many food and other products.¹² P. Siedler, J. Milne, T. Bokorny, and L. Vignon reported its presence in water containing carbon dioxide, or in water distilled through copper condenser tubes. Its presence has been reported in bread,¹³ jam,¹⁴ pickles,¹⁵ green fruits,¹⁶ cheese,¹⁷ cocoa,¹⁸ bones,¹⁹ sugar,²⁰ fruit syrups,²¹ yeast,²² beer,²³ wine,²⁴ vinegar,²⁵ gin,²⁶ etc. The copper in many cases is derived from contact with copper vessels in the process of manufacturing these products. It has also been reported in various drugs,²⁷ geranium oil, olive oil, bergmot oil, etc. Traces are not uncommon in many alloys not usually regarded as cupriferous.²⁸

REFERENCES,

- ¹ C. H. Fulton, *Tech. Paper Bur. Mines U.S.A.*, 143, 1916; W. H. Weed, *The Copper Mines of the World*, New York, 1908; *Min. Ind.*, 1915.
² T. Carnelley, *Phil. Mag.*, (5), 18, 194, 1884; C. T. Blanshard, *Chem. News*, 32, 151, 1875; E. W. Wetherell, *ib.*, 90, 271, 1904; C. Zenghelis, *Chem. Ztg.*, 30, 294, 316, 1906; G. Tammann, *Zeit. anorg. Chem.*, 49, 113, 1906.

* Imperial Mineral Resources Bureau, *Copper*, 1922; W. H. Weed, *Copper Handbook*, New York, 1915; *Mineral Ind.*, 29. 150, 1921; L. H. Quin, *Metal Handbook and Statistics*, London, 1921.

⁴ W. S. Yeates, *Amer. Journ. Science*, (3), 38. 405, 1889; W. Lindgren, *Prof. Paper U.S. Geol. Sur.*, 43. 101, 1905; H. Credner, *Neues Jahrb. Min.*, 1. 1869; F. F. Grout, *Econ. Geol.*, 5. 471, 1910; W. F. Clarke, *The Data of Geochemistry*, Washington, 655, 1916; V. Lewis, *Eng. Min. Journ.*, 84. 688, 1907; F. Wibel, *Jahrb. Min.*, 855, 1864; W. Mörke, *ib.*, i, 87, 1899; J. F. Kemp, *Econ. Geol.*, 1. ii, 1907; E. C. Sullivan, *Journ. Amer. Chem. Soc.*, 27. 976, 1905; H. Laspeyres, *Zeit. Kryst.*, 20. 529, 1892; C. G. C. Bisehof, *Lehrbuch der chemischen und physikalischen Geologie*, Bonn, 3. 691, 693, 835, 862, 1871; G. Suekow, *Die Verwitterung im Mineralreiche*, Leipzig, 1848; P. Krusch, *Zeit. prakt. Geol.*, 15. 5, 1907.

⁵ R. Pumpelly, *Amer. Journ. Science*, (3), 2. 348, 1871; *Proc. Amer. Acad.*, 13. 253, 1878; R. D. Irving, *Monograph U.S. Geol. Sur.*, 5. 10, 1883; H. N. Stokes, *Econ. Geol.*, 1. 648, 1906; H. C. Biddle, *Journ. Geol.*, 9. 430, 1901; *Amer. Chem. Journ.*, 26. 377, 1901; G. Fernekcs, *Econ. Geol.*, 2. 581, 1907; A. Gautier, *Compt. Rend.*, 142. 1465, 1906; F. E. Wright, *Science*, 25. 389, 1907; H. de Sénarmont, *Ann. Chim. Phys.*, (3), 32. 140, 1851; R. Beck, *Lehre von den Erzlagern*, Berlin, 1903; New York, 1905; E. Haworth and J. Bennett, *Bull. Geol. Soc. America*, 12. 2, 1900; E. J. Schmitz, *Trans. Amer. Inst. Min. Eng.*, 26. 101, 1896.

⁶ B. J. Harrington, *Amer. Journ. Science*, (4), 16. 151, 1903; E. H. Kraus and P. Goldsberry, *ib.*, (4), 37. 539, 1914.

⁷ C. C. Hutehins, *Amer. Journ. Science*, (3), 37. 476, 1889; E. Cohen, *Ann. Hofmuseums*, 13. 473, 1899; 15. 74, 351, 1900; W. N. Hartley, *Journ. Chem. Soc.*, 89. 1566, 1906; A. Ward, *Amer. Journ. Science*, (4), 19. 240, 1905; G. S. Jamieson, *ib.*, (4), 19. 413, 1905; E. E. Howell, *ib.*, (4), 25. 49, 105, 1908; R. Wawnikiewicz, *Liebig's Ann.*, 123. 255, 1862; L. H. Merrill and H. N. Stokes, *Proc. Washington Acad.*, 2. 41, 1900; H. D. Campbell, *Amer. Journ. Science*, (4), 15. 469, 1903.

⁸ L. Dieulaufait, *Ann. Chim. Phys.*, (5), 17. 377, 1879; (5), 18. 349, 1879; P. Lenard and V. Klatt, *Ann. Phys.*, (4), 15. 665, 1904; F. Sandberger, *Jahrb. Min.*, 291, 1878; E. Hussak, *Centr. Min.*, 333, 1906; F. Henrich, *Zeit. prakt. Geol.*, 15. 253, 1907; F. Cornu, *ib.*, 15. 321, 1907; A. Carnot, *Ann. Mines*, (9), 8. 321, 1895; T. L. Phipson, *Chem. News*, 65. 217, 1892; S. Kreutz, *Bull. Acad. Cracow*, 122, 1895; F. Cornu, *Oester. Zeit. Berg. Hütt.*, 55. 571, 1907; G. d'Aehiardi, *Neues Jahrb. Min.*, i, 16, 1900; F. W. Clarke and G. Steiger, *Journ. Washington Acad. Science*, 4. 58, 1914; J. D. Robertson, *Missouri Geol. Sur.*, 7. 479, 1894; F. W. Clarke, *The Data of Geochemistry*, Washington, 1920.

⁹ L. Dieulaufait, *Ann. Chim. Phys.*, (5), 17. 377, 1879; (5), 18. 349, 1879; F. J. Malaguti, J. Durocher, and M. Sarzeau, *ib.*, (3), 28. 129, 1850; J. Y. Buchanan, *Chim. News*, 44. 253, 1881; J. Milne, *ib.*, 31. 77, 1875; B. M. Lersch, *Hydrochemie*, Berlin, 432, 1864; P. Berthier, *Pogg. Ann.*, 48. 150, 1839; C. F. Rammelsberg, *ib.*, 72. 571, 1847; L. F. Bley, *Neues Journ. Pharm.*, (2), 18. 69, 1829; F. Ludwig, *Tschermak's Mitt.*, 11. 105, 183, 1890; P. Carles, *Journ. Pharm. Chim.*, (6), 13. 562, 1901; E. Filhol, *ib.*, (3), 13. 13, 1848; A. Chevallier and T. Gobley, *ib.*, (3), 13. 324, 1848; R. F. Marehand, *Journ. Chim. Méd.*, (3), 6. 693, 1850; A. Chevallier, *ib.*, (3), 3. 3, 1847; A. Chevallier and M. Schaeufele, *ib.*, (3), 4. 401, 1848; H. Fischer, *Arch. Pharm.*, (2), 52. 263, 1847; H. Will, *Liebig's Ann.*, 61. 192, 1847; D. Wasowicz and J. Horowitz, *Pharm. Post*, 32. 307, 1899.

¹⁰ M. Sarzeau, *Ann. Chim. Phys.*, (2), 44. 334, 1830; L. Dieulaufait, *ib.*, (5), 19. 550, 1880; *Compt. Rend.*, 90. 703, 1880; O. Girard, *ib.*, 120. 1147, 1895; A. Millardet and U. Gayon, *ib.*, 101. 985, 1885; G. Salet, *ib.*, 110. 282, 1890; *Bull. Soc. Chim.*, (3), 3. 328, 1890; A. Jorissen, *Bull. Acad. Belgique*, 902, 1903; P. Platz, *Stahl Eisen*, 7. 258, 1887; A. Stutzer, *Landw. Vers. Stat.*, 65. 285, 1906; O. Kellner, *ib.*, 25. 273, 1880; D. T. McDougal, *Bot. Gaz.*, 27. 68, 1899; A. Schulz, *Berg. Hütt. Ztg.*, 59. 535, 1900; A. Dupré and W. Odling, *Guy's Hospital Rep.*, 4. 103, 1858; A. Tschersch, *Schweiz. Wochenschr. Pharm.*, 33. 113, 1895; V. Vedrödi, *Chim. Ztg.*, 17. 1932, 1893; K. B. Lehmann, *Arch. Hyg.*, 27. 1, 1896; A. B. Frank and F. Krüger, *Ber. deut. bot. Ges.*, 12. 8, 1894; N. Passerini, *Staz. sperim. agrar. Ital.*, 20. 471, 1890; 21. 20, 565, 1891; P. Peretti, *Journ. Chim. Méd.*, 8. 92, 1832; L. Deschamps, *Journ. Pharm.*, (3), 13. 88, 1847; A. Commaille, *ib.*, (3), 43. 184, 1863; E. Lippmann, *Ber.*, 21. 3492, 1888; K. Dieterich, *Verh. Naturf. Aerzte*, 2. 621, 1901; G. Ulex, *Journ. prakt. Chem.*, (1), 95. 367, 1865; H. Lossen, *ib.*, (1), 96. 460, 1865; 97. 512, 1866; G. B. Frankforter, *Chem. News*, 79. 44, 1899; J. R. Hill, *Pharm. Journ.*, (4), 10. 417, 1900; A. Bogdanoff, *Compt. Rend.*, 45. 688, 1857; 46. 780, 1858; J. T. Willard, *Journ. Amer. Chem. Soc.*, 30. 902, 1908; L. van Itallie and J. J. van Eck, *Proc. Acad. Amsterdam*, 15. 580, 1913.

¹¹ A. Ganjee, *Proc. Roy. Soc.*, 59. 339, 1896; M. Henze, *Zeit. physiol. Chem.*, 33. 370, 1901; C. Cloez, *Bull. Soc. Chim.*, (2), 27. 796, 1877; F. Raoult and H. Breton, *Compt. Rend.*, 85. 40, 1877; A. Devergie, *ib.*, 81. 54, 1875; J. Bergeron and L. l'Hôte, *ib.*, 80. 258, 1875; D. M. Bourneville and P. Yvon, *ib.*, 80. 481, 1875; A. P. A. Rabuteau, *ib.*, 84. 356, 1877; N. A. E. Millon, *ib.*, 26. 41, 1848; A. Béchamp, *ib.*, 49. 895, 1859; M. E. Chevreul, *ib.*, 66. 567, 1868; G. Cuznet, *ib.*, 56. 402, 1863; G. Bizio, *Gazz. Chim. Ital.*, 10. 149, 1880; C. Seliaparelli and G. Peroni, *ib.*, 10. 390, 1880; M. Giunti, *ib.*, 11. 248, 1881; 12. 17, 1882; L. B. Mendel and H. C. Bradley, *Amer. Journ. Physiol.*, 14. 313, 1905; L. H. F. Meslens, *Ann. Chim. Phys.*, (3), 23. 358, 1848; L. Grandeau, *ib.*, (3), 67. 220, 1863; A. Karwowsky, *Ber.*, 14. 1724, 1881; K. B. Lehmann, *Arch. Hyg.*, 23. 18, 73, 1895; A. Dupré and W. Odling, *Guy's Hospital Rep.*, 4. 103, 1858;

- H. Wackenroder, *Arch. Pharm.*, (2), 75. 140, 257, 1852; (2), 76. 1, 1853; B. de Buisson, *Sur l'existence du manganèse dans le sang humain*, Lyon, 1852; F. A. Genth, *Liebig's Ann.*, 81. 68, 1851; E. Cottercau, *Journ. Chim. Méd.*, (3), 5. 179, 1849; V. Legrip, *ib.*, (3), 3. 251, 1847; M. J. B. Orfila, *ib.*, (3), 3. 370, 1847; A. Chevallier, *ib.*, (3), 3. 375, 1847; W. F. Lowe, *Analyst*, 22. 86, 1879; A. H. Church, *Proc. Roy. Soc.*, 17. 436, 1869; *Chem. News*, 68. 32, 1893; W. C. Rose and M. Bodansky, *Journ. Biol. Chem.*, 44. 99, 1920; R. S. Hiltner and H. J. Wichmann, *ib.*, 38. 205, 1919; R. A. Muttikowsky, *Science*, (2), 53. 453, 1921; G. Graff, *Zeit. Nahr. Unters.*, 16. 495, 1908; C. Brebeck, *ib.*, 16. 459, 1908; J. Rieler, *Du cuivre dans les substances alimentaires*, Paris, 1853; A. Duflos, *Schweigger's Journ.*, 60. 357, 1830.
- ¹² J. Milne, *Chem. News*, 31. 77, 1875; T. Bokorny, *Chem. Ztg.*, 29. 687, 1905; L. Vignon, *Bull. Soc. Chim.*, (3), 29. 517, 1903; P. Siedler, *Apoth. Ztg.*, 10. 131, 1895; A. Duflos, *Schweigger's Journ.*, 60. 357, 1830.
- ¹³ L. M. V. Galippe, *Repert. anal. Chem.*, 3. 249, 348, 1883; T. Stevenson, *Analyst*, 8. 110, 1883; R. J. Atcherley, *Chem. News*, 33. 7, 1876; H. C. Piesse, *ib.*, 33. 32, 1876.
- ¹⁴ E. Holdermann, *Arch. Pharm.*, (3), 13. 98, 1878; O. Hehner, *Analyst*, 5. 218, 1880; J. Mayrhofer, *Ver. bayr. angew. Chem.*, 10. 77, 1892; L. Grünhut, *Zeit. anal. Chem.*, 36. 51, 1897.
- ¹⁵ A. R. Leeds, *Journ. Amer. Chem. Soc.*, 3. 134, 1881.
- ¹⁶ J. Muter and H. C. Piesse, *Analyst*, 2. 4, 27, 1877; E. Reichardt, *Arch. Pharm.*, (3), 26. 79, 1888.
- ¹⁷ C. Besana, *Staz. sperim. agrar. Ital.*, 14. 389, 1888; G. Mariani, *ib.*, 17. 257, 1889.
- ¹⁸ L. M. V. Galippe, *Repert. anal. Chem.*, 3. 249, 348, 1883; E. Duclaux, *Bull. Soc. Chim.*, (2), 16. 35, 1871; E. Tisza, *Schweiz. Wochenschr. Pharm.*, 45. 526, 1907.
- ¹⁹ M. Bernhard, *Zeit. Nahr. Unters.*, 4. 121, 1890.
- ²⁰ E. Donath, *Oester. Zeit. Zuckerind.*, 22. 236, 1893.
- ²¹ J. Nessler and M. Barth, *Zeit. anal. Chem.*, 22. 33, 1883.
- ²² E. Comboni, *Staz. sperim. agrar. Ital.*, 17. 302, 1889.
- ²³ T. Schwarz, *Repert. anal. Chem.*, 291, 1883; O. Sendtner, *Arch. Hyg.*, 6. 85, 1887; T. Omcis, *Zeit. Nahr. Unters.*, 6. 116, 1903; F. Sestini and O. Tobler, *L'Orosi*, 10. 289, 1887.
- ²⁴ T. Frühauf and G. Ursic, *Bull. Soc. Adriatica*, 10. 103, 1888; L. Sostegni, *Staz. sperim. agrar. Ital.*, 15. 25, 1888.
- ²⁵ N. Passerini, *Staz. sperim. agrar. Ital.*, 23. 408, 1892; A. Riche, *Journ. Pharm. Chim.*, (4), 26. 23, 1877.
- ²⁶ A. Petermann, *L'Inst.*, 149, 1875.
- ²⁷ H. E. H. Gane, *Journ. Soc. Chem. Ind.*, 21. 224, 1902; C. Hell, *Pharm. Post.*, 27. 182, 1904; O. Jacobsen, *Liebig's Ann.*, 157. 232, 1871; N. Passerini, *Staz. sperim. agrar. Ital.*, 38. 1033, 1906; C. G. Schwalbe, *Zeit. Koll.*, 2. 229, 1908; W. Elborne and C. M. Warren, *Pharm. Journ.*, (4), 26. 692, 1908; E. Dowzard, *Amer. Journ. Pharm.*, 80. 204, 1908.
- ²⁸ A. W. Church, *Proc. Roy. Soc.*, 17. 436, 1869; *Chem. News*, 19. 265, 1869; M. Henze, *Zeit. physiol. Chem.*, 33. 370, 417, 1901; L. B. Mendal and H. C. Bradley, *Amer. Journ. Physiol.*, 14. 313, 1905; F. A. Genth, *Liebig's Ann.*, 81. 68, 1851; C. Schiaparelli and G. Peroni, *Gazz. Chim. Ital.*, 10. 390, 1880; G. Bizio, *ib.*, 10. 149, 1880; M. Giunti, *ib.*, 11. 248, 1881; 12. 17, 1882; C. Cloëz, *Bull. Soc. Chim.*, (2), 27. 196, 1887; F. Raoult and H. Breton, *Compt. Rend.*, 85. 40, 1877; J. Bergeron and L. l'Hôte, *ib.*, 80. 268, 1875; M. Bourneville and M. Yvon, *ib.*, 80. 481, 1875; A. P. A. Rabutau, *ib.*, 84. 356, 1877; G. Cuzent, *ib.*, 56. 402, 1863; A. Béchamp, *ib.*, 49. 895, 1859; M. E. Chevreul, *ib.*, 66. 567, 1868; N. A. E. Millon, *ib.*, 26. 41, 1848; *Ann. Chim. Phys.*, (3), 23. 508, 1849; L. H. F. Meslens, *ib.*, (3), 23. 358, 1848; L. Grandeau, *ib.*, (3), 67. 220, 1863; W. Odling and A. Dupré, *B. A. Rep.*, 55, 1857; H. Wackenroder, *Arch. Pharm.*, (2), 75. 140, 257, 1852; (2), 76. 1, 1853; W. F. Lowe, *Analyst*, 22. 86, 1897; G. Ulex, *Journ. prakt. Chem.*, (1), 95. 367, 1865; H. Lossen, *ib.*, (1), 96. 460, 1865; A. I. Karwowsky, *Journ. Russ. Phys. Chem. Soc.*, 13. 387, 1881; V. Schwarzenbach, *Verh. phys. med. Ges. Würzburg*, 7. 19, 1857; E. Cottereau, *Journ. Chim. Méd.*, (3), 5. 179, 1849; V. Legrip, *ib.*, (3), 3. 251, 1847; M. J. B. Orfila, *ib.*, (3), 3. 370, 1847; A. Chevallier, *ib.*, (3), 3. 375, 1847; L. Deschamps, *Journ. Pharm.*, (3), 13. 88, 1847; (3), 14. 410, 1847; A. Gamgee, *Proc. Roy. Soc.*, 59. 339, 1896; R. Kobert, *Deut. med. Wochenschr.*, 21. 1, 42, 1895; A. Devergie, *Bull. therap.*, 15. 259, 1838; E. P. Danger and C. Flandin, *Ann. hyg. pub.*, 30. 449, 1843; B. de Buisson, *Sur l'existence du manganèse dans le sang humain*, Lyon, 1852; K. B. Lehmann, *Arch. Hyg.*, 24. 18, 73, 1895.

§ 3. The Separation of Copper from its Compounds

The metal can be readily obtained from the various compounds of copper. The processes of reduction illustrate the reduction or decomposition of the copper compounds, and some of them are employed with the object of preparing crystals of the metal. In 1844, C. Watt obtained a patent for the purification of copper by electrically heating the metal. H. Moissan¹ and A. J. P. O'Farrelly distilled all the foreign metals from cupriferos alloys of zinc, cadmium, or lead by heating them for a few minutes in an electric furnace; C. Féry separated the constituents

of brass by fractional distillation; and H. Moissan and T. Watanabe likewise found that all but 3.62 per cent. of silver could be distilled from a 50 per cent. copper-silver alloy.

H. Moissan found that cupric oxide is decomposed when heated in the electric furnace, and A. Guérout also claims to have decomposed the same oxide in a sealed tube at 280°. Several organic salts of copper are decomposed into the metal when heated. For example, P. A. Adet, C. Gehlen, A. Vogel, R. Chenevix, and B. le Roux obtained a mixture of copper and carbon by heating the acetate. According to A. Angel and A. V. Harcourt, the decomposition begins between 150° and 160°; and it is completed at about 330°. C. Gehlen likewise heated the formate, and found the product to be free from carbon. J. W. Döbereiner, P. L. Dulong and J. Pelouze obtained the metal by heating the oxalate; L. A. Planehe, and J. B. Trommsdorff by heating the tartrate; J. Pclouze and H. Engclhardt, by heating the lactate; F. Wöhler and J. von Liebig, by heating a mixture of cuprous chloride, ammonium chloride, and sodium carbonate; A. Gautier, by heating its sulphide with water-vapour.

A. Osann obtained the metal by heating to redness cuprous or cupric oxide, or copper carbonate in a stream of *hydrogen, carbon monoxide, or coal gas*. The reactions have been studied by W. Müller, F. Glaser, C. R. A. Wright and co-workers, I. L. Bell, E. D. Campbell, and W. Spring. According to L. Pfaundler, a mixture of copper and carbon is formed when coal gas is used; and E. D. Campbell found the reduction of cupric oxide begins between 315°–325° with *ethylene*; between 270°–280° with *propylene*; and between 320° and 340° with *butylene*. G. Gore reduced heated cupric chloride with coal gas; and W. Spring, with hydrogen. P. Sabatier and J. B. Senderens reduced nitrocopper, Cu_2NO_2 , with carbon monoxide; W. R. Hodgkinson and C. C. Trench reduced cupric sulphate at 400° with *ammonia*; and D. Stickney, A. Liversidge, and W. M. Hutchings reduced the two sulphides with hydrogen. According to S. U. Pickering, the reaction proceeds at 600° with hydrogen and with carbon monoxide. O. Löw reduced heated copper oxide with *petroleum ether*. G. Bruhns reduced the heated oxide with the vapours of *methyl or ethyl alcohol*—the former acts better than the latter, and, according to L. Pfaundler, the product contains some carbon and hydrogen—A. Guérout used dried *ether*; T. Weyl, *formic acid*; A. Gautier, *water-vapour*; and R. Brauns, *carbon dioxide or sulphuric acid*—P. N. Raikow objects that carbon dioxide will not do the work.

E. Beckmann² reduced the oxide or sulphide with *calcium*; F. M. Perkin and L. Pratt, with *calcium hydride*; and B. Neumann and A. Frölich, with *calcium carbide*. The reaction with calcium carbide has been studied by F. von Kügelgen, S. Fränkel, H. Schillbach, N. Tarugi, H. N. Warren, L. M. Bullier, H. C. Gelmuyden, etc. B. Neumann reduced with *silicon carbide*; H. Moissan used *boron*; J. P. Schweder, and E. Donath, *iron*; C. R. A. Wright and A. P. Luff, M. Lazowsky, J. Garnier, and A. C. Becquerel, *carbon*; C. Winkler, *magnesium*; G. L. de Chalmot, *zinc*; J. L. Sammis, *lead*; A. G. Betts, *aluminium*; J. N. Pring, *aluminium carbide*; and F. Ephraim, *sodium amide*.

Cuprous oxide is decomposed into copper and cupric sulphate by boiling with dil. sulphuric acid; and cuprous nitrate is decomposed into copper and cupric nitrate. F. Gaud³ heated Fehling's soln. (*q.v.*) with alcohol in a sealed tube, and P. Cazeneuve heated the formate or oxalate with ammonia under similar conditions for 5 hours at 156°, when microscopic crystals of the metal were obtained. T. Spencer obtained crystals of copper by allowing copper to stand partially immersed in a soln. of cupric sulphate and partially in one of sodium chloride. F. Clément, H. de Sénarmont, J. P. Wagner, and C. Wertz allowed wood to stand for a long time in contact with a dil. soln. of a cupric salt, and obtained cubes, octohedra, and long four-sided columns of the metal. Cupric or cuprous oxides or salts are reduced to the metal by many other agents—*e.g.* F. Wöhler reduced a warm cupric acetate soln. with *sulphur dioxide*. A. Étard, C. Geitner,

L. P. de St. Gilles, P. Berthier and A. Vogel obtained crystals of the metal by heating the sulphite with water in a sealed tube between 180° and 200°. G. Gin and A. Étard reduced a soln. of copper sulphite by heating it in a sealed tube under press.

C. F. Schönbein, P. Schützenberger, J. Meyer, and O. Brunck reduced an acid soln. of cupric chloride with *sodium hyposulphite*, $\text{Na}_2\text{S}_2\text{O}_4$, cuprous chloride was first deposited, then copper—some sulphide is also formed. F. Wöhler, C. F. Rammelsberg, reduced cupric salts with *phosphorous acid*—L. Amat obtained octohedral crystals of the metal from a soln. of cupric hydrophosphite, CuHPO_3 , in phosphorous acid. According to C. F. Rammelsberg, *phosphites* act but slightly if at all; *barium hydrophosphite*, BaHPO_3 , acts only in the presence of an acid; and, according to A. Sabanejeff, *ammonium dihydrophosphite*, $(\text{NH}_4)\text{H}_2\text{PO}_3$, does not reduce in alkali soln.; the reducing action of *hypophosphites* and *hypophosphorous acid* has been investigated by C. F. Rammelsberg, E. J. Bartlett and W. Merrill, W. Gibbs, and A. Sabanejeff. T. Curtius and F. Schrader, E. Knövenagel and E. Ebler, and E. Riegler reduced cupric salt soln. with *hydrazine sulphate* in alkaline soln.; in acid soln. a pale blue cupric hydrazine sulphate is formed. H. N. Holmes prepared fine tetrahedra of copper by adding cupric sulphate to silica jelly, and covering the mixture with a soln. of hydroxylamine hydrochloride.

According to E. Lenssen, F. Weil, T. Leykauf, and F. Kessler and J. Löwenthal, *stannous chloride* precipitates cuprous chloride from cupric chloride soln. and an excess of the reagent gives metallic copper as well; but ammoniacal soln. are not reduced. A. Lottermoser obtained crystals of copper by allowing cold soln. of cupric and stannous chlorides to stand in contact with sodium citrate. The reduction of cupric by *ferrous salts* has been symbolized: $\text{FeCl}_2 + \text{CuCl}_2 \rightleftharpoons \text{CuCl} + \text{FeCl}_3$, followed by: $\text{FeCl}_2 + \text{CuCl} \rightleftharpoons \text{Cu} + \text{FeCl}_3$. Hence the precipitation of metallic copper by soln. of ferrous salts is a reversible reaction, and the formation of metallic copper is determined by the relative conc. of the four salts: ferric, ferrous, cupric, and cuprous chlorides. This explains some apparently contradictory reports which have been made as to the behaviour of mixed soln. of ferrous and cupric sulphate; some report the formation of metallic copper, others deny this. If the ferric salts have an appreciable conc. they will dissolve metallic copper. The tendency of ferrous salts to reduce cupric salts is shown in the precipitate of cuprous thiocyanate by the action of ammonium thiocyanate on a soln. of ferrous and cupric chlorides; and cuprous chloride is formed when cupric oxide is treated with ferrous chloride. Ferrous salts can reduce alkaline soln. of cupric salts to the metal; for instance, J. M. Eder obtained copper from the cupric acetate or from alkali ferrous oxalate; and A. Müller, and F. Wibel obtained crystalline plates by warming cupric and ferrous sulphates with alkali hydroxide or wollastonite. The reaction has been studied by H. C. Biddle, E. Braun, A. Levöl, A. Job, F. Herrmann, E. Müller and F. Kapeller, and H. R. Ellis and W. H. Collier. The last-named find that when ammonia is added to copper sulphate soln., the distinctive blue coloration is not obtained or is rendered indistinct if ferrous sulphate is present. If an excess of ferrous sulphate be present, no coloration is produced, whilst the iron is precipitated as ferrous and ferric hydroxides; the soln. contains cuprous compounds, and a small quantity is present in the precipitate. The production of the ferric hydroxide is brought about by the oxidizing action of the compound $\text{CuSO}_4 \cdot 5\text{NH}_4\text{OH}$, and the amount of oxidation is proportional to the amount of this substance present. Complete oxidation is brought about when both the copper and ammonia are present in excess. No action takes place between ferrous sulphate and copper sulphate soln. in the cold, but, on boiling, the copper sulphate slowly oxidizes the ferrous hydroxide produced by hydrolysis. Various sugars also reduce the salt soln. to the metal, as in the preparation of cuprous oxide from cupric salts when the reduction is carried to an end (*q.v.*).

Electrolytic copper is usually crystalline. G. Bird⁴ obtained crystals of copper by connecting a zinc plate, dipping in a soln. of sodium chloride, with a copper

plate, dipping in a soln. of cupric sulphate. The latter was contained in a porous pot dipping in the sodium chloride soln. H. N. Warren obtained cubic crystals of the metal by a similar process. Crystals of copper are also found in some galvanic cells containing a copper element, which have stood for some months.

The electro-refining of copper is based upon the older process of electroplating. As far back as 1801,⁵ it was known that if silver be made the negative pole in a soln. of copper sulphate, the silver receives so tenacious a coating of copper that the latter can be burnished; and L. Brugnatelli (1805) gilded silver medals by making them the negative poles in a soln. of gold chloride. E. Davy also stated that in 1830, he gilded, silvered, coppered, and tinned various metals by the voltaic battery. G. R. and H. Elkington, A. Parkes, and O. W. Barratt developed soln. for the electro-deposition of metals, but, prior to 1840, the deposits were thin, with a more or less frosted appearance. The process of electroplating did not meet with commercial success until the use of potassium cyanide had been discovered. The patent by G. R. and H. Elkington (1840) for electroplating copper and its alloys with silver or gold and of iron with copper, by means of an electrolyte containing potassium cyanide, was based on the work of J. Wright, who found in the use of this agent the solution of the problem of electro-depositing bright films of metal. J. Wright, in turn, obtained the hint from C. W. Scheele's memoir, *De materia tingente cœrulei Berolinensis* (1783):

It is remarkable that our colouring matter (hydrocyanic acid), after it has united with the alkali, or with the lime, forms a menstruum, capable not only of dissolving metallic calxes, but also of constituting a triple salt, which is not decomposed by the aerial acid, as happens with the *lixivium sanguinis* (aq. soln. potassium cyanide) and the precipitating liquor, when exposed to the free access of air. Iron is not the only metal which has the property of fixing the colouring matter, the same quality belongs likewise to gold, silver, copper, and probably to several other metallic calxes; for if, after these calxes have been precipitated, a sufficient quantity of precipitating liquor be added, in order to redissolve them, the soln. remains clear in the open air, and in this state the aerial acid does not precipitate the metallic calx.

In **electrotyping**, a coating of copper is deposited on suitable objects by making them the cathode in a soln. of copper sulphate with copper plates as anodes, and, as shown by W. de la Rue in 1836, when the copper plate is stripped off, it has the counterpart of every mark or scratch which was on the original. T. Spencer, and M. H. Jacobi applied the idea in 1838 to convert finely engraved designs on copper into relief; and so, they reproduced copper-plate engravings, medals, ornaments, etc. The process was employed for reproducing patterns for wall papers, making rollers for calico printing, etc. The principle has been adopted for reproducing statues, busts, and casts of models in gypsum or guttapercha. The original is first coated with oil and graphite to make the surface electrically conducting, and then made the cathode in an electrolyte of a copper salt. After a sufficient thickness of metal has been deposited, the interior plaster can be removed. Iron can be coated with copper by dipping it in an alkaline soln. of copper cyanide, and, if necessary, continuing the process electrically with copper sulphate as electrolyte. One of the best electrolytes is made by dissolving 3.13 grms. of copper sulphate in water; adding ammonia until the precipitate redissolves, forming a deep blue soln.; adding potassium cyanide until the blue colour of the soln. disappears; and diluting with water to make 500 c.c. of liquid.⁶

According to W. D. Bancroft, in the electroplating of metals, (1) Bad deposits are due to excessive admixture of some compound or to excessively large crystals. (2) Excessive admixture of any compound may be eliminated by changing the conditions so that the compound cannot precipitate. (3) Increase of the current density, or increase of the potential difference at the cathode, or depression of the temp. decreases the size of the crystals. (4) The size of the crystals is diminished when substances adsorbed by the deposited metal are present at the cathode surface. (5) If a given soln. will yield a good deposit at

any given current density, it will yield a good deposit at any higher current density provided that the conditions at the cathode surface are kept constant. (6) Treering is facilitated by a high fall of potential through the soln. and by conditions favourable to the formation of large crystals. W. Blum found that these observations are applicable over a wide range of conditions, and to a variety of metals. W. E. Hughes regards the polished appearance often observed with metallic deposits formed upon rotating cathodes is due to the smallness of the grains composing the deposit. The smallness of the grain appears to be the result of constancy of the concentration of the metal at the surface of the cathode, and this constancy to be the result of the movement of the cathode and not of any burnishing action, as has been suggested.

The metallic precipitation of copper.—Near the beginning of the fourth century, Zosimus mentioned that when iron is immersed in a soln. of a copper salt, the iron acquires a coating of copper. In the sixteenth century, Paracelsus⁷ precipitated silver from silver nitrate by inserting a plate of copper in the soln., and he noted that the copper is at the same time attacked by the liquid. To the alchemists of the Middle Ages, the precipitation of copper which occurs when a piece of iron is placed in a soln. of copper in aqua fortis appeared to be a veritable transmutation of iron into copper. T. Bergman, in his *De præcipitatis metallicis*, near the middle of the eighteenth century, noted that “the metals precipitate one another after a certain order . . . which is constant and never inverted . . . zinc prevails over iron, iron over lead, lead over tin, tin over copper, copper over silver, silver over mercury, etc.”; and, in his *De attractionibus electivis* (Upsala, 1775), he added :

Since, therefore, metallic solutions are of such a nature, that they cannot restore to its metallic splendour what they hold dissolved, without the accession of a new portion of phlogiston, it is self-evident, as well as conformable to experiment, that this cannot be effected by the addition of calces. If, therefore, ochre be put into a solution of vitriol of copper, no copper will be precipitated; but iron added to the solution is soon observed to be covered with a cupreous pellicle; for it yields part of its phlogiston, which is necessary to the reduction of the copper, and by this means becomes itself soluble without the emission of any inflammable air.

N. W. Fischer,⁸ in his *Das Verhältniss der chemischen Verwandtschaft zur galvanischen Electricität in Versuchen dargestellt* (Berlin, 1830), noted that in cupric nitrate soln. the metal is deposited with decreasing rapidity by zinc, lead, tin, and cadmium. The precipitation of copper by iron was regarded as a simple replacement of the one metal by the other: $\text{Fe} + \text{CuSO}_4 = \text{Cu} + \text{FeSO}_4$; but, in 1857, W. Odling showed that this is not the case, for an eq. of cadmium will completely extract the copper from a soln. of the neutral chloride containing much more than an eq. of copper. J. B. Senderens examined ninety cases of metal precipitation from salt soln. by aluminium, arsenic, cadmium, iron, lead, magnesium, manganese, molybdenum, nickel, palladium, silver, tin, tungsten, uranium, zinc, and by a number of alloys. The precipitation is not always complete, and only in about eleven per cent. of the cases examined was the quantity of metal precipitated approximately eq. to the amount of metal dissolved, and in only one case was the equivalency exact.

According to F. Hiller,⁹ and J. T. A. Mallet, if copper sheet be dipped in a soln. of cupric nitrate, some crystals of copper and of cuprous nitrate are formed; the sulphate does not act so well, although F. Förster and O. Seidel, F. Fischer, F. Wibel, C. Häussermann, and H. Wohlwill obtained crystals of copper by heating the finely divided metal with a feebly acid conc. soln. of the sulphate. G. Quincke, and J. H. Gladstone and A. Tribe also obtained crystals of the metal by dipping copper rods in molten cupric or cuprous chloride. R. M. Caven further observed that in the action of soln. of cupric sulphate on precipitated copper at atm. temp., small quantities of cuprous oxide are produced, and that the conc. of the soln. has little influence on the result. In accord with a suggestion by E. Divers, it is assumed that the cupric sulphate is reduced to cuprous sulphate, which in turn is hydrolyzed to

cuprous oxide, $\text{Cu}_2\text{SO}_4 + \text{H}_2\text{O} \rightleftharpoons \text{Cu}_2\text{O} + \text{H}_2\text{SO}_4$, for if much chalk be also present, the acid product of the hydrolysis is neutralized, and is prevented from accumulating in the system, a comparatively large proportion of cuprous oxide is formed. There is also the decomposition of the cuprous sulphate: $\text{Cu}_2\text{SO}_4 = \text{Cu} + \text{CuSO}_4$, which occurs in acid soln. According to M. C. Lea, finely divided silver reduces cupric chloride, but not the nitrate.

Copper is rapidly precipitated from soln. of its salts by magnesium.¹⁰ According to J. Thomsen, the thermal value of the substitution of copper in an aq. soln. of cupric sulphate by magnesium is 124.22 Cals.; by zinc, 50.13 Cals.; and by iron, 37.24 Cals. J. Thomsen's data for the formation of nitrates and sulphates by the action of an aq. soln. of the acid on the metal are collected in Table III. The data

TABLE III.—HEATS OF FORMATION OF SULPHATES AND NITRATES BY THE DISSOLUTION OF THE METAL IN THE ACID.

E	Heats of formation in calories.		E	Heats of formation in calories.	
	(R, O, SO ₃) _{aq.}	(R, O, N ₂ O ₅) _{aq.}		(R, O, SO ₃) _{aq.}	(R, O, N ₂ O ₅) _{aq.}
K ₂	195,850	192,100	Co	88,070	84,540
Na ₂	186,640	182,620	Ni	86,950	83,420
Li ₂	197,810	194,010	Pb	—	68,070
Sr	188,490	185,410	Tl ₂	70,290	66,540
Ca	180,409	177,160	Cu	55,960	52,410
Mg	180,180	176,480	Hg ₂	—	30,650
Mn	121,250	117,720	Hg	—	28,400
Zn	106,090	102,510	Ag ₂	20,390	16,780
Fe	93,200	89,670	$\frac{3}{2}$ Al	150,630	—
Cd	89,880	86,000	$\frac{3}{2}$ Fe	74,990	—

not only enable the heats of soln. of the metal in dil. sulphuric acid with the evolution of hydrogen to be determined, but also the heat of decomposition of a soln. of a salt of one metal by a salt of another metal. For instance, what is the thermal effect of the dissolution of zinc in dil. sulphuric acid? Here, $(\text{Zn, O, SO}_3)_{\text{aq.}} - (\text{H}_2, \text{O}) = 106.09 - 68.36$, or 37.73 Cals. Again, what is the heat of decomposition of a soln. of copper sulphate by metallic iron? Here, $(\text{Fe, O, SO}_3)_{\text{aq.}} - (\text{Cu, O, SO}_3)_{\text{aq.}} = 93.2 - 55.96$; or 37.24 Cals. As J. Thomsen has shown, however, the results in many cases may be illusory because of secondary reactions—*e.g.* the precipitate, A, and precipitant, B, may form a galvanic couple whereby more of B is dissolved than corresponds with A precipitated; insoluble sulphates may be formed as is the case with lead and barium salts, etc. With silver, copper, and gold, reduction by magnesium is the more energetic the greater the at. wt. of the metal—thus cuprous oxide reduces easily, whilst silver oxide is reduced with explosive violence. Aurous oxide breaks down into its constituents below the ignition point of magnesium.

A. Schmidt noted that magnesium precipitates all the copper as metal from an acid soln. of cupric sulphate; the greatest part of the copper from an acid soln. of cupric chloride; with an ammoniacal soln. of cupric chloride and an excess of magnesium, the blue colour soon disappears, and about 57 per cent. of the copper is precipitated as metal, while the remainder forms cuprous chloride; and with neutral soln. of cupric chloride, a green basic cupric chloride is precipitated and some cuprous hydroxide is formed which passes into cuprous oxide when the soln. is warmed. In 1866, A. Commaillé showed that cuprous oxide and chloride are respectively formed during the reduction of soln. of cupric sulphate and chloride, along with basic cupric salts. He attributed the evolution of hydrogen to the decomposition of water by the copper-magnesium couple in which the very electro-positive metal magnesium is involved. In 1827, G. Wetzlar suggested that when

zinc is used, the precipitated copper forms a *galvanische Kette*. A. Commaille gave an equation which, in modern notation, is $6\text{CuSO}_4 + 5\text{Mg} + 3\text{H}_2\text{O} = 5\text{MgSO}_4 + \text{CuSO}_4 \cdot 2\text{CuO} + \text{Cu}_2\text{O} + \text{Cu} + 3\text{H}_2$, and which may be regarded as his attempt to represent the relation between the relative proportions of magnesium and cupric sulphate consumed, and the products of the reaction at the temp. and soln. conc. employed. W. A. Tilden assumed that the first action of the acid results in the precipitation of copper which formed a couple with the magnesium. Hydrogen is accordingly evolved, and a crust of magnesia formed on the surface of the metal. The former reduces some of the cuprous salt, the magnesia is hydrolyzed, the cuprous salt forming cuprous oxide and a basic cupric salt. E. Divers showed that hydrogen does not reduce soln. of cupric salts, and it is necessary to postulate the existence of an active nascent hydrogen. The latter assumption is unnecessary because zinc reduces chromic to chromous sulphate with the evolution of hydrogen; and with alum soln. also, zinc evolves hydrogen, and precipitates a basic sulphate. It is therefore claimed that the first reaction is more probably that symbolized: $\text{Mg} + 2\text{CuSO}_4 = \text{Cu}_2\text{SO}_4 + \text{MgSO}_4$. R. M. Caven favours Divers' interpretation that the hydrolysis of the cuprous sulphate is the source of the cuprous oxide and sulphuric acid: $\text{Cu}_2\text{SO}_4 + \text{H}_2\text{O} = \text{Cu}_2\text{O} + \text{H}_2\text{SO}_4$; this agrees with F. Förster's observation that the cuprous oxide formed during the electrolysis of conc. soln. of cupric sulphate is due to the formation and hydrolysis of cuprous sulphate. The small amount of metallic copper which is formed, is probably due to the decomposition of the cuprous sulphate: $\text{Cu}_2\text{SO}_4 = \text{Cu} + \text{CuSO}_4$, in the action of dil. sulphuric acid on cuprous oxide: $\text{Cu}_2\text{O} + \text{H}_2\text{SO}_4 = \text{H}_2\text{O} + \text{Cu} + \text{CuSO}_4$. With hot soln. (100°) less copper is produced than with cold sat. soln. The copper is mixed with cuprous oxide and imbedded in a mixture of magnesia and basic cupric sulphate. With cold dil. soln., no free acid can be present because the formation of magnesia and basic cupric sulphate is observed from the beginning of the reaction; with conc. soln. hot or cold, the basic products first formed are redissolved by the sulphuric acid. C. Brückner heated magnesium powder with solid cupric sulphate and observed as products of the reaction: copper, cuprous oxide, cupric sulphide, and thiosulphate, sulphur, and sulphur dioxide.

G. Wetzlar found that zinc precipitates copper from cupric salts even when they contain a large excess of acid; black copper contaminated with zinc is first precipitated and afterwards red copper, because the precipitate, as it increases, falls away from the zinc, and forms a galvanic couple, which results in the zinc being dissolved. In boiling feebly acid soln., D. M. Levy found the copper is quantitatively precipitated, better with zinc than with aluminium. A. Schmidt obtained similar results with zinc and soln. of cupric salts as with magnesium. L. Meyer attributed the evolution of hydrogen during the reaction with neutral soln. to the formation of a copper-zinc couple. He did not observe the formation of any cuprous oxide. T. Leykauf says that much hydrogen is evolved when the reaction occurs at 90° , and some cupric oxide is formed. From the work of R. M. Caven, it is probable that the mechanism of the reaction is similar to that with magnesium, but with zinc a much smaller quantity of cuprous oxide is produced. A. J. J. van de Velde found that more zinc is dissolved than is eq. to the copper precipitated; that the degree of hydrolysis or ionization has no effect on the substitution of copper by zinc; and that chlorine ions accelerate the reduction while sulphate retards the action; A. J. J. van de Velde and C. E. Wasteels noted that alcohol and cane sugar decrease the speed of the reaction at the beginning.

The reaction has been investigated by N. N. Beketoff, J. C. Shengle and E. F. Smith, J. H. Gladstone and A. Tribe, F. Mylius and O. Fromm, J. J. Sudborough, J. B. Senderens, etc. W. K. J. Schoor says cupric hydride is precipitated from acid soln. of the sulphate; L. Meyer and L. Sostegni, basic zinc sulphate; and R. M. Caven found that in hot soln. cuprous sulphate is formed. N. W. Fischer found cuprous chloride as well as copper is precipitated from soln. of cupric chloride. N. W. Fischer reduced an alcoholic soln. of cupric nitrate with zinc. A. Destreiz

noted that with the salts with the strong acids, the pulverulent precipitate is chestnut-brown or black, while feebly alkaline salts—*e.g.* ammonium cupric sulphate—give a red coherent mass. O. Sackur did not get a precipitation of copper with soln. of cupric cyanide or thiocyanate, and F. Spitzer measured the differences of potential between copper and soln. of cuprous potassium cyanide with varying amounts of potassium cyanide, and between zinc and soln. of zinc potassium cyanide under similar conditions. The soln. are all positive to the metal. R. Lorenz electrolyzed fused soln. of zinc and cupric chloride, and obtained as products zinc, copper, and cuprous chloride. N. W. Fischer, and H. Pécheux have studied the action of copper-zinc and silver-zinc alloys; they do not reduce cupric salts. N. W. Fischer, J. B. Senderens, and W. Odling have studied the action of cadmium. The results are much the same as with zinc.

The reduction with zinc or cadmium is sometimes employed in the analysis of soln. of cupric salts. R. Böttger freed the precipitated copper from the more electropositive metal by washing it with dil. sulphuric acid, then with water, and drying it below 75° in air, or in a stream of hydrogen. Aluminium or iron have also been recommended, but these metals may contaminate the precipitated copper with impurities which do not wash out so readily. O. N. Heidenreich¹¹ precipitated soln. of copper salts in dil. hydrochloric acid with aluminium, and G. E. Perkins found the reaction to be quantitative in soln. acidified with sulphuric acid, and an excess of aluminium. A. Cossa found the reaction with soln. of the chloride occurs immediately; it is slower with the acetate, and it begins immediately with soln. of the sulphate or nitrate only if some alkali chloride is present; if the two last-named soln. are pure, the reaction is very slow. J. B. Senderens and D. Tommasi noted the formation of hydrogen in the reduction and the formation of a basic salt. N. Tarugi studied cuprous sulphite soln. B. Setlik obtained a film of copper on aluminium by the action of the latter on a feebly acid soln. of cupric lactate. C. Göttig, F. Weil and D. M. Levy, M. Lansaigne and M. Leblanc, C. Margot, C. T. J. Oppermann, have studied the plating of aluminium with copper. C. Formenti and M. Levi studied the action of aluminium on molten cupric salts as well as on their aq. soln. A. G. Betts separated copper from the molten chloride by means of aluminium.

As previously indicated, the precipitation of copper from soln. of its salts by iron was known in the Middle Ages, and the reaction attracted the attention of T. Bergman, N. W. Fischer, G. Wetzlar, J. B. Senderens, and many others.¹² The reaction in many respects resembles that with zinc. With a cold soln. of cupric sulphate, J. B. Senderens found that hydrogen is evolved, but R. M. Caven obtained no gas with fine iron wire containing an almost imperceptible trace of carbon. The residual copper always contained a trace of cuprous oxide, the soln. was distinctly acid, and the iron in soln. was all in the ferrous condition. Hence it is inferred that the reaction is similar in type to that which occurs with zinc, and that consequently some cuprous sulphate is formed and hydrolyzed. With hot soln. of cupric sulphate of all conc., hydrogen is evolved and the residue consists of cuprous oxide mixed with metallic copper. In the first stage of the latter reaction flecks of orange-coloured hydrated ferric oxide are formed, but these dissolve in the acid and the soln. is reduced to the ferrous state.

G. Wetzlar, J. L. Lassaigne, D. W. Peck, and P. Harting noticed that copper precipitated from neutral soln. may be contaminated with iron; R. M. Caven found a little cuprous oxide and sulphate are formed in cold dil. soln., and no hydrogen is evolved if the iron is well purified. According to J. L. Lassaigne, a soln. of cupric sulphate with one part of copper in 25,000 parts of soln. gives a red deposit on iron in 2 hrs., but with one part of copper in 50,000 to 100,000 parts of soln., no coloration can be detected. C. Paul obtained a precipitate from ammoniacal cupric salts. N. W. Fischer found that with cupric chloride soln., both cuprous chloride and copper are precipitated; and G. Wetzlar noted that alcoholic soln. are also reduced. X. Landerer obtained crystals of copper by boiling steel with a soln. of cupric

chloride acidified with hydrochloric acid. C. Paul, and J. B. Senderens studied the action of iron on soln. of cupric nitrate and acetate. G. Wetzlar noted that at 100° copper is rapidly and completely precipitated from soln. of the acetate; according to G. Wetzlar, ammonium cupric oxalate gives a compact precipitate if air be excluded, but if air be present, the precipitation is retarded; and O. Gaudoin studied the precipitation of copper from soln. of potassium cupric oxalate; G. Wetzlar obtained what he called an alloy (mixture?) of copper and iron by placing iron in a soln. of cupric tartrate; and C. Reiss obtained no reduction with potassium cupric tartrate soln. G. Wetzlar, and N. W. Fischer found that passive iron does not precipitate copper from soln. of the cupric salts. The presence of a little silver nitrate was found to make the iron passive, but, according to W. Heldt, iron made passive with nitric acid of sp. gr. 1.45-1.54, or with platinum in an acid of sp. gr. 1.4, precipitates copper well. W. Heldt also found if the surface of the iron has a film of mercurous nitrate, carbon, or magnetic oxide of iron, its activity is retarded. F. Wöhler obtained no precipitation by treating cupric salts with meteoric iron. O. C. Farrington studied the precipitation with nickel-iron alloys. I. Remsen noticed that copper was deposited on a plate of iron, lying between the poles of a magnet, in such a way that the precipitate forms in lines perpendicular to the lines of magnetic force. C. J. Descharme, F. A. Wolff, and E. Colardeau also studied the effect of a magnetic field on the precipitation, and P. A. M. Janet says that possibly less heat is developed during the precipitation if the iron be magnetized. F. Giolitti studied the etching of polished steel with cupric sulphate soln.

According to M. le Blanc and M. G. Levi,¹³ nickel does not precipitate any copper from a 2 per cent. soln. of cupric sulphate in 30 hrs., but with a 2 per cent. soln. of cupric chloride some nickel passes into soln., and cuprous chloride is formed. J. B. Senderens made a similar observation with respect to the chloride. According to W. D. Bancroft, "copper does not precipitate nickel to any appreciable extent when immersed in a copper sulphate soln. The nickel becomes passive, and is probably covered with a thin film of oxide." E. Günther obtained a deposition of copper from an acid soln. of cupric sulphate and finely divided copper reduced by hydrogen. N. W. Fischer found that if a copper-nickel alloy be treated with an excess of nitric acid, the undissolved portion remains covered with a film of copper. J. B. Senderens found that cobalt, unlike nickel, readily reduces soln. of cupric salts; O. Prelinger, that powdered and purified manganese separates copper from aq. soln. of its salts; and A. C. Chapman, that palladium reduces cupric salts to the cuprous state, and with a prolonged action, to copper. According to E. F. Smith, copper is also precipitated by molybdenum and by tungsten; and C. Zimmermann also noted the reducing action of uranium.

F. Wöhler¹⁴ and W. Wicke obtained crystals of metallic copper mixed with copper phosphides by allowing sticks of phosphorus to stand some months in contact with copper wires under a soln. of copper sulphate. This reaction was studied by L. F. Boeck in 1804. A. Vogel noted that the cupric salt soln. is completely decolorized in a few days. According to R. Böttger, copper is first precipitated from boiling soln. of cupric sulphate, and afterwards transformed into phosphide. M. Sidot noted that when the copper is nearly all precipitated, hydrogen begins to appear, possibly from the decomposition of phosphine formed in the reaction—W. Straub tried to follow the mechanism of the reaction. A stick of yellow phosphorus becomes black when immersed in a soln. of cupric sulphate. The black deposit is copper phosphide, and when removed from the soln. it does not react with atm. oxygen. The black coating is covered by a red film owing to the deposition of copper, and this continues so long as the copper and phosphorus are present. As the reaction proceeds, the phosphoric acid in soln. increases. There is a constant relationship between the quantity of phosphorus which passes into soln. and the amount of reduced metal, provided oxygen is rigorously excluded and the reaction is not carried to an end. At the point where the reaction is just complete, the soln. contains sulphuric acid and phosphoric acid in the proportion

1:0.5, and consequently one molecule of phosphorus separates two molecules of copper from the copper sulphate soln.; the oxygen which oxidizes the phosphorus must come from the water because the amount of sulphuric acid undergoes no diminution. The reduced copper is not acted on by the sulphuric acid, but is oxidized by the atm. oxygen, and the copper oxide dissolves to form copper phosphate, which is then reduced to phosphide. The dark film on the phosphorus is produced in a soln. containing only one mol of crystallized copper sulphate in 100,000 litres of water, and at a dilution 10 times as great, the film is produced in the course of two months.

M. Kohn¹⁵ found that when Fehling's soln., etc. are heated in sealed tubes alkaliine soln. of copper salts, they are rapidly reduced by antimony, arsenic, or bismuth. C. Strzyzowsky found Fehling's soln. (*q.v.*) is reduced at 50° by **arsenic**, and according to M. H. Descamps an arsenide is formed. Fehling's soln. is not reduced under similar conditions by **antimony**, and J. B. Senderens found that antimony has virtually no action, although it becomes covered with an unweighably thin film of the metal which acquires an indigo blue colour by oxidation. N. W. Fischer and J. B. Senderens found a boiling soln. of cupric nitrate to be imperfectly reduced by **bismuth**; cuprous chloride and bismuth oxychloride are formed. H. Pécheux studied the action of bismuth-aluminium alloys. G. Wetzlar¹⁶ found that tin precipitates copper from the chloride, nitrate, and sulphate, but not from the acetate. N. W. Fischer noted that with the nitrate, some stannic oxide is formed. J. B. Senderens says that the precipitation from conc. soln. of cupric chloride is slow but complete, and that some stannous hydroxychloride, $\text{Sn}(\text{OH})\text{Cl}$, is formed. G. Wetzlar noted that lead precipitates copper from soln. of the sulphate; J. B. Senderens from soln. of the acetate; dil. soln. of the chloride; but not from the nitrate. N. W. Fischer said that copper is slightly precipitated from nitrate soln., and he studied the precipitation by the addition of alloys of silver and tin or lead.

REFERENCES.

¹ H. Moissan and T. Watanabe, *Compt. Rend.*, **144**, 17, 1907; A. Guérout, *ib.*, **79**, 221, 1874; P. Sabatier and J. B. Senderens, *ib.*, **116**, 757, 1893; A. Gautier, *ib.*, **142**, 1465, 1906; A. Étard, *ib.*, **93**, 725, 1881; H. Moissan and A. J. P. O'Farrelly, *ib.*, **138**, 1659, 1904; *Bull. Soc. Chim.*, (3), **31**, 1022, 1904; (3), **35**, 261, 1906; C. Féry, *Ann. Chim. Phys.*, (7), **28**, 428, 1903; H. Moissan, *ib.*, (7), **4**, 136, 1895; J. Pelouze, *ib.*, (2), **49**, 112, 1832; (3), **13**, 256, 1845; A. Reynoso, *ib.*, (3), **48**, 385, 1856; P. A. Adet, *ib.*, (1), **27**, 299, 1798; R. Chenevix, *ib.*, **69**, 5, 1809; C. Watt, *Brit. Pat. No.* 10441, 1844; F. Braun, *Ann. Physik*, (4), **17**, 359, 1905; T. Weyl, *Ber.*, **15**, 604, 1139, 1882; A. Vogel, *Journ. Pharm. Chim.*, **1**, 339, 1815; G. Bruhns, *Zeit. öffent. Chem.*, **3**, 573, 1897; C. Gehlen, *Schweigger's Journ.*, **4**, 23, 1812; J. W. Döbereiner, *ib.*, **23**, 66, 1818; P. L. Dulong, *ib.*, **17**, 229, 1816; H. Engelhardt, *Liebig's Ann.*, **70**, 241, 1849; F. Wöhler and J. von Liebig, *Pogg. Ann.*, **21**, 582, 1831; A. Osann, *ib.*, **52**, 406, 1841; W. Müller, *ib.*, **136**, 51, 1869; C. R. A. Wright and A. P. Luff, *Journ. Chem. Soc.*, **33**, 1, 1878; C. R. A. Wright and A. E. Menke, *ib.*, **37**, 791, 1880; S. U. Pickering, *ib.*, **39**, 401, 1881; E. D. Campbell, *Amer. Chem. Journ.*, **17**, 681, 1895; D. Stickney, *ib.*, **13**, 502, 1896; I. L. Bell, *Chem. News*, **23**, 258, 1871; W. R. Hodgkinson and C. C. Trench, *ib.*, **66**, 223, 1892; A. Liversidge, *ib.*, **35**, 68, 1877; W. M. Hutchings, *ib.*, **35**, 117, 180, 1877; G. Gin, *ib.*, **88**, 5, 1903; W. Spring, *Zeit. anorg. Chem.*, **1**, 240, 1892; F. Glaser, *ib.*, **36**, 11, 1903; L. Pfaundler, *Chem. Ztg.*, **16**, 145, 1892; P. N. Raikow, *ib.*, **31**, 142, 1907; K. Heydenreich, *Zeit. anal. Chem.*, **45**, 741, 1906; O. Löw, *Neues Jahrb. Pharm.*, **21**, 340, 1864; R. Brauns, *Chemische Mineralogie*, Leipzig, **408**, 1896; B. le Roux, *Rev. Scient.*, **3**, 5, 1846; L. A. Planché, *Journ. Pharm.*, **12**, 364, 1826; J. B. Trommsdorff, *Neues Journ. Pharm.*, **3**, 1, 151, 1819; A. Angel and A. V. Harcourt, *Journ. Chem. Soc.*, **81**, 1395, 1902; G. Gore, *Pop. Science Rev.*, **1**, 327, 1862.

² H. C. Geelmuyden, *Compt. Rend.*, **130**, 1026, 1900; J. Garnier, *ib.*, **118**, 588, 1894; A. C. Becquerel, *ib.*, **74**, 83, 1872; L. M. Bullier, *ib.*, **130**, 1109, 1900; H. Moissan, *ib.*, **114**, 617, 1892; *Ann. Chim. Phys.*, (7), **6**, 314, 1895; E. Beckmann, *Ber.*, **38**, 904, 1905; C. Winkler, *ib.*, **23**, 44, 1890; F. M. Perkin and L. Pratt, *Trans. Faraday Soc.*, **3**, 179, 1907; J. L. Sammis, *Journ. Phys. Chem.*, **10**, 612, 1906; G. P. Schweder, *Berg. Hütt. Ztg.*, **38**, 82, 105, 1879; E. Donath, *Dingler's Journ.*, **236**, 327, 1880; J. N. Pring, *Journ. Chem. Soc.*, **87**, 1530, 1905; G. L. de Chalmot, *Amer. Chem. Journ.*, **20**, 437, 1898; H. Schillbach, *Zeit. angew. Chem.*, **16**, 1081, 1903; A. Frölich, *ib.*, **10**, 1178, 1899; *Chem. Ztg.*, **25**, 418, 1901; B. Neumann, *ib.*, **24**, 1013, 1900; F. von Kugelgen, *ib.*, **24**, 1060, 1900; *Zeit. Elektrochem.*, **7**, 558, 1901; F. Ephraim, *Ber.*, **44**, 185, 1905; M. Lazowsky, *Journ. Chim. Méd.*, (3), **3**, 629, 1847; *Chem. Gaz.*, **6**, 43, 1848; S. Fränkel, *Mitt. tech. Gewerbe*,

(2), 13. 128, 1903; N. Tarugi, *Gazz. Chim. Ital.*, 29. i, 509, 1899; H. N. Warren, *Chem. News*, 75. 2, 1897; A. G. Betts, *German Pat.*, D.R.P. 125674, 1900.

⁸ F. Wöhler, *Liebig's Ann.*, 79. 126, 1851; W. Wicke, *ib.*, 82. 145, 1852; C. Geitner, *ib.*, 129. 350, 1864; J. Meyer, *Zeit. anorg. Chem.*, 34. 49, 1903; J. M. Eder, *Sitzber. Akad. Wien*, 81. 196, 1880; A. Müller, *Verh. Nat. Ges. Basel*, 434, 1856; L. Amat, *Ann. Chim. Phys.*, (6), 24. 319, 1891; L. P. de St. Gilles, *ib.*, (3), 42. 28, 1854; E. Riegler, *Ann. Scient. Univ. Jassy*, 1. 321, 1901; F. Wibel, *Reduktion von Kupferoxydsalzen*, Hamburg, 1864; A. Étard, *Compt. Rend.*, 93. 726, 1881; F. Gaud, *ib.*, 119. 862, 1894; P. Cazeneuve, *ib.*, 89. 525, 1879; A. Lottermoser, *Journ. prakt. Chem.*, (1), 59. 492, 1899; J. P. Wagner, *Schweigger's Journ.*, 47. 325, 1826; H. de Sénarmont, *Ann. Chim. Phys.*, (3), 32. 140, 1851; F. Clément, *ib.*, (2), 27. 440, 1824; C. Weltz, *Berg. Hütt. Ztg.*, 21. 41, 1862; T. Spencer, *Jahrb. Min.*, 230, 1840; P. Berthier, *Ann. Chim. Phys.*, (2), 7. 80, 1818; A. Levol, *ib.*, (2), 65. 320, 1837; A. Vogel, *Journ. prakt. Chem.*, (1), 29. 273, 1843; (2), 30. 39, 1843; C. F. Schönbein, *ib.*, (1), 61. 193, 1854; T. Curtius and F. Schrader, *ib.*, (2), 50. 311, 1894; E. Lenssen, *ib.*, (1), 79. 90, 1860; T. Leykauf, *ib.*, (1), 19. 125, 1840; P. Schützenberger, *Compt. Rend.*, 69. 196, 1869; F. Weil, *ib.*, 70. 997, 1870; A. Job, *ib.*, 127. 59, 1898; O. Brunck, *Liebig's Ann.*, 327. 243, 1903; C. F. Rammelsberg, *Sitzber. Akad. Berlin*, 572, 1872; *Journ. Chem. Soc.*, 26. 13, 1873; A. Sabanejeff, *Zeit. anorg. Chem.*, 17. 485, 1898; E. Ebler, *ib.*, 47. 371, 1905; E. J. Bartlett and W. Merrill, *Amer. Chem. Journ.*, 17. 185, 1895; H. C. Biddle, *ib.*, 26. 377, 1901; W. Gibbs, *Amer. Journ. Science*, (2), 44, 210, 1867; E. Knövenagel and E. Ebler, *Ber.*, 35. 3055, 1902; F. Kessler and J. Löwenthal, *Zeit. Chem.*, 7. 602, 1864; E. Braun, *ib.*, 10. 568, 623, 1867; *Bull. Soc. Chim.*, (2), 8. 409, 1867; (2), 9. 214, 1868; F. Herrmann, *Chem. Ind.*, 30. 152, 1907; E. Müller and F. Kapeller, *Zeit. Elektrochem.*, 14. 76, 1908; H. R. Ellis and W. H. Collier, *Proc. Chem. Soc.*, 23. 264, 1907; H. N. Holmes, *Journ. Phys. Chem.*, 21. 709, 1917.

⁴ A. K. Huntington, *Trans. Faraday Soc.*, 1. 324, 1906; L. Addicks, *Electrochem. Ind.*, 3. 267, 1905; W. Hampe, *Chem. Ztg.*, 18. 1901, 1894; G. von Rath, *Pogg. Ann.*, 152. 24, 1874; W. G. Brown, *Amer. Journ. Science*, (3), 32. 372, 1886; W. Holtz, *Phys. Zeit.*, 6. 480, 1905; 7. 660, 1906; H. N. Warren, *Chem. News*, 57. 184, 1888; G. Bird, *Phil. Mag.*, (3), 10. 376, 1837.

⁵ W. de la Rue, *Phil. Mag.*, (3), 9. 484, 1836; M. H. Jacobi, *ib.*, (3), 15. 161, 1839; W. Nicholson, *Nicholson's Journ.*, 4. 179, 1800; L. Brugnatelli, *Journ. Phys.*, 62. 298, 1806; E. Davy, *Phil. Trans.*, 121. 147, 1831; G. R. and H. Elkington, *Brit. Pat. Nos.* 7134, 7304, 7496, 1836-8; 8447, 1840; O. W. Barratt, *ib.*, 7742, 1838; 9077, 1842; J. S. Woolrich, *ib.*, 9431, 1842; C. W. Scheele, *Opuscula chimica et physica*, Lipsiæ, 1. 148, 1788; R. E. Leader, *Journ. Inst. Metals*, 22. 305, 1919; C. Christofle, *Histoire de la dorure et de l'argenterie électro-chimique*, Paris, 1851; A. Smee, *Elements of Electro-Metallurgy*, London, 1842; G. Gore, *Pop. Science Rev.*, 1. 327, 1862; W. H. Carbutt, *Metal Ind.*, 6. 101, 1914; C. W. Denny, *The Electro-deposition of Copper, and its Industrial Application*, London, 1921; H. W. Doughty and B. Freeman, *Journ. Amer. Chem. Soc.*, 43. 700, 1921; T. Spencer, *Jahrb. Min.*, 230, 1840; A. Parkes, *Brit. Pat. Nos.* 1036, 1844; 835, 1887; J. Wright, *Phil. Mag.*, (5), 13. 265, 1882.

⁶ W. D. Bancroft, *Journ. Phys. Chem.*, 9. 277, 1905; 12. 75, 1908; *Trans. Amer. Electrochem. Soc.*, 6. 27, 1904; 23. 266, 1913; W. Blum, *ib.*, 36. 213, 232, 1919; W. E. Hughes, *Journ. Phys. Chem.*, 25. 495, 1921; O. W. Brown and F. C. Mathers, *ib.*, 10. 42, 1905; C. W. Denny, *The Electrodeposition of Metals*, London, 1921; F. W. Studt, *U.S. Pat. No.* 1378145, 1921; P. R. Middleton, *ib.*, 1397547, 1921.

⁷ Paracelsus, *Opera omnia medico-chimico-chirurgica*, Geneva, 1858; T. Bergman, *Opuscula physica et chemica*, Lipsiæ, 2. 349, 1788.

⁸ N. W. Fischer, *Pogg. Ann.*, 8. 492, 1826; J. Kern, *Chem. News*, 32. 309, 1875; 33. 112, 236, 1876; D. Vitali, *L'Orosi*, 18. 289, 1895; J. B. Senderens, *Bull. Soc. Chim.*, (3), 17. 271, 1897; W. Odling, *Journ. Chem. Soc.*, 9. 289, 1857.

⁹ F. Hiller, *Liebig's Ann.*, 85. 253, 1853; J. T. A. Mallet, *Amer. Journ. Science*, (2), 30. 253, 1860; F. Förster and O. Seidel, *Zeit. anorg. Chem.*, 14. 106, 1897; R. M. Caven, *Journ. Soc. Chem. Ind.*, 19. 18, 1900; F. Förster, *Zeit. Elektrochem.*, 5. 511, 1899; H. Wohlwill, *ib.*, 9. 311, 1903; F. Wibel, *Ueber die Reduktion von Kupferoxydsalzen*, Göttingen, 1864; F. Fischer, *Zeit. phys. Chem.*, 48. 177, 1904; J. H. Gladstone and A. Tribe, *Phil. Mag.*, (5), 11. 508, 1881; E. Divers, *Proc. Chem. Soc.*, 13. 57, 1898; *Chem. News*, 77. 127, 1898; G. Quincke, *Wied. Ann.*, 26. 270, 1888; C. Häusscrmann, *Zeit. ges. Schiess. Spring*, 1. 305, 1906; M. C. Lea, *Amer. Journ. Science*, (3), 44. 444, 1892.

¹⁰ J. Thomsen, *Ber.*, 7. 452, 1874; *Thermochemische Untersuchungen*, Leipzig, 3. 308, 518, 1883; F. Mylius and O. Fromm, *ib.*, 27. 640, 1894; L. Meyer, *ib.*, 9. 512, 1876; S. Kern, *Chem. News*, 31. 236, 1875; F. Clowes, *ib.*, 78. 155, 1898; H. N. Warren, *ib.*, 61. 183, 1890; 71. 92, 1895; C. C. Duncan, *ib.*, 61. 308, 1890; E. G. Bryant, *ib.*, 76. 90, 1897; 77. 139, 1898; F. Clowes and R. M. Caven, *ib.*, 76. 297, 1897; *Proc. Chem. Soc.*, 13. 221, 1898; R. M. Caven, *ib.*, 15. 232, 1900; *Chem. News*, 80. 303, 1899; E. Divers, *ib.*, 77. 127, 1898; *Proc. Chem. Soc.*, 13. 57, 1898; A. Villiers and F. Borg, *Compt. Rend.*, 116. 1524, 1893; A. Commaille, *ib.*, 63. 556, 1866; H. Mouraour, *ib.*, 130. 140, 1900; A. Schmidt, *Ueber die Einwirkung von Magnesium auf Chloride*, Göttingen, 1891; K. Seubert and A. Schmidt, *Liebig's Ann.*, 267. 227, 1892; H. Schiff, *ib.*, 118. 89, 1861; R. Böttger, *ib.*, 39. 172, 1841; D. Vitali, *L'Orosi*, 18. 289, 1895; O. Löw, *Neues Jahrb. Pharm.*, 21. 340, 1864; R. M. Caven, *Journ. Soc. Chem. Ind.*, 19. 13, 1900; J. J. Sudborough, *ib.*, 19. 22, 1900; C. Brückner, *Sitzber. Akad. Wien*, 114. 247, 1905; F. Spitzcr, *Zeit. Elektrochem.*, 11. 345, 391, 1905; O. Sackur, *ib.*, 10. 841, 1904; F. Förster, *ib.*, 5. 511, 1899;

- W. K. J. Schoor, *Arch. Néerl.*, 12. 96, 1877; L. Sostegni, *Staz. sperim. agrar. Ital.*, 28. 167, 1895; A. J. J. van de Velde, *Chem. Weekbl.*, 4. 381, 1907; *Rev. Gén. Chim. Pure Appl.*, 11. 57, 1908; A. J. J. van de Velde and C. E. Wasteels, *Bull. Acad. Belgique*, 461, 1905; 35, 1906; *Bull. Assoc. Belg. Chim.*, 18. 279, 1904; N. N. Beketoff, *Bull. Soc. Chim.*, (2), 40. 71, 1883; J. B. Senderens, *ib.*, (3), 15. 1245, 1896; (3), 17. 282, 1897; D. Tommasi, *ib.*, (3), 21. 885, 1899; N. W. Fischer, *Gilbert's Ann.*, 72. 289, 1822; *Pogg. Ann.*, 12. 504, 1828; G. Wetzlar, *Schweigger's Journ.*, 50. 98, 1827; D. M. Levy, *Eng. Min. Journ.*, 84. 262, 1907; A. Destrem, *Compt. Rend.*, 106. 489, 1888; H. Pécheux, *ib.*, 138. 1170, 1904; 140. 1535, 1905; 142. 575, 1906; R. Lorenz, *Zeit. anorg. Chem.*, 10. 78, 1895; J. C. Shengle and E. F. Smith, *Journ. Amer. Chem. Soc.*, 21. 932, 1899; J. H. Gladstone and A. Tribe, *Journ. Chem. Soc.*, 26. 452, 1873; W. Odling, *ib.*, 9. 289, 1857; T. Leykauf, *Journ. prakt. Chem.*, (1), 19. 124, 1840; W. A. Tilden, *Proc. Roy. Soc.*, 66. 244, 1900.
- ¹¹ O. N. Heidenreich, *Zeit. anal. Chem.*, 40. 15, 1901; G. E. Perkins, *Journ. Amer. Chem. Soc.*, 24. 478, 1902; A. Cossa, *Nuovo Cimento*, (2), 3. 75, 1870; C. Margot, *Arch. Sciences Genève*, (3), 33. 161, 1895; *Proc. Inst. Civil Eng.*, 121. 105, 1895; N. Tarugi, *Gazz. Chim. Ital.*, 33. ii, 223, 1903; J. B. Senderens, *Bull. Soc. Chim.*, (3), 17. 277, 1897; D. Tommasi, *ib.*, (2), 37. 467, 1882; (3), 17. 584, 1897; B. Setlik, *Chem. Ztg.*, 25. 46, 1901; F. Weil and D. M. Levy, *Brit. Pat. No.* 22961, 1897; M. Lansaigne and M. Leblanc, *Journ. Pharm. Chim.*, (6), 8. 77, 1898; C. Göttig, *Ber.*, 27. 1825, 1894; C. T. J. Oppermann, *German Pat.*, D.R.P. 82423, 1894; 128319, 1899; A. G. Betts, *ib.*, 125674, 1900; C. Formenti and M. Levi, *Bull. Chim. Farm.*, 40. 689, 1901.
- ¹² N. W. Fischer, *Pogg. Ann.*, 6. 52, 1826; 8. 492, 1826; 10. 604, 1827; G. Wetzlar, *Schweigger's Journ.*, 50. 88, 134, 1827; J. B. Senderens, *Bull. Soc. Chim.*, (3), 15. 678, 1896; (3), 17. 281, 1897; F. Giolitti, *Gazz. Chim. Ital.*, 36. ii, 142, 1906; C. Paul, *Dingler's Journ.*, 208. 47, 1873; O. Gaudoin, *ib.*, 208. 50, 1873; P. Harting, *Journ. prakt. Chem.*, (1), 22. 51, 1841; W. Heldt, *ib.*, (1), 90. 275, 1863; E. Colardeau, *Journ. Phys.*, (2), 6. 129, 1887; P. A. M. Janet, *ib.*, (2), 6. 286, 1887; C. J. Deschamps, *La lumière électrique*, 26. 69, 1887; C. Riess, *Arch. Kaiser. Ges. Amt.*, 22. 663, 1905; D. W. Peck, *Pharm. Journ.*, (4), 61. 159, 1898; J. L. Lassaigne, *Journ. Chim. Méd.*, 8. 580, 1832; O. C. Farrington, *Amer. Journ. Science*, (4), 14. 38, 1902; I. Remsen, *Amer. Chem. Journ.*, 3. 157, 1881; F. A. Wolff, *ib.*, 17. 122, 1895; X. Landerer, *Buchner's Repert. Pharm.*, 8. 38, 1859; F. Stolba, *Casopsis pro prumysl chem.*, 6. 13, 1896; R. M. Caven, *Journ. Soc. Chem. Ind.*, 19. 18, 1900; F. Wöhler, *Liebig's Ann.*, 79. 128, 1851.
- ¹³ M. le Blanc and M. G. Levi, *Boltzmann's Festschrift*, 187, 1904; W. D. Bancroft, *Journ. Phys. Chem.*, 9. 277, 1905; E. Günther, *Zeit. Elektrochem.*, 9. 241, 1903; J. B. Senderens, *Bull. Soc. Chim.*, (3), 15. 698, 1896; (3), 17. 281, 1897; N. W. Fischer, *Pogg. Ann.*, 11. 495, 1827; O. Prelinger, *Monatsh.*, 14. 369, 1893; C. Zimmermann, *Ber.*, 15. 847, 1882; A. C. Chapman, *Analyst*, 29. 346, 1904; E. F. Smith, *Zeit. anorg. Chem.*, 1. 360, 1892.
- ¹⁴ L. F. Boeck, *De reductione metallorum*, Tübingen, 1804; A. Vogel, *Journ. prakt. Chem.*, (1), 8. 109, 1836; W. Straub, *Zeit. anorg. Chem.*, 35. 460, 1903; M. Sidot, *Compt. Rend.*, 84. 1454, 1877; A. Oppenheim, *Ber.*, 5. 979, 1872; L. Santi, *Bull. Chim. Farm.*, 41. 777, 1903; J. Nicklès, *Journ. Pharm. Chim.*, (4), 9. 101, 1869; R. Böttger, *Jahrb. Phys. Ver. Frankfurt*, 31, 1856; F. Wöhler, *Liebig's Ann.*, 79. 126, 1851; W. Wicke, *ib.*, 82. 145, 1852.
- ¹⁵ C. Strzyzowsky, *Oester. Chem. Ztg.*, 7. 77, 1904; J. B. Senderens, *Bull. Soc. Chim.*, (3), 17. 277, 1897; M. H. Descamps, *Compt. Rend.*, 86. 1023, 1878; H. Pécheux, *ib.*, 138. 1170, 1904; 140. 1535, 1905; 142. 575, 1906; N. W. Fischer, *Pogg. Ann.*, 11. 495, 1827; M. Kohn, *Monatsh.*, 42. 831, 1921.
- ¹⁶ J. B. Senderens, *Bull. Soc. Chim.*, (3), 17. 272, 1897; G. Wetzlar, *Schweigger's Journ.*, 50. 98, 1827; N. W. Fischer, *Gilbert's Ann.*, 72. 289, 1822; *Pogg. Ann.*, 12. 504, 1828.

§ 4. The Extraction of Copper

Copper is extracted from its ores by pyro-, electro-, or hydro-metallurgical processes. The actual method employed depends upon the character of the ore, and upon the local conditions—cost of labour, fuel, refractory materials, transit, etc. These questions are discussed in special books.¹ If the ore contains no sulphur—as is the case with the carbonates and oxides—the metal can be obtained by simply reducing the ore, mixed with suitable fluxes and coke, in a furnace heated by a blast. The smelting of the oxidized ores furnishes a metal, called *black copper*, which contains iron and other impurities which have to be removed by refining. High grade and medium grade ores are smelted because the cost of this operation is less the richer the ore; but with low grade ores, a large proportion of gangue has to be converted into slag. Low grade ores, copper mattes, and copper containing the noble metals, may be leached by solvents which take little more than the copper into soln. Electrolytic processes are used with mattes, and with copper containing gold or silver. Assuming that the ore to be smelted is a typical chalcopyrite, the operations involved in extracting the copper are somewhat complex, because (1) a large number of impurities are present in the ore; (2) copper of a high degree of

purity is needed; and (3) it will probably be profitable to recover gold and silver from the crude metal.

The concentration of ores.—In many cases, the native ore is not rich enough to be smelted profitably for the metal, and in other cases, the smelting may be more remunerative if a certain proportion of the gangue be removed in order to avoid the expense of passing waste or barren rock through the furnaces. The proportion of waste rock—gangue or tailings—in copper ore generally exceeds the valuable portion—the *concentrate*—and the process of separating the concentrate from the gangue is called **concentration**. The more important concentration processes—not necessarily all adapted for the treatment of copper ores—are: (1) *Hand picking*. This is one of the simplest types of concentration. The rough ore is separated into valuable and waste by sorting. The operation may be practised to some extent in the mine itself to avoid sending valueless rock to the surface. (2) *Water concentration*. The ore is crushed with water, and the product or *pulp* is subjected to a shaking, throwing, and flowing motion in suitable machines whereby the gangue, on account of its lower sp. gr., is diverted from the denser ore. One form of the apparatus in which water concentration is performed is called a *jig*, and the operation is called *jigging*. The concentration of material too fine for the jig is performed in other types of machine—concentrating tables, vanners, etc. No machine can separate barren rock completely. On account of the small difference in the sp. gr. of the iron and copper pyrites, it is not practicable to concentrate copper ores by water concentration to the same extent as is possible, say, with lead or tin ores. (3) *Magnetic separation*. Here a stream of the powdered or roasted ore is allowed to fall in a stream past a magnetic field of high intensity. The particles which are more sensitive to the magnetic influence are deflected from the main stream, so as to form two streams—one contains the concentrates, and the other the tailings to be rejected. The process has been specially treated by C. G. Gunther, and D. Korda.² (4) *Electrostatic separation*. Here a stream of the powdered or roasted ore is exposed to an electrostatic field. Good conductors—the metal sulphides, magnetite, hæmatite, etc.—are separated from poorer conductors—silicates, carbonates, zinc blende, etc.—by electric repulsion. The process has been specially treated by D. Korda. (5) *Flotation*. The selective adhesion of oils for certain minerals is here utilized. Certain minerals, when ground with oil and water, become coated with oils under conditions where other minerals (usually gangue) remain unaffected. The selective action is in some cases materially increased by the use of an acid or other substance. When the froth or pulp of crushed ore, oil and water is exposed to a current of water, the uncoated gangue sinks through the surface of the water and settles rapidly as tailings, while the oiled minerals float on the water and are collected as concentrates quite independently of the fact that the latter have the greater sp. gr. The flotation process is largely employed for the conc. of copper sulphide ores.³ The theory of the process is discussed by W. H. Coghill and C. O. Anderson.

Roasting sulphide ores.—The sulphur and iron in pyritic or sulphide ores are oxidized by roasting, but sufficient sulphur is left still combined with the copper and iron to form subsequently what is called a *matte*, and sufficient silica must also be present to unite with the iron oxide to form a fusible ferrous silicate slag. In roasting a mixed copper iron sulphide, the copper sulphide oxidizes less rapidly than the iron sulphide; such is the difference that if a mixture of the two sulphides be heated in air, it is commonly stated that “the copper sulphide is not attacked until all the iron sulphide is oxidized.” The reaction in the extreme case is represented: $2\text{CuFeS}_2 + 6\text{O}_2 = \text{Cu}_2\text{O} + \text{Fe}_2\text{O}_3 + 4\text{SO}_2$. It may or may not be convenient to use the by-product sulphur dioxide for the manufacture of sulphuric acid. The object of roasting is therefore to oxidize iron and copper sulphides, and to remove as much of the volatile impurities, like arsenic, antimony, and bismuth, as possible. In practice, the crushed ore is roasted in stacks or heaps, in stalls, in kilns, on grids, in muffles, in reverberatory furnaces, in revolving cylinders, or in automatic

reverberatory calciners. F. le Play's analyses of samples of the raw and roasted ore are :

Cu ₂ O.	CuFeS ₂ .	FeS ₂ . Fe ₂ S ₃ .	Other sulphides.	Fe ₂ O ₃ .	Various oxides.	SiO ₂ .	Earthy matters.	H ₂ O, CO ₂ , SO ₂ .
0.47	26.79	26.32	1.18	0.71	0.35	40.47	2.36	0.59
6.91	14.34	14.34	0.79	14.98	0.77	43.90	2.56	1.41

Smelting the roasted ore for copper matte.—There are three methods in general practice for the smelting of copper ores to furnish copper matte: (1) *Reverberatory smelting*, in which the sulphide ores are treated; (2) *Blast furnace smelting*, in which any class of ore is heated with carbonaceous fuel in a reducing atm.; and (3) *Pyritic smelting*, in which sulphide ores are heated alone or with a small amount—say 5 per cent.—of carbonaceous fuel in an oxidizing atm. The partially roasted ore, or a mixture of roasted and unroasted ore, is heated in a reverberatory furnace, or in a blast furnace lined with firebricks—the former is sometimes called the English or the Swansea process, the latter the American or pyritic smelting process. The blast furnace for smelting copper sulphide ore is usually water-jacketed for cooling the furnace walls (Fig. 2).

The blast furnace may be used for reducing the roasted ore, $2\text{CuO} + \text{C} = 2\text{Cu} + \text{CO}_2$, etc., or it may be used for oxidizing pyritic ore in which the heat necessary for the reaction is derived from the oxidation of the pyritic ore. The blast furnace is preferred for the smelting of rough ore, and the reverberatory furnace for fines and concentrates.⁴ The ore probably contains some siliceous materials; if not, some must be introduced into the furnace in order that a fusible slag may be formed. The air burns the carbon to carbon monoxide: $2\text{C} + \text{O}_2 = 2\text{CO}$. Part of the cuprous oxide, formed in the roasting, is reduced to copper by the joint effect of the carbon and carbon monoxide: $\text{Cu}_2\text{O} + \text{CO} = 2\text{Cu} + \text{CO}_2$ —the copper oxide is much more readily reduced than iron oxide. The metallic copper reacts with the sulphides in the ore: $3\text{Cu} + \text{Fe}_2\text{S}_3 = 3\text{CuS} + 2\text{Fe}$; some of the unreduced cuprous oxide forms cuprous sulphide: $3\text{Cu}_2\text{O} + \text{Fe}_2\text{S}_3 = 3\text{Cu}_2\text{S} + \text{Fe}_2\text{O}_3$; and some cuprous sulphide and cuprous oxide react to form metallic copper and sulphur dioxide: $\text{Cu}_2\text{S} + 2\text{Cu}_2\text{O} = 6\text{Cu} + \text{SO}_2$ —a curious reaction which is a kind of *self-reduction*. According to F. O. Doeltz and C. A. Graumann,⁵ the velocity of the reaction increases with rise of temp. T , such that if W denotes the weight of the sulphur dioxide which is evolved, $\log W = 34 \times 10^{-16} T^5$. The reaction is virtually complete at 1000° .

Metallic copper also may react with iron sulphide as just described. Any cupric sulphide present is reduced to cuprous sulphide. The result of the smelting for matte is (i) The transformation of the copper into cuprous sulphide; (ii) The formation of a fusible slag by the union of the iron oxide with the silica; and (iii) The reduction of ferric sulphide to ferrous sulphide which remains in soln. with the cuprous sulphide to form the matte itself. The lighter slag in the furnace rises to the surface and is run into a pit; the matte collecting at the bottom of the furnace is drawn off from time to time.

In the so-called *pyritic smelting*, the roasting and smelting of the sulphide ores for matte are conducted in one operation. The high temp. required is derived from the rapid oxidation of sulphur and iron in the blast furnace. Attempts have been made to apply *electro-thermic smelting* of copper ores containing too little sulphur to enable them to be pyritically smelted, and which require the use of carbonaceous fuel to facilitate fusion. Electro-smelting could be applied profitably only where fuel is expensive and electric power cheap. Several experimental plants have given promising results.

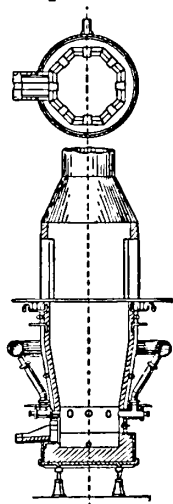

FIG. 2.—Cupola Furnace.

Matte or regulus.—A *matte* or *regulus* is an artificial metal sulphide, or a conglomerate of several metal sulphides; it is formed as an intermediate product in the smelting of copper, nickel, or lead ores. Copper matte is a more or less impure mixture of cuprous and ferrous sulphides containing the eq. of 20–75 per cent. of copper; 12–45 per cent. of iron; and 19–25 per cent. of sulphur. F. le Play's analysis of a sample of regulus, matte, or coarse metal is:

Cu.	Fe.	Ni, Co, Mn.	Sn.	As.	S.	Slag.
33·7	33·6	1·0	0·7	0·3	29·2	1·1 per cent.

The impurities or minor constituents of copper matte are arsenic, antimony, bismuth, manganese, nickel, cobalt, zinc, lead, selenium, tellurium, gold, and silver. Matte is an excellent solvent for the precious metals, so that auriferous or argentiferous copper ores containing less than 2 per cent. of copper may be profitably smelted and the precious metals recovered.

According to A. Baykoff and N. Troutneff,⁶ the relations between the primary constituents of copper matte are represented diametrically in Fig. 3. The area I represents dissociated mixtures of cuprous and ferrous sulphides; the area II represents solid soln. of the two sulphides; the area IV represents a matte with iron and copper in soln.; and area III, a eutectic mixture of the matte characteristic of area II, and of the solid soln. of area IV.

FIG. 3.—Triangular Diagram for Ternary Mixtures of Copper, Iron, and Sulphur.

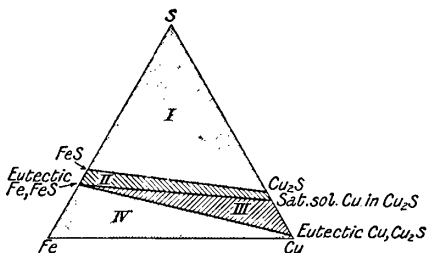

The f.p. curve of mixtures of cuprous and ferrous sulphides is shown in Fig. 4. P. Röntgen⁷ obtained a curve with maximal points corresponding with the double sulphides $\text{Cu}_2\text{S} : \text{FeS} = 3 : 2$ melting at about 980° ; $1 : 1$ melting at about 1025° ; and $2 : 5$ melting at about 1050° ; while H. O. Hofman found no evidence of the formation of definite compounds, but rather obtained a eutectic mixture, with 85 per cent. of ferrous sulphide and 15 per cent. of cuprous sulphide, melting at 850° .

The freezing curve of a mixture of iron with ferrous sulphide furnishes a eutectic melting at 983° , as illustrated in Fig. 5;⁸

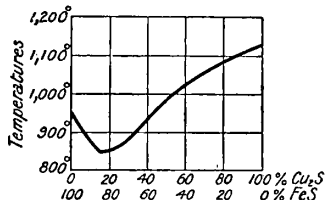

FIG. 4.—Freezing Curve of Mixtures of Ferrous and Cuprous Sulphides.

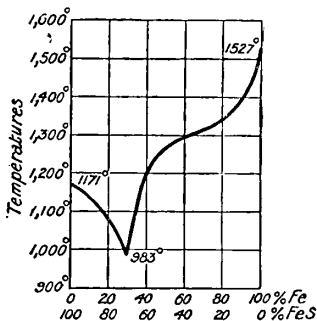

FIG. 5.—Freezing Curve of Mixtures of Iron and Ferrous Sulphide.

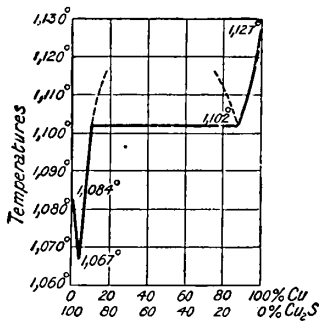

FIG. 6.—Freezing Curve of Mixtures of Copper and Cuprous Sulphide.

while a mixture of copper with copper sulphide furnishes a freezing curve like that shown in Fig. 6.⁹ There is a quick rise in the f.p. with additions of cuprous sulphide

until a mixture melting at 1102° is obtained ; a further addition of cuprous sulphide produces no further rise of temp. until the mixture contains nearly 86 per cent. of cuprous sulphide, when any further addition produces a rise in the f.p. until 1127° —the f.p. of pure cuprous sulphide. **Speise** is an artificial arsenide or conglomerate of arsenides which is related to a matte in that arsenic and some antimony replace some of the sulphur. The arsenic and antimony are usually eliminated by a series of oxidizing roasts and reducing fusions.

The conversion of matte into blister copper in the reverberatory furnace.—The matte is converted into metallic copper by roasting and further smelting either in a (i) reverberatory furnace—*blister roasting* or *roaster smelting*, or (ii) in a converter—*bessemerizing*. The richer mattes with from 87.5 of Cu_2S and 12.5 of FeS to 100 per cent. Cu_2S , are called *white metal*. F. le Play's analysis of white metal is :

Cu.	Fe.	Sn, As, etc.	S.	Slag.
77.4	0.7	0.1	21.0	0.3 per cent.

When the conversion is effected in a reverberatory furnace, Fig. 7, the lumps of matte on the hearth of the furnace are slowly oxidized, and the oxidation is continued until the sulphur is nearly all removed, and a bath of metallic copper, sat. with more or less cuprous oxide and sulphide, remains. The reactions are supposed to be those represented by the equations: $\text{Cu}_2\text{S} + \text{O}_2 = 2\text{Cu} + \text{SO}_2$; and $2\text{Cu}_2\text{S} + 3\text{O}_2 = 2\text{Cu}_2\text{O} + 2\text{SO}_2$. The copper oxide and sulphide react to form metallic copper and sulphur dioxide: $2\text{Cu}_2\text{O} + \text{Cu}_2\text{S} = \text{SO}_2 + 6\text{Cu}$. The metal is called *coarse copper* or *blister copper*, from the blister produced on its upper surface by the escape of sulphur dioxide during solidification. The blister copper contains iron, sulphur, arsenic, etc., as impurities. F. le Play's analysis of blister copper is :

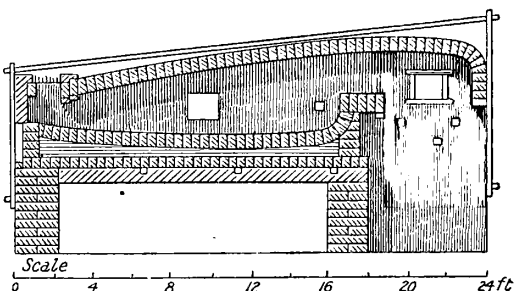

FIG. 7.—Reverberatory Furnace.

Cu.	Fe.	Ni, Co, etc.	Sn, As, etc.	S.
98.4	0.7	0.3	0.4	0.2 per cent.

The copper can be further refined by an oxidizing fusion followed by a reducing fusion in a reverberatory furnace, or it can be refined electrolytically.

The conversion of matte into blister copper in the converter.—Much of the copper produced to-day is made in a modified form of Bessemer's converter, Fig. 8. The matte is bessemerized by blowing air through the molten metal contained in a converter analogous to that employed in the manufacture of steel. The converter may be lined with siliceous material—*acid converter*—or with magnesite—*basic converter*.

In 1866, A. Rath patented a process of oxidizing the iron and sulphur in matte by blowing air through the molten mass ; in 1867, A. von Jossa and N. Latetin reported that white metal (72–80 per cent. Cu) was made in a converter, but blister copper could not be produced. The process of oxidizing copper matte to metallic copper in a Bessemer's converter was patented by J. Holloway¹⁰ in 1878, and between 1880 and 1884 P. Manhès established the technical and commercial success of the process for the treatment of copper mattes. In bessemerizing pig iron, the oxidation of the 6 to 7 per cent. of impurity generates enough heat to keep the iron molten, and the oxidation of a much larger proportion of impurity in the case of copper furnishes an ample amount of heat to keep the charge molten, but a more

voluminous slag results. The time occupied by the copper "blow" is five to fifteen times as long as is needed for steel; with steel, too, the iron itself is oxidized towards the end of the blow, but this is not the case with copper, and accordingly, molten copper is only chilled by the blast. In consequence, P. Manhès placed the tuyères in the copper converter, not at the bottom, as is the case with iron, but laterally at some distance from the bottom above the pool of molten metal which accumulates at the bottom of the converter. Matte converters are side blown, and not bottom blown as is the case of large steel converters. The tuyères are directed below the surface of the matte in a position where, if choked, they can be easily "punched" clear by the attendant. In the converter, the iron sulphide is oxidized to iron oxide, and this unites with the silica present to form a slag; the sulphur is oxidized to sulphur dioxide. The operator can tell from the appearance of the flame issuing from the converter when it is time to stop the blast. The converter is tilted and the slag run off; white metal remains. The white metal formed in the first stage of the process is further oxidized, and the cuprous oxide and sulphide react as in the reverberatory furnace process. The product obtained from the second blow in the converter is the so-called blister copper containing about 99 per

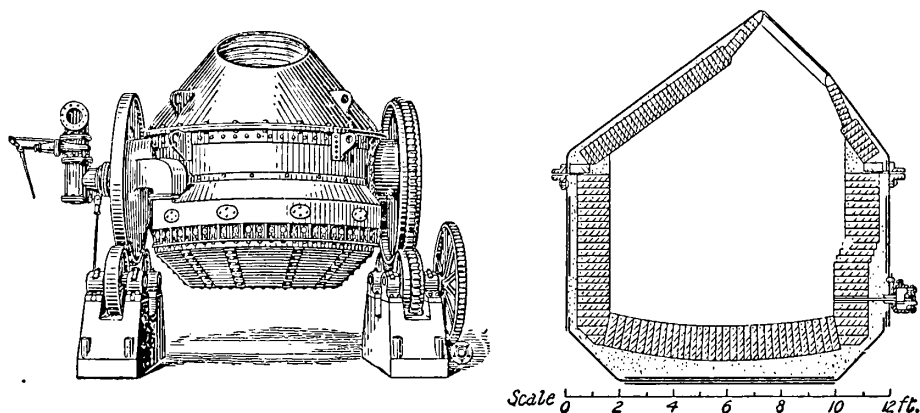

FIG. 8.—Converter.

cent. of copper. As the copper cools, the sulphur dioxide dissolved by the metal is liberated and the resulting blisters give the copper its characteristic appearance. The copper is then refined on the hearth of a reverberatory furnace and poled as indicated previously.

Refining copper by fusion in the reverberatory furnace.—The metal to be refined is first heated on the hearth of a reverberatory furnace in an oxidizing atm.—the *oxidizing fusion*—and the molten metal agitated to assist the oxidation of the iron, lead, etc. The impurities form a slag with the siliceous matters of the lining of the furnace, etc. The cuprous oxide simultaneously formed dissolves in the copper and facilitates the oxidation of the dissolved cuprous sulphide and ensures that the other impurities are converted into oxides; the cuprous oxide also reduces the tendency of the metal to dissolve gases, and generally improves the quality of the metal. The refiner tries to make a metal, called *dry copper*, containing 6 to 7 per cent. of cuprous oxide. The slag is skimmed off. Refinery slag contains from 20 to 50 per cent. of copper as silicate, and it is mixed with the charge for the furnace in an earlier stage of the smelting. If much arsenic or antimony is to be removed, caustic soda and lime are repeatedly added towards the end of the oxidizing fusion, and continued until a sample of the metal shows that the purification has gone far enough.

The molten metal is now subjected to a *reducing fusion*. The surface of the metal is covered with charcoal or anthracite, and a pole of green wood is introduced

below the surface of the molten metal. Vigorous ebullition occurs owing to the evolution of gas from the wood, and sulphur dioxide is also liberated. When the reduction has proceeded far enough, the metal is called *tough pitch copper*, and it contains up to about one per cent. of cuprous oxide in soln. W. Stahl¹¹ gives the following analyses of the refining of blister copper at Mansfeld :

	Cu.	Ag.	Pb.	Ni.	As.	O.
Blister copper . . .	98.140	0.011	1.060	0.610	0.058	0.121
After melting . . .	98.950	0.010	0.330	0.350	0.058	0.302
After fining . . .	98.550	0.010	0.160	0.350	0.055	0.875
After dense poling . . .	99.060	0.009	0.190	0.360	0.057	0.324
After tough poling . . .	99.300	0.009	0.170	0.360	0.054	0.107

A test bar of tough pitch copper can be bent through 180° without cracking, and when broken, the fractured surface is salmon-red in colour, with a fibrous texture, and silky lustre. During the operation, samples are removed at intervals from the furnace so that the progress of the operation can be determined; the man in charge has learned to judge this from the appearance of the sample. Over-poled copper is brittle, and it must be oxidized back to dry copper either by flapping—that is, by vigorously striking the surface of the molten metal with an iron rabble so that the metal is splashed about—or else by forcing compressed air on or beneath the surface of the molten metal. The re-oxidized metal is then re-poled. Under-poled copper is brittle, and the fractured surface is brick-red in colour.

Refining copper by electrolysis.—A great deal of the copper in commerce—at least a third, perhaps one half—passes through an electrolytic refining process. The metal refined in the furnace is not pure enough for many commercial purposes for it contains base metal impurities which interfere with its electrical conductivity—*e.g.* arsenic and antimony—or which make the metal brittle—*e.g.* lead and tellurium—the metal may also contain some gold and silver which can be profitably extracted. M. von Leuchtenberg proved in 1847 that impure copper can be refined electrolytically, and J. B. Elkington¹² applied the process successfully on a large scale in 1865, at Pembrey (Wales). The modern process is described in L. Addicks' *Copper Refining* (New York, 1921). The metal to be refined—blister copper, or copper from the refining furnace—is cast into plates—say 36 ins. sq., and 2 or 3 ins. thick. These plates are provided with lugs, and used as anodes with sheets of refined copper as cathodes or “starting sheets.” The electrolyte is a soln. containing 12 to 14 per cent. of copper sulphate with 5 to 10 per cent. of sulphuric acid. In the so-called *multiple* or *parallel system*, the cathodes are all connected with one pole of the circuit, so also all the anodes are connected with the other pole; in the so-called *series system* the anodes and cathodes are connected in pairs. The electrolyzing vats are wooden tanks, lead-lined. In some cases, 20 or 30 anodes about 3 ins. apart, and with the same number of intermediate cathode plates, form a working unit. During the electrolysis, the electrolyte is agitated, say, by arranging the vats in terraces so that the outflow from the vat on the top row passes into that in the next row below, and so on until finally the outflow runs into a well whence it is pumped into the distributing box, to pass again in a cascade through the electrolysis vats. During the electrolysis, with a current between 4 and 15 amperes per sq. ft. and 0.1 to 0.3 volts, the copper is continuously dissolved from the anode, and re-deposited in a purified condition on the cathode sheet. The zinc, iron, nickel, and cobalt accumulate in the soln., but are not deposited on the cathode; part of the arsenic, antimony, bismuth, and tin is also deposited, and part remains in soln.; while the copper sulphide, gold, silver, tellurium, and most other impurities remain undissolved, and fall as *anode mud* or *anode slime* at the bottom of the electrolyzing vat.

It is stated that the anode mud contains from 15 to 55 per cent. of copper; 5 to 50, silver; 0.02 to 0.70, gold; 0.5 to 6.0, lead; 2 to 8, antimony; 1.5 to 6, arsenic; 0.2 to 8.0, bismuth; 0.5 to 1.5, iron; 0.1 to 2.5, selenium; 0.1 to 3.5, tellurium; and 0.5 to 12 per cent. of SO₃. The mud is screened to separate particles of copper which have fallen

from the anodes, and the slime may be (1) fused on a dolomitic clay bed in a reverberatory furnace; the slag removed and the resulting metal cupelled for silver and gold; or (2) the dried slime may be oxidized and scorified on the lead bath of a cupelling furnace; or (3) leached with sulphuric acid and afterwards fused with nitre in a reverberatory furnace; or (4) the slime may be roasted, pulverized, leached with sulphuric acid, and afterwards fused in a reverberatory furnace with nitre as a flux. The nitre slag may contain up to 20 per cent. tellurium. The silver alloy is afterwards parted to recover the gold.

The more important main and secondary reactions which occur at the cathode during electrolysis may now be indicated.¹³ When copper electrodes are dipped in a soln. of copper sulphate or copper chloride, say the latter, the reaction symbolized: $\text{CuCl}_2 + \text{Cu} = 2\text{CuCl}$, takes place. Thus, if an acid soln. of cupric sulphate be boiled with powdered copper, metallic copper will be deposited from the filtered soln. on cooling—presumably owing to the reoxidation of the cuprous sulphate. The equilibrium constant K at room temp. is $K[\text{CuCl}_2] = [\text{CuCl}]^2$, where the bracketed symbols represent the conc. of the salts in question. When a current is passing through a soln., the possible cathodic reactions are therefore $2\text{CuCl}_2 = 2\text{CuCl} + \text{Cl}_2$; $2\text{CuCl} = 2\text{Cu} + \text{Cl}_2$; and $2\text{CuCl}_2 = 2\text{Cu} + \text{Cl}_2$. The relative magnitudes of these different reactions is determined by (1) the temp.; (2) the current density. A low current density favours the oxidation and hydrolysis of the cuprous salt, and allows time for the reaction to occur. If the current density be too high, the precipitated copper will have a spongy appearance:

Temp.	Current density amps. per sq. metre.			
	0·3	30	100	300
20° . .	80	—	100	100
70° . .	—	96	98	100
100° . .	—	47	83	99

(3) The conc. of the soln. If the conc. of the copper salt in soln. be high, a correspondingly large conc. of the cuprous salt must be maintained to satisfy the equilibrium constant. With normal sulphuric acid soln., and a current density of 0·135 amp. per sq. cm.:

CuSO_4 normality.	Cu_2O .	Cu.
0·05	—	0·121
0·25	—	0·083
2·00	—	0·0086

(4) The presence of dissolved oxygen; and (5) the acidity or conc. of the H^+ -ions. A high conc. of the acid is favourable to the oxidation of cuprous chloride, and a low acid conc. favours hydrolysis and the consequent precipitation of cuprous oxide. According to A. Sieverts and W. Wippelmann,¹⁴ copper deposited electrolytically from acid soln. of the sulphate is crystalline; neutral soln. give a mixture of cuprous oxide and crystallites of copper; and alkaline soln., a mixture of complex copper salts give structureless (colloidal) copper. With 0·25N- CuSO_4 , and a current density 0·135 amp. per sq. cm.:

H_2SO_4 normality.	Cu_2O .	Cu.
0	0·368	—
0·01	0·413	trace
0·025	0·061	trace
0·1	—	0·071
1·0	—	0·083

If the conc. of the cuprous salt at the cathode falls below the equilibrium value, the yield of precipitated copper per unit quantity of electricity during electrolysis will be low. This may occur owing to (i) a rise of temp. which favours the formation of cuprous chloride and increases the value of K ; (ii) the hydrolysis of cuprous chloride: $\text{CuCl} + \text{H}_2\text{O} = \text{Cu}(\text{OH}) + \text{HCl}$, which leads to the precipitation of cuprous oxide; and (iii) the oxidation of cuprous chloride back to cupric chloride by the dissolved atm. oxygen: $4\text{CuCl} + 4\text{HCl} + \text{O}_2 = 2\text{H}_2\text{O} + 4\text{CuCl}_2$. Although copper is deposited as a bivalent element in accord with Faraday's law—two farads of electricity transform one eq. of bivalent copper Cu^{++} to the metallic state—yet the actual cathodic yield of the metal may appear to fall below the theoretical requirements. The above discussion shows the conditions which favour high yields: (1) Low temp.; (2) Fairly high current density; (3) Moderately conc. soln. of the cupric salt; (4) Absence of oxidizing agents; (5) Fairly high acid conc. These favourable conditions are also necessary for the successful working of a copper voltameter. G. Grube and co-workers have made a metallographic study of electro-deposited copper.

Attempts to use copper ore or copper matte as anode in an acidulated soln. of copper sulphate, with sheet copper as cathode, have not been very successful commercially; although the electrolysis of soln. with anodes of copper mattes containing little more than cuprous sulphide, have given very fair results—*e.g.* in E. Marchese's process¹⁵ an electrolyte containing copper and ferrous sulphates and dil. sulphuric acid is used with anodes of copper iron matte.

Hydrometallurgical or wet processes for extracting copper from its ores.—A comparatively small proportion of the world's output of copper is extracted from its ores by leaching the ore¹⁶ with suitable solvents—dil. sulphuric, hydrochloric, or sulphurous acid,¹⁷ ferric sulphate, ferrous chloride, ferric chloride,¹⁸ cuprous chloride,¹⁹ ammonia or its salts²⁰—and subsequently precipitating the metal by iron, ferrous sulphide, hydrogen sulphide, sulphur dioxide, sodium or calcium polysulphide, lime water, or by electrolysis. The more important hydrometallurgical processes can be classified²¹ as:

I. Chemical processes.—The copper is dissolved and precipitated by chemical agents involving (1) Alkali processes (*e.g.* leaching with ammoniacal soln.); (2) Sulphate processes (*e.g.* the Rio Tinto process); (3) Sulphite process (*e.g.* J. M. Neil's); (4) Chloride processes (*e.g.* C. Dötsch's, O. Frölich's, T. S. Hunt and J. Douglas', and W. Longmaid and W. Henderson's processes).

II. Electrolytic processes.—The copper is dissolved chemically and precipitated electrolytically. The electrolysis is usually accompanied by the regeneration of the solvent. These processes include the so-called (i) Sulphate processes (*e.g.* E. W. von Siemens and J. G. Halske's process); Chloride processes (*e.g.* C. Höpfner's process).

The wet processes may be profitably used in some cases where the proportion of copper, or the precious metals—gold and silver—in the ore is not sufficient to pay for bringing fuel and fluxes to the mine, or taking the mined ore to a locality where fuel and fluxes are cheaper. The wet processes are applicable to low grade ores with finely disseminated copper minerals and a gangue which is not attacked by the solvent. As a rule, the wet processes do not recover the precious metals owing to the insolubility of these elements in ordinary solvents. With the poorer ores, the commercial success of a copper extracting proposition may be determined by the possibility of recovering gold and silver with a comparatively small additional cost; ores which carry small quantities of copper, but relatively large amounts of silver and gold, may be treated by wet processes, but this merely as a preliminary treatment in a process mainly devised for the extraction of the two precious metals. In the ideal case, the ore for treatment by wet processes contains the greater part of its copper as oxide or carbonate, since these substances are relatively easily

dissolved by dil. acids; copper silicate or copper sulphide ores do not so readily yield their copper to solvents.

The cupriferous pyrites of Rio Tinto (Spain) contains about 3 per cent. of copper. The ore is built in large heaps arranged with channels so that there is as free a circulation of air as possible in the interior. The heaps are sprayed with water at suitable intervals. As a result, according to C. H. Jones,²² the pyrites, FeS_2 , is first oxidized to ferrous sulphate, and then to ferric sulphate. The latter converts copper oxide or sulphide into soluble copper sulphate: $\text{Cu} + \text{Fe}_2(\text{SO}_4)_3 = \text{CuSO}_4 + 2\text{FeSO}_4$; $3\text{CuO} + \text{Fe}_2(\text{SO}_4)_3 = 3\text{CuSO}_4 + \text{Fe}_2\text{O}_3$; and $\text{Cu}_2\text{S} + 2\text{Fe}_2(\text{SO}_4)_3 = 4\text{FeSO}_4 + 2\text{CuSO}_4 + \text{S}$. Some cupric sulphide is simultaneously formed as an intermediate product of the oxidation. According to A. N. Winchell, cuprous sulphide is more readily oxidized than pyrites, FeS_2 , and he suggests that the cuprous sulphide is oxidized first, and hastens the oxidation of the iron pyrites. The sulphides of nickel, lead, zinc, arsenic, antimony, and bismuth are simultaneously oxidized and dissolved. The soln. which drains from the heaps of pyrites contains both ferric and cupric sulphates; the former is converted to ferrous sulphate by passing the soln. through a layer of fresh ore, and the liquid is then led through troughs in which scrap iron, or lumps of spongy iron (reduced from roasted pyrites), or pigs of iron have been laid. Copper is precipitated upon the iron as a brownish-red powder. The precipitation of copper on iron is sometimes called *cementation*, and the product, *cement copper*. The copper is removed from time to time, fused, and refined in the usual manner. The refining is commonly needed because cement copper usually contains iron oxide, sand, and other extraneous matters. In some places, the ore is converted into sulphate by roasting with or without the addition of other sulphates—ferrous sulphate, aluminium sulphate, sodium hydrogen sulphate, etc. The operation is called *sulphatizing roast*. In E. W. von Siemens and J. G. Halske's process,²³ the roasted ore is treated directly with an acidified soln. of ferric sulphate.

In some mines, and dumps, the air has already oxidized the sulphide to water soluble sulphate, and the water percolating from the mine, or dump, is charged with sufficient copper sulphate to pay for the recovery of the copper—e.g. at Wicklow (Ireland), Schmoellnitz (Hungary), Rammelsberg (Germany), Ashio (Japan), Wallaroo (Australia), Gumeshevsky (Russia), Butte (Montana), Bisbee (Arizona), Iron Mountains (California), etc.

T. S. Hunt and J. Douglas' process²⁴ depends on the fact that ferrous chloride in the presence of hot brine (at 70°) converts copper oxide into soluble cuprous chloride. The copper in the ore must therefore be first converted into oxide by heating the carbonates, or roasting the sulphides. The ore is treated with a soln. of ferrous sulphate containing an excess of sodium chloride with or without calcium chloride. The reaction with cuprous oxide is represented: $3\text{Cu}_2\text{O} + 2\text{FeCl}_2 = 2\text{Cu} + 4\text{CuCl} + \text{Fe}_2\text{O}_3$, and the cuprous chloride is held in soln. by the other chlorides which are present; with cupric oxide the reaction is represented: $3\text{CuO} + 2\text{FeCl}_2 = 2\text{CuCl} + \text{CuCl}_2 + \text{Fe}_2\text{O}_3$. The copper is then precipitated by iron. In a later modification of the process, the copper oxide is extracted by dil. sulphuric acid, and ferrous or calcium chloride is added to the soln. to convert sulphates to chlorides. Cuprous chloride is then precipitated by blowing sulphur dioxide through the soln.: $\text{CuCl}_2 + \text{SO}_2 + \text{CuSO}_4 + 2\text{H}_2\text{O} = 2\text{CuCl} + 2\text{H}_2\text{SO}_4$. The precipitate is converted into cuprous oxide by treatment with milk of lime, and the washed oxide is smelted with carbon for copper. Part of the sulphur dioxide is recovered from the soln. by blowing hot air through the liquid; and the calcium chloride, left after treating the cuprous chloride with milk of lime, is used for chloridizing the copper in the sulphate soln.

W. Longmaid and W. Henderson's process was invented by W. Longmaid in 1842, and improved by W. Henderson in 1860.²⁵ The process is suited for the treatment of burnt pyrites or *blue billy*—the residue obtained when cupriferous pyrites has been roasted for sulphur dioxide in the manufacture of sulphuric acid. The roasted ore contains from 1 to 5 per cent. of copper—partly as cupric

sulphate, cupric oxide, cuprous sulphide, and copper iron sulphide, FeCuS_2 . The crushed and burnt ore is mixed with 12 to 15 per cent. of rock salt and roasted in a reverberatory furnace whereby the copper is converted into soluble chloride—*chloridizing roast*. The mass is then lixiviated with water, and the copper precipitated from the soln. by scrap iron. If much gold and silver are present, these elements may be precipitated before the copper by the addition of sodium iodide (F. Mayer), zinc iodide (F. Claudet), treatment with hydrogen sulphide (T. Gibb), or by dilution with water (W. Jardine and H. Chadwick).

Instead of precipitating the copper by cementation, electrolysis with insoluble electrodes may be used—lead anodes stand well in sulphate soln.; carbon anodes stand well with chloride but not sulphate soln. H. Carmichael²⁶ used an acidified soln. of cupric sulphate impregnated with sulphur dioxide as electrolyte, and insoluble lead anodes. S. von Laszczymsky used an acidified soln. of copper sulphate as electrolyte, and the lead anodes were enclosed in tight-fitting cotton bags in order to hinder the oxidation of the ferrous sulphate into ferric sulphate at the anode.

Numerous analyses of commercial copper are recorded in literature. In the United States, the three important brands are casting copper, lake copper, and electrolytic copper. In casting copper, the amount of precious metals is too small to justify their extraction, and the impurities are too small to make them objectionable for many purposes. The following²⁷ is a selection:

	Casting.	Lake.	Electrolytic Copper.
Cu	99.44	99.890	99.953
Ag	0.01	0.0096	0.0018
Pb	0.05	0.0031	0.0010
Bi	0.01	—	—
As	0.02	0.0062	—
Sb	0.05	—	0.0009
Se+Te	n.d.	0.0020	0.0026
Fe	0.30	0.0028	0.0038
Ni	0.15	0.0090	0.0028
S	0.002	0.0016	0.0026
O	n.d.	0.0753	0.0315
Sn	0.18	—	—

A. Eilers found selenium in all the varieties of copper he examined, but a few contained no tellurium. Copper from Garfield (Utah) contained:

Gold.	Silver.	Platinum.	Palladium.	Selenium.	Tellurium.	Bismuth.	Nickel.
14,400	174,000	17	59	44,800	4432	4880	32,000

ounces per 5000 tons. O. Nielsen discusses the standardization of copper in grades according to its degree of purity.

The preparation of highly purified copper by Richards' process.²⁸—Commercially pure copper was dissolved in sulphuric acid mixed with a little nitric acid, and evaporated to dryness. The mass was heated in a porcelain dish on an asbestos plate until the fumes of sulphuric acid were no longer evolved. The copper sulphate was then dissolved in water, and twice re-crystallized. A dil. soln. of the crystals was boiled and shaken for three hours with water containing a little potassium hydroxide. The soln. was filtered, and copper sulphate crystallized from the hot soln. a number of times. An aq. soln. of the crystals was strongly acidified with sulphuric acid and a little nitric acid, and electrolyzed in a cell with platinum plates. The electrolytic copper was then washed with a dil. soln. of potassium hydroxide, dil. sulphuric acid, and then boiled for half an hour with water, washed, dried, and heated red-hot in a stream of hydrogen. The metal was allowed to cool in the stream of hydrogen.

Sometimes copper is used in organic chemistry as a condensing agent, for which purpose it must be in a fine state of subdivision. For colloidal copper *vide* gold. Finely divided copper is obtained by the action of zinc dust on copper sulphate soln.

L. Cohn's process for preparing finely divided copper.²⁹—Zinc dust is shaken through a fine

sieve into a cold sat. soln. of copper sulphate in a porcelain dish while the liquid is being thoroughly stirred so as to prevent the formation of clots; the zinc dust is added so long as the liquid has any but the faintest trace of a blue colour. The temp. will probably have risen to about 80° during the addition. The finely divided copper settles to the bottom of the vessel; and the dark red mass is well washed with water. In order to remove any zinc which may be present, dil. hydrochloric acid is added so long as any effervescence is observable. The mass is then washed by decantation, and then on a filter until the washings are free from acid. The metal is easily oxidized, even if dried, and it is best preserved in closely stoppered bottles. O. Ohmann prepared what he called *copper wool*; and J. Piccard, *catalytic copper*.

REFERENCES,

- ¹ E. D. Peters, *Principles of Copper Smelting*, New York, 1907; *Modern Copper Smelting*, New York, 1895; *Practice of Copper Smelting*, New York, 1911; H. Lang, *Matte Smelting*, New York, 1896; H. O. Hofman, *Metallurgy of Copper*, New York, 1914; L. Grüner, *Métallurgie du cuivre*, Paris, 1884; W. Borchers and R. Franke, Halle, 1905.
- ² C. G. Gunther, *Electro-magnetic Ore Separation*, New York, 1909; D. Korda, *La séparation électro-magnétique et électrostatique des minerais*, Paris, 1905.
- ³ H. A. Megraw, *The Flotation Process*, New York, 1916; T. J. Hoover, *Concentrating Ores by Flotation*, London, 1912; G. D. van Arsdale, *Eng. Min. Journ.*, 101. 851, 1916; W. H. Coghill and C. O. Anderson, *Journ. Phys. Chem.*, 22. 237, 1918; H. L. Suhnan, *Bull. Inst. Min. Met.*, 95, 1919; P. Vageler, *Die Schwimmaufbereitung der Erze*, Dresden, 1921.
- ⁴ T. A. Rickard, *Pyrite Smelting*, New York, 1905; R. Sticht, *Ueber das Wesen des Pyrit-Schmelzverfahrens*, Halle, 1906; P. Trachot, *Rev. Gén. Pure Appl.*, 7. 421, 1904; *Les pyrites*, Paris, 1907; T. T. Reid, *Recent Copper Smelting*, San Francisco, 1915; D. H. Lyon and R. M. Keeney, *The Smelting of Copper Ores in the Electric Furnace*, Washington, 1915; F. le Play, *Description des procédés métallurgiques employés dans le pays des Galles*, Paris, 1848; *Ann. Mines*, (4), 13. 3, 389, 557, 1848; A. M. Levy, *Rev. Univ. Min.*, 16. 286, 1884.
- ⁵ F. O. Doeltz and C. A. Graumann, *Met.*, 4. 421, 1907; F. O. Doeltz, *ib.*, 4. 468, 1907; E. T. Bradford, *Trans. Amer. Inst. Min. Eng.*, 1902.
- ⁶ A. Baykoff and N. Troutneff, *Rev. Mét.*, 6. 519, 1909; K. Bornemann and F. Schreyer, *Met.*, 6. 619, 1909; E. Munster, *Berg. Hütt. Ztg.*, 36. 195, 210, 219, 1877; M. N. Bolles, *Trans. Amer. Inst. Min. Eng.*, 35. 666, 1904; C. H. Fulton and J. E. Goodner, *ib.*, 39. 584, 1908.
- ⁷ P. Röntgen, *Met.*, 3. 479, 1906; A. Gibb and R. C. Philp, *Trans. Amer. Inst. Min. Eng.*, 1193, 1905; H. O. Hofman, *ib.*, 38. 142, 1908; 36. 665, 1906; H. O. Hofman, W. S. Caypleas, and E. E. Harrington, *ib.*, 38. 424, 1908.
- ⁸ W. Treitschke and G. Tammann, *Zeit. anorg. Chem.*, 49. 320, 1906; *Met.*, 4. 54, 1907; K. Friedrich, *ib.*, 7. 257, 1910; K. Friedrich and A. Leroux, *ib.*, 2. 536, 1905.
- ⁹ E. Heyn and O. Bauer, *Met.*, 3. 76, 1906; G. G. Urazoff, *Ann. Inst. Polyt. Petrograd*, 23. 593, 1915.
- ¹⁰ J. Holloway, *Brit. Pat. No. 4549*, 1878; P. Manhès, *Ber.*, 14. 2432, 1881; A. Rath, *U.S. Pat. No. 57376*, 1866; *Eng. Min. Journ.*, 27. 260, 1879; 35. 250, 1883; A. von Jossa and N. Latetin, *Berg. Hütt. Ztg.*, 30. 7, 17, 57, 1871; P. Jannetaz, *Les convertisseurs pour cuivre*, Paris, 1902; F. Mayr, *Das bessemern von Kupfersteinen*, Freiberg, 1906; G. Kroupa, *Oester. Zeit. Berg. Hütt.*, 51. 695, 715, 1903; F. Kupelwieser, *ib.*, 34. 1, 1886.
- ¹¹ W. Stahl, *Mct.*, 9. 362, 377, 1912.
- ¹² M. von Luchtenberg, *Dingler's Journ.*, 104. 293, 1847; 106. 35, 1847; J. B. Elkington, *Brit. Pat. Nos. 2838*, 1865; 3120, 1870; T. Ulke, *Modern Electrolytic Copper Refining*, New York, 1903; L. Addicks, *Journ. Franklin Inst.*, 160. 421, 1905; A. Föhring, *Dingler's Journ.*, 268. 124, 1888; N. A. E. Millon and A. Commaille, *Compt. Rend.*, 56. 1249, 1863; A. C. Becquerel, *ib.*, 74. 1310, 1872; B. B. Ross, *Journ. Anal. App. Chem.*, 7. 83, 1893; A. L. Flanigen, *Journ. Amer. Chem. Soc.*, 29. 455, 1907; C. Richter, *Elektrochem. Zeit.*, 13. 186, 1906; F. Spitzer, *ib.*, 11. 345, 391, 1905; C. Brebeck, *Zeit. Unters. Nahr. Genuss.*, 13. 548, 1907.
- ¹³ F. Förster and O. Seidel, *Zeit. anorg. Chem.*, 14. 106, 1897; F. Förster and G. Coffetti, *Ber.*, 38. 2934, 1905; F. J. Schwab and I. Baum, *Journ. Phys. Chem.*, 7. 493, 1903; G. Bödlander and O. Storbeck, *Zeit. anorg. Chem.*, 31. 458, 1902; E. Abel, *ib.*, 26. 361, 1901; M. E. Heiberg, *ib.*, 2. 137, 1903; G. Grube, *Zeit. Elektrochem.*, 27. 53, 1921.
- ¹⁴ A. Sieverts and W. Wippelmann, *Zeit. anorg. Chem.*, 91. 1, 1915; G. Grube and V. Reuss, *Zeit. Elektrochem.*, 27. 45, 1921; G. Grube, *ib.*, 27. 53, 1921.
- ¹⁵ E. Marchese, *German Pat.*, D.R.P. 42243, 1880; *Traitement électrolytique des mattes cuivreuses au Stolberg*, Gênes, 1885.
- ¹⁶ W. E. Greenawalt, *The Hydrometallurgy of Copper*, New York, 1912; M. Eissler, *Hydrometallurgy of Copper*, London, 1902; C. Defrance, *Extraction du cuivre, de l'argent, et de l'or par la voie humide*, Paris, 1897; H. O. Hofman, *Metallurgy of Copper*, 1914.
- ¹⁷ J. M. Neil, *Min. Ind.*, 10. 216, 1902; *Eng. Min. Journ.*, 85. 556, 1908; G. Gin, *Zeit. Elektrochem.*, 9. 857, 1903; *Ber. Internat. Cong. App. Chem.*, 2. 116, 1903; G. D. van Arsdale, *Eng. Min. Journ.*, 75. 853, 1903.
- ¹⁸ A. Fournier, *Berg. Hütt. Ztg.*, 41. 461, 1882; *Eng. Min. Journ.*, 34. 163, 1882; O. Frölich, *Met.*, 5. 206, 1908.

- ¹⁹ C. Höpfner, *Chem. Ztg.*, **18**, 1906, 1894; *German Pat.*, D.R.P. 73179, 1892.
- ²⁰ L. Jumau, *German Pat.*, D.R.P. 189643, 1905; D. Lance, *ib.*, 188793, 1905; E. Hermite, *British Pat. No.* 2157, 1884; E. A. le Sueur, *Amer. Pat. No.* 755302, 1884; H. Hirsching, *ib.*, 581160, 1884; C. H. Ehrenfeld and J. R. Grove, *ib.*, 866849, 1906.
- ²¹ R. R. Goodrich, *Chem. Eng.*, **20**, 52, 1914.
- ²² F. Thomas, *Mét.*, **1**, 8, 39, 59, 1904; C. H. Jones, *ib.*, **1**, 171, 1904; *Trans. Amer. Inst. Min. Eng.*, **35**, 3, 1905; W. L. Austin, *Min. Month.*, **2**, 5, 1911; P. Trichot, *Rev. Gén. Chim. Pur. Appl.*, **9**, 202, 1906; H. N. Stokes, *Econ. Geol.*, **2**, 14, 1907; A. N. Winchell, *ib.*, **2**, 290, 1907.
- ²³ E. W. von Siemens and J. G. Halske, *German Pat.*, D.R.P. 42243, 1886; 48959, 1889.
- ²⁴ T. S. Hunt, *Chem. News*, **44**, 198, 1881; *Trans. Amer. Inst. Min. Eng.*, **1**, 258, 1873; **4**, 327, 1876; **10**, 11, 1882; **16**, 80, 1888; *The Hunt and Douglas Process for Extracting Copper from its Ores*, Boston, 1876; J. Douglas, *Mineral Resources of the United States*, Washington, 397, 1884; *Eng. Min. Jour.*, **92**, 51, 1911; H. O. Hofman, *Min. Ind.*, **17**, 296, 1908.
- ²⁵ W. Longmaid, *Brit. Pat. Nos.* 9496, 1842; 10797, 1845; W. Henderson, *ib.*, 2525, 1860; *Dingler's Journ.*, **204**, 290, 1891; E. Pctigaud, *Berg. Hutt. Ztg.*, **17**, 89, 1853; M. Schaffner, *ib.*, **21**, 175, 1862; F. Mayer, *Journ. Pharm.*, **29**, 127, 1856; F. Claudet, *Compt. Rend.*, **75**, 580, 1872; *Ann. Chim. Phys.*, (**4**), **27**, 407, 1872; T. Gibb, *Trans. Newcastle Chem. Soc.*, **2**, 76, 1874; H. Chadwick and W. Jardine, *Brit. Pat. No.* 2951, 1875.
- ²⁶ N. S. Keith, *Journ. Franklin Inst.*, **160**, 147, 1905; W. McA. Johnson, *Electrochem. Ind.*, **1**, 274, 1903; K. Reinartz, *Mét.*, **5**, 202, 1908; H. Carmichael, *Amer. Journ. Science*, (**3**), **32**, 129, 1886; S. von Laszczyński, *German Pat.*, D.R.P. 144282, 1902.
- ²⁷ O. Nielsen, *Metal Erz.*, **17**, 4, 1920; W. H. Bassett, *Records Circuit Court of U.S.*, Oct. 17, 1907; E. Keller, *Min. Ind.*, **7**, 243, 1898; L. Guillet, *Rev. Mét.*, **6**, 1245, 1909; A. Hollard and L. Bertiaux, *ib.*, **3**, 205, 1906; A. Eilers, *Trans. Amer. Inst. Min. Eng.*, **47**, 217, 1913.
- ²⁸ T. W. Richards, *Proc. Amer. Acad.*, **22**, 342, 1887; **23**, 177, 1887; *Chem. News*, **58**, 68, 1888.
- ²⁹ L. Cohn, *Arbeitsmethoden für organisch-chemische Laboratorien*, Hamburg, 360, 1903; O. Ohmann, *Ber.*, **45**, 2973, 1912; J. Piccard, *Helvetica Chim. Acta*, **5**, 147, 1922.

§ 5. The Physical Properties of Copper

The colour of copper in compact masses is yellowish-red by reflected light, the tint ranging from orange-red to a rose colour dependent upon the temp. at which the metal was quenched from the liquid condition. The deep red colour of metallic copper is best seen when the light has been reflected many times from the surface of the metal, *e.g.* when a sheet of the metal is bent to an acute angle (about 45°), and viewed with the eye directed to the point where the two inner surfaces of the copper approach one another. The metal precipitated from soln. is brownish-red, and the colloidal metal ranges in colour from crimson or scarlet to various shades of blue and brown. Thin films of copper appear greenish-blue by transmitted light. According to W. I. Baragiola,¹ copper distilled ten times or more in a high vacuum has a pale rose colour. According to C. Bischof² molten copper has a bluish-green colour. Thin layers of copper, said M. Faraday, are green; G. B. Rizzo said bluish-green; E. Braun, blue; and C. Bischof, reddish-violet. According to G. T. Beilby, the red colour of copper in reflected light is conditioned by a glassy variety of the metal. W. L. Dudley says that copper vapour is green. The compact metal has a bright metallic lustre, and takes a bright polish which is soon tarnished when exposed to the air.

J. G. Wallerius³ first described the crystalline form of copper in 1772; he said *cuprum est figura octaedrica vel cubica*. J. B. L. Romé de l'Isle, J. D. Dana, G. Rose, J. W. Mallet, etc., have since described the crystals. The crystals of copper belong to the cubic system—hexakis-octahedra (ἑξάκεις, six times)—whether the metal occurs naturally or is reduced from its soln., or congeals from a molten condition. Twin crystals are common; an example of *dendritic copper* is illustrated by Fig. 12 in the chapter on crystals. G. W. A. Kahlbaum and co-workers obtained small octahedra when the metal was sublimed in vacuo, and similar crystals have been obtained by slow deposition from dil. soln. W. L. Bragg's X-radiogram of a crystal of copper shows that the atoms are arranged in the pattern of the simple face-centred cubic lattice with side 3.60 Å., and closest approach of the atoms, 2.54 Å. P. Scherrer gave 3.61×10^{-8} cms. for the length of the edge of the elementary cube. H. Böhlin also studied the X-radiogram of copper. S. Nishikawa and G. Asahara,

and M. Ettisch and co-workers, found that rolled copper gives an ill defined X-radiogram with a symmetry related to the direction of rolling; on annealing definite spots replace ill-defined patches, but the copper still shows the direction of rolling after annealing 2 hrs. at 800°. K. F. Slotte estimated the edge of the molecular cube of liquid and solid copper to be 5.8×10^{-9} cm. W. L. Bragg computed the radius of the atomic spheres of the crystals to be $0.137 \mu\mu$, or 137 Å. M. N. Saha also made estimates of this magnitude.

J. Percy said that the term **moss copper** is employed in copper-works to designate accumulations of filamentous or moss-like copper which is formed in cavities on ingots of certain kinds of regulus. Under the microscope, he added, the filaments present numerous minute parallel and longitudinal lines or grooves, as though they consisted of bundles of extremely delicate fibres. Moss copper is also said to be remarkable for its purity. F. le Play found at the junction of the regulus and slag of a copper furnace a geode filled with extremely delicate threads of metallic copper, containing Cu, 98.2 per cent.; Fe, 0.4 per cent.; Ni, 0.6 per cent.; and admixed sand and carbon, 0.2 per cent. The so-called **filiform or hair copper** was obtained by A. Liversidge by heating native cupric sulphide in hydrogen at a temp. below the m.p. of copper. Moss silver has been discussed by W. Hampe, W. Hittorf, E. Murmann, H. Moissan, J. Margottet, and E. Weinschenk. A. Beutell has made some observations on this subject—*vide* moss silver.

The surface of cast copper, under the microscope, appears to be composed of large primary and small secondary polygonal granules definitely oriented; a sheet of electro-deposited copper appears to consist of primary granules only, without definite orientation. The crystalline structure of electrolytic copper has been described by O. Faust, G. Grube and co-workers, M. von Schwarz, Z. Jeffries, A. Sieverts and W. Wippelmann, H. S. Rawdon, etc. A low current density gives large well-formed crystals, and a high current density gives crystals which grow at right angles to the surface of deposition, and which have a columnar appearance; with a still higher current density, the structure is broken up, and twinned crystals are common—the twinning is at right angles to the direction of crystal growth. The production of idiomorphic crystals of copper was found by W. E. Hughes to follow the same general laws as those involved in the formation of well-shaped crystals in salt soln.

The metal is an aggregate of crystals so that each grain has a definite orientation which is different from that of its neighbours. The external shape is polyhedral. The grains may grow in the solid metal: (1) When heated below the crystallizing temp. after cold plastic deformation; (2) when a hot-worked or annealed metal is heated to a higher temp. than was previously used, or for a longer time at a lower temp.; (3) when the compressed powder is heated to a high temp. below the m.p.; and (4) when the metal is heated or cooled through certain transition temps. When just crystallized after cold-drawing or rolling, the grains of copper approximate 0.0002 to 0.0012 cm., and after annealing, 0.002 to 0.006 cm. in diameter. G. Tammann has studied the regrouping of the atoms during annealing whereby new crystals are formed. H. Baucke clamped the polished surfaces of two pieces of copper, one piece hammered and the other annealed, and found that, at 105°, the hammered surface became considerably recrystallized, but when the surfaces were separated, or insulated with an oil film, there was practically no modification even after 48 hrs. heating at 180°. This confirms the general observation that forged or drawn metals are in a less stable condition with respect to crystallization than the same metal in the soft state—*e.g.* if plates of forged and soft metals be made the poles of a galvanic cell in a soln. of a salt of the same metal, the forged metal becomes charged negatively and passes into soln. The presence of all but very minute proportions of cuprous oxide, bismuth, and lead is evidenced as discrete particles under the microscope; whereas silver, gold, nickel, manganese, antimony, arsenic, zinc, phosphorus, etc., dissolve to a greater or less extent in the solid metal, and may leave no trace of their presence except possibly in the appearance of the

crystals. During rolling, the primary granules are elongated in the direction of the rolling, and this gives the metal its characteristic fibrous structure. M. Ettisch and co-workers say that the crystallites in soft wires are arranged irregularly, while those in hard wires are regularly arranged. E. Rassow and L. Velde have plotted on a triaxial diagram the degree of cold working, the annealing temp. (time constant), and the mean diameter of the grains of copper. Copper is etched for microscopic examination by aqua ammonia, or ammonium persulphate, or an ammoniacal soln. of hydrogen peroxide.⁴

The production and properties of thin films of copper have been discussed by A. W. Wright,⁵ W. Betz, L. Houllévigüe, W. Spring, A. Knop, M. Faraday, O. Brunck, T. Curtius and F. Schrader, F. D. Chattaway, G. T. Beilby, and P. Neogi.

As previously indicated, in the Arabian, *The Book of the Best Things for the Knowledge of Mineral Substances*, by Abu-r-Raihan,⁶ written towards the end of the tenth century, the **specific gravity** of copper is stated to be 8.70, which is not far removed from the value accepted to-day. He also gave 8.82 for the sp. gr. of bronze, and 8.57 for that of brass. Another Arabian writer, Al-Khazini, in his *Book on the Balance of Wisdom*, written in the twelfth century, gave 8.66 for the sp. gr. of copper. An early determination of the sp. gr. of this element by R. Boyle (1690) gave 9; and one by D. G. Fahrenheit (1725) gave 8.834 for Swedish copper, and another 8.799 for Japanese copper. C. Hatchett (1803) gave 8.895; A. T. Kupffer (1824), 8.78; C. J. B. Karsten (1832), 8.721; T. Herapath (1824), 8.900; R. Mallet, 8.667; and H. Schiff, 8.902 (12°). According to W. Stahl, the sp. gr. of copper at different temp. is:

Sp. gr.	15°	1100°	1125°	1150°	1175°	1200°	1250°
.	8.8604	8.3601	8.3492	8.3384	8.3276	8.3168	8.2953

The sp. grs. of the pure metal, measured by different observers, do not agree. The sp. gr. is greatly influenced by the thermal history of the metal, and the presence of impurities. The sp. gr. of ordinary commercial copper usually ranges from 8.6 to 8.9; the standard value is 8.89 at 20°; M. J. Brisson (1787) reported that the sp. gr. of the cast metal is 8.788, and that of the rolled metal 8.878; A. Baudrimont found that slowly-cooled cast copper had a sp. gr. 8.4525; and wire prepared in several different ways had a sp. gr. varying from 8.3912 to 8.8893. Similar observations were made by R. Böttger, and C. O'Neill, while R. F. Marchand and T. Scheerer found for electrolytic copper, 8.914; A. Dick, 8.937; and L. Playfair and J. P. Joule, 8.920; and for finely divided copper, the latter also gave 8.931 (4°), and A. Dick, 8.938. For copper plate at 0°, G. Quincke gave 8.902. The cold working of copper affects the mechanical and the physical properties—elasticity, sp. gr., e.m.f., thermal and electrical conductivities, etc.—of the metal. F. C. A. H. Lantsberry found that the sp. gr. of the cold-worked metal is 8.8313 and of the annealed metal 8.8317. G. W. A. Kahlbaum and E. Sturm⁷ state that the sp. gr. of native crystalline copper is 8.94; electrolytic copper, 8.914; cast copper, 8.921; drawn copper, not annealed, 8.939 to 8.949; drawn annealed copper, 8.930; hammered copper, 8.951; copper reduced by hydrogen, 8.367 to 8.416; copper cast in an atm. of coal gas, 8.95. According to W. Hampe (1872), the sp. gr. of pure electrolytic copper at 0° is 8.945; and 8.952 according to H. Schröder (1859). After hammering, the sp. gr. changes from 8.952 to 8.958; and according to G. W. A. Kahlbaum and co-workers (1902), the sp. gr. of the distilled metal is 8.93258 at 20°, and 8.93764 after being subjected to a press. of 10,000 atm. After being subjected to a still higher press., the sp. gr. begins to diminish. According to T. Scheerer and R. F. Marchand, the low sp. gr. of cast copper is due to the **porosity** of the metal, which is supposed to be caused by the absorption of gases at a high temp., and their subsequent evolution during cooling. T. M. Lowry and R. G. Parker say that the sp. gr. of copper increases when the metal is annealed at 100°, and that while the sp. gr. of the metal *en masse* is 8.9153,

that of the filings is 8.8900. P. Pascal and J. Jouniaux found the sp. gr. of liquid copper at its m.p. 1083°, in an atm. of an inert gas, is 8.40, and at 1200°, 8.32; L. Playfair and J. P. Joule gave 7.272; and W. C. Roberts-Austen and T. Wrightson, 8.217.

W. Spring has shown that many substances after compression have a lower sp. gr. than before. For example, lead, tin, cadmium, and silver, after being forced through small apertures under press., also show a slight diminution in sp. gr., while with bismuth there is a slight increase. When two plates of a metal—one of which has been compressed, and the other not compressed—are used as plates of a cell in a soln. of one of the salts of the metal, an electric current is generated such that the metal which has been compressed by hammering, etc., is negative to the annealed metal. The current is in the opposite direction with bismuth—which contracts on liquefaction—to what it is with lead, tin, cadmium, and silver—which expand on liquefaction. W. Spring supposed that the metals change under compression to the mol. condition characteristic of liquids; otherwise expressed, metals under great compression assume an allotropic form corresponding with the liquid or amorphous condition which P. Duhem calls *métal flué*, as distinct from the crystalline state—*métal recuit*—obtained by slowly cooling the molten metal.

G. T. Beilby⁸ also considers that the metals can exist in two distinct solid phases: (i) the hardened or amorphous state; and (ii) the annealed or crystalline state; and he gives evidence to show that the former is converted into the latter by annealing; and that the latter is converted into the former when work is done on the crystalline metal—*e.g.* polishing the surface of a metal produces what he assumes to be an amorphous film which can be removed by suitable solvents so as to show the underlying crystalline phase; similarly, when a piece of metal is strained by, say, wire-drawing, the friction of the crystals produces an encircling net-work of the amorphous hardened phase between the crystals which increases the tensile strength of the metal. According to G. T. Beilby, the transition temp. between the two phases of gold lies between 250° and 280°; copper, between 250° and 290°; silver, between 230° and 265°; and magnesium, between 300° and 360°.

W. Rosenhain⁹ also has given much indirect evidence of the existence of an intercrystalline amorphous film in normally crystalline metals. As a rule, an amorphous substance is more susceptible to attack by chemical agents than the same substance in a crystalline state. According to S. W. Smith, if two buttons of silver—one slowly and the other rapidly cooled—be treated with nitric acid, the one which has been cooled most rapidly will be most quickly dissolved; and according to W. Rosenhain, the loss by volatilization of rapidly chilled castings of silver is greater than with slowly cooled castings. With slow cooling, the crystals are larger and the intercrystalline amorphous cement is less abundant than with sudden chilling where the crystals are smaller. It is inferred that the volatilization is mainly from the amorphous cement, and that the amorphous cement is likewise attacked most rapidly by acids. In the latter case, too, the faster the amorphous cement is dissolved, the greater the surface exposed to the action of the acid, and the more quickly will the metal be dissolved.

O. W. Ellis,¹⁰ therefore, infers that the cold-working of metals favours the production of the amorphous at the expense of the crystalline metal in the balanced reaction: $\text{Cu}_{\text{crystalline}} \rightleftharpoons \text{Cu}_{\text{amorphous}}$, and that the amorphous matter produced by the strain undergoes recrystallization when the stress is relieved. The crystallization of deformed metals has been studied by D. Hanson and many others. As a result, it is inferred by D. Hanson that for every degree of deformation in strained metals, there is a critical recrystallization temp. at which crystal growth is extremely rapid, and the size of the crystals produced by this growth is greater, the smaller the amount of deformation preceding such annealing. According to Z. Jeffries and R. S. Archer, 200° is the lowest temp. at which the recrystallization of the cold-worked metal has been observed.

The pure metal is highly ductile and malleable, for it can be rolled into sheets,

hammered into foil, or drawn into wire. When subjected to mechanical treatment of this kind, the metal becomes hard; the hardness can be removed by annealing between 500° and 700° in an atm. free from sulphur. When the metal is mechanically worked, it must be frequently annealed to avoid fracture. This is illustrated by the curve, Fig. 9, showing the effect of annealing at different temp. on the elastic limit; the tensile strength curve changes with temp. in an analogous manner. According to E. Heyn,¹¹ by annealing the metal at 500° , the crystal granules increase in size until they become visible to the naked eye.

According to G. Tammann, cold-work increases the energy content of a metal because the formation of gliding planes, and the translation of particles, leads to a decomposition and an increase in the potential energy; and further, processes take place within the atom which lead to a similar increase.

A cold-worked metal is less noble, *i.e.* more chemically active, in the hard than in the soft state. Since, however, the surface layers are alone affected, a superficially hardened piece, still soft in the interior, may behave less nobly than a thoroughly hardened piece. The change in the chemical activity of a metal by working is ascribed to an alteration in the properties of the particles of the metal which, once displaced, are held less firmly in the lattice than before.

The fracture of cast copper is more or less granular; that of rolled or drawn copper is fibrous. The malleability of a metal refers to its property of permanently extending in all directions without rupture when a stress—pressure (rolling) or impact (hammering)—is applied. The ductility refers to the property which enables metals to be drawn into wires. The malleability of copper¹² is equal to that of gold and silver; it has been hammered into sheets 0.0026 mm. thick. The ductility of copper is also high. E. S. Shepherd and G. B. Upton found the ductility expressed in *percentage elongation* during the application of a tensile stress to vary from 12.0 to 22.5 per cent. for cast copper, and from 18.5 to 28.0 per cent. for copper kept a week at 540° and then quenched in water. G. D. Bengough and D. Hanson found that there is a range of low ductility for copper between 250° and 450° ; and that the presence of oxygen and arsenic increase the high temp. ductility of the metal.

The ductility of copper is increased by annealing, and G. V. Caesar and G. C. Gerner, and B. E. Curry have shown that the temp. range within which this softening takes place most rapidly is from 200° to 350° for pure copper; but this is affected by (i) the extent of the previous cold reduction; and (ii) the impurities. Arsenic and silver raise the annealing temp. range of copper. The properties of copper are not affected like those of steel after annealing or rolling. From the work of A. Martens, and F. Johnson, it is generally believed that quenching copper in water after annealing produces a softer metal than if it be slowly cooled, although there is some evidence for and against this view. B. Hopkinson, and J. E. Sears have studied the momentary expansion which occurs on percussion. C. J. B. Karsten pointed out that the greater the purity of copper the greater its malleability and softness, and the less heat required to render the brittle metal malleable. The effects of various foreign metals on the physical properties of copper have been much investigated.

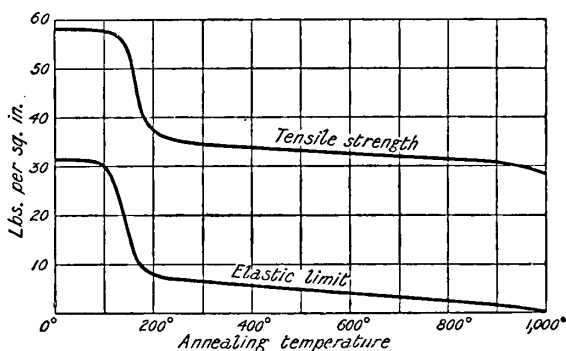

FIG. 9.—The Effect of Annealing at different Temperatures on the Tensile Strength and Elastic Limit of Electrolytic Copper (C. Grard).

Copper is malleable when cold, and at a red-heat; a metal malleable at a red-heat, and not so when cold, is said to be *cold-short*; and a metal malleable when cold, but not so at a red-heat, *red-short*. According to E. Cohen, the Greek Theophrastus, about 371 B.C., stated that he had noticed the disintegration of copper during a severe winter.

Pure copper is comparatively soft. As indicated in the general remarks on hardness, in connection with the alkali metals, this property can be expressed in several different ways, many of them quite arbitrary. On F. Mohs' or the mineralogical scale, the **hardness**¹³ of copper is about 3, when that of iron is 4.5, and silver 2.7. O. Faust and G. Tammann's values for the sclerometric hardness measured by the width of a scratch made with a load of 10 grms., is 0.014–0.016 mm. for soft and 0.016 for the hard metal; and with a load of 17 grms., 0.022–0.027 mm. for the soft and hard metals. J. A. Brinell's test for hardness measures the diameter of an impression made by the application of a load applied for a definite time—say 15 seconds. J. A. Brinell's hardness number of copper cast and slowly cooled is 52.8; C. A. Edwards gave 53.0. The numbers for rolled sheet copper unannealed range from 65 to 75, when the value for mild steel is about 104. J. A. Brinell's hardness test can also be represented as a press. in kgrms. exerted per sq. mm. of the ball segment. Copper then gives a hardness of 35.3 kgrms. per sq. mm. A kilogram, under standard conditions, is eq. to 981,000 dynes, or a dyne is eq. to 0.0000101937 kgrm. The curve showing the decrease in the hardness of copper with temp. is slightly concave towards the temp. axis. A. Kürth gave for a load of 400 kgrms.:

	–83°	–50°	18°	100°	200°	300°	390°	523°
Hardness	41.3	40.1	37.4	35.2	30.8	26.7	23.4	17.6

L. Guillet has shown that the ratio of the tensile strength to Brinell's hardness varies with the hardness of the metal. E. H. Pierce found that in the hard-drawing of copper wire the effect is the same throughout the whole section, and no hard or exterior skin is formed. While M. Hanriot, and Z. Jeffries detected no change in the microstructure of compressed metals, the Brinell's hardness of copper was raised by compression at 10,000 kgrms. per sq. mm. from 27.0 to 46.1. C. Calvert and R. Johnson give the relative hardnesses of gold, silver, and copper as 4:5:7.2; J. R. Rydberg gives 2.5:2.7:3.0; S. Bottone, 979:990:1360; and F. Auerbach, 97:91:95.

According to G. Quincke, the **surface tension** of copper at its m.p. is 581 dynes per cm., and the **capillary constant**, a^2 , is 14.44 sq. mm.; and for solid copper he gives for the capillary constant in grms. $a^2 r \pi + \beta r^2 \pi$ for wires r mm. diameter, where $a=0$ for soft copper and 2388 for hard-drawn copper. S. W. Smith found the surface tension at 1150° to be 1178 dynes per cm., and $a^2=28.85$ sq. mm. According to I. Traube, the **internal pressure** of the solid metal is 236,100 megabars. A. Johnsen found the **plastic flow** of copper is not diminished by cooling the metal in liquid air. C. A. Edwards, and W. E. Dalby, and E. C. Bain and Z. Jeffries, also studied the plastic flow of copper. According to H. E. Diller, when a bar of steel was packed in cupric oxide and carbon and heated for some time at 1000°, metallic copper penetrated the steel to the extent of 21.4 per cent., thus demonstrating the **diffusion** of copper into iron. R. J. Anderson measured the rate of diffusion of solid copper in molten aluminium and found it to increase rapidly with rise of temp.; G. Sirovich and A. Cartoceti demonstrated the diffusion of manganese from ferro-manganese into copper at 900°; and H. Weiss studied the diffusion of copper into molten zinc. The **velocity of sound** in copper is 39.7×10^4 cms. per second. According to J. Kleber, the velocity V of sound in solid metals is proportional to the square root of the quotient of the sp. ht. C and the coeff. of linear expansion a such that $V=57.698 \sqrt{C/a}-637$. This applies to copper, silver, gold, magnesium, aluminium, tin, lead, iron, nickel, and platinum, but with tantalum there is a difference, presumably because the constants have not been determined

with sufficient accuracy. The velocity of sound is also proportional to the square root of the quotient of the modulus of elasticity, E , by the density, D , such that $V=99.04\sqrt{E/D}$. Consequently, $99.04\sqrt{E/D}=57.698\sqrt{C/a}-637$, and if any three of these constants be known, the fourth can be computed to within five per cent. of its value. The internal **viscosity** of copper has been investigated by M. Ishimoto by the use of tuning-forks and torsion pendulums. K. Honda and S. Konno found the viscosity of rolled copper to be 4.83×10^8 at 15° ; and that of the metal annealed at 300° , to be 5.13×10^8 at 15° .

It must be emphasized that the data for the mechanical properties of the metals are more or less dependent upon the methods employed in the measurements. The values for the elastic qualities, for example, are more or less dependent upon the size and shape of the test-pieces, and on the rate at which the stress is applied, as well as on the previous mechanical and thermal treatment of the material, this quite apart from the influence of traces of impurities on the results. It is therefore usually safer to give ranges of values for pure material treated in different ways rather than to assign definite values for an arbitrarily selected mode of testing these characteristics. It is generally considered that copper may be normalized—*normalized copper*—for tensile strength determinations by casting, rolling, and drawing, followed by annealing for 30–60 min. at 500° with slow or quick cooling, because when prepared under these conditions there is less variation between different samples than in any other condition.¹⁴

Copper does not break down by fracture; when compressed, it yields indefinitely and becomes flattened out. According to R. H. Thurston,¹⁵ if c denotes the resistance to compression in lbs. per sq. in., e the fractional compression, $c=145000e^3$ for compressions up to 50 per cent. The **compressibility** of a substance is the change in volume dv which unit volume v undergoes per unit change of press. p (say, a kilogram per sq. cm.), or the ratio of the compression dv/v , to the press. dp applied, that is, dv/vdp . The compressibility of copper is 0.75×10^{-6} (20°), meaning the fractional change of the original volume caused by a press. of a megabar, that is, 10^6 dynes per sq. cm., between 100 and 500 megabars. L. H. Adams, E. D. Williamson, and J. Johnston give 0.75×10^{-6} ; and they represent the change in volume between the press. p_0 and p by $0.00001+0.000000749(p-p_0)$. E. H. Amagat gave 0.857 per atm.; H. V. Regnault, 1.23; J. Y. Buchanan, 0.864; S. Lussana, 1.0 to 1.1 for press. from 100 to 3000 atm. E. Madelung and R. Fuchs gave $3.101(\pm 0.004) \times 10^{-12}$ dynes per sq. cm. According to B. Lera, the relation between the compressibility β , the coeff. of expansion α , the at. wt. w , and sp. gr. D , is represented by $(\alpha/\beta)(D/w)^3=0.048$. Unit volume of copper at 0° is estimated to change 0.0089 vol. when the press. is raised to 12,000 kgrms. per sq. cm. H. Grüneisen found that the compressibility of copper, β , increases rapidly with rise of temp., and that the greater the expansion with rise of temp., the greater the change of compressibility. Thus the value of β for copper at -191° is 0.718×10^{-6} ; at 17.5° , 0.773×10^{-6} ; at 133° , 0.815×10^{-6} ; and at 165° , 0.828×10^{-6} . A. Mallock found at -190° , 0.718×10^{-6} ; at 17° , 0.778×10^{-6} ; and at 100° , 0.801×10^{-6} .

Copper is considered to be a very elastic metal. If a strain of ω kilograms exerted on a cylinder of s sq. mm. sectional area, and length l , produces an increase in length, dl , the modulus of elasticity, or the longitudinal elasticity, Young's modulus, or the coefficient of resistance to extension, is $(l/dl)(\omega/s)$ kilograms per sq. mm. The modulus of elasticity is therefore the product of the longitudinal stress by the longitudinal extension or compression; and the value for highly purified copper is between 10,000 and 13,000 kilograms per sq. cm., or about 12.20×10^{11} dynes per sq. cm., or 1220×10^6 dynes per sq. mm., or 17.3 lbs. per sq. in. The observed maximum and minimum values are 1323 and 1052 dynes per sq. mm. A. Gray, V. J. Blyth, and J. S. Dunlop found for electrolytic hard-drawn copper an elastic modulus of 13,220 kgrms. per sq. mm. (19.5°), and for commercial copper, 11,354 (17.4°); G. Wertheim gave 10,519 (15°); and for wire drawn, 12,513; K. Zöppez gave 12,646; E. H. Amagat, 12,145; K. F. Slotte,

12,550; G. Angenheister, 12,240; W. Voigt, 10,850; J. Kiewiet, 10,800; C. Benedicks, 12,300; F. Kohlrausch and F. E. Loomis, 12,140; H. Buff, 12,270; G. F. C. Searle, 12,400 kgrms. per sq. mm., and 17.6×10^6 lbs. per sq. in. for drawn and 18.3×10^6 lbs. per sq. in. for annealed copper. The best representative value may be taken as 12,200 kgrms. per sq. mm. with maximum and minimum values 13,230 and 10,520 kgrms. per sq. mm. B. Welbourn measured the elastic modulus of a number of stranded cables of hard-drawn copper wire. P. Galy-Aché has measured the elastic deformation which copper possesses in the amorphous intercrystalline medium and in the crystalline part; and F. Rehkuh, the effect of temp. on the restoration of the elastic deformation. M. Rudeloff's values for the effect of temp. on Young's modulus for different samples of copper were:

20°	100°	200°	300°	400°
17.8—18.1 × 10 ⁶	18.1 × 10 ⁶	14.3—15.6 × 10 ⁶	11.8—13.5 × 10 ⁶	10.1 × 10 ⁶ lbs. per sq. in.

The steady and gradual fall of the modulus of elasticity of copper as the temp. rises¹⁶ to 1000° is illustrated by Fig. 10, due to K. R. Koch and C. Dannecker. According to F. Kohlrausch and F. E. Loomis, the elastic modulus at θ is $E = E_0(1 - 0.000572\theta - 0.00000028\theta^2)$. A. Wassmuth gives for the temp. coeff. of the elasticity $E = E_0(1 - 0.000359\theta)$. According to C. Bischof, copper becomes very brittle just below its m.p. F. Streintz, M. C. Noyes, H. Walker, H. L. Dodge, G. A. Shakespeare, etc., have made observations on the effect of temp. on this modulus. Heating by an electric current shows no other than a temp. effect. According to W. Sutherland, the observed variations of Young's modulus with temp. are linear, and approximately in accord with the empirical relation $E/E_0 = 1 - 0.823(\theta/\theta_m)$, where E denotes the value of Young's modulus at θ° , and E_0 its value at absolute zero; and θ_m denotes the

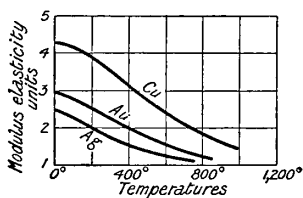

FIG. 10.—Effect of Temperature on the Modulus of Elasticity.

m.p. of the solid. The relation was found to hold good for a number of metals between atm. temp. and 102°, but it is imperfect in that it gives a finite value for the modulus at the m.p. when it ought to give a zero value. C. Schäfer gave 3.627 for the temp. coeff., or the percentage increase in Young's modulus in passing from 20° to -182°. E. A. Lewis noted the elasticity is increased by alloying the metal with arsenic, and A. Riche found the same thing with iron.

The ratio of the contraction in a lateral direction to the longitudinal extension of a body stretched by a longitudinal stress is called **Poisson's ratio**: the value of this constant for copper ranges from 0.338 to 0.378; E. H. Amagat gave 0.327. The best representative value is 0.34, with a temp. coeff. of about 0.00023 per degree between 0° and 150°. Investigations on Poisson's ratio have also been made by G. Angenheister, who found 0.382; P. Cardani, 0.374; J. Morrow, 0.327; J. R. Benton, 0.322; C. E. Stromeyer and W. Kennedy, 0.322; A. Mallock, 0.348; and W. Voigt, 0.350 for electrolytic copper. A. Bock found Poisson's ratio to be 0.340 at 20°; 0.355 at 60°; 0.352 at 100°; and 0.370 at 150°.

If a uniform press. p kilograms per sq. cm. changes the volume v by dv , the ratio dv/v is called the compression, and the quotient of p by the compression, pv/dv , is called the **volume elasticity** of the substance; the value of this constant for copper is from 13.1×10^{11} to 16.8×10^{11} dynes per sq. cm. The resistance to shearing, or the quotient of the shearing stress by the shear, is called the **rigidity** of the substance to transverse distortion—that is, the **torsion or shear modulus**. The value of this constant for copper is 4.47×10^{11} to 4.55×10^{11} dynes per sq. cm. W. Voigt gave 4780 kgrms. per sq. mm.; N. Savart, 4213; S. Katzenelsohn, 3587; A. Gray, 4199; C. Schäfer, 3967; G. Angenheister, 3587; M. Baumeister, 4450; and J. Kiewiet, 4664 kgrms. per sq. mm. G. Pisati's value for the rigidity n at θ° , when the value at 0° is 3972 kgrms. per sq. mm., is $n = 3972(1 - 0.002716\theta - 0.000230\theta^2)$

$-0.0_{8}47\theta^3$); F. Kohlrausch and F. E. Loomis give $n=3900(1-0.000572\theta+0.0_{6}28\theta^2)$ kgrms. per sq. mm. F. Horton gives 4.37×10^{11} dynes per sq. cm. at 15° for purified copper, and at 0° the value is $n=4.37 \times 10^{11}\{1-0.00039(\theta-15)\}$ dynes per sq. cm. For commercial copper, he gives $n=3.80 \times 10^{11}\{1-0.00038(\theta-15)\}$ dynes per sq. cm. K. R. Koch and C. Dannecker give 4240 kgrms. per sq. mm. or 6.15×10^6 lbs. per sq. in., and for the values at different temp. :

20°	100°	200°	300°	500°	800°	1000°
6.02×10^6	5.82×10^6	5.58×10^6	4.85×10^6	3.96×10^6	2.72×10^6	2.10×10^6

W. Sutherland¹⁷ gives 4300 kgrms. per sq. mm. for the rigidity at 15° , and estimates that at -273° , the rigidity is 4530 kgrms. per sq. mm. According to H. Tomlinson, the torsion of a wire is increased by raising the temp. to 100° .

The tensile strength or tenacity of a substance is the greatest longitudinal stress which it can suffer without rupture ; the tensile strength of cast copper is 1.2 to 1.9×10^9 dynes per sq. cm., and of rolled copper 2.0 to 2.5×10^9 dynes per sq. cm. The tensile strength of cast copper has been almost doubled by mechanical working. E. H. Pierce found the tensile strength of copper wire to be equally affected throughout its whole section by hard drawing. The observed skin effects are due to the rolling of oxide scale into the wire. T. Bolton, D. R. Pye, and W. E. Alkins have studied the effect of cold work on copper. In general, the work of P. Gocrens, W. R. Webster, and others has shown that cold work changes the elastic limit, the yield point, the tensile strength, the hardness, sp. gr., magnetic permeability, electrical conductivity, solubility in acids, etc. W. E. Alkins has shown that the effect of progressive cold-drawing is to change the tenacity T of the wire with the sectional area S as illustrated in Fig. 11. The portion AB of the curve corresponds with the equation $T=31.6-67S$; the portion CD with $T=30.83-82.66S$; and the portion BC with $T=23.2-(S-0.107)^{\frac{1}{2}}$. The results are explained by assuming that the first change which occurs when copper is drawn through the dies is allotropic; when this change is complete, a second change occurs, forming either an allotropic or an amorphous variety of the metal. F. Johnson showed that the presence of cuprous oxide is not responsible for the abrupt change which occurs. O. W. Ellis studied the phenomenon in connection with a zinc-copper alloy. Annealing reduces the tensile strength of cast copper from 40 to 21 kgrms. per sq. mm., or, according to C. W. Bennett,¹⁸ from 60,000 or 70,000 to 30,000 or 40,000 lbs. per sq. inch. The tensile strength of electrolytic copper annealed for 2 hrs. at 750° in an atm. of carbon dioxide, decreases as the temp. is raised, passing from 13 tons per sq. in. at 22° to 2.0 tons per sq. in. at 975° as illustrated by the curve, Fig. 9. G. Charpy gave for rolled copper with a tensile strength of 30 kgrms. per sq. mm., the following values when annealed at different temp. :

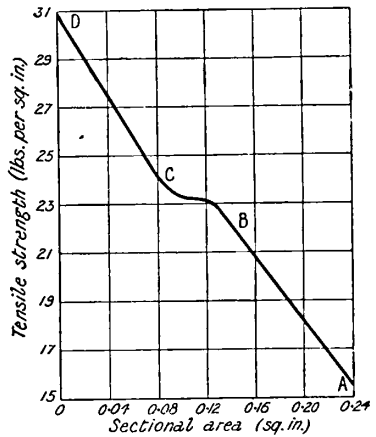

FIG. 11.—Effect of Sectional Area on the Tensile Strength of Copper Wire.

Annealing temp.	200°	280°	420°	500°	730°	850°
Tensile strength	30.8	30.5	22.1	22.2	22.2	22.0

Any stress within the elastic limit results in an elastic deformation from which the metal recovers on releasing the stress ; if the stress exceeds the elastic limit, plastic deformation or permanent set results. In this overstrained state, the material stretches at an enormously greater rate than before, and the yield is mainly

plastic. Under the action of small loads the strains increase at a still greater rate and deviate further from the law of proportionality to stress; as the load is applied, the material exhibits a strain which is increased by creeping more or less slowly. A. Morley and G. A. Tomlinson showed that copper gives practically the same results immediately after overstrain as before it, showing that if the properties are altered by overstrain, recovery is very rapid.

According to J. Dewar, the breaking stress of copper wires 0.098 in. in diameter is 200 lbs. at 15°, and 300 lbs. at -182°. F. A. and C. A. Lindemann found for the tensile strength of copper 60.10 kgrms. per sq. mm. at -252.6°; 48.8 kgrms. per sq. mm. at -192°; and 35.8 kgrms. per sq. mm. at 17°. A. Mallock obtained 1.37 for the ratio of Young's modulus at 0° K. to that at 273° K. E. S. Shepherd and G. B. Upton found the tensile strength of cast copper to lie between 17,990 and 23,740 lbs. per sq. in., and after annealing one week at 540° and then quenching

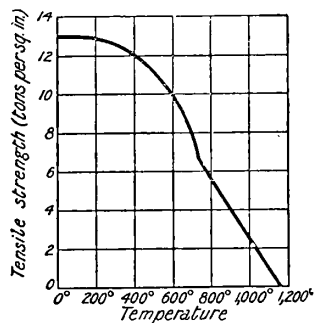

FIG. 12.—The Tensile Strength of Copper at different Temperatures.

in water, 22,600–24,540 lbs. per sq. in. The lowering of the ultimate tensile strength of copper with rise of temp. is indicated in Fig. 12. F. Johnson studied the effect of impurities on the annealing temp. of copper. P. D. Merica gives for the ultimate tensile strength of normalized copper 35,000 ± 5000 lbs. per sq. in., elongation in 2 in., 40–60 per cent., and reduction in area, 40–60 per cent. The determination of the **elastic or proportional limit** does not yield a measurable value because annealed copper yields slightly with the slightest loads applied in the testing machine; with hot-rolled copper, there is a small value with very small loads. The elongation with annealing follows just the opposite course to the tenacity. C. Grard's experiments, Fig. 9, give 150°–200° as the transition range, but E. S. Bardwell gives 300°–430°, and the difference is said to be due to the greater oxygen content of C. Grard's test-pieces.

A. Martens has studied the effect of variations in the size and shape of the test-pieces on the measurement of tensile strength. A. Martens measured the effect of time in testing and found that with a variation of 0.5 to 40 per cent. in the elongation per min., the observed difference in the ultimate tensile strength is less than 2 per cent.; while P. Ludwik found that a wire of electrolytic copper, 0.5 mm. diameter, sustained a load of 4958 grms. for 5 min., one of 4500 grms. for 90 hrs., and one of 3950 grms. for one and a half years. M. von Hübl studied the effect of varying current density on the mechanical properties of electro-deposited copper; and C. W. Bennett obtained electrolytic copper with a tensile strength approaching that of hard-drawn copper—viz. 68,000 lbs. per sq. in.—by varying the current density and using a rapidly rotating cathode. G. D. Bengough and D. Hanson found that the nature of the atm. has a marked influence on the tensile strength of copper at a high temp. An oxidizing atm. gives a high ductility at a high temp. L. Dufour has studied the influence of an electric current on the breaking stress of a wire. Traces of impurities like lead and tellurium make copper brittle, while phosphorus, arsenic, or antimony make the metal tougher. For example, according to G. D. Bengough and B. P. Hill:

Amount of arsenic	. 0.04	0.05	0.75	0.94	1.91 per cent.
Maximum stress	. 15.55	15.75	15.65	16.55	16.90 tons per sq. in.

R. H. Thurston¹⁹ has measured what he calls the *torsion test*, the *shear test*, and the *transverse bending test* of copper. F. Johnson, and A. K. Huntington have studied the effect of the so-called *fatigue test*, or the *alternating stress test*, on copper up to 500°. H. Baucke has investigated the so-called *impact test* on copper at ordinary temp. L. Guillet and V. Bernard carried the impact tests up to 1000°, and found that there is a linear decrease in the specific impact work needed to bend the specimens examined.

The coeff. of thermal expansion of copper between 0° and 100° was measured by A. L. Lavoisier and P. S. Laplace in 1782, and they found 0.00001722 and 0.00001712. The *Physikalisch-Technische Reichsanstalt* gives 0.002917 for the linear expansion of unit length between -191° and 16° ; and P. Glatzel, 0.001705 mm. for the expansion of a dm. rod per degree. According to H. Fizeau,²⁰ the coefficient of thermal expansion (linear) at 20° is 0.00001669; at 46° , 0.0000170; W. Voigt gives 0.00001669 at 20° ; and H. le Chatelier, 0.0000170, and at 1000° , 0.000020. For the mean coeff. of expansion between 0° and 100° , H. Fizeau gives $0.041596 + 0.091025\theta$; and A. Matthiessen, $0.041481 + 0.07185\theta$. The linear expansion of copper is not a linear function of temp.; but is well expressed between -40° and 300° by a quadratic equation. W. Dittenberger gives for $dl/l_0 \times 10^6 = 16.07\theta + 0.00403\theta^2$. F. Henning found a contraction between 0° and -191° of 2.917 mm. per 100 cms. This does not fit Dittenberger's formula. P. D. Merica has quoted a sample, 99.956 per cent. purity, of hot-rolled and cold-drawn electrolytic copper which, between -24° and 64° , had a unit linear expansion (within 0.000003) of $dl/l_0 \times 10^6 = 16.48\theta + 0.00382\theta^2$; and another sample of 99.968 per cent. copper hot-rolled, drawn and annealed, had (within 0.000009) between -49° and 305° , $dl/l_0 \times 10^6 = 16.34\theta + 0.00413\theta^2$; F. A. Lindemann from 85° K. to 292° K., $dl/dt = 124 \times 10^{-6}$; from 20° K. to 80° K., 49×10^{-6} ; and from 80° K. to 90° K., 75×10^{-6} . W. E. Dorsey found the coeff. to be lowered by reducing the temp. Thus:

Abs. temp.	283°	243°	223°	203°	183°	163°	143°	123°	103°
$\alpha \times 10^6$	1635	1610	1595	1500	1468	1437	1305	1206	1039

F. A. Lindemann verified for copper E. Grüneisen's relation: coeff. of expansion \div sp. ht. = a constant independent of temp. According to I. Zakrzewsky, the coeff. between -103° and -78° is 0.00001516; between -78° and 0° , 0.00001602; between 0° and 25° , 0.00001699; and between 25° and 100° , 0.00001753. The coeff. with hammered copper is rather less than with cast copper. According to A. Matthiessen, if the volume of copper is unity at 0° , it is 1.004998 at 100° . The coeff. of cubical expansion is 5.0×10^{-5} . L. Holborn and E. Grüneisen found 0.0000532 for the mean coeff. of cubical expansion between 0° and 100° , and 0.0000598 between 0° and 300° . E. Grüneisen found the coeff. of expansion, between -190° and 17° , was decreased from 14.18×10^{-6} to 14.09×10^{-6} by raising the press. from one to 1000 atm.; and between 17° and 100° , from 16.36×10^{-6} to 16.25×10^{-6} . F. Wehrenfennig found that by heating and rapidly cooling a copper rod 1.8 metres long and 55 mm. thick, it expanded 3.3 mm. permanently in length. W. Stahl gives for the coeff. of cubical expansion of purified molten copper 0.000054; and for copper after refining by poling 0.0000436. The difference is attributed to the absorption of gases.

The thermal conductivity of copper is rather less than that of silver or of gold. According to G. Poloni,²¹ if the conductivity of gold is 1000, that of copper is 888; G. Wiedemann and R. Franz give that of commercial copper 732 when silver is 1000, and L. Lorenz gives 0.7198 absolute units for the conductivity of copper at 0° , and 0.7226 at 100° . These numbers represent the amount of heat in cal. which is conducted per second across a plane one cm. thick and one sq. cm. sectional area, when the difference of temp. on the two surfaces of the plane is 1° . H. F. Weber gives 0.8190; W. Schaufelberger, 0.9382. According to C. H. Lees (1908), the thermal conductivity at -160° is 1.679; and according to W. Jäger and H. Diesselhorst (1900), at 18° , 0.918; and at 100° , 0.908 cal. per second per degree per sq. cm. E. Schott found for copper crystals at 0° , 4.1×1.0 C.G.S. units; and at -252.6° , 4.1×31.0 C.G.S. units; for commercial copper at 0° and -251° , the numbers are respectively 3.93×1.0 , and 3.93×33.4 . A. C. Mitchell, E. H. Hall, G. Glage, A. Berget, and others have also studied this property of copper. If K be the thermal conductivity; D the sp. gr.; and C , the sp. ht., then $K/DC = a^2$ represents the thermal conducting capacity

at 0°. K. Angström found $a^2=1.163$; at 18°, E. Grüneisen found 1.144, and W. Jäger and H. Diesselhorst, 1.13; at 75°, G. Glage obtained 1.15; and at 100°, W. Jäger and H. Diesselhorst found 1.09. For a phosphor-copper G. Kirchhoff and G. Hanse-mann obtained $a^2=0.5059$ at 15°. A. Rietzsch found that the presence of phosphorus and arsenic as impurities diminish the heat conductivity more than they do the electrical conductivity. L. Lorenz found the thermal conductivity to be proportional to the absolute temp.; R. W. Stewart found at θ° , the thermal conductivity of copper is $1.10(1-0.00053\theta)$. W. Jäger and H. Diesselhorst gave 0.00026 for the temp. coeff. of the thermal conductivity; K. L. Hagström gave 0.00064; O. Chwolson, 0.04389; and L. Lorenz, 0.04389. P. W. Bridgman found the thermal conductivity of copper decreases linearly with press.

The specific heat of copper was measured by P. L. Dulong and A. T. Petit,²² and they found 0.0949 between 0° and 100°, and 0.1013 between 0° and 300°. The sp. ht. increases with rise of temp., and the metal thus offers an increasing resistance to a rise of temp. the higher the temp. Numerous determinations have been made since then by H. Kopp, H. V. Regnault, H. Buff, H. Tomlinson, A. Bartoli and E. Stracciati, W. A. Tilden, P. Galy-Aché, U. Behn, etc. According to G. W. A. Kahlbaum, K. Roth, and P. Siedler (1902), the sp. ht. of pure distilled copper is 0.09272, and after compression at 6000 atm., 0.09266. The sp. ht. increases with rise of temperature. H. E. Schmitz (1903) found that the sp. ht. between -192° and 20° to be 0.0798; between 20° and 100°, 0.0936; and U. J. J. le Verrier obtained the value 0.104 between 0° and 360°; 0.125 between 360° and 580°; 0.09 between 580° and 780°; and 1.118 between 780° and 1000°. J. Dewar obtained 0.0245 for the sp. ht. of copper at 50° K. or -223°. W. Nernst and F. Koref have determined the sp. ht. of copper at low temp. showing that the sp. ht., and hence also the at. ht., approach zero at absolute zero:

-258°	-223°	-173°	-123°	-73°	-23°	0°
Sp. ht. 0.00077	0.0208	0.0620	0.0794	0.0854	0.0895	0.0909

at temp. above 0°, the values for solid copper are:

	50°	100°	200°	400°	500°	800°	1000°	1083°
Sp. ht. .	0.0931	0.0952	0.0985	0.1050	0.1115	0.1180	0.1245	0.1272

The sp. ht. of 99.87 per cent. copper, at θ° , between 0° and 50°, may be regarded as a linear function of the temp., and may be represented by $0.0917+0.000048(\theta-25^\circ)$. F. Wüst, A. Meuthen, and R. Durrer give $0.10079+0.0000061\theta$, between 0° and 1084°; and $-0.4150+0.0001312\theta$ between 1084° and 1300°. E. Bède gives 0.09680 for the mean value of the sp. ht. between 17° and 247°; F. Glaser, 0.1172 for the sp. ht. at the m.p.; and A. Naccari, $0.092455+0.0421258(\theta-17)$ at the temp. θ between 0° and 300°, and H. Schimpff, $0.091996+0.0000228545(\theta-17)-0.0000002022(\theta-17)^2$. E. Grüneisen found that the change in the sp. ht. of copper with pressure is $-dC_p/C_p dp=0.35 \times 10^{-6}$ kgrm. per sq. cm. The sp. ht. and the density suffer changes of about the same order of magnitude with changes of press. The coeff. of expansion and sp. ht. undergo changes of approximately the same magnitude down to about -190°. W. H. Keesom and H. K. Onnes have carried the measurements of the sp. ht. of copper down to 14.5° K. or -258.5°. F. Glaser gives 0.15563 for the sp. ht. of molten copper at 1084°. The corresponding atomic heat rises from 0.0396 at -258° to 5.78 at 0°, to 8.08 at 1083°; J. Dewar's value at -223° is 1.56. P. L. Dulong and A. T. Petit's constant is 6.02; H. V. Regnault found 5.93 for hammered copper and 6.04 for annealed copper.

L. B. Guyton de Morveau (1799)²³ gave 1207° for the melting point of copper; J. F. Daniell gave 1398°; and J. Violle, 1054°. A. von Riemsdyk said that the m.p. of copper is higher than that of silver, and lower than that of gold. The early determinations are erroneous. According to C. J. B. Karsten, a number of dull stellate spots quickly form on the mirror-like surface of molten copper, and as

quickly disappear; these phenomena probably represent the formation and dissolution of cuprous oxide. He added that copper with euprous oxide in soln. fuses more readily than purer copper, but it does not form so mobile a liquid, and it does not solidify so quickly. Accordingly, if the metal be melted in air, cuprous oxide is formed and dissolved by the metal, and the m.p. is accordingly lowered down to the eutectic indicated in E. Heyn's diagram, Fig. 24. In harmony with this L. Holborn and A. L. Day reported that the m.p. rises from 1064.9° when melted in air to 1084° when air is excluded. The m.p. is also altered by the presence of other metals. J. K. Clement gives $1080.2^\circ \pm 1.5^\circ$; and A. L. Day, R. B. Sosman, and E. T. Allen give $1082.6^\circ \pm 0.8^\circ$ for m.p. of the pure metal; E. Rudolfi found 1083° ; E. Tiede and E. Birnbräuer, 1085° ; F. Wüst and co-workers, and T. W. Richards, 1084° ; and C. T. Heycock and F. H. Neville, 1081° . The best representative value is 1083° ; this is in agreement with the lists of L. I. Dana and P. D. Foote, and K. Scheel; W. Guertler and M. Pirani give 1084° for the best representative value. J. Johnston has shown that the relation between the press. p and the m.p. of the metal at the temp. θ is $p = 95.1\lambda D \log(T/\theta)$, where λ denotes the heat of fusion per gram, T , the m.p. at ordinary press. on the absolute scale. For copper, $p = 95.1 \times 43 \times 8.93 \log(1356/\theta)$; at ordinary temp. copper will therefore melt when the press. is about 24,000 atm.; and the m.p. of copper is depressed $1355/(41.3 \times 43 \times 8.93) = 0.086^\circ$ per additional atm. R. Wright and R. C. Smith showed that very finely divided copper shows signs of sintering considerably below its m.p.

According to G. J. Meyer, a copper wire 4 mm. thick melts in 130 secs. by the passage of 500 amps., and a 3.5 mm. thick wire in 48 secs., and L. Lincoln found that if the current strength be represented by C , a copper wire of diameter d melts when $C = 0.14d^{1.7} + 2.3$; and W. H. Preece gives $C = ad^3$, where a depends on the length of the wire, being 80 if the length is 3 mm., and 70 if it be 150 mm. C. Matignon and R. Trannoy found the melting of copper wires in ammonia or alkyl-amine vapours is probably preceded by the formation of nitrides. Plane clean surfaces of two cylinders of copper were found by W. Spring to be welded together after heating for 8 days at 403° , and the metal can be readily brazed under microcosmic salt, borax, salt, etc. C. J. B. Karsten noted that molten copper expands on solidification, but if the metal has a large proportion of the oxide in soln., the expansion does not occur; and the addition of 0.1 per cent. of potassium, zinc, or lead is likewise sufficient to prevent expansion on solidification. C. T. Heycock and F. H. Neville studied the lowering of the f.p. of cadmium, tin, lead, and bismuth by copper.

C. M. Despretz noticed the volatility of copper in a stream of hydrogen, at a white heat; and copper may be boiled in the oxy-hydrogen flame. A. von Riemsdyk could detect no volatilization of the metal below its m.p., but C. Zenghelis detected signs of volatilization at ordinary temp.; E. Tiede and E. Birnbräuer, at 960° in vacuo; and W. Spring, at 400° . R. Blondlot suggested that the volatilization at a bright red heat is due to the formation of a nitride. C. A. Mahoney found that if sodium chloride is present the volatility of copper is augmented; and J. Roskell found a loss in assaying due to the formation of volatile products when copper ore is fused with fluorspar and borax. H. Moissan and A. J. P. O'Farrelley found that when alloys of lead or zinc with copper are heated in the electric furnac, the more volatile lead or zinc is rapidly distilled off leaving comparatively pure copper; tin is not eliminated from a tin and copper alloy so readily. H. Moissan distilled 50 grms. copper from an electric furnace running at 300 amps. and 110 volts; in 6 min., 16.0 grms. were distilled; and in 8 min., 23.3 grms. C. R. Groves and T. Turner, W. E. Thorneycroft, G. D. Bengough and D. E. Hill, J. Johnston, T. K. Rose, and W. H. Bassett have studied this question in more detail. A. Butts found the volatilization of copper in wire-bar furnaces to be quite appreciable at 1120° . H. Moissan and T. Watanabe found the boiling point of copper is above that of silver. Owing to experimental difficulties, it has not been found possible to determine the b.p. very accurately; O. Ruff and B. Bergdahl

gave 2305° at atm. press.; J. A. M. van Liempt, 2282°; C. Féry, about 2100°; E. Tiede and E. Birnbräuer, 2000°; and H. von Wartenberg, over 2200°. H. C. Greenwood found the b.p. of copper to be 2310° (760 mm.), and the effect of press. on the b.p. of copper is similar to that of mercury such that if T_1 and T_1' are respectively the b.p. of copper and mercury at 1 atm. press., and T_2 and T_2' their b.p. at some other press., these four magnitudes are so related that $T_1/T_2 = T_1'/T_2'$.

H. C. Greenwood found the **vapour pressure** to be 1 atm. at 2310°; 0.34 atm. at 2180°; and 0.13 atm. at 1980°; or, the vap. press. p mm. of mercury at T° K., is given by $\log p = 14 - 16400T^{-1}$. Hence, the vap. press. at the m.p. is near 0.001 mm. O. Ruff and co-workers observed the vap. press. 124 mm. at 2105°; 209 mm. at 2175°; 300 mm. at 2215°; 404 mm. at 2245°; and 752 mm. at 2300°. J. A. M. van Liempt represented the vap. press. $\log_{10} p = -23600T^{-1} + 9.20$ for p in atm.; this gives Trouton's constant 42.12. J. W. Richards gave $\log_{10} p = -24180T^{-1} + 9.64$. A. Henglein compared the vap. press. formula for copper. The vap. press. of mercury at 115° (388° K.) is approximately 1 mm., and hence copper at 1300° (1573° K.) will have the same vap. press. since the b.p. of copper and mercury are respectively 2583° K. and 630° K. J. H. Hildebrand gives $\log p = -14600T^{-1} + 7.85 + \log 4.65$ for the vap. press. p in mm. of mercury; and J. Johnston $\log p = -16400T^{-1} + 9.14$; and for the temp. at which the vapour is 10^{-3} mm., 1080°; 1 mm., 1520°; 10 mm., 1740°; 100 mm., 2030°; and 760 mm., 2350°. According to F. Kraft, with cathode rays in vacuo, vaporization begins at 1090°, and it is quite fast at 1315°; F. Kraft and E. Bergfeld say that under these conditions vaporization begins at 960° and the metal boils at 1600°. E. Tiede and E. Birnbräuer distilled 3 grms. of copper in 10 min. in a high vacuum. According to L. Hamburger, the thin film of copper deposited on the walls of the vessel in which the metal is heated, is a network of ultramicros. M. Knudsen has studied the condensation of the vapour of copper on clean glass and mica surfaces; below 350°-575° all the vapour is condensed, and above that temp. an appreciable fraction of vapour is not condensed on the surface.

The **latent heat of fusion** L can be calculated from E. Heyn's data, and J. H. van't Hoff's formula $L = 0.02wT^2/fM$ calcs. per gram, where f denotes the lowering of the m.p., when w grms. of the solute of mol. wt. M are present in 100 grms. of the metal; and T denotes the absolute temp. of fusion. The result is 38 calcs. F. Glaser found experimentally 41.4 calcs., F. Wüst and co-workers found 40.97 calcs., J. W. Richards, 43.3 calcs.; J. Johnston gave 75 Calcs. per mol.; and T. W. Richards 8 kilojoules per gram atom, or 30 calcs. per gram. J. W. Richards' estimate of the **latent heat of vaporization** is 858 calcs. per gram. J. A. M. van Liempt calculated from O. Ruff and B. Bergdahl's data, 120000 calcs. for the latent heat of vaporization at the b.p.

According to E. Priwoznik,²⁴ if copper dips in a neutral soln. of cupric chloride it is blackened by exposure to light, and G. le Bon adds that the metal is sensitive only to rays of shorter wave-length than 0.252μ . J. Waterhouse believes that the effect is conditioned by the formation of a film of allotropic copper. Copper, free from radium, was found by N. R. Campbell to emit a peculiar radiation carrying a positive charge, W. J. Russell and A. Colson detected a very slight action of the metal on a photographic plate such that the sensitive surface is darkened when the plate is developed. A. Colson found also that air in the vicinity of some metals acts in a similar way, and he attributed the **photographic activity** of metals to the action of their vapours. W. J. Russell supposed the active agent to be hydrogen peroxide because of the perfect analogy between the effect, and the action of hydrogen peroxide; B. von Lengyel looked upon hydrogen as the active agent; and J. H. Vincent showed that some inactive bodies become active when treated with small quantities of ozone. F. Streintz and O. Strohschneider could detect no action of copper on silver bromide photographic paper, or on potassium iodide paper. R. Emden found a dark grey radiation begins at 415°. C. B. Thwing found that the

radiation from molten copper is half as great as that of molten iron, and about 0.14 of that emitted by a black body. P. Desains and P. Curie found the heat radiation from copper at 150° and at 300° to have a maximum intensity for wave-length 0.00400. The respective intensities for an incandescent platinum lamp, copper at 300° and 150°, were 5785, 33, and 2 for a wave-length of 0.00186; 2123, 60, and 9 for a wave-length of 0.00400; and 225, 26, and 6 for a wave-length of 0.00700. The heat radiation has also been studied by D. McFarlane, and H. Knoblauch.

Copper takes a fairly high polish, and reflects well. P. Drude²⁵ found that copper is the most transparent of the metals for sodium light. H. Rubens found the reflecting power of copper to be stronger than that of nickel or iron, and changes quickly with changes of the wave-length of the incident light.

According to P. Drude, there are two constants which characterize a metal optically—the refractive index μ , and the absorption index k . The latter is defined in the following manner: The amplitude of a wave, after travelling one wave-length, λ_1 , measured in the metal, is reduced in the ratio 1 : $e^{-2\pi k/\lambda_1}$, or, for any distance l , 1 : $e^{-2\pi \mu k l/\lambda_1}$, where μk is called the extinction coefficient. Again, plane polarized light reflected from a polished metal surface is in general elliptically polarized because of the relative change in the difference of phase between the two rectangular components vibrating in and perpendicular to the place of incidence. For a certain angle, ϕ , the angle of principal incidence, the change is 90°, and if the plane polarized incident beam of light has a certain azimuth, ψ , the angle of principal azimuth, circularly polarized light results. A selection of these constants for copper is shown in Table IV, which also includes the percentage reflecting power R of copper in air, that is, the ratio of the intensity of the reflected ray to that of the incident ray, for light of wave-length λ . P. Drude and L. P. Wheeler studied the reflecting power of copper in water, alcohol, cassia oil, and carbon disulphide. I. C. Gardner measured the reflection coeff. in Schumann's region of the spectrum. A. Kundt

TABLE IV.—OPTICAL CONSTANTS OF COPPER.

λ	ϕ	ψ	μ	k	μk	R per cent.
231 $\mu\mu$	65° 57'	26° 14'	1.39	1.05	1.45	29
347 „	65° 6'	28° 16'	1.19	1.23	1.47	32
500 „	70° 44'	33° 46'	1.10	2.13	2.34	56
650 „	74° 16'	41° 30'	0.44	7.4	3.26	86
870 „	78° 40'	42° 30'	0.35	11.0	3.85	91
1750 „	84° 4'	42° 30'	0.83	11.4	9.46	96
2250 „	85° 13'	42° 30'	1.03	11.4	11.7	97
4000 „	87° 20'	42° 30'	1.87	11.4	21.3	—
5500 „	88° 00'	41° 50'	3.16	9.0	28.4	—

gives 0.65 for the index of refraction for white light; for red light, 0.75; and for blue light, 0.95; P. Drude gives for yellow sodium light, 0.54; and 0.53 for red light; and E. van Aubel gives for the A -line of the solar spectrum 2.63. J. H. Gladstone gave for the refraction equivalent $(\mu-1)/D=0.184$, and $A(\mu-1)/D=11.7$, where A is the at. wt. of the metal. W. J. Pope gave 13.52. A. Schrauf found the refraction eq. for molten copper to be 0.03876. The above scheme also contains a selection or interpolations from E. Hagen and H. Ruben's values for reflecting power R of the metals expressed in per cent. of the rays vertically incident on the reflecting surface. The relative emissivities of copper at 20° by J. T. Tate and at 1090°, 1127°, and 1174° by C. M. Stubbs, for different wave-lengths, λ in microns, are:

λ	0.475	0.500	0.550	0.560	0.660	0.650	0.660	0.700 μ
20°	—	0.51	—	0.42	0.29	—	0.22	0.210 μ
1090°	0.374	0.374	0.340	—	0.210	0.148	—	0.106 μ
1127°	0.473	0.381	0.340	—	0.210	0.152	—	0.130 μ
1174°	—	0.402	0.349	—	0.197	0.136	—	1.124 μ

According to G. K. Burgess and R. G. Waltenburg, the emissivity of a mass of copper 0.01 mgrm., area 0.25 mm., and thickness 0.005 mm., is 0.33 for red light $\lambda=0.65\mu$; and 0.38 for $\lambda=0.55\mu$; and it is for light of wave-length 0.65μ , 0.10 for solid copper, and 0.15 for the liquid; similarly, for light of wave-length 0.55μ , the emissivity of solid copper is 0.38, and of the liquid 0.36. According to C. C. Bidwell, C. M. Stubbs, and G. K. Burgess and R. G. Waltenburg, there is practically no temp. variation of the emissivity between 20° and 1500° . The selective emissivity is evident from the strong absorption and emissivity at the blue end of the spectrum. H. Lubowsky and F. Henning also measured the emissivity of copper. M. Faraday noted the polarization of thin films of copper prepared by electrically deflagrating the wire in hydrogen. B. Pogany measured the Faraday effect, that is, the rotation of the plane of polarization of thin films of copper.

The photo-electric action in which the metal loses a negative and acquires a positive charge when exposed to light, was found by W. Hallwachs²⁶ to be the same with a copper plate polished with fine and with coarse emery. The attempts which have been made to arrange the metals in the order of their photo-electric activity have given very different results in different hands—E. Ladenburg, W. Ramsay and J. F. Spencer, K. Herrmann, and R. A. Millikan and G. Winchester. The latter also measured the positive potential assumed by the metals in vacuo under the influence of ultra-violet light, and found :

Ag.	Fe.	Au.	Cu.	Ni.	Mg.	Al.	Sb.	Zn.	Pb.
1.340	1.225	1.215	1.135	1.126	0.839	0.738	0.394	1.197	0.0?

O. Stuhlmann found the photo-electric effect of a beam of ultra-violet light is 1.08 times greater after it has passed through a thin film of copper. W. Frese found the photoelectric sensitiveness of copper is not affected by treatment with water or alcohol; but oxidizing agents generally increase the sensitiveness, and reducing agents decrease it. The absorption and reflection of cathode rays by thin plates of copper has been studied by E. Warburg and S. Williams. The X-ray spectrum has been studied by A. Duvallier, F. K. Richtmyer, E. Hjalmar, E. H. Kurth, etc. The action of X-rays by J. H. Gladstone and W. Hibbert, W. Duane and F. Shimizu, A. Hébert and G. Reynaud, D. Hurmuzescu, A. Voller and B. Walter, and T. Cooksey; of radium radiations has been investigated by J. A. McClelland; and of Hertz waves by J. R. von Geitler. G. W. C. Kaye, and C. S. Brainin have studied the X-radiations from copper. J. Chadwick measured the nuclear charge of the atom.

According to W. H. Bragg, the stopping power s of substances for the α -rays is approximately proportional to the sq. root of the at. wt. A , and for copper, $s=2.43$ and $\sqrt{A}=7.97$. H. R. von Trautenberg found the range of the α -particles in copper to be 18.3×10^{-4} cm. J. Crowther found the coeff. of absorption μ for the β -rays is approximately proportional to the sp. gr. D , and for copper, $\mu/D=6.8$. According to A. S. Russell and F. Soddy, for copper up to 7.6 cm. in thickness, and brass up to 5.86 cm. in thickness, the coeff. of absorption of copper for the radium rays is $\mu=0.351$; and of brass, $\mu=0.325$; for the uranium rays, μ is respectively 0.416 and 0.392 for copper and brass; for the thorium-D rays, μ is respectively 0.294 and 0.271 for copper and brass; and for mesothorium rays, μ is respectively 0.375 and 0.355 for copper and brass. I. G. Barber studied the emission of electrons from copper surfaces. E. Rutherford and J. Chadwick obtained little if any evidence of the emission of long-range α -particles, or charged hydrogen atoms, when copper is exposed to α -rays from radium C.

R. Boyle (1685)²⁷ noticed that a flame is coloured blue or green by a soln. of cupric nitrate. C. L. Bourdelin (1755) also mentioned the coloration of the alcohol flame by copper. A. S. Marggraf (1765) used copper salts for making green fire; and B. Higgins (1773) made observations in the same direction. According to J. Formanek,²⁸ the flame spectrum of cupric chloride has green lines $\lambda=5507$ and 5386, and blue lines $\lambda=4437, 4413, 4332,$ and 4354. According to W. Lanzrath,

the strongest lines in the oxy-coal gas flame are $\lambda=3274$ and 3247 . When a bead of cupric chloride is introduced into the Bunsen flame, a yellow patch of light with a reddish fringe appears; this in turn is bordered with a blue colour, which is surrounded by a green colour. As soon as the cupric chloride is all converted into oxide, the blue colour disappears while the green persists. If hydrogen chloride be introduced into the flame, the blue colour is restored. Copper and cupric oxide give the spectrum of the chloride when hydrogen chloride is introduced into the flame. The spectra of the oxide and chloride of copper, due to W. M. Watts, are shown in Figs. 13 and 14. They are usually superposed one on the other in the same spectrum.

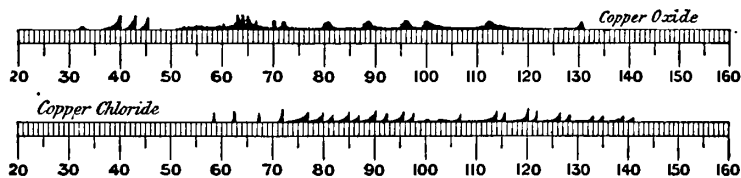

FIGS. 13 and 14.—Flame Spectra of Copper Oxide and Chloride.

Hence, argued A. Smithells, the green colour is produced by copper oxide, the blue by copper chloride, and the yellowish-red colour by metallic copper, at a temp. not high enough to produce its characteristic spectrum. A. Smithells and W. D. Bancroft and H. B. Weiser obtained a deposit of copper by holding in the flame glass or porcelain basins cooled with water. The last-named concluded:

Copper chloride introduced into the Bunsen flame by a platinum wire gives light blue fringed with grass green. There is a diffuse red coloration through the flame and especially at the tip. The bromide and iodide of copper give a similar coloration except that there is a tendency toward greenish-blue in the inner portion. Cooling a flame coloured green by cupric chloride gives a blue in the cooled region. A flame coloured with an excess of copper chloride gives a spectrum that differs from that obtained with the nitrate, sulphate or oxide. A part of this difference is due to the coloured vapours of the chloride itself. Copper salts dissociate in the flame, and the subsequent oxidation is most important in producing the luminescence. Cupric oxide is stable under the conditions of the Bunsen flame. Copper vapours impart to a gas flame or a hydrogen flame an intense grass-green colour. Copper powder sprinkled into the gas flame, the hydrogen flame, or the carbon monoxide flame, colours it an intense grass green. Copper burns in chlorine with a red glow. When chlorine is impinged on molten copper, the cupric chloride vapours above it are violet-red in colour. An excess of copper chloride in a carbon monoxide flame colours it blue. A jet of hydrogen impinged on it gives green at the point of contact. Copper in the hydrogen flame burning in chlorine gives chiefly blue with an edge of reddish-brown. Copper in the chlorine flame burning in excess of hydrogen gives chiefly green. Copper chloride in the flame of air burning in hydrogen gives green. There is a ruddy colour in the interior of the copper flame, particularly marked when the flame is made strongly reducing.

They also suggest that the green luminescence is due to the copper \rightarrow cuprous ion reaction; the red luminescence to the cuprous ion \rightarrow cuprous salt reaction; and the blue luminescence to the cuprous ion \rightarrow cupric ion or salt reaction. W. N. Hartley found that cupric oxide in the oxy-hydrogen flame gives two copper lines, and a fine band spectrum, Fig. 13. C. Fredenhagen obtained the cuprous chloride or bromide spectrum by warming the compound in a Geissler's tube and passing an electric discharge. A. Gouy obtained the spectrum of copper by spraying cuprous chloride into the Bunsen flame. According to E. Cappel, the sensitiveness of the spark spectrum is seventy times that of Bunsen's flame. B. de la Roche studied the effect of reducing gases on the spectrum of copper.

The emission spectrum in the electric arc in vacuo gives prominent lines of wavelength 3248 and 3274 in the ultra-violet; 4023 and 4063 in the violet; 5105.543, 5153.251, and 5218.202 in the green; and 5700.000, 5782.090, and 5782.159 in the yellow. W. G. Duffield studied the effect of press. on the arc spectrum of copper. The spectrum in the ultra-violet is characteristic. There is a large number of lines

in the spectrum of copper. 444 lines between $\lambda=4704\cdot8$ and 2105 have been recorded by W. N. Hartley, G. D. Liveing and J. Dewar, A. de Gramont, F. Exner and E. Haschek, L. and E. Bloch, etc. The arc spectrum of copper though so much richer in lines than the spectra of silver and gold, appears to be built on the same general plan. This has been studied by H. Kayser and C. Runge, W. Huppers, K. Hasbach, W. Randall, M. A. Catalan, J. R. Rydberg, etc. The spectra all show a strong pair of doublets in the ultra-violet; a series of lines in the red which are proved to belong to the same system by their Zeemann patterns; and a series in the immediate ultra-red. With copper and silver a few other lines have been assigned to these two series, but with gold none have been so allocated. F. Handke has studied the spark spectrum in Schumann's region. H. Kayser and C. Runge pick out two triplets and six pairs of doublets, and suggest that the pair of lines $\lambda=3274\cdot06$ and $3247\cdot65$, which forms the strongest in the spectrum of copper, be regarded as the first member of the principal series, and that the other components of the series have not yet been found, but they probably occur far in the ultra-violet in Schumann's region. The pair of lines for $\lambda=5782\cdot30$ and $5700\cdot39$ belong to no known series. There is an associated series with the two pairs of lines:

$$\lambda^{-1} \times 10^8 = 31591\cdot6 - 131150n^{-2} - 1085060n^{-4}; \quad 31840\cdot1 - 131150n^{-2} - 1085060n^{-4}$$

when $n=4, 5$, and 6, Fig. 15, and another line $\lambda=3654\cdot6$, which does not fit this series for $n=3$ or $n=7$. A second associated series with two pairs of lines:

$$\lambda^{-1} \times 10^8 = 31591\cdot6 - 124809n^{-2} - 440532n^{-4}; \quad 31840\cdot1 - 124809n^{-2} - 440532n^{-4}$$

with $n=4$ and 5, as in Fig. 15. W. M. Hicks has made a more elaborate study of the series spectral lines of copper, silver, and gold. A. Fowler has summarized the available data on this subject.

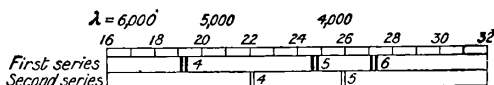

FIG. 15.—Series Spectra of Copper.

R. A. Millikan followed the ultra-violet spectrum to $\lambda=149\cdot5$ A.; J. C. McLennan studied the vacuum arc spectrum. The effect of the magnetic field has been studied by

J. R. Rydberg, and by C. Runge and F. Paschen.

N. Lockyer and W. C. Roberts-Austen found that copper vapour gives a continuous absorption in the blue. Thin sheets of glass coloured with cuprous oxide give a small absorption near $\lambda=5702$; and glass coloured with cupric oxide gives an absorption in the orange-yellow and the red part of the spectrum. G. A. Hemsalech found the spectral lines due to thermoelectric and chemical excitation are of the same type. M. N. Saha made observations on the ionizing potential of copper; and B. E. Moore, on the excitation stages in the arc spectrum of copper.

The electrical conductivity of copper is rather less than that of silver, and greater than that of platinum; and on account of the technical importance of copper wires or cables as conductors of electricity, the subject has attracted a great deal of attention.²⁹ Remembering that the electrical conductivity is the reciprocal of the electrical resistance of a cm. cube, expressed in ohms, when mercury at 0° has the value $1\cdot063 \times 10^{-4}$ ohms, copper has a conductivity of $58\cdot83 \times 10^{-4}$ at 25° , and $44\cdot23 \times 10^{-4}$ at 100° ; and a specific resistance of $1\cdot700 \times 10^6$ ohms per cm. cube at 25° , and $2\cdot261 \times 10^6$ at 100° . The International Electrical Commission of 1913 recommended the adoption of the following values for the electrical resistance of annealed copper at 20° : $0\cdot017241$ ohm (metre, sq. mm.); $0\cdot15328$ ohm (metre, gram); and $0\cdot67879$ microhm (cubic inch). The conductivity diminishes or the resistance increases as the temp. rises such that, according to A. Matthiessen and M. von Bose, the resistance R at θ° when the resistance at 0° is R_0 is given by $R=R_0(1-0\cdot0036701\theta+0\cdot00009009\theta^2)$; J. Dewar and J. A. Fleming gave $R=R_0(1+0\cdot00428\theta)$; the standard of the *Verbandes deutscher*

Elektrotechniker is $R=R_0(1+0\cdot004\theta)$; and L. Benoist gives $R(1+0\cdot003637\theta+0\cdot000000587\theta^2)$. E. F. Northrup's values for the electrical resistance of copper in microhms per cm. cube at high temp. are :

Resistance . . .	20°	1000°	1082°6'	1082°6'	1100°	1340°	1443°
	1·7347	9·42	10·20	21·30	21·43	23·39	24·22
	Solid.			Liquid.			

G. W. O. Howe has studied the electrical resistance of multiple-stranded wires. According to E. S. Bardwell, the electrical conductivity of copper wires increases slowly with the temp. of annealing up to 300°, and a rapid rise then occurs as the annealing temp. reaches 430°, after that there is very little change up to 650° when the conductivity falls very considerably owing to the deterioration of the metal. A. L. Feild calculated the resistance of *amorphous copper* at 20° to be 12·67 micro-ohms per c.c. The resistance diminishes rapidly as the temperature falls and approaches zero below -200°, as illustrated in Fig. 16. J. Dewar, J. A. Fleming, and H. Dickson have given data for the resistance of copper down to -206°, and G. Niccolai values for the resistance of a cm. cube in ohms.

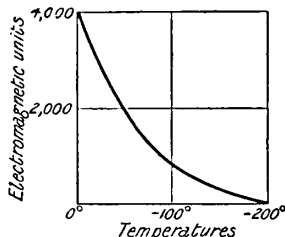

FIG. 16.—Effect of Low Temperature on Electrical Resistance of Copper.

Ohms . . .	0°	-50°	-100°	-150°	-192°9'	-206°6'	-251°1'	-252°8'	-258°6'
	1·578	1·240	0·904	0·567	0·249	0·163	0·028	0·016	0·014

The temp. resistance curve for silver cuts that of copper below -70°, when copper has a greater resistance than silver. L. Holborn gave 0·00433 for the mean coeff. per degree between 0° and 100°. R. Schott gave for the electrical conductivity of crystals of copper at 0° and -252°6', respectively $62\cdot1 \times 10^4$, and $62\cdot1 \times 834 \times 10^4$ C.G.S. units; and for commercial copper, respectively $63\cdot0 \times 10^4$, and $63 \times 48 \times 10^4$ C.G.S. units.

E. Wartmann and O. D. Chwolson found that the resistance of copper is increased by *pressure*. P. W. Bridgman found the electrical resistance of copper to be influenced by the press. such that

Resistance . . .	0°	25°	50°	75°	100°
Press. coeff. 0 kgm.	1·000	1·1073	1·2146	1·3219	1·4293
Press. coeff. 12,000 kgms.	-0·0 ₅ 201	-0·0 ₅ 196	-0·0 ₅ 192	-0·0 ₅ 188	-0·0 ₅ 184
	-0·0 ₅ 175	-0·0 ₅ 174	-0·0 ₅ 173	-0·0 ₅ 172	-0·0 ₅ 171

This gives a temp. coeff. 0·004293 for 99·995 per cent. copper; the result is a shade higher than 0·00428 of W. Jäger and H. Diesselhorst for copper with 0·05 per cent. of zinc. The press. coeff. at 0° was -0·0₅2008, while E. Lisell's value is -0·0₅187. A. Matthiessen found that the resistance does not change by the passage of feeble currents, but W. H. Preece and F. Larroque found it is increased by strong currents. E. Lax studied the effect of *mechanical stresses* on the resistance of copper. According to J. Bergmann, the resistance of copper depends on the *structure*, and H. P. Brown showed that it is influenced by working the metal. Hard-drawn copper was found by G. W. A. Kahlbaum and E. Sturm to have a greater resistance than annealed copper since the resistance of a wire 4·25 m. long and 0·27 mm. diameter was 1·00953 ohm in the first case and 1·00321 ohm in the second. For electrolytic copper at 0°, the specific resistance of hard wire is $1\cdot603 \times 10^{-6}$ with a temp. coeff. of 0·00408 between 18° and 48°; and of soft wire, $1\cdot563 \times 10^{-6}$ with a temp. coeff. 0·00416 between 18° and 48°. L. de Marchi, H. Tomlinson, J. Hopps, and

A. Mousson found that the resistance of copper wire is increased by stretching. J. and A. Bidwell reported that vertical wire conducts better downwards than upwards; G. Ercolini, that the twisting and untwisting of copper wire increases the resistance; L. L. Grunmach, that the resistance increases by transverse magnetization; and B. Sabat, that the resistance is increased by exposure to radium radiations.

The influence of impurities on the electrical conductivity is so marked that quantities almost inappreciable by chemical analysis raise considerably the electrical resistance. Lord Kelvin and P. Drude investigated the decrease in the conductivity of copper by melting the purified metal in air. According to A. Matthiessen, this phenomenon does not occur if lead, silver, or tin be present, because these metals retard the formation of cuprous oxide. Generally, the presence of impurities lowers the conductivity of the metal, and that, as J. Dewar and J. A. Fleming showed, particularly at low temp. G. Kamensky found the conductivity of copper is reduced if antimony be present; A. Matthiessen and M. Holzmann that phosphorus, arsenic, or iron acts in the same way; and L. Addicks, that the presence of 0.0013 per cent. of arsenic, or 0.0071 per cent. of antimony, lowers the electrical conductivity of copper 1 per cent. as illustrated in Fig. 17. He also noted that oxygen is inclined to raise

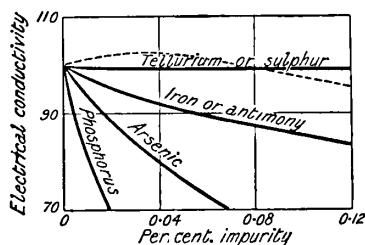

FIG. 17.—Effect of Impurities on the Electrical Conductivity of Copper.

of cast copper. A. L. Williams and J. C. McLennan found that when fused with mica there is a marked fall in the resistance with a rise of temp.

Good conductors of electricity are in general good conductors of heat. In 1852, G. Wiedemann and R. Franz³⁰ discovered empirically the interesting relation that the electrical conductivity of the metals at 20° is approximately proportional to their thermal conductivity; otherwise expressed, the ratio of the thermal to the electrical conductivity of good conducting metals has always the same value when the temperature is constant—Wiedemann and Franz's law; meaning that the ratio of the thermal to the electrical conductivity is a universal constant and independent of the nature of the metal. This rule has been found to be valid for silver, copper, gold, zinc, tin, lead, platinum, bismuth, and for a number of alloys. A. W. Porter and F. Simeon showed that with sodium and mercury the ratio holds quite well when carried through a change of state, for while the thermal conductivities change abruptly in passing from the solid to the liquid state, their electrical resistivities likewise increase abruptly on fusion. Similarly, E. F. Northrup and F. R. Pratt compared bismuth and tin under like conditions; the electrical resistances of these two metals change abruptly in opposite directions on fusion, and they found, in agreement with G. Wiedemann and R. Franz's rule, that the thermal resistivities likewise change abruptly in the opposite direction. The results with iron are not so satisfactory. G. Kirchhoff and G. Hansemann consider that the disturbance is connected with the magnetic properties of iron, but E. Grüneisen showed that the exceptional behaviour of iron is due to the impurities present in the metal. The law holds exceedingly well for pure metals, less accurately for alloys, and not at all for poor conductors. How well may be gathered from the comparisons of the thermal and electrical conductivities of the metals shown in Table V.

TABLE V.—THERMAL AND ELECTRICAL CONDUCTIVITIES OF SOME METALS.

Metal.	Thermal conductivity —cals. per cm. per sec. at 0° (K).	Electrical conductivity —reciprocal ohms per cm. at 0° (κ).	Ratio.	
			0°	18°
Copper	0·7198	457,400	$6\cdot35 \times 10^{-11}$	$7\cdot38 \times 10^{-11}$
Magnesium	0·3760	244,700	6·51	—
Aluminium	0·3435	244,600	6·54	7·06
Cadmium	0·2200	144,100	6·55	7·84
Iron	0·1665	103,700	6·23	8·90
Tin	0·1528	93,500	6·12	8·16
Lead	0·0836	51,400	6·15	7·94
Antimony	0·0443	22,000	4·97	—
Bismuth	0·0177	9,200	5·26	10·68

In 1872, L. Lorenz showed experimentally that in many cases the temperature variation of Wiedemann and Franz's ratio between 0° and 100° is proportional to the absolute temperature : or G. Wiedemann and R. Franz's ratio is equal to $1\cdot367T$; or, if k denotes the thermal conductivity, and κ the electrical conductivity, $k_{100} = \kappa_0 / \kappa_{100} K_0 = 1\cdot367$. The observed values for the constants are :

Copper.	Magnesium.	Aluminium.	Cadmium.	Iron.	Tin.	Lead.
1·358	1·398	1·367	1·315	1·530	1·334	1·304

More, generally, for the metals copper, silver, gold, nickel, zinc, cadmium, lead, tin, L. Lorenz's temp. coeff. is appreciably constant within the limits of experimental error. W. Meissner showed that the divergences of copper from the G. Wiedemann, R. Franz, and L. Lorenz's law increase as the temp. is reduced. With platinum and palladium, both G. Wiedemann and R. Franz's ratios and the temp. coeff. are rather large ; with aluminium, G. Wiedemann's and R. Franz's ratio is rather low, and the temp. coeff. rather large ; and with bismuth, the converse obtains. C. H. Lees found that the deviation from L. Lorenz's 1·367 is rather larger at the temp. of liquid air than at ordinary temp. In a general way it may be said that alloys show considerable deviations from both G. Wiedemann and R. Franz's and L. Lorenz's laws, although with some alloys the two laws apply very well. The increase in the electrical resistance of some metals, say silver, with the addition of a trace of impurity has not been explained by a decrease in the number of mobile ions. Lord Rayleigh has pointed out that since the flow of an electric current from one metal to another produces an absorption or development of heat at the junction—the Peltier effect—the observed resistance of heterogeneous alloys will be affected by the local thermoelectric junctions in the interior of the metal.

Table V seems to show that the two effects are somehow related, and it has been assumed that both heat and electricity are conducted by the same agent, namely, rapidly-moving electrons assumed to be normally present in the metal. With good conductors, the amount of heat distributed by radiation and the dynamical action of the molecules is assumed to be small in comparison with that distributed by the rapidly-moving electrons ; and with poor conductors, the amount of heat distributed by radiation and mol. motion is appreciably greater than with good conductors. Accordingly, G. Wiedemann and R. Franz's ratio will be greater with poor than with good conductors.

The mathematical investigation of the assumption that the conduction of both heat and electricity in good conducting metals is effected mainly by the agency of free electrons, leads to the conclusion that the ratio of the thermal and electrical conductivities is a constant which is independent of the nature of the metal, and proportional to the absolute temp. If k denotes the thermal conductivity ; κ , the electrical conductivity ; R , the gas constant ; e , the electrical charge carried by a

univalent electrolytic ion ; and T , the absolute temp., then N. R. Campbell has shown from the electron theory of conduction that, at 18° , G. Wiedemann and R. Franz's ratio, will be :

$$\frac{k}{\kappa} = \frac{4}{3} \left(\frac{R}{e} \right)^2 T ; \text{ or } \frac{k}{\kappa} = 7.15 \times 10^{-11}$$

This is in close agreement with the observed results ; and with the assumption that the deviation with poor thermal or electrical conductors is due to an appreciable contribution to the thermal conductivity by atomic or mol. motions. Substances like quartz or paraffin wax, which are exceedingly poor electrical conductors, have an appreciable thermal conductivity—*e.g.* the thermal conductivity of quartz, 0.029 , exceeds that of some of the metals.

According to H. Davy,³¹ two pieces of the same polished copper introduced at the same time into an aq. soln. of potassium sulphide, exhibit no electrical effect, but if introduced in succession, there is sometimes a marked electrical effect—the piece of metal first immersed in the liquid is negative, the other positive. Again, copper hardened by hammering is negative to rolled copper ; a specimen of brittle copper, in which no impurity could be detected, was negative with respect to soft copper ; and over-poled or under-poled copper, containing in the one case probably a little carbon, and in the other a little oxide, are negative to pure copper. The **Volta difference of potential** of two metals in contact, in air at about 18° , varies with the condition of the metal surface, and the nature of the surrounding atm. The following results in volts for copper and brass are therefore more or less of an approximation :

	C.	Cu.	Fe.	Pb.	Pt.	Sn.	Zn.	Zn amal- gam.	Brass.
Copper . .	-0.370	—	0.146	0.542	-0.238	0.456	0.750	0.894	0.087
Brass . .	-0.414	-0.087	0.064	0.472	-0.287	0.372	0.679	0.822	—

These results must not be confused with the e.m.f. at the junction of two metals in metallic contact.

A. Walker found that copper filings are positive towards a copper plate if the two be separated with paper moistened with sodium sulphate or chloride ; and negative, if the paper be moistened with ammonia or dil. sulphuric acid. S. Marianini found that a polished plate of copper is positive when opposed in a soln. of sodium chloride to a similar plate which has been made brown by heat ; and A. Gouy and H. Rigollot found the potential difference is augmented when the browned plate is illuminated ; hence, H. Rigollot proposed to utilize the phenomenon to make an *electrochemical actinometer*. A. Pacinotti, W. Hankel, and H. Pellat found that an illuminated plate of copper is electronegative towards a similar plate in darkness, and if the illuminated plate has been oxidized, it is electropositive. W. Ramsay and J. F. Spencer obtained an e.m.f. of 10 millivolts by illuminating one of two such copper plates with ultra-violet light.

E. Abel placed copper next to silver in the electrochemical series, and according to G. de Overbeck, a film of copper 0.000001 mm. thick suffices to show these electrochemical effects. According to H. Buff, W. Hankel, W. Skey, R. B. Clifton, B. W. Gerland, J. C. Poggendorff, and W. Ostwald, copper is *negative* in aq. potassium hydroxide, conc. soln. zinc sulphate (indifferent in a dil. soln.), aq. potassium hydrosulphide, aq. potassium cyanide, *positive* towards cupric sulphate soln., the haloid acids, and towards nitric, sulphuric, phosphoric, formic, acetic, propionic, oxalic, and benzene sulphonic acids. H. Buff says it is negative towards water, W. Skey says positive.

The e.m.f., E , of a metal in contact with a soln. of a salt of this metal is, according to W. Nernst's theory, described in the first volume :

$$E = \frac{RT}{nF} \log \frac{P}{p} ; \text{ or } E = \frac{RT}{nF} \log P - \frac{RT}{nF} \log p$$

where n represents the valency of the cation; p the osmotic press. of the metal cation; $F=96,540$ coulombs; and P is a magnitude which is called the soln. press. of the metal. For copper, at 18° , $E=0.0577n^{-1} \log_{10}(P/p)$. If E_0 be the potential of a metal at 18° against a soln. of a salt of the metal with a gram-ion of the metal per litre, and p_0 the corresponding osmotic press. of the ions, in the above expression $(RT/nF) \log P=E_0$ when $p=p_0$. If C and c denote the conc. of the ions in gram-ions per litre,

$$E = \frac{RT}{nF} \log \frac{C}{c}; \quad \text{or, } E = \frac{RT}{nF} \log C - \frac{RT}{nF} \log c$$

The electrolytic solution potential of an N -soln. of copper (ous), Cu^+ ions against the hydrogen electrode is reported to be -0.43 volt by G. Bodländer; -0.465 volt by C. Immerwahr; -0.470 volt by G. Bodländer and O. Storbeck; and -0.487 volt by R. Luther; for an N -soln. of copper (ic), Cu^{++} ions against the hydrogen electrode, N. T. M. Wilsmore gives -0.329 volt; W. Nernst, and G. Bodländer give -0.34 volt; G. Bodländer and O. Storbeck, -0.344 volt. G. Magnanini found the difference of potential in volts between zinc in a normal soln. of sulphuric acid and copper immersed in the given soln. containing M mols per litre, $\frac{1}{2}M\text{-H}_2\text{SO}_4$, 1.007 volt; $M\text{-NaOH}$, 0.802 volt; $M\text{-KOH}$, 0.770 volt; $\frac{1}{2}M\text{-Na}_2\text{SO}_4$, 1.013 volt; $M\text{-Na}_2\text{S}_2\text{O}_3$, 0.388 volt; $\frac{1}{2}M\text{-K}_2\text{CrO}_4$, 0.946 volt; $\frac{1}{2}M\text{-K}_2\text{Cr}_2\text{O}_7$, 1.236 volt; $\frac{1}{2}M\text{-K}_2\text{SO}_4$, 0.957 volt; $\frac{1}{2}M\text{-(NH}_4)_2\text{SO}_4$, 1.015 volt; $\frac{1}{4}M\text{-K}_4\text{FeCy}_6$, not constant; $0.167M\text{-K}_3\text{FeCy}_6$, 1.107 volt; $M\text{-KCNS}$, 0.525 volt; $M\text{-NaNO}_3$, 1.036 volt; $\frac{1}{2}M\text{-Sr(NO}_3)_2$, 1.030 volt; $\frac{1}{2}M\text{-Ba(NO}_3)_2$, 1.096 volt; $M\text{-KNO}_3$, 1.048 volt; $\frac{1}{2}M\text{-KClO}_3$, 1.053 volt; $0.167M\text{-KBrO}_3$, 1.113 volt; $M\text{-NH}_4\text{Cl}$, 0.812 volt; $M\text{-KF}$, 0.613 volt; $M\text{-NaCl}$, 0.809 volt; $M\text{-KBr}$, 0.736 volt; $M\text{-KCl}$, 0.816 volt; $\frac{1}{2}M\text{-Na}_2\text{SO}_3$, 0.899 volt; $M\text{-NaOBr}$, with a quantity of bromine was used corresponding to NaOH , 1.0 volt; $M\text{-tartaric acid}$, 1.046 volt; $\frac{1}{2}M\text{-tartaric acid}$, 1.109 volt; $\frac{1}{2}M\text{-potassium sodium tartrate}$, 1.008 volt.

The potential of a normal calomel electrode is -0.56 volt. N. T. M. Wilsmore hence calculates that at 18° the potential of a soln. of a copper salt, containing a gram-ion per litre, against a copper electrode, is -0.606 volt; it follows that the electrode potential is $-0.606=0.0289 \log_{10} P$, if the unit of press. be 23.9 atm., for this is the osmotic or soln. press. of the metal at 18° ; and therefore $\log p=\log 1=0$. Hence the soln. press. of copper in its passage from $\text{Cu}\rightarrow\text{Cu}^+$ at 18° is 3×10^{-20} atm. This small magnitude means that metallic copper has but a small tendency to form cupric ions. Similarly, for a normal soln. of cuprous ions $\text{Cu}\rightarrow\text{Cu}^+$, at 18° , $-0.731=0.058 \log(P/23.9)$, or $P=24\times 10^{-11}$ atm. Hence, also, cuprous copper is more electro-positive than cupric copper. If the potential of the normal hydrogen electrode be conventionally regarded as zero, what has been called the absolute potential, under the assumption that the true potential of the normal calomel electrode is -0.56 volt, must have 0.277 volt added to it to give the electrolytic potential. Thus, the electrolytic potential of copper, $\text{Cu}\rightarrow\text{Cu}^+$, is $-0.606+0.277=-0.329$ volt, where the sign denotes the charge of the soln. against that of the electrode. Usually, however, the potential of the electrode is under discussion, and since in a voltaic combination, the electrode metal with the higher potential is said to be its positive pole, and the charge of the electrode against that of the soln. is to be understood. S. Labendzinsky found for the potential of copper against the hydrogen electrode with soln. containing N gram-eq. of the salt per litre:

N .	1.0	0.1	0.01
CuSO_4	0.304	0.284	0.262 volt
$\text{Cu(NO}_3)_2$	0.331	0.294	0.266 ,,
$\text{Cu(C}_2\text{H}_3\text{O}_2)_2$	0.278	0.264	0.242 ,,

For the absolute potentials add 0.277 to these values. The soln. of copper acetate marked $1.0N$ was sat., approximately $0.8N$. In addition, many other determinations of the potential of the copper electrode against different soln., have been

made; the potential of copper against aq. soln. of sulphuric, hydrochloric, and nitric acids, by F. Exner and J. Tuma; cupric sulphate, by H. Pellat, J. Miesler, N. T. M. Wilsmore, B. Neumann, M. le Blanc, W. E. Ayrton and J. Perry, F. Paschen, C. Immerwahr and F. Braun; cupric nitrate, by B. Neumann, and F. Exner and J. Tuma; cupric acetate, by B. Neumann and C. Immerwahr; copper anodes in alkaline soln., by F. Jirsa; cupric chloride, by F. Exner and J. Tuma; and cupric tartrate and cupric ammino-compounds, by C. Immerwahr. The latest-named also has studied soln. with suspensions of cupric carbonate, hydroxide, oxide and sulphide, and of cuprous chloride, bromide, iodide, and thiocyanate; and R. Luther has dealt with soln. of cuprous sulphate. G. Thompson, F. Spitzer, A. von Oettingen, S. B. Christy, and F. Kunschert have studied the potential of copper against cupric salts in soln. of potassium cyanide. S. B. Christy found

Per cent. KCy	6.5	0.65	0.065	0.0065	0.00065	0.000065	0.0000065
Potential	+0.930	+0.680	+0.430	-0.050	-0.250	-0.270	-0.280 volt

F. Spitzer found the potential increases with the proportion of cupric salt and of cyanide which are present. F. Kunschert found that in normal soln. with free Cy^- ions, the potential is 0.157 volt, or, $1.130 - 0.0575 \log \left(\frac{[\text{CuCy}_4]}{[\text{Cy}^-]^4} \right)$. U. Sborgi and A. Donati, G. Magnanini, and N. R. Dhar, studied the potential of copper in various salt soln.

L. W. Ohlm studied the e.m.f. of the cell with copper or copper amalgam in cupric sulphate soln. against mercurous sulphate and mercury. A. Voller found that the potential of copper in soln. of cupric sulphate at 91° is 0.43 of its value at 22° ; and in soln. of zinc sulphate at 80° , 0.33 of its value at 25° . The potential in soln. of sodium chloride is raised at 78° to 0.17 of its value at 21° . G. N. Lewis and W. N. Lacey found the normal potential of the copper electrode against cupric ions at 25° , to be -0.3469 volt. P. Chroustchoff and A. Sitnikoff found the temp. coeff. between 0° and 50° is 0.00066 volt per degree. From E. Bouty's, and A. Gockel's measurements $dE/dT = 0.000756$, F. Exner also found copper at 92° to be less negative in sulphuric acid (1 per cent.), nitric acid (0.6 per cent.), and acetic acid (0.6 per cent.) than at ordinary temp., and more negative in acetic acid (7 per cent.), potassium hydroxide (5 per cent.), and sodium hydroxide (0.3 per cent.); he also found that the potential of a copper tube is not affected if one of the gases hydrogen, oxygen, carbon dioxide, coal gas, carbon disulphide, or the four hydrogen halides, is streaming through the tube. According to A. Fischer, and G. Coffetti and F. Förster, the decomposition potential falls with increasing current density.

G. Carrara and L. d'Agostini found the potential of copper towards soln. of cupric sulphate, chlorate, or nitrate in methyl alcohol; N. P. Kazankin, in amyl alcohol; and L. Kahlenberg, in pyridine soln. J. Brown investigated the potential of copper against fused chlorides; J. H. Gladstone and A. Tribe fused cupric chloride; J. L. Hoorweg used a copper-iron couple in fused waxes, sulphur, etc.

G. Bodländer³³ found the ionization constant for $\text{Cu}^{\cdot+} \rightarrow \text{Cu}^+$, $K = [\text{Cu}^{\cdot+}]/[\text{Cu}^+]^2$, to be 1.4×10^{-6} ; R. Luther gave 1.5×10^{-6} ; for $\text{Cu}^+ + \text{Cl}^- = \text{CuCl}$, G. Bodländer gave 2×10^{-6} , and R. Luther, 2.2×10^{-7} ; the latter also gave for $\text{Cu}^+ + \text{Br}^- = \text{CuBr}$, 8.2×10^{-9} . J. Traube found the atomic solution volume of 63.6 parts of Cu^+ to be the same as H^+ , and $\text{Cu}^{\cdot+}$, the same as zinc and nickel. W. R. Bousfield and T. M. Lowry found the heat of formation of Cu^+ is -8.57 Cals. According to W. Ostwald and H. Jahn, the decrease of free energy which occurs in the ionization of a gram-atom of copper in a soln. of copper sulphate $\text{Cu} \rightleftharpoons \text{Cu}^+$ is equal to the electrical energy developed $2FE$, where E is the electro-potential of copper against an N -soln. of copper sulphate at 18° ; the heat absorbed from the surroundings in an isothermal reversible process is $2FT \cdot dE/dT$ per gram-atom of copper; and Q represents the decrease in the total energy in cal. per gram-atom of copper. From H. von Helmholtz's equation, $2FR = Q + 2FT dE/dT$; and, from S. Labenzinsky's measurements, $2FE = -2 \times 96,540 \times 0.58$ joules, or -26,800 cal.; while $2FT dE/dT$

$= 2 \times 96,540 \times 291 \times 0.000756$ joules, or $-10,200$ cal. Hence, $Q = -26,800 + 10,200 = -16,600$ cal. Hence, the heat of ionization of metallic copper in an eq. soln. of cupric sulphate at 18° is attended by an increase of energy eq. to $16,600$ cal. per gram-atom; the consumption of electrical energy is $26,800$ cal., and the heat absorbed from the surroundings is $10,200$ cal. W. Ostwald's value for the heat of ionization is -175 cal.; and W. Vaubel gave -144 cal. for $\text{Cu}_2 = 2\text{Cu}$. A. Coehn and Y. Osaka found the oxidation potential of copper in potassium hydroxide soln. to be 0.46 volt; and oxygen is given off from the metal or oxide at 1.48 volts. W. P. Davcy gave 0.63 A. for the atomic radius of copper in cuprous iodide, and 0.76 A. for cuprous chloride and bromide. The effects of telluric acid on the depolarization of copper anodes was studied by F. Jirsa; and the anodic behaviour of copper in soln. of sodium sulphide by V. Kohlschütter and H. Stäger.

The separation of a gram-atom of copper from an N -cupric soln. requires work eq. to $0.606 \times 2F$ volt-coulombs, and from an N -cuprous soln. $0.731F$ volt-coulombs. In order that one can be compared with the other, it is necessary that chemically or electrochemically eq. amounts be employed. Hence, the free energies of normal soln. of cupric and cuprous salts are respectively $0.606F$ and $0.731F$, so that cuprous salts have a smaller electro-affinity than cupric salts. This is in agreement with the lower solubility of cuprous salts, and their greater tendency to form complexes. The electro-affinity of cuprous ions is related with the electro-affinity of mercury and silver, while that of the cuprous ions is related more to the iron group.

A. Volta,³⁴ J. W. Ritter, J. C. Poggendorff, and C. H. Pfaff placed copper near the electro-negative end of the electrochemical series:

K, Ba, Mg, Al, Mn, Zn, Cd, Fe, Co, Ni, Sn, Pb, H, **Cu**, Bi, Sb, Hg, Ag, Pd, Pt, Au, and A. MacFarlane did the same thing for the series with frictional electricity. S. Kyropoulos showed that different parts of a piece of metal may exhibit different electric potentials, and have different degrees of "nobility."

The relative position of copper in the electro-chemical series changes with different kinds of soln. Thus, J. B. Biot noted that it alters its position with respect to iron in soln. of potassium sulphide; J. Brown found the same thing applies in an atm. of hydrogen sulphide; and J. C. K. Schrader, in fused liver of sulphur. M. Faraday found that copper retains the same relative position with fused salts as it has in acids. G. McP. Smith and Mc. A. Johnson noted that cadmium and zinc are precipitated by copper from conc. KCy soln. of their salts, although zinc or cadmium precipitate copper from aq. soln. of its salts. T. Andrews studied the e.m.f. of cells with copper and platinum in fused potassium carbonate, chloride, chlorate, and nitrate. According to A. de la Rive, copper is negative towards iron in salt soln. and in potash-lye; and it is positive towards iron in ammoniacal soln. W. E. Ayrton and J. Perry noted that at 18° commercial copper against carbon gave 0.370 volt; platinum, 0.238 volt; brass, -0.087 volt; iron, -0.146 volt; tin, -0.456 volt; lead, -0.542 volt; zinc, -0.750 volt; and amalgamated zinc, -0.894 volt. H. Götz and A. Kurz found for copper and graphite a difference of potential of 0.61 volt; F. Exner for Cu : Pt, 0.367 volt; and with radio-tellurium in air to make it conducting, H. Greinacher found, at room temp., Mg : Cu, -1.974 volt; Zn : Cu, -1.344 volt; Al : Cu, 1.055 volt, and the latter at -180° , 1.03 volt. Other combinations have been studied by G. C. Simpson, B. Gaede, F. Kohlrausch, B. W. Gerland, R. B. Clifton, W. Hallwachs, G. T. Fechner, W. Hankel, etc. G. Trümpler studied the e.m.f. of copper against the normal calomel electrode.

The hardness or softness of the metal and the surface impurities were shown by H. Pellat to have an influence on the position of the metal in the series, and he also noted that a rise of temp. made the metal more positive, while a fall of temp. made it more negative. G. Carrara and L. d'Agostini found that methyl alcohol did not alter the relative position of Volta's series from that obtained with other salts, although it altered the difference of potential. The difference of potential of copper with various metals in sulphuric, hydrochloric, nitric acids, soln. of sodium carbonate,

and chloride; potassium bromide, iodide, and cyanide; has been studied by B. C. Damien, W. Wolff, C. R. A. Wright and C. Thompson, T. Erhard, A. Naccari and M. Bellati, S. P. Thompson, J. and A. Bidwell, etc. Copper and cadmium in an N -soln. of cupric nitrate were found by F. M. G. Johnson and N. T. M. Wilsmore to give -0.68 volt; in $\frac{1}{10}N$ -soln., -0.70 volt; and in $\frac{1}{100}N$ -soln., -0.58 volt. *Daniell's cell*, Cap. 16, has been investigated by F. Streintz, C. R. A. Wright and C. Thompson, E. Cohen, F. D. Chattaway, and W. Tombrock, etc. The direction of the current is reversed if an excess of potassium cyanide is added to the cupric soln. The reducing action of the *copper-zinc couple* of J. H. Gladstone and A. Tribe³⁵ has been indicated in connection with hydrogen.

W. R. Grove,³⁶ G. Planté, and H. Buff electrolyzed dil. sulphuric acid with a copper plate as anode and observed much gas was evolved at first, but later, the anode was covered with a film of what they regarded as cupric oxide, and this interrupted the passage of the current owing to polarization. The deposit gradually cleared off when the circuit was broken. The polarized plate is negative towards platinum, and if warmed with dil. sulphuric acid, the liquid becomes turbid as the film is loosened from the plate; only a little copper passes into soln. E. Wohlwill regarded the film as due to copper formed by the decomposition of primarily formed cuprous sulphate, Cu_2SO_4 . F. Fischer made a cell with an anode of purified copper, 2 mm. thick, immersed to a depth of 10 mm. in sulphuric acid of maximum conductivity, and a copper plate as cathode; when an e.m.f. of 20 volts was applied, the pulverization of the anode was accompanied by a singing sound; a cloud of copper-coloured dust was formed; and copper sulphate was found in the soln. When a gradually increasing e.m.f. is applied, a coating forms on the anode, and this is suddenly pulverized when the e.m.f. has reached about 20 volts. The pulverization is accompanied by a sudden increase in the current to more than fifty times its initial value. The temp. of the cathode rises to between 106° and 108° during the pulverization. It is supposed that the coating which forms on the anode consists of cuprous sulphate, which, owing to its high resistance, becomes heated, until finally the liquid contained in its pores boils and disperses suddenly into the surrounding cold soln., where it decomposes into cupric sulphate and finely-divided metallic copper. By cooling a hollow cathode internally, pulverization occurs at a much higher voltage. The resistance of the anode coating diminishes as the temp. rises, and disappears at about 80° . In a more dil. soln. of sulphuric acid, or in a soln. of sodium sulphate, cuprous hydroxide is formed instead of finely-divided copper. The behaviour of aluminium in sulphuric acid is quite similar in many ways to that of copper; by cooling an aluminium anode internally, the non-conducting layer will withstand 220 volts, whilst under ordinary circumstances 20 volts suffice to break it down. The pulverized copper reduces potassium permanganate, chromic anhydride, ferric sulphate, etc. W. Holtz prepared electrolytic-valve cells of copper in cupric chloride or sulphate, which resembled the aluminium cell for moderate e.m.f.

In 1821, A. Seebeck³⁷ discovered that if two metal wires be in contact at one of their ends, and a low resistance galvanometer be in circuit with the free ends of the wires, an electric current is generated when the wires are heated and flows from copper to iron through the hot junction—**Seebeck's effect**. With some metals the e.m.f. E of the current is nearly proportional to the difference of temp. between the hot and cold junctions, and the principle is therefore applied in the construction of thermo-electric pyrometers, and in the construction of thermopiles, etc. Again, if a galvanic battery replaces the galvanometer in A. Seebeck's experiment, A. Peltier (1834) found that heat is absorbed at what was previously the hot junction, and generated at what was previously the cold junction. This phenomenon is called **Peltier's effect**. F. Rziha, and P. Czermak have studied Peltier's effect with a copper-nickel couple; F. F. le Roux, with the copper-iron couple; H. Jahn, with copper coupled with zinc, cadmium, iron, nickel, silver, or platinum; and E. Sedström, with copper coupled with zinc or nickel.

The thermoelectric properties of copper are discussed in F. Peter's *Thermoelemente und Thermosäulen* (Halle, 1908). Copper is rather strongly negative, and this the more, the purer the metal. Between 0° and 100°, K. Noll³⁸ found a mercury-copper thermocouple of mercury and iron-free hard-drawn copper gave an e.m.f. of 725.58 microvolts; and with annealed copper, 725.64 microvolts; the copper-lead thermocouple gave an e.m.f. of 3.22 microvolts, and with commercial copper, 1.376 microvolt. J. Dewar and J. A. Fleming found the e.m.f. of a copper-lead thermocouple diminished as the temp. fell from 100° to -205.1°. Expressing the e.m.f. in C.G.S. units:

E.m.f.	100.1°	51.6°	8.8°	-9.1°	-3.52°	-53.6°	-104.7°	-205.1°
	+31590	+14320	+1985	-2630	-8830	-13130	-24180	-41350

At atm. press., and θ° , the e.m.f. of the copper-lead thermocouple is $E=(2.777\theta+0.00483\theta^2)\times 10^{-6}$ volts; the Peltier effect $P=(2.777+0.00966\theta)(\theta+273)\times 10^{-6}$ volts; and the Thomson effect $\sigma=0.00966(\theta+273)\times 10^{-6}$ volts per degree. E. Lecher measured the Thomson effect of copper between 252° and 678° and found $(3.28+0.00340\theta)10^{-7}$ gram-cals. per coulomb. P. W. Bridgman's observations on the effect of press., in kgms. per sq. cm., on the Seebeck, Peltier, and Thomson effects are indicated in Table VI; where the heat effects are with couples with the compressed

TABLE VI.—THE EFFECT OF PRESSURE ON THE SEEBECK, PELTIER, AND THOMSON EFFECTS.

Temp.	Seebeck effect. Volts $\times 10^6$.			Peltier effect. Joules per coulomb $\times 10^6$.			Thomson effect. Joules per coulomb $\times 10^6$.		
	Press., kgms. per sq. cm.			Press., kgms. per sq. cm.			Press., kgms. per sq. cm.		
	2000	6000	12,000	2000	6000	12,000	2000	6000	12,000
10°	+0.058	+0.154	+0.288	+1.6	+4.1	+ 7.6	0	+3.7	+6.3
40°	0.231	0.668	1.256	1.8	5.7	10.8	0	1.3	3.5
60°	0.350	1.038	1.976	2.1	6.3	12.2	0	1.0	3.4
100°	0.584	1.828	3.546	2.2	7.8	15.9	0	3.8	7.5

and uncompressed metals. The Seebeck and Peltier effects are positive and rise regularly with temp. and press.; Thomson's effect is zero at low press., becoming positive at higher press., and passing through a minimum with rising temp. and constant press. E. Wagner made some observations on the effect of press. on the Seebeck effect. The e.m.f. of couples with a copper wire under ordinary conditions and one with tension up to 700 kgms. per sq. cm. were found to vary linearly with tension, so that at 95°, the e.m.f. $= (0.00056T)10^{-6}$ volts. The direction of the e.m.f. is from the unstretched to the stretched wire at the hot junction; this corresponds to a current from the compressed to the uncompressed metal at the hot junction, and is opposite in sign from the pure press. effect. G. Borelius and F. Gunnerson found the Thomson effect, in microvolts per degree, to be 2.36 at 400° K., 1.63 at 300° K., 0.76 at 200° K., 0.06 at 140° K., -0.08 at 120° K., and -0.16 at 100° K. A. Cöhn and A. Lotz studied the contact electricity of copper against glass in vacuo.

A. Heil measured the thermoelectric force of the copper-constantan (an alloy of 60 per cent. copper, 40 per cent. nickel) thermocouple; E. Lecher, and F. F. le Roux, the copper-iron thermocouple; F. Rziha, and P. Czermak, the copper-nickel thermocouple. G. Gore found that hot copper is positive to cold copper in many soln., and in others negative. If the two copper-iron junctions be initially at 10°, the maximum current obtains at 270°, and there is no current at 530°, above that temp. the direction of the current is reversed. Let the two junctions of the

couple be initially at T° , and let one be raised in temp. dT when the e.m.f. dE is generated—the ratio dE/dT is called the **thermoelectric power** of the two metals at T° . From W. Jäger and H. Diesselhorst's, J. Dewar and J. A. Fleming's, K. Noll's, and W. H. Steele's measurements, the thermoelectric power of *copper-platinum* thermocouple at 100° is $+0.74$ millivolt; for *copper-constantan* couple at -190° , F. G. Wick gives $+5.20$ millivolts; $+3.10$ millivolts at -100° ; -4.00 millivolts at 100° ; -8.80 millivolts at 200° ; and -14.9 millivolts at 300° . G. Reichard obtained similar results at 100° – 200° . G. Reichard also obtained for *copper-cobalt* and *copper-nickel* couples at 100° respectively -2.74 and -2.69 millivolts, and at 200° , respectively -6.30 and -5.55 millivolts. H. Péchaux measured the Cu : Co-couple up to 900° when -28.4 millivolts were obtained. W. W. Coblenz found that with the *tungsten-copper* couple at -190° , an e.m.f. of $+0.58$ millivolt was obtained; at -100° , $+0.24$; at 100° , $+0.04$; and at 200° , $+0.34$ millivolt. L. H. Adams' value for copper-platinum at θ° , is $aE/d\theta = 5.85 + 0.0406\theta - 7.46 \times 10^{-5}\theta^2 + 1.096 \times 10^{-7}\theta^3$; and for the copper-lead couple, $dE/d\theta$ is $2.84 + 0.0082\theta - 0.84 \times 10^{-5}\theta^2 + 0.236 \times 10^{-7}\theta^3$. The thermal e.m.f. E obtained by integrating $\int (dE/d\theta)d\theta$ between 0° and θ° is $E = 5.85\theta + 0.0203\theta^2 - 2.48 \times 10^{-5}\theta^3 + 0.274 \times 10^{-7}\theta^4$ for the Cu-Pt couple, and $E = 2.84 + 0.0041\theta + 0.0041\theta^2 - 0.28 \times 10^{-5}\theta^3 + 0.0565 \times 10^{-7}\theta^4$ for the Cu-Pb couple. For the copper-constantan couple, L. H. Adams and J. Johnston, and R. B. Sosman give $E = 38.105\theta + 0.0442\theta^2 - 0.00002856\theta^3$. K. Noll obtained for the *copper-mercury* couple between 0° and 100° , 725 microvolts both for hardened and annealed copper; and $+443$ and $+435$ microvolts respectively for hardened and annealed brass. P. W. Bridgman gave for a thermocouple of commercial and electrolytic copper $E = (0.03468\theta + 0.0000133\theta^2) \times 10^{-6}$ volts. W. G. Duffield, T. H. Burnham, and A. H. Davis studied the electric arc between copper electrodes.

In 1879, E. H. Hall³⁹ discovered that when a powerful magnet is made to act on a current flowing in a very thin strip of metal, the equipotential lines are deflected from their original position at right angles to the lines of flow of the current in the strip. This is the so-called **Hall effect**. If a magnetic field of strength H , carrying a current I in a plate of thickness t , the difference of potential e produced by the deflection of the equipotential lines is $e = RIH/t$, where R is a **Hall constant**. For copper, $R = -0.00052$. The attendant thermomagnetic and thermoelectric phenomena have been studied by A. von Ettinghausen and W. Nernst, A. Leduc, H. Zahn, and F. Unwin. M. Faraday⁴⁰ found copper to be feebly diamagnetic. The **magnetic susceptibility**, or the intensity of magnetization of electrolytic copper per unit field, is -0.82×10^{-6} vol. units, according to J. Königsberger, and according to S. Meyer, -0.66×10^{-6} at 15° . O. C. Clifford gave -1.22×10^{-6} mass units for native copper; and G. Chéneveau, -0.90×10^{-6} . The magnetic behaviour is profoundly altered by traces of iron; as little as 0.04 per cent. of iron makes the metal paramagnetic. M. Owen found for electrolytic copper with 0.0004 per cent. of iron, -0.085×10^{-6} , and for electrolytic copper with 0.008 per cent. of iron, K. Honda found -0.86×10^{-6} mass units. J. Königsberger found for the temp. coeff. -0.0015 , so that the magnetic susceptibility decreases with rise of temp. S. Meyer gave 0.0044×10^{-6} for the atomic magnetism. A. Günther-Schulze⁴¹ studied the **electrolytic valve-action** of copper in sulphuric acid. V. L. Chrisler⁴² studied the potential gradient in the arc with copper electrodes.

REFERENCES.

- ¹ W. I. Baragiola, *Schweiz. Apoth. Ztg.*, 53, 477, 1915.
- ² C. Bischof, *Das Kupfer und seine Legierungen*, Berlin, 1865; M. Faraday, *Phil. Mag.*, (4), 14, 401, 1857; W. L. Dudley, *Amer. Chem. Journ.*, 14, 185, 1892; E. Braun, *Vierteljahr. Nat. Ges. Zürich*, 63, 1866; G. B. Rizzo, *Atti Accad. Torino*, 28, 823, 1893; G. T. Beilby, *B. A. Rep.*, 604, 1901.
- ³ G. W. A. Kahlbaum, K. Roth, and P. Siedler, *Zeit. anorg. Chem.*, 29, 177, 1902; W. L. Bragg, *Phil. Mag.*, (6), 28, 355, 1914; (6), 40, 169, 1920; J. G. Wallerius, *Mineralogie*, Berlin, 346.

1772; J. B. L. Romé de l'Isle, *Crystallographie*, Paris, 3, 306, 1783; J. D. Dana, *Amer. Journ. Science*, (3), 32, 416, 1886; (3), 33, 190, 1886; J. H. Brown, *ib.*, (3), 32, 377, 1886; J. W. Mallet, *ib.* (2), 30, 253, 1860; S. Nishikawa and G. Asahara, *Phys. Rev.*, (2), 15, 38, 1920; J. Percy, *Metallurgy of Copper, Zinc, and Brass*, London, 359, 1861; A. Liversidge, *Chem. News*, 35, 68, 1877; W. M. Hutchings, *ib.*, 35, 117, 186, 1877; J. Margottet, *Compt. Rend.*, 85, 1142, 1877; H. Moissan, *ib.*, 141, 855, 1905; W. Hampe, *Chem. Ztg.*, 9, 1442, 1885; 17, 1693, 1893; E. Weinschenk, *Zeit. Kryst.*, 17, 494, 1890; E. Murmann, *Monatsh.*, 17, 705, 1896; H. Bohlin, *Ann. Physik*, (4), 61, 434, 1920; A. Beutell, *Centr. Min.*, 14, 1919; K. F. Slotte, *Acta Soc. Fennica*, 40, 3, 1911; F. le Play, *Description des procédés métallurgiques employés dans le pays de Galle pour la fabrication du cuivre*, Paris, 1848; G. Rose, *Mineralogisch-geognostische Reise nach dem Ural*, Berlin, 1, 384, 1837; 2, 454, 1842; G. vom Rath, *Zeit. Kryst.*, 17, 109, 1890; *Pogg. Ann.*, 152, 24, 1874; A. Schrauf, *Tschermak's Mitt.*, 290, 1873; O. Mügge, *Zeit. Kryst.*, 20, 308, 1896; H. Baucke, *Internat. Zeit. Met.*, 4, 155, 1913; Z. Jeffries, *Journ. Inst. Metals*, 20, 109, 1918; F. G. Smith, *Bull. Amer. Inst. Min. Eng.*, 1361, 1919; Z. Jeffries, *Trans. Amer. Inst. Min. Met. Eng.*, 50, 474, 1919; G. Grube and V. Reuss, *Zeit. Elektrochem.*, 27, 45, 1921; G. Grube, *ib.*, 27, 53, 1921; E. Rasso and L. Velde, *Zeit. Metallkunde*, 12, 369, 1920; G. Tammann, *Zeit. anorg. Chem.*, 113, 163, 1920; 114, 278, 1920; M. von Schwarz, *Internat. Zeit. Metallog.*, 7, 124, 1915; E. Bergmann, *Wied. Ann.*, 36, 783, 1889; D. Pantanelli, *Atti Accad. Lincei*, (5), 5, i, 11, 1896; W. Gowland, *Chem. News*, 68, 307, 1894; K. W. Zenger, *Sitzber. Akad. Wien*, 44, 318, 1861; W. Campbell, *Journ. Franklin Inst.*, 154, 131, 1902; *Met.*, 4, 808, 1907; P. Galy-Aché, *Ann. Chim. Phys.*, (7), 30, 326, 1903; S. Kalischer, *Ber.*, 15, 702, 1882; E. Heyn, *Zeit. Ver. deut. Ing.*, 44, 503, 1882; W. Ewing and W. Rosenhain, *Phil. Trans.*, 193, A, 353, 1900; P. Scherrer, *Phys. Zeit.*, 19, 23, 1918; R. J. Haiji, *Traité de minéralogie*, Paris, 3, 518, 1801; O. Faust, *Zeit. anorg. Chem.*, 78, 151, 1912; A. Sieverts and W. Wippelmann, *ib.*, 93, 287, 1915; F. Robin, *Rev. Mét.*, 10, 750, 1913; W. Campbell, *Journ. Franklin Inst.*, 154, 14, 1902; *Met.*, 4, 828, 1907; W. H. Bassett, *Met. Chem. Eng.*, 4, 164, 1912; F. Johnson, *ib.*, 9, 396, 1921; E. S. Bardwell, *Trans. Inst. Min. Eng.*, 46, 742, 1913; W. Blum, H. D. Holler, and H. S. Rawdon, *Trans. Amer. Electrochem. Soc.*, 30, 159, 174, 1916; H. S. Rawdon, *Trans. Amer. Inst. Metals*, 10, 198, 1916; W. E. Hughes, *Metal Ind.*, 16, 332, 1920; M. Ettisch, M. Polyani, and K. Weissenberg, *Zeit. phys. Chem.*, 99, 332, 1921; M. N. Saha, *Nature*, 107, 682, 1921.

⁴ H. S. Rawdon and M. G. Lorentz, *Bur. Standards Science Papers*, 399, 1920; *Bull. Bur. Standards*, 15, 641, 1920; W. Guentler, *Internat. Zeit. Metallog.*, 8, 228, 1916; O. F. Hudson, *Journ. Inst. Metals*, 13, 193, 1915.

⁵ A. W. Wright, *Amer. Journ. Science*, (3), 13, 49, 1877; W. Betz, *Ann. Physik*, (4), 18, 600, 1905; *Eine methode zur Bestimmung der Dichte und optischen Konstanten durchsichtiger Metallschichten*, Leipzig, 1905; L. Houllévigie, *Boltzmann's Festschrift*, 62, 1904; W. Spring, *Zeit. anorg. Chem.*, 1, 240, 1892; P. Neogi, *ib.*, 59, 213, 1908; G. Tammann, *ib.*, 111, 78, 1920; O. Brunck, *Liebigs Ann.*, 327, 244, 1893; A. Knop, *Neues Jahrb. Min.*, 543, 1861; T. Curtius and F. Schrader, *Journ. prakt. Chem.*, (2), 50, 323, 1894; F. D. Chattaway, *Chem. News*, 96, 85, 1907; 97, 19, 1908; *Proc. Roy. Soc.*, 80, A, 88, 1907; T. Turner, *ib.*, 81, A, 301, 1908; G. T. Beilby, *ib.*, 72, 218, 1902; *Journ. Soc. Chem. Ind.*, 22, 1166, 1903; *Electrochem. Met. Ind.*, 3, 806, 1904; M. Faraday, *Phil. Trans.*, 147, 145, 1857.

⁶ J. J. C. Mullet, *Journ. Asiatique*, (5), 11, 379, 1876; N. Khanikoff, *Journ. Amer. Oriental Soc.*, 6, 1, 1859; H. C. Bolton, *Quart. Journ. Science*, 13, 494, 1876.

⁷ G. W. A. Kahlbaum and E. Sturm, *Zeit. anorg. Chem.*, 46, 256, 1905; G. W. A. Kahlbaum, K. Roth, and P. Siedler, *ib.*, 29, 177, 1902; T. Scheerer and R. F. Marchand, *Journ. prakt. Chem.*, (1), 27, 193, 1843; J. A. Groshans, *Rec. Trav. Chim. Pays-Bas*, 4, 236, 1885; H. Moissan, *Compt. Rend.*, 141, 855, 1905; F. Nies and A. Winkelmann, *Wied. Ann.*, 13, 43, 1881; A. Riche, *Ann. Chim. Phys.*, (4), 30, 351, 1873; P. Galy-Aché, *ib.*, (7), 30, 326, 1903; *Recherches sur les propriétés mécaniques et physiques du cuivre*, Paris, 1903; J. W. Swan and J. G. A. Rhodin, *Proc. Roy. Soc.*, 56, 64, 1894; H. Tomlinson, *ib.*, 37, 107, 1884; A. Baudrimont, *Journ. prakt. Chem.*, (1), 7, 287, 1856; *Ann. Chim. Phys.*, (3), 30, 304, 1850; R. Boyle, *Hydrostatic Balance*, London, 1690; R. Böttger, *Tabellarische Uebersicht der spezifischen Gewichte der Körper*, Frankfurt, 1837; C. Hatchett, *Phil. Trans.*, 93, 88, 1803; M. J. Brisson, *Pésanteur spécifique des corps*, Paris, 1787; A. T. Kupffer, *Ann. Chim. Phys.*, (2), 25, 356, 1824; F. C. A. H. Lantsberry, *Proc. Birmingham Met. Soc.*, 5, 101, 1913; T. M. Lowry, *Journ. Inst. Metals*, 21, 359, 1919; C. J. B. Karsten, *Schweigger's Journ.*, 65, 394, 1832; M. Bouilhet, *Berg. Hütt. Ztg.*, 47, 113, 1888; T. Herapath, *Phil. Mag.*, (1), 64, 394, 1824; A. Dick, *ib.*, (4), 11, 409, 1856; W. Weston, *ib.*, (4), 50, 542, 1875; R. Mallet, *Phil. Mag.*, (4), 49, 231, 1875; *Proc. Roy. Soc.*, 22, 366, 1873; 23, 29, 1875; W. C. Roberts-Austen, *ib.*, 23, 481, 1875; L. Playfair and J. P. Joule, *Mem. Chem. Soc.*, 3, 57, 77, 1848; *Journ. Chem. Soc.*, 1, 121, 1849; D. Watson, *Journ. Soc. Chem. Ind.*, 2, 153, 1883; C. O'Neill, *Mem. Manchester Lit. Phil. Soc.*, (3), 1, 243, 1862; H. Schiff, *Liebigs Ann.*, 107, 59, 1858; H. Schröder, *Pogg. Ann.*, 106, 226, 1859; 107, 113, 1859; G. Quincke, *ib.*, 97, 396, 1856; P. Schützenberger, *Journ. Pharm. Chem.*, (4), 28, 366, 1878; W. C. Roberts-Austen and T. Wrightson, *Nature*, 24, 470, 1881; *Phil. Mag.*, (5), 11, 295, 1881; (5), 13, 360, 1882; F. C. Kelley, *Metal Ind.*, 14, 61, 1919; W. Hampe, *Zeit. Berg. Hütt. Sal.*, 20, 256, 1872; J. D. Whitney, *Amer. Journ. Science*, (2), 28, 11, 1859; R. Hennig, *Wied. Ann.*, 27, 338, 1886; A. Trippel, *Eng. Min. Journ.*, 35, 436, 1888; P. Pascal and J. Jouniaux, *Compt. Rend.*, 158, 414, 1914; J. H. Dellinger, *Elect. Rev.*, 58, 889, 1911; D. G. Fahrenheit, *Phil. Trans.*, 33, 114, 1726;

Anon., *Circ. Bur. Standards*, 31, 1914; H. Gewecke, *Elektrotech. Zeit.*, 33, 22, 1912; W. Stahl, *Metal Erz*, 16, 443, 1919; 17, 93, 1920; *Berg. Hütt. Ztg.*, 48, 323, 1889; 45, 416, 1886; 49, 299, 1890; 60, 78, 1901; S. Stein, *ib.*, 40, 236, 1881; A. Dick, *Phil. Mag.*, (4), 11, 409, 1856; W. J. Russell and A. Mattheissen, *ib.*, (4), 23, 81, 1862; A. Riche, *Ann. Chim. Phys.*, (4), 30, 351, 1873; W. Hampe, *Zeit. Berg. Hütt. Sal.*, 24, 6, 1876; C. Heusler, *German Pat.*, D.R.P. 36607, 1885; O. Hesse, *ib.*, 3993, 1877; T. Scheerer and R. F. Marchand, *Journ. prakt. Chem.*, (1), 27, 195, 1842; W. Spring, *Bull. Acad. Belg.*, (3), 6, 11, 1883; *Journ. Chim. Phys.*, 1, 593, 1904; *Rec. Trav. Chim. Pays-Bas*, 23, 1, 1904; L. Grunmach, *Ann. Phys.*, (2), 67, 227, 1899; C. E. Fawcitt, *Proc. Roy. Soc. Edin.*, 25, 2, 1906; P. Duham, *Journ. Phys. Chem.*, 2, 438, 1904; T. M. Lowry and R. G. Parker, *Journ. Chem. Soc.*, 107, 1005, 1915.

⁸ G. T. Beilby, *Journ. Soc. Chem. Ind.*, 22, 1166, 1903; *Electrochem. Met.*, 3, 806, 1904; *Phil. Mag.*, (6), 8, 273, 1904; *Chem. News*, 92, 85, 1905; *Journ. Inst. Metals*, 6, 16, 1911; 8, 186, 1912; *Proc. Roy. Soc.*, 72, 218, 1902; 79, A, 463, 1907; 82, A, 599, 1909; G. T. and H. N. Beilby, *ib.*, 76, 462, 1905.

⁹ W. Rosenhain, *Journ. Inst. Metals*, 8, 149, 1912; 10, 119, 1913; S. W. Smith, *ib.*, 8, 175, 1912; L. Holborn and F. Henning, *Sitzber. Akad. Berlin*, 936, 1902; Z. Jeffries, *Journ. Amer. Inst. Metals*, 11, 300, 1918; *vide* I, 11, 4.

¹⁰ W. Rosenhain, *Journ. I. S. Inst.*, 70, iii, 189, 1906; O. W. Ellis, *Journ. Birmingham Met. Soc.*, 7, 71, 1919; *Journ. Inst. Metals*, 19, 319, 1918; D. Hanson, *ib.*, 20, 141, 1918; J. E. Stead, *Journ. I. S. Inst.*, i, 145, 1898; ii, 137, 1898; C. Chappell, *ib.*, 89, i, 460, 1914; A. Sauveur, *Proc. Internat. Assoc. Testing Mat.*, 2, 1, 1912; F. Robin, *Rev. Mét.*, 10, 722, 758, 1913; R. J. Anderson, *Trans. Faraday Soc.*, 14, 150, 1919; A. Joisten, *Met.*, 7, 456, 1910; R. H. Sherry, *Met. Chem. Eng.*, 10, 666, 1912; W. E. Ruder, *Trans. Amer. Inst. Min. Eng.*, 47, 569, 1913; G. H. Mathewson and A. Phillips, *ib.*, 54, 608, 1916; H. M. Howe, *ib.*, 56, 515, 1917; Z. Jeffries, *ib.*, 54, 658, 1916; 56, 571, 1917; *Journ. Inst. Metals*, 20, 109, 1918; *Trans. Faraday Soc.*, 12, 40, 1917; W. E. Alkins, *Metal Ind.*, 16, 347, 1920; Z. Jeffries and R. S. Archer, *Met. Chem. Eng.*, 26, 343, 1922.

¹¹ F. Johnson, *Met. Chem. Eng.*, 9, 187, 1911; E. Heyn, *Zeit. Ver. deut. Ing.*, 46, 1119, 1902; W. Stahl, *Met.*, 5, 289, 1908; E. Heyn, *Journ. I. S. Inst.*, ii, 745, 1902; A. Thomas, *Iron*, 40, 399, 1892; G. W. Cummins, *Eng. Min. Journ.*, 50, 216, 1890; H. M. Howe, *Trans. Amer. Inst. Min. Eng.*, 13, 646, 1885; C. W. Bennett, *Trans. Amer. Electrochem. Soc.*, 21, 243, 1912; *Met. Chem. Eng.*, 10, 298, 1912; C. Grand, *Rev. Mét.*, 6, 1069, 1909; A. K. Huntington, *Journ. Inst. Metals*, 8, 127, 1912; W. Müller, *Metal Erz*, 10, 220, 1913; M. Weidig, *Verh. Ver. Beförd. Gewerbef.* 90, 459, 525, 1911; G. Tammann, *Gött. Nachr.*, 1, 351, 1918.

¹² C. J. B. Karsten, *System der Metallurgie*, Berlin, 5, 244, 1830; W. Hampe, *Zeit. Berg. Hütt. Sal.*, 21, 273, 1873; 22, 97, 1874; *Chem. Ztg.*, 16, 728, 1892; E. Murrmann, *Monatsh.*, 17, 697, 1896; L. Archbutt, *Analyst*, 30, 385, 1905; E. A. Lewis, *Chem. News*, 83, 3, 1901; *Eng. Min. Journ.*, 58, 285, 1904; O. Pufahl, *Berg. Hütt. Ztg.*, 43, 37, 1884; A. M. Levy, *ib.*, 44, 509, 1885; M. Leuschner, *Dingler's Journ.*, 202, 476, 1871; A. H. Hiorns, *Journ. Soc. Chem. Ind.*, 25, 622, 1906; A. Matthiessen and M. Holzmann, *Pogg. Ann.*, 110, 222, 1860; B. Hopkinson, *Proc. Roy. Soc.*, 74, 498, 1905; E. S. Shepherd and G. B. Upton, *Journ. Phys. Chem.*, 9, 441, 1905; B. E. Curry, *ib.*, 11, 425, 1907; G. D. Bengough and D. Hanson, *Journ. Inst. Metals*, 12, 56, 1914; G. V. Cæsar and G. C. Gerner, *Trans. Amer. Inst. Metals*, 10, 208, 1916; A. Martens, *Mitt. tech. Versuchsanst.*, 12, 37, 1894; F. Johnson, *Journ. Inst. Metals*, 4, 163, 1910; *Metal Ind.*, 16, 307, 1920; J. E. Sears, *Proc. Cambridge Phil. Soc.*, 14, 257, 1907; J. Fuller, *The Art of Copper Smelting*, London, 1912; W. Küppers, *Zeit. Ver. deut. Ing.*, 50, 1889, 2022, 1906; D. R. Pye, *Journ. Inst. Metals*, 6, 165, 1911; E. Cohen, *Proc. Acad. Amsterdam*, 17, 200, 1914.

¹³ C. A. Thompson, *Trans. Faraday Soc.*, 12, 30, 1917; A. Portevin, *Rev. Mét.*, 21, 235, 1919; E. H. Pierce, *Amer. Soc. Testing Materials*, 17, 115, 1917; L. Guillet, *Rev. Mét.*, 12, 819, 1910; C. Grand, *ib.*, 6, 1069, 1909; P. Rossi, *Ital. Met.*, 11, 416, 1919; C. A. Edwards, *Metal Ind.*, 17, 221, 1921; C. Calvert and R. Johnson, *Mem. Manchester Lit. Phil. Soc.*, (2), 15, 113, 1858; *Phil. Mag.*, (4), 17, 114, 1859; S. Bottone, *Chem. News*, 28, 215, 1873; T. Turner, *Journ. I. S. Inst.*, 75, i, 434, 1909; J. R. Rydberg, *Zeit. phys. Chem.*, 33, 355, 1900; P. Ludwik, *ib.*, 91, 232, 1916; N. Kurnakoff, S. F. Schemtschuschny and M. Schesdateleff, *Journ. Inst. Metals*, 15, 305, 1916; N. S. Kurnakoff and S. F. Schemtschuschny, *Zeit. anorg. Chem.*, 50, 1, 1908; E. Heyn and O. Baur, *ib.*, 52, 141, 1907; J. Martens, *Verh. Ver. Beförd. Gewerbef.*, 41, 1888; T. Turner, *Proc. Birmingham Phil. Soc.*, 5, 282, 1887; H. N. Beilby, *Phil. Mag.*, (6), 8, 258, 1904; *Proc. Roy. Soc.*, 76, A, 462, 1905; W. J. Lewis, *Eng. Min. Journ.*, 68, 285, 1904; F. A. Abel, *Journ. Chem. Soc.*, 18, 249, 1865; F. A. Barrett, *Monit. Scient.*, (3), 4, 91, 1874; C. A. Edwards, *Inst. Metals*, 20, 86, 1918; F. Auerbach, *Wied. Ann.*, 43, 61, 1891; *Ann. Physik*, (4), 3, 108, 1900; M. Hanriot, *Compt. Rend.*, 155, 1502, 1912; O. Faust and G. Tammann, *Zeit. phys. Chem.*, 75, 108, 1910; P. Ludwik, *ib.*, 91, 232, 1916; R. J. Anderson, *Metal Ind.*, 18, 24, 1921; H. Weiss, *Compt. Rend.*, 171, 108, 1920; A. Kürth, *Zeit. Ver. deut. Ing.*, 53, 85, 209, 1909; F. C. Kelley, *Trans. Amer. Electrochem. Soc.*, 34, 325, 1918; E. C. Bain and Z. Jeffries, *Chem. Met. Eng.*, 25, 775, 1921; G. Quincke, *Pogg. Ann.*, 134, 356, 1868; 135, 261, 1869; 138, 141, 1869; *Phil. Mag.*, (4), 36, 267, 1868; (4), 38, 78, 1869; *Wied. Ann.*, 61, 267, 1897; 52, 1, 1894; J. Kleber, *Ann. Physik*, (4), 46, 1054, 1915; H. E. Diller, *Foundry*, 47, 779, 1919; M. Ishimoto, *Proc. Math. Phys. Soc. Japan*, (3), 1, 267, 1919; S. W. Smith, *Journ. Inst. Metals*, 12, 168, 1914; 17, 65, 1917; I. Traube, *Ber. deut. phys. Ges.*, 11, 231, 1909; *Ber.*, 42, 86, 1909; A. Johnsen, *Centr.*

Min., 233, 1918; K. Honda and S. Konno, *Phil. Mag.*, (6), 42, 115, 1921; M. Hanriot, *Compt. Rend.*, 155, 1502, 1902; W. E. Dalby, *Phil. Trans.*, 221. A, 117, 1920; Z. Jeffries, *Journ. Inst. Metals*, 18, 243, 1917; G. Sirovich and A. Cartoceti, *Gazz. Chim. Ital.*, 51, ii, 245, 1921.

¹⁴ P. D. Merica, *Met. Chem. Eng.*, 18, 192, 1918.

¹⁵ T. W. Richards and E. P. Bartlett, *Journ. Amer. Chem. Soc.*, 37, 470, 1643, 1915; *Zeit. Elektrochem.*, 13, 519, 1907; T. W. Richards and W. N. Stull, *Zeit. phys. Chem.*, 51, 196, 1908; E. H. Amagat, *Ann. Chim. Phys.*, (6), 22, 95, 1891; J. Y. Buchanan, *Proc. Roy. Soc.*, 73, 296, 1904; E. J. Mills, *ib.*, 26, 504, 1877; S. Lussana, *Nuovo Cimento*, (5), 7, 369, 1904; B. Lera, *Rend. Accad. Lincei*, (4), 6, 165, 1890; R. H. Thurston, *Materials of Engineering*, New York, 1890; M. Hanriot, *Compt. Rend.*, 155, 1502, 1912; E. Grüneisen, *Ann. Physik*, (4), 33, 1239, 1910; A. M. Mallock, *Proc. Roy. Soc.*, 74, 50, 1904; E. Madelung and R. Fuchs, *Ann. Physik*, (4), 65, 289, 1921; Z. Jeffries, *Journ. Inst. Metals*, 18, 243, 1917; L. H. Adams, E. D. Williamson and J. Johnston, *Journ. Amer. Chem. Soc.*, 41, 12, 1919; H. V. Regnault, *Ann. Chim. Phys.*, (2), 62, 337, 1836.

¹⁶ M. Rudeloff, *Mitt. Tech. Versuchsanst.*, 16, 1171, 1898; A. Wassmuth, *Sitzber. Akad. Wien*, 115, 223, 1906; K. R. Koch and C. Dannecker, *Ann. Physik*, (4), 47, 197, 1915; N. Campbell, *Met.*, 4, 808, 1907; A. Gray, V. J. Blyth, and J. S. Dunlop, *Proc. Roy. Soc.*, 67, 180, 1900; C. E. Stromeyer and W. Kennedy, *ib.*, 55, 373, 1894; G. Wertheim, *Ann. Chim. Phys.*, (3), 12, 610, 1844; (3), 13, 385, 1844; A. Masson, *ib.*, (3), 3, 451, 1841; P. Cardani, *Phys. Zeit.*, 4, 449, 1903; A. Riche, *ib.*, (4), 30, 351, 1873; P. Galy-Aché, *ib.*, (7), 30, 326, 1903; *Recherches sur les propriétés mécaniques et physiques du cuivre*, Paris, 1903; J. Morrow, *Proc. Phys. Soc.*, 18, 582, 1903; *Phil. Mag.*, (6), 6, 417, 1903; A. M. Mallock, *Proc. Roy. Soc.*, 95, A, 469, 1919; H. Buff, *Pogg. Ann. Jubelbd.*, 349, 1874; K. Zöppritz, *Pogg. Ann.*, 129, 219, 1866; F. Kohlrausch and F. E. Loomis, *ib.*, 141, 481, 1870; E. A. Lewis, *Chem. News*, 83, 3, 1901; A. T. Küpffer, *Mém. Acad. St. Petersburg*, (7), 14, 273, 1870; (6), 5, 233, 1856; (6), 6, 397, 1857; G. Angenheister, *Ann. Physik*, (4), 11, 188, 1903; C. Schäfer, *ib.*, (4), 5, 220, 1901; J. R. Benton, *ib.*, (4), 3, 477, 1900; *Phys. Rev.*, (1), 12, 36, 1901; K. F. Slotte, *Acta Soc. Fenn.*, 26, 1899; 29, 1900; C. Benedicks, *Recherches sur l'acier au carbone*, Upsala, 1904; W. Sutherland, *Phil. Mag.*, (5), 32, 31, 215, 524, 1891; G. F. C. Searle, *ib.*, (5), 49, 193, 1900; A. Morley and G. A. Tomlinson, *ib.*, (6), 11, 380, 1906; F. Rehkuh, *Wied. Ann.*, 35, 476, 1888; W. Voigt, *ib.*, 15, 497, 1882; J. Kiewiet, *ib.*, 29, 650, 1886; E. H. Amagat, *Compt. Rend.*, 108, 228, 1889; C. Bischof, *Schweigger's Journ.*, 3, 195, 1825; B. Welbourn, *Journ. Inst. Elect. Eng.*, 54, 54, 1916; *Metal. Ind.*, 12, 70, 1918; W. E. Dalby, *Phil. Trans.*, 221. A, 117, 1920; F. Streitz, *Pogg. Ann.*, 150, 368, 1873; M. C. Naves, *Phys. Rev.*, (1), 2, 279, 1895; (2), 3, 433, 1896; H. L. Dodge, *ib.*, (2), 2, 431, 1913; H. Walker, *Proc. Roy. Soc. Edin.*, 27, 343, 1907; G. A. Shakespear, *Phil. Mag.*, (5), 47, 539, 1899.

¹⁷ W. Sutherland, *Phil. Mag.*, (5), 32, 31, 1891; H. Tomlinson, *ib.*, (5), 24, 253, 1887; W. Hampe, *Chem. Ztg.*, 16, 728, 1892; K. R. Koch and C. Dannecker, *Ann. Physik*, (4), 47, 197, 1915; W. Voigt, *Wied. Ann.*, 48, 674, 1893; M. Baumeister, *ib.*, 18, 578, 1883; A. Bock, *ib.*, 52, 609, 1894; N. Savart, *Pogg. Ann.*, 16, 206, 1829; J. Kiewiet, *Wied. Ann.*, 29, 650, 1886; G. Pisati, *Nuovo Cimento*, (3), 5, 34, 135, 1879; F. Kohlrausch and F. E. Loomis, *Pogg. Ann.*, 141, 481, 1870; F. Horton, *Phil. Trans.*, 204. A, 1, 1905; *Proc. Roy. Soc.*, 73, 334, 1904; 74, 401, 1905; G. Angenheister, *Ann. Physik*, (5), 11, 188, 1903; C. Schäfer, *ib.*, (4), 5, 233, 1901; A. Gray, V. J. Blyth, and J. S. Dunlop, *Proc. Roy. Soc.*, 67, 180, 1900; S. Katzenelsohn, *Ueber den Einfluss der Temperatur auf die Elasticität der Metalle*, Berlin, 1887.

¹⁸ E. H. Pierce, *Proc. Amer. Testing Materials*, 17, 115, 1917; C. W. Bennett, *Trans. Amer. Electrochem. Soc.*, 21, 243, 1912; G. D. Bengough, *Journ. Inst. Metals*, 7, 123, 1912; G. D. Bengough and D. Hanson, *ib.*, 12, 56, 1914; A. K. Huntington, *ib.*, 13, 23, 1915; 8, 126, 1912; 12, 234, 1914; C. Grand, *Rev. Mét.*, 6, 1069, 1909; R. Baumann, *Die Festigkeitsigenschaften der Metalle in Wärme und Kälte*, Stuttgart, 1907; E. S. Shepherd and G. B. Upton, *Journ. Phys. Chem.*, 9, 441, 1905; J. Dewar, *Chem. News*, 71, 200, 1895; E. A. Lewis, *ib.*, 83, 3, 1901; A. Baudrimont, *Ann. Chim. Phys.*, (3), 30, 304, 1850; P. Galy-Aché, *ib.*, (7), 30, 326, 1903; G. T. and H. N. Beilby, *Proc. Roy. Soc.*, 76, A, 462, 1905; G. T. Beilby, *ib.*, 79, A, 470, 1907; H. Fritz, *Monatsh.*, 13, 751, 1892; E. Murmann, *ib.*, 17, 726, 1896; M. Rudeloff, *Mitt. Tech. Versuchsanst.*, 16, 171, 1898; H. Baucke, *Intern. Zeit. Metallg.*, 3, 195, 1912; A. le Chatelier, *Compt. Rend.*, 109, 24, 1889; L. Guillet and V. Bernard, *ib.*, 156, 1899, 1903; L. Dufour, *Arch. Sciencs Genève*, (2), 28, 156, 1855; H. O. Hofman, R. Hayden, and H. B. Hallowell, *Trans. Inst. Min. Eng.*, 14, 275, 1907; M. Knoerzer, *Bull. Soc. Chim.*, (3), 9, 731, 1893; F. Foerster, *Zeit. Elektrochem.*, 5, 508, 1899; E. Brunner and M. Filliot, *Schweiz. Electrotech. Zeit.*, 4, 478, 493, 510, 527, 542, 557, 1908; O. Fröhlich, *Ann. Physik*, (4), 29, 431, 1909; F. A. and C. A. Lindemann, *Nernst's Festschrift*, 264, 1904; W. E. Dalby, *Phil. Trans.*, 221. A, 117, 1920; A. Martens, *Mitt. Tech. Versuchsanst.*, 12, 37, 1894; P. Ludwik, *Zeit. Ver. deut. Ing.*, 57, 209, 1913; 59, 657, 1915; E. S. Bardwell, *Trans. Amer. Inst. Min. Eng.*, 2075, 1914; O. Colonnetti, *Atti Accad. Lincei*, (5), 23, 165, 225, 421, 1914; M. von Hübl, *Mitt. Militär. Geog. Inst.*, 6, 51, 1886; C. W. Bennett, *Trans. Amer. Electrochem. Soc.*, 21, 253, 1912; R. H. Thurston, *Materials of Engineering*, New York, 1890; G. D. Bengough and B. P. Hill, *Journ. Inst. Metals*, 3, 23, 1910; F. Johnson, *ib.*, 8, 210, 1912; 4, 163, 1910; 21, 355, 1919; *Met. Chem. Eng.*, 8, 648, 1916; W. E. Alkins, *Metal Ind.*, 16, 307, 1920; *Journ. Inst. Metals*, 20, 33, 1819; O. W. Ellis, *ib.*, 21, 319, 1919; D. R. Pye, *ib.*, 6, 165, 1911; T. Bolton, *Elect. Rev.*, 60, 131, 1907; P. Goerens, *Carnegie Scholarship Memoirs*, 3, 320, 1911; W. R. Webster, *Rev. Mét.*, 10, 106, 1913; K. F. Slotte, *Oefv. Finska*, 35, 1893; 26, 1899; 29, 1900; A. Morley and G. A. Tomlinson, *Phil. Mag.*, (6), 11, 380, 1906;

F. Johnson, *Journ. Inst. Metals*, 26, 173, 1921; P. D. Mercia, *Met. Chem. Eng.*, 18, 121, 1918; A. Mallock, *Proc. Roy. Soc.*, 46, 233, 1889; G. Charpy, *Compt. Rend.*, 121, 494, 1895.

¹⁹ R. H. Thurston, *Materials of Engineering*, New York, 1890; F. Johnson, *Journ. Inst. Metals*, 8, 210, 1912; 4, 163, 1910; *Met. Chem. Eng.*, 8, 648, 1916; A. K. Huntington, *Journ. Inst. Metals*, 8, 126, 1912; 12, 234, 1914; H. Baucke, *Intern. Zeit. Met.*, 3, 195, 1912; L. Guillet and V. Bernard, *Compt. Rend.*, 156, 1899, 1899.

²⁰ H. Fizeau, *Compt. Rend.*, 68, 1125, 1869; H. le Chatelier, *ib.*, 108, 1097, 1889; I. Zakre-zewsky, *Bull. Acad. Cracovie*, 2, 1889; A. Matthiessen, *Phil. Trans.*, 156, 231, 1866; *Phil. Mag.*, (4), 31, 149, 1866; (4), 32, 472, 1866; G. Wiedemann, *Pogg. Ann.*, 106, 180, 1859; P. Glatzel, *ib.*, 160, 497, 1877; G. R. Dahlander, *ib.*, 145, 147, 1872; P. L. Dulong and A. T. Petit, *Ann. Chim. Phys.*, (2), 7, 113, 1818; H. Tomlinson, *Proc. Phys. Soc.*, 9, 67, 1887; *Phil. Mag.*, (5), 24, 253, 1888; H. Kopp, *Liebig's Ann.*, 81, 1, 1852; *Phil. Mag.*, (4), 3, 268, 1852; W. Voigt, *Wied. Ann.*, 49, 697, 1893; F. Wehrenfennig, *Centr. Opt. Mech.*, 7, 154, 1886; A. L. Lavoisier and P. S. Laplace, *Mém. Acad.*, 355, 1780; *Recueil des mémoires de chimie de Lavoisier*, Paris, 1, 121, 1805; *Ostwald's Klassiker*, 40, 1892; A. T. Kupffer, *Mém. Acad. St. Petersburg*, 14, 273, 1870; W. Dittenberger, *Zeit. Ver. deut. Ing.*, 46, 1532, 1902; F. A. Lindemann, *Phys. Zeit.*, 12, 1197, 1911; W. Broniewsky, *Journ. Chim. Phys.*, 4, 292, 1906; F. Henning, *Ann. Physik*, (4), 22, 631, 1907; E. Grüneisen, *ib.*, (4), 33, 65, 1910; E. H. Hall, *Proc. Nat. Acad. Sciences*, 6, 613, 1921; T. Turner and D. M. Levy, *Proc. Roy. Soc.*, 80, A, 1, 1908; P. D. Merica, *Met. Chem. Eng.*, 18, 121, 1918; W. Stahl, *Metal Erz*, 16, 443, 1919; W. E. Dorsey, *Phys. Rev.*, (1), 25, 887, 1902; L. Holborn and E. Grüneisen, *Ann. Physik*, (4), 6, 136, 1901; F. Hidnert, *Scient. Paper Bur. Standards*, 410, 1921.

²¹ G. Poloni, *Rend. Ist. Lombardi*, (2), 15, 15, 1882; G. Wiedemann and R. Franz, *Pogg. Ann.*, 89, 498, 1853; L. Lorenz, *Wied. Ann.*, 13, 422, 582, 1881; G. Kirchhoff and G. Hansemann, *ib.*, 13, 406, 1881; H. F. Weber, *Zürich Vierteljahr.*, 25, 184, 1880; *Wied. Ann.*, 11, 345, 1880; A. C. Mitchell, *Trans. Roy. Soc. Edin.*, 33, 535, 1887; 35, 947, 1890; *Proc. Roy. Soc. Edin.*, 17, 300, 1890; W. Jäger and H. Diesselhorst, *Sitzber. Akad. Berlin*, 719, 1899; A. Berget, *Compt. Rend.*, 107, 1524, 1888; W. Schaufelberger, *Ann. Physik*, (4), 7, 589, 1902; A. Rietzsch, *ib.*, (4), 3, 403, 1900; E. Grüneisen, *ib.*, (4), 3, 43, 1900; C. Hering, *Trans. Amer. Inst. Elect. Eng.*, 29, 485, 1910; C. H. Lees, *Proc. Roy. Soc.*, 80, A, 145, 1908; R. W. Stewart, *ib.*, 53, 151, 1893; J. H. Gray, *ib.*, 56, A, 199, 1894; F. Glaser, *Mét.*, 1, 125, 1904; E. Bède, *Mém. Couronnées Acad. Belg.*, 27, 1856; F. A. Schulze, *Wied. Ann.*, 66, 207, 1898; 63, 23, 1897; J. Trowbridge, *Science*, 8, 6, 1898; C. D. Child and R. W. Quick, *Phys. Rev.*, 2, 412, 1895; C. D. Child and B. S. Lanphear, *ib.*, 3, 1, 1895; F. Neumann, *Ann. Chim. Phys.*, (3), 66, 286, 1862; G. Glage, *Ann. Physik*, (4), 18, 904, 1905; K. L. Hagström, *Övers. Akad. Förh.*, 45, 289, 381, 1891; K. Angström, *Pogg. Ann.*, 114, 513, 1861; 118, 423, 1862; 123, 628, 1864; R. Schott, *Ber. deut. phys. Ges.*, 18, 27, 1916; W. Meissner, *Verh. deut. phys. Ges.*, 16, 262, 1914; O. Chwolson, *Mém. Acad. St. Petersburg*, 37, 12, 1890; *Exner's Repert.*, 27, 1, 1891; E. H. Hall, *Proc. Nat. Acad. Sciences*, 6, 613, 1921; P. W. Bridgman, *Phys. Rev.*, (2), 18, 115, 1921.

²² U. J. J. le Verrier, *Compt. Rend.*, 114, 907, 1892; J. Pionchon, *ib.*, 102, 675, 1886; P. Galy-Aché, *Ann. Chim. Phys.*, (7), 30, 331, 1903; P. L. Dulong and A. T. Petit, (2), 10, 395, 1819; H. V. Regnault, *ib.*, (2), 73, 1, 1840; (3), 1, 129, 1841; (3), 9, 322, 1843; L. Holborn and E. Grüneisen, *Ann. Physik*, (4), 6, 145, 1901; (4), 33, 65, 1910; (4), 55, 371, 1918; F. Wüst, A. Meuthen, and R. Durrer, *Zeit. Instrumentenk.*, 39, 294, 1919; H. Kopp, *Liebig's Ann. Suppl.*, 3, 290, 1864; H. Buff, *Pogg. Ann.*, 145, 626, 1872; *Phil. Mag.*, (4), 44, 544, 1872; H. T. Weber, *Zürich Vierteljahr.*, 25, 184, 1880; *Wied. Ann.*, 11, 345, 1880; H. Tomlinson, *Proc. Roy. Soc.*, 37, 107, 1884; H. E. Schmitz, *ib.*, 72, 177, 1903; W. A. Tilden, *ib.*, 66, 244, 1900; *Chem. News*, 78, 16, 1898; A. Bartoli and E. Stracciati, *Gazz. Chim. Ital.*, 25, 389, 1895; A. Naccari, *ib.*, 18, 13, 1888; *Atti Accad. Torino*, 23, 107, 1887; U. Behn, *Wied. Ann.*, 66, 237, 1898; L. Schütz, *ib.*, 46, 177, 1892; F. Dörinckel and M. Werner, *Zeit. anorg. Chem.*, 115, 1, 1920; G. J. Meyer, *Zur Theorie der Abschmelzsicherungen*, München, 1906; W. Nernst, *Ann. Physik*, (4), 36, 295, 1911; F. Koref, *ib.*, (4), 36, 49, 1911; R. Ewald, *ib.*, (4), 44, 1213, 1914; L. Rolla, *Gazz. Chim. Ital.*, 44, i, 646, 1914; W. Nernst and F. A. Lindemann, *Zeit. Elektrochem.*, 17, 817, 1911; *Sitzber. Akad. Berlin*, 263, 1910; 306, 494, 1911; W. Nernst, F. Koref, and F. A. Lindemann, *ib.*, 247, 1910; T. W. Richards and F. G. Jackson, *Zeit. phys. Chem.*, 70, 414, 1910; H. Schimpff, *ib.*, 71, 257, 1910; A. Magnus, *Ann. Physik*, (4), 31, 597, 1910; W. H. Keesom and H. K. Onnes, *Comm. Phys. Lab. Leiden*, 143, 24, 1914; 147, 3, 1915; D. R. Harpor, *Bull. Bur. Standards*, 2, 259, 1914; J. W. Richards, *Chem. News*, 68, 58, 69, 82, 93, 105, 1893; P. Schübel, *Zeit. anorg. Chem.*, 87, 81, 1914; E. H. and E. Griffiths, *Phil. Trans.*, 214, A, 319, 1914; E. Bède, *Mém. Couronnées Acad. Belgique*, 27, 1856; F. Glaser, *Mét.*, 1, 103, 121, 1904; F. A. Waterman, *Phil. Mag.*, (5), 40, 419, 1895; J. Dewar, *Proc. Roy. Soc.*, 89, A, 158, 1913; J. Trowbridge, *Science*, (2), 8, 6, 1898; G. W. A. Kahlbaum, K. Roth, and P. Siedler, *Zeit. anorg. Chem.*, 29, 177, 1902.

²³ J. F. Daniell, *Phil. Trans.*, 120, 257, 1830; 123, 443, 1831; J. K. Clement, *Phys. Rev.*, (1), 24, 531, 1907; L. Holborn and W. Wicn, *Wied. Ann.*, 56, 360, 1895; 47, 32, 1892; L. Holborn and A. L. Day, *ib.*, 68, 817, 1899; *Ann. Physik*, (4), 2, 523, 1900; (4), 4, 99, 1901; A. L. Day, R. B. Sosman, and E. T. Allen, *Amer. Journ. Science*, (4), 29, 93, 1910; A. L. Day and J. K. Clement, *ib.*, (4), 26, 405, 1908; F. Wüst, A. Meuthen, and R. Durrer, *Zeit. Instrumentenk.*, 39, 294, 1919; A. Ledebur, *Wied. Ann.*, 5, 650, 1881; G. Quincke, *Pogg. Ann.*, 138, 141, 1869; C. Bischof, *ib.*, 3, 195, 1825; *Das Kupfer und seine Legierungen*, Berlin, 1865; J. Violle, *Compt.*

Rend., 89. 702, 1879; E. M. Lécmeray, *ib.*, 131. 1291, 1900; C. Matignon and R. Trannoy, *ib.*, 142. 1211, 1906; C. M. Despretz, *ib.*, 48. 362, 1858; R. Blondlot, *ib.*, 102. 210, 1886; H. Moissan and T. Watanabe, *ib.*, 144. 17, 1907; H. Moissan, *ib.*, 116. 420, 1893; 141. 855, 1905; *Ann. Chim. Phys.* (7), 9. 133, 1896; C. Féry, *ib.*, (7), 28. 428, 1903; H. Moissan and A. J. P. O'Farrelley, *Bull. Soc. Chim.*, (3), 31. 1022, 1904; J. W. Richards, *Chem. News*, 68. 58, 69, 82, 93, 105, 1893; *Journ. Franklin Inst.*, 143. 379, 1897; *Metallurgical Calculations*, New York, 1. 68, 1906; H. von Wartenberg, *Zeit. anorg. Chem.*, 56. 320, 1907; E. Tiede and E. Birnbräuer, *ib.*, 87. 129, 1914; Anon., *Circular Bur. Standards*, 35, 1918; T. W. Richards, *Amer. Journ. Science*, (4), 13. 377, 1902; *Zeit. phys. Chem.*, 42. 617, 1903; H. C. Greenwood, *ib.*, 76. 487, 1911; C. Zenghelis, *ib.*, 57. 90, 1906; G. J. Meyer, *Zur Theorie der Abschmelzsicherungen*, München, 1906; J. Johnston, *Journ. Amer. Chem. Soc.*, 34. 788, 1912; W. Spring, *Bull. Acad. Belgique*, 28. 23, 1894; *Zeit. phys. Chem.*, 15. 77, 1894; F. Krafft, *Ber.*, 36. 1706, 1903; F. Krafft and E. Bergfeld, *ib.*, 38. 254, 1905; W. C. Roberts-Austen, *Proc. Roy. Soc.*, 63. 450, 1898; W. C. Roberts-Austen and T. K. Rose, *ib.*, 67. 105, 1900; W. H. Preece, *ib.*, 43. 280, 1880; 44. 109, 1880; T. Turner and D. M. Levy, *ib.*, 80. A. 1, 1907; S. W. Holman, R. R. Lawrence, and L. Barr, *Phil. Mag.*, (5), 42. 37, 1896; E. Rudolphi, *Zeit. anorg. Chem.*, 53. 219, 1907; B. E. Curry, *Journ. Phys. Chem.*, 11. 429, 1907; C. T. Heycock and F. H. Neville, *Journ. Chem. Soc.*, 61. 888, 1892; 67. 160, 1240, 1895; *Chem. News*, 71. 33, 1895; E. Heyn, *Mitt. tech. Versuchsanst.*, 315, 1900; *Zeit. anorg. Chem.*, 39. 11, 1904; *Rev. Mét.*, 3. 233, 1906; C. J. B. Karsten, *Schweigger's Journ.*, 66. 255, 1832; L. Lincoln, *Zeit. Elektrochem.*, 12. 130, 1894; W. Stahl, *Berg. Hütt. Ztg.*, 48. 323, 1889; *Met.*, 5. 289, 1908; F. Glaser, *ib.*, 1. 103, 121, 1904; A. von Riemsdyk, *Chem. News*, 20. 32, 1869; C. W. Siemens and A. K. Huntington, *ib.*, 46. 163, 1882; J. Roskell, *ib.*, 33. 77, 1876; C. A. Mahoney, *ib.*, 26. 243, 1872; F. H. Cinget, *Rev. Elctct.*, 8. 37, 1907; H. L. Callendar, *Phil. Mag.*, (5), 48. 519, 1899; A. Butts, *Met. Chem. Eng.*, 16. 84, 1917; C. R. Groves and T. Turner, *Journ. Chem. Soc.*, 101. 585, 1912; T. Turner, *Journ. Inst. Metals*, 7. 105, 1912; W. E. Thornycroft and T. Turner, *ib.*, 12. 214, 1914; G. D. Bengough and D. E. Hill, *ib.*, 4. 94, 1910; J. Johnston, *Journ. Amer. Inst. Metals*, 12. 15, 1918; H. C. Greenwood, *Proc. Roy. Soc.*, 82. A. 396, 1909; 82. A. 483, 1910; O. Ruff and B. Bergdahl, *Zeit. anorg. Chem.*, 106. 76, 1919; J. A. M. van Liempt, *ib.*, 114. 105, 1920; A. Henglein, *Zeit. Elektrochem.*, 26. 431, 1920; L. I. Dana and P. D. Footc, *Trans. Faraday Soc.*, 15. 186, 1920; W. Guertler and M. Pirani, *Zeit. Metallkunde*, 11. 1, 1911; L. Hamburger, *Koll. Zeit.*, 23. 177, 1918; J. H. Hildebrand, *Journ. Amer. Chem. Soc.*, 40. 45, 1918; W. H. Bassett, *Journ. Ind. Eng. Chem.*, 4. 164, 1912; J. Johnston, *ib.*, 9. 873, 1917; T. K. Rose, *Journ. Soc. Chem. Ind.*, 33. 170, 1914; K. Schcel, *Zeit. angew. Chem.*, 32. 347, 1919; T. K. Nair and T. Turner, *Proc. Chem. Soc.*, 29. 151, 1913; J. W. Richards, *Journ. Franklin Inst.*, 143. 379, 1897; L. B. Guyton de Morveau, *Mém. P'Inst.*, 12. ii, 89, 1811; R. Wright and R. C. Smith, *Journ. Chem. Soc.*, 119. 1683, 1921; O. Ruff and S. Mugdan, *Zeit. anorg. Chem.*, 117. 147, 1921; M. Knudsen, *Ann. Physik*, (4), 50. 472, 1916.

²⁴ E. Priwoznik, *Dingler's Journ.*, 221. 38, 1876; G. le Bon, *Compt. Rend.*, 135. 32, 1902; A. Colson, *ib.*, 123. 51, 1897; P. Desains and P. Curie, *ib.*, 90. 1506, 1880; J. Waterhouse, *Chem. News*, 80. 161, 1899; J. H. Vincent, *ib.*, 79. 302, 1899; W. J. Russell, *ib.*, 75. 302, 1897; 77. 167, 1898; *Proc. Roy. Soc.*, 63. 102, 1898; D. McFarlane, *ib.*, 20. 90, 1872; N. R. Campbell, *Proc. Cambridge Phil. Soc.*, 13. 282, 1906; *Phil. Mag.*, (6), 9. 531, 1905; (6), 11. 206, 1906; F. Streintz and O. Strohschneider, *Ann. Physik*, (4), 18. 198, 1905; M. Knudsen, *ib.*, (4), 50. 472, 1916; F. Streintz, *Phys. Zeit.*, 5. 736, 1904; B. von Lengyel, *Wied. Ann.*, 66. 1162, 1898; H. Knoblauch, *ib.*, 10. 654, 1880; 24. 258, 1885; C. B. Thwing, *Zeit. Elektrochem.*, 6. 83, 1908; F. Wüst, A. Meuthen, and R. Durrer, *Zeit. Instrumentcnk.*, 39. 294, 1919; R. Emden, *Wied. Ann.*, 36. 214, 1889.

²⁵ L. R. Ingersoll, *Astrophys. Journ.*, 32. 265, 1910; K. S. Minor, *Ann. Physik*, (4), 10. 581, 1903; K. Försterling and V. Frödericksz, *ib.*, (4), 40. 201, 1913; E. Hagen and H. Rubens, *ib.*, (4), 1. 352, 1900; (4), 8. 1, 1902; (4), 11. 873, 1903; S. Nakamura, *ib.*, (4), 20. 807, 1906; W. Rathenau, *Die Absorption des Lichts in Metallen*, Berlin, 1889; E. A. Javal, *Ann. Chim. Phys.*, (8), 4. 137, 1905; J. H. Gladstone, *Proc. Roy. Soc.*, 60. 140, 1896; B. Pogany, *Ann. Physik*, (4), 64. 196, 1921; C. M. Stubbs, *ib.*, 88. A. 195, 1913; J. T. Tate, *Phys. Rev.*, (2), 4. 321, 1914; C. C. Bidwell, *ib.*, 3. 439, 1914; G. K. Burgess, *Bur. Standards Scient. Paper*, 121, 1909; G. K. Burgess and R. G. Waltenburg, *ib.*, 242, 1914; A. Kundt, *Sitzber. Akad. Berlin*, 255, 1387, 1888; *Phil. Mag.*, (5), 28. 473, 1889; *Wied. Ann.*, 34. 469, 1889; 36. 502, 1889; H. Rubens, *ib.*, 37. 249, 1889; P. Drude, *ib.*, 39. 537, 1890; *Phil. Mag.*, (5), 28. 473, 1889; L. P. Wheeler, *ib.*, (6), 22. 229, 1911; H. Lubowsky, *Elekt. Zeit.*, 42. 79, 1921; J. Trowbridge and W. C. Sabine, *Wied. Ann.*, (5), 26. 316, 1888; T. Bayley, *ib.*, (5), 5. 222, 1878; *Journ. Chem. Soc.*, 37. 418, 1880; A. Schrauf, *Sitzber. Akad. Wien*, 52. 176, 1865; E. van Aubel, *Zeit. phys. Chem.*, 30. 566, 1899; J. D. Mackenzie, *Elect. Rev.*, 60. 701, 1907; J. Kannonikoff, *Journ. prakt. Chem.*, (2), 31. 338, 1885; W. J. Pope, *Journ. Chem. Soc.*, 69. 1530, 1896; I. C. Gardner, *Astrophys. Journ.*, 45. 1, 1917; F. Henning, *Jahrb. Rad. Elektron.*, 17. 30, 1920; M. Faraday, *Phil. Trans.*, 147. 145, 1857.

²⁶ W. Hallwachs, *Ann. Physik*, (4), 23. 465, 1907; E. Ladenburg, *ib.*, (4), 12. 558, 1903; R. A. Millikan and G. Winchester, *Phil. Mag.*, (6), 14. 188, 1907; O. Stuhlmann, *ib.*, (6), 20. 331, 1910; (6), 22. 854, 1911; W. Ramsay and J. F. Spencer, *ib.*, (6), 12. 397, 1896; L. T. More, *ib.*, (6), 13. 708, 1907; K. Herrmann, *Beiträge zum Hallwachseffekt*, Berlin, 1908; A. E. Hennings and W. H. Kadesch, *Phys. Rev.*, (2), 8. 209, 1916; T. C. Sutton, *Phil. Mag.*, (6), 47. 679, 1915; G. Reoul, *Compt. Rend.*, 158. 477, 1914; G. W. C. Kaye, *Proc. Roy. Soc.*, 93. A. 427, 1917;

C. S. Brainin, *Phys. Rev.*, (2), 10, 461, 1917; E. Warburg and S. Williams, *Sitzber. Akad. Berlin*, 458, 1905; J. R. von Geitler, *Ann. Physik*, (4), 22, 246, 1907; W. Duane and T. Shimizu, *Phys. Rev.*, (2), 14, 525, 1919; I. G. Barber, *ib.*, (2), 17, 322, 1921; E. Rutherford and J. Chadwick, *Nature*, 107, 41, 1921; H. R. von Trautenberg, *Zeit. Physik*, 2, 268, 1920; A. Voller and B. Walter, *Wied. Ann.*, 61, 88, 1897; A. Hébert and G. Reynaud, *Compt. Rend.*, 132, 408, 1901; T. Cooksey, *Amer. Journ. Science*, (4), 24, 291, 1907; J. H. Gladstone and W. Hibbert, *Chem. News*, 78, 258, 1906; J. A. McClelland, *Phil. Mag.*, (6), 9, 230, 1905; J. Chadwick, *ib.*, (6), 40, 734, 1920; W. H. Bragg, *Phil. Mag.*, (6), 11, 617, 1906; J. Crowther, *ib.*, (6), 12, 379, 1906; A. S. Russell and F. Soddy, *ib.*, (6), 21, 130, 1911; A. Duvalier, *Compt. Rend.*, 173, 649, 1921; 174, 443, 1922; D. Hurmuzescu, *Eclair. Élect.*, (5), 15, 166, 1898; (5), 16, 314, 1898; *Compt. Rend.*, 127, 422, 1899; *Ann. Scient. Jassy.*, 3, 258, 1905; F. K. Richtmyer, *Phys. Rev.*, (2), 18, 13, 1921; E. H. Kurth, *ib.*, (2), 18, 461, 1921; W. Frese, *Zeit. wiss. Photochem.*, 21, 37, 1921; E. Hjalmar, *Zeit. Physik*, 7, 341, 1921.

²⁷ R. Boyle, *An Essay on the great Effects of even languid and unheeded motion, whereunto is annexed an experimental discourse of some little observed causes of the Insalubrity and Salubrity of the Air, and its Effects*, London, 1685; C. L. Bourdelin, *Mém. Acad.*, 397, 1755; A. S. Marggraf, *Chymische Schriften*, Berlin, 1768; B. Higgins, *Phil. Trans.*, 63, 137, 1773.

²⁸ J. Formanek, *Die qualitative Spektralanalyse anorganischer und organischer Körper*, Berlin, 157, 1905; W. Lanzrath, *Ueber das Bandenspektrum des Kupfers in der Knallgasflamme*, Bonn, 1904; H. Auerbach, *Spektroskopische Untersuchungen über das Verhalten der Metallsalze in Flammen von verschiedener Temperatur*, Berlin, 1907; J. Landauer, *Die Spektralanalyse*, Braunschweig, 1896; M. A. Catalan, *Ann. Soc. Espan. Fis. Quim.*, 15, 432, 1917; J. M. Eder and E. Valenta, *Beiträge zur Photochemie und Spektralanalyse*, Wien, 1904; E. Bauer, *Kurzer Abriss Spektroskopie und Kolormetrie*, Leipzig, 1907; G. A. Hemsalech, *Recherches sur les Spectres d'étincelles*, Paris, 1901; L. de Boisbaudran, *Spectres lumineux*, Paris, 1874; W. M. Watts, *An Introduction to the Study of Spectrum Analysis*, London, 1904 (Figs. 13 and 14 are loaned from this work); C. E. Gissing, *Spark Spectra of the Metals*, London, 1910; J. Landauer, *Die Spektralanalyse*, Braunschweig, 1896; W. N. Hartley, *Journ. Chem. Soc.*, 41, 84, 1882; 83, 227, 1903; *Chem. News*, 58, 304, 1888; *B. A. Rep.*, 127, 1883; *Phil. Trans.*, 105, 161, 1893; *Proc. Roy. Soc.*, 36, 421, 1884; 49, 449, 1891; 79, A, 242, 1907; W. N. Hartley and W. E. Adcney, *ib.*, 35, 148, 1883; W. N. Hartley and H. W. Moss, *ib.*, 87, A, 38, 1912; J. C. McLennan, J. F. T. Young, and H. J. C. Ireton, *ib.*, 98, A, 95, 1920; A. Schuster, *ib.*, 31, 337, 1881; G. D. Liveing and J. Dewar, *ib.*, 28, 471, 1879; 29, 398, 1879; 34, 132, 1882; W. G. Duffield, *ib.*, 81, A, 378, 1908; N. Lockyer and W. C. Roberts-Austen, 23, 344, 1875; B. de la Roche, *Bull. Soc. Chim.*, (4), 25, 305, 1919; N. Lockyer, *ib.*, 70, 31, 1902; *Astrophys. Journ.*, 15, 190, 1902; A. S. King, *ib.*, 27, 353, 1908; R. Derrichswiler, *Zeit. wiss. Phot.*, 4, 401, 1907; F. Schön, *ib.*, 5, 349, 1907; W. Gallenkamp, *ib.*, 5, 299, 1907; P. Kien, *ib.*, 6, 337, 1908; C. Fredenhagen, *Ann. Physik*, (4), 20, 148, 1906; B. Walter, *ib.*, (4), 21, 223, 1906; A. S. King, *ib.*, (4), 16, 373, 1905; H. M. Koenen, *ib.*, (4), 9, 750, 1902; E. Mitscherlich, *Pogg. Ann.*, 121, 459, 1864; E. Cappel, *ib.*, 139, 628, 1870; A. Gouy, *Compt. Rend.*, 84, 231, 1877; 85, 439, 1877; A. de Gramont, *ib.*, 144, 1101, 1907; 118, 594, 1894; J. de Kowalsky and P. B. Huber, *ib.*, 142, 994, 1906; A. Cornu, *ib.*, 73, 332, 1871; L. and E. Bloch, *ib.*, 171, 909, 1920; H. Debray and A. Joannis, *ib.*, 99, 583, 1884; E. Diacon, *ib.*, 56, 653, 1863; *Ann. Chim. Phys.*, (4), 6, 1, 1865; A. Smithells, *Journ. Chem. Soc.*, 61, 223, 1892; *Phil. Mag.*, (5), 39, 127, 1895; G. A. Hemsalech, *ib.*, (6), 40, 296, 1920; J. Trowbridge and W. C. Sabine, *ib.*, (5), 26, 342, 1888; H. Crew and R. Tatnall, *ib.*, (5), 38, 385, 1894; J. M. Eder and E. Valenta, *Denks. Akad. Wien*, 63, 189, 1896; G. Camician, *Sitzber. Akad. Wien*, 76, 499, 1878; F. Exner and E. Haschek, *ib.*, 104, 919, 1895; 105, 396, 1896; J. M. Eder, *ib.*, 102, 1, 1893; C. C. Hutchins, *Amer. Journ. Science*, (3), 37, 474, 1889; W. Ritz, *Phys. Zeit.*, 9, 521, 1908; W. D. Bancroft and H. B. Weiser, *Journ. Phys. Chem.*, 18, 213, 281, 762, 1914; H. Kayser and C. Runge, *Wied. Ann.*, 46, 225, 1892; J. R. Rydberg, *ib.*, 62, 119, 1894; *Astrophys. Journ.*, 6, 239, 1897; *Svensk. Akad. Handb.*, 23, 11, 1890; C. Runge and F. Paschen, *Sitzber. Akad. Berlin*, 380, 1902; W. M. Hicks, *Phil. Mag.*, (6), 38, 1, 301, 1919; (6), 39, 457, 1920; A. S. C. Dunstan and B. A. Wooten, *Astrophys. Journ.*, 54, 65, 1921; M. N. Saha, *Nature*, 107, 682, 1921; R. A. Millikan, *Proc. Nat. Acad. Sciences*, 7, 289, 1921; B. E. Moore, *Astrophys. Journ.*, 54, 246, 1921; W. Huppers, *Zeit. wiss. Photochem.*, 13, 59, 1914; K. Hasbach, *ib.*, 13, 399, 1914; M. Randall, *Astrophys. Journ.*, 34, 1, 1911; J. R. Rydberg, *ib.*, 6, 239, 1897; J. C. McLennan, *Proc. Roy. Soc.*, 98, A, 105, 1920; A. Fowler, *Report on Series in Line Spectra*, London, 109, 1922; F. Handke, *Untersuchungen im Gebiete der Schumann Strahlen*, Berlin, 1909.

²⁹ Anon., *Temperature Coefficients of Conductivity Copper*, London, 1899; E. Lax, *Ueber die Aenderung des Widerstandes in Drähten durch Dehnung*, Berlin, 1919; W. H. Preece, *B. A. Rep.*, 206, 1887; A. Matthiessen, *ib.*, 126, 1863; A. Matthiessen and M. von Bose, *Pogg. Ann.*, 115, 353, 1862; W. Siemens, *ib.*, 110, 18, 1860; C. S. M. Pouillet, *ib.*, 15, 92, 1829; J. Mooser, *Wied. Ann.*, 42, 657, 1891; A. Oberbeck and J. Bergmann, *ib.*, 31, 308, 1887; J. Bergmann, *ib.*, 36, 783, 1889; S. von Wroblewsky, *ib.*, 26, 27, 1885; R. Haas, *ib.*, 52, 673, 1894; L. Lorenz, *ib.*, 13, 422, 582, 1881; G. Kirchhoff and G. Hansmann, *ib.*, 13, 406, 1881; P. Drude, *ib.*, 39, 551, 1890; K. Bäcker, *Ann. Physik*, (4), 22, 749, 1907; L. Grunmach, *ib.*, (4), 22, 141, 1907; L. Holborn, *ib.*, (4), 59, 145, 1919; *Zeit. Physik*, 8, 58, 1921; A. Berget, *Compt. Rend.*, 110, 76, 1890; L. Benoist, *ib.*, 76, 342, 1873; J. Pionchon, *ib.*, 102, 1454, 1886; A. Broca and M. Turchini, *ib.*, 140, 1238, 1905; B. Sabat, *ib.*, 140, 644, 1905; H. le Chatelier, *ib.*, 111, 455, 1890; L. Cailletet and E. Bouty, *ib.*, 100, 1188, 1885; E. Branly, *ib.*, 120, 689, 1895; L. Weiller, *Dingler's Journ.*, 253, 134, 1884;

W. Stahl, *Met.*, 4. 771, 1907; A. Emo, *Atti Ist. Veneto*, (6), 2. 1153, 1884; A. E. Kennelly and E. R. Shepard, *Trans. Amer. Inst. Elect. Eng.*, 26. 969, 1907; F. Larroque, *La lumière électrique*, 31. 161, 1889; W. H. Mordey, *ib.*, 28. 486, 1888; H. le Chatelier, *ib.*, 14. 130, 1884; F. Credner, *Zeit. phys. Chem.*, 82. 457, 1913; E. S. Bardwell, *Trans. Amer. Inst. Min. Eng.*, 49. 753, 1914; A. Sieverts, *Internat. Zeit. Metallg.*, 3. 37, 1912; H. P. Brown, *Eng. Min. Journ.*, 63. 280, 1897; J. O. Arnold and J. Jefferson, *ib.*, 61. 354, 1896; G. W. A. Kahlbaum and E. Sturm, *Zeit. anorg. Chem.*, 46. 217, 1905; W. Guertler, *ib.*, 51. 425, 1906; A. C. Becquerel, *Ann. Chim. Phys.*, (3), 17. 253, 1846; O. D. Chwolson, *Bull. Acad. St. Petersburg*, 23. 465, 1877; 26. 253, 1880; W. H. Johnson, *Chem. News*, 42. 76, 1880; T. Bolton, *Elect. Rev.*, 60. 131, 1907; F. B. Crocker, *Elect. World*, 49. 385, 1907; E. Wartmann, *Arch. Phys. Nat. Genève*, (2), 4. 12, 1859; L. de Marchi, *Nuovo Cimento*, (3), 9. 31, 1881; G. Ercolini, *ib.*, (5), 13. 5, 1907; H. Tomlinson, *Proc. Roy. Soc.*, 26. 401, 1877; Lord Kelvin (W. Thomson), *ib.*, 10. 300, 1860; J. W. Swan and J. Rhodin, *ib.*, 56. 64, 1894; J. Hopps, *Phil. Mag.*, (5), 18. 433, 1884; J. and A. Bidwell, *ib.*, (5), 23. 499, 1887; H. L. Callender, *ib.*, (5), 47. 191, 1899; J. Dewar and J. A. Fleming, *ib.*, (5), 34. 331, 1892; (5), 36. 286, 1893; H. Dickson, *ib.*, (5), 45. 528, 1898; A. L. Williams and J. C. McLennan, *ib.*, (6), 40. 281, 1920; A. Matthiessen, *ib.*, (4), 22. 545, 1861; G. Kamcuský, *ib.*, (5), 17. 270, 1884; L. L. Grunmach and F. Weidert, *Ber. deut. phys. Ges.*, 4. 359, 1906; *Phys. Zeit.*, 7. 729, 1906; G. Nicolai, *ib.*, 9. 367, 1908; *Atti Accad. Lincei*, (5), 16. i, 906, 1907; (5), 16. ii, 185, 1907; E. d'Agostino, *ib.*, (5), 17. i, 531, 1908; E. Weintraub, *Met. Chem. Eng.*, 8. 629, 1910; G. W. O. Howe, *Proc. Roy. Soc.*, 93. A, 468, 1917; S. Lindeck, *Ber. deut. phys. Ges.*, 13. 65, 1911; L. Addicks, *Chem. Met. Eng.*, 22. 449, 1920; *Journ. Franklin Inst.*, 160. 421, 1905; E. F. Northrup, *ib.*, 177. 1, 1914; K. Feussner and S. Lindeck, *Abh. phys. tech. Reichsanst.*, 2. 501, 1895; O. Hesse, *Electrotech. Rund.*, 79, 1885; A. Mousson, *Neue Schweiz. Zeit.*, 14. 37, 1855; P. W. Bridgman, *Proc. Amer. Acad.*, 52. 573, 1917; *Phys. Rev.*, (2), 9. 269, 1917; E. Lisell, *Om tryckets inflytande på det elektriska ledningsmotståndet hos metaller samt en ny metod att mäta höga Tryck*, Upsala, 1902; W. Jäger and H. Diesselhorst, *Phys. Tech. Reichsanst.*, 3. 269, 1900; F. Haber, *Zeit. Elektrochem.*, 9. 390, 1903; W. Hampe, *Chem. Ztg.*, 16. 1726, 1892; G. J. Meyer, *Zur Theorie der Abschmelzsicherungen*, München, 1906; R. Schott, *Ber. deut. phys. Ges.*, 18. 27, 1916; J. H. Dellinger, *Bur. Standards*, 147, 1912; A. Matthiessen and M. Holzmann, *Pogg. Ann.*, 110. 190, 1860; A. L. Fchild, *Met. Chem. Eng.*, 21. 566, 1919.

²⁰ G. Wiedemann and R. Franz, *Pogg. Ann.*, 89. 489, 1853; G. Wiedemann, *ib.*, 95. 337, 1855; 108. 405, 1859; P. G. Tait, *Trans. Roy. Soc. Edin.*, 28. 717, 1878; G. Forbes, *Proc. Roy. Soc. Edin.*, 1. 133, 1860; F. C. Achard, *Sammlung physikalischer und chemischer Abhandlung*, Berlin, 1784; F. E. Neumann, *Ann. Chim. Phys.*, (3), 66. 183, 1862; F. A. Schulze, *Wied. Ann.*, 63. 23, 1897; W. Jäger and H. Diesselhorst, *Ber.*, 38. 719, 1899; E. Grüneisen, *Ann. Physik*, (4), 3. 43, 1900; G. Kirchhoff and G. Hausemann, *Wied. Ann.*, 13. 417, 1881; L. Lorenz, *Pogg. Ann.*, 147. 429, 1872; *Wied. Ann.*, 13. 422, 1881; F. Kohlrausch, *ib.*, 33. 678, 1888; *Ber.*, 38. 711, 1899; *Ann. Physik*, (4), 1. 195, 1900; C. H. Lees, *Phil. Trans.*, 208. A, 381, 1908; Lord Rayleigh, *Nature*, 54. 154, 1896; C. Roberts, *Phil. Mag.*, (5), 8. 551, 1879; A. Rietzsch, *Ann. Physik*, (4), 3. 403, 1900; A. L. Bernoulli, *Zeit. Elektrochem.*, 15. 647, 1909; A. W. Porter and F. Simeon, *Proc. Phys. Soc.*, London, 27. 307, 1915; E. F. Northrup and F. R. Pratt, *Journ. Franklin Inst.*, 184. 675, 1917; N. R. Campbell, *Modern Electrical Theory*, Cambridge, 68, 1913; R. Schott, *Ber. deut. phys. Ges.*, 18. 27, 1916; G. Hardebeck, *Ueber das Verhalten einiger Legierungen zum Gesetze von Wiedemann und Franz*, Aachen, 1909.

²¹ H. Davy, *Phil. Trans.*, 116. 408, 1826; A. Walker, *Pogg. Ann.*, 4. 324, 1825; O. Henrici, *ib.*, 55. 258, 1842; 79. 569, 1850; H. Schröder, *ib.*, 54. 57, 1841; G. T. Fechner, *ib.*, 47. 14, 1839; P. S. Munck, *ib.*, 47. 418, 1839; B. W. Gerland, *ib.*, 133. 513, 1868; *Wied. Ann.*, 18. 357, 1883; W. Hankel, *ib.*, 1. 402, 1877; G. de Overbeck, *ib.*, 31. 337, 1887; G. Wetzlar, *Schweigger's Journ.*, 58. 302, 1830; H. C. Oersted, *ib.*, 33. 163, 1821; S. Marianini, *ib.*, 49. 43, 1827; *Ann. Chim. Phys.*, (2), 33. 113, 1826; (2), 45. 43, 121, 1830; H. Rigollot, *ib.*, (6), 22. 567, 1891; A. C. Becquerel, *ib.*, (2), 23. 135, 1823; W. Meissner, *Ver. deut. phys. Ges.*, 16. 262, 1914; A. Gouy and H. Rigollot, *Compt. Rend.*, 106. 1470, 1888; H. Pellat, *ib.*, 89. 227, 1879; M. Krouschkoll, *ib.*, 104. 1436, 1887; J. M. Gaugain, *ib.*, 69. 1302, 1869; F. W. Martini, *Riv. Sc. Ind.*, 23. 135, 1891; A. Pacinotti, *Nuovo Cimento*, 18. 373, 1863; W. Ostwald, *Zeit. phys. Chem.*, 1. 583, 1887; W. Ramsay and J. F. Spencer, *Phil. Mag.*, (6), 12. 397, 1906; E. Abel, *Zeit. anorg. Chem.*, 26. 413, 1901; H. Buff, *Liebigs Ann.*, 42. 5, 1842; 45. 137, 1843; R. B. Clifton, *Proc. Roy. Soc.*, 26. 299, 1877; J. C. Poggendorff, *Pog. Ann.*, 50. 263, 1840; 66. 597, 1845; W. Skey, *Chem. News*, 35. 224, 1877.

²² G. Bodländer, *Zeit. Elektrochem.*, 7. 159, 1900; S. Labendzinsky, *ib.*, 10. 77, 1904; F. Spitzer, *ib.*, 11. 350, 1905; A. Fischer, *ib.*, 13. 470, 1907; G. Carrara and L. d'Agostini, *ib.*, 11. 386, 1905; *Gazz. Chim. Ital.*, 35. i, 132, 1905; G. Bodländer and O. Storbeck, *Zeit. anorg. Chem.*, 31. 468, 1902; C. Immerwahr, *ib.*, 24. 269, 1900; F. Kunschert, *ib.*, 41. 372, 1904; R. Luther, *Zeit. phys. Chem.*, 34. 488, 1900; 36. 385, 1901; N. T. M. Wilshire, *ib.*, 35. 296, 1900; 36. 92, 1901; W. Ostwald, *ib.*, 11. 305, 1893; E. Cohen, F. D. Chattaway, and W. Tombrock, *ib.*, 60. 706, 1907; B. Neumann, *ib.*, 14. 193, 1894; M. le Blanc, *ib.*, 12. 345, 1893; F. Fischer, *ib.*, 52. 55, 1905; E. Abel, *ib.*, 37. 623, 1901; F. Exner, *Sitzber. Akad. Wien*, 103. 856, 1894; F. Exner and J. Tuma, *ib.*, 97. 917, 1888; *Monatsh.*, 9. 903, 1888; F. Exner, *ib.*, 12. 276, 1891; J. Miesler, *ib.*, 8. 626, 1887; *Sitzber. Akad. Wien*, 95. 642, 1887; 96. 183, 983, 1321, 1888; W. E. Ayrlton and J. Perry, *Phil. Trans.*, 171. 1, 1880; *Proc. Roy. Soc.*, 27. 196, 1878; G. Thompson, *ib.*, 42. 387, 1887; F. Paschen, *Wied. Ann.*, 41. 117, 1890; 43. 568, 1891; F. Braun, *ib.*, 41. 448, 1890;

G. Magnanini, *Gazz. Chim. Ital.*, 20. 308, 1890; *Atti Accad. Lincei*, (4), 6. 182, 1890; A. Voller, *Pogg. Ann.*, 149. 394, 1873; J. C. Poggendorff, *ib.*, 50. 263, 1840; 66. 597, 1845; H. Pellat, *ib.*, 108. 667, 1889; *Séances Soc. Phys. Franç.*, 187, 1890; *Journ. Phys.*, (2), 7. 557, 1888; G. G. de Villemonté, *ib.*, (2), 10. 76, 1891; E. Bouty, *ib.*, (2), 9. 229, 1890; *Compt. Rend.*, 90. 917, 1880; A. Gockel, *Wied. Ann.*, 24. 618, 1885; A. von Oettingen, *Journ. Chem. Met. Soc. S. Africa*, 2. 9, 1899; S. B. Christy, *Trans. Amer. Inst. Min. Eng.*, 27. 354, 1902; *Amer. Chem. Journ.*, 37. 345, 1902; L. W. Ohlms, *Medd. Vet. Nobelinst.*, 5. 4, 1919; F. Jirsa, *Zeit. Elektrochem.*, 27. 30, 1921; G. N. Lewis and W. N. Lacey, *Journ. Amer. Chem. Soc.*, 36. 804, 1914; P. Chroustchoff and A. Sitnikoff, *Compt. Rend.*, 108. 937, 1889; G. Coffetti and F. Förster, *Ber.*, 38. 2939, 1905; L. Kahlenberg, *Journ. Phys. Chem.*, 3. 379, 1899; J. Brown, *Electrician*, 29. 305, 1892; N. P. Kazankin, *Journ. Russ. Phys. Chem. Soc.*, 27. 276, 1895; A. J. Allmand, *Journ. Chem. Soc.*, 95. 2151, 1909; J. L. Hoorweg, *Wied. Ann.*, 9. 562, 577, 1880; 11. 133, 1880; J. H. Gladstone and A. Tribe, *Phil. Mag.*, (4), 49. 425, 1875; (5), 11. 508, 1881; U. Sborgi and A. Donati, *Nuovo Cimento*, (6), 21. 211, 1921; N. R. Dhar, *Zeit. anorg. Chem.*, 118. 75, 1921.

³³ G. Bodländer, *Zeit. Elektrochem.*, 7. 159, 1907; R. Abegg, *ib.*, 9. 569, 1903; R. Luther, *Zeit. phys. Chem.*, 34. 488, 1900; 36. 385, 1901; W. Ostwald, *ib.*, 11. 507, 1893; *Grundriss der allgemeinen Chemie*, Leipzig, 281, 1899; H. Jahn, *Grundriss der Elektrochemie*, Wien, 1905; J. Traube, *Zeit. anorg. Chem.*, 8. 23, 1895; G. Bodländer and O. Storbeck, *ib.*, 31. 1, 458, 1902; A. Cohn and Y. Osaka, *ib.*, 34. 90, 1903; E. Abel, *ib.*, 26. 261, 1901; W. R. Bousfield and T. M. Lowry, *Trans. Faraday Soc.*, 3. 133, 1907; W. Vaubel, *Journ. prakt. Chem.*, (2), 55. 542, 1897; F. Jirsa, *Chem. Listy*, 14. 8, 33, 1920; *Zeit. Elektrochem.*, 27. 30, 1921; S. Labendzinsky, *ib.*, 10. 77, 1904; V. Kohlschütter and H. Stäger, *Helvetica Chem. Acta*, 4. 821, 1921; W. P. Davey, *Phys. Rev.*, (2), 19. 248, 1922.

³⁴ A. Volta, *Gilbert's Ann.*, 10. 421, 1802; J. W. Ritter, *ib.*, 16. 293, 1804; C. H. Pfaff, *Gehlen's Journ.*, 5. 95, 1808; *Pogg. Ann.*, 51. 209, 1840; J. C. Poggendorff, *ib.*, 50. 263, 1840; 66. 597, 1845; 70. 60, 1847; O. Henrici, *ib.*, 79. 570, 1850; F. Kohlrausch, *ib.*, 88. 472, 1853; B. W. Gerland, *ib.*, 133. 513, 1868; W. Hankel, *ib.*, 115. 57, 1862; 126. 286, 1865; *Sächs. Ber.*, 6. 1, 1864; 7. 385, 1865; 11. 671, 1865; A. MacFarlane, *Proc. Roy. Soc. Edin.*, 13. 412, 1884; J. B. Biot, *Ann. Chim. Phys.*, (1), 47. 5, 1804; A. de la Rive, (2), 37. 225, 1828; B. C. Damien, *ib.*, (6), 5. 289, 1885; J. and A. Bidwell, *Phil. Mag.*, (5), 20. 328, 1885; J. Trowbridge and E. K. Stevens, *ib.*, (5), 16. 435, 1883; J. H. Gladstone and A. Tribe, *ib.*, (5), 11. 508, 1881; C. R. Wright, *ib.*, (5), 14. 188, 1882; C. R. A. Wright and C. Thompson, (5), 19. 17, 209, 1885; J. Brown, (5), 7. 109, 1879; *Proc. Roy. Soc.*, 41. 294, 1887; R. B. Clifton, *ib.*, 26. 299, 1877; S. P. Thompson, *ib.*, 45. 387, 1887; G. T. Fechner, *Schweigger's Journ.*, 53. 61, 131, 1828; J. C. K. Schrader, *ib.*, 33. 22, 1821; W. Wolf, *Ueber Sauerstoffzellen*, Freiburg, 1888; F. Streintz, *Sitzber. Akad. Wien*, 103. 98, 1894; F. Exner and J. Tuma, *ib.*, 97. 917, 1888; F. Exner, *ib.*, 80. 1879, 1880; 84. 511, 1881; *Wied. Ann.*, 9. 591, 1880; 15. 412, 1881; W. Hallwachs, *ib.*, 29. 10, 1586; C. Fromme, *ib.*, 12. 399, 1881; T. Erhard, *ib.*, 14. 504, 1881; V. Fuchs, *ib.*, 11. 795, 1880; J. L. Hoorweg, *ib.*, 11. 133, 1880; H. Pellat, *Journ. Phys.*, (1), 10. 68, 1881; *Compt. Rend.*, 90. 990, 1880; *Différence de potentiel des couches électriques qui recouvrent deux métaux au contact*, Paris, 1881; W. E. Ayrton and J. Perry, *Proc. Roy. Soc.*, 27. 222, 1878; *Phil. Trans.*, 171. 1, 1880; M. Faraday, *ib.*, 123. 675, 1833; G. Carrara and L. d'Agostini, *Gazz. Chim. Ital.*, 35. 1, 132, 1905; G. C. Simpson, *Phys. Zeit.*, 4. 480, 1903; B. Gaede, *Ann. Phys.*, (4), 14. 641, 1904; H. Greinacher, *ib.*, (4), 16. 708, 1905; H. Götz and A. Kurz, *Electrotch. Zeit.*, 11. 30, 1890; W. Skey, *Chem. News*, 35. 224, 1877; T. Andrews, *Zeit. Elektrochem.*, 3. 118, 1896; F. M. G. Johnson and N. T. M. Wilmrose, *Trans. Faraday Soc.*, 3. 70, 1907; A. Naccari and M. Bellati, *Nuovo Cimento*, (2), 11. 120, 1874; C. Hockin and H. A. Taylor, *Tel. Eng. Journ.*, 8. 282, 1879; E. Branly, *Ann. École Norm.*, (2), 2. 228, 1873; E. Cohen, F. D. Chattaway, and W. Tombrock, *Zeit. phys. Chem.*, 60. 706, 1907; Mc. A. Johnson, *Trans. Amer. Electrochem. Soc.*, 3. 92, 1903; C. J. Reed, *ib.*, 3. 92, 1903; G. McP. Smith, *Journ. Amer. Chem. Soc.*, 27. 540, 1905; S. Kyropoulos, *Zeit. anorg. Chem.*, 114. 157, 1920; G. Trümpler, *Zeit. phys. Chem.*, 99. 9, 1921.

³⁵ J. H. Gladstone and A. Tribe, *Proc. Roy. Soc.*, 20. 218, 1872; *Journ. Chem. Soc.*, 26. 445, 678, 961, 1873; 27. 208, 406, 410, 415, 615, 1874; 28. 508, 1875; 31. 561, 1877; 33. 139, 306, 1878; T. E. Thorpe, *ib.*, 26. 541, 1873; H. Eccles, *ib.*, 29. 856, 1876.

³⁶ W. R. Grove, *Phil. Mag.*, (3), 15. 292, 1840; *Arch. l'Électr.*, 4. 167, 1844; G. Planté, *Recherches sur l'électricité*, Paris, 1883; H. Buff, *Liebig's Ann.*, 85. 13, 1853; 102. 270, 1857; E. Wohlwill, *Zeit. Elektrochem.*, 9. 311, 1903; F. Förster, *ib.*, 3. 479, 1897; 5. 510, 1899; F. Fischer, *ib.*, 9. 507, 1903; 10. 421, 1904; *Zeit. phys. Chem.*, 48. 177, 1904; F. Förster and O. Seidcl, *Zeit. anorg. Chem.*, 14. 106, 1897; K. R. Koch and A. Willner, *Wied. Ann.*, 45. 793, 1892; W. Holtz, *Phys. Zeit.*, 6. 481, 1905; L. H. Adams and J. Johnston, *Amer. Journ. Science*, (4), 33. 534, 1912; R. B. Sosman, *ib.*, (4), 30. 1, 1910; W. G. Duffield, T. H. Burnham, and A. H. Davis, *Proc. Roy. Soc.*, 97. A, 326, 1920.

³⁷ A. Seebeck, *Pogg. Ann.*, 6. 133, 253, 1826; *Sitzber. Akad. Berlin*, 265, 1823; *Gilbert's Ann.*, 73. 115, 430, 1823; J. C. von Yelin, *ib.*, 73. 415, 1823; A. van Beek, *ib.*, 73. 435, 1823; E. Lecher, *Sitzber. Akad. Wien*, 114. 1, 1905.

³⁸ J. Stefan, *Pogg. Ann.*, 124. 633, 1865; K. Noll, *Wied. Ann.*, 53. 874, 1894; J. Dewar and J. A. Fleming, *Phil. Mag.*, (5), 40. 95, 1895; W. H. Steele, *ib.*, (5), 37. 218, 1894; A. Heil, *Zeit. Elektrochem.*, 9. 92, 1903; P. W. Bridgman, *Proc. Amer. Acad.*, 53. 269, 1918; E. Wagner, *Ann. Physik*, (4), 27. 955, 1908; A. Ebeling, *Wied. Ann.*, 30. 530, 1887; H. Jahn, *ib.*, 34. 755,

1888; *Sitzber. Akad. Wien*, 97. 546, 1888; F. Rziha, *ib.*, 116. 715, 1907; E. Lecher, *ib.*, 114. 1599, 1905; *Phys. Zeit.*, 7. 34, 1906; *Ann. Physik*, (4), 19. 853, 1906; P. Czermak, *ib.*, (4), 24. 351, 1907; E. Sedström, *ib.*, (4), 59. 134, 1919; J. Monckman, *Proc. Roy. Soc.*, 44. 220, 1888; G. Gore, *ib.*, 19. 324, 1871; A. Martens, *Dingler's Journ.*, 250. 515, 1883; W. W. Coblenz, *Bull. Bur. Standards*, 6. 107, 1909; W. Jäger and H. Diesselhorst, *Abh. phys. tech. Reichsanst.*, 3. 269, 1900; F. F. le Roux, *Compt. Rend.*, 99. 842, 1884; H. Péchaux, *ib.*, 139. 1202, 1904; E. Bouty, *ib.*, 90. 917, 1880; A. Peltier, *ib.*, 6. 303, 1838; G. Reichard, *Ann. Phys. Chem.*, (4), 6. 832, 1901; F. G. Wick, *Phys. Rev.*, (1), 25. 382, 1907; J. Johnston and L. H. Adams, *Amer. Journ. Science*, (4), 31. 510, 1911; R. B. Sosman, *ib.*, (4), 30. 1, 1910; W. G. Duffield, T. H. Burnham, and A. H. Davis, *Proc. Roy. Soc.*, 97. A. 326, 1920; G. Borelius and G. Gunnesson, *Ann. Physik*, (4), 65. 520, 1921; A. Cöhn and A. Lotz, *Zeit. Physik*, 5. 242, 1921.

³⁹ E. H. Hall, *Amer. Journ. Math.*, 2. 287, 1879; *Amer. Journ. Science*, (3), 20. 52, 161, 1880; (3), 29. 117, 1885; (3), 36. 131, 277, 1888; *Phil. Mag.*, (5), 10. 136, 1880; (5), 12. 257, 1881; (5), 15. 341, 1883; A. von Ettinghausen and W. Nernst, *Sitzber. Akad. Wien*, 94. 500, 1886; A. von Ettinghausen, *ib.*, 94. 808, 1886; A. Leduc, *Compt. Rend.*, 102. 358, 1886; F. Unwin, *Proc. Roy. Soc. Edin.*, 34. 208, 1914; H. Zahn, *Ann. Physik*, (4), 14. 886, 1904.

⁴⁰ M. Faraday, *Phil. Trans.*, 136. 41, 1846; T. Carnelley, *Phil. Mag.*, (5), 8. 461, 1879; J. Königsberger, *Wied. Ann.*, 66. 698, 1898; *Ann. Physik*, (4), 6. 506, 1901; M. Owen, *ib.*, (4), 37. 657, 1912; K. Honda, *ib.*, (4), 32. 1027, 1910; S. Meyer, (4), 1. 664, 1901; *Wied. Ann.*, 68. 325, 1899; 69. 236, 1899; K. Noll, *ib.*, 53. 874, 1894; O. C. Clifford, *Phys. Rev.*, (2), 26. 424, 1908; J. G. Gray and A. D. Ross, *Phys. Zeit.*, 10. 59, 1909; F. Behnsen, *ib.*, 12. 1157, 1911; G. Chéneveau, *Journ. Phys.*, 9. 163, 1901; A. R. S. Trève, *Compt. Rend.*, 90. 35, 1880; C. Maurain, *Ann. Chim. Phys.*, (7), 14. 227, 1898; O. Urbasch, *Zeit. Elektrochem.*, 7. 114, 1902.

⁴¹ A. Günther-Schulze, *Ann. Physik*, (4), 21. 929, 1906; (4), 22. 543, 1907; (4), 23. 226, 1907; (4), 24. 43, 1907; (4), 25. 775, 1908; (4), 26. 372, 1908; (4), 28. 787, 1909; (4), 31. 1053, 1910; (4), 34. 657, 1911; (4), 41. 593, 1913; (4), 44. 1106, 1914; (4), 65. 223, 1921; *Zeit. Elektrochem.*, 14. 333, 1908; 17. 510, 1911; 18. 22, 326, 1912; 19. 122, 1913; 20. 307, 592, 1914.

⁴² V. L. Chrissler, *Astrophys. Journ.*, 54. 273, 1921.

§ 6. The Chemical Properties of Copper

According to R. Fink,¹ the affinity of copper for oxygen is greater than that of magnesium, manganese, zinc, cobalt, or nickel. While purified electrolytic copper has no catalytic activity on certain reactions—say, $C_2H_5OH = H_2 + CH_3CHO$ —copper prepared by reducing the oxide is active. The activity was found by W. G. Palmer to be greater the lower the temp. of reduction; and it also depends on the reducing agent. The difference may be due (i) to the presence of an oxide in solid soln. in the copper; (ii) to the presence of one or more labile forms of copper which slowly pass into a stable inactive form; or (iii) to different degrees of fineness of the particles. Copper is so readily attacked by various reagents that the old alchemists called it *meretrix metallorum*—the harlot among metals.

P. A. von Bonsdorff showed that the surface of a piece of copper does not oxidize at ordinary temp. in dry air, or even in moist air unless carbon dioxide be present. According to C. R. A. Wright and A. P. Luff, copper obtained by the reduction of cupric oxide by carbon monoxide at 100° is *pyrophoric*; and J. J. Berzelius found that copper reduced by hydrogen below a red-heat is readily transformed into cuprous oxide under conditions where the metal reduced at a red-heat in hydrogen is stable. A. Smits, A. Kettner, and A. L. W. Gee believe that the pyrophoric condition of a metal is not only due to the fine state of subdivision, but also to the initial formation of the metal in a metastable state; the metal loses its pyrophoric character when heated.

C. R. A. Wright and A. E. Menke observed that no change occurs when the metal is heated in air for many hours at 100°; at 130° a slight action was noticed after two hours; and at higher temp., the action was more vigorous. According to H. Debray and A. Joannis, copper begins to oxidize at about 350° when the vap. press. of cupric oxide, CuO , is about 0.2 atm.; at about 500°, finely-divided copper forms cuprous oxide, Cu_2O . According to F. Enich, finely-divided copper and wire-gauze are rapidly and quantitatively converted into cuprous oxide at 500°; while E. F. Anthon found that when copper plate is heated in a muffle to bright redness,

cuprous oxide is the main product so long as any metal is present, after that a larger proportion of cupric oxide appears. Copper burns with a blue flame when heated to a high temp., and cupric oxide is formed as *flores cupri* or *flowers of copper*.

According to R. Schwirkus, and F. von Leichtenstein, when the temp. of a piece of copper is gradually raised to redness, the surface of the metal appears to acquire a brownish-orange colour at about 200°, and it then passes through a gradation of colours—rose-red, violet, steel-blue, brass-yellow, red, greenish-grey, grey, and finally black. The red coloration is probably due to the formation of cuprous oxide, the black to cupric oxide, so that the surface of a plate of copper, after heating to redness in air, is covered with a film of cupric oxide, CuO , and below this is a layer of cuprous oxide, Cu_2O . If the hot metal be now quenched in water, the oxide falls off in scales furnishing the so-called *scale copper oxide*. L. Maumené assumed a series of intermediate oxides are formed, but this is probably wrong. W. Elkan obtained what he called a *red patina* by polishing the outer black film so as to leave the red exposed. Some of the oxidation colours are produced as a special effect on ornamental vessels, although usually the metals are coloured by “pickling” in suitable reagents as described in G. Buchner's *Die Metallfärbung* (Berlin, 1910) and other special works—*vide infra* for patina effects.

W. J. Russell and A. Matthiessen² detected no absorption of gas when oxygen is passed into molten copper, but W. Stahl found that an absorption of gas does occur, and E. Heyn further showed that cuprous oxide is formed and dissolved by the molten metal. When copper is heated in oxygen gas, the results resemble those obtained with air. C. H. Mathewson and G. V. Cæsar have studied the action of cuprous oxide on copper. In manufacturing commercial copper, a little oxygen is allowed to remain combined with the metal in order that it may retain the desirable qualities of malleability and ductility, and in order to prevent the spitting or spewing of the metal during the cooling of a casting. The ease with which copper takes up oxygen during the smelting renders “poling” necessary until the small amount of oxygen required to produce tough pitch copper remains. This oxygen is present as cuprous oxide in all copper not specially deoxidized, and it forms a matrix around the primary grains of copper. According to F. Dezeine, the difference in the chemical reactions of colloidal and compact copper with acids and salt soln. in which copper ions or basic copper precipitates are formed without evidence of any reducing action, may be explained by the action of the dissolved oxygen on the very extensive surface of copper. W. Manchot showed that copper reacts with **ozone** at a temp. rather lower than that at which it reacts with oxygen. According to A. Berliner, finely divided copper begins to act catalytically on electrolytic gas at about 280°; and according to M. Traube, finely divided copper acts catalytically on **hydrogen peroxide** without forming cupric hydroxide as supposed by F. Cintolesi.

According to E. Mitscherlich,³ when copper is melted in air, comparatively large crystals of cuprous oxide are sometimes formed. The cuprous oxide formed on the surface of molten copper is immediately dissolved, but it is rejected as the metal solidifies; as a result, a polished surface of the metal, when magnified, shows the presence of this oxide. According to S. Lucas, as the metal, which has been melted while exposed to the air, solidifies, some oxygen may escape and make the metal porous, or the gas may force its way through the skin of solid which first forms on the surface, and produce a kind of spitting or spewing—*das Spritzen oder Spratzen des Kupfers*. L. W. Gilbert records the projection of particles of copper to a height of 8 ins. during the spitting. C. M. Marx stated that a hissing noise attends the escape of gases from spitting copper. The spitting produces the so-called *blister copper*—*Blasenkupfer*. Copper which spits after refining is brittle owing to the presence of cuprous oxide, whereas that which does not spit is ductile. E. Abel found that if copper be melted in a graphite crucible and allowed to cool while exposed to the air, spitting occurs just before the metal solidifies. H. Caron melted the metal in glazed porcelain crucibles in an atm. of hydrogen or carbon monoxide, and noticed

that the cooling liquid remains at rest until, just before solidification, it sets up internal movements as the evolution of gas begins. Some carbon dioxide was present in the evolved gases; it was formed by the oxidation of carbon monoxide during the reduction of the dissolved cuprous oxide. It is doubtful if the gas which escapes from the solidifying metal is really oxygen as S. Lucas, O. L. Erdmann and R. F. Marchand, and T. Scheerer supposed; W. J. Russell and A. Matthiessen say the gas is a mixture of carbon monoxide and sulphur dioxide. T. Graham extracted both hydrogen and carbon monoxide by heating copper in vacuo; M. Guichard says that the gas so extracted is mainly carbon dioxide. A. Caron, S. Stein, W. Stahl and W. Hampe also attribute the spitting to the escape of these gases. T. R. Merton proposed to utilize the ready absorption of gases by finely-divided copper to produce high vacua.

According to W. Hampe, spongy copper does not adsorb hydrogen at ordinary temp.; but, according to A. Sieverts, copper prepared by reducing the oxide at a red-heat in a stream of hydrogen, contains 0.79 to 0.49 vol. of hydrogen, and there are no signs of the formation of a hydride. H. Meslens showed that the hydrogen absorbed by spongy copper reduced from the oxide affects the weight of the metal to the extent of about 3 parts in 100,000, or 0.0029 gm. of hydrogen (at a red-heat) per 100 grms. of metal reduced from oxide; and in another experiment (at 175°) he obtained 0.0200 gm. of hydrogen. T. Graham obtained 0.0006 gm. of hydrogen per 100 grms. of reduced oxide; 0.0003 gm. per 100 grms. of wire; G. S. Johnson, 0.0074 gm. for rolled wire; and O. Leitzenmeyer 0.0061 for wire-gauze. Otherwise expressed, H. Meslens, and O. L. Erdmann and R. F. Marchand found 3 vols. of hydrogen were occluded by copper at a red-heat; T. Graham, 0.6 vol.; G. Neumann and F. Streintz, 4.81 vols.; C. P. Baxter, 1.4 to 2.1 vols.; A. Leduc, 1.8 vols.; G. S. Johnson, 1.2 to 3 vols.; and O. Leitzenmeyer, 5 to 6 vols. The older reports of the amount of hydrogen occluded or adsorbed by copper are stated by A. Sieverts to be too high in consequence of inadequate methods of analysis. According to A. Sieverts, a piece of copper wire begins to adsorb hydrogen at 400°, the amount adsorbed increases with temp. E. Jurisch found the amounts of hydrogen absorbed—expressed in mgrms. per 100 grms. of copper—to be

Temp.	416°	518°	620°	724°	827°	930°	981°	1033°
Gas absorbed .	0.006	0.016	0.030	0.048	0.072	0.108	0.132	0.159

vol. of gas per vol. of copper; and the metal retains 0.05 vol. on cooling. A. Sieverts found that the hydrogen adsorbed between 20° and 920°, and atm. press., has scarcely any effect on the electrical conductivity. R. Lenz found that electrolytic copper contained the eq. of 3.4 vols. of hydrogen; 0.37 vol. of carbon monoxide; carbon eq. to 0.49 vol. of carbon dioxide; and 1.14 vols. of water vapour per volume of copper. The metal is supposed to have been cooled in an atm. of hydrogen. According to J. L. W. Thudichum and H. W. Hake, new wire adsorbs six times as much hydrogen as wire which has been re-oxidized and re-reduced. G. S. Johnson pointed out the importance of the adsorption of hydrogen by the copper wire used in organic analyses. The occluded hydrogen is given off when heated in vacuo. J. L. W. Thudichum and H. W. Hake say that the hydrogen can be completely expelled by carbon dioxide, but G. Neumann says that this is not the case at 220°; and A. Leduc found that the hydrogen is not expelled by passing air over the red-hot metal. E. Heyn found that the sp. gr. of the metal, heated in hydrogen at 600°, falls from 8.9 to 8.4, and L. Archbutt also found that an expansion of the metal occurs during the adsorption of hydrogen. According to W. E. Ruder, the brittleness due to the so-called *burning* of copper, and the alleged expansion of the metal during the adsorption of hydrogen or reducing gases, is essentially due to the reduction of cuprous oxide about the primary grains of metal (solid) leaving a more or less spongy mass of little mechanical strength. The brittleness begins to appear with dry hydrogen at about 400°, at 600° in wet hydrogen, at 800° in carbon monoxide, and at 700° in steam. Copper, completely deoxidized while fused,

remains unaffected by the reduction. N. B. Pilling also showed that the deterioration in the mechanical strength of copper which contains disseminated oxide, and which has been exposed to reducing gases, is due to a reaction with the cuprous oxide which is attended by the formation of steam at a press. great enough to cause lack of mechanical cohesion in the puffed copper. At 700° , the rates of diffusion of hydrogen, steam, carbon monoxide, and carbon dioxide in copper, were respectively as 1000, 65, 17, and 0.6. The diffusion with hydrogen was considerable between 400° and 500° . W. C. Hothersall and E. L. Rhead found evidence that solid copper retains a little hydrogen permanently in soln., and studied the effect of occluded hydrogen on the casting of molten copper; H. Moore and S. Beckinsale, W. C. Hothersall and E. L. Rhead, and N. B. Pilling investigated the action of reducing gases; and G. Tammann, the evolution of gas during the annealing or recrystallization of copper. H. S. Taylor and R. M. Burns studied the absorption of hydrogen, carbon dioxide and monoxide, and ethylene by finely divided copper.

E. G. Bartlett and W. Merrill⁴ obtained what they supposed to be a cupric hydride, CuH_2 , by passing hydrogen over heated cupric oxide until the weight is constant. A. Leduc reported the formation of *copper hydride* by passing a stream of hydrogen for about two hours over a quantity of copper, contained in a combustion tube, heated to cherry-redness at the middle and to 300° at the ends, a solid of a hyacinth-red colour was formed at those parts which had reached, but not exceeded, dull redness, and when these parts were subsequently heated to bright redness in a stream of carbonic anhydride, the escaping gas was found to contain hydrogen, together with a little carbon monoxide. He argued that a definite compound is formed because the dissociation press. of hydrogen in copper attains a definite lower limit—between 0.5 and 0.8 mm. of mercury—but A. Sieverts and W. Krumbhaar show that the alleged hydride probably does not exist, but a solid soln. is formed; but A. Sieverts did obtain what he regarded as **cuprous hydride**, CuH , by the action of sodium hypophosphite on cuprous chloride. W. K. J. Schoor also believed that a copper hydride is formed when a soln. of cupric sulphate acidified with sulphuric acid is treated with zinc, and, according to F. Mylius and O. Fromm, a copper-zinc alloy is precipitated as a black amorphous powder. The black powder—*black copper*—obtained by J. C. Pogendorff, H. Buff, C. Ullmann, and M. Colletas in the electrolysis of a dil. 7 per cent. soln. cupric sulphate, with 10 per cent. of free sulphuric acid with copper electrodes at 2.5 to 3.5 volts, and current density over unity, was shown by A. Soret to contain an amount of occluded hydrogen dependent on the temp. and acidity of the soln. F. Mylius and O. Fromm found that the black product has only a few vols. of occluded hydrogen. F. Förster and O. Seidel, and F. Mylius and O. Fromm believe the so-called black copper to be a kind of hydrogen alloy. The electrolysis of a very dil., slightly acid, $\frac{1}{20}N$ -soln. of copper sulphate with a high current density at the cathode furnishes a deposit of black copper if the soln. be not stirred, and of red copper if the soln. be stirred. With a $\frac{1}{100}N$ -soln. as electrolyte, the black deposit is obtained in either case. The electrolysis of a $\frac{1}{100}N$ -soln. of copper nitrate also furnishes black copper, but if ammonium nitrate is added to the electrolyte, red copper is deposited, and hydrogen is evolved.

So far there is no adequate evidence of the formation of a definite copper hydride. A. Wurtz, however, treated an aq. soln. of cupric sulphate below 70° with hypophosphorous acid, and obtained a yellow precipitate which soon changed to a reddish-brown colour. The experiment has been repeated by F. Mawrow and W. Muthmann, C. F. Rammelsberg, and H. Rose. D. Vorländer and F. Meyer recommend adding 100 grms. of sodium hypophosphite, NaH_2PO_2 , in 310 grms. of sulphuric acid of sp. gr. 1.13 to a soln. of 75 grms. of crystallized cupric sulphate in 300 c.c. of water. If an excess of hypophosphorous acid is used, some copper remains in soln. E. A. van der Burg said the precipitate contains some copper, and copper phosphate, and develops less hydrogen than corresponds with CuH . A. Wurtz's analyses gave 1.22 per cent. of hydrogen, whereas the theoretical value

for CuH is 1.55 per cent. E. J. Bartlett and W. Merrill claim that *cupric hydride*, CuH_2 , is the product of the action of hypophosphorous acid or of the hypophosphites on cupric sulphate or oxide. M. Berthelot has stated that the alleged hydride is formed with an absorption of heat, and always contains water, phosphorus, and oxygen, probably present as a very basic cuprous phosphate. P. Schützenberger claimed that hyposulphurous acid and its salts precipitate cuprous hydride admixed with metal from soln. of cupric sulphate, but J. Meyer and O. Brunck could not obtain satisfactory evidence of the formation of the alleged hydride on repeating P. Schützenberger's experiments.

R. Nasini and F. Anderlini say that the hydrogen line is not present in the spark spectrum or the oxyhydrogen flame spectrum of copper hydride. A. Wurtz found that his product in moist air readily forms yellow cupric hydroxide, and in dry air it blackens in about a day. According to H. Moissan, fluorine in the cold gives a green flame with copper hydride, and forms a black mass; it was also found by A. Wurtz to inflame in chlorine and bromine. W. K. J. Schoor found that it develops hydrogen when treated with water, and more energetically when treated with hydrochloric acid; O. Brunck found that sulphurous acid decomposes the product with the evolution of gas. J. H. Gladstone and A. Tribe found it converts chlorates into chlorides, and nitrates into nitrites and ammonia; and ferricyanides to ferrocyanides. According to E. J. Bartlett and W. Merrill, arsenic trioxide is not changed, but if a drop of hypophosphorous acid is added, arsine is developed. D. Vorländer and F. Meyer, and L. Chiozza have studied the reduction of organic compounds by the alleged copper hydride; A. A. Pollitt, the hydrogenation of oils with copper as the catalytic agent. F. Mylius and O. Fromm say that copper hydride dissolves rapidly in a soln. of potassium cyanide with the evolution of hydrogen; with a soln. of cupric sulphate it slowly forms sulphuric acid and crystalline copper; it dissolves in soln. of ferric chloride; and with auric chloride it gives a black mixture of copper and gold.

Violent explosions have been reported as a result of pouring water on the surface of molten copper, and also as a result of a workman spitting in a large crucible of the molten metal. This, however, is largely an effect of the sudden change in the state of aggregation of water, rather than of a chemical action between the heated metal and the water. In 1800, J. L. Proust reported that water is decomposed by copper. H. V. Regnault⁵ found that the water is slowly decomposed at a white-heat forming cupric oxide. S. Kern noted the formation of oxides of copper when steam is superheated in copper tubes; and G. K. Elliott found that under these conditions, the copper becomes crystalline and brittle; the cause of the disturbance is indicated above. L. Wöhler and O. Bale studied the equilibrium of steam in contact with copper at 450° , and observed no other than cuprous and cupric oxides are formed.

Water alone acts very slowly on copper; this is shown when water is distilled through a copper tube condenser, but M. E. Chevreul⁶ reported that such water is slightly contaminated by copper. According to M. T. Mengarini and A. Scala, copper in contact with distilled water gradually yields a colloidal soln. in which the particles of copper can be detected ultramicroscopically. According to M. C. Schuyten, copper reduced by hydrogen does not decompose water even if potassium permanganate be present, nor could W. van Rijn or M. M. P. Muir detect any action of distilled water on copper. H. T. Barnes and G. W. Shearer could detect no signs of the formation of hydrogen peroxide when air is passed through water in the presence of copper.

T. Carnelley showed that distilled water dissolves a distinct amount of copper on standing in contact with the metal for an hour. The amount dissolved is increased by the time of exposure, and by the extent of metal surface in contact with the water. 100 c.c. of water at ordinary temp. when in contact with 2 sq. decm. of copper, dissolved:

Time exposed	1	2	3	4	6	24	48	54	72 hrs.
Cu dissolved .	0.035	0.050	0.070	0.085	0.155	0.168	0.210	0.290	0.280 mgrms.

The presence of solder diminishes the solvent action of water on copper, but is probably itself readily attacked, since the solder functions as the electropositive or sacrificial element in the solder-copper couple. The copper is always discoloured if exposed alone, but with solder, the copper remains quite bright. The action is less marked between 90° and 100° than it is at ordinary temp.

In view of G. T. Moody's and J. N. Friend's experiments on the rusting of iron, and of B. Lambert's experiments on the corrosion of lead, it is probable that in the *absence* of air (dissolved oxygen), highly purified water would have no action on purified copper. Indeed, G. D. Bengough and O. F. Hudson removed all but about 1 c.c. of air per litre from distilled water, and they could detect no corrosive action on copper during the first 24 hrs.; a very slight tarnish then appeared; and subsequently no further action could be detected. According to J. Aston, when two strips of iron in electrical contact are placed in an electrolyte, and a stream of air is allowed to bubble about one of them an e.m.f. is established between the two strips—the aerated strip acts as cathode. If one of the strips is covered with a colloid, it becomes the anode. J. Aston also noted that the iron beneath a spot of rust is anodic to the neighbouring clear metal. G. D. Bengough and O. F. Hudson made analogous observations with strips of copper and cupriferous alloys.

G. D. Bengough and O. F. Hudson thus described the ionic hypothesis of corrosion: Metals pass into soln. by electrolytic action whenever a clean metallic surface is in contact with a liquid which contains ions less electropositive than the metal itself. The nature and conc. of these ions determine the corrosiveness of the liquid as regards the electrolytic type of attack; and:

When an atom of copper passes into soln. it must obtain one or two positive charges, according as it passes into soln. as cuprous or cupric ion. Alternatively one or two negative charges may appear, which comes to the same thing. Now in salt soln., such as sea-water, the cations with the least soln. press. are the hydrogen ions; hence if copper is to pass into soln. it must displace hydrogen. From quite pure salt soln. copper cannot displace hydrogen; but if there is present in the soln. some depolarizer which will remove the hydrogen by oxidation sufficiently quickly at the moment it is about to be discharged, then the copper can replace hydrogen. The depolarizer in the case of sea-water is oxygen.

On this hypothesis, the copper is assumed to pass into soln. displacing hydrogen, and to be reprecipitated back on the copper as cuprous oxide. In the exchange of copper and hydrogen ions, N. K. Chaney believes that each point on the surface of copper can act as anode and cathode; the alternative view is that the surface is made up of anodic and cathodic areas, and that the copper passes into soln. only on the anodic areas. W. R. Dunstan and J. R. Hill maintain that there is no evidence to show that dissolved oxygen can directly oxidize hydrogen at the cathode surface at ordinary temp., or that oxygen can act as a depolarizer, while reagents like potassium dichromate, etc., known to act as depolarizers under certain circumstances, may render metals passive and delay corrosion. G. D. Bengough and O. F. Hudson were never able to detect the direct displacement of hydrogen by copper from distilled water or dil. acids. According to W. Ostwald and N. T. M. Wilmore, the electrode potentials of hydrogen and copper at 0° are respectively -0.277 and -0.606 volt, so that although the values are close together, the former is the more electropositive, while O. P. Watts and N. D. Whipple say that the position of hydrogen in the electrochemical series is below that of copper. In any case, G. D. Bengough and O. F. Hudson found that the effects of slight variations in the physical conditions are of more importance than small variations in the e.m.f.; and that differences in the rate of oxidation have a greater effect on the speed of corrosion than small differences of potential. For example, if strips of copper and brass be electrically connected while immersed in 1 per cent. hydrochloric acid, the brass becomes anodic, yet the cathodic copper is also attacked. Hence, it is assumed that the copper is directly oxidized; that the oxide is dissolved by the acid; and that the most important factor in determining the rate of corrosion is the rate of direct oxidation by oxygen in soln.

G. D. Bengough and O. F. Hudson found that the action of distilled water on copper in the presence of air is attended by the immediate formation of a layer of tarnish over the surface of the metal. This tarnish consists of the lower oxide of copper. Under certain conditions the tarnish may be formed uniformly over the whole specimen, and be very resistant to further oxidation. The tarnish appears to be formed directly on the metal and resembles and reinforces that formed by air oxidation. The tarnish is readily soluble in dil. acids, such as hydrochloric acid (1 : 10,000), and even in distilled water to a minute extent; it undergoes ultimately a further chemical change, becoming darker in colour and porous. This change is probably due to further oxidation, and perhaps hydration. Carbon dioxide probably also plays a part.

Some time after the formation of the tarnish its further oxidation may take place at certain spots, and increased action occurs at such spots with the formation of shallow pits. This increased attack may be due to (a) electrolytic action, *i.e.* ionic exchange between copper and hydrogen ions in the water, or (b) increased oxidation of the copper due to the porous character of the oxide scale at these points. The centres of increased action on the metal are definitely associated with the dark oxidized areas of the copper. These areas are covered with porous material, and the result is that oxidation becomes conc. on the underlying metal, a loose amorphous and probably readily soluble oxide being formed by the rapid attack. The increase in the rate of oxidation may possibly cause the metal to become anodic, and electrolytic action may take place to some extent. Later, the dark oxide tends to become detached and flake off, leaving the loose, porous, and non-protective oxide exposed. The action is thus localized. Part of the copper which passes into soln. by electrolytic action or by soln. of amorphous cuprous oxide may be reprecipitated as a crystalline form of cuprous oxide. This substance is quite easily distinguishable from the amorphous or subcrystalline oxide which forms the original tarnish. It may be called the secondary oxide.

Both the primary and secondary oxides may undergo slow changes with time, and may eventually form black cupric oxide and blue-green hydroxide, possibly associated with traces of basic carbonate. The secondary oxide, however, frequently persists for long periods of time. The hydroxide or carbonate is not infrequently seen at the bottom of the pits. After three months of immersion the surface condition of cast copper was found to be as follows: (a) Certain areas still exhibit the original tarnish in an unchanged condition. Such areas will usually form but a very small portion of the whole, not more than 1 or 2 per cent., but may amount to nearly 40 per cent. (b) The greater part of the surface is covered with oxidized and porous primary and secondary oxides and hydroxide. (c) Beneath this layer are present a number of shallow pits formed by electrolytic action, or by increased local oxidation. The latter view is the more probable. The net result of the whole action, at the end of several months' immersion, is to cover nearly the whole surface of the metal with a layer of oxide of varying degrees of thickness, oxidation, and physical condition.

Copper soon becomes covered with a greenish film when exposed to the joint action of carbon dioxide and moist air, as demonstrated by P. A. von Bonsdorff.⁷ A. W. Carpenter exposed sheets of copper (99.5–99.76 per cent.), aluminium, iron, and steel to corrosion in different places, and measured the rate of corrosion in loss of thickness per surface inch per year:

	On roof of office building.	In railway tunnel.	In smoke-stack plates.
Copper	0.0000	0.004	0.014
Aluminium	0.0011	0.013	—
Iron	0.001–0.004	0.15	0.018
Steel	—	0.12	0.020

According to F. B. Ahrens, the attack is more rapid in the air of towns; and more rapid in countries with hygroscopic atm. than in dry climates like that of Egypt. The

greyish-green basic carbonate formed under these conditions is called *verdigris*—from *vert de gris*, greyish-green—although the latter term is more correctly applied to the basic acetate. Ancient bronzes preserved in museums, are liable to develop a light green colour at one or more points upon their surfaces, and this spreads by degrees over the whole surface of the *métaux malades*. The disease is called *rogn*a or *caries* of bronze, and it is regarded as a pest or plague in archæological museums.

The copper and bronze antiquities found in the earth or in graves are also usually covered with a green or blue crust—called *patina* or *ærogo nobilis*—varying in thickness from a very thin film to one several mm. thick. The outer green crust is mainly basic copper carbonate, and below this, next to the metal, is a reddish layer mainly composed of cuprous oxide. The patina may contain malachite, $\text{CuCO}_3 \cdot \text{Cu(OH)}_2$; azurite, $2\text{CuCO}_3 \cdot \text{Cu(OH)}_2$; atacamite, $\text{CuCl}_2 \cdot 3\text{Cu(OH)}_2$; admixed with covellite, CuS , tin oxide, silver oxide, iron oxide, lead carbonate or chloride, and ammoniacal salts are sometimes present.⁸ The composition naturally depends on the composition of the alloy, the texture of the metal, the nature of the soil, and the length of time the metal has been exposed to particular conditions. Chlorides are common in the patina of Egyptian bronze antiquities, and this is to be anticipated when it is remembered that Egypt was once the bottom of a sea, and that the soil water is brackish with sea-salt.

Many natural waters can take copper into soln. when passing through pipes of this metal. According to E. Reichardt, ordinary water which had passed through copper pipes contained 7·24 mgrms. of copper per litre when the pipes were first laid in 1859, but, in 1872, thirteen years later, 0·8 mgrm. per litre was dissolved, and even this small quantity gave a perceptibly green soap. B. Roux also reported that an epidemic in a village was supposed to be due to the presence of this metal in the water which had passed through copper pumps and pipes. G. Wetzlar found that copper is readily attacked by saline soln., and less readily when potassium carbonate is present. A. Vogel could detect no effect by exposing copper to the action of lime-water, diluted with twice its own volume of water. Water containing carbon dioxide in soln. has an appreciable action on copper, and, according to M. M. P. Muir, the attack is hastened if the water contains chlorides or nitrates in soln. but not so much if carbonates are present; indeed, if much carbonate is present, the water does not attack the copper. P. D. Merica and R. W. Woodward noticed that the corrosion of manganese bronze in water and moist air did not appear to be affected if the metals were exposed while subjected to a stress.

T. Carnelley found that a 48 hrs. exposure of a sq. dcm. of copper to salt soln. of different conc. dissolved the amounts of copper expressed in mgrms. indicated in Table VI. With the exception of the ammonium salts, the nature of the base appears to have but little influence on the result, the action depends principally on

TABLE VI.A.—EFFECT OF DIFFERENT SALT SOLUTIONS ON COPPER.

Grms. of salt in soln.	0·001	0·01	0·05	0·50	5·00
Potassium nitrate .	0·13	0·07	0·13	0·14	0·16
Sodium nitrate .	—	—	0·18	—	0·19
Ammonium nitrate .	0·08	0·19	0·68	3·33	60·00
Calcium sulphate .	—	—	0·10	—	—
Potassium sulphate .	0·11	0·09	0·12	0·16	0·28
Magnesium sulphate.	—	—	0·16	—	0·34
Ammonium sulphate	0·17	0·17	0·66	2·35	28·50
Sodium carbonate .	0·06	0·06	0·11	0·29	2·80
Potassium carbonate	—	—	0·14	—	2·35
Sodium chloride .	0·07	0·07	0·14	1·63	7·50
Potassium chloride .	—	—	—	—	8·17
Ammonium chloride.	—	—	0·92	—	158·75

the acid radicle, and this increases in passing from nitrates to sulphates, carbonates, and chlorides. The chlorides are the most active. The action of ammonium salts is far in excess of that of any of the other salts tried. The solvent action increases with the time of exposure, and with the surface area of the metal exposed. The action with potassium nitrate and sulphate was decreased by raising the temp. to between 90° and 100°, but with sodium carbonate and chloride, and ammonium sulphate, the action was increased. G. D. Bengough and O. F. Hudson attribute the greater solvent action of soln. of ammonium chloride to the removal of the protective film of oxide as fast as it is formed owing to the solubility of the oxide in ammonium chloride soln.

According to W. A. Tilden, the action of soln. of sodium chloride is greater than that of soln. of magnesium or calcium chloride. The air is of great importance in hastening the action. W. A. Tilden says that "brass may be boiled with a soln. of salt for any length of time without alteration, provided air is excluded;" and that the action of sea-water on the copper sheathing of ships is generally much the worst near the water-line. Although T. Carnelley found that the speed of attack increased with the conc. of the soln., W. A. Tilden, in agreement with H. Davy, found that very conc. salt soln. did not act so vigorously as more dil. soln.—presumably because conc. soln. absorb oxygen less rapidly than dil. soln. The subject has also been studied by G. Lunge and L. Weibcl, H. Keil, X. Rocques, H. Fleck, H. Ost, A. Wagner, etc. T. Carnelley reported that the action of sodium chloride is augmented by sodium nitrate and more so by potassium sulphate; the action of ammonium sulphate is slightly increased by the presence of potassium nitrate, while that of ammonium nitrate is scarcely affected; the activity of ammonium chloride is lessened by sodium chloride, less so by potassium nitrate, and sulphate. O. P. Watts and N. D. Whipple studied the corrosion of copper by hydrochloric, perchloric, phosphoric, nitric, chromic, sulphuric, and acetic acids; by sodium hydroxide, and by a number of oxidizing agents—hydrogen peroxide; sodium arsenate and nitrite; ferric sulphate and chloride; potassium dichromate, chlorate, permanganate, nitrate, bromide, and iodide; and mercuric chloride. A. J. Hale and H. S. Foster studied the action of soln. of sodium, magnesium, and calcium chlorides, sodium hydroxide and carbonate, and aq. ammonia.

The general conclusion is that waters contaminated by sewage and nitrogenous products have a greater action on copper vessels, brass taps, and machinery fittings than water free from these impurities. According to A. Daubrée, waters containing sulphates and organic matter deposit a film of cupric sulphide on the surface of copper. F. W. Shaw and T. Carnelley say that a thin layer of cupric sulphide, obtained by washing the surface of the metal with ammonium sulphide, facilitates the attack by water, but reduces that of salt soln. F. Uehmann puts a spiral of iron or steel wire inside copper tubes to protect them from attack by salt soln. H. Davy also protected copper from salt soln. by joining it to a piece of zinc.

If salty water charged with air and carbon dioxide is allowed to act on copper or copper alloys, an oxychloride, analogous with the mineral atacamite, $3\text{CuO}\cdot\text{CuCl}_2\cdot 3\text{H}_2\text{O}$, is said to be formed. M. Berthelot has given an elaborate series of equations to represent the formation of patina on copper or bronze vessels buried in soils containing salty water. He supposed that the simultaneous action of water and the oxygen and carbon dioxide of the air and the sodium chloride upon the copper furnishes copper oxychloride: $4\text{Cu} + 2\text{O}_2 + \text{CO}_2 + 2\text{NaCl} + 3\text{H}_2\text{O} = 3\text{CuO}\cdot\text{CuCl}_2\cdot 3\text{H}_2\text{O} + \text{Na}_2\text{CO}_3$. A little of the oxychloride dissolves in the salt soln., and this in contact with the copper forms cuprous oxide and a double salt of cuprous and sodium chlorides: $3\text{CuO}\cdot\text{CuCl}_2\cdot 3\text{H}_2\text{O} + 4\text{Cu} + 2\text{NaCl} = 2\text{CuNaCl}_2 + 3\text{Cu}_2\text{O} + 3\text{H}_2\text{O}$. The double salt is oxidized by air, $6\text{CuNaCl}_2 + 3\text{O} + 3\text{H}_2\text{O} = 2\text{CuCl}_2 + 3\text{CuO}\cdot\text{CuCl}_2\cdot 3\text{H}_2\text{O} + 6\text{NaCl}$. The cupric chloride so formed, in contact with air and copper, may form cuprous oxide, or be converted into the oxychloride: $\text{CuCl}_2 + 3\text{Cu} + 3\text{O} + 3\text{H}_2\text{O} = 3\text{CuO}\cdot\text{CuCl}_2\cdot 3\text{H}_2\text{O}$. The cycle constantly recurs under the influence of moist air. The patina crust may vary from a very thin film to a

crust several millimetres in thickness. Some patinas are free from chlorides and were probably formed out of contact with soluble chlorides. Some patinas are comparatively stable, and do not change under normal conditions; others, principally those containing chlorides, are unstable, and are liable to spread and deepen. The former type of patina is not prejudicial to the preservation of bronzes, and has accordingly been called *noble patina* or *Edelpatina*.

If the green crust of a typical patina be removed by washing in dil. sulphuric acid, there remains a reddish crust of cuprous oxide which may be removed by washing with aqua ammonia so as to expose the underlying metal. The layer of cuprous oxide has been remarked by B. G. Sage (1778), J. Davy (1825), etc. It has been suggested that the presence of cuprous oxide shows that the formation of this oxide is the first stage in the patinization of copper objects, and the carbonates represent the later completed stage. F. Wibel, on the contrary, assumed that the cuprous oxide is formed by the reduction of the copper carbonate formed by the action of moist air and carbon dioxide on copper. When such a film is moistened, a layer of a soluble copper salt is in contact with the metal, the metal reduces the soln. to cuprous oxide or even to copper itself; this is exemplified by the occurrence of copper crystals in some patinas; and by an experiment due to C. F. Bucholz when the lower half of a strip of copper is immersed in a conc. neutral soln. of copper nitrate, and the upper half of the strip is immersed in a layer of distilled water superposed on the copper nitrate soln. The lower half of the strip becomes coated with crystals of copper and of cuprous oxide.

Copper is rapidly corroded by **sea-water**. When a piece of copper is immersed in sea-water, the liquid soon exhibits a bluish-white cloudiness, and, after a time, if the metal be exposed to the air, it becomes covered with a green crust. F. C. Calvert and R. Johnson⁹ found that the following numbers represent the relative action of sea-water on a number of metals; the results are expressed in grams of metal dissolved by 100 litres of sea-water per sq. metre of surface, in a month, at ordinary temp. :

Steel.	Iron.	Cu (best).	Cu (cake).	Zn.	Iron (galv.).	Tin.	Lead.
29·16	27·37	12·96	13·85	5·60	1·12	1·45	trace

A green deposit is formed on the copper, and this is readily washed from the surface of the metal if the water is in motion. Hence, if the water be in motion, but little of the green deposit is seen; the copper is rapidly corroded; and the surface of the metal often becomes dark red owing to the formation of cuprous oxide. F. C. Calvert and R. Johnson hence stated that the mechanical action of sea-water accelerates the attack. The composition of the crust was investigated by H. Davy. A. H. Sexton's analysis (1906) of a sample of the green deposit furnished :

Copper carbonate.	Copper chloride.	Copper oxide.	Water.
29·77	8·39	59·38	2·46

The action thus appears to be a chemical attack by the oxygen, carbon dioxide, and chlorides in soln. in the sea-water. If air and carbon dioxide are removed from sea-water, the action is rather slight. The attack may be uniform over the whole surface, more usually it is irregular, if not erratic, so that portions may be in holes while the remainder is quite sound. When brass or copper tubes are used in marine engines with salt waters, the metal may be rapidly pitted or the tube perforated. The cause of the pitting is not known; it has been attributed to the local voltaic action set up by contact with particles of metal or oxides less electropositive than copper. W. A. Tilden found that the portions of metal which have been bent or distorted in any way, are more rapidly attacked than the undisturbed metal by hydrochloric acid or chlorides; etc. E. L. Rhead found hard copper to be much more readily corrodible than soft copper. T. A. Eastick attributed local corrosion to the presence of hard and soft areas in the metal. Corrosion was found by A. Philip to be accelerated locally by contact with electronegative substances like

carbon or coke. G. D. Bengough and O. F. Hudson also found particles of string, clinker, anthracite, sand, glass, and ferric hydroxide may accelerate local action, while calcium carbonate generally exerts a protective action, and red lead is harmless. Much, however, depends on the physical condition of the particles.

H. Davy argued that "since chemical attractions may be exalted, modified, or destroyed by changes in the electrical state of bodies, and since copper is only weakly positive in the electrochemical scale, if it could be rendered slightly negative, the corroding action of sea-water on it would be nil." H. Davy demonstrated that the attack by ordinary sea-water is retarded if the copper be in contact with the electropositive metals—zinc, iron, etc.—but the protective action extends over a small area in the vicinity of the protective metal, and the remedy failed in practice because the sheathing thus protected became quickly covered with an earthy deposit on which sea-weeds and barnacles gathered more abundantly than when protectors were not used. M. Diegel has studied the protective action of metals in relation to their contact difference of potential in sea-water. Tinning the condenser tubes may protect the copper so long as the coating of tin remains intact, but directly the underlying brass or copper is exposed, the action of sea-water is increased.

It has long been assumed that the rapid decay of the copper sheathing of ships could be hindered by alloying copper with other metals. Thus, J. Keir (1779), W. Collins (1817), R. Mushet (1823), J. Revere (1830), M. Uzielli (1830), G. G. Bompas (1830), G. F. Muntz (1832), etc., have patented alloys of copper, zinc, tin, or iron. The brasses containing over 70 per cent. of copper are attacked by sea-water, but not so rapidly as copper. The zinc may be preferentially removed from these brasses much more rapidly than the copper, so that the brass is dezincified; in some cases the copper is dissolved and partly redeposited on the corroding metal. Brasses containing less than 70 per cent. of copper are much more readily attacked than the more cupriferos brasses. The first attack of sea-water on a brass, with $\text{Cu} : \text{Zn} = 1 : 1$, is almost wholly confined to the zinc. Acid, mine, and other waters rapidly attack the zinc in brass alloys.

According to G. D. Bengough and O. F. Hudson, the action of distilled water on brass in the presence of air may be regarded as taking place in three stages: (1) The formation of a translucent tarnish consisting of oxide. It is nearly uniform and not very porous to water or oxygen. A part of the zinc passes into soln., probably after being first oxidized; most of the copper oxide is found on the metal, but a trace is found in soln. (2) The further oxidation of the tarnish, beginning at widely scattered patches and areas, to form a dark purple or black oxide and a basic salt of an amorphous nature. (3) The commencement of local pitting. The positions at which this action begins are definitely related to the oxide areas characteristic of the second stage.

A. Philip¹⁰ explains the corrosion of brass by assuming that the alloy is an agglomeration of minute metallic couples of zinc and copper, but he says that the couples may also be formed of the different phases of the copper zinc-alloys. C. A. Edwards suggests that in the case of ordinary brass, the metallic couples are of copper and Cu_2Zn_3 , where the latter is slightly electropositive to copper. W. E. Gibbs believes that in brass, the characteristics of the component metals are to some extent altered, the zinc more than the copper; as a result, instead of a 70 : 30 brass being rapidly dezincified in aerated water, as is the case with a copper-zinc couple, copper is lost rather more rapidly than zinc. He also stated that the corrosive action of sea-water results in the dissolution of the copper by the dissolved salts, and in the dissolution of the zinc by the dissolved gases. G. D. Bengough and O. F. Hudson say that the normal action of neutral or nearly neutral sea-water is predominantly one of oxidation, and that the action of couples, if such exist, is too seriously hampered to be effective. Under some conditions, such as occur beneath certain deposits of basic salts of a semi-permeable nature, and in other conditions where the rate of oxidation is slow, zinc may be removed in its

entirety from the brass together with part of the copper, and some copper is left behind. This suggests that part at least of the copper is not directly associated with the zinc in any form of aggregate. The rest of the copper may be so associated, perhaps in the way suggested by W. E. Gibbs; there is therefore the possibility of couple action under non-oxidizing conditions. It does not appear certain, however, that any copper is left *in situ* when zinc passes into soln.; what appears to be left may really be redeposited. There is, however, a little evidence that the oxidation of the zinc does actually get slightly ahead of the oxidation of the copper.

The bronzes resist attack by sea-water and other corrosive agents better than copper or brass. If much zinc be present, the bronze may be attacked as readily as if it were brass itself. According to A. Carnot, manganese bronze resists the action of mine and acid waters better than the other cupriferous alloys.

According to A. Chodnoff,¹¹ if **potassium hydroxide** be fused in copper vessels, without access of air, cuprous oxide is formed and the mass is coloured blue. The aq. extract of the fused cake contains both cuprous and cupric oxide in soln., but G. N. Antonoff and B. V. Malyscheff found evidence of the formation of a peroxide. In 1833, A. Payen observed that copper is oxidized in a dil. soln. of potassium hydroxide in which iron remains bright, and the action is more particularly marked where the metal is in contact with air and water at the same time. Copper wetted with a conc. soln. of alkali hydroxide is coloured brownish-black in a few hours by exposure to air. The action is slower in dil. soln. The solubility of copper in alkali hydroxide soln. has been investigated by E. Murmann, G. Lunge and L. Weibel, A. Wagner, etc. According to M. Honigmann, copper vessels are much attacked when used for the evaporation of soln. of alkali hydroxide; the action is lessened if a piece of iron wire be present. R. G. van Name and L. Gräfenberg found copper electrodes are oxidized energetically when used with a current alternating 110 times per second.

According to H. Moissan,¹² **fluorine** attacks copper superficially at ordinary temp. and, just over 500°, it forms the white fluoride; at ordinary temp. J. Davy found that **chlorine** forms cuprous and cupric chlorides. The metal reduced by hydrogen was found by A. Osann and S. B. Christy to burn in a stream of chlorine at ordinary temp. with a white or bluish-white flame and to furnish cupric chloride. In 1889, T. Andrews pointed out that if the chlorine be thoroughly dried, there is no appreciable action. H. Gautier and G. Charpy found that a piece of copper wire sealed in a tube with liquid chlorine increased 3.241 per cent. in weight after standing four months at 15°. According to A. Colson, **bromine** acts at ordinary temp. on copper reduced below 280°; at 500°, it forms copper bromide. H. Gautier and G. Charpy found a piece of copper wire 2 mm. thick at 15°, lost 0.371 per cent. in weight in 8 days in darkness with dry bromine, and 1.740 per cent. in 4 months; at 100°, it lost 6.62 per cent. in 8 days; a piece of similar wire 5 cms. long dissolved in bromine water with an excess of bromine in over 7 days. **Iodine** vapour or **iodine monochloride**, ICl, reacts with finely divided copper; a plate of copper immersed in an aq. soln. of iodine is soon covered with crystals of copper iodide, CuI. According to J. B. Hannay, the reaction with liquid iodine chloride is very slow for the first few minutes; cuprous iodide and chloride are formed as well as a little cupric chloride. G. Tammann studied the surface coloration of copper by exposing the metal to iodine vapour at ordinary temp. There are three different types of action according as (i) the metal has been rolled and cleaned; (ii) the metal has been melted and thus covered with large crystallites; or (iii) the metal has been left unworked and thus covered with multitudinous small dendritic crystals. C. Poulenc found **hydrogen fluoride** to have scarcely any action on copper at ordinary temp. According to M. Berthelot, dry **hydrogen chloride** has but little action on copper at ordinary temp., but if oxygen be present, some cuprous chloride is formed, and the presence of water retards the action. J. Thomsen says the reaction with copper begins at 200°, and, according to P. Jannasch and H. Heimann, a mixture of both chlorides is obtained. According to M. Ribalkin, dry

hydrogen chloride begins to react with copper slowly between 92° and 100°, forming cuprous chloride: $2\text{Cu} + 2\text{HCl} \rightleftharpoons 2\text{CuCl} + \text{H}_2$, and the action is rapid at 230°—see cuprous chloride. H. E. Patten also showed that in the absence of moisture, soln. of hydrogen chloride in many organic and inorganic solvents—chloroform, carbon tetrachloride, ethyl chloride, benzene, silicon tetrachloride, stannic tetrachloride, phosphorus trichloride, arsenic trichloride, antimony pentachloride, sulphur monochloride, and thionyl chloride—have no appreciable action on copper. According to R. S. Norris and F. G. Cottrell, liquid hydrogen chloride does not attack copper, while liquid hydrogen iodide forms cuprous iodide at ordinary temp. The action of liquid hydrogen iodide on brass was noticed by M. Faraday in 1844.

According to C. Poulenc, aq. **hydrofluoric acid** has scarcely any action on copper. M. Berthelot¹³ noted that **hydrochloric acid** in contact with copper is in air rapidly coloured greenish-blue, but I. Kupferschläger says that if air be excluded, hydrochloric acid alone does not attack the metal. According to W. Odling, copper slowly dissolves in hydrochloric acid, forming cuprous chloride and liberating hydrogen. The same result was recorded by J. L. Proust in 1799. The action, says T. Charlton, is quite rapid if the copper be finely divided. W. A. Tilden confirmed W. Odling's observation with finely-divided copper, and found that rolled sheet copper is slowly dissolved in boiling conc. hydrochloric acid. This explains how "brass is capable of being dissolved entirely in hot hydrochloric acid; the zinc is for the most part attacked, and the residual spongy copper is then dissolved quite readily." F. C. Calvert and R. Johnson showed that an alloy of about equal weights of copper and zinc, immersed in conc. hydrochloric acid, gives up in a few days nearly the whole of the zinc, leaving the copper behind in a spongy state. According to J. Löwe, cold hydrochloric acid (sp. gr. 1.12) has scarcely any action on sheet copper at ordinary temp.; a more dil. acid (sp. gr. 1.083) acts slowly, and the hot acid forms cuprous chloride and liberates hydrogen. According to R. Engel, the action begins between 15° and 19° with an acid of sp. gr. 1.083 (16.5 per cent. HCl), and is very slow when the liquid is sat. with cuprous chloride. C. Weltzien, A. Vogel and C. Reischauer, A. J. Hale and H. S. Foster, and H. Vogel have investigated the reaction. S. Dushman found that air-free hydrochloric acid sat. with carbon dioxide dissolves copper anodically. H. Hager studied the action of copper on arseniferous acid, and of hydrochloric acid on arseniferous copper. According to J. E. Gerock, seleniferous hydrochloric acid attacks copper more rapidly than the ordinary acid. W. F. Brugman observed no evolution of hydrogen sulphide from copper containing some ferrous sulphide. The action of soln. of **sodium chloride**, **potassium chloride**, and **ammonium chloride** has already been discussed, *vide* Table V; and G. Quincke found that copper dissolves in molten **cupric chloride**. M. Berthelot observed that both **hydrobromic acid** and **hydriodic acid** dissolve copper more readily than hydrochloric acid. H. Rose reported that hydrogen is given off with the latter, and J. Thomsen, with the former provided platinum is present. Copper is also stated to resist dil. hydriodic acid.

In 1834, A. J. Balard,¹⁴ and, in 1903, A. D. White found that copper filings are partly dissolved by **hypochlorous acid**, forming cupric chloride, and partly converted into a green powder of a copper oxychloride. Chlorine gas mixed with a little oxygen is at the same time evolved. A. J. Balard also added that copper is readily converted into the oxychloride by soln. of hypochlorites, and there is a slight disengagement of chlorine mixed with oxygen. E. Soubeiran (1831) stated that when a sheet of copper is immersed in an aq. solution of **bleaching powder**, a blue layer of the oxychloride is gradually formed on its surface; small bubbles of oxygen are at the same time evolved. The reaction is faster with powdered copper, and the oxychloride is green. The evolution of oxygen is said to be a remarkable fact first attributed to the spontaneous decomposition of the hypochlorite. A. D. White found that with copper turnings, and an aq. soln. of bleaching powder, a green oxychloride is formed, and 60 c.c. of 94.3 per cent. oxygen were formed in the first 12 hrs.; 70 c.c. of 96.86 per cent. oxygen were formed in the second 12 hrs.; and

55 c.c. of 98.85 per cent. oxygen in the third 12 hrs. W. S. Hendrixson found that 2*N*-chloric acid, at 50°, acts rapidly on copper; the metal simply disappears, forming a clear blue soln. In no case is any hydrogen evolved. When a normal soln. of chloric acid is electrolyzed in the cold, using a copper anode, the latter is attacked regularly over its whole surface and becomes coated with a layer of cuprous chloride which, however, disappears on warming. Similarly, when copper is dissolved in a cold normal soln. of chloric acid, the metal becomes covered with a layer of hydrated cuprous oxide. It appears, therefore, that the metal passes into soln. in the cuprous form, the cuprous compound first produced being dissolved, if there is an excess of chloric acid present, forming cupric chloride and chlorate. With the conc. acid, the reaction is complicated by the formation of oxygenated compounds of chlorine, and in the absence of an excess of free chloric acid, complex basic salts are precipitated. A. L. Voegelé found that copper, though but slightly attacked by sulphuric acid alone, is readily dissolved in the presence of **potassium chlorate**, and an almost quantitative yield of potassium chloride results. This reduction by copper without electrolysis is about four times that by zinc for eq. quantities dissolved, though zinc dissolves much more slowly than does copper. With copper electrodes the electrolytic reduction is probably less than with zinc electrodes. According to W. D. Bancroft, a hot aq. soln. of potassium chlorate is not appreciably affected by copper, but G. H. Burrows showed that reduction is complete at 93°. L. Rossi has also studied the reduction of sulphuric acid soln. of potassium chlorate between copper electrodes. O. P. Watts and N. D. Whipple have studied the action of **perchloric acid** on copper. A. Ditte found that copper is attacked by soln. of **hydriodic acid**.

The members of the family: **sulphur, selenium, and tellurium**, all attack copper, forming respectively sulphide, selenide, and telluride—*q.v.*¹⁵ C. R. Hayward measured the rate of penetration of copper by sulphur vapour by placing copper rods a definite time in boiling sulphur; when cold, the specimen was broken open, and the copper core removed from the shell of sulphide, and weighed. The percentage loss in weight represented the copper converted to sulphide:

Time	5	10	15	30	60	120	180	240 mins.
Loss	1.95	2.86	3.39	4.58	6.0	8.59	9.90	9.73 per cent.

E. Obaeh found that copper acts on impure **carbon disulphide**, but not on the pure liquid; and A. Cavazzi, that at a high temp., copper reacts with the vapour of carbon disulphide, forming graphite and cuprous sulphide. In a study of absorbents for the vapour of carbon disulphide, A. Eiloart found that when a mixture of carbon dioxide and carbon disulphide vapour is passed over copper heated to redness, almost pure carbon monoxide is abundantly evolved with simultaneous formation of copper sulphide, Cu₂S. Carbon disulphide alone is decomposed when passed over copper heated below redness, and if copper, coated with carbon from the decomposition of carbon disulphide, is heated in a stream of carbon dioxide, only a limited and small quantity of carbon monoxide is slowly produced. Hence, the mixture of gases is necessary for the above reaction, and decomposition and combination evidently go on at the same time. Without copper, the mixture of gas is not decomposed in this manner, for instance, when passed over heated pumice. Sulphur dioxide and carbon disulphide, when passed over copper or pumice heated even below redness, give rise to carbon dioxide, and as a secondary product carbonic monoxide. J. Thomsen obtained what he regarded as carbon monosulphide by passing a mixture of nitrogen and carbon disulphide vapour over heated copper. V. Merz and W. Weith found that **hydrogen sulphide** has virtually no action at ordinary temp. on finely-divided copper, but if air be present, a vigorous reaction occurs. If copper (precipitated from a soln. of the sulphate by metallic zinc) is brought into a cylinder containing 2 vols. of oxygen and 1 of sulphuretted hydrogen, it immediately turns black, then grows red hot, and ignites the sulphuretted hydrogen. According to A. Ditte, a soln. of **potassium monosulphide** does not act on the metal if air be excluded, but if air be admitted, cuprous sulphide

and potassium cuprous sulphide are formed. A soln. of **ammonium hydrosulphide** was found by G. Lunge and L. Weibel to dissolve appreciable quantities of the metal. According to E. Priwoznik, the ammonium and the alkali polysulphides are converted into the monosulphides. The reaction has also been studied by V. Merz and W. Weith, and K. Heumann. C. Strüver found that at ordinary temp. several natural sulphides are reduced by copper, forming cupric sulphide—*e.g.* *arsenical pyrites* and *cobaltite* are not reduced; *hauerite* is reduced in 3 days; *pyrite* acts more slowly, *marcasite* rapidly, *magnetic pyrites* very rapidly. The reduction of **aluminium sulphide** and **magnesium sulphide** has been investigated by F. G. Reichel; of **cadmium sulphide** by A. Colson; of **ferrous sulphide** by A. Colson, and E. Schütz; and of **nickel sulphide** by G. P. Sehwerder. **Zinc sulphide** and **lead sulphide** are desulphurized by heating with copper. K. Heumann found that **mercuric sulphide** is rapidly reduced when boiled with finely-divided copper and water.

When copper is heated in a stream of **sulphur dioxide**, J. Uhl¹⁶ found that cuprous sulphide, sulphate, and a little sublimate are formed. E. Heyn and O. Bauer found that the sulphide begins to form at 900° if reducing agents be present, but not if they are absent. According to W. Hampe, molten copper absorbs sulphur dioxide, and part is retained when the metal solidifies, which is not removed, except perhaps superficially, and very slowly, by heating the metal in a stream of an indifferent gas. J. Uhl found that a mixture of dry sulphur dioxide and air is not transformed into sulphur trioxide when heated in presence of copper, but the surface of the metal is blackened owing to the formation of a compound which gives hydrogen sulphide when heated in a stream of hydrogen. A. Sieverts and E. Bergner found the solubility of sulphur dioxide in copper increases with the temp., and the amount w dissolved varies with the sq. root of the press. p up to conc. of about 7 per cent., so that $w = kp^{\frac{1}{2}}$, where k is constant. The observed results are in part explained by assuming that the sulphur dioxide is decomposed in soln., forming cuprous sulphide and oxide: $\text{SO}_2 + 6\text{Cu} = \text{Cu}_2\text{S} + 2\text{Cu}_2\text{O}$, and the corresponding equilibrium holds only in a qualitative manner.

According to S. U. Piekering, while **sulphurous acid** under some circumstances may dissolve some copper, yet if that metal be heated in sulphurous acid while a stream of sulphur dioxide is drawn through the liquid, the copper remains untarnished and unattacked. G. Barruel left some copper and sulphurous acid in a sealed tube for six months, and found copper sulphate and a black body were formed; the latter was probably copper sulphide: $2\text{Cu} + 2\text{H}_2\text{SO}_3 = \text{CuS} + \text{CuSO}_4 + 2\text{H}_2\text{O}$. H. Causse found that an aq. soln. of sulphur dioxide acts slowly on metallic copper, forming cupric sulphite and hyposulphurous acid; if, however, a large excess of sulphurous acid is present, hydrogen sulphide is formed, precipitating the sulphide from the soln. of cupric sulphite, and coating the metallic copper with a film of sulphide; a precipitate of sulphur is also produced. These reactions appear to take place more rapidly when the copper is exposed to an atm. of moist sulphur dioxide. L. P. de St. Gilles noticed that when copper filings wetted with hydrochloric acid are treated with sulphurous acid, copper sulphide is formed; C. Geitner also obtained cupric sulphide by heating copper with sulphurous acid to 200°; H. Reinsch and J. Uhl found that copper is converted, by an aq. sulphuric acid or hydrochloric acid soln. of sulphur dioxide, into cuprous sulphide. M. Berthelot also noted that when copper is heated with sulphurous acid, the colour becomes dark red or reddish-brown owing to the formation of an oxysulphide or cuprous sulphite, and cupric sulphide slowly appears. G. Bredig studied the catalytic action of copper on the oxidation of sulphites, and noted the retardation of the action by mannite or glycerol; and H. Rössler also noted the catalytic oxidation of sulphurous acid at 100° in the presence of copper.

According to E. Divers and T. Shimidzu,¹⁷ copper is not acted upon by **sulphur trioxide** provided moisture be rigorously excluded; and when spongy copper, reduced in hydrogen, is treated with **pyrosulphuric acid**—fuming sulphuric acid—there is a slight effervescence, the copper soon blackens, and then further action proceeds

with extreme slowness. Only traces of copper are present in the acid liquid. Water dissolves a little sulphate from the blackened copper, but leaves the black coating of cuprous sulphide. It therefore appears that, in the cold, the first reaction is: $5\text{Cu} + 4\text{H}_2\text{SO}_4 = 3\text{CuSO}_4 + \text{Cu}_2\text{S} + 4\text{H}_2\text{O}$, but further progress is quickly arrested by the insolubility of the products. G. Barruel found that the reaction between copper and sulphuric acid occurs at ordinary temp. if sufficient time be allowed. C. Baskerville said the action began at 0° . E. Salkowsky showed that in the presence of hydrogen peroxide, sulphuric acid readily attacks copper. Under these conditions, however, the action is so slow that F. C. Calvert and R. Johnson failed to note any action below 130° and supposed that none takes place; and L. W. Andrews says that the reduction of 98.4 per cent. sulphuric acid by copper does not begin below 86° , that is, not until the acid has become partially dissociated into sulphur trioxide and water—the dissociation of the acid begins just below 70° .

According to M. Berthelot, if air be excluded, cold conc. sulphuric acid acts slowly on copper, giving, in about 8 days, considerable amounts of sulphur dioxide, and forming a layer of cupric sulphide and sulphate; the unattacked copper has a reddish tint—possibly due to the formation of a basic sulphite. According to F. Cintolesi, if air be excluded, the solubility of copper in sulphuric acid is less the more dil. the acid; cold dil. sulphuric acid attacks copper only in the presence of air. According to S. U. Pickering, at 100° the amount of copper dissolved in half an hour by sulphuric acid of different conc. is as follows:

	H_2SO_4	$\text{H}_2\text{SO}_4 + \frac{1}{2}\text{H}_2\text{O}$	$\text{H}_2\text{SO}_4 + \text{H}_2\text{O}$	$\text{H}_2\text{SO}_4 + 2\text{H}_2\text{O}$
Sp. gr.	1.843	1.8295	1.780	1.62
Per cent. of Cu dissolved	2.380	0.585	0	0

S. U. Pickering also gave Table VII in illustration of the influence of temp. on the products of the reaction, between copper foil and sulphuric acid of sp. gr. 1.843. J. J. Berzelius mentioned the formation of a black insoluble powder, oxidizable

TABLE VII.—EFFECT OF TEMPERATURE ON THE SOLUBILITY OF COPPER IN SULPHURIC ACID.

Temp.	Time. d = days m = mins.	Proportion of copper converted into		Percentage composition of insoluble residuc.			Percentage amount of copper dissolved.	Percentage amount of copper dissolved per minute.
		Cu_2S	CuSO_4	Cu_2S	CuS	S		
19°C .	14 d	17.33	83.67	100	0	0	5.7	0.0003
60	120 m	5.25	94.75	100	0	0	2.532	0.0211
80	30 m	30.20	69.80	100	0	0	1.503	0.0501
100	30 m	25.00	75.00	100	0	0	3.123	0.1041
124	30 m	21.53	78.47	100	0	0	22.7	0.76
130	30 m	17.60	82.40	100	0	0	32.6	1.09
137	30 m	17.00	83.00	100	0	0	35.0	1.17
150	30 m	13.27	86.73	100	0	0	62.2	2.31
170	10 m	10.82	89.18	100	0	0	51.92	5.19
195	2 m	8.00	98.00	100	0	0	53.5	26.75
220	0.5 m	7.16	92.84	100	0	0	70.57 dissolved in $\frac{1}{2}$ minute	—
270	few secs.	0.0	100.00	100	0	0	nearly all	—

by nitric acid; and he assumed this product is "copper subsulphate." J. Davy noted the formation of cupric sulphate and sulphide; and G. Barruel thus describes the reaction between copper turnings and sulphuric acid in a closed vessel, completely filled with liquid, at ordinary temp.:

At the end of one week, the liquid has a pale rose colour; at the end of three weeks, the liquid is decolorized, and the metal is bright; at the end of eight weeks, a small quantity of brownish powder is deposited at the bottom of the vessel; this powder increases in quantity up to the fifth month, and finally, transparent colourless crystals of anhydrous cupric

sulphate are deposited on the sides of the vessel. After the elapse of six months, the colourless liquid emits a strong odour of sulphur dioxide, and turns blue when mixed with water, showing that it contains anhydrous cupric sulphate dissolved in the sulphuric acid. Hence, it follows that sulphuric acid is slowly decomposed by copper yielding cupric sulphate and sulphur dioxide: $\text{Cu} + 2\text{H}_2\text{SO}_4 = \text{CuSO}_4 + \text{SO}_2 + 2\text{H}_2\text{O}$, and that the latter is wholly consumed in forming cupric sulphide and sulphate: $2\text{Cu} + 2\text{H}_2\text{SO}_3 = \text{CuS} + \text{CuSO}_4 + 2\text{H}_2\text{O}$.

E. G. Maumené analyzed the black body and assumed that it contained cuprous sulphide, Cu_2S ; copper oxysulphides, $\text{CuO} \cdot 2\text{Cu}_2\text{S}$; $\text{CuO} \cdot 2\text{CuS}$; and $\text{CuO} \cdot \text{CuS}$. C. Baskerville also said that in the absence of air an oxysulphide, $\text{CuO} \cdot 2\text{CuS}$, is formed at about 250° . The black film has been studied by J. Laubheimer, and many others; S. U. Pickering found that it contains copper and sulphur but never oxygen. Cuprous sulphide is best formed between 100° and 130° ; at a lower temp. less is produced, and at 270° none appears. T. Kliche found that the relative amounts of cuprous and cupric sulphides, and of sulphur which are produced in the reaction, depend on the duration of the action; at 125° or 130° , sulphur slowly unites with cuprous sulphide to form cupric sulphide.

The action of hot sulphuric acid on copper is thus described by S. U. Pickering: Sulphuric acid attacks copper at all temp. from 19° (and probably even still lower) upwards, to an extent increasing rapidly with the increase of temp.; with the exception of a few minute and occasional bubbles of sulphur dioxide, no gas is evolved from the liquid till about 130° : as soon as the copper begins to be attacked, its surface becomes dull and covered with a film of black cuprous sulphide; when the amount of cuprous sulphide floating in the liquid is small it exhibits a brownish colour, similar to that exhibited by small quantities of the cupric sulphide when suspended in a liquid; but as the quantity of cuprous sulphide increases, the colour deepens and soon appears perfectly black. If the temp. be allowed to rise, the liquid generally begins to boil below 300° , the b.p. of pure conc. sulphuric acid being 327° ; when the source of heat is withdrawn, the suspended sulphide subsides, leaving a bluish-green soln. containing copper sulphate, which, on cooling, crystallizes out from the acid in white acicular anhydrous crystals, leaving the sulphuric acid free from dissolved copper, and, when the proportion of metal and acid above mentioned is used, but little diminished in density. After the copper is entirely dissolved, and sometimes even before this, a deposit of sulphur appears in the neck of the flask. No gas insoluble in water, such as oxygen or hydrogen, is given off during the action.

S. U. Pickering showed that the reaction between sulphuric acid and copper may be supposed to involve two primary actions: (i) $\text{Cu} + 2\text{H}_2\text{SO}_4 = \text{CuSO}_4 + \text{SO}_2 + 2\text{H}_2\text{O}$, which in turn is compounded of a reaction in which cupric sulphate and nascent hydrogen are formed: $\text{Cu} + \text{H}_2\text{SO}_4 = \text{CuSO}_4 + 2\text{H}$; and the reduction of the sulphuric acid by the nascent hydrogen: $2\text{H} + \text{H}_2\text{SO}_4 = \text{SO}_2 + 2\text{H}_2\text{O}$. The other primary reaction is (ii) $5\text{Cu} + 4\text{H}_2\text{SO}_4 = \text{Cu}_2\text{S} + 3\text{CuSO}_4 + 4\text{H}_2\text{O}$, which does not involve nascent hydrogen. Both reactions may take place together, or either may occur alone. The first reaction predominates between 0° and 270° , and above that temp. it occurs alone; the second reaction increases between 0° and 100° , and decreases between 100° and 270° . The several other products which occur may be regarded as being formed by the decomposition of cuprous sulphide by the sulphuric acid: $\text{Cu}_2\text{S} + 2\text{H}_2\text{SO}_4 = \text{CuS} + \text{CuSO}_4 + \text{O}_2 + 2\text{H}_2\text{O}$, and of the cupric sulphide by the same acid: $\text{CuS} + 2\text{H}_2\text{SO}_4 = \text{S} + \text{CuSO}_4 + \text{SO}_2 + 2\text{H}_2\text{O}$. According to this interpretation of the reaction, cuprous sulphide is a direct product of the action of the acid on copper, and cupric sulphide is the result of a secondary reaction. H. Causse found some cuprous sulphite is formed.

T. Andrews, and C. M. van Deventer favour an *oxidation theory* in which cupric oxide, sulphur dioxide, and water are supposed to be the primary products of the reaction rather than the formation of sulphate and hydrogen; in both theories the acid is reduced and acts as an oxidizing agent. No direct proof of the formation of hydrogen has been adduced. He also prefers the assumption that water plays

an important part in first forming cupric oxide and hydrogen : $\text{Cu} + \text{H}_2\text{O} = \text{CuO} + 2\text{H}$; followed by $\text{CuO} + \text{H}_2\text{SO}_4 = \text{CuSO}_4 + \text{H}_2\text{O}$ and by $2\text{H} + \text{H}_2\text{SO}_4 = 2\text{H}_2\text{O} + \text{SO}_2$. According to C. H. Sluiter, the only rational explanation of the formation of copper sulphide is the assumption that hydrogen is liberated, and reduces the sulphur dioxide to hydrogen sulphide. The hypothetical reduction of sulphur dioxide by copper is not supported by evidence. This *reduction theory* is confirmed by the reduction of nitrobenzene, $\text{C}_6\text{H}_5\text{NO}_2$, to aniline, $\text{C}_6\text{H}_5\text{NH}_2$, when heated with copper and sulphuric acid at 130° ; when, however, sulphuric acid containing 12 per cent. of trioxide is heated with copper and nitrobenzene at 140° , sulphur dioxide is formed but no aniline is evolved. S. U. Pickering argued that the copper sulphide is not formed by nascent hydrogen ; nor by the action of hydrogen sulphide on copper sulphate ; nor by the union of metallic copper with free sulphur as assumed by F. C. Calvert and R. Johnson. He believes that the sulphuric acid is decomposed directly by the copper, forming cuprous sulphide, etc. The sulphur is formed by the action of sulphuric acid on the sulphides of copper in the liquid, and not by a reaction between sulphur dioxide and hydrogen sulphide. The sulphide volatilizes from the liquid and is arrested by the simultaneous escape of gas or vapour.

According to J. T. Cundall, when copper is heated with conc. sulphuric acid, and portions of the dark reddish-brown liquid are drawn off at successive stages of the reaction until the copper is nearly all dissolved, and poured into a large volume of water, a bright red precipitate of metallic copper is produced, and not a black precipitate of copper sulphide. It is, therefore, inferred that cuprous sulphate is the first product of the reaction of dil. or conc. sulphuric acid on copper, and this compound is decomposed by water as indicated by A. Recoura : $\text{Cu}_2\text{SO}_4 = \text{CuSO}_4 + \text{Cu}$. If the reddish-brown liquid obtained by the action of sulphuric acid on copper is allowed to remain, or is heated, it becomes dark and deposits a greyish-black precipitate of cuprous sulphide, and if more strongly heated, a greenish-black precipitate of cupric sulphide is formed which re-dissolves if the heating be continued : $\text{CuS} + 4\text{H}_2\text{SO}_4 = \text{CuSO}_4 + 4\text{SO}_2 + 4\text{H}_2\text{O}$. The primary action is therefore $2\text{Cu} + 2\text{H}_2\text{SO}_4 = \text{Cu}_2\text{SO}_4 + 2\text{H}_2\text{O} + \text{SO}_2$, or possibly at low temp., $8\text{Cu} + 4\text{H}_2\text{SO}_4 = 3\text{Cu}_2\text{SO}_4 + \text{Cu}_3\text{S} + 4\text{H}_2\text{O}$; and the secondary products are $5\text{Cu}_2\text{SO}_4 + 4\text{H}_2\text{SO}_4 = \text{Cu}_2\text{S} + 8\text{CuSO}_4 + 4\text{H}_2\text{O}$; and $\text{Cu}_2\text{S} + 2\text{H}_2\text{SO}_4 = \text{CuS} + \text{CuSO}_4 + 2\text{H}_2\text{O} + \text{SO}_2$; and $\text{CuS} + 4\text{H}_2\text{SO}_4 = \text{CuSO}_4 + 4\text{SO}_2 + 4\text{H}_2\text{O}$. A combination of five times the first equation with three times the third gives one of S. U. Pickering's fundamental equations.

S. U. Pickering found that the reaction is faster with impure than with pure copper. With acid of sp. gr. 1.843, and 30 mins. action at 100° , he found that the percentage of copper dissolved with the purest electrolytic copper wire was 2.412 ; with electrolytic copper foil, 3.123 ; with a less pure electrolytic copper foil, 4.068 ; with ordinary copper wire, 4.897 ; with commercial sheet copper, 11.5 ; and with a bronze coin, 14.8. He also tried the effect of sulphuric acid on copper while under the influence of an electric current, by connecting a copper plate with one pole of a small Daniell's cell, while another plate was connected with another pole of the cell, and with a piece of platinum foil dipping in the acid. In another series of experiments, a piece of copper was made electropositive by attaching it to a coil of platinum wire. The more electropositive the copper was made the greater was the speed of dissolution in the acid, so that as much metal was dissolved in 15 mins. as was dissolved in one hour when the metal was neutral or electronegative. Again, when the copper was electropositive, the proportion of sulphide to sulphate formed was increased, and decreased when the copper was made electronegative. The explanation is connected with the speed of dissolution—when fast, more cuprous sulphide is produced and decomposed by the acid in a given time. A. J. Hale and H. S. Foster have also studied the action of sulphuric acid on copper.

W. Ostwald interprets the action of dil. sulphuric acid on copper by saying that in consequence of the slow reaction of the dissolved oxygen with the hydrogen ions

of the acid, cupric ions are formed; J. Sèbor says that the dissolution of the metal in the presence of *hydrogen dioxide* is an ionic reaction involving $\text{Cu} + \text{H}_2\text{SO}_4 = \text{CuSO}_4 + \text{H}_2$, and the hydrogen is depolarized by the dioxide without a primary oxidation of the copper. According to M. Traube, hydrogen peroxide is formed during the slow oxidation of copper in the presence of dil. sulphuric acid. He says that neither moist air nor dil. sulphuric acid alone reacts with copper at ordinary temp., and it appears as if the affinity of copper for the acid SO_4 -group and of oxygen for hydrogen suffice for the decomposition, which probably proceeds, $\text{Cu} + \text{H}_2\text{SO}_4 + \text{O}_2 = \text{H}_2\text{O}_2 + \text{CuSO}_4$, followed by the consecutive reaction $\text{H}_2\text{O}_2 + \text{H}_2\text{SO}_4 + \text{Cu} = \text{CuSO}_4 + 2\text{H}_2\text{O}$. No active oxygen is liberated in the reaction. According to V. Lenher, copper is attacked by warm **selenic acid**.

If conc. sulphuric acid is mixed with **sodium nitrite**, a purple coloration is produced which slowly disappears on standing, or rapidly on warming, or on diluting the mixture with water—cuprous oxide and salts are formed. G. J. Burch and J. W. Dodgson found that copper in contact with *silver* in a mixture of 5 parts of sulphuric acid (sp. gr. 1.84) and one of nitric acid (sp. gr. 1.436) is scarcely attacked at all; but the action increases as the mixture is diluted with water. W. R. E. Hodgkinson and N. E. Bellairs say that molten **ammonium sulphate** does not appear to attack copper, but W. Smith showed that ammonium sulphate does not melt, but rather decomposes, forming ammonium hydrosulphate. The solubility of copper in soln. of ammonium sulphate has been investigated by T. Carnelley, J. W. Turrentine, and G. Lunge and L. Weibel—*vide* Table V, and also for the solubility of copper in soln. of **potassium sulphate**, **calcium sulphate**, and **magnesium sulphate**. During the alternating current electrolysis of soln. of **sodium hydro-sulphate**, with copper electrodes, M. le Blanc and K. Schick say that copper is not dissolved because no complex salts are formed. The conversion of **cupric sulphate** in feebly acid conc. aq. soln. into cuprous sulphate was noted by J. J. Berzelius, and the equilibrium conditions: $\text{Cu} + \text{CuSO}_4 \rightleftharpoons \text{Cu}_2\text{SO}_4$, have been studied by F. Förster and O. Seidell, by T. W. Richards, E. Collins and G. W. Heimrod, and by E. Abel; while R. Namais and J. W. Turrentine have studied the dissolution of copper in an ammoniacal soln. of a **persulphate**. G. Scagliarini and G. Torelli showed that copper acts as a catalytic agent in the oxidation of ammonia by persulphates. H. Ditz observed no formation of activated oxygen or of sulphur dioxide during the action; but M. G. Levi, E. Migliorini, and G. Erèolini found that a gas is slowly evolved, and a layer of cupric oxide is formed on the metal. Potassium persulphate acts more rapidly than the ammonium salt. E. Priwoznik, and F. J. Faktor found that a boiling soln. of **sodium thiosulphate** rapidly converts copper into cuprous sulphide. V. Merz and W. Weith noted the reaction between copper and the molten thiosulphate; and J. Girard studied the production of iridescent films on the metal by the action of double thiosulphates and by the electrolysis of a mixed soln. of sodium and lead thiosulphates and cupric sulphate with copper electrodes.

According to F. Raschig, a soln. of **nitrosulphonic acid** in conc. sulphuric acid is reduced to nitrososulphuric acid, $\text{HO}\cdot\text{NO}\cdot\text{SO}_3\text{H}$, by copper; the blue colour disappears with a more prolonged action, forming nitric oxide and sulphuric acid. E. Fromm found that a soln. of **sulphuryl chloride**, SO_2Cl_2 , in absolute ether, does not dissolve copper. The action of **sulphur monochloride**, S_2Cl_2 , according to P. Nicolardot, is similar to that of hydrogen chloride; the action occurs only at a high temp. F. Wöhler said copper is but slowly attacked by sulphur chloride.

P. L. Aslanoglou¹⁸ heated powdered copper in open air and obtained no evidence of the formation of a nitride such as occurs with magnesium or aluminium under similar conditions. W. R. Grove electrolyzed a soln. of ammonium chloride with a copper plate as cathode, and a platinum plate as anode, and stated that copper nitride is formed; J. F. Daniell, and H. Pauli obtained confirmatory results, but P. L. Aslanoglou, repeating the experiment, obtained only a mixture of cupric oxide

and metallic copper. A. Rossel, however, did obtain evidence of the formation of cupric nitride by heating a mixture of finely-powdered copper with calcium carbide in a crucible in the open air; and L. Arons says that the efflorescence on copper electrodes formed about an electric arc in an atm. of nitrogen consists of copper nitride—*q.v.* If a piece of copper wire be heated in a porcelain tube in a stream of ammonia gas, L. J. Thénard found that the metal becomes brittle and yellow or yellowish-white; but he could detect no increase in weight; F. Savart, however, did find an increase of $\frac{1}{305}$ th and $\frac{1}{273}$ rd in the weight of the metal, and a decrease in sp. gr. to 7.792 in the latter case and 8.866 in the former. C. Despretz also recorded a fall in sp. gr. to 5.5, and he stated that the metal became porous and crystalline and assumed various tints of grey, yellow, green, orange, and rose-red or purple-red. Although the amount of foreign matter in the copper so treated is very small, the metal probably takes up a large quantity of nitrogen during the operation, and gives it up again. C. H. Pfaff analyzed the gas which had passed over the heated metal, and instead of obtaining hydrogen and nitrogen in the ratio of 3 : 1, he obtained a ratio more nearly 3 : $\frac{1}{2}$, showing that some nitrogen must have been taken up by the copper. A. Schrötter and C. W. J. Kastner contradict these reports, and claim that on repeating these experiments they found rather a deficiency in the hydrogen than in the nitrogen, and that if ammonia gas is passed into molten copper, the metal retains its characteristic properties. H. N. Warren also reported the formation of a nitride by heating copper or copper oxide to bright redness in ammonia gas. C. Matignon and R. Trannoy also believed copper nitride is formed when a red-hot copper spiral is introduced into ammonia or a volatile amine. G. T. Beilby and G. G. Henderson repeated the experiments, and showed that the results are consistent with the assumption that a nitride is formed and decomposed in the reaction because the nitride can exist only within a comparatively narrow range of temp. The evidence turns on (i) the ammonia is decomposed into its elements; (ii) the copper suffers a marked change in its physical properties—*e.g.* it loses its metallic lustre, it acquires a pink colour, it develops a spongy structure, and it becomes brittle; and (iii) the maximum quantity of nitrogen fixed by the copper was 4.5 per cent.—the nitride Cu_3N requires 6.86 per cent. Ammonia was found to penetrate the metal quickly, for a copper rod, $\frac{1}{2}$ in. in diam., was attacked through the centre when heated 30 mins. in a stream of ammonia; copper at 800° for seven days was reduced to a fine spongy powder. R. Blondlot heated a disc of copper and a disc of platinum about 3 or 4 mm. apart in an atm. of nitrogen contained in a porcelain globe, the surface of the copper remained bright, that of platinum was much corroded and covered with a black deposit. Since no such result is obtained in an atm. of hydrogen, it is suggested that a nitride of copper is formed and volatilized.

In a well-known process for preparing nitrogen (*q.v.*) a mixture of ammonia and air is passed over heated copper, the hydrogen is oxidized to water, and free nitrogen remains. A soln. of ammonia dissolves copper if air be present. E. Yamasaki studied the rate of dissolution of copper in aq. ammonia, and he represented the reaction by the equation $\text{Cu} + n\text{NH}_3 + \frac{1}{2}\text{O}_2 + \text{H}_2\text{O} = \text{Cu}(\text{NH}_3)_n(\text{OH})_2$, where n is probably 4. W. R. E. Hodgkinson and H. E. Bellairs detected the formation of nitrous acid a few minutes after the reaction had commenced; in time, the ammonia is completely oxidized. M. Prud'homme made some observations on this subject. The phenomenon was noted by T. Bergmann and by L. J. Proust. According to C. F. Schönbein, and N. A. E. Millon, the copper is oxidized to cupric oxide and the ammonia to ammonium nitrite; and M. Berthelot and L. P. de St. Gilles said that the copper takes up twice as much oxygen as the ammonia. E. M. Péligot noted that heat is developed during the reaction, while S. Kappel found that the reaction progresses more quickly as the temp. rises. M. E. Schweizer says that the action is favoured by some drops of aq. ammonium chloride; W. Knop, by a little platinum chloride; S. Kappel, by carbon dioxide; and C. R. A. Wright, by iron. C. R. A. Wright and C. Thompson believe that the primary reaction which occurs when metallic copper, immersed in aq. ammonia, is exposed to a

limited supply of air, is the dissolution of the metal as cuprous oxide; this reaction is very slow if the liquid be at rest. They said:

The reaction can be greatly accelerated by arranging horizontally, near the surface of the liquid, a plate, termed the "aeration" plate, of platinum or other conductor not acted on under the circumstances, and joining this to the copper by a wire. The voltaic element thus formed polarizes rapidly unless the external resistance is very high. Its electromotive force varies from 0.5 to 0.6 volt, and increases with the conc. of the ammonia soln., or when sodium or ammonium chloride is added thereto, or when spongy platinum is substituted for the platinum plate. In the latter case, and with strong ammoniacal brine, it may amount to 0.8 volt, nearly equalling that due to the heat of formation of cuprous oxide (40.810 Cals.), or 0.88 volt.

W. Traube and A. Biltz¹⁹ found the oxidation of the ammonia to nitrite is favoured by the electrolysis of the ammoniacal soln., containing a little copper hydroxide in soln. The cathode was spongy copper and the anode a strip of iron or platinum; a certain amount of free alkali should be present. If an excess of ammonia be present, about eleven per cent. of nitrite can be formed before it begins to oxidize to nitrate. E. Müller and F. Spitzer add that the oxidation to nitrate does not cease when a certain conc. has been reached, but proceeds quite independently of the nitrite conc. If no alkali hydroxide is present, the oxidation of nitrite to nitrate proceeds more rapidly than the oxidation of ammonia to nitrite, and the conc. of the latter tends to decrease; nitrogen is said to be formed during the oxidation. The presence of hydrogen peroxide was found by W. R. E. Hodgkinson and A. H. Coote to favour the action of ammonia on copper. C. Häussermann found that if alcohol be present, some acetaldehyde is formed.

G. Gore found that liquid ammonia gives a blue soln. with copper; E. C. Franklin and C. A. Kraus also found that copper is attacked by liquid ammonia if air be present; but C. A. Seely, and F. M. G. Johnson and N. T. M. Wilshire say that copper is insoluble in liquid ammonia free from water, and even if water be present, it is insoluble provided no free oxygen be present. According to T. Weyl and J. Bronn, a colloidal soln. of copper in liquid ammonia is obtained by dissolving cupric chloride in the liquid, and treating the soln. with one of sodio-ammonium. G. Arth and E. Divers found copper is not dissolved by Divers' fluid if air be excluded.

The solubility of copper in soln. of **ammonium chloride** or **ammonium cupric chloride** was studied by T. Carnelley and J. Schlerschmann, W. R. E. Hodgkinson and A. H. Coote, *vide* Table V. Hammered copper, and copper reduced in hydrogen were found by F. Osmond to give the same rise of temp. when dissolved in ammonium cupric chloride. For the electrolysis of ammonium chloride soln. *vide supra*. The solubility in ammonium nitrate soln. is indicated in Table V. According to M. Prud'homme, a cold **ammonium nitrate** soln. gives nitric oxide, and an ammoniacal soln. of ammonium nitrate gives nitrogen. W. R. E. Hodgkinson, N. E. Bellairs, and A. H. Coote found that molten ammonium nitrate attacks copper with the evolution of ammonia and a little hydrogen; M. Traube has studied the formation of ammonium cupric carbonate by the action of a soln. of **ammonium carbonate** on copper in the presence of hydrogen peroxide; he likens the reaction to that which occurs with dil. sulphuric acid: $\text{Cu} + (\text{NH}_3)_2\text{CO}_3\text{H}_2 + \text{O}_2 = \text{H}_2\text{O}_2 + \text{Cu}(\text{NH}_3)_2\text{CO}_3$; followed by $\text{H}_2\text{O}_2 + \text{Cu} + \text{H}_2\text{CO}_3(\text{NH}_3)_2 = \text{Cu}(\text{NH}_3)_2\text{CO}_3 + 2\text{H}_2\text{O}$. If any active oxygen were here formed, ammonium nitrate would be produced; but none has been observed. J. Tafel found a soln. of **hydroxylamine sulphate** in sulphuric acid does not act on copper sponge or on a copper cathode; A. Flaschner says reduction occurs, but, add J. Tafel and H. Hahl, only when the soln. about the cathode is too feebly acid.

According to P. Sabatier and J. B. Senderens,²⁰ **nitrous oxide** does not act on reduced copper at 200°, but the gas is oxidized above 250° with the formation of nitrogen and cuprous oxide. With a mixture of hydrogen and nitrous oxide, P. Sabatier and J. B. Senderens found that reduced copper at 180° gave nitrogen, but no

ammonia, where the hydrogen is in excess; and if the oxide be in excess, higher nitrogen oxides and a little ammonia are formed, and a slight inflammation. F. Emich found **nitric oxide** is quantitatively reduced by red hot copper; and P. Sabatier and J. B. Senderens found that with compact copper there is only a superficial film of oxide formed at a dull red heat, while with reduced copper the gas is slowly reduced even at 200° —cuprous oxide is formed. T. Gray removed nitric oxide from gases by passing the mixture over heated copper. A mixture of nitric oxide and hydrogen over 180° was found by P. Sabatier and J. B. Senderens to give a mixture of ammonia, water, and nitrogen. The same investigators found that **nitrogen peroxide**, NO_2 , forms a brown copper nitroxyl, Cu_2NO_2 , when in contact with freshly reduced copper warmed to 30° ; and at 250° cupric oxide and nitrogen are formed, and the reaction is attended by a feeble glow. A mixture of nitrogen peroxide and hydrogen behaves like a mixture of hydrogen with nitric oxide, and if the proportion of peroxide is increased, ammonium nitrate and nitrite are formed, and when the proportion exceeds a certain limit, the metal becomes incandescent and an explosion occurs. The action of nitrogen peroxide on copper was studied by H. V. Tarton and W. L. Semon. E. Divers and T. Shimidzu found that spongy copper sealed up with liquid nitrogen peroxide in a tube at first gives a brisk effervescence owing to the escape of nitric oxide, the action soon subsides and the copper turns grey with a greenish or bluish tinge. The excess of nitrogen peroxide becomes an intense deep green which is not due to dissolved copper, because the colour disappears when the liquid is partially evaporated. It was believed that the product of the action was insoluble cuprous nitrate mixed with little cupric nitrate. P. T. Austin says copper does not burn in **nitric acid vapour**. P. Sabatier and J. B. Senderens found mixtures of nitric acid vapour and hydrogen behave like mixtures of hydrogen and nitrogen peroxide when treated with reduced copper at 180° . J. J. Sudborough found that **nitrosyl chloride**, NOCl , is not attacked by copper in the cold, but at 100° it forms a black deliquescent powder: $\text{CuCl}\cdot\text{NOCl}$, which decomposes when heated to 100° , or, when allowed to stand over sulphuric acid for several hours, giving off nitric oxide, and leaving a residue of anhydrous cupric chloride: $\text{CuCl}\cdot\text{NOCl}=\text{NO}+\text{CuCl}_2$.

The rate of corrosion and soln. of metals by different acids—hydrochloric, sulphuric, perchloric, phosphoric, and acetic acids—in the presence of oxidizing agents, led O. P. Watts and N. D. Whipple to class the metals: (1) Metals whose potentials exceed the discharge potential of hydrogen; and (2) Metals whose potentials are less than the discharge potential of hydrogen. The former are above hydrogen in the electrochemical series, and, excepting such as form insoluble salts, they dissolve readily in the acid; the latter occur below hydrogen in the electrochemical series, and dissolve in acids only in the presence of oxidizing agents—*e.g.* copper and silver. The superiority of nitric acid as a solvent for the metals is due to its acting at the same time as an acid and as an oxidizing agent; this enables it to dissolve metals of the second class which non-oxidizing acids are unable to do.

V. H. Veley²¹ has shown that copper rapidly dissolves in **nitrous acid**, less rapidly in a mixture of nitrous and nitric acid, and still less rapidly in nitric acid alone. The metal also readily dissolves in one per cent. nitrous acid. According to E. Divers and T. Haga, hydroxylamine is formed when copper is left in contact with the green soln. of copper sulphate and potassium nitrate. O. Flaschner found that nitrous acid is completely reduced by low cathode potentials—*e.g.* with a copper cathode, nitrous and nitric acid are reduced to ammonia, no hydroxylamine is formed. W. Peters found a 5 per cent. aq. soln. of **sodium nitrite**, in the absence of air, is decomposed, with the evolution of nitrous and nitric oxides and the formation of sodium nitrate, when warmed at 60° with metallic copper. The reaction is chemical, not catalytic, and involves simultaneous oxidation and reduction.

Chemistry, said V. H. Veley, presents few problems at once of such technical importance and of such almost infinite complexity as the transformations of nitric

acid. Ordinary dil. **nitric acid** is regarded as one of the best solvents for copper, but V. H. Veley showed that when a sphere of copper is rotated in dil. nitric acid, there is a period of inertness during which no bubbles of gas are evolved from the metallic surface for some minutes; this period of inertness is followed by a period of acceleration during which the dissolution proceeds with a gradually increasing velocity until a steady stage is attained. The metal then dissolves readily in 27·5 per cent. nitric acid with the evolution of nitric oxide, and gives a soln. of cupric nitrate: $3\text{Cu} + 8\text{HNO}_3 = 3\text{Cu}(\text{NO}_3)_2 + 2\text{NO} + 4\text{H}_2\text{O}$. Nevertheless, nitric oxide, NO, is not the only gaseous product of the reaction between nitric acid and copper; for example, P. C. Rây found that a considerable quantity of *nitrous oxide*, N_2O , is formed when copper dissolves in nitric acid under ordinary conditions employed in preparing nitric oxide; he also said that some *nitrogen* is formed. The green colour of the soln. in the vicinity of the copper appears deep green, indicating that possibly some *copper nitrite*, as well as nitrate, is formed. According to C. Montemartini, dil. nitric acid, below 30 per cent. conc., yields only nitric oxide and nitrous acid; with a more conc. acid, *nitrogen trioxide* and peroxide are formed, so that with 50 per cent. acid only about half the gaseous product is nitric oxide.

J. H. Stansbie found the volume of gas (calculated dry at n.p.t.) generated from a gram of purified copper in 15 c.c. of nitric acid of sp. gr. 1·2 increased with temp. and the contained nitric oxide also increased a little at the expense of the other gases. The speed of the reaction increased 25-fold as the temp. rose from 25° to 95°.

Temp.	25°	35°	45°	55°	65°	75°	85°	95°
Time, <i>t</i> min.	56	30	16	6	5	5	4	3
Vol. of NO c.c.	137·5	139·5	153·0	163·0	176·0	182·0	185·0	192·0
Vol. of gas, <i>v</i> c.c.	142·0	145·5	157·0	167·0	179·0	185·0	186·0	193·5
Velocity <i>v/t</i>	2·5	4·8	9·8	27·8	35·8	37·0	45·5	64·5

J. J. Acworth and H. E. Armstrong investigated the influence of temp. and the conc. of the nitric acid on the composition of the gases, and a selection from their results is indicated in Table VIII.

TABLE VIII.—GASEOUS PRODUCTS OF THE ACTION OF NITRIC ACID ON COPPER.

Temp.	Concentration of acid. Acid : water.	Vol. of gas per unit wt. of metal.	Percentage composition of gas.		
			NO	N_2O	N .
15°	1 : 0	434	54·00	10·30	35·70
15°	1 : 1	8574	98·26	1·15	0·67
13°	1 : 2	15272	97·86	1·47	0·74
12°	1 : 4	12192	94·28	3·57	2·15
16°	1 : 8	12845	71·89	20·74	7·37
8°	1 : 2	8584	96·86	0·30	2·81
11°	1 : 2	13879	97·33	1·55	1·12
50°	1 : 2	9683	96·98	2·27	0·75
90°	1 : 2	14261	97·23	1·82	0·95

There is not much difference in the results with the 1 : 1 and the 1 : 2 acids; the amounts of nitrous oxide and nitrogen increase, while the amount of nitric oxide decreases as conc. of the acid decreases. The metal dissolves in acid more quickly at an elevated temp., but the composition of the gas is not much different from that obtained at ordinary temp. With conc. soln. of cupric nitrate and acid, J. J. Acworth obtained a gas with 85 per cent. of nitrous oxide with some nitric oxide, nitrogen, and he also detected the formation of ammonium nitrate. J. H. Stansbie reported the formation of ammonia, but G. O. Higley could detect no signs of the production of ammonia in the action of nitric acid on copper; and

C. Montemartini could find no ammonia when using between 3.0 and 27.5 per cent. acid. He also found that *nitrogen peroxide* only is obtained from 70 per cent. nitric acid. L. S. Bagster found that gas evolved with 14.5*N*-nitric acid, contains 85–90 per cent. of nitrogen peroxide, and the residue is nitrogen trioxide; with 10*N*-acid there is about 15–20 per cent. of nitrogen peroxide. P. C. Freer and G. O. Higley also said that the sole products of the action of nitric acid of sp. gr. 1.40, on copper, are nitrogen trioxide and peroxide approximately in the proportion 1 : 9; and as the sp. gr. of the acid is reduced by dilution, G. O. Higley found the proportion of nitrogen peroxide decreases and that of nitrogen trioxide rapidly increases until, when the sp. gr. falls below 1.25, nitrogen trioxide is alone produced. The nitric oxide is supposed to be a product of the decomposition of nitrogen trioxide and peroxide. This has been confirmed by L. S. Bagster.

According to G. P. Baxter and C. H. Hickey, if platinum be mixed with the copper, a steady stream of nitric oxide is obtained by dropping nitric acid of sp. gr. 1.2 on the metal; and O. Brunck noted the accelerated action of the acid on copper in contact with platinum. J. H. Stansbie examined the effect of mixing and of alloying the copper with arsenic, antimony, and bismuth on the reaction of the metal with nitric acid of sp. gr. 1.2 at 65°, and found that the results are modified "out of all proportion with the quantity of impurity present." With arsenic, the amounts of gas and of nitric oxide formed with alloys rapidly fall to a minimum with alloys containing 0.25 per cent. of arsenic, or 0.5 per cent. of antimony, and then steadily increase as the proportion of impurity increases up to 10 per cent.; with bismuth, there is a steady fall in the proportions of each gas for alloys ranging up to 10 per cent. impurity. The production of nitrous acid during the reaction was also measured. A. J. Hale and H. S. Foster also studied the action of nitric acid on copper.

In accord with A. de la Rive's view that the dissolution of a metal in an acid depends on the formation of local elements between an impurity in the metal, the metal, and the acid, say $\text{Cu}|\text{HNO}_3|M$, T. Ericson-Aurén and W. Palmacr claim that the addition of anything which increases the e.m.f. of the combination—(i) the addition of certain metal salts, depolarizers, etc.; and (ii) variations in the nature of the negative element *M*—increases the rate of dissolution, and conversely. H. E. Armstrong has adopted a modification of this hypothesis for chemical reactions in general.

The various gaseous products are the result of complex changes taking place both between the nitric acid and its reduction products, and between these products *inter se*. If the nitric acid be freed from all traces of nitrous acid by passing a rapid current of air into nitric acid, sp. gr. 1.41, sheltered from direct sunlight, and at 35°, and diluted to the given conc., the metal remains unacted upon until nitrous acid is formed, when a brisk evolution of gas occurs; if some agent—say, urea, hydrogen peroxide, potassium chlorate, potassium permanganate, etc.—be introduced into the acid so as to destroy any nitrous acid, the metal is not dissolved at 27°, provided it and the acid be kept agitated. Hence it is inferred that nitric acid free from nitrous acid does not dissolve copper. The presence of nitrous acid is necessary for the dissolution of the metal. N. A. E. Millon had previously emphasized the fact that the reaction between nitric acid and the metals is promoted by the presence of nitrous acid which is produced by passing a few bubbles of nitric oxide into the acid: $2\text{NO} + \text{HNO}_3 + \text{H}_2\text{O} \rightleftharpoons 3\text{HNO}_2$, or adding a few drops of a soln. of a nitrite. The reaction was also shown to be hindered by the presence of such substances as ferrous sulphate which removes the nitrous acid as fast as it is formed. He showed that the oxidation of copper by nitric acid is conditioned by (i) the conc. of the acid; (ii) the temp.; (iii) the presence of nitric oxide; and (iv) the solubility of the products of the reaction in the acid. He thus explained the course of the reaction:

La marche générale des oxydations s'explique sans peine; l'acide nitreux forme des nitrites de cuivre, de mercure, d'argent qui sont détruits par l'acide nitrique à mesure

qu'ils se forment ; cette destruction donne naissance au deutoxide d'azote qui, retrouvant de l'acide nitrique refait de l'acide nitreux ; d'où résulte une nouvelle attaque et une nouvelle destruction.

The nitrous acid is thus regenerated, $2\text{NO} + \text{HNO}_3 + \text{H}_2\text{O} = 3\text{HNO}_2$, as fast as it is destroyed : $3\text{HNO}_2 = 2\text{NO} + \text{HNO}_3 + \text{H}_2\text{O}$. This makes it appear as if a metallic nitrite and nitric oxide are among the first products of the reaction, the nitrite is decomposed by the excess of nitric acid to form nitrous acid, and the nitric oxide reduces some nitric acid to form nitrous acid. E. Divers also found that nitrogen trioxide, N_2O_3 , acted as a stimulant—possibly owing to its forming nitrous acid. C. Montemartini represented the first stage of the reaction between dil. nitric acid and copper by the equation : $\text{Cu} + 3\text{HNO}_3 = \text{Cu}(\text{NO}_3)_2 + \text{HNO}_2 + \text{H}_2\text{O}$, and nitric oxide is a result of the decomposition of the nitrous acid : $3\text{HNO}_2 = \text{HNO}_3 + 2\text{NO} + \text{H}_2\text{O}$. In the period of inertness, nitrous acid is being formed, and during the period of acceleration, the rate of production of nitrous acid is greater than its rate of destruction, and in the steady state, the rates of production and destruction are the same. A revolving ball of copper was immersed in 29.86 per cent. nitric acid, at 27° to 27.2° , and V. H. Veley found that the amounts of nitrous acid expressed in mgrms. per c.c. at different periods of time were :

Time (min.)	0	2	11	30	60	90	105	120
Mgrms. HNO_2	0.0042	0.015	0.064	0.111	0.124	0.166	0.195	0.195

If copper be introduced into nitric acid which already contains sufficient nitrous acid, there is no period of inertness ; the reaction starts immediately. The speed of the dissolution of the metal by nitric acid is proportional, not to the quantity of nitric acid, but rather to the amount of nitrous acid which may be present, the two magnitudes vary concomitantly provided a large excess of nitric acid is present. R. Ihle showed that nitric acid just under 8*N*-conc., or 35 per cent. nitric acid by vol. attacks copper without nitrous acid being present. According to M. Drapier, for nitric acid of a given conc., the amount of copper dissolved in a given time is very considerably reduced by shaking or rotating the copper, and if the velocity of rotation is increased sufficiently, may be reduced practically to zero. This is not due to the destruction of local heating effects, since the flow of cold water through a copper tube has no effect on its rate of soln. in nitric acid. The effect is supposed to be due to the distribution of the nitrous acid primarily produced at the surface of the metal, and to the consequent inhibition of its catalyzing effect on the soln. The addition of increasing quantities of sodium nitrite to the nitric acid gradually nullifies the shaking effect.

L. Gmelin explained the reaction by assuming that the nitric acid first oxidizes the metal. The resulting oxide then combines with undecomposed acid to form a salt, and the portion of the acid which oxidizes the metal may be converted into nitrogen peroxide, nitric oxide, nitrous oxide, or nitrogen. If the metal at the same time decomposes water, the resulting hydrogen may produce ammonia. The nature of the products thus depends partly on the affinity of the metal for oxygen, and partly on the temp. and conc. of the acid. J. J. Acworth and H. E. Armstrong hold that the reduction of the acid is due to the displacement of hydrogen from the acid, by the metal, the successive stages in the reduction of nitric acid being \rightarrow nitrogen peroxide \rightarrow nitrous acid \rightarrow nitrous oxide \rightarrow hyponitrous acid \rightarrow hydroxylamine \rightarrow and ammonia. H. E. Armstrong adds that " the primary product of the reduction of nitric acid is nitrous acid, whatever be the nature of the reducing agent, be it hydrogen, or metal, or arsenious acid." E. Divers divides the metals into two classes, according to their behaviour with nitric acid : (1) Those which furnish a nitrite or nitrate but exert no further action, forming neither ammonia nor hydroxylamine. This class is typified by silver, mercury, bismuth, copper, etc. The second class includes (2) Those which form ammonia and generally also hydroxylamine, but do not yield nitrite or nitrous acid ; on the other hand, they readily

form nitrite by acting on their own nitrate. The members of this class are typified by tin, zinc, and other metals with strongly marked basic properties. V. H. Veley does not believe the distinction is valid because when the members of both classes enter into reaction with nitric acid, nitrous acid is formed immediately after chemical change, and that too in the presence of considerable amounts of nitric acid; but he adds that "it is probable that the *amount* of reaction between the metal and the nitric acid is dependent on the proportion of nitrous acid in the case of members of the first class but not of those of the second class." G. N. Lewis and A. Edgar studied the equilibrium between nitric acid, nitrous acid, and nitric oxide. J. J. Acworth and H. E. Armstrong attribute the production of nitrous oxide and nitrogen to secondary reactions, and E. Divers agrees with this, and added:

Nitrous acid is actually formed as a secondary product when some of the nitrite actually produced, that is, produced in the primary action, is decomposed by nitric acid. This decomposition occurs (a) when, as at first, there is not the requisite proportion of nitrous acid already present, and (b) when there is not enough water present to preserve the nitrite from the action of the nitric acid. *Nitric peroxide* appears as a secondary product when the proportion of water is so low that nitrous acid interacts with nitric acid. Lastly, *nitric oxide* results as a secondary product when the proportion of water to nitric acid is so large that the nitric acid fails to prevent the nitrous acid decomposing into this substance and nitric acid: $3\text{HNO}_2 = \text{HNO}_3 + 2\text{NO} + \text{H}_2\text{O}$. The accordance of these assertions with well-known facts is incontrovertible.

J. J. Acworth and H. E. Armstrong found the reduction of nitric acid to be more complete the more dil. the soln. This is in harmony with the observation that the e.m.f. of copper against platinum in conc. nitric acid, sp. gr. 1.5, is greatest, 0.98 volt; and it falls to 0.57 volt with an acid of sp. gr. 1.42; the addition of an equal volume of water raises the e.m.f. to 0.75 volt; and with 3 to 7 volumes of water, the e.m.f. is raised to 0.81 volt. M. Faraday showed that nitric acid is not a good conductor when pure, but the presence of nitrous acid (conjointly with water) gives it this power in a very high degree amongst electrolytes. G. J. Burch and V. H. Veley have also shown that the e.m.f. of a $\text{Cu}|\text{HNO}_3|\text{Pt}$ cell is dependent on the conversion of nitric to nitrous acid. The e.m.f. is at first very small; it then rises slowly; then more or less rapidly; and finally very slowly to a maximum value. The effects of the conc. of the acid, temp., and presence of nitrous acid were also investigated.

During electrolysis, a dil. soln. of nitric acid is quantitatively reduced to ammonia at the cathode, and this fact has been utilized in the quantitative determination of the nitrates. The conditions for successful work have been studied by C. Luckow, G. Vortmann, K. Ulsch, A. Becker, W. H. Easton, and L. H. Ingham. The action is eq. to a nascent hydrogen reduction: $4\text{H}_2 + \text{HNO}_3 = \text{NH}_3 + 3\text{H}_2\text{O}$. On the other hand, copper reduces nitric acid chemically, not to ammonia, but to nitric oxide, yet it does reduce nitrobenzene to aniline. J. Girard found that a mixture of commercial nitric acid with 7 to 12 times its volume of commercial sulphuric acid dissolves silver from silver-plated copper without attacking the copper. According to J. Tafel, a mixture of nitric and sulphuric acids reacts with copper, forms nitric oxide: $2\text{HNO}_3 + 3\text{Cu} + 3\text{H}_2\text{SO}_4 = 3\text{CuSO}_4 + 2\text{NO} + 4\text{H}_2\text{O}$, and neither ammonia nor hydroxylamine is produced; whereas in the electrolytic reduction, hydroxylamine is formed—if the sulphuric acid be omitted, ammonia is produced. J. Tafel's general conclusion from these and other reactions is that electrolytic reduction is distinct in nature from chemical reduction. W. D. Bancroft takes the opposite view; he argues that the peculiarity of an electrolytic reduction is that the process occurs in two places, at the anode and at the cathode, and this peculiarity is less marked by bringing the electrodes closer together until, at the limit, the electrolytic and chemical processes are the same. In illustration, when copper is dissolved in sulphuric acid, the formation of copper sulphate is the anode reaction, and the reduction of sulphuric acid the cathode process. J. W. Turrentine concluded from his study: *Copper cathodes in nitric acid*, that the apparent discrepancy between

the electrochemical and chemical reduction of nitric acid by copper is entirely due to the different conditions under which the two sets of reactions are performed. In the electrolytic reduction of nitric acid with a copper cathode, the reaction occurs in a soln. practically free from a copper salt; while in the chemical reduction by copper in nitric acid, the copper nitrate is formed at the same place that the reduction occurs. He showed that ammonia is formed in the reaction between copper and nitric acid when the conc. of the copper salt is kept sufficiently low. The reduction of nitrates to nitrites in neutral or feebly alkaline soln. depends on the nature of the cathode—*e.g.* gold, platinum, lead, or iron cathodes give ammonia as the main product; and E. Müller and J. Weber found that spongy copper, spongy silver, or an amalgamated copper cathode give nitrites. E. Müller and F. Spitzer further showed that the chemical behaviour runs parallel with the depolarization values, even though E. Müller, J. Tafel, and R. Russ have shown that these values are not always trustworthy because of catalytic effects due to the metals. F. Pearce and C. Couchet found that alkali nitrates are not reduced with an alternating current and copper, iron, or carbon electrodes, but with cadmium and zinc electrodes the reduction to nitrites is quantitative. J. H. Gladstone and A. Tribe's copper-zinc couple reduces a soln. of potassium nitrate to nitrite and then to ammonia—a process analogous with E. Müller and F. Spitzer's electrolytic reduction with a copper cathode. T. E. Thorpe developed a quantitative method for the reduction of nitrites to ammonia by working in hot soln., and he showed that small quantities of ammonia are produced in the reduction of nitrates by finely divided copper. J. F. Persoz, H. Müller and C. Pauli, and H. Kunheim found that finely divided copper reduces molten alkali nitrates quantitatively to nitrites. E. Divers showed that *cupric nitrate* is reduced by copper to cuprous nitrate. For the effect of alkali nitrate or *ammonium nitrate* soln. on copper, *vide* Table V. T. Fairley showed that copper and, indeed, many other metals dissolve with increased facility in acids containing hydrogen peroxide, and that no gaseous products are evolved in those cases where they would otherwise be obtained, and the metal dissolves quietly without losing its metallic brilliancy. This enables many of the non-ferrous metals to be dissolved in nitric acid without being troubled with the escape of nitrous fumes.

The passivity of copper.—In 1837 T. Andrews²² found that copper rod in nitric acid of sp. gr. 1.4 is rapidly attacked, but if the rod be touched by platinum under the liquid, the soln. in the acid is checked, although the surface remains bright so long as contact with the platinum is maintained. If the platinum be removed, the metal remains in the "peculiar state" which enables it to resist chemical action, and it becomes covered by a black film which is very slowly removed by the acid. M. Faraday pointed out that this action is the reverse of that which would be anticipated from an application of the theory of galvanic couples, for the platinum would be expected to make the copper more electropositive and so dissolve quicker. If the copper, while covered with the film be raised from the liquid, the adherent acid immediately dissolves away the film of what T. Andrews supposed to be oxide, and the copper is now in its ordinary state. T. Andrews found that the peculiar state of the metal is developed in nitric acid of sp. gr. 1.5. When alone in acid of sp. gr. 1.47, there is at first a violent action, and the copper then acquires the peculiar state whereby it is but slowly soluble in the acid. If a strip of passive copper and a strip of ordinary metal be suspended in distilled water, the former remains bright for three or four weeks, the latter is covered by a film of oxide in three days, and is completely oxidized in three weeks. If a piece of passive copper immersed in distilled water is scratched with a glass rod, the scratched part begins to oxidize in a couple of days, the rest of the surface remains bright. Ordinary copper treated in the same way shows no difference between the scratched and unscratched parts. Again, if pieces of active and passive copper be dipped in a 0.1 per cent. soln. of silver nitrate, the former is at once coated with a furry grey deposit of silver, while the latter remains unchanged for three or four minutes.

W. Heldt attributes the protective action to a film of cupric nitrate, E. Jordis to the passage of the metal into a metalloidal state; W. R. Dunstan and J. R. Hill to the formation of a non-metallic film, probably oxide; C. W. Bennet and W. S. Burnham to the coating of the metal by adsorption with a film of higher oxide which, being more noble than the metal, protects it from the soln.; G. D. Bengough and O. F. Hudson believe the film is a lower oxide, possibly Cu_2O , which is stabilized by the copper—*vide* the passivity of iron. Copper can be rendered passive by immersion in a one per cent. soln. of chromic acid, potassium dichromate, or chromate for 12 hrs., and washing in distilled water. According to W. A. Hollis, the copper loses its passivity in nitric acid if the temp. exceeds 10° , and the critical temp. is affected by the degree of purity of the metal. G. Wiedemann, G. Berson and A. Destrem, and E. Duter found that a copper anode is rendered passive during the electrolysis of a 50 per cent. soln. of potassium or sodium hydroxide; E. Müller thus describes the behaviour of a copper anode in a conc. soln. of sodium hydroxide:

When a clean copper plate is immersed in a 1*N*-soln. of sodium hydroxide which is free from dissolved oxygen, the copper is negative compared with the soln.; measured against the $\frac{1}{10}$ *N*-calomel electrode its potential is -0.66 volt. When a very small current, 2×10^{-6} amp. per sq. cm., is passed, the potential rises at first slowly, then rapidly to about -0.54 volt. If electrolysis is continued with a larger current density, a blue soln. of cupric hydroxide is formed, and the potential rises again, at first slowly, then rapidly to $+0.76$ volt, at which point oxygen is evolved and copper ceases to be dissolved. The first rise is accompanied by the formation of a skin of cuprous oxide, the second by the formation of a skin of cupric oxide. During the last period, a little copper peroxide is always formed. In the earliest period, the change $\text{Cu} + \text{F} \rightleftharpoons \text{Cu}^{\cdot}$ takes place; when the soln. is sat. with cuprous ions, which very soon occurs, a skin of cuprous oxide forms, and the potential rises to the point at which the reaction $\text{Cu}^{\cdot} + \text{F} \rightleftharpoons \text{Cu}^{\cdot\cdot}$ can occur; this goes on until the soln. (in contact with the anode) is sat. with cupric hydroxide; owing to the greater solubility of this substance, this stage lasts longer or requires a larger current; when the skin of solid cupric oxide is formed, the potential again rises until the reaction $\text{Cu}^{\cdot\cdot} + \text{F} = \text{Cu}^{\cdot\cdot\cdot}$ occurs. The peroxide is, however, unstable, and decomposes spontaneously, giving off oxygen.

O. W. Brown and F. C. Mathers found that the copper anode may become passive during the electrolysis of potassium sodium tartrate, and instead of dissolving "becomes covered with a thin coating probably of cuprous oxide"; R. Lorenz, that the passive state is induced by molten alkali hydroxides; and M. le Blanc, that a copper electrode which has been heated in the flame of a blowpipe until fusion begins, and then quenched in alcohol, has a smooth even surface; it is in a noble or passive condition in a soln. of cupric sulphate; and it gives a difference of potential of 13 millivolts against ordinary copper. The passive state is removed by treatment with nitric acid. M. le Blanc and K. Schick found that when an alternating current, of current density 4.6 amp. per sq. decm., is passed through a 4*N*-soln. of potassium cyanide between copper electrodes, the amount of copper which dissolves depends on the frequency of the current alternations, the conc. of the soln., the current density, etc. With a frequency 700 per min. the copper went quantitatively into soln., with 3400 per min., 91 per cent. of the theoretical; with 17,600 per min., 58 per cent.; and with 38,600 per min., 33 per cent. With a $\frac{1}{10}$ *N*-soln., current density 2.3, and frequency 40,000 per min., no copper passes into soln. A. Brochet and J. Petit obtained similar results. The diminution in the amount of copper which passes into soln. has been ascribed to a passive condition of the metal; A. Löb explains the phenomenon as a result of over-voltage—as the over-voltage increases, the amount of hydrogen liberated by the current decreases, and, as a consequence, the amount of copper liberated will increase. The phenomenon is more pronounced with a zinc electrode and less pronounced with a nickel electrode than with one of copper; this corresponds with the higher over-voltage of the zinc electrode and the lower over-voltage of the nickel electrode over one of copper.

From the heat of the reaction, and the contraction which occurs during

combination, W. Müller-Erzbach²³ deduced that the affinity of copper for phosphorus is smaller than that of palladium, platinum, or iron, and greater than that of manganese, nickel, cobalt, zinc, silver, or gold. According to W. Straub, phosphorus can react slowly with copper at ordinary temp. A. Granger did not obtain any marked reaction at 360°, but over 400° the copper assumed a grey colour and became very brittle, but the transformation into a definite phosphide is incomplete. O. Emmerling obtained combination by heating the two components in a sealed tube. Many of the metallic phosphides, when heated, react with copper—e.g. E. Defacqz found that tungsten phosphide, WP₂, at 1200°, was completely decomposed by copper. The commercial alloy *phosphor-copper* is made by the action of phosphorus vapour on fused copper, and it contains 9–15 per cent. of phosphorus. Alloys with over 14 or perhaps 15 per cent. of phosphorus cannot be made by the fusion process, although E. Heyn claims to have made alloys with as much as 20 per cent. of phosphorus by mixing copper filings and red phosphorus in crucibles connected together in series like a train of wash-bottles, and heating them one at a time to 300° or 400°—not over 700°—the vapour from the crucible being heated is condensed by the others. Phosphor-copper was made by A. S. Marggraf (1740), and B. Pelletier (1789), from phosphorus and the metal; by B. Pelletier (1789), B. G. Sage (1792), C. Künzel (1888), H. Schwarz (1875), P. Berthier (1826), and P. Mellmann (1888) from copper, carbon, and phosphoric acid or a phosphate—e.g. bone ash; from the reduction of phosphoric acid with copper electrodes, by H. Davy (1807); from copper oxide, carbon, and phosphorus, by H. N. Warren (1887), P. Burckhard (1870), and T. Dill (1897); by G. Seyboth, from the electrolysis of molten phosphates with copper electrodes; from the reduction of cupric phosphate with carbon, by P. Berthier (1826), L. Gnéat and J. Chavanne (1883), and C. Matignon and R. Trannoy (1905); from the reduction of aq. soln. of cupric salts either by electrolysis or by treating them with phosphorus, by D. S. Ashbrook, E. Goerke, A. Oppenheim, A. Joannis, O. N. Heidenreich, and R. Böttger. Phosphor-copper is steel-grey in colour, fine-grained, and brittle; it is so hard that it is filed with difficulty. It is used in making phosphor bronze; and for adding phosphorus to copper which is to be rolled, for the metal then works more uniformly. It probably acts by deoxidizing the cuprous oxide. The addition of a little phosphor-copper to brass mixtures cleans the metal and increases its fluidity. Small proportions of phosphorus make copper hard, copper with 0.05 to 0.10 per cent., and not over 0.04 per cent. oxygen, can be rolled. J. L. Jones gives Brinell's hardness, the tensile strength (lbs. per sq. in.), and the elongation in 2 ins. of copper with different proportions of phosphorus:

P per cent.	. . .	2.5	4.5	6.5	8.5	10	12
Hardness	. . .	92	136.0	197.0	229.0	212.0	223.0
Tenacity	. . .	52,800	69,500	79,000	34,250	26,500	—
Elongation	. . .	28.2	15.2	2.8	0	0	—

F. A. Abel, A. H. Hiorns, E. Munker, H. de Ruolz-Montchal and H. de Fontenay, etc., have studied the properties of these alloys. E. Hcyn and O. Bauer's equilibrium diagram for the binary system, and the *copper phosphides*, are discussed in connection with phosphorus.

According to E. Rubénovitch,²⁴ between 180° and 200° copper is attacked by phosphine, forming copper phosphide. H. Moissan also obtained copper phosphide by heating copper with phosphorus trifluoride; A. Granger, with all three phosphorus halides at a dull red heat; H. Goldschmidt, with phosphorus pentachloride; and B. Reinitzer and H. Goldschmidt, with phosphorus oxychloride. According to H. Rose, finely-divided copper dissolves slowly in molten phosphoric acid. As indicated above, O. P. Watts and N. D. Whipple have studied the action of phosphoric acid on copper. D. Wilson found a conc. soln. of sodium phosphate dissolves no copper.

Copper forms an alloy with arsenic when arsenic is dropped into molten copper

or when a compound of arsenic is melted with copper under charcoal. T. Bergman,²⁵ in the eighteenth century, reported that copper takes up five-sixths of its weight under these conditions. K. Friedrich found that 44 per cent. is the greatest amount of arsenic which can be alloyed with copper by fusion. The mechanical properties of copper are not harmed by small amounts of arsenic; according to W. C. Roberts-Austin, copper with 0.8 per cent. of arsenic can be drawn into the finest wire, but with one per cent. of arsenic, red-shortness appears; as noted by C. J. B. Karsten, much arsenic is injurious, making the metal brittle and hard. P. Jolibois and P. Thomas studied the effect of arsenic on the oxygen content of copper. W. Stahl, E. A. Lewis, G. D. Bengough and B. P. Hill, F. Johnson, R. H. Greaves, L. Archbutt, W. C. Roberts-Austin, P. Oberhoffer, H. D. Law, H. Baucke, etc., have studied the tensile strength, the elongation, and the elastic limit of copper with up to 1.8 per cent. of arsenic. G. D. Bengough and B. P. Hill find :

(1) Arsenic in small quantities tends to increase the maximum stress without affecting appreciably the ductility of these alloys. (2) It increases their resistance to reducing gases at high temp. (3) Alloys with low percentages of arsenic tend to be unhomogeneous, but with increase in the arsenic this ceases to be apparent. (4) In ordinary oxidizing atm. no heat treatment (for three hours or less) short of an approximation to fusion seriously affects the properties of these alloys. The only result of annealing is to render the bars slightly more homogeneous and to lower the yield-point somewhat. This statement, however, does not apply to annealing temp. in the neighbourhood of 1000° C. (5) Alloys containing less than 1 per cent. of arsenic are ruined by the action of reducing gases for three hours at 700° C. or above it; in some cases the action is apparent at 600° C. (6) The yield-points of these alloys are somewhat variable and unsatisfactory.

A. Mathiessen and C. Vogt studied the electrical conductivity, and J. H. Stansbie, the solubility of copper-arsenic alloys in dil. nitric acid. The f.p. curves of mixtures of copper and arsenic have been studied by K. Friedrich and G. D. Bengough and B. P. Hill. K. Friedrich's curve is shown in Fig. 18.

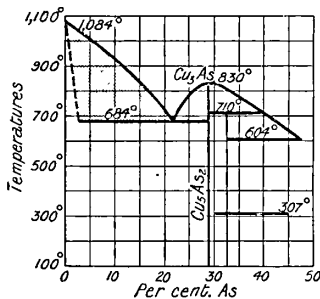

Fig. 18.—Freezing Point Curves of Copper-Arsenic Alloys.

A solid soln. is formed which attains a maximum at 684° with 4 per cent. of arsenic at the terminus of the eutectic line. The eutectic at 684° with 21.5 per cent. arsenic is made up of the solid soln. with 4 per cent. As, and the compound Cu₃As. There is a maximum in the curve for cupric arsenide Cu₂As, at 830°. At 710° there is evidence of the formation of an unstable compound Cu₅As₂ with 32.1 per cent. of arsenic. The eutectic at 604° and the transformation line at 307° have not been definitely settled. G. D. Bengough and B. P. Hill believe there is a series of solid soln. between the two compounds Cu₃As and Cu₅As₂.

C. W. Scheele studied the action of copper on arsenic acid. According to H. Hager, and H. Carmichael, copper separates arsenic from acid soln. of arsenic salts; and, according to E. Priwoznik and K. Heumann, a mixture of arsenic, copper, and sulphur is obtained by treating ammoniacal soln. of arsenic sulphide with copper. The activating of the zinc by introducing a little copper, in Marsh's test for arsenic, has been studied by C. Mai and H. Hurt, A. Gautier, G. Lockemann, Z. de Vamossy, M. Vizern and L. Guillet, E. T. Allen, etc., and A. C. Chapman and H. D. Law found that the reduction of arsenious or arsenic oxide by copper cathodes is not quantitative; H. J. S. Sand and J. E. Hackford obtained no reduction in dil. soln. N. Puschin and E. Dischler have studied the electrical conductivity of these alloys.

Alloys of copper with antimony are prepared in a manner similar to those with arsenic. G. Kamensky prepared a series of alloys and showed that with increasing proportions of antimony, the colour passes from that of copper to violet or purple when between 45 and 75 per cent. of antimony has been added; the colour then

becomes grey. The alchemists called the violet alloys *regula veneris*. The effect of antimony on the mechanical properties of copper resembles that with arsenic. P. Jolibois and P. Thomas found that antimony did not reduce the proportion of copper oxide. The tensile strength of the metal is increased with up to half per cent. of antimony, but when other metals are present, the effects of this small amount of antimony are not necessarily advantageous. As noted by C. J. B. Karstcn, much antimony makes the copper brittle when hot and when cold. Over one per cent. of antimony makes the fracture appear dull yellowish-grey, and its injurious effects are more marked than with arsenic. The tenacity of the copper-antimony alloys has been studied by W. Hampe, E. A. Lewis, R. H. Greaves, L. Archbutt, F. Johnson, H. D. Law, L. Guillet, G. Kamensky, etc. F. Johnson concluded :

(1) Antimony up to 0.5 per cent. has no detrimental influence on the hot-forging qualities of tough-pitch copper free from other impurities. It is even possible to forge copper containing 1 per cent. antimony if sufficient oxygen be present. (2) In copper which has been over-poled, antimony tends to mitigate the phenomenon of spewing during solidification. (3) Tough-pitch arsenical copper (0.4 per cent. arsenic) is slightly hardened after hot-rolling by the presence of antimony (0.2 per cent.), but otherwise its mechanical properties are slightly improved. (4) The mechanical properties of tough-pitch pure copper after rolling and annealing are but slightly altered by small additions of antimony. The tensile strength is slightly raised (5 per cent.), and the elongation lowered (10 per cent.). The slight gain in toughness is probably traceable to the greater soundness of the ingot. (5) With regard to the structural condition of antimony in tough-pitch copper, it exists in two forms: (a) partly in solid soln. (as Cu_3Sb); (b) partly as an insoluble compound with oxygen (slate-coloured oxidules). Oxygen in excess exists as Cu_2O . The latter together with the antimony oxides form a ternary eutectic with the solid soln.

P. Braesco found the mean coeff. of expansion of copper-antimony alloys between 100° and 300° to be a maximum 0.0000234 for alloys with 38.6 per cent. of antimony. The electrical conductivity has been studied by G. Kamensky, E. J. Ball, etc.; the sp. gr. and specific volume by G. Kamensky, E. Macy, etc.; the hardness by A. A. Baikoff; the thermal expansion by H. le Chatelier, and P. Braesco; and the action of dil. nitric acid by J. H. Stansbie. The f.p. curves and the microstructure of the alloys have been studied by J. E. Stead, A. A. Baikoff, G. Charpy, J. A. Mathews, W. Campbell, A. H. Hiorns, W. Guertler, etc. A. A. Baikoff's diagram is shown in Fig. 19.

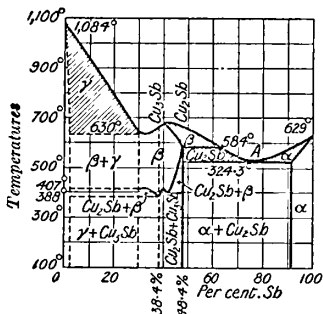

Fig. 19.—Freezing Point Curves of Copper-Antimony Alloys.

Starting from antimony melting at 629° , a solid soln., α , is formed which reaches a maximum with 10 per cent. of copper. The eutectic A, at 524° and 25 per cent. of antimony, is a mixture of the solid soln. α and copper antimonide, Cu_2Sb ; the eutectic line extends to 49 per cent. of antimony. This compound has a purple colour and it is formed at 584° by the union of the grey compound Cu_3Sb with antimony. The latter compound, Cu_3Sb , solidifies at 681° ; and between 681° and 584° the solid soln. β of Cu_3Sb and antimony separates, and at 584° is, in part, transformed into β and Cu_2Sb . The solid soln. β separates unchanged between 46.5 and 31 per cent. of antimony; and above 630° with between 31 and 0.4 per cent. of antimony, there separates out a solid soln. of Cu_3Sb , and a solid soln. γ of copper with 2.5 per cent. of antimony. Below 630° , the solid soln. of Cu_2Sb is transformed into the solid soln. β and γ . Another transformation occurs below 407° , leaving on the antimony side of the ordinate—39 per cent. of antimony—and a mixture of Cu_2Sb and Cu_3Sb , and on the copper side, a mixture of γ and Cu_3Sb .

Alloys of copper with bismuth were prepared by C. M. Marx²⁶ by heating the two metals at a temp. below the m.p. of copper. The f.p. curves have been investigated by H. Gautier, A. H. Hiorns, K. Jeriomin, C. T. Heycock and F. H. Neville, and A. Portevin. The general conclusion is that there are neither compounds nor solid soln. There is a V-shaped curve with a eutectic at 0.25 per cent.

of bismuth—Fig. 20—where the scale is too small to show the eutectic. H. Gautier's curve, with two eutectics and a maximum corresponding with copper bismuthide, CuBi, is probably wrong. The eutectic is prone to undercooling. As indicated

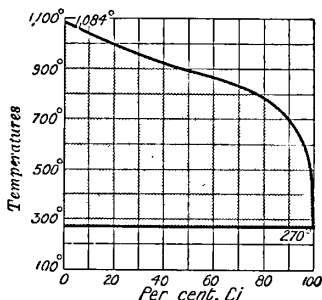

FIG. 20.—Freezing Point Curves of Copper-Bismuth Alloys.

by C. J. B. Karsten, a small proportion of bismuth in copper makes the metal hot-short and cold-short. W. Hampe, for instance, found as little as 0.02 per cent. of bismuth makes copper red-short; and 0.1 per cent. makes it very brittle. H. N. Lawrie's correction of H. Baucke's data show that 0.05 per cent. of bismuth makes copper brittle at a red heat, and 0.025 makes it cold-short; H. N. Lawrie says that the presence of 0.0005 per cent. of bismuth prevents copper being drawn into wire. F. Johnson found that arsenic counteracts to some extent the evil effects of bismuth; and N. Parravano says that antimony acts in the same direction. F. Johnson concluded:

The effect of bismuth on the mechanical properties of tough arsenical copper which has been rolled is not serious up to 0.1 per cent.; but no commercial arsenical copper could be regarded as fit for working at a red heat which contained so much bismuth. With 0.02 per cent., although the hot-working properties would be noticeably worse than if no bismuth were present, the copper would not be ruined. Any crude copper containing over 0.01 per cent. bismuth should be regarded with suspicion, since the copper might contain traces of other impurities, e.g. nickel, which, while intensifying the injurious effect of bismuth, would hinder the corrective action of arsenic.

According to P. Jolibois and P. Thomas, bismuth oxide is less injurious than bismuth. C. M. Marx noted that an alloy of copper with twice its weight of bismuth expands a considerable time after solidification; and W. C. Roberts-Austen explains the injurious effects of bismuth by assuming that the bismuth with perhaps a little copper remains fluid until the temp. of the mass has fallen to at least 268°, the m.p. of bismuth.

According to G. J. L. de Chalmot,²⁷ the affinity of silicon and copper for one another is smaller than that of silicon for iron, manganese, or chromium, and about the same as it is for silver and zinc. A. L. Williams could detect no sign of combination. M. Philips found the two elements begin to unite at about 775°. E. Rudolphi's fusion curve shows the existence of two silicides (*q.v.*). According to O. Ruff and B. Bergdahl, molten copper can dissolve a little carbon. J. H. Vivian²⁸ was of the opinion that a compound of copper and carbon was present in over-poled copper; C. J. B. Karsten believed a compound is formed when copper plate and powdered carbon are heated in alternate layers for several hours at a red heat when the copper takes up 0.2 per cent. of carbon; and W. Hampe thought a compound is formed when cupric succinate is reduced by hydrogen. There is, however, no trustworthy evidence here of chemical combination, and C. J. B. Karsten showed that even if a little carbon is absorbed by the copper, the metal readily gives up its carbon when fused in air. H. Moissan found that carbon is dissolved by copper at its b.p., and rejected as the metal solidifies.

According to W. Hampe,²⁹ carbon monoxide behaves like hydrogen towards molten copper; E. Jurisch did not detect any absorption of carbon monoxide by copper between 620° and 930°; and I. L. Bell found that spongy copper is not changed by heating it with carbon monoxide. P. Sabatier and J. B. Senderens found carbon monoxide is not affected by heating it with copper to 450°, but M. Berthelot heated copper with carbon monoxide in a sealed tube at 550° and obtained some carbon and carbon dioxide. W. Hampe found no carbon dioxide is absorbed by molten copper, although both G. Neumann and K. Heydenreich reported that copper, reduced in hydrogen, occludes carbon dioxide at a red heat. According to L. Pfaundler some carbon dioxide is decomposed by copper at 220°.

and a little carbon is retained by the metal; and H. Limpricht also reported a slight reduction of carbon dioxide to the monoxide by spongy, not sheet, copper. According to F. von Bacho, copper turnings free from hydrogen do not react with carbon dioxide at a full red heat, but at 1070° there is a slight action with the formation of cuprous oxide and carbon monoxide; the reaction is quicker at the m.p. of the metal. P. Sabatier and J. B. Senderens found that carbon dioxide, mixed with hydrogen, is reduced to carbon monoxide, not methane, when passed over heated copper. For the occlusion of carbon monoxide and dioxide *vide supra*.

W. Hampe³⁰ found copper, at a temp. a little above its m.p., decomposes **methane**, and J. C. Bull patented a process for removing oxygen, phosphorus, arsenic, and antimony from copper by melting the metal in an atm. of hydrocarbon vapour. P. Sabatier and J. B. Senderens found that **ethylene** is not attacked by finely divided copper at 400°. W. R. Hodgkinson found copper heated up to its m.p. is not affected by **acetylene**. For the occlusion of this gas *vide supra*. Ordinary acetylene, contaminated with ammonia, attacks brass, and, according to N. Caro, forms an explosive acetylde. A. Denacyer found that the purified gas does not act on copper turnings; and N. Caro also noted that dry acetylene has no action on copper, on brass, or on bronze, but there is a slow reaction with the moist gas resulting in the formation of a trace of acetylde in about six months; if ammonia be also present, the action is fairly rapid, and the explosive acetylde is formed. According to H. Erdmann and P. Köthner, and H. Alexander, finely divided copper begins to react with acetylene between 225° and 260°, producing graphite. P. Sabatier and J. B. Senderens say that the reaction begins at 180° with reduced copper, and between 200°–250° with copper wire or foil. More or less of a condensation product, *cuprene*, (C₂H₂)_n, is obtained, which can be freed from copper by washing it with hot hydrochloric acid; cuprene is not attacked by sulphuric acid, but it reacts with nitric acid. It is decomposed over 400°, and when prepared with the acetylene under press., J. Fuchs patented its use as a cork *Ersatz*. A. Mailhe, and P. Sabatier and J. B. Senderens also found that acetylene begins to be hydrogenized when it is mixed with hydrogen, and passed over finely-divided reduced copper at 130°—if compact copper is used, the action begins at 180°. Ethane is formed at 200°. P. Sabatier and J. B. Senderens observed no change with **benzene** between 350° and 400°. According to F. Bellamy, when a mixture of air and acetylene is passed over red-hot copper, the metal becomes incandescent, and an explosion occurs; and N. Caro found copper-asbestos becomes incandescent in an explosive mixture of acetylene and air.

According to M. Berthelot,³¹ copper at 300° has no action on **cyanogen**, but between 500° and 550°, it forms a little cyanide, some carbonaceous matter, and nitrogen. An aq. soln. of **potassium cyanide** dissolves copper with the evolution of hydrogen; the action takes place if air be excluded. G. A. Goyder found that allowing for the presence of a little cyanate, and for the solubility of the gas, the reaction corresponds with the equation: $2\text{Cu} + 4\text{KC}y + 2\text{H}_2\text{O} = 2\text{KC}y_2 + 2\text{KOH} + \text{H}_2$; and W. Nernst says the action is turbulent if the copper be in contact with a platinum wire. F. Kunschert has investigated the free energy and potential of copper towards potassium cyanide soln.—*vide passive copper*. A. Brochet and J. Petit found that hydrogen is evolved in the reaction which they represent: $2\text{Cu} + 8\text{KC}y + 2\text{H}_2\text{O} = 2(\text{Cu}y_3 \cdot 3\text{KC}y) + 2\text{KOH} + \text{H}_2$. Amalgamated copper dissolves about ten times as fast as the ordinary metal.

In the presence of copper, **hydrocarbon oils** are oxidized by air, and, according to C. Engler and E. Kneis,³² the copper at the same time dissolves as oxide; if air or oxygen be excluded, the mineral oils have no action on metals. A. Gawalowsky also says crude petroleum is not attacked. S. Macadam found the paraffin burning-oils act on metals and that the different effects by different samples could not be traced to impurities. The **fatty oils** and **fats** also attack copper slowly. The action does not bear any simple relation to the acid content of the oil. C. W. Volney found with olive oil, cotton-seed oil, and lard oil, the first had the

greatest action on brass, and the last had the least action. W. Thomson found that *olive oil*, *palm oil*, *neatsfoot oil*, *tallow oil*, *palm-nut oil*, *ground-nut oil*, and *lard oil* form a green coating on the copper, but a very small quantity if any copper passes into soln.; refined *rape oil*, *linseed oil*, *sperm oil*, *cod-liver oil*, and *seal oil* left the surface of the copper bright, but dissolved large proportions of copper; *eastor oil*, *brown rape oil*, *raw linseed oil*, and English *neatsfoot oil* tarnished the metal and dissolved a large proportion of copper; and *seal oil*, *whale oil*, *cod oil*, *shark oil*, and East Indian *fish oil* left the copper bright but dissolved moderate quantities of metal; W. H. Watson found that after ten days' exposure in contact with 8 sq. ins. of a surface of copper, the amounts in grains dissolved by 500 water grain measures of oil were: linseed oil, 0.3000; olive oil, 0.2200; *colza oil*, 0.0170; *almond oil*, 0.1030; seal oil, 0.0485; sperm oil, 0.0030; castor oil, 0.0065; English neatsfoot oil, 0.1100; *sesame oil*, 0.1700; and *paraffin oil*, 0.0015. I. J. Redwood also experimented on the same subject. N. J. B. G. Guibourt found copper to be soluble in *cajuput oil*. A. Livache, and W. Lippert found copper accelerates the oxidation of oils in air. C. A. Fodin also recommends copper cathodes in the electrolytic reduction of the fatty acids because of the activity of the occluded hydrogen. A. Carpené found the solubility of copper in wine to be greater than nickel and less than iron. According to J. Golding and E. Feilmann, copper is acted upon by milk, especially in the presence of air, and from one to a hundred parts go into soln. per 10^6 parts of milk. D. Klein and A. Berg found copper is not attacked by a soln. of sugar between 115° and 120° , but J. H. Gladstone found aq. soln. dissolve appreciable quantities of copper in a few days. A. Lidow found alkaline soln. of gelatine also dissolve copper.

H. Fleck³³ states that dil. acetic acid acts slowly on copper in the absence of air; the reaction is quicker if air has access. Cold glacial acetic acid in the presence of hydrogen peroxide dissolves copper. P. Sabatier and J. B. Scnderens found that acetic acid is slowly decomposed when heated with finely divided copper at 260° , the action is rapid between 390° and 410° , carbon dioxide, methane, and acetone are formed. T. Bergman noted the gradual formation of copper oxalate in aq. soln. of oxalic acid. H. C. Bolton found a boiling sat. soln. of citric acid in presence of sodium nitrate dissolves copper. K. B. Lehmann, T. Schwarz, and A. Gawalowsky found that the attack of copper by organic acids is retarded in the presence of sugar, etc.

Copper or copper oxide dissolves in glasses and glazes producing a blue or a green colour—the former when the alkalis predominate. A red colour is produced when about 0.1 per cent. of copper is dissolved in the silicate.³⁴ This colour is exemplified by the copper ruby glass, and in the *sang de bœuf* or *rouge flamé* Chinese porcelain glazes, and the modern imitations. It was assumed by P. Hautfeuille that the green colour is due to the formation of a soln. of cupric silicate; and the blue colour, of a soln. of an alkali cupric silicate. When heated in a reducing atm., the cupric silicate was assumed to decompose into cuprous oxide and silicate, and the former was supposed to colour the glaze or glass red. It is now believed that the red colour is due to the formation of red colloidal copper (*q.v.*).

Reactions of analytical interest.—Cupric sulphate (*q.v.*) is usually regarded as a typical salt. The addition of potassium hydroxide in a cold soln. of cupric sulphate gives a blue precipitate of cupric hydroxide, $\text{Cu}(\text{OH})_2$; with cuprous chloride a yellow precipitate of cuprous hydroxide, CuOH , is formed. On boiling, the former changes to brownish-black cupric oxide, the latter to red cupric oxide. T. G. Wormley³⁵ detected one part of copper (ic) in 12,500 of liquid by means of a soln. of sodium hydroxide; and F. Jackson, 1 in 16,000. The presence of alkali tartrates—*e.g.* Rochelle salt—prevents the precipitation by alkalis. With a mixed soln. of silver and cupric nitrates, P. Jolibois and co-workers showed that all the silver is precipitated as hydroxide before the copper hydroxide begins to separate. The alkali carbonates precipitate a pale-green basic carbonate, $\text{Cu}_2(\text{OH})_2\text{CO}_3$, with cupric salts, and a yellow precipitate with cuprous salts. T. G. Wormley

detected one part of copper (ie) in 12,500 parts of liquid by this reaction; F. Jackson, 1 in 16,000. The carbonates of the alkaline earths and magnesium do not precipitate cupric salts in the cold, but they do so when heated to 60°. Aqua ammonia added slowly to a cupric salt soln. precipitates a green pulverulent basic salt soluble in excess of ammonia, forming an azure-blue soln. T. G. Wormley detected one part of copper in 12,500 of liquid by this reaction; A. B. Prescott and E. C. Sullivan, 1 in 20,000; A. Wagner, 1 in 25,000; and F. Jackson, 1 in 8000. If alcohol be added to the cone. blue soln., a bluish-violet ammino-sulphate is precipitated. Ammonia produces no precipitate with solns. of cuprous salts, and the ammoniacal soln. is colourless, but turns blue on exposure to air. Similar results are obtained with ammonium carbonate.

When a neutral or slightly acid soln. of a cupric salt is treated with hydrogen sulphide, black colloidal cupric sulphide, CuS , is formed, which runs through the filter paper. If an excess of acid be present, the precipitate is coagulated. The sensitiveness of the reaction is such that T. G. Wormley was able to detect one part of the metal in 12,500 of liquid; A. B. Prescott and E. C. Sullivan detected 1 in 100,000; F. Jackson, 1 in 16,000; and A. Wagner, 1 in 2,500,000. The precipitate becomes blue on exposure to air owing to its being oxidized to sulphate. Copper sulphide is soluble in hot dil. acid, insoluble in boiling sulphuric acid, soluble in a soln. of potassium cyanide, appreciably soluble in ammonium sulphide, but, unlike mercuric sulphide, it is insoluble in potassium or sodium sulphide. Hydrogen sulphide gives no precipitate with cupric salts if an excess of potassium cyanide be present—the complex salt, K_3CuCy_4 , is formed. With cuprous salts, hydrogen sulphide gives a black precipitate of cuprous sulphide, Cu_2S , and this is soluble in warm nitric acid, forming blue cupric nitrate and free sulphur; and also in a soln. of potassium cyanide. An aq. soln. of an alkali sulphide gives similar results.

Cupric salts with potassium cyanide give at first a yellow precipitate of cupric cyanide, CuCy_2 , which immediately changes to white cuprous cyanide, Cu_2Cy_2 , and this dissolves in more potassium cyanide, forming the complex salt, K_3CuCy_4 . F. Jackson detected one part of the salt in 2000 parts of liquid by this reaction. With cuprous salts, white cuprous cyanide is formed, and this is soluble in an excess of the reagent. Cupric salts with potassium thiocyanate give black cupric thiocyanate, $\text{Cu}(\text{CyS})_2$, which is slowly changed into white cuprous thioeyanate, CuCyS , or quickly on adding sulphurous acid. Cuprous salts give the white cuprous thiocyanate directly. This latter salt is insoluble in water, dil. hydrochloric, and sulphuric acid. When a neutral or acid soln. of a cupric salt is treated with potassium ferrocyanide, an amorphous dark reddish-brown precipitate of cupric ferrocyanide, Cu_2FeCy_6 , is formed, which is insoluble in dil. acids, and soluble in ammonia. T. G. Wormley detected one part of copper in 31,250 parts of liquid by this reaction; A. B. Prescott and E. C. Sullivan, 1 in 100,000; and F. Jackson, 1 in 16,000. A. Wagner says that the ferrocyanide test is nearly as delicate as the hydrogen sulphide test, and, according to A. J. Cooper, it is ten times more sensitive than the ammonia test. In acid soln. one part of copper in 1,000,000 parts of soln. can be detected by the ferrocyanide test; in neutral soln. 1 in 1,500,000; and in neutral soln. containing ammonium nitrate or chloride, 1 in 2,500,000. The red precipitate does not occur in alkali soln. since the precipitate is decomposed by potassium hydroxide, forming blue cupric hydroxide and potassium ferrocyanide; the blue hydroxide when heated forms the black oxide. With cuprous salts, potassium ferrocyanide gives a white precipitate which becomes brownish-red on exposure to air. With cupric salts under similar conditions, potassium ferricyanide gives a brownish-yellow precipitate; and a brownish-red precipitate with cuprous salts. Potassium iodide gives a white precipitate of cuprous iodide, CuI , with both cuprous and cupric salts. T. G. Wormley detected one part of copper in 12,500 of liquid by this reaction; and F. Jackson, 1 in 8000. Potassium chromate gives a yellowish-brown precipitate with a soln. of cupric sulphate. T. G. Wormley found the reaction sensitive to 1 in 125 000 and F. Jackson, 1 in 16,000. Potassium xanthate gives

a yellow coloration with very dil. soln. of a cupric salt, and A. Wagner detected one part of copper in 900,000 parts of water by its means. A soln. of nitroso- β -naphthol in 50 per cent. acetic acid was found by M. Ilinsky and G. von Knorre to precipitate copper quantitatively from a soln. of a copper salt acidulated with hydrochloric acid, and this in presence of lead, mercury, cadmium, manganese, and zinc salts. P. Cazeneuve found that an alcoholic soln. (1:100) of *s*-diphenyl-carbazide in neutral or feebly acid soln. of cupric salts gives an intense violet coloration which can be recognized with one part of the metal in 100,000 parts of soln. Soln. of silver and gold give rose colorations with the precipitation of the metal; ferric salts give a peach-flower coloration; mercuric salts give a blue; and chromates a violet. K. W. Charitschkoff found that a soln. of naphthenic acid in benzene is a delicate test for copper giving a green coloration with neutral or feebly acid soln. Cobalt salts give an eosin-red, and nickel salts a pale green, coloration.

Some uses of copper.—Copper is used for making various utensils—boilers, cooking utensils, steam pipes, etc. Owing to its high thermal conductivity it is used for locomotive fire-boxes and similar purposes. It is used still more extensively in the form of alloys—bronzes, brasses, etc. Enormous quantities are used in the electrical industries as fittings, battery plates, etc. Owing to its high electrical conductivity it is used for telephone and other conducting wires. Copper nails, rivets, and sheets were once extensively used for sheathing wooden ships. Owing to its being little acted upon by many chemical dye-stuffs, and its being so soft as to be easily engraved, it is used for rollers for calico and other kinds of printing. The oxide and various salts are used for colouring glass and pottery glazes green, blue, or red. The hydroxide, carbonate, silicate, etc., are made into blue or green paints. The salts are used medicinally; for combating plant diseases and pests; and as an antiseptic. Copper is used in a finely-divided condition as a catalyzer in oxidizing and reducing reactions.³⁶ It was once largely used for coinage, but it is now generally replaced by alloys—*e.g.* bronze in Great Britain, nickel-silver in Germany and the United States.

REFERENCES.

- ¹ C. R. A. Wright and A. E. Menke, *Journ. Chem. Soc.*, 37, 785, 1880; R. Fink, *Ber.*, 20, 2106, 1887; C. R. A. Wright and A. P. Luff, *Journ. Chem. Soc.*, 33, 1, 1878; A. Colson, *Compt. Rend.*, 128, 1459, 1899; W. G. Palmer, *Proc. Roy. Soc.*, 98, A, 13, 1920; 101, A, 175, 1922; P. A. von Bonsdorff, *Pogg. Ann.*, 41, 293, 1837; 42, 325, 1837; R. Schwirkus and F. von Leichtenstein, *Zeit. angew. Chem.*, 4, 589, 1889; H. Debray and A. Joannis, *Compt. Rend.*, 99, 583, 688, 1884; L. Maumené, *ib.*, 99, 757, 1884; E. F. Anthon, *Repert. Pharm.*, 76, 216, 1842; W. Elkan, *German Pat.*, D.R.P. 153308, 1903; T. Turner, *Proc. Roy. Soc.*, 81, A, 301, 1908; J. J. Berzelius, *Liebig's Ann.*, 61, 1, 1847; F. Emich, *Monatsh.*, 13, 76, 1892; 15, 378, 1894; A. Smits, A. L. W. Gee, and A. Kettner, *Proc. Acad. Amsterdam*, 16, 999, 1914.
- ² F. Dezeine, *Journ. Pharm. Belg.*, 2, 238, 257, 281, 305, 329, 349, 389, 433, 1890; W. Manchot, *Ber.*, 42, 3942, 1909; J. E. Greaves, *Journ. Inst. Metals*, 7, 218, 1912; W. Hampe, *Zeit. Berg. Hütt. Sal.*, 22, 97, 1874; C. H. Mathewson and G. V. Cæsar, *Internat. Zeit. Metallog.*, 9, 1, 1916; W. E. Ruder, *Trans. Amer. Electrochem. Soc.*, 29, 515, 1916; W. J. Russell and A. Matthiessen, *Phil. Mag.*, (4), 23, 81, 1862; W. Stahl, *Berg. Hütt. Ztg.*, 48, 323, 1889; E. Heyn, *Zeit. Ver. deut. Ing.*, 46, 1119, 1902; *Zeit. anorg. Chem.*, 39, 1, 1904; M. Traube, *Ber.*, 12, 1877, 1885; F. Cintolesi, *Ann. Inst. Tech. Livorno*, 9, 2, 1898; L. Archbutt, *Analyst*, 30, 385, 1905; A. Berliner, *Wied. Ann.*, 35, 791, 1888.
- ³ S. Lucas, *Ann. Chim. Phys.*, (2), 12, 402, 1819; H. Meslens, *ib.*, (3), 8, 205, 1843; L. W. Gilbert, *Gilbert's Ann.*, 37, 378, 1811; C. M. Marx, *Schweigger's Journ.*, 56, 108, 1829; P. F. Chevillot, *ib.*, 53, 195, 1828; E. Abel, *Journ. Chem. Soc.*, 17, 164, 1864; J. L. W. Thudichum and H. W. Hake, *ib.*, 30, 251, 1876; G. S. Johnson, *ib.*, 35, 232, 1878; 29, 176, 1876; *Chem. News*, 37, 271, 1878; 67, 99, 1893; O. L. Erdmann and T. Scheerer, *Journ. prakt. Chem.*, (1), 27, 195, 1842; O. L. Erdmann and R. F. Marchand, *ib.*, (1), 31, 389, 1844; R. Lenz, *ib.*, (1), 108, 438, 1869; W. J. Russell and A. Matthiessen, *Phil. Mag.*, (4), 23, 81, 1862; A. Dick, *ib.*, (4), 11, 409, 1856; T. Graham, *ib.*, (4), 32, 532, 1886; *Phil. Trans.*, 156, 399, 1866; N. B. Pilling, *Elect. Journ.*, 17, 320, 1920; *Journ. Franklin Inst.*, 186, 373, 1918; G. Tammann, *Zeit. anorg. Chem.*, 114, 279, 1920; W. E. Ruder, *Trans. Amer. Electrochem. Soc.*, 29, 515, 1916; M. Guichard, *Bull. Soc. Chim.*, (4), 11, 49, 1912; H. Moore and S. Beckinsale, *Metal Ind.*, 17, 230, 1921; H. Caron, *Compt.*

Rend., 63, 1129, 1866; A. Leduc, *ib.*, 113, 71, 1891; S. Stein, *Berg. Hütt. Ztg.*, 40, 236, 1881; W. Stahl, *ib.*, 45, 414, 1886; 48, 423, 1889; 49, 299, 1890; W. Hampe, *Zeit. Berg. Hütt. Sal.*, 21, 256, 1873; A. Sieverts, *Zeit. phys. Chem.*, 60, 140, 1907; *Internat. Zeit. Metallog.*, 3, 37, 1912; W. C. Hotherhall and E. L. Rhead, *Metal Ind.*, 16, 293, 1920; A. Sieverts and W. Krumbhaar, *Ber.*, 43, 893, 1910; O. Lietzenmeyer, *ib.*, 11, 306, 1878; E. H. Archibald, *Analyst*, 30, 385, 1905; G. Neumann and F. Streintz, *Monatsh.*, 12, 655, 1891; G. Neumann, *ib.*, 13, 40, 1892; D. P. Smith, *Journ. Phys. Chem.*, 23, 186, 1919; G. P. Baxter, *Amer. Chem. Journ.*, 22, 362, 1899; L. Pfaundler, *Chem. Ztg.*, 16, 145, 1892; E. Mitscherlich, *Sitzber. Akad. Berlin.*, 34, 1823; E. Heyn, *Zeit. Ver. deut. Ing.*, 44, 508, 1900; *Zeit. anorg. Chem.*, 39, 1, 1904; T. R. Merton, *Journ. Chem. Soc.*, 105, 645, 1914; W. C. Hotherhall and E. L. Rhead, *Journ. Indust. Metals*, 23, 367, 1920; T. G. Bamford and W. E. Ballard, *ib.*, 24, 155, 1920; E. Jurisch, *Studien über die Löslichkeit von Gasen in festen Metallen und Legierungen*, Leipzig, 1912; Discussion, *Trans. Faraday Soc.*, 14, 173, 1919; H. S. Taylor and R. M. Burns, *Journ. Amer. Chem. Soc.*, 43, 1273, 1921.

⁴ A. Leduc, *Compt. Rend.*, 113, 71, 1891; P. Schützenberger, *ib.*, 69, 196, 1869; L. Chiozza, *ib.*, 36, 632, 1853; M. Berthelot, *ib.*, 89, 1005, 1097, 1879; E. Duter, *ib.*, 109, 108, 1889; A. Soret, *ib.*, 107, 733, 1888; 108, 1298, 1889; A. Wurtz, *ib.*, 18, 102, 1844; 89, 1066, 1879; 90, 22, 1880; *Ann. Chim. Phys.*, (3), 11, 250, 1844; H. Moissan, *ib.*, (6), 24, 261, 1891; M. Berthelot, *ib.*, (7), 14, 203, 1898; F. Mylius and O. Fromm, *Ber.*, 27, 647, 1894; W. K. J. Schoor, *Arch. Néerl.*, 12, 96, 1877; J. C. Poggendorff, *Pogg. Ann.*, 75, 337, 1848; E. A. van der Burg, *Maandbl. Nat.*, 7, 102, 1877; A. A. Pollitt, *Chem. Age*, 3, 200, 1920; H. Buff, *Arch. Sciences Genève*, 29, 198, 1855; A. Coehn, *Zeit. phys. Chem.*, 38, 618, 1901; F. Förster and O. Seidel, *Zeit. anorg. Chem.*, 14, 106, 1897; F. Mawrow and W. Muthmann, *ib.*, 11, 268, 1896; J. Meyer, *ib.*, 34, 50, 1903; D. Vorländer and F. Meyer, *Liebig's Ann.*, 320, 143, 1902; O. Brunck, *ib.*, 327, 242, 1903; C. F. Rammelsberg, *Journ. Chem. Soc.*, 26, 1, 1873; J. H. Gladstone and A. Tribe, *ib.*, 33, 306, 1878; *Chem. News*, 37, 245, 1878; E. J. Bartlett and W. Merrill, *Amer. Journ. Science*, 17, 185, 1895; M. J. B. A. Colletas, *Brit. Pat. No.* 18256, 1901; C. Ullmann, *Zeit. Elektrochem.*, 3, 516, 1897; R. Nasini and F. Andolini, *Rend. Accad. Lincei*, (5), 13, i, 368, 1904; W. C. Hotherhall and E. L. Rhead, *Metal Ind.*, 16, 293, 1920; A. Sieverts, *Zeit. anorg. Chem.*, 64, 29, 1909; A. Sieverts and W. Krumbhaar, *Zeit. phys. Chem.*, 74, 277, 1910; H. Rose, *Pogg. Ann.*, 58, 212, 1843.

⁵ J. L. Proust, *Journ. Phys.*, 51, 181, 1800; H. V. Regnault, *Ann. Chim. Phys.*, (2), 62, 364, 1836; S. Kern, *Chem. News*, 91, 91, 1905; G. K. Elliott, *Chem. Ztg.*, 32, 150, 1908; L. Wöhler and O. Balz, *Zeit. Elektrochem.*, 27, 406, 1921.

⁶ R. Meldrum, *Chem. News*, 78, 209, 1898; M. E. Chevreul, *Compt. Rend.*, 77, 1137, 1873; E. Prinz, *Journ. Gasbeleucht.*, 49, 39, 1906; M. C. Schuyten, *Chem. Ztg.*, 20, 129, 1896; W. van Rijn, *Chem. Weekb.*, 5, 1, 1908; H. T. Barnes and G. W. Shearer, *Journ. Phys. Chem.*, 12, 468, 1908; M. M. P. Muir, *Proc. Manchester Lit. Phil. Soc.*, 15, 40, 1876; T. Carnelley, *Journ. Chem. Soc.*, 30, 1, 1876; M. T. Mengarini and A. Scala, *Koll. Zeit.*, 10, 113, 1912; G. D. Bengough and O. F. Hudson, *Journ. Inst. Metals*, 21, 37, 1919; B. Lambert and H. E. Cullis, *Journ. Chem. Soc.*, 107, 210, 1915; B. Lambert and J. C. Thomson, *ib.*, 97, 2426, 1910; B. Lambert, *ib.*, 101, 2056, 1912; 107, 218, 1915; *Trans. Faraday Soc.*, 9, 108, 1913; G. T. Moody, *Journ. Chem. Soc.*, 89, 720, 1906; W. R. Dunstan and J. R. Hill, *ib.*, 99, 1853, 1911; H. E. Armstrong, *Science Progress*, 5, 642, 1910; 6, 310, 1911; 8, 12, 1913; N. T. M. Wilmshire and W. Ostwald, *Zeit. phys. Chem.*, 36, 92, 1901; J. N. Friend, *Journ. I. S. Inst.*, ii, 16, 1908; *The Corrosion of Iron and Steel*, London, 57, 1911; *Proc. Chem. Soc.*, 26, 179, 1910; J. Aston, *Journ. Amer. Electrochem. Soc.*, 29, 449, 1916; O. P. Watts and N. D. Whipple, *ib.*, 32, 257, 1917; N. K. Chaney, *ib.*, 29, 447, 1916.

⁷ P. A. von Bonsdorff, *Pogg. Ann.*, 42, 337, 1837; E. Heyn, *Mitt. Materialsprüf.*, 29, 29, 1911; J. J. Eastick, *Met. Chem. Eng.*, 11, 524, 1913; F. B. Ahrens, *Chem. Zeit.*, 2, 413, 1903; J. Rothe and W. F. Hinrichsen, *Mitt. Materialsprüf.*, 24, 276, 1906; M. Diegel, *Verh. Ver. Beford. Gewerb.*, 78, 313, 1899; 80, 93, 119, 157, 1903; A. W. Carpenter, *Proc. Amer. Soc. Testing Materials*, 13, 617, 1913; A. A. B. Bussy, *Ann. Chem. Phys.*, 26, 41, 1824.

⁸ M. Berthelot, *Compt. Rend.*, 118, 764, 768, 1894; *Bull. Soc. Chim.*, (3), 11, 859, 1894; *Ann. Chim. Phys.*, (7), 4, 546, 1895; E. von Bibra, *Die Bronzen und Kupferlegierungen der alten und ältesten Völker*, Erlangen, 1869; F. Rathgen, *The Preservation of Antiquities*, Cambridge, 1905; F. Wibel, *Jahrb. Min.*, 400, 1865; F. A. Reuss, *ib.*, 813, 1860; M. E. Chevreul, *Compt. Rend.*, 43, 733, 989, 1856; J. Elster, *Verhand. Ver. Beford. Gewerb.*, 182, 1869; E. Priwoznik, *Dingler's Journ.*, 204, 483, 1878; J. Schuler, *ib.*, 232, 333, 1879; A. Arche and C. Hassack, *ib.*, 253, 514, 1884; G. Coffey, *B. A. Rep.*, 873, 1899; H. Bassett, *Proc. Chem. Soc.*, 19, 95, 1903; K. Natterer, *Monatsh.*, 21, 256, 1900; E. Krause, *Verhand. Berlin anthropol. Ges.*, 537, 1882; L. Mond and G. Cuboni, *Atti Accad. Lincei*, 2, 498, 1893; F. de Villenoisy, *Revue Archéologique*, 28, 67, 202, 1896; J. Nöggerath, *Schweigger's Journ.*, 43, 129, 1825; A. C. Becquerel, *Ann. Chim. Phys.*, (1), 51, 106, 1832; A. Terrell, *Journ. prakt. Chem.*, (1), 94, 314, 1865; C. Mitzopoulos, *Berg. Hütt. Ztg.*, 37, 329, 1878; L. A. Buchner, *Bayer. Ind. Gewerbl.*, 22, 239, 1890; O. A. Rhousopoulos, *Chem. Ztg.*, 29, 1198, 1905; E. Kalkowsky, *Zeit. Kryst.*, 42, 666, 1907; P. Argall, *Eng. Min. Journ.*, 86, 369, 1908; C. F. Bucholz, *Liebig's Ann.*, 85, 253, 1853; G. Lunge and L. Weibel, *Chem. Ind.*, 9, 47, 1886; J. Sebelien, *Chem. Ztg.*, 30, 56, 1906; E. Reichardt, *Repert. Pharm.*, 22, 680, 1873; *Arch. Pharm.*, (3), 2, 513, 1873; B. Roux, *Journ. Pharm. Chim.*, (4), 14, 104, 1871; G. Wetzlar, *Schweigger's Journ.*, 49, 488, 1827; A. Vogel, *Journ. prakt. Chem.*, (1), 14, 107, 1838; A. Daubrée,

Compt. Rend., 93. 572, 1881; R. Dubois, *ib.*, 111. 655, 1890; M. M. P. Muir, *Chem. News*, 33. 102, 125, 145, 1876; F. W. Shaw and T. Carnelley, *ib.*, 35. 82, 1877; *Journ. Chem. Soc.*, 30. 642, 1876; T. Carnelley, *ib.*, 33. 199, 1876; *ib.*, 30. 1, 1876; W. Stahl, *Met.*, 5. 292, 1908; X. Rocques, *Bull. Soc. Chem.*, (2), 33. 499, 1880; *Monit. Scient.*, (3), 10. 911, 1880; W. A. Tilden, *Journ. Soc. Chem. Ind.*, 5. 84, 1886; H. Ost, *Chem. Ztg.*, 26. 845, 1902; 27. 87, 1903; A. Wagner, *Dingler's Journ.*, 221. 259, 1876; F. Rathgen, *ib.*, 301. 45, 1896; R. Weber, *ib.*, 245. 86, 1882; H. Kämmerer, *ib.*, 254. 353, 1884; 257. 196, 1887; F. Utehmann, *German Pat.*, D.R.P. 157585, 1903; 171007, 1904; H. Keil, *Wochenschr. Brauerei*, 22. 495, 1905; P. D. Merica and R. W. Woodward, *Bur. Standards Tech. Paper*, 135, 1919; J. Davy, *Ann. Phil.*, (2), 10. 465, 1825; *Phil. Trans.*, 115. 55, 1825; B. G. Sage, *Mém. Acad.*, 210, 1779; H. Davy, *Phil. Trans.*, 114. 151, 242, 1824; 115. 328, 1825; O. P. Watts and N. D. Whipple, *Trans. Amer. Electrochem. Soc.*, 32. 257, 1917; H. Fleck, *Jahresb. chem. Centralstelle Dresden*, 51, 1888; A. J. Hale and H. S. Foster, *Journ. Soc. Chem. Ind.*, 34. 464, 1915.

⁹ A. A. Hayes, *Amer. Journ. Science*, (2), 11. 241, 324, 1851; S. U. Pickering, *Journ. Chem. Soc.*, 33. 112, 1878; F. C. Calvert and R. Johnson, *ib.*, 19. 434, 1866; *Chem. News*, 11. 171, 1865; *Proc. Manchester Lit. Phil. Soc.*, 4. 115, 1866; W. H. Watson, *ib.*, 16. 185, 1877; *Chem. News*, 35. 192, 1877; E. Bates, *Engg.*, 99. 172, 1915; F. Lyon, *Eng.*, 116. 451, 1913; Anon., *Internat. Zeit. Metall.*, 2. 178, 1912; W. Jorissen, *Zeit. angew. Chem.*, 23. 2305, 1910; F. Giolliti and O. Cccurelli, *Gazz. Chim. Ital.*, 39. 557, 1909; W. R. Webster, *Amer. Soc. Testing. Mat.*, 17. 156, 1917; A. J. Hale and H. S. Foster, *Journ. Soc. Chem. Ind.*, 34. 464, 1915; C. H. Desch, *ib.*, 34. 258, 1915; T. A. Eastick, *Metal Ind.*, 6. 22, 1914; A. Phillip, *Journ. Inst. Metals*, 7. 50, 1912; 9. 61, 1913; 12. 133, 1914; G. D. Bengough and R. M. Jones, *ib.*, 10. 13, 1913; E. Cumberland, *ib.*, 15. 192, 1916; W. E. Gibbs, R. H. Smith, and G. D. Bengough, *ib.*, 15. 37, 1916; G. D. Bengough and O. F. Hudson, *ib.*, 21. 37, 1919; C. H. Desch and S. Whyte, *ib.*, 10. 304, 1913; 11. 235, 1914; S. Whyte, *ib.*, 13. 80, 1915; C. H. Desch and H. Hyman, *ib.*, 14. 189, 1915; O. P. Watts and N. D. Whipple, *Trans. Amer. Electrochem. Soc.*, 32. 257, 1917; P. T. Bruhl, *Chem. Met. Eng.*, 20. 239, 1919; J. Kewley, *Journ. Soc. Chem. Ind.*, 37. 39, 1918; H. S. Rawdon, *Teel. Paper Bur. Standards*, 103, 1917; *Journ. Amer. Inst. Metals*, 11. 148, 1918; P. D. Merica and R. W. Woodward, *Amer. Machinist*, 51. 217, 1919; G. D. Bengough, *Journ. Inst. Metals*, 5. 23, 1911; E. L. Rhead, *ib.*, 2. 73, 1909; W. A. Tilden, *Journ. Soc. Chem. Ind.*, 5. 84, 1886; P. D. Merica, *Trans. Amer. Inst. Metals*, 10. 109, 1916; C. J. Reed, *Electrochem. Met. Ind.*, 7. 316, 1909; M. Diegel, *Stahl Eisen*, 19. 170, 224, 1899; 24. 572, 1904; J. Keir, *Brit. Pat. No.* 1240, 1779; W. Collins, *ib.*, 4115, 1817; R. Mushet, *ib.*, 4802, 1823; G. F. Muntz, *ib.*, 6325, 1832; J. Revere, *ib.*, 5892, 1830; M. Uzielli, *ib.*, 5952, 1830; G. G. Bompas, *ib.*, 6031, 1830; A. H. Sexton, *The Corrosion and Protection of Metals*, Manchester, 1906; E. E. Thum, *Chem. Met. Eng.*, 26. 301, 1922.

¹⁰ A. Philip, *Trans. Faraday Soc.*, 11. 244, 1915; W. E. Gibbs, *ib.*, 11. 258, 1915; C. A. Edwards, *Journ. Inst. Metals*, 5. 150, 1911; 6. 259, 1911; G. D. Bengough and O. F. Hudson, *ib.*, 21. 37, 1919; A. Carnot, *Bull. Soc. Enc.*, (3), 11. 464, 1884.

¹¹ A. Chodneff, *Journ. prakt. Chem.*, (1), 28. 217, 1843; A. Vogcl, *ib.*, (1), 14. 107, 1838; G. N. Antonoff and B. V. Malyschiff, *Journ. Russ. Phys. Chem. Soc.*, 38. 884, 1906; M. Honigmann, *Dingler's Journ.*, 261. 550, 1886; 263. 163, 1887; A. Wagner, *ib.*, 221. 259, 1876; A. Payen, *Journ. Chim. Méd.*, 9. 205, 1833; G. Lunge and L. Weibel, *Chem. Ind.*, 9. 47, 1886; E. Murrman, *Monatsh.*, 17. 708, 1896; R. G. van Name and L. Gräfenberg, *Zeit. Elektrochem.*, 10. 303, 1904.

¹² H. Gautier and G. Charpy, *Compt. Rend.*, 113. 597, 1891; H. Moissan, *ib.*, 128. 1543, 1899; *Ann. Chim. Phys.*, (6), 24. 247, 1891; C. Poulenq, *ib.*, (7), 2. 12, 1894; M. Berthelot, *ib.*, (7), 13. 73, 1898; *Compt. Rend.*, 125. 746, 1897; R. Engel, *ib.*, 121. 528, 1895; A. Colson, *ib.*, 128. 1459, 1899; L. Houllevigne, *ib.*, 137. 47, 1903; *Boltzmann's Festschrift*, 62, 1904; A. Osann, *Pogg. Ann.*, 52. 406, 1841; J. Davy, *Phil. Trans.*, 116. 55, 1826; 102. 169, 1812; S. B. Christy, *Trans. Amer. Inst. Min. Eng.*, 27. 354, 1902; P. Jannasch and H. Heimann, *Journ. prakt. Chem.*, (2), 74. 473, 1906; M. Ribalkin, *Journ. Russ. Phys. Chem. Soc.*, 21. 155, 1889; *Bull. Acad. St. Petersburg*, 33. 279, 1890; 34. 165, 1891; J. B. Hannay, *Journ. Chem. Soc.*, 26. 822, 1873; T. Andrews, *Trans. Roy. Irish Acad.*, 19. 398, 1842; H. E. Patten, *Journ. Phys. Chem.*, 7. 153, 1903; G. Tammann, *Gött. Nachr.*, 225, 1919; R. S. Norris and F. G. Cottrill, *Amer. Chem. Journ.*, 13. 96, 1897; M. Faraday, *Phil. Trans.*, 135. 155, 1845; J. Thomsen, *Zeit. anorg. Chem.*, 34. 193, 1903.

¹³ M. Berthelot, *Ann. Chim. Phys.*, (7), 14. 204, 1898; *ib.*, (7), 16. 433, 1898; *Compt. Rend.*, 91. 871, 1880; 127. 619, 1898; R. Engel, *ib.*, 106. 273, 1888; 121. 528, 1895; *Bull. Soc. Chim.*, (2), 50. 93, 1888; I. Kupferschläger, *ib.*, (3), 2. 134, 1889; J. Löwe, *Zeit. anal. Chem.*, 4. 361, 1865; W. Odling, *Journ. Chem. Soc.*, 9. 291, 1856; F. C. Calvert and R. Johnson, *ib.*, 19. 434, 1866; W. A. Tilden, *Journ. Soc. Chem. Ind.*, 5. 84, 1886; W. D. Richardson, *Trans. Amer. Electrochem. Soc.*, 38. 245, 1920; G. D. Bengough and O. F. Hudson, *Journ. Inst. Metals*, 21. 37, 1919; S. Dushman, *Electrochem. Ind.*, 6. 232, 1908; *Trans. Amer. Electrochem. Soc.*, 13. 313, 1908; O. P. Watts and N. D. Whipple, *ib.*, 32. 257, 1919; T. Charlton, *Chem. News*, 62. 201, 1890; W. F. Brugman, *ib.*, 54. 290, 1886; H. Vogel, *Schweigger's Journ.*, 32. 301, 1821; C. Weltzien, *Liebig's Ann.*, 136. 109, 1865; A. Vogel and C. Reischauer, *Neues Jahrb. Pharm.*, 12. 345, 1859; H. Hager, *Pharm. Centr.*, (2), 7. 439, 1886; *Zeit. anal. Chem.*, 11. 306, 1872; J. E. Gerock, *ib.*, (2), 34. 360, 1893; J. L. Proust, *Ann. Chim. Phys.*, (1), 32. 26, 1799; A. J. Hale and H. S. Foster, *Journ. Soc. Chem. Ind.*, 34. 464, 1915; G. Quincke, *Wied. Ann.*, 36. 270, 1889; J. H. Gladstone and A. Tribe, *Phil. Mag.*, (5), 11. 508, 1881.

¹⁴ A. J. Balard, *Taylor's Scientific Memoirs*, 1. 269, 1837; *Ann. Chim. Phys.*, (2), 57. 225, 1834; E. Soubeiran, *ib.*, (2), 48. 126, 1831; A. D. White, *Journ. Soc. Chem. Ind.*, 22. 133, 1903; A. Ditte, *Compt. Rend.*, 70. 621, 1870; A. Brochet, *ib.*, 136. 155, 1903; 138. 200, 1904; *Bull. Soc. Chim.*, (3), 29. 156, 1903; (3), 31. 287, 1904; L. Rossi, *L'Ind. Chim.*, 6. 333, 1904; W. D. Bancroft, *Trans. Amer. Electrochem. Soc.*, 1. 65, 1902; G. H. Burrows, *Journ. Phys. Chem.*, 6. 417, 1902; A. L. Voegelé, *ib.*, 3. 577, 1899; W. S. Hendrixson, *Journ. Amer. Chem. Soc.*, 26. 755, 1904; O. P. Watts and N. D. Whipple, *Trans. Amer. Electrochem. Soc.*, 32. 257, 1919.

¹⁵ E. Obaeh, *Journ. prakt. Chem.*, (2), 26. 281, 1882; F. G. Reiehl, *ib.*, (2), 12. 55, 1875; A. Cavazzi, *Mem. Accad. Ist. Bologna*, (4), 7. 27, 1887; A. Eiloart, *Chem. News*, 52. 183, 1885; J. Thomsen, *Zeit. anorg. Chem.*, 34. 193, 1903; G. Lunge and L. Weibel, *Chem. Ind.*, 9. 2, 1891; E. Priwoznik, *Liebig's Ann.*, 164. 46, 1872; 171. 110, 1874; K. Heumann, *ib.*, 173. 21, 1874; *Ber.*, 6. 1291, 1873; 7. 752, 1874; A. Ditte, *Compt. Rend.*, 98. 1429, 1884; A. Colson, *ib.*, 93. 74, 1881; 129. 826, 1899; V. Merz and W. Weith, *Zeit. Chem.*, 12. 244, 1869; *Ber.*, 13. 718, 1880; E. Schütz, *Met.*, 4. 663, 1907; E. Donath, *Dingler's Journ.*, 236. 327, 1880; G. P. Sehweider, *Berg. Hütt. Ztg.*, 38. 82, 105, 1879; C. Strüver, *Centr. Min.*, 257, 401, 1901; *Atti Accad. Lincei*, (5), 10. 124, 233, 1901; C. R. Hayward, *Met. Chem. Eng.*, 18. 650, 1918; E. S. Sperry, *Brass World*, 9. 91, 1913.

¹⁶ J. Uhl, *Ber.*, 23. 2151, 1890; E. Heyn and O. Bauer, *Met.*, 3. 73, 1906; W. Hampe, *Zeit. Berg. Hütt. Sal.*, 21. 276, 1873; W. Stahl, *Dingler's Journ.*, 222. 272, 1876; H. Rössler, *ib.*, 242. 278, 1881; H. Causse, *Bull. Soc. Chim.*, (2), 45. 3, 1886; L. P. de St. Gilles, *Ann. Chim. Phys.*, (3), 42. 36, 1829; M. Berthelot, *ib.*, (7), 14. 203, 1898; C. Geitner, *Liebig's Ann.*, 129. 350, 1864; H. Reinseh, *Neues Jahrb. Pharm.*, 25. 202, 1866; G. Bredig, *Zeit. angew. Chem.*, 19. 1985, 1906; A. Sieverts and E. Bergner, *Zeit. phys. Chem.*, 82. 257, 1913; S. U. Piekerling, *Journ. Chem. Soc.*, 33. 136, 1878; G. Barruel, *Journ. Pharm.*, 20. 13, 1834.

¹⁷ E. Divers and T. Shimidzu, *Journ. Chem. Soc.*, 47. 636, 1885; F. C. Calvert and R. Johnson, *ib.*, 19. 435, 1866; J. T. Cundall, *ib.*, 105. 60, 1914; T. Carnelley, *ib.*, 32. 82, 1877; S. U. Piekerling, *ib.*, 33. 112, 1878; *Chem. News*, 37. 36, 1878; J. J. Berzelius, *Ann. Chim. Phys.*, (2), 2. 228, 1816; G. Barruel, *Journ. Pharm.*, 20. 13, 1834; J. Laubheimer, *Chem. Ztg.*, 12. 1110, 1888; M. G. Levi, E. Migliorini, and G. Ercolini, *Gazz. Chim. Ital.*, 38. 1, 583, 1908; E. G. Maumené, *Monit. Scient.*, (3), 11. 541, 1881; *Ann. Chim. Phys.*, (3), 18. 311, 1846; A. Ditte, *ib.*, (6), 19. 68, 1890; M. Berthelot, *ib.*, (7), 14. 200, 1898; H. Causse, *Bull. Soc. Chim.*, (2), 45. 3, 1886; C. Baskerville, *Journ. Amer. Chem. Soc.*, 17. 90, 1895; 18. 942, 1896; V. Lenher, *ib.*, 24. 354, 1902; L. W. Andrews, *ib.*, 18. 253, 1896; *Amer. Chem. Journ.*, 10. 251, 1896; T. Andrews, *Chem. News*, 70. 152, 1894; G. J. Bureh and J. W. Dodgson, *ib.*, 69. 225, 1894; T. Kliehe, *Arch. Pharm.*, 228. 374, 1890; E. Priwoznik, *Liebig's Ann.*, 164. 46, 1872; *Sitzber. Akad. Wien*, 65. 87, 1872; C. M. van Deventer, *Chem. Weekb.*, 2. 137, 1905; 3. 515, 1906; C. H. Sluiter, *ib.*, 3. 63, 1906; V. Merz and W. Weith, *Zeit. Chem.*, 12. 244, 1869; F. Cintolesi, *Ann. Ist. Tccn. Livorno*, 9. 2, 1891; J. Šebor, *Věstník král. české společnosti nauk Praze*, 22, 1904; E. Salkowsky, *Chem. Ztg.*, 40. 448, 1916; P. Sabatier, *Compt. Rend.*, 122. 1417, 1896; A. Reoura, *ib.*, 148. 1105, 1909; F. J. Faktor, *Pharm. Post*, 38. 219, 1905; A. Vogel, *Schweigger's Journ.*, 32. 301, 1821; H. Ditz, *Journ. prakt. Chem.*, (2), 78. 343, 1908; W. Ostwald, *Zeit. phys. Chem.*, 9. 545, 1892; G. Lunge and L. Weibel, *Chem. Ind.*, 9. 47, 1886; J. W. Turrentine, *Journ. Phys. Chem.*, 11. 625, 1907; F. Wöhler, *Liebig's Ann.*, 73. 374, 1850; M. le Blanc and K. Schieck, *Zeit. Elektrochem.*, 9. 636, 1903; R. Namais, *L'Orosi*, 23. 218, 1900; J. Girard, *Rcv. Chim. Pure App.*, 6. 464, 1903; J. Davy, *Edin. Phil. Journ.*, (2), 8. 229, 1829; G. D. Bengough and O. F. Hudson, *Journ. Inst. Metals*, 21. 37, 1919; F. Förster and O. Seidell, *Zeit. anorg. Chem.*, 14. 103, 1897; E. Abel, *ib.*, 26. 361, 1901; T. W. Richards, E. Collins, and G. W. Heimrod, *Proc. Amer. Acad.*, 35. 123, 1899; W. R. E. Hodgkinson and N. E. Bellairs, *Chem. News*, 71. 73, 1895; W. Smith, *Journ. Soc. Chem. Ind.*, 14. 629, 1895; M. Traube, *Ber.*, 18. 1887, 1885; F. Rasehig, *Ber.*, 40. 4580, 1907; E. Fromm, *ib.*, 41. 3397, 1908; P. Nicolardot, *Compt. Rend.*, 147. 1304, 1908; O. P. Watts and N. D. Whipple, *Trans. Amer. Electrochem. Soc.*, 32. 257, 1917; W. D. Richardson, *ib.*, 38. 245, 1920; A. J. Hale and H. S. Foster, *Journ. Soc. Chem. Ind.*, 34. 464, 1915; G. Seagliarini and G. Torclli, *Gazz. Chim. Ital.*, 51. ii. 277, 1921.

¹⁸ L. J. Thénard, *Ann. Chim. Phys.*, (1), 85. 61, 1813; F. Savart, *ib.*, (2), 37. 326, 1828; C. Despretz, *ib.*, (2), 42. 122, 1829; H. Pauli, *Zeit. Elektrochem.*, 4. 138, 1897; C. H. Pfaff, *Pogg. Ann.*, 42. 164, 1837; A. Schrötter, *Liebig's Ann.*, 37. 131, 1841; C. W. J. Kastner, *Kastner's Archiv.*, 12. 455, 1827; E. Yamasaki, *Science Rep. Tokoku Univ.*, 9. 169, 1920; *Proc. Internat. Cong. App. Chem.*, 7. x, 174, 1909; G. T. Beilby and G. G. Henderson, *Journ. Chem. Soc.*, 79. 1245, 1901; J. F. Daniell, *Phil. Trans.*, 127. 144, 1837; P. L. Aslanoglou, *Chem. News*, 64. 313, 1891; J. 73. 115, 1896; H. N. Warren, *ib.*, 55. 156, 1887; A. Rossel, *ib.*, 73. 62, 1896; *Compt. Rend.*, 121. 941, 1895; C. Matignon and R. Trannoy, *ib.*, 142. 1211, 1906; E. M. Péligot, *ib.*, 47. 1034, 1858; R. Blondlot, *ib.*, 102. 210, 1886; W. R. Grove, *Phil. Mag.*, (3), 19. 100, 1841; L. Arons, *Natur. Rund.*, 14. 453, 1899.

¹⁹ W. Traube and A. Biltz, *Ber.*, 37. 3130, 1904; 39. 166, 1906; W. Traube and A. Sehönwald, *ib.*, 38. 828, 1905; M. Traube, *ib.*, 18. 1887, 1885; E. Müller and F. Spitzer, *ib.*, 38. 778, 1188, 1905; *Zeit. Elektrochem.*, 11. 917, 1905; M. Berthelot, *Bull. Soc. Chim.*, (3), 2. 643, 1889; C. F. Sehönbein, *Sitzber. Akad. Berlin*, 580, 1856; M. Berthelot and L. P. de St. Gilles, *Ann. Chim. Phys.*, (4), 1. 381, 1863; N. A. E. Millon, *Compt. Rend.*, 51. 289, 1860; E. M. Péligot, *ib.*, 47. 1034, 1858; F. Osmond, *ib.*, 100. 1230, 1885; G. Arth, *ib.*, 100. 1588, 1885; E. Divers, *ib.*, 101. 847, 1885; S. Kappel, *Arch. Pharm.*, (3), 20. 567, 1882; W. Knop, *Chem. Centrbl.*, 463,

1859; M. E. Schweizer, *Journ. prakt. Chem.*, (1), 76. 344, 1859; M. Prud'homme, *Monit. Scient.*, (5), 5. 681, 1891; C. Häussermann, *Chem. Ztg.*, 29. 667, 1905; C. R. A. Wright, *Journ. Soc. Chem. Ind.*, 3. 121. 1884; W. Smith, *ib.*, 14. 629, 1895; G. Gore, *Proc. Roy. Soc.*, 21. 143, 1873; C. R. A. Wright and C. Thompson, *ib.*, 42. 212, 1887; *Chem. News*, 55. 167, 1887; W. R. E. Hodgkinson and A. H. Coote, *ib.*, 90. 142, 1904; 92. 38, 1905; W. R. E. Hodgkinson and N. E. Bellairs, *ib.*, 71. 73, 1895; T. Carnelley and J. Schlerschmann, *ib.*, 52. 6, 1885; P. L. Aslanoglu, *ib.*, 73. 115, 1896; C. A. Seely, *ib.*, 23. 169, 1870; E. C. Franklin and C. A. Kraus, *Amer. Chem. Journ.*, 20. 820, 1898; T. Weyl, *Pogg. Ann.*, 123. 353, 1864; J. Bronn, *Ann. Physik*, (4), 16. 171, 1905; F. M. G. Johnson and N. T. M. Wilsmore, *Trans. Faraday Soc.*, 3. 70, 1907; *Zeit. Elektrochem.*, 14. 203, 1908; J. Tafel, *Chem. Ztg.*, 32. 135, 1908; *Zeit. anorg. Chem.*, 31. 319, 1902; J. Tafel and H. Hahl, *ib.*, 56. 375, 1908; O. Flaschner, *Monatsh.*, 28. 209, 1907.

²⁰ P. Sabatier and J. B. Senderens, *Compt. Rend.*, 114. 1429, 1892; 115. 237, 1892; 116. 756, 1893; 120. 619, 1895; 135. 278, 1902; *Bull. Soc. Chim.*, (3), 13. 871, 1896; *Ann. Chim. Phys.*, (7), 7. 353, 1896; F. Emich, *Sitzber. Akad. Wien*, 101. 88, 1892; *Monatsh.*, 13. 73, 1892; T. Gray, *Journ. Soc. Chem. Ind.*, 17. 741, 1898; E. Divers, *Proc. Chem. Soc.*, 14. 57, 1898; E. Divers and T. Shimidzu, *Journ. Chem. Soc.*, 47. 630, 1885; J. J. Sudborough, *ib.*, 59. 658, 1891; J. H. Gladstone and A. Tribe, *Chem. News*, 47. 277, 1883; A. Mailhe, *Chem. Ztg.*, 31. 1118, 1907; P. T. Austen, *Amer. Chem. Journ.*, 11. 172, 1889; *Chem. News*, 59. 208, 1889; H. V. Tartar and W. L. Semon, *Jour. Amer. Chem. Soc.*, 43. 494, 1921.

²¹ V. H. Veley, *Journ. Soc. Chem. Ind.*, 8. 858, 1889; 10. 204, 1891; *Proc. Roy. Soc.*, 46. 216, 1889; 48. 458, 1891; *Ber.*, 28. 928, 1895; *Phil. Trans.*, 182. A. 279, 1891; V. H. Veley and G. J. Burch, *ib.*, 182. A. 319, 1891; M. Faraday, *ib.*, 130. 61, 1840; E. Divers and T. Haga, *Journ. Chem. Soc.*, 51. 48, 1887; E. Divers, *ib.*, 75. 95, 1899; L. S. Bagster, *ib.*, 119. 82, 1921; T. Fairley, *ib.*, 31. 5, 1877; F. C. Calvert and R. Johnson, *ib.*, 19. 435, 1866; J. J. Acworth and H. E. Armstrong, *ib.*, 32. 60, 1877; J. J. Acworth, *ib.*, 28. 828, 1875; E. Divers, *ib.*, 43. 443, 1883; *Journ. Soc. Chem. Ind.*, 23. 1182, 1904; P. C. Ray, *ib.*, 23. 1185, 1904; J. H. Stansbie, *ib.*, 25. 45, 1071, 1906; O. Flaschner, *Monatsh.*, 28. 209, 1907; N. A. E. Millon, *Ann. Chim. Phys.*, (3), 6. 98, 1842; *Compt. Rend.*, 14. 904, 1842; F. Pearce and C. Couchot, *ib.*, 138. 361, 1904; T. Ericson-Aurén and W. Palmaer, *Zeit. phys. Chem.*, 39. 1, 1901; 45. 182, 1903; A. de la Rive, *Ann. Chim. Phys.*, (2), 43. 425, 1830; H. E. Armstrong, *B. A. Rep.*, 962, 1885; *Proc. Roy. Soc.*, 40. 287, 1886; 70. 99, 1902; 74. 86, 1904; *Proc. Chem. Soc.*, 2. 182, 1886; *Journ. Chem. Soc.*, 49. 112, 1886; 67. 1122, 1895; 83. 1088, 1903; *Chem. News*, 52. 212, 1886; C. C. Duncan, *ib.*, 61. 308, 1890; R. Ihle, *Zeit. phys. Chem.*, 19. 577, 1895; G. N. Lewis and A. Edgar, *Journ. Amer. Chem. Soc.*, 33. 292, 1911; L. Gmelin, *Handbook of Chemistry*, London, 1848; O. Brunck, *Ber.*, 34. 604, 1901; G. Vortmann, *ib.*, 19. 11, 1886; 23. 2798, 1890; *Chem. Ztg.*, 15. 1159, 1891; C. Luckow, *ib.*, 15. 739, 1891; A. Becker, *ib.*, 14. 1557, 1890; L. Guillet, *Rev. Mét.*, 4. 1035, 1907; G. P. Baxter and C. H. Hickey, *Amer. Chem. Journ.*, 33. 300, 1905; P. C. Freer and G. O. Higley, *ib.*, 15. 71, 1893; G. O. Higley, *ib.*, 17. 18, 1895; C. Montemartini, *Gazz. Chim. Ital.*, 22. i. 384, 397, 426, 1892; J. W. Turrentine, *Trans. Amer. Electrochem. Soc.*, 10. 49, 1906; *Journ. Phys. Chem.*, 10. 715, 1906; W. D. Bancroft, *ib.*, 9. 277, 1905; 12. 75, 1908; J. Girard, *Ann. Chim. Anal. App.*, 4. 342, 1899; J. F. Persoz, *Dingler's Journ.*, 173. 75, 1864; E. Müller and J. Weber, *Zeit. Elektrochem.*, 9. 955, 1903; E. Müller and F. Spitzer, *ib.*, 11. 509, 1905; K. Ulsch, *ib.*, 3. 546, 1897; J. Tafel, *ib.*, 9. 645, 1903; *Zeit. anorg. Chem.*, 31. 291, 1902; W. Peters, *ib.*, 107. 313, 1919; E. Müller, *ib.*, 26. 1, 1901; R. Russ, *Zeit. phys. Chem.*, 44. 641, 1904; H. Müller and C. Pauli, *Arch. Pharm.*, (3), 14. 245, 1879; H. Kunheim, *Zeit. angew. Chem.*, 20. 1065, 1907; T. E. Thorpe, *Journ. Chem. Soc.*, 26. 541, 1873; J. H. Gladstone and A. Tribe, *ib.*, 33. 140, 1878; 25. 461, 1872; *Proc. Roy. Soc.*, 20. 218, 1872; W. H. Easton, *Journ. Amer. Chem. Soc.*, 25. 1042, 1903; L. H. Ingham, *ib.*, 26. 1251, 1904; O. P. Watts and N. D. Whipple, *Trans. Amer. Electrochem. Soc.*, 32. 257, 1917; W. D. Richardson, *ib.*, 38. 245, 1920; M. Drapier, *Compt. Rend.*, 158. 338, 1914; G. H. Burch and V. H. Veley, *Phil. Trans.*, 182. A. 319, 1891; M. Faraday, *ib.*, 130. 93, 1840; A. J. Halc and H. S. Foster, *Journ. Soc. Chem. Ind.*, 34. 464, 1915; J. S. Bagster, *Journ. Chem. Soc.*, 119. 82, 1921.

²² T. Andrews, *Phil. Mag.*, (3), 11. 554, 1837; (3), 12. 305, 1838; M. Faraday, *ib.*, (3), 11. 555, 1837; W. A. Hollis, *Proc. Cambridge Phil. Soc.*, 12. 462, 1904; N. le Blanc, *Zeit. Elektrochem.*, 11. 705, 1905; E. Müller, *ib.*, 13. 133, 1907; A. Lorenz, *ib.*, 9. 334, 1903; A. Löb, *ib.*, 12. 87, 1906; 13. 789, 1907; *Elektrolytische Untersuchungen mit symmetrischen und asymmetrischen Wechselstrom*, Halle, 1905; C. W. Bennet and W. S. Burnham, *Trans. Amer. Electrochem. Soc.*, 29. 217, 1916; G. D. Bengough and O. F. Hudson, *Journ. Inst. Metals*, 21. 37, 1919; W. Heldt, *Journ. prakt. Chem.*, (1), 90. 264, 1863; E. Jordis, *Zeit. angew. Chem.*, 20. 2241, 1907; G. Wiedemann, *Pogg. Ann.*, 99. 187, 1856; G. Berson and A. Destrem, *Compt. Rend.*, 106. 1794, 1888; E. Duter, *ib.*, 104. 354, 1887; A. Brochet and J. Petit, *ib.*, 138. 359, 1904; O. W. Brown and F. C. Mathers, *Journ. Phys. Chem.*, 10. 42, 1906; M. le Blanc and K. Schick, *Zeit. phys. Chem.*, 46. 213, 1903; W. R. Dunstan and J. R. Hill, *Journ. Chem. Soc.*, 99. 1853, 1911.

²³ W. Straub, *Zeit. anorg. Chem.*, 35. 467, 1903; A. Granger, *Bull. Soc. Chim.*, (3), 7. 611, 1892; *Ann. Chim. Phys.*, (7), 14. 59, 1898; P. Berthier, *ib.*, (1), 33. 180, 1800; B. Pelletier, *ib.*, (1), 1. 93, 1789; (1), 13. 113, 1792; H. Moissan, *ib.*, (6), 24. 263, 1891; *Bull. Soc. Chim.*, (3), 31. 1001, 1904; *Compt. Rend.*, 138. 789, 1904; E. Defacqz, *ib.*, 130. 916, 1900; A. Joannis, *ib.*, 128. 1322, 1899; C. Matignon and R. Trannoy, *ib.*, 141. 190, 1905; H. de Ruolz-Montchal and H. de Fontenay, *ib.*, 83. 783, 1876; A. Oppenheim, *Ber.*, 5. 146, 1872; O. Emmerling, *ib.*,

12. 152, 1879; O. N. Heidenreich, *ib.*, 29. 1585, 1896; E. A. Lewis, *Met. Chem. Eng.*, 10. 540, 1912; A. H. Hiorns, *Journ. Soc. Chem. Ind.*, 25. 622, 1906; E. Munker, *Met.*, 9. 185, 1912; *Journ. Inst. Metals*, 7. 272, 1912; F. A. Abel, *Journ. Chem. Soc.*, 18. 249, 1865; P. Burekhard, *Zeit. Chem.*, (2), 6. 212, 1870; A. S. Marggraf, *Chemischen Schriften*, Berlin, 1. 42, 1762; E. G. Sage, *Mém. Acad.*, 210, 1779; *Crell's Ann.*, 33, 1792; *Gehlen's Journ.*, 3. 704, 1804; E. Goerke, *Ueber den Genauigkeitsgrad elektroanalytischer Arbeitsmethoden, sowie über die katodische Abscheidung von Kohlenstoff, Schwefel, und Phosphor*, Bonn, 1900; H. N. Warren, *Chem. News*, 56. 154, 1887; 64. 302, 1891; W. Müller-Erzbach, *Ber. deut. phys. Ges.*, 15. 19, 1882; R. Lüpke, *Zeit. phys. Chem. Unterr.*, 3. 282, 1890; H. Schwarz, *Dingler's Journ.*, 218. 58, 1875; C. Künzel, *ib.*, 270. 171, 1888; L. Gnätat and J. Chavanne, *ib.*, 250. 30, 1883; D. S. Ashbrook, *Journ. Amer. Chem. Soc.*, 26. 1284, 1904; R. Böttger, *Met. Review*, 2. 456, 1878; H. Davy, *Phil. Trans.*, 97. 36, 1807; G. Seyboth, *German Pat.*, D.R.P. 190450, 1906; T. Dill, *ib.*, 99128, 1897; P. Mellmann, *ib.*, 45175, 1888; E. Heyn and O. Bauer, *Zeit. anorg. Chem.*, 52. 129, 1907; J. L. Jones, *Metall Ind.*, 20. 147, 1922.

²⁴ D. Wilson, *Ann. Phil.*, 1. 365, 1813; H. Rose, *Pogg. Ann.*, 14. 188, 1828; 24. 328, 1832; E. Rubénovitch, *Compt. Rend.*, 127. 271, 1898; 128. 1398, 1899; B. Reinitzer and H. Goldschmidt, *Sitzber. Akad. Wiss.*, 81. 823, 1880; H. Goldschmidt, *Chem. Centr.*, 492, 1881; H. Moissan, *Ann. Chim. Phys.*, (6), 6. 437, 1885; A. Granger, *Contribution à l'étude des phosphures métalliques*, Paris, 1898; O. P. Watts and N. D. Whipple, *Trans. Amer. Electrochem. Soc.*, 32. 257, 1917.

²⁵ T. Bergman, *De Arsenico*, Stockholm, 1777; *Physical and Chemical Essays*, London, 287, 1788; C. W. Scheele, *Acta Acad. Stockholm*, 1, 1775; K. Friedrich, *Met.*, 2. 484, 1905; 5. 530, 1908; W. Stahl, *ib.*, 6. 611, 1909; P. Jolibois and P. Thomas, *Rev. Mét.*, 10. 1204, 1913; E. Maey, *Zeit. phys. Chem.*, 50. 214, 1905; W. Guertler, *Zeit. anorg. Chem.*, 51. 418, 1906; A. H. Hiorns, *Electrochem. Met.*, 3. 648, 1904; *Journ. Inst. Metals*, 3. 54, 1910; *Chem. News*, 89. 200, 1904; *Journ. Soc. Chem. Ind.*, 25. 617, 1906; J. H. Stansbie, *ib.*, 25. 47, 1071, 1906; G. Kamensky, *Phil. Mag.*, (5), 17. 270, 1884; *Proc. Phys. Soc.*, 6. 53, 1884; A. A. Baikoff, *Journ. Russ. Phys. Chem. Soc.*, 36. 111, 1904; A. Matthiessen and C. Vogt, *Pogg. Ann.*, 122. 19, 1864; H. Carmichael, *Amer. Journ. Science*, (3), 32. 129, 1886; A. C. Chapman and H. D. Law, *Analyst*, 31. 3, 1906; H. J. S. Sand and J. E. Hackford, *Journ. Chem. Soc.*, 85. 1018, 1904; E. J. Ball, *ib.*, 53. 167, 1888; P. Braesco, *Compt. Rend.*, 170. 103, 1920; W. Campbell, *Journ. Franklin Inst.*, 154. 209, 1902; J. A. Mathews, *ib.*, 153. 122, 1902; H. Hager, *Pharm. Centr.*, 27. 439, 1886; M. Vizern and L. Guillet, *Ann. Chim. Pure Appl.*, 9. 416, 1904; C. Mai and H. Hurt, *Zeit. anal. Chem.*, 43. 557, 1904; A. Gautier, *Compt. Rend.*, 81. 286, 1875; *Bull. Soc. Chim.*, (2), 24. 250, 1875; (3), 35. 207, 1906; Z. de Vamosy, *ib.*, (3), 35. 24, 1906; E. T. Allen, *Chem. News*, 82. 305, 1900; E. A. Lewis, *ib.*, 83. 3, 1901; *Engg.*, 76. 733, 1903; *Journ. Soc. Chem. Ind.*, 20. 254, 1901; 22. 1351, 1903; J. E. Stead, *ib.*, 17. 1112, 1898; N. Puschin and E. Dischler, *Zeit. anorg. Chem.*, 80. 65, 1913; P. Oberhoffer, *Metal Erz*, 17. 49, 345, 1920; W. Stahl, *ib.*, 15. 395, 1918; K. Heumann, *Liebig's Ann.*, 171. 110, 1874; 173. 21, 1874; E. Priwoznik, *ib.*, 164. 46, 1872; 171. 110, 1874; W. C. Roberts-Austen, *Rep. Alloys Research Committee*, London, 2. 119, 1893; G. D. Bengough and B. P. Hill, *Journ. Inst. Metals*, 3. 34, 1910; R. H. Graves, *ib.*, 7. 218, 1912; L. Archbutt, *ib.*, 7. 262, 1912; H. D. Law, *ib.*, 8. 222, 1912; F. Johnson, *ib.*, 4. 163, 1910; 8. 192, 1912; 10. 275, 1913; *Met. Chem. Eng.*, 8. 570, 1910; A. E. Lewis, *ib.*, 10. 540, 1912; H. Baucke, *Internat. Zeit. Metall.*, 3. 195, 1913; C. J. B. Karsten, *System der Metallurgie*, Berlin, 1831; W. C. Roberts-Austen, *Proc. Inst. Mech. Eng.*, 108, 1893; G. Lockemann, *Zeit. angew. Chem.*, 18. 416, 1905.

²⁶ H. Gautier, *Bull. Soc. d'Encourag.*, (5), 1. 1309, 1896; C. J. B. Karsten, *System der Metallurgie*, Berlin, 1831; H. Gautier, *Contributions à l'étude des alliages*, Paris, 110, 1901; K. Jeriomini, *Zeit. anorg. Chem.*, 55. 412, 1907; G. Tammann, *ib.*, 49. 117, 1906; C. M. Marx, *Schweigger's Journ.*, 58. 470, 1830; A. Portevin, *Rev. Mét.*, 4. 1078, 1907; P. Jolibois and P. Thomas, *ib.*, 10. 1264, 1913; O. Ruff and B. Bergdahl, *Zeit. anorg. Chem.*, 106. 76, 1919; C. Calvert and R. Johnson, *Phil. Mag.*, (4), 13. 354, 1859; W. Hampe, *Zeit. Berg. Hütt. Sal.*, 22. 122, 1874; C. T. Heycock and F. H. Neville, *Phil. Trans.*, 189. A, 46, 1897; *Journ. Chem. Soc.*, 61. 911, 1892; W. C. Roberts-Austen, *Rep. Alloys Research Committee*, London, 2. 121, 1893; H. N. Lawrie, *Trans. Amer. Inst. Min. Eng.*, 40. 604, 1909; H. Baucke, *Internat. Zeit. Metall.*, 3. 193, 1913; N. Parravano, *ib.*, 1. 89, 1911; F. Johnson, *Journ. Inst. Metals*, 8. 192, 1912; A. H. Hiorns, *Journ. Soc. Chem. Ind.*, 25. 616, 1906; J. H. Stansbie, *ib.*, 25. 45, 1075, 1906; E. A. Lewis, *Engg.*, 76. 753, 1903; M. Knoertzer, *Bull. Soc. Chim.*, (3), 9. 731, 1893; E. Matthey, *Proc. Roy. Soc.*, 43. 172, 1887; 49. 78, 1891; *Chem. News*, 56. 241, 1887; 63. 30, 1891.

²⁷ G. J. L. de Chalmot, *Amer. Chem. Journ.*, 19. 871, 1897; 20. 437, 1898; M. Philips, *Beiträge zur Kenntnis des Kupfersilicids*, Berlin, 1904; E. Rudolff, *Zeit. anorg. Chem.*, 53. 223, 1907.

²⁸ J. H. Vivian, *Ann. Phil.*, 21. 121, 1823; C. J. B. Karsten, *System der Metallurgie*, Berlin, 5. 246, 265, 1831; *Schweigger's Journ.*, 66. 395, 1832; W. Hampe, *Zeit. Berg. Hütt. Sal.*, 21. 275, 282, 1873; H. Moissan, *Compt. Rend.*, 141. 853, 1905; A. Dick, *Phil. Mag.*, (4), 11. 409, 1856; A. L. Williams, *ib.*, (6), 40. 285, 1920.

²⁹ W. Hampe, *Zeit. Berg. Hütt. Sal.*, 21. 275, 1873; I. L. Bell, *Chem. News*, 23. 258, 1871; P. Sabatier and J. B. Senderens, *Compt. Rend.*, 134. 689, 1902; *Bull. Soc. Chim.*, (3), 29. 294, 1903; M. Berthelot, *Ann. Chim. Phys.*, (7), 22. 303, 1901; H. Limpricht, *Liebig's Ann.*, 108.

46, 1858; 109, 301, 1859; L. Pfaundler, *Chem. Ztg.*, 16, 145, 1892; K. Heydenreich, *Zeit. anal. Chem.*, 45, 741, 1906; G. Neumann, *Monatsh.*, 13, 40, 1892; F. von Baeho, *ib.*, 37, 119, 1916; W. R. Hodgkinson, *Journ. Soc. Chem. Ind.*, 37, 86, 1918; E. Juriseh, *Studien über die Löslichkeit von Gasen in festen Metallen und Legierungen*, Leipzig, 1912.

³⁰ W. Hampe, *Zeit. Berg. Hütt. Sal.*, 21, 275, 1873; J. C. Bull, *Brit Pat No 6399*, 1892; P. Sabatier and J. B. Senderens, *Bull Soc. Chim.*, (3), 25, 682, 1901; *Compt. Rend.*, 131, 267, 1900; 130, 1559, 1900; 132, 566, 1901; F. Bellamy, *ib.*, 100, 1460, 1885; H. Alexander, *Ber.*, 32, 2381, 1899; N. Caro, *Verh. Ver. Beförd. Gewerb.*, 217, 281, 1906; A. Denaeayer, *Pharm. Centrbl.*, 38, 606, 1897; H. Erdmann and P. Köthner, *Zeit. anorg. Chem.*, 18, 48, 1898; J. Fuehs, *German Pat.*, D.R.P. 167780, 1905; A. Mailhe, *Chem. Ztg.*, 32, 244, 1908.

³¹ M. Berthelot, *Ann. Chim. Phys.*, (5), 18, 378, 1879; *Compt. Rend.*, 89, 63, [1879]; G. A. Goyder, *Chem. News*, 69, 269, 1894; W. Nernst, *Ber.*, 30, 1560, 1897; F. Kunsehert, *Zeit. anorg. Chem.*, 41, 359, 1905; A. Brochet and J. Petit, *Bull. Soc. Chim.*, (3), 31, 359, 1255, 1904; *Chem. News*, 91, 67, 1905.

³² C. Engler and E. Kneis, *Dingler's Journ.*, 263, 193, 1887; C. Engler, *Chem. News*, 41, 284, 1880; W. Thomson, *ib.*, 34, 176, 200, 213, 1876; W. H. Watson, *ib.*, 36, 200, 1877; I. J. Redwood, *Journ. Soc. Chem. Ind.*, 5, 362, 1886; J. Golding and E. Feilmann, *ib.*, 24, 1285, 1905; S. Macadam, *Journ. Chem. Soc.*, 34, 355, 1878; C. W. Volney, *Analyst*, 8, 68, 1883; N. J. B. G. Guibourt, *Journ. Chim. Méd.*, 7, 586, 1831; C. Reinhardt, *Zeit. angew. Chem.*, 3, 634, 1888; J. Sehenkel, *ib.*, 4, 66, 1889; A. Carpené, *Boll. Soc. Gen. Viticoltori Ital.*, 3, 482, 1888; D. Klein and A. Berg, *Bull. Soc. Chim.*, (2), 45, 864, 1886; *Compt. Rend.*, 102, 1170, 1886; A. Livaehé, *ib.*, 96, 260, 1883; 97, 1311, 1883; W. Lippert, *Chem. Rev. Fett. Harz-Ind.*, 6, 65, 1899; J. H. Gladstone, *Journ. Chem. Soc.*, 7, 195, 1854; A. Lidow, *Journ. Russ. Phys. Chem. Soc.*, 31, 571, 1899; C. A. Fodin, *ib.*, 38, 419, 1906; A. Gawalowsky, *Zeit. anal. Chem.*, 38, 769, 1899.

³³ P. Sabatier and J. B. Senderens, *Ann. Chim. Phys.*, (8), 4, 433, 1905; H. Fleck, *Chem. Centrbl.*, 1626, 1888; T. Schwarz, *Repert. anal. Chém.*, 3, 291, 1883; A. Gawalowsky, *Zeit. anal. Chem.*, 38, 769, 1899; K. B. Lehmann, *Arch. Hyg.*, 63, 66, 1908; H. C. Bolton, *Ber.*, 13, 726, 1880; T. Bergman, *De acido sacchari*, Upsala, 1776.

³⁴ P. Ebell, *Ber.*, 16, 2429, 1883; C. Paal and W. Leuze, *ib.*, 39, 1551, 1906; V. Augur, *Compt. Rend.*, 144, 422, 1907; L. Lemal, *ib.*, 124, 1097, 1897; H. le Chatelier and P. Chapuy, *ib.*, 127, 433, 1898; R. Franehot, *ib.*, 141, 1020, 1037, 1905; H. le Chatelier, *ib.*, 129, 387, 477, 1899; P. Hautefeuille, *Répert. Chim. App.*, 3, 475, 1861; 4, 16, 1861; M. von Pettenkofer, *Abh. Bayer. Akad.*, 1, 121, 1856; A. Leerenier, *Bull. Soc. Belgique*, 18, 395, 1905; W. Spring, *ib.*, 1014, 1900; *Rec. Trav. Chim. Pays-Bas*, 19, 339, 1900; F. Wöhler, *Liebig's Ann.*, 45, 134, 1843; E. Frémy and M. Clémandot, *Journ. Pharm.*, (3), 9, 174, 1846; F. Wibel, *Ueber die Reduktion von Kupferoxydsalzen*, Hamburg, 1864; F. Knapp, *Natur. Runds.*, 9, 431, 1894; E. Zalkowsky, *Chem. Ind.*, 20, 134, 1897; L. Jitsehewsky, *Proc. Russ. Min. Soc.*, 37, 57, 1901; H. S. Washington, *Amer. Journ. Science*, (3), 48, 411, 1894; J. C. M. Garnett, *Proc. Roy. Soc.*, 76, A, 370, 1905; *Phil. Trans.*, 203, A, 385, 1904; 205, A, 237, 1905; H. Schwarz, *Tagb. Nat. Ver.*, 267, 1886; C. E. Guignet and L. Magne, *Journ. Soc. Chem. Ind.*, 9, 736, 1890; C. Lauth and G. Dutailly, *Bull. Soc. Chim.*, (2), 49, 596, 1888; *Monit. Cer. Ver.*, 19, 237, 1889; H. Seger, *Tonind. Ztg.*, 14, 671, 687, 1890; C. Otsuki, *Zeit. angew. Chem.*, 18, 1054, 1905; W. H. Zimmer, *Sprech.*, 40, 85, 1907.

³⁵ F. Jaekson, *Journ. Amer. Chem. Soc.*, 25, 992, 1903; P. Jolibois, R. Boussuet, and M. Chevry, *Compt. Rend.*, 172, 373, 1921; A. B. Prescott and E. C. Sullivan, *First Book of Qualitative Analysis*, New York, 1879; T. G. Wormley, *Microchemistry of Poisons*, New York, 1867; A. Wagner, *Zeit. anal. Chem.*, 20, 349, 1881; A. J. Cooper, *Journ. Soc. Chem. Ind.*, 5, 84, 1886; T. Carnelley, *Chem. News*, 32, 308, 1875; M. Ilinsky and G. von Knorre, *Ber.*, 18, 699, 2728, 1885; 20, 283, 1886; *Chem. News*, 52, 301, 1885; P. Cazeneuve, *Bull. Soc. Chim.*, (4), 23, 592, 701, 769, 1900; *Chem. Ztg.*, 24, 684, 1900; K. W. Charitsehkov, *ib.*, 34, 479, 1910.

³⁶ J. A. Trillat, *Oxydation des alcools*, Paris, 1901; P. Sabatier, *La catalyse en chimie organique*, Paris, 1913; W. G. Palmer, *Proc. Roy. Soc.*, 98, A, 13, 1920; 99, A, 412, 1921.

§ 7. The Atomic Weight of Copper

According to H. E. Roscoe and A. Harden,¹ in a note-book, dated March, 1804, J. Dalton wrote 44 for the at. wt. of copper when oxygen is 5.5; this number becomes 56 when oxygen is 7, and this is the number—or 28, $\frac{1}{2}$ of 56—employed by J. Dalton in his *A New System of Chemical Philosophy* (Manchester, 2, 352, 1810)—if oxygen be 16, Dalton's number becomes 2×64 . In 1814, from the analytical data of J. L. Proust and R. Chénevix, W. H. Wollaston calculated the value $\text{Cu} = 40$ if oxygen is 10, or 64, if oxygen be 16.

(1) *The determination of the ratio* $\text{CuO}:\text{Cu}$.—Between 1811 and 1820, J. J. Berzelius made numerous analyses of cupric oxide, and determined the weight of metal set

free when purified cupric oxide is reduced in hydrogen; he calculated the ratio $\text{CuO} : \text{Cu} = 79.3 : 63.3$, which gave the at. wt. of copper 63.298 when that of oxygen is 16. These experiments have been discussed by J. Sebelien, and H. G. Söderbaum. The standard for oxygen used by J. J. Berzelius was 100. As late as 1820, J. Dalton's theory had not been refined by Avogadro's hypothesis, and there were some differences of opinion as to whether the at. wt. of copper should be 2×64 , 64, or $\frac{1}{2} \times 64$ —J. J. Berzelius employed the first value, J. J. G. Meinecke the second, and L. Gmelin the third. The value approximating to 64 fits in with the rule, and the law of isomorphism. An application of Avogadro's hypothesis to the volatile chlorides is not so decisive because the smallest quantity of copper present in a molecule of the vapour of cuprous chloride (*q.v.*) is twice as great as corresponds with the accepted at. wt. This is attributed to the doubling of the molecule. With some solvents, J. H. van't Hoff's methods furnish results in harmony with the accepted value as representing the at. wt. of a single atom. Thus, G. Tammann and G. Meyer have shown that the element dissolved in mercury is probably monatomic on the assumption that the at. wt. approximates 64; F. Haber, however, regards this as doubtful.

In 1844, O. L. Erdmann and R. F. Marchand repeated J. J. Berzelius' determination, and corrected the results for weighing in air; they obtained 63.462. J. B. A. Dumas reduced copper oxide, and transformed the product into cuprous sulphide. He said that his numbers varied from 63 to 64, but gave no details, and he put 63.5 for the at. wt. of copper. In 1863, N. A. E. Millon and A. Commaille reduced cupric oxide by hydrogen, and checked the results by weighing the synthesized water. They obtained 63.125. In 1873, W. Hampe tried reducing a silver salt by means of copper, but did not get satisfactory results, and fell back on the original Berzelian method, reducing the weighings to the vacuum standard. He thus obtained 63.344. In 1891, T. W. Richards showed that all previous results were vitiated by the occlusion of gases by the reduced copper, for these are not expelled by heat. By making the necessary correction, he obtained 63.602 for the at. wt. of copper. In 1906, E. Murmann reduced cupric oxide, and reoxidized the metal. He selected values varying between 63.512 and 63.560 to represent his results.

(2) *The analysis of cupric sulphate or cupric bromide.*—H. Baubigny calcined anhydrous cupric sulphate and calculated the at. wt. 63.466 from the ratio $\text{CuSO}_4 : \text{CuO}$, or $\text{CuO} : \text{SO}_3$. T. W. Richards also obtained 63.555 from the ratio $\text{CuO} : \text{CuSO}_4$, obtained by the synthesis of cupric sulphate from cupric oxide; 63.472 from the ratio $\text{Cu} : \text{CuSO}_4$, obtained by the synthesis of the same salt from copper; and 63.601 from the ratio $\text{CuSO}_4 : \text{Cu}$, obtained by decomposing a soln. of anhydrous cupric sulphate electrolytically—W. Hampe had previously used the same process and obtained 63.32. T. W. Richards also analyzed the pentahydrated sulphate and obtained 63.550. He electrolyzed a soln. of cupric sulphate; determined the free acid by titration with a standard soln. of sodium carbonate; and obtained from the ratio $\text{Cu} : \text{Na}_2\text{CO}_3$, 63.533. He also measured the amount of sodium sulphate produced, and obtained from the ratio $\text{Cu} : \text{Na}_2\text{SO}_4$, 63.558; and in another series the sulphuric acid was determined as barium sulphate, $\text{Cu} : \text{BaSO}_4 = 63.679$. The data enable the at. wt. of copper to be computed from other ratios, $\text{CuSO}_4 : \text{Na}_2\text{CO}_3$, 63.441; $\text{CuSO}_4 : \text{Na}_2\text{SO}_4$, 63.481; $\text{CuSO}_4 : \text{BaSO}_4$, 63.802; $\text{CuSO}_4 \cdot 5\text{H}_2\text{O} : \text{Na}_2\text{CO}_3$, 63.533; $\text{CuSO}_4 \cdot 5\text{H}_2\text{O} : \text{Na}_2\text{SO}_4$, 63.558; and $\text{CuSO}_4 \cdot 5\text{H}_2\text{O} : \text{BaSO}_4$, 64.082. T. W. Richards also analyzed cupric bromide—determining the copper by electrolysis, and the acid as silver bromide; this gave the ratios, $\text{CuBr}_2 : \text{Cu} : 2\text{AgBr}$, from which he computed at. wts. varying, in five different series, from 63.548 to 63.589.

(3) *The determination of the electrochemical equivalent of copper, that is, the ratio $\text{Cu} : 2\text{Ag}$.*—Lord Rayleigh and H. Sidgwick measured the ratio in 1885, and obtained for the at. wt. of copper 63.38 (silver, 107.93); T. Gray likewise in 1886–9 obtained 63.31 to 63.50; W. N. Shaw in 1886, 63.49; T. W. Richards in 1887 and 1888,

63.599 and 63.600 respectively; A. Vanni in 1891, 63.41; T. W. Richards, E. Collins, and G. W. Heimrod in 1899, 63.60; T. W. Richards and G. W. Heimrod in 1902, 63.601; and G. Gallo in 1905, 63.555.

Taking all these values into consideration, and applying corrections for the various known sources of error in the earlier work, F. W. Clarke arrived at 63.5550 as the best representative value for the at. wt. of copper; and added: "This value is possibly, but not certainly, a little too low. The rejection of the values derived from cupric oxide raises the general mean to 63.564, which may be nearer the truth." B. Brauner also arrives at what he calls the *antiker Wert* 63.60, with silver 107.93, as the basis of calculation; and the *moderner Wert* 63.56, with silver 107.883, as the basis. The International Table of Atomic Weights for 1920 gives 63.57, or, in round figures, 63.6. The **atomic number** of copper is 29.

Lord Kelvin² estimated from the theory of contact electricity that 10^{-8} cms. is the minimum admissible diameter for the molecules of copper or zinc; or that it would be impossible to make thinner plates without splitting atoms; or that when these metals combine to form an alloy, they do not approach closer than this. G. Jäger also calculated a value from the electrical conductivity of the sulphate.

According to M. Traube,³ copper is bivalent both in cupric compounds and in cuprous compounds. The extraordinary compounds found in the brasses and bronzes have led N. A. Puschin and others to believe that the ordinary valency rules are quite inapplicable. B. Brauner and B. Kuzma suggested that the atom has a maximum tervalency in the so-called potassium tellurocuprate, $2K_2O \cdot Cu_2O_3 \cdot 3TeO_3 \cdot nH_2O$, although there is very little evidence to justify the deduction. E. Müller also believes that copper may be uni-, bi-, ter-, and quadri-valent in its behaviour towards oxygen; he assumes the individuality of the oxides, Cu_2O , CuO , Cu_2O_3 , and CuO_2 . A. Rosenheim and W. Stadler, and J. V. Kohlschütter assign to copper the co-ordination number 3.

In his statement of the periodic law, D. I. Mendeléeff pointed out that when an element like copper forms two series of compounds, in one of which it has the same valency as its neighbour in the horizontal row, its compounds in this state of oxidation will be similar to those of its neighbour, and the resemblance of copper to zinc is cited in illustration. D. I. Mendeléeff considered the possibility of allocating copper to Group VIII, because this element does seem out of place when grouped along with the univalent elements of the alkali family. In developing Mendeléeff's law, it was the fashion to seek for similarities rather than dissimilarities, for analogies rather than discrepancies. If the periodic rule be confined to the elements, there are many striking relations and analogies. When it is remembered that the cuprous and cupric compounds represent two states of matter which are very different, and which have no other relation than that the corresponding compounds can be converted one into the other by oxidation or reduction, the form of matter representing cuprous copper is distinct from that representing cupric copper, although each can be converted into metallic copper. The one form is univalent, the other is bivalent, and, according to G. Bodländer and O. Storbeck,⁴ and E. Abel, cuprous copper is a much nobler element than cupric copper, perhaps even nobler than silver. In allocating the metal copper to Group I of the periodic table, the properties of the cuprous compounds are arbitrarily selected as typical of the element. Had it been necessary to fit the element into Group II, the bivalent properties would have been emphasized. This has actually been done with thallium whose univalent qualities are even more pronounced than those of copper, and yet it is as arbitrarily grouped with the trivalent elements in the periodic table. M. Reinganum showed that the spectral series justified the inclusion of silver and copper in one family; and R. Lorenz believes his rule of twin elements agrees with the recognized position of copper in the periodic table.

W. Ramsay and A. T. Cameron⁵ believed that they had transmuted copper into lithium by exposing sat. soln. of cupric sulphate or nitrate to the emanation from radium. E. Gléditsch could find no simple relation between the amounts of

lithium and copper in a number of radioactive minerals such as would be anticipated if W. Ramsay's transmutation were real. For example :

	Per cent. Cu.	Per cent. Li.	Radioactivity.
Joachimsthal pitchblende	1.2	0.00017	1.5
Colorado pitchblende	0.15	0.00034	1.75
Carnotite	0.15	0.030	0.52
Chalcolite	6.54	0.00011	2.0
Autunite	0	0.00083	1.48
Thorite	trace	0.0033	0.59

M. S. Curie and E. Gleditsch, however, showed that the inference is faulty since the lithium was derived from extraneous sources ; by using apparatus—quartz and glass vessels—quite free from lithium, none was found.

REFERENCES.

- ¹ H. E. Roscoe and A. Harden, *A New View of the Origin of Dalton's Atomic Theory*, London, 1896 ; J. L. Proust, *Ann. Chim. Phys.*, (1), 32, 26, 1799 ; (1), 59, 321, 343, 1804 ; R. Chénevis, *Phil. Trans.*, 91, 227, 1801 ; J. J. G. Meinelcke, *Die chemische Messkunst*, Halle, 1817 ; T. Thomson, *Ann. Phil.*, (2), 1, 241, 1821 ; L. Gmelin, *Handbuch der theoretischen Chemie*, Frankfurt a. M., 1817 ; W. H. Wollaston, *Phil. Trans.*, 104, 21, 1814 ; J. J. Berzelius, *Gilbert's Ann.*, 37, 284, 1811 ; *Schweigger's Journ.*, 30, 384, 1820 ; *Pogg. Ann.*, 8, 182, 1826 ; J. Sebelien, *Beiträge zur Geschichte der Atomgewichte*, Braunschweig, 176, 1884 ; H. G. Söderbaum, *Berzelius' Werden und Wachsen*, 1779–1821, Leipzig, 159, 1809 ; O. L. Erdmann and R. F. Marchand, *Journ. prakt. Chem.*, (1), 31, 380, 1844 ; J. B. A. Dumas, *Ann. Chim. Phys.*, (3), 55, 129, 1859 ; N. A. E. Millon and A. Commaille, *Compt. Rend.*, 57, 145, 1863 ; H. Baubigny, *ib.*, 97, 906, 1883 ; W. Hampe, *Zeit. Berg. Hütt. Sal.*, 21, 218, 1874 ; *Zeit. anal. Chem.*, 13, 354, 1874 ; G. Tammann, *Zeit. phys. Chem.*, 3, 441, 1889 ; G. Meyer, *ib.*, 7, 477, 1891 ; F. Haber, *ib.*, 41, 399, 1902 ; E. Murmann, *Monatsh.*, 27, 351, 1906 ; T. W. Richards, *Proc. Amer. Acad.*, 22, 342, 1887 ; 23, 177, 1888 ; 25, 195, 1890 ; 26, 240, 276, 1891 ; T. W. Richards, E. Collins, and G. W. Heimrod, *ib.*, 35, 123, 1900 ; T. W. Richards and G. W. Heimrod, *ib.*, 37, 415, 1902 ; T. W. Richards, *Experimentelle Untersuchungen über Atomgewichte*, Hamburg, 1909 ; W. N. Shaw, *Phil. Mag.*, (5), 23, 138, 1886 ; T. Gray, *ib.*, (5), 22, 389, 1886 ; (5), 25, 179, 1888 ; Lord Rayleigh and H. Sidgwick, *Phil. Trans.*, 175, 470, 1884 ; A. Vanni, *Wied. Ann.*, 44, 214, 1891 ; G. Gallo, *Atti Accad. Lincei*, (5), 14, 23, 1905 ; F. W. Clarke, *A Recalculation of the Atomic Weights*, Washington, 155, 1910 ; B. Brauner, in R. Abegg, *Handbuch der anorganischen Chemie*, Leipzig, 2, i, 455, 1908.
- ² Lord Kelvin (W. Thomson), *Nature*, 28, 203, 1883 ; O. J. Lodge, *Phil. Mag.*, (5), 49, 371, 1900 ; G. Jäger, *Monatsh.*, 8, 498, 1887 ; G. G. Longinescu, *Ann. Univ. Jassy*, 179, 1045, 1903.
- ³ M. Traube, *Ber.*, 19, 1117, 1886 ; B. Brauner and B. Kuzma, *ib.*, 40, 3371, 1907 ; N. A. Fuschin, *Journ. Russ. Phys. Chem. Soc.*, 39, 869, 1907 ; E. Müller, *Zeit. anorg. Chem.*, 54, 422, 1907 ; A. Rosenheim and W. Stadler, *ib.*, 49, 3, 1906 ; J. V. Kohlschütter, *Ber.*, 36, 1151, 1903.
- ⁴ G. Bodländer and O. Storbeck, *Zeit. anorg. Chem.*, 31, 465, 1902 ; E. Abel, *ib.*, 26, 361, 1901 ; R. Lorenz, *ib.*, 12, 329, 1896 ; 14, 103, 1897 ; J. R. Rydberg, *ib.*, 14, 66, 1897 ; M. Reinganum, *Phys. Zeit.*, 5, 302, 1904 ; E. Donath and J. Mayrhofer, *Ber.*, 16, 1588, 1883.
- ⁵ W. Ramsay, *Nature*, 76, 269, 1907 ; H. N. McCoy, *ib.*, 77, 79, 1907 ; A. T. Cameron and W. Ramsay, *Journ. Chem. Soc.*, 91, 1593, 1907 ; E. Gleditsch, *Compt. Rend.*, 145, 1148, 1907 ; 146, 331, 1908 ; M. S. Curie and E. Gleditsch, *ib.*, 147, 345, 1908.

§ 8. Alleged Allotropic Forms of Copper

The temp. at which there is an abrupt change in any physical property may be employed to determine the *transition temperature* of a substance. There is therefore a comparatively wide range of available methods, and the right choice is determined by the particular conditions most suitable for the specific problem in hand.

The more common methods employed in the determination of transition points are ; (1) Solubility ; (2) Vapour press. ; (3) Heating or cooling curves ; (4) Change of colour ; (5) Change of volume. In this method, a dilatometer *D*, Fig. 21, contains the metal under investigation. The dilatometer *D* is placed in a bath fitted with stirrer *SS*, thermometer *T*,

and thermostat *P* for maintaining any required uniform temp. The level *l* of the liquid in the dilatometer is read from time to time by means of a cathetometer. If expansion or contraction occurs, the substance under investigation is above or below its transition temp.

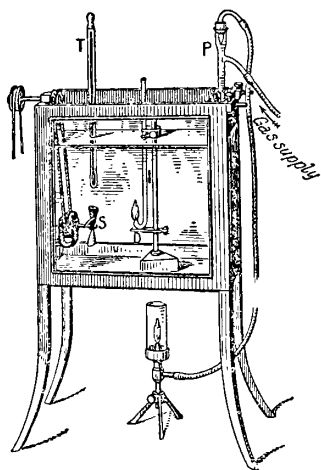

FIG. 21.—The Determination of Transition Temperatures.

If no change in volume occurs the substance is at its transition temp. (6) Change in the electromotive force of a cell. The cell shown in the diagram, Fig. 22, contains white tin in one limb, grey tin in the other, and is nearly filled with a soln. of ammonium stannic chloride. The cell is placed in a bath which can be adjusted at any desired temp. A delicate galvanometer is placed in the circuit. When the temp. is above 18°, the current flows from the grey tin through

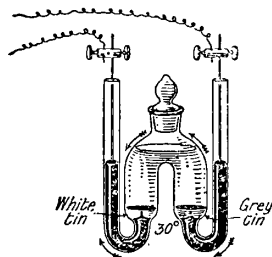

FIG. 22.—Electrical Method for Finding the Transition Point.

the soln. to the white tin so that the former is dissolved, and white tin is deposited; below 18°, the direction of the current and the behaviour of the metals, are reversed. Hence it is inferred that 18° is a transition temp.

A number of allotropic modifications of copper have been reported, but in no case is the evidence clear and decisive. In spite of the many reports which

have been made of the existence of allotropes of copper, it is assumed that the form which is stable at ordinary temp. is the same as that which occurs at lower and higher temp. The thermal analysis, electrical resistance measurements, and the microscopic examination do not disclose unequivocal evidence of a chemical transformation of copper into different allotropic forms.

P. Schützenberger's allotrope.—In 1878, P. Schützenberger¹ electrolyzed a neutral or feebly alkaline 10 per cent. soln. of copper acetate between a copper anode and a small platinum cathode, and, by keeping the temp. low, obtained a metallic deposit which (i) was extremely brittle; (ii) was easily oxidized, so that plates washed with boiling water became deep indigo-blue when exposed to air; the deposit also oxidized quickly in water (with air in soln.), and in conc. soln. of basic copper acetate; (iii) developed nitrous oxide, N_2O , with 10 per cent. nitric acid; (iv) had a sp. gr. of 8.0 to 8.2—lower than copper; (v) was less red and more of a bronze colour than copper; and (vi) had a higher electrical resistance than copper. The deposit passed into ordinary copper when rapidly warmed to 100°, or by prolonged contact with dil. sulphuric acid. Ordinary copper was also obtained if the temp. of the soln., during electrolysis, was raised, or if the electrolyte was too acid. It was accordingly inferred that P. Schützenberger had prepared an allotropic form of copper. If the alleged allotrope be powdered under water and washed, some acetate and oxide are obtained; the deposit obtained by P. Schützenberger's process contains less than 5 per cent. of oxide.

G. Wiedemann (1856) had previously shown that in the electrolysis of neutral soln. of cupric acetate, a peculiar bronze-like deposit is produced at the cathode, and that "the copper deposited at the negative pole takes with it a quantity of copper oxide from the soln. and the deposit is then very brittle and dark brown. The amount of copper oxide held by this deposit is dependent on the conc. of the soln." G. Wiedemann prepared specimens with 12 to 35 per cent. of oxide by increasing the conc. of the soln. It was therefore suggested that the alleged allotrope is nothing more than a soln. or an intimate mixture of copper oxide and copper. This, however, cannot be right because, as P. Schützenberger showed, the sp. gr. of the allotropic form is too low, and the peculiar properties disappear spontaneously

when the alleged allotrope is heated to 100° or 150°. J. B. Mackintosh showed that the alleged allotrope contained appreciable amounts of carbon and hydrogen, as well as of oxide, and he explained the rapid oxidation, etc., by assuming that the deposit is very porous. D. I. Mendeléeff attributed the peculiar properties of P. Schützenberger's allotrope to the presence of occluded hydrogen or to the formation of a hydride. Again, according to C. Benedicks, although the copper prepared by P. Schützenberger's process contains some cuprous oxide, the amount is small, and this the less the greater the current density and the less the conc. of the soln. By using a current density of about 0.025 amp. (10 volts) per sq. em. between 18° and 29°, a rapidly rotating cathode, and an electrolyte containing 0.7*N*-copper acetate and 0.3*N*-acetic acid, a deposit can be obtained practically free from cuprous oxide. Hence, C. Benedicks argued that it is more likely that P. Schützenberger's allotrope is a solid soln. of acetic acid in copper because the product invariably contains carbon and hydrogen very nearly in the proportions corresponding with anhydrous acetic acid, and, when warmed, sometimes without warming, it smells of acetic acid. T. R. Briggs rejects P. Schützenberger's allotrope hypothesis and C. Benedicks' solid soln. hypothesis. By analogy with other known colloidal forms of the elements, and by its behaviour and mode of preparation, the alleged allotrope is a colloidal hydrogen of the normal metal. Its formation during the electrolysis of acetate soln. is explained by assuming that in such soln. a gelatinous protective colloid, probably copper hydroxide, is formed by hydrolysis; and this has been confirmed by emulsion experiments with benzene.

E. Cohen's allotropes.—E. Cohen and W. D. Heldermann² found that the density of cast copper, 8.890, did not change when kept for 24 hours in a soln. of copper sulphate (half sat. at 100°), but if kept for 24 hours at 25°, the sp. gr. rose to 8.900; and, by measuring the rate at which the volume of the copper changes when heated in a dilatometer at temp. between 25° and 90°, the minimum rate of expansion occurred about 70°. Hence it is argued: (i) there are two modifications of copper—the form stable below 71.7° is called *α*-copper, and the one stable above that temp. *β*-copper; (ii) the transition temp. from the one form to the other is in the vicinity of 70°; (iii) the so-called pure copper at ordinary temp. is always a mixture of two modifications—stable and unstable; (iv) the unstable variety is in a metastable condition at ordinary temp.; and (v) the physical constants of copper hitherto determined refer to indefinite mixtures of the two modifications. A. Smits and P. Spuyman could find no signs of a transition temp. at 70° in their study of the e.m.f. of a copper-silver couple immersed in a soln. of cupric sulphate.

G. K. Burgess and I. N. Kellberg could find no signs of the supposed modifications of copper in the continuity of the curves relating to the electrical resistance of the metal at temp. between 0° and 100°; nor could P. W. Bridgman find any evidence of the supposed allotropism in the effects of press. on the electrical resistance of the metal. A. Smits and J. Spuyman could find no sign of a transition point at about 70°; nor did P. W. Bridgman's measurements of the e.m.f. of thermocouples suggest any allotropism of the copper. E. Janeeke, however, subjected the metal to a high press., and measured the press. at different temp. (heating and cooling), the resulting *PT*-curves showed a slight bend in the vicinity of 99°. This was taken to agree with the existence of two allotropic modifications of copper. The fact that the transition temp. by E. Cohen and others is somewhat divergent may mean that some other phenomenon, not allotropism, is under observation—*e.g.* (i) press. may distort the crystal grains and make them decrease the intercrystalline spaces and so change the density; and (ii) small changes in density may be produced by the gradual water-logging of a specimen heated in a soln. of the metal sulphate, for water can be forced through many metals when subjected to high press. The small backward and forward changes of density on a falling and rising temp. may be explained by the changes in the amounts of soln. retained in the interstitial spaces at different temp., owing to the expansion and contraction of the soln. It is also possible that E. Cohen's results are due to the presence of cuprous oxide or to the use of chips or

wire in a state of internal strain or of unstable fine crystalline structure. In reply, E. Cohen said that (i) the transformations often take place so slowly that, to accelerate them to such an extent as to enable them to be detected, it is necessary to work with fine powders in contact with a soln. of an electrolyte with which the metal is in equilibrium; (ii) W. Rosenhain's objection that the electrochemical eq. by different observers negatives the hypothesis that the metal *en masse* is a mixture of unstable forms is explained by the fact that the eq. is a question of mass, and independent of the polymorphic form taken by the metal after losing its charge.

REFERENCES.

¹ P. Schützenberger, *Compt. Rend.*, 86. 1265, 1397, 1878; *Bull. Soc. Chim.*, (2), 31. 291. 1879; G. Wiedemann, *Pogg. Ann.*, 99. 193, 1856; *Wied. Ann.*, 6. 81, 1878; C. Benedicks, *Met.*, 4. 5. 33, 1907; J. B. Mackintosh, *Amer. Chem. Journ.*, 3. 354, 1881; *Chem. News*, 44. 279, 1881; T. R. Briggs, *Journ. Phys. Chem.*, 17. 281, 1913; D. I. Mendeléeff, *Principles of Chemistry*, London, 2. 404, 1891.

² E. Cohen and W. D. Helder mann, *Zeit. phys. Chem.*, 87. 419, 1914; 89. 630, 1915; E. Cohen, *Die Ingenieur*, 25. 349, 1910; G. K. Burgess and I. N. Kellberg, *Journ. Washington Acad. Sciences*, 5. 657, 1915; P. W. Bridgman, *Proc. Amer. Acad.*, 52. 573, 1917; 53. 269, 1918; E. Janecke, *Zeit. Phys. Chem.*, 90. 313, 1915; W. D. Helder mann, *Journ. Inst. Metals*, 16. 84, 1916; P. C. Merica, *Met. Chem. Eng.*, 18. 124, 1918; A. Vosmaer, *ib.*, 13. 535, 1915; T. R. Briggs, *Journ. Phys. Chem.*, 17. 299, 1913; A. Smits and J. Spuyman, *Proc. Acad. Amsterdam*, 23. 977, 1921; W. Rosenhain, *Journ. Inst. Metals*, 16. 108, 1917; E. Cohen and A. L. T. Moesveld, *Versl. Akad. Amsterdam*, 28. 762, 1920; A. Smits and J. Spuyman, *ib.*, 29. 327, 1921.

§ 9. The Copper Suboxides

In the first century of our era, Dioscorides knew that when copper is heated it becomes covered with a red film which can be removed from the surface of the metal, and he added that the powder is black if the metal be heated too strongly. Pliny, and Geber also made analogous statements. The chemists of the phlogiston period knew that the metal can be oxidized (dephlogisticated) in different stages, but J. L. Proust ¹ first showed that in addition to the black copper oxide which is formed during the calcination of ordinary salts of copper, a definite lower oxide can be prepared by reducing a soln. of one of the copper salts with stannous chloride, and treating the resulting cuprous chloride with potash lye. The new oxide so precipitated was found to furnish metallic copper and a salt of the higher oxide when treated with sulphuric or dil. nitric acid.

Copper thus forms two well-defined oxides, the lower oxidized form is now called *cuprous oxide*, Cu_2O , and the other *cupric oxide*, CuO . Each oxide is the base of a characteristic series of salts. The copper base in each series behaves as if two different elements are involved—one a univalent element related to silver, and the other a bivalent element related to nickel. There are also hydrated forms of cuprous and cupric oxides which are colloidal gels, or true hydroxides. In addition, *copper sesquioxide*, Cu_2O_3 , and *copper dioxide or peroxide*, $\text{CuO}_2 \cdot \text{H}_2\text{O}$, have been reported. The so-called *cuprosocupric oxide*, $2\text{Cu}_2\text{O} \cdot \text{CuO}$, might be more correctly symbolized $\text{Cu}_2\text{O} \cdot n\text{CuO}$, since it is probably a solid soln. of one oxide in the other. Two suboxides, *copper tritoxide*, Cu_3O , and *copper quadrantoxide*, or *tetrifitoxide*, Cu_4O , have been also reported, but proofs of their individuality as homogeneous chemical species are wanting.

H. Rose ² prepared what he regarded as **copper quadrantoxide**, Cu_4O , or **copper tetrifitoxide**, by adding freshly prepared and moist cuprous chloride to a dil. soln. of stannous chloride in potassium hydroxide—if the soln. be too dil. or if too much stannous chloride be employed metallic copper is precipitated. The same product was obtained by using a soln. of cuprous sulphate instead of cuprous chloride. H. Rose's directions are :

300 c.c. of a soln. of copper sulphate (containing the eq. of 10 grms. of copper) are added, with constant agitation, to a litre of a well-cooled soln. of 50 grms. of potassium oxide and

mixed with sufficient stannous chloride to oxidize 30 grms. of iodine. The operation is conducted in a flask just large enough to hold the soln. After the mixture has stood for 24 hrs. the olive-green precipitate is washed in an atm. of an inert gas—hydrogen or nitrogen—first with dil. potassium hydroxide; then with aqua ammonia which flocculates the precipitate; and finally with water.

J. H. Gladstone and A. Tribe also say that if a copper-silver couple be placed in a soln. of cupric nitrate, a film of this oxide may be deposited on the silver plate. A. Recoura obtained Rose's oxide by the decomposition of cuprous oxide, *q.v.* H. Rose thus describes the properties of copper quadrantoxide: The olive-green powder is stable if kept under water out of contact with air, and it gradually becomes denser and less readily oxidized; but it cannot be dried without change. When the oxide is heated in a limited supply of air, it acquires a yellow film of cuprous oxide. Dil. sulphuric acid converts it into copper and cupric sulphate in the proportions $\text{Cu} : \text{CuSO}_4 = 3 : 1$ (nearly); the equation is presumably $\text{Cu}_4\text{O} + \text{H}_2\text{SO}_4 = \text{H}_2\text{O} + \text{CuSO}_4 + 3\text{Cu}$ —since cuprous oxide is soluble in dil. sulphuric acid, L. Moser says that the quadrantoxide is either decomposed by the dil. acid or else it is a mixture of cuprous oxide and copper. Hydrochloric acid first darkens the quadrantoxide—possibly forming *copper subchloride*—and then furnishes a mixture of copper and cuprous chloride; and hydrocyanic acid forms a black substance—possibly *copper subcyanide*—soluble in dil. nitric acid. Hydrogen sulphide transforms copper quadrantoxide into a black homogeneous substance—possibly *copper sub-sulphide*—which gradually gives off hydrogen and forms a higher sulphide. The quadrantoxide is insoluble in aqua ammonia or in an ammoniacal soln. of ammonium carbonate. J. H. Gladstone and A. Tribe add that silver nitrate is reduced to filiform silver by copper suboxide. Analyses of the product correspond with 95 per cent. Cu_4O , and 5 per cent. of stannous oxide. The chemical individuality of the quadrantoxide has not therefore been established, and when further investigated, it may prove to be a hydrogel of variable composition. L. Wöhler and O. Balz observed no signs of the quadrantoxide in their study of the dissociation $2\text{CuO} \rightarrow \text{Cu}_2\text{O} \rightarrow 2\text{Cu}$.

Cuprous oxide, Cu_2O .—It is probable that the copper mineral likened by Theophrastus to the "carbuncle," refers to a native form of this oxide, and called by G. Agricola³ (1546) "red copper." References to the same mineral occur in the writings of J. B. L. Romé de l'Isle (1783), A. J. Cronstedt (1758), B. G. Sage (1772), J. C. Wallerius (1778), and R. J. Haüy (1801). The latter called it *cuivre oxydé rouge*, and pointed out that, unlike the carbonate, it dissolves in hydrochloric acid without effervescing; he expressed the opinion that the earth is nothing more than *cuivre peu chargé d'oxygène*. This was proved by R. Chénevix, who showed by analysis that the Cornish mineral *red copper ore* is a crystalline form of cuprous oxide—copper 88.5, oxygen 11.5 per cent.—and M. H. Klaproth confirmed this by analyzing a sample from Siberia. In consequence of this colour cuprous oxide has received many different designations—*livery copper ore*; *ruberite*; and *Ziegelerz*—that is, *tile ore*—a term which was contracted to *ziguéline*. In 1845, W. Haidinger suggested the term *cuprite* which is now generally accepted. A form of the same mineral occurring in slender fibres resembling fine hair, is called *chalcotrichite*— $\chi\alpha\lambda\kappa\acute{o}\varsigma$, copper; $\tau\rho\iota\chi\acute{o}\varsigma$, hair—and also *flowers of copper*, or *flores cupri*. According to F. Sandberger, and E. Weinschenk, this mineral is the colouring agent of the hyacinth. W. Autenrieth found 0.07 per cent. of iodine in some samples of red copper oxide. Octohedral crystals of cuprite have been reported in copper slags and furnace products by E. Mitscherlich, J. L. Jarman and J. F. McCaleb, J. F. L. Hausmann, A. Arzruni, etc. Crystals of the mineral along with cassiterite have been found by B. G. Sage, J. Davy, C. Grewingk, A. Lacroix, etc., in the oxidized crust on old bronze figures. The synthesis of the mineral artificially has been discussed by L. Bourgeois, C. W. C. Fuchs, F. Fouqué and A. Michel-Levy, etc.

The preparation of cuprous oxide by oxidizing metallic copper.—R. F. Marchand⁴ heated thick copper wire in a muffle for half an hour to a white heat, and then for

several hours to a dull red heat. He said the cuprous oxide is deposited on the remaining button of metal in black masses of crystals which give a purple-red powder. A. Vogel and C. Reischauer found that cupric oxide is converted into cuprous oxide when heated to a high temp. H. Debray and A. Joannis say that even if a large excess of copper be heated to redness in a stream of air, cuprous oxide is formed. There is nothing here to show how much cupric oxide is formed at the same time, since it is all a question of temp. and press. how much of each is formed. According to R. H. Bradford, at ordinary press., cupric oxide is transformed into cuprous oxide at 1050°. L. Wöhler and A. Foss found that the reaction is of the balanced type: $4\text{CuO} \rightleftharpoons 2\text{Cu}_2\text{O} + \text{O}_2$, and the dissociation press. at different temp. is quite analogous in principle with the dissociation of barium dioxide: $2\text{BaO}_2 \rightleftharpoons 2\text{BaO} + \text{O}_2$. The partial press. p of the oxygen, at different temp., expressed in mm. of mercury, is:

	960°	1000°	1010°	1020°	1030°	1040°	1050°	1060°	1070°
p	50	118	142	174	212	258	314	380	458
p'	31	65	—	—	108	—	—	164	—

There is a complication, however, for they assumed that cuprous and cupric oxides are soluble in one another forming a single phase, and the dissociation press. of this soln. likewise depends on the temp. and the conc. of the cuprous oxide dissolved in the cupric oxide. For a mixture of equimolecular parts of the two oxides, the dissociation press. p' at different temp. are indicated in the above table, and the values of p and p' are likewise plotted in Fig. 23. The two-component system—solid soln. of the two oxides, and gas—remained until all the oxygen required by the reaction was removed and cuprous oxide alone remained. H. W. Foote and E. K. Smith showed that the values estimated for the dissociation press. by W. Stahl are much too small. F. H. Smyth and H. S. Roberts showed that it is unlikely that a solid soln. of the two oxides is formed at a temp. at which both oxides remain solid, and that previous results are vitiated by inadequate temp. control; and in their study of the dissociation press. they

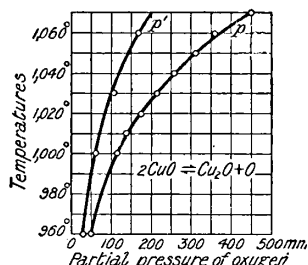

FIG. 23.—Dissociation Pressures, $2\text{CuO} \rightleftharpoons \text{Cu}_2\text{O} + \text{O}_2$.

found no evidence of the formation of solid soln. between copper, and cuprous and cupric oxides. The reaction has also been studied by R. N. Pease and H. S. Taylor.

G. H. Bailey and W. B. Hopkins heated cuprous oxide to a high temp.—over 1500°—in a gas injector furnace, and obtained a yellowish-red mass of sp. gr. 3.81. Analysis corresponded with Cu_3O , copper tritoxide. The finely-powdered product was not acted upon by conc. or dil. mineral acids, but it was slowly attacked by hydrofluoric acid. It could be obtained in a soluble form by fusion with potassium hydroxide, in which it dissolved. Brown flakes separated when the cold cake of potassium hydroxide was digested with water. These flakes dissolved readily in acid. E. Jordis and W. Rosenhaupt believe the product to be a solid soln. of copper in cuprous oxide or of cupric oxide and copper quadrant-oxide. In any case, although the attempt was made to maintain an oxidizing atm., it is very improbable if the attempt was successful in view of the known difficulties of obtaining oxidizing atm. in high temp. gas furnaces.

R. Chénevis prepared cuprous oxide by heating a mixture of finely-divided metallic copper with 1.25 times its weight of cupric oxide to a low red heat in a closed vessel; and J. J. Berzelius heated alternate layers of copper oxide and copper plate. The red oxide can then be readily separated from the unoxidized metal. F. Emich, and P. Sabatier and J. B. Senderens obtained cuprous oxide of a fine cochineal red colour by heating reduced copper above 250° and below a dull red heat in a stream of nitric or nitrous oxide. The oxidation is said to go no further than the desired Cu_2O . A. C. Becquerel obtained crystals of cuprous oxide by

dipping a strip of copper in wetted mercurous chloride or a mixture of mercurous and silver chlorides.

The preparation of cuprous oxide by reducing cupric oxide or salts.—The higher temp. reduction of cupric oxide by heat and by red-hot metallic copper has been already discussed. A. C. Becquerel⁵ obtained crystals of cuprous oxide by forming a soln. of cupric nitrate on an excess of cupric oxide and allowing the mixture to stand in contact with a copper plate for some time. L. Bourgeois also obtained orange-red octahedra by adding cupric oxide to molten calcium chloride—oxygen is given off and cuprous oxide formed. L. Bourgeois found that if an excess of copper oxide be melted with tin or stannic oxide in a porcelain crucible, and slowly cooled, dark reddish-yellow crystals of cuprite and colourless needles of stannic oxide are formed. Many other reducing agents may be used. A. Knop added a mixture of ferrous sulphate and sodium carbonate to a soln. of copper sulphate, and after the mixture had stood some time, he obtained crystals of cuprite. F. Wibel added ammonia to the same mixture. J. de Girard and A. de Saporta used hydrazine sulphate in alkaline soln.—E. Rimini says the reduction here goes to metallic copper; W. H. Foster used phenylhydrazine; E. Péchard, D. Vörländer and F. Meyer, and L. Moser used hydroxylamine hydrochloride in alkaline soln.—W. H. Foster says some cuprous oxide remains in soln. P. Jannasch used an alkaline soln. with tartaric acid and hydrogen peroxide. D. Tommasi treated a mixed soln. of potassium chlorate and cupric sulphate with zinc.

A. Étard heated a mixture of cuprosocupric sulphite in a current of carbon dioxide and obtained a mixture of both cupric and cuprous oxide; S. B. Newbury heated a basic cupric sulphite with water; T. Curtius and R. Jay heated hydrazine cupric sulphate. P. Cazeneuve heated a soln. of cupric acetate to 200°; J. Riban heated cupric oxide with a soln. of acetic acid; E. Priwoznik heated metallic copper with acetic acid and ammonium chloride; A. Vogel heated a soln. of cupric acetate with sulphur dioxide; J. M. Eder heated cupric acetate or oxalate with potassium ferro-oxalate; E. Ehrmann boiled Schweinfurt's green with alkali-lye; K. G. Thurlach heated a dil. soln. of cupric glycerate; M. Prud'homme heated a blue soln. of cupric hydroxide in alkali-lye with chromic acid; A. Guérout heated malachite with ether in a sealed tube at 280°. A convenient way of making cuprous oxide is to reduce a conc. soln. of cupric sulphate and sodium chloride with sulphur dioxide, and expel the excess of the latter by heat. The addition of sodium carbonate to the hot soln. precipitates bright red cuprous oxide, which can be readily washed by decantation.

Many organic agents reduce copper oxide, cupric hydroxide. For example, with sugar, E. Mitscherlich reduced cupric sulphate, and R. Böttger, cupric hydroxide suspended in water. E. Mitscherlich's process offers a convenient method of preparing cuprous oxide:

Sodium hydroxide is added to a soln. containing equal parts of cupric sulphate and grape sugar until the precipitated cupric hydroxide at first formed is redissolved. When this soln. is warmed, the cuprous oxide is precipitated as a powder, which is free from hydroxide, and is not changed by exposure to air.

L. Grünhut used benzoic acid; H. W. F. Wackenroder used gallic acid; J. J. Berzelius, indigo white; A. Vogel, turpentine; A. M. Butlcroff, mannite soln. at 60°–70°—G. C. Wittstein denied this reaction; L. Hunton and W. H. Foster, and R. Böttger also used mannite in alkaline soln.; N. A. E. Millon and A. Commaille, and E. Mitscherlich employed several different kinds of sugar; R. Böttger used sugar and potassium sodium tartrate; J. Habermann and M. Honig used levulose, dextrose, invert sugar, cane sugar, and lactose, and found the reduction proceeds faster in the presence of barium hydroxide. J. Löwe used glycerol and grape sugar; P. Degener, E. Feder, and H. Frischer used potassium sodium tartrate in alkaline soln.; T. A. Glendinning used maltose. E. Feder and E. Schaer found that the alkali can be replaced by oxides of the alkaline earths, magnesia, borax,

sodium carbonate, by many alkaloids, and by organic nitrogen bases. W. Müller and J. Hagen used *grape sugar* in neutral soln. ; R. Böttger, *dextrine* in alkaline soln. F. W. Traphagen and W. M. Cobleigh say that cuprous oxide reduced by sugar is not pure ; and F. Zerban and W. P. Naquin say it is more or less hydrated. According to V. V. Sarma, the yellow substance formed by the reduction of an alkaline cupric salt contains besides cuprous oxide an appreciable amount of cuprous hydroxide, which persists after heating the substance to 110°. Red crystalline cuprous oxide is precipitated by boiling Fehling's soln. with *dextrose*.

M. Ruoss prepared a colloidal soln. of cuprous oxide by boiling 1 c.c. of Fehling's soln. with 0.5 c.c. of a 1 per cent. soln. of dextrose, and 1.5 c.c. of urine, and 7 c.c. of water. The filtrate contains bright red colloidal cuprous oxide. The character of the precipitated cuprous oxide depends upon the relative proportion of tartrate used ; with an excess of tartrate, red crystalline cuprous oxide is formed, and with but little tartrate, the cuprous oxide is yellow and amorphous—probably a hydroxide. L. Moser says the yellow precipitate is probably a hydroxide, and, in the absence of air, the colour passes quickly through orange to brick-red, probably with the loss of water ; it can then be dried without further change—it then contains 2 to 3 per cent. of water. At a low red heat the red crystalline form appears ; consequently, the yellow oxide is the primary metastable form, and the red crystalline oxide the stable form. A yellow precipitate of cuprous oxide is obtained by treating a soln. of cuprous chloride with sodium hydroxide, and drying the washed precipitate in an atm. of hydrogen free from oxygen. Some consider the yellow precipitate is cuprous hydroxide—Cu(OH) ; and the red precipitate, cuprous oxide—Cu₂O. According to M. Gröger, the difference in colour is due to the difference in the size of the granules. As in the case of red and yellow mercuric oxide, the larger the granules the redder the tint.

The so-called Egyptian ointment, the *unguentum Ægyptiacum* of the older pharmacopœia, was for a long time considered a valuable medicine ; it was prepared by boiling a mixture of verdigris, honey, and a few drops of vinegar. A. Baumé attributed the striking change of colour which occurs to the plogiston of the acetic acid uniting with the verdigris, forming metallic copper. H. Vogel (1815) showed that the reddish-brown precipitate is not metallic copper but cuprous oxide, and is also produced if the honey be replaced by many other varieties of sugar. J. A. Buchner confirmed the results of H. Vogel, but believed the precipitate was a compound of copper with one of the cleavage products of sugar. C. Trommer (1841) showed that an alkaline soln. of a copper salt becomes a valuable means of differentiating between different sugars. L. C. A. Barreswil, stimulated by a prize offered by the *Société d'encouragement pour l'industrie nationale*, prepared a soln. which could be employed volumetrically for the quantitative determination of sugar. H. Schwartz extended the method to starch which was to be hydrolyzed to glucose by a prior treatment with dil. sulphuric acid. H. von Fehling worked out many details for the success of the method, and the liquid came to be called after him. F. Soxhlet demonstrated the exact conditions necessary in order that the test might give satisfactory results, and to avoid the use of an unstable standard liquid, introduced the two-standard soln. to be mixed when required. The so-called *Fehling's solution* is an alkaline soln. of copper sulphate mixed with *Rochelle salt* or *Seignette's salt*—two names for potassium sodium tartrate, C₄H₄O₆.KNa.4H₂O, applied in honour of its discovery by P. Seignette of Rochelle in 1672—to keep the cupric oxide in soln. When required it is made by mixing equal volumes of a soln. of 34.64 grms. of cupric sulphate in 500 c.c. of water, with 76.5 grms. of sodium hydroxide and 175 grms. of Rochelle salt, also made up to 500 c.c. The mixture is a very sensitive test for dextrose—0.00001 grm. of dextrose produces a red precipitate of cuprous oxide and 0.000001 grm. a red coloration.

A sample of H. von Fehling's soln. which had stood 10 years was reported by F. Cornu to have spontaneously deposited cuprite crystals on the walls of the flask ; L. G. Patterson says exposure for a month to sunlight brings about the same result ; I. Bolin and G. Linder, A. Benrath and J. Oberbach, studied the precipitation of cuprous oxide from Fehling's soln. by exposure to light filtered through glass, and to ultra-violet light. L. Rosenthaler also studied the decomposition of Fehling's soln. F. Gaud reduced Fehling's soln. with *alcohol* in a sealed tube ; A. Renard used *benzoyl glycol* ; C. Böttinger, *ammonium imidopyrroacetate* ; H. Hlasiwetz,

phloroglucin; H. Hlasiwetz and L. Barth, *resorcin*; etc. N. A. E. Millon stated that when Fehling's soln. is treated with chlorine or a hypochlorite, the precipitate first obtained is pale yellow cuprous oxide, and later orange-yellow oxide. He showed that the tartaric acid is oxidized by the chlorine. With calcium hypochlorite, said he, a yellow double salt of calcium carbonate and cuprous formate is produced. J. Aldridge and M. P. Appleby could find no evidence of the formation of carbon dioxide, and say the yellow product is finely divided cuprous oxide.

C. Ullgren heated cupric sulphate with copper filings in a closed vessel; F. Förster left a neutral soln. of copper sulphate standing in contact with metallic copper in a stoppered vessel; and F. Förster and F. Blankenberg assume that some copper dissolves, forming cuprous sulphate, which is then hydrolyzed to cuprous oxide—E. Abel has also studied the reaction. E. Weinschenk heated an ammoniacal soln. of cupric sulphate for 6 hrs. in a sealed tube at 150°. F. J. Malaguti heated a mixture of dry cupric sulphate, sodium carbonate, and copper filings, and leached the product with water. L. Ouvrard melted cupric phosphate with cupric oxide; and C. Reichard heated the basic arsenate with alkali-lye.

L. Moser found the best way of making the yellow oxide is to reduce an alkaline soln. of a cupric salt with hydroxylamine; and he made it electrolytically by using a soln. of alkali sulphate as electrolyte, and an anode of copper. According to J. Errera, a soln. of copper nitrate may be partially reduced by electrolysis in the presence of metallic copper or by simply heating the soln. with the metal. In a 0.2*N*-copper nitrate soln. at 97°, in the presence of copper, the conc. of the cuprous ions is 5×10^{-4} g. per litre, while the ratio $\text{Cu}^{+}/(\text{Cu}^{2+}) = 5 \times 10^5$; and, by hydrolysis, cuprous oxide is formed. It is probably by some similar reaction that this compound is formed in carbonate and silicate soln., for experiment has shown that it is produced on heating an aq. suspension of the carbonate in a sealed air-free tube in the presence of copper gauze. This is suggested as a possible explanation of the occurrence of cuprite with malachite and native copper in ore deposits.

The preparation of cuprous oxide from cuprous salts.—Cuprous oxide can be obtained from cuprous salts. For example, M. Gröger⁶ slowly dropped a soln. of 10 grms. cuprous chloride, 50 grms. of sodium chloride, and 250 c.c. of water, freed from dissolved air, into a soln. of 10 grms. of potassium sodium tartrate, 10 grms. of sodium hydroxide, and 150 c.c. of water. The flask was then filled with water and agitated on a shaking machine. The product was allowed to settle, washed by decantation with a soln. of potassium sodium tartrate, then with air-free cold water, filtered, and dried on a plate. W. Hampe, and F. Wöhler and J. von Liebig melted a mixture of dry cuprous chloride and dry sodium carbonate in a covered crucible, and washed out the red pulverulent cuprous oxide from the cold mass. J. L. Proust had previously employed a similar process using potassium carbonate. E. J. Russell reduced a conc. soln. of cupric sulphate and sodium chloride with sulphur dioxide, and after removing the excess of gas by boiling, precipitated the cuprous oxide from the hot soln. by means of sodium carbonate. A. Guntz and H. Bassett were unable to remove all the cuprous chloride from the precipitate by 150 washings in an atm. of hydrogen.

The preparation of cuprous oxide by electrolysis.—G. Bird⁷ made crystals of cuprous oxide by the slow electrolysis of a soln. of cupric sulphate. D. Tommasi found crystals of cuprite to be formed on the copper anode during the electrolysis of dil. sulphuric acid with high voltage currents. P. Schoop, and T. A. Edison found that reduced copper in a finely-divided state is oxidized when made the anode during the electrolysis of dil. potassium hydroxide. R. Luther electrolyzed H. von Fehling's soln., and found cuprous oxide was copiously produced on the anode. A. Chassy obtained crystals of cuprous oxide during the electrolysis of a neutral soln. of cupric sulphate at 100°—current density 1 amp. per sq. dm., platinum electrodes; analogous results were obtained by E. Wohlwill, F. Oettel, and Q. Majorana. The electrolysis of a soln. of sodium chloride between copper electrodes below 60°

furnishes yellow cuprous hydroxide; above 95° , red cuprous oxide; and at intermediate temp. a mixture of the two compounds. A. C. Becquerel conducted the electrolysis under high press. L. Wernicke electrolyzed a soln. containing 30 grms. of sodium hydroxide, 60 grms. of potassium sodium tartrate, 25 grms. of hydrated cupric sulphate, and 500 c.c. of water between a one sq. dm. platinum cathode, and two anodes of copper about a sq. mm. surface and 2 cms. apart. The current for electrolysis was obtained from a Bunsen's cell. The surface of the platinum becomes yellow, brown, purple, blue, pale green, and finally red. A piece of freshly coppered tinfoil was charged with hydrogen by using it as cathode in the electrolysis of soda-lye of sp. gr. 1.035, and it was then placed in an alkaline soln. of cupric sulphate. The foil then acquires the gradation of colours just indicated, and if the treatment be repeated a thick film of cuprous oxide is formed.

The properties of cuprous oxide.—Native cuprite occurs in well-formed carmine or cochineal-red lustrous octahedral and cubic crystals belonging to the cubic system. There is also the hair-like chalcotrichite. It also occurs massive, and earthy (tile ore). According to W. L. Bragg,⁸ F. Rinne, W. P. Davey, and A. Grün, the X-radiogram of cuprite is typical of a face-centred cubic lattice with the heavy copper atoms arranged in a face-centred lattice, with the shortest distance between the atoms of 1.84 Å. The oxygen atoms are so light that they make comparatively little difference to the intensities of the spectra, and they lie on a cube-centred lattice which intersects the face-centred lattice of the copper atoms. This structure has a holohedral symmetry—the mineral is usually plagioclinal. The artificial crystals are also carmine-red, and the colour is the brighter the finer and purer the sample; these crystals are commonly octahedral and less frequently dodecahedral and hexahedral. The artificial oxide or hydrated oxide may be yellow, brownish-yellow, or orange-yellow, and amorphous. The etching figures in sulphuric, hydrochloric, and nitric acid, and in potash-lye have been studied by H. Traube, H. A. Miers, and F. Wallerant. The specific gravity by J. F. Persoz varies from 5.375 to 5.340; F. Gaud's sample reduced from Fehling's soln. had a sp. gr. 5.881; L. Wernicke's electrolytically prepared sample, 5.975. For the natural crystals, J. B. A. Dumas and M. A. le Royer gave 5.749; C. J. B. Karsten gives 6.093; W. Herapath, 5.992; and W. Haidinger, 5.975. The hardness of cuprite is stated to be 3.5 to 4.0, and a little harder than the similarly coloured proustite, Ag_3AsS_3 , which has a hardness of 3.5.

H. Fizeau's value for the coefficient of cubical expansion of cuprite is 0.00000279 at 40° . The linear coeff. α is 0.0000093, and $da/dT=0.000000210$. The expansion per degree decreases rapidly with a falling temp., and attains a minimum at 4.1° , thus:

α	50°	40°	30°	20°	10°	4.1°	0°
.	+0.0,1059	+0.0,823	+0.0,597	+0.0,367	+0.0,136	0	-0.0,95

below 4° a contraction occurs with a rise of temp. Like water, cuprite thus has a temp. of maximum density at 4° ; the diamond has one at -38.8° . Cuprite melts at a red heat. R. Cusack gives 1162° for the melting point; H. S. Roberts and F. H. Smyth gave 1235° at 0.6 mm. mercury; E. Heyn gives 1084° , and R. E. Slade and F. D. Farrow give 1210° . The three workers last-named have also investigated the m.p. of mixtures of cuprous oxide and copper, and their results are illustrated by the curves, Fig. 24. There is a eutectic at 1065° with 3.5 per cent. cuprous oxide. At a temp. exceeding 1195° mixtures having a composition between 20 and 95 per cent. cuprous oxide separate into two layers—one a soln. of cuprous oxide in copper, the other a soln. of copper in cuprous oxide. The solubility curves for these solns. gradually converge as the temp. rises to 1400° , showing that the increase of temp. increases only slightly the solubility of each component in the other. The system within this range of composition is analogous to that of phenol and water—characteristic of partially miscible liquids which approach a critical soln. temp. where miscibility is complete. The cuprous oxide separates from soln. in the molten metal

on cooling. The amount of cuprous oxide in a sample of copper can be estimated on a polished surface under the microscope, by measuring the relative areas of the portions occupied by the eutectic and by the copper. Hence, E. Jordis and W. Rosenhaupt could say that oxygen alloys with copper as if it were a metal. H. S. Roberts and F. H. Smyth made observations ranging from copper alone up to copper with 81 per cent. of cuprous oxide. A maximum at 1235° represents the m.p. of cuprous oxide, and there is a eutectic at 1080·2° with about 69 per cent. of cupric oxide. According to F. Beijerinck, when cuprite is heated it becomes dark and opaque, owing, it is assumed, to its decomposition into cupric oxide and copper; on cooling, the mineral again becomes transparent and crystalline. If the mineral be heated near to its m.p., it remains opaque on cooling. J. L. Proust said that at a high temp. cuprous oxide is converted into a brown mixture of cupric oxide and metallic copper. H. W. Footc and E. K. Smith say that cuprous oxide is stable only between 1025° and 1070°—below these limits it rapidly passes into cupric oxide—P. T. Walden says that even at 750° the change is rapid. Cuprous oxide dissociates when heated to a high temp. $2\text{Cu}_2\text{O} \rightleftharpoons 4\text{Cu} + \text{O}_2$. W. Biltz, and L. Wöhler and O. Balz have discussed the dissociation of cuprous oxide. A. J. Allmand measured the e.m.f. of the cell $\text{Cu} | \text{Cu}_2\text{O} \cdot \text{NaOH} | \text{Pt} \cdot \text{H}_2$, and calculated the dissociation press. of the system, $\text{Cu}_2\text{O}_{\text{solid}} - \text{Cu}_{\text{solid}} - \text{Cu}_{\text{vapour}}$, at 17°, and found 3×10^{-53} atm. He also calculated this press. p by means of W. Nernst's formula, $\log p = -Q/4 \cdot 57 T + 1 \cdot 75 \log T + C$, where $C = 2 \cdot 8$, and $Q = 81,600$, whence at 17°, $p = 3 \times 10^{-55}$ atm. W. Stahl also calculated that at 1662°, $p = 0 \cdot 21$ atm., and R. E. Slade and F. D. Farrow, at 1250°, $p = 0 \cdot 45 \times 10^{-3}$ atm. Cuprous oxide is therefore volatile at about 1300°. E. Heyn found that the equilibrium temp. between the partial press. of oxygen of the air and that of the dissociating oxide is 1935° K. W. Biltz gave 1800° as the dissociation temp. E. Heyn computed the dissociation press. to be :

	500°	1000°	1500°	1800°	1900°	2000°	2100°	2300°	2500°
p	0·0 ₂₈ 65	0·0 ₃ 16	0·0 ₃ 28	0·038	0·138	0·446	0·292	8·312	40·19

H. S. Roberts and F. H. Smyth found the dissociation press. between 1119° and 1184·6° to be between 0·028 and 0·041 mm. The heat of fusion of cuprous oxide is given as 12·5 Cals. per mol, or 87 cals. per gram. They also show that solid soln. between cupric oxide, cuprous oxide, and copper are non-existent, or negligibly small. F. E. Neumann's value for the specific heat is 0·1073, and the mol. ht. is 15·3; H. Kopp's values are respectively 0·111 and 15·9. A. Magnus gave 0·1146 from 17° to 100° and 0·1242 from 17° to 541°. J. Thomsen gives for the heat of formation, $(2\text{Cu}, \text{O}) = \text{Cu}_2\text{O} + 40 \cdot 81$ Cals.; $(\text{Cu}, \text{CuO}), 3 \cdot 66$ Cals.; and $(\text{Cu}_2\text{O}, \text{O}) = 2\text{CuO} + 33 \cdot 6$ Cals. M. Berthelot gave for $(2\text{Cu}, \text{O}), 43 \cdot 8$ Cals., and added that the heat of formation from cuprous sulphide, Cu_2S , is 23·5 Cals.; from the selenide, Cu_2Se , 35·0 Cals.; and from the telluride, Cu_2Te , 35·4 Cals. The heat of dissociation is $2\text{Cu}_2\text{O} = 4\text{Cu} + \text{O}_2 + 81 \cdot 600$ Cals. at 17°; and between 1205° and 1260° was estimated at -90·060 Cals.—by R. E. Slade and F. D. Farrow; and at -55·890 Cals. between 1260° and 1324°. J. Thomsen gave 40·81 Cals. for the heat of formation $(\text{Cu}_2\text{O}, n\text{H}_2\text{O})$. M. Berthelot and J. Thomsen give respectively for the heats of neutralization of the solid oxide with dil. hydrochloric acid, 17·2 and 14·66 Cals., with dil. hydriodic

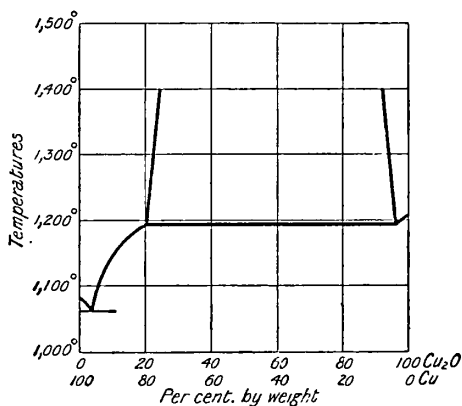

FIG. 24.—Fusion Curve of Mixtures of Copper and Cuprous Oxide.

acid, 32.8 and 33.72 Cals., and, according to J. Thomsen, with hydrobromic acid, 20.76 Cals.

G. K. Burgess gives for the relative emissivity of cuprous oxide at 1100° , 0.68 for $\lambda=0.500\mu$, and 0.60 for $\lambda=0.650\mu$. The index of refraction by L. Wernicke is 2.534 for the *B*-line; 2.558 for the *C*-line; 2.705 for the *D*-line; 2.816 for the *E*-line; carbon disulphide is 1.6120, and he found the magnetic rotatory power, *i.e.* rotation of the plane of polarization in a magnetic field, to be forty-five times as large as that of water. A. de Gramont obtained the spectrum of copper when the mineral is sparked. W. Hallwachs found the photoelectric effect for cuprous oxide is nearly the same as for copper.

S. Meyer found the cuprous oxide to be paramagnetic; the magnetic susceptibility is $+0.73 \times 10^{-6}$ mass units at 17° . Cuprite has rather a low electrical conductivity. K. Bädcker gives the specific resistance of cuprite as 40 when that of copper is 0.0006017. F. Beijerinck says that the electrical resistance of cuprite to a continuous current is 5000 Siemens' units at 120° , and this falls to 4000 at 125° , 3000 at 140° , 1800 at 180° , 1500 at 205° , and 700 at 250° , when electrolysis occurs. With an alternating current, the resistance falls to 2200 units at 50° much more rapidly, but no electrolysis occurs. The resistance of a column of cuprous oxide 1 cm. diam. and 10 cms. long at 137° was found by A. Sommerville to be 10^7 ohms. K. Bädcker gives 480 microvolts per 1° for the thermoelectric force towards platinum between 0° and 100° . G. C. Schmidt found that electrodes of cuprite in sodium hydroxide gradually become more positive but are not affected by light. T. W. Case found that exposure to light made no difference to the conductivity of chalcotrichite, but increased that of cuprite as predicted by A. H. Pfund. T. W. Case also made a photosensitive cell $\text{Cu}|\text{Cu}_2\text{O}$, copper formate + formic acid, $\text{Cu}_2\text{O}|\text{Cu}$, which gave an e.m.f. up to 0.085 volt and a current of 0.003 amp. with plates 20×3.2 cms., when one electrode was illuminated. K. Bädcker found the thermoelectric force of cuprous oxide against platinum to be 480 microvolts per degree between 0° and 100° .

Cuprous oxide is not soluble in water. It forms a colourless soln. in aqua ammonia.

An ammoniacal soln. of cuprous oxide probably containing a complex cuprous amino-oxide is formed by shaking together in a stoppered flask copper filings with aq. ammonia; or copper filings with a compound of cupric oxide and ammonia; or cuprous oxide or hydrated cuprous oxide with aq. ammonia. The reactions were studied by T. Bergmann, and by J. L. Proust.⁹ R. Wagner made the ammoniacal soln. by mixing equal mol. parts of cupric sulphate and sodium thiosulphate, precipitating with sodium hydroxide, and dissolving the washed precipitate in aqua ammonia. D. Vorländer and F. Meyer reduced the cupric salt with hydroxylamine or ferrous sulphate and dissolved the product in aqua ammonia; and H. Frischer used soln. of ferrous salt. The colourless liquid gradually turns blue from the surface downwards, on exposure to air. The oxidation has been studied by P. Schützenberger and C. Risler, and by J. Meyer. The soln. of cuprous amino-oxide is a powerful reducing agent. The same product has also been obtained by the electrolytic reduction of Schweitzer's liquid. G. Bodländer studied the electrical properties of the soln.; and S. Kern proposed to take advantage for gas analysis of the property this soln. possesses of absorbing oxygen.

Although precipitated by alkali-lye, this oxide is soluble in excess. Cuprous oxide is soluble in molten copper, but insoluble in the cold metal—*vide* Fig. 24. C. H. Mathewson and C. H. Stokesburg found that cuprous oxide dissolves in molten silver and that the system $\text{Ag}-\text{Cu}_2\text{O}$ closely resembles that of $\text{Cu}-\text{Cu}_2\text{O}$. There is a eutectic at 1.3 per cent. Cu_2O and 945° . The slope of the f.p. curve is 1.5 times as great as that calculated for the presence of Cu_2O alone, thus showing that a balanced reaction, $\text{Cu}_2\text{O} + 2\text{Ag} \rightleftharpoons 2\text{Cu} + \text{Ag}_2\text{O}$, is involved; but in the solid state the copper is all present as cuprous oxide. M. Gröger found it is dissolved by a soln. of potassium sodium tartrate in the presence of air. J. L. Proust found that nitric acid attacks cuprous oxide with the development of much heat, and evolution of nitrous fumes. P. Schützenberger showed that when finely powdered cuprous oxide is treated with cold 10 per cent. nitric acid it behaves like a mixture of copper

and cupric oxide; cupric nitrate is formed in soln. without any evolution of gas, and finely-divided copper remains in a condition not attacked by dil. nitric acid at ordinary temp. J. L. Proust found that **sulphuric acid** or **phosphoric acid**, or cold very dil. nitric acid decomposes cuprous oxide into metallic copper, which separates as a red powder, and cupric oxide which dissolves. The reaction has also been studied by R. Ehrenfeld. W. Jäger noticed **hydrofluoric acid** behaved similarly, and J. L. Gay Lussac and E. Pelouze found many **organic acids**—*e.g.* lactic acid—behaved like sulphuric acid. A soln. of **sulphurous acid** dissolves cuprous oxide forming the cuprous salt. J. L. Proust says that **hydrochloric acid** forms cuprous chloride; and N. School¹⁰ found that **hydriodic acid** forms cuprous iodide, and if sulphuric acid and air be present some iodine is separated.

Cuprous oxide is reduced to the metal when heated in a stream of **hydrogen**. The reaction has been studied by A. Osann, and by S. Hauser; the latter found the reduction temp. ranges from 232° to 248°. H. Debray and A. Joannis found that hot but not molten cuprous chloride absorbs **oxygen** from the air more easily than copper; T. Andrews gives 36·608 Cals. for the heat of combustion to cupric oxide. E. Nihoul, L. Grünhut, and A. Prager have experimented on the oxidation of cuprous oxide by heat with or without a preliminary moistening with nitric acid. H. Rose found that when heated with sulphur, in hydrogen, cuprous sulphide is formed; and A. Orłowsky found that, unlike cupric and many other metal oxides, cuprous oxide is blackened by boiling the acid soln. with milk of sulphur, or if it be allowed to stand in the cold in contact with a piece of roll sulphur. J. B. Senderens found that when sulphur and cuprous oxide are boiled with water, cupric sulphate is first formed and then cupric sulphide—the reaction at 100° is completed in a few hours, at 90° in some days. J. Thomsen gives 38·53 Cals. for the heat of the reaction $\text{Cu}_2\text{O} + \text{H}_2\text{Saq.}$ A. Vogel, and L. P. de St. Gilles have also studied the reaction of sulphur dioxide on hydrated cuprous oxide. For the action of alkali polysulphides see these salts. J. Landauer found that cuprous oxide is blackened when boiled with a soln. of **sodium thiosulphate**, and F. Field and C. and J. Bhaduri found that cold sodium thiosulphate forms a colourless soln. with hydrated cuprous oxide, and cuprous sulphide is later precipitated.

According to A. J. Balard, **bromine** water oxidizes cuprous oxide to cupric oxide and bromide; and it is also oxidized by **chlorine** and by bromine. G. Gore said that cuprous oxide is attacked by **liquid ammonia**. A. Guntz and H. Bassett say two hours' treatment of precipitated and washed cuprous oxide with **ammonia** converts it into copper nitride, Cu_3N_2 . S. Hauser found that above 280°, cuprous oxide is reduced by the gas. P. Sabatier and J. B. Senderens found that **nitrogen peroxide** at 300° rapidly converts cuprous into cupric oxide; **nitrous oxide** acts at 350°, and **nitric oxide** does not oxidize at a red heat. With **phosphorus**, copper phosphide is formed. Cuprous oxide is reduced by **carbon**. C. R. Wright and A. P. Luff found no action occurred with hydrogen at 150°, but the reduction was marked at 160°. F. Glaser gives 155° for the temp. at which reduction begins. W. Manchot and J. A. N. Friend say the hydrated oxide does not absorb carbon monoxide. According to H. Erdmann and P. Köthner, F. A. Gooch and F. Baldwin with **acetylene** at 225° or 250°, a polymerized product is formed. S. Hauser found that cuprous oxide is reduced by **carbon monoxide** at temp. exceeding 195°; while C. F. Schlagdenhauffen and M. Pagel say the reaction commences above 100°, and is complete at 300°. R. Brauns says red copper oxide can be reduced by **carbon dioxide** to copper, but P. N. Raikow found freshly precipitated cuprous hydroxide is not reduced. The oxide is reduced by the vapour of **alcohol**. G. Rauter found the **silicon tetrachloride** forms silica and cuprous chloride when heated 14 hrs. at 270°–280° with cuprous chloride. When melted with **silica** and **ferrous sulphide**, FeS, it forms cuprous sulphide, Cu_2S , and ferrous silicate, Fe_2SiO_4 .

Molten **alkali metals** reduce cuprous oxide with incandescence. **Magnesium** and **aluminium** were found to act similarly when strongly heated with cuprous oxide in a closed glass tube. C. H. Mathewson and C. H. Stokesburg found that cuprous oxide

readily dissolves in molten **silver**. There is a eutectic at 914° , with 1.3 per cent. of the oxide; and with 12 per cent. of the oxide, the f.p. rises to 1085° . Solid soln. are not formed. The observed lowering of the f.p. is greater than the value calculated from the latent heat, possibly owing to the reaction: $\text{Cu}_2\text{O} + 2\text{Ag} \rightleftharpoons 2\text{Cu} + \text{Ag}_2\text{O}$. Small amounts of the oxide are not decomposed by melting the soln. in hydrogen. J. A. Hedvall and N. von Zweigbergh noted that cuprous oxide reacts violently with **barium dioxide**, forming cupric oxide, which then decomposes the dioxide catalytically. M. Gröger found that soln. of the **chlorides of the alkalis and alkaline earths**—in an atm. of carbon dioxide but not in hydrogen—form double salts; and, according to H. Ost, the reaction proceeds more quickly at 100° . M. Gröger says that when a sat. soln. of sodium chloride is digested with cuprous oxide in an atm. of hydrogen, only a small trace of cuprous chloride is formed. The sulphates do not act in this way. W. Bersch states that cuprous oxide is soluble in a soln. of **potassium iodide** giving a soln. with an alkaline reaction. When digested with a soln. of cuprous chloride, free from hydrochloric acid, M. Gröger found that a basic chloride is precipitated. E. Wohlwill says a boiling soln. of **copper sulphate** neutralized with ammonium carbonate does not affect cuprous oxide; metallic copper under similar conditions is dissolved, so that this soln. can be used for separating copper from cuprous oxide. A soln. of **silver nitrate** was stated by C. J. B. Karsten to have no action on cuprous oxide; but C. F. Rammelsberg, H. Rose, W. Hampe, J. Dewey, and P. Sabatier find that a mixture of silver and a basic cupric nitrate is precipitated; the reaction with a cold dil. soln. begins slowly and progresses with a rapidly increasing velocity; the reaction begins immediately in conc. soln., or at 40° in dil. soln., and proceeds the more rapidly the more finely divided the cuprous oxide. R. H. Bradford found that with silver nitrate at 670° the metal is formed. According to R. Gedault, an ammoniacal soln. of **silver chloride** forms cupric oxide and chloride. J. H. Gladstone and A. Tribe have studied the action of silver nitrate on hydrated cuprous oxide. T. S. Hunt found soln. of **magnesium or zinc chloride** form magnesium or zinc hydroxide and magnesium or zinc cuprous chloride, and that **ferric chloride** partially reduces cuprous oxide to copper: $4\text{Cu}_2\text{O} + 3\text{FeCl}_3 = 6\text{CuCl} + 2\text{Cu} + \text{Fe}_2\text{O}_3$. W. Stahl and H. Koch found with **ferric oxide** at 750° – 800° , a mixture of ferrosferric oxide and cupric oxide is formed. According to P. T. Walden, the product of the reaction does not include magnetic oxide of iron, but rather $\text{Cu}(\text{FeO})_2$, cupric ferrite, which at 750° decomposes into cupric oxide, etc. D. Miklosich, R. K. Meade, H. O. Jones and F. W. Carpenter, F. Thomas, and M. de K. Thompson have studied the quantitative oxidation of cuprous to cupric oxide by soln. of ferric salts. C. F. Schönbein found that some potassium ferrocyanide is produced when **potassium ferricyanide** is treated with finely divided cuprous oxide. The oxidizing action of **potassium permanganate** has been studied by R. M. Caven and A. Hill. D. Vorländer and F. Meyer have studied the reduction of aromatic **diazonium salts** in ammoniacal or hydroxylamine soln. Platinum was found by E. Ehrmann, and B. B. Ross to be quantitatively precipitated from soln. of **alkali chloroplatinates**.

In the reaction between cupric and cuprous oxide in the decomposition of cupric oxide, by heat: $4\text{CuO} = 2\text{Cu}_2\text{O} + \text{O}_2$, the solid product obtained by heating cuprous oxide to different temp. will contain a mixture or a solid soln. of $n\text{CuO}$ with $m\text{Cu}_2\text{O}$, and if the heating be conducted under definite conditions, a product with a constant composition will be obtained—but not necessarily a chemical individual—a cuprosic oxide. This remark applies to P. A. Favre and L. Maumené's Cu_5O_3 , *i.e.* $2\text{Cu}_2\text{O} \cdot \text{CuO}$, obtained by heating cupric oxide to the m.p. of copper,¹¹ A. Joannis could find no sign of this compound, or of Cu_5O_3 , on the dissociation press. curve of cupric oxide. L. Wöhler and A. Foss showed that the cupric oxide forms a solid soln. with the cuprous oxide formed by its dissociation: $4\text{CuO} = 2\text{Cu}_2\text{O} + \text{O}_2$; the conc. of the soln. increases slowly as the dissociation progresses, and this lowers the dissociation press.

Similar remarks might be applied to the products precipitated from soln. containing partially oxidized cuprous salts, or partially reduced cuprous salts. For instance, E. Francke obtained a product which he regarded as $\text{CuOH} \cdot 3\text{Cu}(\text{OH})_2 \cdot 5\text{H}_2\text{O}$ by adding hydroxylamine to cupric hydroxide; with a still greater quantity of reducing agent, cuprous hydroxide was

obtained. Similarly, the salt $2\text{Na}_2\text{S}_2\text{O}_3 \cdot \text{Cu}_2\text{S}_2\text{O}_3 \cdot \text{CuS}_2\text{O}_3 \cdot 4\text{NH}_3$ obtained by adding ammonia to a mixed soln. of sodium thiosulphate and a cupric salt, can be regarded as being derived from a partially reduced cupric salt; and when a soln. is precipitated with caustic-lye furnishes a mixture of oxides, which M. Siewert regarded as Cu_2O_3 , i.e. $2\text{Cu}_2\text{O} \cdot \text{CuO} \cdot n\text{H}_2\text{O}$. M. Siewert also obtained a pale blue precipitate of what he regarded as $\text{Cu}_2\text{O} \cdot 2\text{CuO} \cdot 5\text{H}_2\text{O}$, by allowing an ammoniacal soln. of sodium cuprous chloride to stand for 12 hrs.

Cuprous oxide in the form of ground scales is used in preparing some ceramic colours; in making some galvanic baths; and in making some anti-rust paints. A. Lionet¹² recommended it for purifying hydrogen. He says metallic copper removes all the impurities except hydrogen phosphide and silicide, and the hydrocarbons; while cuprous oxide removes all but hydrogen silicide and the hydrocarbons; and that cupric oxide removes all the hydrocarbons.

Hydrated cuprous oxide, cuprous hydroxide.—The so-called *hydrocuprite* is hydrated $\text{Cu}_2\text{O}(\text{H}_2\text{O})_n$, and it is amorphous or colloidal. According to W. T. Schaller the supposed *vanadium ochre* from Lake Superior is really hydrocuprite. A. Brochet¹³ obtained hydrated cuprous oxide by the action of a normal soln. of chloric acid on copper. Many of the methods of preparation indicated above furnish hydrated amorphous orange-yellow cuprous oxide. For example, working with dil. soln. R. Böttger reduced freshly-precipitated cupric hydroxide with milk sugar; T. Sandmeyer reduced a soln. of cupric sulphate with grape sugar in alkaline soln; E. Müller reduced cupric hydroxide suspended in alkali-lye with copper; F. D. Chattaway reduced an ammoniacal soln. of cupric hydroxide with phenylhydrazine—ferrous sulphate can be here used as reducing agent. A. Vogcl reduced a soln. of cupric acetate with sulphurous acid. A neutral soln. of cupric sulphate can be reduced by ferrous sulphate and potassium fluoride. J. L. Proust treated a hydrochloric acid soln. of cuprous chloride with alkali-lye—E. Frémy used alkali carbonate; and T. S. Hunt used boiling milk of lime. The reduction is best conducted in an atm. of hydrogen to prevent oxidation. N. A. E. Millon and A. Commaille found that yellow-hydrated cuprous oxide never contains less than 4 per cent. of cupric oxide. F. Fischer, E. Müller, R. Lorenz, and J. H. Gladstone and A. Tribe, also prepared hydrated cuprous oxide by electrolytic processes—e.g. R. Lorenz electrolyzed a soln. of potassium chloride constantly stirred with a rotating copper anode.

C. Paal and co-workers prepared **colloidal cuprous oxide** as an intermediate product in the preparation of colloidal soln. of copper by the reducing action of alkali lysalbinat; and by heating finely-powdered and dry colloidal cupric oxide to 150° – 170° in a stream of hydrogen. C. A. L. de Bruyn prepared the hydrosol with gelatine as a protective colloid. M. Gröger also prepared colloidal cuprous oxide by reducing a soln. of sodium cuprous chloride with potassium sodium tartrate in the cold. P. Pascal made colloidal cuprous oxide by gradually adding a soln. of cupric sulphate to a soln. of alkali ferropyrphosphate. The precipitate first formed redissolves, forming a colloidal soln. A. Gutbier prepared a colloidal soln. by reducing ammoniacal cupric sulphate soln. with hydrazine; and A. Lottermoser, by reducing with stannous chloride.

According to H. G. F. Schröder, the sp. gr. of the hydrate prepared by reducing cupric oxide with lactic acid is 3.368. E. Mitscherlich found that when heated to 100° , J. L. Proust's product holds most of its water, but it retains only 3 per cent. at 360° , and becomes orange-yellow; at red-heat, the red oxide is formed. When hydrated cuprous hydroxide is exposed to air it gradually forms cupric hydroxide.

Cuprous oxide or hydroxide may be regarded as the basic oxide of **cuprous salts** where copper is univalent, Cu' . Cuprous oxide is decomposed by many acids—sulphuric, phosphoric, dil. nitric, acetic, oxalic, and many other organic acids—furnishing metallic copper, and a soln. of cupric oxide, and since the same oxide is oxidized by many other acids, comparatively few cuprous salts have been prepared. E. Frémy¹⁴ said that hydrated cuprous oxide prepared by J. L. Proust's process, dissolves in even the weakest of acids, forming cuprous salts, and that if the cuprous

oxide is dehydrated, it loses its basic property and is decomposed by the same acids. Cuprous salts have been obtained by reducing cupric salts with copper and other reducing agents—e.g. P. Rohland used a methyl alcohol soln. of ferrous sulphate; E. Eblér used hydroxylamine or hydrazine salts, etc.

The cuprous salts are generally colourless, but some are yellow, others red. They are usually insoluble in water, but soluble in ammonia, pyridine, and hydrochloric acid. They are readily oxidized to cupric salts by exposure to air while moist, and by treatment with oxidizing agents. R. M. Caven and A. Hill studied the oxidation of cuprous salts with nitric or hypochlorous acid, and with potassium permanganate. P. Sabatier proposed to detect nitrites from the violet coloration produced when a little cuprous oxide, or a small quantity of a cuprous salt, is added to a soln. containing a little nitrite dissolved in sulphuric acid. The colour disappears slowly on standing, rapidly on heating, or on dilution with water. Cuprous oxide is reduced to the metal by many reducing agents—*vide* cupric oxide. Soln. of potassium or sodium hydroxides, carbonates or bicarbonates precipitate yellow cuprous hydroxide insoluble in excess. Aqua ammonia or ammonium carbonate gives colourless soln. if air be excluded—if otherwise the soln. is blue—alkalies precipitate cuprous hydroxide from these soln., but barium carbonate was found by H. Rose to give no precipitate. Soln. of sodium phosphate give a yellow precipitate. A. Orłowsky found milk of sulphur precipitates the copper as cuprous sulphide, ammonium hydrosulphide acts similarly on neutral soln.; the precipitate is insoluble in excess. Potassium cyanide precipitates cuprous cyanide which is soluble in excess, forming a soln. from which hydrogen sulphide, ammonium sulphide, or the alkali hydroxides give no precipitation. Potassium ferrocyanide gives a rose-coloured precipitate; and potassium ferricyanide a reddish-brown precipitate. According to F. Herrmann, ferric sulphide oxidizes acid soln. of the cuprous salts, but, according to H. R. Ellis and W. H. Collier, only by a prolonged boiling. Ammonium oxalate gives a bluish-white precipitate. A. Fonseca found with silver sulphide and cuprous chloride: $\text{Ag}_2\text{S} + 2\text{CuCl} = \text{CuCl}_2 + \text{CuS} + 2\text{Ag}$. Acetylene precipitates acetylides from ammoniacal soln. of cuprous chloride; and ammoniacal or acid soln. of cuprous chloride are good solvents for carbon monoxide.

REFERENCES.

- ¹ J. L. Proust, *Ann. Chim. Phys.*, (1), 32. 26, 1799; (1), 59. 321, 343, 1804.
- ² H. Rose, *Pogg. Ann.*, 120. 1, 1863; A. Recoura, *Compt. Rend.*, 148. 1105, 1909; J. H. Gladstone and A. Tribe, *Chem. News*, 25. 193, 1872; L. Moser, *Zeit. anorg. Chem.*, 64. 200, 1909; L. Wöhler and O. Balz, *Zeit. Elektrochem.*, 27. 406, 1921.
- ³ G. Agricola, *Interpretatis Germanica vocum rei metallicæ*, Basil, 462, 1546; J. B. L. Romé de l'Isle, *Cristallographie*, Paris, 3. 331, 1783; A. J. Cronstedt, *Mineralogie*, Stockholm, 173, 1758; J. G. Wallerius, *Systema mineralogicum*, Vindobonæ, 2. 348, 1778; B. G. Sage, *Éléments de minéralogie docimastique*, Paris, 2. 227, 1772; R. J. Haüy, *Traité de minéralogie*, Paris, 3. 555, 1801; *Mém. Acad.*, 210, 1778; R. Chénevix, *Phil. Trans.*, 91. 227, 1801; M. H. Klaproth, *Beiträge zur chemischen Kenntniss der Mineralkörper*, Berlin, 4. 31, 1807; W. Haidinger, *Handbuch der bestimmenden Mineralogie*, Wien, 548, 1845; F. Sandberger, *Neues Jahrb. Min.*, 1. 258, 1881; C. Grevingk, *ib.*, 76, 1871; E. Weinschenk, *Zeit. anorg. Chem.*, 12. 375, 1896; J. Davy, *Ann. Phil.*, (2), 10. 465, 1825; A. Lacroix, *Bull. Soc. Min.*, 6. 175, 1883; L. Bourgeois, *ib.*, 11. 58, 1888; *La synthèse minéralogique*, Paris, 1884; J. F. L. Hausmann, *Ges. Wiss. Göttingen*, 4. 237, 1850; J. L. Jarman and J. F. McCaleb, *Amer. Journ. Science*, (3), 11. 30, 1889; E. Mitscherlich, *Sitzber. Akad. Berlin*, 34, 1823; A. Arzruni, *Zeit. Kryst.*, 18. 58, 1891; C. W. C. Fuchs, *Die künstlich dargestellten Mineralien*, Haarlem, 68, 1872; F. Fouqué and A. Michel-Lévy, *Synthèse des minéraux et des roches*, Paris, 378, 1882; W. Autenrieth, *Chem. Ztg.*, 23. 626, 1899.
- ⁴ R. F. Marchand, *Journ. prakt. Chem.*, (1), 20. 505, 1840; A. Vogel and C. Reischauer, *Neues Jahrb. Pharm.*, 11. 328, 1859; W. Mayer, *German Pat.*, D.R.P. 152586, 1903; P. Christoffe and H. Bouilhet, *Compt. Rend.*, 78. 1019, 1874; H. Debray and A. Joannis, *ib.*, 99. 583, 688, 1884; A. C. Becquerel, *ib.*, 75. 1729, 1872; A. Joannis, *ib.*, 100. 999, 1885; P. A. Favre and L. Mauvené, *ib.*, 18. 658, 1844; P. Sabatier and J. B. Senderens, *ib.*, 114. 1429, 1892; 120. 619, 1895; *Bull. Soc. Chim.*, (3), 13. 871, 1895; *Ann. Chim. Phys.*, (7), 1. 30, 1896; H. W. Foote and E. K. Smith, *Journ. Amer. Chem. Soc.*, 30. 1344, 1908; F. H. Smyth and H. S. Roberts, *ib.*, 42. 2582, 1920; 43. 1061, 1921; R. H. Bradford, *Trans. Amer. Inst. Min. Eng.*, 33. 50, 1902;

L. Wöhler and A. Foss, *Zeit. Elektrochem.*, 12, 781, 1906; W. Stahl, *Met.*, 4, 682, 1907; F. Emich, *Sitzber. Akad. Wien*, 101, 88, 1892; *Monatsh.*, 13, 73, 1892; R. Chénevix, *Phil. Trans.*, 91, 227, 1801; G. H. Bailey and W. B. Hopkins, *Journ. Chem. Soc.*, 57, 270, 1890; E. Jordis and W. Rosenhaupt, *Zeit. angew. Chem.*, 21, 51, 1908; R. N. Pease and H. S. Taylor, *Journ. Amer. Chem. Soc.*, 43, 2179, 1921.

⁵ A. Baumé, *Elémens de pharmacie théorique et pratique*, Paris, 1762; L. Bourgeois, *La synthèse minéralogique*, Paris, 1884; A. Guérout, *Compt. Rend.*, 79, 221, 1874; F. Gaud, *ib.*, 119, 863, 1894; A. Renard, *ib.*, 91, 175, 1880; E. Péchar, *ib.*, 136, 504, 1903; A. Étard, *ib.*, 92, 726, 1881; L. Ouvrard, *ib.*, 111, 179, 1890; P. Cazeneuve, *ib.*, 89, 525, 1879; J. Riban, *ib.*, 93, 1140, 1881; D. Tommasi, *ib.*, 136, 1005, 1903; *Bull. Soc. Chim.*, (3), 29, 482, 1903; L. Grünhut, *Chem. Ztg.*, 18, 477, 1894; H. Frischer, *ib.*, 32, 1005, 1908; C. Reichard, *ib.*, 26, 1142, 1902; H. Vogel, *Schweigger's Journ.*, 13, 162, 1815; J. A. Buchner, *ib.*, 14, 224, 1815; A. M. Butleroff, *Zeit. Chem.*, 5, 482, 1862; G. C. Wittstein, *Viertelj. prakt. Pharm.*, 15, 268, 1866; P. Jannasch, *Ber.*, 26, 2330, 1893; J. de Girard and A. de Saporta, *Bull. Soc. Chim.*, (3), 31, 905, 1904; A. Guntz and H. Bassett, *ib.*, (3), 35, 203, 1906; M. Prud'homme, *ib.*, (2), 17, 253, 1872; *Bull. Soc. Ind. Mulhouse*, 59, 607, 1889; E. Rimini, *Atti Accad. Lincei*, (5), 14, i, 386, 1905; A. Knop, *Jahrb. Min.*, 543, 1861; F. Cornu, *Tschermak's Mitt.*, (2), 26, 342, 1907; F. Wibel, *Reduktion von Kupferoxydsalzen*, Hamburg, 1864; L. Hunton, *Phil. Mag. Journ.*, 11, 154, 1837; E. Feder, *Arch. Pharm.*, 242, 699, 1904; L. Rosenthaler, *ib.*, 241, 479, 1903; E. Mitscherlich, *Journ. prakt. Chem.*, (1), 19, 458, 1840; R. Böttger, *ib.*, (1), 90, 163, 1863; H. W. F. Wackenroder, *ib.*, (1), 23, 209, 1841; (1), 24, 33, 1841; T. Curtius and F. Schrader, *ib.*, (2), 50, 323, 1894; A. Vogel, *ib.*, (1), 29, 280, 1843; J. Habermann and M. Honig, *Anz. Akad. Wien*, 18, 1881; H. Hlasiwetz, *Sitzber. Akad. Wien*, 17, 382, 1856; H. Hlasiwetz and L. Barth, *ib.*, 49, 203, 1864; J. M. Eder, *ib.*, 81, 196, 1880; J. Löwe, *Zeit. anal. Chem.*, 22, 495, 1883; E. Schaer, *ib.*, 42, 1, 1903; F. Soxhlet, *ib.*, 18, 20, 425, 1879; P. Degener, *Zeit. Ver. Rübenzucker-Ind.*, 31, 349, 1881; W. H. Foster, *Proc. Cambridge Phil. Soc.*, 14, 90, 1907; T. A. Glendinning, *Journ. Chem. Soc.*, 67, 999, 1895; F. W. Traphagen and W. M. Cobleigh, *Journ. Amer. Chem. Soc.*, 21, 369, 1899; F. Zerban and W. P. Naquin, *ib.*, 30, 1456, 1908; B. Herstein, *ib.*, 32, 779, 1910; L. G. Patterson, *Chem. News*, 25, 149, 1872; E. J. Russell, *ib.*, 68, 308, 1893; T. Curtius and R. Jay, *Journ. prakt. Chem.*, (2), 39, 27, 1889; S. B. Newbury, *Amer. Chem. Journ.*, 6, 407, 1885; 8, 196, 1886; H. Král, *Pharm. Centr.*, 35, 411, 1894; W. Müller and J. Hagen, *Pflüger's Archiv*, 23, 221, 1880; R. Böttger, *Jahrb. Phys. Ver. Frankfurt*, 16, 1879; *Liebig's Ann.*, 39, 176, 1841; C. Böttger, *ib.*, 208, 122, 1881; E. Busch, *ib.*, 57, 57, 1846; C. Trommer, *ib.*, 39, 360, 1841; H. Schwartz, *ib.*, 90, 54, 1849; M. Ruoss, *Zeit. anal. Chem.*, 58, 193, 1919; E. Ehrmann, *Liebig's Ann.*, 12, 92, 1834; K. G. Thurlakh, *ib.*, 182, 190, 1876; D. Vorländer and F. Meyer, *ib.*, 320, 125, 1902; L. Moser, *Zeit. anorg. Chem.*, 105, 112, 1919; C. Ullgren, *Pogg. Ann.*, 55, 527, 1842; F. Förster, *Zeit. Elektrochem.*, 3, 481, 1897; F. Förster and F. Blankenberg, *Ber.*, 39, 4429, 1906; E. Abel, *Zeit. anorg. Chem.*, 26, 399, 1901; E. Weinschenk, *Zeit. Kryst.*, 17, 494, 1890; F. J. Malaguti, *Ann. Chim. Phys.*, (2), 54, 216, 1833; A. C. Becquerel, *ib.*, (2), 41, 353, 1829; N. A. E. Millon and A. Commaillé, *ib.*, (4), 3, 283, 1864; N. A. E. Millon, *Compt. Rend.*, 55, 513, 1862; J. Aldridge and M. P. Appleby, *Journ. Chem. Soc.*, 121, 238, 1922; W. Hampe, *Zeit. Berg. Hütt. Sal.*, 21, 225, 1873; E. Priwoznik, *Dingler's Journ.*, 224, 313, 1877; H. P. Pearson, *Journ. Soc. Chem. Ind.*, 22, 731, 1903; L. C. A. Barreswil, *Journ. Pharm.*, (3), 6, 301, 1844; H. von Fehling, *Liebig's Ann.*, 72, 106, 1849; 106, 75, 1859; I. Bolin and G. Linder, *Zeit. phys. Chem.*, 93, 721, 1919; V. V. Sarma, *Chem. News*, 122, 99, 1921; M. Gröger, *Zeit. anorg. Chem.*, 28, 154, 1901; G. Errera, *Bull. Acad. Belg.*, (5), 1, 36, 1921; A. Benrath and J. Oberbach, *Zeit. phys. Chem.*, 98, 498, 1921.

⁶ M. Gröger, *Zeit. anorg. Chem.*, 31, 326, 1902; F. Wöhler and J. von Liebig, *Pogg. Ann.*, 21, 581, 1831; J. L. Proust, *Ann. Chim. Phys.*, (1), 32, 26, 1799; (1), 59, 321, 343, 1804; W. Hampe, *Zeit. Berg. Hütt. Sal.*, 21, 225, 1873; E. J. Russell, *Chem. News*, 68, 308, 1893; A. Guntz and H. Bassett, *Bull. Soc. Chim.*, (3), 35, 203, 1906.

⁷ D. Tommasi, *Traité théorique et pratique d'électrochimie*, Paris, 1889; P. Schoop, *Zeit. Elektrochem.*, 1, 247, 1894; R. Luther, *ib.*, 8, 647, 1902; E. Wohlwill, *ib.*, 9, 317, 1903; G. Bird, *Phil. Trans.*, 127, 37, 1837; T. A. Edison, *Brit. Pat. No.* 20960, 1900; A. C. Becquerel, *Compt. Rend.*, 44, 939, 1857; A. Chassy, *ib.*, 119, 271, 1894; *Journ. Pharm. Chim.*, (5), 40, 396, 1894; Q. Majorana, *Atti Accad. Lincei*, (5), 4, i, 371, 1895; F. Oettel, *Chem. Ztg.*, 17, 543, 1893; F. Förster and O. Seidel, *Zeit. anorg. Chem.*, 14, 106, 1897; L. Wernicke, *Pogg. Ann.*, 139, 139, 1870.

⁸ L. Wernicke, *Pogg. Ann.*, 139, 132, 1870; W. Hcrapath, *Phil. Mag.*, (1), 64, 321, 1824; H. A. Miers, *ib.*, (5), 18, 127, 1884; C. J. B. Karsten, *Schweigger's Journ.*, 65, 394, 1832; J. F. Persoz, *Journ. prakt. Chem.*, (1), 47, 84, 1849; *Introduction à l'étude de la chimie moléculaire*, Paris, 1839; L. Playfair and J. P. Joule, *Mem. Chem. Soc.*, 2, 401, 1845; 3, 82, 1845; M. A. le Royer and J. B. A. Dumas, *Ann. Pharm. Chim.*, 92, 408, 1821; W. Biltz, *Ges. Wiss. Göttingen*, 293, 1908; H. W. Foote and E. K. Smith, *Journ. Amer. Chem. Soc.*, 30, 1344, 1908; P. T. Walden, *ib.*, 30, 1350, 1908; W. L. Bragg, *Phil. Mag.*, (6), 28, 355, 1914; (6), 40, 174, 1920; F. Rinne, *Ber. Sächs. Ges. Wiss.*, 67, 303, 1915; A. Grünh, *Centr. Min.*, 85, 1918; A. Magnus, *Ann. Physik.*, (4), 31, 597, 1910; S. Meyer, *ib.*, (4), 1, 664, 1900; *Wied. Ann.*, 68, 325, 1899; 69, 236, 1899; W. Haidinger, *Handbuch der bestimmenden Mineralogie*, Wien, 548, 1845; F. Wallerant, *Bull. Soc. Min.*, 21, 236, 1898; H. Traube, *Neues Jahrb. Min. B. B.*, 10, 455, 1895; F. Beijerinck, *ib.*, 11, 427, 1898; F. Gaud, *Compt. Rend.*, 119, 863, 1894; H. Fizeau, *ib.*, 62, 1133, 1866; A. de Gramont, *ib.*, 118, 746, 1894; E. Becquerel, *ib.*, 80, 1376, 1875; 84, 211, 1877; *Ann. Chim. Phys.*, (5), 12, 5, 1877;

M. Berthelot, *ib.*, (5), 20. 519, 1880; (7), 4. 471, 1895; *Compt. Rend.*, 91. 871, 1880; *Thermo- chimie*, Paris, 1. 317, 1897; H. Ludwig, *Ber.*, 4. 539, 1871; K. Bädeler, *Ann. Physik*, (4), 22. 749, 1907; G. C. Schmidt, *Wied. Ann.*, 67. 563, 1899; F. E. Neumann, *Pogg. Ann.*, 23. 32, 1831; H. Kopp, *Liebig's Ann. Suppl.*, 3. 292, 1864; R. Cusack, *Proc. Irish Acad.*, (3), 4. 399, 1899; J. Thomsen, *Journ. prakt. Chem.*, (2), 12. 283, 1875; (2), 19. 1, 1879; *Thermochemische Unter- suchungen*, Leipzig, 3. 320, 1883; G. K. Burgess, *Bur. Standards Scientific Paper*, 121, 1909; E. Heyn, *Zeit. anorg. Chem.*, 39. 1, 1904; *Mitt. Königl. tech. Versuchsanst.*, 18. 315, 1890; H. O. Hoff- man, C. F. Green, and R. B. Yerxa, *Trans. Amer. Inst. Min. Eng.*, 34. 677, 1903; *Rev. Mét.*, 3. 543, 1906; P. Dejean, *ib.*, 3. 233, 1906; W. Biltz, *Zeit. anorg. Chem.*, 109. 132, 1919; E. Jordis and W. Rosenhaupt, *Zeit. angew. Chem.*, 21. 59, 1908; A. J. Allmand, *Journ. Chem. Soc.*, 95. 2163, 1909; A. Sommerleitner, *Met. Chem. Eng.*, 10. 422, 1912; W. Stahl, *Berg. Hütt. Ztg.*, 40. 127, 1890; *Met.*, 4. 686, 1907; R. E. Slade and F. D. Farrow, *Proc. Roy. Soc.*, 87. A, 524, 1912; T. W. Case, *Trans. Amer. Electrochem. Soc.*, 31. 351, 1917; *Phys. Rev.*, (2), 9. 305, 1917; A. H. Pfund, *ib.*, (2), 7. 298, 1916; W. Hallwachs, *Compt. Rend. Cong. Radiologie*, 2, 1910; K. Bädeler, *Ueber die elektrische Leitfähigkeit und die thermoelektrische Kraft einiger Schwermetallverbindungen*, Leipzig, 1906; H. S. Roberts and F. H. Smyth, *Journ. Amer. Chem. Soc.*, 42. 2582, 1920; 43. 1061, 1921; J. L. Proust, *Journ. Phys.*, 51. 183, 1800; W. P. Davey, *Phys. Rev.*, (2), 18. 102, 1921; L. Wöhler and O. Balz, *Zeit. Elektrochem.*, 27. 406, 1921.

⁹ P. Schützenberger, *Compt. Rend.*, 86. 1397, 1878; J. L. Gay Lussac and E. Pelouze, *Ann. Chim. Phys.*, (2), 52. 410, 1833; G. Bodländer, *Dedekind's Festschrift*, 153, 1901; F. P. Lavalle, *Ber.*, 38. 2170, 1905; J. L. Proust, *Journ. Phys.*, 51. 183, 1800; A. Guntz and H. Bassett, *Bull. Soc. Chim.*, (3), 35. 204, 1906; M. Gröger, *Zeit. anorg. Chem.*, 28. 158, 1901; R. Ehrenfeld, *ib.*, 60. 208, 1908; W. Jäger, *ib.*, 27. 32, 1901; S. Kern, *Chem. News*, 33. 5, 1876; T. Bergmann, *Opuscula physica et chemica*, Holmia, 3. 389, 1790; D. Vorländer and F. Meyer, *Liebig's Ann.*, 320. 126, 1902; V. Bonsdorff, *Zeit. anorg. Chem.*, 41. 140, 1904; R. Wagner, *Chem. Centr.*, 239, 1863; A. Osann, *Pogg. Ann.*, 52. 406, 1841; M. Prud'homme, *Monit. Scient.*, (4), 5. 681, 1891; P. Schützenberger and C. Risler, *Bull. Soc. Chim.*, (2), 20. 145, 1873; J. Meyer, *Ber.*, 35. 3932, 1902; H. Frischer, *Chem. Ztg.*, 32. 1005, 1908; C. H. Mathewson and C. I. Stokesburg, *Internat. Zeit. Metallog.*, 5. 193, 1914; N. Schoorl, *Zeit. angew. Chem.*, 12. 633, 1899.

¹⁰ H. Debray and A. Joannis, *Compt. Rend.*, 99. 688, 1884; T. S. Hunt, *ib.*, 69. 1357, 1869; P. Sabatier, *ib.*, 124. 363, 1897; J. H. Gladstone and A. Tribe, *Chem. News*, 25. 247, 1872; 26. 109, 1872; T. Andrews, *Phil. Mag.*, (3), 32. 321, 426, 1847; H. Rose, *Pogg. Ann.*, 110. 120, 1860; A. Orłowsky, *Zeit. anal. Chem.*, 21. 215, 1882; J. B. Senderens, *Bull. Soc. Chim.*, (3), 6. 802, 1891; (3), 17. 782, 1897; A. Guntz and H. Bassett, *ib.*, (3), 35. 204, 1906; J. Thomsen, *Journ. prakt. Chem.*, (2), 19. 1, 1897; H. Rose, *ib.*, (1), 71. 412, 1857; J. Landauer, *Ber.*, 5. 406, 1872; C. Winkler, *ib.*, 23. 54, 1890; C. F. Rammelsberg, *ib.*, 10. 1780, 1877; P. Sabatier and J. B. Senderens, *Ann. Chim. Phys.*, (7), 7. 395, 1896; A. J. Balard, *ib.*, (2), 32. 337, 1826; L. P. de St. Gilles, *ib.*, 42. 36, 1854; G. Gore, *Proc. Roy. Soc.*, 21. 140, 1873; W. Manchof and J. A. N. Friend, *Liebig's Ann.*, 357. 100, 1908; E. Wohlwill, *Zeit. Elektrochem.*, 9. 314, 1903; E. Nihoul, *Chem. Ztg.*, 18. 881, 1894; L. Grünhut, *ib.*, 18. 447, 1894; H. Ost, *ib.*, 26. 845, 1902; P. N. Raikow, *ib.*, 31. 142, 1907; A. Prager, *Zeit. angew. Chem.*, 7. 520, 1894; N. Schoorl, *ib.*, 12. 633, 1899; D. Miklosich, *ib.*, 14. 753, 1901; F. A. Gooch and F. Baldwin, *Amer. Journ. Science*, (4), 8. 356, 1899; S. Hauser, *Ueber Reduktion einiger Metalloxyde durch Gase*, Strassburg, 1907; C. F. Schlagdenhauffen and M. Pagel, *Compt. Rend.*, 128. 309, 1899; H. Erdmann and P. Köthner, *Zeit. anorg. Chem.*, 18. 49, 1899; M. Gröger, *ib.*, 28. 158, 1901; C. and J. Bhaduri, *ib.*, 17. 12, 1898; G. Rauter, *Liebig's Ann.*, 270. 236, 1892; D. Vorländer and F. Meyer, *ib.*, 320. 122, 1902; W. Bersch, *Zeit. phys. Chem.*, 8. 394, 1891; C. J. B. Karsten, *System der Metallurgie*, Berlin, 5. 267, 1831; W. Hampe, *Zeit. Berg. Hütt. Sal.*, 21. 239, 1873; M. de K. Thompson, *Electrochem. Ind.*, 2. 227, 1904; R. H. Bradford, *Trans. Amer. Inst. Min. Eng.*, 33. 50, 1902; R. Gedault, *Monit. Scient.*, (4), 2. 62, 1888; J. A. Hcdvall and N. von Zweigbergh, *Zeit. anorg. Chem.*, 108. 119, 1919; C. H. Mathewson and C. H. Stokesburg, *Internat. Zeit. Metallog.*, 5. 193, 1914; E. Ehrmann, *Bull. Assoc. Chim. Belgique*, 10. 537, 1897; B. B. Ross, *Journ. Amer. Chem. Soc.*, 16. 549, 1894; R. K. Meade, *ib.*, 20. 610, 1898; P. T. Walden, *ib.*, 30. 1350, 1908; H. O. Jones and F. W. Carpenter, *Proc. Cambridge Phil. Soc.*, 12. 218, 1908; *Journ. Chem. Soc.*, 83. 1394, 1903; F. Field, *ib.*, 16. 28, 1863; W. Stahl and H. Koch, *Met.*, 4. 689, 1907; F. Thomas, *ib.*, 1. 8, 1904; R. M. Caven and A. Hill, *Journ. Soc. Chem. Ind.*, 16. 934, 1897; 17. 124, 1898; J. Dewey, *Journ. Anal. Chem.*, 3. 33, 1889; R. Brauns, *Chemische Mineralogie*, Leipzig, 408, 1896; C. R. Wright and A. P. Luff, *Journ. Chem. Soc.*, 33. 1, 1878; F. Glaser, *Zeit. anorg. Chem.*, 36. 1, 1903; A. Osann, *Pogg. Ann.*, 52. 406, 1841; A. Vogel, *Journ. prakt. Chem.*, (1), 29. 280, 1843.

¹¹ L. Maumené, *Compt. Rend.*, 99. 757, 1884; A. Joannis, *ib.*, 99. 583, 1884; 100. 999, 1885; P. A. Favre and L. Maumené, *Inst.*, 123, 1844; M. Siowert, *Zeit. ges. Naturwiss.*, 26. 483, 1866; E. Francke, *Zur Kenntnis der Oxydation des Hydrazins und Hydroxylamins*, Berlin, 1907; L. Wöhler and A. Foss, *Zeit. Elektrochem.*, 12. 783, 1906; W. Stahl, *Met.*, 4. 686, 1907.

¹² A. Lionet, *Compt. Rend.*, 89. 410, 1879.

¹³ J. L. Proust, *Journ. Phys.*, 51. 182, 1800; A. Brochet, *Bull. Soc. Chim.*, (3), 31. 289, 1904; M. Ruoss, *Zeit. anal. Chem.*, 58. 193, 1919; C. Paal, *ib.*, 59. 166, 1920; C. A. L. de Bruyn, *Rec. Trav. Chim. Pays-Bas*, 19. 251, 1900; F. D. Chattaway, *Chem. News*, 97. 19, 1908; T. Sandmeyer, *Ber.*, 20. 1494, 1887; F. Fischer, *Zeit. Elektrochem.*, 10. 429, 1904; E. Müller, *ib.*, 13. 136, 1907; R. Lorenz, *Zeit. anorg. Chem.*, 12. 438, 1896; M. Gröger, *ib.*, 28. 158, 1901; E. Frémy, *Ann. Chim. Phys.*, (3), 23. 391, 1847; N. A. E. Millon and A. Commaille, *Compt. Rend.*, 57. 145, 1863;

A. Vogel, *Journ. prakt. Chem.*, (1), 29. 280, 1843; E. Mitscherlich, *ib.*, (1), 19. 450, 1840; C. Paal and W. Leuze, *Ber.*, 35. 2195, 1902; 39. 1545, 1553, 1906; C. Paal and A. Dcxheimer, *ib.*, 47. 2195, 1914; R. Böttger, *Jahrb. phys. Ver. Frankfurt*, 16, 1879; T. S. Hunt, *Amer. Journ. Science*, (4), 41. 211, 1915; W. T. Schaller, *ib.*, (4), 39. 404, 1915; W. Manchot and J. A. N. Friend, *Liebig's Ann.*, 359. 100, 1908; H. G. F. Schröder, *Dichtigkeitsmessungen*, Heidelberg, 3, 1873; J. H. Gladstone and A. Tribe, *Chem. News*, 25. 247, 1872; 26. 109, 1872; P. Pascal, *Compt. Rend.*, 146. 862, 1908; A. Gutbier, *Zeit. anorg. Chem.*, 32. 355, 1902; 44. 227, 1905; A. Lottermoser, *Ueber anorganische Colloide*, Stuttgart, 1901; A. F. Rogers, *Journ. Geol.*, 25, 529, 1917.

¹⁴ E. Frémy, *Ann. Chim. Phys.*, (3), 23. 391, 1847; P. Rohland, *Zeit. anorg. Chem.*, 18. 323, 1898; E. Ebler, *ib.*, 47. 371, 1905; *Analytische Operationen mit Hydroxylamin- und Hydrazinsalzen*, Heidelberg, 1905; R. M. Cavcn and A. Hill, *Journ. Soc. Chem. Ind.*, 16. 981, 1897; P. Sabatier, *Compt. Rend.*, 122. 1417, 1479, 1538, 1896; H. R. Ellis and W. H. Collier, *Proc. Chem. Soc.*, 23. 264, 1907; *Chem. News*, 97. 121, 1908; F. Herrmann, *Chem. Ind.*, 30. 152, 1907; H. Rose, *Sitzber. Akad. Berlin*, 104, 1851; R. Schiiff, *Liebig's Ann.*, 123. 36, 1862; A. Orlovsky, *Ber.*, 14. 2844, 1881; *Zeit. anal. Chem.*, 21. 215, 1882; R. Böttger, *Repert. Pharm.*, 23. 627, 1874; A. Fonseca, *Rev. Univ. Min.*, 31. 409, 1895; J. L. Proust, *Ann. Chim. Phys.*, (1), 32. 26, 1799; (1), 59, 321, 343, 1804.

§ 10. Cupric Oxide

Black oxide of copper, **cupric oxide**, CuO , must have been known for a very long time, since it is formed when copper is heated in air. *Black copper*, *cuvivre oxidé noir*, or *Kupferschwärze* is mentioned by the mineralogists near the end of the eighteenth century—C. A. S. Hoffmann,¹ L. A. Emmerling, J. F. L. Hausmann, etc.—and the beginning of the nineteenth century as occurring in nature, and it was classed with the red oxide of copper and iron oxide among the mineral oxides. J. G. Wallerius called it *ochra cupri nigra*; and J. C. Delaméthérie, *oxide noir de cuivre*. F. S. Beudant called it *melaconise*—from μέλας, black; and κόνις, dust—and this term was altered by J. D. Dana to *melaconite*; E. F. Glocker called it *chalkomelan*—χαλκός, copper; μέλας, black—and, as others had done previously, he emphasized the fact that it usually contained both manganese and iron oxides as impurities. G. Semmola named the black oxide found among the Vesuvian minerals, *tenorite*, in honour of the Italian botanist. Crystalline tenorite is rare—samples have been reported from Cornwall, Vesuvius, Keweenaw Point (Michigan). Amorphous or colloidal melaconite, $\text{CuO}(\text{H}_2\text{O})_n$, is fairly common in the oxidized zone of a copper mine. It is considered to be either an adsorption compound or a solid soln. of cupric oxide and water, with silica, and often manganese dioxide as impurities. The so-called melanochalcite of G. A. Koenig² is a cupric silico-carbonate, and is considered by E. H. Kraus and W. F. Hunt to be a mechanical mixture of melaconite, tenorite, and chrysocolla.

The preparation of cupric oxide from metallic copper.—Cupric oxide can be prepared by heating finely-divided copper or cuprous oxide in air or oxygen. If the latter be not finely divided R. Hefelmann³ found the reaction is not completed; and analogous remarks apply to copper, for E. C. C. Stanford found but a 40 per cent. conversion after 12 hrs. heating in a muffle; while P. Schützenberger found that the so-called allotropic copper powder oxidizes very rapidly in air to cupric oxide. According to W. Müller, pure oxygen acts more slowly than air, because it forms a protective film of a non-volatile oxide on the surface of the metal; while E. Jordis and W. Rosenhaupt found that the oxidation of copper by oxygen commences at about 80°—with tin at 100°, and with zinc at 150°. The fact that above 145° air attacks copper more energetically than does oxygen, and the more energetic action of moist than of dry oxygen is ascribed to the participation of oxidation products of nitrogen and water in the reaction. Progressive oxidation depends on the behaviour of the surface layer. An oxidizable surface may be the result of (a) the soln. of the oxygen in the metal as such or as an alloy of copper and oxygen; (b) the diffusion of the oxygen through the layer of oxide which may dissolve the oxygen or be merely porous to it; (c) the alternate formation of lower and higher oxides; or (d) the layer of oxide scaling off from the metal. The dissociation press. of cupric oxide and the formation of cuprous and cuprosocupric oxides have been discussed in

connection with the preparation of cuprous oxide. According to J. C. Richardson, copper filings, dipping in alkali-lye, are oxidized to cupric oxide by exposure to air. V. Kohlschütter and T. Goldschmidt found black microscopic plates were deposited on the edges of a copper cathode in oxygen.

A. C. Becquerel converted ordinary cupric oxide into crystals by heating it to 500°–550° with four to six times its weight of potassium hydroxide; washing the cold mass with water; and separating the flocculent from the crystalline cupric oxide by levigation with water.

The preparation of cupric oxide from cupric salts.—Cupric oxide is formed by heating the hydroxide to 100°, or by boiling it in water. Cupric oxide is formed by the calcination of cupric nitrate, $\text{Cu}(\text{NO}_3)_2$. By soaking asbestos in a soln. of cupric nitrate, and afterwards igniting the mass; or by soaking asbestos in a soln. of copper sulphate and afterwards treating the mass with dil. potash-lye, washing, and igniting, U. Kreuzler⁴ obtained *copper oxide-asbestos*, used as a catalytic agent in gas analysis. O. L. Erdmann and R. F. Marchand, and W. Hampe have discussed the preparation of a highly-purified cupric nitrate for this purpose. T. W. Richards also discussed the preparation of cupric oxide of a high degree of purity, and studied the contamination of the product with occluded gases.

O. L. Erdmann and R. F. Marchand noticed that cupric oxide readily condenses air on its surface, and, according to P. Holland, the absorbed air is given off when the oxide is heated to redness. G. S. Johnson found cupric oxide absorbs carbon dioxide, and gives it up again on melting; E. Frankland and H. E. Armstrong that cupric oxide absorbs both nitrogen and carbon dioxide; T. Hilditch that red-hot cupric oxide occludes oxygen, but, according to P. Schützenberger, no peroxide is formed; J. L. W. Thudichum and C. T. Kingzett that in order to obtain cupric oxide wholly free from carbon dioxide, the oxide must be ignited in vacuo. A. Joannis noted that water is retained very tenaciously by cupric oxide, even at 110° in vacuo, and it required 8 hrs. at 440° in vacuo to remove all the water from 5 grms. of the oxide; E. W. Morley that when cupric oxide is heated in vacuo it slowly gives off a gas; and T. W. Richards that cupric oxide prepared from the nitrate contained 0.004 per cent. of occluded gas—mainly nitrogen; and he also showed that cupric oxide can absorb four or five times its own volume of nitrogen. Hence, the use of cupric oxide prepared from the nitrate is not recommended for the determination of nitrogen in organic products. The wire form of cupric oxide prepared by oxidizing the metal is not open to this objection. T. W. Richards also showed that there is no appreciable amount of oxidized nitrogen or of water in copper oxide that has been calcined at a red heat. According to A. Lionet, cold cupric oxide absorbed the hydrogen compounds of arsenic, sulphur, phosphorus, silicon, antimony, selenium, and chlorine, but not hydrogen or the hydrocarbons.

H. D. A. Ficinus described the preparation of cupric oxide by calcining the basic copper nitrate made by exposing a mixture of copper filings with twice its weight of copper nitrate to the air until all is converted into a basic nitrate. G. Rousseau and G. Tite also prepared the oxide by heating basic copper nitrate with water for 20 hrs. in a sealed tube. A. Vogel and C. Reischauer divided a neutral soln. of cupric nitrate into two parts, treated one half with ammonia until the precipitate just redissolved, mixed the two parts together and boiled the soln. The precipitated black oxide was well washed with water. E. Erlenmeyer removed chlorine from cupric oxide by heating the oxide in a stream of water vapour. T. Klobb obtained crystalline cupric oxide by calcining cupric sulphate or basic sulphate red hot; H. Schulze heated cuprous chloride in oxygen and obtained crystals of cupric oxide. J. A. Morrell heated cupric sulphide with ammonium nitrate; E. C. C. Stanford calcined a mixture of equimolecular parts of cupric sulphate and sodium carbonate; T. W. Richards obtained cupric oxide free from occluded gas by calcining cupric carbonate; K. Seubert and G. Rauter calcined cupric ammonio-oxalate; and A. Lieben and A. Rossi heated a dil. soln. of cupric valerianate. F. Zambonini obtained artificial tenorite by heating cupric chloride in water vapour.

M. Prud'homme found that cupric oxide is deposited when an alkaline soln. of cupric chromate has stood some time. The dark red crystals of cupric oxide prepared by J. W. Mallet by leaving a copper plate to stand in a soln. of the nitrate were probably basic cupric nitrate.

The preparation of cupric oxide by electrolysis.—The black precipitate obtained on the copper anode during the electrolysis of dil. sulphuric acid, or of acidified cupric sulphate, is not cupric oxide as supposed by H. Buff⁵ and G. Planté, but, according to H. Meidinger, it is derived from the impurities in the metal, and, according to E. Wohlwill, it contains some disintegrated copper. E. Müller prepared cupric oxide by the electrolysis of 5*N*-sodium hydroxide for a long time with a copper cathode either at 12° with stirring, or at 60° without stirring. E. Müller and F. Spitzer also electrolyzed a soln. of cupric hydroxide in 12–14*N*-NaOH with not too high a current density. W. D. Bancroft and G. H. Burrows electrolyzed a 5 per cent. soln. of potassium chlorate between copper electrodes at 93°—the anode was small. Possibly cupric chlorate is first formed which is converted by alkali hydroxide and the copper anode into oxide. A part of the oxide is reduced by the hydrogen of the cathode. The subject has been investigated by M. Wildermann, C. Luckow, W. Borchers, A. Brochet, R. Kroupa, etc.

The properties of cupric oxide.—Cupric oxide usually appears as a brownish-black powder which is jet black when hot, or else in brownish-black brittle scales or granules. The measurements of N. S. Maskelyne⁶ show that the crystals of Cornish melaconite are pseudomonoclinic and belong to the triclinic system; they have the axial ratios $a:b:c=1.4902:1:1.3604$ with $\alpha=90^\circ$; $\beta=99^\circ 32'$; $\gamma=90^\circ$. E. Kalkowsky showed that these measurements agree with G. Jenzsch's for Vesuvian tenorite. The **X-radiogram** has been studied by J. A. Hedvall; and he concluded that all the different forms of the oxide—artificial and natural—have the same X-radiogram. The native oxide usually occurs in black or greyish-black earth. G. A. König reported a tetragonal modification of cupric oxide at Bisbec (Arizona), and it was called *paramelaconite*—the analysis agreed with CuO, 87.66 per cent.; Cu₂O, 11.70, and Fe₂O₃, 0.64 per cent. The reported⁷ values for the **specific gravity** of cupric oxide range from 6.130 of P. F. G. Boullay and J. F. Persoz to 6.451 of G. Jenzsch. W. Herapath gives 6.401 at 16.5°, and an analogous number was also obtained by J. F. Persoz. L. Playfair and J. P. Joule obtained 5.90 for the dried oxide, and 6.414 for the ignited oxide, C. F. Rammelsberg's value for melaconite is 5.952, and J. D. Whitney's, 6.25. G. A. König gives 5.833 for paramelaconite. The **hardness** of melaconite is between 3 and 4; G. A. König gives for paramelaconite a hardness of 5. According to F. Streintz, powdered cupric oxide is not united to a rod by a press. of 13,000 atm.

L. Wöhler and A. Foss⁸ found the **melting point** to be 1064°. F. H. Smyth and H. S. Roberts found that cupric oxide alone does not melt without dissociation below 1233°, and that the eutectic temp. with cuprous oxide is 1082°–1080.2° and 390 mm.; they also found that from 900° up to the temp. at which no liquid phase appears—the eutectic temp. 1082°—the dissociation press., p , of cupric oxide, expressed in mm. of mercury, is $\log_{10} p = -132167^{-1} + 12.35$. The dissociation press. of cupric oxide have been also measured by L. Wöhler and A. Foss, H. W. Foote and E. K. Smith, and J. Hagenacker—*vide* cuprous oxide. When molten cupric oxide has cooled, it has a crystalline fracture. According to A. Gouy, a flame which reduces cupric oxide can retain that compound in the state of vapour. The flame of coal gas is coloured green when it has passed over cupric oxide at a dull red heat. The oxide also volatilizes in pottery ovens over 1000°; L. Elsner also noticed that the oxide volatilizes in porcelain ovens, say, at 1400°. The oxide is partially decomposed when the vap. press. of the oxide attains one-fifth of that of the atm.; this occurs at a red heat; the reaction is $4\text{CuO} = 2\text{Cu}_2\text{O} + \text{O}_2$, and the porous mass re-oxidizes when cooled in air. H. Moissan found that the decomposition: $2\text{CuO} = 2\text{Cu} + \text{O}_2$, occurs at 2500° in the electric arc. The equilibrium conditions in the dissociation: $4\text{CuO} \rightleftharpoons 2\text{Cu}_2\text{O} + \text{O}_2$ have been discussed in connection with cuprous

oxide; similar remarks apply to W. Stahl's calculations of the **dissociation pressures** for both reactions between 500° and 2500°. H. le Chatelier says the quotient of the latent heat of dissociation by the absolute dissociation temp. is not constant. L. Wöhler and A. Foss believed that cupric oxide forms solid soln. with the cuprous oxide produced in its dissociation, but F. H. Smyth and H. S. Roberts showed that this is probably not the case. L. Wöhler and O. Balz have discussed the dissociation of cupric oxide. F. E. Neumann gave 0.137 for the **specific heat** of the oxide; H. V. Regnault, 0.1420; and H. Kopp, 0.128; the respective atomic heats are then 10.9, 11.3, and 10.2. A. Magnus found 0.1342 for the sp. ht. from 17° to 100°, and 0.1537 between 17° and 537°. J. Thomsen's value⁹ for the **heat of formation** is (Cu, O) 37.16 Cals.; M. Berthelot's, 42.0 Cals.; and P. A. Favre and J. T. Silbermann's, 43.77 Cals.; A. Joannis gives 32.12 Cals. for the heat of formation from the sulphate; 32.36 Cals. from the nitrate; and M. Berthelot gives from the sulphide, 30.1 Cals.; and from the selenide, 22.4 Cals. P. L. Dulong gives for (Cu₂O, O), 35 Cals.; J. Thomsen, 33.51 Cals.; and T. Andrews, 36.2 Cals. F. H. Smyth and H. S. Roberts calculate 60,568 cal. for the change 4CuO → 2Cu₂O + O₂; and for the decrease in free energy $2.303RT \log_{10}(p/760)$, or -60719 + 43.604T. M. Berthelot and J. Thomsen respectively give for the **heat of neutralization** of $\frac{1}{2}$ Cu with sulphuric acid (one eq. in 4 litre), 9.2 and 9.4 Cals.; hydrochloric acid, 7.5 and 7.635 Cals.; nitric acid, 7.5 and 7.625 Cals.; and acetic acid, 6.2 and 6.59 Cals. W. Ostwald has discussed the affinity of cupric oxide towards nitric and hydrochloric acids. J. Thomsen also found with chloric acid, (CuO, 2HClO₃aq.) 15.91 Cals.; hydrobromic acid, (CuO, 2HBr_{aq.}) 15.27 Cals.; and ethyl hydro-sulphuric acid, (CuO, 2(C₂H₅)HSO₄aq.) 15.2 Cals. P. Sabatier gave (CuO, 2HCl_{aq.}) 16.4 Cals.; (CuO, 2HBr_{aq.}) 16.1 Cals.; (CuO, 2HNO₃aq.) 16.2 Cals.; and (CuO, H₂SO₄aq.) 19.2 Cals.

W. W. Jaques,¹⁰ J. Stefan, and A. Sehliermaker have studied the **radiation of heat** by cupric oxide. With respect to the work of the former, H. Kayser says *es ist nicht ein einziges der gefundenen Resultate richtig*. F. Paschen gives for the total radiation of cupric oxide at different temp.:

288°	373°	473°	573°	673°	773°	973°	1173°	1373° K.
0.378	1.23	3.62	8.71	18.1	34.1	97.5	22.8	467

not far from the corresponding values for carbon. O. Vogel found that the **spectrum** in the oxycoal-gas flame gives the characteristic green lines of copper. W. N. Hartley found that in the oxyhydrogen blowpipe flame, cupric oxide gives a fine band spectrum with two lines of the metal. L. de Boisbaudran studied the **fluorescence** of cupriferous lime, and V. Klatt and P. Lenard, cupriferous sulphides of the alkaline earths. E. L. Nicols and D. T. Wilber observed no signs of flame phosphorescence with cupric oxide. A. Kundt found the mean **index of refraction** for forms of cupric oxide for the red ray to be 2.63, for the white, 2.84, and for the blue, 3.18. The **photoelectric effect** was found by W. Hallwachs to be nearly the same as for copper.

According to S. Meyer,¹¹ eupric oxide is paramagnetic; the **magnetic susceptibility** is about $+3.1 \times 10^{-6}$ mass units at 17°; and, according to G. Chêneveau, $+3.6 \times 10^{-6}$. C. B. Thwing gives 18.10 for the **dielectric constant**. F. S. Smith said that additions of small proportions of cupric oxide to ferric oxide make the latter magnetic. E. Thomson noted the orientation of finely divided particles of cupric oxide in an intense magnetic field. The subject was discussed by O. J. Lodge, R. W. Gray, and J. B. Speakman.

F. Streintz said powdered cupric oxide is a non-conductor of electricity, but it conducts much better when it has been fused. According to K. Bädcker, the specific resistance is 400 when that of copper is 0.0000017. F. Horton measured the **resistance and conductivity** of fused rods of eupric oxide $1.006 \times 1.994 \times 0.2179$ c.c., and found:

	12°	66°	157°	385°	618°	733°	944°	1038°
Resistance	645100	74560	5930	96.2	5.87	1.455	0.196	0.021
Conductivity	3.38×10^{-7}	2.92×10^{-6}	3.67×10^{-5}	2.26×10^{-3}	0.03711	0.1497	1.111	10.37

No sign of electrolysis was here observed at ordinary temp., but at 700°, electrolysis can be detected. K. Bädeker gave 400 absolute units for the metallic conductivity of cupric oxide (the value for copper is 0.0000017). According to A. A. Sommerville, a column of oxide, 1 cm. diam. and 10 cms. long, has a resistance of 107 ohms at 395° if it has been twice heated, and at 290° if once heated. The resistance at the m.p. is 35 ohms. The resistance of cupric oxide after melting is greater at all temp. T. W. Case found that exposure to light had no measurable effect on the conductivity of tenorite. According to P. Fritsch, the addition of the oxides of magnesium, zinc, cadmium, aluminium, or bismuth raises the conductivity of cupric oxide, while it is lowered by lead oxide. According to J. Perrin, cupric oxide is electrically neutral in aq. soln., positive in acid and negative in alkaline liquids; and, according to G. C. Schmidt, the electrodes of cupric oxide in sodium hydroxide gradually become more positive. According to E. A. Byrnes, the e.m.f. of cupric oxide against copper in molten sodium hydroxide at 360° is 0.20–0.25 volt. E. van der Ven has also studied the e.m.f. of cells with cupric oxide. G. C. Schmidt and M. Wildermann studied the effect of illumination on the potential of electrodes in sodium hydroxide. A. Coehn and Y. Osaka found 1.48 volts are necessary for the development of oxygen at an anode of cupric oxide against a standard hydrogen cathode.

Cupric oxide is hygroscopic, so much so that W. Müller-Erbach suggested the absorbed water is chemically united with the oxide; the **hygroscopicity** is less when the oxide has been calcined to a high temp., and this the more the higher the temp. of calcination; C. F. Cross¹² says that the oxide prepared by heating copper in oxygen is not hygroscopic even in an atm. sat. with water vapour, while the oxide prepared by precipitation or by calcining the nitrate is hygroscopic. Cupric oxide is insoluble in water. The oxide prepared at a low temp. quickly dissolves in dil. acids, but the oxide which has been calcined at a high temp. dissolves very slowly even in hot conc. acids. A. Joannis says the oxide dissolves quickly in a mixture of ammonium iodide and hydrochloric acid. Cupric oxide is readily reduced by gently heating it in a current of **hydrogen**. During the reduction, the mass sometimes becomes incandescent. J. J. Berzelius noticed that the action seems to begin at a definite temp., which is lower the lower the temp. at which the oxide has previously been calcined. Thus, W. Müller-Erbach found that the oxide prepared by drying the hydroxide at 300° is reduced at 135°; if the oxide has been pre-heated to a higher temp., reduction occurs at 140°; the oxide prepared by the direct oxidation of the metal is reduced at 193°, and that prepared from the nitrate is reduced at 205°. C. R. A. Wright and A. P. Luff found that precipitated cupric oxide washed and dried at 130° showed no signs of reduction at 83°, but at 87°–90° reduction could be detected; with a sample prepared by ignition, no action could be detected up to 170°, but at 175° reduction was appreciable. F. Glaser gives 150° for the temp. at which reduction begins with oxide prepared from the nitrate; and 199° for powdered cupric oxide prepared by direct oxidation. The reaction has also been studied by A. Osann, and by S. Hauser. According to R. N. Pease and H. S. Taylor, the reduction of copper oxide by hydrogen is autocatalytic, metallic copper being the catalyst. The reaction takes place at the copper-copper oxide interface. The presence of water vapour retards the formation of the copper nuclei but does not interfere with the subsequent action at the interface; oxygen has the reverse action. For the **adsorption of gases**—hydrogen, etc.—*vide supra*. The reduction also occurs about the cathode from which electrolytic hydrogen is being evolved; A. Löb also found that the reduction occurs in potassium cyanide soln. of cupric salts with an alternating current.

According to H. Moissan,¹³ **fluorine** does not react in the cold with cupric oxide, but when red hot, a black substance is produced which is assumed to be *cupric oxyfluoride*. For the solubility of the oxide in **hydrofluoric acid**, *vide* cupric fluoride. M. G. Levi and M. Voghera obtained cupric chloride and chlorine when cupric oxide is heated to 300° in a stream of air and **hydrogen chloride**, the cupric chloride then

forms an oxychloride. L. Santi says ammonium chloride calcined with cupric oxide forms cuprous chloride coloured brown by a little cupric chloride. According to W. D. Bancroft, hypochlorites are decomposed by cupric oxide, and F. Oettel has shown that the yield of **hypochlorites** in the electrolysis of soln. of calcium chloride is diminished by this agent. W. O. de Coninck and L. Arzalier stated that when a mixture of cupric oxide and **ammonium chloride** is pounded in a mortar, or strongly compressed, some cupric chloride is formed and ammonia evolved; while with **ammonium bromide**, an unstable ammoniacal copper oxybromide is formed which is soluble in dil. ammonia, and gradually loses ammonia, forming a green hydrated copper oxybromide mixed with a little bromide. According to G. Denigès, oxygen is formed when **bromine drops** into sodium hydroxide in the presence of cupric oxide. Liquid **hydrogen iodide** was found by R. S. Norris and F. G. Cottrel to produce cupric iodide, CuI_2 . B. Szilard has shown that iodine is liberated when cupric oxide is added to a soln. of cupric nitrate and **potassium iodide**. Cupric oxide also stimulates the decomposition of potassium chlorate—*q.v.*; according to C. R. A. Wright and A. P. Luff, some chlorine is formed at the same time.

According to M. Jordan,¹⁴ if cupric oxide be heated with an excess of sulphur, cupric sulphide and a trace of the sulphate are formed; with the cupric oxide in excess, the products are cuprous oxide and cupric sulphate—in the former case much sulphur dioxide is produced, and in the latter case very little. If the temp. be near the decomposition point of the sulphate, the reaction is symbolized: $7\text{CuO} + \text{S} = \text{CuSO}_4 + 3\text{Cu}_2\text{O}$. When heated with sulphur in a stream of hydrogen, H. Rose and K. Klüss found all the cupric oxide is converted into cuprous sulphide. When cupric oxide is triturated with **sulphur** and water, and heated in a closed vessel to 100° , J. B. Senderens noted that blue crystals of cupric sulphate are formed. G. Keppeler obtained a quantitative reduction of cupric oxide by **sulphur dioxide** at 450° : $3\text{CuO} + \text{SO}_2 = \text{CuSO}_4 + \text{Cu}_2\text{O}$. H. Briegleb showed that the cupric oxide may be employed as a contact catalyst for accelerating the union of sulphur dioxide and oxygen in the formation of sulphur trioxide for sulphuric acid, and several patents have been taken in this connection. It might also be added that M. Traube, W. A. Bone and R. V. Wheeler, J. Krutwig and A. Derroncourt, C. D. Brindley, and F. Eschbaum have drawn attention to the use of cupric oxide in stimulating the oxidizing action of oxygen. **Ammonium monosulphide**, according to K. Heumann, forms cuprous sulphide with some cupric sulphide and yellow ammonium sulphide; the **alkali or ammonium polysulphides** were found by E. Priwoznik to form salts of the type $\text{M}_2\text{Cu}_2\text{S}_7$; H. Debus says thiosulphates are formed. H. B. Baker found that dry **sulphur trioxide** has no action on dry cupric oxide. W. Spring found that **sodium hydrosulphate**, NaHSO_4 , reacts energetically when ground with copper oxide in an agate mortar.

When **ammonia** is passed over heated copper oxide, nitrogen gas is obtained—*q.v.*—and this is one of the recognized methods of preparing that gas in the laboratory. S. Hauser¹⁵ found the reduction commences between 265° – 308° . H. N. Warren said that if the cupric oxide be warm, a green powdered copper nitride is formed which detonates at a more elevated temp. F. de Lassone, and J. L. Proust noted the solubility of cupric oxide in aqua ammonia, a series of cupric amino-oxides has been reported—*q.v.* According to E. Murmann, the dissolution takes place very slowly if the oxide has been calcined, and if ammonium salts are present, the solvent action is much greater. According to L. Maumené, cupric oxide is soluble in aqua ammonia only if ammonium salts be present. According to J. L. Proust, the oxide dissolves in a hot soln. of **ammonium chloride**, and an equal portion forms a basic chloride and the addition of much water or alcohol precipitates a blue hydrated compound from the soln. L. Juman found the oxide also dissolves in hot soln. of **ammonium sulphate** or **ammonium sulphite**; and C. Schnabel found 15 per cent. of oxide dissolves in a soln. of **ammonium carbonate** in 24 hrs., and cupric oxide or a basic carbonate is precipitated by boiling the soln.; while zinc precipitates the copper from the soln. D. Lance

has studied the solubility of cupric oxide in various amines; V. Dessaignes in benzamide; R. Piria in acid amides; E. Fischer in polypeptides; and K. Kraut in piperidine acetate. According to A. Cahours, it is not soluble in piperidine. J. L. Proust said that oils dissolve cupric oxide forming a green soln. Soln. of the ammonium salts when boiled with precipitated cupric oxide give green soln. and form a basic cupric salt. P. Sabatier and J. B. Senderens say that nitric oxide below 500° has no action. C. A. L. de Bruyn found hydrazine to react vigorously with cupric oxide; and, according to A. Thum, the same is also the case with hydroxylamine—the cupric oxide is reduced in both cases. F. Haber found the reaction to proceed more quickly in the presence of alkali-lye. E. Francke found the speed of the reduction is reduced by lowering the temp. With phosphorus and water, W. J. J. Le Venier obtained red copper; copper phosphide and phosphate are formed. A. Michaelis found that when cupric oxide is heated to 160° in a sealed tube with phosphorus trichloride, cupric phosphate and chloride, cuprous chloride, and phosphorus oxychloride are formed; and A. Gautier reported that some of the lower oxides of phosphorus are quickly oxidized by cuprous oxide.

Copper oxide is reduced to the metallic state by gentle ignition with carbon. According to C. R. A. Wright and A. P. Luff,¹⁶ freshly precipitated and dried cupric oxide is reduced by sugar charcoal at 390°, cupric oxide from the nitrate at 430°, and that made by roasting copper, at 440°. J. Garnier, and A. C. Becquerel followed the course of the reduction by noting the changes in the resistance of an electric current passing through the mixture. F. O. Doeltz and C. A. Graumann say that cupric oxide is reduced by carbon at 700°. I. L. Bell said that the reduction by carbon monoxide is incomplete at the temp. of melting zinc. W. Spring adds that if the temp. of reduction be below the m.p. of copper, the metal will be obtained in a finely powdered condition. C. R. A. Wright, A. P. Luff, and E. H. Rennie reported that as in the case of hydrogen the higher the pre-heating of the cupric oxide, the higher the temp. required for the reduction with carbon monoxide to begin. Thus, the reduction begins at 60° with precipitated cupric oxide, washed, and dried at 130°, and the action is well marked at 68°; with ignited cupric nitrate the action begins at 125° and is well marked at 133°; and with roasted copper, the action begins at 146° and is well marked at 150°. S. Hauser found the reduction begins about 265°. E. D. Campbell found that with a given sample of cupric oxide, the reduction with hydrogen began at 175°–180°; with carbon monoxide, at 100°–105°; with acetylene, at 315°–325°; with propylene, at 270°–280°; and with butylene, at 320°–340°. E. Jäger found methane begins its action at a red heat. F. C. Phillips says that the hydrocarbons can be completely oxidized by hot cupric oxide; and L. Pfaundler adds that if coal gas be used for the reduction, as indicated by A. Osann, the reduced copper will be contaminated with carbon and adsorbed hydrogen. J. N. Pring noted the reduction of cupric oxide by aluminium carbide, and B. Neumann and O. Fröhlich by calcium carbide. A. Gautier says that the vapour of carbon disulphide does not form cupric oxysulphide, CuOS. F. A. Gooch and de F. Baldwin says that acetylene acts on cupric oxide like it does on cuprous oxide. K. Andriik and H. Hranicka, and W. Bruhns noted the reduction of cupric oxide with methyl alcohol; A. Geurout with ether; F. Bullheimer with glycerol; L. Hunton, with sugar; A. Kling, acetal; O. Loew, petroleum ether; T. Weyl, formic acid; P. Woog, toluene; L. Maumené, naphthalene; etc.

G. Lunge, and W. C. Zeise have studied the removal of sulphur from rock oils and petroleum by distillation with cupric oxide. According to H. N. Warren, when cupric oxide is heated with silicon it forms a silicide or metallic copper; and O. Ruff and K. Albert says that silicochloroform, SiHCl₃, exerts a reducing action. According to C. H. Burgess and A. Holt,¹⁷ cupric oxide is not soluble in fused boric oxide, B₂O₃, but it is soluble if one of the alkali bases be present—lithium, sodium, potassium, caesium, or rubidium. E. Dufau says that alumina and magnesia are coloured reddish-brown by cupric oxide. The alkali silicates

are coloured blue by cupric oxide, and pottery glazes are usually coloured green by cupric oxide. According to H. Schwarz, an old blue Venetian glass contained 1.32 per cent. of cupric oxide. The green colour imparted to glass by copper oxide was known to the ancients and to the later alchemists; advantage was taken of this property to make artificial emeralds. Thus, the pseudo-Basil Valentine says "the emerald contains sulphur veneris." There is a delicate relation between the various constituents of a pottery glaze which enables the copper turquoise blue to be obtained. Old Persian-blue tiles have the turquoise-blue glaze. With less than one per cent. of cupric oxide and a reducing atm. copper colours glazes red. This colour is shown on the Chinese *sang de bœuf* and *rouge flambé* glazes. The colour is probably produced by colloidal copper. An oxidizing atm., says G. Rauter, favours the development of green and blue copper colours.

Cupric oxide is reduced to metallic copper when heated with **potassium** or **sodium** at temp. below their m.p. The reaction proceeds with vivid incandescence. C. Winkler¹⁸ found the reduction of heated cupric oxide by admixed **magnesium** is accompanied by incandescence and a detonation. H. Moissan found **boron** exerts a vigorous reducing action. E. Beckmann found **calcium** is a vigorous reducing agent; F. M. Perkin and L. Pratt say **calcium hydride** also acts energetically. **Copper** reduces cupric to cuprous oxide.

O. Loew,¹⁹ A. Chodneff, and W. F. O. de Coninek have studied the action of alkali hydroxides. A. Völker showed that cupric oxide is slightly soluble in a soln. of **potassium** or **sodium hydroxide**. A 70 per cent. soln. of sodium hydroxide takes up copper in the proportion Cu : NaOH, and the blue liquid does not deposit copper oxide when diluted with 3 or 4 vols. of water. The oxide also dissolves in fused alkali hydroxides to which it imparts a blue colour, and the product is soluble in a little cold water. According to J. A. Hedvall and W. von Zweigbergk, cupric oxide decomposes **barium dioxide** catalytically with an optimum temp. of 600°. Soln. of salts of the **alkalies, alkaline earths, and magnesium** were found by H. Ost not to attack pure cupric oxide. According to J. A. Hedvall and co-workers, they found that **potassium chloride** could not be used as a flux in the fusion of cupric oxide with aluminium oxide on account of a reaction taking place between the potassium chloride and copper aluminate. When cupric oxide is added in small quantities to a mixture of potassium and sodium chlorides at 1000° and the heating continued for one and a half hours, cuprous oxide is formed and oxygen evolved. At the same time, a basic cupric chloride is formed. C. R. C. Tichborne says a 10 per cent. soln. of **sodium hydrocarbonate** mixed with phenolphthalein, and just decolorized with nitric acid is not altered by trituration with cupric oxide. J. von Liebig found cupric oxide to be reduced and alkali cyanate to be formed by fusion with **potassium cyanide**; and J. Lemberg found that black oxide of copper is soluble in a boiling soln. of potassium cyanide. J. L. Proust, and A. Vogel noted that when cupric oxide is boiled with **stannous chloride**, cuprous chloride passes into soln., and stannic oxide is precipitated. M. de K. Thompson found that a soln. of **ferrous sulphate** forms ferric oxide and cupric sulphate, **ferric sulphate** furnishes the same end-products, but if the cupric oxide is in excess, a basic sulphate is formed. According to T. S. Hunt, **ferrous chloride** furnishes cuprous and cupric chlorides and ferric oxide. A. Levöl noted that **hydrated ferrous oxide** and cupric oxide form cuprous and ferric oxides. Gin et Soc. Anon. found cupric oxide precipitates ferric oxide from a soln. of basic ferric sulphate at 90°. C. J. B. Karsten found that when cupric oxide is fused with **ferrous sulphide**, cupric sulphide is formed. M. Vallety says that a soln. of **silver nitrate** forms basic copper nitrate. According to G. Bonnet, a soln. of **arsenious acid** in potassium or sodium hydroxide gives the alkali arsenate and cuprous oxide; the reaction does not occur with the alkali carbonates or with calcium hydroxide; with aqua ammonia, half the cupric oxide is reduced to cuprous oxide and half dissolves in the ammonia, forming a blue soln. M. Prud'homme found alkaline soln. of the **alkali chromates** dissolve cupric

oxide, and when boiled, deposit cuprous oxide, leaving the alkali chromate in soln. According to a patent by the Chemische Fabriken Billwärdler, cupric oxide acts as a catalytic agent in oxidizing chrome iron ore or chromate during its fusion in alkali hydroxides.

According to M. von Nencki,²⁰ commercial cupric oxide may contain lime; according to P. Drawe, cuprous oxide, and, according to H. Violette, selenium as well as the usual impurities associated with copper. The property possessed by cupric oxide of imparting the necessary oxygen for the combustion of hydrocarbons, and many other organic compounds, has led to its being used extensively in organic and gas analysis. It is also used for colouring glasses, glazes, and enamels green, red, or blue, as previously indicated. A contact process for sulphuric acid is based on the stimulating action of cupric oxide—alone or in conjunction with chrome iron ore or ferric oxide—on the union of sulphur dioxide and oxygen. It has been used by E. Fischer as depolarizer for the cathode in the electrolysis of alkali chlorides. There are several patents for its use in this connection. F. de Lalande and G. Chaperon, P. Schoop, C. Grimm, etc., have discussed the use of copper oxide as positive electrode in primary and secondary cells. A. Lionet says the precipitated oxide dried at 100° removes arsine from hydrogen, and also, according to H. Reckleben and G. Lockemann, hydrogen sulphide. E. Viel patented its use for removing silicon from aluminium.

Cupric oxide forms with acids a series of stable cupric salts, for cupric oxide is generally readily soluble in the acids. Cupric oxide is a stronger base than cuprous oxide. The anhydrous cupric salts are usually white, a few, e.g. cupric chloride, are brown. The salts of the volatile acids lose their acids when calcined. The salts are usually readily soluble in water, and their soln. redden litmus owing to hydrolysis. L. Moser found that the cupric salts are not oxidized by ozone; but they are readily reduced by hydrogen, hydrogen sulphide, and the metals. For example, J. B. Senderens, S. Kern, and D. Vitali found that soln. could be reduced with the precipitation of copper by many metals, but the amount of metal dissolved is rarely eq. to the amount of copper precipitated.

REFERENCES.

- ¹ C. A. S. Hoffmann, *Berg. Journ.*, 2, 2042, 1789; L. A. Emmerling, *Lehrbuch der Mineralogie* Giessen, 2, 244, 1796; J. F. L. Hausmann, *Handbuch der Mineralogie*, Göttingen, 243, 1813; F. S. Beudant, *Traité élémentaire de minéralogie*, Paris, 2, 714, 1832; J. D. Dana, *System of Mineralogy*, New York, 518, 1850; E. F. Glocker, *Generum et specierum mineralium synopsis*, Hamburg, 69, 1847; G. Semmola, *Opera minori*, Napoli, 41, 1841; *Bull. Soc. Géol.*, 13, 206, 1841; J. G. Wallerius, *Systema mineralogicum*, Vindobonæ, 2, 291, 1778; J. C. Delaméthérie, *Théorie de la terre*, Paris, 312, 1797.
- ² A. F. Rogers, *Journ. Geol.*, 25, 529, 1917; E. H. Kraus and W. F. Hunt, *Amer. Journ. Science*, (4), 41, 211, 1915; G. A. Koenig, *Proc. Philadelphia Acad.*, 284, 1891.
- ³ R. Hefelmann, *Pharm. Centrbl.*, 36, 637, 1895; E. C. C. Stanford, *Chem. News*, 7, 81, 1863; W. Müller, *Pogg. Ann.*, 141, 95, 1870; P. Schützenberger, *Compt. Rend.*, 86, 1265, 1878; E. Jordis and W. Rosenhaupt, *Zeit. angew. Chem.*, 21, 54, 1908; *Chem. Ztg.*, 32, 19, 1908; J. C. Richardson, *Brit. Pat. No.* 4114, 1892; V. Kohlschütter and T. Goldschmidt, *Zeit. Elektrochem.*, 14, 229, 1908.
- ⁴ O. L. Erdmann and R. F. Marchand, *Journ. prakt. Chem.*, (1), 31, 385, 1844; W. Hampe, *Zeit. Berg. Hütt. Salz.*, 21, 266, 1873; T. W. Richards, *Amer. Chem. Journ.*, 20, 701, 1898; *Chem. News*, 66, 29, 47, 57, 74, 1892; *Proc. Amer. Acad.*, 25, 195, 1890; 26, 240, 1891; T. W. Richards and G. P. Baxter, *ib.*, 23, 245, 1900; T. W. Richards and E. F. Rogers, *ib.*, 28, 200, 1893; *Chem. News*, 68, 240, 250, 1893; E. Frankland and H. E. Armstrong, *Journ. Chem. Soc.*, 21, 89, 1868; J. L. W. Thudichum and C. T. Kingzett, *ib.*, 30, 363, 1876; H. D. A. Ficinus, *Schweigger's Journ.*, 34, 251, 1822; G. Rousseau and G. Tite, *Compt. Rend.*, 113, 192, 1891; J. A. Morrell, *Journ. Amer. Chem. Soc.*, 2, 146, 1881; E. C. C. Stanford, *Chem. News*, 7, 81, 1863; K. Seubert and G. Rauter, *Ber.*, 25, 2823, 1892; A. Lieben and A. Rossi, *Liebig's Ann.*, 159, 58, 1871; U. Kreusler, *Landw. Vers. Stat.*, 31, 207, 1884; H. Schulze, *Journ. prakt. Chem.*, (2), 21, 413, 1880; E. Erlenmeyer, *Zeit. Chem.*, 6, 157, 1863; E. W. Morley, *Amer. Journ. Science*, (3), 41, 231, 1891; T. Hilditch, *Chem. News*, 49, 37, 1884; G. S. Johnson, *ib.*, 37, 271, 1878; P. Holland, *ib.*, 18, 1, 1868; T. Klobb, *Compt. Rend.*, 115, 232, 1892; A. Joannis, *ib.*, 102, 1161, 1886; P. Schützenberger, *ib.*, 98, 1520, 1884; A. Lionet, *ib.*, 89, 440, 1879; F. Zambonini, *Atti Accad. Lincei*, (5), 15, ii, 235, 1906; M. Prud'homme, *Bull. Soc.*

Mulhouse, 59. 607, 1889; A. C. Becquerel, *Ann. Chim. Phys.*, (2), 51. 101, 1832; A. Vogel and C. Reishauer, *Dingler's Journ.*, 153. 197, 1859; J. W. Mallet, *Amer. Journ. Science*, (2), 30. 253, 1860.

⁵ H. Buff, *Liebig's Ann.*, 85. 1, 1853; G. Planté, *Recherches sur l'électricité*, Paris, 1879; E. Wohlwill, *Zeit. Elektrochem.*, 9. 313, 1903; E. Müller, *ib.*, 13. 138, 1907; E. Müller and F. Spitzer, *ib.*, 13. 25, 1907; W. Borehers, *ib.*, 3. 484, 1897; M. Wildermann, *Zeit. phys. Chem.*, 59. 734, 1907; H. Meidinger, *Dingler's Journ.*, 219. 141, 1876; C. Luekow, *German Pat.*, D.R.P. 91707, 1894; W. D. Baneroff, *Trans. Amer. Electrochem. Soc.*, 1. 65, 1902; G. H. Burrows, *Journ. Phys. Chem.*, 6. 417, 1902; R. Kroupa, *Oester. Zeit. Berg. Hütt.*, 53. 611, 1905; A. Broecht, *Bull. Soc. Chim.*, (3), 29. 156, 1903; *Compt. Rend.*, 136. 155, 1903.

⁶ N. S. Maskelyne, *B. A. Rep.*, 33, 1865; E. Kalkowsky, *Zeit. Kryst.*, 3. 279, 1879; G. A. König, *ib.*, 19. 597, 1891; *Proc. Philadelphia Acad.*, 284, 1891; G. Jenzsch, *Pogg. Ann.*, 107. 647, 1861; H. E. Behenek, *Journ. Phys. Chem.*, 23. 283, 1919; J. W. Mallet, *Amer. Journ. Science*, (2), 30. 253, 1860; J. A. Heilvall, *Zeit. anorg. Chem.*, 120. 327, 1922.

⁷ W. Herapath, *Phil. Mag.*, (1), 64. 321, 1824; G. A. König, *Zeit. Kryst.*, 19. 597, 1891; *Proc. Acad. Philadelphia*, 284, 1891; P. F. G. Boullay, *Ann. Chim. Phys.*, (2), 43. 266, 1830; E. Filhol, *ib.*, (3), 21. 415, 1847; C. F. Rammelsberg, *Pogg. Ann.*, 80. 287, 1850; G. Jenzsch, *ib.*, 107. 647, 1861; C. J. B. Karsten, *Schweigger's Journ.*, 65. 394, 1832; L. Playfair and J. P. Joule, *Mcm. Chem. Soc.*, 3. 82, 1845; J. F. Persoz, *Journ. prakt. Chem.*, (1), 47. 84, 1849; T. Klobb, *Compt. Rend.*, 115. 232, 1892; W. Hampe, *Zeit. Chem.*, 13. 363, 1870; F. Streintz, *Ann. Physik*, (4), 9. 857, 1902; J. D. Whitney, *Amer. Journ. Science*, (2), 20. 53, 1855.

⁸ L. Wöhler and A. Foss, *Zeit. Elektrochem.*, 12. 784, 1906; L. Wöhler and O. Balz, *ib.*, 27. 406, 1921; W. Stahl, *Met.*, 4. 686, 1907; H. Debray and A. Joannis, *ib.*, 99. 688, 1884; A. Gouy, *ib.*, 85. 439, 1877; H. Moissan, *ib.*, 115. 1036, 1892; *Bull. Soc. Chim.*, (3), 9. 957, 1893; H. le Chatelier, *ib.*, (2), 47. 482, 1887; F. E. Neumann, *Pogg. Ann.*, 23. 32, 1831; H. Kopp, *Liebig's Ann. Suppl.*, 3. 292, 1864; H. V. Regnault, *Ann. Chim. Phys.*, (3), 1. 129, 1841; A. Magnus, *Ann. Physik*, (4), 31. 597, 1910; L. Elsner, *Chem. Tech. Mitt.*, 36, 1858; F. H. Smyth and H. S. Roberts, *Journ. Amer. Chem. Soc.*, 42. 2582, 1920; 43. 1031, 1921; H. W. Foote and E. K. Smith, *ib.*, 30. 1344, 1908; J. Hagenacker, *Ueber die Dissoziationsspannung einiger Metalloxyde*, Weida i. Th. 1909.

⁹ J. Thomsen, *Journ. prakt. Chem.*, (2), 12. 271, 1875; *Pogg. Ann.*, 143. 354, 497, 1871; *Thermochemische Untersuchungen*, Leipzig, 3. 320, 1883; T. Andrews, *Phil. Mag.*, (3), 32. 321, 1848; P. L. Dulong, *Compt. Rend.*, 7. 871, 1838; A. Joannis, *ib.*, 78. 1177, 1874; 162. 1161, 1886; P. Sabatier, *ib.*, 125. 301, 1897; M. Berthelot, *ib.*, 86. 528, 1878; *Ann. Chim. Phys.*, (5), 15. 185, 1878; (7), 4. 471, 1895; P. A. Favre and J. T. Silbermann, *ib.*, (3), 37. 442, 1853; W. Ostwald, *Wied. Ann.*, 2. 429, 1877; F. H. Smyth and H. S. Roberts, *Journ. Amer. Chem. Soc.*, 42. 2582, 1920; 43. 1061, 1921.

¹⁰ E. L. Nieols and D. T. Wilber, *Phys. Rev.*, (2), 17. 707, 1921; A. Schleiernaeker, *Wied. Ann.*, 26. 287, 1885; W. W. Jaques, *Proc. Amer. Acad.*, 14. 142, 1879; *Distribution of Heat in the various sources of Radiation*, Baltimore, 1879; A. Kundt, *Sitzber. Akad. Berlin*, 255, 1387, 1888; L. de Boisbaudran, *Compt. Rend.*, 106. 1386, 1888; W. Hallwachs, *Compt. Rend. Cong. Radiologie*, 2, 1910; J. Stefan, *Sitzber. Akad. Wien*, 79. 391, 1879; V. Klatt and P. Lenard, *Wied. Ann.*, 38. 90, 1889; O. Vogel, *Zeit. anorg. Chem.*, 5. 48, 1894; H. Kayser, *Handbuch der Spectroscopie*, Leipzig, 2. 92, 1902; F. Pasehen, *Gött. Naehr.*, 6, 1895; *Wied. Ann.*, 58. 455, 1896; 60. 662, 1897; W. N. Hartley, *Chem. News*, 67. 279, 1893.

¹¹ A. A. Sommerville, *Met. Chem. Eng.*, 10. 422, 1912; F. S. Smith, *Compt. Rend.*, 80. 301, 1875; F. Streintz, *Ann. Physik*, (4), 9. 864, 1902; K. Bädeker, *ib.*, (4), 22. 749, 1907; F. Horton, *Phil. Mag.*, (6), 11. 505, 1906; T. W. Case, *Phys. Rev.*, (2), 9. 305, 1917; K. Bädeker, *Ueber die elektrische Leitfähigkeit und die thermoelektrische Kraft einiger Schwermetalverbindungen*, Leipzig, 1906; J. Perrin, *Compt. Rend.*, 136. 1441, 1903; P. Fritzsche, *Wied. Ann.*, 60. 313, 1897; G. C. Schmidt, *ib.*, 67. 563, 1899; M. Wildermann, *Zeit. phys. Chem.*, 59. 734, 1907; C. B. Thwing, *ib.*, 14. 292, 1894; A. Coehn, *Zeit. Elektrochem.*, 9. 642, 1903; A. Coehn and Y. Osaka, *Zeit. anorg. Chem.*, 34. 86, 1903; E. A. Byrnes, *Trans. Amer. Electrochem. Soc.*, 2. 115, 1902; S. Meyer, *Wied. Ann.*, 68. 325, 1899; 69. 235, 1899; *Ann. Physik*, (4), 1. 664, 1900; G. Chénaveau, *Journ. Phys.*, 9. 163, 1910; E. van der Ven, *Arch. Musée Teyler*, (2), 2. 97, 1886; E. Thomson, *Nature*, 107. 520, 619, 1921; O. J. Lodge, *ib.*, 107. 553, 1921; R. W. Gray, *ib.*, 107. 619, 1921; J. B. Speakman, *ib.*, 107. 619, 1921.

¹² W. Müller-Erzbaeh, *Pogg. Ann.*, 136. 51, 1869; F. C. G. Müller, *ib.*, 151. 286, 398, 1874; C. R. A. Wright and A. P. Luff, *Journ. Chem. Soc.*, 33. 1, 1878; 35. 475, 1879; F. Glaser, *Zeit. anorg. Chem.*, 36. 1, 1903; A. Löb, *Zeit. Elektrochem.*, 12. 88, 1906; S. Hlauser, *Ueber Reduktion einiger Metalloxyde durch Gase*, Strassburg, 1907; A. Osann, *Pogg. Ann.*, 52. 406, 1841; J. J. Berzelius, *Liebig's Ann.*, 61. 1, 1866; E. D. Campbell, *Amer. Chem. Journ.*, 17. 681, 1895; C. F. Cross, *Jour. Chem. Soc.*, 35. 795, 1879; A. Joannis, *Compt. Rend.*, 102. 1161, 1886; R. N. Pease and H. S. Taylor, *Journ. Amer. Chem. Soc.*, 43. 2179, 1921.

¹³ H. Moissan, *Ann. Chim. Phys.*, (6), 24. 261, 1891; M. G. Levi and M. Voghera, *Gazz. Chim. Ital.*, 36. i, 513, 1906; L. Santi, *Boll. Chim. Farm.*, 43. 673, 1904; G. Denigès, *Journ. Pharm. Chim.*, (5), 19. 303, 1889; R. S. Norris and F. G. Cottrel, *Amer. Chem. Journ.*, 18. 96, 1896; B. Szilard, *Compt. Rend.*, 145. 433, 1907; F. Oettel, *Zeit. Elektrochem.*, 51. 1, 1898; W. D. Baneroff, *Trans. Amer. Electrochem. Soc.*, 1. 68, 1902; C. R. A. Wright and A. P. Luff, *Journ. Chem. Soc.*, 33. 1, 1878; 35. 475, 1879; W. O. de Coninck and L. Arzalier, *Bull. Acad. Belg.*, 713, 800, 1907.

¹⁴ M. Jordan, *Journ. prakt. Chem.*, (1), 28. 222, 1843; H. Rose, *Pogg. Ann.*, 110. 120, 1860; J. B. Senderens, *Compt. Rend.*, 104. 58, 1887; K. Heumann, *Ber.*, 6. 748, 1873; E. Priozonnik, *ib.*, 6. 1291, 1873; M. Traube, *ib.*, 16. 126, 1883; H. Debus, *Proc. Roy. Soc.*, 30. 198, 1880; K. Klüss, *Liebig's Ann.*, 246. 207, 1888; G. Kuppeler, *Zeit. angew. Chem.*, 21. 579, 1908; H. Brigglieb, *German Pat.*, D.R.P. 121906, 1900; C. D. Brindley, *Brit. Pat. No.* 11981, 1906; F. Eschbaum, *Pharm. Centrbl.*, 38. 133, 1897; W. A. Bone and R. V. Wheeler, *Proc. Roy. Soc.*, 77. A, 146, 1906; J. Krutwig and A. Dernoncourt, *Rev. Trav. Chim. Pays-Bas*, 17. 349, 1898; W. Spring, *ib.*, 23. 187, 1904; *Bull. Acad. Belgique*, 290, 1904; H. B. Baker, *Journ. Chem. Soc.*, 65. 611, 1894; *Chem. News*, 67. 263, 1893; 69. 270, 1894.

¹⁵ J. L. Proust, *Journ. Phys.*, 59. 395, 1904; E. Murmann, *Oester. Chem. Ztg.*, 7. 272, 1904; S. Hauser, *Ueber Reduktion einiger Metalloxyde durch Gase*, Strassburg, 1907; A. Froment, *German Pat.*, D.R.P. 139714, 1900; D. Lance, *ib.*, 188793, 1905; V. Dessaignes, *Ann. Chim. Phys.*, (3), 34. 146, 1852; W. J. J. Le Venier, *ib.*, (2), 65. 257, 1837; R. Piria, *ib.*, (3), 22. 160, 1848; A. Cahours, *ib.*, (3), 38. 76, 1853; *Compt. Rend.*, 34. 481, 1852; P. Sabatier and J. B. Senderens, *ib.*, 114. 1476, 1892; *Ann. Chim. Phys.*, (7), 7. 361, 1896; L. Juman, *Electrochem. Ind.*, 6. 258, 1908; K. Kraut, *Liebig's Ann.*, 157. 66, 1871; E. Fischer, *Ber.*, 39. 530, 1906; C. Schnabel, *Zeit. Berg. Hütt. Sal.*, 28. 282, 1880; J. Tuttsche, *Zeit. Chem.*, (2), 6. 110, 1870; C. A. L. de Bruyn, *Rec. Trav. Chim. Pays-Bas*, 15. 179, 1897; F. Haber, *Ber.*, 29. 2444, 1896; A. Thum, *Monatsh.*, 14. 305, 1893; E. Francke, *Zur Kenntnis der Oxydation des Hydrinzins und Hydroxyamins*, Berlin, 25, 1907; L. Maumené, *Compt. Rend.*, 95. 223, 1882; A. Gautier, *ib.*, 76. 49, 173, 1873; H. N. Warren, *Chem. News*, 55. 155, 1887; A. Michaelis, *Journ. prakt. Chem.*, (2), 4. 449, 1871; F. D. Lassone, *Mém. Acad.*, 46, 1742; 70, 1743.

¹⁶ I. L. Bell, *Chem. News*, 23. 258, 1871; C. R. A. Wright and A. P. Luff, *Journ. Chem. Soc.*, 33. 1, 1878; C. R. A. Wright, A. P. Luff, and E. H. Rennie, *ib.*, 35. 475, 1879; C. R. A. Wright and A. E. Menke, *ib.*, 37. 791, 1880; E. D. Campbell, *Amer. Chem. Journ.*, 17. 681, 1895; F. C. Phillips, *ib.*, 16. 163, 1894; S. Hauser, *Ueber Reduktion einiger Metalloxyde durch Gase*, Strassburg, 1907; K. Heydenrich, *Zeit. anal. Chem.*, 45. 741, 1906; W. Spring, *Zeit. anorg. Chem.*, 1. 240, 1892; L. Pfaunder, *Chem. Ztg.*, 16. 145, 1892; W. Bruhns, *Zeit. öffent. Chem.*, 3. 573, 1897; E. Jäger, *Journ. Gasbeleucht.*, 41. 764, 1899; A. Osann, *Pogg. Ann.*, 52. 406, 1841; F. O. Doeltz and C. A. Graumann, *Met.*, 4. 420, 1907; J. Garnier, *Compt. Rend.*, 118. 583, 1894; A. Gautier, *ib.*, 107. 911, 1888; A. C. Becquerel, *ib.*, 74. 83, 1872; A. Geurout, *ib.*, 79. 221, 1874; J. N. Pring, *Journ. Chem. Soc.*, 87. 1530, 1905; B. Neumann, *Chem. Ztg.*, 24. 1013, 1900; O. Frölich, *ib.*, 25. 418, 1901; H. N. Warren, *Chem. News*, 64. 75, 1891; F. A. Gooch and de F. Baldwin, *Amer. Journ. Science*, (4), 8. 365, 1899; L. Hunton, *Phil. Mag. Journ.*, 11. 154, 1837; T. Weyl, *Ber.*, 15. 604, 1139, 1882; O. Ruff and K. Albert, *ib.*, 38. 2222, 1905; F. Bullnheimer, *Forsch. Lebensm.*, 4. 12, 1897; K. Andriik and H. Hranicka, *Zeit. Zuckerind. Böhmen*, 22. 216, 1898; E. Herschsohn, *Pharm. Zeit. Russ.*, 32. 705, 1893; P. Woog, *Compt. Rend.*, 145. 124, 1907; A. Kling, *Bull. Soc. Chim.*, (3), 29. 92, 1903; L. Maumené, *ib.*, (2), 7. 72, 1867; W. C. Zeise, *Pogg. Ann.*, 31. 369, 1834; G. Lunge, *Zeit. angew. Chem.*, 8. 69, 1894; O. Loew, *Zeit. anal. Chem.*, 9. 463, 1870.

¹⁷ C. H. Burgess and A. Holt, *Trans. Cer. Soc.*, 5. 163, 1906; *Chem. News*, 88. 269, 1903; E. Dufau, *Journ. Pharm. Chem.*, (6), 14. 25, 1901; H. Hecht, *Tonind. Ztg.*, 19. 453, 1895; G. Rauter, *Zeit. angew. Chem.*, 14. 753, 1901; G. Starkl, *Verh. geol. Reichsanst. Wien*, 45, 1889; H. Schwarz, *Dingler's Journ.*, 205. 425, 1872.

¹⁸ C. Winkler, *Ber.*, 23. 44, 1890; E. Beckmann, *ib.*, 38. 904, 1905; H. Moissan, *Compt. Rend.*, 114. 617, 1892; *Ann. Chim. Phys.*, (7), 6. 314, 1895; F. M. Perkin and L. Pratt, *Electrochem. Ind.*, 6. 30, 1908.

¹⁹ O. Loew, *Zeit. anal. Chem.*, 9. 463, 1870; A. Völker, *Liebig's Ann.*, 59. 34, 1846; A. Chodneff, *Journ. prakt. Chem.*, (1), 23. 217, 1843; W. F. O. de Coninek, *Bull. Assoc. Chim. Belgique*, 18. 89, 1904; H. Ost, *Chem. Ztg.*, 26. 845, 1902; C. R. C. Tichborne, *Chem. News*, 91. 110, 1905; J. Lemberg, *Zeit. deut. geol. Ges.*, 52. 491, 1900; J. L. Proust, *Journ. Phys.*, 59. 395, 1804; A. Vogel, *Kastner's Archiv*, 23. 85, 1834; A. Levöl, *Ann. Chim. Phys.*, (2), 60. 320, 1835; M. de K. Thompson, *Electrochem. Ind.*, 2. 226, 1904; T. S. Hunt, *Compt. Rend.*, 69. 1357, 1869; M. Prud'homme, *Bull. Soc. Chim.*, (2), 17. 253, 1872; Gin et Soc. Anon., *German Pat.*, D.R.P. 144992, 1902; Chemische Fabriken Billwärder, *ib.*, 163814, 1904; C. J. B. Karsten, *Schweigger's Journ.*, 66. 401, 1832; G. Bonnet, *Pogg. Ann.*, 37. 300, 1836; M. Vallery, *Ann. Chim. Anal. App.*, 10. 193, 1905; J. A. Hedvall and N. von Zweigbergk, *Zeit. anorg. Chem.*, 108. 119, 1919; J. A. Hedvall and J. Heuberger, *ib.*, 116. 137, 1921; J. A. Hedvall and G. Booberg, *ib.*, 119. 213, 1921.

²⁰ L. and P. Wöhler and W. Plüddemann, *Zeit. phys. Chem.*, 62. 649, 1908; M. von Nencki, *Monatsh.*, 10. 233, 1889; P. Drawe, *Zeit. angew. Chem.*, 14. 586, 1901; H. Violette, *Compt. Rend.*, 70. 730, 1870; H. Reckleben and G. Lockemann, *Zeit. angew. Chem.*, 21. 435, 1908; E. Viel, *Frensch Pat. No.* 380087, 1907; E. Fischer, *Dingler's Journ.*, 256. 26, 1885; F. de Lalande and G. Chaperon, *Compt. Rend.*, 97. 164, 1883; F. de Lalande, *ib.*, 112. 1243, 1891; P. Schoop, *Die Sekundär-Elemente*, Halle, 3. 11, 1895; C. Grimm, *Die chemischen Stromquellen der Elektrizität*, München, 1908; E. J. Wade, *Secondary Batteries*, London, 1902; W. R. Cooper, *Primary Batteries*, London, 1901; L. Moser, *Zeit. anorg. Chem.*, 54. 125, 1907; J. B. Senderens, *Bull. Soc. Chim.*, (3), 17. 271, 1897; S. Kern, *Chem. News*, 32. 309, 1875; 33. 112, 236, 1876; D. Vitali, *Orosi*, 18. 289, 1895; A. Lionet, *Compt. Rend.*, 89. 440, 1880.

§ 11. The Hydrated and Colloidal Cupric Oxides

A. Lottermoser¹ prepared a cupric oxide sol by oxidation of a colloidal soln. of copper in air. T. Svedberg obtained a colloidal solution of cupric oxide by sparking the solid under isobutyl alcohol. H. Ley and F. Werner obtained a colloidal soln. of cupric oxide by allowing a dil. aq. soln. of copper succinimide to stand for some days; the colour changes slowly from dark-green to yellowish-brown and finally dark brown. C. Paal and W. Leuze prepared the colloids by their process with sodium protalbinat or lysalbinat. V. Kohlschütter and J. L. Tüscher prepared cupric oxide dispersed in a gaseous medium by making the metal one electrode of an electric arc and oxidizing the vapour.

C. F. Cross² found that cupric oxide prepared by the ignition of the nitrate when exposed to an atm. sat. with moisture takes up from 2 to 4 per cent. approximating $8\text{CuO}\cdot\text{H}_2\text{O}$, whereas the oxide prepared by igniting the metal in oxygen takes up no water and is permanently anhydrous. The hydrate prepared by precipitation from the sulphate and drying at 100° , had a composition corresponding with $4\text{CuO}\cdot\text{H}_2\text{O}$. This product was thought to rehydrate *per saltum*, forming in 24 hrs. $\text{CuO}\cdot\text{H}_2\text{O}$; in 48 hrs. $2\text{CuO}\cdot 3\text{H}_2\text{O}$; and then approximated slowly to the limit $\text{CuO}\cdot 2\text{H}_2\text{O}$. E. Rubénovitch also reported this latter hydrate by precipitating cupric sulphate with potassium hydroxide and washing the product until the water is removed. E. Frémy, and W. Spring and M. Lucion obtained similar results. B. Kosmann regards this product as having the constitution $\text{HCu}(\text{OH})_3$. A. Mailhe prepared a similar product to the $4\text{CuO}\cdot\text{H}_2\text{O}$, that is, $\text{Cu}(\text{OH})_2\cdot 3\text{CuO}$, or $\text{Cu}_4\text{O}_3(\text{OH})_2$ and called *tetracupric trioxydihydroxide*, obtained by C. F. Cross; and P. Sabatier claimed to have obtained $7\text{CuO}\cdot\text{H}_2\text{O}$ by dehydrating $2\text{CuO}\cdot\text{H}_2\text{O}$, in the cold or at 100° .

According to M. Schaffner, the dark brown product obtained when freshly precipitated cupric hydroxide is heated under its own mother liquid, or heated with water, or exposed to direct sunlight, has the composition: $6\text{CuO}\cdot\text{H}_2\text{O}$. E. Müller and F. Spitzer obtained the same product by electrical endosmose. F. Mawrow also claimed to have made this same product by suspending cupric hydroxide in 16.7 times its weight of potash-lye of sp.gr. 1.4 and passing chlorine into the liquid, at 50° – 60° , or at a boiling temp., until the colour no longer changes. The product is dried over sulphuric acid. M. Schaffner says that the dark brown pulverulent mass does not lose its water at 130° ; and H. Rose, that from 1 to 2.3 per cent. remains when it is heated to 200° or 300° . According to E. Harms, the product $6\text{CuO}\cdot\text{H}_2\text{O}$ is really $3\text{CuO}\cdot\text{H}_2\text{O}$, and, according to E. Francke, it is partially reduced to CuOH by hydroxylamine. There is little more than the analysis to show that these products are individuals, and it is extremely probable that most or all of them are mixtures of cupric oxide with absorbed water. Similar remarks apply to the product obtained by A. Joannis by boiling ammoniacal cupric soln., and to the black products obtained by E. Müller and F. Spitzer on the platinum or iron anodes during the electrolysis of soln. of copper salts in alkali-lye, or of Fehling's soln.

Cupric hydroxide, $\text{Cu}(\text{OH})_2$, or $\text{CuO}\cdot\text{H}_2\text{O}$.—A blue colloidal hydrated form of cupric oxide is formed by adding a slight excess of dil. potassium hydroxide to a cold soln. of a cupric salt. It is repeatedly and rapidly washed with large quantities of cold water—a litre of water per gram of hydrate. The mass is collected on a cloth filter after each washing. The operation should not occupy more than an hour. According to P. Grouvelle,³ the precipitate still retains some alkali after the washing. In order to avoid the formation of basic salts, A. Ogliarolo said that it is best to pour the copper soln. into the excess of alkali. The hydrate is liable to turn black, even during washing, owing to the formation of cupric oxide. Hence, A. Villiers recommended using iced water, and keeping the temp. below 0° . G. Fassbender said that the change to the black oxide is retarded if some glycerol be present. According to L. S. Finch, cupric oxide jellies, made by adding a suitable quantity of ammonia to a sat. soln. of copper acetate, are not permanent, for sooner or later cupric hydroxide separates out. The stability is increased if a little manganese sulphate, potassium sulphate, or sulphuric acid be present in the cupric acetate soln. before precipitation.

According to J. M. van Bemmelen, the pure hydrogel is a thick, bright blue jelly, which, after pressing between porous earthenware for two hours, still contains a large quantity (20 mols.) of "water of absorption." It retains its colour under

water at the ordinary temp. for several days, whether in the dark or in sunlight, but in hot water, unlike the crystalline variety, undergoes gradual modification, the colour changing to green. When exposed at the ordinary temp. to an artificially dried atm., it loses water until its vap. press. is equal to that of the aq. vapour in the atm., and when the press. is zero, the composition approaches the limit $\text{CuO} \cdot \text{H}_2\text{O}$. This last molecule of water is only partially eliminated at 100° ; the second, although not so tenaciously attached, is more firmly combined than the others, the number of which varies, as before stated, with the press. With the elimination of water, the compound becomes more stable, and like the crystalline hydrate in character, whilst the ease with which the water is eliminated diminishes as time elapses. The dried substance absorbs a certain amount (4 mols.) of the water again, when exposed to a moist atm., the exact amount depending, as before, on the press. of the aq. vapour in the atm. Fig. 25 shows the isothermal hydration and dehydration curves (15°) for the water conc. of the solid in mols. of H_2O per mol. of CuO , and the vap. press. of the gas phase in mm. of mercury. According to V. Kohlschütter and J. L. Tüscher, the dehydration of copper hydroxide is due to an internal neutralization, and is to be represented by the equations $\text{Cu}(\text{OH})_2 = \text{Cu}'' + 2\text{OH}'$; $\text{CuH}_2\text{O}_2 \rightleftharpoons \text{CuO}_2'' + 2\text{H}'$; $2\text{H}' + 2\text{OH}' \rightleftharpoons 2\text{H}_2\text{O}$; and $\text{CuO}_2'' + \text{Cu}'' = 2\text{CuO}$. It is, however, not simple $\text{Cu}(\text{OH})_2$ mols. that are involved in the reaction, but molecular complexes of colloidal dimensions, so that the degree of dispersity, and hence the reactivity of the complexes, varies with the conditions of formation.

N. G. Chatterji and N. R. Dhar regard soln. of the so-called cupric hydroxide as a true peptized colloid, and not of chemical combination.

Cupric hydroxide was prepared by J. Habermann and R. Ehrenfeld by the action of potassium hydroxide on basic cupric sulphate; J. M. van Bemmelen used basing cupric nitrate; W. Bonsdorff used ammonium cupric sulphate or nitrate; J. J. Berzelius, A. Bouzat, J. Löwe, E. M. Péligot, and J. M. van Bemmelen treated a feebly ammoniacal soln. of cupric oxide or carbonate with dil. potassium hydroxide. A. C. Becquerel obtained a growth of crystals of the hydroxide on a sheet of collodion or paper separating a soln. of cupric nitrate from a soln. of potassium hydroxide, potassium aluminate, or potassium silicate. The crystalline hydroxide, $\text{Cu}(\text{OH})_2$, is prepared by the slow action of dil. alkalis on various copper salts in the cold. The product is not affected by alkalis or by heat, and may be boiled with water without undergoing any change. The assumption of this stable form is in some way connected with the action of the alkali, as the same phenomenon is observed with beryllia and alumina. A. Krefling obtained thread-like masses of cupric hydroxide by dipping copper in a soln. of potassium ferricyanide and sodium chloride to which one or two drops of sodium hydroxide have been added. The formation develops more quickly if copper be in contact with platinum.

J. L. Proust obtained cupric hydroxide by shaking cupric carbonate with calcium hydroxide and water. J. M. Bell and W. C. Taber obtained cupric hydroxide by adding calcium hydroxide to a soln. of cupric sulphate. A. C. Becquerel found limestone in a soln. of cupric nitrate is gradually covered with green basic nitrate, and when dipped into dil. potassium carbonate forms blue needles of cupric hydroxide. E. Julius used calcium carbonate. G. de Bechi prepared the same compound by adding zinc or magnesium oxide or hydroxide to soln. of cupric salts; C. Millberg used manganous hydroxide. E. M. Péligot obtained cupric hydroxide by the action of a large proportion of water or cupric amino-nitrite on an ammoniacal soln. of cupric nitrate. J. M. van Bemmelen diluted with an excess of water, the soln. obtained by exposing copper and ammonia to air.

F. Bullheimer and E. Seitz added ammonia to a boiling soln. of cupric sulphate

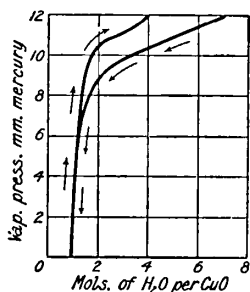

Fig. 25.—Hydration and Dehydration Curves of the Hydrogel of Cupric Oxide.

until a blue precipitate was formed, and then added a soln. of alkali hydroxide. T. Graham dialyzed the liquid obtained by adding potassium hydroxide to a soln. of cupric chloride and sugar, and obtained a green colloidal soln. of cupric oxide. R. Ludwig mixed gum arabic and added an excess of alkali hydroxide, when a deep blue colloidal soln. of cupric hydroxide was formed. B. Szilard peptized cupric hydroxide by adding it to a boiling 2 per cent. soln. of thorium or uranyl nitrate. The resulting colloidal soln. was blue or green. E. Grimaux dialyzed Schweigger's liquid and also decomposed it by five or six volumes of water, or by small quantities of magnesium, calcium, or aluminium sulphate, acetic acid, or by heating it to 40° or 50°. In the latter case, the precipitate slowly dissolves on cooling. A soln. of native cupric oxide or carbonate in an aq. soln. of an amine; or better, a mixture of amine and aqua ammonia, when heated, forms cupric hydroxide. If the oxides of zinc, cadmium, cobalt, nickel, etc., are also in soln., the hydroxides are precipitated consecutively as the temp. rises—for example, zinc hydroxide separates at 95°, cupric hydroxide at 100°, and silver hydroxide at a still higher temp. A. Gutbier obtained a yellow unstable hydrosol of cupric hydroxide by treating a very dil. neutral soln. of cupric sulphate with hydrazine hydrate. K. Elbs, and R. Lorenz prepared cupric hydroxide by electrolyzing a soln. of potassium nitrate or sodium sulphate with a rotating copper anode.

The properties of cupric hydroxide.—Cupric hydroxide prepared as just described appears as a blue hydrogel or in blue crystals—macro- or micro-scopic. It also forms colloidal sols. The hydrogel dries to greenish-blue friable lumps, with a conchoidal fracture. According to H. G. F. Schröder,⁴ the sp. gr. of a sample derived from the action of aqua ammonia on cupric sulphate is 3.368. The dry mass and the crystals are fairly stable at ordinary temp., but, as noted by C. L. Berthollet, the hydrogel standing under water is more or less dehydrated, forming first a green, then a brown, and finally a black more or less hydrated oxide; E. Harms says that the hydrogel can be heated over 100° without change under liquids which exercise no chemical action on the product; and M. Schaffner says that the product dried over quicklime can be heated to over 100° without change. According to H. E. Schenck, copper oxide, precipitated together with alumina by a slight excess of sodium hydroxide from a soln. of copper and aluminium sulphates, is light blue in colour after drying at 110°. On heating successively in a Bunsen flame and a blowpipe flame, the colour changes to light greyish-blue if the mixture does not contain more than 5 per cent. of copper oxide. With 10 per cent. of copper oxide the mixture shows signs of blackening in the blowpipe flame. H. E. Schenck believes that alumina stabilizes the blue oxide, and that the change from blue to black is due to an agglomeration of the particles. N. G. Chatterji and N. R. Dhar also found that blue cupric hydroxide is stabilized by the presence of a trace of undecomposed cupric salt.

The dehydration under water is dependent (i) on the temp.—*e.g.* W. Spring and M. Lucion found freshly precipitated hydrogel which had a composition corresponding with $\text{CuO} \cdot 2\text{H}_2\text{O}$, formed the black product when kept at 15° for nine months; at 30°, in 96 hrs.; at 38°, in 38 hrs.; and over 54°, a lower hydrate is usually formed. As shown by J. L. Proust, the dehydration is also dependent (ii) on the nature of the salts in the soln.—thus, D. Tommasi found the dehydration to occur in a 5 per cent. soln. of sodium carbonate at 50°; 10 per cent. soln. of potassium chloride at 71°; 10 per cent. soln. sodium hydroxide at 74°; water at 77°; 10 per cent. soln. of sodium acetate at 79°; 10 per cent. soln. of sodium sulphate at 79°; one per cent. soln. of sodium hydroxide at 83°; 0.5 per cent. soln. of sodium hydroxide at 85°; 10 per cent. soln. of potassium bromide or of potassium chlorate at 85°; and 10 per cent. soln. of potassium iodide at 86°. In the presence of calcium chloride, manganese sulphate, and sugar, cupric hydrogel remains unchanged at 100°—only a trace of manganese sulphate is needed to hinder the formation of the black oxide. W. Spring and M. Lucion say that the chlorides of the univalent metals affect the action in the same way, and nearly half as slowly as chlorides

of the bivalent metals. C. Ochsenius also found the sulphates of sodium, magnesium, and manganese to act similarly. According to J. M. van Bemmelen, the blue hydrogel is stable towards alkalies and alkali salts, but it precipitates bromides and iodides almost completely as basic cuprous salts. The fresher the preparation, the more vigorous the action. According to B. Kosmann, the ready dehydration of the hydrogel is connected with the low value of the heat of hydration. W. Spring and M. Lucion believe there is some relation between the dehydrating action of the alkalies and their osmotic press. J. L. Proust says that alcohol does not decompose the fresh or dried hydrate.

According to J. L. Proust, A. Chlodneff, E. Frémy, and W. Spring and M. Lucion, the hydrate is soluble in alkali-lye—at 15°, the latter say that a mol. of the hydrate is soluble in a soln. with 37 mols. of potassium hydroxide, or 32.5 of sodium hydroxide, and H. W. Fischer adds that the solubility of cupric hydroxide in soda-lye is less the more dil. the lye and that the solubility is affected but very slightly by sodium carbonate. According to E. Müller, an aq. soln. of sodium hydroxide, sp. gr. 1.345–1.370, or of potassium hydroxide, of sp. gr. 1.453–1.498, will just dissolve 0.78 gm. of cupric hydroxide per 100 c.c. The bright blue soln. does not give a precipitate when boiled directly, or when diluted. If a more dil. soln. of alkali be used to dissolve the cupric hydroxide, a soln. is obtained which is not stable when further diluted and boiled. The violet soln. obtained when cupric hydroxide is dissolved in 12*N*-NaOH, gives a brown precipitate on standing, and it dissolves when more alkali is added, forming a brown soln. E. Müller does not think the explanation is due to colloids, but is rather due to the formation of a complex: $\text{Cu}(\text{OH})_2 + 2\text{OH}' = \text{CuO}_2'' + 2\text{H}_2\text{O}$. The constant $K = \frac{[\text{CuO}_2'']}{[\text{Cu}(\text{OH})_2][\text{OH}']^2}$, and is approximately constant for 6.09 to 15.50*N*-NaOH. E. Müller noted that after the soln. has stood a long time, it deposits the black oxide. N. G. Chatterji and N. R. Dhar stated that cupric hydroxide is peptized by sodium hydroxide, and there is no evidence of chemical combination. According to E. Müller, when cupric oxide or hydroxide is shaken with conc. soln. of sodium hydroxide, the amount dissolved depends on the conc. of the alkali. The maximum solubility is reached at about 15.8*N*-sodium hydroxide and is about 0.4 mol of copper per litre in the case of the hydroxide and 0.05 mol in the case of the black oxide. On increasing the conc. of the alkali, the solubility suddenly falls in both cases to the same figure, and in 18*N*-soln. there is practically no copper in soln. In soln. of lower conc. than 15*N*, the stable solid phase is black cupric oxide, whilst with soln. of higher conc. it is **sodium cuprite**, which appears as a blue precipitate similar in appearance to cupric hydroxide, which, however, on warming the soln. in which it is produced and again allowing to cool, crystallizes. The crystals cannot be washed free from excess of alkali as they decompose into the black oxide in contact with an excess of water.

C. Arnold found that freshly precipitated cupric hydroxide is soluble in a sat. soln. of *potassium carbonate or hydrocarbonate*. The hydrate was also found by H. W. Fischer to be soluble in soln. of *sodium carbonate or hydrocarbonate*. The solubility of cupric hydroxide in alkali-lye is augmented by the presence of many organic substances—e.g. G. Städeler and W. Krause found *tartaric acid* very effective; B. Coray, *malic and citric acids*; J. Wolff and W. Weith, *salicylic acid*; E. Salkowsky, *milk and grape sugar*; F. Hofmeister, *glycerol, sarcosine, leucine, tyrosine, and glutaminic acid*; J. Löwe, *glycerol*; Kalle & Co., *albumenoids*; J. Rosenthal, *starch*; A. Vogel and C. Reischauer, *casein and soap*. A. C. Becquerel, E. P. Péligot, J. Peschier, J. L. Lassaigne, and E. Hunton studied the effect of *sugar* on the solubility in soln. of the hydroxides of the alkalies and alkaline earths. J. L. Lassaigne obtained a blue compound from a soln. containing sugar, cupric hydroxide, and potassium hydroxide. J. Rosenthal studied the effect of a *magnetic field* on the soln. containing cupric hydroxide and starch. E. Demoussy studied the compounds formed with starch and other carbohydrates. B. Moreau found cupric hydroxide soluble in a solution of *ammonium persulphate*. W. Bonsdorff

has studied the solubility of cupric hydroxide in aqua ammonia, and in soln. of the ammonium salts. He found :

Ammonia	2.540	1.965	1.280	0.973	0.870	0.540	0.391N
Grms. Cu per litre .	6.26	6.28	4.13	3.36	3.08	2.35	2.04

and A. Seyewetz and P. Trawitz found that when the soln. is boiled, nitrogen is evolved and cupric sulphate and ammonium hydrosulphate are formed. J. Tüttscheff obtained a basic salt by boiling cupric hydroxide with soln. of ammonium salts; H. von Helmholt obtained a double salt. M. Prud'homme studied the increased solubility of cupric hydroxide in alkali-lye, and in aqua ammonia in the presence of chromic salts. P. Jannasch and W. Cohen found cupric hydroxide to be soluble in hydroxylamine, and, according to A. Thum, and E. Francke, the hydroxylamine is slowly and incompletely oxidized in the cold, and the action is less energetic in the presence of potassium hydroxide. G. von Knorre and K. Arndt say some nitrous and nitric oxides are developed; F. Field, in cold soln. of sodium thiosulphate—on warming the soln. some of the solute is precipitated; H. Grossmann found cupric hydroxide is soluble in alkali cyanide, and C. F. von Reichenbach, in creasote.

Cupric hydroxide is readily soluble in acids. Carbon dioxide was found by P. N. Raikow⁵ not to act on cupric hydroxide, but some of the colloidal forms were found by E. M. Péligré to absorb carbon dioxide from the air. G. Carrara and G. B. Vespignani say that cupric hydroxide is more feebly basic than magnesium hydroxide, but stronger than the hydroxides of zinc, cadmium, iron, or aluminium. According to A. Recoura, and P. Sabatier, it forms basic double salts with the metal sulphates. L. Mailhe says the hydroxide dissolves in soln. of most of the metal salts, forming basic salts which are usually amorphous; most of these so-called basic salts are possibly solid soln. D. Tommasi found a little sodium hydroxide is formed when cupric hydroxide is treated with a soln. of sodium carbonate or sodium chloride. W. Spring and M. Lucion found that when cupric hydroxide is agitated with a soln. of potassium bromide at 25°, some potassium hydroxide, $K_2O_2 \cdot H_2O$, is formed, and that this then decomposes with the evolution of oxygen. J. M. van Bemmelen found the hydrogel does not decompose a 10 per cent. soln. of potassium bromide at 30° to 45°; and a 10 per cent. soln. of potassium iodide is slightly decomposed at 30°, and more so at 45°. A. Level found that ferrous hydroxide forms ferric and cuprous hydroxides, and E. Braun that a neutral soln. of ferrous sulphate forms a basic ferric sulphate and cuprous hydroxide as a yellowish-brown precipitate; when an excess of a hot soln. of ferrous sulphate is used, a black precipitate is obtained. Cupric hydroxide is reduced by many organic substances as indicated under the preparation of cupric oxide and hydroxide. R. Herth found that cupric hydroxide desulphurizes thiourea in ammoniacal soln., and D. M. Kennedy used it for desulphurizing crude petroleum. Hydrogen peroxide was found by T. Bayley to give a yellowish-red product—probably a peroxide, *q.v.* A. Guyard says potassium ferrocyanide precipitates cuprous ferrocyanide even from soln. in ammonium tartrate. L. de Boisbaudran says that cupric hydroxide gives a precipitate with dil. soln. of gallium salts.

REFERENCES.

- ¹ A. Lottermoser, *Ueber anorganische Colloide*, Stuttgart, 1901; T. Svedberg, *Ber.*, 39. 1714, 1906; H. Ley and F. Werner, *ib.*, 39. 2178, 1906; C. Paal, *Zeit. Koll.*, 30. 1, 1922; *Ber.*, 35. 2208, 1902; C. Paal and W. Leuze, *ib.*, 39. 1547, 1906; H. Ley, *ib.*, 39. 2201, 1906; C. Paal and H. Steyer, *ib.*, 30. 1, 1922; V. Kohlschütter and J. L. Tuscher, *Zeit. Elektrochem.*, 27. 225, 1921.
- ² C. F. Cross, *Journ. Chem. Soc.*, 35. 796, 1879; E. Rubénovitch, *Compt. Rend.*, 129. 336, 1899; P. Sabatier, *ib.*, 125. 102, 1897; A. Joannis, *ib.*, 102. 1161, 1886; E. Frémy, *Ann. Chim. Phys.*, (3), 23. 388, 1847; A. Mailhe, *ib.*, (7), 27. 393, 1902; J. L. Gay Lussac, *ib.*, (2), 37. 335, 1828; W. Spring and M. Lucion, *Zeit. anorg. Chem.*, 2. 202, 1892; F. Mawrow, *ib.*, 23. 235, 1900; E. Müller and F. Spitzer, *ib.*, 50. 322, 1906; *Zeit. Koll.*, 1. 44, 1906; F. Spitzer, *Zeit. Elektrochem.*,

11. 407, 1905; E. Harms, *Arch. Pharm.*, (2), 89. 35, 1857; H. Rose, *Pogg. Ann.*, 84. 480, 1851; M. Schaffner, *Liebigs Ann.*, 51. 168, 1844; E. Francke, *Zur Kenntnis der Oxydation des Hydrazins und Hydroxylamins*, Berlin, 1907; B. Kosmann, *Zeit. anorg. Chem.*, 3. 371, 1893.

³ J. M. van Bemmelen, *Zeit. anorg. Chem.*, 5. 468, 1894; R. Lorenz, *ib.*, 12. 438, 1896; A. Gutbier, *ib.*, 32. 355, 1902; J. Hausmann, *ib.*, 40. 120, 1904; J. Habermann and R. Ehrenfeld, *ib.*, 50. 318, 1906; W. Bonsdorff, *ib.*, 41. 134, 1904; *Beiträge zur Kenntnis der komplexen Ammoniakhydroxyde des Kupfers, Nickels, Kadmiums, Zinks, und Silbers*, Helsingfors, 1904; J. J. Berzelius, *Lehrbuch der Chemie*, Dresden, 2. i, 245, 1826; W. Spring and M. Lucion, *ib.*, 2. 195, 1892; P. Grouvelle, *Ann. Chim. Phys.*, (2), 17. 356, 1821; A. Bouzat, *ib.*, (7), 29. 373, 1903; E. M. Péligot, *ib.*, (3), 63. 347, 1861; *Compt. Rend.*, 53. 209, 1861; A. Villiers, *ib.*, 120. 324, 1895; *Bull. Soc. Chim.*, (3), 13. 323, 1895; V. Kohlschütter and J. L. Tüschler, *Zeit. anorg. Chem.*, 111. 193, 1920; N. G. Chatterji and N. R. Dhar, *Chem. News*, 121. 253, 1920; L. S. Finch, *Journ. Phys. Chem.*, 18. 26, 1914; E. Grimaux, *ib.*, (2), 42. 156, 1884; *Compt. Rend.*, 98. 1434, 1884; A. C. Becquerel, *ib.*, 34. 573, 1852; 78. 1081, 1874; 79. 82, 1874; 80. 585, 1875; G. Fassbender, *Ber.*, 13. 1822, 1880; F. Bullnheimer and E. Seitz, *ib.*, 33. 817, 1900; J. Löwe, *Dingler's Journ.*, 149. 270, 1858; R. Böttger, *Jahrb. Phys. Ver. Frankfurt*, 28, 1857; D. Lance, *German Pat.*, D.R.P. 188793, 1905; G. de Bechi, *ib.*, 100242, 1897; C. H. Jacob, *ib.*, 100425, 1898; J. M. Bell and W. C. Taber, *Journ. Phys. Chem.*, 11. 634, 1907; J. L. Proust, *Journ. Phys.*, 59. 399, 1804; C. Millberg, *Chem. Ztg.*, 30. 512, 1906; A. Krefling, *Chem. Ind.*, 31. 509, 1898; K. Elbs, *Zeit. angew. Chem.*, 17. 291, 1903; E. Julius, *Neder. Tijdschr. Pharm.*, 209, 1892; E. Francke, *Zur Kenntnis der Oxydation des Hydrazins und Hydroxylamins*, Berlin, 1907; T. Graham, *Phil. Trans.*, 151. 183, 1861; B. Szilard, *Journ. Phys. Chem.*, 5. 636, 1907; R. Ludwig, *Brandes Archiv*, 82. 157, 1855; A. Oglialoro, *Gazz. Chim. Ital.*, 6. 324, 1876.

⁴ C. L. Berthollet, *Essai de statique chimique*, Paris, 467, 1803; J. L. Proust, *Journ. Phys.*, 59. 395, 1804; *Ann. Chim. Phys.*, (2), 32. 41, 1826; A. Bouzat, *ib.*, (7), 29. 373, 1903; A. C. Becquerel, (2), 47. 7, 1831; E. M. Péligot, *ib.*, (3), 54. 377, 1858; *Compt. Rend.*, 32. 333, 1851; E. Harms, *Arch. Pharm.*, (2), 89. 35, 1857; M. Schaffner, *Liebigs Ann.*, 51. 168, 1844; W. Spring and M. Lucion, *Zeit. anorg. Chem.*, 2. 195, 1892; J. M. van Bemmelen, *ib.*, 5. 468, 1894; B. Kosmann, *ib.*, 3. 371, 1893; E. Müller, *ib.*, 54. 418, 1907; H. W. Fischer, *ib.*, 40. 40, 1901; H. von Helmolt, *ib.*, 3. 116, 1893; W. Bonsdorff, *ib.*, 41. 182, 1904; H. Grossmann, *ib.*, 58. 269, 1908; G. Tammann, *Zeit. phys. Chem.*, 6. 237, 1890; A. Guyard, *Bull. Soc. Chim.*, (2), 31. 436, 1879; M. Prud'homme, *ib.*, (2), 17. 253, 1872; D. Tommasi, *ib.*, (2), 37. 197, 1882; *Compt. Rend.*, 99. 37, 1884; F. Field, *Journ. Chem. Soc.*, 16. 28, 1863; B. Moreau, *Apot. Ztg.*, 16. 383, 1901; A. Thum, *Monatsh.*, 14. 294, 1893; E. Francke, *Zur Kenntnis der Oxydation des Hydrazins und Hydroxylamins*, Berlin, 1907; G. von Knorre and K. Arndt, *Ber.*, 33. 30, 1900; A. Seyewetz and P. Travitz, *Bull. Soc. Chim.*, (3), 29. 875, 1903; *Compt. Rend.*, 137. 130, 1903; E. Demoussy, *ib.*, 192. 933, 1906; C. Arnold, *Ber.*, 38. 1175, 1905; B. Coray, *Ueber die quantitativen Verhältnisse der Verhinderung der Fällung des Kupferoxyd durch die Gegenwart einiger organischer Körper*, Zurich, 1868; C. Ochsenius, *Zeit. anal. Chem.*, 16. 853, 1877; J. Löwe, *ib.*, 9. 20, 1870; A. Chlodneff, *Journ. prakt. Chem.*, (1), 28. 217, 1843; (1), 38. 217, 1846; E. Hunton, *ib.*, (1), 11. 409, 1837; P. Jannasch and W. Cohen, *ib.*, (2), 72. 14, 1905; H. G. F. Schröder, *Dichtigkeitsmessungen*, Heidelberg, 1873; G. Städeler and W. Krause, *Journ. Pharm.*, 28. 483, 1855; J. L. Lassaigne, *Journ. Chim. Méd.*, 18. 820, 1844; W. Weith, *Ber.*, 9. 342, 1896; E. Salzkowsky, *Pflüger's Archiv*, 6. 221, 1872; F. Hofmeister, *Liebigs Ann.*, 189. 20, 1877; J. Tüttscheff, *Zeit. Chem.*, (2), 6. 109, 1870; Kalle & Co., *German Pat.*, D.R.P. 171936, 171937, 172725, 1901; C. F. von Reichenbach, *Schweigger's Journ.*, 68. 352, 1833; G. Carrara and G. E. Vespignani, *Gazz. Chim. Ital.*, 30. ii. 35, 1900; J. Peschier, *Journ. Pharm. Chim.*, 3. 510, 1820; H. E. Schenck, *Journ. Phys. Chem.*, 23. 283, 1919; J. Wolff, *Ann. Chim. Anal. App.*, 5. 445, 1900; J. Rosenthal, *Sitzber. Akad. Berlin*, 20, 1908; A. Vogel and C. Reischauer, *Repert. Pharm.*, (2), 8. 529, 1860; E. J. Müller, *Compt. Rend.*, 167. 779, 1918; E. Müller, *Zeit. angew. Chem.*, 33. 303, 1920; 34. 371, 1921; N. G. Chatterji and N. R. Dhar, *Chem. News*, 121. 253, 1920; E. Frémy, *Ann. Chim. Phys.*, (3), 23. 288, 1848.

⁵ A. Recoura, *Compt. Rend.*, 132. 1414, 1901; P. Sabatier, *ib.*, 125. 175, 1897; 129. 211, 1899; L. Mailhe, *ib.*, 133. 226, 1901; 134. 42, 233, 1902; D. Tommasi, *ib.*, 92. 453, 1881; L. de Boisbaudran, *Compt. Rend.*, 94. 1154, 1882; A. Colson, *ib.*, 139. 857, 1904; L. Mailhe, *Ann. Chim. Phys.*, (7), 27. 393, 1902; A. Levol, *ib.*, (2), 65. 320, 1837; E. M. Péligot, *ib.*, (3), 54. 377, 1858; P. N. Raikow, *Chem. Ztg.*, 31. 55, 1907; W. Spring and M. Lucion, *Zeit. anorg. Chem.*, 2. 218, 1892; J. M. van Bemmelen, *ib.*, 23. 372, 1900; E. Braun, *Vierteljahr. nat. Ges. Zurich*, 63, 1866; R. Herth, *Sitzber. Akad. Wien*, 80. 1078, 1880; T. Bayley, *Phil. Mag.*, (5), 7. 126, 1879; D. M. Kennedy, *German Pat.*, D.R.P. 43145, 1887; A. Guyard, *Bull. Soc. Chim.*, (2), 31. 436, 1879; G. Carrara and G. E. Vespignani, *Gazz. Chim. Ital.*, 30. ii. 35, 1900.

§ 12. Higher Copper Oxides

Anhydrous copper dioxide, CuO_2 , is not known, but L. J. Thénard¹ prepared what is regarded as monohydrated copper dioxide, $\text{CuO}_2 \cdot \text{H}_2\text{O}$, by shaking cupric hydroxide with an excess of a very dil. alkaline soln. of hydrogen

peroxide at 0°, washing the product with cold water, and drying it in vacuo by press. between filter paper. G. Krüss worked with conc. hydrogen peroxide at 6°; and W. Schmid believed that a trace of a ferrous salt is necessary for the oxidation, but G. Krüss showed that the ferrous hydroxide or salt accelerates the oxidation, which proceeds in its absence if the cupric hydroxide be finely divided. T. B. Osborne noted that when a small proportion of hydrogen peroxide is used, the blue hydrogel becomes green, and, with increasing proportions of hydrogen peroxide, the green colour changes to yellowish-green, yellow, and brown. The proportions CuO : O in the differently coloured products are :

	Grass-green.	Yellowish-green.	Yellow (green tinge).	Yellow.	Yellowish-brown.	Brown (yellow tinge).	Brown.
CuO : O	12·2 to 12·7 : 1	7·5 : 1	5·14 : 1	3·1 : 1	1·66 : 1	1·48 : 1	1·2 : 1

The products indicated on the left of this table are presumably mixtures of reddish-brown $\text{CuO}_2 \cdot \text{H}_2\text{O}$ with blue hydroxide $\text{Cu}(\text{OH})_2$. L. Moser prepared the hydrated dioxide by the action of hydrogen peroxide in neutral soln., and washing the product many times by decantation with ice-cold water until the washings were free from hydrogen peroxide by the titanium sulphate test; the product was then washed with alcohol, then with ether, and dried in vacuo. The last traces of ether were retained very tenaciously. C. Weltzien prepared the same compound by adding hydrogen peroxide to a soln. of cupric tetrammino-sulphate; L. J. Thénard, cupric nitrate; and A. Gawalowsky, basic cupric sulphate. D. Vitali obtained a brownish-black precipitate by adding bromine to a soln. of a cupric salt. A. Piccini adds that a true peroxide cannot be obtained by the action of chlorine or bromine on alkaline soln. of cupric salts, and L. Moser found that oxygen is developed during the reaction and the washed product had $\text{CuO} : \text{O} = 73 : 1$; and with cupric hydroxide suspended in water, gave a product with $\text{CuO} : \text{O} = 64$ to 95 : 1. Hence he added that probably a higher oxide is formed as a primary product which rapidly decomposes.

W. Schmid obtained a similar product by shaking cupric sulphate with recently precipitated manganese hydrated dioxide, or lead dioxide, but L. Moser says manganese or lead peroxide forms no copper dioxide under these conditions; nor could L. Moser make the dioxide by the action of chlorine or bromine in alkaline soln., although there is evidence of the formation of an unstable dioxide; ozone was found to have no action on cupric salts; and persulphates in alkaline soln. did not oxidize cupric hydroxide (*vide infra*). B. C. Brodie obtained a higher peroxide by adding sodium peroxide to an excess of a cupric salt soln., but L. Moser found the cupric dioxide could not be isolated because of its rapid catalytic decomposition in alkaline soln. G. Krüss considers that B. C. Brodie's product was a mixture of cupric hydroxide and dioxide, and he obtained the hydrated dioxide by the action of octohydrated sodium peroxide on $\frac{1}{2}N\text{-CuSO}_4$ soln. cooled by ice-water. L. Moser obtained copper dioxide by the action of ozone on cupric hydroxide in the presence of soda-lye—the product decomposed immediately into oxygen and cupric oxide. E. Bamberger suggested the brownish-black precipitate obtained by adding alkali to a soln. of cupric sulphate, in the presence of Caro's reagent, is a hydrate of cupric dioxide.

Analyses by L. J. Thénard, G. Krüss, C. Weltzien and L. Swiontkowsky indicate that the brown or brownish-black microcrystalline mass has in the limiting case a composition corresponding with $\text{CuO}_2 \cdot \text{H}_2\text{O}$; G. Krüss represents the formula graphically : $\text{HO} \cdot \text{Cu} \cdot \text{O} \cdot \text{OH}$. The green or greenish-brown products are probably mixtures of cupric hydroxide with hydrated cupric dioxide. The product obtained by the action of hydrogen peroxide on cupric hydroxide always shows a deficiency of peroxidic oxygen which is due either to the instability of the cupric peroxide or to the inclusion of cupric hydroxide. Either no precipitation occurs when soln. of cupric salts, alkaline soln., or ammoniacal soln. are treated, or else the precipitate is rapidly decomposed. J. Aldridge and M. P. Applebey found that when a soln. of

sodium cupric carbonate, in a sat. soln. of sodium carbonate or hydrocarbonate, is treated with hydrogen peroxide, a yellowish-brown peroxide is immediately formed and most of the copper is removed from the soln. The product contains more oxygen than corresponds with copper sesquioxide, but never reaches that required for copper dioxide. This is due to the decomposition of the dioxide in the presence of the alkaline soln.

The product has no taste, and is without action on litmus; when dry, it is fairly stable, but less stable when moist—L. J. Thénard's sample was completely decomposed after keeping 12 hrs. at ordinary temperatures; boiling water decomposed it immediately. The decomposition is accelerated by the presence of conc. alkali-lye. The dioxide was found by L. J. Thénard to be decomposed below 100° into oxygen and cupric oxide; G. Krüss found that the samples he prepared did not change colour at 170° in 10 hrs., but at 180° decomposed to cupric oxide; L. Moser found that specimens with a trace of ether may decompose explosively when heated. The compound is insoluble in water; readily soluble in dil. acids, forming cupric salts and hydrogen peroxide, and the evolution of a little oxygen. With conc. hydrochloric acid oxygen and chlorine are given off; and with dil. hydrochloric acid, in the presence of copper, gold, or mercury, C. Weltzien obtained very little oxygen, but there was formed respectively cupric, auric, or mercurous chloride. L. Moser found that with finely-divided platinum oxygen is evolved; a soln. of potassium permanganate is decolorized; and it acts catalytically on a neutral or alkaline soln. of hydrogen peroxide. L. Moser concluded that the chemical behaviour of cupric dioxide resembles that of a true peroxide, although it may be readily a compound of cupric hydroxide and hydrogen peroxide.

Copper sesquioxide, or cupric anhydride, Cu_2O_3 .—This compound is not known in the free state. M. Krüger noticed that when chlorine is passed into alkali-lye in which cupric hydroxide is suspended, gas is evolved, and the soln. reddens owing to the formation of a higher oxide of copper. Such an oxide, however, has not been isolated from these products. E. Müller and F. Spitzer,² L. Moser, and F. Mawrow, working at low temp., succeeded in separating cupric hydroxide from the red soln. A trace of active oxygen was present, and this L. Moser regarded as a sign that the primarily formed dioxide has been almost completely decomposed. J. Aldridge and M. P. Applebey said that the pink colour is produced by the formation of permanganates by traces of manganese present as impurity in the soln. By treating cupric hydroxide with potassium hypochlorite, E. Frémy noted the formation of a brown soln. which, on dilution, gave off oxygen and deposited cupric oxide. E. Müller also obtained the same product by the action of alkali hypochlorites or hypobromites on cupric hydroxide; during the reaction the colour changes from sky-blue to a greyish-blue, a brownish-blue, and a bluish-black; if the soln. is very strongly alkaline, the colour becomes carmine red, violet, and finally brownish-black. W. Crum, and also M. Krüger, treated cupric nitrate with bleaching powder. The oxygen evolved by the product corresponded with that required by the equation: $2\text{Cu}_2\text{O}_3 = 4\text{CuO} + \text{O}_2$. The carmine-red precipitate which gradually becomes rose-coloured is assumed by W. Crum to be **calcium cuprate**, CaCu_2O_4 , the calcium salt of **cupric acid**, $\text{H}_2\text{Cu}_2\text{O}_4$, which has the constitutional formula, HO.Cu.O.Cu.O.OH . The evidence available is not sufficient to establish the formula with any degree of certainty. M. Krüger prepared **barium cuprate**, BaCu_2O_4 , in a similar manner; and T. B. Osborne made some observations on the cuprates of the alkaline earths. J. Aldridge and M. P. Applebey said that the compounds with the alkaline earths are chemical individuals, and not, like M. Krüger's alkali compounds, mixtures with impurities.

The rose-red coloured liquid obtained by E. Frémy during the dissolution of brass (low in zinc) in nitric acid is supposed to contain a higher oxide of copper. G. Krüss dissolved cupric oxide in molten potassium hydroxide; when the mass is dissolved in water at 18° , a blue liquid is obtained which deposits a mixture of what is thought to be cupric oxide and a yellow higher oxide. The liquid is

stable on boiling, but is decolorized by shaking it with the oxides of copper or lead, but not zinc or mercury oxide; soln. of salts of the alkaline earths, magnesium, aluminium, chromium, iron, cobalt, or nickel. G. Krüss obtained a similar product as a yellow precipitate by working at 0°. The same product was obtained by using alkali chlorides in place of the alkali hydroxide. G. N. Antonoff and B. V. Malysheff found that when copper or copper oxide is dissolved in melted potassium hydroxide above 360°, the resulting cake, when dissolved in water and neutralized, decolorizes permanganate solution. The soln., however, gives no reaction for peroxides, and continues to decolorize permanganate when a current of hydrogen is passed through it. This decolorizing action is due to the presence of cuprous oxide, Cu_2O , formed by the dissociation of cupric oxide above 360°.

When potassium or hydrogen peroxide is added to the soln. of copper oxide in potash, a red colour is first produced which vanishes quickly; then a yellow precipitate separates, which also redissolves, quickly reproducing the original blue soln., which now contains no trace of either peroxide or cuprous oxide. The yellow precipitate is **copper dioxide**, $\text{CuO}_2 \cdot \text{H}_2\text{O}$, or $\text{CuO} \cdot \text{H}_2\text{O}_2$, its production being a first stage in the decomposition of the peroxide by copper oxide. This reaction is vigorous only in alkaline soln. Commercial potash contains some peroxide, and whilst, when acting on iron, the latter is converted into ferrous oxide, at the expense probably of the water present in the potash, the action on copper and also on silver is due to the presence of these peroxides.

Contrary to the statement of L. Moser (*vide supra*), G. Scagliarini and G. Torelli found that the action of potassium persulphate on cupric hydroxide in presence of barium hydroxide at temp. obtained by cooling with ice and salt results in various changes in the colour of the soln. and in the deposition of a tenuous amaranth-red precipitate, which may be purified by repeated washing with ice-water by decantation. The compound thus obtained yields oxygen when treated with sulphuric acid, and the amount of oxygen is in agreement with the formula Cu_2O_3 ; it oxidizes hydrochloric acid with liberation of chlorine, oxidizes ammonia in the cold with production of nitrogen, nitrous acid, and traces of nitric acid, decolorizes permanganate, and decomposes potassium iodide with liberation of iodine in quantity greater than that corresponding with the proportion of copper present. Since it does not yield hydrogen peroxide when treated with dil. acid, the compound lacks the grouping characteristic of peroxides, and is thus different from the orange-yellow copper peroxide obtained by means of hydrogen peroxide.

B. Brauner and B. Kuzma obtained an intense red coloration by the oxidation of a soln. containing copper and tellurium with potassium persulphate—if an excess is used the colour is destroyed. The coloration is attributed to the formation of a derivative of *tellurocupric acid*. By processes of hydrolysis, unstable dark red precipitates of *potassium tellurocuprates*, $2\text{K}_2\text{O} \cdot \text{Cu}_2\text{O}_3 \cdot 3\text{TeO}_3 \cdot n\text{H}_2\text{O}$, and $2\text{K}_2\text{O} \cdot \text{CuO} \cdot \text{Cu}_2\text{O}_3 \cdot 3\text{TeO}_3 \cdot n\text{H}_2\text{O}$. The last-named product has also been obtained by the electrolytic oxidation of telluric acid in an alkaline soln., with a copper anode. *Silver telluroargentate* has also been obtained, $\text{Ag}_2\text{O} \cdot 5\text{Ag}_2\text{O}_3 \cdot 9\text{TeO}_3$

L. Moser thinks that cupric sesquioxide is possibly an intermediate product in the slow decomposition of copper dioxide; and J. Meyer obtained indications of the formation of a higher oxide by shaking ammoniacal cupric sulphate with water and air. The product obtained by A. V. Brochet by heating a conc. soln. of cupric chlorate with copper turnings is thought to be the sesquioxide. According to E. Müller and F. Spitzer, an orange-yellow to red coloured film is obtained by electrolyzing with a copper anode and a platinum cathode in a porous cell, a soln. 12 to 14*N*- NaOH , cooled by a freezing mixture, and with a current density less than 0.1 amp. per sq. cm. The product is stable at a low temp. under the soda-lye, but it gives off oxygen and becomes white when warmed; it oxidizes hydrochloric acid, forming chlorine; converts nitrites to nitrates; and oxidizes alcohol to aldehyde. A. C. Becquerel, and F. Schmiedt have also studied the formation of the higher copper oxides during the electrolysis of alkali-lye.

REFERENCES.

- ¹ L. J. Thénard, *Ann. Chim. Phys.*, (2), 9. 51, 1818; G. Krüss, *Ber.*, 17. 2594, 1884; P. Jannasch, *ib.*, 24. 3947, 1891; 26. 2329, 1893; B. Brauner and B. Kuzma, *ib.*, 40. 3370, 1907; E. Bamberger, *ib.*, 33. 1959, 1900; W. Schmid, *Journ. prakt. Chem.*, (1), 98. 136, 1866; C. Weltzien, *ib.*, 140. 207, 1866; E. Schaer, *ib.*, 323. 48, 1902; T. B. Osborne, *Amer. Journ. Science*, (3), 32. 334, 1886; L. Moser, *Zeit. anorg. Chem.*, 54. 127, 1907; A. Piccini, *ib.*, 12. 169, 1896; D. Vitali, *Boll. Chim. Farm.*, 38. 665, 1899; B. C. Brodie, *Proc. Roy. Soc.*, 12. 210, 1862; A. Gawalowsky, *Rundsch.*, 4. 79, 1890; L. Swiontkowsky, *Liebig's Ann.*, 141. 205, 1867; E. Müller, *Zeit. anorg. Chem.*, 54. 418, 1917; J. Aldridge and M. P. Applebey, *Journ. Chem. Soc.*, 121. 238, 1922.
- ² E. Müller and F. Spitzer, *Zeit. Elektrochem.*, 13. 25, 1907; E. Müller, *ib.*, 13. 133, 1907; *Zeit. anorg. Chem.*, 54. 417, 1907; F. Mawrow, *ib.*, 23. 233, 1900; L. Moser, *ib.*, 54. 121, 1907; B. Brauner and B. Kuzma, *Ber.*, 40. 3362, 1907; E. Frémy, *Ann. Chim. Phys.*, (3), 12. 457, 1844; M. Krüger, *Pogg. Ann.*, 62. 447, 1844; W. Crum, *Liebig's Ann.*, 55. 213, 1845; *Mem. Chem. Soc.*, 2. 387, 1845; *Phil. Mag.*, (3), 27. 294, 1845; *Proc. Phil. Soc. Glasgow*, 2. 68, 1848; J. Meyer, *Ber.*, 35. 3956, 1902; G. Krüss, *ib.*, 17. 2597, 1884; G. N. Antonoff and B. V. Malysheff, *Journ. Russ. Phys. Chem. Soc.*, 38. 884, 1906; A. V. Brochet, *Bull. Soc. Chim.*, (3), 29. 156, 1903; *Compt. Rend.*, 136. 155, 1903; *Zeit. Elektrochem.*, 9. 160, 1903; F. Schmiedt, *ib.*, 15. 53, 1908; A. C. Becquerel, *Compt. Rend.*, 71. 197, 1870; G. Scagliarini and G. Torelli, *Gazz. Chim. Ital.*, 51. ii, 225, 1921; T. B. Osborne, *Amer. Journ. Science*, (3), 32. 334, 1886; J. Müller, *Compt. Rend.*, 167. 779, 1918; J. Aldridge and M. P. Applebey, *Journ. Chem. Soc.*, 121. 238, 1922.

§ 13. Cupric Ammino-oxides

L. Maumené¹ says that it is very doubtful if a definite compound of ammonia and cupric oxide has been prepared, although R. Kane claimed that when aqua ammonia, not in excess, is added to a soln. of cupric chloride, a blue precipitate resembling hydrated cupric oxide is obtained. This precipitate is said to be easy to wash, and not to lose ammonia on drying; it undergoes no change at 149°, but at a somewhat higher temp., it decomposes with a slight hissing noise, yielding nitrogen, ammonia, water, and a red mixture of copper and cuprous oxide. No chlorine appeared in the analysis which agreed with the formula: $3\text{CuO} \cdot 4\text{NH}_3 \cdot 6\text{H}_2\text{O}$, that is, hexahydrated tricupric tetrammino-oxide. From their study of the soln. obtained by digesting freshly precipitated cupric hydroxide in aq. ammonia, H. M. Dawson and J. McCrae believe that a dissociating compound, cupric diammino-oxide, $\text{CuO} \cdot 2\text{NH}_3$, or cupric diammino-hydroxide, $\text{Cu}(\text{OH})_2 \cdot 2\text{NH}_3$, is formed, which ionizes, forming $\text{Cu}(\text{NH}_3)_2^{++}$ and OH^- ions, i.e. $\text{Cu}(\text{OH})_2 + 2\text{NH}_3 \rightleftharpoons \text{Cu}(\text{NH}_3)_2^{++} + (\text{OH})_2^{--}$. The work of W. Bonsdorff on the electrical conductivity of soln. of cupric hydroxide in aq. ammonia points in the same direction when only a small excess of ammonia is present; but with a large excess of ammonia, the complex is probably $\text{Cu}(\text{OH})_2 \cdot 4\text{NH}_3$, cupric tetrammino-hydroxide. F. J. Malaguti and M. Sarzeau claim to have obtained large azure-blue deliquescent needles of tetrahydrated cupric tetrammino-oxide, $\text{CuO} \cdot 4\text{NH}_3 \cdot 4\text{H}_2\text{O}$, by cooling the mother liquid obtained in the preparation of cupric ammino-chromate. The crystals are said to be decomposed by water, and by exposure to air; and when heated, to give off water and ammonia, and leave a residue of copper.

From his study of the heat of neutralization, W. Bonsdorff estimates cupric ammino-oxide to be a stronger base than either of its components, and to be weaker than silver or cadmium oxides, but stronger than zinc oxide. A. Bouzat found that it displaces ammonia from its salts, it precipitates calcium oxide, and enters into competition with potassium hydroxide for the acids. For the heat of formation in soln. containing two mols. of ammonia per litre, CuO (precipitated) + 28NH_3 (in soln.) = $\text{CuO} \cdot 28\text{NH}_3$ (in 14 litres of soln.) + 4.3 Cals.; and the heat of neutralization of $\text{CuO} \cdot 28\text{NH}_3$ in 14 litres of soln. with two mols. of acid in 4 litres, is 35.5 Cals. for sulphuric acid; 32.1 Cals. for hydrochloric acid; 31.8 Cals. for nitric acid; and 30.0 Cals. for acetic acid. Variations in the conc. of the ammonia or of the soln. have very little influence on the heat of neutralization.

An azure-blue soln. of cupric amino-oxide is formed by exposing the soln. of cuprous amino-oxide to air, the colourless soln. then becomes blue as recorded by T. O. Bergman² in the eighteenth century. The same soln. was made by E. M. Péligot, E. Schweizer, and others by exposing copper filings to the action of aq. ammonia and air. J. J. M. A. Vermeesch has described a continuous process. An ammoniacal soln. of cupric oxide is often called *Schweizer's reagent*, or *Schweizer's liquid*; a soln. of copper hydroxide in alkali-lye has many similar properties which were studied by W. Traube. According to C. F. Schönbein, some ammonium nitrite, and, according to F. J. Malaguti and M. Sarzeau, some ammonium nitrate is always formed at the same time; while M. Berthelot noted that oxygen is absorbed by the soln. Several patents have been obtained for the process—*e.g.* Société Anonyme de Bruxelles, E. Bronnert, M. Fremery, and J. Urban, C. L. and A. Schäffer, etc. The same soln. is obtained by treating cupric oxide or hydroxide with aq. ammonia. J. J. Berzelius says that if all acids, even carbonic acid, be excluded, the aq. ammonia dissolves scarcely a trace of the anhydrous oxide, but if a drop of a soln. of an ammonium salt be present, cupric oxide is copiously dissolved. E. Schweizer found the soln. is promoted by adding some ammonium chloride to the aq. ammonia, and H. Kopp found that platonic chloride acts in the same way. The liquid no doubt contains one or more cupric amino-oxides. W. Bonsdorff's investigation on the electrical conductivity agrees with the assumption that the liquid contains a complex with ammonia and copper in the molecular proportion 4:1, and A. Hantzsch and P. W. Robertson's investigation with the spectral photometer likewise indicates that the non-isolated base has the composition $[\text{Cu}(\text{NH}_3)_4](\text{OH})_2$. M. Prud'homme obtained the blue liquid by treating copper with ammonium nitrate in the presence of aq. ammonia; and H. M. Dawson and J. McCrae by using cupric oxide or nitrite with aq. ammonia and air, and they add that ordinary cupric oxide appears to be dissolved more easily than the oxide obtained by precipitation. W. Bonsdorff found that cupric hydroxide which has been dried dissolves less readily than the fresh and moist hydroxide. A. Froment patented the use of aq. ammonia sat. with nitrogen, which it is claimed dissolves cupric oxide more quickly than when free nitrogen is absent. A. Leccœur, and E. Grimaux recommend removing the nitrites and other crystallizable compounds from the soln. by dialysis. W. Bonsdorff recommends removing the excess of ammonia by keeping the soln. in vacuo over conc. sulphuric acid—hydrogen and air freed from carbon dioxide act too slowly, nor is there any advantage in shaking out with chloroform.

E. Grimaux says the soln. is colloidal, and A. Leccœur adds that if only colloids are present, as is the case when the product has been dialyzed, the liquid does not change at ordinary temp. According to A. Bouzat, the blue liquid gradually changes on exposure to air into cupric nitrite and carbonate. H. M. Dawson and J. McCrae say that a 0.08*N*-soln. containing the molecular proportion $\text{CuO}:\text{NH}_3=1:7$, gradually deposits cupric hydroxide. When E. Schweizer's liquid is diluted with a large proportion of *water*, cupric hydroxide is deposited; a soln. of *potassium hydroxide* likewise precipitates the same compound, and more is needed for the precipitation the greater the excess of ammonia in Schweizer's liquid. According to A. Bouzat, the potassium and ammonium hydroxides attain a state of equilibrium in competing for the complex acidic radicle; on boiling the liquid with potassium hydroxide, black cupric oxide is precipitated. Almost all the copper was found by A. Vogel to be precipitated as reddish-brown cuprous oxide by treating Schweizer's liquid with *sulphur dioxide*. According to N. W. Fischer, *phosphorus* decolorizes the blue soln., forming metallic copper, along with a compound of ammonia and cuprous oxide, and, according to A. Oppenheim, a little copper phosphide. *Zinc* and *cobalt* precipitate the copper; *iron* precipitates the copper imperfectly; *arsenic*, *tin*, and *cadmium* precipitate very little copper; and *lead* precipitates mere traces of copper. G. Wetzlar says iron exerts no action on the pure soln., but there is a slow precipitation of copper if

ammonium or sodium chloride, or potassium nitrate or sulphate, be present. A large excess of ammonia prevents the precipitation. According to M. Prud'homme, *indigo* soln. are bleached by Schweizer's liquid. G. Rosset found it to be decolorized when used as depolarizer in a galvanic cell, and to be reoxidized by exposure to air. When electrolyzed it also gives metallic copper. C. R. A. Wright and C. Thompson found that if a copper plate be dipped in the ammoniacal soln., and connected electrically with a platinum plate, a current of from 0.5 to 0.6 volt is obtained; the voltage is higher if spongy platinum be used, and also higher the greater the conc. of the ammonia. W. Traube and A. Biltz found that ammonium nitrite is formed during electrolysis. C. E. Guignet found that *sugar* soln. do not precipitate the copper and that starch and inuline abstract cupric oxide from the soln.

E. Schweizer showed that unlike *eau céleste*—a soln. of cupric sulphate in an excess of ammonia—the liquid dissolves cellulose at ordinary temp. without the development of heat. The action has been studied by E. M. Péligot, C. Cramer, O. L. Erdmann, M. Payen, A. Haller, W. Minajeff, E. Frémy, J. Schlossberger, W. Massot, H. Baubigny, E. Grandmougin, etc.; and it has been the subject of numerous patents—by J. P. Bemberg, H. Pauly, E. Krusche, etc. The addition of acids, sugar, or gum re-precipitate the cellulose. E. Winterstein found that E. Schweizer's liquid dissolves animal cellulose—*e.g.* tunicine; G. Büttner and J. Neuman, C. G. Schwalbe, that it dissolves hydrocellulose—but E. Bronnert said not so; W. von Bongé that it dissolves nitrocellulose; C. Cramer, inuline and gum arabic; O. Popp, inuloid; and A. Helbronner and E. A. Vallée, osseine. J. Schlossberger said that it does not dissolve gun-cotton; E. Frémy, nor paracellulose, vasculose, fibrine, and cutine; F. A. Flückiger and O. Obermeier, nor Irish moss; W. Meigen and A. Spreng, nor yeast-cellulose. E. Thiele obtained soln. of cupric oxide in alkylamines—*e.g.* methylamine—which dissolved cellulose.

REFERENCES.

- ¹ L. Maumené, *Compt. Rend.*, 95. 224, 1882; A. Bouzat, *ib.*, 134. 1310, 1892; *Ann. Chim. Phys.*, (7), 29. 358, 1903; R. Kane, *ib.*, (2), 72. 283, 1839; F. J. Malaguti and M. Sarzeau, *ib.*, (3), 9. 438, 1843; H. M. Dawson and J. McCrae, *Journ. Chem. Soc.*, 77. 1257, 1900; W. Bonsdorff, *Zeit. anorg. Chem.*, 41. 184, 1904; F. F. Selivanoff, *Journ. Russian Phys. Chem. Soc.*, 34. 13, 1902.
- ² T. O. Bergman, *Opuscula physica et chemica*, Holmia, 3. 389, 1790; E. M. Péligot, *Compt. Rend.*, 47. 344, 1857; M. Payen, *ib.*, 48. 772, 1859; E. Frémy, *ib.*, 48. 202, 275, 1859; H. Baubigny, *ib.*, 104. 1617, 1887; C. E. Guignet, *ib.*, 109. 528, 1889; E. J. Maumène, *ib.*, 95. 224, 1882; E. Schweizer, *Journ. prakt. Chem.*, (1), 72. 109, 1857; O. L. Erdmann, *ib.*, (1), 76. 385, 1859; C. Cramer, *ib.*, (1), 73. 1, 1858; J. Schlossberger, *ib.*, (1), 73. 369, 1858; *Liebig's Ann.*, 107. 24, 1858; 108. 62, 1858; O. Popp, *ib.*, 156. 190, 1870; C. F. Schönbein, *Sitzber. Akad. Berlin*, 580, 1856; W. Traube and A. Biltz, *Ber.*, 37. 3130, 1904; E. Müller and F. Spitzler, *ib.*, 38. 778, 1905; W. Traube, *ib.*, 38. 824, 1905; J. J. M. A. Vermeesch, *U.S. Pat. No.* 850693, 1907; C. L. and A. Schäffer, *ib.*, 884298, 1907; Société Anonyme de Bruxelles, *German Pat.*, D.R.P. 186880, 1905; E. Bronnert, M. Fremery, and J. Urban, *ib.*, 115980, 1900; A. Froment, *ib.*, 139714, 1900; E. Bronnert, *ib.*, 109996, 1899; A. Helbronner and E. A. Vallée, *ib.*, 197250, 1905; J. P. Bemberg, *ib.*, 162866, 1900; 174508, 1905; H. Pauly, *ib.*, 98642, 1897; E. Krusche, *ib.*, 106043, 1898; A. Lecœur, *ib.*, 1858294, 1906; R. Böttger, *Repert. Pharm.*, 23. 732, 1874; G. C. Wittstein, *ib.*, 57. 32, 1836; F. A. Flückiger and O. Obermeier, *Pharm. Vierteljahr.*, 17. 519, 1869; F. J. Malaguti and M. Sarzeau, *Ann. Chim. Phys.*, (3), 9. 441, 1818; M. Berthelot and L. P. de St. Giles, *ib.*, (4), 1. 381, 1864; H. M. Dawson and J. McCrae, *Journ. Chem. Soc.*, 77. 1257, 1900; M. Berthelot, *Bull. Soc. Chim.*, (2), 13. 314, 1870; G. Rosset, *ib.*, (3), 25. 541, 1901; E. Grimaux, *ib.*, (2), 42. 156, 1884; *Compt. Rend.*, 98. 1434, 1884; M. Prud'homme, *Monit. Scient.*, (4), 5. 681, 1891; A. Oppenheim, *Ber.*, 5. 979, 1872; A. Hantzsch and P. W. Robertson, *ib.*, 41. 4332, 1908; A. Haller, *Zeit. Farbenind.*, 7. 1. 1908; E. Thiele, *Leipz. Färbertg.*, 56. 56, 1907; H. Kopp, *Chem. Centr.*, 463, 1859; C. R. A. Wright and C. Thompson, *Chem. News*, 55. 167, 1887; W. Minajeff, *Proc. Assoc. Adv. Ind. Moscow*, 10. 114, 1906; H. B. Gibson, *La Cellule*, 9. 397, 1893; E. Grandmougin, *Chem. Ztg.*, 32. 241, 1891; E. Winterstein, *Zeit. physiol. Chem.*, 18. 63, 1893; W. Meigen and A. Spreng, *ib.*, 55. 48, 1908; W. von Bongé, *Ueber die Einwirkung wasserfreier Salpeter- und Schwefel-säure auf Cellulose, nebst einigen Beobachtungen über das Schweizerische Reagens*, Leipzig, 1904; B. Rassow and W. von Bongé, *Zeit. angew. Chem.*, 21. 733, 1908; W. Massot, *ib.*, 21. 344, 1908; C. G. Schwalbe, *ib.*, 20. 2171, 1907; G. Büttner and J. Neuman, *ib.*, 21. 2609, 1908; N. W. Fischer, *Pogg. Ann.*, 8. 492, 1826; G. Wetzlar, *Schweigger's Journ.*, 50. 101, 1827; A. Vogel, *Kastner's Arch.*, 23. 85, 1832; W. Traube, *Ber.*, 54. 3220, 1921; A. Bouzat, *Compt. Rend.*, 134. 1310, 1502, 1902; *Ann. Chim. Phys.*, (7), 29. 358, 1903.

§ 14. Copper Fluorides

According to H. Moissan,¹ fluorine gas acts on copper at a dark red heat forming white clouds of cupric fluoride, but anhydrous hydrofluoric acid, according to C. Poulenc, has scarcely any action on the metal. There are two definite fluorides—cuprous fluoride, CuF , and cupric fluoride, CuF_2 .

Cuprous fluoride, CuF .—J. J. Berzelius (1824)² prepared a compound which he regarded as cuprous fluoride by the action of an excess of aq. hydrofluoric acid on cuprous hydroxide; the very sparingly soluble salt was rapidly washed with alcohol, pressed, and dried. C. Poulenc (1892), and F. Mauro (1892) were unable to make cuprous fluoride by this process, for they obtained metallic copper and a soln. of cupric fluoride which does not reduce potassium permanganate; they therefore consider that J. J. Berzelius' product was nothing but cupric fluoride and the metal: $2\text{CuOH} + 2\text{HF} = 2\text{H}_2\text{O} + \text{Cu} + \text{CuF}_2$. F. Mauro could not obtain this salt by passing a stream of hydrogen fluoride and carbon dioxide over heated cuprous oxide; nor did A. G. Betts make it by the action of copper on cupric fluoride. C. Poulenc, however, prepared cuprous fluoride by the action of hydrogen fluoride on cuprous chloride heated to dull redness; the action is complete only when the temp. is between 1100° and 1200° , and near the volatilization temp. of cuprous fluoride. The same compound is obtained by heating anhydrous cupric fluoride to 600° in a stream of hydrogen fluoride, and then raising the temp. between 1100° and 1200° towards the end of the operation.

Cuprous fluoride forms a ruby-red crystalline mass which, according to T. Carnelley, melts at 908° ; and, according to C. Poulenc, sublimes between 1100° and 1200° to a dusty red powder. Cuprous fluoride is stable in dry air, but in ordinary air, it is converted into cupric fluoride, and the mass acquires a blue colour; the conversion is much more rapid in contact with water, in which menstruum, says C. Poulenc, cuprous fluoride is insoluble. Cuprous fluoride is insoluble in alcohol at 90° ; it is insoluble in hydrofluoric acid; but soluble in conc. hydrochloric acid, and, according to C. Poulenc, unlike cuprous chloride under similar conditions, it is not precipitated when the soln. in boiling conc. hydrochloric acid is diluted. J. J. Berzelius says it is precipitated, but he was possibly dealing with a mixture containing some cuprous chloride, not fluoride. Cuprous fluoride is only slightly attacked by sulphuric acid, even when heated; but nitric acid acts energetically with the evolution of nitrogen oxides. Heated in air, cuprous fluoride is converted into the oxide, and it is easily reduced by hydrogen at a red heat. At 400° , it forms cupric oxide, and hydrogen fluoride with water vapour; cupric sulphide with hydrogen sulphide; and cuprous chloride with hydrogen chloride. When fused with alkali carbonates it is converted into alkali fluoride and cupric oxide.

Cupric fluoride, CuF_2 .—H. Moissan³ made this salt by the action of fluorine on metallic copper; A. G. Betts, by the action of finely-divided copper on ferric fluoride; C. Poulenc, by the action of hydrogen fluoride on cupric oxide at 400° , and by the action of hydrogen fluoride on dihydrated cupric fluoride, $\text{CuF}_2 \cdot 2\text{H}_2\text{O}$, below 500° . An amorphous powder is obtained by fusing dihydrated cupric fluoride with ammonium fluoride at 260° in a stream of carbon dioxide to remove the excess of ammonium fluoride. This powder readily becomes crystalline when heated in a stream of hydrogen fluoride to 500° . A. Pochettino found the order of activity for the photoelectric effect with the cupric halides is CuI_2 , 39; CuBr_2 , 32; CuCl_2 , 20; CuF_2 , 3. The order of increasing stability is the order of decreasing photoelectric effect.

Cupric fluoride forms small white crystals which on exposure to moist air become blue owing to the absorption of water; the crystals likewise become blue when placed in ether or alcohol containing traces of water. The salt is soluble in water, and in hydrofluoric, hydrochloric, or nitric acid; with hot sulphuric acid it

forms cupric sulphate. When heated above 500° , cuprous fluoride is formed; the dissociation: $2\text{CuF}_2 \rightleftharpoons 2\text{CuF} + \text{F}_2$, is not complete below 1100° . Cupric fluoride is completely converted into cupric oxide when heated in air to 300° ; and it is readily reduced by hydrogen; water vapour converts the hot fluoride into hydrogen fluoride and cupric oxide; sulphuric acid, into cupric sulphate; and hydrogen chloride, into cupric chloride. J. Schröder found cupric fluoride to be soluble in pyridine; A. Naumann, soluble in ethyl acetate; and G. Gore, insoluble in liquid ammonia. N. G. Chatterji and N. R. Dhar found that cupric fluoride is not precipitated by sodium hydroxide soln. in the presence of glycerol or sugar.

Dihydrated cupric fluoride, $\text{CuF}_2 \cdot 2\text{H}_2\text{O}$.—Blue crystals of this salt were made by C. W. Scheele,⁴ by J. L. Gay Lussac and L. J. Thénard, and by J. J. Berzelius by evaporating the blue soln. obtained by treating cupric oxide or carbonate with an excess of hydrofluoric acid. According to J. J. Berzelius:

If the copper carbonate be treated with hydrofluoric acid, it will dissolve with effervescence, but a salt is soon precipitated as a heavy powder; if the addition of carbonate be continued, the effervescence continues, and the salt already formed decomposes, especially if the mixture be warmed, and a pulverulent basic salt is produced. If the addition of carbonate be discontinued before the basic salt is formed, and the soln. evaporated, a crystalline crust is formed. . . . In this process, the excess of acid contained by the dissolved salt is given off. If the crystalline salt be covered with a small proportion of water, and allowed to stand at room temp. for a long time, a sat. soln. is obtained which deposits crystals of the same salt on evaporation; but if the mixture is heated to the b.p. with a large proportion of water, the salt is decomposed, part dissolves in the liberated acid, and part remains undissolved as a basic salt.

L. Balbiano obtained J. J. Berzelius' dihydrated fluoride by treating the blue soln. with 95 per cent. alcohol; washing the precipitated crystals with hot alcohol; and drying them over conc. sulphuric acid in vacuo. J. J. Berzelius' analyses of the crystals correspond with $\text{CuF}_2 \cdot 2\text{H}_2\text{O}$.

E. Böhm evaporated a conc. soln. of cupric oxide or carbonate in hydrofluoric acid, in vacuo over sulphuric acid, and obtained pale-blue monoclinic pleochroic crystals of **hydrated cupric pentahydroheptafluoride, $\text{CuF}_2 \cdot 5\text{HF} \cdot 5\text{H}_2\text{O}$** , or, more probably $\text{CuF}_2 \cdot 5\text{HF} \cdot 6\text{H}_2\text{O}$. F. H. Edmister and H. C. Cooper preferred to make the fluoride with cupric hydroxide because it reacts faster than the carbonate. The soln. precipitates a basic salt on standing exposed to air, but the product redissolves in more acid. If the soln. be evaporated slowly, small irregular blue crystals are deposited, but if evaporated quickly, a clear crystalline crust appears; both products have the same composition— $\text{CuF}_2 \cdot 2\text{H}_2\text{O}$. These crystals are sparingly soluble in water, and a white crust forms on the surface, but if dissolved in an excess of warm water, and evaporated, well-defined prismatic monoclinic crystals of hexahydrated cupric pentahydroheptafluoride, $\text{CuF}_2 \cdot 5\text{HF} \cdot 6\text{H}_2\text{O}$, are formed. The refractive indices are $\alpha=1.395$; $\beta=1.440$; $\gamma=1.444$; and the crystals are not isomorphous with those of the analogous salts of cobalt, nickel, and manganese. These crystals are very soluble in water and dil. acids; they effloresce rapidly and lose hydrogen fluoride when exposed to air; when heated, they lose water and hydrogen fluoride, and, as E. Böhm showed, are converted into oxides—it is assumed that hydrogen fluoride is lost first, and that the water of crystallization hydrolyzes the cupric fluoride.

According to E. Peterson, the heat of neutralization, $\text{Cu}(\text{OH})_2 + 2\text{HF} = 20.17$ Cals.; and in dil. soln., the heat of formation, $\text{Cu} + \text{F}_2 + \text{aq.} = \text{CuF}_2 \text{aq.} = 89.6$ Cals. M. Berthelot found the heat of the displacement of chlorine by fluorine in soln. of cupric chloride to be 27.1 Cals. The blue crystals of dihydrated cupric fluoride pass into the oxyfluoride after standing some days. The crystals are very soluble in water. A. Jäger noticed the solubility is diminished by the addition of alkali fluorides. This is taken to prove the non-existence of complex fluorides. The aq. soln. is hydrolyzed, and a basic salt or an oxyfluoride is precipitated.

The basic salt, prepared as described above by J. J. Berzelius, corresponded

with hydrated cupric oxyfluoride, $\text{Cu}_2\text{OF}_2 \cdot \text{H}_2\text{O}$, or cupric hydroxyfluoride, $\text{Cu}(\text{OH})\text{F}$. L. Balbiano attempted to make cupric fluoride by the double decomposition of cupric sulphate and potassium fluoride, but obtained instead a soln. of potassium cupric sulphate, $\text{K}_2\text{Cu}(\text{SO}_4)_2$, and a greenish-white precipitate of the oxyfluoride: $2\text{KF} + 2\text{CuSO}_4 + \text{H}_2\text{O} = \text{CuK}_2(\text{SO}_4)_2 + \text{HF} + \text{Cu}(\text{OH})\text{F}$. L. Balbiano also made the same compound by heating cupric fluosilicate, $\text{CuSiF}_6 \cdot 6\text{H}_2\text{O}$, above 100° . When this oxyfluoride is heated in air, it passes into cupric oxide. H. Moissan obtained a black mass of what was regarded as the anhydrous oxyfluoride, Cu_2OF_2 or $\text{CuO} \cdot \text{CuF}_2$, by the action of fluorine on copper oxide or sulphate at a red heat.

L. Balbiano's attempts to make an ammino-fluoride were not successful, for although he found that ammonia is absorbed in accord with: $\text{CuF}_2 \cdot 2\text{H}_2\text{O} + 2\text{NH}_3 = \text{CuF}_2(\text{NH}_3)_2 + 2\text{H}_2\text{O}$, the oxyfluoride was always obtained. Similarly, if ammonia be conducted over hydrated cupric oxyfluoride, $\text{Cu}_2\text{OF}_2 \cdot \text{H}_2\text{O}$, or hexahydrated cupric fluosilicate, $\text{CuSiF}_6 \cdot 6\text{H}_2\text{O}$, much ammonia is absorbed, and hydrated cupric tetrammino-oxyfluoride, $\text{Cu}_2\text{OF}_2 \cdot 4\text{NH}_3 \cdot \text{H}_2\text{O}$, is formed. This compound may also be formulated as cupric diammino-hydroxyfluoride, $\text{Cu}(\text{OH})\text{F} \cdot 2\text{NH}_3$, so long as the mol. wt. is unknown. The aq. soln. may give a precipitate of hydrated cupric oxyfluoride when treated with alcohol; or when the alcoholic soln. is heated to about 50° ; or when the aq. soln. is evaporated to dryness.

H. von Helmholtz⁵ has prepared double fluorides of copper with ammonium, potassium, and rubidium. The salt, $\text{CuF}_2 \cdot 2\text{NH}_4\text{F} \cdot 2\text{H}_2\text{O}$, i.e. dihydrated ammonium cupritetrafluoride, $(\text{NH}_4)_2\text{CuF}_4 \cdot 2\text{H}_2\text{O}$, was obtained as a blue crystalline powder by the slow evaporation of a conc. soln. of ammonium fluoride almost sat. with freshly precipitated cupric hydroxide; or eq. quantities of the two carbonates in a large excess of hydrofluoric acid. The double salt is almost insoluble in water, and decomposes in contact with water into an insoluble white powder and soluble ammonium fluoride. It does not appreciably attack glass, but, according to J. Haas, it dissolves ferrosilicon, developing a gas—possibly H_2SiF_6 —with the separation of copper; it has but a slight action on 80 per cent. ferromanganese. The ammonium cupritrifluoride, $\text{CuF}_2 \cdot \text{NH}_4\text{F} \cdot 2\frac{1}{2}\text{H}_2\text{O}$, was made as a sparingly soluble bluish-white powder by mixing eq. quantities of copper and ammonium carbonates in hydrofluoric acid; or copper carbonate in an acid soln. of ammonium fluoride; or by treating an acid soln. of cupric fluoride with ammonium carbonate or aq. ammonia. Potassium trifluorocuprate, $\text{CuF}_2 \cdot \text{KF}$ or KCuF_3 , and rubidium trifluorocuprate, $\text{CuF}_2 \cdot \text{RbF}$ or RbCuF_3 , were similarly prepared.

REFERENCES.

- ¹ H. Moissan, *Ann. Chim. Phys.*, (6), 24, 247, 1891; C. Poulenc, *ib.*, (7), 2, 12, 68, 1894.
- ² J. J. Berzelius, *Pogg. Ann.*, 1, 28, 1824; C. Poulenc, *Ann. Chim. Phys.*, (7), 2, 68, 1894; *Compt. Rend.*, 115, 1446, 1892; F. Mauro, *Atti Accad. Lincei*, (5), 1, 194, 1892; *Zeit. anorg. Chem.*, 2, 30, 1892; A. G. Betts, *Zeit. Elektrochem.*, 3, 142, 1905; T. Carnelley, *Journ. Chem. Soc.*, 33, 275, 1878.
- ³ H. Moissan, *Ann. Chim. Phys.*, (6), 24, 247, 1891; C. Poulenc, *ib.*, (7), 2, 58, 1894; G. Gore, *Proc. Roy. Soc.*, 21, 140, 1873; A. Naumann, *Ber.*, 37, 4609, 1904; J. Schröder, *Reaktionen von Metallsalzen in Pyridin*, Giessen, 1901; A. G. Betts, *Zeit. Elektrochem.*, 3, 142, 1905; A. Pochettino, *Atti Accad. Lincei*, (5), 16, 58, 1907; G. C. Schmidt, *Wied. Ann.*, 64, 708, 1898; G. Reboul, *Compt. Rend.*, 154, 429, 1912; N. G. Chatterji and N. R. Dhar, *Chem. News*, 121, 253, 1920.
- ⁴ C. W. Scheele, *Svenska Vet. Acad. Handl.*, 120, 1771; *Journ. Phys.*, 2, 473, 1773; J. L. Gay Lussac and L. J. Thénard, *Ann. Chim. Phys.*, (1), 69, 204, 1809; M. Berthelot, *ib.*, (7), 4, 454, 1895; H. Moissan, *ib.*, (6), 24, 261, 1894; L. Balbiano, *Gazz. Chim. Ital.*, 14, 78, 1884; J. J. Berzelius, *Pogg. Ann.*, 1, 28, 1824; *Ann. Chim. Phys.*, (2), 24, 61, 1823; F. H. Edmister and H. C. Cooper, *Journ. Amer. Chem. Soc.*, 42, 2419, 1920; *Chem. News*, 122, 27, 1921; N. G. Chatterji and N. R. Dhar, *ib.*, 121, 253, 1920; E. Peterson, *Zeit. phys. Chem.*, 4, 384, 1889; A. Jäger, *Ueber die Löslichkeit von Fluoriden*, Breslau, 1901; *Zeit. anorg. Chem.*, 27, 29, 1901; E. Deussen, *ib.*, 44, 419, 1905; E. Böhm, *ib.*, 43, 329, 1905.
- ⁵ H. von Helmholtz, *Zeit. anorg. Chem.*, 3, 115, 1893; J. Haas, *Chem. Ztg.*, 32, 8, 1908.

§ 15. Copper Chlorides—Cuprous Chloride

In his paper, *Sur les muriates de cuivre verd et blanc* (1804), J. L. Proust¹ recognized two distinct forms of copper chloride, and these are the two typical chlorides of copper which, in to-day's nomenclature, are called cuprous chloride, CuCl ; and cupric chloride, CuCl_2 . Attempts have been made to establish the existence of two others—copper subchloride, Cu_2Cl , and cuprosocupric chloride, $\text{CuCl}_x\text{CuCl}_2$ —but neither of these has been isolated in a pure state, and the evidence in both cases is somewhat dubious in the absence of a decisive test for a chemically homogeneous individual.

E. Wohlwill² claimed to have obtained indications of a *copper subchloride* of unknown composition by the electrolysis of hydrochloric acid with copper anodes. When a soln. of cuprous chloride in a conc. soln. of sodium chloride is treated with an excess of aqua ammonia, and the filtrate is allowed to stand for some days, a pale blue precipitate free from ammonia is deposited, which when pressed and dried over sulphuric acid, is claimed by M. Siewert to have the composition $2\text{Cu}_2\text{Cl.CuCl}_2.10\text{H}_2\text{O}$. J. H. Gladstone and A. Tribe also claim to have obtained indications of the formation of a subchloride by the action of a copper-silver or copper-platinum couple on a soln. of copper sulphate containing a chloride.

Cuprous chloride was first made by Robert Boyle,³ in the middle of the seventeenth century, by heating *Venetian sublimate*—mercuric chloride—with copper plates in a retort. He noticed the formation of mercury, and that the plates were covered with a white crust which on further heating melted to a brittle mass which, said he, "I can compare to nothing more fitly than a lump of good benjamin," and, again, to a "metalline gum." This product was later called Boyle's *resina cupri*, and *cuprum gummatosum*. In modern symbols, Boyle's reaction is symbolized: $\text{HgCl}_2 + 2\text{Cu} = 2\text{CuCl} + \text{Hg}$. J. L. Proust prepared cuprous chloride by the action of stannous chloride on cupric chloride, and he called it *white muriate of copper*, and J. Davy called it *cuprane* in contrast with *cupranea* applied to cupric chloride in accord with a nomenclature suggested by H. Davy.

Cuprous chloride occurs in Chile as the mineral *nantokite*, or *nantouquite*, which is white or water-clear, and has a sp. gr. 3.93, and hardness 2.0–2.5. A. Lacroix⁴ also found it in the fumaroles of Vesuvius in 1906.

The preparation of cuprous chloride.—1. *By the chlorination of copper or copper oxide.*—Copper foil or finely-divided copper, obtained by reducing the heated carbonate in a stream of hydrogen, burns in chlorine gas at ordinary temp., forming a mixture of cupric and cuprous chlorides—the former can be removed by washing the mass with water acidified with a little sulphurous acid. According to H. Gautier and G. Charpy,⁵ liquid chlorine confined in a sealed tube along with a copper plate very slowly attacks metallic copper at 15°. Hydrogen chloride when dry does not act on copper at ordinary temp., but, according to M. Ribalkin,⁶ the reaction proceeds slowly at 92°, and fairly rapidly at 230°. There is a condition of equilibrium: $2\text{Cu} + 2\text{HCl} \rightleftharpoons 2\text{CuCl} + \text{H}_2$, at 230°, 93 per cent. of the hydrogen chloride is decomposed; at 440°, 66 per cent. With hydrogen and cuprous chloride at 230°, about 5 per cent. of hydrogen chloride, is formed, and at 440°, about 35 per cent. According to M. Berthelot, the reaction proceeds more quickly if oxygen be present.

J. L. Proust⁷ noticed that when a copper plate is immersed in hydrochloric acid, exposed to the air, it is soon covered with small white tetrahedral crystals of cuprous chloride. A. C. and A. E. Becquerel recommended sinking some charcoal with the copper in the acid. If hydrochloric acid be in contact with copper while exposed to air, the liquid becomes greenish-blue, and copper is gradually dissolved as cuprous chloride, and, according to W. Odling, hydrogen is formed. If an oxidizing agent—e.g. nitric acid, or potassium chlorate—be present, copper is rapidly dissolved by conc. hydrochloric acid at 70°–80°. The brown liquid first formed is soon

decolorized. On cooling the soln., crystals of cuprous chloride are deposited, and when water is added to the soln. more cuprous chloride is precipitated. The precipitate can be washed by air-free water, or better, with water acidified with sulphurous acid. This process is recommended by S. Lupton.⁸ Copper can also be chlorinated to cuprous chloride by treatment with a dil. soln. of ferric chloride or of potassium chromate in hydrochloric acid as recommended by H. V. Regnault, J. L. Proust, and R. Chenevix made cuprous chloride by dissolving cuprous oxide in hydrochloric acid under conditions where access of air was prevented. H. Schwarz used a solution of sodium chloride in place of hydrochloric acid. K. Heumann added a mixture of cupric oxide with half its weight of zinc-dust, in small quantities at a time, to hydrochloric acid. If a mixture of cupric oxide and ammonium chloride be pounded together in a mortar, or if strongly compressed, W. O. de Coninck and L. Arzalier found much cupric chloride is formed and ammonia evolved. W. Stahl converted cupric oxide or carbonate into a mixture of cupric and cuprous chlorides by treatment with a solution of ferrous chloride. C. E. Baker and A. W. Burwell prepared cuprous chloride by passing the vapour of sulphur chloride, SCl_2 , over heated cupric sulphide.

2. *By the reduction of cupric chloride.*—As J. L. Proust⁹ showed in 1799, when cupric chloride is heated to redness in the absence of air, it loses half of its combined chlorine, and forms cuprous chloride. J. L. Proust removed the unconverted cupric chloride by washing with water. A dil. soln. of sulphurous acid is better; thus, F. Wöhler (1864) and M. Rosenfeld (1879) recommend the following procedure:

A mixed soln. of 20 grms. of cupric sulphate and $4\frac{1}{2}$ grms. of potassium, sodium, or ammonium chloride in 300 c.c. of water is sat. with sulphur dioxide when cuprous chloride is slowly deposited as a white precipitate—an excess of sulphur dioxide retards the precipitation so that when the clear soln. is boiled to expel the excess of sulphur dioxide, a further quantity of cuprous chloride is deposited. The salt is purified by first washing it with sulphurous acid, then with glacial acetic acid, and finally drying it pressed between folds of filter paper, or porous tiles, in a warm place.

Cuprous chloride cannot be washed with water without decomposition, for as soon as the excess of acid is removed, a reaction: $8\text{CuCl} + \text{O}_2 = 2\text{Cu}_2\text{O} + 4\text{CuCl}_2$, begins in the presence of air, and this is rendered evident by the orange-red coloration. Indeed, the cuprous chloride can be completely decomposed by this treatment. J. L. Proust exposed a mixture of ether and a soln. of cupric chloride to sunlight; a colourless liquid was obtained which by cooling or by treatment with water furnished cuprous chloride. Various reducing agents have been employed for reducing soln. of cupric to cuprous chloride—for example, J. Nicklès used a soln. of phosphorus in carbon disulphide; P. Kulisch, phosphine; L. P. de St. Gilles, W. Wardlaw and F. W. Pinkard, F. Wöhler, and M. Rosenfeld, sulphurous acid or a sulphite; A. Cavazzi, sodium hypophosphite; J. L. Proust, stannous chloride; K. Heumann, zinc; J. L. Proust, copper turnings or filings; E. Vigouroux, and J. B. Senderens, aluminium; S. B. Newbury, powdered silver; A. Purgotti, hydrazine sulphate; W. Lossen, A. Angel, and E. Péchard, hydroxylamine chloride; J. V. Kohlschütter, acetone; V. Thomas, and E. Péchard, nitric oxide, or nitrogen tetroxide; F. C. Phillips, methyl hydrosulphide; and E. Postel, sugar. Numerous other organic substances have been used. The more usual process of preparing cuprous chloride is to reduce the cupric chloride with copper as originally done by J. L. Proust. The following is based on M. Gröger's process¹⁰:

Dissolve 42 grms. of crystalline cupric chloride in 200 c.c. of hydrochloric acid (sp. gr. 1.175) mixed with 100 c.c. of water, add say 25 grms. of copper turnings, and warm the mixture on a water-bath until the dark colour has disappeared. Pour the clear liquid into a vessel containing two litres of cold water acidified with a little sulphurous acid. The white cuprous chloride which is precipitated is collected by means of a suction filter and washed with dil. sulphuric acid (1:20), and then successively with absolute alcohol and with ether. Dry the product in a hot-water oven. Yield, 22–23 grms.

Instead of using a soln. of cupric chloride, an eq. mixture of say one mol. of cupric sulphate with two mols. of sodium chloride, can be employed as recommended by G. Denigès, F. Wöhler, etc. Potassium or ammonium chlorides can also be used in place of the sodium salt.

Cuprocupric chloride is said¹¹ to be present in the brown-coloured soln. formed when cupric chloride in acetone is allowed to stand; when a hydrochloric acid soln. of cuprous chloride is oxidized; when an aq. soln. of cupric chloride is reduced on or at the cathode; when an aq. soln. of cupric chloride is electrolyzed. There is every sign that the alleged cuprocupric chloride is a mixture of the two chlorides.

3. *By the electrolysis of solutions of copper chloride.*—According to R. Böttger,¹² during the electrolysis of a soln. of cuprous chloride in hydrochloric acid with copper anodes, small white crystals of cuprous chloride are deposited on the anode. By electrolyzing a soln. of cupric chloride, with a copper anode and platinum cathode, cuprous chloride is deposited on the latter, and copper is dissolved from the former; if both electrodes are of platinum, cuprous chloride is deposited on the cathode, and chlorine is given off at the anode.

The properties of cuprous chloride.—Hot soln. of cuprous chloride in hydrochloric acid on cooling furnish small hexakis-tetrahedral crystals belonging to the cubic system.¹³ R. W. G. Wyckoff and E. Posnjak found that the X-radiograms correspond with the double face-centred cubic lattice of the zinc sulphide class with the sides of the cube 5.49 Å., and the nearest distance of the atoms 2.32 Å. L. Bourgeois made the crystals by passing sulphur dioxide into a soln. of cupric chloride; A. C. Becquerel, by the action of metallic copper on a soln. of sodium chloride; and R. Böttger, by the electrolysis of soln. of copper chloride. The specific gravities which have been published¹⁴ range from L. Playfair and J. P. Joule's mean 3.53 to H. Schiff's 3.70 for the artificial crystals, and 2.6777 for the fused salt; R. W. G. Wyckoff and E. Posnjak gave 4.136 at 30°/4°. P. Walden, and F. A. Henglein studied the mol. vol. of the cuprous halides.

J. L. Proust noticed that cuprous chloride melts below a red heat, without decomposition, and T. Carnelley's¹⁵ value for the melting point is 434° ± 4°; K. Mönkemeyer's value is 419°; G. Poma and G. Gabbi's value, 415°; C. Sandonnini's value, 422°; and L. Graetz's value, 440°. C. Sandonnini finds that the thermal analysis of mixtures of cuprous and lithium chlorides—melting respectively at 602° and 422°—shows the existence of two species of mixed crystals, with a gap of miscibility extending from 25 to 55 mols. per cent. of CuCl. The fusion curve has a minimum rich in cuprous chloride, corresponding with 80 mols. per cent. of cuprous chloride. C. Sandonnini, P. de Cesaris, and G. Poma and G. Gabbi find that cuprous chloride forms a eutectic with sodium chloride at 314° with nearly 75 mols. per cent. of cuprous bromide. With potassium chloride there are two arrests in the fusion curve with cuprous chloride—viz. 136° to 142° and 226° to 236°. The former represents the eutectic temp. with just over 65 mols. per cent. of cuprous chloride; and a compound CuCl.2KCl is formed which dissociates at 226°–236°. With rubidium chloride, there are three arrests in the fusion curve: (i) a eutectic at 150°; (ii) one corresponding with the dissociation of the compound 2RbCl.3CuCl at 190°; and (iii) one corresponding with the breaking down of the compound 2RbCl.CuCl at 250°. T. Carnelley and W. C. Williams' value for the boiling point is 954°–1054°. It has long been known that in melting copper containing chlorine the fumes evolved may interfere with the charging, or drive workmen from the building. The flue-dust from furnaces melting copper with but traces of chlorine, may yield up to 15 per cent. cuprous chloride. S. Skowronsky and K. W. McComas have shown that any copper-leaching process which gives chlorides either from ore or solvent will electrolytically deposit cuprous chloride on the cathode, and that this is subsequently volatilized and lost to the bath.

The vapour density, according to V. and C. Meyer,¹⁶ is 6.96 at 1560°; and 6.60 to 6.44 at 1692°. These numbers correspond with a molecular weight in

agreement with the formula Cu_2Cl_2 , which requires a vapour density 6.825. There is, therefore, no dissociation $\text{Cu}_2\text{Cl}_2 \rightleftharpoons 2\text{CuCl}$. E. Beckmann's determinations of the b.p. of dil. soln.¹⁷ of cuprous chloride in quinoline agree with the formula CuCl ; and in conc. soln., Cu_2Cl_2 ; and in soln. of pyridine, and of methyl and ethyl sulphides, A. Werner found a similar variation. N. Castoro obtained values in soln. of urea in agreement with Cu_2Cl_2 . L. Rügheimer and E. Rudolf's value for the f.p. of soln. of cuprous chloride in molten bismuth chloride agrees with CuCl ; E. Beckmann and F. Junker's values, with molten mercuric chloride, vary from CuCl to Cu_2Cl_2 ; and E. Abel's values for the f.p. of hydrogen chloride, with Cu_2Cl_2 .

The specific heat of solid cuprous chloride,¹⁸ which has been fused, is, according to H. V. Regnault, 0.1383, and the atomic heat, 13.7. The heat of formation, $\text{Cu} + \text{Cl} = 35.6$ Cals. (M. Berthelot); 32.875 Cals. (J. Thomsen); $\text{Cu} + \text{Cl}_2 = 26.5$ Cals. (M. Berthelot). For its formation from chlorine and cuprous oxide, M. Berthelot gives 26.0 Cals.; and J. Thomsen gives for its heat of formation from hydrogen chloride and cuprous oxide, 24.65 Cals., and from hydrochloric acid, HCl_2 , 7.33 Cals. M. Ribalkin's value for $\text{Cu} + \text{HCl}$ is 10 Cals. R. Luther and D. R. Wilson's value for the work of oxidation in forming CuCl from copper, -0.5640 volt; M. de K. Thompson gives for the free energy of formation -27.8 Cals. with gaseous chlorine, or with liquid chlorine, -28.1 Cals.; G. Bodländer and O. Storbeck give -30.0 Cals.; and M. de K. Thompson's value for the total energy of formation is -33.8 and -31.6 Cals. respectively for gaseous and liquid chlorine. M. Berthelot's values (1879) for the heat of solution of cuprous chloride in hydrochloric acid vary from -820 cal. for the acid $\text{HCl} + 5\text{H}_2\text{O}$ to -9500 cal. for the acid $\text{HCl} + 66.4\text{H}_2\text{O}$. This is taken to indicate the formation of a cuprous hydrochloride which progressively dissociates with the absorption of heat by the action of water.

According to B. Gossner,¹⁹ the crystals obtained from conc. soln. are singly refracting, but, according to K. Mönkemeyer, after they have been fused they are doubly refracting. M. Faraday²⁰ first electrolyzed molten cuprous chloride and thereby obtained metallic copper; cupric chloride is formed at the anode, and copper is dissolved—the loss, according to H. L. Buff, is greater than corresponds with theory. W. Negbauer gives for the e.m.f. of the cell $\text{Pt} | \text{CuCl} | \text{Zn}$, 0.725 volt. The electrical resistance of a c.c. at 50° over the m.p. is 6 ohms. L. Graetz's values for the electrical conductivity (mercury unity) are: 37.25×10^{-6} at 490°; 21.20×10^{-6} at 460°; 19.60×10^{-6} at 450°; 19.60×10^{-6} at 420°; 19.5×10^{-6} at 400°; 14.20×10^{-6} at 300°; 0.71×10^{-6} at 200°; and 0.09×10^{-6} at 140°.

Cuprous chloride is reduced to the metal: $2\text{CuCl} + \text{H}_2 \rightleftharpoons 2\text{HCl} + 2\text{Cu}$, when heated in a stream of hydrogen. According to M. Ribalkin,²¹ if the gas is dry, the reaction begins at about 230° when about 5 per cent. of hydrogen chloride is formed in 18 hrs.; at 270°, 10 per cent. of hydrogen chloride is formed in 9 hrs.; and at 440°, 35 per cent. of hydrogen chloride is formed. Cuprous chloride is also reduced by water gas. According to M. Trautz, sulphuryl chloride, SO_2Cl_2 , has no perceptible action after an hour's heating at 99.3°, 742 mm. press.; C. Poulenc found that hydrogen fluoride forms cuprous fluoride; H. Rose, that phosphine forms copper phosphide, Cu_3P ; and W. A. Jones, that dry carbon monoxide has no action on dry cuprous chloride.

Dry cuprous chloride remains unchanged in dry air, and it is not affected by light²²; but if moisture be present, it slowly turns green and yellowish-brown, the colours due to the formation of a green basic salt, possibly atacamite, $\text{CuCl}_2 \cdot 3\text{CuO} \cdot 3\text{H}_2\text{O}$. F. Thomas studied the influence of light on the oxidation of cuprous chloride. J. L. Proust stated that the salt is insoluble in water, but with the more sensitive methods available to modern chemistry, G. Bodländer²³ showed that the solubility of cuprous chloride in water in an atm. of hydrogen or carbon dioxide between 19.3° and 21.7° is 0.000629 mol per litre. In contact with water, the cuprous chloride is partially hydrolyzed: $2\text{CuCl} + \text{H}_2\text{O} \rightleftharpoons \text{Cu}_2\text{O} + 2\text{HCl}$; and partially decomposed: $2\text{CuCl} \rightarrow \text{CuCl}_2 + \text{Cu}$. A sat. soln. contained 0.002222 mol

of cupric and 0.000629 of cuprous chloride per litre, together with 0.000363 mol of HCl. H. Lescœur, and J. K. Haywood found that when cuprous chloride is washed with successive portions of water of approximately the same volume each washing, the amount of acid in the wash water, after the first few washings, remains practically constant until all the chloride is converted into oxide. If the extraction be carried out in darkness in an atm. of hydrogen or carbon dioxide, the residue is almost pure cuprous oxide; but in light, the residue is red owing to the formation of a little copper. The system contains three components—cuprous oxide, water, and acid—and four phases—cuprous chloride, cuprous oxide, solution, and vapour. By the phase rule, therefore, at any given temp. there can be only one conc. for which the system is in equilibrium; and as long as there is an excess of hydrochloric acid, there will be no cuprous oxide, and the system will be bivariant, and capable of existing at different conc. for a given temp.

According to M. Gröger, when water acts on cuprous chloride in the presence of a little air, an orange-red residue of cuprous oxide, mixed with about 5 per cent. of basic cupric chloride, is formed. The amount of cupric compound in the residue is always small, presumably because most passes into soln.; by the action of water and air, sufficient for complete oxidation, the end-product has a composition approximating to that of atacamite, $3\text{CuO} \cdot \text{CuCl}_2 \cdot 3\text{H}_2\text{O}$. The primary action is the hydrolysis of cuprous chloride, and the liberated hydrochloric acid in the presence of oxygen acts upon more cuprous chloride forming the cupric compound which reacts with the cuprous oxide formed during the primary hydrolysis producing cuprous chloride and basic cupric chloride. Cuprous chloride remains white in the presence of a soln. of **cupric chloride**, when protected from air, and this even in sunlight. Boiling water soon changes cuprous chloride into cuprous oxide and copper, and cupric chloride passes into soln. According to J. W. Mallet, a stream of moist air between 100° and 200° , converts cuprous chloride almost instantaneously into the oxychloride atacamite, $\text{CuCl}_2 \cdot 3\text{CuO} \cdot 3\text{H}_2\text{O}$.

Dil. **nitric acid**, said M. Rosenfeld, does not attack cuprous chloride in darkness, but in light, the salt rapidly darkens and acquires a copper lustre; while J. L. Proust said that nitric acid develops much heat with the evolution of nitric oxide, and the soln. becomes violet and then blue. B. Lean and W. H. Whatmough found that freshly precipitated cuprous chloride is redissolved by **sulphurous acid**. According to G. Vortmann and C. Padberg, a boiling acid soln. of cuprous chloride reacts with **sulphur**: $2\text{CuCl} + \text{S} = \text{CuS} + \text{CuCl}_2$; W. Wardlaw and F. W. Pinkhard found that the oxidation $4\text{CuCl} + \text{SO}_2 + 4\text{HCl} = 4\text{CuCl}_2 + 2\text{H}_2\text{O} + \text{S}$ does not occur at 95° if the conc. of the acid be less than 38 c.c. of 33 per cent. hydrochloric acid per 250 c.c. of soln.; with soln. containing over 150 c.c. of acid per 250 c.c. of soln., sulphur is precipitated; with between 112 and 150 c.c. of acid, sulphur and cuprous sulphide is precipitated; while in soln. with 38 to 112 c.c. of acid, cuprous sulphide alone is precipitated. Dil. **sulphuric acid** does not act on cuprous chloride; the conc. acid has no appreciable action in the cold, but the attack is perceptible when the acid is warmed. H. Feigl²⁴ found a soln. of **sulphur chloride** in benzene colours cuprous chloride brown, and it is partly converted into cupric chloride, and sulphur. Very dil. **hydrochloric acid** in an inert atm. changes the colour of cuprous chloride from white, through green, to a dark copper brown, and the residue contains metallic copper: $2\text{CuCl} \rightarrow \text{Cu} + \text{CuCl}_2$. Conc. hydrochloric acid dissolves cuprous chloride without changing colour, and this the more the greater the proportion of hydrogen chloride. This is shown by the measurements of H. le Chatelier at 17° , and of R. Engel at 0° . Extracting a few numbers from their data, and expressing the results in mols. per litre:

	0°				17°			
HCl.	1.8975	4.475	6.85	10.4	0.8975	1.57	4.78	5.70
CuCl	0.0475	0.825	1.55	3.3	0.0475	0.14	0.825	1.15
Sp. gr.	1.50	1.08	1.261	1.345	—	1.050	1.135	—

The fact that the solubility of cuprous chloride in hydrochloric acid is greater the more conc. the acid, led A. Ditte²⁵ to infer the presence of a hydrochloride; and, as previously indicated, the fact that the heat absorbed during the soln. of cuprous chloride in hydrochloric acid is greater the more dil. the acid, led M. Berthelot to a similar conclusion. M. le Blanc and A. A. Noyes argued that the soln. contains a complex of cuprous chloride and hydrogen chloride, because the f.p. of hydrochloric acid is not changed by the addition of cuprous chloride; and from solubility determinations, E. Abel deduced the presence of the complex ion, Cu_2Cl_4 , which would make the complex $\text{H}_2\text{Cu}_2\text{Cl}_4$, or $(\text{HCuCl}_2)_2$, i.e. $\text{Cu}_2\text{Cl}_2 \cdot 2\text{HCl}$ —**chlorocuprous acid**, or **cuprous dihydro-dichloride**. R. Engel was not able to isolate any crystals by cooling to -40° a soln. sat. at 0° , but G. Neumann claims to have obtained grey needle-like crystals of this compound by dissolving cuprous chloride in hydrochloric acid in the presence of powdered copper, in an atm. of carbon dioxide, and then saturating the soln. by means of hydrogen chloride, while cooled by a freezing mixture. The crystals become blue on exposure to air, and the soln. in water is colourless.

The soln. of cuprous chloride in hydrochloric acid is used in gas analysis for the absorption of carbon monoxide.²⁶ F. W. L. Brandt studied the absorption of carbon monoxide, ethylene, and nitric oxide by soln. of cuprous chloride. One eq. of copper dissolves nearly one eq. of carbon monoxide, and carbonyl cuprous chloride is formed. There appears to be a reversible reaction between the cuprous hydrochloride in soln. and the carbon monoxide. By saturating the soln. with carbon monoxide M. le Blanc obtained a compound $2\text{CuCl} \cdot \text{CO} \cdot 2\text{H}_2\text{O}$; and W. A. Jones, $\text{CuCl} \cdot \text{CO} \cdot 2\text{H}_2\text{O}$. According to H. Hammerl, the heat of soln. of carbon monoxide in the soln. is 11.37 Cals. The soln. is not applicable for the determination of small proportions of carbon monoxide. A. Frank reported that carbon monoxide is but incompletely removed from water-gas by this solvent. H. Drehschmidt says that if a soln. of carbon monoxide in the cuprous chloride soln. be shaken in nitrogen gas, some carbon monoxide is given up to the nitrogen. The soln. of cuprous chloride in hydrochloric acid becomes brown on exposure to air, and, says M. Traube,²⁷ the autoxidation of the soln. in the presence of water develops some hydrogen peroxide. The acid soln. of cuprous chloride copiously absorbs phosphine—according to J. Riban, about 132 times its volume. The soln. deposits needle-like crystals of $\text{CuCl} \cdot \text{PH}_3$, which are stable only in the mother liquid from which they have separated. When exposed to the air, or when heated, or when treated with water, the crystals rapidly dissociate into a black copper phosphide, Cu_3P , and phosphine and hydrogen chloride: $3\text{CuCl} \cdot \text{PH}_3 = \text{Cu}_3\text{P} + 2\text{PH}_3 + 3\text{HCl}$. If the passage of gas be continued, the crystals dissolve, and a compound richer in phosphine is in all probability formed, but which has not been isolated. The soln. so obtained can be preserved and used for giving off pure phosphine. According to W. Hempel, 10 c.c. of the soln. absorbs 2 c.c. of carbonyl sulphide, and the soln., says M. Berthelot, gradually forms carbon dioxide and cuprous sulphide. A. R. Frank says acetylene is not appreciably absorbed; and, according to N. Caro, the organic sulphides are absorbed in small quantities. W. Hempel found that the soln. absorbs the heavy hydrocarbons. Fuming nitric acid colours the soln. brown; G. Vortmann and C. Padberg found that when boiled with flowers of sulphur cupric chloride and cuprous sulphide are formed; J. Riban found that mercury is attacked by the brown soln., forming mercurous chloride, but it is not attacked by the colourless soln.

Cuprous chloride is soluble in soln. of the alkali chlorides. T. S. Hunt found that a sat. soln. of *sodium chloride* dissolves more than 16 per cent. of cuprous chloride at 90° , and more than 8 per cent. at 40° . A soln. with 15 parts of sodium chloride in 100 of water dissolves 10 per cent. of cuprous chloride at 90° ; 60 per cent. at 40° ; and 3.5 per cent. at 14° . A soln. with 5 parts of sodium chloride in 100 of water dissolves 2.6 per cent. of cuprous chloride at 90° , and 1.1 per cent. at 40° . When the soln. are diluted with water, cuprous chloride is deposited as a white crystalline powder. G. Bodländer²⁸ and O. Storbeck found cuprous chloride dissolves without decomposition in a soln. of *potassium chloride* if the soln. are more conc. than 0.05*N*. Some of the cuprous chloride is converted into the cupric salt. For example, expressing the conc. in grams per litre, 16° – 20° , the two forms of copper in soln. of various conc. of potassium chloride are:

KCl	0	0.186	0.746	1.492	7.460	14.92	149.2
Cu (ous)	0.040	0.034	0.048	0.071	0.299	0.603	24.42
Cu (ic)	0.141	0.090	0.030	0.021	0	0	0

K. Hachmeister²⁹ determined the f.p. and b.p. curves of binary mixtures of cuprous and ammonium chlorides. With mixtures with *w* per cent. of ammonium chloride :

<i>w</i>	. . .	53.31	43.45	38.52	32.64	27.40	21.61	12.91	5.06
B.p.	. . .	338°	339°	—	345°	351°	361°	378°	415°
F.p.	. . .	—	305°	253°	201°	170°	196°	320°	390°

The eutectic temp. of the f.p. curve is near 140°. P. P. Dehérain prepared prismatic crystals of **ammonium trichlorocuprite**, $\text{NH}_4\text{Cu}_2\text{Cl}_3$, or $\text{NH}_4\text{Cl} \cdot 2\text{CuCl}$, from a soln. of cuprous hemiammino-chloride. They are stable only when kept in contact with the mother liquid. H. L. Wells and E. B. Hurlburt prepared crystals of **ammonium pentachlorocuprite**, $(\text{NH}_4)_2\text{Cu}_3\text{Cl}_5$, or $2\text{NH}_4\text{Cl} \cdot 3\text{CuCl}$, from a hot hydrochloric acid soln. of the component salts cooled in the presence of copper wire. H. Ritthausen also prepared crystals of this salt. The colourless crystals can be kept in air for a long time without change, but they gradually turn green. P. P. Dehérain obtained needle-like crystals of **ammonium dichlorocuprite**, NH_4CuCl_2 , or $\text{NH}_4\text{Cl} \cdot \text{CuCl}$, but they are stable only under the mother liquor; H. L. Wells and E. B. Hurlburt could not make them. E. Mitscherlich mentioned **ammonium trichlorocuprite**, $2\text{NH}_4\text{Cl} \cdot \text{CuCl}$, and H. L. Wells and E. B. Hurlburt obtained colourless prisms by dissolving cuprous chloride in a large excess of a hot soln. of ammonium chloride in dil. hydrochloric acid, and cooling in the presence of copper wire and an atm. of carbon dioxide. The crystals rapidly turn brown and then green on exposure to air. P. P. Dehérain reported brown crystals of a monohydrate.

A. Chassevant found cuprous chloride is readily soluble in a hot conc. soln. of lithium chloride in an atm. of carbon dioxide, and colourless octahedral crystals, presumably lithium chlorocuprite, are formed, which immediately decompose as the mother liquor is withdrawn, and also on exposure to light, or contact with organic matter—*e.g.* paper. E. Mitscherlich prepared what he regarded as **sodium trichlorocuprite**, NaCuCl_3 ; O. Dieffenbach obtained a sodium salt by heating cupric sodium chloride; and J. B. J. D. Boussingault, and A. C. Becquerel also prepared the sodium salt in colourless tetrahedra. A. Chassevant said the salt readily decomposes, while J. B. J. D. Boussingault found it does not volatilize at 550°. G. Bodländer and O. Storbeck assumed that soln. of cuprous chloride in 0.05 to 0.4*N* soln. of potassium chloride contain **potassium dichlorocuprite**, KCuCl_2 , or $\text{KCl} \cdot \text{CuCl}$, and that more conc. soln. contain **potassium trichlorocuprite**, K_2CuCl_3 . E. Mitscherlich, H. le Chatelier, and A. C. Becquerel made the former salt in colourless octahedral crystals isomorphous with potassium chloride. The crystals in conc. soln. remain colourless; in dil. soln. they gradually turn green or violet; P. P. Dehérain³⁰ said they are decomposed by cupric or zinc chloride. H. L. Wells prepared white prisms of **caesium trichlorocuprite**, CsCu_2Cl_3 , or $\text{CsCl} \cdot 2\text{CuCl}$, from a hot dil. soln. of cupric chloride, copper wire, an excess of caesium chloride and hydrochloric acid. The crystals become yellow when dried. He also obtained **caesium pentachlorocuprite**, $3\text{CsCl} \cdot 2\text{CuCl}$, in colourless plates, and prismatic crystals of monohydrated **caesium tetrachlorocuprite**, $3\text{CsCl} \cdot \text{CuCl} \cdot \text{H}_2\text{O}$, or $\text{Cs}_3\text{CuCl}_4 \cdot \text{H}_2\text{O}$. They dissolve in ammonium thiosulphate soln. and form colourless crystals of $\text{NH}_4(\text{CuCl}_2) \cdot 4(\text{NH}_4)_2\text{S}_2\text{O}_3$.

When a conc. soln. of cuprous chloride in alkali halide is treated with a soln. of iodine in xylene, G. A. Barbieri found that cuprous iodide is formed. The mixed soln. of cuprous and alkali chloride transforms silver sulphide into the chloride, converts ruby silver ore into a grey mixture of³¹ copper and silver chloride, antimony, and sulphur; and, according to F. Raschig, it converts lead, zinc, cadmium, iron (ous), cobalt (ous), bismuth, and tin (ous and ic) into the respective chlorides—with cuprous, lead, and zinc sulphides the conversion is incomplete; and with mercuric sulphide it forms the double salt, $\text{HgS} \cdot 2\text{CuCl}$; and with silver sulphide, $\text{AgS} \cdot 2\text{CuCl}$. Sulphur is separated from the arsenic sulphides. C. Häussermann

states that metallic copper is attacked. G. Bodländer and O. Storbeck have measured the solvent action of soln. of *copper sulphate* on cuprous chloride, and F. Raschig, the solvent action of *cupric chloride*. In the latter case, the soln. becomes brown, and this the more the higher the temp., and the greater the conc. of the soln., and much of the cuprous chloride separates during the cooling of a boiling conc. soln. With cupric sulphate soln. a portion of the cuprous chloride is converted into the cupric salt. Expressing conc. in milligram-molecules per litre :

CuSO ₄	0	0.987	1.975	2.962	4.937
Total Cu	2.880	3.602	4.553	5.193	7.276
Cu (ic)	2.258	3.145	4.131	4.625	6.546
Cu (ous)	0.622	0.457	0.422	0.509	0.730

If calcium hydroxide be added to a hydrochloric acid soln. of cuprous chloride, C. Künzel³² considers that **cuprous oxychloride**, CuO.CuCl, or Cu₂OCl, is formed. J. L. Proust previously stated that a similar oxychloride remains after the calcination of cupric oxychloride, 3CuO.CuCl₂. B. Kosmann also supposed that **trihydrated cuprous oxydichloride**, CuO.2CuCl.3H₂O, is slowly formed when a soln. of barium or zinc chloride acts upon hydroxide, and also when cupric hydroxide is mixed with cupric chloride, and the excess of cupric chloride removed by dialysis. It is not clear if these products are the result of arrested reactions.

J. L. Proust,³³ in his early work at the end of the eighteenth century, noted the solubility of cuprous chloride in aqua ammonia; and W. Gaus obtained a soln. containing 0.02*N*-CuCl in a normal soln. of ammonia. According to N. A. E. Millon and A. Commaille, 100 c.c. of aqua ammonia, of sp. gr. 0.924, dissolves 13.98 grms. of cuprous chloride. The colourless soln. rapidly turns blue on exposure to air. The ammoniacal soln., like that in hydrochloric acid, absorbs carbon monoxide.

The ammoniacal soln. of cuprous chloride is also used by W. Hempel, etc., in place of the hydrochloric acid soln. for gas analysis,³⁴ and some consider with better results. According to G. Denigès, it absorbs phosphine, and, according to M. Berthelot, propylene. A. Favorsky, and A. Béhal obtained a red precipitate with acetylene, propyl acetylene, and hexylene, but not with dimethyl-acetylene, methyl-ethyl-acetylene, or ethyl-propyl-acetylene. E. A. le Sueur found that on electrolysis, half the copper is precipitated as metal and half is converted into the cupric form.

E. C. Franklin and C. A. Kraus³⁵ also found cuprous chloride to be easily soluble in liquid ammonia. Five different cuprous ammino-chlorides have been reported, but S. J. Lloyd's study of the vap. press. obtained by saturating cuprous chloride with ammonia gas, and measuring the vap. press. at a constant temp. between 0° and 150° as the ammonia was gradually withdrawn, shows that only three such compounds can exist under these conditions—dark brown **cuprous hemiammino-chloride**, 2CuCl.NH₃, melting about 162°, is made by saturating cuprous chloride with ammonia, and removing the excess until the press. of the gas is 522 mm. at 90°. The vap. press. at 87° is 518 mm.; at 120°, 680 mm.; and at 135.5°, 819 mm. P. P. Dehérain claimed to have made a dihydrated salt: 2CuCl.NH₃.2H₂O, by boiling ammonium chloride soln. with cupric oxide and an excess of copper. According to S. J. Lloyd, light brown **cuprous sesquiammino-chloride**, 2CuCl.3NH₃, melting about 144°, is made like the hemiammino-chloride, but at a press. of 650 mm. The vap. press. at 67.5° is 324 mm.; at 85°, 567 mm.; at 92°, 700 mm.; and at 100°, 845 mm.; W. Biltz and W. Stollenwerk found the heat of formation to be 16.73 Cals., and the dissociation press. at 326° is 100 mm. Green **cuprous triammino-chloride**, CuCl.3NH₃, melting at about 123°, is formed by leading ammonia gas slowly over cuprous chloride cooled by a freezing mixture. Its vap. press. at 88° is 736 mm.; at 90°, 780 mm.; at 110°, 1650 mm. F. Ephraim gives the vap. press. 760 mm. at 46.3°; and he added that the cuprous trihalides are almost of identical stability. W. Biltz and W. Stollenwerk found the heat of formation of the triammino-chloride to be 9.48 Cals.

In 1853, H. Ritthausen reported the formation of **cuprous ammino-chloride**, CuCl.NH₃, and this was confirmed by P. P. Dehérain in 1862. The latter boiled a soln. of cuprous

chloride in hydrochloric acid, along with a little ammonia and copper; H. Ritthausen boiled ammonium chloride with finely-divided copper until ammonia began to be evolved. With rapid cooling the soln. deposits small white crystals of this salt, and with slow cooling blue rhombohedral crystals of $2\text{NH}_4\text{Cl} \cdot \text{CuCl}_2 \cdot 2\text{H}_2\text{O}$, so that by rightly timing the operation, the crystallizing liquid can be decanted from the white crystals before the blue ones are deposited. The crystals can be washed with alcohol. H. Ritthausen also says that the white crystals can be obtained by pouring the boiling liquid into half its volume of water; filtering off the precipitated cuprous hydroxide, and cooling the soln. F. Förster and F. Blankenberg also says this salt is formed when copper is treated with a strong soln. of cupric chloride in aqua ammonia of sp. gr. 0.88. The crystals are colourless rhombohedra which acquire a violet colour on exposure to air, and at 100° lose ammonia, and are browned by oxidation. Water decomposes the crystals, colouring them yellow; they are also decomposed by acids, but not by alcohol. W. Biltz and W. Stollenberg found the heat of formation of the monamminochloride to be 16.73 Cals., and the dissociation press. at 417.5° to be 100 mm. According to H. Ritthausen, the crystals formed by A. C. and A. E. Becquerel when a mixed soln. of copper sulphate and ammonium chloride is electrolyzed have the same composition; and, according to P. P. Dehérain, crystals of this salt with two molecules of water are formed along with $\text{CuCl}_2 \cdot 2\text{NH}_4\text{Cl}$, when copper is allowed to stay in contact with a soln. of ammonium chloride. P. P. Dehérain's report that crystals of $\text{CuCl}_2 \cdot 2\text{NH}_3$ are formed by the action of ammonia on cuprous chloride lack confirmation. On account of the extreme readiness with which the ammino-compounds absorb water, their formation in aq. soln. seems to S. J. Lloyd to be improbable.

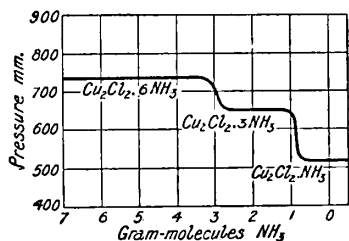

FIG. 26.—Vapour Pressure Curves of the Cuprous Ammino-chlorides.

What H. Ritthausen considers to be **hydrated cuprosic tetrammino-chloride**, $\text{CuCl} \cdot \text{CuCl}_2 \cdot 4\text{NH}_3 \cdot \text{H}_2\text{O}$, is deposited in blue rhombic prisms when a soln. of cuprous ammino chloride, $\text{CuCl} \cdot \text{NH}_3$, is exposed to the air; and P. P. Dehérain also made it by boiling ammonium chloride with copper oxide and an excess of copper. The crystals decompose rapidly on exposure to air; but they are more stable if well dried, although even then they gradually lose water and ammonia, and absorb oxygen. They lose water rapidly at 100° , traces of ammonia are also lost, and the colour becomes dark brown. They are decomposed by acids—with hydrochloric acid prisms of $2\text{CuCl} \cdot \text{NH}_4\text{Cl}$ and cubes or octahedra of $2\text{NH}_4\text{Cl} \cdot \text{CuCl}_2 \cdot 2\text{H}_2\text{O}$ are deposited. According to C. Winkler,³⁶ soln. of *sodium thiosulphate*, $\text{Na}_2\text{S}_2\text{O}_3$, dissolve freshly prepared acid-free cuprous chloride. The cold soln. is not altered by dil. nitric, hydrochloric, or sulphuric acid, but when warmed, black cuprous sulphide is precipitated without the evolution of sulphur dioxide; and R. Böttger says the soln. is not readily oxidized; but M. Rosenfeld found a brown precipitate is slowly formed by potassium chromate. Cuprous chloride dissolves in a soln. of *ammonium thiosulphate*, and the soln. gives tetragonal crystals which A. Rosenheim and S. Steinhäuser's analysis makes: $4(\text{NH}_4)_2\text{S}_2\text{O}_3 \cdot \text{NH}_4\text{Cl} \cdot \text{CuCl}$. When the colourless liquid is treated with ammonia it becomes blue. According to M. Siewert, cuprous chloride is insoluble in soln. of *sodium dithionate*, $\text{Na}_2\text{S}_2\text{O}_6$.

According to W. Eidmann,³⁷ it is insoluble in *phosgene*, *methylal*, and *acetone*; according to E. Alexander, in *ethyl acetate*; and, according to H. Arctowsky, in *carbon disulphide*. It forms a double compound with *acetanilide* investigated by W. J. Comstock³⁸; with *benzonitrile* and other aromatic nitriles (A. Werner, C. Rabaut, and A. Naumann); with *ethyl sulphide* (A. Werner); with *thioacetamide* (N. Kurnakoff); with *alkyl phosphates* (A. E. Arbusoff), etc. It dissolves in *pyridine* (J. Schröder)³⁹; in *piperidine* (A. Werner and P. Ferchland); and in *quinoline* (E. Beckmann and W. Gabel). W. A. Jones obtained evidence of the formation of a compound $4\text{CuCl} \cdot 3\text{CO}$ when carbon monoxide is passed into a pyridine soln. at 0° , but the compound was not isolated. It decomposes on raising the temp., and at 100° the decomposition is nearly complete. *Hydrocyanic acid*, says R. Varet, transforms cuprous chloride into cuprous cyanide.

REFERENCES.

- ¹ J. L. Proust, *Ann. Chim. Phys.*, (1), 32. 26, 1799; (1), 59. 350, 1804.
- ² E. Wohlwill, *Zeit. Elektrochem.*, 9. 330, 1903; M. Siewert, *Bull. Soc. Chim.*, (2), 7. 242, 1867; J. H. Gladstone and A. Tribe, *Chem. News*, 25. 193, 1872.
- ³ R. Boyle, *Considerations and experiments about the origin of forms and qualities*, Oxford, 1666; J. L. Proust, *Ann. Chim. Phys.*, (1), 32. 26, 1799; (1), 59. 350, 1804.
- ⁴ A. Lacroix, *Bull. Soc. Min.*, 30. 219, 1907; J. Domeyko, *Elementos de mineralogia de Chile*, Santiago, 51, 1873; A. Breithaupt, *Berg. Hütt. Ztg.*, 27. 3, 1868.
- ⁵ J. Davy, *Phil. Trans.*, 112. 169, 1812; H. Gautier and G. Charpy, *Compt. Rend.*, 113. 597, 1891; S. B. Christy, *Trans. Amer. Inst. Min. Eng.*, 7. 3, 1888; A. Osann, *Pogg. Ann.*, 52. 406, 1841.
- ⁶ M. Ribalkin, *Bull. Acad. St. Petersburg*, 34. 165, 1891; *Journ. Russ. Phys. Chem. Soc.*, 21. 155, 1889; M. Berthelot, *Ann. Chim. Phys.*, (7), 13. 73, 1898; *Compt. Rend.*, 125. 746, 1897; R. Engel, *ib.*, 121. 528, 1895; P. Jannasch and E. Heimann, *Journ. prakt. Chem.*, (2), 74. 473, 1906; J. Thomsen, *Danske Vid. Selsk. Forh.*, 5. 3, 1852; F. Wöhler, *Liebig's Ann.*, 105. 360, 1858.
- ⁷ J. L. Proust, *Ann. Chim. Phys.*, (1), 32. 26, 1799; A. C. and A. E. Becquerel, *Traité expérimental de l'électricité et du magnétisme*, Paris, 2. 86, 1855; W. Odling, *Journ. Chem. Soc.*, 9. 291, 1856.
- ⁸ J. L. Proust, *Ann. Chim. Phys.*, (1), 32. 26, 1799; R. Chenevix, *Nicholson's Journ.*, 5. 132, 171, 229, 1802; H. Schwarz, *Dingler's Journ.*, 218. 214, 1875; K. Heumann, *Ber.*, 7. 720, 1874; W. Stahl, *Berg. Hütt. Ztg.*, 50. 13, 1891; H. V. Regnault, *Compt. Rend.*, 59. 558, 1864; W. O. de Coninck and L. Arzalier, *Bull. Acad. Belgique*, 713. 800, 1907; S. Lupton, *Chem. News* 30. 233, 1874; C. E. Baker and A. W. Burwell, *U.S.A. Pat. No. 841103*, 1905.
- ⁹ J. L. Proust, *Ann. Chim. Phys.*, (1), 32. 26, 1799; H. Rose, *Pogg. Ann.*, 38. 121, 1836; T. S. Hunt, *Berg. Hütt. Ztg.*, 41. 315, 1882; L. P. de St. Gilles, *Ann. Chim. Phys.*, (3), 42. 38, 1854; P. Kulisch, *Ueber die Einwirkung des Phosphorwasserstoffs auf Metallsalzlösungen*, Berlin, 1885; *Liebig's Ann.*, 231. 327, 1885; F. Wöhler, *ib.*, 130. 373, 1864; J. Nicklès, *Journ. Pharm. Chim.*, (4), 9. 101, 1869; E. Postel, *ib.*, (1), 18. 570, 1839; A. Cavazzi, *Gazz. Chim. Ital.*, 16. 167, 1886; A. Purgotti, *ib.*, 26. ii, 559, 1906; K. Heumann, *Ber.*, 7. 720, 1874; W. Lossen, *ib.*, 8. 257, 1875; J. V. Kohlschütter, *ib.*, 37. 1170, 1904; M. Rosenfeld, *ib.*, 12. 954, 1879; A. Angel, *Journ. Chem. Soc.*; 89. 345, 1906; S. B. Newbury, *Amer. Chem. Journ.*, 8. 196, 1886; V. Thomas, *Bull. Soc. Chim.*, (3), 15. 1092, 1896; E. Vigouroux, *ib.*, (4), 1. 7, 1907; J. B. Senderens, *ib.*, (3), 17. 271, 1897; F. C. Phillips, *Zeit. anorg. Chem.*, 6. 249, 1894; E. Péchard, *Compt. Rend.*, 136. 504, 1903; W. Wardlaw and F. W. Pinkard, *Journ. Chem. Soc.*, 121. 210, 1922.
- ¹⁰ M. Gröger, *Zeit. anorg. Chem.*, 28. 154, 1901; G. Bodländer and O. Storbeck, *ib.*, 31. 7, 1902; E. Abel, *ib.*, 26. 406, 1901; C. Immerwahr, *ib.*, 24. 278, 1900; W. Hampe, *Zeit. Berg. Hütt. Sal.*, 21. 238, 1873; G. Quincke, *Wied. Ann.*, 36. 270, 1889; G. Denigès, *Compt. Rend.*, 108. 567, 1889.
- ¹¹ J. V. Kohlschütter, *Ber.*, 37. 1170, 1904; F. Peschig, *Liebig's Ann.*, 228. 9, 1885; J. L. Proust, *Ann. Chim. Phys.*, (1), 32. 26, 1799.
- ¹² R. Böttger, *Journ. prakt. Chem.*, (2), 2. 135, 1870; J. H. Gladstone and A. Tribe, *Journ. Chem. Soc.*, 27. 130, 1874; E. Rossi, *L'Indust. Chim.*, 6. 333, 1904; H. M. Granier, *German Pat.*, D.R.P. 156354, 1903; E. Wohlwill, *Zeit. Elektrochem.*, 9. 317, 1903; S. Dushman, *Electrochem. Ind.*, 5. 258, 1907; A. C. Becquerel, *Compt. Rend.*, 75. 1729, 1872.
- ¹³ E. Mitscherlich, *Journ. prakt. Chem.*, 19. 449, 1840; R. Böttger, *ib.*, (2), 2. 135, 1870; O. Lehmann, *Zeit. Kryst.*, 1. 459, 1877; B. Gossner, *ib.*, 38. 131, 1902; A. C. Becquerel, *Ann. Chim. Phys.*, (2), 35. 33, 1829; *Compt. Rend.*, 75. 1730, 1872; L. Bourgeois, *Réproduction artificielle des minéraux*, Paris, 111, 1884; R. W. G. Wyckoff and E. Posnjak, *Journ. Amer. Chem. Soc.*, 44. 30, 1922.
- ¹⁴ I. Playfair and J. P. Joule, *Mem. Chem. Soc.*, 2. 401, 1845; G. Karsten, *Schweigger's Journ.*, 55. 394, 1832; H. Schiff, *Liebig's Ann.*, 108. 21, 1858; P. Walden, *Zeit. anorg. Chem.*, 115. 241, 1920; R. W. G. Wyckoff and E. Posnjak, *Journ. Amer. Chem. Soc.*, 44. 30, 1922.
- ¹⁵ T. Carnclley, *Journ. Chem. Soc.*, 33. 273, 1878; T. Carnclley and W. C. Williams, *ib.*, 37. 125, 1880; S. Skowronsky and K. W. McComas, *Journ. Amer. Inst. Min. Eng.*, 60. 307, 1919; L. Graetz, *Wied. Ann.*, 40. 28, 1890; J. L. Proust, *Ann. Chim. Phys.*, (1), 32. 26, 1799; (1), 59. 350, 1804; K. Mönkemeyer, *Neues Jahrb. Min. B.B.*, 22. 1, 1906; G. Poma and G. Gabbi, *Atti Accad. Lincei*, (5), 20. i, 464, 1911; P. de Cesaris, *ib.*, (5), 20. i, 597, 1911; C. Sandonnini, *ib.*, (5), 20. i, 457, 758, 1911; G. Bruni and C. Sandonnini, in H. Landolt, and R. Börnstein, *Physikalisch-chemische Tabellen*, Berlin, 621, 1912.
- ¹⁶ V. and C. Meyer, *Ber.*, 12. 609, 1112, 1185, 1292, 1879; H. Biltz and V. Meyer, *ib.*, 22. 725, 1889; *Zeit. phys. Chem.*, 4. 249, 1889.
- ¹⁷ E. Beckmann and F. Junker, *Zeit. anorg. Chem.*, 55. 179, 1907; E. Beckmann and W. Gabel, *ib.*, 51. 240, 1906; A. Werner, *ib.*, 15. 19, 1897; E. Abel, *ib.*, 26. 405, 1901; N. Castoro, *Gazz. Chim. Ital.*, 28. ii, 317, 1898; L. Rügheimer and E. Rudolf, *Liebig's Ann.*, 339. 333, 1905.
- ¹⁸ H. V. Regnault, *Ann. Chim. Phys.*, (3), 1. 129, 1841; M. Berthelot, *ib.*, (5), 20. 514, 1880; (7), 4. 464, 1895; *Compt. Rend.*, 89. 769, 1879; 91. 871, 1880; J. Thomsen, *Journ. prakt. Chem.*, (2), 12. 284, 1872; G. Bodländer and O. Storbeck, *Zeit. anorg. Chem.*, 31. 7, 1902; R. Luther

and D. R. Wilson, *Zeit. phys. Chem.*, 34, 488, 1900; M. de K. Thompson, *Journ. Amer. Chem. Soc.*, 28, 762, 1906; M. Ribalkin, *Bull. Acad. St. Petersburg*, 34, 165, 1891.

¹⁹ B. Gossner, *Zeit. Kryst.*, 38, 131, 1904; K. Mönkemeyer, *Neues Jahrb. Min. B.B.*, 22, 42, 1906.

²⁰ M. Faraday, *Phil. Trans.*, 123, 507, 1833; R. V. Matteucci, *Bibl. Univ. Genève*, (2), 21, 153, 1839; H. L. Buff, *Liebigs Ann.*, 110, 267, 1859; C. C. Garrard, *Zeit. Elektrochem.*, 6, 216, 1899; G. Quincke, *Wied. Ann.*, 36, 270, 1889; W. Hampe, *Chem. Ztg.*, 11, 116, 1887; J. W. Richards, *Electrochem. Ind.*, 5, 399, 1907; L. Graetz, *Wied. Ann.*, 40, 28, 1890; W. Negbauer, *ib.*, 47, 27, 1892; R. Luther, *Zeit. phys. Chem.*, 36, 386, 1901.

²¹ H. Rose, *Pogg. Ann.*, 4, 110, 1825; 6, 205, 1826; M. Ribalkin, *Bull. Acad. St. Petersburg*, (2), 1, 219, 1889; J. Gathy, *Brit. Pat. No. 18574*, 1906; M. Trautz, *Zeit. Elektrochem.*, 14, 535, 1908; C. Poulenc, *Ann. Chim. Phys.*, (7), 2, 69, 1894; W. A. Jones, *Amer. Chem. Journ.*, 22, 287, 1899.

²² M. Gröger, *Zeit. anorg. Chem.*, 28, 154, 1901; J. L. Proust, *Ann. Chim. Phys.*, (1), 32, 26, 1799; (1), 59, 350, 1804; F. Thomas, *Verzögerung und Beschleunigung chemischer Vorgänge durch Licht*, Freiburg, 1908.

²³ G. Bodländer, *Zeit. phys. Chem.*, 27, 58, 1898; G. Bodländer and O. Storbeck, *Zeit. anorg. Chem.*, 31, 1, 458, 1902; H. Lesœur, *Ann. Chim. Phys.*, (7), 2, 97, 1894; J. K. Haywood, *Journ. Phys. Chem.*, 1, 411, 1897; A. Vogel, *Dingler's Journ.*, 136, 337, 1855; B. Lean and W. H. Whatmough, *Journ. Chem. Soc.*, 73, 148, 1902; J. W. Mallet, *Compt. Rend.*, 66, 349, 1867; M. Rosenfeld, *Ber.*, 12, 954, 1899; M. Gröger, *Zeit. anorg. Chem.*, 28, 154, 1901; J. L. Proust, *Ann. Chim. Phys.*, (1), 32, 26, 1799; (1), 59, 350, 1804; G. Vortmann and C. Padberg, *Ber.*, 22, 2642, 1889; W. Wardlaw and F. W. Pinkard, *Journ. Chem. Soc.*, 121, 210, 1922.

²⁴ R. Engel, *Ann. Chim. Phys.*, (6), 17, 372, 1889; *Compt. Rend.*, 121, 529, 1895; H. le Chatelier, *ib.*, 98, 814, 1884; H. Feigel, *Verhalten von Schuermetallverbindungen gegen Polysulfide und Chlorschwefel*, Erlangen, 1905.

²⁵ M. le Blanc, *Zeit. phys. Chem.*, 6, 396, 1890; E. Abel, *Zeit. anorg. Chem.*, 26, 406, 1901; M. Berthelot, *Compt. Rend.*, 88, 967, 1879; A. Ditte, *ib.*, 92, 353, 1881; *Ann. Chim. Phys.*, (6), 17, 377, 1889; G. Neumann, *Monatsh.*, 15, 493, 1894.

²⁶ J. W. Thomas, *Journ. Chem. Soc.*, 33, 72, 1878; R. Dubois, *Bull. Assoc. Belg. Chim.*, 16, 145, 1902; C. Winkler, *Lehrbuch der technischen Gasanalyse*, Freiburg, 1884; M. le Blanc, *Compt. Rend.*, 30, 483, 1850; H. Hammerl, *ib.*, 89, 97, 1879; H. Gautier, *ib.*, 126, 871, 1898; L. de St. Martin, *ib.*, 126, 1036, 1898; A. Frank, *Zeit. angew. Chem.*, 20, 1684, 1907; T. Lonatschewsky-Petruniaka, *Journ. Russ. Phys. Chem. Soc.*, 1, 108, 1888; H. Drehschmidt, *Ber.*, 20, 2752, 1887; 21, 2158, 1888; W. Hempel, *ib.*, 21, 898, 1888; F. W. K. Brandt, *Ueber die Aethylen-, Kohlenoxyd-, und Stickoxyd-Verbindungen des Blutfarbstoffes und des Kupferchlorürs*, Würzburg, 1909; M. le Blanc, *Compt. Rend.*, 30, 483, 1850; M. Berthelot, *Ann. Chim. Phys.*, (3), 46, 488, 1856; W. A. Jones, *Amer. Chem. Journ.*, 22, 287, 1899.

²⁷ A. Joannis, *Compt. Rend.*, 128, 1322, 1899; J. Riban, *ib.*, 128, 1452, 1899; 88, 581, 1879; *Bull. Soc. Chim.*, (2), 31, 385, 1879; G. Vortmann and C. Padberg, *Ber.*, 22, 2643, 1889; M. Traube, *ib.*, 15, 659, 1882; W. Hempel, *ib.*, 20, 2344, 1887; *Zeit. angew. Chem.*, 14, 867, 1901; A. R. Frank, *ib.*, 11, 1050, 1898; F. Ullmann and J. Goldberg, *Journ. Gasbeleucht.*, 42, 374, 617, 1899; N. Caro, *ib.*, 42, 616, 1899; C. Künzel, *Berg. Hütt. Ztg.*, 33, 6, 1874; M. Berthelot, *Bull. Soc. Chim.*, (2), 5, 192, 1866.

²⁸ G. Bodländer, *Dedekind's Festschrift*, 153, 1901; T. S. Hunt, *Amer. Chem.*, 1, 199, 1871; G. Bodländer and O. Storbeck, *Zeit. anorg. Chem.*, 31, 7, 1902; R. Luther, *Zeit. phys. Chem.*, 36, 386, 1901; H. le Chatelier, *Compt. Rend.*, 98, 813, 1884.

²⁹ P. P. Dehérain, *Répert. Chim. App.*, 2, 154, 1860; *Compt. Rend.*, 55, 808, 1862; H. le Chatelier, *ib.*, 98, 813, 1884; K. Hachmeister, *Zeit. anorg. Chem.*, 109, 145, 1920; G. Bodländer and O. Storbeck, *ib.*, 31, 7, 1902; E. Mitscherlich, *Ann. Chim. Phys.*, (2), 73, 384, 1840; A. C. Becquerel, *ib.*, (2), 41, 33, 1829; A. Chassevant, *ib.*, (6), 30, 32, 1893; J. B. J. D. Bous-singault, *ib.*, (2), 51, 352, 1832; H. L. Wells and E. B. Hurlburt, *Amer. Journ. Science*, (3), 50, 390, 1895; H. L. Wells, *ib.*, (3), 47, 96, 1894; H. Ritthausen, *Journ. prakt. Chem.*, (1), 59, 369, 1853; O. Dieffenbach, *German Pat.*, D.R.P. 197955, 1906.

³⁰ E. Mitscherlich, *Ann. Chim. Phys.*, (2), 73, 384, 1840; H. L. Wells and E. B. Hurlburt, *Amer. Journ. Science*, (3), 50, 390, 1895; H. L. Wells, *ib.*, (3), 47, 96, 1894; H. Ritthausen, *Journ. prakt. Chem.*, (1), 59, 369, 1853; P. P. Dehérain, *Compt. Rend.*, 55, 808, 1862; A. Rosenheim and S. Steinhauser, *Zeit. anorg. Chem.*, 25, 103, 1900; E. Brun, *Compt. Rend.*, 114, 667, 1892; A. C. Becquerel, *Ann. Chim. Phys.*, (2), 41, 33, 1829.

³¹ C. F. Rammelsberg, *Sitzber. Akad. Berlin*, 79, 1881; F. Raschig, *Ueber die Einwirkung der Kupferchloride auf Schwefelmetalle*, Berlin, 1885; *Ber.*, 17, 697, 1884; C. Häussermann, *Zeit. angew. Chem.*, 9, 100, 1895; O. W. Huntington, *Chem. News*, 46, 177, 1882; G. Bodländer and O. Storbeck, *Zeit. anorg. Chem.*, 31, 22, 1902; G. A. Barbieri, *Atti Accad. Lincei*, (5), 16, i, 528, 1907.

³² C. Künzel, *Berg. Hütt. Ztg.*, 33, 6, 1874; B. Kosmann, *Zeit. anorg. Chem.*, 3, 374, 1893; W. Spring and M. Lucion, *ib.*, 2, 212, 1892; J. L. Proust, *Ann. Chim. Phys.*, (1), 32, 26, 1879.

³³ J. L. Proust, *Ann. Chim. Phys.*, (1), 32, 26, 1879; (1), 59, 350, 1804; N. A. E. Millon and A. Commaille, *ib.*, (4), 3, 285, 1864; W. Gaus, *Zeit. anorg. Chem.*, 25, 258, 1900.

³⁴ A. F. Weinhold, *Dingler's Journ.*, 209, 409, 1876; E. Hauser, *Sci. Espan. Fis. Quim.*, 6, 77, 1908; A. Wäagner, *Oester. Chem. Ztg.*, 6, 410, 1903; W. Hempel, *Ber.*, 20, 2752, 1887:

T. Lonatoscheffsky-Petroniaka, *Journ. Russ. Phys. Chem. Soc.*, 1, 108, 1888; M. Berthelot, *Bull. Soc. Chim.*, (2), 5, 192, 1866; A. Favorsky, *ib.*, (2), 47, 168, 1887; A. Bchal, *ib.*, (2), 43, 216, 1887; E. A. le Sueur, *U.S.A. Pat. No.* 755302, 1899; G. Denigès, *Compt. Rend.*, 108, 567, 1889.

³⁵ E. C. Franklin and C. A. Kraus, *Amer. Chem. Journ.*, 20, 827, 1898; S. J. Lloyd, *Journ. Phys. Chem.*, 12, 398, 1908; H. Ritthausen, *Journ. prakt. Chem.*, (1), 59, 373, 1843; P. P. Dehérain, *Compt. Rend.*, 55, 807, 1862; F. Förster and F. Blankenberg, *Ber.*, 39, 4436, 1906; A. C. and A. E. Becquerel, *Traité expérimental de l'électricité et du magnétisme*, Paris, 1855; F. Ephraïm, *Ber.*, 52, B, 236, 940, 1919; W. Biltz and W. Stollenwerk, *Zeit. anorg. Chem.*, 119, 97, 1921.

³⁶ C. Winkler, *Journ. prakt. Chem.*, (1), 88, 428, 1863; R. Böttger, *Neues Repert. Pharm.*, 23, 627, 1874; M. Rosenfeld, *Ber.*, 12, 954, 1879; A. Rosenheim and S. Steinhäuser, *Zeit. anorg. Chem.*, 25, 106, 1900; M. Siewert, *Bull. Soc. Chim.*, (2), 7, 242, 1867; M. B. Renault, *Compt. Rend.*, 59, 558, 1864.

³⁷ W. Eidmann, *Ein Beitrag zur Kenntnis des Verhaltens chemischer Verbindungen in nicht-wässrigen Lösungen*, Göttingen, 1899; A. Naumann, *Ber.*, 37, 4331, 1904; E. Alexander, *Reaktionen von Salzen in Aethylacetat*, Giessen, 1899; H. Arctowsky, *Zeit. anorg. Chem.*, 6, 257, 1894.

³⁸ W. J. Comstock, *Amer. Chem. Journ.*, 20, 77, 1898; A. Werner, *Zeit. anorg. Chem.*, 15, 7, 1897; A. Naumann, *Ber.*, 32, 1002, 1899; N. Kurnakoff, *Journ. Russ. Phys. Chem. Soc.*, 25, 565, 1894; A. E. Arbusoff, *ib.*, 38, 293, 1906; C. Rabaut, *Bull. Soc. Chim.*, (3), 19, 785, 1898.

³⁹ J. Schröder, *Reaktionen von Metallsalzen in Pyridin*, Giessen, 1901; A. Werner and P. Ferchland, *Zeit. anorg. Chem.*, 15, 11, 1897; E. Beckmann and W. Gabel, *ib.*, 51, 240, 1906; R. Varet, *Compt. Rend.*, 121, 598, 1895; W. A. Jones, *Amer. Chem. Journ.*, 22, 287, 1899.

§ 16. Cupric Chloride

The existence of cupric chloride as a distinct individual apart from cuprous chloride was established by the work of J. L. Proust, about 1799. M. de la Durandière¹ reported the presence of crystals of hydrated cupric chloride in the underground concrete of Paris. A. Scacchi, A. Lacroix, and P. Franco also found the hydrated salt in sublimates in the fumaroles of Vesuvius, and the mineral $\text{CuCl}_2 \cdot n\text{H}_2\text{O}$ has been called *eriochalcite*.

The preparation of cupric chloride.—Cupric chloride is formed along with some cuprous chloride during the combustion of copper in chlorine gas, but if heated in an excess of chlorine, the cuprous is soon converted into the cupric salt. The action of hydrochloric acid on metallic copper is too slow for this to be a satisfactory means of preparing this salt; and further, if prepared by wet processes, **dihydrated cupric chloride**, $\text{CuCl}_2 \cdot 2\text{H}_2\text{O}$, is formed. For example, copper is dissolved in aqua regia and the product repeatedly evaporated with hydrochloric acid to drive off the nitric acid. Precipitated cupric oxide or cupric oxide prepared at a low temp. is readily soluble in dil. hydrochloric acid, but if the oxide has been calcined at a high temp., it dissolves very slowly even in the conc. acid. A soln. of cupric chloride can therefore be formed by dissolving the oxide or carbonate in the acid.

Dissolve cupric oxide by warming it in a flask with four times its weight of 25 per cent. hydrochloric acid. Evaporate the filtered soln. on a water-bath until a film begins to form on the surface. The crystals which separate on cooling are pressed between filter paper or porous tiles. Good crystals can be obtained by recrystallization from boiling alcohol to which a few drops of hydrochloric acid have been added.

T. Rieckler² mixed soln. of cupric sulphate and sodium chloride and obtained crystals of dihydrated chloride after the crystals of sodium sulphate and chloride had separated out. The crystals of the dihydrated salt readily separate by concentrating the soln. in hydrochloric acid. According to H. M. Dawson and J. McCrae,³ the neutral salt can be obtained if a soln. of the oxide in the acid be evaporated to dryness, the residue dissolved in water and again evaporated.

The hydrated salt loses its water when heated over 100° ; or, according to P. Sabatier, when heated to 150° in a stream of hydrogen chloride. The anhydrous salt is also formed, according to R. Kane and C. Hensgen, by the action of dry hydrogen chloride on powdered copper sulphate— CuSO_4 , or $\text{CuSO}_4 \cdot \text{H}_2\text{O}$. It is possible that the addition product, $\text{CuSO}_4 \cdot 2\text{HCl}$, is first formed, which subsequently decomposes into cupric chloride, etc. H. C. Jones and W. R. Veazey say that

the last traces of adsorbed hydrogen chloride can be removed from the salt by allowing it to stand in vacuo over sulphuric acid and potassium hydroxide. According to P. Sabatier, also, the crystals lose their combined water if they are allowed to stand for three months at the room temp. over conc. sulphuric acid, in vacuo; the dehydration is much quicker over phosphorus pentoxide; and, according to K. Krafft, the salt loses its water in a day over barium oxide.

D. Vitali⁴ also obtained cupric chloride by pouring conc. sulphuric acid into a soln. containing an excess of cupric sulphate along with an alkali chloride; by adding hydrochloric acid to a soln. of cupric sulphate in conc. sulphuric acid; or by mixing a little cupric chloride with an excess of conc. sulphuric acid. This shows that although conc. sulphuric acid liberates the halogen acids from their alkaline salts when salts of the heavy metals are absent, this does not always occur when such salts are present. G. Viard has shown that if an aq. soln. of cupric chloride (1 : 10) be treated with twice its volume of sulphuric acid, yellow anhydrous cupric chloride separated from the hot soln. if the acid be added so slowly that the temp. does not rise high enough to decompose the chloride; but if the liquid contains less than 68·4 per cent. of sulphuric acid, green dihydrated cupric chloride separates out.

According to F. W. O. de Coninck and L. Arzalier,⁵ anhydrous cupric oxide is formed by heating a mixture of ammonium chloride and cupric oxide under press.; and, according to C. E. Baker and A. W. Burwell, by heating cupric sulphide with sulphur chloride, S₂Cl₂; and by heating to 60° or 70° a soln. of carbonyl chloride in toluene in which the copper compound of benzoylacetone is suspended. Crystals of anhydrous cupric chloride are formed when a strip of silver dipping in silver chloride is covered with a conc. soln. of cupric nitrate.

Properties of cupric chloride.—Anhydrous cupric chloride occurs as a yellow or yellowish-brown micro-crystalline powder. The dihydrated salt forms sky-blue or greenish-blue⁶ rhombic bipyramidal crystals whose axial ratios, according to J. C. G. de Marignac,⁷ are $a : b : c = 0·9179 : 1 : 0·4627$. They show slight pleochroism. O. Lehmann obtained microscopic needles from strongly acid soln. F. Rüdorff did not find the crystals to be isomorphous with ammonium chloride with which it forms characteristic double salts; nor did J. W. Retgers find it isomorphous with dihydrated barium chloride. The **specific gravity** of the anhydrous cupric chloride is 3·054, according to L. Playfair and J. P. Joule,⁸ and for the dihydrated salt 3·535 (16°), according to C. H. D. Bödeker, 2·47 (18°), and, according to P. A. Favre and C. A. Valson, 2·390 (22·9°).

The anhydrous salt has the **melting point** 498° ± 4°, according to T. Carnelley,⁹ and it forms cuprous chloride when heated to just over redness. G. Rousseau found that the dihydrated salt melts at about 110° in its water of crystallization, and, according to E. Bödtker, it loses all its water at 110° without forming a basic salt. H. Lescœur found the **dissociation pressure** of the dihydrated salt at 80° to be 62 mm.; at 90°, 107 mm.; and at 100°, 185 mm.; and F. Ephraim found the dissociation pressure of anhydrous cupric chloride to be :

	450°	465°	478°	494·5°	501·5°	510°	515°	520°
Press.	28	53	85	225	296	410	535	650 mm.

and he says that the reported m.p. 498° is right only when the chlorine is given off during the heating of the substance. According to T. Carnelley and W. C. Williams, the **boiling point** of cupric chloride is between 954° and 1032°. The **molecular weight** of cupric chloride determined by A. Werner¹⁰ from its effect on the b.p. of pyridine and methyl sulphide, by H. Ley in alcohol, and by L. Rügheimer in bismuth trichloride, is normal—in the latter case there is a very small amount of cuprous chloride formed. The salt is strongly polymerized in acetone. N. Castoro's determination of the effect of cupric chloride on the f.p. of urethane gives a mol. wt. corresponding with Cu₂Cl₄.

The reported values for **heat of formation** of cupric chloride from its elements vary from J. Thomsen's 51·63 Cals. to M. Berthelot's 66·2 Cals.¹¹ M. Berthelot's value for its formation from cupric oxide is 11·7 Cals.; from cupric oxide in soln.,

22.8 Cals.; from cupric bromide, 11.3 Cals.; from cupric bromide in soln., 14.2 Cals.; from cuprous chloride, 16 Cals.; and from cuprous chloride in soln., 27 Cals. J. Thomsen's value for the heat of formation of cupric chloride in soln. ($\text{Cu}, \text{Cl}_2, \text{aq.}$) is 62.71 Cals.; for ($\text{CuO}, 2\text{HCl}, \text{aq.}$), 15.27 Cals. For the heat of solution of the anhydrous chloride, J. Thomsen gives 11.08 Cals. for 600 mols of water, a value which agrees with P. Sabatier's values 11.2 (13°), 10.8 (11°); and 3.455 Cals. are developed when a mol of the solid absorbs a mol of water. According to L. T. Reicher and C. M. van Deventer the heat developed in the solution of a mol of $\text{CuCl}_2 \cdot 2\text{H}_2\text{O}$ in m mols of water rises from -800 cal. for $m=83$ to $+4210$ cal. for $m=398$; and the heat developed by the soln. of n mols of $\text{CuCl}_2 \cdot 2\text{H}_2\text{O}$ in 198 mols of water falls from $+3710$ cal. when $n=1$ to -19800 cal. when $n=24.75$; the heat of dissolution attains a maximum when $n=8$, so that 8 mols of the dihydrated salt dissolves in 198 mols without any thermal effect. The heat of soln. of a mol of the dihydrated salt in 400 mols of water is 4.21 Cals., and the heat of soln. when the dil. soln. contains a mol of CuCl_2 to 200 mols of water, 3.71 Cals. The heat of soln. in the sat. soln. is negative, -300 cal.; and the integral heat of soln., -800 cal.; the heat of hydration, $\text{CuCl}_2 + 2\text{H}_2\text{O}_{\text{liq.}} = \text{CuCl}_2 \cdot 2\text{H}_2\text{O} + 6.87$ Cals.

Anhydrous cupric chloride is hygroscopic and readily dissolves in water; the solubility of the dihydrated salt in water¹² expressed as the number of grams of the salt in 100 grms. of soln. is:

Solubility	-20°	0°	20°	40°	60°	80°	100°
	37.0	41.4	43.5	45.6	47.7	49.8	51.9

A. Étard's equation for the solubility S at θ° represents a straight line: $S=41.4 + 0.105\theta$. This equation was found by L. T. Reicher and C. M. van Deventer to give rather low results below 91° . The fact that the solubilities between -20° and $+91^\circ$ can be represented by a straight line shows that the dihydrated salt is stable between these limits, provided slight deviations in the results have not been smoothed out as experimental errors. F. Rüdorff represents the solubility when ice exists as a solid phase in equilibrium with the soln., as 20.7 and 33.9 grms. of CuCl_2 in 100 grms. of water at -10° and -18.1° respectively. E. Chuard, and H. Lescœur reported that *trihydrated cupric chloride*, $\text{CuCl}_2 \cdot 3\text{H}_2\text{O}$, crystallizes from aq. soln. below 0° ; and A. Ditte, and H. Lescœur also reported *hydrated cupric chloride*, $\text{CuCl}_2 \cdot \text{H}_2\text{O}$, to be formed when the dihydrated salt is heated to 100° , and when hydrogen chloride is passed into a soln. of 29 grms. of salt in 100 c.c. of water at 12° ; if the soln. be cooled by a freezing mixture, the trihydrated salt is formed. The salt is said to furnish ochre-yellow needles with a greenish tinge. Neither P. Sabatier nor R. Engel could confirm the individuality of the monohydrated salt, nor could R. Engel confirm the individuality of the trihydrated salt. P. Sabatier and A. Werner also believe that tetrahydrated cupric chloride, $\text{CuCl}_2 \cdot 4\text{H}_2\text{O}$, exists, but H. Ley questions the validity of the evidence.

The specific gravities of aq. soln. containing w per cent. of cupric chloride at 17.5° (water at 17.5° unity), and the volumes which 100 c.c. of water assumes when w grms. of CuCl_2 are dissolved therein, are, according to B. Franz¹³:

w	5	10	15	20	25	30	35	40
Sp. gr.	1.0455	1.0920	1.1565	1.2223	1.2918	1.3618	1.4447	1.5284
Vol.	100.68	101.25	101.72	102.27	103.21	104.83	105.49	109.01

E. Irueste has also measured the sp. gr. of soln. of cupric chloride, and he found that the conc. per gram of soln. at 15° when D and D_0 respectively denote the sp. gr. of soln. and of water, is $1.05390(D - D_0) - 0.42804(D - D_0)^2$. J. Traube's molecular solution volumes v , for soln. of different sp. gr. (water at 0° unity), are:

θ°	8.073 per cent. CuCl_2			39.417 per cent. CuCl_2		
	0°	30.5°	65°	0°	30.5°	65°
Sp. gr.	1.0796	1.0766	1.0734	1.4797	1.4642	1.4511
v	11.7	9.5	9.3	23.9	25.4	23.9

The viscosities of N -, $\frac{1}{2}N$ -, $\frac{1}{4}N$ -, and $\frac{1}{8}N$ -soln. of cupric chloride ¹⁴ at 25° are respectively 1.2050, 1.0977, 1.0470, and 1.0179. H. Sentis has measured the surface tension of aq. soln. J. Schuhmeister's value for the diffusion coefficient at 10° is 0.426 for 0.1 N - to 2 N -soln. J. C. G. de Marignac's values ¹⁵ for the specific and molecular heat of aq. soln. between 19° and 51°, containing an eq. of the salt in m eq. of water, are:

m	.	.	.	10	25	50	100	200
Sp. ht.	.	.	.	0.6241	0.7790	0.8642	0.9200	0.9563
Mol. ht.	.	.	.	196.1	455	894	1778	3571

W. von Beetz's value for the thermal conductivities between 8° and 14° is 407 and 425 respectively for soln. of sp. gr. 1.125 and 1.255 (water 413); and between 28° and 36°, 666 and 566 for soln. of sp. gr. 1.125 and 1.258 respectively (water 662).

H. Lescœur's values for the vapour pressures ¹⁶ of sat. soln. at 10° is 4.8 mm.; at 40°, 41.5 mm.; at 80°, 310 mm.; and T. Ewan and W. R. Ormandy's value for 1.69 grms. of CuCl_2 in 100 grms. of water is 18.410 mm. (water 18.521 mm.); 12.99 grms. CuCl_2 , 17.472 mm. (water 18.405 mm.); and 43.98 grms. CuCl_2 , 14.946 mm. (water 18.462)—between 20.9° and 21.02°. W. Pieper measured the vap. press. of soln. of cupric chloride. A. Benrath's value for the raising of the boiling point,¹⁷ by the soln. of 3.7 grms. of the dihydrated salt in 100 grms. of water, is 0.190°; for 3.7 grms. of $\text{CdCl}_2 \cdot 2\text{H}_2\text{O}$, 0.100°; and for a mixture of the two, 0.298°, whereas the calculated value, by the law for the raising of the b.p., is 0.290; similarly for 7.1 grms. of HCl , the rise is 1.860°, and for a mixture of the two 2.090°, whereas the calculated value is 2.050°. With 5 grms. of mercuric chloride, the rise is 0.108°, and for the mixture, 0.208°, whereas the calculated value is 0.298°, which is greater than the observed value; with the other mixtures, the reverse obtains. D. Isaachsen found for soln. with between 2.298 and 5.652 grms. of CuCl_2 per 100 grms. of water, the mean value 55.4 for the mol. wt.; this gives the value $i=2.43$ for J. H. van't Hoff's ionization constant; W. Biltz and J. Meyer ¹⁸ found the mol. lowering of the freezing point to fall from 48.9 for with 0.035 mol per litre soln. to 48.1 for soln. with 0.1337 mol per litre and then to rise with increasing conc. to 53.2 for soln. with 0.7149 mol per litre. H. C. Jones and co-workers also found a decrease to a minimum value which is attributed to the hydration of the constituent in soln. S. Arrhenius calculates for the mol. lowering of the f.p. of soln. with 0.0377 mol of $\text{CuCl}_2 \cdot 2\text{H}_2\text{O}$ per litre, 5.12°; and for soln. with 0.393 mol per litre, 4.86°; the corresponding values for J. H. van't Hoff's i are 2.71 and 2.57, representing the degrees of ionization 85 and 78 per cent.

According to G. Chéneveau,¹⁹ the refractive index of soln. of cupric chloride minus that of water is 0.0002466; and, according to H. C. Jones and F. H. Getman, the refractive index of soln. with 0.065 mol of CuCl_2 per litre is 1.32735; for 1.3010 mols, 1.36163; and for 2.6030 mols, 1.3949. For the photoelectric effect, see cupric fluoride.

The electrical conductivity of soln. of dihydrated cupric chloride shows that this salt is as easily ionized as hydrochloric acid. From the work of T. Ewan,²⁰ it appears that the ionization occurs in two stages, there is first $\text{CuCl}_2 \rightleftharpoons \text{CuCl} + \text{Cl}^-$ in conc. soln. followed by $\text{CuCl}_2 \rightleftharpoons \text{Cu}^{++} + 2\text{Cl}^-$. The specific conductivity curve shows a maximum when the conc. is near 18 per cent. CuCl_2 . V. Kohlschütter measured the specific conductivities of soln. of different conc. expressed in grms. of cupric chloride per litre of water; the results are graphed in Fig. 27.

According to H. C. Jones and A. P. West, the mol. conductivities μ and

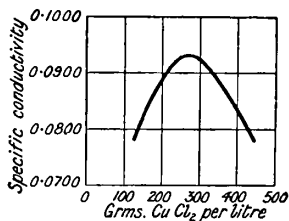

FIG. 27.—Specific Conductivity and Concentration Curve of CuCl_2 .

percentage degrees of ionization α for soln. containing a mol of the salt in v litres of water are, at 0° :

v	.	.	.	2	8	16	32	128	512	1024
μ	.	.	.	68.95	87.57	94.82	101.3	111.5	118.4	123.0
α	.	.	.	56.1	71.1	77.1	82.4	90.7	96.3	100.0

and at 25° :

μ	.	.	.	119.8	158.3	173.5	187.5	210.1	224.0	232.2
α	.	.	.	51.6	68.2	74.7	80.7	90.5	96.5	100.0

The percentage ionization is therefore smaller the higher the temp. According to S. Arrhenius, the percentage ionization by the f.p. method is greater than by the conductivity method.

According to D. Isaachsen, the curve showing the variation of the electrical conductivity of soln. of copper chloride with temp. has a point of inflexion at about 40° . R. J. Holland represents the conductivity λ at θ° by $\lambda = \lambda_{20} \{1 + 0.01841(\theta - 20) - 0.0000405(\theta - 20)^2\}$. V. Kohlschütter attributes the fall in the specific conductivity with rising temp. to the presence of a hydrated cation, $[\text{CuCl}(\text{H}_2\text{O})_3]^+$, which is in equilibrium with water: $[\text{CuCl}(\text{H}_2\text{O})_3]^+ + \text{H}_2\text{O} \rightleftharpoons [\text{Cu}(\text{H}_2\text{O})_4]^+ + \text{Cl}^-$, and the equilibrium is displaced in favour of the components on the right side when the temp. rises. G. Dickhaus also studied this subject.

According to W. Bein,²¹ the **transport number** of Cu^{++} ions in a 0.05 eq. soln. of cupric chloride, at 23° , is 0.405; and, according to G. Carrara, in methyl alcohol soln. for $v=5.3$, 0.358; and for $v=16.4$, 0.382. According to V. Kohlschütter, the transport numbers of the Cu-ion in soln. of cupric chloride are:

Mols CuCl_2 per litre	.	.	.	5.29	4.35	3.72	3.30
Transport number	.	.	.	-0.835	-0.632	-0.411	+1.795

The negative numbers mean that the copper element is accumulating about the anode, and the fact that the positive number is greater than unity means that the copper ion is associated as a complex with some chlorine, say $(\text{CuCl})'$, or even more complex anions—*vide* cupric bromide. V. Kohlschütter translated the facts by the aid of the assumption that the ions are hydrated; and he represented the changes in terms of A. Werner's theory:

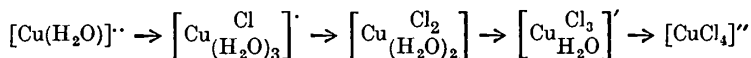

A soln. of cupric chloride in pyridine has the same blue colour as the aq. soln., although the latter is almost a non-conductor. Hence, it is inferred that both in soln. and in the solid state the un-ionized or neutral molecules, $[\text{CuCl}_2\text{Py}_2]$ and $[\text{Cu}(\text{H}_2\text{O})_2\text{Cl}_2]$, are blue. The difference between aq. and pyridine soln. is that the former can furnish complex ions, $[\text{Cu}(\text{H}_2\text{O})_3\text{Cl}]^+$, $[\text{Cu}(\text{H}_2\text{O})_4]^{2+}$, etc. The green or greenish-yellow soln. in ethyl alcohol and acetone have a small electrical conductivity, and in alcohol, the molecule approximates to CuCl_2 , in acetone it is more complex. Excluding the possible association of solute and solvent, F. G. Donnan suggests that the soln. contains un-ionized molecules and the ions Cu^{++} and CuCl_4^{2-} , while the acetone soln. contains a more complex molecule, say $\text{Cu}[\text{CuCl}_4]$, which suffers less ionization. The "double molecule" in urethane soln. is regarded as a complex $\text{Cu}[\text{CuCl}_4]$.

The **magnetic susceptibility** of the powdered salt by J. Königsberger²² is 9.1×10^{-6} mass units at 22° ; S. Meyer gave 11×10^{-6} at 17° , and G. Chéneveau 10×10^{-6} ; and for the aq. soln., J. Königsberger gave 13×10^{-6} at 22° , and O. Liebknecht and A. P. Wills, 12×10^{-6} at 18° . A. Heydweiller found the **dielectric constant** of the powdered and compact dihydrate to be 3.51 and 7.51 when $\lambda=478$ cm.

The colour of cupric chloride solutions.—In 1843, E. Solly²³ noted that the soln. of cupric chloride, CuCl_2 , in a small proportion of water is dark brown, and J. H. Gladstone showed that the colour gradually changes to very dark green as the proportion of water is increased, and this passes through various shades of green to light green, bluish-green, greenish-blue, and with very dil. soln. the colour is pale sky-blue. One part of dihydrated cupric chloride, $\text{CuCl}_2 \cdot 2\text{H}_2\text{O}$, with one of water is dark green; with two of water bluish-green; and with five parts of water pure blue. W. N. Hartley found that in diluting a soln. of a mol of $\text{CuCl}_2 \cdot 2\text{H}_2\text{O}$ with 50 mols of water, 2·565 Cals. of heat are developed. According to L. C. de Coppet, a soln. with 60 parts of $\text{CuCl}_2 \cdot 2\text{H}_2\text{O}$ and 100 parts of water at $21\cdot5^\circ$ is green; at 0° , it is bluish-green; and at -23° , blue; a soln. with 40 parts of the same salt to 100 of water at $21\cdot5^\circ$, green; at 0° , greenish-blue; and at $-14\cdot5^\circ$, at which temp. the soln. freezes, the colour is blue; a soln. with 18 parts of the same salt to 100 parts of water is green at 50° ; greenish-blue at 24° ; and blue at $+10\cdot5^\circ$, and at $-6\cdot4^\circ$ when the soln. freezes. According to R. C. Tichborne, if a blue soln., slightly acidified to avoid the formation of a basic salt, be scaled up in a tube and heated, it becomes green, then yellow, and finally dark brown. These colour changes are reversed on cooling.

According to J. H. Gladstone, conc. soln. of cupric chloride become yellow when treated with hydrochloric acid, and they turn blue again when treated with water; while the addition of sodium, ammonium, calcium, and other chlorides have no effect on the colour. A. Ditte made similar observations. H. C. Jones and H. P. Bassett found that the addition of salts with a strong tendency to form hydrates—*e.g.* anhydrous calcium chloride or bromide, aluminium chloride, etc.—turn blue soln. green; A. Benrath found that a warm dil. green soln. of cupric chloride becomes blue when treated with mercuric chloride—most other chlorides either have no perceptible action, or turn green soln. yellow.

The absorption spectrum of soln. of copper in all the solvents tried, excepting acetone, show two regions of absorption, one in the ultra-violet, and one in the red. Acetone soln. also give an absorption band about $\lambda=4700$. It is convenient to assume that the absorption of light is due to the presence of vibrating electrons associated with ions, molecules, or complexes, and the character of the absorption will generally depend on the nature of the system with which the vibrating electron is associated—which, for convenience, may be called the absorber. E. Wiedemann attributed the changes which occur when chromatic salts soln. are diluted to the progressive hydration of the solute: (brown) $\text{CuCl}_2 + n\text{H}_2\text{O} \rightleftharpoons \text{CuCl}_2 \cdot n\text{H}_2\text{O}$ (blue). E. Chuard (1888) said the blue soln. formed below 0° is due to the presence of trihydrated cupric chloride, $\text{CuCl}_2 \cdot 3\text{H}_2\text{O}$, in the soln., above that temp. to the dihydrated salt, $\text{CuCl}_2 \cdot 2\text{H}_2\text{O}$. F. Rüdorff (1862) also attributed the variation in the tint to the formation of hydrates. W. Ostwald assumed that the absorbers in the soln. were ions and un-ionized molecules which were supposed to have different colours: CuCl_2 (brown) $\rightleftharpoons \text{Cu}^{++}$ (blue) + $2\text{Cl}'$ (colourless). W. Ostwald sought to establish his theory by showing that the absorption spectra of thirteen permanganates were identical at great dilutions when presumably the salts were completely ionized; W. Ostwald did not examine conc. soln., but when they were examined, they too were also identical, so that the spectroscopic evidence cannot be cited in favour of the ionic hypothesis. Y. Shibata and K. Matsuno studied the absorption spectra of soln. of cupric amino-salts. F. G. Donnan and H. Basset attributed the colour changes on dilution to the formation and dissociation of complex ions: CuCl_4^{--} (brown) $\rightleftharpoons \text{CuCl}_2$ (blue) + $2\text{Cl}'$. G. N. Lewis tried to show that neither W. Ostwald's nor F. G. Donnan and H. Basset's hypothesis fits in with the law of mass action which requires that the equilibrium between the brown and blue constituents depends only on the conc. of the Cl' -ions; while if the equilibrium depends on some such relation as CuCl_2 (brown) + $\text{H}_2\text{O} = \text{Cu}(\text{H}_2\text{O})_n^{++}$ (blue) + $2\text{Cl}'$, the equilibrium will depend upon the conc. of both the Cl' -ions and the water. The last-named equation may also be taken to cover the case where the colour change

is due to the passage from one hydrate to another with more or less water. The colour changes with cupric chloride, though similar are not so marked as is the case with cupric bromide, so that the results obtained for the one salt apply to the other. In order to decide between these two types of hypotheses, G. N. Lewis made the following experiment :

The same quantity of cupric bromide was added to 10 c.c. of a thrice-normal soln. of each of the following bromides, KBr, NH_4Br , NaBr, LiBr. In these soln. the conc. of bromide-ion are nearly alike, being somewhat greater in the case of KBr, somewhat less in the case of LiBr. If this were the only factor determining the colour, we should expect the soln. in KBr to be the most brown, that in LiBr the least. The facts are just opposite. The NH_4Br and NaBr soln. have nearly the same colour, that of KBr is less brown, while the LiBr soln. is very much browner. In all these soln. the blue is so faint, as compared with the brown, that the relative brownness of the soln. can be found by means of a colorimeter. Columns of LiBr, NaBr, and KBr soln., respectively 14, 18.5, and 20 mm. thick, appeared equally brown. These experiments were repeated several times, a different quantity of cupric bromide being used in each instance. The results were the same. A small change in the conc. of cupric bromide in any soln. changes only the density of the colour, but not its character. It is obvious that something influences the colour besides the conc. of the bromide-ion. . . . Similar experiments were made with cupric chloride and soln. of the five chlorides, KCl, NH_4Cl , NaCl, LiCl, and HCl. Here the colours are not so pronounced as in the previous case. All the soln. are green. No difference could be detected in the first three, but the LiCl soln. was decidedly greener and the HCl soln. still more so. When the chlorides of the alkaline earths were used, the influence upon the colour was found to be much greater, the order being SrCl_2 , CaCl_2 , MgCl_2 , BeCl_2 .

Consequently, G. N. Lewis inferred that in addition to the Cl^- -ion, water enters into the reactions which produce the colour changes, and the salt is hydrated in soln. S. U. Pickering studied the effect of acids on the colour of various copper salts.

G. N. Lewis, and W. Biltz have shown that a rise of temp. should cause a dissociation of the hydrated ion into one less hydrated or even a non-hydrated ion, and H. C. Jones and A. P. West deduced from their measurements of the temp. coeff. of a great number of salts with varying degrees of hydration : (i) The temp. coeffs. of an aq. soln. are greater the greater the hydrating power of the electrolyte ; (ii) the large increase in conductivity with rise of temp. with salts forming hydrated ions, is in part due to the complexity of the hydrates, so that the equilibria $\text{Cu}(\text{H}_2\text{O})_n \rightleftharpoons \text{Cu}(\text{H}_2\text{O})_{n-m} + m\text{H}_2\text{O} \rightleftharpoons \text{Cu} + n\text{H}_2\text{O}$ will be driven to the right, and abnormally low transport numbers must then tend to approach the normal value with rise of temp. provided the abnormality arises from a hydration effect. On the other hand, according to the complex ion theory, the formation of complexes is an endothermal process, and is therefore favoured by a rise of temp., so that a rise of temp. should result in a decrease in the transport number due to the equilibrium : $2\text{Br}^- + n\text{CuBr}_2 \rightleftharpoons [(\text{CuBr}_2)_n\text{Br}_2]^{2-}$. S. B. Watkins and H. G. Denham have also shown that the decrease in the transport number with rise of temp. favours the complex ion theory and contradicts the hydration theory. W. Bein has also shown that the effect of temp. is but slight on many salts which are believed to be much hydrated—e.g. CaCl_2 and LiCl.

The mechanism of the cathode process with a soln. of a copper salt may be represented by (i) $\text{Cu}^{2+} \rightarrow \text{Cu} + 2\text{e}^-$; (ii) $\text{Cu}^+ \rightarrow \text{Cu} + \text{e}^-$; or (iii) $\text{Cu}^{2+} \rightarrow \text{Cu} + 2\text{e}^-$, or if the copper ions are hydrated, by (ia) $\text{Cu}(\text{H}_2\text{O})_n \rightarrow \text{Cu}(\text{H}_2\text{O})_m + (n-m)\text{H}_2\text{O} + \text{e}^-$; (iia) $\text{Cu}(\text{H}_2\text{O})_n \rightarrow \text{Cu} + m\text{H}_2\text{O} + \text{e}^-$; or (iiia) $\text{Cu}(\text{H}_2\text{O})_n \rightarrow \text{Cu} + n\text{H}_2\text{O} + 2\text{e}^-$. If equation (iii) or (iiia) represents the cathode process, the ratio of Cu : Ag by weight will be 0.295, and with any of the other four equations 0.590. The results obtained by S. B. Watkins and H. G. Denham for cupric chloride and bromide in aq. or alcoholic soln., as well as confirmatory results by F. Förster and O. Seidal, F. Förster and G. Coffetti, M. von Bose, M. E. Heiberg, E. Abel, G. Bodländer and O. Storböck show that with dil. soln. the discharge is mainly from cupric to cuprous ions, so that the deposits are heterogeneous mixtures of copper and cuprous halides, so that the electrode processes are mainly (i) or (ia), or (iii) or (iiia), where the cuprous ion

is precipitated as cuprous halide. The result depends on temp., conc. of soln., current density, and conc. of acid, but it is not influenced by the hydration of the ions. With conc. soln. the Cu : Ag ratio does not agree with Faraday's laws because the ratio may fall down to zero where no copper or cuprous salt is deposited on the cathode. The hydration theory does not fit into these facts, but the theory of auto-complexes gives a satisfactory explanation, for, the un-ionized salts of weak electro-affinity form complex anions, and since cuprous salts have a weaker electro-affinity than cupric salts, they will be more prone to form complex anions; and hence, where no copper or copper salt is precipitated on the cathode during electrolysis, the discharge at the cathode is wholly: $\text{Cu}^{\cdot\cdot} \rightarrow \text{Cu}^+ + \ominus$, or $\text{Cu}(\text{H}_2\text{O})_n^{\cdot\cdot} \rightarrow \text{Cu}(\text{H}_2\text{O})_m^+ + (n-m)\text{H}_2\text{O} + \ominus$, and the cuprous salt formed is not precipitated in conc. soln. as it is in dil. soln., but rather forms a soluble cupricupro-salt; and the transport number is negative.

A compromise between the hydration theory and F. G. Donnan and H. Bassett's theory of complex ions, explains the colour changes as a result of displacing the equilibrium condition: $\text{CuCl}_2 \cdot n\text{H}_2\text{O}$ (brown) $+ m\text{Cl}^- \rightleftharpoons (n-p)\text{H}_2\text{O} + [\text{CuCl}_2 \cdot \text{Cl}_m \cdot p\text{H}_2\text{O}]^-$. V. Kohlschütter bases his equilibrium equation on the assumption that the hydrates formed in soln. correspond with the ammonia complexes whose existence has been demonstrated, and in accord with A. Werner's co-ordination theory, assigning to copper the co-ordination number 4.

H. C. Jones attributes the absorption band in the ultra-violet to the hydrated un-ionized molecules, (i) because this band narrows rapidly with dilution even when the mol. conc. is kept constant; and (ii) because the band also widens rapidly with a rise of temp., showing that the absorbing power of the complex increases rapidly with a decrease in the complexity of the complex. The absorption band in the red is attributed to the solvated metallic ion.

If a ray of light of intensity I passes through a layer of homogeneous medium of thickness dx , the intensity is reduced dI so that $dI = -kI dx$, where k is a constant whose magnitude depends on the nature of the substance and the wave-length of the incident light. Integrating this relation for the condition that when $x=0$, $I=I_0$, then neglecting any loss due to reflection, it follows that $I = I_0 e^{-kl}$, a relation known as *J. H. Lambert's law*. For soln. and gases, the absorption on the conc., C , as well as on the thickness, l , of the layer, J. H. Lambert's law was extended by A. Beer to include the assumption that each molecule—absorber—absorbs the same fractional portion of the incident light when the conc. C is proportional to the number of the molecules in the soln. Hence follows the so-called *Beer's law* for monochromatic light: $I = I_0 e^{-kCl}$, meaning that the absorption of light of a given wave-length is proportional to the number of absorbers in the path of the light. When Beer's formula is referred to the base a , instead of the base e , it becomes $I = I_0 a^{-aCl}$, where a denotes a constant sometimes called the *molecular extinction coefficient*. If the absorption is proportionally greater in the more conc. solutions, A. Beer's law fails, and the coef. a decreases inversely as the concentration. It is found that for dil. soln. the deviations from A. Beer's law are small. The rule, of course, will not be applicable if mol. aggregates or complexes are formed.

With the chromatic soln. whose colour changes with conc. the relative conc. of the absorbers are continually changing, and hence A. Beer's law is not applicable, for it assumes that the conc. of the different absorbers do not change with dilution. The law breaks down, for example, with the ultra-violet band of cupric chloride, which narrows with dilution even when the number of molecules in the track of the beam of light is kept constant, so that the product of the conc. C and thickness l is constant. For conc. soln. of cupric chloride, bromide, sulphate, and nitrate, E. Müller showed that the values of a are nearly the same; while, according to T. Ewan, the absorption spectra of these soln. change on dilution, tending to become identical in dil. soln., so that a change in the conc. of the soln. has not the same effect as a corresponding change in the thickness of the layer through which light passes, as would be the case if Beer's rule obtained. This is taken to mean that the acid and basic parts of the salt are associated in producing absorption in conc. soln., but in dil. soln. they act independently. He also adds that the results can be

explained by the ionization hypothesis, but not by hydrolysis as postulated by H. Knoblauch, or mol. aggregation assumed by H. E. Armstrong and J. Traube. H. C. Jones also assumes that the results are not produced by mol. aggregates which are broken down by a rise of temp., since the absorption is increased and not decreased by a rise of temp.

W. N. Hartley and others have shown that the absorption bands which widen with a rise of temp. also widen with increased conc., so that a rise of temp. produces much the same effect as an increased conc. If the observed change were due to the formation of complexes between the solute molecules and the solvent, this would not be expected, because the change produced by a rise of temp. on such complexes is just the opposite to that produced by an increase in conc. On the other hand, H. C. Jones and J. A. Anderson have shown that the changes produced in the properties of complexes formed by the union of ions and the solvent by a rise of temp. are the same as are produced by an increase in conc. As a soln. becomes more conc. these complexes become simpler and simpler, since fewer molecules of the solvent are combined with each part of the dissolved substance; and a rise in temp. also breaks down the complexes into simpler ones. The work of E. Müller and R. A. Houston has shown that ionization alone, as postulated by W. Ostwald, is not able to explain the deviations from A. Beer's law, hence, R. A. Houston assumes that a watery atm. forms round the acid radicle and another round the basic radicle, and only when there is not sufficient water to form a proper watery atm. the spectrum is affected. H. C. Jones therefore argued that Ostwald's theory may be dismissed, not because it is erroneous, but because it is incomplete. It leaves out of account certain changes which occur in soln. which produce other absorbers for light than those which the ion theory considers. H. C. Jones further considers that the coloured ion is usually surrounded by an "atmosphere" of the solvent, in other words, the coloured ions are hydrated.

From his study of the absorption spectra of soln. of cupric chloride and of binary mixtures of cupric chloride with the chloride of hydrogen, potassium, lithium, calcium aluminium, or zinc, F. H. Getman inferred that in extremely dil. soln., the absorption of light is assumed to be due to the presence of copper atoms holding in combination as many molecules of solvent as correspond to the co-ordination number of the metal, which, in this case, is four. In extremely conc. soln., complex anions containing copper have been shown to be present, and to these the hypothetical formula, CuCl_4 , has been assigned. Other complex ions, in which, one, two, or three of the water molecules of the tetrahydrated copper ion have been replaced by chlorine atoms, are assumed to be present in soln. of intermediate concentrations.

Solutions of cupric chloride in non-aqueous solvents.—Anhydrous cupric chloride is soluble in alcohol. The soln. in *methyl alcohol* is brown when cold, and, according to A. Étard,²⁴ it deposits a green precipitate when heated to 30°. According to C. A. L. de Bruyn, 100 parts of methyl alcohol dissolve 68 parts of the salt at 15.5°; and, according to A. Étard, the sat. soln. at 22° contains 36.8 per cent.; at 40°, 37.5 per cent.; at 50°, 37.1 per cent.; and at 60°, 37.5 per cent. The mol. vol. of a mol of the salt in 1.979 to 126.656 litres of methyl alcohol ranges from 0.52 to 33.4. The mol. conductivity μ for a mol of CuCl_2 in v litres of methyl alcohol is $\mu=8.08$ when $v=1.997$; and $\mu=61.014$ when $v=225.616$. The corresponding degrees of ionization, α , are $\alpha=0.08$ and $\alpha=0.12$ respectively. H. C. Jones and W. R. Veazey have studied the electrical conductivity and the temp. coeff. of the conductivity of this salt in mixtures of methyl alcohol and water. F. W. O. de Coninck also found the dihydrated salt to be very soluble in methyl alcohol, forming a green or yellow soln. The anhydrous and dihydrated salts are both soluble in *ethyl alcohol*. E. Bödtker²⁵ found much heat to be developed in the former case, and a dark brown soln. is formed; in the latter case the colour of the soln. varies from green to yellow. According to C. A. L. de Bruyn, 100 parts of ethyl alcohol at 15.5° dissolves between 52.9 and 53.9 parts of the anhydrous salt; and, according to A. Étard, the

solubility rises from 25 per cent. at -20° to 45 per cent. at 55° . According to E. Böttker, if a drop of water is added to the alcoholic soln., crystals of $\text{CuCl}_2 \cdot 2\text{H}_2\text{O}$ are immediately precipitated, and if the alcoholic soln. be conc. in vacuo, crystals of *cupric dialcoholchloride*, $\text{CuCl}_2 \cdot 2\text{C}_2\text{H}_5\text{OH}$, are formed. H. C. Jones and C. F. Lindsay observed a maximum viscosity and a minimum conductivity in mixtures of alcohol and water, and W. M. Blanchard attributes this to the presence of a maximum in the amount of the associated cupric chloride molecules. The refractive indices of alcoholic soln. have been determined by C. Chéneveau; the thermal conductivity by W. von Beetz; the raising of the b.p. by H. Ley; the eq. conductivity by H. Ley; the mol. conductivity by V. Kohlschütter and M. Kutscheroff; and the electrical conductivity and the temp. coeff. of soln. in aq. alcohol by H. C. Jones and W. R. Veazey. According to A. Étard, a sat. soln. of the salt in normal *propyl alcohol* contains 30.9 per cent. of CuCl_2 at 19° , and 30.5 per cent. at 60° ; *isopropyl alcohol*, 11.0 per cent. at 32° , 28.3 per cent. at 70° , and 28.7 per cent. at 84° ; *allyl alcohol*, 23.4 per cent. at -20° , 23.3 per cent. at 32° ; and normal *butyl alcohol*, 15.8 per cent. at 23° , 16.1 per cent. at 55° , and 16.7 per cent. at 92° . F. W. O. de Coninck also found the dihydrated salt is very soluble in propyl, isobutyl, or *amyl alcohol*.

A conc. soln. of anhydrous cupric chloride in *acetone* is dark yellowish-green and, according to H. Ley,²⁶ after standing some weeks it becomes pale yellowish-brown, and its electrical conductivity increases. H. C. Jones and W. R. Veazey found that a compound is formed between cupric chloride and acetone; with long standing the soln. forms cuprous chloride. A sat. soln. at 20° contains 8.86 per cent. of $\text{CuCl}_2 \cdot 2\text{H}_2\text{O}$, and at 20° , 2.88 per cent. of CuCl_2 . According to A. Étard, and W. Eidmann, the solubility increases with rise of temp. rather more than is the case with ethyl alcohol. A. Naumann's value for the sp. gr. of a sat. soln. at 18° is 0.8154. H. Ley has measured the electrical conductivity and the b.p. of the soln. A. Naumann, and W. Eidmann report that stannous chloride precipitates cuprous chloride from the acetone soln.; ammonia gas precipitates $\text{CuCl}_2 \cdot 2\text{NH}_3$; arsenic, chromium, gold, and platinum do not act on the soln.; silver, magnesium, cadmium, copper, mercury, cobalt, nickel, lead, and bismuth act slowly forming cuprous chloride; iron acts slowly, zinc acts rather more quickly forming copper; aluminium and tin form both copper and cuprous chloride. The soln. of dihydrated cupric chloride in acetone is greenish-yellow.

Anhydrous *ether* dissolves a little anhydrous cupric chloride, 0.043 per cent. according to G. Böttker,²⁷ the soln. is greenish-yellow, and it is decolorized on exposure to light with the formation of cuprous chloride which, according to A. F. Gehlen and P. Rohland, is precipitated on the addition of water; it is also decolorized in a blue but not in a red flask, and when ammonia is added to the liquid no blue coloration appears. According to F. W. O. de Coninck, dihydrated cupric chloride is insoluble in ether, but, according to G. Böttker, 100 grms. of absolute ether dissolves 0.061 grm. of the chloride. The salt also dissolves in acidified ether forming a brown soln. 100 grms. of *ethyl acetate*, says E. Alexander, dissolves 0.4 part of CuCl_2 , forming a brown soln. of sp. gr. 0.9055 (18°); A. Étard says the solubility is 3 per cent. at -20° , and 1.3 per cent. at 72° ; and *ethyl formate*, 10.2 per cent. at -20° , 9.4 per cent. at 24° , and 7.2 per cent. at 50° .

Anhydrous cupric chloride forms double compounds or other products²⁸ with the *fatty amines*, *acetamide*, *piperidine*, *pyridine*, *quinoline*, *aniline*, *methylaniline*, *toluidine*, *naphthylamine*, *dimethylaniline*, *thiourea*, *methyl sulphide*, and with *ethyl sulphide* the soln. forms cuprous chloride when boiled for a long time. According to R. Varet, anhydrous cupric chloride and zinc cyanide in soln. or dry at 160° – 170° gives cyanogen, and this has been recommended as a convenient means of preparing this gas.

According to G. Bruni and A. Manuelli,²⁹ anhydrous cupric chloride is soluble in *urethane*; according to A. Werner, it is soluble in *benzonitrile* and the other aromatic nitriles. According to F. W. O. de Coninck, dihydrated cupric chloride dissolves in *formic acid*, *pyridine*, *α -picoline*, and *acetonitrile*; it is insoluble in *benzaldehyde*, *trimethylamine*, *aniline*, **o*-toluidine*, *methylene chloride*, *ethyl iodide*, *propyl iodide*, *ethylene bromide*, *benzene*, *toluene*, **o*-xylene*, *ligroin*, *nitrobenzene*, and *turpentine*; and is insoluble in cold but soluble in hot *glycol*, *glycerol*, *paraldehyde*, and *acetic acid*.

Chemical properties of cupric chloride.—M. C. Lea³⁰ did not succeed in transforming cupric into cuprous chloride by press.; and R. Abegg, and E. Wiedemann and G. C. Schmidt observed no change when the anhydrous salt is exposed to cathode rays. The anhydrous chloride deliquesces in air and forms the dihydrated salt. P. Fireman and E. G. Portner found anhydrous cupric chloride shows the first sign of dissociation at 344° ; when calcined in oxygen, H. Schulze found cuprio

chloride to be transformed into oxide with the evolution of chlorine; and when heated with a mixture of hydrogen chloride and oxygen, it stimulates the oxidation with the formation of chlorine as in Deacon's process for chlorine—probably forming an oxychloride. C. Poulenc found cupric chloride to be incompletely decomposed by hydrogen fluoride at 300°. The salt is reduced to the metal when heated in a stream of hydrogen, coal gas, or when heated with calcium carbide. According to F. Wöhler, if cupric chloride be fused in an atm. of ethylene, C_2H_4 , large bubbles of ethylene chloride, $C_2H_4Cl_2$, are evolved which ignite and burn with a red flame, forming hydrogen chloride and soot; copper and cuprous chloride are formed. E. Filhol and J. B. Senderens found that no sensible decomposition occurs when sulphur is heated with soln. of cupric chloride, nitrate, or sulphate; but W. Wardlaw and F. W. Pinkard showed that in the presence of conc., not dil., hydrochloric acid, about five per cent. of the cupric chloride is reduced: $6CuCl_2 + S + 4H_2O = 6CuCl + 6HCl + H_2SO_4$; and A. Manuelli found that when a soln. of cupric chloride acidified with hydrochloric acid is heated with sulphur in a sealed tube at 150°–180°, part of the cupric chloride is reduced to the cuprous salt. P. Fireman found cupric chloride is reduced to cuprous chloride when heated with ammonium chloride in a tube at 400°—hydrogen chloride, nitrogen, and ammonium chloride vapours are evolved. H. Rose showed that cupric chloride is not decomposed in the cold by sulphur trioxide vapour; and when melted with phosphorus, phosphorus pentachloride and cupric phosphide are formed; heated with phosphine, cupric phosphide and hydrogen chloride are produced. When heated with arsenic sulphide, cupric sulphide and arsenic trichloride are readily formed, but, according to C. F. Rammelsberg, not so readily with antimony sulphide. H. Feigel found that cupric chloride is converted by sulphur chloride into cupric sulphide. Nitrosyl chloride does not affect cupric chloride. T. S. Hunt said that when heated with ferrous oxide, cuprous chloride or copper is produced, and ferrous chloride and ferric oxide. K. Heumann obtained a brilliant orange-yellow powder, $CuCl.HgS$, by heating a mixture of cupric chloride and mercuric sulphide: $3HgS + 2CuCl_2 = 2(CuCl.HgS) + HgCl_2 + S$. According to G. Quincke, molten cupric chloride dissolves metallic copper. According to N. Dhar, when cupric chloride is boiled with organic acids—tartaric, citric, lactic, and malic acid—no reduction to the cuprous salts occurs, but if an oxidizing agent like potassium permanganate be present, reduction occurs. No precipitation of the cuprous salts occurs, but a complex remains in soln. Cupric oxalate is immediately precipitated from soln. of cupric chloride by oxalic acid.

Cupric oxychlorides.—When cupric chloride is exposed to the air, what appears to be an oxychloride is formed. A great number have been reported, but probably most of them are mixtures, and there is no guide in distinguishing chemical individuals from mixtures until they have been investigated in the light of the phase rule. For convenience, representing the mol. ratio $CuO : CuCl_2 : H_2O$ by numbers, the following eighteen basic cupric chlorides have been reported:

1.1.1 (G. Rousseau,³¹ and C. Reichard); 2.1.0 (R. Kane, and J. H. Gladstone); 2.1.3 (A. Scacchi, and C. F. Rammelsberg)—represented by the mineral *ateline*; 3.1.0 (M. Berthelot, and J. L. Proust); 3.1.1½ (A. Colson, and H. Baubigny); 3.1.2 (W. L. Miller and F. B. Kenrick); 3.1.3; 3.1.3½; 3.1.4; 3.1.4½ (F. Field, C. A. Burghardt and J. Tüttscheff)—represented by *atacamite* from Tocopilla (Bolivia); 3.1.5 (K. Kraut); 3.1.6 (P. Berthier, F. Field, and A. H. Church)—represented by the minerals *botallacite* (Cornwall), and *atacamite* from Tocopilla (Bolivia); 3½.1.4½ (F. Reindel); 4.1.6 (R. Kane); 4.1.8 (A. H. Church)—represented by the mineral *tallingite* (Cornwall); 6.1.9 (C. A. Neumann); 6.1.12 (A. H. Church)—found as a natural product in Cornwall; and 8.1.12 (G. A. König, and L. Darapsky)—represented by the mineral *footeite*. J. A. Hedvall and G. Booberg obtained 3.1.4 by the action of copper oxide on a mixture of alkali chlorides at 1000°, and heating for a long time with a soln. of alkali chloride.

The basic salt, $3CuO.CuCl_2.3H_2O$, or $3Cu(OH)_2.CuCl_2$, is regarded by A. Werner³² as a *hexolcupric chloride*, $[Cu(HO.Cu.OH)_3]Cl_2$; E. Ludwig supposes the copper

in the molecule to be quadrivalent; while J. Dupont and H. Jansen, finding that two-thirds of the water is lost at 200° , supposed the last molecule to be differently constituted: $\text{Cl}-\text{Cu}-\text{O}-\text{Cu}-\text{Cl}\cdot\text{H}_2\text{O}$; while A. Mailhe regards it as a tetracupric chloride. The mineral called *atacamite* has a composition which varies between 3.1.3 and 3.1.6; and which is usually taken to be 3.1.4; and to distinguish this from 3.1.3-salt, G. F. H. Smith proposed to call the latter *paratacamite*.

J. Dupont and H. Jansen prepared the 3.1.3-salt by heating a neutral dil. soln. of cupric chloride, or a mixture of cupric oxide and a soln. of cupric chloride, in a sealed tube at 225° ; P. Sabatier treated cupric oxide, CuO , hydroxide, $\text{Cu}(\text{OH})_2$, or the brown $4\text{CuO}\cdot\text{H}_2\text{O}$, with a hot or cold soln. of cupric chloride; A. Mailhe treated a soln. of cupric chloride with cold nickel hydroxide or carbonate, or with heated nickel oxide; A. Mailhe also obtained a blue precipitate by adding freshly precipitated mercuric oxide to a soln. of cupric chloride—the dry yellow or red oxide acts very slowly—according to H. Rose, only the oxide is precipitated. L. Sabbatani boiled a soln. of ammonium cuprichloride with water.

The bluish-green amorphous precipitate remains many hours in contact with water in a sealed tube unchanged. It begins to decompose at 200° , and at 250° forms a dark brown hygroscopic mixture of cupric chloride and oxide; and at a higher temp. water and hydrogen chloride are given off.

The 3.1.3-mineral paratacamite forms trigonal crystals; hardness, 3; sp. gr., 3.74; refractive index, 1.864. The 4.1.4-mineral atamacite forms emerald-, grass-, or dark green crystals which are rhombic bipyramids with axial ratios $a:b:c=0.6613:1:0.7515$; hardness, 3.0–3.5; sp. gr., 3.763–4.314.

M. Berthelot³³ synthesized the 4.1.4-mineral by exposing copper foil, moistened with hydrochloric acid or a soln. of ammonium chloride, to the action of air. The resulting green powder was washed. Sodium chloride and sulphuric acid can be used in place of hydrochloric acid. Copper foil can also be laid on a mush of copper sulphide, sodium chloride, and water. K. Kraut warmed a mixture of copper oxide and hydrochloric acid; C. Friedel heated a mixture of cuprous oxide with ferric chloride soln. for 48 hrs. in a sealed tube. Green crystals of artificial atacamite appeared. J. L. Proust made it by exposing moist cuprous chloride to the air, and removing the cupric chloride simultaneously formed by washing; M. Gröger passed air through a soln. of cuprous chloride in cupric chloride free from hydrochloric acid; E. Brun sat. a hot soln. of potassium, sodium, or ammonium chloride with cuprous chloride, and on cooling a crystalline powder separated out. G. Rousseau heated a mixture of cupric chloride soln. and magnesite in a sealed tube for three days at 180° – 200° ; J. L. Proust digested a soln. of cupric chloride with cupric hydroxide, or of cupric chloride mixed with a little alkali hydroxide; L. Bourgeois treated a soln. of cupric chloride with urea in a sealed tube at 130° . V. von Lang decomposed the double compound $\text{CuCl}_2\cdot 2\text{C}_5\text{H}_5\text{N}$ with boiling water; W. Crum boiled a soln. of cupric nitrate or sulphate with a little calcium or sodium hypochlorite; H. Debray heated a conc. soln. of sodium chloride with basic copper nitrate or copper tetrammino-sulphate for some days at 200° . The product of these reactions is a green powder, crystalline or amorphous. The heat of formation, according to M. Berthelot, $3\text{CuO} + \text{CuCl}_2 + 4\text{H}_2\text{O} = 23$ Cals. According to G. Rousseau and G. Tite,³⁴ the product scarcely loses any weight if dried for several days between 150° and 200° , between 210° and 220° it loses all its water and blackens; at 240° it begins to decompose. According to T. C. Cloud, when heated in a current of oxygen, cupric oxide remains, cuprous chloride sublimes. It is not soluble in water; it is decomposed by sulphuric acid. The so-called 3.1.3 $\frac{1}{2}$ -salt is probably the 3.1.4-salt. W. T. Casselmann, and F. Field obtained what was considered to be this product by treating a boiling soln. of cupric chloride with acetates of the alkali or alkaline earths, magnesium, zinc, cadmium, manganese, nickel, or cobalt; or by treating copper acetate under similar conditions with the chlorides in question. Formates, propionates, or valerates may be used instead of the acetate. F. Reindel, and J. Habermann have also studied this product.

REFERENCES.

- ¹ A. Scacchi, *Bull. Soc. Min.*, 1. 132, 1870; M. de la Durandière, *ib.*, 26. 135, 1904; A. Lacroix, *ib.*, 30. 219, 1907; P. Franco, *Rend. Accad. Napoli*, (3), 3. 192, 1899; J. L. Proust, *Ann. Chim. Phys.*, (1), 32. 26, 1800; *Journ. Phys.*, 51. 173, 1801.
- ² T. Rieckler, *Jahrb. prakt. Pharm.*, 10. 243, 1845.
- ³ J. L. Proust, *Ann. Chim. Phys.*, (1), 32. 26, 1879; (1), 59. 350, 1804; J. Davy, *Phil. Trans.*, 112. 169, 1812; J. H. Gladstone, *Journ. Chem. Soc.*, 8. 211, 1856; T. Graham, *Phil. Trans.*, 127. 47, 1837; A. Vogel, *Dingler's Journ.*, 136. 239, 1855; P. Sabatier, *Bull. Soc. Chim.*, (3), 1. 88, 1889; (3), 11. 549, 1894; (3), 13. 600, 1895; H. C. Jones and W. R. Veazey, *Zeit. phys. Chem.*, 61. 654, 1908; D. W. Horn, *Amer. Chem. Journ.*, 39. 203, 1908; H. M. Dawson and J. McCrae, *Journ. Chem. Soc.*, 77. 1245, 1900; K. Krafft, *Ber.*, 40. 4770, 1907; R. Kane, *Phil. Mag.*, (3), 8. 353, 1836; C. Hensgen, *Ber.*, 9. 1674, 1876; 10. 259, 1877.
- ⁴ D. Vitali, *L'Orosi*, 12. 225, 1889; G. Viard, *Compt. Rend.*, 135. 168, 1902.
- ⁵ F. W. O. de Coninck and L. Arzalier, *Bull. Acad. Belgique*, 714, 1907; C. E. Baker and A. W. Burwell, *U.S.A. Pat. No.* 841103, 1906; V. Vaillant, *Bull. Soc. Chim.*, (3), 33. 458, 1905; A. C. Becquerel, *Compt. Rend.*, 75. 1729, 1872.
- ⁶ H. Ley, *Zeit. phys. Chem.*, 22. 78, 1897; W. N. Hartley, *Journ. Chem. Soc.*, 28. 206, 1875; K. Kohlschütter, *Ber.*, 37. 1169, 1904.
- ⁷ J. C. G. de Marignac, *Mem. Soc. Phys. Genève*, 14. 219, 1855; O. Lehmann, *Zeit. Kryst.*, 1. 483, 1877; 8. 437, 1883; C. Friedländer, *ib.*, 3. 182, 1879; J. W. Retgers, *Zeit. phys. Chem.*, 5. 436, 1890; F. Rüdorff, *Pogg. Ann.*, 148. 456, 1873.
- ⁸ L. Playfair and J. P. Joule, *Mem. Chem. Soc.*, 2. 401, 1845; C. H. D. Bödeker, *Die Beziehungen zwischen Dichte und Zusammensetzung bei festen und liquiden Stoffen*, Leipzig, 1860; P. A. Favre and C. A. Valson, *Compt. Rend.*, 79. 968, 1874.
- ⁹ T. Carnelley, *Journ. Chem. Soc.*, 33. 273, 1878; T. Carnelley and W. C. Williams, *ib.*, 37. 126, 1880; A. Vogel, *Dingler's Journ.*, 136. 239, 1855; W. Hampe, *Zeit. Berg. Hüt. Sal.*, 21. 238, 1873; H. Rose, *Pogg. Ann.*, 38. 121, 1836; P. Sabatier, *Compt. Rend.*, 106. 1725, 1888; G. Rousseau, *ib.*, 110. 1262, 1890; H. Lescœur, *Ann. Chim. Phys.*, (7), 2. 96, 1894; *Bull. Soc. Chim.*, (3), 11. 549, 1894; E. Böttker, *Zeit. phys. Chem.*, 22. 506, 1897; F. Ephraim, *Ber.*, 50. 1069, 1917.
- ¹⁰ A. Werner, *Zeit. anorg. Chem.*, 15. 20, 1897; L. Rügheimer, *Ber.*, 36. 3030, 1903; L. Rügheimer and E. Rudolf, *Liebigs Ann.*, 339. 334, 1905; H. Ley, *Amer. Chem. Journ.*, 19. 753, 1897; *Zeit. phys. Chem.*, 22. 81, 1897; N. Castoro, *Gazz. Chim. Ital.*, 28. 317, 1898; G. Bruni and A. Manuelli, *Zeit. Elektrochem.*, 10. 602, 1904; W. Biltz, *Zeit. phys. Chem.*, 40. 199, 1902.
- ¹¹ P. A. Favre and J. T. Silbermann, *Ann. Chim. Phys.*, (3), 37. 450, 1853; M. Berthelot, *ib.*, (5), 15. 185, 1878; (7), 4. 464, 1895; (5), 20. 504, 1880; *Bull. Soc. Chim.*, (2), 31. 302, 1879; *Compt. Rend.*, 86. 628, 1878; 89. 967, 1879; J. Thomsen, *Journ. prakt. Chem.*, (2), 12. 271, 1875; (3), 18. 1, 1878; (2), 16. 323, 1877; T. Andrews, *Phil. Mag.*, (3), 32. 321, 426, 1848; P. Sabatier, *Bull. Soc. Chim.*, (3), 13. 600, 1895; L. T. Reicher and C. M. van Deventer, *Zeit. phys. Chem.*, 5. 559, 1890.
- ¹² L. T. Reicher and C. M. van Deventer, *Zeit. phys. Chem.*, 5. 560, 1890; A. Étard, *Ann. Chim. Phys.*, (7), 2. 528, 1894; F. Rüdorff, *Pogg. Ann.*, 116. 70, 1862; E. Chuard, *Arch. Phys. Nat. Genève*, (3), 19. 477, 1888; H. Lescœur, *Ann. Chim. Phys.*, (7), 2. 95, 1894; R. Engel, *ib.*, (6), 17. 353, 1889; A. Ditte, *ib.*, (5), 22. 561, 1881; *Compt. Rend.*, 92. 353, 1881; P. Sabatier, *ib.*, 106. 1725, 1888; *Bull. Soc. Chim.*, (3), 11. 549, 1894; H. Ley, *Zeit. phys. Chem.*, 22. 78, 1897; A. Werner, *Zeit. anorg. Chem.*, 9. 408, 1895.
- ¹³ B. Franz, *Journ. prakt. Chem.*, (2), 5. 286, 1872; H. C. Jones and H. P. Bassett, *Amer. Chem. Journ.*, 33. 576, 1905; H. C. Jones and J. N. Pearce, *ib.*, 38. 716, 1907; P. A. Favre and C. A. Valson, *Compt. Rend.*, 79. 968, 1874; G. Charpy, *Ann. Chim. Phys.*, (6), 29. 24, 1893; J. Traube, *Zeit. phys. Chem.*, 8. 30, 1895; J. Wagner, *ib.*, 5. 37, 1890; G. T. Gerlach, *Zeit. anal. Chem.*, 28. 468, 1889; W. W. J. Nicol, *Phil. Mag.*, (5), 18. 179, 1884; J. H. Hassenfratz, *Ann. Chim. Phys.*, (1), 28. 2, 1788; E. Irueste, *Ann. Soc. Espan. Fis. Quim.*, 13. 462, 1915.
- ¹⁴ J. Wagner, *Zeit. phys. Chem.*, 5. 37, 1890; H. Euler, *ib.*, 25. 538, 1898; H. Sentsis, *Compt. Rend.*, 118. 1132, 1894; J. Schuhmeister, *Sitzber. Akad. Wien*, 79. 612, 1879.
- ¹⁵ J. C. G. de Marignac, *Arch. Phys. Nat. Genève*, 55. 113, 1876; W. von Beetz, *Wied. Ann.*, 7. 435, 1879.
- ¹⁶ H. Lescœur, *Ann. Chim. Phys.*, (6), 16. 394, 1889; (7), 2. 95, 1894; T. Ewan and W. R. Ormandy, *Journ. Chem. Soc.*, 61. 775, 1892; W. Pieper, *Dampfspannungen wässriger und alkoholischer Salzlösungen*, Bonn, 1917.
- ¹⁷ A. Benrath, *Zeit. anorg. Chem.*, 54. 329, 1907; D. Isaachsen, *Zeit. phys. Chem.*, 8. 146, 1891.
- ¹⁸ W. Biltz and J. Meyer, *Zeit. phys. Chem.*, 40. 199, 1902; H. C. Jones and H. P. Bassett, *Amer. Chem. Journ.*, 33. 576, 1905; H. C. Jones and J. N. Pearce, *ib.*, 38. 716, 1907; H. C. Jones and F. H. Getman, *ib.*, 31. 327, 1904; D. Isaachsen, *Zeit. phys. Chem.*, 8. 145, 1891; S. Arrhenius, *ib.*, 2. 491, 1888; L. C. de Coppet, *Ann. Chim. Phys.*, (4), 25. 502, 1871; F. Rüdorff, *Pogg. Ann.*, 145. 599, 1871; R. Salvadori, *Gazz. Chim. Ital.*, 26. 237, 1896.
- ¹⁹ G. Chéneveau, *Compt. Rend.*, 138. 1483, 1904; B. Walter, *Wied. Ann.*, 42. 511, 1891, H. C. Jones and F. H. Getman, *Amer. Chem. Journ.*, 31. 327, 1904.
- ²⁰ A. A. Noyes, *Zeit. phys. Chem.*, 9. 603, 1892; D. Isaachsen, *ib.*, 8. 146, 1896; H. Ley,

ib., 22. 77, 1879; S. Arrhenius, *ib.*, 2. 490, 1888; J. H. van't Hoff and L. T. Reicher, *Rec. Trav. Chim. Pays-Bas*, 8. 322, 1889; T. Ewan, *Proc. Roy. Soc.*, 57. 131, 1894; R. Salvadori, *Gazz. Chim. Ital.*, 26. 237, 1896; G. Fousseureau, *Compt. Rend.*, 104. 1161, 1887; G. Vincenti, *Atti Accad. Torino*, 20. 869, 1885; M. Nozari, *Atti Accad. Lincei*, 42. 233, 1907; E. Wiedemann, *B. A. Rep.*, 243, 1887; *Wied. Ann.*, 41. 260, 1890; R. J. Holland, *ib.*, 50. 349, 1893; J. Trötsch, *ib.*, 41. 259, 1890; R. Overbeck, *Pogg. Ann.*, 155. 595, 1875; V. Kohlschütter, *Ber.*, 37. 1153, 1904; H. C. Jones and A. P. West, *Amer. Chem. Journ.*, 34. 409, 1905; H. C. Jones and J. N. Pearce, *ib.*, 38. 716, 1907; H. C. Jones and F. H. Getman, *ib.*, 31. 327, 1904; H. C. Jones and H. P. Bassett, *ib.*, 33. 576, 1905; H. C. Jones, *Hydrates in Aqueous Solution*, Washington, 1907; S. B. Watkins and H. G. Denham, *Journ. Chem. Soc.*, 115. 1269, 1919; G. Dickhaus, *Einfluss der Temperatur auf die Leitfähigkeit von Elektrolyten in wässriger Lösung*, Bonn, 1912.

²¹ G. Carrara, *Mém. Accad. Lincei*, (5), 4. 338, 1901; *Gazz. Chim. Ital.*, 33. i, 241, 1903; W. Bein, *Zeit. phys. Chem.*, 27. 1, 1898; 28. 439, 1898; G. N. Lewis, *ib.*, 52. 244, 1905; 56. 223, 1906; F. G. Donnan, *ib.*, 53. 317, 1905; V. Kohlschütter, *Ber.*, 37. 1153, 1904; V. Kohlschütter and M. Kutocheroff, *ib.*, 37. 3044, 1904; A. Chassy, *Ann. Chim. Phys.*, (6), 21. 241, 1890; W. C. D. Whetham, *Proc. Roy. Soc.*, 52. 284, 1892; *Phil. Trans.*, 184. A, 337, 1892; O. Masson, *ib.*, 192. A, 331, 1899; *Zeit. phys. Chem.*, 29. 501, 1898; A. A. Noyes and A. B. Blanchard, *ib.*, 36. 1, 1901; S. Lussana, *Atti Ist. Veneto*, (7), 4. 13, 1894; J. S. Bridges, *The Transference Numbers of Copper Chloride in Concentrated Solutions*, Boston, 1904; F. G. Donnan, H. B. Bassett, and J. J. Fox, *Journ. Chem. Soc.*, 81. 939, 1902; S. E. Watkins and H. G. Denham, *ib.*, 115. 1269, 1909; H. G. Denham, *Zeit. phys. Chem.*, 65. 64, 1909.

²² O. Liebknecht and A. P. Wills, *Ann. Physik*, (4), 1. 178, 1900; S. Meyer, *ib.*, (4), 1. 664, 1900; *Wied. Ann.*, 68. 325, 1899; 69. 236, 1899; *Ann.* 66. 698, 1898; J. Königsberger, *Ann. Physik*, (4), 6. 506, 1901; G. Chéneveau, *Journ. Phys.*, 9. 163, 1910; A. Heydweiller, *Zeit. Physik*, 3. 308, 1920.

²³ E. Wiedemann, *B. A. Rep.*, 346, 1887; W. Ostwald, *Gründlinien der anorganischen Chemie*, Leipzig, 1900; F. G. Donnan and H. Basset, *Journ. Chem. Soc.*, 81. 939, 1902; S. B. Watkins and H. G. Denham, *ib.*, 115. 1269, 1919; J. H. Gladstone, *ib.*, 8. 211, 1855; W. N. Hartley, *ib.*, 82. 401, 1903; G. N. Lewis, *Zeit. phys. Chem.*, 56. 223, 1906; 52. 222, 1905; W. Biltz, *ib.*, 40. 199, 1902; H. Ley, *ib.*, 22. 78, 1897; D. Isaachsen, *ib.*, 8. 148, 1891; W. Bein, *ib.*, 27. 50, 1898; R. Luther, *ib.*, 34. 488, 1900; 36. 385, 1901; B. E. Moore, *ib.*, 55. 641, 1906; A. Bijl, *ib.*, 61. 1, 1907; *Ber.*, 39. 1243, 1906; J. Traube, *ib.*, 23. 3582, 1890; H. W. Vogel, *ib.*, 11. 622, 1878; L. C. de Coppet, *Ann. Chim. Phys.*, (4), 23. 386, 1871; N. N. Tzuchanoff, *Journ. Russian Phys. Chem. Soc.*, 25. 151, 1893; Y. Shibata and K. Matsumoto, *Journ. Coll. Science Imp. Univ. Tokyo*, 41. 6, 1920; V. Kohlschütter, *Ber.*, 37. 1168, 1904; E. Chuard, *Arch. Sciences Genève*, (3), 19. 477, 1888; F. Rüdorff, *Pogg. Ann.*, 116. 64, 1862; *Proc. Roy. Soc.*, 85. A, 273, 1911; R. A. Houstoun, *Proc. Roy. Soc. Edin.*, 32. 40, 1912; A. R. Brown, *ib.*, 33. 44, 1913; R. A. Houstoun and A. H. Gray, *ib.*, 33. 137, 1913; R. C. Tichborne, *Chem. News*, 25. 134, 1872; W. N. Hartley, *Proc. Roy. Soc.*, 22. 243, 1874; A. Benrath, *Zeit. anorg. Chem.*, 54. 329, 1907; E. Solly, *Phil. Mag.*, (3), 22. 367, 1843; H. C. Jones and H. S. Uhler, *Amer. Chem. Journ.*, 37. 244, 1907; H. C. Jones and A. P. West, *ib.*, 34. 409, 1905; H. C. Jones and J. A. Anderson, *The Absorption Spectra of Solutions*, Washington, 1909; J. H. Lambert, *Photometria sive de mensura et gradibus luminis colorum et umbrarum*, Augsburg, 1760; A. Beer, *Pogg. Ann.*, 86. 78, 1856; G. Rudorf, *Jahrb. Rad. Elek.*, 3. 422, 1906; 4. 380, 1907; W. N. Hartley, *Trans. Roy. Soc. Dublin*, (2), 7. 253, 1900; *Proc. Roy. Soc.*, 22. 241, 1874; J. N. Lockyer and W. C. Roberts-Austen, *ib.*, 23. 344, 1875; F. Förster and O. Seidall, *Zeit. anorg. Chem.*, 14. 106, 1897; G. Bodländer and O. Storbeck, *ib.*, 14. 106, 1897; F. Förster and G. Coffetti, *Zeit. Elektrochem.*, 10. 736, 1904; M. von Bose, *ib.*, 5. 163, 1898; M. E. Heiberg, *ib.*, 9. 137, 1903; E. Abel, *ib.*, 9. 268, 1903; H. E. Armstrong, *Journ. Chem. Soc.*, 53. 125, 1888; E. C. Baly and C. H. Desch, *ib.*, 93. 1747, 1908; T. Bailey, *ib.*, 37. 828, 1880; 39. 362, 1881; *Chem. News*, 42. 242, 1880; 43. 244, 1881; *Phil. Mag.*, (5), 5. 222, 1878; J. H. Gladstone, *ib.*, (4), 14. 418, 1857; T. Ewan, *ib.*, (5), 33. 317, 1892; *Proc. Roy. Soc.*, 56. 286, 1894; W. Coblentz, *Phys. Rev.*, (1), 25. 136, 1907; H. Knoblauch, *Wied. Ann.*, 43. 738, 1891; V. Klatt and P. Lenard, *ib.*, 38. 90, 1889; P. Glan, *ib.*, 3. 65, 1878; E. Müller, *Ann. Physik*, (4), 12. 767, 1903; H. C. Jones and W. W. Strong, *A Study of the Absorption Spectra*, Washington, 1910; H. C. Jones, *Hydrates in Aqueous Solution*, Washington, 1907; A. Ditte, *Compt. Rend.*, 92. 353, 1881; H. C. Jones and H. P. Bassett, *Amer. Chem. Journ.*, 33. 534, 1905; 34. 290, 1905; S. U. Pickering, *Journ. Chem. Soc.*, 105. 464, 1914; F. H. Getman, *Journ. Phys. Chem.*, 26. 217, 1922.

²⁴ A. Étard, *Ann. Chim. Phys.*, (7), 2. 503, 1894; *Compt. Rend.*, 114. 113, 1893; F. W. O. de Coninck, *ib.*, 131. 58, 1900; P. Rohland, *Zeit. anorg. Chem.*, 18. 329, 1898; C. A. L. de Bruyn, *Rec. Trav. Chim. Pays-Bas*, 11. 112, 1892; G. Carrara and M. G. Levi, *Gazz. Chim. Ital.*, 30. 206, 1900; H. C. Jones and W. R. Veazey, *Zeit. phys. Chem.*, 61. 44, 1908.

²⁵ E. Böttker, *Zeit. phys. Chem.*, 22. 506, 1897; H. Ley, *ib.*, 22. 77, 1897; H. C. Jones, C. F. Lindsay, and C. G. Carroll, *ib.*, 56. 129, 1906; H. C. Jones and W. R. Veazey, *ib.*, 61. 641, 1908; 62. 44, 1908; C. A. L. de Bruyn, *Rec. Trav. Chim. Pays-Bas*, 11. 112, 1892; A. Étard, *Ann. Chim. Phys.*, (7), 2. 503, 1894; W. M. Blanchard, *Journ. Amer. Chem. Soc.*, 26. 1315, 1904; W. A. Noyes and W. M. Blanchard, *ib.*, 22. 726, 1901; C. Chéneveau, *Compt. Rend.*, 142. 1520, 1906; F. W. O. de Coninck, *ib.*, 131. 58, 1900; W. von Beetz, *Wied. Ann.*, 7. 435, 1879; W. Hampe, *Chem. Ztg.*, 11. 816, 1887; V. Kohlschütter and M. Kutscheroff, *Ber.*, 37. 3049, 1904.

²⁶ H. Ley, *Zeit. phys. Chem.*, 22. 83, 1897; H. C. Jones and W. R. Veazey, *ib.*, 61. 641, 1908;

62. 44, 1908; W. Eidmann, *Ein Beitrag zur Erkenntnis des Verhaltens chemischer Verbindungen in nichtwässrigen Lösungen*, Giessen, 1899; *Zeit. anorg. Chem.*, 23. 89, 1900; A. Naumann, *Ber.*, 37. 4329, 1904; V. Kohlschütter and M. Kutscheroff, *ib.*, 37. 3049, 1904; A. Etard, *Ann. Chim. Phys.*, (7), 2. 503, 1894.

²⁷ W. Hampe, *Chem. Ztg.*, 11. 816, 1887; P. Rohland, *ib.*, 23. 581, 1899; E. Böttker, *Zeit. phys. Chem.*, 22. 506, 1897; A. F. Gehlen, *Gehlen's Journ.*, 3. 570, 1804; A. Vogel, *Journ. Pharm.*, 1. 196, 1816; F. W. O. de Coninck, *Compt. Rend.*, 131. 58, 1900; R. C. Tichborne, *Chem. News*, 25. 134, 1872; E. Alexander, *Reaktionen von Salzen in Acetylacetat*, Giessen, 1899; A. Étard, *Ann. Chim. Phys.*, (7), 2. 503, 1894.

²⁸ A. Werner, *Zeit. anorg. Chem.*, 15. 34, 1897; J. Schröder, *Reaktionen von Metallsalzen in Pyridin*, Giessen, 1901; A. Naumann, *Ber.*, 37. 4612, 1904; B. Ath Rke, *ib.*, 14. 1774, 1881; W. Meyerhoffer, *Monatsh.*, 14. 165, 1893; G. André, *Compt. Rend.*, 102. 115, 1886; R. Varet, *ib.*, 106. 1080, 1888; F. C. Phillips, *Journ. Amer. Chem. Soc.*, 23. 250, 1901.

²⁹ G. Bruni and A. Manuelli, *Zeit. Elektrochem.*, 11. 862, 1905; A. Werner, *Zeit. anorg. Chem.*, 15. 34, 1897; F. W. O. de Coninck, *Compt. Rend.*, 131. 58, 1900.

³⁰ H. Feigl, *Verhalten von Schwermetallverbindungen gegen Polysulfide und Chlorschwefel*, Erlangen, 1905; M. C. Lea, *Zeit. anorg. Chem.*, 6. 351, 1894; R. Abegg, *Zeit. Elektrochem.*, 4. 119, 1897; E. Wiedemann and G. C. Schmidt, *Wied. Ann.*, 56. 204, 1895; P. Fireman and E. G. Portner, *Journ. Phys. Chem.*, 8. 503, 1904; P. Fireman, *Journ. Amer. Chem. Soc.*, 26. 746, 1904; H. W. Hake, *Proc. Chem. Soc.*, 13. 147, 1897; W. N. Hartley, *Journ. Chem. Soc.*, (2), 7. 313, 1901; J. J. Sudborough, *ib.*, 59. 658, 1891; N. Dhar, *ib.*, 111. 690, 1917; H. Schulze, *Journ. prakt. Chem.*, (2), 21. 407, 1880; C. Poulenc, *Ann. Chim. Phys.*, (7), 2. 71, 1894; A. Manuelli, *Mém. Accad. Lincei*, (5), 15. i, 703, 1906; H. Rose, *Pogg. Ann.*, 38. 121, 1836; 27. 117, 1833; F. Wöhler, *ib.*, 13. 297, 1828; C. F. Rammelsberg, *Sitzber. Akad. Berlin*, 79, 1881; T. S. Hunt, *Compt. Rend.*, 69. 1357, 1869; K. Heumann, *Ber.*, 7. 1390, 1874; G. Quincke, *Wied. Ann.*, 36. 270, 1889; E. Filhol and J. B. Senderens, *Compt. Rend.*, 93. 152, 1881; W. Wardlaw and F. W. Pinkard, *Journ. Chem. Soc.*, 121. 210, 1922.

³¹ G. Rousseau, *Compt. Rend.*, 110. 1262, 1892; C. Reichard, *Pharm. Ztg.*, 50. 214, 1905; R. Kane, *Ann. Chim. Phys.*, (2), 79. 277, 1839; J. L. Proust, *ib.*, (1), 32. 26, 1799; (1), 59. 350, 1804; M. Berthelot, *ib.*, (5), 23. 566, 1881; *Bull. Soc. Chim.*, (2), 35. 365, 1882; *Compt. Rend.*, 91. 450, 1880; A. Colson, *ib.*, 140. 274, 1905; H. Baubigny, *ib.*, 97. 906, 1883; J. H. Gladstone, *Journ. Chem. Soc.*, 8. 211, 1855; F. Field, *ib.*, 7. 193, 1855; A. H. Church, *ib.*, 17. 81, 212, 1866; A. Scacchi, *Contribuzione Mineralogia*, Napoli, 2. 22, 1885; C. F. Rammelsberg, *Handbuch der Mineralchemie*, Berlin, 1886; W. L. Miller and F. B. Kenrick, *Trans. Roy. Soc. Canada*, (2), 8. 35, 1902; C. A. Burghardt, *Chem. News*, 37. 215, 1878; J. Tütttscheff, *Zeit. Chem.*, (2), 6. 110, 1870; K. Kraut, *Liebig's Ann.*, 266. 297, 1891; P. Berthier, *Ann. Mines*, (3), 7. 542, 1835; C. A. Neumann, *Repert. Pharm.*, 37. 304, 1831; L. Darapsky, *Jahrb. Min.*, 2. ii, 1, 1889; G. A. König, *Zeit. Kryst.*, 19. 601, 1891; F. Reindel, *Journ. prakt. Chem.*, (1), 106. 378, 1869; J. A. Hedvall and G. Booberg, *Zeit. anorg. Chem.*, 119. 213, 1921.

³² A. Werner, *Ber.*, 40. 4444, 1907; E. Ludwig, *Liebig's Ann.*, 169. 74, 1873; J. Dupont and H. Jansen, *Bull. Soc. Chim.*, (3), 9. 193, 1893; A. Mailhe, *Ann. Chim. Phys.*, (7), 27. 365, 394, 1902; *Compt. Rend.*, 132. 1275, 1901; P. Sabatier, *ib.*, 125. 103, 1897; G. F. H. Smith, *Zeit. Kryst.*, 43. 28, 1907; H. Rose, *Pogg. Ann.*, 107. 278, 1859; L. Sabbatani, *Ann. Chimica*, 1, 1898.

³³ L. Bourgeois, *Bull. Soc. Min.*, 13. 66, 1890; *Bull. Soc. Chim.*, (3), 3. 500, 1890; J. L. Proust, *ib.*, (1), 32. 48, 1799; A. Vogel, *Dingler's Journ.*, 136. 238, 1855; M. Gröger, *Zeit. anorg. Chem.*, 28. 158, 1901; M. Berthelot, *ib.*, (3), 11. 859, 1894; *Compt. Rend.*, 118. 764, 1894; *Ann. Chim. Phys.*, (7), 4. 546, 1895; (5), 20. 504, 1880; C. Friedel, *Compt. Rend.*, 77. 214, 1873; E. Brun, *ib.*, 109. 66, 1889; G. Rousseau and G. Tite, *ib.*, 113. 193, 1891; V. von Lang, *Ber.*, 21. 1581, 1888; K. Kraut, *Liebig's Ann.*, 266. 297, 1891.

³⁴ C. Friedel, *Compt. Rend.*, 77. 214, 1873; G. Rousseau and G. Tite, *ib.*, 113. 193, 1891; A. C. Becquerel, *ib.*, 71. 197, 1870; E. Brun, *ib.*, 109. 66, 1889; *Bull. Soc. Chim.*, (3), 2. 211, 1889; H. Debray, *ib.*, (2), 7. 104, 1867; F. Field, *Phil. Mag.*, (4), 24. 123, 1862; W. Crum, *Liebig's Ann.*, 55. 213, 1845; T. C. Cloud, *Chem. News*, 34. 254, 1876; F. Field, *Journ. Chem. Soc.*, 26. 575, 1873; F. Reindel, *Journ. prakt. Chem.*, (1), 106. 378, 1869; J. Habermann, *Sitzber. Akad. Wien*, 90. 268, 1884; *Monatsh.*, 5. 439, 1884; W. T. Casselmann, *Liebig's Ann.*, 98. 213, 1856.

§ 17. Complex Salts of Cupric Chloride

The solubility of cupric chloride in hydrochloric acid first decreases as the proportion of the acid increases and reaches a minimum when about 20 per cent. of HCl is present. The following is a selection from R. Engel's results¹ with the conc. expressed in milligram eq. $\frac{1}{2}$ CuCl₂—per 100 c.c. at 0°:

HCl	0	4.5	10.5	37.5	70.25	102.5	128.0
CuCl ₂	91.75	86.8	79.35	50.0	22.8	23.5	26.7
Sp. gr.	1.490	1.475	1.435	1.319	1.231	1.288	1.323

The increase in solubility is attributed to the formation of complexes. R. Engel obtained dark red needles of the compound **trihydrated cupric hydro-trichloride**, $\text{CuCl}_2 \cdot \text{HCl} \cdot 3\text{H}_2\text{O}$, by passing hydrogen chloride over dihydrated cupric chloride, or by saturating a soln. of about 20 per cent. cupric chloride at 20° – 25° with hydrogen chloride, and cooling the product to 0° . The compound can be regarded as a **trichlorocupric acid**, $\text{HCuCl}_3 \cdot 3\text{H}_2\text{O}$, corresponding with the sodium, ammonium, and rubidium salts. This product rapidly loses hydrogen chloride in dry air and becomes green; and the green crystals become red again in a stream of hydrogen chloride. According to A. Naumann and E. Alexander, when the yellowish-brown soln. of cupric chloride in ethyl acetate is treated with dry hydrogen chloride, a brown mass is obtained which becomes green on exposure to air. W. Eidmann found a similar product is formed when a soln. of cupric chloride in acetone is similarly treated. It is readily soluble in water, and its composition corresponds with cupric dihydro-tetrachloride, $\text{CuCl}_2 \cdot 2\text{HCl}$, or tetrachlorocupric acid, H_2CuCl_4 ; P. Sabatier obtained hyacinth-red needles of the **penta hydrated cupric dihydro-tetrachloride**, $\text{CuCl}_2 \cdot 2\text{HCl} \cdot 5\text{H}_2\text{O}$, by leading hydrogen chloride into a soln. of cupric chloride sat. with hydrogen chloride, and cooling the brown product to -10° . It loses hydrogen chloride on exposure to air, forming dihydrated cupric chloride. G. Naumann obtained red needles of **cupric trihydro-pentachloride**, $\text{CuCl}_2 \cdot 3\text{HCl}$, or **pentachloro-cupric acid**, H_3CuCl_5 , by passing chlorine and hydrogen chloride into a soln. of 18 grms. of $\text{CuCl}_2 \cdot 2\text{H}_2\text{O}$ in 45 c.c. of water, and after standing for an hour separating the crystals by means of a suction filter.

A. Chassevant² found that transparent garnet-red crystals of the double chloride of lithium and copper were formed when conc. soln. of eq. amounts of cupric and lithium chlorides are mixed together and the magma evaporated in vacuo over phosphoric acid or on a water-bath. The green crystals of cupric chloride first formed dissolve forming a red soln., and this deposits crystals of the double salt which A. Chassevant regarded as $\text{CuCl}_2 \cdot \text{LiCl} \cdot 2\frac{1}{4}\text{H}_2\text{O}$, but which W. Meyerhoffer showed to be **dihydrated lithium trichlorocuprate**, $\text{CuCl}_2 \cdot \text{LiCl} \cdot 2\text{H}_2\text{O}$. W. Meyerhoffer found the saturation curve of the double salt and lithium chloride to be $0.67\text{CuCl}_2 + 30.8\text{LiCl}$ per 100 mols of water at 14.6° , and $4.00\text{CuCl}_2 + 50.9\text{LiCl}$ at 98.6° ; while the saturation curve of the double salt and dihydrated cupric chloride at 18.3° is $4.04\text{CuCl}_2 + 21.0\text{LiCl}$ at 18.3° and $14.22\text{CuCl}_2 + 19.4\text{LiCl}$ at 98.5° . In this temp. interval the double salt is decomposed by the water, and it is present in aq. soln. only when an excess of lithium chloride is present. F. A. H. Schreinemakers and A. C. Noorduynd studied the ternary system, $\text{LiCl} - \text{CuCl}_2 - \text{H}_2\text{O}$, at 30° , and found dihydrated lithium cuprichloride to be the only double salt formed.

Fig. 28 represents an equilateral triangle, PQR , with each side divided into 10 equal parts and with lines parallel to each of the three sides. If the apices be taken to represent pure components; points on the sides of the triangle will represent corresponding binary mixtures; and points in the interior of the triangle ternary mixtures. The vertical distance of any line from the side opposite the apex represents the percentage amount of that constituent in the ternary mixture. The area ABC represents sat. soln. which for equilibrium deposit dihydrated cupric chloride, and CB represents the composition of a sat. soln. of this salt at 30° when in equilibrium with the solid phase; A represents the solid salt. Similarly, the region BDC represents a sat. soln. which for equilibrium deposit the double salt $\text{CuCl}_2 \cdot \text{LiCl} \cdot 2\text{H}_2\text{O}$, and BD represents a sat. soln. of the solid in equilibrium with the solid phase. Likewise also the area DEF and the line DF with respect to the solid phase

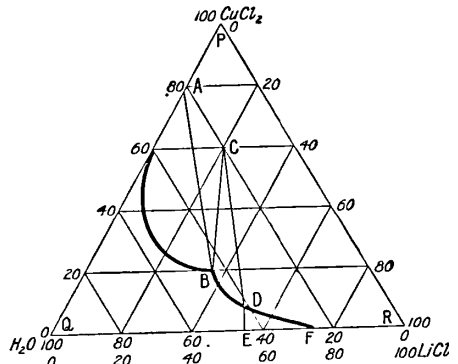

FIG. 28.—Equilibrium Diagram for the Ternary System, $\text{CuCl}_2 - \text{LiCl} - \text{H}_2\text{O}$, at 30° .

$\text{LiCl} \cdot \text{H}_2\text{O}$. The above data for the mutual solubilities of the two chlorides are plotted in Fig. 29. Points in the area $ABDQ$ represent unsaturated soln.; points on the line AB represent sat. soln. of sodium chloride, in the presence of cupric chloride— A represents the

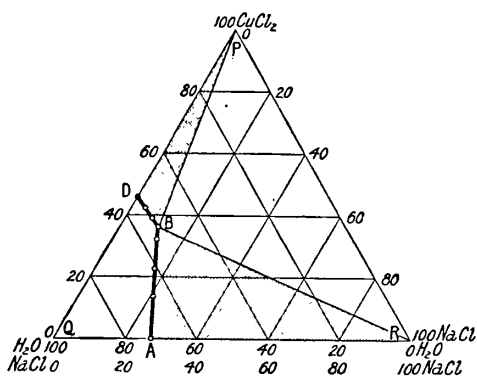

Fig. 29.—Equilibrium Diagrams for the Ternary System, CuCl_2 — NaCl — H_2O , at 30° .

solubility of sodium chloride in water at 30° , and D , that of cupric chloride—points on DB represent sat. soln. of cupric chloride in the presence of sodium chloride; the point B represents a soln. sat. with respect to both sodium chloride and cupric chloride. Soln. represented by points in the sector BDP represent soln. which for equilibrium break up into a sat. soln. and $\text{CuCl}_2 \cdot 2\text{H}_2\text{O}$ as a solid phase; points in the sector ABR represent soln. which for equilibrium break up into sat. soln. and NaCl as a solid phase; and points in the sector BRP represent soln. which for equilibrium break up into a sat. soln. with both NaCl and $\text{CuCl}_2 \cdot \text{H}_2\text{O}$ as two solid phases. The triangular diagram, Fig. 30, for the ternary system, CuCl_2 — NH_4Cl — H_2O , is a step more complicated.

When crystals of the double salt are exposed to the air, they become opaque and decompose, forming crystals of dihydrated cupric chloride and deliquescent lithium chloride. The salt is also decomposed by water, but can be recovered by crystallization from a soln. of lithium chloride. The crystals melt in their water of crystallization when rapidly heated to 130° , forming a black liquid which, like lithium chloride, when heated to a higher temp., decomposes with the evolution of chlorine; if slowly heated between 100° and 120° , they become anhydrous and at the same time lose some hydrochloric acid; the crystals are best dehydrated by heating to 120° in a stream of dry air mixed with hydrogen chloride. L. Cambi has prepared dark red $\text{LiCuCl}_3 \cdot \text{HCOOH}$ and yellowish-red $\text{LiCuCl}_3 \cdot \text{CH}_3\text{CN}$ by crystallization respectively from formic acid and acetonitrile.

T. S. Hunt³ has made a few determinations of the solubilities of cupric chloride in soln. of sodium chloride of different conc. between 11° and 90° . No double salt has been made. M. Siewert also failed to crystallize a *sodium chlorocuprocuprate*, which he claims to have obtained as an oily liquid by boiling a soln. containing cupric, cuprous, and sodium chlorides in the mol. proportions 1 : 2 : 2, and adding a mixture of alcohol and ether. F. A. H. Schreinemakers and F. W. C. de Baat have investigated the ternary system, CuCl_2 — NaCl — H_2O , and found no evidence of the formation of a double compound. The following numbers are selected from their data, representing the percentage solubility of cupric chloride in soln. of sodium chloride at 30° :

NaCl	.	0	4.28	6.41	10.25	12.25	15.40	20.61	26.47
CuCl_2	.	43.95	41.06	39.40	36.86	32.40	23.72	11.03	0

O. Hautz⁴ reported that blue crystals of the double chloride, *dihydrated ammonium trichlorocuprate*, $\text{CuCl}_2 \cdot \text{NH}_4\text{Cl} \cdot 2\text{H}_2\text{O}$, are obtained by mixing eq. quantities of cupric and ammonium chloride in aq. soln.—one prepared by neutralizing copper carbonate with hydrochloric acid, and the other by neutralizing ammonia with the same acid. The crystals are soluble in twice their weight of water. P. P. Dehérain made the same salt by dissolving cupric amino-chloride in hydrochloric acid. According to P. A. Meerburg, O. Hautz's salt is not stable in aq. soln. in the vicinity of 11° , and he doubts if it is a chemical individual. The ternary system, CuCl_2 — NH_4Cl — H_2O , at 11° , shows no evidence of Hautz's compound.

The results are indicated in Fig. 30. The curve $ABCD$ is plotted from the following observations, where 100 grms. of a sat. soln. at 30° contain:

CuCl_2	.	0	1.9	3.6	10.5	19.9	29.4	41.4	43.2	43.9
NH_4Cl	.	29.5	28.6	25.9	16.5	9.4	4.9	2.1	2.0	0

The curve *AB* represents the composition of soln. in equilibrium with ammonium chloride whose solubility in water at 30° is represented by the point *A*; the line *DC* represents similarly the composition of soln. in equilibrium with dihydrated cupric chloride; and the curve *BC* represents the solubility of dihydrated ammonium cupri-tetra chloride. The quadruple points *B* and *C* represent the composition of soln. in equilibrium with two solid phases, $\text{CuCl}_2 \cdot 2\text{NH}_4\text{Cl} \cdot 2\text{H}_2\text{O}$ respectively with NH_4Cl and with $\text{CuCl}_2 \cdot 2\text{H}_2\text{O}$. The composition of unsaturated soln. at 30° is included. Within the region *ABCDQ* the soln. is unsaturated; and the composition of soln. which separates at 30° into one or two solid phases is included in the region *ABCDPR*. All points in the sector *ABR* represent soln. which form a soln. and solid ammonium chloride; *BCX*, soln. and solid $\text{CuCl}_2 \cdot 2\text{NH}_4\text{Cl} \cdot 2\text{H}_2\text{O}$; *CDT*, soln. and solid $\text{CuCl}_2 \cdot 2\text{H}_2\text{O}$; *BXR*, soln. and two solid phases NH_4Cl and $\text{CuCl}_2 \cdot 2\text{NH}_4\text{Cl} \cdot 2\text{H}_2\text{O}$; *CTX*, soln. and the two solid phases $\text{CuCl}_2 \cdot 2\text{H}_2\text{O}$ and $\text{CuCl}_2 \cdot 2\text{NH}_4\text{Cl} \cdot 2\text{H}_2\text{O}$; and *TPR*, systems which separate into three solid phases NH_4Cl , CuCl_2 , and $\text{CuCl}_2 \cdot 2\text{H}_2\text{O}$. The point *a* represents the salt 1.2.2; *b*, the salt 1.2.1; and *c*, the salt 1.2.4, none of which finds a place in this diagram as a chemical individual at 30°, and a further quest between -11° and 80° likewise proved nugatory.

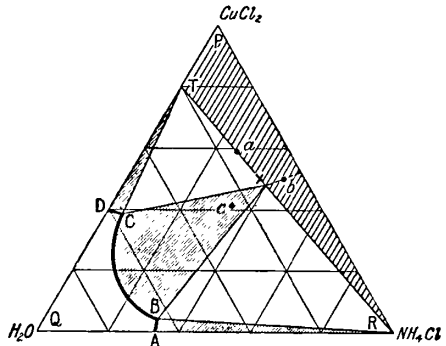

FIG. 30.—Equilibrium Curves for Ternary Systems, CuCl_2 — NH_4Cl — H_2O . at 30°.

The 1.2.2-double chloride, *i.e.* dihydrated ammonium chlorocuprate, $\text{CuCl}_2 \cdot 2\text{NH}_4\text{Cl} \cdot 2\text{H}_2\text{O}$, was prepared by A. Vogel by mixing soln. of cupric sulphate and ammonium chloride; the first crop of crystals was a double sulphate of the two bases, then followed crystals of the 1.2.2-double chloride. The same salt was more conveniently prepared, by T. Graham, and E. Mitscherlich,⁵ by mixing conc. soln. of dihydrated cupric chloride and ammonium chloride in mol. proportions. P. A. Cap and O. Henry made it by evaporating a soln. formed by adding ammonia to a soln. of cupric chloride until the precipitate first formed redissolved. A. Bouzat made the salt in an analogous manner; R. H. Brett crystallized the soln. obtained by dissolving cupric oxide, hydroxide, or carbonate in a soln. of ammonium chloride; and P. P. Dehérain, by dissolving cupric diammino-chloride in hydrochloric acid.

According to G. Wyruboff, the pale blue crystals form ditetragonal bipyramids which have the axial ratios: $a : c = 1 : 0.7417$. According to O. Lehmann, this salt forms mixed crystals with ammonium chloride, the double salt, $3\text{NH}_4\text{Cl} \cdot \text{FeCl}_3$ (bluish-green), and cobalt chloride (rose-red). G. Tschermak gives the sp. gr. 2.066; A. Johnsen, 2.01; G. Wyruboff, 1.963. V. von Lang found the ratio of the thermal conductivities parallel and vertical to the chief axis to be in the ratio 1 : 0.93; he also found the crystals to be paramagnetic. A. de Sénarmont showed that the crystals have a negative double refraction with refractive indices for the *D*-line $\omega = 1.744$, $\epsilon = 1.724$. According to A. Bouzat, the heat of formation, $\text{CuCl}_2 \cdot 2\text{NH}_3(\text{solid}) + \text{HCl}(\text{gas}) = 38.9$ Cals., and in soln., 31.75 Cals. The solubility, according to P. A. Meerburg, rises steadily from 20.46 per cent. of $\text{CuCl}_2 \cdot 2\text{NH}_4\text{Cl}$ at -10° to 43.36 per cent. at 80°; or,

$\text{CuCl}_2 \cdot 2\text{NH}_4\text{Cl}$	-10.5°	-10.8°	-11°	-10°	0°	20	50°	80°
	3.87	20.12	20.3	20.46	22.02	25.95	33.24	43.36
Solid phase	ice			←Both→		$\text{CuCl}_2 \cdot 2\text{NH}_4\text{Cl} \cdot 2\text{H}_2\text{O}$		

H. L. Maxwell found by diffusion experiments evidence of the partial separation of the complex in aq. soln. into its component salts. H. C. Jones and H. P. Bassett have measured the electrical conductivity and the lowering of the f.p.; the latter has also been determined by P. A. Meerburg, and by F. Rüdorff. Soln. with a mol of the salt per litre are approximately 43.6 per cent. ionized, and soln. with 0.05 mol

per litre 83.2 per cent. According to W. Meyerhoffer, the sat. soln. freezes at -13° , at -18° in the presence of ammonium chloride, and at -30° in the presence of dihydrated cupric chloride. Aqua ammonia precipitates a basic chloride from the aq. soln., and, according to R. Engel, hydrogen chloride gas precipitates the salt from its aq. soln. The crystals lose their water completely when heated between 110° and 120° —without decomposition, said C. Temme; with the loss of ammonium chloride, said T. Graham. According to W. Meyerhoffer, the transition temp., $\text{CuCl}_2 \cdot 2\text{NH}_4\text{Cl} \cdot 2\text{H}_2\text{O} \rightleftharpoons \text{CuCl}_2 \cdot \text{NH}_4\text{Cl} + \text{NH}_4\text{Cl} + 2\text{H}_2\text{O}$, is 146° . According to P. A. Cap and O. Henry, the crystals decompose when strongly heated with the loss of ammonium chloride, and the formation of some acid vapour and cuprous chloride. The aq. soln. of ammonium cupric tetrachloride dissolves iron but not carbon, and consequently a conc. soln. with about 5 per cent. of hydrochloric acid can be used for the determination of carbon in steel. The soln. decomposes when heated with ferrous sulphide. According to E. C. Franklin and C. A. Kraus, the salt is soluble in liquid ammonia; and, according to P. A. Cap and O. Henry, it dissolves in alcohol without decomposition.

P. A. Meerburg could find no evidence of the 1.2.1 monohydrated salt, $\text{CuCl}_2 \cdot 2\text{NH}_4\text{Cl} \cdot \text{H}_2\text{O}$, reported by P. A. Cap and O. Henry; nor of the 1.2.3 trihydrated salt reported by L. Bourgeois; nor of the tetrahydrated salt reported by F. Rüdorff, K. Heumann, and P. A. Cap and O. Henry. Nor is there any satisfactory evidence of P. P. Dehérain's $\text{CuCl}_2 \cdot 4\text{NH}_4\text{Cl}$, or of his $\text{CuCl}_2 \cdot 6\text{NH}_4\text{Cl}$. H. Ritthausen obtained cubic crystals of ammonium diammino-tetrachlorocuprate, $\text{CuCl}_2 \cdot 2\text{NH}_4\text{Cl} \cdot 2\text{NH}_3$, in the mother liquid remaining after the precipitation of ammonium cupric tetrachloride.

F. A. H. Schreinemakers and A. C. Noorduyn⁶ have investigated the ternary system, CuCl_2 — LiCl — H_2O , at 30° . W. Meyerhoffer has investigated the conditions of equilibrium for part of the ternary system, CuCl_2 — KCl — H_2O , and established the existence of the two double salts, $\text{CuCl}_2 \cdot 2\text{KCl} \cdot 2\text{H}_2\text{O}$ and $\text{CuCl}_2 \cdot \text{KCl}$, which can be conveniently represented as the 1.2.2-salt and the 1.1-salt respectively. The system has three components, CuCl_2 , KCl , and H_2O . From the phase rule, therefore, bivariant systems will have three phases—one solid, a liquid, and a vapour; univariant systems will have four phases—two solids, a liquid, and a vapour; and invariant systems, five phases—three solids, a liquid, and a vapour. W. Meyerhoffer's experiments, ranging between 39° and 92° , may be represented on a triangular diagram as indicated by W. D. Bancroft, but they cover only a small portion of the field. The triangular diagrams, Figs. 30 and 31, represent isothermal systems. If the apices of a triangle also represent the m.p. of the components, and the temp. of points on the sides of the triangle are known, a series of isothermal curves can be drawn for the interior of the triangle, and thus not only composition, but a rough idea of the corresponding temp. can be obtained.

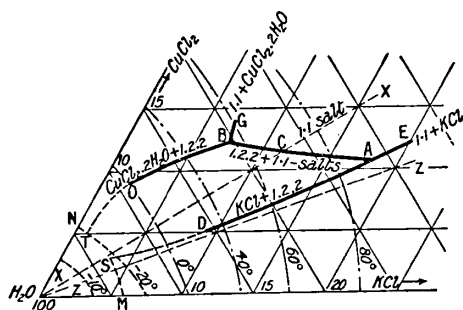

FIG. 31.—Equilibrium Curves of Portion of the Ternary System, CuCl_2 — KCl — H_2O , between -25° and 100° .

the 1.2.2-salt appears at both *S* and *T*. Each of these points, therefore, represents an invariant system with three solid phases, liquid, and vapour; but this portion of the diagram has not been closely investigated. Along a curve connecting *S* and

points on the sides of the triangle are known, a series of isothermal curves can be drawn for the interior of the triangle, and thus not only composition, but a rough idea of the corresponding temp. can be obtained. In Fig. 31, *M* is the cryohydric point -11.4° for ice and potassium chloride; *N*, approximately -23° , is the corresponding point for ice and dihydrated cupric chloride. Following W. D. Bancroft's treatment: along *MS*, ice and potassium chloride are solid phases; along *NT*, ice and dihydrated cupric chloride. The two curves do not meet, since probably

T the solid phases will be ice and the 1.2.2-salt, and, as shown below, the temp. will rise in passing from *T* to *S*. Along *SDA*, the solid phases are the 1.2.2-salt and potassium chloride, and at *A*, 92.4°, the red 1.1-salt is formed. The point *A* represents an invariant system with three solid phases—KCl, and the 1.2.2 and 1.1-salts—and along *AE* the univariant system with two solid phases—1.1-salt and KCl. Starting from *T* along *TOB*, the solid phases are the 1.2.2-salt and $\text{CuCl}_2 \cdot 2\text{H}_2\text{O}$. The point *B*, 56.2°, is a quintuple point representing an invariant system with three solid phases— $\text{CuCl}_2 \cdot 2\text{H}_2\text{O}$, the 1.2.2-salt and 1.1-salt—liquid, and vapour. Beyond *B*, along *BG*, the univariant system has two solid phases—1.1-salt and $\text{CuCl}_2 \cdot 2\text{H}_2\text{O}$. Along *BA*, the two solid phases are the 1.2.2-salt and the 1.1-salt. Potassium chloride exists as solid phase in the bivariant region bounded by *MSDAE*; dihydrated cupric chloride in the region bounded by *NTOBG*; the 1.2.2-salt, in the region *SDABOT*; and the 1.1-salt, in the region *GBAE*. The dotted line *ZZ* represents soln. containing twice as much KCl as CuCl_2 , yet it does not pass into the region of stability for the 1.2.2-salt, and therefore this salt is decomposed by water with the precipitation of potassium chloride, and the green colour of the 1.2.2-salt corresponds with a slight decomposition and the presence of traces of mother liquid containing cupric chloride. The aq. soln. is stable in the presence of potassium chloride. The dotted line *XX* represents soln. with the ratio CuCl_2 ; KCl=unity; the field for the 1.1-salt is cut by this line at *C*, 72°, and from this temp. upwards it is possible to obtain a soln. with the salts in the same ratio as they are in the solid phase. Between 56.2° and 72°, the 1.1-salt is decomposed by water, forming the 1.2.2-salt—the range of instability is nearly 16°. The line *ZZ*, extending from the $100\text{H}_2\text{O}$ apex representing the m.p. of ice, connects this point with the m.p. of potassium cupric tetrachloride, and hence the temp. should rise in passing from *T* to *S*. The salt component present at *S* is necessarily that which is precipitated by the action of water on the 1.2.2-salt, or, as F. A. H. Schreinemakers expresses it :

The cryohydric temp. of a soln. in equilibrium with a double salt and the component which does not precipitate, is lower than the cryohydric temp. of a soln. in equilibrium with double salt and the component which precipitates.

If the double salt be not decomposed by water, the points *T* and *S* in Fig. 31 would lie on opposite sides of the line *ZZ*, and there would be a maximum temp. at the point where *ZZ* cuts the curve, joining *T* and *S*. According to the so-called theorem of A. C. van Rijn van Alkemade, and in agreement with F. A. H. Schreinemakers and W. Meyerhoffer :

If the two points in the triangle which correspond to the compositions of two solid phases be connected by a line, the temp. at which these same two phases can be in equilibrium with soln. and vapour, rises as the boundary curve approaches this line, becoming a maximum at the intersection, though the boundary curve often ceases to be stable before this point is reached. When the two solid phases are two of the components, the line connecting the m.p. is one of the sides of the triangle—

and therefore, if this theorem be correct, the temp. must rise in passing along a boundary curve to the side of a triangle. For example, dihydrated ammonium cupric tetrachloride, $\text{CuCl}_2 \cdot 2\text{NH}_4\text{Cl} \cdot 2\text{H}_2\text{O}$, is in equilibrium with ice and ammonium chloride at -15° , with ice and dihydrated cupric chloride at -42° , while the curve connecting these points passed through a maximum at -12.7° .

M. Gröger⁷ made potassium trichlorocuprate, KCuCl_3 or $\text{KCl} \cdot \text{CuCl}_2$, by the action of a soln. of cupric chloride in hydrochloric acid (sp. gr. 1.19) on powdered potassium chloride—say by shaking for 3 hrs. a mixture of 10 grms. of dihydrated cupric chloride; 4 grms. of potassium chloride; and 50 c.c. of hydrochloric acid. Filter the mixture out of contact with air; press the crystals on filter paper; and dry in vacuo over sulphuric acid. W. Meyerhoffer purified the 1.2.2-salt by dissolving it in fairly warm conc. acetic acid; garnet-red needles of the 1.2.2-salt separate out on cooling the brown soln. The needle-like crystals are filtered while still warm, and dried in the air-bath at 100° . W. Meyerhoffer showed that this

compound is formed by melting the two solids together—but there is a considerable loss of chlorine; or by evaporating a mixed soln. of the two salts with continued stirring so as to avoid the separation of potassium chloride. The sp. gr. of the crystals is 2·86; and, according to A. Chassevant, they can be heated to redness without decomposition. They dissolve in cold water, forming a blue soln.; they decompose in moist air, $2\text{KCuCl}_3 + 4\text{H}_2\text{O} = \text{CuCl}_2 \cdot 2\text{KCl} \cdot 2\text{H}_2\text{O} + \text{CuCl}_2 \cdot 2\text{H}_2\text{O}$, but the mixture reforms $\text{KCl} \cdot \text{CuCl}_2$ after standing some hours in a desiccator. W. Meyerhoffer investigated the solubility of this salt in the presence of cupric and potassium chlorides. J. G. C. Vriens found the heat of soln. of a mol of the salt KCuCl_3 in 200 mols of water to be 3·55 Cals., and also showed that the vap. press. of $1.2.2 + \text{CuCl}_2 \cdot 2\text{H}_2\text{O} + \text{soln.} + \text{vapour}$, and of $1.2.2 + 1.1 + \text{CuCl}_2 \cdot 2\text{H}_2\text{O} + \text{vapour}$: $1.2.2 + 1.1 + \text{soln.} + \text{vapour}$; and $1.2.2 + 1.1 + \text{CuCl}_2 \cdot 2\text{H}_2\text{O} + \text{vapour}$; and of $1.1 + \text{CuCl}_2 \cdot 2\text{H}_2\text{O} + \text{soln.} + \text{vapour}$, all coincide at 56°.

F. Godeffroy⁸ mixed a conc. soln. of potassium chloride and of cupric chloride in conc. hydrochloric acid, and obtained no precipitate. C. Hensgen claimed to have prepared anhydrous potassium cupric tetrachloride, K_2CuCl_4 or $\text{CuCl}_2 \cdot 2\text{KCl}$, by passing hydrogen chloride into a sat. soln. of $\text{K}_2\text{SO}_4 \cdot \text{CuSO}_4 \cdot 6\text{H}_2\text{O}$, when green crystals of the **dihydrated potassium tetrachlorocuprate**, $\text{K}_2\text{CuCl}_4 \cdot 2\text{H}_2\text{O}$, separate out; if the crystals themselves be treated with the gas, the colour changes from blue to green, and bright red spots appear, which disappear if the crystals be melted. The red crystals were probably the 1.1-salt, the green crystals the 1.2.2-salt. E. Mitscherlich, C. F. Rammelsberg, and V. A. Jacquelin prepared the 1.2.2-salt by cooling a warm conc. soln. of the two component salts. According to W. Meyerhoffer, the soln. can be evaporated just under the b.p. without decomposition. According to G. Wyruboff,⁹ C. F. Rammelsberg, and A. Fock, the greenish-blue crystals form ditetragonal bipyramids with the axial ratio $a : c = 1 : 0.7525$. They form mixed crystals with the corresponding ammonium salt, and, according to A. Fock, there is a lacuna in the series between 27·77 and 54·87 per cent. of $\text{CuCl}_2 \cdot 2\text{KCl} \cdot 2\text{H}_2\text{O}$. The sp. gr. is 2·392, according to H. G. F. Schröder; H. Kopp gave 2·359; and H. Schiff, 2·4. According to W. Meyerhoffer, when heated, the salt decomposes into $\text{KCl} \cdot \text{CuCl}_2$ and KCl . In sat. soln. the garnet-red 1.1-salt is formed at 93°; at lower temp., in the presence of cupric chloride, the 1.2.2-salt appears at 56°. The transformation $\text{CuCl}_2 \cdot 2\text{KCl} \cdot 2\text{H}_2\text{O} \rightleftharpoons \text{CuCl}_2 \cdot \text{KCl} + \text{KCl} + 2\text{H}_2\text{O}$ occurs at 92·4° and the transformation $2\text{KCuCl}_3 + 4\text{H}_2\text{O} \rightleftharpoons \text{CuCl}_2 \cdot 2\text{KCl} \cdot 2\text{H}_2\text{O} + \text{CuCl}_2 \cdot 2\text{H}_2\text{O}$ is at 56·2°. These two transformations illustrate the rule stated by W. D. Bancroft: when one of the solid phases can change at a quintuple point into the other two with the addition or subtraction of water, the inversion point is a minimum temp. for that phase if water be added to complete the reaction, and a maximum temp. if the water be subtracted—for 92·4° is a maximum and 56·2° a minimum temp. According to P. A. Favre and C. A. Valson,¹⁰ the heat of soln. of $\text{K}_2\text{CuCl}_4 \cdot 2\text{H}_2\text{O}$ is -6·982 Cals., while for the individual salts $\text{CuCl}_2 \cdot 2\text{H}_2\text{O} + 2\text{KCl}$ it is -4·502 Cals.; J. G. C. Vriens, the heat of soln. of a mol of the 1.2.2-salt in 200 mols of water is -6·958 Cals. F. M. Raoult, and H. C. Jones and H. P. Bassett have determined the lowering of the f.p., and the two latter also the sp. gr. and electrical conductivities of soln. of this salt. J. G. C. Vriens' values for the vap. press. of the systems $1.2.2 + \text{KCl} + \text{soln.}$ and vapour; $1.2.2 + 1.1 + \text{soln.}$ and vapour; and $1.2.2 + 1.1 + \text{KCl} + \text{vapour}$; $1.1 + \text{KCl} + \text{soln.}$ and vapour, all coincide at 92·6°.

An aq. soln. of cupric chloride with an excess of caesium chloride is bright yellow, resembling the yellow colour of the soln. of cupric chloride in hydrochloric acid. F. Godeffroy¹¹ prepared brilliant yellow rhombic prisms of **caesium tetrachlorocuprate**, $\text{CuCl}_2 \cdot 2\text{CsCl}$ or Cs_2CuCl_4 , by mixing in soln. 50 grms. of caesium chloride with 5 to 25 grms. of cupric chloride. The salt can be crystallized if redissolved to form very conc. soln.; with dil. soln. hydrated salts are deposited. H. L. Wells and L. C. Dupre found an unstable bluish-green **dihydrated caesium tetrachlorocuprate**, $\text{Cs}_2\text{CuCl}_4 \cdot 2\text{H}_2\text{O}$, to be formed by the spontaneous evaporation at low

temp. of soln. containing nearly eq. proportions of the two salts. They also made dark brown triclinic crystals of **dihydrated caesium heptachlorodicuprate**, $\text{Cs}_3\text{Cu}_2\text{Cl}_7 \cdot 2\text{H}_2\text{O}$ or $3\text{CsCl} \cdot 2\text{CuCl}_2 \cdot 2\text{H}_2\text{O}$, by allowing soln. with the required proportions of the two salts to evaporate at ordinary temp. If the soln. be too conc. and warm, one or both of the anhydrous chlorides, Cs_2CuCl_4 or CsCuCl_3 , will be deposited. The crystals are nearly stable at ordinary temp.; the crystals lose their water at 100° . Similarly, H. L. Wells and L. C. Dupre made garnet-red slender hexagonal prisms which were black by reflected light, and which had the composition of **caesium trichlorocuprate**, $\text{CuCl}_2 \cdot \text{CsCl}$ or CsCuCl_3 . The crystals were formed under a wide variation of conditions up to the point where the mixed soln. is sat. with cupric chloride. E. H. Duclaux studied the caesium salt.

When a soln. of cupric chloride is treated with aqua ammonia, a greenish-blue hydroxide is precipitated, and this is soluble in excess of the ammonia, forming an intense blue soln. The soln. contains a compound with at least $\text{CuCl}_2 : \text{NH}_3 = 1 : 4$, and a higher ammino-compound may be formed if the conc. of the ammonia be great and the temp. low. The reaction between the ammonia and copper salt is attended by the development of much heat. A. Bouzat¹² found that by treating a mol of cupric chloride with four mols of ammonia, 18.05 Cals. of heat are developed; with 5 mols, 19.5 Cals.; with 6, 20.20 Cals.; with 7, 20.65 Cals.; with 8, 21.0 Cals.; with 10, 21.50 Cals.; and with 12, 21.9 Cals. N. W. Fischer treated a soln. of cupric chloride in an excess of aqua ammonia with cadmium, and found the copper to be completely precipitated as metal and basic salt; iron partially precipitates the copper; lead, a little copper; and tin, antimony, or bismuth, no copper.

M. Faraday noted that "chloride of copper fused is powerfully acted upon by ammonia. It immediately bursts open upon being placed in the gas and, absorbing great quantities, falls into a blue powder." H. Rose's estimate of the amount—73.7 per cent.—absorbed was shown by A. Bouzat to be too high, and his result was probably complicated by the presence of moisture, because not more than 43.5 per cent. of dry ammonia gas is absorbed after the anhydrous chloride has stood 22 hrs. in the gas. This corresponds with **cupric hexammino-chloride**, $\text{CuCl}_2 \cdot 6\text{NH}_3$. According to G. Gore, dihydrated cupric chloride is insoluble in liquid ammonia; but A. Bouzat found the anhydrous chloride is converted into a similar blue powder when in contact with liquid ammonia at -30° . If the temp. of the liquid be at -70° , and subsequently raised to -40° , A. Bouzat thinks there are indications of an ammino-compound still richer in ammonia than the hexammino-salt. E. Alexander and A. Naumann also obtained cupric hexammino-chloride as a green precipitate by the action of dry ammonia on a soln. of cupric chloride in ethyl acetate. The product was washed with ethyl acetate. According to A. Bouzat, the heat of formation is 94.5 Cals. M. Faraday said that when the product is heated, it melts and gives off its ammonia while cupric chloride remains; E. Alexander said that some chlorine is lost as ammonium chloride and H. Rose that cuprous chloride remains. According to R. Kane and A. Bouzat, it loses 2NH_3 at 90° , and another 2NH_3 is lost between 135° and 149° —L. Sabbatani gives 100° – 125° . According to F. Ephraim, at room temp. a mol of cupric chloride takes up 5.75 mols of ammonia, and the resulting compound on heating slowly loses ammonia up to 103° , when it contains 5.08 mols; a further elevation of the temp. up to 107° , produces a sudden fall in the ammonia content to 3.36 mols, corresponding with the deep ultramarine-blue, **tricupric decammino-chloride**, $3\text{CuCl}_2 \cdot 10\text{NH}_3$; the ammonia content then remains constant up to 124° , when gas is again evolved, and at 127° , the residue contains 2.09 mols of ammonia, and does not evolve ammonia until 270° , when it melts, and on cooling solidifies to a hard cake. D. W. Horn found that the hexammino-compound is stable up to 20° , and dissociates at 46.7° under a press. of 20 mm. The salt is insoluble in liquid ammonia, but is soluble in water, forming an ammoniacal soln. of cupric chloride—some blue hydroxide may be precipitated if the proportion of water is great.

Anhydrous cupric pentammino-chloride, $\text{CuCl}_2 \cdot 5\text{NH}_3$, is not known, but F. Ephraim says that cupric pentammino-chloride forms solid soln. below 105° , which attain the composition $\text{CuCl}_2 + 5\text{NH}_3$ at about -15° . A. Bouzat claims to have prepared the sesquihydrated pentammino-salt, $\text{CuCl}_2 \cdot 5\text{NH}_3 \cdot 1\frac{1}{2}\text{H}_2\text{O}$, by cooling an ammoniacal soln. of cupric chloride to -15° , or by the action of ammonia on the same soln. at 0° . The heat of formation, according to A. Bouzat, is 84.1 Cals. at 14° ; 81.7° cal. at 13° . The dark blue crystals form the diammino-salt when heated, and are soluble in water and in aq. ammonia. The aq. soln. precipitates cupric hydroxide when diluted. The crystals remain unchanged in an atm. of dry ammonia, but if allowed to stand under a bell-jar over potassium hydroxide and a mixture of lime and ammonium chloride the hemihydrated salt, $\text{CuCl}_2 \cdot 5\text{NH}_3 \cdot \frac{1}{2}\text{H}_2\text{O}$, is formed.

A. Bouzat prepared anhydrous cupric tetrammino-chloride, $\text{CuCl}_2 \cdot 4\text{NH}_3$, obtained by heating the hexamino-salt to 90° in a closed vessel with an exit tube dipping under mercury; and L. Sabbatani by allowing the dihydrated salt to stand over a mixture of lime and ammonium chloride. The blue salt is unstable, it is soluble in a little water, and when diluted, cupric hydroxide is precipitated, but not if ammonium chloride be present. It dissociates at about 140° , forming the diammino-salt; its heat of formation is 72.07 Cals. According to F. Ephraim, tricupric decammino-chloride, $3\text{CuCl}_2 \cdot 10\text{NH}_3$, is formed at 105° and is stable up to 124° when it furnishes the diammino-salt. By passing ammonia through a hot sat. soln. of cupric chloride, until the precipitate first formed has redissolved, and the soln. allowed to cool, R. Kane and A. Johnsen obtained blue monoclinic crystals of hydrated cupric tetrammino-chloride, $\text{CuCl}_2 \cdot 4\text{NH}_3 \cdot \text{H}_2\text{O}$. V. Kohlschütter precipitated the same compound by adding alcohol to an ammoniacal soln. of cupric chloride. It forms deep blue pleochroic crystals belonging to the monoclinic system. The salt loses ammonia on drying, and if heated below 149° it loses all the combined water and half the ammonia. The violet soln. obtained by the addition of potassium chloride and ammonia, becomes blue when warmed. The addition of a *N*-KCl soln. precipitates the diammino-salt. Dihydrated cupric tetrammino-chloride, $\text{CuCl}_2 \cdot 4\text{NH}_3 \cdot 2\text{H}_2\text{O}$, was made by A. Bouzat by evaporating an ammoniacal soln. of cupric chloride in an atm. of ammonia at ordinary temp.—say under a bell-jar over a mixture of lime and ammonium chloride. The same salt was made by cooling a hot conc. soln. of cupric chloride in ammonia. The deep blue crystals lose ammonia and water between 100° and 125° , forming the diammino-compound. The salt dissolves in a little water, and when the soln. is diluted, cupric hydroxide is precipitated. The heat of formation is 79.0 Cals. at 11° , 75.9 Cals. at 13° .

R. Kane made cupric diammino-chloride, $\text{CuCl}_2 \cdot 2\text{NH}_3$, by heating the higher ammino-compounds to 149° ; A. Bouzat to 135° ; and L. Sabbatani to 100° – 125° . F. Ephraim describes it as being pure green when hot, and light greenish-blue when cold. T. Graham made it by saturating warm cupric chloride with ammonia; V. Kohlschütter, by adding ammonia to a sat. soln. of cupric chloride; and W. Eidmann by leading ammonia into a soln. of cupric chloride in acetone. The green salt does not change in air; it yields cuprous chloride and nitrogen, ammonia, and ammonium chloride when heated. With water it gives a bluish-green precipitate of a basic chloride, $4\text{CuO} \cdot \text{CuCl}_2 \cdot 6\text{H}_2\text{O}$. According to F. Ephraim, the diammino-chloride decomposes below 270° . V. Kohlschütter found it to be soluble in an excess of aqua ammonia, forming complex cations $\text{Cu}(\text{NH}_3)_4^{2+}$. The heat of formation is 45.55 to 45.6 Cals., and that of the $\frac{1}{4}$ -hydrated salt, 46.2–46.6 Cals. Small bluish-green microscopic crystals, which A. Bouzat claims to be $\text{CuCl}_2 \cdot 2\text{NH}_3 \cdot \frac{1}{4}\text{H}_2\text{O}$, are formed by precipitation from an ammoniacal soln. of cupric chloride at 50° by the addition of alcohol. If the temp. is too low, some cupric tetrammino-chloride is precipitated; and if too high, some cupric hydroxide is precipitated.

K. A. Hofmann and E. C. Marburg treated cupric chloride with an alcoholic

soln. of hydrazine hydroxide and obtained pale blue crystals approximating in composition cupric dihydrazine chloride, $\text{Cu}(\text{N}_2\text{H}_4)_2\text{Cl}_2$; they soon decomposed when kept in a desiccator.

REFERENCES.

- ¹ P. Sabatier, *Compt. Rend.*, 106. 1724, 1888; 107. 40, 1888; R. Engel, *ib.*, 106. 273, 1888; 107. 178, 1888; *Ann. Chim. Phys.*, (6), 17. 351, 1889; A. Ditte, *ib.*, (5), 22. 561, 1881; G. Naumann, *Monatsh.*, 15. 489, 1894; E. Alexander, *Reaktionen von Salzen in Aethylacetat*, Giessen, 1899; A. Naumann, *Ber.*, 32. 1002, 1899; W. Eidmann, *Ein Beitrag zur Erkenntnis der Verhaltens chemischer Verbindungen in nichtwässrigen Lösungen*, Giessen, 1899.
- ² A. Chassevant, *Compt. Rend.*, 113. 646, 1891; W. Meyerhoffer, *Sitzber. Akad. Wien*, 101. 590, 1892; L. Cambi, *Atti Accad. Lincei*, (5), 16. 1, 1403, 1907; F. A. H. Schreinemakers and A. C. Noorduyn, *Chem. Weekbl.*, 15. 118, 1918.
- ³ F. A. H. Schreinemakers and F. W. C. de Baat, *Zeit. phys. Chem.*, 65. 586, 1909; T. S. Hunt, *Amer. Journ. Science*, (2), 40. 154, 1870; M. Siewert, *Zeit. ges. Naturwiss.*, 26. 486, 1865.
- ⁴ O. Hautz, *Liebig's Ann.*, 66. 280, 1848; W. Meyerhoffer, *Zeit. phys. Chem.*, 3. 340, 1889; P. P. Dehérain, *Compt. Rend.*, 55. 808, 1862; P. A. Meerburg, *Chem. Weekbl.*, 1. 551, 1904; *Zeit. anorg. Chem.*, 45. 1, 1905; H. L. Maxwell, *Chem. News*, 116. 247, 1917.
- ⁵ E. Mitscherlich, *Journ. prakt. Chem.*, (1), 19. 449, 1840; A. Vogel, *ib.*, (1), 2. 194, 1834; P. A. Cap and O. Henry, *ib.*, (1), 13. 184, 1838; *Journ. Pharm.*, 23. 617, 1837; T. Graham, *Phil. Trans.*, 137. 47, 1837; A. Bouzat, *Ann. Chim. Phys.*, (7), 29. 350, 1903; P. P. Dehérain, *Compt. Rend.*, 55. 807, 1862; W. Meyerhoffer, *Zeit. phys. Chem.*, 5. 99, 1890; *Monatsh.*, 14. 184, 1893; L. Bourgeois, *Bull. Soc. Chim.*, (3), 19. 786, 1898; G. Wyruboff, *Bull. Soc. Min.*, 10. 125, 1887; A. Johnsen, *Neues Jahrb. Min.*, 11. 118, 1903; G. Tschermak, *Sitzber. Akad. Wien*, 45. 609, 1862; O. Lehmann, *Ber.*, 17. 1733, 1884; *Molekularphysik*, Berlin, 1. 431, 1888; R. Engel, *Compt. Rend.*, 117. 485, 1893; W. F. K. Stock, *Chem. News*, 40. 159, 1879; K. Heumann, *Repert. Pharm.*, 37. 304, 1831; V. von Lang, *Sitzber. Akad. Wien*, 54. 167, 1866; H. de Sénarmont, *Ann. Chim. Phys.*, (3), 33. 1851; H. C. Jones and H. P. Bassett, *Amer. Chem. Journ.*, 33. 376, 1905; F. Rüdorff, *Pogg. Ann.*, 116. 64, 1862; C. Temme, *Zeit. ges. Naturw.*, 10. 38, 1857; R. H. Brett, *Phil. Mag.*, 10. 96, 1837; H. L. Maxwell, *Chem. News*, 116. 247, 1917; P. A. Meerburg, *Chem. Weekbl.*, 1. 551, 1904; *Zeit. anorg. Chem.*, 45. 6, 1905; E. C. Franklin and C. A. Kraus, *Amer. Chem. Journ.*, 20. 827, 1897; H. Ritthausen, *Journ. prakt. Chem.*, (1), 59. 373, 1843.
- ⁶ W. Meyerhoffer, *Sitzber. Akad. Wien*, 102. 200, 1893; *Zeit. phys. Chem.*, 3. 339, 1889; 5. 98, 1890; F. A. H. Schreinemakers and A. C. Noorduyn, *Chem. Weekbl.*, 15. 118, 1918; F. A. H. Schreinemakers, *ib.*, 12. 85, 1893; A. C. van Rijn van Alkemade, *ib.*, 11. 289, 1893; H. W. B. Roozeboom, *Die heterogenen Gleichgewichte*, Braunschweig, 3. 181, 1911; W. D. Bancroft, *The Phase Rule*, Ithaca, 175, 1897; W. C. Geer, *Journ. Phys. Chem.*, 8. 257, 1904.
- ⁷ M. Gröger, *Zeit. anorg. Chem.*, 19. 328, 1899; W. Meyerhoffer, *Zeit. phys. Chem.*, 3. 338, 1889; 5. 102, 1890; J. G. C. Vriens, *ib.*, 7. 217, 1891; A. Chassevant, *Ann. Chim. Phys.*, (6), 30. 37, 1893; F. A. H. Schreinemakers and W. C. de Baat, *Proc. Acad. Amsterdam*, 15. 467, 1913.
- ⁸ C. Hensgen, *Ber.*, 11. 1778, 1878; F. Godeffroy, *ib.*, 8. 10, 1875; C. F. Rammelsberg, *Pogg. Ann.*, 94. 507, 1855; E. Mitscherlich, *Journ. prakt. Chem.*, (1), 19. 449, 1840; W. Meyerhoffer, *Zeit. phys. Chem.*, 3. 338, 1889; V. A. Jacquelin, *Ann. Chim. Phys.*, (3), 32. 195, 1851.
- ⁹ G. Wyruboff, *Bull. Soc. Min.*, 10. 125, 1887; C. F. Rammelsberg, *Handbuech der krystallographischen Chemie*, Berlin, 308, 1855; A. Fock, *Zeit. anorg. Chem.*, 12. 657, 1894; W. Meyerhoffer, *Zeit. phys. Chem.*, 3. 338, 1889; 5. 98, 1890; 9. 644, 1892; J. J. Berzelius, *Pogg. Ann.*, 13. 458, 1828; O. Lehmann, *Molekularphysik*, Leipzig, 1. 670, 1888; H. C. Jones and H. P. Bassett, *Amer. Chem. Journ.*, 34. 322, 1905; W. D. Bancroft, *Journ. Phys. Chem.*, 1. 337, 1897; H. G. F. Schröder, *Diehtigkeitsmessungen*, Heidelberg, 1875; H. Schiff, *Liebig's Ann.*, 108. 21, 1858; H. Kopp, *ib.*, 36. 1, 1840.
- ¹⁰ F. M. Raoult, *Compt. Rend.*, 99. 914, 1884; H. C. Jones and H. P. Bassett, *Amer. Chem. Journ.*, 34. 322, 1905; J. Trötsch, *Wied. Ann.*, 41. 274, 283, 1890; J. G. C. Vriens, *Zeit. phys. Chem.*, 7. 217, 1891; P. A. Favre and C. A. Valsom, *Compt. Rend.*, 73. 1150, 1871.
- ¹¹ F. Godeffroy, *Ber.*, 8. 9, 1875; H. L. Wells and L. C. Dupre, *Amer. Journ. Science*, (3) 47. 94, 1894; E. H. Duclaux, *Anal. Assoc. Quim. Argentina*, 9. 215, 1921.
- ¹² G. Gore, *Proc. Roy. Soc.*, 21. 140, 1873; P. P. Dehérain, *Compt. Rend.*, 55. 807, 1862; A. Bouzat, *ib.*, 134. 1218, 1902; 135. 293, 1902; *Ann. Chim. Phys.*, (7), 29. 312, 1903; R. Kane, *ib.*, (2), 72. 276, 1835; N. W. Fischer, *Pogg. Ann.*, 8. 492, 1826; H. Rose, *ib.*, 20. 155, 1830; M. Faraday, *Quart. Journ. Science*, 5. 74, 1818; A. Naumann, *Ber.*, 32. 1002, 1899; E. Alexander, *Reaktionen von Salzen in Aethylacetat*, Giessen, 1899; D. W. Horn, *Amer. Chem. Journ.*, 39. 203, 1903; L. Sabbatani, *Ann. Chimica*, 26. 337, 1897; V. Kohlschütter and P. Pudschies, *Ber.*, 37. 1160, 1904; V. Kohlschütter, *ib.*, 37. 1156, 1904; A. Johnsen, *Neues Jahrb. Min.*, ii, 115, 1903; F. Ephraim, *Ber.*, 52. 940, 1919; W. Eidmann, *Ein Beitrag zur Kenntnis des Verhaltens chemischer Verbindungen in nichtwässrigen Lösungen*, Giessen, 1899; *Zeit. anorg. Chem.*, 28. 90, 1900; T. Graham, *Phil. Trans.*, 127. 47. 1837, K. A. Hofmann and E. C. Marburg, *Liebig's Ann.*, 305. 222, 1899.

§ 18. Cuprous Bromide

Copper reacts with bromine vapour at a dark red heat vigorously and with incandescence, forming a mixture of cupric and cuprous bromides; if the bromine be in excess, cupric bromide is formed. According to A. Colson,¹ the reaction occurs at ordinary temp. with finely divided copper which has been reduced at a temp. below 280°. According to H. Gautier and G. Charpy, copper wire is slowly attacked in darkness by dry bromine—thus, at 15° a copper wire lost 0.371 per cent. in weight in 8 days and 1.740 per cent. in four months; at 100°, it lost 6.62 per cent. in 8 days; and a piece of wire 5 cms. in length and 2 mm. in thickness dissolved in bromine water in contact with an excess of bromine in 7 to 8 days. M. B. Renault found a layer of cuprous bromide is formed by boiling a plate of copper with a soln. of bromine in potassium, ferric, or cupric bromide; and G. Bodländer and O. Storbeck obtained a film of colourless tetrahedral crystals of cuprous bromide under these conditions. T. Sandmeyer also boiled one part of copper turnings with a soln. of one part of crystalline copper sulphate, and four parts of potassium bromide, acidulated with one or two parts of acetic acid. The cuprous bromide is precipitated as a white powder which is then washed and dried. G. Denigés employed a similar process for the chloride.

C. F. Rammelsberg² noted that when cupric bromide is heated to redness, it is reduced to cuprous bromide, and E. A. Atkinson found that by heating copper to redness in a stream of hydrogen bromide cuprous bromide is formed—if elements which form volatile bromides are present they are expelled—arsenic and antimony each in 1½ hrs., and bismuth in about 2½ hrs. With hydrogen chloride, under similar conditions, a much longer period—6 to 8 hrs.—is required for the separation of these elements. Hence the method is recommended for certain analytical separations.

B. Lean and W. H. Whatmough³ extended F. Wöhler's process to the preparation of cuprous bromide by the action of sulphur dioxide on a mixed aq. soln. of copper sulphate and alkali bromide:

About 20 grms. of copper sulphate and 8 grms. of sodium bromide were dissolved in 300 c.c. of water, and treated with a stream of sulphur dioxide. Small white crystals of cuprous bromide were formed. These were filtered rapidly from the mother liquid, washed with sulphurous acid, spread on a porous tile, and exposed over potassium hydroxide in vacuo. The resulting crystals were coloured pale greenish-yellow. The mother liquid furnished more crystals when warmed to expel the sulphur dioxide. G. Bodländer and O. Storbeck used a similar process working with a warm soln. The water used for washing the cuprous bromide was previously boiled in a stream of carbon dioxide to expel dissolved air which decomposes cuprous bromide.

Cupric bromide, according to V. Thomas, is reduced to the cuprous salt by nitrogen dioxide, NO, or tetroxide, NO₂; and, according to A. K. Christomanos, phosphorous bromide, PBr₃, reacts turbulently with cupric nitrate—solid or in soln—forming cuprous bromide, and at the same time, nitrogen peroxide and bromine vapour are evolved. A. Naumann also found that a soln. of calcium bromide in acetone precipitates a little cuprous bromide from a soln. of cupric chloride in the same solvent—presumably the acetone reduces a little of the solute to the cuprous form.

The properties of cuprous bromide.—Cuprous bromide, CuBr, like the corresponding iodide and chloride, crystallizes in hexakis-tetrahedra. According to B. Gossner,⁴ the tetrahedral crystals are readily obtained by crystallization from hot hydrobromic acid; and by G. Bodländer and O. Storbeck, by leaving a copper plate standing in a soln. of potassium bromide. The crystals are possibly isomorphous with those of the chloride. K. Mönkemeyer obtained a continuous series of mixed crystals between cuprous bromide and cuprous iodide, between cuprous chloride and cuprous bromide, and between cuprous chloride and cuprous iodide; with the latter, there is a gap in the mixed crystal series so that the liquidus

curve forms two separate branches meeting at a eutectic. R. W. G. Wyckoff and E. Posnjak found that the **X-radiograms** correspond with the double face-centred cubic lattice of the zinc sulphide class, with sides 5.82 Å., and the nearest distance of the atoms 2.49 Å. According to C. H. D. Bödeker, the **specific gravity** of cuprous bromide is 4.72 (12°). P. Walden studied the mol. vol.

C. Löwig⁵ reported in 1829 that cuprous bromide melts at a red heat, and T. Carnelley and W. C. Williams found the **melting point** to be $504^{\circ} \pm 7^{\circ}$, while K. Mönkemeyer, and P. de Cesaris gave 480° . According to K. Mönkemeyer, there is a transformation at about 384° , which corresponds with the fact that between this temp. and the m.p. the solid is doubly refracting, and singly refracting below this temp., α -CuBr (doubly refracting) \rightleftharpoons β -CuBr (singly refracting). P. de Cesaris places the transition temp. at 384° . According to K. Mönkemeyer, α -cuprous bromide, melting at 480° , forms a continuous series of mixed crystals with cuprous chloride, melting at 419° , and the liquidus curve has a minimum about 408° , corresponding with about 60.71 per cent. of cuprous chloride. The progressive addition of cuprous chloride steadily lowers the transition temp. of cuprous bromide from 384° to 373° when 22.82 per cent. of cuprous bromide has been added. P. de Cesaris found that when mixed with cuprous bromide, the m.p. of potassium bromide falls from 760° down to a minimum at 182° when about 66 mol. per cent. of cuprous bromide has been added. At 234° , a new solid phase, $2\text{KBr}\cdot\text{CuBr}$, appears. This is illustrated by P. de Cesaris' curve, Fig. 32. T. Carnelley and W. C. Williams' value for the **boiling point** of cuprous bromide is 861° to 954° . A. Werner's values⁶ for the **molecular weights** of cuprous bromide determined from its effect on the b.p. of pyridine, methyl sulphide, and ethyl sulphide are respectively 148.44, 139, and 220–226; when the calculated value for CuCl is 143. G. Bodländer and O. Storbeck's calculations from the equilibrium between cuprous and cupric ions and of the undissociated salt; and from the e.m.f. of conc. cells, agree with the formula Cu_2Br_2 .

The **heat of formation** of cuprous bromide from its elements is $\text{Cu} + \text{Br}_{\text{liq.}} = \text{CuBr} + 24,985$ Cals. (J. Thomsen),⁷ 30 Cals. (M. Berthelot), the heat of formation $\text{Cu}_2\text{O}_{\text{solid}} + 2\text{HBr} = 60.64$ Cals. (M. Berthelot), or in soln., 20.76 Cals. (J. Thomsen). Assuming the heat of formation is 25 Cals., G. Bodländer and O. Storbeck give the **free energy** of formation -22.3 Cals. R. Luther and D. R. Wilson's value for the **work of oxidation** in the formation of cuprous bromide from copper corresponds with an e.m.f. of -0.5640 volt. M. de K. Thompson's value for the free energy of formation from liquid bromine is -23.7 Cals. at 18° ; and the **total energy**, -25 Cals. The heat evolved in replacing chlorine by bromine is 2.9 Cals.

According to M. B. Renault, and P. Rohland, cuprous bromide forms a white crystalline powder which, when exposed to sunlight, becomes a dark blue; the change is much slower in diffused daylight. F. Thomas also studied the action of light on the oxidation of this salt. Cuprous bromide does not decompose when heated in a closed tube, but in a crucible, the vapour which is given off colours the flame green. J. B. Berthelot⁸ supposed this salt to be insoluble in water, but between 18° and 20° , G. Bodländer observed a solubility of 0.0002501 mol of cuprous bromide per litre. As in the case of cuprous chloride, cuprous bromide is hydrolyzed in aq. soln., $2\text{CuBr} + \text{H}_2\text{O} = 2\text{HBr} + \text{Cu}_2\text{O}$, and it is partly converted into cupric chloride and metallic copper, $2\text{CuCl} = \text{CuCl}_2 + \text{Cu}$. The hydrolysis is not so marked with cuprous bromide as with the chloride. According to B. Lean and H. W. Whatmough, in the presence of air, cuprous bromide, like the chloride, is

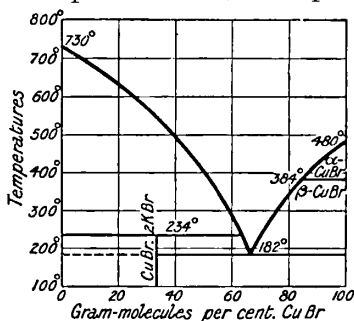

FIG. 32.—Fusion Curves of the Binary mixtures, KBr—CuBr.

decomposed by water, but the action does not take place so readily. Cuprous bromide is soluble in hydrochloric or hydrobromic acid, and the soln. in the last-named acid, *sans doute*, contains in soln. colourless **cuprous hydro-bromide**. Water precipitates cuprous bromide from the soln. According to C. Löwig, the soln. of cuprous bromide in hydrobromic acid when treated with ferrous sulphate gives a precipitate of metallic copper while ferrous bromide and ferric sulphate are formed: $2\text{CuBr} + 3\text{FeSO}_4 = 2\text{Cu} + \text{FeBr}_2 + \text{Fe}_2(\text{SO}_4)_3$; mercuric bromide is reduced to mercurous bromide; and gold is precipitated from soln. of gold chloride or bromide. Cuprous bromide is soluble in sodium chloride, and sodium thiosulphate, and the solubility, says M. B. Renault, is much less when the cuprous bromide has been previously exposed to light. The solubility, add G. Bodländer, and O. Storbeck, is increased if potassium bromide be present. Thus, with soln. containing in mols per litre:

KBr	0.025	0.040	0.060	0.080	0.100	0.500
Cu (total)	0.000119	0.000200	0.000310	0.000423	0.0005836	0.008719
Cu (ous)	0.000107	0.000187	0.000285	0.000411	0.0005836	0.008719

This is evidence of the formation of complexes analogous to those with cuprous chloride. According to G. A. Barbieri, when cuprous bromide dissolved in a conc. soln. of an alkali halide is treated with a soln. of iodine in xylene in an atm. of carbon dioxide, cuprous iodide is formed. When cuprous hydroxide is treated with a soln. of potassium bromide a green product is obtained which W. Spring and M. Lucion regard as a **cuprous oxybromide**, $\text{Cu}_2\text{O} \cdot 2\text{CuBr} \cdot \text{H}_2\text{O}$. Cuprous bromide, says C. Löwig, dissolves in *nitric acid* with the evolution of nitric oxide; it also dissolves in *sulphurous acid*, but, according to B. Lean and W. H. Whatmough, less readily than cuprous chloride. J. B. Berthemot found that it is not decomposed by boiling conc. *sulphuric acid*, or by boiling *acetic acid*; *hydrocyanic acid*, says R. Varet, converts it into copper cyanide. A. Werner found cuprous bromide to be soluble in *methyl* and *ethyl sulphides*; and J. Schröder, and A. Naumann, soluble in *pyridine*. W. Eidmann says cuprous bromide is not soluble in *acetone*. T. Sandmeyer noticed that with *aromatic amido-compounds* the bromine of cuprous bromide displaces the NH_2 -group.

Cuprous bromide dissolves in aqua *ammonia*, and, according to J. B. Berthemot,⁹ the soln. gives crystals of a double compound. T. W. Richards and B. S. Merigold prepared **cuprous ammino-bromide**, $\text{CuBr} \cdot \text{NH}_3$, by dissolving 10 grms. of cuprous bromide in the least possible quantity of ammonia, and adding 25 c.c. of acetic acid. The crystalline product was washed with alcohol and ether, and dried over sulphuric acid under diminished press. All the operations were conducted in an atm. of hydrogen. The crystals are long flat colourless prisms which are quite stable when dry, but quickly oxidize when exposed to air in contact with water. The salt is readily soluble in ammonia and in nitric acid, but not in the other mineral acids, or in acetic acid. According to S. J. Lloyd, if cuprous bromide be sat. with ammonia gas, at 0° , and a curve be drawn showing the relation between the vap. press. and temp. as the ammonia gas is gradually withdrawn from the system, curves corresponding with the formation of $\text{CuBr} \cdot 1\frac{1}{2}\text{NH}_3$ and $\text{CuBr} \cdot 3\text{NH}_3$ are obtained—*cf.* Fig. 26, at 100° and 90° . The first compound, **cuprous sesquiammino-bromide**, $2\text{CuBr} \cdot 3\text{NH}_3$, is made by saturating cuprous bromide at 0° with ammonia gas, and gradually withdrawing the gas from the system until the press. reaches 352 mm. at 100° . The salt has a brown colour, and melts at 135° . The vap. press. at 83° is 200 mm.; at 100° , 352 mm.; at 110° , 456 mm.; and at 120° , 620 mm. By withdrawing ammonia gas from cuprous bromide sat. with ammonia gas until the press. reaches 86.7 mm. at 100° , S. J. Lloyd prepared **cuprous triammino-bromide**, $\text{CuBr} \cdot 3\text{NH}_3$, as a green compound melting at 115° . According to T. W. Richards and B. S. Merigold, the same compound is obtained by conducting dry ammonia gas over finely-powdered cuprous bromide, cooled in ice. The black powder is decomposed by water, it is soluble in aq. ammonia and in nitric acid; it is very unstable and readily

gives off ammonia; its vap. press. at 69° is 214 mm.; at 78·5°, 347 mm.; at 90·5°, 601 mm.; and at 100°, 865 mm. F. Ephraim obtained a vap. press. of 760 mm. at 49·3°. According to W. Biltz and W. Stollenwerk:

	CuBr·3NH ₃	CuBr·1½NH ₃	CuBr·NH ₃
Heat of formation in Cals.	9·50	13·15	14·64
Temp. when diss. press. is 100 mm.	283·0°	339·0°	369·0°

H. L. Wells and E. B. Hurlburt¹⁰ prepared ammonium cuprotribromide, CuBr·2NH₄Br, or (NH₄)₂CuBr₃, by mixing hot soln. of an excess of ammonium bromide, with cuprous bromide and hydrobromic acid in presence of copper wire, and cooling the mixture for crystallization. This product does not oxidize so readily as the corresponding chloride, but the long colourless prisms do become green after a prolonged exposure to air. By using rather more cuprous bromide, colourless rhombohedra of hydrated ammonium cuprodibromide, NH₄CuBr₂·H₂O or NH₄Br·CuBr·H₂O, are formed more stable than the preceding salt. E. Fleurent has prepared ammonium triammino-cuprotribromide, NH₄Br·2CuBr·3NH₃. Cuprous and potassium bromides also form potassium cuprotribromide, CuBr·2KBr, melting at 234°. Cuprous bromide melts at 480°, and potassium bromide at 730°. These salts can also be regarded as bromocuprites.

REFERENCES.

- ¹ C. Löwig, *Das Brom und seine chemischen Verhältnisse*, Heidelberg, 1829; *Pogg. Ann.*, 14. 485, 1828; J. B. Berthelot, *Ann. Chim. Phys.*, (2), 44. 224, 385, 1830; A. Colson, *Compt. Rend.*, 128. 1459, 1899; H. Gautier and G. Charpy, *ib.*, 113. 597, 1891; M. B. Renault, *ib.*, 59. 319, 1864; G. Denigès, *ib.*, 108. 567, 1889; G. Bodländer and O. Storbeck, *Zeit. anorg. Chem.*, 31. 459, 1902; T. Sandmeyer, *Ber.*, 16. 1633, 2650, 1883.
- ² C. F. Rammelsberg, *Pogg. Ann.*, 55. 216, 1842; E. A. Atkinson, *Journ. Amer. Chem. Soc.*, 20. 797, 1898.
- ³ B. Lean and W. H. Whatmough, *Journ. Chem. Soc.*, 73. 148, 1898; G. Bodländer and O. Storbeck, *Zeit. anorg. Chem.*, 31. 459, 1902; A. K. Christomanos, *ib.*, 41. 289, 1904; *Ber.*, 37. 2883, 1904; A. Naumann, *ib.*, 32. 1002, 1899; V. Thomas, *Bull. Soc. Chim.*, (3), 15. 1092, 1893.
- ⁴ B. Gossner, *Zeit. Kryst.*, 38. 131, 1902; G. Bodländer and O. Storbeck, *Zeit. anorg. Chem.*, 31. 459, 1902; K. Mönkemeyer, *Neues Jahrb. Min. B.B.* 22. 42, 1906; C. H. D. Bodeker, *Die Beziehungen zwischen Dichte und Zusammensetzung bei festen und liquiden Stoffen*, Leipzig, 1860; P. Walden, *Zeit. anorg. Chem.*, 115. 241, 1920; R. W. G. Wyckoff and E. Posnjak, *Journ. Amer. Chem. Soc.*, 44. 30, 1922.
- ⁵ C. Löwig, *Das Brom und seine chemischen Verhältnisse*, Heidelberg, 1829; K. Mönkemeyer, *Neues Jahrb. Min. B.B.*, 22. 42, 1906; T. Carnelley and W. C. Williams, *Journ. Chem. Soc.*, 37. 125, 1880; P. de Cesaris, *Atti Accad. Lincei*, (5), 20. i, 749, 1911.
- ⁶ A. Werner, *Zeit. anorg. Chem.*, 15. 19, 1897; G. Bodländer and O. Storbeck, *ib.*, 31. 459, 1902.
- ⁷ J. Thomsen, *Journ. prakt. Chem.*, (2), 12. 271, 1875; *Thermochemische Untersuchungen*, Leipzig, 3. 320, 1885; M. Berthelot, *Compt. Rend.*, 87. 619, 1878; *Ann. Chim. Phys.*, (5), 16. 433, 1879; G. Bodländer and O. Storbeck, *Zeit. anorg. Chem.*, 31. 439, 1902; R. Luther and D. P. Wilson, *Zeit. phys. Chem.*, 34. 488, 1900; M. de K. Thompson, *Journ. Amer. Chem. Soc.*, 28. 762, 1906.
- ⁸ J. B. Berthelot, *Ann. Chim. Phys.*, (2), 44. 385, 1830; G. Bodländer, *Zeit. phys. Chem.*, 27. 61, 1898; P. Rohland, *Chem. Ztg.*, 23. 567, 1899; M. B. Renault, *Compt. Rend.*, 59. 319, 1864; B. Lean and W. H. Whatmough, *Journ. Chem. Soc.*, 73. 148, 1898; C. Löwig, *Das Brom und seine chemischen Verhältnisse*, Heidelberg, 1829; G. A. Barbieri, *Atti Accad. Lincei*, (5), 16. 528, 1907; R. Varet, *Compt. Rend.*, 121. 598, 1895; T. Sandmeyer, *Ber.*, 17. 2652, 1884; J. Schröder, *Reaktionen von Metallsalzen in Pyridin*, Giessen, 1901; A. Naumann, *Ber.*, 37. 4609, 1904; A. Werner, *Zeit. anorg. Chem.*, 15. 19, 1897; W. Spring and M. Lucion, *ib.*, 2. 211, 1892; W. Eidmann, *Ein Beitrag zur Kenntnis des Verhaltens chemischer Verbindungen in nichtwässrigen Lösungen*, Giessen, 1899; F. Thomas, *Verzögerung und Beschleunigung chemischer Vorgänge durch Licht*, Freiburg, 1908; G. Bodländer and O. Storbeck, *Zeit. anorg. Chem.*, 31. 458, 1902.
- ⁹ J. B. Berthelot, *Ann. Chim. Phys.*, (2), 44. 385, 1830; S. J. Lloyd, *Journ. Phys. Chem.*, 12. 393, 1908; T. W. Richards and B. S. Merigold, *Zeit. anorg. Chem.*, 17. 245, 1898; F. Ephraim, *Ber.*, 52. 236, 1919; W. Biltz and W. Stollenwerk, *Zeit. anorg. Chem.*, 119. 97, 1921.
- ¹⁰ H. L. Wells and E. B. Hurlburt, *Amer. Journ. Science*, (3), 50. 390, 1895; E. Fleurent, *Compt. Rend.*, 113. 1045, 1891.

§ 19. Cupric Bromide

T. W. Richards¹ prepared anhydrous cupric bromide, CuBr_2 , by treating the action of an excess of bromine in the presence of water upon copper.

Copper is treated with a slight excess of purified bromine in the presence of water. When the reaction is complete, the excess of bromine is expelled by gentle evaporation to dryness in a glass dish, and the nearly normal cupric bromide dissolved in a small amount of water, and the soln. filtered through asbestos contained in a Gooch's crucible. The filtrate is barely acidified with hydrobromic acid, and conc. to the consistency of syrup, and the containing vessel left in vacuo for 36 hrs. On agitation and cooling with ice, the resulting odourless, black, supersaturated soln. immediately crystallized to a mass of brownish-green needles which were collected on a Gooch's crucible, and washed three times with a very little water.

According to N. S. Kurnakoff and A. A. Sementschenko, if the evaporation occurs below 29° – 30.5° , **tetrahydrated cupric bromide**, $\text{CuBr}_2 \cdot 4\text{H}_2\text{O}$, is formed. The transition from the hydrate to the anhydrous salt, therefore, occurs at a lower temp. with the bromide than with the chloride. If the brown soln. of cupric bromide be evaporated spontaneously at the ordinary temp. of a winter's day the pale blue dil. soln. becomes emerald green, and as the conc. proceeds, the colour becomes darker and darker until at last it acquires a brownish-red colour recalling that of iodine; crystals of the tetrahydrated salt are deposited. The seeding of the soln. may be required if under-cooling occurs.

P. Jannasch and E. Rose made the anhydrous salt by passing bromine vapour in a stream of carbon dioxide over heated cupric sulphide. C. Löwig evaporated a soln. of cupric oxide or carbonate in hydrobromic acid, and melted the mass at a low temp. J. B. Berthemot used a mixture of hydrobromic and nitric acid; C. F. Rammelsberg, P. Sabatier, and T. W. Richards evaporated the soln. in vacuo over sulphuric acid. H. and W. Biltz used the following process:

A soln. of 16 grms. of copper oxide in hydrobromic acid (33 grms. of HBr) is filtered; and evaporated to a small volume whereby the colour becomes very dark. The basin and contents are placed in a desiccator which, for preference, is evacuated. A solid mass of crystals is formed in a few days. The mass is thoroughly broken up each day to facilitate the desiccation.

The addition of conc. sulphuric acid to a soln. of cupric bromide precipitates that salt as in the corresponding case of cupric chloride; and, according to G. Viard, the bromide is attacked rather more than the chloride, although, even if the soln. be warm, the proportion decomposed is small. According to W. O. de Coninck and L. Arzalier, when a mixture of cupric oxide and ammonium bromide is pounded in a mortar, or strongly compressed, an unstable ammoniacal cupric oxybromide is formed which is soluble in ammonia, and gradually loses ammonia, and forms a green hydrated oxybromide, and a little cupric bromide. A. C. Christomanos obtained a dark bluish-green soln. of cupric bromide as a by-product in the preparation of copper phosphide by shaking a soln. of phosphorus in ether or benzene with an excess of a 10 per cent. soln. of cupric nitrate and bromine; he then converted cuprous bromide into the cupric salt by warming it with bromine on a water-bath. According to C. Löwig, if the emerald green soln. of cupric bromide in water be evaporated rectangular crystals of **dihydrated cupric bromide**, $\text{CuBr}_2 \cdot 2\text{H}_2\text{O}$, are formed; and, according to J. B. Berthemot, greenish-yellow needles of the same salt.

The properties of cupric bromide.—According to P. Sabatier,² the prismatic crystals of anhydrous cupric bromide belong to the monoclinic system; they are almost black with a colour resembling that of iodine; and the crystals of the tetrahydrated salt form long green needle-like crystals also belonging to the monoclinic system. According to T. Carnelley, the **melting point** of cupric bromide lies between

491° and 511°—say 498°. P. Jannasch and E. Rose found the salt is rather more volatile than lead bromide. Some bromine is lost when it is heated to its m.p., and, according to J. B. Berthelot, and C. F. Rammelsberg, it loses half its bromine when heated below redness, forming cuprous bromide; and C. Löwig applied similar remarks to the hydrated salt. If the cupric bromide is calcined in air, P. Sabatier showed that a little oxybromide is formed at the same time.

M. Berthelot³ found the **heat of formation** of cupric bromide from its elements to be 60 Cals.; and J. Thomsen gives $\text{Cu} + \text{Br}_{2(\text{liq.})} = \text{CuBr}_2 + 32.58$ Cals., and the heat of formation in dil. soln. is $\text{Cu} + \text{Br}_2 + \text{aq.} = \text{CuBr}_{2(\text{aq.})} + 40.83$ Cals.; this makes the **heat of solution** of a mol of the bromide in 400 mols of water at the room temp., 8.25 Cals. P. Sabatier gives for the **heat of solution** of a mol of CuBr_2 in dil. soln. at 12°, 7.9 Cals., and for the heat of soln. of a mol of the tetrahydrated salt, $\text{CuBr}_2 \cdot 4\text{H}_2\text{O}$, at 7.5°, -1.5 Cals. For the **heat of hydration**, $\text{CuBr}_{2(\text{solid})} + 4\text{H}_2\text{O}_{(\text{liq.})} = \text{CuBr}_2 \cdot 4\text{H}_2\text{O}_{(\text{solid})} + 9.7$ Cals.; or, if all the constituents are in soln., 3.7 Cals. M. Berthelot also gives for the heat evolved in the displacement of the bromine by chlorine, 2×3.4 Cals. For the **photoelectric effect**, see cupric fluoride. The **magnetic susceptibility** has been measured by J. Königsberger, O. Liebknecht and A. P. Wills, and S. Meyer, and they obtained 7.0 to 7.5×10^{-6} mass units for the powdered salt, and 2.5×10^{-6} mass units for the aq. soln. at 17°.

The anhydrous and hydrated salts are deliquescent, and, according to P. Sabatier, the tetrahydrated salt effloresces in dry air, and loses all its water; its behaviour in moist air depends on the degree of humidity. The solubility, calculated by G. Bodländer, is 1.3 eq. per litre. The changes of colour which occur with soln. of cupric bromide of various conc. are analogous with those which obtain with cupric chloride, and they are explained in a similar manner. Presumably, on account of the small electro-affinity of the Br^- ions there is a greater tendency to form complexes with cupric chloride than with the bromide. According to P. Sabatier, even when protected from light, the soln. of cupric bromide, after a little time, contain free bromine, the quantity of which increases rapidly with an increase in the quantity of cupric bromide, but is not proportional to it, the proportions of free bromine per litre after several months being 0.880 grm., 5.120 grms., and 6.08 grms., for 0.0255 grm., 0.175 grm., and 1.2 grms. of copper. The hydrobromic acid is probably oxidized in presence of the cupric bromide in the same manner as hydrochloric acid in presence of certain chlorides. P. Sabatier further found that very conc. soln. of cupric bromide are comparatively opaque, and their absorption spectrum can be obtained only in layers less than 1 mm. thick. The absorption spectrum of such a soln. resembles that of a soln. in alcohol. The absorption is greatest in the green, and the transmission is a maximum in the red. As the soln. is diluted, the absorptior in the green decreases, and that in the red increases, until, with very dil. soln., the absorption is a maximum in the red, and very slight in the green.

The general properties of soln. of cupric bromide resemble those of the corresponding chloride (*q.v.*). The colour and the transport number, v , with soln. of different conc., C , at 25°, are, according to H. G. Denham⁴:

C	. . . 0.106	0.414	1.690	2.218	3.187	4.055	5.288
v	. . . 0.445	0.440	0.069	0.052	-0.086	-0.159	-0.39%
Colour	. . . Bl-green	Green	Br-green	Br-green	Brown	Deep br.	Deep br.

The negative values for the migration numbers are interpreted to mean that complex anions are formed—say $(\text{CuBr}_4)''$, $(\text{Cu}_2\text{Br}_6)''$, etc.—which carry out all the copper from the cathode compartment. If the equilibrium $\text{Cu}^+ + \text{CuBr}_2 + 2\text{Br}^- \rightleftharpoons \text{Cu}^+ + (\text{CuBr}_4)''$ lies almost wholly to the right, the transport number would be zero, and if appreciable $(\text{Cu}_2\text{Br}_6)''$ -ions were present, $\text{Cu}^+ + 2\text{CuBr}_2 + 2\text{Br}^- = \text{Cu}^+ + (\text{Cu}_2\text{Br}_6)''$, the values would be less than zero.

P. Sabatier⁵ says that *alcohol* dissolves the anhydrous bromide, forming highly opaque yellowish-red soln. According to W. Eidmann, cupric bromide, CuBr_2 , is soluble in *acetone*, forming a dark green soln. which slowly deposits cuprous bromide

as a pale green precipitate ; and mercuric chloride precipitates cupric bromide from the dil. soln. J. Schröder, and A. Naumann find it to be soluble in *pyridine* ; and D. W. Horn, soluble in liquid ammonia.

C. Löwig⁶ reported that during the evaporation of a soln. of cupric bromide, some bromine is lost, and when water is added some cuprous bromide is precipitated. A. Löwig also noted that a little ammonia gives a pale green precipitate with aq. soln. of cupric bromide which is regarded as an oxybromide ; and T. W. Richards that cuprous bromide, under water, deposits a little oxybromide after standing six months in darkness. The composition of the **cupric oxybromide** is generally represented as $3\text{CuO} \cdot \text{CuBr}_2 \cdot 3\text{H}_2\text{O}$, *i.e.* $3\text{Cu}(\text{OH})_2 \cdot \text{CuBr}_2$. E. Brun claims to have made it by allowing a hot sat. soln. of cuprous bromide in potassium bromide to stand in the air ; and by adding hydrogen peroxide to the soln., an immediate precipitate is obtained. An aq. soln. of cupric bromide deposits a little oxybromide ; and J. Dupont and H. Jansen prepared the oxybromide by heating a neutral dil. soln. of cupric bromide in a sealed tube to 200° or 225° . The oxybromide was made by T. W. Richards by the prolonged digestion of cupric oxide with a conc. soln. of cupric bromide ; and P. Sabatier obtained a similar result with cupric hydroxide—with cupric oxide, said he, crystals are slowly formed, with the hydroxide the product is amorphous. A. Mailhe also obtained the oxybromide by the action of nickel oxide, hydroxide, or carbonate on a soln. of cupric bromide. E. Brun also made the oxybromide by adding a conc. soln. of potassium bromide to a soln. of copper ammino-sulphate at 100° .

The crystals of the oxybromide are dark green hexagonal or rhombohedral plates. According to T. W. Richards, the crystals do not lose their combined water when dried over conc. sulphuric acid ; and, according to E. Brun, they lose very little water at 180° to 190° ; at 210° to 215° , almost all is lost ; and at 240° to 250° , they are completely transformed into cupric bromide and oxide ; while, according to J. Dupont and H. Jansen, they lose about two-thirds their water at 200° , and all the water at 250° —hence they regarded the oxybromide as being analogous with atacamite, and as being constituted $\text{Br}-\text{Cu}-\text{O}-\text{Cu}-\text{OH}+\text{H}_2\text{O}$. The oxybromide is insoluble in water, but by a prolonged boiling in water, T. W. Richards converted it into cupric bromide and a dark insoluble product. According to E. Brun, the oxybromide is soluble in ammonia and in dil. mineral acids ; and, according to T. W. Richards, it is soluble in dil. acetic acid, but not in dil. potassium bromide, although it is slightly soluble in a conc. soln. of cuprous bromide.

According to P. Sabatier, when a minute quantity of cupric bromide is added to conc. hydrobromic acid, an intense purple coloration is produced, in consequence, probably, of the formation of a hydrobromide of the bromide. This reaction is more sensitive than either the ferrocyanide or sulphide reaction, and will detect 0.0015 milligram of copper in a drop of a soln. of the bromide, but the hydrobromic acid must be conc. A mixture of potassium bromide with a sat. soln. of phosphoric acid can be used instead of hydrobromic acid. By leading hydrogen bromide into a conc. soln. of cupric bromide, the black crystals of cupric bromide first deposited are redissolved, and when the soln. cools crystals of the **dihydrated cupric hydrobromide**, either $\text{CuBr}_2 \cdot \text{HBr} \cdot 2\text{H}_2\text{O}$ or $3\text{CuBr}_2 \cdot 2\text{HBr} \cdot 6\text{H}_2\text{O}$ are formed—the available analyses may represent either, but the first formula is the more probable. The crystals are separated from the mother liquid, and dried on porous tiles. The crystals easily decompose with the evolution of hydrogen bromide, but they are fairly stable in an excess of conc. hydrobromic acid which is thereby coloured purple, and the purple soln. slowly becomes yellow on standing. If a soln. of cupric bromide in 40 per cent. hydrobromic acid be left in contact with the product of the action of hydrogen bromide on heated molybdenum trioxide, R. F. Weinland and W. Knöll found that black hygroscopic needle-like crystals of **decahydrated cupric hydrobromide**, $\text{CuBr}_2 \cdot \text{HBr} \cdot 10\text{H}_2\text{O}$, are formed. If the molybdenum salt be omitted, crystals of cupric bromide are alone obtained. When dry cupric bromide is exposed to ammonia gas, it swells up, forming a voluminous blue powder to which

C. F. Rammelsberg ⁷ ascribed the formula $\text{CuBr}_2 \cdot 5\text{NH}_3$, but T. W. Richards showed that C. F. Rammelsberg must have analyzed a product which had lost some ammonia by exposure to air, and D. W. Horn also suggests that C. F. Rammelsberg must have used a cupric bromide which was not thoroughly dried, because to get **cupric hexammino-bromide**, $\text{CuBr}_2 \cdot 6\text{NH}_3$, the cupric bromide should be finely powdered and thoroughly dried over phosphorus pentoxide. At atm. press., this compound is stable over temp. ranging from its sat. soln. in liquid ammonia up to 20° ; and under a press. of 20 mm. it dissociates at $54 \cdot 9^\circ$. F. Ephraim found that blue **cupric pentammino-bromide**, $\text{CuBr}_2 \cdot 5\text{NH}_3$, is unstable above 116° , yielding solid soln. below this temp., which may have the composition $\text{CuBr}_2 \cdot 6\text{NH}_3$ at about 0° . He obtained the following relation between temp. θ and composition $\text{CuBr}_2 + n\text{NH}_3$:

θ	-10°	0°	15°	32°	51°	65°	81°	92°	103°	115°	124°
n	6·04	6·04	5·89	5·82	5·65	5·48	5·28	5·19	5·15	5·08	3·32

He also says that greyish-black **tricupric decammino-bromide** is formed decomposing at 155° , at 170° decomposition being complete, and the product containing $2 \cdot 01\text{NH}_3$; this melts at 260° and gives off gas. The higher ammino-salts lose part of their ammonia on exposure to the air, forming an olive-green powder of **cupric diammino-bromide**, $\text{CuBr}_2 \cdot 2\text{NH}_3$. The colour is almost black at 200° . The same product is obtained by heating the hexammino-salt to 165° . This salt dissolves in a conc. soln. of ammonium bromide, but it is decomposed by water whereby a trace of copper passed into soln. but most is precipitated as hydroxide or hydroxybromide. The diammino-salt absorbs ammonia reforming the hexammino-bromide, and it can be heated to 200° without decomposition. F. Ephraim says it decomposes at about 260° . At higher temp. all the ammonia is lost—a small part as ammonium bromide, and a residue of cupric bromide with a little cupric oxide is obtained. The salt forms a blue-coloured liquid when treated with a little water, and the soln. deposits cupric hydroxide on dilution. It dissolves in an aq. soln. of ammonium bromide without decomposition, and may seemingly be recrystallized from this liquid. Similar crystals are formed when ammonia is cautiously added to a mixture of cupric and ammonium bromides.

C. F. Rammelsberg, in 1842, reported the preparation of **cupric triammino-bromide**, $\text{CuBr}_2 \cdot 3\text{NH}_3$, by treating an ammoniacal sat. soln. of cupric bromide with alcohol; the dark green crystalline product behaves like the hexammino-salt when heated, and when treated with water. T. W. Richards and H. G. Shaw made repeated attempts to prepare this salt, but always obtained deep indigo, almost black crystals, of a **tricupric decammino-bromide**, $3\text{CuBr}_2 \cdot 10\text{NH}_3$; consequently, it is supposed that C. F. Rammelsberg's salt does not exist. The crystals are best obtained by cautiously adding conc. hydrobromic acid to a mixture of cupric bromide and alcohol with just enough ammonia to keep all the copper in soln. When enough hydrobromic acid has been added to neutralize all the ammonia, the crystals which are almost insoluble in alcohol begin to form. V. Kohlschütter and P. Pudschies dissolved cupric bromide in conc. ammonia and added rather more than an eq. quantity of potassium bromide. On warming, crystals of the salt are obtained. The crystals rapidly lose ammonia when exposed in the moist state to air, but if dry, they are much more stable. When heated slowly to 160° , they form the olive-green diammino-salt. Water decomposes the decammino-salt; a little copper passes into soln. in the form of the hexammino-salt while cupric hydroxide is precipitated: $\text{Cu}_3(\text{NH}_3)_{10}\text{Br}_6 + 4\text{H}_2\text{O} = \text{Cu}(\text{NH}_3)_6\text{Br}_2 + 4\text{NH}_4\text{Br} + 2\text{Cu}(\text{OH})_2$, but the exact nature of the product depends on the proportion of water. When a cold soln. of the decammino-salt is decomposed with potassium bromide, V. Kohlschütter and P. Pudschies found that crystals of a bluish-green **cupric diammino-oxy-bromide**, $2\text{CuO} \cdot \text{CuBr}_2 \cdot 2\text{NH}_3 \cdot 3\text{H}_2\text{O}$ or $\text{Cu}(\text{NH}_3)_2\text{Br}_2(\text{CuO})_2 \cdot (\text{H}_2\text{O})_3$, are formed.

L. L. de Koninck ⁸ gradually added bromine to a well-cooled mixture of 100 grms. of copper turnings and 200 c.c. of water until the copper and cuprous bromide had disappeared, the excess of bromine was expelled by gently warming the dark brown

soln.; 309 grms. of ammonium bromide are added, and the filtered claret-coloured soln. is crystallized by evaporation. Dil. soln. are bluish-green, conc. soln. claret-red. Emerald-green crystals of **dihydrated ammonium bromocuprate**, $2\text{NH}_4\text{Br}\cdot\text{CuBr}_2\cdot 2\text{H}_2\text{O}$, are formed; they are probably monoclinic, and isomorphous with the corresponding chloride. The crystals gradually lose water in a desiccator, and form a black powder; at 100° they are partially decomposed. T. W. Richards and A. H. Whitridge made an ammonium cupri-bromide by leading ammonia into a soln. of cupric bromide in alcohol and glacial acetic acid; and ammonio-complexes of ammonium cupri-bromide were also prepared. P. Sabatier prepared lithium cupri-bromide, $\text{LiBr}\cdot\text{CuBr}_2$, by slowly evaporating, over sulphuric acid, a conc. soln. of lithium bromide mixed with three times its weight of cupric bromide; and N. S. Kurnakoff and A. A. Sementschenko evaporated on a water-bath a mixed soln. of cupric bromide with twice its weight of lithium bromide, and obtained black prismatic crystals of hexahydrated dilithium cupri-bromide, $\text{CuBr}_2\cdot 2\text{LiBr}\cdot 6\text{H}_2\text{O}$, which melt in a closed tube between 75° and 80° . The crystals decompose in air. The purple-red soln. is supposed to contain undecomposed salt. P. Sabatier made **potassium bromocuprate**, $\text{CuBr}_2\cdot\text{KBr}$, by a process analogous to that employed for the corresponding lithium salt. The crystals are probably monoclinic and lose one-third of their bromine when heated. H. L. Wells and P. T. Walden prepared **dicaesium bromocuprate**, Cs_2CuBr_4 or $2\text{CsBr}\cdot\text{CuBr}_2$, from mixed soln. of 50 grms. of caesium bromide in the presence of 5 to nearly 70 grms. of cupric bromide; with a higher proportion of cupric bromide, the rhombic crystals are small, short prisms, and with the lower proportions elongated prisms. The crystals are black with a greenish tinge. Opaque, dark, hexagonal crystals of **caesium bromocuprate**, CsCuBr_3 or $\text{CsBr}\cdot\text{CuBr}_2$, are formed from soln. containing 50 grms. of caesium bromide and 70 of cupric bromide with 70 grms. of cupric bromide in 200 c.c. of water; the proportion of cupric bromide can be increased until the soln. is sat. with that salt. Unlike the corresponding CsCuCl_3 , if the salt CsCuBr_3 be recrystallized from water, Cs_2CuBr_4 is obtained. No hydrated salts are obtained, so that it cannot be said that the tendency to combine with water increases with the at. wt. of the halogen, as I. Remsen observed to be the case with the alkaline lead halides.

REFERENCES.

- ¹ T. W. Richards, *Proc. Amer. Acad.*, 25. 206, 1890; *Chem. News*, 63. 20, 1891; P. Jannasch and E. Rose, *Zeit. anorg. Chem.*, 9. 194, 1895; A. C. Christomanos, *ib.*, 41. 312, 1904; N. S. Kurnakoff and A. A. Sementschenko, *ib.*, 19. 337, 1899; C. F. Rammelsberg, *Pogg. Ann.*, 55. 246, 1842; W. O. de Coninck and L. Arzalier, *Mém. Acad. Belgique*, 800, 1907; P. Sabatier, *Bull. Soc. Chim.*, (3), 11. 676, 1894; *Compt. Rend.*, 118. 980, 1894; G. Viard, *ib.*, 135. 169, 1902; H. and W. Biltz, *Uebungsbeispiele aus der anorganischen Experimentalchemie*, Leipzig, 1907; C. Löwig, *Das Brom und seine chemischen Verhältnisse*, Heidelberg, 1829; J. B. Berthelot, *Ann. Chim. Phys.*, (2), 44. 385, 1830.
- ² P. Sabatier, *Compt. Rend.*, 118. 980, 1894; *Bull. Soc. Chem.*, (3), 11. 676, 1894; T. Carnelley, *Journ. Chem. Soc.*, 33. 273, 1879; P. Jannasch and E. Rose, *Zeit. anorg. Chem.*, 9. 194, 1895; J. B. Berthelot, *Ann. Chim. Phys.*, (2), 44. 385, 1830; C. F. Rammelsberg, *Pogg. Ann.*, 55. 246, 1842; C. Löwig, *Das Brom und seine chemischen Verhältnisse*, Heidelberg, 1829; G. L. Heath, *Trans. Amer. Min. Eng.*, 27. 390, 1897.
- ³ M. Berthelot, *Ann. Chim. Phys.*, (7), 4. 464, 1895; *Compt. Rend.*, 86. 628, 787, 859, 920, 1878; 87. 575, 667, 1878; P. Sabatier, *ib.*, 118. 980, 1894; J. Thomsen, *Journ. prakt. Chem.*, (2), 16. 323, 1877; *Thermochemische Untersuchungen*, Leipzig, 3. 320, 1883; J. Königsberger, *Wied. Ann.*, 66. 698, 1898; *Ann. Physik*, (4), 6. 506, 1901; O. Liebknecht and A. P. Wills, *ib.*, (4), 1. 178, 1900; S. Meyer, *ib.*, (4), 1. 664, 1900; *Wied. Ann.*, 68. 325, 1899; 69. 236, 1899; G. Bodländer, *Zeit. phys. Chem.*, 27. 61, 1898.
- ⁴ H. G. Denham, *Zeit. phys. Chem.*, 65. 64, 1909; S. B. Watkins and H. G. Denham, *Journ. Chem. Soc.*, 115. 1269, 1919.
- ⁵ W. Eidmann, *Ein Beitrag zur Kenntnis des Verhaltens chemischer Verbindungen in nicht-wässrigen Lösungen*, Giessen, 1899; *Zeit. anorg. Chem.*, 23. 90, 1900; J. Schröder, *Reaktionen von Metallsalzen in Pyridin*, Giessen, 1901; A. Naumann, *Ber.*, 37. 4609, 1904; P. Sabatier, *Compt. Rend.*, 118. 980, 1042, 1144, 1894; D. W. Horn, *Amer. Chem. Journ.*, 39. 184, 1908.
- ⁶ T. W. Richards, *Proc. Amer. Acad.*, 25. 195, 1890; *Chem. News*, 63. 20, 34, 43, 1891; P. Sabatier, *Compt. Rend.*, 125. 103, 1897; E. Brun, *ib.*, 109. 67, 1889; *Bull. Soc. Chim.*, (3), 2. 211, 1889; J. Dupont and H. Jansen, *ib.*, (3), 9. 193, 1893; A. Mailhe, *Ann. Chim. Phys.*,

(7), 27. 395, 1902; C. Löwig, *Das Brom und seine chemischen Verhältnisse*, Heidelberg, 1829; R. F. Weinland and W. Knöll, *Zeit. anorg. Chem.*, **44**, 115, 1905.

⁷ C. F. Rammelsberg, *Pogg. Ann.*, **55**, 246, 1842; T. W. Richards, *Ber.*, **23**, 3790, 1890; T. W. Richards and H. G. Shaw, *Chem. News*, **69**, 48, 1894; *Proc. Amer. Acad.*, **28**, 247, 1893; *Amer. Chem. Journ.*, **15**, 651, 1893; D. W. Horn, *ib.*, **39**, 204, 1908; V. Kohlschütter and P. Pudsches, *Ber.*, **27**, 1159, 1904; F. Ephraim, *ib.*, **52**, 940, 1919.

⁸ L. L. de Koninck, *Zeit. angew. Chem.*, **2**, 507, 1888; T. W. Richards and A. H. Whitridge, *Amer. Chem. Journ.*, **17**, 145, 1895; P. Sabatier, *Bull. Soc. Chim.*, (3), **11**, 683, 1892; *Compt. Rend.*, **118**, 1263, 1894; N. S. Kurmakoff and A. A. Sementschenko, *Journ. Russian Phys. Chem. Soc.*, **30**, 701, 1898; H. L. Wells and P. T. Walden, *Amer. Journ. Science*, (3), **47**, 94, 1894; I. Rensen, *ib.*, (3), **46**, 37, 1893.

§ 20. Cuprous Iodide

Small translucent reddish-brown crystals of cuprous iodide, CuI, occur in nature as the mineral *marshite* from Broken Hill (Australia). C. W. Marsh¹ regards the mineral as being tetragonal and hemihedral, and H. A. Miers as being cubic and hemihedral. W. Autenrieth also believes that iodine occurs in some New South Wales cuprites as marshite. When finely-divided copper is heated, it reacts with iodine vapour, and, according to M. B. Renault,² if a copper plate be exposed to iodine vapour, or to a soln. of iodine, it becomes covered with crystals of cuprous iodide; and if a strip of copper in mercuric iodide be covered with a layer of magnesium chloride soln., A. C. Becquerel found octahedral crystals of cuprous iodide are deposited electrolytically on the plate. H. Rose noted that copper is readily dissolved by hot conc. hydriodic acid with the evolution of hydrogen and the formation of cuprous iodide; the action, said M. Berthelot, is more vigorous than with hydrochloric acid. Iodine is liberated during the reaction, and the resulting cuprous iodide is pulverulent—if a trace of hydrogen sulphide be present, the separation of iodine is prevented. E. Meusel noted that when the reaction takes place slowly at ordinary temp., the resulting cuprous iodide is crystalline. Dil. hydriodic acid does not act on the metal, while R. S. Norris and F. G. Cottrel found that liquid hydrogen iodide dissolves copper slowly, and cupric oxide rapidly, forming in both cases cuprous iodide—in the latter case, iodine is separated.

E. Meusel noted that when cuprous sulphide is treated with hydriodic acid, yellowish-green tetrahedral crystals are formed. Cuprous iodide is precipitated from a hydrochloric acid or ammonium chloride soln. of cuprous chloride by the addition of potassium iodide; and J. A. Buchner has shown that if too much hydrochloric acid be present, some cuprous iodide remains in soln., and if too little be present, some cuprous chloride is precipitated. According to R. Varet,³ cuprous cyanide is transformed into the iodide when it is treated with hydriodic acid.

J. B. Berthelot found that when soln. of copper sulphate are treated with potassium iodide, half the iodine is precipitated as cuprous iodide, and half is liberated as free iodine: $2\text{CuSO}_4 + 4\text{KI} = \text{I}_2 + 2\text{CuI} + 2\text{K}_2\text{SO}_4$. The precipitate can be washed with alcohol. Measurements show that the speed of the reaction is proportional to the conc. of the cupric sulphate, and to the square of the conc. of the potassium iodide. Hence, the reaction may be represented $\text{CuSO}_4 + 2\text{KI} = \text{CuI} + \text{K}_2\text{SO}_4 + \text{I}$, followed by $\text{I} + \text{I} = \text{I}_2$. According to M. Traube, if not more than 4 mols of potassium iodide are present for every 2 mols of cupric sulphate, the precipitate contains a mixture of cupric and cuprous iodides; but J. W. Walker and M. V. Dover do not agree with this, and they show some evidence that more probably the precipitate contains some polyiodide, CuI_4 . L. Moser showed that, in dil. soln., the reaction is not complete, and that the presence of sulphuric acid favours the reaction. According to A. H. Low, cupric acetate gives better results than the sulphate.

It is probable that in the reaction between cupric sulphate and potassium iodide, cupric iodide is first formed: $\text{CuSO}_4 + 2\text{KI} \parallel \text{K}_2\text{SO}_4 + \text{CuI}_2$, and that the latter is immediately decomposed: $2\text{CuI}_2 \rightleftharpoons \text{I}_2 + 2\text{CuI}$, by a reversible reaction, so that some

cupric iodide remains in soln. K. Elbs, therefore, argued that if the cupric salt or cupric ions are removed the reaction must proceed from right to left; this may be achieved by adding to the mixture of cuprous iodide and iodine a salt which forms complexes with the cupric ion. Ammonium oxalate serves this purpose, and if ammonium oxalate is added to the mixture of cuprous iodide and iodine, an intensely blue soln. of cupric ammonium oxalate is formed. Conversely, if the free iodine be removed from the system as fast as it is formed, the formation of cuprous iodide will proceed to an end; for quantitative results P. E. Browning showed that an excess of potassium iodide and the presence of iodine, or hydriodic acid, should be avoided. K. Elbs used sodium thiosulphate for removing the liberated iodine in the reaction to ensure the complete conversion of cupric to cuprous iodide; A. Duflos used sulphurous acid for this purpose; P. N. Raikow, phenylhydrazine; E. Fleischer, stannous chloride; and E. Souberain, ferrous sulphate. The reaction by A. Duflos' process is represented: $2\text{CuSO}_4 + 2\text{KI} + \text{SO}_2 + 2\text{H}_2\text{O} = 2\text{CuI} + \text{K}_2\text{SO}_4 + 2\text{H}_2\text{SO}_4$, and it is conducted by B. Lean and W. H. Whatmough in the following manner:

Two mols of copper sulphate are dissolved in three litres of water, the soln. is sat. with sulphur dioxide, and two mols. of potassium iodide dissolved in 150 c.c. of water are added. The pale yellow precipitate which is immediately formed is allowed to settle, the supernatant liquid poured off, and the residue washed with sulphurous acid soln. by decantation until the whole of the sulphate has been removed. It is then boiled with water to make it granular, collected on linen, spread on a porous tile, and finally exposed over sulphuric acid in vacuo. Cuprous iodide retains moisture somewhat obstinately; after an exposure for three weeks over sulphuric acid, a sample still contained 0.18 per cent. of moisture, but this was removed after further exposure.

According to M. Guichard, dry hydrogen iodide liberates iodine in the presence of dry cupric chloride at ordinary temp., heat is developed and iodine is sublimed; a white residue of cuprous iodide remains. If cupric chloride, dehydrated at 200° in a current of dry hydrogen chloride, is cooled to -40° in a stream of hydrogen iodide, the gas liquefies on the chloride and iodine is liberated colouring the mass violet-red. The free iodine can be removed by washing with cold dry ether, and grey cuprous iodide remains. Thus, the reactions in the dry state and at low temp. are the same as in aq. soln. at ordinary temp. According to A. Naumann, soln. of cupric chloride in acetone or ethyl acetate furnish precipitates of cuprous iodide when treated with a metal iodide—e.g. cadmium iodide. According to D. Vitali, a cone. sulphuric acid liberates iodine from an alkali iodide, and if cupric sulphate be present, the mixture becomes black and cuprous iodide is formed, which remains as a white precipitate on adding water. Chlorides under similar conditions give a yellow coloration, and bromides a deep violet coloration; both colours are discharged on adding water, and hence D. Vitali suggests the reactions as a means of distinguishing the three halides. P. Rohland precipitated cuprous iodide from a soln. of a cupric salt in the presence of a ferric salt, by mercuric iodide. B. Lean and W. H. Whatmough obtained cuprous iodide of 98 per cent. purity by heating copper with iodoform. By the action of a soln. of potassium iodide on cupric hydroxide, W. Spring and M. Lucion obtained a dark green substance whose analyses corresponded with cuprous oxyiodide, $\text{CuO} \cdot 2\text{CuI} \cdot \text{H}_2\text{O}$.

The properties of cuprous iodide.—M. B. Renault⁴ found cuprous iodide to be less sensitive to light than either cuprous bromide or chloride. G. Tammann studied the colour of films of cuprous iodide. The crystals probably belong to the cubic system. R. W. G. Wyckoff and E. Posnjak found that the **X-ray-digrams** correspond with the double face-centred cubic lattice of the zinc sulphide class with side 6.10 Å., and the nearest distance of the atom centres 2.63 Å. According to W. Spring, the **specific gravity** is 5.631–5.653 (15.5°) for the dried or fused salt, and 5.289 for the freshly precipitated and moist salt. G. T. Prior's value for the marshite of Broken Hill is 5.590. H. Schiff's value 4.41 is in all probability wrong. R. W. G. Wyckoff and E. Posnjak gave 5.667 at $30^\circ/4'$. P. Walden studied the mol. vol. The sp. vol., according to W. Spring, is 33.61

to 34.73, when the additive rule gives a calculated value 32.72; consequently, the formation of the compound is attended by a slight expansion. According to W. Spring, the salt is not decomposed into its elements by a press. of 8000 atm. P. W. Bridgman found that there are two modifications of cuprous iodide with a transition of the ice-type. B. Gossner stated that the ordinary cubic form becomes doubly refracting at a high temp. P. W. Bridgman found the form stable at a low temp. is the less compressible, for it has a coeff. of compressibility of 0.0000004; it also has a smaller expansibility; and a lower sp. ht. P. W. Bridgman found the transition temp. θ° to be related to the press. as follows:

θ°	100°	120°	140°	160°	180°	200°
Press.	11950	11544	11138	10732	10326	9920
δv	0.00538	0.00525	0.00515	0.00505	0.00495	0.00485
L	0.405	0.419	0.432	0.444	0.455	0.466

when the press. is expressed in kgrms. per sq. cm. Expressing the change in vol., δv , in. c.c. per grm., and the latent heat, L , in kilogram-metres per grm., he also found the results indicated above.

Numbers representing the m.p. range from T. Carnelley and L. T. O'Shea's 628°, T. Carnelley's 601° \pm 3°, to K. Mönkemeyer's 590°. According to E. J. Houston, when cuprous iodide is heated, the colour changes to dark red, then to reddish-brown, brown, dark brown, and black; on cooling, the original colour is soon restored. According to T. Carnelley and W. C. Williams, cuprous iodide boils between 759° and 772°. By adding cuprous chloride, K. Mönkemeyer found the m.p. falls to a minimum at 290° with 60 mols per cent. of cuprous chloride, and then gradually rises up to the value for pure cuprous chloride. L. Houllevigue gives **refractive index** 2.09; and, according to B. Gossner, the salt is singly refracting at ordinary temp., and doubly refracting at higher temp. For the **photoelectric effect**, see cupric fluoride.

G. F. Rodwell failed to find the transition temp. by the dilatometric method, but K. Mönkemeyer found the transition temp.: β -CuI (singly refracting) \rightleftharpoons α -CuI (doubly refracting) lies between 397° and 400° by the thermal method. When mixed with 10 per cent. of cuprous chloride, the transition temp. falls to 372°, with 20 per cent. cuprous chloride to 238°, and with over 30 per cent. to 216°. With additions of cuprous bromide, the m.p. falls to a minimum at 443° when 69 mols per cent. of cuprous bromide has been added. The transition temp. also falls to a minimum at 357°, with about 44 mols per cent. of cuprous bromide.

J. Thomsen's value ⁶ for the **heat of formation** of cuprous iodide from its elements is 16.26 Cals.; M. Berthelot's value is $\text{Cu} + \text{I} = 21.9$ Cals., the thermal value of the reaction: $\text{Cu}_2\text{O} + 2\text{HI} = 72.15$ Cals.; and for $\text{Cu}_2\text{O} + 2\text{HI} + \text{aq.} = 33.73$ Cals. G. Bodländer and O. Storbeck's value for the **free energy** of formation is -16.6 Cals.; M. de K. Thompson gives -23.7 Cals. for liquid or solid iodine, and for the **total energy** of formation, -16.6 Cals. iodine solid. A. Klein's value for the exothermal reaction: $\text{CuBr}_{\text{solid}} + \text{KI}_{\text{sol.}} = \text{CuI}_{\text{solid}} + \text{Br}_{\text{sol.}}$, is 6.495 Cals., calculated from the e.m.f. 0.2041 volt, and for the change of free energy, 4.744 Cals. According to M. Berthelot, the displacement of iodine by chlorine develops 23.4 Cals., and by bromine, 7.3 Cals.

According to K. Bädeker,⁷ cuprous iodide has a relatively high electrical conductivity (electrolytic); the **specific resistance** of cuprous iodide is 0.045 when that of 30 per cent. sulphuric acid is 1.35; with a layer 180 μ thick, the resistance is 0.010 ohm, and this increases after standing some days in the presence of air or hydrogen to a very high value. K. Bädeker also found that cuprous iodide absorbs about 0.003 per cent. of iodine vapour in three days, and its conductivity then increases very much; the conductivity of cuprous iodide alone also increases when exposed to light. G. O. Greiner studied the conductivity of cuprous iodide with dissolved iodine. G. Trumpler measured the e.m.f. of cells with cuprous iodide.

Air-dried cuprous iodide, said E. Souberain,⁸ retains 4 per cent. of moisture;

and after standing 24 hrs. in vacuo, or for several days at 130°, M. Guichard still found 0.2 per cent. to be retained, and this is lost when heated to 300° in vacuo. B. Lean and W. H. Whatmough found that cuprous iodide may be heated until it fuses in a stream of carbon dioxide; but M. Guichard found that it oxidizes below 200° when heated in air: $2\text{CuI} + \text{O}_2 = 2\text{CuO} + \text{I}_2$; the action of air is fairly rapid at 220°–240°, and B. Lean and W. H. Whatmough prepared iodine of a high degree of purity by passing air over purified cuprous iodide at this temp.; they also found that if air be passed over cuprous iodide at ordinary temp. there are indications of the liberation of iodine after 3 hrs. in light, but none after 3 days in darkness; nor could any effect be noticed with oxygen in darkness; nitrogen peroxide or nitric oxide liberates iodine at once, in light or in darkness. H. Rose observed an incomplete decomposition when heated with hydrogen. E. Souberain noted that iodine is liberated when the iodide is heated with oxidizing agents—*e.g.* manganese peroxide.

F. Kohlrausch and F. Rose calculated the **solubility** of cuprous iodide from the electrical conductivity of aq. soln., and found 8.0 mgrms. or 0.04 mgrm. eq. of CuI to be dissolved per litre at 18°; and it is not perceptibly decomposed by water. The salt is soluble in sulphuric acid if freshly precipitated—E. Fleischer, and B. Lean and W. H. Whatmough; in sulphuric acid forming a violet soln.—D. Vitali; but insoluble in $\frac{1}{10}N$ -sulphuric acid—L. Moser, and decomposed by conc. sulphuric acid into iodine, sulphur dioxide, and cupric sulphate—E. Souberain; soluble in $\frac{1}{10}N$ -hydrochloric acid; decomposed by nitric acid giving iodine, nitric oxide, and cupric nitrate—E. Souberain; the freshly-precipitated iodide, and that which has changed by exposure to light, are soluble in aq. ammonia, dil. nitric, hydrochloric, or sulphuric acid, and in soln. of sodium thiosulphate—E. Meusel. According to E. Brun, the soln. in sodium thiosulphate gives no sign of the formation of double thiosulphates, and ammonium hydrosulphide precipitates copper quantitatively from thiosulphate soln. Cuprous iodide is soluble in potassium cyanide, but not in soln. of sodium chloride, or sulphate, in potassium nitrate, or bromide, or in ammonium chloride—J. B. Berthemot. According to G. Bodländer and O. Storbeck, $\frac{1}{2}N$ -soln. of potassium iodide dissolves 0.000157 mol of cuprous iodide per litre. G. O. Greiner found that the absorption of iodine by cuprous iodide is a reversible process, and that the iodine is dissolved, not adsorbed. A soln. of ferrous chloride dissolves cuprous iodide—E. Fleischer; but ferric chloride displaces iodine—G. L. Ulex; cupric chloride forms cuprous chloride and iodine—G. Topf; alkali hydroxides give iodides with the formation of cuprous oxide, while alumina and the carbonates of the alkaline earths or magnesia do not decompose cuprous iodide—J. B. Berthemot. A warm soln. of cupric sulphate liberates no iodine. G. A. Barbieri found that when cuprous iodide is heated with cupric bromide or chloride, it loses all its iodine, *e.g.* $2\text{CuI} + 2\text{CuCl}_2 = 4\text{CuCl} + \text{I}_2$; and conversely cuprous chloride or bromide dissolved in a conc. soln. of alkali chloride when treated with a soln. of iodine in *o*-xylene, is converted into cuprous iodide, *e.g.* $4\text{CuCl} + \text{I}_2 = 2\text{CuCl}_2 + 2\text{CuI}$. The conc. of the salts and the temp. determines which of these reactions predominates. H. Moissan found that fluorine does not attack cold cuprous iodide, but it does so at a dark red heat; nor does boron attack cuprous iodide. If water with cuprous iodide in suspension be treated with hydrogen sulphide, hydriodic acid is formed—G. Langbein. According to J. B. Berthemot, and G. L. Ulex, when cuprous iodide is boiled with zinc, tin, or iron it is reduced to the metal, and the metal iodide is formed as well as some free iodine. S. M. Jørgensen says the reaction with zinc is complete. E. C. Franklin and C. A. Kraus found cuprous iodide to be soluble in liquid ammonia. According to J. W. Retgers, it is virtually insoluble in methylene iodide; and, according to H. Arctowsky, insoluble in carbon disulphide.

In 1839 C. F. Rammelsberg⁹ reported that 100 parts of cuprous iodide absorbed 19.728 parts of ammonia which could be completely expelled by heat. This amount of ammonia corresponds with cuprous diammino-iodide, $\text{CuI} \cdot 2\text{NH}_3$. If cuprous iodide at 0° be sat. with ammonia gas, and a curve be drawn corresponding with the change of press. with the composition, as in Fig. 26, S. J. Lloyd found that there

are two terraces corresponding respectively with cuprous sesquiammino-iodide, $2\text{CuI}\cdot 3\text{NH}_3$; and cuprous triammino-iodide, $\text{CuI}\cdot 3\text{NH}_3$, and no others. The last-named compound—**cuprous triammino-iodide**, $\text{CuI}\cdot 3\text{NH}_3$ —is formed when dry ammonia is passed slowly over cuprous iodide cooled by a freezing mixture. It is a pale green hygroscopic compound, with vap. press. 150 mm. at $18\cdot 25^\circ$; 422 mm. at $37\cdot 5^\circ$; 615 mm. at 46° ; and 794 mm. at 52° . F. Ephraim gives a vap. press. of 760 mm. at 50° . According to S. J. Lloyd, the triammino-salt melts at 105° if the press. of the gas be allowed to fall to 490 mm.; at $51\cdot 75^\circ$, a dark brown hygroscopic compound—**cuprous sesquiammino-iodide**, $2\text{CuI}\cdot 3\text{NH}_3$ —is formed which melts at 117° ; and which has a vapour press. of 60 mm. at $17\cdot 5^\circ$; 75 mm. at $20\cdot 25^\circ$; 272 mm. at 41° ; 490 mm. at $51\cdot 75^\circ$; 742 mm. at $59\cdot 5^\circ$; 999 mm. at 65° .

A. Levöl also prepared what he regarded as **cuprous diammino-iodide**, $\text{CuI}\cdot 2\text{NH}_3$, by shaking a copper plate with ammonia and a sat. soln. of a cupric salt in a flask until the colour disappeared; the resulting fluid was poured into a soln. of potassium iodide, and colourless crystals of this compound separated. These crystals cannot be dried without decomposition in air, ammonia is given off, and the residu is green. The mother liquid becomes blue on exposure to the air, and forms an ammino-cupric iodide. A. Saglier made the same product by boiling copper with equal parts by weight of an ammoniacal soln. of cupric hydroxide and a 10 per cent. alcoholic soln. of iodine, until the soln. was decolorized. On cooling, white needle-like crystals of cuprous diammino-iodide separate from the liquid, O. Silberrad reported the formation of an olive-green crystalline powder of **dihydrated cuprous hemiammino-iodide**, $\text{CuI}\cdot \frac{1}{2}\text{NH}_3\cdot 2\text{H}_2\text{O}$, by treating cupric ammino-polyiodide, $2\text{CuI}\cdot \text{I}_4\cdot 5\text{NH}_3\cdot \text{H}_2\text{O}$, with a 25 per cent. soln. of potassium iodide. The residual salt is insoluble in water, soluble in aqua ammonia. According to W. Biltz and W. Stollenwerk:

	$\text{CuI}\cdot 3\text{NH}_3$	$\text{CuI}\cdot 2\text{NH}_3$	$\text{CuI}\cdot \text{NH}_3$	$\text{CuI}\cdot \frac{1}{2}\text{NH}_3$
Heat of formation in Cals.	10·37	11·00	14·70	15·22
Diss. press. is 100 mm. at	$286\cdot 5^\circ$	$298\cdot 0^\circ$	$371\cdot 0^\circ$	$390\cdot 0^\circ$

A. Saglier dissolved 100 grms. of ammonium iodide in a litre of water, and mixed the soln. with 10–15 grms. of cupric hydroxide which dissolves in the warm liquid. This liquid was boiled with a large excess of copper until it became colourless; the liquid was conc. and allowed to cool slowly, when it deposited white needle-like crystals of what he regarded as $\text{Cu}_2\text{I}_2\cdot 2\text{NH}_4\text{I}\cdot \text{H}_2\text{O}$. H. L. Wells and E. B. Hurlburt could obtain only one **ammonium iodocuprite**, $\text{CuI}\cdot \text{NH}_4\text{I}$, by the use of varying proportions of ammonium and cuprous iodides in soln. of hydriodic acid; and this compound corresponds in every respect with A. Saglier's description of his product, except that it is anhydrous. The crystals can be preserved under the mother liquid, but even here they become brown on standing. In air, the compound loses ammonia and ammonium iodide, and when heated furnishes black cuprous iodide; it is decomposed by water and alcohol. The mother liquid, on standing, deposits crystals of **dihydrated ammonium ammino-iodocuprite**, $\text{CuI}\cdot \text{NH}_4\text{I}\cdot \text{NH}_3\cdot 2\text{H}_2\text{O}$. E. Fleurent also prepared **ammonium triammino-iodocuprite**, $\text{NH}_4\text{I}\cdot 2\text{CuI}\cdot 3\text{NH}_3$. A. C. Becquerel reported the formation of white needle-like crystals of potassium cupro-iodide by dipping a copper cathode in a soln. of potassium iodide in a cell, with the anode dipping in a soln. of cupric sulphate. E. Brun prepared a double compound of cuprous iodide with potassium thiosulphate and also with ammonium thiosulphate. A. Rosenheim and S. Steinhauser also obtained the complex $4(\text{NH}_4)_2\text{S}_2\text{O}_3\cdot \text{NH}_4\text{I}\cdot \text{CuI}$.

REFERENCES.

- 1 C. W. Marsh, *Proc. Roy. Soc. N.S.W.*, 26. 326, 1902; H. A. Miers, *Zeit. Kryst.*, 24. 207, 1894; W. Autenrieth, *Chem. Ztg.*, 33. 626, 1899; A. Dieseldorff, *Zeit. prakt. Geol.*, 321, 1899.
- 2 M. B. Renault, *Compt. Rend.*, 59. 319, 1864; A. C. Becquerel, *ib.*, 75. 1729, 1872; H. Rose, *Pogg. Ann.*, 4. 110, 1825; R. S. Norris and F. G. Cottrel, *Amer. Chem. Journ.*, 18. 96, 1896; E. Meusel, *Ber.*, 3. 123, 1870; J. A. Buchner, *Repert. Pharm.*, 78. 8, 1854.
- 3 J. B. Berthénot, *Journ. Pharm.*, 14. 614, 1830; L. Moser, *Zeit. anal. Chem.*, 43. 597, 1904;

A. H. Low, *Eng. Min. Journ.*, 59, 124, 1895; P. E. Browning, *Amer. Journ. Science*, (3), 46, 280, 1893; A. Duflos, *Liebig's Ann.*, 39, 253, 1841; P. N. Raikow, *Chem. Ztg.*, 18, 1661, 1739, 1894; E. Fleischer, *Chem. News*, 19, 206, 1869; E. Souberain, *Journ. Pharm.*, 13, 427, 1832; B. Lean and W. H. Whatmough, *Journ. Chem. Soc.*, 73, 148, 1898; J. W. Walker and M. V. Dover, *ib.*, 87, 1584, 1905; M. Traube, *Ber.*, 17, 1064, 1884; A. Naumann, *ib.*, 32, 1002, 1899; D. Vitali, *L'Orosi*, 12, 225, 1889; P. Rohland, *Zeit. anorg. Chem.*, 18, 324, 1898; M. Guichard, *Compt. Rend.*, 144, 1430, 1907; *Bull. Soc. Chim.*, (4), 21, 897, 1907; K. Elbs, *Zeit. Elektrochem.*, 23, 147, 1917; R. Varet, *Compt. Rend.*, 121, 598, 1895; W. Spring and M. Lucion, *Zeit. anorg. Chem.*, 2, 211, 1892.

⁴ M. B. Renault, *Compt. Rend.*, 59, 319, 1864; W. Spring, *Zeit. anorg. Chem.*, 27, 308, 1901; *Rec. Trav. Chim. Pays-Bas*, 20, 79, 1901; 21, 294, 1902; G. T. Prior, *Min. Mag.*, 13, 186, 1903; H. Schiff, *Liebig's Ann.*, 108, 24, 1858; G. Tammann, *Zeit. anorg. Chem.*, 111, 78, 1920; P. Walden, *ib.*, 115, 241, 1920; P. W. Bridgman, *Proc. Amer. Acad.*, 52, 91, 1916; B. Gossner, *Zeit. Kryst.*, 38, 110, 1903; R. W. G. Wyckoff and E. Posnjak, *Journ. Amer. Chem. Soc.*, 44, 30, 1922.

⁵ T. Carnelley, *Journ. Chem. Soc.*, 33, 273, 1878; T. Carnelley and L. T. O'Shea, *ib.*, 45, 409, 1884; T. Carnelley and W. C. Williams, *Journ. Chem. Soc.*, 37, 126, 1880; K. Mönkemeyer, *Neues Jahrb. Min. B.B.*, 22, 42, 1906; B. Gossner, *Zeit. Kryst.*, 38, 131, 1904; G. F. Rodwell, *Phil. Trans.*, 173, 1151, 1882; L. Houllévigie, *Festschrift Ludwig Boltzmann*, Leipzig, 62, 1904; E. J. Houston, *Chem. News*, 24, 177, 1871; B. Lean and W. H. Whatmough, *Journ. Chem. Soc.*, 73, 148, 1898.

⁶ J. Thomsen, *Journ. prakt. Chem.*, (2), 12, 271, 1875; M. Berthelot, *Compt. Rend.*, 87, 619, 1878; *Ann. Chem. Phys.*, (5), 16, 433, 1878; (7), 4, 454, 1895; G. Bodländer and O. Storbeck, *Zeit. anorg. Chem.*, 31, 476, 1902; M. de K. Thompson, *Journ. Amer. Chem. Soc.*, 28, 762, 1906; A. Klein, *Zeit. phys. Chem.*, 36, 369, 1901.

⁷ K. Bädcker, *Ueber die elektrische Leitfähigkeit und die thermoelektrische Kraft einiger Schwermetallverbindungen*, Leipzig, 1906; *Ann. Physik*, (4), 22, 749, 1907; *Phys. Zeit.*, 9, 431, 1908; K. Bädcker and F. Pauli, *ib.*, 9, 431, 1908; G. O. Greiner, *Die Leitfähigkeit von jodhaltigem Kupferjodür*, Coburg, 1912; G. Trumpler, *Zeit. phys. Chem.*, 99, 9, 1921.

⁸ E. Souberain, *Journ. Pharm.*, 13, 427, 1832; J. B. Berthemot, *ib.*, 14, 614, 1830; G. L. Ulex, *Arch. Pharm.*, (3), 5, 524, 1874; M. Guichard, *Bull. Soc. Chim.*, (4), 2, 897, 1907; B. Lean and W. H. Whatmough, *Journ. Chem. Soc.*, 73, 149, 1898; H. Rose, *Pogg. Ann.*, 4, 110, 1825; G. Langbein, *Ber.*, 7, 765, 1874; F. Kohlrausch and F. Rose, *Wied. Ann.*, 50, 127, 1893; *Sitzber. Akad. Berlin*, 453, 1893; *Zeit. phys. Chem.*, 12, 241, 1893; F. Kohlrausch, *ib.*, 44, 224, 1903; G. Bodländer and O. Storbeck, *Zeit. anorg. Chem.*, 31, 476, 1902; H. Arctowsky, *ib.*, 6, 255, 1894; J. W. Retgers, *ib.*, 3, 343, 1893; L. Moser, *ib.*, 56, 144, 1908; *Zeit. anal. Chem.*, 43, 604, 1904; G. Topf, *ib.*, 26, 288, 1887; E. Fleischer, *Chem. News*, 19, 206, 1869; E. Brun, *Compt. Rend.*, 114, 667, 1892; H. Moissan, *ib.*, 114, 617, 1892; *Ann. Chim. Phys.*, (6), 24, 258, 1891; E. Meusel, *Ber.*, 3, 123, 1870; D. Vitali, *L'Orosi*, 12, 225, 1889; G. A. Barbieri, *Atti Accad. Lincei*, (5), 16, 1, 528, 1906; E. C. Franklin and C. A. Kraus, *Amer. Chem. Journ.*, 20, 827, 1898; S. M. Jörgensen, *Journ. prakt. Chem.*, (2), 2, 347, 1870; G. O. Greiner, *Die Leitfähigkeit von jodhaltigem Kupferjodür*, Coburg, 1912.

⁹ S. J. Lloyd, *Journ. Phys. Chem.*, 12, 398, 1908; C. F. Rammelsberg, *Pogg. Ann.*, 48, 162, 1839; A. Levöl, *Journ. Pharm.*, (2), 4, 328, 1843; A. Saglier, *Compt. Rend.*, 102, 1554, 1886; 104, 1441, 1887; O. Silberrad, *Journ. Chem. Soc.*, 87, 67, 1905; H. L. Wells and E. B. Hurlburt, *Amer. Journ. Science*, (3), 50, 390, 1895; E. Fleurent, *Compt. Rend.*, 113, 1047, 1891; E. Brun, *ib.*, 114, 668, 1892; A. C. Becquerel, *Ann. Chim. Phys.*, (2), 41, 33, 1829; A. Rosenheim and S. Steinhauser, *Zeit. anorg. Chem.*, 25, 107, 1900; F. Ephraim, *Ber.*, 52, 236, 1919; W. Biltz and W. Stollenwerk, *Zeit. anorg. Chem.*, 119, 97, 1921.

§ 21. Cupric Iodide and the Copper Polyiodides

Solid cupric iodide has not been prepared, but there is some evidence that cupric iodide exists in dil. aq. soln. If the formation of cuprous iodide depends on the reaction: $2\text{Cu}^{++} + 4\text{I}^{-} \rightleftharpoons 2\text{CuI} + \text{I}_2$, the assumed backward change implies the existence of cupric iodide. M. Traube¹ showed that when a very dil. soln. of potassium iodide is added to a dil. soln. of cupric sulphate, the separation of iodine and the precipitation of cuprous iodides takes place very slowly. A soln. of $\frac{1}{3}$ rd per cent. of potassium iodide added to a 1 per cent. soln. of cupric sulphate produces a precipitate in 10 minutes; with a $\frac{1}{2}$ th per cent. soln. the liquid becomes yellow in an hour; and with a $\frac{1}{20}$ th per cent. soln. the liquid remains clear and colourless, there are no signs of a blue coloration with starch, and the liquid gives the reactions of a cupric salt. M. Traube digested cuprous iodide with a sat. soln. of iodine in water, and obtained a green soln. containing 0.08 grm. of what he regarded as cupric iodide per 100 c.c. Later, D. J. Carnegie claimed to have made a soln. by working at

80°. In no case could the alleged cupric iodide be isolated in the solid form because, although it is stable in soln. at a boiling temp. it loses half its iodine when evaporated to dryness, and when the attempt is made to concentrate it by removing the water as ice. For the **photoelectric effect**, see cupric fluoride.

J. W. Walker and M. V. Dover found that the precipitate obtained when, say, 200 c.c. of a soln. containing a mol of CuSO_4 per litre, and 60 c.c. of water, were shaken for half an hour with 20 c.c. of a soln. of potassium iodide (2 mols per litre) in which 5.08 grms. of iodine had been dissolved, contains a heavy green substance along with cuprous iodide; much of this green substance is soluble in water, forming a deep brown soln. which contained only traces of potassium iodide. The olive-green substance is unstable in that on exposure to air, it changes to white cuprous iodide. The soln. and solid contain copper and iodine in approximately the atomic ratio 1 : 4, which would make it appear as if the olive-green solid at least contains a **copper tetraiodide**, CuI_4 . By heating the soln. to 80° with an excess of iodine, values approximating with those required for **copper hexaiodide**, CuI_6 , were obtained, but on cooling, the soln. deposited iodine, leaving a remainder in agreement with the ratio $\text{Cu} : \text{I}_4$. By the action of alcoholic soln. of iodine on cuprous iodide at 30°, S. M. Jörgensen likewise obtained indications of decaiodide, CuI_{10} . By washing the precipitate with alcohol, and evaporating the alcoholic soln., J. W. Walker and M. V. Dover obtained a product roughly corresponding with **copper enneaiodide**, CuI_9 .

When the deep red soln., obtained by treating copper tetraiodide with water, is diluted and shaken with cuprous iodide, the liquid becomes bluish-green, and it contains no iodine capable of reacting with starch, nor does it yield up iodine when shaken with ether or carbon tetrachloride. Soln. of the polyiodides under similar conditions give up iodine and precipitate cuprous iodide. According to M. Traube, the soln. of cupric iodide gives no precipitate with a soln. of silver nitrite, but J. W. Walker and M. V. Dover show that at the conc. in question cupric and potassium chlorides give only an opalescence, and that a soln. of cupric chloride with 0.095 per cent. CuCl_2 gives a precipitate at once with silver nitrate, while a 0.063 per cent. soln. gives no precipitate. According to M. Traube, the soln. of cupric iodide is decomposed by ferrous sulphate in the presence of hydrogen peroxide in acid soln., and in this way may be distinguished from other metal iodides. The soln. also gives the reaction of a cupric salt with potassium hydroxide and potassium ferrocyanide. The bluish-green soln. of cupric iodide containing 0.104 per cent. of cupric iodide does give a colour reaction with starch which is discharged by the addition of 0.05 c.c. of $\frac{1}{50}N$ -sodium thiosulphate. This means that at 24°, a soln. containing more than 0.1 per cent. of cupric iodide decomposes into polyiodide, and D. J. Carnegie's soln. therefore contained polyiodides. According to J. W. Walker and M. V. Dover, the insolubility of cuprous iodide and the existence of a polyiodide, CuI_n , explain the apparent instability of cupric iodide, since, from the equation: $(n-2)\text{CuI} + \text{CuI}_n \rightleftharpoons (n-1)\text{CuI}_2$, the mass law requires that for equilibrium $C_2 = K C_1$, where C_1 and C_2 respectively denote the conc. of the polyiodide and of cupric iodide. Any variation in the volume of water must therefore displace the equilibrium point, decreasing the volume, for instance, causes C_1 to increase relatively to C_2 . Values of n agreeing with $\text{CuI}_6 + 4\text{CuI} \rightleftharpoons 5\text{CuI}_2$, give values of K of one order of magnitude.

The affinity or driving force² of the conversion of cupric salts, or of cupric to cuprous ions: $\text{Cu}^{++} \rightarrow \text{Cu}^+$ is $0.204 + 0.058 \log \frac{[\text{Cu}^{++}]}{[\text{Cu}^+]}$ volt-coulombs per faraday (95,540 coulombs = one farad., F), where the conc. of the ions are represented by the square brackets. The reaction $\text{Cu}^{++} \rightarrow \text{Cu}^+$ is usually accompanied by a decrease of free energy, and has therefore a tendency to occur spontaneously. If, however, the cupric ions are in the presence of anions with a strong electroaffinity — e.g. SO_4^- , NO_3^- , F^- , Cl^- , and Br^- ions — the net decrease is not sufficient to enable the reaction to occur. For instance, the driving force of the reaction $\text{Cu}^{++} \rightarrow \text{Cu}^+$ is opposed by that of, say, $\text{I}^- \rightarrow \text{I}^0$, for which the decrease of free energy, or the driving

force of the reaction, is $0.520 - 0.058[I']$ volt-coulombs per faraday. Consequently, for the reaction $Cu^{+} + I' \rightarrow Cu + I$, when the soln. is sat. with iodine, the free energy or the affinity of the reaction is $-0.316 + 0.058\{\log([Cu^{+}]/[Cu]) + \log[I']\}$. On account of the negative term -0.316 in this expression, and the small value of $[I']$, the decrease of free energy can be large only when the ratio $[Cu^{+}]/[Cu]$ is large; and since the conc. $[Cu^{+}]$ cannot increase very much, the driving force of the reaction $Cu^{+} \rightarrow Cu$ can exceed that of $I \rightarrow I'$ when the conc. $[Cu]$ is very small. The low solubility of cuprous iodide supplies this condition. With sat. soln. of cuprous iodide, the solubility product at 18° , when the system is in equilibrium, and the free energy is zero, is obtained from (1): $-0.316 + 0.058 \log [Cu^{+}][I']^2/[Cu][I] = 0$; it follows that $[Cu^{+}][I'] = 5.06 \times 10^{-12}$; and for cupric iodide $[Cu^{++}][I']^2 = 0.14 \times 10^{-5}$. Consequently, with the greatest possible conc. of $[I']$, the solubility product of cupric iodide cannot be attained in conc. aq. soln.; and therefore (excluding cases of false equilibria), it will be impossible to obtain solid cupric iodide from aq. soln. at 18° ; and further, cupric ions in the presence of cuprous ions will form solid cuprous iodide and solid iodine until the product $[Cu^{+}][I']^2$ has fallen to 0.14×10^{-5} . Consequently, when cuprous iodide and iodine are shaken together with water at 18° , only very little cupric iodide can be formed in the soln.

The corresponding value for the free energy or driving force of the reaction $Cl' \rightarrow Cl$ is $1.417 - 0.058 \log [Cl']$ volt-coulombs per faraday; and for $Br' \rightarrow Br$, $0.993 - 0.058 \log [Br']$. For sat. soln. also the solubility products of the copper halides are:

		Chloride.	Bromide.	Iodide.
Cuprous	.	1.2×10^{-6}	4.15×10^{-8}	5.06×10^{-12}
Cupric.	.	10	1.66×10^{-8}	0.14×10^{-5}

Here the solubility products of both these cupric salts are comparatively large, cuprous bromide or chloride will be transformed by the halogens into the solid cupric salts. The factors which condition the instability of cupric iodide are therefore: (1) The low solubility of the cuprous iodide; (2) The tendency to form complex cuprous salts; (3) The low electroaffinity of the iodine anions; and (4) the low solubility of the anions.

The heat of formation of cupric iodide computed by J. Thomsen³ is $Cu + I_2 + aq. = 10.41$ Cals. W. Autenrieth assumes that iodine is present in iodiferous malachites in the form of *cupric oxyiodide*, $CuO.CuI_2.H_2O$. Several cupric ammonio-iodides have been reported. V. Kohlschütter and P. Pudschies,⁴ and F. Ephraim prepared *tricupric decammino-iodide*, $3CuI_2.10NH_3$, that is, $Cu_3(NH_3)_{10}I_6$, by warming a soln. of cupric tetrammino-iodide on a water-bath for a long time; or by mixing soln. of cupric tetrammino-iodide and potassium iodide. The colour of the soln. changes from violet to green, and then deposits black crystals. T. W. Richards and G. Oenslager prepared the same salt by boiling on a water-bath a soln. of 8 grms. of cupric acetate in 50 c.c. aqua ammonia (sp. gr. 0.90) with 30 c.c. of 57 per cent. acetic acid, 6 grms. of ammonium iodide, and 50 c.c. of alcohol; black crystals are obtained on evaporating the soln. in air. The crystals are three-sided pyramids with a bronze lustre. They lose ammonia and iodine on exposure to air; they are decomposed by water, and the deep blue soln. in hot aq. or alcoholic ammonia furnishes pale blue needles on cooling. When powdered $3CuI_2.10NH_3$ is exposed to ammonia gas, the brown powder becomes green, then blue, and forms *cupric hexammino-iodide*, $CuI_2.6NH_3$; the same compound is formed by dissolving $3CuI_2.10NH_3$ in liquid ammonia. D. W. Horn found the deep blue crystals to be stable at all temp. between the b.p. of a sat. soln. in liquid ammonia, and 20° , under atm. press.; they dissociate at 67.4° under a press. of 20 mm. They are stable if moisture be excluded, but they decompose rapidly in air leaving a dark brown residue. F. Ephraim found 6.3 mols of ammonia are taken up by a mol of cupric iodide at -18° ; at room temp. 5.9 mols of ammonia; at 119.5° , 5.0 mols, so that cupric hexammino-iodide yields solid soln. with cupric pentammino-iodide,

$\text{CuI}_2 \cdot 5\text{NH}_3$, which have the composition of the latter at 119.5° . As the temp. rises, ammonia is given off continuously, until the residue has the composition $3\text{CuI}_2 \cdot 10\text{NH}_3$; this remains stable up to 147° , and at 152° the greenish-grey diammino-salt is formed.

In 1830, J. B. Berthelot prepared blue crystals of **hydrated cupric tetrammino-iodide**, $\text{CuI}_2 \cdot 4\text{NH}_3 \cdot \text{H}_2\text{O}$, by treating a sat. soln. of cupric sulphate or acetate with warm aqua ammonia; the crystals can be purified by recrystallization from warm ammonia water. In 1839, C. F. Rammelsberg noted that aqua ammonia does not dissolve an appreciable quantity of cuprous iodide unless air has access to the liquid; a blue soln. is then formed. If the warm liquid be cooled, colourless crystals of cupric diammino-iodide, $\text{CuI}_2 \cdot 2\text{NH}_3$, separate, and the mother liquid gives crystals of hydrated cupric tetrammino-iodide on the addition of alcohol. D. W. Horn (1908) prepared the same salt by adding a soln. of potassium iodide to ammoniacal copper sulphate, and saturating the liquid with ammonia at 0° ; M. E. Pozzi-Escot (1900) treated an ammoniacal soln. of a cupric salt with ammonium iodide, or sodium iodide; and A. Saglier (1886) by allowing a mixture of an ammoniacal soln. of cupric hydroxide and alcoholic iodine to stand for some hours. The dark blue tetrahedral crystals decompose rapidly in air with the loss of ammonia, forming a dark brown residue. If the violet soln. is warmed on a water-bath the colour changes to steel-blue, and on cooling crystals of **tricupric decammino-iodide**, $3\text{CuI}_2 \cdot 10\text{NH}_3$, separate. Cold alcohol or ether has no action, but the soln. becomes brown when boiled. According to F. Ephraim, the decammino-salt passes into **cupric diammino-iodide**, $\text{CuI}_2 \cdot 2\text{NH}_3$, at 147° .

Some ammino-compounds of the copper polyiodides have been prepared; ⁵ thus O. Silberrad obtained small crystalline plates of **hydrated dicupric pentammino-hexa-iodide**, $2\text{CuI}_4 \cdot 5\text{NH}_3 \cdot \text{H}_2\text{O}$ or $2\text{CuI}_3 \cdot 5\text{NH}_3 \cdot \text{H}_2\text{O}$, by dropping 100 c.c. of a 20 per cent. soln. of potassium iodide in a soln. with a small excess of cupric tetrammino-sulphate in 1200 c.c. of water. The compound is not explosive, and when heated it gives off iodine. S. M. Jørgensen made **cupric tetrammino-tetraiodide**, $\text{CuI}_2 \cdot \text{I}_2 \cdot 4\text{NH}_3$ or $\text{CuI}_4 \cdot 4\text{NH}_3$, by adding warm alcoholic ammonia to the brown soln. of cupric iodide in a soln. of iodine in alcohol at 30° , the crystalline precipitate was washed with alcohol and dried over calcium chloride. A. Saglier made the polyiodide by gradually adding 20 grms. of iodine to 100 c.c. of an ammoniacal soln. of cupric sulphate on the water-bath, and then cooling the liquid; and M. E. Pozzi-Escot, by adding sodium or ammonium iodide to a warm soln. of a cupric salt in more ammonia than is required for the soln. of the precipitate first formed. The dark brown rhombic crystal plates decompose on exposure to air. F. Ephraim and P. Mosimann made **cupric tetrammino-hexaiodide**, $[\text{Cu}(\text{NH}_3)_4]_2 \cdot 2\text{I}_2$.

S. M. Jørgensen also prepared cupric tetrammino-hexaiodide, $\text{CuI}_2 \cdot \text{I}_4 \cdot 4\text{NH}_3$ or $\text{CuI}_6 \cdot 4\text{NH}_3$, with some combined water— $x\text{H}_2\text{O}$ —by mixing warm (30°) soln. of cupric tetrammino-nitrate and of iodine in potassium iodide, and filtering through a hot water funnel as rapidly as possible; on standing, brown rectangular plates separate which can be washed with cold water, and preserved under water a long time without decomposition, otherwise they decompose too quickly for analysis. A. Saglier made the same crystals by dissolving iodine in the mother liquid remaining after the separation of crystals of $\text{CuI}_4 \cdot 4\text{NH}_3$.

A. Guyard prepared dark violet or garnet red crystals of cupric iodide and nitrogen iodide, $\text{CuI}_2 \cdot \text{N}_2\text{H}_4\text{I}_2$, by the action of a soln. of iodine in potassium iodide on cupric tetrammino-sulphate; A. Saglier crystals of tetrahydrated **ammonium cupric diammino-iodide**, $2\text{NH}_4\text{I} \cdot \text{CuI}_2 \cdot 2\text{NH}_3 \cdot 4\text{H}_2\text{O}$, by boiling mixed soln. of 100 grms. of ammonium iodide in 200 c.c. of water, and 10 to 15 grms. of cupric hydroxide; very dark green needles separate from the filtered soln. on cooling. The crystals are insoluble in alcohol and water, but soluble in ammonia water. The last-named soln. yields blue crystals of $\text{CuI}_2 \cdot 4\text{NH}_3 \cdot \text{H}_2\text{O}$. A. Saglier also prepared black crystals of the polyiodide, $2\text{NH}_4\text{I} \cdot \text{CuI}_2 \cdot \text{I}_2 \cdot 2\text{NH}_3 \cdot 12\text{H}_2\text{O}$, by proceeding as before with a soln. containing in addition a gram eq. of iodine per gram-eq. of ammonium iodide. The dark violet needles or plates decompose in air and water. They dissolve in dil. ammonia water.

A. C. Becquerel prepared white needle-like crystals of *potassium cupro-iodide*, by dipping a copper cathode in a soln. of potassium iodide, and an anode in a soln. of cupric sulphate. The crystals soon decompose into cuprous iodide, etc.

REFERENCES.

- ¹ M. Traube, *Ber.*, 17, 57, 1889; D. J. Carnegie, *Chem. News*, 59, 57, 1889; J. W. Walker and M. V. Dover, *Journ. Chem. Soc.*, 87, 1584, 1905; E. Abel, *Zeit. anorg. Chem.*, 26, 410, 1901; R. Abegg, *Zeit. Elektrochem.*, 9, 572, 1903; S. M. Jörgensen, *Journ. prakt. Chem.*, (2), 2, 347, 1870; E. Schaer, *Arch. Pharm.*, 239, 620, 1901.
- ² F. G. Donnan, *R. Abegg's Handbuch der anorganischen Chemie*, Leipzig, 2, i, 517-523, 1908; G. Bodländer and O. Storbeck, *Zeit. anorg. Chem.*, 31, 1, 458, 1902; F. W. Küster and F. Crotogins, *ib.*, 23, 87, 1900.
- ³ J. Thomsen, *Journ. prakt. Chem.*, (2), 12, 271, 1875; W. Autenrieth, *Chem. Ztg.*, 23, 636, 1899.
- ⁴ V. Kohlschütter and P. Pudschies, *Ber.*, 37, 1153, 1904; F. Ephraim, *ib.*, 52, 940, 1919; T. W. Richards and G. Oenslager, *Amer. Chem. Journ.*, 17, 302, 1895; D. W. Horn, *ib.*, 39, 204, 1908; J. B. Berthemot, *Journ. Pharm.*, 15, 445, 1830; M. E. Pozzi-Escot, *Compt. Rend.*, 139, 90, 1900; A. Saglier, *ib.*, 102, 1554, 1886; C. F. Rammelsberg, *Pogg. Ann.*, 48, 162, 1839; C. Hahn, *Arch. Pharm.*, (2), 97, 40, 1859.
- ⁵ O. Silberrad, *Journ. Chem. Soc.*, 87, 66, 1905; S. M. Jörgensen, *Ber.*, 2, 460, 1869; *Journ. prakt. Chem.*, (2), 2, 353, 1870; A. Saglier, *Compt. Rend.*, 102, 1554, 1886; A. C. Becquerel, *ib.*, 75, 1729, 1872; M. E. Pozzi-Escot, *ib.*, 130, 90, 1900; A. Guyard, *Bull. Soc. Chim.*, (2), 41, 16, 1884; F. Ephraim and P. Mosimann, *Ber.*, 54, B, 385, 396, 1921.

§ 22. Cuprous Sulphide

The action of sulphur on copper was noticed by Geber in his *Summa perfectionis magisterii*, probably written about the thirteenth century. Albertus Magnus,¹ also of the thirteenth century, occupied himself with a study of the action of sulphur on the metals. Copper forms two clearly defined sulphides. This fact was first established by J. L. Proust in 1801. There are a number of other intermediate sulphides and polysulphides whose individuality is not so sharply defined.

In 1546, G. Agricola² distinguished the mineral cuprous sulphide from other copper ores, and he likened it to *Kupferglas*. J. G. Wallerius, in 1747, gave it a variety of names, *cuprum vitreum*, *Kupferglaserz*, etc. A. J. Cronstedt referred to it as *cuprum sulphure mineralisatum*. J. von Born called it *cuiivre sulfuré*. L. A. Emerling applied the term *Kupferglanz* as synonymous with *Kupferglas*—hence the terms *copper-glance* and *vitricous copper* now applied to this mineral. F. S. Beudant called it *chalcosine*, which in its English dress is *chalcocite*. J. Nicol called the variety from Redruth (Cornwall), *redruthite*. Other terms have been applied to particular varieties—*Lscherz*, *cuprcin*, *coperite*, *digenite*, *carmenite*, and the mineral *harrisite*. Cuprous sulphide also occurs united or associated with many other sulphides in the copper sulphide ores. The mineral was analyzed by R. Kirwan,³ M. H. Klaproth, R. Chenevix, and A. Gueniveau.

Cuprous sulphide is formed in a great many reactions and it has been reported in many furnace products. J. F. L. Hausmann,⁴ T. Scheerer, P. von Sustrschinsky, C. F. Rammelsberg, etc., found it in the slags of copper furnaces; A. Daubrée, A. Lacroix, C. A. de Gouvenain, E. Priwoznik, etc., detected its crystals on old Roman coins or bronze relics in the neighbourhood of the thermal springs at Bourbonne-les-Bains, and other places with hydrogen sulphide springs. A. Kerner, and W. R. von Haidinger and E. Kögeler found crystals of cuprous sulphide associated with the brass clasps of old books.

The formation and preparation of cuprous sulphide.—Copper and sulphur readily react when heated forming cuprous sulphide, Cu_2S , cupric sulphide, CuS , or a mixture of both. There is also a possible series of higher sulphides, as well as a series of intermediate sulphides; although some of those which have been reported are in all probability mixtures.

1. *From sulphur and copper or copper oxide.*—Copper foil burns vigorously in sulphur vapour; and when a mixture of copper filings is heated with about one-third of its weight of sulphur, the mixture becomes incandescent, and cuprous sulphide is formed.⁵ C. R. Hayward found the product should be broken up, and mixed with more sulphur; he also made cuprous sulphide by boiling sulphur with copper turnings in a large casserole for an hour. To ensure complete conversion to cuprous sulphide, the sulphur was poured off, and the porous mass mixed with 15 per cent. of sulphur and melted for 5 hrs. in a graphite crucible. The same compound is made by the action of hydrogen sulphide or the vapour of sulphur or of some other sulphur compound at a red heat, and cooling the product in the vapour; the excess of sulphur can be removed by heating it with copper. H. Rose, and E. Mitscherlich obtained octahedral crystals of cuprous sulphide by melting together copper and sulphur; and J. Margottet obtained similar crystals by the action of sulphur vapour, carried with a stream of nitrogen, over red-hot copper. Dry sulphur was found by C. Strüver to react very slowly with copper at ordinary temp. G. C. Winkelblech found sulphide is formed when a dry or moist mixture of sulphur and copper is triturated together. According to W. Spring, when a mixture of copper filings and sulphur are subjected a number of times to a press. of 65 atm., cuprous or cupric sulphide can be formed; and with the former the volume decreases from 138 to 100 units. These press. reactions were discussed in an earlier chapter. A. Orłowsky found copper to be blackened by immersion in a soln. of sulphur in carbon disulphide. J. L. Proust prepared cuprous sulphide by calcining the oxide with sulphur. H. Rose also found that cuprous sulphide is formed when copper oxides, oxysulphides, or cupric salts are heated with sulphur. E. Weinschenk obtained octahedral crystals of cuprous sulphide by heating an intimate mixture of cupric oxide, sulphide, and ammonium chloride, until the latter has all sublimed. This method was employed by F. Wöhler with iron oxide.

2. *By displacement with other sulphides.*—The affinity of copper for sulphur is estimated by O. Schumann to be nearly the same as that of copper for oxygen. A. Orłowsky⁶ considers that the affinity of copper for sulphur is greater than that of any other metal—excepting, adds E. Schürmann, palladium, mercury, and silver. E. F. Anthon says that this affinity is smaller than that of silver, but greater than that of lead, cadmium, iron, nickel, cobalt, and manganese; to this list E. Schütz added zinc and tin, and placed manganese with silver as possessing a greater affinity than copper for sulphur. F. G. Reichel⁷ found that aluminium and magnesium sulphides are reduced at a very high temp. $2\text{Cu} + \text{MgS} = \text{Cu}_2\text{S} + \text{Mg}$. A. Colson found that little cadmium sulphide is decomposed when it is heated with copper in accord with $2\text{Cu} + \text{CdS} = \text{Cu}_2\text{S} + \text{Cd}$, because the cadmium compound is dissociated below 600° . Sublimed cadmium also collects in the cooler parts of the tube; and he also noted that with iron pyrites and copper in an atm. of carbon dioxide sulphur separates from the pyrites and unites with the copper. E. Schütz observed that at 1195° , copper removed 85.06 per cent. of the sulphur from ferrous sulphide; G. P. Schweder noted that copper removes sulphur from nickel sulphide; K. Heumann found that if mercuric sulphide be boiled under water with copper, it is rapidly decomposed; and G. Strüver found that many dry natural sulphides react with copper at ordinary temp., forming copper sulphide—*e.g.* hauerite acts markedly in about three days, pyrite acts more slowly, marcasite more quickly, and magnetic pyrites more quickly still—no action was observed with arsenical pyrites or cobaltite.

3. *From copper or copper oxide and hydrogen sulphide.*—E. Murmann⁸ made cuprous sulphide contaminated with cupric sulphide by the action of hydrogen sulphide on red-hot copper. E. Brunner, L. E. Rivot, and H. Rose prepared cuprous sulphide for weighing in analytical work by heating the precipitated copper sulphide in a crucible to redness in a stream of hydrogen. R. Wegscheider says the temp. should not exceed 600° – 700° or some copper is reduced. E. Murmann says that if cuprous sulphide with a fragment of sulphur be repeatedly heated in a stream of hydrogen, the product varies less than ± 0.05 per cent. from the theoretical. The

admixture of a little hydrogen sulphide with the hydrogen has also been recommended. When carbon dioxide is employed in the reduction E. Murmann found the results too high. At ordinary temp., dry hydrogen sulphide has very little action on the dry metal, but if oxygen or air be present, the metal is attacked. If hydrogen sulphide be passed through water standing over copper, the metal is scarcely attacked, but if air be present, the metal is quickly blackened. Copper slowly decomposes an aq. soln. of hydrogen sulphide at 200°. Powdered copper very slowly develops hydrogen in an aq. soln. of hydrogen sulphide; if the powdered copper has been calcined it is not so active, but if the powder has been moistened with a soln. of platinic chloride, and ignited, it decomposes hydrogen sulphide more readily than copper alone. An alcoholic soln. of hydrogen sulphide behaves similarly; a soln. in nitrobenzene favours the formation of cuprous sulphide with the simultaneous production of aniline and benzidine. O. Sehumann found cuprous sulphide to be formed by the action of hydrogen sulphide on cupric or cuprous oxide. The action takes place in the cold with the development of heat and the formation of water; with cupric oxide, probably cupric sulphide is formed as an intermediate product. C. Doelter heated cupric oxide between 250° and 400° or gently warmed cuprous oxide with hydrogen sulphide, and obtained crystalline cuprous sulphide. J. Milbauer heated to redness a mixture of a cupric oxide and potassium thiocyanate. The reaction is very energetic, the product is washed with hot water and alcohol. If the heating be too protracted $K_2Cu_3S_6$ is formed.

4. *From copper and carbon disulphide.*—A. Cavazzi obtained cuprous sulphide by passing the vapour of carbon disulphide over metallic copper at a high temp.—some graphite is formed at the same time. According to J. Thomsen, if the carbon disulphide is carried along with a stream of nitrogen carbon monosulphide is formed. V. Merz and W. Weith say that at 250° a product with 20 per cent. sulphur (almost the theoretical value for Cu_2S) is formed—the product is admixed with carbon.

5. *The action of hydrogen sulphide on copper salts.*—Hydrogen sulphide gives a precipitate of black cupric sulphide, CuS , from neutral or acid soln.: $CuSO_4 + H_2S = CuS + H_2SO_4$. If the soln. be neutral or feebly acid, the precipitate is inclined to form a colloidal soln., and a considerable excess of acid is required to flocculate the sulphide. The precipitate readily oxidizes in air: $CuS + 2O_2 = CuSO_4$. If the acid soln. be boiling, the sulphide dissolves in hydrochloric acid, forming cupric chloride, which is then reduced to cuprous chloride: $CuS + CuCl_2 = 2CuCl + S$, and, according to L. L. de Koninck, and T. Kliche, some sulphate is formed at the same time: $CuS + 8CuCl_2 + 4H_2O = CuSO_4 + 8HCl + 8CuCl$. Hydrogen sulphide with acid soln. of cuprous salts gives a precipitate of cuprous sulphide: $Cu_2Cl_2 + H_2S = Cu_2S + 2HCl$.

The dark greenish-black precipitate obtained by the action of hydrogen sulphide on an excess of a soln. of a cupric salt, and removing the hydrogen sulphide by a current of carbon dioxide, furnishes numbers in agreement with $Cu : S = 1 : 1$. Not all the sulphur, however, is combined—some is free and can be removed by treatment with carbon disulphide or sodium sulphide. The residue contains copper and sulphur in proportions which depend upon the acidity, temp., and concn. of the soln., and on the rate at which the hydrogen sulphide is passed through the soln. The precipitate washed free from uncombined sulphur is thought to be a mixture of cupric and cuprous sulphides containing $nCuS + mCu_2S$. It is supposed that copper behaves like the more negative elements of the analytical group—germanium, tin, arsenic, antimony, molybdenum, tellurium, tungsten, platinum, iridium—and forms an unstable copper thio-salt—*vide* cadmium, mercury, and lead thio-salts—this is then decomposed, forming the two sulphides as symbolized in general terms: $(m+n)Cu + nS_2Cl_2 = nCuCl_2 + mCuS + nS$.

The precipitate is oxidized by air less readily than cupric sulphide. E. Weinschenk made crystals of cuprous sulphide by the action of hydrogen sulphide under pressure on a soln. of cuprous chloride; H. Sommerlad⁹ likewise from cuprous chloride and arsenious sulphide; and J. Durocher made six-sided plates by the action of cuprous chloride vapour and hydrogen sulphide at a high temp. P. Sabatier

and J. B. Senderens treated CuNO_2 with hydrogen sulphide; H. de Sénarmont treated a soln. of a cupric salt with sodium carbonate and hydrogen sulphide or potassium hydrosulphide at 200° ; A. Orłowsky boiled a hydrochloric acid soln. of a cuprous salt with sulphur; T. Parkman found sulphur dioxide acts more quickly than milk of sulphur; C. Himley, and G. Vortmann recommended sodium thiosulphate; and F. J. Faktor treated dry cupric chloride with dry sodium thiosulphate.

6. *The action of alkali or ammonium sulphide on copper or copper salts.*—Alkali sulphides act on soln. of cupric salts like hydrogen sulphide: $\text{CuCl}_2 + \text{K}_2\text{S} = \text{CuS} + 2\text{KCl}$. J. Pelouze¹⁰ reported that some oxysulphide is formed if the soln. is warm; and T. Kliche found that the precipitate is a mixture of both cupric and cuprous sulphides. Copper is not attacked by a soln. of potassium sulphide in the absence of air or oxygen, but A. Ditte showed that in the presence of air black crystals of cupric sulphide, or of $\text{K}_2\text{S} \cdot \text{Cu}_2\text{S}$, are formed and a little passes into soln.; G. Lunge and F. Weibel found that at 20° a soln. of sodium hydrosulphide—about 4 grms. per litre—dissolves 0.6217 gm. of copper in seven days. According to E. Priwoznik, a soln. of potassium hydrosulphide converts copper into crystalline cuprous sulphide, and gas is developed at the same time. He also found that copper reduces the polysulphides of ammonium or the alkalies to the monosulphides, some sulphur may separate, and a brownish-black crust of cupric sulphide is formed on the metal; in a few days this crust is reduced to black cuprous sulphide. Colourless ammonium sulphide in the absence of air produces only a greyish-black film on copper after some months' exposure; if air be present, ammonium hydroxide is obtained. V. Merz and W. Weith noted that a little of the ammonium hydroxide is decomposed furnishing hydrogen. The hydrogen is not developed with dil. soln. A little copper sulphide passes into soln. when a conc. soln. of ammonium monosulphide acts on copper—crystals of cuprous sulphide are simultaneously formed. The copper sulphide which is dissolved is largely precipitated by dilution with water or treatment with hydrochloric acid. According to K. Heumann, the first product of the action of a sat. soln. of sulphur in ammonium monosulphide is a reddish deposit of $(\text{NH}_4)_2\text{Cu}_2\text{S}_7$. V. Merz and W. Weith also found that the reaction with ammonium hydrosulphide is accelerated if platinized copper is used, but even then the action is slow.

7. *The reduction of the oxysulphur compounds by copper.*—J. Uhl¹¹ found that a mixture of dry sulphur dioxide and air does not form sulphur trioxide, but copper is blackened by the reduction of the sulphur dioxide and the formation of copper sulphide; moist sulphur dioxide was found by H. Causse to give a mixture of cupric sulphite and sulphide, and some hydrosulphurous acid is simultaneously formed. B. D. Steele noted that in the electrolysis of a soln. of potassium iodide in liquid sulphur dioxide with copper electrodes, a black film—presumably cuprous sulphide—is formed. L. Maumené noticed that with conc. sulphuric acid (4 : 5), copper is converted into brown amorphous cuprous sulphide; C. Baskerville found the conversion is quite rapid between 100° and 130° . S. U. Pickering believed that the cuprous sulphide is formed by the direct action of copper on the sulphur of the acid. E. Divers and T. Shimidzu found that reduced spongy copper gives a slight effervescence when placed in fuming sulphuric acid, but the copper soon blackens and the reaction is then very slow. The black film is presumably cuprous sulphide. According to V. Merz and W. Weith, when copper is heated with sodium thiosulphate which has melted in its own water of crystallization, the formation of copper sulphide begins at about 115° , and is completed in about 40 mins. Very little normal sodium sulphite is formed when copper is heated to 120° in aq. soln. of sodium thiosulphate, but at 170° the reaction is rapid. J. Girard noted the formation of cuprous sulphide when a soln. of sodium cuprous thiosulphate is treated with copper.

8. *The reduction of cupric sulphide.*—When dry cupric sulphide is calcined in an open crucible, E. Ulrici¹² found that a mixture of cuprous sulphide and copper

oxide is formed, and W. Hittorf says that some cupric sulphide remains undecomposed even at a white heat. A. Mourlot reduced precipitated and dry cupric sulphide by heating it for 5 mins. with 20 vols. of alcohol; with a long heating, metallic copper is formed. T. Kliche found cupric sulphide is reduced to cuprous sulphide by a conc. hot ammoniacal soln. of a copper salt; A. Ditte says that with potassium monosulphide, cuprous sulphide and then a double salt is formed; R. F. Weinland and L. Storz reduced cupric sulphide with a soln. of sodium arsenite. F. Cornu made crystals of cuprous sulphide by heating covellite in a porcelain crucible out of contact with air; A. Frenzel heated cupric sulphide in a stream of coal gas; E. Weinschenk, and F. Wibel reduced cupric sulphide in a stream of hydrogen. F. Damm and F. Krafft found that cupric sulphide is reduced to cuprous sulphide by exposing it in vacuo at 400° to the cathode light. A. Mourlot reduced cupric sulphide by heating it with a current of 35 amps. and 35 volts—and he adds that it is not decomposed by a current of 300 amps. and 50 volts if it is not in contact with carbon—*vide* cupric sulphide.

9. *From cupric sulphate.*—P. Berthier¹³ obtained a mixture of copper and cuprous sulphide by heating cupric sulphate in a carbon crucible to a white heat. C. Brückner heated a mixture of cupric sulphate with sulphur. Pyrites in a soln. of cupric sulphate was found by H. V. Winchell to become slowly covered with a film of cuprous sulphide. P. Hess precipitated a film of cuprous sulphide on iron placed in cupric sulphate soln. and treated with sodium thiosulphate. This protected the iron from oxidation. F. Mylius and O. Fromm found that if a soln. of cupric sulphate with a mixture of a soln. of sulphur in benzene or carbon disulphide be poured on an anodic copper plate at the bottom of a vessel, and a platinum wire cathode be used, a plate of cuprous sulphide is formed at the surface of separation of the two liquids.

C. A. Burghardt supposed that cuprous sulphide has been formed along with hydrogen sulphide, and iron sulphate by the action of steam under press., and over 120°, on cupriferous pyrites. W. Lindgren and W. F. Hillebrand, V. Lewis, H. N. Stokes, and J. F. Kemp seem to regard the mineral as having been originally contained in pyrites from which the ferruginous sulphides have been leached by soln. of cupric sulphate.

The physical properties of cuprous sulphide.—The mineral is greyish-black, blue, green, or violet; and the artificial product is black or bluish-black. Cuprous sulphide is dimorphous. In addition to the methods previously indicated for preparing crystals of cuprous sulphide by E. Weinschenk, J. Margottet, E. Mitscherlich,¹⁴ H. Rose, etc., F. Rössler dissolved the amorphous sulphide in fused lead and obtained octahedral crystals by slowly cooling the soln. The crystals of the artificial product are usually octahedra belonging to the cubic system, while the bipyramidal crystals of the natural mineral belongs to the rhombic system and, according to W. H. Miller, it has the axial ratios $a : b : c = 0.5822 : 1 : 0.9701$. Both R. J. Haüy and A. Lévy supposed the mineral to belong to the hexagonal system, but F. Mohs showed that this is wrong. The pseudohexagonal symmetry of the mineral, like aragonite and chrysoberyl, is accentuated by its forming twins and triplets about the prism planes.

The cubic crystals appear to be the form stable at a high temp. W. Mönch found both natural and artificial crystals show discontinuous changes in their electrical conductivity at 95° and at 150°. According to M. Bellati and S. Lussana, the first of these changes corresponds with a considerable change in the sp. ht., and they place the transition temp. at 103°, but R. von Sahmen and G. Tammann were unable to detect any discontinuity in the volume-temperature curve. The reported¹⁵ numbers for the specific gravity of the artificial product vary from C. F. Rammelsberg's 5.388 to C. J. B. Karsten's 5.9775. The best representative value approaches C. Doelter's 5.80, or W. Herapath's 5.792 (17.7°). The mineralogists give for the sp. gr. of the mineral 5.5 to 5.6. The hardness on F. Mohs' scale is 2.5 to 3.0.

C. J. B. Karsten reported that cuprous sulphide melts more readily than copper. H. le Chatelier¹⁶ found the melting point to be 1100°; G. Bodländer and K. S. Idaszewsky found 1091°; K. Friedrich gave 1125°–1135° for the f.p. and E. Heyn and O. Bauer, 1127°. Molten cuprous sulphide does not mix in all proportions with copper—the eutectic at about 1070° has, according to G. G. Urazoff, 0.88 per cent. of sulphur, or 4.36 per cent. of Cu_2S , by weight, and from about 9 per cent. to the f.p. of the two layers, the alloy separates into two layers, one rich in cuprous sulphide, and the other rich in copper; the f.p. of the upper layer is 1121°, and of the lower, 1070°. According to G. G. Urazoff, during the cooling of solid soln. of $\beta\text{-Cu}_2\text{S}$ rich in copper, the former passes into $\alpha\text{-Cu}_2\text{S}$; and cuprous sulphide rich in sulphur remains stable. *Copper moss* grows slowly in cooling soln. by the breaking up of the solid soln. of copper in cuprous sulphide. G. Bodländer and K. S. Idaszewsky found that molten cuprous oxide does not mix in the fluid state with copper, but, when above the m.p., copper is dissolved, and, on cooling, the metal separates out again. When polished surfaces of copper containing cuprous sulphide are etched with ammonium tetrachlorocuprate, $(\text{NH}_4)_2\text{CuCl}_4$, and with hydrofluoric acid, the red cuprous sulphide remains unchanged. H. Kopp gave 0.120 for the sp. ht. between 19° and 52°. M. Bellati and S. Lussana found the sp. ht. to decrease on a rising temp. up to the transformation temp. 103°; and the sp. ht. at a temp. below 103° is $C=0.10938+0.0002453\theta$; and above 103°, $C=0.16269-0.0000912\theta$; they also give 5.630 Cals. for the heat of transformation. J. Thomsen found the heat of formation ($2\text{Cu}, \text{S}$) to be 20.24 Cals., and ($\text{Cu}_2\text{O}, \text{H}_2\text{Saq.}$), 38.53 Cals. M. Wasjuchnowa gave ($2\text{Cu}, \text{S}$)=18.9 Cals., and $\frac{1}{2}(\text{Cu}_2\text{S}, \text{S})=2.45$ Cals.

A. de Grammont has studied the spark spectrum of cuprous sulphide, and found that it gives lines characteristic of sulphur and copper—the presence of iron is also shown spectroscopically by some characteristic lines in the violet. O. Rohde, and K. Herrmann have studied the photoelectric effect of cuprous sulphide.

T. Erhard¹⁷ found that the electrical conductivity of copper-glance is virtually nil, and T. W. Case found exposure to light had no perceptible effect on the conductivity of chalcocite; but M. Faraday found that it does conduct if heated to a temp. far below its m.p. W. Hittorf says that it conducts well when it contains copper. G. Bodländer and K. S. Idaszewsky say that cuprous sulphide is an electrolyte and that at a high temp. it is decomposed by the current into copper and non-electrolytic cupric sulphide. According to G. Burckhardt, and T. du Moncel, it conducts like a metal, while W. Hittorf, and R. von Hasslinger find that at 110° or over it conducts like an electrolyte. The latter says that over 500° it conducts both as an electrolyte, and as a metal. W. Mönch also measured the conductivity of the sulphide. S. P. Thompson says that the resistance at 0°, 51°, and 191° is respectively 1130, 120, and 2 units, and W. Kohlrausch adds that if the specific resistance be R , when mercury zero is the unit,

	0°	10°	51°	85°	107°	136°	184°	192°
$R \times 10^{-3}$	7430	4470	790	264	62	34	14.5	13 units

S. Bidwell found that precipitated cuprous sulphide pressed between silver and copper plates conducts electrolytically; while F. Streintz found that a rod made by press. from the powder is a worse conductor than cupric sulphide. C. Tubandt found that cubic crystals of cuprous sulphide is an electrolyte with positive cuprous ions. G. Trumpler studied cells of cuprous sulphide, and measured the e.m.f. against soln. of sodium sulphide. According to W. Skey, copper-glance is more electronegative towards a soln. of sodium chloride than is silver; A. Schrauf and E. S. Dana say that it is electropositive towards copper; E. Becquerel observed an e.m.f. of 0.28 volt when artificial cuprous sulphide is in contact with nickel silver. E. Hermite and C. F. Cooper proposed to diminish the internal resistance of cuprous sulphide by heating it in the vapour of sulphur,

and cooling out of contact with air. For the preparation of thermopiles with cuprous sulphide, see F. Peters' *Thermoelemente und Thermosaulen* (Halle, 1908). C. Tissot and F. Pellin have studied the use of cuprous sulphide for thermoelectric detectors in wireless telegraphy. S. Meyer gave -0.14×10^{-6} mass units at 17° for the magnetic susceptibility.

The chemical reactions of cuprous sulphide.—According to S. U. Pickering,¹⁸ amorphous cuprous sulphide, when dried at 100° , does not oxidize in air, although K. Heumann found some samples acquired a steel-blue lustre when exposed to moist air. W. Hittorf found that when heated in the absence of air, cuprous sulphide decomposes into sulphur and cupric sulphide, and A. Mourlot obtained similar results with electrical heating. If heated with a limited access of air, sulphur dioxide, cupric oxide, and sulphate are formed. E. F. Smith effected the complete oxidation of the sulphur by heating the powder on molten potassium hydroxide in a nickel dish which served as an anode for an electric circuit. If heated with water vapour, H. V. Regnault, and A. Gautier, found that some is decomposed, at a bright red heat, copper, sulphur dioxide, and hydrogen are produced: $\text{Cu}_2\text{S} + 2\text{H}_2\text{O} = 2\text{Cu} + \text{SO}_2 + 2\text{H}_2$. The sulphur of hydrogen sulphide may be oxidized by water at a red heat, forming sulphur dioxide and hydrogen along with traces of sulphur, sulphuric and thionic acids. Oxygen is therefore not necessary to account for the presence of sulphur dioxide in volcanic gases. O. Weigel found that water dissolves 3.1×10^{-6} mols of Cu_2S per litre at 18° . W. Hampe found that hydrogen slowly and completely reduced cuprous sulphide at a red heat. E. Schütz found that a stream of hydrogen passing at the rate of 0.75 litre per min. reduces 0.75 per cent. of cuprous sulphide heated for 3 hrs. between 600° and 610° , ferrous sulphide under similar conditions lost 3.46 per cent.—J. Uhl, and R. Wegscheider obtained a greater amount of reduction at 800° . According to F. C. Phillips, and A. Liversidge, reduction does take place at 600° , but, added W. M. Hutchings, only when the hydrogen is moist and the effect is then produced by the water vapour. The work of G. P. Schweder, A. Classen, and H. Rose shows that the calcination of cuprous sulphide obtained in analysis, in a stream of hydrogen, does not reduce sufficient cuprous sulphide to interfere with the result, provided the temp. is not over that of the ordinary gas blowpipe flame. A. Ledebur found that some reduction occurs when cuprous sulphide is melted with copper in dry hydrogen. A. T. Weightman, and T. W. Richards showed that if cuprous sulphide be used as cathode in the electrolysis of dil. sulphuric acid, the compound is not reduced so readily as with lead sulphide.

Cuprous sulphide at a dull red heat was found by H. Rose¹⁹ and E. Schäfer to be but slowly decomposed by chlorine: and the latter found that under these conditions it is not attacked by bromine vapour. J. Lemberg found alkaline lye and bromine forms a skin of cupric oxide on copper-glance. 5*N*-hydrochloric acid attacks cuprous sulphide very slowly, but J. Egli found that the action is faster in the presence of chlorine. H. Knop said that dil. hydrochloric acid converts copper glance into cupric sulphide; and K. Heumann found that the boiling conc. acid slowly reacts with cuprous sulphide, forming cuprous chloride and hydrogen sulphide.

E. Priwoznik²⁰ studied the action of alkali and ammonium sulphides on cuprous sulphide—cuprous sulphide with the alkali sulphides forms fusible double sulphides; the alkali polysulphides form products like they do with cupric oxide; K. Heumann studied the action of ammonium polysulphide, and obtained a red compound, $(\text{NH}_4)_2\text{Cu}_2\text{S}_7$; K. Friedrich and P. Schön obtained only a single branch in the f.p. curve of mixtures of zinc sulphide and cuprous sulphide; if a eutectic is formed it must lie close to the m.p. of cuprous sulphide; K. Friedrich, with mixtures of cuprous sulphide and lead sulphide, obtained the typical V-curve with a eutectic at 540° and about 52 per cent. lead sulphide; P. Röntgen obtained indications of the formation of four compounds, $\text{Cu}_2\text{S} : \text{FeS} = 3 : 2$; $1 : 1$; $2 : 5$; and $1 : 2$ on the f.p. curve of mixtures of cuprous sulphide and ferrous sulphide.

S. U. Pickering found that with **sulphuric acid**, cuprous sulphide furnishes sulphur dioxide, cupric sulphide and sulphate : $\text{Cu}_2\text{S} + 2\text{H}_2\text{SO}_4 = \text{CuS} + \text{CuSO}_4 + 2\text{H}_2\text{O} + \text{SO}_2$; and M. de K. Thompson showed that the action of the dil. acid is very slow in the presence of oxygen. K. Heumann noticed that some varieties of the crystalline sulphide are not attacked by dil. or conc. acid. C. E. Baker and A. W. Burwell found that when **sulphur chloride**, S_2Cl_2 , is heated with cuprous sulphide, cupric chloride and sulphur are formed.

According to W. Hampe,²¹ and G. P. Schweder, **carbon** has no appreciable reducing action on cuprous sulphide at a red heat; W. Hampe found that cuprous sulphide is not appreciably reduced by **carbon monoxide** at a red heat; G. P. Schweder found a loss of 0.8 per cent. which W. Hampe attributed to the presence of a little air, for the reducing gases act more rapidly if air is present. When strongly heated in the presence of **carbon dioxide** there is but a slight decomposition and loss of weight. E. Fleischer found that while fusion with **sodium carbonate** has scarcely any action on cuprous sulphide, a mixture of sodium carbonate and hydroxide reduces part of the sulphide to copper; and P. Berthier, and E. Fleischer noted that a mixture of sodium carbonate and cuprous oxide reduces about half the latter to copper, and the other half forms a compound of sodium and cuprous sulphides; at a white heat almost all is converted to copper. P. Berthier noted that sodium carbonate with cuprous sulphide and **iron** also furnishes copper. E. Fleischer also fused a mixture of cuprous sulphide, and sodium carbonate and chloride, with **potassium chlorate**, and obtained a more energetic oxidation than occurs with aqua regia. P. Berthier found that a similar action occurs if the sodium carbonate is replaced by **lime** or **baryta**, and double cuprous barium or calcium sulphides are formed.

Cuprous sulphide was found by M. Malzac²² to be converted by aq. **ammonia**, in the presence of air, into a soln. of a cupric salt. J. Lemberg found that by treating copper-glance with aqua ammonia, and then acidifying the soln. with sulphuric acid, copper is precipitated on the iron. K. Heumann says that cold **nitric acid** gives cupric sulphide and half the copper passes into soln.; and with warm nitric acid, sulphur is separated; when fused with **sodium nitrate**, cuprous sulphide furnishes copper. J. Matuschek says that if the copper-glance be too finely powdered cupric oxide may be formed, and that large crystals are scarcely attacked by sodium nitrate, but they are by **potassium nitrate**. H. Rose found **phosphine** slowly decomposes cuprous sulphide, forming hydrogen sulphide and copper phosphide. P. Watts²³ reported that **aluminium** and **calcium carbide** reduce native cuprous sulphide when heated in an electric furnace. C. J. B. Karsten obtained no decomposition by fusing cuprous sulphide with **lead**, although P. Berthier found that when fused with **lead oxide**, there is formed cuprous oxide, lead, and sulphur dioxide : $\text{Cu}_2\text{S} + 3\text{PbO} = \text{Cu}_2\text{O} + 3\text{Pb} + \text{SO}_2$. C. J. B. Karsten, and F. Schweder found that when heated with **iron** there is an incomplete decomposition, forming ferruginous copper, and cupiferous iron; E. Schütz found that when the mixture is heated to 1205° , 93.6 per cent. of the sulphur remains with the copper. E. D. Campbell noted the diffusion of cuprous sulphide into cast iron at a red heat. C. J. B. Karsten obtained a slight decomposition of cuprous sulphide by heating it with **ferric oxide**, but none with **ferric silicate**. F. Schweder observed no action when **nickel** is heated with cuprous sulphide. C. J. B. Karsten found that when calcined with **cupric oxide**, sulphur dioxide and copper or cuprous oxide are formed; the reaction was also studied by E. Heyn and O. Bauer,²⁴ who found that if reducing agents are present, the sulphur dioxide is partially reduced to sulphur, which re-forms the sulphide. W. Stahl studied the corresponding reaction with **cuprous oxide**. G. Bodländer found cuprous sulphide to be more soluble in **water** than silver sulphide, and more soluble than lead sulphide; according to O. Weigel, a litre of water dissolved 3.1×10^{-6} mol of copper-glance. Cuprous sulphide was found by J. Egli to be slightly soluble in 4.5*N*-**sodium hydroxide**. E. Berglund says that the precipitated sulphide slowly reduces zinc from a soln. of a **zinc salt**;

E. Heyn and F. W. Hinrichsen, and O. Bauer studied the action of a soln. of **cadmium acetate** mixed with potassium cyanide on copper containing cuprous sulphide, when alcohol is added, a yellow precipitate occurs. E. Cumenge and R. Wimmer found that when cuprous sulphide is treated with **ferric chloride** soln. cuprous chloride, ferrous chloride, and sulphur are formed; on the other hand, H. Kammerer showed that when heated in a sealed tube at 120° with ferric chloride, there are formed sulphur and cupric and ferrous chlorides, but not cuprous chloride. Similar results were obtained with a soln. of **ferric sulphate**, and V. Thomas found this last-named solvent readily dissolves copper-glance, forming sulphur and ferrous and cupric sulphates which do not act further on cuprous sulphide. According to T. Kliche, ammoniacal soln. of cupric salts do not attack the sulphide. A boiling conc. soln. of **cupric chloride** in the presence of hydrochloric acid or sodium chloride was found by F. Raschig to decompose cuprous sulphide into cuprous chloride and sulphur; whilst a **cuprous chloride** soln. has no action. M. Vallety, and A. Schneider symbolized the reaction with a soln. of **silver nitrate**: $4\text{AgNO}_3 + \text{Cu}_2\text{S} = 2\text{Ag} + \text{Ag}_2\text{S} + 2\text{Cu}(\text{NO}_3)_2$. K. Heumann pointed out that the reaction is very slow with the crystalline form of cuprous sulphide. S. Meunier has stated that the metals are precipitated from soln. of the **rare-earth salts** by copper-glance.

REFERENCES.

- ¹ Albertus Magnus, *De rebus metallicis et mineralibus*, Rouen, 1476; Gebri Arabis, *Chimica cum correptione et medulla G. Lugduni Bataavorum*, 1668; J. L. Proust, *Journ. Phys.*, 53. 89, 1801.
- ² G. Agricola, *Interpretatis Germanica vocum rei metallicæ*, Basil, 461, 1546; J. G. Wallerius, *Mineralogie*, Berlin, 282, 1747; A. J. Cronstedt, *Mineralogie*, Stockholm, 174, 1758; J. von Born, *Catalogue méthodique et raisonné de la collection des fossiles de Stolle. Elconore de Raab*, Vienna, 2. 309, 1790; L. A. Emmerling, *Lehrbuch der Mineralogie*, Giessen, 2. 222, 1796; F. S. Beudant, *Traité élémentaire de minéralogie*, Paris, 2. 408, 1832; J. Nicol, *Manual of Mineralogy*, Edinburgh, 1849; T. Wada, *Minerals of Japan*, Tokyo, 1904.
- ³ R. Kirwan, *Elements of Mineralogy*, London, 263, 1784; M. H. Klaproth, *Beiträge zur chemischen Kenntniss der Mineralkörper*, Berlin, 2. 279, 1797; 4. 39, 1807; R. Chenevix, *Phil. Trans.*, 91. 203, 1801; A. Gueniveau, *Journ. Mines*, 21. 110, 1821.
- ⁴ J. F. L. Hausmann, *Specimen crystallographiæ metallurgicæ*, Göttingen, 16, 1820; T. Scheerer, *Berg. Hütt. Ztg.*, 14. 303, 1855; P. von Sustrschinsky, *Zeit. Kryst.*, 38. 264, 1903; E. Priwoznik, *Sitzber. Akad. Wien*, 65. 81, 1872; A. Kerner, *ib.*, 51. 192, 1865; W. R. von Haidinger and E. Kögeler, *ib.*, 51. 485, 493, 1865; C. A. de Gouvenain, *Compt. Rend.*, 80. 1297, 1875; A. Daubrèe, *ib.*, 92. 57, 1881; 93. 572, 1881; *Ann. Mines*, (7), 8. 439, 1875; C. F. Rammelsberg, *Lehrbuch der chemischen Metallurgie*, Berlin, 224, 1850; A. Lacroix, *Minéralogie de la France*, Paris, 2. 515, 1897.
- ⁵ H. N. Warren, *Chem. News*, 57. 95, 1888; E. Hermite and C. F. Cooper, *Brit. Pat. No.* 2835, 1901; C. Striiver, *Centr. Min.*, 257. 401, 1901; *Atti Accad. Lincei*, (5), 10. i, 124, 233, 1901; A. Orłowsky, *Journ. Russian Phys. Chem. Soc.*, 13. 547, 1881; G. C. Winkelblech, *Liebig's Ann.*, 21. 34, 1837; F. Wöhler, *ib.*, 17. 260, 1836; W. Spring, *Bull. Acad. Belgique*, (3), 5. 492, 1883; (3), 16. 43, 1888; *Bull. Soc. Chim.*, (2), 39. 641, 1883; *Zeit. phys. Chem.*, 2. 536, 1886; H. Rose, *Pogg. Ann.*, 110. 120, 1860; E. Mitscherlich, *ib.*, 28. 157, 1833; J. Margottet, *Compt. Rend.*, 85. 1142, 1877; A. Cavazzi, *Mem. Accad. Bologna*, (4), 7. 27, 1887; J. Thomsen, *Zeit. anorg. Chem.*, 34. 193, 1903; H. Sommerlad, *ib.*, 18. 435, 1898; E. Weinschenk, *Zeit. Kryst.*, 17. 489, 1890; J. Durocher, *Compt. Rend.*, 32. 825, 1851; C. R. Hayward, *Met. Chem. Eng.*, 18. 650, 1918; J. L. Proust, *Ann. Chim. Phys.*, (1), 32. 26, 1799.
- ⁶ A. Orłowsky, *Journ. Russian Phys. Chem. Soc.*, 13. 547, 1881; E. Schütz, *Met.*, 4. 697, 1907; E. F. Anthon, *Journ. prakt. Chem.*, (17), 10. 355, 1837; E. Schürmann, *Liebig's Ann.*, 249. 342, 1888; O. Schumann, *ib.*, 187. 315, 1877.
- ⁷ F. G. Reichel, *Journ. prakt. Chem.*, (2), 12. 55, 1875; A. Colson, *Compt. Rend.*, 93. 1074, 1881; 129. 826, 1899; E. Schütz, *Met.*, 4. 663, 1907; G. P. Schweder, *Berg. Hütt. Ztg.*, 38. 82, 105, 1879; E. Donath, *Dingler's Journ.*, 236. 327, 1880; K. Heumann, *Ber.*, 7. 752, 1874; G. Striiver, *Atti Accad. Lincei*, (5), 10. i, 124, 233, 1901; *Centr. Min.*, 257. 401, 1901.
- ⁸ E. Murmann, *Monatsh.*, 17. 706, 1896; R. Wegscheider, *ib.*, 18. 44, 1897; *Chem. Ztg.*, 17. 759, 1893; V. Merz and W. Weith, *Zeit. Chem.*, 12. 241, 1869; C. Doelter, *Zeit. Kryst.*, 11. 35, 1886; J. Milbauer, *Zeit. anorg. Chem.*, 42. 440, 1904; E. Brunner, *Pogg. Ann. Ergb.*, 3. 289, 1851; L. E. Rivot, *Compt. Rend.*, 38. 868, 1854; H. Rose, *Pogg. Ann.*, 110. 120, 1860; L. L. de Koninck, *Lehrbuch der qualitativen und quantitativen chemische Analyse*, Berlin, 2. 12, 1904; T. Kliche, *Arch. Pharm.*, 228. 374, 1890; *Ber.*, 23. 2859, 1890; J. Pelouze, *Ann. Chim. Phys.*, (3), 16. 417, 1846; O. Schumann, *Liebig's Ann.*, 187. 309, 1877; H. Rose, *Pogg. Ann.*, 110. 135, 1851; A. Cavazzi, *Mem. Accad. Bologna*, (4), 7. 27, 1887; J. Thomsen, *Zeit. anorg. Chem.*, 34. 193, 1903.

⁹ G. Vortmann, *Zeit. anal. Chem.*, 20, 416, 1881; F. J. Faktor, *Pharm. Post.*, 38, 527, 1905; H. Sommerlad, *Zeit. anorg. Chem.*, 18, 435, 1898; C. Himley, *Liebig's Ann.*, 43, 150, 1842; T. Parkman, *Amer. Journ. Scienc.*, (2), 33, 328, 1861; P. Sabatier and J. B. Senderens, *Compt. Rend.*, 116, 758, 1893; J. Durocher, *Compt. Rend.*, 32, 825, 1851; A. Orłowski, *Journ. Russ. Phys. Chem. Soc.*, 13, 547, 1881; H. de Sénarmont, *Ann. Chim. Phys.*, (3), 32, 166, 1851.

¹⁰ A. Ditte, *Compt. Rend.*, 98, 1429, 1884; G. Lunge and F. Weibel, *Chem. Ind.*, 9, 2, 1891; E. Priwoznik, *Ber.*, 6, 1291, 1873; *Sitzber. Akad. Wien*, 65, 87, 1872; *Liebig's Ann.*, 164, 46, 1872; 171, 111, 1874; K. Heumann, *ib.*, 173, 22, 1874; *Ber.*, 6, 21, 1873; V. Merz and W. Weith, *Zeit. Chem.*, 12, 241, 1869; J. Pclouze, *Ann. Chim. Phys.*, (3), 16, 417, 1846; T. Kliche, *Arch. Pharm.*, 228, 374, 1890.

¹¹ J. Uhl, *Ber.*, 23, 2151, 1890; H. Causse, *Bull. Soc. Chim.*, (2), 45, 3, 1886; H. Reinsch, *Neues. Jahrb. Pharm.*, 25, 202, 1866; L. Maumené, *Ann. Chim. Phys.*, (3), 18, 312, 1846; S. U. Pickering, *Journ. Chem. Soc.*, 33, 112, 1878; E. Divers and T. Shimidzu, *ib.*, 47, 636, 1885; V. Merz and W. Weith, *Zeit. Chem.*, 12, 241, 1869; J. Girard, *Rev. Gén. Chim. Pure App.*, 6, 461, 1903; B. D. Steele, *Chem. News*, 96, 224, 1907; F. J. Faktor, *Pharm. Post.*, 38, 527, 1905; E. Weinschenk, *Zeit. Kryst.*, 17, 489, 1890; C. Doelter, *ib.*, 11, 35, 1886; J. Milbauer, *Zeit. anorg. Chem.*, 42, 440, 1904; F. Wibel, *Reduktion von Kupferoxydsalzen*, Göttingen, 1864; F. Cornu, *Neues. Jahrb. Min.*, 1, 32, 1908; A. Frenzel, *ib.*, 680, 1875; F. Damm and F. Krafft, *Ber.*, 40, 4778, 1907; C. Baskerville, *Journ. Amer. Chem. Soc.*, 17, 904, 1895.

¹² A. Mourlot, *Compt. Rend.*, 124, 769, 1897; *Ann. Chim. Phys.*, (7), 17, 567, 1899; E. Ulrici, *Journ. prakt. Chem.*, (1), 107, 110, 1869; A. Ditte, *Compt. Rend.*, 98, 1429, 1884; T. Kliche, *Arch. Pharm.*, 228, 374, 1890; R. F. Weinland and L. Storz, *Zeit. anorg. Chem.*, 56, 430, 1908; *Ber. deut. pharm. Ges.*, 17, 272, 1907; *Zeit. angew. Chem.*, 20, 1484, 1907; F. Damm and F. Krafft, *Ber.*, 40, 4778, 1907; A. Frenzel, *Neues. Jahrb. Min.*, 680, 1875; W. Hittorf, *Pogg. Ann.*, 84, 11, 1851; F. Cornu, *Neues. Jahrb. Min.*, 1, 32, 1908; E. Weinschenk, *Zeit. Kryst.*, 17, 489, 1890; F. Wibel, *Reduktion von Kupferoxydsalzen*, Göttingen, 28, 1864.

¹³ C. A. Burghardt, *Chem. News*, 37, 49, 1878; *Min. Mag.*, 9, 227, 1891; F. Mylius and O. Fromm, *Wied. Ann.*, 51, 617, 1894; W. Lindgren and W. F. Hillebrand, *Amer. Journ. Science*, (4), 18, 448, 1901; V. Lewis, *Eng. Min. Journ.*, 84, 688, 1907; J. F. Kemp, *ib.*, 83, 1192, 1907; H. N. Stokes, *Econ. Geol.*, 1, 644, 1906; P. Hess, *Dingler's Journ.*, 221, 94, 1876; P. Berthier, *Ann. Chim. Phys.*, (2), 22, 236, 1823; H. de Sénarmont, *ib.*, (3), 32, 166, 1851; C. Brückner, *Sitzber. Akad. Wien*, 114, 1162, 1905; H. V. Winchell, *Bull. U.S. Geol. Sur.*, 14, 269, 1903.

¹⁴ E. Mitscherlich, *Pogg. Ann.*, 28, 157, 1833; H. Rose, *ib.*, 110, 120, 1860; F. Rössler, *Zeit. anorg. Chem.*, 9, 50, 1895; W. Mönch, *Neues. Jahrb. Min. B.B.*, 20, 365, 1905; M. Bellati and S. Lussana, *Atti Ist. Veneto*, (6), 7, 1051, 1890; R. von Sahmen and G. Tamman, *Ann. Physik*, (4), 10, 879, 1903; R. J. Haiiy, *Traité de minéralogie*, Paris, 3, 553, 1801; A. Lévy, *Description d'une collection de minéraux formée par H. Heuland*, Londres, 3, 28, 1837; F. Mohs, *Grundriss der Mineralogie*, Dresden, 2, 564, 1824; J. Margottet, *Compt. Rend.*, 85, 1142, 1877; E. Weinschenk, *Zeit. Kryst.*, 17, 489, 1890; W. H. Miller in W. Phillips' *Introduction to Mineralogy*, London, 1852.

¹⁵ C. F. Rammelsberg, *Handbuch der kristallographisch-physikalischen Chemie*, Leipzig, 1, 177, 1881; C. Doelter, *Zeit. Kryst.*, 11, 35, 1886; T. Scheerer, *Pogg. Ann.*, 65, 292, 1845; C. J. B. Karsten, *Schweigger's Journ.*, 185, 394, 1832; W. Herapath, *Phil. Mag.*, (1), 64, 321, 1824; H. Kopp, *Liebig's Ann.*, 36, 1, 1840; J. Margottet, *Compt. Rend.*, 85, 1142, 1877; *Ann. École Norm. Sup.*, 8, 247, 1879; H. G. F. Schröder, *Dichtigkeitsmessungen*, Heidelberg, 1873.

¹⁶ M. Bellati and S. Lussana, *Atti Ist. Veneto*, (6), 7, 8, 1809; J. Thomsen, *Journ. prakt. Chem.*, (2), 19, 1, 1879; *Thermochemische Untersuchungen*, Leipzig, 3, 320, 1885; *Ber.*, 11, 2043, 1878; H. le Chatelier, *Bull. Soc. Chim.*, (2), 47, 300, 1887; G. Bodländer and K. S. Idaszewsky, *Zeit. Electrochem.*, 11, 163, 1905; K. Friedrich, *Met.*, 4, 672, 1907; 5, 53, 1908; E. Heyn and O. Bauer, *ib.*, 3, 75, 1906; W. Hampe, *Chem. Ztg.*, 17, 1693, 1893; H. Kopp, *Phil. Trans.*, 155, 71, 1865; *Liebig's Ann. Suppl.*, 3, 289, 1865; G. G. Urazoff, *Ann. Inst. Poly. St. Petersburg*, 23, 593, 1915; O. Rohde, *Ann. Physik*, (4), 19, 935, 1906; K. Herrmann, *Beiträge zum Hallwackseffekt*, Berlin, 1908; M. Wasjuchnowa, *Das Gleichgewicht Cupri-Cuprosulfid*, Berlin, 1909; A. de Grammont, *Compt. Rend.*, 118, 593, 1894.

¹⁷ T. Erhard, *Jahrb. Berg. Hütt.-Sachsen*, 175, 1885; M. Faraday, *Phil. Trans.*, 123, 507, 1833; R. von Hasslinger, *Monatsh.*, 28, 173, 1907; *Chem. Ztg.*, 31, 116, 1907; *Sitzber. Akad. Wien*, 115, 1521, 1906; F. Streintz, *Ann. Physik*, (4), 9, 867, 1902; S. Meyer, *ib.*, (4), 1, 664, 1900; *Wied. Ann.*, 68, 325, 1899; 69, 236, 1899; S. P. Thompson, *Nature*, 32, 366, 1885; F. Beijerinck, *Neues. Jahrb. Min. B.B.*, 11, 441, 1898; W. Mönch, *ib.*, 20, 365, 1905; O. Weigel, *ib.*, 21, 366, 1905; *Nachr. Gött.*, 525, 1906; *Zeit. phys. Chem.*, 58, 294, 1907; W. Hittorf, *Pogg. Ann.*, 84, 11, 1851; F. Braun, *ib.*, 153, 556, 1874; *Wied. Ann.*, 1, 95, 1877; 4, 476, 1878; 19, 340, 1883; W. Kolrausch, *ib.*, 17, 642, 1882; E. Hermite and C. F. Cooper, *German Pat.*, D.R.P. 132476, 1901; T. W. Case, *Phys. Rev.*, (2), 9, 305, 1917; G. Bodländer and K. S. Idaszewsky, *Zeit. Electrochem.*, 11, 163, 1905; A. Schrauf and E. S. Dana, *Sitzber. Akad. Wien*, 69, 142, 1874; *Amer. Journ. Science*, (3), 8, 255, 1874; W. Flight, *Phil. Mag.*, (4), 30, 337, 1865; S. Bidwell, *ib.*, (5), 20, 328, 1885; G. Burckhardt, *Jena Zeit.*, 5, 393, 1870; W. Mönch, *Ueber die elektrische Leitfähigkeit von Kupfersulfür, Silber-, Blei-, und Schwärzigen Quecksilbersulfid*, Stuttgart, 1905; H. E. Armstrong, *Proc. Roy. Soc.*, 40, 268, 1886; *Chem. News*, 53, 299, 241, 253, 1886; W. Skey, *ib.*, 23, 255, 1871; E. Becquerel, *Compt. Rend.*, 60, 313, 1865; 63, 943, 1866; *Ann. Chim. Phys.*, (2), 34, 157, 1827; T. du Moncel, *ib.*, (5), 10, 194, 459, 1877; C. Tissot and

F. Pellin, *Compt. Rend.*, 147. 791, 1908; C. Tubandt, *Zeit. anorg. Chem.*, 115. 105, 1921; 117. 1, 48, 1921; G. Trumpler, *Zeit. phys. Chem.*, 99, 9, 1921.

¹⁸ S. U. Pickering, *Journ. Chem. Soc.*, 33. 112, 1878; K. Heumann, *Liebig's Ann.*, 173. 22, 1874; *Ber.*, 6. 21, 1873; A. Mourlot, *Compt. Rend.*, 124. 769, 1897; A. Gautier, *ib.*, 142. 1465, 1906; W. Hittorf, *Pogg. Ann.*, 84. 11, 1851; A. Guard, *Chem. Ztg.*, 5. 979, 1881; A. Ledebur, *ib.*, 9. 302, 1885; W. Hampe, *ib.*, 9. 1442, 1885; *Zeit. Berg. Hütt. Sal.*, 22. 97, 1874; G. P. Schweder, *Berg. Hütt. Ztg.*, 36. 386, 1877; 38. 84, 1879; A. Classen, *Zeit. anal. Chem.*, 4. 437, 1865; H. Rose, *Pogg. Ann.*, 4. 109, 1825; E. F. Smith, *Ber.*, 23. 2276, 1890; E. F. Smith and D. L. Wallace, *ib.*, 24. 2938, 1891; J. Uhl, *ib.*, 23. 2151, 1890; H. V. Regnault, *Ann. Chim. Phys.*, (2). 62. 378, 1836; H. Schliephake, *Dingler's Journal*, 263. 613, 1887; E. Schütz, *Met.*, 4. 697, 1907; R. Wegscheider, *Monatsh.*, 14. 315, 1893; O. Weigel, *Zeit. phys. Chem.*, 58. 294, 1907; F. C. Phillips, *Chem. News*, 70. 189, 1894; A. Liversidge, *ib.*, 35. 68, 1877; W. M. Hutchings, *ib.*, 35. 117, 168, 1877; T. W. Richards, *Electrochem. Ind.*, 5. 400, 1907; A. T. Weightman, *Trans. Amer. Electrochem. Soc.*, 2. 76. 1902; *Journ. Phys. Chem.*, 7. 18, 1903.

¹⁹ H. Rose, *Pogg. Ann.*, 42. 540, 1837; J. Lemberg, *Zeit. deut. geol. Ges.*, 46. 794, 1894; K. Heumann, *Liebig's Ann.*, 173. 22, 1874; *Ber.*, 6. 21, 1873; J. Egli, *Zeit. anorg. Chem.*, 30. 42, 1902; E. Schäfer, *Zeit. anal. Chem.*, 45. 145, 1906; H. Knop, *Jahrb. Min.*, 533, 1861.

²⁰ E. Priwoznik, *Sitzber. Akad. Wien*, 65. 87, 1872; *Ber.*, 6. 1291, 1873; *Liebig's Ann.*, 164. 46, 1872; 171. 111, 1874; K. Heumann, *ib.*, 173. 22, 1874; *Ber.*, 6. 21, 1873; K. Friedrich, *Met.*, 4. 671, 1907; K. Friedrich and P. Schön, *ib.*, 5. 114, 1908; P. Röntgen, *ib.*, 3. 479, 1906. S. U. Pickering, *Journ. Chem. Soc.*, 33. 112, 1878; *Chem. News*, 37. 36, 1878; M. de K. Thompson, *Electrochem. Ind.*, 2. 225, 1904; C. E. Baker and A. W. Burwell, *Zeit. Elektrochem.*, 13. 654, 1907; *U.S. Pat. No.* 841103, 1906; N. V. Hybinette and A. R. Ledoux, *Eng. Min. Journ.*, 63. 328, 1897.

²¹ W. Hampe, *Zeit. Berg. Hütt. Sal.*, 22. 97, 1874; G. P. Schweder, *Berg. Hütt. Ztg.*, 36. 386, 1877; 38. 84, 1879; E. Busse, *Zeit. anal. Chem.*, 17. 53, 1878; E. Fleischer, *Chem. News*, 19. 206, 1869; P. Berthier, *Ann. Chim. Phys.*, (2), 33. 160, 1826.

²² K. Heumann, *Liebig's Ann.*, 173. 22, 1874; *Ber.*, 6. 21, 1873; M. Malzac, *German Pat.*, D.R.P. 163473, 1904; J. Matuschek, *Chem. Ztg.*, 29. 511, 1905; J. Lemberg, *Zeit. deut. geol. Ges.*, 46. 794, 1894; H. Rose, *Pogg. Ann.*, 6. 209, 1826; 24. 328, 1832.

²³ P. Watts, *Bull. Univ. Wisconsin*, 145, 1906; C. J. B. Karsten, *Schweigger's Journ.*, 66. 401, 1832; P. Berthier, *Ann. Chim. Phys.*, (2), 39. 246, 1828; E. Schütz, *Met.*, 4. 662, 1907; F. Schweder, *Berg. Hütt. Ztg.*, 36. 386, 1877; 38. 84, 1879; W. Stahl, *ib.*, 49. 99, 1890; E. D. Campbell, *Stahl Eisen*, 17. 960, 1897.

²⁴ G. Bodländer, *Zeit. phys. Chem.*, 27. 64, 1898; O. Weigel, *ib.*, 58. 294, 1907; J. Egli, *Zeit. anorg. Chem.*, 30. 42, 1902; E. Berglund, *Zeit. anal. Chem.*, 22. 184, 1883; E. Heyn and O. Bauer, *Mct.*, 3. 84, 1906; F. W. Hinrichsen and O. Bauer, *Mitt. Materialprüf. Amt.*, 25. 119, 1915; E. Cumenge and R. Wimmer, *Dingler's Journ.*, 250. 85, 1883; V. Thomas, *Met.*, 1. 8, 1904; M. de K. Thompson, *Electrochem. Ind.*, 2. 225, 1904; T. Kliche, *Arch. Pharm.*, 228. 374, 1890; F. Raschig, *Liebig's Ann.*, 228. 9, 1885; K. Heumann, *ib.*, 173. 22, 1874; *Ber.*, 6. 21, 1873; S. Meunier, *ib.*, 10. 896, 1877; A. Schneider, *Pogg. Ann.*, 152. 471, 1874; M. Vallery, *Ann. Chim. Anal. App.*, 10. 193, 1905; H. Kammerer, *Berg. Hütt. Zeit.*, 50. 262, 1891.

§ 23. Cupric Sulphide

The blue *Kupferglas* described by J. C. Freiesleben¹ no doubt referred to the native cupric sulphide; it was named *indigo copper* by C. A. S. Hoffmann and A. Breithaupt. The composition was determined by N. Covelli, and F. S. Bucdant named it *covellite*, E. J. Chapman, *breithauptite*.

The formation and preparation of cupric sulphide.—M. Berthelot² obtained cupric sulphide by the action of hydrogen sulphide on solid cupric acetate, but not the chloride. A. Ditte obtained crystals of cupric sulphide by the action of a dil. soln. of potassium sulphide on copper when air is excluded. E. Murmann found that cupric sulphide precipitated by alkali sulphides from cupric salt soln. always contains alkali as impurity. E. Priwoznik obtained crystals of cupric sulphide by the action of a soln. of sulphur in aq. ammonium sulphide on copper. K. Heumann noted that when dry cupric oxide is treated with a conc. soln. of ammonium monosulphide, (NH₄)₂S, much heat is developed and a violent reaction occurs; a mixture of variable proportions of cuprous and cupric sulphides is formed. F. Cornu evaporated a mixture of malachite and ammonium hydrosulphide to dryness, and extracted the sulphur with carbon disulphide. Crystals of cupric sulphide remained. V. Staněk converted amorphous into crystalline cupric sulphide

by heating it for four hours with ammonium sulphide soln. in a sealed tube at 150°–200°; W. Spring heated the amorphous sulphide in vacuo to 150° for about nine days of 7–8 hours' duration. Sodium or ammonium thiosulphate precipitates a mixture of cuprous and cupric sulphide from warm soln. of cupric salts. This reaction has been studied for analytical purposes by A. Carnot, J. Girard, C. Himley, E. Fleischer, H. Nissenson and B. Neumann, A. Orłowsky, G. Vortmann and M. Willenz. E. Priwoznik says a cold soln. of sodium thiosulphate colours copper black in a week's time; a boiling soln. of the salt acts on the finely-divided metal much more rapidly. The same reagent was used by C. Puscher in producing lustre films of the sulphide on copper or its alloys.

F. C. Phillips noted that carbonyl sulphide slowly precipitates cupric sulphide from an aq. soln. of cupric sulphate; and rapidly from an ammoniacal soln.; K. Preis used sodium thioarsenate and boiling soln. J. B. Senderens obtained crystals of cupric sulphide by heating an intimate mixture of sulphur, water, and cupric oxide to 100°. A. Gautier used E. Frémy's process for preparing crystalline metal sulphides in which the vapour of carbon disulphide is passed over the heated oxide. Some cupric sulphide is produced during the action of conc. sulphuric acid on copper (*q.v.*). J. Thomsen³ showed that the affinity of copper for sulphur is satisfied by the formation of cuprous sulphide, in the sense that no further heat is evolved if the copper takes up no more sulphur, until cupric sulphide is formed. It has hence been argued that the formation of the intermediate sulphides is very doubtful—*e.g.* A. Étard's Cu_3S_2 —obtained by the action of hydrogen sulphide at 180° on cuprous sulphite, and supposed to be represented in nature by the minerals *digenite* and *carmenite*; J. Thomsen's Cu_4S_3 —obtained by the action of sodium sulphide on cupric sulphate both in very dil. soln.; A. B. Griffiths' Cu_6S_4 , a grey mineral which is probably a mixture of copper-glance and indigo-copper. These compounds do not appear on the f.p. curve of binary mixtures of sulphur and copper previously discussed.

The precipitate obtained by the action of hydrogen sulphide on a soln. of a cupric salt is usually regarded as cupric sulphide.⁴ According to J. Thomsen, the precipitate is a mixture of the intermediate sulphide Cu_4S_3 with sulphur; A. Ditte does not believe that the precipitate contains cuprous sulphide. B. Brauner found that some free sulphur is present, and when this is removed by digesting the precipitate with carbon disulphide, the product appears to contain variable proportions of cuprous and cupric sulphides. E. Abel believes that the two sulphides are in a state of equilibrium in the solid state. A. Rössing argues that the precipitate is cupric sulphide because it immediately forms silver sulphide, Ag_2S , with silver nitrate soln. J. B. Coppock also says that if a soln. of cupric sulphate freely acidified with nitric acid be poured into an aq. soln. of hydrogen sulphide; washed with acid and water; digested seven days with carbon disulphide; washed with alcohol; and dried in an atm. of carbon dioxide at 100°, the product is cupric sulphide, CuS . W. Antony and A. Lucchesi say that to get pure cupric sulphide the precipitation must be made at 0°, with water sat. with hydrogen sulphide, washed by decantation at 0°, and maintained at this temp. until the precipitate collects at the bottom of the vessel. It is then filtered and washed in an atm. of hydrogen sulphide, and dried in nitrogen at 120°. H. W. F. Wackenroder found that no precipitation occurs if the cupric salt soln. contains potassium cyanide; an excess of ammonia; or tannin. A. Löb, and F. P. Treadwell and G. von Girsawald attribute the non-precipitation of cupric sulphide in these solns. to the formation of complex cupric ions which are not decomposed by the hydrogen sulphide. G. Chesneau has investigated the action of hydrogen sulphide on mixed soln. of lead and cupric nitrates. C. Doelter obtained crystals of cupric sulphide by the action of aq. hydrogen sulphide on copper in a sealed tube at 200°; he also used malachite at 80° in place of metallic copper; E. Weinschenk used a soln. of a cupric sulphate with twice as much ammonium thiocyanate as is needed to convert the copper to the thiosulphite; and with a slight excess of acetic acid. F. von Hochstetter suggested that in some cases

cupric sulphide crystals may have been formed in nature by the joint action of calcium sulphate and organic substances on copper or bronze.

B. D. Steele⁵ says that cupric sulphide is probably formed during the electrolysis of salt soln. in liquid sulphur dioxide with a copper cathode. A. C. Becquerel says that the crystalline sulphide is formed on the anode during the electrolysis of a soln. of cupric nitrate separated from a soln. of alkali sulphide by a collodion or paper diaphragm.

A. C. Becquerel introduced a cracked test-tube filled with a conc. soln. of copper nitrate into a test-glass containing a soln. of sodium monosulphide, keeping the two liquids at the same level. If the soln. were simply mixed, cupric sulphide and sodium nitrate would be formed, but a brilliant deposit of metallic copper soon appears in the crack, and as the deposit increased, the crack enlarged, and the tube ultimately broke. If the experiment be varied by making a galvanic couple with a copper or platinum wire, copper is deposited on the wire dipping in the cupric salt soln.; no trace of copper appears in the crack, until the wires are removed. A. C. Becquerel then assumed the liquid in the crack plays the part of a solid conductor and electrolysis occurs. Hence, the effects are classed as *electro-capillary* or *chemico-capillary actions*. The chemical effects produced in capillary spaces were studied with other salts—silver, lead, gold, tin, cobalt, and nickel.

The physical properties of cupric sulphide.—Artificial cupric sulphide is usually black, bluish-black, greenish-black, or brown; the native mineral is also black, bluish-black, indigo-blue, dark violet or dark green. A. Lottermoser⁶ says that when cupric sulphide is precipitated by hydrogen sulphide from a cold cupric salt soln. it is quite brown and that the product from a hot soln. has a greenish tinge. A. Breithaupt supposed the crystals of covellite belonged to the hexagonal system, and C. A. Kennigott gave the axial ratio $a : c = 1 : 3.9720$. According to S. Stevanović, the crystals of covellite belong to the monoclinic system with axial ratios $a : b : c = 0.5746 : 1 : 0.6168$, and $\beta = 90^\circ 46'$ although they appear to be pseudohexagonal; he also described various forms, and complicated twins. J. W. Retgers says the crystals are not isomorphous with cinnabar. The reported values⁷ for the **specific gravity** range from C. Doelter's 3.9 to S. Stevanović's 4.668. W. F. Hillebrand gives 4.76 at 26° . The mineral covellite has a sp. gr. 4.59–4.64, and its **hardness** is 1 to 2. W. Hittorf⁸ converted cuprous to cupric sulphide by heating it up to about 444° with flowers of sulphur; M. Faraday effected the conversion by triturating cuprous sulphide with cold conc. nitric acid. A. Knop treated copper-glance with dil. sulphuric acid, hydrochloric acid, acetic acid, and aq. ammonia, and obtained crystals of cupric sulphide. As previously indicated, W. Spring produced copper sulphide by the action of high press. on mixtures of powdered copper and sulphur. W. Biltz discussed the dissociation of cupric sulphide, and P. W. Bridgman stated that it has a transition point at about 103° similar in character to that exhibited by silver sulphide. A. S. Russell gives the **specific heat** at -135° as 0.0853, and at 25° as 0.1243. K. Bornemann and O. Hengstenberg found the sp. ht. of cupric sulphide rose from 0.1432 at 100° to 0.1690 at 300° , and thereafter diminished to 0.1369 at 1050° . C. H. Lees found the **thermal conductivity** of cupric sulphide to be 0.014 in cal. per cm. M. Cole gave for the conductivity at θ° , $K = 0.0016 + 0.0643\theta$. M. Berthelot⁹ found that the **heat of formation** ($\frac{1}{2}\text{CuO}$, $\frac{1}{2}\text{H}_2\text{S}$ in 8 litres of water) is 15.8 Cals.; $\{\text{Cu}(\text{C}_2\text{H}_3\text{O})_2, \text{NH}_4\text{HS}\}$, 25.9 Cals.; and with sodium monosulphide, 20.1 Cals. J. Thomsen gives $(\text{Cu}, \text{S}, n\text{H}_2\text{O}) = 9.73$ Cals.; $\{\text{Cu}(\text{NO}_3)_2\text{aq.}, \text{H}_2\text{Saq.}\} = 16.42$ Cals.; (Cu, S) , 9.76 Cals., and $\frac{1}{2}(\text{Cu}_2\text{S}, \text{S}) = 0.3$ Cal.; while M. Berthelot gives 10.1 Cals., H. von Wartenberg, 11.6 Cals., and M. Wasjuchnowa, $(\text{Cu}, \text{S}) = 11.9$ Cals.; and $(\text{Cu}_2\text{S}, \text{S}) = 4.9$ Cals.

A. Verneuil¹⁰ studied the effect of cupric sulphide on the **phosphorescence** of calcium sulphide, and found the colour of the glow is altered a little, but the intensity remains the same. O. Rohde, and K. Herrmann have studied the **photoelectric effect** with cupric sulphide.

According to F. Beijerinck,¹¹ the **electrical conductivity** of covellite is better than that of copper-glance or, according to W. Hittorf, better than precipitated

cuprous sulphide. K. Bädeker gives 0·000125 for the specific resistance of cupric sulphide at ordinary temp. when that of copper is 0·0000017. F. Streintz measured the conductivity of rods prepared by compressing the powder to between 10,000 and 13,000 atm. The resistance remains unchanged at 0·0190 ohm up to 90°; and it decreases slowly to 0·0143 ohm as the temp. rises to 250°; when the mass is cooled, its resistance is smaller than before, viz. 0·0023 ohm. G. Bodländer and K. S. Idaszewsky, and W. Hittorf say that it conducts like a metal and not electrolytically. T. W. Case found that exposure to light had no measurable influence on the conductivity of covellite. K. Bädeker found the e.m.f. against copper between 20° and 200° increases 7·33 microvolts per degree. H. Davy found cupric sulphide to be electronegative against copper in potassium hydrosulphide soln. G. Trümpler measured the e.m.f. against soln. of sodium sulphide. S. Bidwell observed that the conductivity of cupric sulphide is very small when pressed between silver and copper plates, but if some free sulphur is present, the conductivity is good. W. Spring, and G. Bredig found that when suspended in water, in an electrolytic cell, finely divided, cupric sulphide migrates to the anode. M. Lucas found that when cupric sulphide is suspended in ammonium sulphide soln., only a trace of copper appears on the cathode during electrolysis. E. E. Brooks studied its use as an element in combustion cells; C. Tissot described its use in detecting electric waves; and K. Bädeker found the thermoelectric force against copper to be 7·33 microvolts per degree between 0° and 100°. S. Meyer gave $-0·16 \times 10^{-6}$ mass units at 17° for the magnetic susceptibility; and E. Wilson gave for copper pyrites 0·0102 to $0·0169 \times 10^{-6}$.

The chemical properties of cupric sulphide.—J. W. Döbereiner,¹² and W. Hittorf found that when cupric sulphide is heated to redness in the absence of air, it is reduced to cuprous sulphide, and the product is then stable over a wide range of temp. Consequently, the high temp. reactions of cupric sulphide are really concerned with cuprous sulphide. A. Mourlot found that in the electric furnace, cupric sulphide is reduced first to cuprous sulphide, and then to the metal. M. Wasjchnowa investigated the reaction. For the production of moss copper from cupric sulphide, *vide* silver sulphide. F. Damm and F. Kraft found that, in vacuo, it is reduced by the cathode rays even at 400°. Moist cupric sulphide rapidly oxidizes in air, and as shown by P. de Clermont and H. Guiot, heat is developed during the oxidation. A. Maifert found cupric sulphide to be also oxidized by ozone. Cupric sulphide is easily reduced by hydrogen under atm. press. E. Brunner,¹³ S. U. Pickering, and J. Uhl have studied the reduction of cupric sulphide in hydrogen, and find the reduction to copper occurs at 600° in hydrogen, and at 300°–350° in carbon monoxide; D. Stickney also found that it is completely reduced in the coal-gas flame. According to K. Heumann, cupric sulphide is reduced by nascent hydrogen; black cuprous sulphide appears to be formed when it is treated with zinc and dil. sulphuric or hydrochloric acid. According to O. Weigel, a litre of water dissolves $3·51 \times 10^{-6}$ mol of cupric sulphide; F. Cornu found that the compound is attacked by water, and this is accompanied by some oxidation, but P. de Clermont and M. J. Frommel observed no action at 100°. H. V. Regnault found that when heated to a high temp. with water vapour, copper, sulphur, and much hydrogen are formed.

Gaseous hydrogen chloride, and fuming hydrochloric acid were found by M. Berthelot¹⁴ to decompose cupric sulphide. According to A. W. Hofmann, it dissolves with difficulty in hot conc. hydrochloric acid with the separation of sulphur, and the formation of hydrogen sulphide and cuprous chloride. W. Antoni and L. Niccoli found hydrochloric acid of medium conc. does not decompose cupric sulphide.

S. E. Linder and H. Picton¹⁵ say that some cupric sulphide is dissolved when it is treated with hydrogen sulphide. S. W. Young and N. Preston studied the joint action in sealed tubes of the copper sulphide minerals on liquid hydrogen sulphide and water or dil. sulphuric acid, with and without iron compounds. According

to A. Rössing, cupric sulphide is insoluble in a soln. of **sodium monosulphide**, but it is soluble in sodium polysulphide, forming $\text{Na}_2\text{Cu}_2\text{S}_7$; on the contrary, G. F. Becker says it is slowly dissolved by a soln. of sodium monosulphide, in a sat. soln. of hydrosulphide, and in a mixture of hydrosulphide and carbonate. E. Prost and A. van de Castele examined the solubility of cupric sulphide in potassium polysulphide. J. N. Mukherjee and N. N. Sen found that the stability of a sol of cupric sulphide is increased by dilution irrespective of the nature of the electrolyte. The adsorption theory of coagulation *per simpliciter* predicts that dilution will diminish the stability. A. Lottermoser, and J. N. Mukherjee and N. N. Sen found also that dissolved hydrogen sulphide stabilizes cupric sulphide sol both in aq. and non-aq. media. Potassium and sodium sulphides have a more marked protective action; similarly also with ammonium, potassium, barium, and strontium chlorides, and aluminium sulphate. Alkali hydroxides act similarly, and a trace greatly facilitates the preparation of sols rich in sulphide, and largely increases their stability. A. S. Cushman found cupric sulphide to be soluble in ordinary **ammonium sulphide**; and L. Storch says that it is perceptibly soluble in sodium and ammonium thio-salts of molybdenum, tungsten, arsenic, antimony, vanadium, and tin. A. Guerout says aq. **sulphur dioxide** dissolves it without change. According to S. U. Pickering, conc. **sulphuric acid** decomposes it into cupric sulphate, sulphur dioxide, and sulphur: $\text{CuS} + 2\text{H}_2\text{SO}_4 = \text{S} + \text{CuSO}_4 + 2\text{H}_2\text{O} + \text{SO}_2$. T. Kliche adds that so long as copper is present, cuprous sulphide is formed. A. W. Hofmann says that cupric sulphide is decomposed, but not dissolved by boiling dil. sulphuric acid (1 : 6). G. Gore, and E. C. Franklin and C. A. Kraus find cupric sulphide to be insoluble in liquid **ammonia**. A. W. Hofmann, and W. Antoni and L. Niccoli say that cupric sulphide is decomposed by **nitric acid** with the separation of sulphur and the formation of sulphuric acid. N. D. Costeanu could detect no action when **carbon dioxide** is passed over cuprous sulphide at 550° , but at 760° , a reaction, $\text{Cu}_2\text{S} + \text{CO}_2 = \text{Cu}_2\text{O} + \text{CO} + \text{S}$, occurs.

According to A. S. Cushman, cupric sulphide is insoluble in a soln. of **potassium hydroxide**; insoluble in an acidified conc. aq. soln. of **alkali chloride** (distinction from cadmium sulphide); and, according to A. L. Flanigen, it is soluble in a soln. of **potassium cyanide**, a reaction which enables it to be separated from cadmium sulphide. M. Ragg found cupric sulphide to be insoluble in an alkaline soln. of **sodium xanthogenate**. E. Cumenge and R. Wimmer say that it is soluble in a soln. of **ferric chloride** with the separation of sulphur; C. F. Mohr says that it is oxidized by a boiling soln. of **ferric sulphate**—J. Hanus adds that the residue probably contains an oxysulphide, and M. de K. Thompson that for the complete soln. of the copper, $\text{CuS} + \text{Fe}_2(\text{SO}_4)_3 = \text{CuSO}_4 + \text{S} + 2\text{FeSCl}_2$, air must have free access to the solvent. According to J. Perino, a soln. of **ferric nitrate** at 40° – 70° transforms it into cupric sulphate—nitrogen peroxide is first given off, then nitric oxide. In the presence of hydrochloric acid or sodium chloride, a boiling soln. of **cupric chloride** transforms it almost quantitatively into cuprous chloride; and if ammonia is present, much of the sulphur forms sulphuric acid, and, according to J. Pelouze, it forms oxysulphides. According to F. Raschig, very dil. soln. of cupric chloride have very little action, while cuprous chloride acts still less. C. Friedheim says that ammoniacal soln. of cupric salts act very rapidly on cupric sulphide, and cupric oxide separates from the alkaline soln. According to T. Kliche, an ammoniacal soln. of a cupric salt forms cuprous sulphide, and this the more the higher the temp. and the more conc. the soln. The sulphur is oxidized to sulphuric acid, and the cupric oxide reduced to cuprous oxide. Neutral or acid soln. of sulphate, chloride, nitrate, or acetate give the same reactions, but no oxygen is given off; and no oxysulphides are formed. An excess of cupric sulphide was found by E. F. Anthon to give a precipitate when boiled with a soln. of silver nitrate, but not with cobalt or nickel nitrate, cadmium or manganese sulphate, ferric chloride or lead acetate; E. Schürmann also found that when cupric sulphide is added to soln. of silver nitrate or of mercuric or palladium chloride the metal sulphide is precipitated. According to F. Stolle, a litre of a

10 per cent. soln. of sugar dissolves 0.5672 (17.5°), 0.3659 (45°), and 1.1345 (75°) grms. of cupric sulphide; while a 30 per cent. soln. dissolves 0.8632 (17.5°), 0.7220 (45°), and 1.2033 (75°) grms.; and a 50 per cent. soln. 0.9076 (17.5°), 1.0589 (45°), and 1.2809 (75°) grms.

Colloidal solutions of copper sulphide.—T. Svedberg¹⁶ prepared an isobutylalcosol of cuprous sulphide by his process of sparking terminals under the liquid. L. T. Wright found that if precipitated copper sulphide be boiled 10 mins. with an insufficient amount of potassium cyanide soln. for complete soln., and then filtered, the insoluble sulphide immediately passes through the filter paper when the attempt is made to wash it with water. The dark opaque filtrate contains what he called "colloidal" cupric sulphide, which partially flocculates and settles on standing. W. Spring also made colloidal soln. or hydrosol of cupric sulphide by treating a dil. soln. of cupric sulphate with an aq. soln. of hydrogen sulphide. P. Ebell showed that the cupric sulphide colloid is not in a state of true soln., but contains particles in such a fine state of subdivision that they remain in suspension an indefinite time. W. L. Miller and R. H. McPherson found that colloidal copper sulphide does not distribute between aq. alcohol and ether, and therefore argues that the colloidal soln. is far removed from the state of true soln. N. Ljubawin, A. Sabanǰeff, C. Winsinger, S. E. Linder and H. Picton, etc., have further studied these soln.

In place of hydrogen sulphide, J. Thomsen substituted a dil. soln. of sodium sulphide; and in place of cupric sulphate, W. Muthmann and L. Stützel used a dil. soln. of potassium cupric thiosulphate; L. Vanino and F. Hartl, a dil. soln. of potassium cupric cyanide; J. Schröder and A. Neumann, a soln. of cupric chloride in pyridine; and A. Lottermoser, a dil. soln. of a glycosol cupric salt. By working in alcoholic soln., A. Lottermoser also prepared alcosols of cupric sulphide; and with aceto-acetic ethereal soln., etherosols of cupric sulphide. J. Hausmann studied the periodic or rhythmic precipitation which occurs when a soln. of cupric sulphate is allowed to diffuse into gelatine containing ammonium or sodium sulphide.

S. E. Linder and H. Picton showed that the precipitate obtained by the action of hydrogen sulphide on a dil. soln. of a cupric salt contains an excess of hydrogen sulphide "combined with the freshly precipitated sulphide," and that the proportion of $\text{CuS} : \text{H}_2\text{S}$ depends on the concentration of the soln. They conclude that $7\text{CuS} \cdot \text{H}_2\text{S}$ is first formed, and that this is broken down by the action of acids through successive stages expressible more or less approximately by the formulæ $9\text{CuS} \cdot \text{H}_2\text{S}$ and $22\text{CuS} \cdot \text{H}_2\text{S}$, till there remains a molecule composed of $(\text{CuS})_n$ alone. Here n is possibly a higher multiple than 22CuS . In the light of later work on colloidal chemistry, it is probable that S. E. Linder and H. Picton's cupric hydrosulphides are merely adsorption products of colloidal cupric sulphide and hydrogen sulphide. In the simultaneous precipitation of copper and zinc sulphides, the amount of zinc carried down decreases rapidly with an increase in the conc. of the acid, and when the latter is constant, it also decreases with rise of temp. K. Scheringa concludes that the zinc sulphide is not adsorbed superficially, but forms a solid soln. at the moment of precipitation with the cupric sulphide.

The higher cupric sulphides.—J. J. Berzelius, H. Schiff,¹⁷ and H. Peltzer obtained dirty yellow to brown precipitates by treating cupric salt soln. with ammonium or potassium polysulphide, or an ammoniacal soln. of sodium cupric thiosulphate with alcohol. J. J. Berzelius says the precipitate is soluble in an aq. soln. of potassium carbonate, and consists of a mixture of cupric sulphide and pentasulphide, or of cupric di-, tri-, or tetra-sulphides. H. Peltzer said that all the precipitates are soluble in an excess of a soln. of ammonium polysulphide. T. Parkman also obtained what he regarded as a mixture of cupric oxysulphide and polysulphide by boiling sulphur with a soln. of cupric acetate; but J. B. Senderens obtained cupric sulphide from soln. of cupric sulphate or nitrate. H. Debus also prepared what he regarded as a cupric tetrasulphide, Cu_2S_4 , by the action of cupric acetate on Wackenroder's soln. A. Rössing did not succeed in making the tetrasulphide, Cu_2S_4 , nor indeed cupric pentasulphide, Cu_2S_5 , although F. Bodroux claims to

have made it as a reddish-brown mass by pouring an excess of a 1 per cent. soln. of cupric acetate into a dil. soln. of calcium polysulphide, all at 0°. The precipitate was washed with iced water, and with alcohol, and then shaken with cold carbon disulphide. The product was dried at a low temp. in vacuo. The product rapidly decomposes into cupric sulphide and sulphur with a small rise of temp.; it is insoluble in a soln. of alkali sulphide—presumably “colourless,” adds A. Rössing.

A. Rössing made **cupric hexasulphide**, Cu_2S_6 , mixed with free sulphur by treating a soln. of ammonium or sodium thiocuprate with dil. acids. He also prepared it by fusing a mixture of anhydrous copper sulphate, sodium carbonate, and sulphur, dissolving the fused mass in cold water in an atm. of hydrogen, and precipitating the clear soln. with hydrochloric acid; the orange-red precipitate is dried over sulphuric acid and extracted with carbon disulphide. All operations must be conducted at a low temp. and with the least possible exposure to the air. Analyses deviate within narrow limits from 60·10 per cent. of sulphur, and 39·71 per cent. of copper—theory for Cu_2S_6 is Cu, 39·85; S, 60·15 per cent. A. Rössing believes that the hexasulphide is the anhydride of a dibasic **hydrosulphocupric acid**, $\text{H}_2\text{Cu}_2\text{S}_7$, with the constitution:

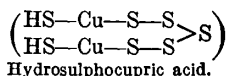

Hydrosulphocupric acid.

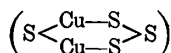

Sulphocupric anhydride.

and that the acid forms sulphocuprates (*q.v.*) represented by $(\text{NH}_4)_2\text{Cu}_2\text{S}_7$ prepared by A. G. Bloxam, H. Vohl, K. Heumann, E. Priwoznik, and H. Peltzer. The amorphous powder is orange-red when dry, reddish-brown when moist. When freshly precipitated, it dissolves rapidly in soln. of the alkali or barium polysulphides, and is re-precipitated by carbon dioxide. It is decomposed when warmed, and when treated with colourless soln. of alkali sulphide, forming cupric sulphide; with silver nitrate it forms silver sulphide. **Cupric pentasulphide**, Cu_2S_5 , is made by shaking moist cupric hexasulphide, Cu_2S_6 , with ammonia. The washed and dried precipitate can be extracted with carbon disulphide. The dark blue amorphous powder is not decomposed at 100°, or by boiling with water. A. Rössing also made **cupric trisulphide**, Cu_2S_3 , by heating on a water-bath the dried hexasulphide with carbon disulphide or ether in a flask fitted with a reflux condenser. The insoluble residue was washed with carbon disulphide and dried at ordinary temp. The dark brown amorphous mass is decomposed by boiling alcohol into cupric sulphide. A. Rössing suggests that the formula of this sulphide is:

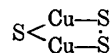

The state of our knowledge of the cupric sulphides is rather unsatisfactory, because it is not at all convincing to depend upon carbon disulphide or indeed upon other solvents to remove all the free sulphur—if sulphur adsorbed by the colloidal solid be regarded as free, *i.e.* not chemically combined. The fusion curve is indicated in Fig. 6.

Copper oxysulphides.—As indicated above, T. Parkman¹⁸ obtained evidence which he regarded as indicating the formation of an impure oxysulphide in the products obtained by boiling a soln. of cupric acetate with sulphur. In the by-products obtained in the preparation of sulphur dioxide by the action of conc. sulphuric acid on copper, E. J. Maumené stated that brown *cuprous oxydisulphide*, $2\text{Cu}_2\text{S}\cdot\text{CuO}$, is formed when one-fifth the available sulphur dioxide has been evolved; *cupric oxydisulphide*, $2\text{CuS}\cdot\text{CuO}$, when two-thirds of the available sulphur dioxide has escaped; and the end-product is *cupric oxymonosulphide*, $\text{CuS}\cdot\text{CuO}$. C. Baskerville also obtained a black oxysulphide by the action of sulphuric acid, sp. gr. 1·84, on copper at 250°. J. Pelouze prepared what he regarded as *cupric oxypentasulphide*, $5\text{CuS}\cdot\text{CuO}$, by the action of precipitated cupric sulphide on dil. soln. of cupric sulphate; the soln. is gradually decolorized; the action is faster in ammoniacal soln.

If an ammoniacal soln. of a cupric salt at about 75° be just decolorized with sodium sulphide, and the black precipitate washed with air-free water, pressed, and dried in vacuo, its composition is $\text{CuO} \cdot 5\text{CuS}$. These oxysulphides may ultimately prove to be all mixtures of sulphide and oxide. T. Kliche, indeed, says that the products prepared by E. J. Maumené's and J. Pelouze's processes did not contain oxygen, only copper and sulphur, and accordingly *es wären alle Oxysulfide zu streichen*. The action of an ammoniacal soln. of cupric oxide on the sulphide removes sulphur from the sulphide, and with increasing conc., increasing amounts of cuprous sulphide are formed—the sulphur forms sulphuric acid, and the cupric oxide is reduced to cuprous oxide.

Double salts of copper sulphide and the alkali sulphides.—P. Berthier¹⁹ prepared what were thought to be double salts by fusing cupric sulphate, potassium sulphate, and sulphur in a carbon crucible; and L. N. Vauquelin by fusing potassium polysulphide with copper. The composition of the products is rather indefinite.

G. Bodländer and K. S. Idaszewsky²⁰ found cuprous and sodium sulphides are mutually soluble to a limited extent, and they prepared the **sodium sulphocuprite**, $\text{Na}_2\text{S} \cdot \text{Cu}_2\text{S}$, or NaCuS , by melting an intimate mixture of equimolecular parts of the component sulphides. Steel-blue needles of the double salt remain when the solid mass is extracted with water. When a fused mixture of the two salts is electrolyzed, copper migrates to the anode as a complex anion, and a little copper appears at the cathode owing to the secondary action of the sodium there formed. The corresponding **potassium sulphocuprite**, $\text{K}_2\text{S} \cdot \text{Cu}_2\text{S}$, was also made in a similar manner by fusing the component salts at 800° . By melting proper proportions of cuprous and sodium sulphides, G. Bodländer and K. S. Idaszewsky also prepared crystalline plates of the composition $\text{Na}_2\text{S} \cdot 2\text{Cu}_2\text{S}$ —*sodium trisulphocuprite*. A. Dittc prepared **potassium pentasulphocuprite**, $\text{K}_2\text{S} \cdot 4\text{Cu}_2\text{S}$, by the action of a conc. cold soln. of potassium monosulphide upon precipitated cupric sulphide. The cupric is reduced to cuprous sulphide. The liquid becomes orange-yellow, and after some hours, the precipitate is converted into a mass of crystals—partly octagonal or quadratic plates, deep red by transmitted light, partly into long slender needles. If the liquid be boiled, bronze-coloured slender needles are formed. All these varieties of crystals have the same composition, $\text{K}_2\text{S} \cdot 4\text{Cu}_2\text{S}$. If the alkaline soln. be too dil., the cupric sulphide is not affected. Long needles of the same salt were also made by immersing metallic copper in a conc. soln. of the alkali sulphide. If the liquid is exposed to air, the amount of the double compound gradually increases, but if it is contained in a closed vessel, the formation of the double sulphide ceases after a time. The action of the alkaline sulphide on the copper is due to the presence of oxygen, for if the soln. is perfectly free from oxygen and the latter is carefully excluded, the copper is not attacked. The first reaction consists in the formation of potassium hydroxide and cupric sulphide, and the latter as fast as it is formed splits up into cuprous sulphide, which forms the double compound, $\text{K}_2\text{S} \cdot 4\text{Cu}_2\text{S}$, and sulphur, which forms polysulphides. A soln. of potassium sulphide too dil. to decompose cupric sulphide attacks metallic copper in presence of air or oxygen, but the product is the simple sulphide CuS .

R. Schneider prepared a sodium salt with a composition corresponding with $\text{Na}_2\text{S} \cdot \text{Cu}_2\text{S} \cdot \text{CuS}$, $\text{Na}_2\text{Cu}_3\text{S}_3$; and a potassium salt, $\text{K}_2\text{S} \cdot 3\text{Cu}_2\text{S} \cdot 2\text{CuS}$, $\text{K}_2\text{Cu}_6\text{S}_6$, by melting the dry alkali carbonate, sulphur, and copper. J. Milbauer also prepared the potassium salt by heating a mixture of cupric oxide with potassium thiocyanate for half an hour. In both cases, the mass was extracted with water, and dark steel-blue crystals remained. The sodium salt forms very dark blue hygroscopic crystals which are attacked by the oxygen and carbon dioxide of the air. They melt below redness in vacuo without decomposition; they deflagrate when heated in air; hydrogen converts them into a mixture of cuprous and sodium sulphide; and they readily dissolve in nitric acid with the separation of sulphur. When the potassium salt is heated, sulphur is given off, and a mixture of cuprous and potassium sulphides remains. When heated in a stream of hydrogen, one-sixth of the sulphur is lost

in hydrogen sulphide ; it is insoluble in dil. hydrochloric acid, but is attacked by the conc. acid ; and with silver nitrate it reacts : $K_2Cu_8S_8 + 18AgNO_3 = 8Cu(NO_3)_2 + 2KNO_3 + 6Ag_2S + 6Ag$. K. A. Hofmann and F. Höchtlen²¹ have shown that the compound prepared by H. Peltzer, A. G. Bloxam, A. Gescher, K. Heumann, H. Vohl, and E. Priwoznik is not, as was previously supposed, $(NH_4)_2Cu_2S_7$, $(NH_4)_2S_2CuS_3$, or $(NH_4)_2S_5 \cdot 2CuS$, but rather **ammonium tetrasulphocuprate**, NH_4CuS_4 , the copper ammonium salt of F. W. Küster's hydrogen tetrasulphide, $H.HS_4$. Analyses show that the atomic ratio S : Cu is not 7 : 2 but 4 : 1. H. Peltzer prepared this salt by the action of ammonium polysulphide on sodium copper thiosulphate ; K. Heumann, by pouring a soln. of cupric sulphate into a conc. soln. of ammonium pentasulphide ; A. Gescher, by the action of a dil. ammoniacal soln. of cupric sulphate on yellow ammonium sulphide ; A. G. Bloxam by dissolving freshly precipitated cupric oxide in a sat. soln. of sulphur in ammonium sulphide ; H. Vohl, by pouring a soln. of cuprous chloride (free from the cupric salt) in ammonium chloride, or a colourless soln. of cupric chloride in sodium thiosulphate, or an ammoniacal soln. of ammonium sulphicuprite, carefully, with constant stirring, and exclusion of air, into a conc. soln. of ammonium polysulphide ; K. Heumann, by the action of yellow ammonium sulphide on freshly precipitated cupric sulphide ; and E. Priwoznik, by the action of the same reagent on cuprous sulphide or on cupric or cuprous oxide, or, more slowly, on metallic copper. H. Vohl's process probably gives the purest product. H. Biltz and P. Herms used the following process :

Dil. 200 c.c. conc. (25 per cent.) aq. ammonia with 50 c.c. of water ; saturate the soln. with hydrogen sulphide ; and saturate half the soln. at 40° with 60 grms. of sulphur ; filter this liquid ; and mix the two soln. Stir up the liquid with a soln. of 20 grms. crystalline cupric sulphate in 200 c.c. of water ; filter rapidly and allow the filtrate to stand overnight while cooled by a freezing mixture. Wash the crystals first with water, then with alcohol, and dry overnight in vacuo over sulphuric acid. Yield 14 grms.

The needle-like crystals have a garnet-red colour ; when heated, they lose ammonia and ammonium sulphide, and become brown, but the primitive colour is restored when they are heated in the vapour of ammonium sulphide. The crystals are sparingly soluble in cold water, but they dissolve in warm water leaving a black residue. The yellow soln. on standing becomes dark green and gives a black precipitate with hydrochloric acid. Dil. nitric, sulphuric, or hydrochloric acid has no action on the cold, but when heated with the crystals, gives brown cupric sulphide mixed with sulphur, and gives off hydrogen sulphide, and ammonia—nitric acid oxidizes some of the sulphur. Conc. hydrochloric or sulphuric acid has no action in the cold ; and nitric acid causes much effervescence, when nitrous fumes are evolved, and sulphur is separated. The crystals are slightly soluble in alcohol and an aq. soln. of sodium carbonate ; but are insoluble in ether.

The crystals of ammonium tetrasulphocuprate are soluble in sodium hydroxide lye, but crystals of the sodium salt have not been obtained ; E. Priwoznik prepared a soln. of the sodium salt by the action of a soln. of sodium pentasulphide on cuprous sulphide or cupric oxide. The soln. of the ammonium salt in sodium hydroxide gives precipitates of the potassium, rubidium, or caesium salts when treated with the corresponding hydroxides. Dark red crystals of **potassium tetrasulphocuprate**, $KCuS_4$, were made by K. Heumann, E. Priwoznik, H. Biltz and P. Herms, by the action of potassium pentasulphide on copper, cupric oxide, sulphide, or other compounds. H. Biltz and P. Herms also used a mixed soln. of sodium pentasulphide and thiosulphate, and they recommend the following process :

A cold soln. of 2 grms. of ammonium tetrasulphocuprate in 6 c.c. of 2*N*-NaOH is mixed with 3.5 c.c. of 6*N*-KOH in 30 c.c. of alcohol. Filter the soln. rapidly, and stir the filtrate, with twice or three times its volume of alcohol while it is cooled by a freezing mixture. Wash the dark red crystals with alcohol by decantation, and after suction, dry in vacuo over sulphuric acid.

Crystals of **rubidium tetrasulphocuprate**, $RbCuS_4$, were made by H. Biltz and

P. Herms in a similar manner. The dark red crystals have a yellow tinge. Yellowish-red or brick-red prisms of **cæsium tetrasulphocuprate**, CsCuS_4 , were made by a similar process. These salts are to be regarded as salts of *hydrotetrasulphocupric acid*, HCuS_4 . H. Biltz and P. Herms say that these salts crystallize in small prisms, and the colour passes from the garnet-red of the ammonium salt to the brownish-red colour of the cæsium salt. The salts are sparingly soluble in cold water and in alcohol. The solubility increases with increasing at. wt. They decompose slowly in air at ordinary room temp. but rapidly when heated; the decomposition is favoured by the presence of moisture; the dry salt may be kept for weeks without appreciable change. Nitric, sulphuric, or hydrochloric acid decomposes the salts very slowly in the cold, but rapidly when boiled. Dil. acids attack the salt more rapidly when hot, cupric sulphide and sulphur separate, and hydrogen sulphide is given off.

H. Biltz and P. Herms obtained small black and prismatic crystals of **potassium decasulphotricuprate**, $\text{K}_2\text{Cu}_3\text{S}_{10}$, or $2\text{KCuS}_4 \cdot \text{CuS}_2$, by shaking a soln. of 2 grms. of ammonium tetrasulphocuprate in 6 c.c. of 2N-NaOH with 3.5 c.c. of 6N-KOH, while cooled with ice. Alcohol is carefully added so as to avoid the formation of the red-coloured salt. The crystals are sparingly soluble in alcohol, easily soluble in water. The aq. soln. rapidly decomposes at the ordinary temp. of the room. The soln. gives a brownish-red precipitate with alkali hydroxides, a dirty brown precipitate with potassium monosulphide, and with potassium tetrasulphide in the presence of alcohol, it furnishes potassium tetrasulphocuprate, KCuS_4 . It is rapidly decomposed by dil. acids, slowly by conc. acids. The corresponding **rubidium decasulphotricuprate**, $\text{Rb}_2\text{Cu}_3\text{S}_{10}$, or $2\text{RbCuS}_4 \cdot \text{CuS}_2$, has also been prepared.

When cuprous oxide or sulphide is dissolved in the pentasulphide soln. at 0° , deep brown-coloured liquids are obtained, from which alcohol throws down yellowish-red prisms of a complex compound, **potassium dioxyneausulphodicuprate**, $\text{K}_3\text{Cu}_2\text{O}_2\text{S}_9$. When freshly precipitated, the crystals dissolve readily in water, and with cæsium hydroxide soln. give a quantitative yield of cæsium copper tetrasulphide.

REFERENCES.

¹ J. C. Freiesleben, *Geognostische Arbeite*, Freiberg, 3, 129, 1815; N. Covelli, *Ann. Chim. Phys.*, (2), 35, 105, 1827; *Atti Accad. Napoli*, 4, 9, 1839; F. A. Walchner, *Schweigger's Journ.*, 49, 160, 1827; F. S. Beudant, *Traité élémentaire de minéralogie*, Paris, 2, 410, 1832; E. J. Chapman, *Practical Mineralogy*, London, 125, 1843; C. A. S. Hofmann and A. Breithaupt, *Handbuch der Mineralogie*, Freiberg, 3, ii, 108, 1816.

² M. Berthelot, *Compt. Rend.*, 78, 1247, 1874; K. Heumann, *Liebig's Ann.*, 173, 31, 1874; E. Murmann, *Monatsh.*, 17, 706, 1896; C. Himley, *Liebig's Ann.*, 43, 150, 1842; K. Preis, *ib.*, 257, 201, 1890; E. Priwoznik, *ib.*, 164, 46, 1872; 171, 111, 1874; *Ber.*, 6, 1291, 1873; E. Fleischer, *Chem. News*, 19, 206, 1869; G. Vortmann, *Zeit. anal. Chem.*, 20, 416, 1881; A. Orłowski, *ib.*, 21, 215, 1882; A. Ditte, *Compt. Rend.*, 98, 1429, 1884; J. B. Scnderens, *ib.*, 104, 58, 1887; E. Frémy, *ib.*, 35, 27, 1852; A. Gautier, *ib.*, 107, 911, 1888; A. Carnot, *ib.*, 102, 621, 678, 1886; *Bull. Soc. Chim.*, (2), 46, 812, 1886; H. Nissenon and B. Neumann, *Chem. Ztg.*, 19, 1591, 1895; J. Girard, *Ann. Chim. Anal. App.*, 4, 382, 1899; M. Willenz, *ib.*, 5, 2, 1900; F. C. Phillips, *Zeit. anorg. Chem.*, 6, 246, 1894; C. Puscher, *Dingler's Journ.*, 199, 406, 1871; F. Cornu, *Neues Jahrb. Min.*, i, 30, 1908; W. Spring, *Zeit. phys. Chem.*, 18, 557, 1895; V. Staněk, *Zeit. anorg. Chem.*, 17, 118, 1898.

³ J. Thomsen, *Ber.*, 11, 2043, 1878; A. Étard, *Compt. Rend.*, 93, 726, 1881; A. B. Griffiths, *Chem. News*, 47, 169, 1883; G. Lindström, *Geol. För. Förh.*, 7, 678, 1885; C. F. Rammelsberg, *Handbuch der Mineralchemie, Suppl.*, Leipzig, 80, 1886; C. F. Plattner, *Pogg. Ann.*, 61, 673, 1844.

⁴ F. Raschig, *Liebig's Ann.*, 228, 2, 1885; S. E. Linder and H. Picton, *Chem. News*, 61, 200, 1890; B. Brauner, *ib.*, 74, 99, 1896; J. B. Coppock, *ib.*, 76, 231, 1897; W. Antony and A. Lucchesi, *Gazz. Chim. Ital.*, 20, 545, 1890; J. Thomsen, *Ber.*, 11, 2043, 1878; E. Abel, *Zeit. anorg. Chem.*, 26, 411, 1901; A. Rössing, *ib.*, 25, 413, 1900; F. P. Treadwell and G. von Girssewald, *ib.*, 38, 99, 1904; A. Ditte, *Ann. Chim. Phys.*, (8), 12, 229, 1907; G. Chesneau, *Compt. Rend.*, 111, 269, 1890; H. W. F. Wackenroder, *Brandes' Archiv.*, (2), 28, 38, 1841; A. Löb, *Zeit. Elektrochem.*, 12, 90, 1906; C. Doelter, *Zeit. Kryst.*, 11, 34, 1886; E. Weinschen, *ib.*, 17, 497, 1890; F. von Hochstetter, *Sitzber. Akad. Wien*, 79, 122, 1880.

⁵ B. D. Steele, *Trans. Faraday Soc.*, 3, 165, 1907; R. Lorenz, *Zeit. anorg. Chem.*, 12, 442, 1896; A. C. Bequerel, *Compt. Rend.*, 79, 1281, 1874; *Phil. Mag.*, (4), 36, 437, 1868.

⁶ S. Stevanović, *Zeit. Kryst.*, 44, 349, 1908; C. A. Kenngott, *Sitzber. Akad. Wien*, 12, 22

1854; A. Breithaupt, *Pogg. Ann.*, 61. 674, 1844; J. W. Retgers, *Zeit. phys. Chem.*, 14. 1, 1894; A. Lottermoser, *Journ. prakt. Chem.*, (2), 75. 304, 1907; A. Lallemand, *Ann. Chim. Phys.* (5), 8. 93, 1876.

⁷ S. Stevanović, *Zeit. Kryst.*, 44. 349, 1908; C. Doelter, *ib.*, 11. 34, 1886; C. J. B. Karsten, *Schweigger's Journ.*, 65. 394, 1832; W. F. Hillebrand, *Amer. Journ. Science*, (4), 7. 51, 1899; V. von Zepharovich, *Sitzber. Akad. Wien*, 12. 286, 1854.

⁸ W. Hittorf, *Pogg. Ann.*, 84. 1, 1851; M. Faraday, *Quart. Journ. Science*, 21. 183, 1827; W. Spring, *Bull. Acad. Belgique*, (3), 5. 492, 1883; A. S. Russell, *Phys. Zeit.*, 13. 59, 1912; C. H. Lees, *Proc. Manchester Lit. Phil. Soc.*, 42. 4, 1898; W. Biltz, *Zeit. anorg. Chem.*, 109. 132, 1919; P. W. Bridgman, *Proc. Amer. Acad.*, 52. 91, 1916; A. Knop, *Zeit. ges. Naturwiss.*, 17. 47, 1861; K. Bornemann and O. Hengstenberg, *Metall. Erz.*, 17. 313, 339, 391, 1921; M. Icoles, *Ann. Chim. Phys.*, (8), 25. 137, 1912; *vide*, 1. 13, 18.

⁹ M. Berthelot, *Compt. Rend.*, 78. 1175, 1874; *Ann. Chim. Phys.*, (7), 5. 162, 1895; J. Thomsen, *Journ. prakt. Chem.*, (2), 19. 1, 1879; H. von Wartenberg, *Zeit. phys. Chem.*, 67. 446, 1909; *Zeit. Elektrochem.*, 15. 866, 1909; M. Wasjuchnowa, *Das Gleichgewicht Cupri-Cuprosulfid*, Berlin, 1909.

¹⁰ A. Verneuil, *Compt. Rend.*, 103. 600, 1886; *Bull. Soc. Chim.*, (2), 46. 302, 1886; O. Rohde, *Ann. Physik*, (4), 19. 935, 1906; K. Herrmann, *Beiträge zum Hallwachsseffekt*, Berlin, 1908.

¹¹ F. Beijerinck, *Neues Jahrb. Min., B.B.*, 11. 441, 1897; W. Hittorf, *Pogg. Ann.*, 84. 1, 1851; T. W. Case, *Phys. Rev.*, (2), 9. 305, 1917; F. Streintz, *Ann. Physik*, (4), 9. 868, 1902; K. Bädeker, *ib.*, (4), 22. 749, 1907; *Ueber die elektrische Leitfähigkeit und die thermoelektrische Kraft einiger Schwermetallverbindungen*, Leipzig, 1906; G. Bodländer and K. S. Idaszewsky, *Zeit. Elektrochem.*, 11. 161, 1905; G. Bredig, *ib.*, 9. 738, 1903; H. Davy, *Phil. Trans.*, 116. 408, 1826; S. Bidwell, *Phil. Mag.*, (5), 20. 328, 1885; *Chem. News*, 52. 219, 1885; E. E. Brooks, *Elect. Rev.*, 35. 190, 1894; C. Tissot, *Compt. Rend.*, 147. 37, 1908; M. Lucas, *Bull. Soc. Chim.*, (3), 19. 817, 1893; S. Meyer, *Wid. Ann.*, 68. 325, 1899; 69. 236, 1899; *Ann. Physik*, (4), 1. 664, 1900; W. Spring, *Bull. Acad. Belg.*, (3), 35. 780, 1898; E. Wilson, *Proc. Roy. Soc.*, 98. A, 274, 1921; G. Trümpler, *Zeit. phys. Chem.*, 99. 9, 1921.

¹² P. de Clermont and H. Guio, *Compt. Rend.*, 84. 714, 1877; A. Mailfert, *ib.*, 94. 1186, 1882; J. W. Döbereiner, *Schweigger's Journ.*, 17. 414, 1816; M. Wasjuchnowa, *Das Gleichgewicht Cupri-Cuprosulfid*, Berlin, 1909; W. Hittorf, *Pogg. Ann.*, 84. 1, 1851; F. Damm and F. Kraft, *Ber.*, 40. 4778, 1907; E. Pollacci, *Monit. Scient.*, (4), 22. 373, 1908; A. Mourlot, *Compt. Rend.*, 124. 768, 1897.

¹³ E. Brunner, *Pogg. Ann.*, 15. 477, 1829; S. U. Pickering, *Journ. Chem. Soc.*, 33. 112, 1878; *Chem. News*, 37. 36, 1878; J. Uhl, *Ber.*, 23. 2151, 1890; D. Stickney, *Amer. Chem. Journal*, 18. 502, 1896; K. Heumann, *Liebig's Ann.*, 173. 39, 1874; A. C. Becquerel, *Compt. Rend.*, 63. 5, 1866; 82. 354, 1876; O. Weigel, *Zeit. phys. Chem.*, 58. 294, 1907; *Gött. Nachr.*, 525, 1906; F. Cornu, *Neues Jahrb. Min.*, i, 30, 1908; P. de Clermont and M. J. Frommel, *Compt. Rend.*, 86. 828, 1878; *Ann. Chim. Phys.*, (5), 18. 189, 1879; H. V. Regnault, *ib.*, (2), 62. 374, 1836.

¹⁴ M. Berthelot, *Compt. Rend.*, 78. 1247, 1874; W. Antoni and L. Niccoli, *Gazz. Chim. Ital.*, 22. ii, 408, 1892; A. W. Hofmann, *Liebig's Ann.*, 115. 286, 1860.

¹⁵ S. E. Linder and H. Picton, *Journ. Chem. Soc.*, 61. 121, 1892; A. Rössing, *Zeit. anal. Chem.*, 41. 1, 1902; G. F. Becker, *Amer. Journ. Science*, (3), 33. 207, 1887; E. Prost and A. van de Castele, *Bull. Assoc. Belg. Chim.*, 11. 103, 1897; A. S. Cushman, *Amer. Chem. Journ.*, 17. 379, 1895; L. Storch, *Ber.*, 16. 2015, 1883; A. Guerout, *Compt. Rend.*, 75. 1276, 1872; S. U. Pickering, *Journ. Chem. Soc.*, 33. 112, 1878; A. W. Hofmann, *Liebig's Ann.*, 115. 286, 1860; F. Raschig, *ib.*, 228. 2. 1885; E. Schürmann, *ib.*, 249. 326, 1888; T. Kliche, *Arch. Pharm.*, 228. 374, 1890; G. Wittstein, *Pharm. Vierteljahr.*, 17. 461, 1869; W. Antoni and L. Niccoli, *Gazz. Chim. Ital.*, 22. ii, 408, 1892; A. L. Flanigen, *Journ. Amer. Chem. Soc.*, 29. 455, 1907; F. W. Hinrichsen and O. Bauer, *Met.*, 4. 316, 1907; E. Cumenge and R. Wimmer, *Dingler's Journ.*, 250. 123, 1883; A. Lottermoser, *Journ. prakt. Chem.*, (2), 75. 293, 1907; J. N. Mukherjee and N. N. Sen, *Journ. Chem. Soc.*, 115. 461, 1919; C. F. Mohr, *Lehrbuch der chemischanalytischen Titrimethode*, Braunschweig, 212, 1877; M. de K. Thompson, *Electrochem. Ind.*, 2. 228, 1904; J. Perino, *Berg. Hütt. Ztg.*, 47. 177, 1888; 48. 47, 1889; C. Friedheim, *Ber.*, 20. 59, 1483, 1887; E. F. Anthon, *Journ. prakt. Chem.*, (1), 10. 355, 1837; J. Hanus, *Zeit. anorg. Chem.*, 17. 111, 1898; M. Ragg, *Chem. Ztg.*, 32. 677, 1908; J. Pelouze, *Ann. Chim. Phys.*, (3), 17. 393, 1846; G. Gore, *Proc. Roy. Soc.*, 21. 140, 1873; E. C. Franklin and C. A. Kraus, *Amer. Chem. Journ.*, 20. 827, 1898; F. Stolle, *Zeit. Ver. Zuckerind.*, 50. 340, 1900; N. D. Costeanu, *Étude de l'action du gaz carbonique sur les sulfures minéraux*, Paris, 1914; S. W. Young and N. P. Moore, *Econ. Geol.*, 11. 349, 574, 1916.

¹⁶ T. Svedberg, *Ber.*, 39. 1714, 1906; L. T. Wright, *Journ. Chem. Soc.*, 43. 163, 1883; *Ber.*, 16. 1448, 1883; W. Spring, *ib.*, 16. 1142, 1883; J. Thomsen, *ib.*, 11. 2043, 1878; W. Muthmann and L. Stützel, *ib.*, 31. 1734, 1898; L. Vanino and F. Hartl, *ib.*, 37. 3622, 1904; P. Ebell, *ib.*, 16. 2429, 1883; W. Spring and G. de Boeck, *Bull. Soc. Chim.*, (2), 28. 165, 1887; C. Winssinger, *ib.*, (2), 49. 452, 1888; *Bull. Acad. Belgique*, (3), 15. 390, 1888; N. Ljubawin, *Journ. Russ. Phys. Chem. Soc.*, 21. 297, 1889; 37. 4609, 1904; A. Sabanjéeff, *ib.*, 23. 80, 1891; J. Schröder and A. Neumann, *Ber.*, 44. 10, 1905; A. Lottermoser, *Journ. prakt. Chem.*, (2), 75. 303, 1907; J. Thomsen, *ib.*, (2), 19. 1, 1879; J. Hausmann, *Zeit. anorg. Chem.*, 40. 123, 1904; W. L. Miller and R. H. McPherson, *Journ. Phys. Chem.*, 12. 715, 1908; S. E. Linder and H. Picton, *Journ. Chem. Soc.*, 61. 120, 1892; *Chem. News*, 61. 200, 1890; K. Scheringa, *Pharm. Weekbl.*, 55. 431, 1918.

¹⁷ H. Schiff, *Liebig's Ann.*, 115. 68, 1860; H. Peltzer, *ib.*, 128. 180, 1863; H. Debus, *ib.*, 244. 109, 1888; E. Priwoznik, *Ber.*, 6. 700, 1873; K. Heumann, *ib.*, 6. 700, 1873; H. Vohl, *Journ. prakt. Chem.*, (2), 102. 32, 1867; J. B. Scnderens, *Bull. Soc. Chim.*, (3), 6. 804, 1891; T. Parkman, *Amer. Journ. Science*, (2), 33. 328, 1861; J. J. Berzelius, *Schwigger's Journ.*, 30. 381, 1820; A. Rössing, *Zeit. anorg. Chem.*, 25. 407, 1900; F. Bodroux, *Compt. Rend.*, 130. 1397, 1900; *Bull. Soc. Chim.*, (3), 23. 501, 1900; A. G. Bloxam, *Journ. Chem. Soc.*, 18. 94, 1865; K. Heumann, *Liebig's Ann.*, 173. 24, 1874.

¹⁸ T. Parkman, *Amer. Journ. Science*, (2), 33. 328, 1861; C. Baskerville, *Journ. Amer. Chem. Soc.*, 17. 912, 1895; E. J. Maumené, *Ann. Chim. Phys.*, (3), 18. 311, 1846; J. Pelouze, *ib.*, (3), 17. 393, 1846; T. Kliche, *Pogg. Ann.*, 152. 374, 1874.

¹⁹ P. Berthier, *Ann. Chim. Phys.*, (2), 22. 294, 1823; L. N. Vauquelin, *ib.*, (2), 6. 25, 1817.

²⁰ G. Bodländer and K. S. Idaszewsky, *Zeit. Elektrochem.*, 11. 181, 1905; A. Ditte, *Compt. Rend.*, 98. 1429, 1884; *Ann. Chim. Phys.*, (8), 12. 266, 1907; R. Schneider, *Pogg. Ann.*, 138. 311, 1869; J. Milbauer, *Zeit. anorg. Chem.*, 42. 440, 1904; A. Rössing, *ib.*, 25. 407, 1911.

²¹ K. A. Hofmann and F. Höchtlen, *Ber.*, 36. 1146, 3090, 1903; F. Höchtlen, *Ueber kristallisierte Polysulfide und Thiocarbonate von Schwermetallen*, München, 1904; H. Biltz and P. Herms, *Ber.*, 40. 976, 1907; H. Peltzer, *Liebig's Ann.*, 128. 180, 1863; A. Gescher, *ib.*, 141. 350, 1867; 143. 375, 1867; E. Priwoznik, *ib.*, 171. 112, 1874; A. G. Bloxam, *Journ. Chem. Soc.*, 18. 94, 1865; F. W. Küster, *Verh. deut. Nat. Aerzte*, 121, 1901; A. Rössing, *Zeit. anorg. Chem.*, 25. 411, 1900; H. Vohl, *Journ. prakt. Chem.*, (1), 102. 32, 1867; K. Heumann, *Liebig's Ann.*, 173. 24, 1874.

§ 24. Cuprous Sulphate

Up to 1909, the existence of cuprous sulphate, Cu_2SO_4 , was inferred (i) from the existence of certain complex salts like cuprous phenylhydrazine sulphate and cuprous pyridine sulphate prepared by J. Moitessier;¹ cuprous thiourea sulphate prepared by B. Rathke, A. Rosenheim and W. Löwenstamm, and V. Kohlschütter and C. Brittlebank; and hydrated cuprous carbonyl sulphate and cuprous tetramminosulphate, by A. Joannis; and (ii) from certain reactions in aq. soln. Thus, the leaching of roasted cupriferous pyrites with warm water was supposed by C. Bischoff to yield a soln. containing some subsulphate; the dissolution of copper by boiling aq. soln. of cupric sulphate was supposed by C. Soret to be due to the formation of a soluble cuprous sulphate, and H. Rössler showed that when treated with sodium chloride, the green soln. gave a precipitate of cuprous chloride, and when exposed to the air, it became blue.

F. Förster and F. Blankenberg showed that the dissolution of copper by an acid soln. of cupric sulphate proceeds until an equilibrium $2\text{Cu} \rightleftharpoons \text{Cu} + \text{Cu}^{\cdot\cdot}$ is established, and the same result also obtained in ammoniacal soln. of cupric sulphate decolorized by copper. The appearance of cuprous oxide among the products of the reduction of cupric sulphate soln. by magnesium, zinc, and iron was explained by R. M. Caven by assuming that the cupric salt is reduced by nascent hydrogen; by the direct action of the displacing metal; or by the action of precipitated copper on cupric sulphate, and he favoured both the last-named hypotheses. H. Kiliani also showed that the liquid obtained by the electrolysis of a neutral soln. of cupric sulphate with a copper anode contains cuprous sulphate, for it re-deposits copper during its decomposition. A. Matthiessen and M. von Bose found two decomposition potentials in the electrolysis of cupric salt soln. At cathode potentials below the larger one, F. Förster and G. Cofetti showed that cuprous oxide is deposited from neutral soln., and cuprous sulphate from acid soln. The formation of the cuprous salt is favoured by a rise of temp. and a low current density. A rise of temp. favours the formation of cuprous copper, and F. Förster and O. Seidell found the hot soln. deposits copper on cooling so that the equation: $\text{Cu}_2\text{SO}_4 \rightleftharpoons \text{Cu} + \text{CuSO}_4$, or the ionic eq.: $2\text{Cu}^{\cdot} \rightleftharpoons \text{Cu}^{\cdot\cdot} + \text{Cu}$, represents the balanced reaction. In the electrolysis of sulphuric acid with copper anodes, F. Fischer estimates that 50 per cent. of the copper which goes into soln. is univalent. R. Luther computed that at 25°, the conc. of the cuprous sulphate in a 2*N*-soln. of cupric sulphate acidified by *N*-sulphuric acid is 1.67×10^{-4} mol of Cu_2SO_4 ; and E. Abel gives at ordinary temp. $[\text{Cu}^{\cdot}]/[\text{Cu}^{\cdot\cdot}] = 0.66 \times 10^{-6}$; and at 25°, a 0.0064*N*-soln. of cuprous sulphate is in equilibrium with a *N*-soln. of cupric sulphate.

In neutral soln., say F. Förster and G. Coffetti, cuprous ions are constantly removed by hydrolysis and precipitation of cuprous oxide, and from acid soln. by the oxidation by atm. oxygen. At a copper anode, similarly, the copper dissolves in the cuprous condition until equilibrium is attained, and since the layer of soln. in contact with the anode always contains more cupric sulphate than the body of the soln., a greater number of cuprous ions will be formed there than can exist in the more dil. mass of the liquid, and therefore as the conc. soln. diffuses away from the anode copper must be deposited. This explains the fact that the loss of weight of the anode is greater than the gain of weight of the cathode, and also the presence of copper dust in the anode slime. The conc. of aq. soln. of cuprous sulphate is attended by the hydrolysis and precipitation of cuprous oxide: $\text{Cu}_2\text{SO}_4 + \text{H}_2\text{O} = \text{Cu}_2\text{O} + \text{CuSO}_4$; or by the deposition of copper: $\text{Cu}_2\text{SO}_4 \rightleftharpoons \text{Cu} + \text{CuSO}_4$.

A. Recoura has shown that by operating in the absence of water, methyl sulphate and cuprous oxide react to form cuprous sulphate and ether: $\text{Cu}_2\text{O} + (\text{CH}_3)_2\text{SO}_4 = \text{Cu}_2\text{SO}_4 + (\text{CH}_3)_2\text{O}$. Ethyl sulphate reacts in a similar manner. Two grams of powdered cuprous oxide are mixed with 20 c.c. of methyl sulphate at 160° until methyl ether ceases to be evolved—about 15 min. The cuprous sulphate, precipitated as a greyish-white powder, is washed with ether while air is carefully excluded, and finally dried in vacuo. The salt is stable in dry air, but is immediately decomposed by moisture: $\text{Cu}_2\text{SO}_4^{\text{solid}} + \text{Aq.} = \text{CuSO}_4^{\text{soln.}} + \text{Cu} + 21 \text{ cal.}$ The development of heat in this decomposition is contrary to the behaviour of other cuprous salts, and explains why cuprous sulphate cannot be prepared in aq. soln. Freshly prepared cuprous sulphate if allowed to oxidize before drying is converted into a soot-black powder, from which cupric sulphate is dissolved by water, leaving an oxide with all the properties of Rose's oxide, Cu_4O . Dry Cu_2SO_4 , oxidized at 100° , yields the basic salt, $\text{CuO}, \text{CuSO}_4$. Cuprous sulphate is soluble in conc. hydrochloric acid, in ammonia, and in glacial acetic acid, the last giving an intensely violet soln.

G. Denigès prepared double compounds of **cuprous hydrosulphate**, CuHSO_4 , with aniline, toluidine, and *o*-xylydine. F. Förster and O. Seidel prepared yellow amorphous basic cuprous sulphate or **cuprous oxysulphate** by the electrolysis of a 2*N*-soln. of cupric sulphate acidified to make the soln. 0.01*N*- H_2SO_4 . Temp. 40° , current density 7.3 amps. per sq. decm., and 1.5 volts.

Cupric sulphate forms complexes in ammoniacal soln. which can be easily reduced to the cuprous state; at the same time, the blue colour of the cupric soln. disappears, forming a colourless liquid. J. Meyer² used sodium sulphite for the reduction; A. Bernthsen, and P. Schutzenberger and C. Risler, sodium hyposulphite; J. A. Joannis, carbon monoxide; F. Förster and F. Blankenberg, copper; and F. Ebler, hydrazine sulphate; A. Joannis obtained an ammoniacal soln. of cuprous sulphate by treating cuprous oxide with a soln. of ammonium sulphate in liquid ammonia. P. Schutzenberger and C. Risler found that when shaken with air, an ammoniacal soln. of cuprous sulphate absorbs twice as much oxygen as is needed for the conversion of the cuprous to the cupric salt, and they suggested that half the oxygen is used in forming hydrogen peroxide; C. Engler suggested that a peroxidized body is formed; but J. Meyer found that hydrogen peroxide cannot exist in the presence of cuprous salts even at 0° . According to J. Meyer, an unstable intermediate oxide, Cu_2O_3 , may possibly be formed; but the oxidation proceeds on normal lines, in accord with the equation: $2\text{Cu}_2\text{O} + \text{O}_2 = 4\text{CuO}$, and the abnormal result previously obtained is due to the presence of sodium sulphite, which reacts: $\text{Cu}_2\text{O} + \text{SO}_2 + \text{O}_2 = 2\text{CuO} + \text{SO}_3$. The oxidation of ammoniacal cuprous sulphate has been utilized for the measurement of oxygen dissolved in water by P. Schützenberger and C. Risler, F. Tiemann and C. Preusse, J. König and C. Krauch, etc. According to S. L. Bigelow, the reaction occurs in the presence of alcohol.

When hydroxylamine sulphate is added to an alcoholic ammoniacal soln. of cupric sulphate, E. Péchard found that **cuprous tetrammino-sulphate**, $\text{Cu}_2(\text{NH}_3)_4\text{SO}_4$, contaminated with ammonium sulphate is precipitated. He obtained the pure salt

by reducing a suspension of basic cupric carbonate, $\text{CuCO}_3 \cdot \text{Cu}(\text{OH})_2$, in dil. ammonia soln. with hydroxylamine sulphate at 80° . Carbon dioxide, nitrogen, and nitrous oxide are evolved, and when alcohol is added to the cooled soln., a heavy white precipitate of the required salt is obtained. A. Angel likewise prepared the same compound by adding hydroxylamine sulphate or hydrazine sulphate to an ammoniacal soln. of cupric formate, and precipitated the salt by the addition of alcohol. A. Bouzat obtained the same salt as a white crystalline powder by adding alcohol to a soln. of cuprous oxide and ammonium sulphate in aq. soln. at 50° in an atm. of hydrogen. According to E. Péchard, the salt forms white hexagonal plates. It is readily oxidized in air, and soluble in aqua ammonia, insoluble in alcohol, and is decomposed by water. When heated to 100° , it does not lose ammonia, but above this temp., it loses ammonia and the residual cuprous sulphate decomposes. A. Bouzat's method of preparation shows that ammoniacal cuprous oxide, like the corresponding cupric compound, is a sufficiently strong base to displace ammonium from its salts. Cuprous tetrammino-sulphate reduces nitric acid with the copious evolution of nitrous fumes. Dil. sulphuric acid precipitates copper from the ammino-sulphate soln., and leaves a soln. of cupric and ammonium sulphates.

F. Förster and F. Blankenberg obtained colourless monohydrated cuprous tetrammino-sulphate, $\text{Cu}_2(\text{NH}_3)_4\text{SO}_4 \cdot \text{H}_2\text{O}$, by reducing a soln. of 0.5 mol of cupric sulphate and 8.7 mols of ammonia with copper in an atm. of hydrogen. The prismatic and needle-like crystals which separate are washed with alcohol. They can be kept some weeks in a sealed tube at ordinary temp. Small traces of moisture colour the crystals brown in a few days. When heated in hydrogen to 100° , the crystals lose ammonia, and leave a dark brown-coloured mass containing copper, a cupric salt, ammonia, and water. Dil. sulphuric acid colours the crystals pale red owing to the separation of copper.

A. Joannis found that when carbon monoxide is passed into a soln. of cupric sulphate containing in suspension finely divided copper, or a sheet of platinum coated electrolytically with copper, the gas is slowly absorbed and the liquid becomes colourless. If now the soln. be placed in a vacuum, it loses carbon monoxide (free from carbon dioxide), and when the press. of this gas in the apparatus falls to 2 or 3 mm., a pellicule of copper separates at the surface of the liquid and the liquid becomes blue. If carbon monoxide be again passed into the liquid the copper gradually redissolves and the blue colour disappears. When carbon monoxide is passed into an ammoniacal soln. of cupric sulphate containing finely-divided copper, the soln. becomes colourless, but comparatively little copper dissolves. The whole of the dissolved carbon monoxide cannot be extracted in a vacuum, but part remains in the liquid as ammonium carbonate. There is no separation of metallic copper, and the soln. remains colourless. Even in absence of metallic copper, ammoniacal soln. of cupric sulphate are slowly decolorized by carbon monoxide, and then behave in the manner just described. It would seem that, in these cases, cuprous sulphate exists in the soln. in combination with ammonia, whilst in the cases first described it exists in combination with carbon monoxide. The white crystals have the composition of monohydrated cuprous dicarbonyl-sulphate, $\text{Cu}_2\text{SO}_4 \cdot 2\text{CO} \cdot \text{H}_2\text{O}$. They effloresce readily, and under diminished press., the solid and the soln. decompose into copper and cupric sulphate, which suggests that cuprous sulphate cannot exist except in combination with another molecule, such as carbon monoxide or phosphorus hydride. Soln. of cupric nitrate, formate, or acetate, in contact with metallic copper, absorb carbon monoxide and at the same time are decolorized.

REFERENCES.

- ¹ J. Moitessier, *Bull. Soc. Chim.*, (3), **21**, 668, 1899; B. Rathke, *Ber.*, **17**, 301, 1884; F. Förster and F. Blankenberg, *ib.*, **39**, 4429, 1906; F. Förster and G. Coffetti, *Zeit. Elektrochem.*, **10**, 736, 1904; F. Fischer, *ib.*, **10**, 427, 1904; A. Rosenheim and W. Löwenstamm, *Zeit. anorg. Chem.*, **34**, 68, 1903; E. Abel, *ib.*, **26**, 386, 1901; F. Förster and O. Seidell, *ib.*, **14**, 106, 1897; R. Luther, *Zeit. phys. Chem.*, **36**, 396, 1901; H. Kiliani, *Berg. Hütt. Ztg.*, **44**, 294, 1885; V. Kohlschütter and

C. Brittlebank, *Liebig's Ann.*, 349. 246, 1906; A. Joannis, *Compt. Rend.*, 125. 948, 1897; 136. 615, 1903; G. Denigès, *ib.*, 112. 803. 871, 1891; A. Rccoura, *ib.*, 148. 1105, 1909; C. Soret, *Ann. Chim. Phys.*, (3), 42. 257, 1854; H. Rössler, *Dingler's Journ.*, 242. 278, 1881; R. M. Caven, *Journ. Soc. Chem. Ind.*, 19. 21, 1900; T. W. Richards, E. Collins, and G. W. Heimrod, *Proc. Amer. Acad.*, 35. 123, 1899; A. Matthiessen and M. von Bose, *Pogg. Ann.*, 115. 353, 1862; C. Bischoff, *Schweigger's Journ.*, 3. 195, 1825.

² J. Meyer, *Ber.*, 35. 3952, 1902; A. Bernthsen, *ib.*, 13. 2279, 1880; F. Förster and F. Blankenberg, *ib.*, 39. 4435, 1906; F. Tiemann and C. Preusse, *ib.*, 12. 1768, 1879; C. Engler, *ib.*, 33. 1102, 1900; A. Joannis, *Compt. Rend.*, 125. 949, 1897; 136. 615, 1903; 138. 1498, 1904; A. Bouzat, *ib.*, 146. 76, 1908; E. Péchard, *ib.*, 136. 505, 1903; P. Schützenberger and C. Risler, *Bull. Soc. Chim.*, (2), 20. 145, 1873; J. König and C. Krauch, *Zeit. anal. Chem.*, 19. 259, 1880; S. L. Bigelow, *Zeit. phys. Chem.*, 25. 493, 1898; A. Angel, *Journ. Chem. Soc.*, 89. 345, 1906; E. Ebler, *Zeit. anorg. Chem.*, 47. 374, 1905.

§ 25. Cupric Sulphate

Cupric sulphate is known in the anhydrous form, CuSO_4 , and as the mono-, tri-, and penta-hydrates. The pentahydrated is the usual form. Several other hydrates have been reported—*e.g.* the di-, hexa-, hepta-, and ennea-hydrated sulphates—but their individuality is not well defined. The blue salt which crystallizes from aq. soln. at ordinary temp. is pentahydrated cupric sulphate, $\text{CuSO}_4 \cdot 5\text{H}_2\text{O}$, and it has been known for many years as *blue vitriol* or *Cyprian vitriol*. There are allusions in Dioscorides and in Pliny to what is thought to be this salt.¹ Geber and Basil Valentine also speak of blue vitriol from Cyprus. The earlier observers confused cupric and ferrous sulphates, since both salts often occur in the same mine waters, and they can crystallize together to form a mixed vitriol—thus Valentine says that “Venus and Mars can be united by soln. and coagulation into a virtuous vitriol.” Some of the alchemists sought for the *materia prima* in the mixed vitriols, and Valentine said that “when copper and iron are present, *der Saame des Goldes* will not be far away.” *Magistral* is an impure blue vitriol with ferric oxide, sodium sulphate, and chloride, etc., obtained by powdering more or less oxidized cupriferos pyrites. It is used in the amalgamation of silver ores at the Mexican and South American silver mines. A. Libavius described the preparation of *vitriolum veneris* in 1595; J. B. van Helmont prepared the same salt in 1644 from a mixture of copper and sulphur which had been fused together and exposed to rain water.

Several basic sulphates of not very definite composition occur in nature—*brochantite*, $\text{Cu}_2\text{SO}_4(\text{OH})_2$, is perhaps the most important. C. F. Rammelsberg² reported the anhydrous salt in the fumaroles of Vesuvius, and called *idrociانو*, that is, *hydrocyanite*, by G. Tschermak, and A. Scacchi. The mineral *chalcantinite*, $\text{CuSO}_4 \cdot 5\text{H}_2\text{O}$, has been found deposited from cupriferos mine waters either in crystals or in stalactitic formations; and, according to H. Oehmichen, it occurs as a workable ore at Copacquire (Chile), where it has probably been formed by the oxidation of chalcopyrite. The Californian mineral *boothite* is reported by W. T. Schaller to have the composition $\text{CuSO}_4 \cdot 7\text{H}_2\text{O}$.

The action of sulphuric acid on copper has been previously discussed. The general results show that at ordinary temp. sulphuric acid and copper slowly form cupric sulphate and sulphide. This was early established by the work of J. Davy,³ and G. Barruel. The latter also showed that dil. sulphuric acid slowly acts on copper if air has access to the liquid, and J. E. Bérard based a process on this reaction for making cupric sulphate on a large scale. G. Barruel obtained cupric sulphate by the joint action of air and sulphurous acid on the metal, and G. de Bechi and H. Gall proposed to make the salt by the action of water vapour, and air, with about 10 per cent. sulphur dioxide on the metal; and E. W. von Siemens and J. G. Halske, by the action of sulphur dioxide and air on cupric oxide, carbonate, or silicate over 500°. Cupric sulphate was made in 1648 by J. R. Glauber, by the action of hot sulphuric acid on the metal. For example, if a mixture of gram-atom of copper be heated with two mols of sulphuric acid, evaporated to dryness, exhausted with hot water, filtered

from copper and cupric sulphide, blue crystals of the **pentahydrated cupric sulphate**, $\text{CuSO}_4 \cdot 5\text{H}_2\text{O}$, separate on cooling. G. E. Stahl in 1723 showed that if nitric acid be mixed with sulphuric acid, the formation of cupric sulphate is facilitated. For example, E. F. Anthon kept a mixture of 100 parts of copper with 150 parts of sulphuric acid and 168 parts of nitric acid (sp. gr. 1.26) in a warm place, and obtained a soln. which when boiled, filtered, and cooled gives crystals of the pentahydrate. The same process was used by W. Hampe. T. Savage recommended using sodium nitrate in place of nitric acid. Cupric sulphate is formed by the electrolysis of dil. sulphuric acid, or soln. of sulphates by means of copper anodes. H. J. U. Palas, F. A. J. Cotta, P. A. Mackay, and E. Gouin have a process for applying this reaction on a large scale.

Perhaps the simplest method of preparing a soln. of cupric sulphate is to dissolve cupric oxide, hydroxide, carbonate, or oxychloride in hot dil. sulphuric acid, and evaporate the liquid for crystallization.⁴ On a large scale, cupriferous by-products—roasted copper ores; copper scale; copper-waste or scrap; etc.—are treated with sulphuric acid. Many of these processes are indicated in connection with the extraction of copper. In general, cupriferous pyrites is roasted so that the copper is largely oxidized to the sulphate while the iron is converted into ferric oxide. The hot roasted ore is extracted with water, and the liquid concentrated for crystallization. Cupric sulphate is also a by-product in the extraction of silver from its ores by digesting the roasted ore in sulphuric acid. The lead and gold are precipitated; plates of copper are inserted in the soln. of silver sulphate when silver, arsenic, and antimony are deposited, and copper sulphate passes into soln. This liquid is allowed to crystallize for the required salt. E. V. Zappi discussed the manufacture of copper sulphate from chalcopyrite with 10 per cent. of copper; and H. Suchanek, from old scrap copper; cupriferous residues, slags, and ashes; cupriferous pyrites and poor copper ores; and impure cupriferous liquors.

According to M. de la Source,⁵ the pentahydrate is readily converted into **trihydrated cupric sulphate**, $\text{CuSO}_4 \cdot 3\text{H}_2\text{O}$, for when the powdered salt is dried in a desiccator beside phosphorus pentoxide for about 11 days at 25°–30°, it loses about 14.5 per cent. of water, and it loses no more if kept for a longer time. The product thus contains the amount of water required for the trihydrate. By drying the powdered salt in vacuo beside phosphorus pentoxide, 28.5 per cent. of moisture is lost, and **monohydrated cupric sulphate**, $\text{CuSO}_4 \cdot \text{H}_2\text{O}$, is formed. W. Müller-Erzbach obtained the trihydrate by exposing the anhydrous salt to air with moisture eq. to 28 to 30 per cent. of the vap. press. of water; if the air contains 17 per cent. moisture, monohydrated cupric sulphate is formed. T. Graham obtained the monohydrate by warming the pentahydrate in vacuo at 38°—*vide infra*—and W. R. Hodgkinson and co-workers heated the powdered pentahydrate a week at 98°; D. W. Horn and E. D. Taylor heated the pentahydrate to 100° in a current of dry air; and F. Krafft, 60 hrs. over sulphuric acid in vacuo. A. Étard obtained the trihydrate by heating a sat. soln. of cupric sulphate in a sealed tube at 108°–110° for 48 hrs.; and he obtained the monohydrate by heating a soln. of the pentahydrated salt in the smallest possible quantity of water with a great excess of conc. sulphuric acid to 200°, and then cooling the mixture. A. Scacchi and C. F. Rammelsberg crystallized the salt from a sulphuric acid soln. of cupric sulphate. The correct conc. of the acid for producing both the trihydrate and the monohydrate will appear from J. M. Bell and W. C. Taber's study, Fig. 33. C. A. L. de Bruyn found crystals of the trihydrated salt separated from a methyl alcohol soln. of the pentahydrate after some minutes, or immediately on the addition of water, or raising the temp. C. F. Cross boiled the pentahydrated sulphate with absolute alcohol, and finally obtained the monohydrate.

J. L. Proust,⁶ and G. Barruel obtained **anhydrous cupric sulphate**, CuSO_4 , by heating copper with conc. sulphuric acid in a closed vessel. A. Étard crystallized it from a soln. of the pentahydrate in boiling sulphuric acid; and B. Schwalbe, by cooling a sat. soln. of the pentahydrate with solid carbon dioxide. C. Poulenc

obtained the anhydrous salt by dissolving cupric fluoride in conc. sulphuric acid, and evaporating the liquid on a sand-bath. The conditions under which the anhydrous sulphate crystallizes from sulphuric acid soln. have been indicated by J. M. Bell and W. C. Taber, Fig. 33. According to P. Latschinoff, when the pentahydrate is heated to 180°, it loses 4·75H₂O, and all passes off at 360°; F. Krafft found all the water is lost from the pentahydrate in vacuo at 250°; and D. W. Horn that all the water is expelled by heating the salt in a stream of air dried by conc. sulphuric acid. The dissociation of hydrated cupric sulphate has also been studied by W. Hampe, H. Lescœur, and D. W. Horn and E. E. Taylor. According to T. W. Richards, 0·042 per cent. of water is retained by the salt heated to 365°, and he dehydrated it by gradually raising the temp. to 400°. T. Klobb prepared the salt by heating ammonium cupric sulphate, (NH₄)₂SO₄·CuSO₄, and also by heating a mixture of ammonium sulphate and the pentahydrate in a platinum crucible.

J. M. Bell and W. C. Taber have studied the three-component system CuO—SO₃—H₂O. The equilibrium conditions for cupric sulphate, sulphuric acid,

TABLE IX.—EQUILIBRIUM CONDITIONS FOR COPPER SULPHATE, SULPHURIC ACID, AND WATER (25°).

Soln.			Residue.		Solid phases.
Sp. gr.	CuO per cent.	SO ₃ per cent.	CuO per cent.	SO ₃ per cent.	
1·2142	9·17	9·26	30·24	30·35	CuSO ₄ ·5H ₂ O
1·2248	5·91	15·90	30·62	31·30	
1·2593	3·39	23·09	29·11	31·08	
1·2934	1·82	28·75	31·15	31·70	
1·4061	1·32	39·74	30·34	32·08	
1·4256	—	41·29	29·81	35·26	CuSO ₄ ·5H ₂ O ; CuSO ₄ ·3H ₂ O
1·4249	—	41·04	27·4	38·47	
1·4516	1·38	43·63	32·65	38·29	CuSO ₄ ·3H ₂ O
1·4915	1·02	47·82	32·77	38·70	
1·5124	—	49·07	20·16	47·54	CuSO ₄ ·H ₂ O
1·5408	0·38	51·46	30·42	46·89	
1·5643	0·368	53·51	26·34	48·73	
1·6824	0·109	62·14	26·46	51·76	
1·7752	0·105	68·34	31·82	51·82	
1·8118	0·15	72·41	30·50	54·12	
1·8266	0·07	74·26	30·50	59·70	

and water at 25° are indicated in Table IX and Fig. 33. The penta-, tri-, and monohydrated cupric sulphates were the only hydrates which appeared to be stable. The curve *BE* approaches the side of the triangle, showing that the solubility of cupric sulphate is depressed by the addition of sulphuric acid; and between *B* and *C* the lines joining corresponding points for soln. and residue all meet at the point 5, and hence the solid phase is the pentahydrated salt, CuSO₄·5H₂O; from *C* to *D*, the lines meet at the point 3, and this represents the trihydrate, CuSO₄·3H₂O; and from *D* to *E*, the corresponding lines meet at the point *I* representing the monohydrate, CuSO₄·H₂O. Only one line was determined beyond *E*, and this indicates that the solid phase is the anhydrous sulphate,

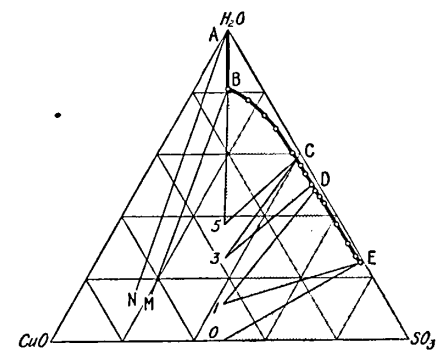

FIG. 33.—Ternary System, CuO—SO₃—H₂O, at 25°.

CuSO_4 . There are two solid phases at *C*, $\text{CuSO}_4 \cdot 5\text{H}_2\text{O}$ and $\text{CuSO}_4 \cdot 3\text{H}_2\text{O}$. The exact positions of the points *C* and *D* have not been definitely determined.

The solubility curve of a salt, say, cupric sulphate, with continually increasing amounts of a foreign substance, say, sulphuric acid, will show (i) a varying solubility and constant composition of solid; or (ii) a constant solubility and a varying composition of the solid. In the former case, a pure salt is present, and in the latter, a mechanical mixture of two salts is present. From the results with copper sulphate and water with gradually increasing proportions of sulphuric acid, H. W. Foote showed that at 25° the range of stability of the pentahydrate is from 0 to about 47.66 per cent. of sulphuric acid; of the trihydrate, 50.23 to 54.78 per cent. sulphuric acid; of the monohydrate, 61.79 to 85.46 per cent. sulphuric acid; and of the anhydrous salt, upwards from 86.04 per cent. sulphuric acid. At a lower temp., 12°, the conc. of sulphuric acid required for the dehydration is rather greater. Similar results were obtained by J. Kendall and A. W. Davidson with anhydrous sulphuric acid; cupric sulphate is only slightly soluble in this acid, forming a colourless soln., which becomes bluish-green when heated to the b.p. G. Poma showed that the blue colour of aq. soln. may be due to hydrated Cu^{+} ions, but not these ions themselves. The colour in the heated soln. would then be due to a loss of sulphur trioxide eq. to the addition of water. No acid salts were observed. F. Bergius made some observations on the solubility of cupric sulphate in sulphuric acid. H. M. Goodwin and W. G. Horsch measured the conductivity of soln. of cupric sulphate in sulphuric acid.

In addition to the penta-, tri-, and mono-hydrates, T. Graham⁷ assumed that *dihydrated cupric sulphate*, $\text{CuSO}_4 \cdot 2\text{H}_2\text{O}$, is formed when the pentahydrate is confined in a dry space for a week at 20°. T. E. Thorpe and J. I. Watts claimed to have made the same salt by mixing a cold sat. soln. of cupric sulphate with an equal vol. of conc. sulphuric acid. M. Berthelot gives the heat of formation from cupric hydroxide as 21 Cals.; J. Thomsen, the heat of soln., +6.09 Cals.; T. E. Thorpe and J. I. Watts, the sp. vol., 67.0. From his measurements of the vap. press., H. Lescœur concluded that no such compound exists, nor do the solubility measurements of J. M. Bell and W. C. Taber lend any support to T. Graham's assumption. R. Dietz and co-workers found evidence of the existence of *enneahydrated cupric sulphate*, $\text{CuSO}_4 \cdot 9\text{H}_2\text{O}$, at low temp., and of a transformation into *hexahydrated cupric sulphate*, $\text{CuSO}_4 \cdot 6\text{H}_2\text{O}$, at -20.3°; and in his study of the effect of press. on hydrated cupric sulphate, E. Jänecke found evidence of the existence of *hemihydrated cupric sulphate*, $\text{CuSO}_4 \cdot \frac{1}{2}\text{H}_2\text{O}$. L. de Boisbaudran obtained *hexahydrated cupric sulphate*, $\text{CuSO}_4 \cdot 6\text{H}_2\text{O}$, and *heptahydrated cupric sulphate*, $\text{CuSO}_4 \cdot 7\text{H}_2\text{O}$, respectively, by adding a small crystal of nickel sulphate, $\text{NiSO}_4 \cdot 6\text{H}_2\text{O}$, or of ferrous sulphate, $\text{FeSO}_4 \cdot 7\text{H}_2\text{O}$, to a supersaturated soln. of copper sulphate. Metastable crystals isomorphous with these salts separated, but soon changed into the pentahydrated salt. W. T. Schaller believed that the Californian mineral *boothite* is the heptahydrate. L. de Boisbaudran and J. W. Retgers reported the crystals are monoclinic with $a : b : c = 1.1622 : 1 : 1.5000$, and $\beta = 105^\circ 36'$; the hardness is 2.0 to 2.5, and the sp. gr., 2.1. T. W. Schaller gives 1.944 at 19°. W. Stortenbeker says the solubility cannot be determined. P. A. Favre and C. A. Valson give 2.13 Cals. for the heat of soln. of an eq. of the salt in a litre of water. J. L. Andrae's work on the vap. press. of copper sulphate crystals in various stages of hydration, and J. M. Bell and W. C. Taber's work on the solubility of cupric sulphate in sulphuric acid, show that only the penta-, tri-, and mono-hydrated salts exist under the conditions of their experiments. The hexahydrate is stated by H. Dufet to exist in isomorphous mixtures with nickel sulphate.

The solubility of cupric sulphate in water has been measured by many workers—A. Étard,⁸ T. Gruner and R. Brandes, E. Cohen, J. E. Trevor, L. C. de Coppet, G. J. Mulder, etc. The best representative values for the solubility expressed in 100 grms. of soln. and 100 grms. of water, are :

	0°	10°	20°	30°	40°	60°	100°	140°	180°
Soln.	12.5	14.8	17.2	20.0	22.5	28.5	43.0	44.5	43.0
Water	14.3	17.4	20.7	25.0	28.5	40.0	75.4	80.2	75.4
Solid phases	$\text{CuSO}_4 \cdot 5\text{H}_2\text{O}$						$3\text{H}_2\text{O}$	H_2O	

The eutectic at -2° has 16.89 per cent. of the anhydrous salt, so that F. Guthrie's cryohydrate is $\text{CuSO}_4 + 44\text{H}_2\text{O}$; L. C. de Coppet gives at -166°, 13.5 grms. for

100 grms. of water. According to A. Étard, the solubility S at θ° referred to the anhydrous salt between -2° and 105° can be represented by two curves $S=11.6+0.2614\theta$, between -2° and 55° ; and $S=26.5+0.3700\theta$, between 55° and 105° , the subsequent decrease in solubility up to 190° is represented by $S=45.0-0.0293\theta$. According to E. Cohen, the solubility curve has a break at 56° in consequence of a transformation of the salt into $3\text{CuSO}_4 \cdot 4\text{Cu}(\text{OH})_2 \cdot 8\text{H}_2\text{O}$. R. Dietz, R. Funk, J. von Wrochem, and F. Mylius give evidence of the transformation $\text{CuSO}_4 \cdot 9\text{H}_2\text{O} \rightleftharpoons \text{CuSO}_4 \cdot 6\text{H}_2\text{O} + \text{sat. soln.}$ at about -20.3° . E. Jänecke also found that in addition to the three transition points between the $0-1\text{H}_2\text{O}$, $1-3\text{H}_2\text{O}$ about 130° ; and the $3-5$ hydrate about 100° ; there is evidence of another hydrate, $\text{CuSO}_4 \cdot \frac{1}{2}\text{H}_2\text{O}$, because, in agreement with K. Friedrich, there are two clearly defined breaks in the heating curve of monohydrated cupric sulphate—one at 215° and another at 270° . These are interpreted to mean that at 215° , $2(\text{CuSO}_4 \cdot \text{H}_2\text{O}) \rightarrow 2\text{CuSO}_4 \cdot \text{H}_2\text{O} + \text{H}_2\text{O}$; and at 270° , $2\text{CuSO}_4 \cdot \text{H}_2\text{O} \rightarrow 2\text{CuSO}_4 + \text{H}_2\text{O}$. I. Guareschi represents the hemihydrated salt with the doubled formula; graphically:

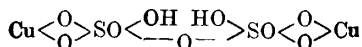

H. T. F. Rhodes considers that one water mol. in pentahydrated cupric sulphate differs from the remaining four because when the pentahydrate is treated with ammonia, only four mols. of water are displaced. A. Körbs found the solubility of different faces of a crystal of the pentahydrate in an under-saturated soln. to be different. H. C. Sorby measured the influence of press. on the solubility of the salt.

F. Pfaff measured the influence of a number of salts on the solubility of cupric sulphate. R. Engel found that sulphuric acid and ammonium sulphate depress the solubility. E. Diacon studied the influence of magnesium sulphate; W. Stortenbeker, of zinc and manganese sulphates; F. Rüdorff, of ferrous sulphate—*vide infra*. J. Keppel, and G. Massol and M. Maldès found that with sodium sulphate, a double salt, $\text{CuSO}_4 \cdot \text{Na}_2\text{SO}_4 \cdot 6\text{H}_2\text{O}$, is formed. J. M. Bcll and W. C. Taber say that a sat. soln. of calcium sulphate dissolves as much cupric sulphate as water does. R. Engel measured the solubility of the salt in soln. of ammonium sulphate and found it to be smaller the more conc. the soln. J. Holmes and P. J. Sagemann found that a smaller expansion occurs on mixing soln. of cupric sulphate and sulphuric acid than with the alkali or zinc sulphates and the same acid.

C. A. L. de Bruyn found that 100 grms. of absolute *methyl alcohol* dissolves 1.05 grm. of CuSO_4 at 18° , and 15.6 grms. of the pentahydrate at 18° , and 13.4 grms. at 3° ; while 100 grms. of 93.5 and 50 per cent. methyl alcohol dissolve respectively 0.93 and 0.40 grm. of the pentahydrate; and A. Klepl, V. Auger, and P. Rohland have also examined the solubility of cupric sulphate in methyl alcohol. R. de Forcrand obtained greenish-blue crystals of a double compound, $\text{CuSO}_4 \cdot \text{CH}_3\text{OH}$, by shaking anhydrous cupric sulphate with absolute methyl alcohol. The homologous alcohols do not form similar compounds. 100 grms. of absolute *ethyl alcohol* at 3° dissolve 111 grms. of the pentahydrate. H. Schiff found the solubility in 10, 20, and 40 per cent. alcohol at 15° to be respectively 15.3, 3.2, and 0.25 grms. of the pentahydrate per 100 grms. of solvent. 100 grms. of *glycerol* dissolve 30 grms. of the pentahydrate at 15.5° , and, according to F. Guthrie, the soln. has an emerald-green colour. W. F. C. de Coninck found 100 grms. of a sat. soln. of *glycol* at 14.6° has 7.6 grms. of the pentahydrate. The last-named salt is insoluble in *acetone*, and soluble in the *amines*. H. D. Gibbs found liquid *methylamine* forms an intense blue insoluble mass with cupric sulphate. A. Lieben found *ether* is changed in contact with cold anhydrous cupric sulphate. W. R. Hodgkinson and A. Leahy obtained compounds with *acetic acid* and *benzoic acid*; A. Werner, with amines of the fatty acids, *pyridine*, and *piperidine*; B. Lachowicz, with *quinoline*, *aniline*, *methyl aniline*, and *toluidine*; A. Werner, with *methyl sulphide*.

Anhydrous cupric sulphate forms colourless transparent crystals, white prisms, or a white powder which, according to T. Klobb, consists of fine prismatic needles.

The rhombic bipyramidal crystals of anhydrous cupric sulphate (hydrocyanite) were found by A. Scacchi⁹ to have the axial ratios $a : b : c = 0.7968 : 1 : 0.5650$. The monohydrate forms a greenish-white crystalline powder; the trihydrate, a bluish-white crystalline powder; the crystals from the sulphuric acid soln. are monoclinic, and A. Scacchi found the axial ratios to be $a : b : c = 0.4321 : 1 : 0.5523$, and $\beta = 96^\circ 25'$. The pentahydrate forms ultramarine-blue crystals belonging to the triclinic system, and, according to A. E. H. Tutton, they have the axial ratios $a : b : c = 0.5715 : 1 : 0.5575$, and $\alpha = 82^\circ 16'$, $\beta = 107^\circ 26'$, $\gamma = 102^\circ 40'$. G. Boeris found that the crystals from rapidly cooled conc. soln. and slowly cooled more dil. soln. of cupric sulphate exhibited twinning. S. Meyer found no evidence that a magnetic field has any influence on the crystallization. M. Kuhara studied the percussion figures of crystals of cupric sulphate. W. Spring says that the powdered salt under a press. of 6000 atm. forms a homogeneous solid.

The sulphates of the vitriol series form mixed crystals which have been studied by J. W. Retgers, W. Stortenbeker, A. Fock, R. Hollmann, H. W. Foote, etc. There are three types of mixed crystals with zinc and cupric sulphates: (i) *Rhombic*, almost colourless crystals with $7H_2O$; (ii) *Monoclinic*, pale blue crystals with $7H_2O$; and (iii) *Triclinic*, dark blue crystals with $5H_2O$. According to W. Stortenbeker, at 18° , the limits of the crystal phases are, in mol per cent. of copper, *i.e.* 100 mol Cu/(mol Cu+mol Zn) :

Crystal	Rhombic.	Monoclinic.	Triclinic.
Soln.	0 to 1.97	14.9 to 31.9	82.8 to 100
	0 to 8.36	8.36 to 21.5	21.5 to 100

The composition of the soln. in equilibrium with the different kinds of crystals is shown in W. Stortenbeker's diagram, Fig. 34; and the relation between the copper

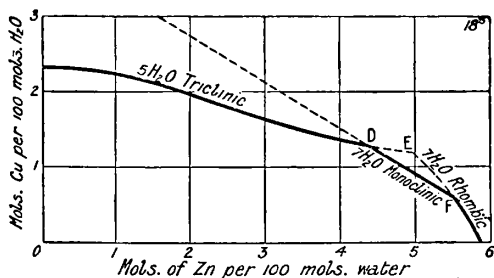

FIG. 34.—Limiting Range in Composition of Soln. for Mixed Crystals of Copper and Zinc Sulphates.

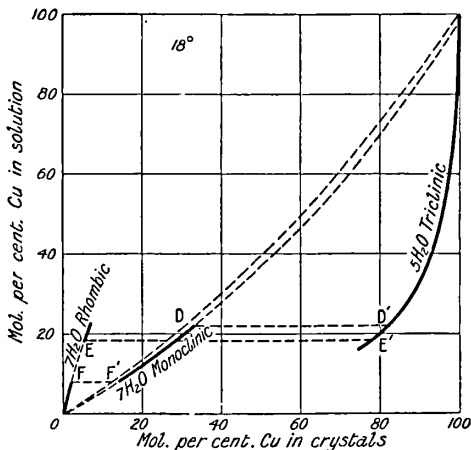

FIG. 35.—Relation between Copper and Zinc in the Mixed Crystals and in the Soln.

in the mixed crystals and in the soln. is indicated in Fig. 35. The dotted lines in both diagrams represent metastable states. Soln. containing between 21.5 and 100 mols per cent. of copper furnish triclinic mixed crystals poor in zinc, and with further concentration monoclinic crystals appear corresponding with soln. containing between 8.36 and 21.5 mols per cent. of copper. Then a mixture of monoclinic and rhombic crystals are formed, and finally soln. with 0 to 8.36 per cent. of copper give rhombic crystals with *F*, Fig. 35, as the end-point of the crystallization. H. W. Foote has investigated the effect of variations of temp. At 40° , the rhombic heptahydrated crystals, $(Cu, Zn)SO_4 \cdot 7H_2O$, pass into the hexahydrated,

(Cu, Zn)SO₄.6H₂O. At 45° the monoclinic phase of the heptahydrated crystals disappears. R. Hollmann has investigated the vap. press. of these crystals.

J. W. Retgers and R. Hollmann have likewise investigated mixed crystals of *cupric and magnesium sulphates* and found the composition of the solid phases to be: rhombic: 4.25 per cent. CuSO₄.7H₂O; monoclinic: 34.06 and 46.13 per cent. CuSO₄.7H₂O; and triclinic: 95.43 per cent. CuSO₄.5H₂O. R. Hollmann has measured the vap. press. With mixed crystals of *cupric and cadmium sulphates*, J. W. Retgers found monoclinic crystals with 0.55 parts CuSO₄.7H₂O, and triclinic crystals with 98.29 parts CuSO₄.5H₂O. J. W. Retgers found mixed crystals of *cupric and ferric sulphates* to be monoclinic between the limits 0 and 53.17 per cent. CuSO₄.7H₂O, and triclinic between 94.88 and 100 per cent. of CuSO₄.5H₂O. Similar results were obtained with mixed crystals of *cupric and cobalt sulphates*. H. Dufet, A. Fock, and J. W. Retgers have likewise investigated mixed crystals of *cupric and nickel sulphates*. At low temp. there are three series of mixed crystals, rhombic and monoclinic with 7H₂O, and triclinic with 5H₂O. Below 33° the nickel sulphate is rhombic, NiSO₄.7H₂O; above 33°, it is tetragonal, NiSO₄.6H₂O; and over 60°, monoclinic, NiSO₄.6H₂O. J. W. Retgers, R. Hollmann, and W. Stortenbeker have likewise studied mixed crystals of *cupric and manganous sulphates*.

The **specific gravity** of crystals of anhydrous cupric sulphate reported by P. I. Bachmetjeff¹⁰ is 3.516 and O. Pettersson gives 3.83 (18°). Several intermediate values have been reported—*e.g.* P. A. Favre and C. A. Valson gave 3.707 (25.3°) and H. Schröder for the salt dehydrated without fusion, 3.640. The best representative value is 3.6—T. E. Thorpe and J. I. Watts found 3.606 at 15°. For the monohydrated salt, the reported values vary from T. E. Thorpe and J. I. Watts' 3.289 at 15°, to H. Schröder's 3.038. The best representative value is 3.20. T. E. Thorpe and J. I. Watts give for the trihydrate 2.663 at 15°. The values for the pentahydrated salt range from J. H. Hassenfratz's 2.1943 to F. Rüdorff's 2.330. The best representative value is 2.27 in agreement with H. Kopp's 2.274 and P. I. Bachmetjeff's 2.276. T. E. Thorpe and J. I. Watts give 44.4 for the **specific volume** of the anhydrous salt; 54.3 for the monohydrate; 80.0 for the trihydrate; and 109.1 for the pentahydrate. W. W. S. Nicol also gives 1863.22 for the mol. vol. of the pentahydrate when 0.5 mol is dissolved in 100 mols. of water at 20° (sp. gr. 1.04268). G. Carrara and M. G. Levi give 48.81 to 46.16 for the mol. vol. of a mol in a soln. of 6.30 to 100.80 litres of methyl alcohol.

P. A. Favre and C. A. Valson¹¹ measured the contraction which occurs on soln. According to J. G. MacGregor, the volume of the soln. may be smaller than that of the water employed, the maximum contraction occurs with soln. containing 1.34 per cent. CuSO₄. The sp. gr. *D* of a soln. of cupric sulphate is equal to the sp. gr. of the water at the given temp. plus the product 0.0098427*w*, where *w* denotes the per cent. of anhydrous salt in the soln. H. Schiff found the sp. gr. at 18° of soln. with *w* per cent. of the pentahydrate, CuSO₄.5H₂O, and the results are indicated in Table X.

TABLE X.—SPECIFIC GRAVITIES OF SOLUTIONS OF PENTAHYDRATED CUPRIC SULPHATE AT 18° (H. SCHIFF).

	0	1	2	3	4	5	6	7	8	9
0	1.0000	0063	0196	0190	0254	0319	0384	0450	0516	0582
1	1.0649	0716	0785	0854	0923	0993	1063	1135	1208	1281
2	1.1354	1427	1501	1585	1659	1738	1817	1898	1980	2063
3	1.2164									

G. Charpy, J. Delaite, P. A. Favre and C. A. Valson, G. T. Gerlach, J. A. Groshans, R. J. Holland, F. Kohlrausch, J. G. MacGregor, J. C. G. de Marignac, A. Michel and L. Krafft, W. W. J. Nicol, etc., have also determined the sp. gr. of soln. of cupric

sulphate. According to E. Iruoste, if D and D_0 respectively denote the sp. gr. of soln. and of water at 15° , the conc. per grm. of soln. is $0.95933(D-D_0) - 0.43961(D-D_0)^2$. According to J. Thomsen, the soln. contains molecules of $\text{CuSO}_4 \cdot 5\text{H}_2\text{O}$; R. Luther found the soln. also contains some cuprous sulphate. M. Konowaloff found evidence of the formation of hydrates; H. C. Jones and F. H. Getman, and A. Colson found signs of polymerization in conc. soln. The latter says $(\text{CuSO}_4)_2$. A. Hantzsch attributes the constancy of the colour of the soln. to the presence of complexes. J. Traube gives 12.5 for the mol. soln. vol. of a 19.17 per cent. soln., and 102.6 for a 30 per cent. soln. E. Cohen and A. Étard have also studied this subject. S. Lussana represented the influence of press. p atm. on the temp. θ of maximum density of soln. of cupric sulphate, by $\theta = 0.0053(p-1) - 0.14$.

The diffusion coefficient k , in A. Fick's equation, was found by J. Schuhmeister¹² to be 0.21 at 10° for a soln. with 1.25 grm.-eq. per litre; and J. Thovert, at 17° , found for soln. with 1.95, 0.50, and 0.10 grm.-eq. per litre, respectively 0.23, 0.29, and 0.39. Other investigations on this subject have been made by A. Griffiths, G. Bruni and B. L. Vanzetti, H. de Vries, J. C. G. de Marignac, J. H. Long, etc. The viscosity of soln. of cupric sulphate has been determined by J. Barnes, S. Arrhenius, and J. Wagner. The latter finds at 25° for N -, $\frac{1}{2}N$ -, $\frac{1}{4}N$ -, and $\frac{1}{8}N$ -soln. the respective values 1.3580, 1.1603, 1.0802, and 1.0384 (water unity). A. Brümmer found a distinct minimum in the surface tension, σ , in dynes per cm., and the capillary constant, a^2 sq. mm., of soln. of cupric sulphate at 15° , thus:

Per cent. CuSO_4	.	.	0	5	10	12.5	15	20
a^2	.	.	15.43	14.50	13.41	12.77	13.22	13.84
σ	.	.	77.1	75.1	71.8	70.8	75.9	81.1

Cupric sulphate does not melt when heated. At 99° , F. Rinne¹³ found about a tenth of the water is lost from the pentahydrate and the colour is still dark blue; at 105° , about two-fifths of the water is given off, and the colour paler; at 117° , four-fifths of the water is expelled, and the residue is greenish-white in colour; and all the water is driven off at 258° . I. Guareschi says that over calcium chloride at 21° – 23° , the pentahydrate loses only $2\text{H}_2\text{O}$ and passes into the trihydrate; at 60° it forms the monohydrate. In air, the pentahydrate is not changed at 40° , but loses $2\text{H}_2\text{O}$ at 45° – 50° , and another H_2O at 60° , and the remaining H_2O at 206° . In a current of dry air at 41° – 42° , the pentahydrate loses $1.5\text{H}_2\text{O}$ in 5 hrs., and $0.5\text{H}_2\text{O}$ more in another 5 hrs.; there is no further loss at 50° – 60° , but at 72° , another $2\text{H}_2\text{O}$ is given off. J. I. Pierre's statement that the pentahydrate crystallized above 25° loses all its water in dry air at 114° is wrong. T. Graham found that the last mol of water is lost at 242° , but, according to T. W. Richards, some water still remains at even higher temp., for the anhydrous salt dried at 255° "loses about 0.17 per cent. of its weight, when heated to 365° . . . and a small amount—about 0.12 per cent.—is held even at 400° ." According to D. W. Horn and E. E. Taylor, it is impossible to prepare pure anhydrous or monohydrated cupric sulphate by heating the pentahydrate. The product is brown and the losses in weight are variable even at 220° . In every case the purity of the final product is affected by secondary reactions between the water and the cupric sulphate. This agrees with A. Naumann's observations. J. L. Proust, A. A. B. Bussy, J. L. Gay Lussac, and P. Berthier stated that when heated *au rouge sombre*, the anhydrous salt loses sulphuric anhydride and forms a basic sulphate; if heated to a still higher temp. sulphur trioxide, or sulphur dioxide and oxygen, is given off, and leaves a residue of cupric oxide. R. H. Bradford says that the decomposition begins at 653° , forming a yellow insoluble basic sulphate, and that at 720° it completely decomposes to cupric oxide, etc. S. U. Pickering denied the formation of a basic sulphate, rather is the product a mixture of cupric oxide and undecomposed salt. T. W. Richards found that no acid is lost from anhydrous cupric sulphate heated to 365° . When the temp. of copper sulphate is measured from time to time while the salt is being heated,

arrests in the curve occur at about 340°, 380°, 500°, and 620°. These critical temp. correspond with the points at which the salt begins to decompose, or form the basic salts: $8\text{CuO}\cdot 3\text{SO}_3$, and $2\text{CuO}\cdot \text{SO}_3$. A. Mourlot found that when heated in an electric furnace, cupric sulphate is reduced to the metal. Cupric oxide begins to be formed about 700°.

According to P. I. Bachmetjeff,¹⁴ the coefficient of thermal expansion of crystals of anhydrous cupric sulphate is 0·0000245; for the crystalline pentahydrate, 0·000165; and the amorphous salt, -0·000013. C. Forch gives for the volume of a soln. with 0·517 grm. eq. per litre, at θ° when the volume at 0·01° is unity:

θ	5·09	10·03	15·03	19·84	25·08	29·79	34·92	39·97
Vol.	1·000301	1·000894	1·001769	1·002856	1·004280	1·005754	1·007565	1·009546

and the expansion coeff. per grm. eq. ($\times 10^6$):

0°-5°	5°-10°	10°-15°	15°-20°	20°-25°	25°-30°	30°-35°	35°-40°
118	169	215	258	302	334	331	410

P. I. Bachmetjeff gives 0·184 for the specific heat of the anhydrous salt between 23° and 100°; 0·202 for the monohydrate; and 0·285 for the pentahydrate between 16° and 47°. For soln. of cupric sulphate, $\text{CuSO}_4 + 200\text{H}_2\text{O}$, J. Thomsen gives 0·953, and for $\text{CuSO}_4 + n\text{H}_2\text{O}$ from 18° to 23°. S. Pagliani and J. C. G. de Marignac respectively give for $n=50$, 0·848 and 0·841; for $n=100$, 0·898 and 0·908; for $n=200$, 0·950 and 0·951; and for $n=400$, S. Pagliani gives 0·975. From 22° to 53°, J. C. G. de Marignac gives for $n=50$, 100, and 200, respectively 0·8520, 0·9148, and 0·9528. P. Vaillant, and H. Teudt have also measured the sp. ht. of soln. of this salt. S. Pagliani gives $79 + 18(n-5)$ for the molecular heat for soln. with n mols of water for one mol of $\text{CuSO}_4\cdot 5\text{H}_2\text{O}$, when n ranges from 50 to 400; and J. C. G. de Marignac's values for soln. with 50, 100, and 200 eq. of water are respectively 891, 1780, and 3571 between 18° and 23°; and 902, 1792, and 3582 between 22° and 53°. C. Pape, and W. C. Röntgen have measured the heat conductivity of the pentahydrated salt. According to the former, the heat conductivity ellipsoid has the axial ratios 0·939 : 0·860 : 1. According to H. F. Weber, the heat conductivity of a soln. of sp. gr. 1·160 is 0·00118 abs. units, or 95·26 (water 100); and G. Jäger found that for each per cent. of cupric sulphate, in the soln., the heat conductivity decreases by 0·00272.

According to M. Berthelot,¹⁵ the heat of formation of anhydrous cupric sulphate from its elements is $(\text{Cu}, \text{S}, \text{O}_4) = 181\cdot 7$ Cals.; J. Thomsen gives 182·6 Cals., and for $(\text{Cu}, \text{O}_2, \text{SO}_2)$, 111·49 Cals. M. Berthelot gives for the heat of formation from cupric oxide, 42·6; and from cupric hydroxide, 22·8 Cals. J. Thomsen gives 56·216 to 55·960 Cals. for the heat of formation of the pentahydrate in aq. soln. $(\text{Cu}, \text{S}, \text{O}_4, \text{aq.})$; P. A. Favre from CuO , 9·711 to 9·814 Cals.; J. Thomsen, $(\text{CuO}, \text{SO}_3, \text{aq.})$, 18·8 Cals.; and from anhydrous cupric sulphate, 3·41 Cals. (J. Thomsen), or 3·34 Cals. (P. C. F. Frowein). L. and P. Wöhler and W. Plüddemann give 13 cal. for the heat of dissociation of anhydrous cupric sulphate. According to R. Scholz, the heat of solution expressed in mean gram-calories for a soln. of a gram of the salt in a n times normal soln.:

n	0·125	0·25	0·50	1·0	2·5
$\frac{1}{2}(\text{CuSO}_4\cdot 5\text{H}_2\text{O})$	13·60	13·38	12·98	12·64	11·48

S. U. Pickering gives 2·465 Cals. for the heat of soln. of the pentahydrate at 15°, -2·762 Cals. at 18°; and J. Thomsen for a mol of CuSO_4 in 400 mols of water, 15·8 Cals.; and under similar conditions, for $\text{CuSO}_4\cdot \text{H}_2\text{O}$, 9·33 Cals.; for $\text{CuSO}_4\cdot 3\text{H}_2\text{O}$, 2·81 Cals.; and for $\text{CuSO}_4\cdot 5\text{H}_2\text{O}$, -2·75 Cals. P. A. Favre gives for the heat of soln. of an eq. of salt in 278 eq. of water, -1315 cal., in the presence of 5 eq. of sulphuric acid, -2555 cal., and 1 eq. of that acid, -1998 cal.; and with 5 and 1 eq. hydrochloric acid under similar conditions, -4484 and -3106 cal. According to J. H. Pollok, if a sat. soln. at 9° be diluted with its own vol. of water.

the temp. rises $0\cdot02^{\circ}$ – $0\cdot05^{\circ}$; and J. Thomsen found 41 cal. for the heat of dilution of a soln. $\text{CuSO}_4 + 60\text{H}_2\text{O}$ to $\text{CuSO}_4 + 100\text{H}_2\text{O}$ and 116 cal. for $\text{CuSO}_4 + 60\text{H}_2\text{O}$ to $\text{CuSO}_4 + 200\text{H}_2\text{O}$. The heat of hydration, $\text{CuSO}_{4\text{solid}} + \text{H}_2\text{O}_{\text{liq.}} = 6\cdot47$ Cals.; $\text{CuSO}_{4\text{solid}} + 3\text{H}_2\text{O}_{\text{liq.}} = 12\cdot9$ Cals.; and $\text{CuSO}_{4\text{solid}} + 5\text{H}_2\text{O}_{\text{liq.}} = 18\cdot55$ Cals.

According to F. Rüdorff,¹⁶ the freezing point of a sat. soln. of cupric sulphate is -2° . F. Guthrie's cryohydrate has been previously indicated. The lowering of the f.p. when a gram of salt is dissolved in 100 grms. of water was found by L. C. de Coppet to be $0\cdot070$, and by F. Rüdorff, $0\cdot065$ —the lowering in the former case is $17\cdot5$ per mol. The lowering of the f.p. has been measured by F. M. Raoult, L. Kahlenberg, H. Hausrath, etc. H. C. Jones and F. H. Getman and V. J. Chambers and J. C. W. Frazer found:

Mol CuSO_4 per litre	0·072	0·144	0·476	0·595	0·890	1·190
Mol. lowering	2·33	2·16	1·50	1·45	1·43	1·46

There is some evidence of a minimum. S. U. Pickering measured the lowering of the f.p. of soln. of cupric sulphate, expressed in mols per litre, and the corresponding values calculated from the electrical conductivity agree for soln. up to $0\cdot03$ mol per litre, but for more conc. soln. the computed values are greater than the observed. The values of i calculated from the f.p. data are here indicated:

Mols CuSO_4	0·0003	0·0028	0·0176	0·0553	0·1658	0·4081	0·7453
Lowering f.p.	$0\cdot0009^{\circ}$	$0\cdot0090^{\circ}$	$0\cdot0475^{\circ}$	$0\cdot1337^{\circ}$	$0\cdot3344^{\circ}$	$0\cdot7422^{\circ}$	$1\cdot3258^{\circ}$
i	1·932	1·681	1·472	1·379	1·293	1·231	1·206

According to T. Griffiths,¹⁷ the boiling point of a 45 per cent. soln. is $102\cdot2^{\circ}$ and, according to G. T. Gerlach, soln. with 21·3, 63, and 82·2 per cent. of CuSO_4 , boil respectively at $100\cdot5^{\circ}$, $102\cdot5^{\circ}$, and $104\cdot2^{\circ}$. The raising of the b.p. of soln. of cupric sulphate have been measured by N. Tarugi and G. Bombardini, and L. Kahlenberg. The latter found:

Mols CuSO_4 per litre	0·210	0·489	0·999	2·026	3·583	4·619
Mol. rise	0·43	0·39	0·37	0·43	0·637	0·816

Anhydrous cupric sulphate is very hygroscopic. J. L. Proust¹⁸ noticed that anhydrous cupric sulphate becomes blue when breathed upon, owing to the formation of the blue hydrate. T. Graham found that the hydration of the anhydrous salt raises its temp. 135° ; and, after 3 days' exposure to moist air, R. Brandes found that the pentahydrated salt is formed. C. F. Cross measured the rate of formation of the pentahydrate in moist air; and P. I. Bachmetjeff, the rate of dehydration of the pentahydrate.

The crystals of the pentahydrate were found by C. Pape to effloresce in dry air; this phenomenon will in general occur when the vap. press. of the salt is greater than the partial press. of the moisture in the air. H. Lescœur found the dissociation press. for efflorescence at 20° to be 6·0 mm. H. Baubigny reported that if the salt is crystallized from a feebly acid soln., it will effloresce more rapidly than if crystallized from a neutral soln. E. Blasius has studied the corrosion figures produced on the crystals by exposure to the atm. When the pentahydrate is confined over sulphuric acid, P. Latschinoff found it lost two-fifths of its water, and W. Müller-Erzbach, that the finely powdered salt confined over sulphuric acid at 17° scarcely loses any water the first day, the relative vap. press. then rises to $0\cdot04$ or $0\cdot05$ mm., when it remains constant for a week, and about two-fifths of the combined water is lost. The vap. press. then falls to $0\cdot002$ mm. In a month's time a little more than two-fifths of the water remains with the crystals. About 1·66 mol of water per mol of CuSO_4 remained after the pentahydrate had been confined in a scaled tube for about ten months. The relative vap. press. of the atm. over the pentahydrate at 44° is over $0\cdot21$, and at 41° not over $0\cdot25$.

The vapour pressure determinations of H. Lescœur confirm the existence of

the 1, 3, and 5 hydrates, but not the 2 and 4 hydrates. The dissociation press. at 45° and 78° for a mol of CuSO_4 with $n\text{H}_2\text{O}$ are :

45°	{ $n\text{H}_2\text{O}$	4·85	4·64	3·87	2·37	1·06	0·98
	{Vap. press.	30	30	30	10	15	<1 mm.
		3-5H ₂ O			1-3H ₂ O		
78°	{ $n\text{H}_2\text{O}$	4·13	3·71	3·41	2·61	2·10	1·75
	{Vap. press.	234	238	232	142	145	148
		3-5H ₂ O			1-3H ₂ O		

The constant vap. press. correspond with the univariant systems containing the 3-5 hydrates and vapour, the 1-3 hydrates and vapour, or the 0-1 hydrates and vapour. A. Naumann was unable to get constant vap. press. for definite temp., and G. Wiedemann attributed this to adsorbed air and water imprisoned in the crystals; A. W. C. Menzies has also studied this question. The vap. press. at different temp. are :

	10°	30°	60°	80°	100°	163°	186·5°	206°	220°
3-5H ₂ O	2·8	12·5	72	263	668				
1-3H ₂ O	—	5	45	168	525				
0-1H ₂ O	—	—	—	—	—	11	44	143	666

P. C. F. Frowein has made determinations for the 3-5H₂O system, which W. Müller-Erbach believes are rather low. J. L. Andreae found the changes from one system to the other are abrupt. According to W. Müller-Erbach, the dissociation press. of the 0-1H₂O system is less than 0·3 mm. of mercury; with the 1-3 system at 14·5°, the press. is 0·19 mm., and 0·30 mm. at 17·8°; and with the 3-5H₂O system, it is 0·31 mm. at 17·5°. Observations have been made by A. H. Pareau, J. R. Partington, R. E. Wilson, A. A. Noyes and L. R. Westbrook, H. Schottky, etc. *Vide* 1 9, 11; and for the action of heat on the anhydrous salt, *vide* basic cupric sulphates.

J. Moser found that the vap. press. of water was lowered 12 mm. by the soln. of 25 grms. of the pentahydrate in 100 grms. of water at 30°. J. H. Schüller found the lowering of the vap. press. to be proportional to the quantity of salt dissolved, and he found it to be 0·022 for one per cent. of salt—the value calculated by Helmholtz's formula is 0·0212. H. Sentis has examined the effect of surface tension on the phenomenon.

According to A. Lavenir,¹⁹ the **index of refraction** of cupric sulphate for sodium light is $\alpha=1·51408$, $\beta=1·53684$, $\gamma=1·54345$. M. le Blanc gives for the corresponding molecular refractions 56·33, 58·89, and 59·64 respectively. C. Chéneveau, and M. le Blanc have studied the index of refraction of soln. of cupric sulphate; the latter finds for 5·58, 15·05, and 16·79 per cent. soln. the respective sp. grs. 1·05874, 1·16936, and 1·19125, the respective indices of refraction 1·34376, 1·36260, and 1·36613, and the respective molecular refractions 28·69, 28·55, and 28·48. The optical constants have been measured by C. Pape, F. Kohlrausch, etc. C. Pape also found the crystals of the pentahydrate to have a negative double refraction. D. Gerney found the crystals to be triboluminescent; and P. Gaubert found that the adsorption of methylene blue makes them polychroic. The adsorption of radiant energy by soln. of cupric sulphate has been studied by P. Desains. The absorption spectra have been discussed in connection with cupric chloride. M. Kofler has investigated the absorption of radium emanation by soln. of cupric sulphate.

According to T. Gross,²⁰ solid anhydrous cupric sulphate conducts the electric current, so also does the solid pentahydrate. The subject has been studied by P. Vaillant. A great many observations have been made of the **electrical conductivity** of aq. soln. of cupric sulphate by W. C. D. Whetham, J. G. McGregor and E. H. Archibald, F. Kohlrausch, N. Tarugi and G. Bombardini, T. C. Fitzpatrick, J. H. Long, F. B. de Lenzan and L. Maury, L. Kahlenberg, etc. The

following may be regarded as selected representative values of the eq. conductivity λ at 0° and 18°. The conc. C is in gram-eq. per 1000 grms. of soln.:

C	0.00001	0.0001	0.001	0.01	0.1	1.0	2.0
λ at 0°	69.6	67.4	60.2	44.5	28.2	16.0	13.5
λ at 18°	—	109.9	98.6	71.7	43.8	25.8	20.1
α at 0°	99.8	96.7	86.3	63.8	—	—	—

P. Sack, F. Kohlrausch, and S. Arrhenius have calculated the temperature coefficient of the conductivity. The degrees of ionization expressed in percentages in the above data have been studied by A. Bouzat, W. C. D. Whetham, N. Tarugi and G. Bombardini, G. N. Lewis and M. Randall, etc. A. A. Noyes and K. G. Falk gave 0.629 for the degree of ionization of 0.01 molar soln., computed from λ/λ_∞ ; G. N. Lewis and G. A. Linhart introduced some correction terms and obtained 0.290. S. Arrhenius calculated the heat of ionization to be -1566 cal. at -35° . G. Carrara and G. B. Vespignani calculate the degree of hydrolysis of a $\frac{1}{2}N$ -soln. to be 0.057 per cent. at 25° . The transport numbers of anions and cations have been determined by many observers.²¹ H. Jahn found an apparent maximum for the anion at 15° ; thus, with soln. containing 0.032 per cent. of copper, the values at 1° and 15° are respectively 0.615 and 0.633; with 30 per cent. of copper, 0.611 at 0° and 0.607 at 50° ; and with 0.73 per cent. of copper, 0.632 at 15° and 0.622 at 76° . H. Jahn has for the cation at room temp. and soln. with a mol dissolved in v litres:

v	4.08	7.92	12.20	16.00	32.00	65.44	94.51
	0.328	0.328	0.366	0.373	0.376	0.375	0.375

A. Campetti found the values to increase with rise of temp. J. Dowling and K. M. Preston studied the high frequency resistance of glycerol soln. of cupric sulphate; and A. Gilmour examined soln. of cupric sulphate in glycerol as a source of high resistance of small inductance; and N. Isgarisheff, the polarization of soln. of cupric sulphate in the presence of gelatin, gum, and sucrose.

S. H. Freeman²² has studied the production of a current during the evaporation of a soln. of cupric sulphate. A. Hollard, and H. M. Goodwin and W. G. Horsch measured the conductivity of soln. of cupric sulphate with different proportions of sulphuric acid; J. L. Hoorweg noted that cooling occurs when a current passes from sulphuric acid to cupric sulphate, and cooling produces a current from the acid to the salt. J. T. Barker has measured the effect of glycerol on the conductivity of soln. of cupric sulphate; T. C. Fitzpatrick, the effect of alcohol; and A. Gilmour, the effect of glycerol. The potential difference of copper in soln. of cupric sulphate has been measured by J. von Hepperger, S. Lussana, F. Paschen, etc.; of soln. of cupric sulphate and other soln. by E. Bichat and R. Blondlot, S. Pagliani, H. Bagard, A. Hagenbach, J. Miesler, etc. C. W. Bennett found that in the electrolysis of a soln. of acid copper sulphate, with a rotating copper cathode, the potential drop across the cell, with constant current, increases with the speed of rotation. Since the rotation of the electrode would give an efficient stirring of the soln., and lessen conc. differences, it might be anticipated that a fall of potential would occur. C. W. Bennett and C. O. Brown explained the increase in the potential as an effect of the formation of cuprous ions. As the rotation increases, the stirring becomes more efficient, and the cuprous ions are removed, so that the rate of soln. of the copper is increased, and the voltage is increased. With nitric acid, the potential decreases with increasing speed of rotation because the film of nitrous acid is removed from the copper; this decreases the speed of soln. of the copper and lowers the potential. The decomposition potential of soln. of copper sulphate has been studied by J. Moser, C. Truchot, etc., *vide* copper.

The magnetic susceptibility of anhydrous cupric sulphate has been observed by H. W. March²³ to be 10.47×10^{-6} mass units, in agreement with observations by G. Quincke, O. Liebkecht and A. P. Wills, S. Meyer, and J. Königsberger.

G. Cléneveau gave for the crystalline salt 6.5×10^{-6} mass units. C. K. Studley also measured this constant for soln. of cupric sulphate, and found $10.4D(w/100) - 0.80D(1-w/100)^2$, when w represents the per cent. of water-free salt in the soln., and D the sp. gr. A. Heydweiller found the dielectric constant per mol of water of crystallization in hydrated cupric sulphate to be 6.22, showing that the water is profoundly modified in crystals. For the anhydrous salt respectively powdered and compact, the values are 2.36 and 10.31; and for the pentahydrate respectively 3.44 and 7.84 for $\lambda=478$ cm. R. T. Lattey found the dielectric constants of 0.00114*N*-, 0.00228*N*-, and 0.00456*N*-soln. to be respectively 75.2 (15.1°), 78.2 (13.2°), and 73.9 (14.8°).

According to A. Leighton, the decomposition voltage of a soln. of cupric sulphate between platinum electrodes is not appreciably affected when the anode is illuminated with a mercury lamp, but it is increased when the cathode is so illuminated. J. A. Arfvedson²⁴ found that heated soln. of cupric sulphate is reduced by **hydrogen**; and J. L. Gay Lussac that it is reduced by **carbon**. A 2*N*-soln. of the salt absorbs carbon dioxide -0.0751 grm. per 75 c.c. of soln. at 15°, and 720 mm., but there is no perceptible chemical action.

According to M. C. Lea,²⁵ A. Colson, and R. M. Caven soln. of cupric sulphate made with cold air-free **water** are feebly acid, for they redden blue litmus. F. Clowes, and D. W. Horn and E. E. Taylor say that while a cold soln. is acid towards litmus, it is practically neutral towards methyl orange; R. M. Caven found a dil. cold air-free soln., which has been boiled, gives a precipitate of basic cupric sulphate, and the soln. reacts acid to methyl orange; on the other hand, a conc. soln. of cupric sulphate does not give a precipitate on boiling, nor does such a soln., after boiling, affect methyl orange. The formation of the basic salt, and the development of acidity towards methyl orange are co-related; the one is not produced without the other. The phenomena occur only in dil. soln., and, as shown by D. Tommasi, and E. Divers, they are the result of the **hydrolysis** of cupric sulphate by the mass action of hot water. The amount of sulphuric acid produced by hydrolysis in cold soln. is very small. J. H. Long has compared the hydrolysis in dil. aq. soln. of cupric sulphate and potash alum. The latter alone, in cold soln., affects the colour of methyl orange. After maintaining the two soln., each mixed with saccharose, for 6 hrs. between 50° and 60°, during which no basic salt was precipitated, J. H. Long found that there was an appreciable reduction with the alum soln., and a barely perceptible reduction with the cupric sulphate soln. Hence, it was inferred that only an infinitesimal amount of free sulphuric acid is present in soln. of cupric sulphate from which no basic salt has been precipitated. E. J. Houston noticed that the soln. is green when boiled, and it becomes blue when cold, and a still deeper blue if more strongly cooled. J. L. Andree found that if evaporated in a sealed tube, the penta- and tri-hydrated salts are formed, and if the water be removed, the trihydrate, and finally the monohydrate, is formed. R. C. Tichborne also studied the dehydration of soln. of cupric sulphate when heated in sealed tubes.

R. Kane found that if **hydrogen chloride** be passed over powdered pentahydrated cupric sulphate, the gas is absorbed, heat is developed, and over two-fifths of the water is set free. When the grass-green product is heated, a brown mass is formed, and hydrogen chloride is given off. P. Latschinoff likewise found that when hydrogen chloride is passed over pentahydrated cupric sulphate, at room temp., the gas is absorbed, forming a product, $\text{CuSO}_4 \cdot 5\text{H}_2\text{O} \cdot 3\text{HCl}$, and this then breaks down into $\text{CuSO}_4 \cdot 2\text{H}_2\text{O} \cdot 2\text{HCl}$. When air is passed over the latter compound a complex product, $\text{CuSO}_4 \cdot \text{H}_2\text{O} \cdot \frac{1}{2}\text{HCl}$, is obtained from which the hydrogen chloride cannot be removed by a stream of air. C. Hensgen found that if dry hydrogen chloride be passed over the salt, it is completely converted into grass-green needle-like crystals of cupric chloride, $\text{CuCl}_2 \cdot 2\text{H}_2\text{O}$. According to A. Colson, hydrogen chloride converts the anhydrous sulphate partially into chloride. Pentahydrated cupric sulphate dissolves in **hydrochloric acid**, and the temp. is at the same time lowered about 17°, forming a green liquid. If about two mols of HCl are present per mol of CuSO_4 , crystals of

cupric chloride, $\text{CuCl}_2 \cdot 2\text{H}_2\text{O}$, are formed when the soln. is evaporated and cooled; if the crystals remain in the mother-liquid, crystals of $\text{CuSO}_4 \cdot 5\text{H}_2\text{O}$ are formed. A. B. Prescott found that if a soln. of a gram of the salt with 3.5 c.c. of hydrochloric acid of sp. gr. 1.153, be evaporated to dryness on a water-bath, about 3.6 per cent. of the copper is converted into cupric chloride. The transformation with the anhydrous sulphate is not complete although brownish-yellow cupric chloride, CuCl_2 , is formed. With anhydrous chloride under similar conditions, about two mols of hydrogen chloride are absorbed with the evolution of much heat. A dark brown mass is formed which loses its hydrogen chloride when heated, or which, on soln. in water furnishes crystals of cupric chloride. According to J. Löwe, when a soln. of cupric sulphate is treated with zinc and sulphuric acid, some hydrogen sulphide is formed, and, according to T. Leykauf, and L. Meyer, copper and basic zinc sulphate are precipitated, and zinc sulphate passes into soln. The action of magnesium on soln. of cupric sulphate is attended by the precipitation of cuprous oxide and the evolution of hydrogen. The reaction has been studied by F. Clowes, R. M. Caven, S. Kern, A. Commaille, E. Divers, and D. Vitali. F. Clowes showed that the change is not due to an impurity in the copper salt, and he suggests the reaction, $2\text{Mg} + 2\text{CuSO}_4 + \text{H}_2\text{O} = 2\text{MgSO}_4 + \text{Cu}_2\text{O} + \text{H}_2$. E. Divers believes that the evolution of hydrogen is due to the free sulphuric acid formed by the hydrolysis of the cupric sulphate; cuprous sulphate is formed: $2\text{CuSO}_4 + \text{Mg} = \text{Cu}_2\text{SO}_4 + \text{MgSO}_4$, and the cuprous sulphate is then converted into cuprous oxide—*vide* the metallic precipitation of copper. K. Griessbach studied the action of ammonium and alkali hydroxides and carbonates on soln. of cupric sulphate.

According to A. Vogel,²⁶ and C. J. B. Karsten, a soln. of cupric sulphate forms cupric and ammonium sulphates and cupric chloride when treated with ammonium chloride; and, according to J. B. J. D. Boussingault, an analogous change occurs with sodium chloride. H. Rose,²⁷ A. Joannis, and J. Riban have studied the action of phosphine. C. F. Rammelsberg found that when boiled with antimony pentasulphide, a soln. of cupric sulphate furnishes black cupric thioantimoniate, antimonie oxide, and sulphur trioxide. H. Quantin noted the reduction of a soln. of 0.5 gm. of cupric sulphate per litre by alcoholic ferment, whereby cupric sulphide is formed. J. F. Persoz found glacial acetic acid precipitates the pentahydrate, $\text{CuSO}_4 \cdot 5\text{H}_2\text{O}$; and L. de Bouquet found that alkali thiocarbonates give carbon disulphide. A. Gawalowsky showed that a white precipitate—said to be cuprous sulphate—is formed by the action of potassium permanganate on cupric sulphate soln. which results in the evolution of oxygen; with nitric oxide, the white precipitate gives copper and cupric sulphate.

Ordinary cupric sulphate is used as the starting-point in the preparation of many compounds of copper; in dyeing; in electroplating; in making galvanic cells; etc. It is also used as an antiseptic, and in making preparations for protecting plants from fungoid and other diseases.

REFERENCES.

¹ H. Kopp, *Geschichte der Chemie*, Braunschweig, 4. 168, 1847; Basilius Valentinus, *Letztes Testament*, Strassburg, 1651; A. Libavius, *Alchemia*, Francofurti, 1595; G. Agricola, *De re metallica*, Basilie, 1546; J. B. van Helmont, *De lithiasi*, Amstelodami, 1644; J. R. Glauber, *Furnis novis philosophicis*, Amstelodami, 1648; G. E. Stahl, *Ausführliche Betrachtung und zulanglicher Beweis von den Saltzen des dieselben aus einer zarten Erde mit Wasser innig verbunden bestehenden*, Halle, 1723.

² H. Oehmichen, *Zeit. prakt. Geol.*, 147, 1902; W. T. Schaller, *Amer. Journ. Science*, (4), 17. 191, 1904; C. F. Rammelsberg, *Handbuch der Mineralchemie*, Leipzig, 1. 265, 1875; G. Tschermak, *Tschermak's Mitt.*, 54, 1871; A. Scacchi, *Rend. Accad. Napoli*, 9. 84, 1870.

³ J. Davy, *New Edin. Phil. Journ.*, 8. 229, 1829; G. Burrell, *Journ. Pharm.*, 20. 15, 1834; W. Hampe, *Zeit. Berg. Hütt. Sal.*, 21. 268, 1873; T. Savage, *Brit. Pat. No.* 21953, 1896; J. E. Bérard, *Pogg. Ann.*, 14. 285, 1828; G. de Bechi and H. Gall, *French Pat. No.* 211620, 1891; E. W. von Siemens and J. G. Halske, *German Pat., D.R.P.* 130298, 1901; H. J. U. Palas, F. A. J. Cotta, and E. Gouin, *ib.*, 127423, 1900; E. F. Anthon, *Repert. Pharm.*, 81. 344, 1843; J. R. Glauber, *Furnis novis, philosophicis*, Amstelodami, 1648; G. E. Stahl, *Ausführliche*

Betrachtung und zulänglicher Beweis von den Salzen des dieselben aus einer zarten Erde mit Wasser innig verbunden bestehen, Halle, 1723; P. A. Mackay, *Brit. Pat. No.* 161656, 1920; E. V. Zappi, *Anal. Soc. Quim. Argentina*, 7, 433, 1919; H. Suchanek, *Chem. Ztg.*, 45, 1065, 1921.

⁴ H. Baubigny, *Compt. Rend.*, 97, 854, 1883; M. Bräuning, *Zeit. Berg. Hütt. Sal.*, 25, 156, 1877; H. Fleck, *Dingler's Journ.*, 166, 354, 1862; G. Lunge, *ib.*, 190, 39, 1868; C. Rössler, *Berg. Hütt. Ztg.*, 51, 190, 1892; H. V. Hybinette, *Met. Chem. Eng.*, 11, 6, 1913.

⁵ M. de la Source, *Compt. Rend.*, 83, 899, 1876; A. Étard, *ib.*, 104, 1615, 1887; A. Scacchi, *Rend. Accad. Napoli*, 9, 84, 1870; I. Guareschi, *Atti Accad. Torino*, 50, 1125, 1915; C. F. Rammelsberg, *Handbuch der kristallographischphysikalischen Chemie*, Leipzig, 1, 429, 1881; C. A. L. de Bruyn, *Rec. Trav. Chim. Pays-Bas*, 11, 112, 1892; *Zeit. phys. Chem.*, 10, 788, 1892; W. Müller-Erbach, *ib.*, 19, 146, 1896; J. M. Bell and W. C. Taber, *Journ. Phys. Chem.*, 12, 172, 1908; C. F. Gross, *Chem. News*, 44, 209, 1881; W. R. Hodgkinson and A. Leahy, *ib.*, 80, 198, 1899; T. Graham, *Phil. Mag.*, (3), 6, 419, 1835; D. W. Horn and E. D. Taylor, *Amer. Chem. Journ.*, 32, 276, 1904; F. Krafft, *Ber.*, 40, 4770, 1907.

⁶ J. L. Proust, *Journ. Phys.*, 59, 594, 1804; *Ann. Chim. Phys.*, (1), 32, 33, 1800; C. Poulenc, *ib.*, (7), 2, 72, 1894; G. Barruel, *Journ. Pharm.*, 20, 15, 1834; J. M. Bell and W. C. Taber, *Journ. Phys. Chem.*, 12, 172, 1906; L. W. Andrews, *Journ. Amer. Chem. Soc.*, 18, 253, 1896; D. W. Horn, *Amer. Chem. Journ.*, 39, 194, 1908; D. W. Horn and E. E. Taylor, *ib.*, 32, 277, 1904; P. Latschinoff, *Journ. Russ. Phys. Chem. Soc.*, 20, 585, 1888; T. W. Richards, *Proc. Amer. Acad.*, 26, 240, 1891; H. M. Goodwin and W. G. Horsch, *Chem. Met. Ind.*, 21, 181, 1919; J. Kendall and A. W. Davidson, *Journ. Amer. Chem. Soc.*, 43, 979, 1921; G. Poma, *Gazz. Chim. Ital.*, 40, i, 176, 1910; F. Bergius, *Zeit. phys. Chem.*, 72, 354, 1910; W. Hampe, *Zeit. Berg. Hütt. Sal.*, 21, 218, 1874; H. Lesœur, *Compt. Rend.*, 102, 1468, 1886; A. Étard, *ib.*, 87, 602, 1878; T. Klobb, *ib.*, 114, 837, 1892; 115, 232, 1892; B. Schwalbe, *Zeit. phys. Chem. Unterr.*, 9, 1, 1896; H. W. Foote, *Journ. Amer. Chem. Soc.*, 37, 288, 1915; *Journ. Ind. Eng. Chem.*, 11, 630, 1919; F. Krafft, *Ber.*, 40, 4770, 1907.

⁷ T. Graham, *Phil. Mag.*, (3), 6, 419, 1835; H. Lesœur, *Ann. Chim. Phys.*, (6), 21, 544, 1890; *Bull. Soc. Chim.*, (2), 46, 285, 1886; *Compt. Rend.*, 102, 1466, 1886; L. de Boisbaudran, *ib.*, 65, 1249, 1867; 66, 497, 1868; J. L. Andreac, *Zeit. phys. Chem.*, 7, 260, 1891; J. M. Bell and W. C. Taber, *Journ. Phys. Chem.*, 12, 171, 1908; T. E. Thorpe and J. I. Watts, *Journ. Chem. Soc.*, 37, 104, 1880; A. Scott, *ib.*, 71, 565, 1897; M. Berthelot, *Compt. Rend.*, 77, 24, 1873; P. A. Favre and C. A. Valson, *ib.*, 79, 1036, 1874; R. Dietz, R. Funk, J. von Wrochem, and F. Mylius, *Wiss. Abhandl. phys. tech. Reichsanstalt*, 3, 425, 1900; J. Thomsen, *Journ. prakt. Chem.*, (2), 18, 1, 1878; W. T. Schaller, *Amer. Journ. Science*, (4), 17, 191, 1904; *Bull. Geol. Dept. Univ. California*, 3, 131, 1903; H. Dufet, *Bull. Soc. Min.*, 11, 217, 1888; J. W. Retgers, *Zeit. phys. Chem.*, 15, 563, 1894; W. Stortenbeker, *ib.*, 22, 67, 1897; E. Jäncke, *ib.*, 90, 265, 1915.

⁸ T. Gruner and R. Brandes, *Trommsdorff's Journ.*, 12, 92, 1826; L. C. de Coppet, *Zeit. phys. Chem.*, 22, 239, 1897; J. E. Trevor, *ib.*, 7, 470, 1891; E. Cohen, F. D. Chattaway, and W. Tombrock, *ib.*, 60, 713, 1907; E. Cohen, *ib.*, 31, 173, 1899; W. Stortenbeker, *ib.*, 22, 62, 1897; J. Koppel, *ib.*, 52, 421, 1905; C. A. L. de Bruyn, *ib.*, 10, 786, 1892; *Rec. Trav. Chim. Pays-Bas*, 11, 112, 1892; W. F. C. de Coninck, *Bull. Acad. Belgique*, 257, 1905; P. Rohland, *Zeit. anorg. Chem.*, 18, 322, 1898; R. Engel, *Bull. Soc. Chim.*, (2), 45, 128, 1886; (2), 47, 497, 1887; *Compt. Rend.*, 102, 113, 1886; 104, 507, 1887; V. Auger, *ib.*, 142, 1872, 1906; R. de Forcrand, *ib.*, 102, 551, 1886; G. Massol and M. Maldés, *ib.*, 133, 287, 1901; A. Étard, *ib.*, 104, 1615, 1887; 114, 112, 1892; *Ann. Chim. Phys.*, (7), 2, 503, 1894; A. B. Poggiale, *ib.*, (3), 8, 463, 1843; L. C. de Coppet, *ib.*, (4), 25, 534, 1872; G. E. Patrick and A. B. Aubert, *Trans. Kansas Acad. Science*, 19, 1874; G. J. Mulder, *Bijdragen tot de geschiedenis van het Scheikundig gebonden water*, Rotterdam, 79, 1864; E. Tobler, *Liebig's Ann.*, 95, 193, 1855; F. Pfaff, *ib.*, 99, 224, 1856; H. Schiff, *ib.*, 118, 365, 1861; I. Guareschi, *Atti Accad. Torino*, 50, 1125, 1915; R. Brandes and E. Firnhaber, *Brandes' Archiv.*, 7, 151, 1824; C. J. B. Karsten, *Schweigger's Journ.*, 66, 255, 1832; J. M. Bell and W. C. Taber, *Journ. Phys. Chem.*, 11, 637, 1907; H. D. Gibbs, *Journ. Amer. Chem. Soc.*, 28, 1499, 1906; W. A. Tilden and W. A. Shenstone, *Phil. Trans.*, 175, 32, 1884; W. A. Shenstone, *Journ. Chem. Soc.*, 47, 375, 1885; C. van Hauer, *Journ. prakt. Chem.*, (1), 103, 114, 1868; B. Lachowicz, *ib.*, (2), 39, 99, 1889; A. Klepl, *ib.*, (2), 25, 526, 1882; R. Funk, *Zeit. anorg. Chem.*, 20, 418, 1899; P. Rohland, *ib.*, 18, 322, 1898; A. Werner, *ib.*, 15, 11, 1897; A. Körbs, *Zeit. Kryst.*, 43, 433, 1907; H. C. Sorby, *Proc. Roy. Soc.*, 12, 538, 1863; R. Dietz, R. Funk, J. von Wrochem, and F. Mylius, *Wiss. Abhandl. phys. tech. Reichsanstalt*, 3, 425, 1900; H. Schiff, *Liebig's Ann.*, 118, 362, 1861; F. Guthrie, *Phil. Mag.*, (4), 49, 266, 1875; (5), 6, 105, 1878; *Journ. Chem. Soc.*, 27, 333, 1874; J. Holmes and P. J. Sagemann, *ib.*, 91, 1606, 1907; K. Friedrich, *Met.*, 8, 327, 1911; *Stahl Eisen*, 31, 2040, 1909; *Centr. Min.*, 210, 1912; W. R. Hodgkinson and A. Leahy, *Chem. News*, 80, 198, 1899; E. Diacon, *Mém. Acad. Montpellier*, 6, 1, 45, 1866; F. Rüdorff, *Sitzber. Akad. Berlin*, 355, 1885; *Wied. Ann.*, 25, 636, 1885; *Ber.*, 18, 1159, 1885; A. Lieben, *Ber.*, 4, 758, 1871; E. Jäncke, *Zeit. phys. Chem.*, 90, 265, 1915; T. Klobb, *Compt. Rend.*, 115, 232, 1892; H. T. F. Rhodes, *Chem. News*, 123, 249, 1921.

⁹ A. E. H. Tutton, *Crystallography and Practical Crystal Measurement*, London, 286, 1911; P. Groth, *Chemische Kristallographie*, Leipzig, 2, 419, 1908; A. T. Kupfer, *Pogg. Ann.*, 8, 217, 1826; W. Phillips, *Elementary Introduction to Mineralogy*, London, 556, 1852; G. Boeris, *Atti Soc. Ital. Science*, Milano, 44, 73, 1905; *Riv. Min. Crist.*, 33, 5, 1907; H. W. Foote, *Amer. Chem. Journ.*, 26, 418, 1901; A. J. Hopkins, *ib.*, 25, 413, 1901; A. Scacchi, *Rend. Accad. Napoli*, 9, 84, 1870; S. Meyer, *Sitzber. Akad. Wien*, 108, 513, 1901; J. W. Retgers, *Zeit. phys. Chem.*

15. 571, 1894; 16. 583, 1895; W. Stortenbeker, *ib.*, 22. 60, 1897; 34. 108, 1900; R. Hollmann, *ib.*, 37. 193, 1901; 40. 575, 1902; 54. 98, 1905; H. Dufet, *Bull. Soc. Min.*, 11. 217, 1888; A. Fock, *Zeit. Kryst.*, 28. 337, 1897; W. Spring, *Ann. Soc. Géol. Belgique*, 15. 156, 1888; *Zeit. phys. Chem.*, 2. 534, 1888; M. Kuhara, *Mem. Coll. Eng. Univ. Kyoto*, 2. 53, 1918.

¹⁰ P. A. Favre and C. A. Valson, *Compt. Rend.*, 73. 1144, 1872; 77. 802, 1873; 79. 1036, 1874; T. Klobb, *ib.*, 115. 232, 1892; H. G. F. Schröder, *Dichtigkeitsmessungen*, Heidelberg, 1873; *Journ. prakt. Chem.*, (2), 19. 275, 1879; A. Breithaupt, *ib.*, (1), 11. 151, 1837; F. Stolba, *ib.*, (1), 97. 503, 1866; J. A. Groshans, *Rec. Trav. Chim. Pays-Bas*, 4. 1, 1885; T. E. Thorpe and J. I. Watts, *Journ. Chem. Soc.*, 37. 102, 1880; L. Playfair and J. P. Joule, *ib.*, 1. 138, 1849; *Mém. Chem. Soc.*, 2. 401, 1844; P. I. Bachmetjeff, *Journ. Russ. Phys. Chem. Soc.*, 25. 265, 1893; C. J. B. Karsten, *Schweigger's Journ.*, 65. 394, 1832; E. Filhol, *Ann. Chim. Phys.*, (3), 21. 415, 1817; J. W. Retgers, *Zeit. phys. Chem.*, 3. 511, 1889; H. J. Buignet, *Journ. Pharm. Chim.*, (3), 40. 161, 337, 1860; H. Kopp, *Liebig's Ann.*, 36. 1, 1859; F. Rudorff, *Wied. Ann.*, 6. 288, 1879; *Ber.*, 12. 249, 1879; C. Pape, *Pogg. Ann.*, 120. 368, 1863; O. Pettersson, *Nova Acta*, Upsala, (3), 9. 4, 1874; W. Hampe, *Zeit. Chem.*, 13. 367, 1870; J. H. Hassenfratz, *Ann. Chim. Phys.*, (1), 28. 3, 1798; W. C. Smith, *Amer. Journ. Pharm.*, 53. 145, 1882; W. W. S. Nichol, *Phil. Mag.*, (5), 16. 121, 1883; G. Carrara and M. G. Levi, *Gazz. Chim. Ital.*, 30. ii, 197, 1901.

¹¹ J. G. MacGregor, *Chem. News*, 62. 232, 1890; H. Schiff, *Liebig's Ann.*, 108. 326, 1858; F. Kohlrausch, *Wied. Ann.*, 6. 40, 1879; R. J. Holland, *ib.*, 50. 261, 349, 1893; G. T. Gerlach, *Zeit. anal. Chem.*, 28. 471, 1889; *Dingler's Journ.*, 181. 129, 1866; J. C. G. de Marignac, *Arch. Phys. Genève*, (2), 55. 113, 1876; *Ann. Chim. Phys.*, (5), 8. 410, 1876; G. Charpy, *ib.*, (6), 29. 5, 1893; A. Michel and L. Krafft, *ib.*, (3), 41. 471, 1864; J. Wagner, *Zeit. phys. Chem.*, 5. 37, 1890; E. Cohen, *ib.*, 31. 164, 1899; R. Luther, *ib.*, 52. 627, 1905; J. Koppel, *ib.*, 52. 421, 1905; P. A. Favre and C. A. Valson, *Compt. Rend.*, 79. 1036, 1874; A. Colson, *ib.*, 139. 857, 1901; A. Étard, *ib.*, 104. 1615, 1887; J. Delaite, *Mém. Acad. Belgique*, 51. 1, 1895; J. A. Groshans, *Phil. Mag.*, (5), 18. 405, 1884; W. W. J. Nicol, *ib.*, (5), 18. 179, 1884; J. Traube, *Zeit. anorg. Chem.*, 8. 62, 1895; J. G. MacGregor, *Trans. Roy. Soc. Canada*, (3), 2. 69, 1884; (3), 7. 19, 1889; *Trans. Nova Scotia Inst.*, 7. 368, 1889; M. Konowaloff, *Journ. Russ. Phys. Chem. Soc.*, 31. 910, 1899; H. C. Jones and F. H. Getman, *Amer. Chem. Journ.*, 31. 330, 1904; J. Thomsen, *Thermochemische Untersuchungen*, Leipzig, 1. 51, 1882; A. Hantzsch, *Ber.*, 41. 1216, 1908; S. Lussana, *Nuovo Cimento*, (4), 2. 233, 1895; E. Irueste, *Ann. Soc. Espan. Fis. Quím.*, 13. 462, 1915.

¹² J. Schuhmeister, *Sitzber. Akad. Wiss. Phil. Mag.*, 79. 603, 1879; J. Thovert, *Compt. Rend.*, 133. 1197, 1901; 134. 594, 1902; A. Griffiths, *Phil. Mag.*, (5), 47. 530, 1899; J. H. Long, *ib.*, (5), 9. 313, 413, 1880; *Wied. Ann.*, 9. 613, 1880; J. C. G. de Marignac, *Arch. Sciences Genève*, (2), 50. 89, 1874; *Ann. Chim. Phys.*, (5), 2. 546, 1874; *Compt. Rend.*, 78. 1523, 1874; H. de Vries, *Rec. Trav. Chim. Pays-Bas*, 3. 375, 1884; G. Bruni and B. L. Vanzetti, *Atti Accad. Lincei*, (5), 15. ii, 705, 1906; J. Barnes, *Proc. Nova Scotia Inst.*, 10. 113, 1900; S. Arrhenius, *Zeit. phys. Chem.*, 1. 298, 1887; J. Wagner, *ib.*, 5. 37, 1890; A. Brümmer, *Experimentelle Bestimmung der Oberflächenspannung wässriger Sulfatlösungen*, Berlin, 1902; A. Fick, *Pogg. Ann.*, 94. 59, 1855.

¹³ T. Graham, *Phil. Mag. Journ.*, 6. 419, 1835; F. Rinne, *Neues Jahrb. Min.*, i, 8, 1899; J. L. Proust, *Journ. Phys.*, 59. 346, 1904; J. L. Gay Lussac, *Journ. Mines*, 22. 325, 1807; *Nicholson's Journ.*, 33. 44, 1812; *Ann. Chim. Phys.*, (3), 11. 69, 1837; P. Berthier, *ib.*, (2), 22. 236, 1823; J. I. Pierre, *ib.*, (3), 16. 241, 1846; I. Guareschi, *Atti Accad. Torino*, 50. 1125, 1915; A. Mourlot, *Compt. Rend.*, 124. 768, 1897; T. W. Richards, *Proc. Amer. Acad.*, 26. 240, 1891; S. U. Pickering, *Chem. News*, 47. 182, 1883; A. A. B. Bussy, *Ann. Chim. Phys.*, 26. 411, 1824; R. H. Bradford, *Trans. Amer. Inst. Min. Eng.*, 33. 50, 1902; A. Naumann, *Ber.*, 7. 2, 1573, 1874; D. W. Horn and E. E. Taylor, *Amer. Chem. Journ.*, 32. 277, 1904.

¹⁴ P. I. Bachmetjeff, *Journ. Russ. Phys. Chem. Soc.*, 25. 265, 1893; C. Forch, *Wied. Ann.*, 55. 114, 1895; S. Pagliani, *Atti Accad. Torino*, 16. 595, 1881; J. C. G. de Marignac, *Arch. Science Genève*, (2), 55. 113, 1876; *Ann. Chim. Phys.*, (5), 8. 410, 1876; J. Thomsen, *Pogg. Ann.*, 142. 337, 1871; H. Teudt, *Über die Aenderung der spezifischen Wärmen wässriger Salzlösungen mit der Temperatur*, Erlangen, 1900; P. Vaillant, *Compt. Rend.*, 141. 658, 1905; C. Pape, *Wied. Ann.*, 1. 126, 1877; H. F. Weber, *ib.*, 10. 103, 304, 472, 1880; W. C. Röntgen, *Zeit. Kryst.*, 3. 17, 1878; G. Jäger, *Sitzber. Akad. Wien*, 99. 245, 1890.

¹⁵ M. Berthelot, *Compt. Rend.*, 84. 676, 1877; 77. 24, 1873; *Ann. Chim. Phys.*, (7), 5. 158, 1895; J. Thomsen, *Ber.*, 5. 170, 1872; 6. 710, 1873; *Journ. prakt. Chem.*, (2), 5. 248, 1872; (2), 12. 271, 1875; (2), 18. 1, 1878; *Thermochemische Untersuchungen*, Leipzig, 3. 313, 1883; P. A. Favre, *Compt. Rend.*, 73. 719, 1871; 77. 101, 1873; M. Lorin, *ib.*, 88. 1029, 1879; P. C. F. Frowein, *Zeit. phys. Chem.*, 1. 11, 1887; E. Edlund, *Wied. Ann.*, 19. 287, 1883; R. Scholz, *ib.*, 45. 195, 1902; S. U. Pickering, *Journ. Chem. Soc.*, 49. 269, 1886; 51. 322, 1887; J. H. Pollok, *Chem. News*, 79. 56, 1899; W. Hampe, *Zeit. Berg. Hütt. Sal.*, 21. 269, 1873; L. and P. Wöhler and W. Plüddemann, *Ber.*, 41. 703, 1908.

¹⁶ F. Rudorff, *Pogg. Ann.*, 122. 341, 1864; 145. 1599, 1871; F. Guthrie, *Journ. Chem. Soc.*, 27. 333, 1874; *Phil. Mag.*, (4), 49. 266, 1875; *Chem. News*, 31. 49, 1875; L. C. de Coppet, *Bull. Soc. Vaudoise*, (2), 11. 1, 1871; *Zeit. phys. Chem.*, 22. 239, 1897; *Ann. Chim. Phys.*, (4), 25. 502, 1871; V. J. Chambers and J. C. W. Frazer, *Amer. Chem. Journ.*, 23. 512, 1900; H. C. Jones and F. H. Getman, *ib.*, 31. 329, 1904; L. Kahlenberg, *Journ. Phys. Chem.*, 5. 355, 1901; F. M. Raoult, *Zeit. phys. Chem.*, 2. 489, 1888; H. Hausrath, *Ann. Physik*, (4), 9. 544, 1902; S. U. Pickering, *Ber.*, 25. 1314, 1892.

¹⁷ T. Griffiths, *Journ. Science*, 18. 90, 1825; G. T. Gerlach, *Zeit. anal. Chem.*, 26. 426, 1887;

N. Tarugi and G. Bombardini, *Gazz. Chim. Ital.*, 30. ii, 405, 1900; L. Kahlenberg, *Journ. Phys. Chem.*, 5. 373, 1901.

¹⁸ J. L. Proust, *Journ. Phys.*, 59. 346, 1804; T. Graham, *Phil. Trans.*, 123. 253, 1835; R. Brandes, *Schweigger's Journ.*, 51. 436, 1827; C. F. Cross, *Chem. News*, 44. 209, 1881; *Journ. Chem. Soc.*, 35. 799, 1879; H. Lesœur, *Bull. Soc. Chim.*, (2), 46. 285, 1886; *Compt. Rend.*, 102. 1466, 1886; 103. 1260, 1886; *Ann. Chim. Phys.*, (6), 21. 511, 1890; (7), 4. 213, 1895; M. Berthelot, *ib.*, (7), 14. 203, 1898; H. Baubigny, and E. Péchard, *ib.*, (6), 28. 416, 1893; H. Baubigny, *Compt. Rend.*, 115. 171, 1892; W. Müller-Erbzach, *Zeit. phys. Chem.*, 17. 446, 1895; 19. 135, 1896; *Ber.*, 19. 2877, 1886; 20. 1152, 1887; *Wied. Ann.*, 26. 409, 1885; 23. 607, 1884; 31. 75, 1887; 32. 313, 1887; 34. 1047, 1888; G. Tammann, *ib.*, 33. 322, 1888; A. H. Parceau, *ib.*, 1. 39, 1877; J. L. Andrae, *Zeit. phys. Chem.*, 7. 260, 1891; H. Schottky, *ib.*, 64. 433, 1908; P. C. F. Frowein, *ib.*, 1. 5, 363, 1887; C. E. Linebarger, *ib.*, 13. 506, 1894; E. Blasius, *Zeit. Kryst.*, 10. 221, 1885; P. Latschinoff, *Journ. Russ. Phys. Chem. Soc.*, 20. 657, 707, 1889; P. I. Bachmetjeff, *ib.*, 25. 265, 1893; C. Pape, *Pogg. Ann.*, 133. 364, 1867; G. Wiedemann, *ib.*, 153. 612, 1874; A. Naumann, *Ber.*, 7. 1573, 1874; F. Rinne, *Neues Jahrb. Min.*, 1. 8, 1899; J. Moser, *Sitzber. Akad. Berlin*, 868, 1878; H. Sents, *Compt. Rend.*, 118. 1132, 1894; J. H. Schüller, *Gymnasialbericht. Aachen*, 1. 1, 1890; J. R. Partington, *Journ. Chem. Soc.*, 99. 466, 1911; A. W. C. Menzies, *Journ. Amer. Chem. Soc.*, 42. 1951, 1920; H. W. Foote and S. R. Scholes, *ib.*, 33. 1309, 1911; R. E. Wilson, *ib.*, 43. 704, 1921; A. A. Noyes and L. R. Westbrook, *ib.*, 43. 726, 1921.

¹⁹ A. Lavenir, *Bull. Soc. Min.*, 14. 115, 1891; P. Gaubert, *ib.*, 28. 180, 1905; F. Kohlrausch, *Zeit. Phys.*, 1. 100, 1877; *Verh. phys. med. Ges. Würzburg*, 12, 1877; C. Pape, *Pogg. Ann. Erpbld.*, 6. 35, 1873; D. Gerney, *Compt. Rend.*, 140. 1338, 1905; P. Desains, *ib.*, 70. 985, 1870; C. Chéneveau, *ib.*, 138. 1483, 1904; M. le Blanc, *Zeit. phys. Chem.*, 4. 559, 1889; M. Kofler, *Phys. Zeit.*, 9. 6, 1908.

²⁰ T. Gross, *Sitzber. Akad. Berlin*, 500, 1877; J. G. McGregor and E. H. Archibald, *Phil. Mag.*, (5), 45. 151, 1898; W. C. D. Whetham, *Proc. Roy. Soc.*, 66. 192, 1900; 71. 338, 1903; S. Arrhenius, *Recherches sur la conductibilité galvanique des électrolytes*, Stockholm, 1884; *Zeit. phys. Chem.*, 4. 96, 1889; 9. 339, 1892; W. Bein, *ib.*, 27. 52, 1898; H. Jahn, *ib.*, 37. 707, 1901; G. Bredig, *ib.*, 13. 287, 1894; N. Tarugi and G. Bombardini, *Gazz. Chim. Ital.*, 30. ii, 419, 1900; G. Carrara and G. B. Vespignani, *ib.*, 30. ii, 35, 1900; A. Campetti, *Nuovo Cimento*, (4), 6. 410, 1897; G. Vicentini, *Atti Accad. Torino*, 20. 677, 1885; *Mém. Acad. Torino*, (2), 36. 22, 1884; F. Bouty, *Ann. Phys. Chim.*, (6), 14. 73, 1888; E. Becquerel, *ib.*, (3), 17. 267, 1846; G. Jäger, *Monatsh.*, 8. 722, 1887; *Sitzber. Akad. Wien*, 96. 317, 1888; F. Kohlrausch, *Wied. Ann.*, 6. 145, 1879; 26. 196, 1885; 50. 406, 1893; T. Lohnstein, *ib.*, 47. 299, 1892; J. H. Long, *ib.*, 9. 632, 1880; P. Freund, *ib.*, 7. 44, 1879; J. Trötsch, *ib.*, 41. 270, 1890; P. Sack, *ib.*, 43. 212, 1891; P. Rasehorn, *Die Bestimmung der electrischen Leitungsfähigkeit einiger Salzlösungen auf elektrometrischen Wege*, Halle, 1889; K. Sulzberger, *Methode zum Bestimmung des Leitungsfähigkeit verdünnter Electrolyte mittelst des Condensators und Untersuchung über die Gültigkeit des Ohm'schen Gesetzes für verdünnte Electrolyte*, Zurich, 1889; T. C. Fitzpatrick, *B.A. Rep.*, 328, 1886; F. Kohlrausch and E. Grüneisen, *Sitzber. Akad. Berlin*, 1218, 1904; A. Paalzoff, *Pogg. Ann.*, 126. 489, 1869; C. S. M. Pouillet, *Compt. Rend.*, 4. 785, 1837; A. Bouzart, *ib.*, 136. 1395, 1903; W. G. Hankel, *Pogg. Ann.*, 69. 255, 1846; E. N. Horsford, *ib.*, 70. 238, 1847; G. Wiedemann, *ib.*, 99. 225, 1856; L. Kahlenberg, D. J. Davis, and E. Fowler, *Journ. Amer. Chem. Soc.*, 21. 1, 1899; G. N. Lewis and M. Randall, *ib.*, 43. 1112, 1921; G. N. Lewis and G. A. Linhart, *ib.*, 41. 1951, 1919; G. N. Lewis and W. N. Lacey, *ib.*, 36. 804, 1914; A. A. Noyes and K. G. Falk, *ib.*, 34. 474, 1912; F. Guthrie and C. V. Boys, *Phil. Mag.*, (5), 10. 328, 1880; L. Kahlenberg, *Journ. Phys. Chem.*, 5. 339, 1901; A. Nabl, *Anz. Akad. Wien*, 356, 1899; F. B. de Lenzaizan and L. Maury, *Compt. Rend.*, 173. 227, 1921; P. Vaillant, *Journ. Phys. Radium*, 3. 87, 1922.

²¹ J. F. Daniell and W. A. Miller, *Phil. Trans.*, 134. 1, 1844; O. Masson, *ib.*, 192. 331, 1897; B. D. Steele, *ib.*, 198. 105, 1902; W. Hittorf, *Pogg. Ann.*, 89. 177, 1853; 98. 1, 1856; *Arch. Néer.*, (2), 6. 671, 1902; G. Wiedemann, *Pogg. Ann.*, 99. 177, 1856; M. Kirnus, *Wied. Ann.*, 4. 503, 1878; W. Bein, *ib.*, 46. 29, 1892; R. Lenz, *Mém. Acad. St. Petersburg*, (7), 30. 64, 1882; O. J. Lodge, *B.A. Rep.*, 389, 1886; C. L. Weber, *Zeit. phys. Chem.*, 4. 182, 1889; V. Gordon, *ib.*, 23. 469, 1897; W. Bein, *ib.*, 27. 1, 1898; K. Hopfgartner, *ib.*, 25. 115, 1898; O. Masson, *ib.*, 29. 501, 1898; H. Jahn, *ib.*, 37. 673, 1901; 38. 127, 1901; W. Hittorf, *ib.*, 39. 613, 1902; 43. 239, 1902; A. Chassy, *Ann. Chim. Phys.*, (6), 21. 241, 1890; A. Campetti, *Nuovo Cimento*, (4), 6. 410, 1897; S. Lussana, *Atti Ist. Veneto*, (7), 3. 1111, 1892; (7), 4. 13, 1893; S. Sheldon and G. M. Downing, *Phys. Rev.*, (1), 1. 51, 1893; F. W. Kiister, *Zeit. Elektrochem.*, 4. 105, 1897; A. Schrader, *ib.*, 3. 498, 1897; O. Masson and B. D. Steele, *Journ. Chem. Soc.*, 75. 725, 1899; B. D. Steele, *ib.*, 79. 414, 1901; F. G. Donnan, H. B. Bassett, and C. J. J. Fox, *ib.*, 81. 939, 1902; G. Carrara, *Gazz. Chim. Ital.*, 33. i, 241, 1903; A. Gilmour, *Phil. Mag.*, (6), 41. 544, 1921; J. Dowling and K. M. Preston, *ib.*, (6), 43. 537, 1922; N. Isgarischeff, *Koll. Chem. Beihefte*, 14. 25, 1921.

²² A. Hollard, *Bull. Soc. Chim.*, (3), 35. 1248, 1906; S. H. Freeman, *Phil. Mag.*, (5), 13. 398, 1882; *Amer. Journ. Science*, (3), 23. 428, 1882; J. T. Barker, *Chem. News*, 79. 51, 1908; H. M. Goodwin and W. G. Horsch, *Met. Chem. Eng.*, 21. 181, 1919; A. Gilmour, *Phil. Mag.*, (6), 41. 544, 1921; G. N. Lewis and W. N. Lacey, *Journ. Amer. Chem. Soc.*, 36. 804, 1914; F. Paschen, *Wied. Ann.*, 41. 177, 1890; A. Hagenbach, *ib.*, 53. 460, 1894; J. L. Hoorweg, *ib.*, 9. 552, 1880; U. Saxen, *ib.*, 47. 46, 1892; J. von Hepperger, *Sitzber. Akad. Wien*, 82. 326, 1880; J. Miesler, *Monatsh.*, 8. 626, 1887; J. Moser, *ib.*, 8. 193, 1887; C. Truchot, *Compt. Rend.*, 97. 92, 1883;

H. Bagard, *ib.*, 114. 980, 1892; E. Bichat and R. Blondlot, *ib.*, 97. 1293, 1883; S. Pagliani, *Atti Accad. Torino*, 21. 518, 1886; S. Lussana, *Atti Ist. Veneto*, (7), 3. 1111, 1892; (7), 4. 477, 1893; C. W. Bennett and C. O. Brown, *Journ. Phys. Chem.*, 17. 372, 685, 1913; A. Leighton, *ib.*, 18. 695, 1913; C. W. Bennett, *ib.*, 16. 274, 1912; *Trans. Amer. Electrochem. Soc.*, 21. 253, 1912; F. C. Fitzpatrick, *B A Rep.*, 328, 1886.

²³ C. K. Studley, *Phys. Rev.*, (1), 24. 22, 1907; H. W. March, *ib.*, (1), 24. 29, 1907; G. Quineke, *Wied. Ann.*, 24. 347, 1885; 34. 401, 1888; O. Liebknecht and A. P. Wills, *Ann. Physik*, (4), 1. 178, 1900; J. Königsberger, *ib.*, (4), 6. 506, 1901; *Wied. Ann.*, 66. 698, 1898; S. Meyer, *ib.*, 68. 325, 1899; 69. 236, 1899; *Ann. Physik*, (4), 1. 664, 1900; A. Heydweiller, *Zeit. Physik*, 3. 308, 1920; G. Meslin, *Ann. Chim. Phys.*, (8), 7. 145, 1906; G. Chêneveau, *Journ. Phys.*, 9. 163, 1910; R. T. Lattey, *Phil. Mag.*, (6), 41. 829, 1921; A. Leighton, *Journ. Phys. Chem.*, 17. 695, 1913.

²⁴ J. A. Arfvedson, *Pogg. Ann.*, 1. 74, 1824; J. L. Gay Lussac, *Journ. prakt. Chem.*, (1), 11. 69, 1837; *Ann. Chim. Phys.*, (3), 11. 69, 1837; A. Christoff, *Zeit. phys. Chem.*, 53. 326, 1905.

²⁵ K. Griessbach, *Ueber die durch Einwirkung von Ammonium- und Alkalihydroxyden sowie von Ammonium- und Alkalikarbonaten auf Kupfersulfat entstehenden Niederschläge*, Erlangen, 1912; M. C. Lea, *Amer. Journ. Science*, (3), 45. 478, 1893; D. W. Horn and E. E. Taylor, *Amer. Chem. Journ.*, 32. 295, 1904; R. M. Caven, *Journ. Soc. Chem. Ind.*, 19. 18, 1900; F. Clowes, *Chem. News*, 78. 155, 1898; S. Kern, *ib.*, 33. 236, 1876; E. J. Houston, *ib.*, 24. 188, 1871; R. C. Tichborne, *ib.*, 25. 133, 1872; A. Colson, *Compt. Rend.*, 139. 199, 1904; A. Commaille, *ib.*, 63. 556, 1866; D. Tommasi, *Zeit. Elektrochem.*, 11. 56, 1904; D. Tommasi and E. Pegna, *Mondes*, (3), 2. 562, 1882; J. L. Andreae, *Zeit. phys. Chem.*, 7. 241, 1891; D. Vitali, *L'Orosi*, 18. 289, 1895; E. Divers, *Proc. Chem. Soc.*, 14. 57, 1898; J. H. Long, *Journ. Amer. Chem. Soc.*, 18. 120, 1896; R. Kane, *Phil. Mag.*, (3), 8. 353, 1836; A. Colson, *Compt. Rend.*, 124. 82, 1897; P. Latschinoff, *Journ. Russ. Phys. Chem. Soc.*, 20. 585, 1888; A. B. Prescott, *Chem. News*, 36. 179, 1877; M. G. Levi and M. Voghera, *Gazz. Chim. Ital.*, 36. i. 513, 1906; C. Hensgen, *Ber.*, 10. 259, 1877; 9. 1671, 1876; J. Löwe, *Dingler's Journ.*, 211. 193, 1874; T. Leykauf, *Journ. prakt. Chem.*, (1), 19. 124, 1840; L. Meyer, *Ber.*, 9. 512, 1876.

²⁶ A. Vogel, *Journ. prakt. Chem.*, (1), 30. 39, 1843; C. J. B. Karsten, *Schweigger's Journ.*, 66. 255, 1832; J. B. J. D. Boussingault, *Ann. Chim. Phys.*, (2), 51. 390, 1832.

²⁷ H. Rose, *Pogg. Ann.*, 24. 330, 1832; C. F. Rammelsberg, *ib.*, 52. 241, 1841; A. Joannis, *Compt. Rend.*, 128. 1322, 1899; J. Riban, *ib.*, 128. 1452, 1899; H. Quantin, *ib.*, 103. 888, 1886; J. F. Persoz, *Ann. Chim. Phys.*, (3), 20. 435, 1847; L. de Bouquet, *Monit. Scient.*, (3), 12. 994, 1882; A. Gawalowsky, *Zeit. Oester. Apoth. Ver.*, 43. 377, 1905.

§ 26. Cupric Ammino-Sulphates. Double Cupric Sulphates

G. Gore,¹ and E. C. Franklin and C. A. Kraus found anhydrous cupric sulphate to be insoluble in liquid ammonia. According to W. R. Hodgkinson and C. C. Trench, both anhydrous and hydrated cupric sulphates absorb much ammonia gas. H. Rose found 53·97 per cent. to be absorbed by the anhydrous salt, forming a blue powder. According to A. Bouzat, the reaction is at first very vigorous and the white salt becomes blue; later, the absorption is slow, and the reaction continues for 16 hrs. if the cupric sulphate contains a perceptible quantity of iron. The product is taken to be anhydrous cupric pentammino-sulphate, $\text{Cu}(\text{NH}_3)_5\text{SO}_4$; which, according to A. Bouzat, is best prepared by allowing ammonia gas, thoroughly dried by fused potassium hydroxide, to act on cold dry cupric sulphate. According to D. I. Mendeléeff, the compound gives off no ammonia when confined over sulphuric acid, but, according to D. W. Horn, it slowly loses ammonia on standing; for example, a specimen lost 0·12 mol in 6·5 hrs. and 1·42 mol in 2064 hrs. In moist air, water replaces the ammonia molecule by molecule, forming, according to D. I. Mendeléeff, $\text{Cu}(\text{NH}_3)_4\text{SO}_4 \cdot \text{H}_2\text{O}$, and then $\text{Cu}(\text{NH}_3)_2\text{SO}_4 \cdot 3\text{H}_2\text{O}$; and, according to A. Bouzat, and F. Ephraim, it is stable up to 99°, but when heated between 99° and 141°, it forms anhydrous cupric tetrammino-sulphate, $\text{Cu}(\text{NH}_3)_4\text{SO}_4$. P. Latschinoff found that all the ammonia is expelled at 360°, but about one-fourth of a mol is retained at 320°. The product melts below 200°, turns black, and as the temp. rises, it appears to boil, and near 400° begins to decompose, leaving almost pure metallic copper. According to H. Rose and A. Bouzat, the product is soluble in water, forming an ultramarine blue soln. which deposits a basic salt when diluted.

A. Bouzat found that anhydrous cupric tetrammino-sulphate, $\text{Cu}(\text{NH}_3)_4\text{SO}_4$, indicated above, is obtained by passing ammonia gas over anhydrous cupric sulphate

between 90° and 150°, and D. W. Horn made it by keeping the pentammino-sulphate in a desiccator over sulphuric acid of sp. gr. 1·84. The bluish-violet powder is stated by A. Bouzat to dissociate into **cupric diammino-sulphate**, $\text{Cu}(\text{NH}_3)_2\text{SO}_4$, and ammonia when heated over 150°. It is soluble in a little water, but more water precipitates a basic salt. F. Ephraim found it to be stable up to 141·5°. Both compounds are insoluble in liquid ammonia.

Cupric sulphate dissolves in an excess of aq. ammonia, forming a deep blue liquid, called *eau céleste*, which has been the subject of many investigations. The general results show, as C. Immerwahr found, the simple Cu^{++} cations are to a large extent replaced by more complex ones; and that a complex cupric ammino-sulphate is formed, containing not more than four molecules of ammonia to one of copper. A. Reychler showed that the addition of this proportion of ammonia to a soln. of cupric sulphate made very little difference to the lowering of the f.p. of the soln., presumably because the complex $\text{Cu}(\text{NH}_3)_4\text{SO}_4$ acts as a molecule like CuSO_4 . D. P. Konowloff found that for each mol of cupric sulphate in dil. soln., from 3·4 to 4·04 mols of ammonia were absorbed according to the conc. W. Gaus investigated the lowering of the vap. press of ammoniacal soln. produced by the addition of cupric sulphate, and, assuming that ammonia soln. follow Henry's rule, the vap. press. of a normal soln. of ammonia is 13·45 mm., the ratio of the ammonia to the copper is given by the equation:

$$\frac{\text{Lowering of vap. press.}}{13\cdot45[\text{Cu}]} = \text{Number of molecules NH}_3 \text{ in complex.}$$

When 0·0491 and 0·0982 mol of copper, [Cu], are present in a litre of soln. the vap. press. was lowered 2·49 and 5·02 mm. respectively. Hence, although the conc. of copper are widely different, the two determinations give 3·77 and 3·80 mols of NH_3 in the complex. W. Gaus' results were to a certain extent confirmed by J. Locke and J. Forssall. The distribution ratio of ammoniacal soln. containing varying quantities of copper and ammonia between water and chloroform, was compared by H. M. Dawson and J. McCrae with the distribution ratio for ammonia alone. Selecting the extreme determinations from their list,

Mols Cu	Cu : total NH_3	Cu : Combined NH_3
0·05	1 : 5	1 : 3·14
0·05	1 : 10	1 : 3·76
0·025	1 : 6	1 : 3·16
0·025	1 : 16	1 : 3·96

The ratio gradually increases as the proportion of ammonia increases, and this is thought to mean that more than one complex is formed. The ratio of copper to combined ammonia, in soln. with 0·0235 and 0·0470 mol Cu per litre, was claimed by J. Locke and J. Forssall to be satisfactorily constant, and in agreement with the assumption that all the copper passes into the complex $\text{Cu}(\text{NH}_3)_4\text{SO}_4$, but H. M. Dawson does not agree. The values of the ratio NH_3 : Cu were smaller than 4, and this was attributed by J. Locke and J. Forssall to the lower solubility of ammonia in cupric sulphate soln. than in water. With soln. above 0·1175 mol per litre, there is evidence of the formation of a higher complex $\text{Cu}(\text{NH}_3)_4\text{SO}_4$ or $\text{Cu}(\text{NH}_3)_6\text{SO}_4$ with higher conc. of ammonia. D. W. Horn, however, says that more than 5 mols of NH_3 cannot be added to a mol of CuSO_4 at press. not greater than one atm., and between -30° and 20°.

H. M. Dawson believes that J. Locke and J. Forssall's conclusion is ill-founded. It was shown that the ratio of combined ammonia to the copper, for a given conc. of copper increases with the quantity of ammonia present; and with a fixed proportion of total ammonia to copper, the molecular ratio of combined ammonia to metal increases with the absolute conc. This indicates that dissociation phenomena are involved. The changes which occur when ammonia is gradually added to a soln. of cupric sulphate can be symbolized: $\text{CuSO}_4 + 2\text{NH}_4\text{OH} = \text{Cu}(\text{OH})_2$

$+(NH_4)_2SO_4$, and $Cu(OH)_2+nNH_3\rightleftharpoons Cu(NH_3)_n(OH)_2$; as well as $Cu(NH_3)_n(OH)_2+(NH_4)_2SO_4\rightleftharpoons Cu(NH_3)_4SO_4+(n-2)NH_3+2H_2O$, where n is less than 4 and probably equal to 2. An ammoniacal soln. of cupric sulphate represents a complex system in which copper is present in the form of three different ions: $Cu(NH_3)_4^{++}$, $Cu(NH_3)_n^{+}$, and Cu^{++} , in proportions dependent on the conc. of the soln., and the relative proportions of ammonia and copper salt. A. A. Blanchard studied the evidence from the viscosity data; W. Bonsdorff and D. P. Konowaloff, the electrical conductivity data; W. Gaus, the vap. press. data; A. Bouzat, the thermal data; A. Reycher, the f.p. data; and H. M. Dawson and J. McCrae, the partition coeff.

A compound of ammonia and cupric sulphate was prepared by J. A. Stisser² in 1693, and from an analysis by J. J. Berzelius, it was probably **monohydrated cupric tetrammino-sulphate**, $Cu(NH_3)_4SO_4 \cdot H_2O$. A. Bouzat's opinion is that the formula should be $Cu(NH_3)_4SO_4 \cdot 1\frac{1}{2}H_2O$, but D. W. Horn and E. E. Taylor have shown that A. Bouzat is probably wrong and J. J. Berzelius right. The last-named recommended treating an aq. soln. of cupric sulphate with an excess of ammonia water and adding alcohol to the purple soln. If the alcohol be carefully poured on the purple soln., crystals of the salt separate at the surface of contact of the two liquids; while if the alcohol be added slowly and mixed with the purple soln. the salt separates in pulverulent crystals. The salt so prepared is very unstable, and only small quantities can be dried between filter-paper or on porous tiles without considerable decomposition—evidenced by the smell of ammonia. A. Bouzat cooled a hot conc. soln. of the salt, and quickly dried the crystals between filter-paper. A. Mallaert prepared the salt by the action of ammonia gas on the powdered solid pentahydrate, and D. W. Horn and E. E. Taylor found that the product is a mixture containing basic salts or cupric oxide. G. André prepared the salt by passing ammonia gas into a soln. of cupric sulphate. Fine crystals of the required salt are precipitated as the conc. of the ammonia in the soln. increases. D. W. Horn and E. E. Taylor, and H. M. Dawson recommend this process. The crystals are dried over lime. The product $4CuO \cdot 5SO_4 \cdot 16NH_3$, obtained by S. U. Pickering by adding aq. ammonia to an almost sat. soln. of cupric sulphate until the precipitate first formed had almost redissolved, and allowing the soln. to stand for some time. This is probably the tetrammino-salt contaminated with cupric and ammonium sulphates.

Monohydrated cupric tetrammino-sulphate forms dark ultramarine blue prismatic or needle-like crystals, which are rhombic bipyramids possessing, according to J. C. G. de Marignac, and A. Johnsen, the axial ratios $a : b : c = 0.5903 : 1 : 0.8893$. A. Johnsen found the sp. gr. to be 1.81. According to D. W. Horn and E. E. Taylor, the dry salt has no smell, and it is stable when kept over lime in a closed vessel; but not so in vacuo, or when kept over sulphuric acid, phosphorus pentoxide, or calcium chloride. It loses ammonia in moist air, and forms a green powder, which, according to O. B. Kühn, is a mixture of ammonium sulphate and basic cupric sulphate $CuSO_4 \cdot 3CuO$. H. M. Dawson and J. McCrae found the compound is not much affected by temp. up to 30° . L. Sabbatani said that between 100° and 125° the compound loses all its water and half its ammonia. According to R. Kane, when heated to a temp. not exceeding 149° , it forms an apple-green powder which, when analyzed, led him to say: "By the first action of heat all the water and half the ammonia is driven off, and the green residue consists of copper sulphate united with one equivalent of ammonia. . . . I have tried to separate the water, without loss of ammonia by the most careful management of the flame, but could not." He added that when the temp. is raised to 205° half the remaining ammonia is expelled, and at 260° all the ammonia is given off, leaving anhydrous cupric sulphate. If the powder be suddenly heated, J. J. Berzelius said that ammonium sulphite, and R. Kane that ammonium sulphate is given off, leaving a residue of cuprous oxide and cupric sulphate. In opposition to R. Kane, and L. Sabbatani, D. W. Horn and E. E. Taylor found that when monohydrated cupric tetrammino-sulphate is heated in dry air at 100° , 125° , 149° , 203° , and 260° , no definite

compound, but rather a mixed product is obtained, a result which is characteristic of salts containing copper sulphate combined with water, for such salts cannot change without secondary reactions between the water and copper sulphate. In illustration, they found it impossible to prepare pure monohydrated or anhydrous cupric sulphate by heating the pentahydrate in air; and the mixed product obtained with monohydrated cupric tetrammino-sulphate at 260° is brown, and not, as R. Kane stated, anhydrous cupric sulphate. If mono- or di-ammino-sulphate is formed at all it is mixed with other products. E. Rosenbohm found the magnetic susceptibility of the ammino-sulphate to be $+5.71 \times 10^{-6}$ vol. units, and $+1403 \times 10^{-6}$ mass units.

The solubility of monohydrated cupric tetrammino-sulphate, according to D. W. Horn and E. E. Taylor, is 18.05 grms. of salt per 100 grms. of solvent between 21° and 22°. The salt is decomposed by water with the partial separation of ammonia. This decomposition is probably an hydrolysis, and proceeds as far as the formation and precipitation of basic salts. These changes occur even with an excess of ammonia, and extend over a long period of time. They are hastened by the removal of ammonia, and by great dilution. "The salt gives a clear soln. when water is poured gradually upon it, but if the addition of water is continued, a permanent precipitate is formed at about 0.05 to 0.04-molar conc. When a soln. of the salt is dropped into water, a permanent precipitate is formed at once. A $\frac{1}{10}$ -molar soln., after standing a couple of days in a tightly closed vessel, begins to deposit a crystalline blue solid; this continues for weeks." According to G. André, if the salt is heated with ten times its weight of water for 5 hrs. at 200° in a sealed tube, small crystals of cupric oxide collect on the walls of the tube; similar crystals are formed in small quantities when a soln. of cupric sulphate in aq. ammonia is evaporated in air. A $\frac{1}{10}N$ -soln. of $\text{Cu}(\text{NH}_3)_4\text{SO}_4 \cdot \text{H}_2\text{O}$ behaves differently from a soln. of the same conc. made by adding the calculated quantity of ammonia to a $\frac{1}{10}N$ -soln. of copper sulphate. H. M. Dawson found no evidence of this; and D. W. Horn added that a soln., made by adding ammonia to copper sulphate soln., which has a conc. $\frac{1}{10}N$ - with respect to copper sulphate and $0.4N$ - with respect to ammonia, may be left in a stoppered bottle for a year without visible change. If, however, a soln. of the salt $\text{CuSO}_4 \cdot 4\text{NH}_3 \cdot \text{H}_2\text{O}$ of conc. $\frac{1}{10}N$ - with respect to copper, is kept under the same conditions, a blue, crystalline substance is gradually deposited, although the dry salt is very stable. This change begins directly the salt is dissolved and continues for some time, crystals becoming visible in about thirty-two hours. The crystalline substance has the composition $4\text{CuO} \cdot \text{SO}_3 \cdot 2\frac{2}{3}\text{NH}_3 \cdot 4\frac{1}{3}\text{H}_2\text{O}$. On adding alcohol to the clear soln. from which the basic salt had separated, a compound was obtained in lilac-blue needles which had the composition of ordinary cuprammonium sulphate, $\text{CuSO}_4 \cdot 4\text{NH}_3 \cdot \text{H}_2\text{O}$. The changes occurring are expressed by the equations: $36(\text{CuSO}_4 \cdot 4\text{NH}_3 \cdot \text{H}_2\text{O}) + \text{H}_2\text{O} = 12\text{CuO} \cdot 3\text{SO}_3 \cdot 8\text{NH}_3 \cdot 13\text{H}_2\text{O} + 24(\text{CuSO}_4 \cdot 4\text{NH}_4 \cdot \text{H}_2\text{O})$ (precipitated by alcohol) $+ 9(\text{NH}_4)_2\text{SO}_4 + 22\text{NH}_3$. These results show that the behaviour of a freshly prepared $\frac{1}{10}N$ -soln. of cuprammonium sulphate differs from that of a soln. of the same strength prepared from copper sulphate and ammonia.

V. Schwarzenbach³ says that an explosion occurs when alcohol is poured over an intimate mixture of a mol of the salt with seven gram-atoms of iodine. When alcohol is added to a hot soln. of the tetrammino-salt, the precipitate is not a diammino-compound, but rather is the product a mixture of ammonium sulphate, etc. E. Sommerfeldt, and A. Johnsen have also studied this reaction. According to G. André, the salt is insoluble in conc. aq. ammonia, but it becomes more and more soluble as the conc. of the ammonia decreases. A. Bouzat found that when ammonia is passed into soln. of the salt cooled to -15° , higher compounds are not formed, while H. M. Dawson and J. McCrae say that more ammonia is taken up by the salt at low than at high temp. P. Latschinoff stated that in an atm. of dry ammonia, the molecule of water in $\text{Cu}(\text{NH}_3)_4\text{SO}_4 \cdot \text{H}_2\text{O}$ is replaced by a molecule of ammonia; D. W. Horn and E. E. Taylor say that the salt takes up ammonia when

confined over sticks of potassium hydroxide and a little ammonia water in a desiccator. The ammonia displaced part of the water, but "the reaction is not a clean one, resulting in the formation of $\text{Cu}(\text{NH}_3)_5\text{SO}_4$, but one giving rise to mixed products containing basic salts or cupric oxide."

According to A. Destrem, zinc precipitates copper from the aq. soln. of the salt; and, according to N. W. Fischer, cadmium and lead precipitate copper slowly and imperfectly; arsenic forms copper arsenite; while antimony, bismuth, tin, and iron have no action. H. Schiff could not make double salts with the amino-salts of copper.

T. Klobb⁴ prepared **ammonium trisulphato-cuprate**, or *ammonium dicupric sulphate*, $(\text{NH}_4)_2\text{SO}_4 \cdot 2\text{CuSO}_4$, by melting pentahydrated cupric sulphate with three times its weight of ammonium sulphate at about 300° . It forms pale green transparent prismatic crystals of sp. gr. 2.85; is soluble in water; almost insoluble in alcohol at 90° , but slowly colours the latter solvent blue. The crystals soon become blue and opaque on exposure to air and about 42 per cent. of water is absorbed. Dissociation commences at ordinary temp. in vacuo, for the salt loses $\frac{1}{1000}$ th of its weight in 24 hrs. The salt shows signs of melting at about 200° ; and at 350° , it decomposes, leaving a residue of cupric sulphate. D. M. Torrance and N. Knight found evidence of the dissociation of the complex into its component salts, when the diffusion of aq. soln. is measured.

Cupric sulphate unites with the sulphates of potassium, rubidium, caesium, or with ammonium, forming a group of double salts, $\text{CuSO}_4 \cdot \text{R}_2\text{SO}_4 \cdot 6\text{H}_2\text{O}$, which form pale blue monoclinic prisms. The double sodium salt is not isomorphous with its series. F. A. H. Schrcine-makers studied the ternary system, $\text{CuSO}_4 - (\text{NH}_4)_2\text{SO}_4 - \text{H}_2\text{O}$, at 30° , and his results are indicated in Fig. 36. With the regular conventions, the curve BC represents the solubility with the solid phase $\text{CuSO}_4 \cdot 5\text{H}_2\text{O}$; CE, with the solid phase $\text{CuSO}_4 \cdot (\text{NH}_4)_2\text{SO}_4 \cdot 6\text{H}_2\text{O}$; and EF, with the solid phase $(\text{NH}_4)_2\text{SO}_4$. There are no other double salts stable in the soln. at this temp. J. J. Berzelius, E. Barchet, etc., prepared **ammonium disulphato-cupraté** or *ammonium cupric sulphate*, $(\text{NH}_4)_2\text{SO}_4 \cdot \text{CuSO}_4 \cdot 6\text{H}_2\text{O}$, by crystallization from soln. of equi-

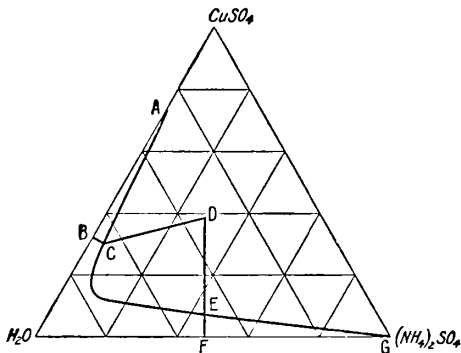

FIG. 36.—Equilibrium Curves in the Ternary System, $\text{CuSO}_4 - (\text{NH}_4)_2\text{SO}_4 - \text{H}_2\text{O}$, at 30° .

molecular parts of the component salts; A. Vogel obtained it from a mixed soln. of ammonium chloride and cupric sulphate; and A. Bouzat, from the soln. obtained by treating cupric tetrammino-sulphate with sulphuric acid. The pale blue monoclinic prisms were found by W. H. Miller to have the axial ratios $a : b : c = 0.7433 : 1 : 0.4838$, and $\beta = 106^\circ 6'$. According to E. Mitscherlich, the crystals are isomorphous with the corresponding magnesium salt, and with many other salts with the alkali and heavy metals in place of ammonium. H. Kopp's value for the sp. gr. is 1.757; J. P. Joule and L. Playfair's, 1.894 at 3.9° ; and H. Schiff's, 1.931. According to H. Schröder, the anhydrous salt has a sp. gr. 2.348. W. Beetz found the heat conductivity of aq. soln. sp. gr. 1.086 to be about 1.6 times that of water. P. A. Favre found the heat of soln. of an eq. of the salt at 8.1° in 71 eq. of water to be 5203 cal.; in 77 eq., 5441 cal.; and in 464 eq., 5622 cal. P. A. Favre and C. A. Valson found the heat of soln. of the single salt to be 2191 cal. A. Bouzat gives 9.85 Cals. for the heat of soln. of the anhydrous salt at 14° .

According to A. Vogel, the crystals effloresce in dry air; according to H. Rheineck, and A. Bouzat, they lose about 27.5 per cent. of water at 120° or 130° , and become white. At a higher temp. the crystals become green and melt, giving off water and

ammonium sulphate. H. Rheineck found that during calcination at a low temp. the salt lost 39.1 per cent. weight, and gave a residue of cupric sulphate; K. Klüss found cuprous oxide was formed at a higher temp. A. Vogel found that 100 parts of boiling water dissolve 66.7 parts of the salt, most of which separates out on cooling. H. C. Jones and B. P. Caldwell observed that the salt is not all dissociated in aq. soln. even when the conc. is less than 0.0005*N*.; R. Engel found that a sat. soln. of ammonium sulphate at 0° can remain in contact with the double salt without acquiring more than a scarcely appreciable blue coloration.

Anhydrous copper sulphate and hydroxylamine, NH_2OH , in methyl alcohol soln. at -10° , furnish pale green crystals of **cupric hydroxylamine sulphate**, $\text{CuSO}_4 \cdot \text{NH}_2\text{OH}$, when the copper sulphate is in excess; and **cupric dihydroxylamine sulphate**, $\text{CuSO}_4 \cdot 2\text{NH}_2\text{OH}$, when the hydroxylamine is in excess, and if in very large excess violet crystals of **cupric pentahydroxylamine sulphate**, $\text{CuSO}_4 \cdot 5\text{NH}_2\text{OH}$. The latter compound is not very stable; the others are stable when dry or in water, alcohol, or ether at 0°. When warmed with water containing a drop of alkali cuprous oxide is precipitated. Cupric hydroxide and hydroxylamine sulphate, or a cold aq. soln. of hydroxylamine with $\text{CuSO}_4 \cdot 2\text{NH}_2\text{OH}$, furnishes the basic salt $\text{Cu}_2\text{OSO}_4 \cdot 2\text{NH}_2\text{OH}$. T. Curtius and F. Schrader prepared pale blue prismatic or tubular crystals of **cupric hydrazine sulphate**, $\text{CuSO}_4 \cdot (\text{N}_2\text{H}_5)_2\text{SO}_4$, from a mixed soln. of the component salts. A litre of water at 10° dissolves 0.871 grm. of the salt. They are decomposed with the evolution of gas by conc. nitric acid, hot conc. sulphuric acid, sodium hydroxide, and aq. ammonia.

C. F. Rammelsberg⁵ believed that **lithium sulphato-cuprate** does not exist. F. A. H. Schreinemakers has studied the behaviour of the quaternary system, $\text{CuSO}_4\text{—Li}_2\text{SO}_4\text{—}(\text{NH}_4)_2\text{SO}_4 \cdot \text{H}_2\text{O}$, at 30° . F. A. H. Schreinemakers' study of the

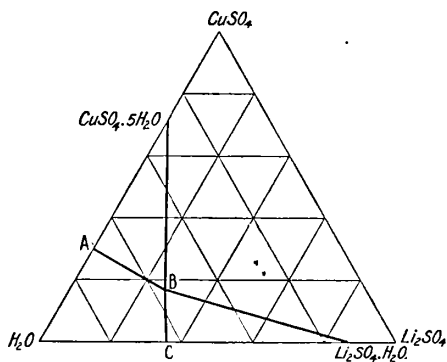

FIG. 37.—Equilibrium Curves of the Ternary System, $\text{Li}_2\text{SO}_4\text{—CuSO}_4\text{—H}_2\text{O}$, at 30° .

ternary system, $\text{CuSO}_4\text{—Li}_2\text{SO}_4\text{—H}_2\text{O}$, at 30° , also confirms this. As illustrated in the diagram, the curve *AB* represents the solubility of pentahydrated cupric sulphate, and *BC* of the hydrated lithium sulphate, $\text{Li}_2\text{SO}_4 \cdot \text{H}_2\text{O}$. No double salt appears. In addition to the three sulphates just indicated, there are two solid complexes involved in the equilibria, hexahydrated ammonium disulphato-cuprate, $(\text{NH}_4)_2\text{SO}_4 \cdot \text{CuSO}_4 \cdot 6\text{H}_2\text{O}$, and ammonium sulphato-lithiate, $(\text{NH}_4)_2\text{SO}_4 \cdot \text{Li}_2\text{SO}_4$.

The mineral *kröhnkite* occurs in Bolivia and Peru,⁶ its composition corresponds with $\text{Na}_2\text{SO}_4 \cdot \text{CuSO}_4 \cdot 2\text{H}_2\text{O}$, or dihydrated **sodium disulphato-cuprate**, or **sodium cupric sulphate**. T. Graham⁷ crystallized this salt from soln. of the component salts. He said that like other double salts of sodium sulphate it cannot be formed directly because it is decomposed by water, and this even when it is attempted to form it by double decomposition from sodium hydrosulphate; in general, a large quantity of the components are separately deposited before the double salt appears. The range of stability of the salt in soln. of different composition is indicated in Table X. F. Rüdorff, and G. Massol and M. Maldès made a few measurements of the solubility of cupric and sodium sulphates in water; and J. Koppel's results for the mol. proportions of CuSO_4 and of Na_2SO_4 in 100 mols of water at different temp. are indicated in Table XI. H. W. Foote also studied the ternary system, $\text{Na}_2\text{SO}_4\text{—CuSO}_4\text{—H}_2\text{O}$, at 12° and 25° , and at the lower temp. he found but one univariant system when the two single salts are present; at the higher temp., he found two univariant systems with solid phases double salt and cupric sulphate, and double salt and sodium sulphate.

	Solid phases	Per cent. H ₂ SO ₄	Per cent. CuSO ₄
12°	Na ₂ SO ₄ .10H ₂ O	9.54	none
	Na ₂ SO ₄ .10H ₂ O + CuSO ₄ .5H ₂ O	10.44	14.65
	CuSO ₄ .5H ₂ O	none	16.15
25°	Na ₂ SO ₄ .10H ₂ O	21.90	none
	Na ₂ SO ₄ .10H ₂ O + Na ₂ Cu(SO ₄) ₂ .2H ₂ O	21.20	6.28
	CuSO ₄ .5H ₂ O + Na ₂ Cu(SO ₄) ₂ .2H ₂ O	10.95	16.85
	CuSO ₄ .5H ₂ O	none	18.47

H. W. Foote has also investigated the quaternary system, Na₂SO₄—CuSO₄—H₂SO₄—H₂O, at 12° and at 25°, but found no other double salts than those here indicated. A. Massink studied the ternary system, Na₂SO₄—CuSO₄—H₂O, at 20° and 35°, and found the region of stability of the double salt, Na₂Cu(SO₄)₂.2H₂O.

TABLE XI.—MUTUAL SOLUBILITY OF SODIUM AND CUPRIC SULPHATES.

	CuSO ₄ .5H ₂ O + Na ₂ SO ₄ .10H ₂ O		Na ₂ Cu(SO ₄) ₂ .2H ₂ O			Double salt + CuSO ₄ .5H ₂ O			Double salt + Na ₂ SO ₄ .10H ₂ O		
	CuSO ₄	Na ₂ SO ₄		CuSO ₄	Na ₂ SO ₄		CuSO ₄	Na ₂ SO ₄		CuSO ₄	Na ₂ SO ₄
0°	13.40	6.23	11.7°	14.34	13.34	17.7°	14.99	13.48	18°	13.53	13.84
10	14.90	9.46	23.0	14.36	12.76	23.0	16.41	11.35	25	6.28	21.20
15	15.18	11.64	40.15	13.73	12.26	40.15	20.56	8.0	37.2	1.49	31.96

The salt forms pale turquoise-blue crystals in octahedral prisms, or needles. They belong to the monoclinic system, and, according to L. Darapsky, and C. Palache and C. H. Warren, the axial ratios are $a : b : c = 0.4463 : 1 : 0.4353$, and $\beta = 107^\circ 19'$. L. Darapsky gives 3 for the hardness and 2.061 (4°) for the sp. gr. of the mineral. J. Koppel found that the salt loses no water at 100°, but after some hours at 160°, it becomes green and anhydrous. The anhydride again takes up water with the development of much heat. The salt melts below a red heat without decomposition, forming a dark green liquid; it loses sulphur trioxide at a red heat. C. Palache and C. H. Warren found *kröhnkite* loses most of its water at 150°, and the rest at 350°. T. Graham found the salt deliquesces slowly in air, and is decomposed into its component salts by water. P. Rohland gives 21° for the transition point: $\text{CuSO}_4.5\text{H}_2\text{O} + \text{Na}_2\text{SO}_4.10\text{H}_2\text{O} \rightleftharpoons \text{Na}_2\text{Cu}(\text{SO}_4)_2.2\text{H}_2\text{O} + 13\text{H}_2\text{O}$; and J. Koppel gives 16.7°, and he adds that 17.7° is the lowest temp. at which the pure double salt is stable in contact with the soln. C. Palache and C. H. Warren considered the emerald-green monoclinic pyramidal crystals of *natrochalcite* to be a basic *sodium hydroxy-sulphato-cuprate*, Na₂SO₄.Cu(OH)₂.3CuSO₄.3H₂O. This mineral has the axial ratios $a : b : c = 1.423 : 1 : 1.214$, and $\beta = 118^\circ 42.5'$; the hardness is 4.5, and the sp. gr. 2.33. It loses water slowly at 150°, and between 350° and 520° it decomposes, giving off sulphur trioxide. It is sparingly soluble in water, easily soluble in acids.

T. Graham⁸ found **potassium disulphato-cuprate**, K₂SO₄.CuSO₄.6H₂O, to be formed by crystallization from a soln. of cupric sulphate and potassium sulphate or hydrosulphate in equimolecular proportions. R. Böttger, and J. I. Pierre also obtained this salt by crystallization from a soln. of cupric oxide or carbonate in an aq. soln. of potassium hydroxide. A. E. H. Tutton obtained the best crystals by the slow evaporation of soln. containing the two constituent sulphates in equi-molecular proportions. J. E. Trevor added a crystal of one component to a sat. soln. of the double salt, and the latter separated out until the soln. was in equilibrium. J. I. Pierre believed the salt was a heptahydrate, not a hexahydrate. D. M. Torrance and N. Knight found evidence of the dissociation of the complex salt in aq. soln. into its component salts, when the diffusion coeff. was measured. Crystals of hexahydrated **rubidium disulphato-cuprate**, Rb₂Cu(SO₄)₂.6H₂O, are obtained in a similar manner and more readily than is the case with the potassium salt. The crystals of hexahydrated **cæsium disulphato-cuprate**, Cs₂Cu(SO₄)₂.6H₂O, were even

more readily obtained than the rubidium salt. G. Brügelmann obtained the potassium salt by crystallization from mixed cold sat. soln. of potassium dichromate and cupric sulphate. A. Scacchi found hexahydrated potassium disulphato-cuprate in the lava of Vesuvius, and he called it *cyanochroite*.

According to A. E. H. Tutton, the light greenish-blue crystals of all three salts are isomorphous and crystallize in the monoclinic system; the habit of the potassium salt is more or less tabular, that of the rubidium salt is tabular or prismatic; and that of the caesium salt is more or less pyramidal. The axial ratios of the potassium salt are $a : b : c = 0.7490 : 1 : 0.5088$, with $\beta = 75^\circ 32'$; those of the rubidium salt, $a : b : c = 0.7490 : 1 : 0.5029$, with $\beta = 74^\circ 42'$; and those of the caesium salt, $a : b : c = 0.7429 : 1 : 0.4946$, with $\beta = 73^\circ 50'$. According to E. Mitscherlich, the crystals are also isomorphous with those of the corresponding ammonium magnesium salt, $(\text{NH}_4)_2\text{SO}_4 \cdot \text{MgSO}_4 \cdot 6\text{H}_2\text{O}$. The reported values of the sp. gr. of the potassium salt—by H. Kopp, H. Schiff, P. A. Favre and C. A. Valson, J. P. Joule and L. Playfair, and H. Schröder—vary from 2.137 to 2.224. A. E. H. Tutton's value 2.2239 ($20^\circ/4^\circ$) is probably the best representative value. F. L. Pérot's value for the sp. gr. of the rubidium salt is 2.58 (15°), A. E. H. Tutton's value 2.5699 ($20^\circ/4^\circ$); and the latter gives 2.8540 ($20^\circ/4^\circ$) for the caesium salt. A. E. H. Tutton's values for the mol. volume of potassium disulphato-cuprate is 199.4; of the rubidium salt, 207.9; and of the caesium salt, 219.3. According to T. Graham, the potassium salt loses nearly half its water of crystallization when heated to 100° in air; at a higher temp., T. Graham, E. Böttger, and J. I. Pierre found the anhydrous salt as a pale green almost colourless powder, which was observed by F. C. Vogel to lose some acid when melted. S. U. Pickering says:

When heated at 100° , this hydrated salt parted quickly with the whole of its water leaving the anhydrous salt in the form of a blue powder as dark in colour as the hydrated substance itself: when, however, this blue salt was heated to a temp. of 150° – 200° , it was found to lose its colour and become white, or very nearly white; this white modification in its turn underwent a change when the temp. was further raised to about 300° or 400° , and became again blue or bluish-green. This third modification remained apparently unchanged by any additional increment of temp. till the m.p. of the salt was reached at a low red heat. The molten salt forms an opaque green liquid, which solidifies to form a glassy mass; as soon, however, as the temp. falls sufficiently low, this glass crumbles into an opaque blue powder resembling in every respect the blue modification obtained at 400° .

S. U. Pickering adds that at 18.25° , the heat of the formation of the α -salt is $\text{K}_2\text{SO}_4 + \text{CuSO}_4 = \alpha \text{K}_2\text{Cu}(\text{SO}_4)_2 - 571$ cals. (endothermal); similarly for the β -salt, 2649 cals. (exothermal); and for the γ -salt, 731 cals. (exothermal). The heat of transformation of the α - to the β -salt is 3220 cals. (exothermal), and of the β - to the γ -salt, -1918 cals. (endothermal). According to P. A. Favre, the sp. gr. of the anhydrous salt is 2.784 (20.5°), and, according to H. Schröder, the salt which has been melted, solidified, and ground, has a sp. gr. 2.754 to 2.789. The anhydrous salt in moist air becomes blue.

The three alkali copper sulphates are readily soluble in water. F. S. Locke gives for the solubility of the potassium salt in a litre of water at 25° , 116.9 grms. or 0.354 mol. of the anhydrous salt; the corresponding numbers for the rubidium salt are 102.8 grms. or 0.241 mol.; and for the caesium salt, 460.0 grms. or 0.882 mol. P. A. Favre and C. A. Valson give 1.0713 (20.2°) for the sp. gr. of a normal soln. of the potassium salt; and the contraction in the joint vol. of the solvent and the anhydrous salt is 18.5 c.c. per litre; and of the hydrated salt, 6.1 c.c. F. M. Raoult gives for the mol. lowering of the f.p. of the soln., ± 58 . T. Griffiths gives 102.8° for the b.p. of a 40 per cent. soln. According to J. Thomsen, the heat of formation, $\text{CuSO}_4 + \text{K}_2\text{SO}_4 = \text{CuK}_2(\text{SO}_4)_2 + 20$ Cals.; and $\text{CuSO}_4 + \text{K}_2\text{SO}_4 + 6\text{H}_2\text{O} = \text{CuK}_2(\text{SO}_4)_2 \cdot 6\text{H}_2\text{O} + 22.99$ Cals. S. U. Pickering gives 9709 cals. for the heat of soln. of a mol. of the α -salt at 18.25° in 800 mols of water; 6489 cals. for the β -salt; and 8407 cals. for the γ -salt. The respective mol. sp. hts. of the α -, β -, and γ -soln. are 56.025, 51.240,

and 58·735. The heat of soln. of the hexahydrated salt at 18° is -13738 cal., and for the anhydrous salt, 9709 cal. P. A. Favre and C. A. Valsou obtained rather lower values. S. U. Pickering found the heat of hydration for each mol of water to be 2330 cal., and J. Thomsen gives for the heat of soln. of $K_2Cu(SO_4)_2$ with nH_2O :

n	0	1	2	3	4	5	6
Cals.	+9396	+4102	+1210	-4295	-7197	-10460	-13570
Diff.		5294	5312	3085	2902	3263	3110

so that if the results be plotted there is a break for $n=2$, corresponding with a possible dihydrated salt, $K_2Cu(SO_4)_2 \cdot 2H_2O$.

A. E. H. Tutton's mean values for the indices of refraction of the potassium, rubidium, and caesium salts for the different rays are:

	<i>Li</i> -line	<i>C</i> -line	<i>Na</i> -line	<i>Tl</i> -line	<i>F</i> -line	<i>G</i> -line
K	1·4834	1·4838	1·4864	1·4889	1·4922	1·4975
Rb	1·4878	1·4882	1·4906	1·4933	1·4966	1·5013
Cs	1·5032	1·5036	1·5061	1·5089	1·5123	1·5174

The mol. refractions of the hexahydrated potassium disulphato-cuprates are respectively 97·29, 102·54, and 111·80. The specific refractions and specific dispersions, by Lorenz and Lorentz's formula, are:

	C-ray.			G-ray.			Dispersion.		
	α	β	γ	α	β	γ	α	β	γ
K	0·1282	0·1295	0·1325	0·1305	0·1322	0·1354	0·0027	0·0027	0·0029
Rb	0·1148	0·1122	0·1147	0·1143	0·1148	0·1174	0·0025	0·0026	0·0027
Cs	0·1035	0·1037	0·1053	0·1059	0·1061	0·1077	0·0024	0·0024	0·0024

According to E. Rieger, a part of the copper is present in the soln. as a complex salt, which, according to J. H. van der Waals, is dissociated into its component simple salts, and J. E. Trevor found that the potassium salt diffused more rapidly through a dialyzer than the cupric salt. E. Rieger found the specific electrical conductivity of aq. soln. at 18° to be 515×10^{-4} for 0·291 mol of the salt per litre; and 378×10^{-4} for 0·191 mol of the salt per litre. J. Trötsch has also measured the conductivity of soln. of the potassium salt. The transport numbers of the potassium salt were measured by J. F. Daniell and W. A. Miller, and E. Rieger.

H. Schiff believed that he had made ammonium potassium disulphato-cuprate, $K(NH_4)SO_4 \cdot CuSO_4 \cdot 6H_2O$; and E. Sommerfeldt obtained a bluish-green product by adding ammonia to a mixed soln. of potassium and cupric sulphates, which is probably mixed crystals of potassium sulphate with cupric tetrammino-sulphate. According to T. Graham and C. Brunner, when the aq. soln. of potassium disulphato-cuprate is heated between 60° and 100°, a pale green crystalline trihydrated potassium hydroxy-tetrasulphato-cuprate, $K_2SO_4 \cdot Cu(OH)_2 \cdot 3CuSO_4 \cdot 3H_2O$, separates out, and is not again dissolved. J. F. Persoz and F. Reindel say different basic cupric sulphates are formed when a soln. of potassium disulphato-cuprate is repeatedly boiled—the former says $3CuO \cdot SO_3 \cdot 2H_2O$; the latter, $7CuO \cdot 2SO_3 \cdot 7H_2O$. F. L. Pérot says that no basic salt is formed if the rubidium salt is boiled with water.

REFERENCES.

- ¹ W. R. Hodgkinson and C. C. Trench, *Chem. News*, 66, 223, 1892; G. Gore, *Proc. Roy. Soc.*, 21, 210, 1873; E. C. Franklin and C. A. Kraus, *Amer. Chem. Journ.*, 20, 827, 1898; J. Locke and J. Forssall, *ib.*, 31, 268, 1904; D. W. Horn, *ib.*, 38, 476, 1907; A. Reychler, *Bull. Soc. Chim.*

(3), 13. 387, 1895; D. P. Konowaloff, *Journ. Russ. Phys. Chem. Soc.*, 31. 910, 1899; H. M. Dawson and J. McCrae, *Journ. Chem. Soc.*, 77. 1239, 1900; 79. 1072, 1901; H. M. Dawson, *ib.*, 89. 1668, 1906; W. Gaus, *Zeit. anorg. Chem.*, 25. 259, 1900; C. Immerwahr, *ib.*, 24. 269, 1900; W. Bunsdorff, *ib.*, 41. 163, 1904; A. A. Blanchard, *Journ. Amer. Chem. Soc.*, 26. 1315, 1904; A. Bouzat, *Ann. Chim. Phys.*, (7), 29. 372, 1903; *Compt. Rend.*, 134. 1218, 1902; H. Baubigny, *ib.*, 104. 1616, 1887; F. Förster and F. Blankenberg, *Ber.*, 39. 4428, 1906; J. McDowall, *Chem. News*, 89. 229, 1904; H. Rose, *Pogg. Ann.*, 20. 150, 1830; D. W. Horn, *Amer. Chem. Journ.*, 39. 194, 1908; D. I. Mendeléeff, *Ber.*, 3. 422, 1870; F. Ephraim, *ib.*, 52. 940, 1919; P. Latschinoff, *Journ. Russ. Phys. Chem. Soc.*, 20. 585, 1888; C. Casthelaz, *Monit. Scient.*, (4), 1. 874, 1887.

² J. A. Stisser, *Actorum laboratorii chemici, Helmstadii*, 1693; J. J. Berzelius, *Gilbert's Ann.*, 40. 300, 1812; A. Bouzat, *Ann. Chim. Phys.*, (7), 29. 305, 1903; R. Kane, *ib.*, (2), 72. 265, 1839; D. W. Horn and E. E. Taylor, *Amer. Chem. Journ.*, 32. 253, 1904; D. W. Horn, *ib.*, 38. 483, 1907; J. C. G. de Marignac, *Ann. Mines*, (5), 9. 26, 1856; A. Mallaert, *Journ. Pharm.*, 4. 217, 1848; G. André, *Compt. Rend.*, 100. 1138, 1885; H. M. Dawson, *Journ. Chem. Soc.*, 89. 1666, 1906; H. M. Dawson and J. McCrae, *ib.*, 79. 496, 1901; S. U. Pickering, *Chem. News*, 47. 277, 1883; A. Johnsen, *Neues Jahrb. Min.*, ii, 120, 1903; O. B. Kühn, *Schweigger's Journ.*, 60. 343, 1830; L. Sabbatani, *Ann. Farm. Chimica*, 26. 337, 1897; 27. 1, 1898; E. Rosenbohm, *Zeit. phys. Chem.*, 93. 693, 1919.

³ A. Destrem, *Compt. Rend.*, 106. 489, 1889; E. Sommerfeldt, *Neues Jahrb. Min.*, ii, 43, 1902; A. Johnsen, *ib.*, ii, 119, 1903; N. W. Fischer, *Pogg. Ann.*, 8. 492, 1826; G. André, *Compt. Rend.*, 100. 1138, 1885; V. Schwarzenbach, *Ber.*, 8. 1233, 1875; H. Schiff, *Liebig's Ann.*, 123. 50, 1862; A. Bouzat, *Ann. Chim. Phys.*, (7), 29. 305, 1903; H. M. Dawson and J. McCrae, *Journ. Chem. Soc.*, 79. 496, 1901; D. W. Horn and E. E. Taylor, *Amer. Chem. Journ.*, 32. 253, 1904.

⁴ T. Klobb, *Compt. Rend.*, 115. 231, 1892; A. Bouzat, *Ann. Chim. Phys.*, (7), 29. 305, 1903; J. J. Berzelius, *Gilbert's Ann.*, 40. 300, 1812; A. Vogel, *Journ. prakt. Chem.*, (1), 2. 194, 1834; H. Schröder, *ib.*, (2), 19. 292, 1879; W. H. Miller, *Phil. Mag.*, (3), 6. 105, 1835; E. Mitscherlich, *Pogg. Ann.*, 18. 152, 1830; A. Murmann and L. Rotter, *Sitzber. Akad. Wien*, 34. 170, 1859; K. Klius, *Liebig's Ann.*, 246. 208, 1888; H. Schiff, *ib.*, 123. 50, 1862; P. A. Favre, *Compt. Rend.*, 73. 720, 1871; 78. 101, 1874; P. A. Favre and C. A. Valson, *ib.*, 73. 1144, 1871; 75. 330, 385, 577, 1066, 1872; R. Engel, *ib.*, 102. 113, 1886; H. C. Jones and B. P. Caldwell, *Amer. Chem. Journ.*, 25. 349, 1901; W. Beetz, *Wied. Ann.*, 7. 435, 1879; E. Barchet, *Neues Jahrb. Min. B. B.*, 18. 398, 1904; H. Rheineck, *Dingler's Journ.*, 202. 271, 1871; J. A. Groshans, *Ree. Trav. Chim. Pays-Bas*, 4. 236, 1885; F. A. H. Schreinemakers, *Chem. Weekb.*, 5. 465, 1908; D. M. Torrance and N. Knight, *Chem. News*, 117. 270, 1918; T. Curtius and F. Schrader, *Journ. prakt. Chem.*, (2), 50. 322, 341, 1894.

⁵ C. F. Rammelsberg, *Sitzber. Akad. Berlin*, 385, 1848; F. A. H. Schreinemakers, *Chem. Weekb.*, 5. 465, 1908; *Proc. Acad. Amsterdam*, 11. 138, 1908.

⁶ J. Domeyko, *Elementos de Minerología de Chile*, Santiago, 1876; C. F. Rammelsberg, *Handbuch der Mineralchemie*, Leipzig, 102, 1895; *Ann. Mines*, (7), 19. 504, 1881; L. Darapsky, *Neues Jahrb. Min.*, i, 192, 1889.

⁷ T. Graham, *Phil. Mag.*, (3), 4. 420, 1834; J. Koppel, *Zeit. phys. Chem.*, 42. 3, 1903; 52. 385, 1905; A. Massink, *ib.*, 92. 351, 1917; P. Rohland, *Zeit. anorg. Chem.*, 35. 203, 1903; G. Massol and M. Maldès, *Compt. Rend.*, 133. 287, 1901; F. Rüdorff, *Pogg. Ann.*, 148. 455, 1873; C. Palache and C. H. Warren, *Amer. Journ. Science*, (4), 26. 345, 1908; L. Darapsky, *Neues Jahrb. Min.*, i, 192, 1889; H. W. Foote, *Journ. Ind. Eng. Chem.*, 11. 629, 1919.

⁸ T. Graham, *Phil. Mag.*, (3), 4. 420, 1834; R. Böttger, *Pogg. Ann.*, 50. 43, 1840; C. Brunner, *ib.*, 15. 476, 1829; 32. 221, 1834; R. Bunsen and G. Kirchhoff, *ib.*, 113. 337, 1861; J. I. Pierre, *Ann. Chim. Phys.*, (3), 16. 251, 1846; J. F. Persoz, *ib.*, (3), 25. 275, 1849; F. L. Perrot, *Arch. Sciences, Genève*, (3), 25. 677, 1891; J. E. Trevor, *Zeit. phys. Chem.*, 7. 468, 1891; W. Meyerhoffer, *ib.*, 9. 646, 1892; A. A. Noyes, *ib.*, 6. 257, 1890; D. M. Torrance and N. Knight, *Chem. News*, 117. 270, 1918; G. Brügelman, *Ber.*, 15. 1840, 1882; A. E. H. Tutton, *Journ. Chem. Soc.*, 63. 400, 1893; 69. 495, 1896; E. Aston and S. U. Pickering, *ib.*, 49. 123, 1886; S. U. Pickering, *ib.*, 49. 1, 260, 1886; *Chem. News*, 52. 245, 1885; H. Schröder, *Dichtigkeitsmessungen*, Heidelberg, 10, 1873; H. J. Brooke, *Ann. Phil.*, 23. 118, 1824; P. A. Favre and C. A. Valson, *Compt. Rend.*, 75. 330, 1872; 77. 907, 1873; F. M. Raoult, *ib.*, 99. 914, 1884; P. A. Favre, *ib.*, 77. 101, 1873; J. P. Joule and L. Playfair, *Mem. Chem. Soc.*, 2. 401, 1845; H. Kopp, *Liebig's Ann.*, 36. 1, 1840; 40. 173, 1841; H. Schiff, *Liebig's Ann.*, 123. 50, 1862; E. Diacon, *Compt. Rend.*, 56. 653, 1863; J. Thomsen, *Journ. prakt. Chem.*, (2), 18. 1, 1878; E. Rieger, *Zeit. Elektrochem.*, 7. 863, 1901; J. F. Daniell and W. A. Miller, *Phil. Trans.*, 134. 1, 1844; J. D. van der Waals, *Die Continuität des gasförmigen und flüssigen Zustandes*, Leipzig, 1869; A. Scacchi, *Spettatore di Vesuvio e dei campi Flegri*, 1887; J. Trötsch, *Wied. Ann.*, 41. 274, 1890; T. Griffiths, *Journ. Science*, 18. 90, 1825; F. S. Locke, *Amer. Chem. Journ.*, 27. 459, 1892; C. F. Gerhardt, *Journ. Pharm.*, (3), 12. 57, 1847; E. Sommerfeldt, *Neues Jahrb. Min.*, ii, 53, 1902; F. Reindel, *Journ. prakt. Chem.*, (1), 100. 1, 1867; F. C. Vogel, *Schweigger's Journ.*, 2. 435, 1811.

§ 27. The Basic Cupric Sulphates

Several basic cupric sulphates have been reported. Various hydrated or anhydrous forms of products with the ratio $\text{CuO} : \text{SO}_3$ as 10 : 1, 5 : 1, 4 : 1, 7 : 2, 3 : 1, 11 : 4, 8 : 3, 5 : 2, 7 : 3, and 2 : 1 have been reported. The best defined of these are possibly the salts with $\text{CuO} : \text{SO}_3$ as 2 : 1; 4 : 1 aq.; 5 : 2 aq.; and 8 : 3 aq., although all are possibly mixtures or solid soln. of cupric oxide or hydroxide, cupric sulphate, and water. For example, in their study of the ternary system, $\text{CuO} - \text{SO}_3 - \text{H}_2\text{O}$, J. M. Bell and W. C. Tabor digested ignited copper oxide or cupric hydroxide with sulphuric acid in order to find if basic sulphates are formed. The line *AB*, Fig. 33, represents the composition of the residue in equilibrium with the soln. The lines joining corresponding points of soln. and residue fall between *NA* and *MB*; they do not meet in a point within the triangle. The points *M* and *N* represent the two basic sulphates which have the best status in literature, namely $5\text{CuO} \cdot 2\text{SO}_3 \cdot 5\text{H}_2\text{O}$, and $4\text{CuO} \cdot \text{SO}_3 \cdot 4\text{H}_2\text{O}$. This indicates that the solid phases consist of a series of solid soln. of cupric oxide, sulphur trioxide, and possibly water; but there is nothing to show that definite basic compounds are formed. The soln. which exist in equilibrium with the solid soln. range from pure water to a sat. soln. of cupric sulphate. The composition of the soln. containing sulphuric acid, water, and copper sulphate, in equilibrium with the solid phase, is represented by *BE*, Fig. 33, which is plotted from the data indicated in Table VIII. The weakness of the evidence for the hypothesis, based largely on analysis, that the basic cupric sulphates are definite compounds, will be emphasized best by a review of their modes of preparation. K. Griessbach has also studied this subject.

S. U. Pickering prepared a blue product of the composition *cupric enneaoxy-sulphate*, $10\text{CuO} \cdot \text{SO}_3$, that is $\text{CuSO}_4 \cdot 9\text{CuO}$, by the action of 0.9*N*-alkali on a dil. soln. of cupric sulphate. He says: "When an alkali is added gradually to a weak soln. of copper sulphate, a point is reached when the liquid begins to show a slight alkaline reaction, but this reaction is temporary, and more alkali must be added before a permanent alkalinity is obtained. The gradual absorption of alkali after the first temporary alkalinity occurs extends over two or three days. The eq. of alkali required to produce the initial and permanent alkaline reaction, together with the eq. required to precipitate the copper completely, were found to be:

	Precipitation complete.	Initial alkalinity.	Permanent alkalinity.
BaO . . .	—	0.903	0.903
CaO . . .	0.752	0.870	0.908
Na ₂ O . . .	0.766	0.842	0.901
Li ₂ O . . .	—	0.808	0.903
K ₂ O . . .	(0.75)	0.805	0.893

The precipitation of the metal is complete when the alkali reaches 0.75 eq., an amount showing that the basic sulphate then formed must have the formula $4\text{CuO} \cdot \text{SO}_3$. This sulphate is evidently converted into a more basic one by further addition of alkali, and permanent alkalinity is reached in all five cases when the amount added amounts to 0.9 eq. This represents the formation of $10\text{CuO} \cdot \text{SO}_3$. In only one instance, that of baryta, is the point of initial alkalinity identical with that of permanent alkalinity, an exception probably connected with the insolubility of barium sulphate. With lithia and potash, initial alkalinity occurs with 0.8 eq., but with soda and lime the values are higher. It seems most probable, however, that in all cases the point of initial alkalinity indicates the existence of a basic sulphate intermediate between the first and final products, although in some cases it may be impossible to obtain this intermediate compound unmixed with a certain amount of the final product, and hence the quantity of alkali absorbed is abnormally

large." The basic copper sulphates have been in use since 1883 as a fungicide under the name Bordeaux mixture or *bouillie bordelaise*. S. U. Pickering adds:

The discovery of its value was accidental. It had been the practice in the vineyards in the neighbourhood of Bordeaux to sprinkle those vines which were near a road with verdigris in order to give them the appearance of having been poisoned, and so to prevent depredations. A mixture of lime and copper sulphate was soon substituted for the verdigris, being cheaper, and, when the downy mildew of America (*Peronospora viticola*) made its appearance in Europe, it was noticed (1882) that those vines which had received the copper dressing were those which kept their leaves longest, and were least affected by the disease.

The so-called "normal" or "1.6" mixture is made by adding 1.1 parts of lime made into milk of lime to 1.6 parts of crystallized cupric sulphate dissolved in 100 parts of water. Occasionally, stronger or weaker mixtures are used, and sometimes the proportion of lime is increased so as to equal that of the copper sulphate. For complete decomposition, the crystallized sulphate requires one-fifth of its weight of pure lime; consequently, the lime used in practice is in considerable excess of that required for complete decomposition even when an allowance is made for impurities. G. Tripodi, and L. Sostegni found Bordeaux mixture to be stable in air, and not affected by atm. carbon dioxide, but it is converted by aq. ammonia or ammonium nitrate into $4\text{CuO}\cdot\text{SO}_3$.—*vide* cupric calcium sulphate. R. Kane¹ prepared what he regarded as $8\text{CuO}\cdot\text{SO}_3\cdot 12\text{H}_2\text{O}$ by precipitating copper from a soln. of the sulphate, and stopping just short of the point where the liquid becomes alkaline. S. U. Pickering also prepared a similar apple-green substance by the action of 9 mols of Na_2O in the form of sodium hydroxide on 10 mols of cupric sulphate. D. Smith failed to confirm the existence of R. Kane's product, and he recorded the formation of pale blue *cupric trioxysulphate*, $5\text{CuO}\cdot\text{SO}_3\cdot 6\text{H}_2\text{O}$, or $\text{CuSO}_4\cdot 4\text{CuO}\cdot 6\text{H}_2\text{O}$, or $\text{CuSO}_4\cdot 4\text{Cu}(\text{OH})_2\cdot 2\text{H}_2\text{O}$. S. U. Pickering obtained a similar precipitate by the action of alkali eq. to 0.8 mol of Na_2O on 10 mols of cupric sulphate. The colour obtained has different tints of blue, according as CaO , K_2O , or Li_2O is the alkali used.

Trioxysulphates with $2, 2\frac{1}{2}, 3, 3\frac{1}{2}, 4, 5,$ and $16\text{H}_2\text{O}$ as well as the anhydrous salt have been reported. S. U. Pickering precipitated a product, *cupric trioxysulphate*, $4\text{CuO}\cdot\text{SO}_3$, that is $\text{CuSO}_4\cdot 3\text{CuO}$, by the action of 134 c.c. of lime water on a soln. of a gram of crystallized cupric sulphate. He also used soln. containing 0.75 eq. of BaO , CaO , Li_2O , Na_2O , or K_2O in place of lime water. D. W. Horn and E. E. Taylor obtained it by the action of a soln. of sodium carbonate on one of cupric tetrammino-sulphate; and A. Recoura, by the action of a cold or hot soln. of cupric sulphate on freshly precipitated cupric hydroxide. S. U. Pickering obtained a blue flocculent precipitate of $4\text{CuO}\cdot\text{SO}_3\cdot 2\text{H}_2\text{O}$, by the action of a cold or hot soln. of sodium acetate on cupric sulphate; the precipitate is not changed by heating it in air at 100° . D. Smith obtained $4\text{CuO}\cdot\text{SO}_3\cdot 3\text{H}_2\text{O}$ by the action of just enough potassium hydroxide on a soln. of copper sulphate to ensure that no copper remains in soln., by the incomplete precipitation of cupric sulphate from a soln. of cupric sulphate by sodium carbonate, and by heating $4\text{CuO}\cdot\text{SO}_3\cdot 5\text{H}_2\text{O}$ between 200° and 240° when two-fifths of the water is expelled; C. Roucher digested finely-powdered $2\text{CuO}\cdot\text{SO}_3$ in cold water, and separated the basic salt from the soln. of cupric sulphate by filtration. S. U. Pickering heated $4\text{CuO}\cdot\text{SO}_3\cdot 2\text{NH}_3\cdot 5\text{H}_2\text{O}$ to 100° for 20 hours; L. Sabbatani boiled cupric tetrammino-sulphate with water; and W. Hampe boiled a neutral soln. of cupric sulphate. It is not definitely settled whether the mineral *brochantite* is $4\text{CuO}\cdot\text{SO}_3\cdot 3\text{H}_2\text{O}$ or $7\text{CuO}\cdot 2\text{SO}_3\cdot 5\text{H}_2\text{O}$. It crystallizes in rhombic pyramids, and A. Werner suggests that it is a hexol-compound, $[\text{Cu}\{\text{Cu}(\text{OH})_2\}_3]\text{SO}_4$.

W. Casselmann reported the formation of $4\text{CuO}\cdot\text{SO}_3\cdot 3\frac{1}{2}\text{H}_2\text{O}$ when a dil. soln. of cupric sulphate is boiled with acetate of potassium, sodium, ammonium, magnesium, manganese, cobalt, nickel, zinc, or cadmium; $6\text{CH}_3\text{COONa} + 4\text{CuSO}_4 + 3\text{H}_2\text{O} = 3\text{Na}_2\text{SO}_4 + 4\text{CuO}\cdot\text{SO}_3 + 6\text{CH}_3\text{COOH}$. Sodium formate, propionate, or valerate may be used instead of the acetate. He also made it by the action of sulphates of

calcium, strontium, silver, and those previously enumerated on cupric acetate. K. Klüss prepared the same salt by the action of an aq. soln. of cupric sulphate, $\text{CuSO}_4 \cdot 5\text{H}_2\text{O}$ (24 grms. per litre), on a soln. of sodium acetate (16 grms. per litre). G. André described the product $4\text{CuO} \cdot \text{SO}_3 \cdot 16\text{H}_2\text{O}$, which he obtained by saturating a hot soln. of ammonium sulphate with cupric oxide, and pouring the liquid into water.

J. L. Proust (1800), and F. Field (1862) made a bright green powder, $4\text{CuO} \cdot \text{SO}_3 \cdot 4\text{H}_2\text{O}$, by the incomplete precipitation of a soln. of cupric sulphate with potassium hydroxide. The product was washed with water. J. Kühn recommended adding insufficient of the alkali to make the soln. react alkaline; and S. U. Pickering used less than $1\frac{1}{2}$ mols of potassium hydroxide to one of cupric sulphate in the cold. A. Vogel and C. Reischauer recommended the use of aqua ammonia, and add that if too much is employed, some cupric hydroxide is formed which later causes the precipitate to blacken. S. U. Pickering also digested the precipitate obtained by adding an excess of potassium hydroxide to a soln. of cupric sulphate for some hours in the cold with a 10 per cent. soln. of cupric sulphate; and J. L. Proust digested cupric hydroxide dried at 100° under similar conditions—cupric oxide does not react in this way. P. Sabatier made prismatic crystals of this product by digesting copper oxide, or hydroxide, or $4\text{CuO} \cdot \text{H}_2\text{O}$, or $\text{Cu}(\text{OH})_2 \cdot 3\text{CuO}$, with a conc. soln. of cupric sulphate. E. C. Sullivan obtained a precipitate analogous to langite or brochantite by the action of natural potassium, sodium, or magnesium silicate on a soln. of cupric sulphate. A. Mailhe digested cupric sulphate with nickel oxide, hydroxide, or carbonate. R. Kane obtained the same product by washing with water the green powder retained by heating cupric ammino-sulphate. S. U. Pickering boils the dark blue precipitate obtained by adding water to an ammoniacal soln. of cupric sulphate with a conc. soln. of cupric sulphate for 10 minutes; but if the soln. is cold, the product has the composition $6\text{CuO} \cdot 2\text{SO}_3 \cdot 5\text{H}_2\text{O}$. A. Vogel and C. Reischauer say that the product obtained by digesting metallic copper with ammonium sulphate soln. in air is $4\text{CuO} \cdot \text{SO}_3 \cdot 4\text{H}_2\text{O}$ contaminated with cupric hydroxide. J. Tüttscheff boiled cupric oxide with a soln. of ammonium sulphate; and evaporated nearly to dryness; and washed with water. The apple-green product was dried at 110° .

According to A. H. Church, P. Berthier, F. Pisani, A. Foullon, F. A. Genth, and C. F. Rammelsberg, this hydrated basic sulphate corresponds with the mineral *langite*, $4\text{CuO} \cdot \text{SO}_3 \cdot 4\text{H}_2\text{O}$, or $\text{CuSO}_4 \cdot 3\text{CuO} \cdot 4\text{H}_2\text{O}$, or $\text{CuSO}_4 \cdot 3\text{Cu}(\text{OH})_2 \cdot \text{H}_2\text{O}$, or $\text{Cu}_4(\text{OH})_6\text{SO}_4 \cdot \text{H}_2\text{O}$. According to N. S. Maskelyne, the blue or greenish-blue mineral crystallizes in the rhombic system, and has the axial ratios $a : b : c = 0.5347 : 1 : 0.6346$, hardness 2.5, and sp. gr. 3.48 to 3.50. G. Tschermak applies the term *devilline* to a mineral which is probably a mixture containing langite. According to J. Kühn, and J. Tüttscheff, the artificial product does not lose water between 150° and 180° , but when heated for a long time at 180° , it loses 1.22 per cent., and with a stronger heat, both water and sulphur trioxide are given off. S. U. Pickering said that 100 c.c. of cold water dissolve 0.0017 grm. of the salt, and that it is not blackened when heated for a long time with water; while J. Tüttscheff, and P. Sabatier say that it is insoluble and unchanged in cold water. A. Werner regards langite as a hexol-sulphate:

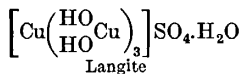
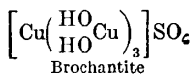

When $\text{CuSO}_4 \cdot \text{CuO} \cdot 4\text{H}_2\text{O}$ is treated with a sat. soln. of cupric sulphate, P. Sabatier found that the basic sulphate passes into green-coloured $5\text{CuO} \cdot 2\text{SO}_3 \cdot 5\text{H}_2\text{O}$, which loses cupric sulphate when treated with water, and forms langite. J. M. Bell and W. C. Tabor's study of the ternary system, $\text{CuO} - \text{SO}_3 - \text{H}_2\text{O}$, lent no support to the hypothesis that any definite basic compound is formed; the reported products are members of a series of solid soln. ranging between $5\text{CuO} \cdot 2\text{SO}_3 \cdot 5\text{H}_2\text{O}$ and

$8\text{CuO}\cdot\text{SO}_3\cdot 12\text{H}_2\text{O}$. Three hydrates of *cupric heptoxydisulphate*, $\text{CuO} : \text{SO}_3 = 7 : 2$, have been reported with respectively 5, 6, and $7\text{H}_2\text{O}$. According to J. L. Proust, cupric hydroxide or freshly-precipitated carbonate passes into the heptahydrated salt, $7\text{CuO}\cdot 2\text{SO}_3\cdot 7\text{H}_2\text{O}$, or $2\text{CuSO}_4\cdot 5\text{Cu}(\text{OH})_2\cdot 2\text{H}_2\text{O}$, or $2\text{CuSO}_4\cdot 5\text{CuO}\cdot 7\text{H}_2\text{O}$, when digested with a soln. of cupric sulphate, and he also made it by the action of aq. potassium hydroxide or aq. ammonia on an excess of cupric sulphate. Similar methods were employed by D. Smith, J. J. Berzelius, M. le Blanc, L. Hünefeld, T. Thomson, and C. Roucher. According to T. Graham, the precipitate carries down with it some potassium sulphate which cannot be removed by washing. E. Brunner used zinc oxide in place of potassium hydroxide, and found the precipitate to be free from zinc. F. Reindel and E. Brunner treated the double salt, $\text{K}_2\text{SO}_4\cdot\text{CuSO}_4$, with hot water, or boiled cupric sulphate with potassium sulphate. G. André digested cupric tetrammino-sulphate with water and metallic copper until the black mass became apple-green; the decanted liquid was treated anew with metallic copper; he also heated cupric oxide with a soln. of ammonium sulphate in a sealed tube at 200° ; and he mixed equal volumes of sat. soln. of cupric sulphate and tetrammino-sulphate, or else heated the mixture in a sealed tube at 150° . The product is a pale-green or bluish-green powder. F. Reindel, and T. Graham found that at 120° , the product loses only 1 or 2 per cent. of hygroscopic moisture, nothing is lost at 200° , and 2 mols of water are lost at 250° ; when further heated, the salt is so changed that cupric sulphate can be extracted with boiling water, but, according to J. L. Proust, if the salt be left to stand for some time, the constituents recombine. The salt is not changed when washed with cold water, it dissolves in boiling water and in acids; according to G. André, the salt is partially soluble in aq. ammonium sulphate; J. Habermann obtained a bluish-green micro-crystalline powder of the hexahydrated salt, $7\text{CuO}\cdot 2\text{SO}_3\cdot 6\text{H}_2\text{O}$, or $2\text{CuSO}_4\cdot 5\text{CuO}\cdot 6\text{H}_2\text{O}$, or $2\text{CuSO}_4\cdot 5\text{Cu}(\text{OH})_2\cdot \text{H}_2\text{O}$, by dropping a conc. soln. of ammonia or sodium carbonate, with constant agitation, into a conc. boiling soln. of cupric sulphate. The product is insoluble in cold or hot water; it does not lose water at 100° in vacuo; when heated to 190° it loses one per cent. of water without perceptible colour change; between 280° and 290° , it suffers a continuous loss of weight and changes its colour; at 320° the colour changes to a dirty green; and at a dark red heat it becomes black. The salt loses its water at a dark red heat, forming an anhydrous product, $7\text{CuO}\cdot 2\text{SO}_3$, or $2\text{CuSO}_4\cdot 5\text{CuO}$. A. C. Becquerel obtained crystals of the pentahydrated salt, $7\text{CuO}\cdot 2\text{SO}_3\cdot 5\text{H}_2\text{O}$, or $2\text{CuSO}_4\cdot 5\text{Cu}(\text{OH})_2$, by allowing porous limestone to stand in a soln. of cupric sulphate; S. Meunier used freshly precipitated cupric carbonate in place of limestone; he also used pieces of galena, when the time occupied is 11 months; and L. Grimbert and M. Barré used spring water with calcium bicarbonate in soln. L. Bourgeois heated a soln. of urea in a sealed tube at 130° ; J. Habermann and R. Ehrenfeld added 50 c.c. of 2*N*-sodium hydroxide to a soln. of 5 grms. of crystalline cupric sulphate in 200 c.c. of water, washed the product in cold water, alcohol, and ether, and dried the mass at 100° ; and S. Meunier allowed an ammoniacal soln. of cupric sulphate to stand for a long time exposed to the air. G. Rousseau and G. Tité found that with water and magnesium carbonate at 240° or 250° the product gives cupric oxide pseudo-morphic after bronchantite.

This compound is supposed to be represented in nature by the mineral *brochantite*. This view is based on the analyses of P. Berthier, A. H. Chester, I. Domeyko, F. Field, G. Forchhammer, E. Ludwig, W. Lindgren and W. F. Hillebrand, F. von Kobell, N. S. Maskelyne, F. Pisani, F. Sandberger, G. Tschermak, and R. Warington. It occurs in dark green or emerald-green prismatic crystals belonging to the rhombic system, and with the axial ratios $a : b : c = 0.7739 : 1 : 0.4871$. The hardness ranges between 3.5 and 4.0; and the sp. gr. 3.78 to 3.90. Several other formulæ have been ascribed to this mineral, $4\text{CuO}\cdot\text{SO}_3\cdot 3\text{H}_2\text{O}$, *vide supra*; $7\text{CuO}\cdot 2\text{SO}_3\cdot 6\text{H}_2\text{O}$; $3\text{CuO}\cdot\text{SO}_3\cdot 2\text{H}_2\text{O}$, *vide infra*; $3\text{CuO}\cdot\text{SO}_3\cdot 3\text{H}_2\text{O}$, *vide infra*.

Five hydrated forms of *cupric dioxysulphate*, $3\text{CuO}\cdot\text{SO}_3$, or $\text{CuSO}_4\cdot 2\text{CuO}$, have

been reported respectively with $1\frac{1}{2}$, 2, $2\frac{1}{2}$, 3, and $4\text{H}_2\text{O}$. According to A. Brězina, the composition of the mineral *urvölggyite*, or *herregrundite*, $3\text{CuO}\cdot\text{SO}_3\cdot 4\text{H}_2\text{O}$, corresponds with that of a basic cupric sulphate; others like C. F. Rammelsberg, and B. von Schenck² believe it to be a cupric calcium sulphate, $\text{CaSO}_4\cdot 3\text{Cu}(\text{OH})_2\cdot \text{CuSO}_4\cdot 3\text{H}_2\text{O}$, or $\text{CaSO}_4\cdot 4\text{CuO}\cdot \text{SO}_3\cdot 6\text{H}_2\text{O}$. J. J. Berzelius and F. Wibel prepared grass-green crystals corresponding with $3\text{CuO}\cdot \text{SO}_3\cdot 3\text{H}_2\text{O}$ by treating cupric sulphate with not quite sufficient ammonia for complete precipitation, washing and drying the product, and then heating it in a retort. F. Wibel also heated in a sealed tube at 210° a soln. of cupric sulphate with finely divided silicates, anthophyllite, or hornblende, and he attributes this formula to the mineral brochantite. S. U. Pickering obtained a bluish-green product, $3\text{CuO}\cdot \text{SO}_3\cdot 1\frac{1}{2}\text{H}_2\text{O}$, by boiling a neutral aq. soln. of cupric sulphate; and C. Roucher by exposing the $\text{CuSO}_4\cdot \text{CuO}$ to moist air. F. Reindel treated an excess of a boiling soln. of cupric sulphate with ammonia, and well washed the product with water; J. Habermann used sodium carbonate for the precipitation; while L. Marchlewsky and J. Sachs heated on a water-bath a sat. soln. of cupric sulphate with an excess of dimethyl or diethyl-aniline, washed with cold water, alcohol, and ether, and dried the bluish-green mass in a desiccator. The product does not decompose below 270° , but does so above that temp. It is very soluble in hydrochloric acid.

W. A. Shenstone, and S. U. Pickering prepared the dihydrated salt, $3\text{CuO}\cdot \text{SO}_3\cdot 2\text{H}_2\text{O}$, that is, $\text{CuSO}_4\cdot 2\text{Cu}(\text{OH})_2$, by heating cupric sulphate with water in a sealed tube at 200° , and washed the resulting solid with water; N. Athanasescu added a little cupric oxide to the tube before sealing it up; and C. L. Berthollet, E. Brunner, D. Smith, and F. Reindel used zinc oxide. C. Roucher heated $2\text{CuO}\cdot \text{SO}_3$ with boiling water; F. Reindel precipitated an excess of a boiling soln. of cupric sulphate with sodium or ammonium carbonate, or basic magnesium carbonate; W. Spring and M. Lucion treated cupric hydroxide with a soln. of magnesium or manganese sulphate; and J. F. Persoz believed that the process employed by F. Reindel and E. Brunner furnished this salt, and not $7\text{CuO}\cdot 2\text{SO}_3\cdot 7\text{H}_2\text{O}$, as was supposed—he stated that this is confirmed by the work of C. Freese on basic cupric chromate. It has been suggested that the emerald-green mineral *brochantite* has this composition, and F. W. Hillebrand gave the name *antlerite* to a variety of this mineral from Arizona. According to H. A. Miers, the mineral *stolznerite* occurs in bipyramids belonging to the rhombic system with axial ratios $a : b : c = 0.4971 : 1 : 0.6881$. A. Arzruni obtained similar numbers. The sp. gr. is 3.884 (4°). According to F. Reindel, the product is stable at 270° , and loses water slowly at 357° , and all the water is lost at 448° . According to W. Spring and M. Lucion, the product decomposes at 15° in 600 to 648 hrs., at 30° in 57 hrs., and at 45° in 29 to 33 hrs. It is insoluble in water, and soluble in dil. sulphuric acid. According to W. A. Shenstone, it redissolves in a few weeks in its own mother liquid. A. Steinmann, and V. Merz and W. Weith prepared bright green microscopic crystals of $3\text{CuSO}_4\cdot \text{SO}_3\cdot 1\frac{1}{2}\text{H}_2\text{O}$ by heating a cold sat. soln. of cupric sulphate in a paraffin bath between 200° and 250° . The product decomposes readily, is insoluble in water, but very soluble in warm acids.

According to F. Clowes and R. M. Caven,³ the basic sulphate which S. U. Pickering formed by boiling a soln. of cupric sulphate, and thought to be $6\text{CuO}\cdot 2\text{SO}_3\cdot 5\text{H}_2\text{O}$, has the composition *cupric heptoxy-tetrasulphate*, $4\text{CuSO}_4\cdot 7\text{Cu}(\text{OH})_2\cdot \text{H}_2\text{O}$, or $11\text{CuO}\cdot 4\text{SO}_3\cdot 8\text{H}_2\text{O}$. R. Schütze reported the formation of *octahydrated cupric trioxy-trisulphate*, $8\text{CuO}\cdot 3\text{SO}_3\cdot 8\text{H}_2\text{O}$, in green needles by boiling a conc. soln. of cupric sulphate; and L. Marchlewsky and J. Sachs, the green decahydrated salt, $8\text{CuO}\cdot 3\text{SO}_3\cdot 10\text{H}_2\text{O}$, by the action of an excess of quinoline on a sat. soln. of cupric sulphate. This salt decomposes at 200° . F. Wibel heated 7 grms. of wollestonite with 30 c.c. of cupric sulphate soln. (1.965 grms. copper) to 100° in a sealed tube, and obtained what he regarded as *trihydrated cupric trioxy-disulphate*, $5\text{CuO}\cdot 2\text{SO}_3\cdot 3\text{H}_2\text{O}$, or $2\text{CuSO}_4\cdot 3\text{Cu}(\text{OH})_2$. P. Sabatier obtained green crystals of the pentahydrated salt, $5\text{CuO}\cdot 2\text{SO}_3\cdot 5\text{H}_2\text{O}$, by the action of a conc. soln. of cupric

sulphate on $4\text{CuO}\cdot\text{SO}_3\cdot 4\text{H}_2\text{O}$; the latter is reformed by the action of cold water on $5\text{CuO}\cdot 2\text{SO}_3\cdot 5\text{H}_2\text{O}$. E. Weinschenk made $5\text{CuO}\cdot 2\text{SO}_3\cdot 6\text{H}_2\text{O}$ by the action of an excess of ammoniacal cupric sulphate on iron wire in a sealed tube at 150° . The composition of the crystals was determined by A. Weisbach. Green microscopic crystals of this product occur in nature as *arnimite*, and when mixed with calcium sulphate, the mineral is called *herrengrundite*—*vide supra*. A. Étard obtained a green crystalline powder of *cupric heptoxy-trisulphate* with the composition $7\text{CuO}\cdot 3\text{SO}_3\cdot 12\text{H}_2\text{O}$, or $2\text{CuSO}_4\cdot 4\text{Cu}(\text{OH})_2\cdot 8\text{H}_2\text{O}$, by heating the preceding salt in a muffle between 55° and 105° . C. Roucher, and T. Klobb, prepared an amorphous orange-yellow powder of *cupric oxyulphate*, $2\text{CuO}\cdot\text{SO}_3$, or $\text{CuSO}_4\cdot\text{CuO}$, by heating cupric sulphate to dull redness in a platinum crucible; and K. Klüss similarly treated basic cupric dithionate, $\text{CuS}_2\text{O}_6\cdot 3\text{CuO}\cdot 4\text{H}_2\text{O}$. L. and P. Wöhler and W. Plüddemann heated cupric sulphate to 800° in a stream of sulphur dioxide. T. Thomson, and L. Gmelin made the same product by digesting cupric oxide with an aq. soln. of the sulphate; and A. Recoura prepared $\text{CuSO}_4\cdot\text{CuO}$ by the oxidation of dry cuprous sulphate at 200° . According to J. E. Strandmark, the salt was found by A. Scacchi in the ejecta of Vesuvius, as the mineral *dolerophanite* described by J. E. Strandmark, and G. Tschermak. It forms monoclinic prisms with the axial ratios $a:b:c=1:323:1:1:203$. The orange-yellow or yellowish-brown powder is said to be isomorphous with cupric sulphate. It is not changed in dry air, but readily decomposes in moist air. L. and P. Wöhler and W. Plüddemann give for the vap. press. 92 mm. at 650° ; 122 mm. at 685° ; 168 mm. at 725° ; 256 mm. at 763° ; and 454 mm. at 800° . The composition has been graphically symbolized:

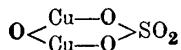

REFERENCES.

¹ P. Sabatier, *Compt. Rend.*, 125. 101, 1897; G. André, *ib.*, 100. 1138, 1885; S. U. Pickering, *Chem. News*, 47. 181, 1883; *Journ. Chem. Soc.*, 43. 337, 1883; 91. 1981, 1988, 1907; A. H. Church, *ib.*, 13. 87, 1865; R. Kane, *Ann. Chim. Phys.*, (2), 72. 269, 1839; A. Mailhe, *ib.*, (7), 27. 395, 1902; P. Berthier, *ib.*, (2), 50. 360, 1832; D. Smith, *Phil. Mag.*, (3), 23. 496, 1843; F. Field, *ib.*, (4), 24. 123, 1862; N. S. Maskelyne, *ib.*, (4), 27. 306, 1864; (4), 29. 473, 1865; J. L. Proust, *Ann. Chim. Phys.*, (1), 32. 34, 1800; *Gehlen's Journ.*, 6. 567, 1808; J. M. Bell and W. C. Tabor, *Journ. Phys. Chem.*, 12. 171, 1908; J. Kühn, *Arch. Pharm.*, (2), 50. 281, 1844; D. W. Horn and E. E. Taylor, *Amer. Chem. Journ.*, 32. 258, 1904; A. Recoura, *Compt. Rend.*, 132. 1415, 1901; F. Pisani, *ib.*, 59. 633, 1864; C. Roucher, *Journ. Pharm.*, (3), 37. 250, 1860; L. Sabbatani, *Ann. Farmacoterap. Chim.*, 1. 1898; W. Hampe, *Zeit. Berg. Hütt. Sal.*, 21. 268, 1873; A. Werner, *Ber.*, 40. 4444, 1907; W. Casselmann, *Zeit. anal. Chem.*, 4. 24, 1865; K. Klüss, *Liebig's Ann.*, 246. 212, 1888; A. Vogel and C. Reischauer, *Neues Jahrb. Pharm.*, 11. 3, 1859; J. Tüttscheff, *Zeit. Chem.*, (2), 6. 111, 1870; E. C. Sullivan, *Bull. U.S. Geol. Surv.*, 312, 1907; G. Tschermak, *Sitzber. Akad. Wien*, 51. 127, 1865; F. A. Genth, *Amer. Journ. Science*, (2), 45. 305, 1868; C. F. Rammelsberg, *Handbuch der Mineralchemie*, Berlin, 2. 266, 1875; G. Tripodi, *Staz. sperim. Agrar. Ital.*, 19. 204, 1890; L. Sostegni, *ib.*, 19. 129, 1890; A. Foullon, *Mém. Soc. Moscou*, 3. 289, 1812; L. Hünefeld, *Journ. prakt. Chem.*, 16. 319, 1839; I. Domeyko, *Ann. Mines*, (3), 18. 75, 1840; G. Forchhammer, *Deut. Nat. Versamm. Ber.*, 281, 1846; K. Griessbach, *Ueber die durch Einwirkung von Ammonium- und Alkalihydroxyden sowie von Ammonium- und Alkalikarbonaten auf Kupfersulfat entstehenden Niederschläge*, Erlangen, 1912; A. H. Chester, *Amer. Journ. Science*, (3), 33. 284, 1887; W. Lindgren and W. F. Hillebrand, *ib.*, (4), 18. 448, 1904; E. Ludwig, *Tschermak's Mitt.*, 38, 1873; R. Warington, *Journ. Chem. Soc.*, 18. 85, 1865; F. von Kobell, *Journ. prakt. Chem.*, (1), 96. 251, 1865; L. Bourgeois, *Bull. Soc. Chim.*, (3), 3. 500, 1890.

² B. von Schenck, *Tschermak's Mitt.*, (2), 2. 311, 1879; C. F. Rammelsberg, *Handbuch der Mineralchemie*, Leipzig, 102, 1885; A. Brézina, *Zeit. Kryst.*, 3. 359, 1879; F. Wibel, *Ueber die Reduktion von Kupferoxydsalzen*, Göttingen, 1864; J. J. Berzelius, *Gilbert's Ann.*, 40. 300, 1812; L. Marchlewsky and J. Sachs, *Zeit. anorg. Chem.*, 1. 405, 1892; B. Kosmann, *ib.*, 3. 374, 1893; W. Spring and M. Lucion, *ib.*, 2. 213, 1892; J. Habermann, *Monatsh.*, 4. 787, 1883; S. U. Pickering, *Chem. News*, 47. 181, 1883; 52. 2, 1885; A. Steinmann, *Ber.*, 15. 1411, 1882; V. Merz and W. Weith, *ib.*, 13. 210, 1880; F. Reindel, *Journ. prakt. Chem.*, (1), 102. 204, 1867; (1), 106. 376, 1869; W. F. Hillebrand, *Neues Jahrb. Min.*, ii, 70, 1891; W. A. Shenstone, *Journ. Chem. Soc.*, 47. 376, 1885; H. A. Miers, *ib.*, 47. 377, 1885; N. Athanasescu, *Bull. Soc. Chim.*, (2), 44. 14, 1885; C. L. Berthollet, *Ann. Chim. Phys.*, (1), 49. 1, 1804; J. F. Persoz, *ib.*, (3), 25. 279, 1849; C. Freese, *Pogg. Ann.*, 140. 186, 1870; E. Brunner, *ib.*, 15. 477, 1829; 32. 223,

1834; C. Roucher, *Journ. Pharm.*, (3), 37, 249, 1860; A. Arzruni, *Zeit. Kryst.*, 18, 58, 1891; R. Warington, *Journ. Chem. Soc.*, 18, 85, 1865; F. Sandberger, *Pogg. Ann.*, 105, 614, 1858; W. Lindgren and W. F. Hillebrand, *Amer. Journ. Science*, (4), 18, 448, 1904; A. H. Chester, *ib.*, (3), 33, 284, 1887; E. Ludwig, *Tschermak's Mitt.*, 33, 1873; G. Rousseau and G. Tité, *Compt. Rend.*, 113, 192, 1891; S. Meunier, *Les méthodes de synthèse en minéralogie*, Paris, 1891; N. le Blanc, *Journ. Phys.*, 55, 301, 1802; J. Habermann and R. Ehrenfeld, *Zeit. anorg. Chem.*, 50, 319, 1906; T. Thomson, *Ann. Phil.*, 17, 244, 1821; F. Reindel, *Journ. prakt. Chem.*, (1), 100, 1, 1867; F. von Kobell, *ib.*, (1), 96, 251, 1865; T. Graham, *Phil. Trans.*, 123, 253, 1833; L. Grimbart and M. Barré, *Journ. Pharm.*, (5), 21, 414, 1890.

³ F. Clowes and R. M. Caven, *Proc. Chem. Soc.*, 13, 221, 1897; F. Clowes, *Chem. News*, 78, 155, 1898; R. Schütze, *Pharm. Centr.*, (2), 8, 295, 1887; L. Marchlewsky and J. Sachs, *Zeit. anorg. Chem.*, 1, 405, 1892; F. Wibel, *Ueber die Reduktion von Kupferoxyd-salzen*, Göttingen, 1864; E. Weinschenk, *Zeit. Kryst.*, 17, 492, 1890; J. E. Strandmark, *ib.*, 36, 456, 1902; A. Étard, *Compt. Rend.*, 104, 1615, 1887; T. Klobb, *ib.*, 115, 232, 1892; P. Sabatier, *ib.*, 125, 104, 1897; A. Recoura, *ib.*, 148, 1105, 1909; C. Roucher, *Journ. Pharm.*, (3), 37, 249, 1860; L. and P. Wöhler and W. Plüddemann, *Ber.*, 41, 710, 1908; K. Klüss, *Liebig's Ann.*, 246, 209, 1888; G. Tschermak, *Tschermak's Mitt.*, 54, 1871; A. Weisbach, *Jahrb. Min.*, 120, 1883; L. Gmelin, *Handbook of Chemistry*, London, 5, 414, 1851; T. Thomson, *A System of Chemistry*, Edinburgh, 1910.

§ 28. Copper Carbonates

Normal cuprous or cupric carbonate has not yet been isolated, although R. Wagner¹ says a carbonate probably exists in aq. soln. to the extent of one in 4000–5000 parts of aq. carbonic acid under a press. of several thousand atm. J. L. Gay Lussac also believed that the black mineral *mysorine* is the normal carbonate, but this is now known to be a basic salt. P. Carles noted the formation of scales on copper exposed to the joint action of air and ammonia on copper. The scales were blue on the outer surface, reddish-yellow in contact with the metal, and malachite green in the interior. In time the blue becomes green, and finally all becomes reddish-yellow. The product is stable, and it dissolves in acids with effervescence. It is assumed some *cuprous carbonate* is present. The soln. in hydrochloric acid gives a white precipitate when diluted with water.

P. N. Raikow says that when freshly precipitated cuprous hydroxide, suspended in water, is treated with carbon dioxide, with the exclusion of air, a *cuprous hydrocarbonate*, $\text{Cu}_2\text{H}(\text{CO}_3)_2$, is precipitated, and this is soon decomposed into cuprous hydroxide and carbon dioxide. The orange-yellow precipitate produced by adding sodium carbonate to a soln. of cuprous chloride in hydrochloric acid assumes a brick-red colour when washed with cold water and is stated by L. Gmelin to be hydrated cuprous oxide, free from carbon dioxide.

According to F. Förster and F. Blankenberg, the colourless or blue soln. which has been used in gas analysis for the absorption of carbon monoxide, contains *cuprous ammino-carbonate*; the soln. precipitates some copper when sulphuric acid is added. Double salts of the normal cuprous and cupric carbonates with ammonium or the other metal carbonates have been prepared. Basic cupric carbonates have been reported with $\text{CuO} : \text{CO}_2 : \text{H}_2\text{O}$ in the ratios 10 : 1 : 6, 8 : 1 : 5, 6 : 1 : 0, 3 : 1 : 2, 8 : 3 : 6, 5 : 2 : 6, 2 : 0 : 1, 2 : 1 : (1 or 2), 5 : 3 : 0, 8 : 5 : 7, and 3 : 2 : 1. Several of these occur as minerals, and from the analyses on which the formulæ are based there is nothing to indicate which are chemical individuals and which are solid soln. The mixture obtained by adding sodium carbonate to copper sulphate is used as a fungicide—the mixture is known as *soda Bordeaux*. S. U. Pickering says that the ordinary cupric carbonate of commerce approximates to $2\text{CuO} \cdot \text{CO}_2 \cdot \text{H}_2\text{O}$, the formula for malachite with 71·94 per cent. of CuO, but H. B. Dunncliff and S. Lal found that the average of thirteen samples from different Indian and European sources approximated more to azurite—the extremes were 66·16 to 78·60 per cent. CuO.

On adding copper sulphate to a large excess of a soln. of sodium carbonate, no precipitate is formed until a considerable quantity of the copper salt has been added, since the small amount of precipitate formed at first dissolves on warming.

A bright blue soln. results. When the soln. is boiled, a green granular precipitate is formed, while the soln. remains a bright blue. After prolonged ebullition, the precipitate is dense black. The green precipitate has a composition analogous with malachite; the black precipitate is largely cupric oxide.

Precipitates from soln. of copper salts and soluble carbonates are invariably basic, and the degree of basicity depends upon the conditions under which the precipitation is made. H. Kühn thus obtained precipitates with the ratio $\text{CuO} : \text{CO}_2$ varying from 6 : 1 to 5 : 3. A bulky blue precipitate is thrown down when soln. of sodium carbonate and cupric sulphate are mixed, and some carbon dioxide is evolved. S. U. Pickering working with dil. soln. found that alkalinity is attained when 1.61 mols of sodium carbonate have been added for each mol of copper sulphate. He also found that precipitation is practically complete when 1.6 mols of the carbonate have been added per mol of copper sulphate. He therefore infers that the reaction is a simple one and does not occur in two stages, as when an alkali hydroxide is added to copper sulphate, in which case the whole of the metal is first precipitated to form one basic sulphate, and this reacts with a further addition of alkali to form a more basic one before the liquid finally becomes alkaline. The precipitate was found to contain no traces of sulphate unless the copper was only partly precipitated, and then only in minute quantities; its formula, therefore, is, presumably, hydrated $5\text{CuO} \cdot 2\text{CO}_2$, its formation being represented by the equation: $5\text{CuSO}_4 + 3\text{H}_2\text{O} + 8\text{Na}_2\text{CO}_3 = 5\text{CuO} \cdot 2\text{CO}_2 + 5\text{Na}_2\text{SO}_4 + 6\text{NaHCO}_3$. The precipitation is never absolutely complete, because the basic carbonate dissolves in the sodium hydrogen carbonate formed in the reaction; but the quantity present when dealing with very dil. soln. is barely recognizable. Where more than 1.6 mols of sodium carbonate are added, the amount of copper dissolved becomes more considerable, and with stronger soln. the liquid becomes quite blue. Exposure to the air, by increasing the proportion of acid carbonate present, increases the amount of copper dissolved.

M. Gröger regards the bluish-green precipitate first obtained by mixing soln. of sodium carbonate and cupric sulphate as a colloidal copper carbonate associated with an indefinite amount of water, and if eq. quantities of the two soln. are employed, the mol. ratio of $\text{CuO} : \text{CO}_2$ is as 2 : 1. The precipitate immediately begins to coagulate and to lose carbon dioxide. S. U. Pickering found that hydrated cupric trioxy-dicarbonate, $5\text{CuO} \cdot 2\text{CO}_2 \cdot n\text{H}_2\text{O}$, or $2\text{CuCO}_3 \cdot 3\text{CuO} \cdot n\text{H}_2\text{O}$, decomposes when in a moist condition, but it can be dried over sulphuric acid, when it contracts to a brittle blue mass; it may likewise be heated to 100° without decomposition. It is then dark green and contains $5\text{CuO} \cdot 2\text{CO}_2 \cdot 3\text{H}_2\text{O}$, but regains its blue colour on exposure to moist air. H. Struve gave $5\text{CuO} \cdot 2\text{CO}_2 \cdot 6\text{H}_2\text{O}$ for the composition of the insoluble residue obtained by washing the double salt $\text{Na}_2\text{CO}_3 \cdot \text{CuCO}_3 \cdot 3\text{H}_2\text{O}$ with water. When the blue precipitate is left in contact with a cold sat. soln. of sodium carbonate for some days or weeks, according to the temp., it loses carbon dioxide and forms cupric hydroxide; on the other hand, if left in contact with a soln. of sodium hydrocarbonate, or its own mother liquid, it takes up carbon dioxide and forms green pulverulent malachite. If the precipitated $5\text{CuO} \cdot 2\text{CO}_2 \cdot n\text{H}_2\text{O}$ is washed on a filter with well-boiled distilled water, or with a *N*-soln. of sodium carbonate, it loses no copper, but it does so if washed with aq. carbonic acid, or with a soln. of sodium hydrocarbonate, forming malachite.

With cone. soln. of sodium carbonate and cupric sulphate, the precipitate soon blackens, and contains only traces of carbonate, and, according to F. Field, if boiling soln. be used, the precipitate has the composition of *cupric pentooxycarbonate*, $6\text{CuO} \cdot \text{CO}_2$, or $\text{CuCO}_3 \cdot 5\text{CuO}$, or, according to H. St. C. Deville, *cupric heptooxycarbonate*, $8\text{CuO} \cdot \text{CO}_2 \cdot 5\text{H}_2\text{O}$, or $\text{CuCO}_3 \cdot 7\text{CuO} \cdot 5\text{H}_2\text{O}$. S. U. Pickering found that the products obtained by F. Field, and H. St. C. Deville are stages in the continuous decomposition of the basic carbonate first precipitated, and that even more basic carbonates are produced. For example, the brown powder obtained in the preparation of sodium cupric carbonate, $\text{Na}_2\text{Cu}(\text{CO}_3)_2 \cdot 3\text{H}_2\text{O}$, is thought by M. Gröger to be

$10\text{CuO}\cdot\text{CO}_2\cdot 6\text{H}_2\text{O}$. D. Strömholm obtained no definite compound by precipitation with a mixture of sodium hydroxide, carbonate, and hydrocarbonate.

According to S. U. Pickering, when a dil. soln. of cupric sulphate is mixed with one of sodium hydrocarbonate, a light blue finely-divided precipitate is slowly formed, and considerable quantities of carbon dioxide are evolved; with conc. soln. of the two salts:

The light blue precipitate first formed re-dissolved, producing a deep blue liquid; warming increases the amount of copper which can thus be dissolved, but on boiling, or before, the substance in soln. decomposes rather suddenly, forming a green precipitate of malachite, and leaving the liquid only slightly blue. This decomposition often takes place during, or after, filtering; but, if it does not do so then, the dark blue soln. decomposes in another manner, depositing gradually throughout twenty-four hours, or more, fairly light blue crystals of the double salt, $\text{CuCO}_3\cdot\text{Na}_2\text{CO}_3\cdot 3\text{H}_2\text{O}$, and leaving the liquid with often only a trace of copper in it.

The precipitation of the copper is never complete, but reaches a maximum of 92–93 per cent. when three mols of sodium hydrocarbonate, or more, are present for every mol of copper sulphate. The amount of acid carbonate used up for the copper precipitated is always more than two eq., and is practically constant at about 2.15 mols of sodium hydrocarbonate for every mol of copper sulphate. The only way in which more than two mols of sodium hydrocarbonate can be used up is by the precipitate combining with additional sodium carbonate, but the compound is decomposed at once on washing. According to M. Gröger, the precipitate obtained from sodium hydrocarbonate and cupric sulphate at a low temp. is colloidal, and has the ratio $\text{CuO}:\text{CO}_2$ as 8:5. The complex is not altered by drying, and when dried over sulphuric acid has the composition of $8\text{CuO}\cdot 5\text{CO}_2\cdot 7\text{H}_2\text{O}$, or $5\text{CuCO}_3\cdot 3\text{CuO}\cdot 7\text{H}_2\text{O}$. S. U. Pickering considers that the ratio $\text{CuO}:\text{CO}_2$ in the washed precipitate corresponds with *cupric dioxy-tricarbonat*e, $5\text{CuO}\cdot 3\text{CO}_2\cdot n\text{H}_2\text{O}$, or $3\text{CuCO}_3\cdot 2\text{CuO}\cdot n\text{H}_2\text{O}$, and when dried at 100° , $n=7$. This basic carbonate dissolves in aq. carbonic acid, but is insoluble in water and in soln. of the normal carbonate.

If the double salt, $\text{CuCO}_3\cdot\text{Na}_2\text{CO}_3\cdot 3\text{H}_2\text{O}$, be washed with water, the whole of the sodium carbonate, but no copper, is removed, and the dark blue residue, when dried at 100° , becomes green. S. U. Pickering's analyses give for the composition: $8\text{CuO}\cdot 3\text{CO}_2\cdot 6\text{H}_2\text{O}$, corresponding with *cupric pentoxy-tricarbonat*e, $3\text{CuCO}_3\cdot 5\text{CuO}\cdot 6\text{H}_2\text{O}$. P. A. Favre stated that he obtained a basic cupric salt, $3\text{CuO}\cdot\text{CO}_2\cdot 3\text{H}_2\text{O}$, or *cupric dioxy-carbonat*e, $\text{CuCO}_3\cdot 2\text{CuO}\cdot 3\text{H}_2\text{O}$, by the hydrolysis of cupric ammonium carbonate with an excess of water; but S. U. Pickering failed to verify this preparation. He digested malachite for two days at 25° with a conc. soln. of ammonium carbonate; but the deep purple liquid thus obtained gave no precipitate at all on dilution. On adding alcohol, a few small crystals of a purple colour, very soluble in water, were obtained on one occasion, these evidently being a cuprammonium salt; on another occasion a good crop of shining, purple, crystalline plates was obtained. These were quite insoluble in water, and consisted apparently of a basic cuprammonium carbonate. H. B. Dunicliff and S. Lal failed to make a carbonate of constant composition by adding a soln. containing 5 per cent. each of sodium carbonate and hydrocarbonate, to a soln. of cupric sulphate sat. at 14.5° and diluted with its own vol. of water. The precipitate after standing in its mother liquid for about a day was filtered, washed free from sulphate, and dried 6 hrs. in a steam oven. The product had a fairly constant composition corresponding with *cupric penta-hydroxydicarbonat*e, $2\text{CuCO}_3\cdot 5\text{Cu}(\text{OH})_2$, or $7\text{CuO}\cdot 2\text{CO}_2\cdot 5\text{H}_2\text{O}$.

The 2:1:0 basic carbonate is represented by the mineral *mysorine*, from Mysore, analyzed by R. D. Thomson² in 1836: CuO , 60.75; CO_2 , 16.70; Fe_2O_3 , 19.50; and SiO_2 , 2.10 per cent. F. R. Mallet's analysis led him to regard *mysorine* as a mixture of malachite with calcite, chrysocolla, barytes, chalcocite, and ferric oxide. L. Franchet's observations on samples from the Urals confirm R. D. Thomson's conclusion that *mysorine* is a definite mineral species of hardness 5.5; and

sp. gr. 4.398. The attempts of J. L. Gay Lussac, F. Field, H. Rose, and J. J. Colin and M. Tallefert to prepare mysorine artificially were not successful. F. S. Beudant's statement that when malachite is heated it forms a product with the characters of mysorine is not confirmed by L. Franchet, for he found that the water and carbon dioxide are simultaneously evolved, and friable black cupric oxide remains. It will be observed that if the formula $2\text{CuO}\cdot\text{CO}_2$, or $\text{CuCO}_3\cdot\text{CuO}$, **cupric oxycarbonate**, correctly represents the composition of this basic carbonate the mineral can be regarded as representing **cupric ortho-carbonate**, Cu_2CO_4 :

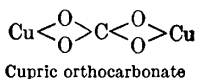
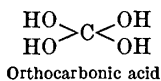

The hydrated forms of this mineral are represented by *malachite*—from *μαλάχη*, a mallow, in allusion to its green colour. The *χρυσόκολλα* and the false emerald of Theophrastus and Dioscorides were possibly malachite. The mineral is mentioned by Pliny, by G. Agricola, and by J. G. Wallerius. It is the *cuivre carbonaté vert* of L'Abbé Fontana. Malachite, $\text{Cu}_2(\text{OH})_2\text{CO}_3$, and the related mineral *azurite*, $\text{Cu}_3(\text{OH})_2(\text{CO}_3)_2$, are common secondary minerals formed in the upper portions of ores deposited by the action of carbonate waters on copper ores, or by reactions between cupriferous waters and limestones. The basic carbonates are also found in the patina of ancient bronzes, *vide* copper. Malachite has been also called *copper rust*, *noble green-span*, *verdigris*, *aerugo nobilis*, etc. The terms *copper-green* and *mineral-green* are also used, but mainly for the artificial product. L. N. Vauquelin, R. Phillips, H. Struve, A. E. Nordenskiöld, J. L. Smith, E. Stöhr, T. Haegge, M. H. Klaproth, J. Macadam, P. Berthier, A. Gawalowsky, J. Tütschegg, etc., have analyzed this mineral. These analyses are in general agreement with the formula $2\text{CuO}\cdot\text{CO}_2\cdot\text{H}_2\text{O}$, or $\text{CuCO}_3\cdot\text{Cu}(\text{OH})_2$, **cupric hydroxycarbonate**. The constitution is unknown. G. Tschermak represents it as a monohydrated cupric orthocarbonate, $\text{Cu}_2\text{CO}_4\cdot\text{H}_2\text{O}$, or as $\text{CuCO}_3\cdot\text{Cu}(\text{OH})_2$, and P. Groth as a normal carbonate of the base CuOH' , namely $(\text{CuOH})_2\text{CO}_3$.

The preparation of malachite.—J. L. Proust observed that malachite is slowly formed when moist cupric hydroxide is exposed to the air, and more rapidly when carbon dioxide is passed through water holding cupric hydroxide in suspension, and P. N. Raikow added that the presence of air favours the reaction. J. Tütschegg warmed precipitated cupric oxide with a soln. of commercial ammonium carbonate, and found that ammonia is given off, and the liquid becomes blue; at the same time, part of the cupric oxide is transformed into a green powder, which when washed with water and dried over sulphuric acid, has a composition like that of malachite. O. Kühling suspended freshly precipitated cupric oxide in a soln. of sodium chloride in one case, and of sodium nitrate in the second, and treated the mixture with a stream of carbon dioxide during from two to five days. The bright green amorphous powders obtained had the constitutions represented by the formulæ, $\text{OH}\cdot\text{CuCl}\cdot\text{CuCl}_2\cdot 5\text{Cu}(\text{OH})_2$, and $\text{OH}\cdot\text{Cu}\cdot\text{O}\cdot\text{CO}\cdot\text{O}\cdot\text{Cu}\cdot\text{OH}$. R. Wagner treated basic cupric carbonate suspended in water with carbon dioxide under 6 atm. press., and found the undissolved basic salt was transformed into crystals of malachite. A. de Schulten also allowed a soln. of basic cupric carbonate in carbonic acid to stand at ordinary temp. for some time, when crystals of malachite were formed. According to L. Bourgeois, amorphous precipitated malachite can be crystallized by heating it with water and ammonium nitrate or chloride, or urea in a sealed tube at 140° .

Many experiments have been made on the synthesis of malachite by the action of potassium or sodium carbonate on a soln. of a cupric salt. H. Rose, for example, used a cold dil. or conc. soln. containing equi-moleeular proportions of the alkali carbonate and cupric sulphate. Hot soln. gave black precipitates containing sulphuric acid. E. Chuard, M. Gröger, and S. U. Pickering precipitated a soln. of cupric sulphate with an equi-moleeular proportion or an excess of alkali carbonate,

and allowed the blue precipitate to remain in contact with the alkaline mother liquid until it had acquired a green colour. Modifications in procedure have been devised by J. A. Crowther, H. Struve, etc.

In illustration, F. Field added sodium hydrocarbonate to a soln. of cupric sulphate so long as no precipitate was formed; on heating the soln. to its b.p., a granular precipitate of the composition of malachite was formed. H. St. C. Deville said that the crystals are sodium cupric carbonate, but F. Field could not confirm this. W. C. Reynolds heated to 100° a soln. of potassium carbonate with a great excess of cupric acetate. E. E. Free mixed eq. proportions of $\frac{1}{2}N\text{-Na}_2\text{CO}_3$ and $\frac{1}{2}N\text{-CuSO}_4$ at 50°, and allowed the mixture to stand overnight. The precipitate was filtered, washed, and suspended in water, and treated for three days with carbon dioxide under a press. slightly greater than that of the atm. A. de Schulten prepared crystals of malachite by heating on a water-bath for eight days, a soln. of precipitated copper carbonate in ammonium carbonate in flasks filled up to the neck. The water was renewed as it evaporated. As the ammonium carbonate volatilizes, green crystals of malachite appear on the sides of the flask. F. Millosevitch spread a gram of dihydrated cupric chloride on the bottom of a glass tube, then a cm. thick layer of china clay, then two grams of decahydrated sodium carbonate, and sealed up the tube. When the tube was heated to 70°-85° he obtained crystals of malachite. H. de Sénarmont and V. Karavodine treated a soluble cupric salt with sodium carbonate or hydrocarbonate between 150° and 225° in a sealed tube. Some preparations have been reported with more water than corresponds with $\text{CuCO}_3\cdot\text{Cu}(\text{OH})_2$. Thus, E. Rubénovitch said that the precipitate agreed with $\text{CuCO}_3\cdot\text{Cu}(\text{OH})_2\cdot 1\frac{1}{2}\text{H}_2\text{O}$. E. Brunner, and J. J. Colin and M. Taillefert dried the washed precipitate at 20°-30°, and obtained analyses in agreement with $\text{CuCO}_3\cdot\text{Cu}(\text{OH})_2\cdot 2\text{H}_2\text{O}$. E. Chuard's, P. A. Favre's, and M. Gröger's precipitates also contained more water than is required for malachite. This is in agreement with what would be anticipated if the precipitate formed is colloidal.

H. de Sénarmont, and A. C. Becquerel heated a soln. of cupric chloride with calcium carbonate in a sealed tube between 150° and 225°; F. Wibel likewise heated a soln. of cupric sulphate with calc-spar, in a sealed tube for 24 hrs. at 150°-170°. A crust of malachite is formed near the calc-spar; calcium sulphate dissolves. At a high temp. the reaction is considered to be: $2\text{CuSO}_4 + 2\text{CaCO}_3 + \text{H}_2\text{O} \rightarrow \text{CuCO}_3\cdot\text{Cu}(\text{OH})_2 + 2\text{CaSO}_4 + \text{CO}_2$; and at a lower temp., the malachite loses water and takes up carbon dioxide: $3\text{Cu}_2(\text{OH})_2\text{CO}_3 + \text{CO}_2 \rightarrow \text{H}_2\text{O} + 2\text{Cu}_3(\text{OH})_2(\text{CO}_3)_2$, *i.e.* azurite. F. Millosevitch kept a mixture of marble with water sat. with carbon dioxide and a dil. soln. of cupric sulphate (5 grms. per litre) for some hours at 10°, and obtained crystals of malachite; and by using a more dil. soln. of cupric sulphate ($2\frac{1}{2}$ grms. per litre), crystals of azurite were obtained. He added: "A greater excess of calcium carbonate to the cupric salt is necessary for the formation of the more basic copper carbonate, azurite. The carbon dioxide is needed for the dissolution of the calcium carbonate to enable it to react readily with the copper salt." A. C. Becquerel placed a piece of porous limestone in a soln. of cupric nitrate of sp. gr. 1.091-1.116, and, after some basic nitrate had been formed, he added a soln. of sodium hydrocarbonate of sp. gr. 1.040, and in some days crystals of malachite appeared.

A. C. Becquerel covered a copper plate with crystals of sodium cupric carbonate, dipped the plate in water, and made it the positive pole of a galvanic circuit. Crystals of malachite were then formed on the metal plate. C. Luckow electrolyzed a 1.5 per cent. soln. of sodium chloride and carbonate in the respective proportions 4:1, between copper electrodes with a current density of 0.5 amp. per sq. dcm., and 2 volts; the feeble alkalinity of the electrolyte was maintained and carbon dioxide and water introduced. E. Gunther, G. Kroupa, A. Lismann, etc., have also prepared malachite by the electrolysis of dil. soln. of carbonate with a copper anode. According to J. Errera, on electrolyzing with a copper anode, a soln. of an alkali hydrocarbonate, free from chlorine, a film of cuprous oxide is formed on the copper, and, on top of this, a layer of a green, insoluble, basic carbonate, $2\text{CuCO}_3\cdot 2\text{Cu}(\text{OH})_2\cdot \text{H}_2\text{O}$, is gradually built up, while a certain amount of copper dissolves as $\text{Na}_2\text{CO}_3\cdot\text{CuCO}_3\cdot 3\text{H}_2\text{O}$. No azurite is formed; but, with high current densities, there is formed a black cathode deposit of copper, which changes to the ordinary form on treatment with acids.

The properties of malachite.—Malachite usually occurs in nature as earthy or compact nodular masses, sometimes with a fibrous structure. A. Wieler³ found a sample with a honeycomb structure. The harder varieties of green malachite have been cut, and polished into table tops, vases, etc.—*e.g.* the mantelpieces, etc., in the Grand Trianon, Versailles. Good crystals are rare. A. Lacroix has described some needle-like crystals. The crystals are usually thin prisms with well-defined twinning. According to V. von Lang, F. Hessenberg, etc., prismatic monoclinic crystals have axial ratios $a : b : c = 0.8809 : 1 : 0.4012$, and $\beta = 118^\circ 10'$. The colour ranges from emerald-green to grass-green. The **specific gravity** has been determined by A. Breithaupt, H. Schröder, V. von Zepharovitch, F. S. Beudant, J. L. Smith, etc. The numbers range from 3.3572 to 4.033. The best representative value is 3.9, the **hardness** is $3\frac{1}{2}$. W. Spring compressed the powder to a glass-like mass under great press.

Malachite decomposes and melts in the blowpipe flame. According to H. Rose, a sample of malachite from the Urals began to decompose at 220° , when it turned brown and black. When a sample, dried at 100° , was heated for a long time at 220° , it lost 0.76 per cent. in weight; at 230° , 1.22 per cent.; at 250° , 2.16 per cent.; and at 300° , 27.71 per cent. The residue then contained 98.74 per cent. of cupric oxide and 1.26 per cent. of water. Precipitated malachite lost 25.12 per cent. by weight at 200° , and contained 96.55 per cent. of cupric oxide, and 3.45 per cent. of water; and at 300° it still retained 0.63 per cent. of water. According to J. L. Gay Lussac, malachite loses carbon dioxide and blackens when boiled with water at 100° . P. E. W. Oeberg found 0.1763 for the **specific heat** of a sample of malachite from the Urals; and J. Joly, 0.1766.

A. Heiduschka says that the green colour persists unchanged at the temp. of liquid air. G. Césaro found that the crystals have a negative double refraction, and they are pleochroic. A. Voller and B. Walter investigated the **absorption of X-rays** by malachite. E. Dorn found the **electrical conductivity** of compressed malachite powder to be 3.4×10^{-6} , and, after warming $2\frac{1}{2}$ hrs. at 140° , 2.8×10^{-6} . K. Zenghelis measured the e.m.f. of precipitated malachite towards copper.

The **solubility** of malachite in water, indeed, the solubilities of all the basic cupric carbonates in this menstruum, is very small; the moistened mineral, according to A. Kenngott,⁴ does not react alkaline. J. L. Lassaigne found malachite to be soluble in water containing carbon dioxide in soln.; 100 parts of water sat. with carbon dioxide dissolve 0.03 part of malachite after 12 hrs. action at 10° , and 755 mm. press. R. Wagner gives 0.0213 part of malachite per 100 parts of water after many months' action at 6 atm. press. The solubility of malachite in aq. soln. of carbon dioxide has also been measured by H. Jahn, P. A. Favre, and E. E. Free. The last-named found the solubility of precipitated malachite increases with the conc. of the carbonic acid. Expressing the results in parts of copper dissolved per million parts of water with carbon dioxide in soln.:

CO ₂	0	157	348	859	1158	1224	1549
Cu	1.5	8.3	17.0	28.0	33.7	34.8	39.7

The last-named soln. was sat. at a little above atm. press. The presence of small amounts of sodium chloride or sulphate or calcium sulphate have no marked effect on the solubility, but when the conc. of the salt attains about 500 parts per million, the solubility of the basic carbonate is augmented. For example, with carbon dioxide approximately 1200 parts per million:

NaCl	0	10	50	100	500	10,000
CO ₂	1268	1404	1158	1326	1255	1276
Cu	35	38	35	36	39	58

The data for sodium and calcium carbonates are nearly the same:

Na ₂ CO ₃	0	100	10,000	CaCO ₃	0	100	1125
Cu	35	10	0.7	Cu	35	7	1.4

C. A. Seyler explains the phenomena by assuming that when a soln. of a copper salt is treated with sodium carbonate, $\text{CuCO}_3 \cdot \text{Cu}(\text{OH})_2$ is precipitated and copper passes into soln. as hydrocarbonate: $\text{CuCO}_3 \cdot \text{Cu}(\text{OH})_2 + 3\text{H}_2\text{CO}_3 \rightleftharpoons 2\text{H}_2\text{O} + 2\text{Cu}(\text{HCO}_3)_2$. The active mass of the solid basic carbonate and the water can be regarded as virtually constant, and, therefore, for equilibrium, $[\text{Cu}]^2[\text{HCO}_3]^{14}/[\text{H}_2\text{CO}_3]^3 = K$. Consequently, when no other salt is present the conc. of the Cu' -ions is always half as great as that of the HCO_3' -ions, and, consequently, small quantities of calcium sulphate, sodium sulphate, or sodium chloride have but little influence; on the other hand, salts which furnish analogous ions— Cu' or HCO_3' —for example, sodium or calcium hydrocarbonate, must lower the solubility.

E. E. Free also found that a precipitate of basic copper carbonate changes its nature under the influence of carbon dioxide and water, whereby its solubility in dil. carbonic acid decreases. The solubility of different precipitates in aq. carbonic acid ranged from 52 to 107 parts of copper per million in soln. of 0.12 per cent. CO_2 . After 4 or 5 days' treatment with dil. carbonic acid, the solubility of all the precipitates was approximately 35 parts per million. The explanation depends either on the transient high solubility with a fine-grained precipitate, or there is a chemical change from a substance with a variable to one of constant composition—but a little more basic.

Malachite is readily soluble with effervescence in *acids*. According to W. Spring, if the speed of dissolution of calcspar in hydrochloric or nitric acid at 15° is unity, that of malachite is 0.231. E. Landrin, and E. Murmann found malachite to be soluble in soln. of *ammonium salts*—e.g. ammonium citrate, which forms a crystalline double salt. G. Gore, and E. C. Franklin and C. A. Kraus found malachite to be insoluble in liquid *ammonia*; J. Schröder and A. Naumann found it to be insoluble in *pyridine*. A. Callegari found that when a suspension of cupric hydroxide in water is poured into a conc. soln. of *hydrazine carbonate*, a violet coloration appears which is assumed to be produced by an hypothetical *cupric hydrazine carbonate* which has not been isolated. J. Lemberg found malachite to be soluble in *potassium cyanide* soln.; J. Peschier in soln. of cane sugar; Kalle & Co., in soln. of alkali salts of the *peptones*. The copper is not precipitated from the soln. with *cane sugar* by alkali carbonates, but it is by ammonium hydrosulphide, and potassium ferrocyanide. According to C. Hassack, malachite is superficially coloured pale grey by *sodium hydroxide* soln., and in the presence of nascent *hydrogen*, it forms a brownish-black mass. D. Tommasi found the moistened salt reacts with *alkali chlorides*. F. C. Phillips noted that artificial malachite is rapidly converted by *methyl hydrosulphide* into a yellow powder. L. Loock found that patina is converted by *sulphur dioxide* or *sulphuric acid*, or organic matters from the atm. into a soluble form. According to A. C. Becquerel, the electrolysis of water with malachite in suspension reduces the copper salt by the agency of the hydrogen at the cathode.

The soln. of cupric hydroxide or of basic cupric carbonate in potassium hydrocarbonate was introduced by A. Soldiani (1876) as a substitute for H. von Fehling's soln. in sugar analysis; H. Ost also recommended the soln., and it is sometimes called *Ost's solution*. This liquid has an intense colour, and, since R. Luther and B. Krsnjavy found it to diffuse readily through parchment, they infer that it is not colloidal. During electrolysis the metal migrates to the anode, and it is assumed to form a complex of ion—say, $[\text{Cu}(\text{HCO}_3)_2]$ of *hydrocupricarbonic acid*, $\text{HCu}(\text{HCO}_3)_2$, and the soln. may therefore contain the salt, $\text{KCu}(\text{HCO}_3)_2$. G. Weltzar found iron precipitates copper from the soln. only in the presence of ammonium or sodium chloride, or potassium nitrate or sulphate. J. W. Döbereiner obtained octahedral crystals from the soln. According to H. Jahn, and R. Wagner, cupric hydrocarbonate, $\text{Cu}(\text{HCO}_3)_2$, may also be formed by the soln. of basic cupric carbonate in water containing carbon dioxide.

The transformations of malachite and azurite have been studied mineralogically by W. Haidinger, and many others.⁵ S. F. Glinka⁶ found a mineral near Atai, with mono-

clinic crystals and yellow and green pleochroism. Its composition corresponded with $2\text{CuCO}_3 \cdot \text{PbCO}_3 \cdot \text{Cu}(\text{OH})_2$, and it was hence called *lead malachite*, or *plumbomalachite*. C. F. Zinken found a bluish-green mineral which contained copper and calcium carbonates, and was hence called *calciomalachite* or *lime-malachite*. It is probably a mixture of several minerals. A. Damour also shows that A. Raimondi's *cuprocalcite* is probably a mixture of calcite and cuprite.

The basic carbonate, $3\text{CuO} \cdot 2\text{CO}_2 \cdot \text{H}_2\text{O}$, or $2\text{CuCO}_3 \cdot \text{Cu}(\text{OH})_2$, **cupric hydroxy-dicarbonate**, occurs as a mineral *chessylite*—French *azurite*, German *Kupferlasur*. The English name is derived from Chessy near Lyons, where the finest crystals have been obtained. This mineral was recognized by J. F. W. Widenmann⁷ in 1791, as a *himmelblau Fossil* from Styria. It was later called *smalt blue*, *native smalt*, *blue felspar*, *mollite*, *blue spar*, *Berlin blue*, etc. A. Stütz called it *unächter Lasurstein*, or false lapis-lazuli; M. H. Klaproth called it *lasurite*, or *lazulite*; F. S. Beudant, *Klaprothite*; etc. Analyses were made by M. H. Klaproth, J. N. von Fuchs, R. Brandes, C. F. Rammelsberg, J. L. Smith and G. J. Brush, L. J. Igelström, L. N. Vauquelin, R. Phillips, F. Wibel, A. H. Church, etc. The corresponding chemical formula, by C. F. Rammelsberg, is $2\text{CuCO}_3 \cdot \text{Cu}(\text{OH})_2$, or, by G. Tschermak, $(\text{CuOH})_2\text{Cu}(\text{CO}_3)_2$. According to the latter, therefore, malachite and azurite are related as

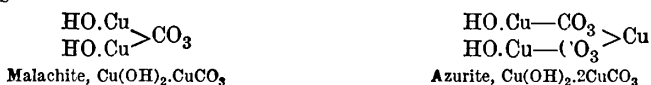

Several modes of preparing azurite have been indicated in connection with malachite; and many properties of the same mineral have been there indicated. Azurite readily passes into malachite by the loss of carbon dioxide and the gain of water, and conversely. The two minerals are usually associated together, and sometimes crystals of azurite from Chessy are transformed at one end into malachite. H. Debray⁸ did not succeed in making azurite by the action of carbon dioxide under a press. of 10 to 14 atm. on malachite, or precipitated basic carbonate; but he did prepare crystals of azurite by enclosing crystals of cupric nitrate with pieces of chalk (in excess) with a little water in a glass tube, so that the press. of the carbon dioxide was kept at 3–4 atm. A basic nitrate was first formed, and this slowly passed into azurite. Potassium carbonate will not serve in place of the calcium carbonate. A. C. Becquerel found a mixture of cupric nitrate, chalk, and sodium hydrocarbonate in the cold furnished crystals of azurite; and he also heated to 125° a soln. of cupric chloride with pieces of limestone, under press. L. M. Michel kept a soln. of cupric sulphate for many years in contact with pieces of Iceland spar at ordinary temp. and obtained a crystalline crust of azurite; F. Millosevitch used pieces of Portland cement in place of Iceland spar; F. Wibel and E. Tüngel heated a soln. of cupric sulphate with pieces of marble in a sealed tube at 200° for a month. A. C. Becquerel found that azurite formed on the walls of collodion or parchment paper separating a soln. of cupric nitrate from one of potassium carbonate or hydrocarbonate. R. Phillips, and F. Fouqué and A. Michel-Lévy have described processes for making azurite for use as a pigment.

Azurite occurs both as an earth and in a crystalline form. The crystals are deep blue, the earth is a lighter blue. The crystals are monoclinic prisms, with axial ratios $a : b : c = 0.8501 : 1 : 1.7614$, and $\beta = 92^\circ 24'$. H. Schröder⁹ gives 3.710 to 3.770 for the sp. gr. of the crystals; J. L. Smith gives 3.88. The hardness is 4. The crystals have a positive double refraction. V. Agafonoff showed that azurite has isolated absorption bands in the red, yellow, orange, green, and greenish-blue; in general, only the blue and bluish-green rays traverse places $1\frac{1}{2}$ mm. thick. R. Handmann showed that the mineral is phosphorescent.

The mineral decomposes and melts in the blowpipe flame. Powdered azurite from Chessy was found by H. Rose to begin to lose weight when heated to 220°, and little volatile matter remains when the temp. reaches 250°; the colour is then greyish-brown; at 300° the product is cupric oxide with a very little water.

When azurite is boiled with water, carbon dioxide is evolved more copiously than with malachite, and the powder is blackened. Azurite is not changed when allowed to stand for three months in water at ordinary temp. or between 60° and 80°. Azurite is soluble in aqua ammonia, forming a dark blue soln.; it is also soluble in a hot conc. soln. of sodium hydroxide, and, according to F. Field, when boiled, the liquid precipitates green malachite.

The transformation products have been studied mineralogically by G. Sillem,¹⁰ L. Buchrucker, E. Döll, R. Blum, W. S. Yeates, etc. A. Breithaupt's deep blue crystalline mineral *zinc-azurite* is probably a mixture of zinc sulphate and azurite; and his *allasite* is probably a mixture of atacamite and azurite or malachite.

According to E. J. Maumené, aq. ammonia free from ammonium salts does not dissolve either cupric hydroxide or cupric oxide. C. Bischof¹¹ dissolved with access of air copper filings, or cupric oxide, hydroxide or carbonate, in an aq. soln. of ammonium carbonate, and obtained an azure-blue liquor—he found that 100 parts of ammonium hydrocarbonate in 1440 parts of water dissolved in 24 hrs., 2.38 parts of cupric oxide, or 17.03 parts of the hydroxide. P. A. Favre showed that this soln. furnishes crystals of **cupric diammino-carbonate**, $\text{Cu}(\text{NH}_3)_2\text{CO}_3$, when treated with alcohol. According to E. J. Maumené, freshly precipitated copper carbonate dissolves in aq. ammonia in the presence of ammonium carbonate, forming a compound $\text{CuO} \cdot 3\text{CO}_2 \cdot 4\text{NH}_3$. D. W. Horn prepared cupric diammino-carbonate by saturating purified cupric carbonate of commerce, $\text{CuCO}_3 \cdot \text{Cu}(\text{OH})_2$, with a mixture of 50 c.c. of a cold sat. soln. of the solid ammonium carbonate of commerce and 10 c.c. of aqua ammonia of sp. gr. 0.9. About 6 grms. of the basic carbonate were employed; 95 per cent. alcohol was slowly added to the filtered soln., and the mixture shaken. Fine crystals of the diammino-salt separated out, these were pressed between filter paper and dried over potassium hydroxide. P. Cazeneuve prepared the same salt by treating a soln. of cupric oxalate with an equal vol. of alcoholic ammonia. F. Ephraim showed that at room temp. cupric carbonate yields only the diammino-salt, although cupric pentammino-carbonate, $\text{CuCO}_3 \cdot 5\text{NH}_3$, formed at -18°, does not decompose until 37°; above this temp., the pentammine slowly passes into the diammine, which is stable at 170°, and above 170° it decomposes completely.

According to C. F. Bucholz, the azure-blue soln. gives off ammonium carbonate when heated, and deposits nearly all the copper in bluish-green crusts which contain ammonia; a similar crust is obtained by the slow evaporation of the soln. D. W. Horn stated that the diammine salt behaves like a sat. compound towards ammonia, for liquid ammonia may be boiled from it for a period of at least an hour, and the salt remains entirely unchanged. According to P. A. Favre, the crystals are insoluble in alcohol and ether, they are decomposed by water with the separation of a basic carbonate, $2\text{CuO} \cdot \text{CO}_2 \cdot 2\text{H}_2\text{O}$. When rapidly heated in carbon dioxide decomposition occurs, ammonium carbonate sublimes, and metallic copper remains. H. Rose found that by boiling the soln. with potassium hydroxide, cupric oxide is precipitated. According to E. Bronnert, M. Frémery, and J. Urban, the soln. dissolves cellulose, forming a more stable liquid than when cupric tetra-ammino-oxide is employed. The soln. is used in the manufacture of artificial silk; and a soln. of copper carbonate in aq. ammonia or ammonium carbonate has been used for many years as a fungicide.

According to J. J. Berzelius,¹² when sodium carbonate is heated with cupric oxide before the blowpipe, a glass is formed which is green while hot, and opaque and white when cold. A. C. Becquerel filled a porous pot with a soln. of sodium hydrocarbonate, and immersed it in a soln. of cupric sulphate. Copper electrodes dipping in each liquid were connected electrically, copper is deposited on the electrode in the cupric sulphate soln., and bluish-green silky needles of a double sodium cupric carbonate are deposited on the other electrode. H. Debray mixed basic cupric nitrate or carbonate with an excess of sodium hydrocarbonate with a little water so as to form a slurry, and heated the mixture in a sealed tube to 160°,

and obtained blue crystals of anhydrous **disodium cupric dicarbonate**, $\text{Na}_2\text{CO}_3\cdot\text{CuCO}_3$. The crystals were not decomposed by water.

H. St. C. Deville described the deep blue soln. obtained by dissolving a basic copper carbonate in conc. soln. of mixed alkali carbonate and normal carbonate. With the sodium salts the soln. furnishes light blue crystals of **trihydrated disodium cupric dicarbonate**, $\text{CuCO}_3\cdot\text{Na}_2\text{CO}_3\cdot 3\text{H}_2\text{O}$, leaving the liquid slightly coloured.

The salt was made by A. C. Becquerel by the prolonged action of an aq. soln. of sodium hydrocarbonate on basic cupric nitrate. H. Struve and J. G. Gentele prepared the salt more or less contaminated with cupric carbonate by a process similar to that used by H. St. C. Deville. M. Gröger recommended mixing a soln. of 20 grms. normal sodium carbonate and 50 grms. of the hydrocarbonate in 700 grms. of cold water with a soln. of 8 grms. of hydrocarbonate in 700 grms. of cold water and a soln. of 8 grms. of pentahydrated cupric sulphate in 20 grms. of water, and allowing the precipitate to stand in contact with the mother liquor. W. C. Reynolds ground solid copper acetate with a conc. soln. of sodium carbonate. M. P. Applebey, and K. W. Lane employed a process similar to that recommended by M. Gröger, using cupric acetate in place of the sulphate.

The change in colour which accompanies crystallization is supposed to indicate that the liquid cannot be a mere soln. of the crystals; and, as M. Gröger has shown, the crystals do not readily dissolve in the mother liquor, and they are decomposed by water; but, according to M. P. Applebey and K. W. Lake, the crystals dissolve in and can be recrystallized from a conc. soln. of sodium carbonate containing hydrocarbonate. W. C. Reynolds, and T. B. Wood and H. O. Jones proved that the liquid contains highly-coloured anions, and that on electrolysis, copper is deposited on both electrodes. Hence, the soln. probably contains both copper cations and carbonato-cupric or cupricarbonate anions: $\text{Na}_2\text{Cu}(\text{CO}_3)_2 = 2\text{Na}^+ + \text{Cu}(\text{CO}_3)_2^{2-}$, and $\text{Cu}(\text{CO}_3)_2^{2-} = \text{Cu}^{+} + 2\text{CO}_3^{--}$. In the one case copper is basic or electropositive, and in the other acidic or electronegative. The cupricarbonates give a clear yellow colour with potassium ferrocyanide, but as the change between them and copper carbonate is a reversible one, the red colour of copper ferrocyanide gradually appears on standing—the actual time depends on the conc. and temp. of the soln. The cupricarbonate has the power of oxidizing dextrose with the precipitation of cuprous oxide. This action takes place in the cold, or, more rapidly, on heating, and is preceded by the formation of some soluble compound of the cupricarbonate with the sugar, for the amount of copper passing into soln. at first is greatly increased by the sugar. No such action, nor any precipitation of cuprous oxide, occurs when the soluble compound present is that containing electropositive copper.

S. U. Pickering determined the percentage of copper in soln. containing different proportions of sodium carbonate and hydrocarbonate when the total mol. proportion of the two carbonates was 5.6 and 2.24 times that of the cupric sulphate. The results are shown in Fig. 38, where the dotted lines represent electronegative copper, and the continuous line electropositive copper. The variation in amount of copper passing into soln. is continuous throughout, and shows no abrupt change when electropositive copper gives way to electronegative copper. S. U. Pickering thus explains the reactions which occur when a conc.

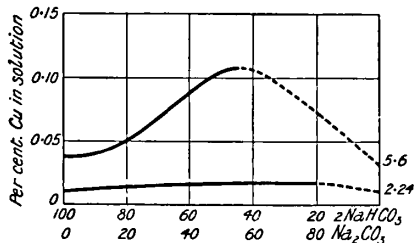

FIG. 38.—Per cent. of + and - Copper in Solutions of the Two Sodium Carbonates.

soln. of copper sulphate is added to one of sodium hydrocarbonate :

The basic carbonate, $5\text{CuO}\cdot 3\text{CO}_2$, is first precipitated, and then gradually absorbs carbon dioxide from the sodium hydrocarbonate present, passing into soln. as the normal copper carbonate, or, rather, as a double carbonate of copper and sodium, forming a deep blue liquid wherein the copper is electropositive. On standing, this soluble compound

gives rise either to the crystalline double carbonate, or else decomposes into malachite, nearly all the copper going out of soln. On heating to the b.p., the change into malachite always takes place if the soln. contains much copper. If the light blue liquid and the malachite resulting from this change are boiled together for some time, the proportion of normal sodium carbonate in the liquid is increased, and the precipitate gradually redissolves, forming again a deep blue liquid, in the form of cupricarbonate, and not malachite. The change from the soluble compound with electronegative copper, is a reversible one. On taking a rather weak soln. of the former and heating it to boiling, it becomes darker, and the copper no longer reacts with ferrocyanide; but, on cooling, it becomes lighter again, and responds to the ferrocyanide test.

The double carbonate is a light blue salt, which, according to C. F. Rammelsberg and P. Groth, belongs to the monoclinic system, and has the axial ratios $a : b : c = 1.5827 : 1 : 2.2665$, and $\beta = 91^\circ 52'$. The salt cannot be crystallized from water without decomposition. The salt is considered by S. U. Pickering to be a molecular compound of the two carbonates in which the copper is electronegative. In the presence of an excess of normal sodium carbonate, the copper becomes electronegative and it is then a complex which S. U. Pickering calls **sodium α -cupricarbonate**, consisting of $\text{Na}_2\text{Cu}(\text{CO}_3)_2$ united with Na_2CO_3 , but in which the copper is joined directly to the carbon atoms, and is in a tetrad condition. It oxidizes dextrose, and the constitution suggested represents the presence of a loosely combined oxygen atom explaining such a reaction. Excess of sodium hydroxide decomposes it, but a greater excess dissolves the basic carbonate thrown down, to form a deep violet-blue soln. of **sodium β -cupricarbonate**, which consists of $\text{Na}_2\text{Cu}(\text{CO}_3)_2$ united with one or two molecules of sodium hydroxide. This, too, oxidizes dextrose, and also combines with cellulose. It is stable in the presence of excess of alkali, whereas the α -compound gradually decomposes, either into the crystalline double salt or into malachite. Sodium cupric carbonate decomposes in a similar manner, but generally into malachite. S. U. Pickering suggested constitutional formula for the α - and β -cupricarbonates, on the assumption that copper is quadrivalent:

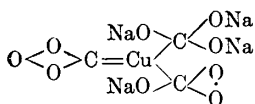
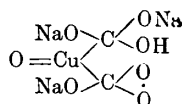
Sodium α -cupricarbonate.Sodium β -cupricarbonate.

M. P. Applebey and K. W. Lane made a partial examination of the solubility equilibria in the case of Na_2CO_3 — $\text{Na}_2\text{Cu}(\text{CO}_3)_2$ — CuCO_3 , at 18° , and, expressing the conc. in grams per litre, found in the soln.:

	Na_2CO_3	NaHCO_3	Cu
Solid phases: $\text{Na}_2\text{Cu}(\text{CO}_3)_2 \cdot 3\text{H}_2\text{O} + \text{NaHCO}_3$	9.27	87.79	—
	11.08	86.45	0.0509
	168.75	53.60	0.1553
$\text{NaHCO}_3 + \text{Na}_2\text{CO}_3 \cdot 10\text{H}_2\text{O}$	185.02	53.77	—
	193.13	18.94	—
$\text{Na}_2\text{CO}_3 \cdot 10\text{H}_2\text{O}$	197.08	18.94	0.257

When the results are represented graphically along with H. N. McCoy and C. D. Test's determinations of the solubility of mixtures of sodium carbonate and hydrocarbonate at 25° , the trona breaks in the curve at 25° do not appear in the curve at 18° in the presence of the cupric salt, possibly because trona dissociates between these two temps. The solubility curves of copper carbonate and the double salt appear to intersect when the conc. of the copper is about 0.045 gm. per litre. Instead of the solubility of each component being depressed by the presence of the other, there is a steady increase, possibly because of the formation of the complex. Unlike the normal behaviour of soln. sat. with double salts, M. P. Applebey and K. W. Lane say that "the increase of conc. of one component brings about an increase in the conc. of the other, the curve apparently rising throughout its whole course." This

abnormal behaviour must, as in the case of the solubility of copper carbonate itself, be occasioned by the formation of a new constituent in the soln. which removes copper from the soln. equilibrium of the double salt, and so leads to an increase in its apparent solubility. The increasing solubility of the double salt with rising conc. of sodium carbonate thus constitutes a direct experimental proof of the view held by H. St. C. Deville that the copper in these soln. was largely present in some form chemically different from the salt which crystallizes out. It is shown that a large proportion of the copper in the soln. is a colloidal substance—either the normal or the basic carbonate. J. M. Haussmann¹³ observed that an aq. soln. of potassium carbonate dissolves basic copper carbonate forming a deep blue liquid. According to H. Ost, the carbonate is not so soluble in a soln. of potassium hydrocarbonate, but is freely soluble in a cold conc. soln. of the normal carbonate. The soln. contains a readily soluble double salt which crystallizes out in needles; when heated, a basic copper carbonate or black oxide is precipitated, but if the soln. contains sufficient potassium hydrocarbonate, it is quite stable even at its b.p. As indicated above, when the soln. is electrolyzed, T. B. Wood and H. O. Jones obtained copper at both electrodes, and J. W. Turrentine says that during the electrolysis, "reduction occurs at the anode due to the formation there of percarbonates, which, breaking down in aq. soln., yield as a product hydrogen peroxide. This acts as a reducing agent."

In 1851, H. St. C. Deville obtained a crystalline mass with the composition $K_2CO_3 \cdot 5CuO \cdot 4CO_2 \cdot 10H_2O$, by allowing the deep blue soln., obtained by mixing sat. soln. of cupric sulphate and potassium hydrocarbonate, to stand for some hours. H. Debray likewise obtained a potassium cupric carbonate by heating basic cupric nitrate with potassium hydrocarbonate with a little water in a sealed tube. According to M. Gröger, the products are contaminated by basic cupric carbonate. The last named prepared a product of the composition $2K_2CO_3 \cdot 8CuO \cdot 7CO_2 \cdot 17H_2O$, by dissolving 20 grms. of potassium hydrocarbonate in 50 c.c. of cold water, and dropping the soln. slowly into 20 c.c. of a *N*-soln. of cupric sulphate. The precipitate was pressed on porous tiles, and dried in air. T. B. Wood and H. O. Jones believe that M. Gröger's salt is a mixture.

W. C. Reynolds prepared potassium cupric carbonate, $K_2CO_3 \cdot CuCO_3$, by adding 13 grms. of finely powdered cupric acetate to 70 c.c. of a conc. soln. of potassium carbonate of sp. gr. 1.35 at 65°. The mixture was rapidly filtered through glass wool, and the filtrate set aside. In about 48 hrs., the crystals were drained by suction on toughened filter paper on a Buchner's filter plate; washed with a mixture of alcohol with half its vol. of glycerol (which floats on the salt soln. without mixing with it); when all the mother liquid is displaced, the washing is completed with alcohol alone until the glycerol is all removed; the crystals are then dried in vacuo over sulphuric acid. The product contains three kinds of crystals (i) dark blue six-sided plates of the anhydrous salt; (ii) light blue silky needles of the monohydrate, $K_2Cu(CO_3)_2 \cdot H_2O$; and (iii) large greenish-blue square plates of the tetrahydrate, $K_2Cu(CO_3)_2 \cdot 4H_2O$. The last-named crystals can be separated by hand. The anhydrous and monohydrated forms appear to be deposited indifferently from soln. of the same conc. and temp. The copper soln. decomposes slowly when heated to 65°, and rather quickly at 85°, cupric oxide being precipitated; if, however, a large quantity of the acetate is added, no black precipitate forms even at 100°, but a green powder of the composition, $Cu_2(OH)_2CO_3$. According to T. B. Wood and H. O. Jones, the same potassium cupric carbonate is obtained by shaking for several days a soln. of 100 grms. of potassium carbonate in 100 c.c. of water with a mixture of the basic copper carbonate, $CuCO_3 \cdot Cu(OH)_2 \cdot 2H_2O$, potassium carbonate, and hydrocarbonate in the proportions required by the equation: $CuCO_3 \cdot Cu(OH)_2 \cdot 2H_2O + 2KHCO_3 + K_2CO_3 = 2(K_2CuCO_3) + 4H_2O$. The double salt decomposes in contact with water, with the production of basic copper carbonate. A soln. of potassium carbonate containing 85 grms. to 100 c.c. of water dissolves the double carbonate, forming a deep blue soln., which, if not sat. with copper carbonate, does not change on boiling.

REFERENCES.

- ¹ R. Wagner, *Zeit. anal. Chem.*, 6, 169, 1867; *Journ. prakt. Chem.*, (1), 102, 235, 1867; J. L. Gay Lussac, *Ann. Chim. Phys.*, (2), 37, 335, 1828; P. A. Favre, *ib.*, (3), 10, 116, 1844; F. Förster and F. Blankenberg, *Ber.*, 39, 4435, 1906; S. U. Pickering, *Journ. Chem. Soc.*, 91, 1982, 1907; 95, 1409, 1909; H. B. Dunnington and S. Lal, *ib.*, 113, 718, 1918; M. Gröger, *Zeit. anorg. Chem.*, 24, 127, 1900; H. Struve, *Journ. Russ. Min. Soc.*, 100, 1857; P. N. Raikow, *Chem. Ztg.*, 31, 142, 1907; L. Gmelin, *Handbook of Chemistry*, London, 5, 414, 1851; H. Kühn, *Liebig's Ann.*, 73, 84, 1850; D. Strömholm, *Ark. Kem. Min.*, 2, 16, 1906; P. Carles, *Bull. Soc. Chim.*, (4), 17, 163, 1915; F. Field, *Journ. Chem. Soc.*, 14, 70, 194, 1860; H. St. C. Deville, *Ann. Chim. Phys.*, (3), 33, 75, 1851; (3), 35, 438, 460, 1852.
- ² R. D. Thomson, *Outlines of Mineralogy*, London, 1, 601, 1836; G. Agricola, *Interpretatis Germanica vocum rei metallicæ*, Basil, 1546; J. G. Wallerius, *Mineralogia*, Stockholm, 278, 1747; L'Abbé Fontana, *Journ. Phys.*, 2, 509, 1778; F. R. Mallet, *A Manual of the Geology of India*, Calcutta, 1881; H. Rose, *Pogg. Ann.*, 84, 466, 1851; J. J. Colin and M. Taillefer, *Ann. Chim. Phys.*, (2), 12, 62, 1819; J. L. Gay Lussac, *ib.*, (2), 37, 335, 1828; J. L. Proust, *ib.*, (1), 32, 40, 1800; H. de Sénarmont, *ib.*, (3), 32, 154, 1851; F. S. Beudant, *ib.*, (2), 38, 398, 1828; G. Tschermak, *Lehrbuch der Mineralogie*, Wien, 1905; P. Groth, *Chemische Krystallographie*, Leipzig, 2, 214, 1908; L. N. Vauquelin, *Ann. Mus. Hist. Nat.*, 20, 1, 1813; R. Phillips, *Journ. Roy. Inst.*, 4, 273, 1818; H. Struve, *Proc. Russ. Min. Soc.*, 100, 1851; *Liebig's Ann.*, 80, 253, 1851; A. E. Nordenskiöld, *Beskrifning öfver de in Finland funna Mineralier*, Helsingfors, 1855; *Acta Soc. Fenn.*, 4, 607, 1856; J. L. Smith, *Amer. Journ. Science*, (2), 20, 249, 1855; E. Stöhr, *Neues Jahrb. Min.*, 129, 1864; F. Wibel, *ib.*, 242, 1873; T. Haeger, *Die Minerale des Siegerlandes*, Jena, 1888; J. Macadam, *Min. Mag.*, 8, 135, 1889; A. Gawalowsky, *Allg. öster. Chem. Ztg.*, 15, 70, 1908; J. Tüttschaff, *Zeit. Chem.*, (2), 6, 111, 1870; P. Berthier, *Ann. Univ. Lyon*, (2), 1, 19, 1906; O. Kühling, *Ber.*, 34, 2849, 1901; E. Chuard, *Arch. Science Genève*, (3), 23, 550, 1890; S. U. Pickering, *Journ. Chem. Soc.*, 95, 1409, 1909; W. C. Reynolds, *ib.*, 73, 264, 1898; F. Field, *ib.*, 14, 48, 70, 194, 1860; *Chem. News*, 2, 279, 1860; E. Brunner, *L'Inst.*, 215, 1844; M. Gröger, *Zeit. anorg. Chem.*, 24, 127, 1900; M. H. Klaproth, *Beiträge zur chemischen Kenntnis der Mineralkörper*, Berlin, 2, 287, 1797; J. A. Crowther, *Electrochem. Ind.*, 6, 120, 1908; E. E. Free, *Journ. Amer. Chem. Soc.*, 30, 1368, 1908; L. Franchet, *Bull. Soc. Philomathique*, (8), 6, 61, 1894; A. de Schulten, *Compt. Rend.*, 110, 202, 1900; 122, 1352, 1896; A. C. Becquerel, *ib.*, 1, 19, 1835; 34, 573, 1852; 44, 939, 1857; E. Rubenovitch, *ib.*, 129, 337, 1899; L. Bourgeois, *ib.*, 103, 1088, 1886; R. Wagner, *Zeit. anal. Chem.*, 6, 169, 1867; F. Millosevitch, *Atti Accad. Lincei*, (5), 15, 732, 1906; (5), 17, 80, 1908; V. Karavodine, *German Pat.*, D.R.P. 11743, 1901; A. Lismann, *ib.*, 43543, 1896; G. Kroupa, *Oester. Zeit. Berg. Hüt.*, 53, 611, 627, 1905; C. Luckow, *Zeit. Elektrochem.*, 3, 485, 1897; E. Gunther, *ib.*, 19, 239, 1913; P. N. Raikow, *Chem. Ztg.*, 28, 1247, 1904; J. Errera, *Bull. Acad. Belg.*, (5), 1, 361, 1921; H. St. C. Deville, *Ann. Chim. Phys.*, (3), 33, 75, 1851.
- ³ A. des Cloizeaux, *Manuel de minéralogie*, Paris, 1874; A. Lacroix, *Bull. Soc. Min.*, 31, 247, 1896; V. von Lang, *Phil. Mag.*, (4), 25, 432, 1863; (4), 27, 502, 1864; F. Hesseberg, *Mineralogische Notizen*, Frankfurt, 1875; A. Breithaupt, *Schweigger's Journ.*, 68, 291, 1833; *Journ. prakt. Chem.*, (1), *ib.*, 475, 1839; H. Schröder, *Neues Jahrb. Min.*, 711, 1874; F. S. Beudant, *Ann. Chim. Phys.*, (2), 38, 398, 1829; J. L. Gay Lussac, *ib.*, (2), 37, 335, 1828; V. von Zepharovitch, *Sitzber. Akad. Wien*, 51, 15, 1864; A. Wieler, *Chem. Ztg.*, 28, 1014, 1904; W. Spring, *Bull. Acad. Belgique*, (3), 16, 53, 1888; *Bull. Soc. Chim.*, (2), 50, 218, 1888; A. Heiduschka, *Arch. Pharm.*, 244, 569, 1906; K. Zenghelis, *Zeit. phys. Chem.*, 12, 313, 1893; H. Rose, *Pogg. Ann.*, 84, 466, 1851; P. E. W. Oeberg, *Ofvers. Vet. Akad. Förh.*, 8, 1885; J. Joly, *Proc. Roy. Soc.*, 41, 250, 1887; E. Dorn, *Wied. Ann.*, 66, 158, 1898; A. Voller and B. Walter, *ib.*, 61, 92, 1897; G. Césaro, *Bull. Acad. Belgique*, 1198, 1904; J. L. Smith, *Amer. Journ. Science*, (2), 20, 250, 1855.
- ⁴ A. Kenngott, *Neues Jahrb. Min.*, 302, 1867; R. Wagner, *Zeit. anal. Chem.*, 6, 169, 1867; J. L. Lassaigne, *Journ. Chim. Méd.*, 4, 312, 1848; *Journ. prakt. Chem.*, (1), 44, 247, 1848; E. E. Free, *Journ. Soc. Chem. Ind.*, 30, 1366, 1908; W. W. Skinner, *ib.*, 28, 361, 1906; H. Jahn, *Liebig's Ann.*, 28, 111, 1838; P. A. Favre, *Ann. Chim. Phys.*, (3), 10, 116, 1844; C. A. Seyler, *Analyst*, 33, 454, 1908; J. Lemberg, *Zeit. deut. geol. Ges.*, 52, 488, 1900; E. Landrin, *Compt. Rend.*, 86, 1336, 1878; D. Tommasi, *ib.*, 92, 453, 1881; A. C. Becquerel, *ib.*, 63, 5, 1866; E. Murmann, *Oester. Chem. Ztg.*, 7, 272, 1904; W. Spring, *Bull. Soc. Chim.*, (3), 3, 176, 1890; J. Peschier, *Journ. Pharm.*, 3, 610, 1820; *Repert. Pharm.*, 6, 85, 1820; G. Gore, *Proc. Roy. Soc.*, 21, 140, 1873; F. C. Phillips, *Zeit. anorg. Chem.*, 6, 251, 1894; L. Looek, *Zeit. öffentl. Chem.*, 14, 226, 1908; C. Hassack, *Dingler's Journ.*, 257, 248, 1885; E. C. Franklin and C. A. Kraus, *Amer. Chem. Journ.*, 20, 827, 1898; J. Schröder, *Reaktionen von Metallsalzen in Pyridin*, Griessen, 20, 1901; A. Naumann, *Ber.*, 37, 4610, 1904; H. Ost, *ib.*, 23, 1025, 3003, 1890; Kalle and Co., *German Pat.*, D.R.P. 171938, 1901; M. Gröger, *Zeit. anorg. Chem.*, 24, 127, 1900; R. Luther and B. Krsnjavy, *ib.*, 46, 172, 1905; A. Callegari, *Gazz. Chim. Ital.*, 36, ii, 63, 1906; A. Soldiani, *ib.*, 6, 322, 1876; J. W. Döbereiner, *Schweigger's Journ.*, 9, 9, 1813; G. Weltzger, *ib.*, 50, 103, 1827.
- ⁵ W. Haidinger, *Pogg. Ann.*, 11, 173, 1827; J. R. Blum, *Die Pseudomorphosen des Minerals*, Stuttgart, 1879; *Neues Jahrb. Min.*, 805, 1868; G. Sillem, *ib.*, 385, 1848; 385, 1851;

513, 1852; C. F. Peters, *ib.*, 278, 1861; F. Wibel, *ib.*, 401, 1865; E. Schleiden, *ib.*, 34, 1834; F. Sandberger, *ib.*, i, 179, 1886; V. Hilber and J. A. Ippen, *Neues Jahrb. Min. B.B.*, 18, 52, 1904; J. Romberg, *ib.*, 9, 346, 1895; R. C. Hills, *Proc. Colorado Scient. Soc.*, 3, 258, 1890; R. Pearce, *ib.*, 2, 134, 150, 1890; E. Döll, *Verh. geol. Reichsanst.*, Wien, 88, 1899; H. Buttgenbach, *Ann. Soc. Géol. Belgique*, 25, 129, 1899; H. F. Collins, *Min. Mag.*, 10, 17, 1892; H. A. Miers, *ib.*, 11, 263, 1897; E. Hall, *Journ. Proc. Roy. Comm. N.S.W.*, 29, 416, 1895; A. F. Rogers, *Amer. Geol.*, 31, 43, 1903; G. Tschermak, *Tschermak's Mit.*, 39, 1873; *Sitzber. Akad. Wien*, 53, 526, 1866; N. von Kokscharoff, *Proc. Russ. Min. Soc.*, 7, 2, 1872; P. Jeremejeff, *ib.*, 31, 398, 1899; E. Söchting, *Zeit. deut. geol. Ges.*, 9, 16, 1857; L. Buchrucker, *Zeit. Kryst.*, 19, 153, 1891; G. Ochsensius, *Chem. Ztg.*, 23, 669, 1899.

⁶ S. F. Glinka, *Proc. Russ. Min. Soc.*, 33, 468, 1901; *Centr. Min.*, 231, 1901; C. F. Zinken, *Berg. Hütt. Ztg.*, 1, 397, 1842; A. Raimondi, *Minéraux du Pérou*, Paris, 135, 1878; A. Damour, *Bull. Soc. Min.*, 1, 130, 1878.

⁷ J. F. W. Widenmann, *Bergm. Journ.*, 346, 1791; M. H. Klaproth, *Beiträge zur chemischen Kenntnis der Mincralkörper*, Berlin, 1, 14, 1795; 4, 279, 1807; A. Stütz, *Einricht. Nat. Wien*, 49, 1798; F. S. Beudant, *Traité élémentaire de minéralogie*, Paris, 464, 1824; J. N. von Fuchs, *Schweigger's Journ.*, 24, 373, 1818; R. Brandes, *ib.*, 30, 385, 1820; C. F. Rammelsberg, *Pogg. Ann.*, 64, 260, 1845; *Handbuch der Mineralchemie*, Leipzig, 2, 245, 1875; J. L. Smith and G. J. Brush, *Amer. Journ. Science*, (2), 16, 370, 1853; J. L. Smith, *ib.*, (2), 20, 250, 1855; L. J. Igelström, *Journ. prakt. Chem.*, (1), 64, 252, 1855; L. N. Vauquelin, *Ann. Mus. Hist. Nat.*, 20, 1, 1813; R. Phillips, *Journ. Roy. Inst.*, 4, 273, 1818; F. Wibel, *Neues Jahrb. Min.*, 242, 1873; F. Sandberger, *ib.*, i, 179, 1886; A. Scacchi, *Spettatore di Vesuvio et dei Campi Flegrei*, Napoli, 1887; G. Tschermak, *Lehrbuch der Mineralogie*, Wien, 1905; A. H. Church, *Journ. Chem. Soc.*, 22, 24, 1869.

⁸ H. Debray, *Compt. Rend.*, 49, 218, 1859; A. C. Becquerel, *ib.*, 63, 1, 1866; 87, 585, 1878; L. M. Michel, *Bull. Soc. Min.*, 13, 139, 1890; F. Millosevitch, *Atti Accad. Lincei*, (5), 15, 732, 1906; (5), 17, 80, 1908; F. Wibel and E. Tüngel, *Ber.*, 4, 138, 1871; R. Phillips, *Journ. Roy. Inst.*, 4, 273, 1818; S. Meunier, *Les méthodes de synthèse en minéralogie*, Paris, 1891; F. Fouqué and A. Michel-Lévy, *Synthèse des minéraux et des roches*, Paris, 1882.

⁹ J. L. Smith, *Amer. Journ. Science*, (2), 20, 250, 1855; P. Groth, *Chemische Krystallographie*, Leipzig, 2, 216, 1908; H. Rose, *Pogg. Ann.*, 84, 484, 1851; R. Handmann, *Zur Kenntnis der Phosphoreszenzerscheinungen einiger Minerale und Gesteine*, Münster, 56, 1910; V. Agafonoff, *Proc. Russ. Min. Soc.*, 39, 497, 1902; F. Field, *Journ. Chem. Soc.*, 14, 194, 1860; *Chem. News*, 2, 279, 1860; H. Schröder, *Neues Jahrb. Min.*, 712, 1874.

¹⁰ G. Sillem, *Neues Jahrb. Min.*, 513, 1852; R. Blum, *Die Pseudomorphosen des Mineralreichs*, Leipzig, 1879; E. Döll, *Verh. geol. Reichsanst. Wien*, 88, 1899; L. Buchrucker, *Zeit. Kryst.*, 19, 153, 1891; W. S. Yeates, *Amer. Journ. Science*, (3), 38, 405, 1889; A. Breithaupt, *Berg. Hütt. Ztg.*, 11, 101, 1852; 24, 310, 1865.

¹¹ C. Bischof, *Schweigger's Journ.*, 64, 72, 1832; C. F. Buchholz, *Beiträge zur Erweiterung und Berichtigung der Chemie*, Erfurt, 1, 92, 1799; D. W. Horn, *Amer. Chem. Journ.*, 39, 215, 1903; P. A. Favre, *Ann. Chim. Phys.*, (3), 10, 116, 1844; P. Cazeneuve, *Compt. Rend.*, 89, 525, 1879; E. J. Maumené, *ib.*, 95, 225, 1882; E. Bronnert, M. Frémery, and J. Urban, *German Pat.*, D.R.P. 119230, 1900; F. Ephraim, *Ber.*, 52, 940, 1919.

¹² J. J. Berzelius, *De l'emploi du chalumneau dans les analyses chimiques et les déterminations minéralogiques*, Paris, 1821; A. C. Becquerel, *Traité expérimental de l'électricité et du magnétisme*, Paris, 2, 86, 1855; *Compt. Rend.*, 34, 573, 1852; 36, 209, 1853; H. Debray, *ib.*, 49, 218, 1859; H. St. C. Deville, *Ann. Chim. Phys.*, (3), 33, 75, 1851; (3), 35, 460, 1852; H. Struve, *Proc. Russian Min. Soc.*, 100, 1851; J. G. Gentele, *Oefvers. Vet. Akad. Förh.*, 259, 1851; M. Gröger, *Ber.*, 34, 431, 1901; *Zeit. anorg. Chem.*, 24, 131, 1900; P. Groth, *Chemische Krystallographie*, Leipzig, 2, 220, 1908; C. F. Rammelsberg, *Die neuesten Forschungen in der Krystallographischen Chemie*, Leipzig, 118, 1857; S. U. Pickering, *Journ. Chem. Soc.*, 95, 1409, 1909; M. P. Applebey and K. W. Lane, *ib.*, 113, 609, 1918; W. C. Reynolds, *ib.*, 73, 266, 1898; T. B. Wood and H. O. Jones, *Proc. Cambridge Phil. Soc.*, 14, 174, 1907; H. N. McCoy and C. D. Test, *Journ. Amer. Chem. Soc.*, 33, 473, 1911.

¹³ J. M. Haussmann, *Scherer's Journ.*, 4, 579, 1800; T. B. Wood and H. O. Jones, *Proc. Cambridge Phil. Soc.*, 14, 174, 1907; J. W. Turrentine, *Journ. Phys. Chem.*, 12, 451, 1908; H. St. C. Deville, *Ann. Chim. Phys.*, (3), 33, 102, 1851; H. Debray, *Compt. Rend.*, 49, 218, 1859; W. C. Reynolds, *Journ. Chem. Soc.*, 73, 262, 1898; M. Gröger, *Ber.*, 34, 429, 1901; H. Ost, *ib.*, 23, 1035, 1890.

§ 29. Copper Nitrates

In his *Furnis novis philosophicis* (Amstelodami, 1648), J. R. Glauber described a dark green mass which he prepared by evaporating a soln. of copper in nitric acid. R. Boyle¹ also described the crystals which he obtained in a similar manner, and in 1685, he noticed that the soln. coloured a flame blue and green. F. Förster and F. Blankenberg found that an ammoniacal soln. of cupric nitrate

is reduced by copper almost completely to the cuprous salt, when air is excluded. There is probably a state of equilibrium between cupric and cuprous ammonio-nitrates. According to J. Sloan, when a soln. of cupric nitrate in liquid ammonia is left in contact with copper foil until the soln. becomes colourless, the salt, **cuprous ammino-nitrate**, $\text{CuNO}_3 \cdot 2\text{NH}_3$, is formed. F. Ephraim² also prepared this salt and noted that while the cuprous halides form triamines, the nitrate and thiocyanate form diammines, and cuprous cyanide only forms a monamine. If the ammonia is allowed to evaporate gradually, **cuprous nitrate**, CuNO_3 , mixed with a little cupric nitrate is formed. Cuprous nitrate rapidly oxidizes when exposed to air. The action of nitric acid on copper has been discussed in connection with the metal. A soln. of the nitrate is best made by the action of dil. nitric acid on the metal, on the oxide, hydroxide, or carbonate. According to W. Jäger, a litre of $N\text{-HNO}_3$ dissolves 0.4802 gram-atom of copper, forming the nitrate. According to T. Graham, a basic nitrate is formed when cupric oxide is drenched with conc. nitric acid, even though the acid be in excess. The resulting green powder is to a large extent insoluble in water. With nitric acid of sp. gr. 1.42, cupric oxide is wholly converted into the nitrate. W. N. Hartley made a soln. of cupric nitrate for his spectroscopic work, by digesting 100 c.c. of $2N\text{-HNO}_3$ with cupric carbonate for two or three days. When the soln. neutral to litmus was diluted to 200 c.c. with distilled water, and allowed to stand for some months, a deposit of either the hydroxide or carbonate is formed—most probably the former.

According to T. Graham, the soln. of copper in dil. nitric acid is at first green, but it changes to a blue colour when it has stood for some time—possibly owing to the formation of a higher hydrate. When the soln. is conc. by evaporation, T. Graham noted that dark blue prismatic crystals of **trihydrated cupric nitrate**, $\text{Cu}(\text{NO}_3)_2 \cdot 3\text{H}_2\text{O}$, and paler blue rhomboidal plates of **hexahydrated cupric nitrate**, $\text{Cu}(\text{NO}_3)_2 \cdot 6\text{H}_2\text{O}$, are formed. R. Funk also prepared crystals of **enneahydrated cupric nitrate**, $\text{Cu}(\text{NO}_3)_2 \cdot 9\text{H}_2\text{O}$. The temp. range of stability of these three hydrates is indicated in Fig. 39. The trihydrated salt was prepared by J. H. Gladstone, H. C. Jones and H. P. Bassett, and C. F. Gerhardt. The latter thought that the salt was tetrahydrated, but T. Graham's analyses showed that, owing to the hygroscopicity of the salt, high results were obtained in the determination of the combined water. J. Ordway, and R. Funk showed that the trihydrated salt is obtained when the salt is allowed to crystallize from its soln. at a temp. over 26° . A. Ditte obtained the same salt by heating the hexahydrated salt until red fumes appear, and then crystallizing the product from a hot soln. in fuming nitric acid; H. Lescœur heated the hexahydrate to 65° —J. Ordway says 26.4° ; T. Graham converted the hexahydrate to the trihydrate by keeping the former in vacuo over sulphuric acid for a night; if kept longer, more water is slowly given off. According to E. Mitscherlich, the trihydrate is precipitated as a crystalline powder when nitric acid of sp. gr. 1.522 is added to a sat. aq. soln. The hexahydrated salt was prepared by J. L. Proust, T. Graham, H. Lescœur, and by H. C. Jones and H. P. Bassett—the latter by cooling a soln. of the salt between 0° and -10° ; and they also obtained the enneahydrate by cooling the soln. between -20° and -24° . R. Funk showed that the enneahydrate is obtained by suction from the melting cryohydrate which freezes at -24° . According to A. Ditte, anhydrous cupric nitrate, $\text{Cu}(\text{NO}_3)_2$, can be obtained by cooling a soln. of the hydrated salt in hot fuming nitric acid which has

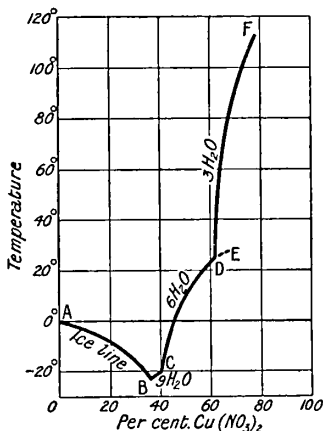

FIG. 39.—Solubility Curve of Cupric Nitrate.

been heated until red fumes appear. A. Guntz and M. Martin used a similar process. Anhydrous nitrates of the heavy metals—manganese, copper, nickel, cobalt, etc.—have been prepared by the action of nitric anhydride or of a soln. of this compound in nitric acid, upon the hydrated salts of the metals. The product is white with a green or blue tinge.

L. Playfair and J. P. Joule found the sp. gr. of the trihydrate is 2.047 (3.9°). The cryohydric point is -24° ; the transformation temp. of the ennea- to the hexahydrate is -20.5° ; of the hexa- to the tri-hydrate about 24.5° ; and the metastable m.p. of the hexahydrate, 26.4° . A. Guntz and M. Martin say the anhydrous salt begins to decompose between 155° and 160° . According to J. Ordway, the trihydrate melts at 114.49° , freezes at 95.56° , and boils at 170° , with the evolution of nitric acid, and the formation of a basic salt; T. Graham noted the formation of a basic salt at 65° . The trihydrate has a caustic metallic taste and cauterizes the skin. According to J. L. Proust, the hexahydrate melts at 38° ; R. Funk, and J. Ordway give 26.4° , at which temp. the salt decomposes into the trihydrate and water. According to T. Graham, the hexahydrate rapidly loses half of its combined water in vacuo over sulphuric acid; the remaining water is retained more strongly because only a small proportion is lost in two days. According to P. Sabatier, the hexahydrate can form the trihydrate by efflorescence in air. The vap. press. of a soln. sat. at 20° is 7.9 mm. The cupric nitrates are all deliquescent. J. Thomsen found the heat of soln. of the hexahydrate in 400 mols of water is -10.71 Cals. P. Sabatier gives -10.5 Cals.; he also gives for the heat of soln. of the trihydrate -2.5 Cals. at about 15° ; and for the heat of hydration $\text{Cu}(\text{NO}_3)_2 \cdot 3\text{H}_2\text{O}_{\text{solid}} + 3\text{H}_2\text{O}_{\text{solid}} = \text{Cu}(\text{NO}_3)_2 \cdot 6\text{H}_2\text{O}_{\text{solid}} + 3.9$ Cals. or 1.3 Cals. per mol of water. A. Guntz and M. Martin give 10.47 cal. for the heat of soln. of the anhydrous salt. J. Thomsen found the heat of formation of the salt in aq. soln. is given as $(\text{Cu}, \text{O}, \text{N}_2\text{O}_{5\text{aq.}}) = 52.41$ Cals. and $(\text{Cu}, 2\text{N}, 6\text{O}, 6\text{H}_2\text{O}) = 92.9$ Cals. J. Thomsen found the heat of dilution of a soln. of a mol of cupric nitrate in 10 mols of water with n more mols of water:

n	.	.	.	12	15	20	50	100	200
Cals.	.	.	.	474	744	940	904	776	729

R. Funk's values for the solubility S of the ennea- and hexa-hydrates, expressed in per cent. $\text{Cu}(\text{NO}_3)_2$, are:

S	.	-23°	-21°	-20°	-21°	-10°	0°	10°	20°	26.4°
		36.08	37.38	40.92	39.52	42.08	45.00	48.79	55.58	63.39
Solids		$\text{Cu}(\text{NO}_3)_2 \cdot 9\text{H}_2\text{O}$			$\text{Cu}(\text{NO}_3)_2 \cdot 6\text{H}_2\text{O}$					

These results are plotted in Fig. 39. The corresponding numbers for the trihydrate are:

S	.	25°	30°	40°	50°	60°	70°	80°	114.5°
		60.01	60.44	61.51	62.62	64.17	65.79	67.51	77.59

E. Mitscherlich found the salt to be soluble in nitric acid, but it is precipitated from its sat. soln. by nitric acid, as indicated above. F. Palm has also studied the reaction. According to A. A. Noyes and A. A. Blanchard, a soln. of 48 grms. of the salt in 10 c.c. of alcohol is pale blue, and green when diluted with five times its vol. of water.

The specific gravity of soln. of cupric nitrate has been determined by B. Franz³ at 17.5° ; C. Bender at 15° ; by J. H. Hassenfratz at 12.5° ; by H. C. Jones and H. P. Bassett at 0° ; and H. C. Jones and J. N. Pearce at 0° . The results by J. H. Hassenfratz are:

Per cent. $\text{Cu}(\text{NO}_3)_2$.	1	5	10	20	30	40	50	56
Sp. gr.	.	1.0059	1.0320	1.0655	1.1350	1.2320	1.3320	1.4440	1.5205

E. Irueste found that if D and D_0 respectively denote the sp. gr. of a soln. of cupric nitrate, and of water, at 15° , the conc. of a gram of the soln. is $1.12679(D - D_0)$

$-0.25321(D-D_0)^2$. J. Traube calculated the **molecular solution volume** from F. Kohlrausch's measurements of the sp. gr. ($15^\circ/4^\circ$), where for soln. with 5, 25, and 35 per cent. of $\text{Cu}(\text{NO}_3)_2$, the sp. gr. was respectively 1.043, 1.248, and 1.377, and the mol. soln. vol., 29.8, 38.0, 40.5. M. Simon found the capillary rise for a sat. soln. to be 1.012 (water unity). S. Arrhenius has measured the **viscosity** of aq. soln. of cupric nitrate, and J. Wagner found at 25° of N -, $\frac{1}{2}N$ -, $\frac{1}{4}N$ -, and $\frac{1}{8}N$ -soln. to be respectively 1.1792, 1.0802, 1.0400, and 1.0179 (water unity). J. C. G. de Marignac found the **specific heat** of soln., between 18° and 50° , with 187.3 gram-eq. of the salt in 50, 100, and 200 c.c. of water, is respectively 0.8256, 0.9475, and 0.9882; and the **molecular heat**, 898, 1788, and 3588. W. Beetz found the **heat conductivity** between 8° and 14° for soln. of sp. gr. 1.187 and 1.455 to be respectively 1.0242 and 0.9782 (water unity); and between 28° and 38° , for soln. of sp. gr. 1.197 and 1.455, respectively 1.0000 and 0.8504 (water unity). F. Rüdorff, H. C. Jones with F. H. Getman, H. P. Bassett, and J. N. Pearce have measured the **lowering of the freezing point**. For soln. of 0.0591 mol per litre, the mol. depression is 5.52; and for soln. with 2.3630 mols per litre, 9.26. A. J. Rossi found the **osmotic pressure** of soln. with 0.5 mol per litre to be greater than with calcium or strontium nitrates.

C. Chéneveau, and H. C. Jones and F. H. Getman have measured the **index of refraction** of soln. of cupric nitrate; the latter find for soln. with 0.0591, 0.4726, and 1.1815 mol per litre, these indices are respectively 1.32751, 1.32979, and 1.35961. The **absorption spectra** of soln. of cupric nitrate have been studied by T. Ewan—*vide* cupric chloride. According to E. Franke, conc. aq. soln. of the salt are much more ionized than corresponding soln. of cupric sulphate. The **electrical conductivity** has been measured by H. C. Jones with F. H. Getman, A. P. West, H. P. Bassett, J. N. Pearce, E. Franke, A. C. Becquerel, and E. Bouty. For soln. with a mol. of the salt in v litres, the molecular conductivities μ at 0° and 35° , and the degrees of ionization α , are:

	v	2	8	16	32	128	512	1024
0°	μ	69.38	86.48	93.0	99.15	109.0	117.7	119.8
	α	57.9	72.2	77.6	82.8	91.0	98.2	100.0
35°	μ	147.1	188.5	204.0	219.9	245.0	266.6	271.7
	α	54.1	69.4	75.1	80.9	90.2	98.0	100.0

The corresponding **temperature coefficients** have also been calculated. H. Herwig found that raising the *pressure* did not affect the resistance of soln. of cupric nitrate. The **transport numbers** have been measured by G. Wiedemann, A. Chassy, and by G. Carrara. According to H. C. Jones and J. N. Pearce if n mols of $\text{Cu}(\text{NO}_3)_2$ are dissolved in a litre of water, there will be m mols of solvate water per mol of the salt:

n	0.025	0.05	0.25	0.5	0.75	0.935	1.5	2.0
m	195.2	48.7	22.4	22.5	22.15	21.3	18.38	17.32

A. Renard, and H. Jahn have studied the electrolysis of soln. of cupric nitrate. C. W. Bennett and C. O. Brown studied the potential of cells with a rotating anode—*vide* cupric sulphate. O. Liebknecht and A. P. Wills,⁴ and G. Chéneveau respectively found the **magnetic susceptibility** to be 8.7×10^{-6} and 9.1×10^{-6} mass units.

The salt has strong oxidizing properties which are dependent on the ease with which it is decomposed. It is accordingly used as an oxidizing agent in dyeing and in calico printing.⁵ L. V. Brugnatelli noted that when cupric nitrate is projected on red-hot charcoal there is a feeble detonation; and B. Higgins found that if some crystals are wrapped in tin foil, and rubbed, decomposition sets in and the accompanying rise of temp. may suffice to cause the emission of sparks. J. Priestley mentioned that paper soaked in the salt and dried readily inflames. According to I. Corne, cupric nitrate oxidizes phosphorus to hypophosphoric acid, $\text{H}_4\text{P}_2\text{O}_6$.

According to N. P. Wassilief, cupric nitrate reacts very slowly with benzene at 100° , but faster at a higher temp. B. Lachowicz found that cupric nitrate

readily unites with ammonia, and with the amines of the fatty acids, pyridine, piperidine, quinoline, aniline, and toluidine; and not so readily with dimethyl aniline, and methylaniline. A. W. Speransky and E. G. Goldberg studied the electrolysis of pyridine soln.

E. C. Franklin and C. A. Kraus⁶ studied the electrical conductivity of soln. of the salt in liquid ammonia. J. J. Berzelius, R. Kane, and P. Pudschies prepared **cupric tetrammino-nitrate**, $\text{Cu}(\text{NO}_3)_2 \cdot 4\text{NH}_3$, by saturating a soln. of cupric nitrate with ammonia. The precipitate which is at first formed redissolves, and the liquid deposits crystals of the salt on cooling. D. W. Horn recommended mixing a hot soln. of 10 grms. of hexahydrated cupric nitrate with 8 c.c. of water and 25 c.c. of aqua ammonia, of sp. gr. 0.9, and shaking the mixture till all is dissolved. On cooling, the crystals which separate are dried by press. between filter paper, and standing in a desiccator over potassium hydroxide. The blue needle-like crystals belong to the rhombic system, and J. C. G. de Marignac found the axial ratios $a : b : c = 0.5475 : 1 : 0.6350$. R. Kane showed that when the crystals are heated, they lose traces of ammonia but no water, and the angles may have blackened tips due to the formation of cupric oxide. The crystals are readily soluble in water from which J. J. Berzelius crystallized the salt unchanged. According to F. Ephraim, the deep blue tetrammino-salt is converted into a similarly coloured hexammino-salt below 15° , and decomposes above 205° into indefinite products. E. Rosenbohm found the magnetic susceptibility of the crystals of the tetrammino-nitrate to be 5.51×10^{-6} vol. units, and 1409×10^{-6} mass units. According to D. W. Horn, the crystals of the tetrammino-nitrate are soluble in approximately their own weight of liquid ammonia, forming **cupric pentammino-nitrate**, $\text{Cu}(\text{NO}_3)_2 \cdot 5\text{NH}_3$, which decomposes: $\text{Cu}(\text{NO}_3)_2 \cdot 5\text{NH}_3 = \text{NH}_3 + \text{Cu}(\text{NO}_3)_2 \cdot 4\text{NH}_3$ between 15.30° and 15.32° at 760 mm. press. D. W. Horn also prepared a still more complex salt $4\text{Cu}(\text{NO}_3)_2 \cdot 23\text{NH}_3$ —possibly *cupric hexammino-nitrate*, $\text{Cu}(\text{NO}_3)_2 \cdot 6\text{NH}_3$ —by the action of liquid ammonia on the tetrammino-salt. It rapidly loses ammonia when exposed to air, and its dissociation temp. is 15° at 760 mm. press. If a mixed soln. of cupric and ammonium nitrates be evaporated, decomposition attended by violent detonation occurs at a certain stage of the conc. F. Förster and F. Blankenberg found that cupric nitrate, in ammoniacal soln., is reduced to cuprous nitrate by copper.

J. Priestley⁷ mentioned the formation of a blue precipitate when a soln. of cupric nitrate is heated, and the redissolution of the precipitate when the mixture is allowed to stand in the cold; the precipitate appeared again as at first by re-heating the soln. J. L. Proust obtained a similar crystalline precipitate of the composition $67\text{CuO} \cdot 16\text{N}_2\text{O}_5 \cdot 17\text{H}_2\text{O}$ —possibly $4\text{CuO} \cdot \text{N}_2\text{O}_5 \cdot \text{H}_2\text{O}$ or $\text{Cu}_4\text{N}_2\text{O}_9 \cdot 3\text{H}_2\text{O}$, or $\text{Cu}(\text{NO}_3)_2 \cdot 3\text{Cu}(\text{OH})_2$, because L. Bourgeois found that bluish-green crystals of **cupric trihydroxy-nitrate** are formed by evaporating an aq. soln. of cupric nitrate on a water-bath, and washing out the soluble matter with water. A basic cupric nitrate was prepared by J. L. Proust, C. F. Gerhardt, T. Graham, and L. Grünhut by heating cupric nitrate to about 170° , and extracting the mass with water. In all these cases the hydrolysis of an aq. soln. of cupric nitrate occurs, which is more marked the higher the temp.

J. L. Proust, F. Field, and E. Reindel prepared basic cupric nitrate by treating a soln. of cupric nitrate with alkali hydroxide insufficient for complete precipitation; C. F. Gerhardt and H. Kühn used ammonium hydroxide, and J. Habermann considered that the pale blue granular product obtained by dropping dil. aq. ammonia into a boiling conc. soln. of cupric nitrate, cooling the mixture, washing the precipitate by suction with cold water before blackening begins, and drying in a desiccator over quicklime, has the composition $\text{Cu}(\text{NO}_3)_2 \cdot \text{Cu}(\text{OH})_2 \cdot \text{CuO}$, but it is usually regarded as **cupric trihydroxy-nitrate**, $\text{Cu}(\text{NO}_3)_2 \cdot 3\text{Cu}(\text{OH})_2$. L. Bourgeois heated a soln. of cupric nitrate with urea in a sealed tube at 130° . J. H. Gladstone prepared the basic nitrate as an amorphous mass by treating cupric nitrate with the hydroxide; while P. Sabatier used $4\text{CuO} \cdot \text{H}_2\text{O}$ (cupric oxide would not do), and obtained a green micaceous powder. N. Athanasescu boiled a conc. aq.

soln. of cupric nitrate for several hours with cupric carbonate, and then heated the mixture in a sealed tube for several hours at 300° and obtained small emerald-green crystals of the basic nitrate. L. Bourgeois, and H. L. Wells and S. L. Penfield prepared a variety of the basic salt $\text{Cu}_4\text{N}_2\text{O}_9 \cdot 3\text{H}_2\text{O}$ in dark green monoclinic plates by boiling a soln. of cupric nitrate with copper, or by heating the mixture in a sealed tube at 150°. A. Mailhe found that the same basic salt could be obtained by heating a soln. of cupric nitrate with nickel oxide, hydroxide, or carbonate.

W. Spring and M. Lucion found that when cupric hydroxide is kept in contact with a soln. of potassium nitrate at 15°, basic cupric nitrate is formed which decomposes at 30°. J. Tüttscheff, and D. Strömholm boiled a soln. of ammonium nitrate with precipitated cupric oxide and obtained what they regarded as basic nitrate of the composition $12\text{CuO} \cdot 2\text{N}_2\text{O}_5 \cdot 12\text{H}_2\text{O}$, that is, $2\text{Cu}(\text{NO}_3)_2 \cdot 10\text{Cu}(\text{OH})_2 \cdot 5\text{H}_2\text{O}$. A. Vogel and C. Reischauer passed nitrous fumes, N_2O_3 , into water with cupric hydroxide in suspension, and they also boiled a mixed soln. of cupric nitrate and potassium nitrate, and obtained greenish-blue plates in both cases. F. P. Dewey treated cuprous oxide with an excess of a cold soln. of silver nitrate, and obtained the basic nitrate $\text{Cu}(\text{NO}_3)_2 \cdot 3\text{Cu}(\text{OH})_2$, *i.e.* $\text{Cu}_4\text{N}_2\text{O}_9 \cdot 3\text{H}_2\text{O}$ —H. Rose used a similar process, and C. F. Rammelsberg believed that the product had the composition $3\text{Cu}(\text{NO}_3)_2 \cdot 7\text{CuO}$, or $\text{Cu}_{10}\text{N}_6\text{O}_{25}$, but H. L. Wells and S. L. Penfield regarded the product as a mixture. G. Rousseau obtained bluish-green thin plates of basic nitrate by heating trihydrated or hexahydrated cupric nitrate between 180° and 330° with marble in a sealed tube for 24–49 hrs.; and L. Michel found that a film of crystals of this same salt are formed on the surface of Iceland spar which has been lying for a few years in a soln. of cupric nitrate. A. Casselmann, J. M. van Bemmelen, and K. Klüss obtained the basic nitrate by heating a boiling dil. soln. of cupric nitrate with formate of sodium, calcium, barium, or lead; with the acetate of potassium, sodium, copper, silver, calcium, barium, magnesium, zinc, cadmium, manganese, nickel, cobalt, or lead; or with sodium and barium propionates; or with sodium valeriate. Conversely, the same product is obtained by treating cupric acetate, propionate, or valerianate with the nitrates of the above metals excepting silver and strontium.

Cupric trihydroxynitrate, $\text{Cu}(\text{NO}_3)_2 \cdot 3\text{Cu}(\text{OH})_2$, occurs as a mineral in the copper mines at Jerome (Arizona), etc., and it was named *gerhardtite*, in honour of C. F. Gerhardt; and W. Lindgren and W. F. Hillebrand regard it as a product of the action of water on cuprififerous porphyry. Some analyses correspond with the composition: $\text{Cu}(\text{NO}_3)_2 \cdot 3\text{CuO} \cdot \text{H}_2\text{O}$, instead of $\text{Cu}(\text{NO}_3)_2 \cdot 3\text{CuO} \cdot 3\text{H}_2\text{O}$, as indicated above. H. L. Wells and S. L. Penfield assume it to be the hydrate of an hypothetical nitric acid, H_3NO_4 , $\text{H}(\text{CuOH})_2\text{NO}_4$, as indicated above. J. P. Cooke gives without any satisfactory evidence $(\text{HO})_3(\text{CuOH})_3 \cdot \text{CuO}_2 \cdot \text{N}_2\text{O}$; N. Athanasescu, and A. Werner respectively, give

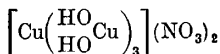
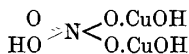

The latter thus regards the basic salt as a hexol-cupric salt.

This basic salt is dark green, emerald green, or bluish-green in colour. H. L. Wells and S. L. Penfield regard the mineral as belonging to the rhombic system with axial ratios $a : b : c = 0.92175 : 1 : 1.56117$, and, as indicated above, they prepared a monoclinic variety; the hardness is 2, and the sp. gr. 3.41–3.426; L. Bourgeois gives 3.41. According to T. Graham, very little decomposition occurs at the m.p. of lead; at higher temp. nitrogen oxides, oxygen, and water are given off. N. Athanasescu says that water begins to come off at 160°–165°, and nitric oxide at 175°; at the same time the salt begins to blacken. L. Grünhut found that a prolonged heating at 200° gives cupric oxide. The basic salt is stable in air; insoluble in water; and soluble in dil. acids. A. Casselmann found that the precipitated salt slowly becomes brown on standing under water, and finally black; and J. M. van Bemmelen noted that the basic salt becomes grey when boiled with

water. G. Rousseau and G. Tité heated the salt with water in a sealed tube at 160° for 20 hrs., and found it decomposes completely into cupric oxide and nitric acid. J. M. van Bemmelen decomposed the salt into cupric hydroxide by treating it with alkali hydroxide. G. Rousseau and G. Tité say that the temp. of decomposition is lower than the temp. of formation, and that the heat of formation is over 10·5 Cals., while the heat of soln. of the solid nitrate in an excess of water is 10·8 Cals. at about 100°; but P. Sabatier gives for the heat of formation $\text{Cu}(\text{NO}_3)_2 \cdot 3\text{H}_2\text{O}_{\text{solid}} + 3\text{CuO}_{\text{dry}} = 12\cdot1$ Cals. The crystals of gerhardtite have a strong negative double refraction; they have a marked pleochroism, being blue in the direction of the c-axis, and green in the direction of the other two axes.

A. Massink studied the ternary system, $\text{Cu}(\text{NO}_3)_2 - \text{NaNO}_3 - \text{H}_2\text{O}$, at 20°, and the ternary system, $\text{Cu}(\text{NO}_3)_2 - \text{CuSO}_4 - \text{H}_2\text{O}$, at 20° and 35°, but obtained no double salts; he also investigated the quaternary system, $\text{Na}_2\text{SO}_4 - \text{NaNO}_3 - \text{Cu}(\text{NO}_3)_2 - \text{CuSO}_4$, at 20°, but obtained no new complex salts. K. A. Hofmann and E. C. Marburg reported the preparation of bluish green cupric hydrazine nitrate, $\text{Cu}(\text{N}_2\text{H}_4)(\text{NO}_3)_2$, which explodes when heated or on detonation.

REFERENCES.

¹ R. Boyle, *Doubts and Experiments touching the various figures of salts*, Oxford, 1664; *An Essay of the Great Effects of even languid and unheeded motion, whereunto is annexed an experimental discourse of some little observed causes of the Insalubrity and Salubrity of the Air, and its Effects*, London, 1685.

² T. Graham, *Phil. Trans.*, 127. 47, 1837; *Phil. Mag.*, (3), 9. 26, 1836; W. N. Hartley, *Journ. Chem. Soc.*, 83. 221, 1903; W. Jäger, *Zeit. anorg. Chem.*, 27. 32, 1901; A. Ditte, *Compt. Rend.*, 89. 576, 641, 1879; *Ann. Chim. Phys.*, (5), 18. 320, 1879; H. Lescoeur, *ib.*, (7), 7. 427, 1896; C. F. Gerhardt, *ib.*, (3), 18. 178, 1846; A. Guntz and M. Martin, *Bull. Soc. Chim.*, (4), 5. 1004, 1909; J. Ordway, *Amer. Journ. Science*, (2), 27. 17, 1859; L. Playfair and J. P. Joule, *Mem. Chem. Soc.*, 2. 401, 1845; 3. 57, 1848; H. C. Jones and H. P. Bassett, *Amer. Chem. Journ.*, 34. 295, 1905; R. Funk, *Zeit. anorg. Chem.*, 20. 412, 1899; *Ber.*, 32. 96, 1899; *Wiss. Abh. Reichsanst.*, 3. 440, 1900; W. A. Tilden, *Journ. Chem. Soc.*, 45. 266, 1884; J. H. Gladstone, *Mem. Chem. Soc.*, 3. 480, 1848; J. Thomsen, *Journ. prakt. Chem.*, (2), 12. 271, 1875; (2), 17. 165, 1878; *Ber.*, 12. 2062, 1879; P. Sabatier, *Compt. Rend.*, 125. 303, 1897; E. Mitscherlich, *Pogg. Ann.*, 18. 152, 1830; F. Förster and F. Blankenberg, *Ber.*, 39. 4435, 1906; J. Sloan, *Journ. Amer. Chem. Soc.*, 32. 972, 1910; F. Ephraim, *Ber.*, 52. 236, 1919; A. A. Noyes and A. A. Blanchard, *Journ. Amer. Chem. Soc.*, 22. 726, 1901.

³ B. Franz, *Journ. prakt. Chem.*, (2), 5. 296, 1872; M. Simon, *Ann. Chim. Phys.*, (3), 32. 5, 1851; H. C. Jones and H. P. Bassett, *Amer. Chem. Journ.*, 33. 578, 1905; H. C. Jones and J. N. Pearce, *ib.*, 38. 718, 1908; H. C. Jones and F. H. Getman, *ib.*, 31. 328, 1904; H. C. Jones and A. P. West, *ib.*, 34. 410, 1905; J. H. Hassenfratz, *Ann. Chim. Phys.*, 28. 281, 1786; 29. 305, 1786; C. Chéneveau, *Compt. Rend.*, 138. 1438, 1904; A. Renard, *ib.*, 101. 747, 1885; J. C. G. de Marignac, *Ann. Chim. Phys.*, (5), 8. 410, 1876; E. Bouty, *ib.*, (6), 14. 73, 1888; A. C. Becquerel, *ib.*, (3), 17. 267, 1846; G. Wiedemann, *Pogg. Ann.*, 99. 177, 1856; A. Chassy, *Ann. Chim. Phys.*, (6), 21. 241, 1890; G. Carrara, *Gazz. Chim. Ital.*, 33. i, 241, 1903; E. Irueste, *Ann. Soc. Espan. Fis. Quim.*, 13. 462, 1915; W. Beetz, *Wied. Ann.*, 7. 435, 1879; J. H. Long, *ib.*, 11. 37, 1880; C. C. Bender, *ib.*, 20. 560, 1883; H. Jahn, *ib.*, 28. 498, 1886; A. J. Rossi, *Gazz. Chim. Ital.*, 31. ii, 501, 1901; E. Franke, *Zeit. phys. Chem.*, 16. 473, 1895; J. Wagner, *ib.*, 5. 31, 1890; S. Arrhenius, *ib.*, 1. 294, 1887; F. Palm, *Monit. Scient.*, (3), 3. 1102, 1873; E. Mitscherlich, *Pogg. Ann.*, 18. 152, 1830; H. Herwig, *ib.*, 160. 110, 1877; A. A. Noyes and A. A. Blanchard, *Journ. Amer. Chem. Soc.*, 22. 726, 1901; C. W. Bennett and C. O. Brown, *Journ. Phys. Chem.*, 17. 373, 1914.

⁴ O. Liebknecht and A. P. Wills, *Ann. Physik*, (4), 1. 178, 1900; G. Chéneveau, *Journ. Phys.*, 9. 163, 1910.

⁵ L. V. Brugnatelli, *Ann. Chim. Phys.*, 33. 113, 1799; B. Higgins, *Phil. Trans.*, 63. 137, 1773; 68. 171, 1778; N. P. Wassilief, *Journ. Russ. Phys. Chem. Soc.*, 34. 33, 1902; A. W. Speransky and E. G. Goldberg, *ib.*, 32. 797, 1900; B. Lachowicz, *Journ. prakt. Chem.*, (2), 39. 99, 1889; *Monatsh.*, 10. 896, 1889; J. Priestley, *Experiments and Observations on different kinds of Air*, Birmingham, 3. 203, 1790.

⁶ E. C. Franklin and C. A. Kraus, *Amer. Chem. Journ.*, 24. 83, 1900; D. W. Horn, *ib.*, 37. 620, 1907; 39. 216, 1908; C. F. Rammelsberg, *Handbuch der Krystallographisch-physikalischen Chemie*, Leipzig, 1. 375, 1881; J. C. G. de Marignac, *Ann. Mines*, (5), 12. 23, 1857; R. Kane, *Ann. Chim. Phys.*, (2), 72. 273, 1839; J. J. Berzelius, *Pogg. Ann.*, 1. 28, 1824; E. Rosenbohm, *Zeit. phys. Chem.*, 93. 693, 1919; P. Pudschies, *Zur Kenntnis der Kupferammoniaksalze*, Strassburg, 1907; I. Corne, *Chem. Centr.*, 53. 611, 1882; F. Ephraim, *Ber.*, 52. 940, 1919; F. Förster and F. Blankenberg, *ib.*, 39. 4435, 1906.

⁷ G. Rousseau, *Compt. Rend.*, **111**, 38, 1890; P. Sabatier, *ib.*, **125**, 102, 1897; G. Rousseau and G. Tité, *ib.*, **113**, 192, 1891; **115**, 174, 1892; C. F. Gerhardt, *ib.*, **22**, 961, 1846; *Ann. Chim. Phys.*, (3), **18**, 178, 1846; J. L. Proust, (1), **32**, 53, 1800; A. Mailhe, *ib.*, (7), **27**, 395, 1902; J. Priestley, *Experiments and Observations on different kinds of Air*, Birmingham, 3, 521, 1790; N. Athanasescu, *Bull. Soc. Chim.*, (3), **11**, 1112, 1894; L. Bourgeois, *ib.*, (3), 3, 501, 1890; L. Michel, *Bull. Soc. Min.*, **13**, 139, 1890; D. Strömholm, *Ark. Kemi.*, **2**, 16, 1906; A. Massink, *Zeit. phys. Chem.*, **92**, 351, 1917; M. Spring and M. Lucion, *Zeit. anorg. Chem.*, **2**, 214, 1892; J. M. van Bemmelen, *ib.*, **5**, 474, 1894; H. L. Wells and S. L. Penfield, *Amer. Journ. Science*, (3), **30**, 50, 1886; W. Lindgren and W. F. Hillebrand, *ib.*, (4), **18**, 448, 1904; K. Kliiss, *Liebig's Ann.*, **246**, 213, 1888; H. Rose, *Pogg. Ann.*, **101**, 513, 1857; C. F. Rammelsberg, *Ber.*, **10**, 1780, 1877; F. P. Dewey, *Journ. anal. Chem.*, **3**, 33, 1899; J. Tiittscheff, *Zeit. Chem.*, (2), **6**, 112, 1870; A. Casselmann, *Zeit. anal. Chem.*, **4**, 38, 1865; A. Vogel and C. Reischauer, *Neues Jahrb. Pharm.*, **11**, 328, 1859; F. Field, *Phil. Mag.*, (4), **24**, 123, 1862; J. H. Gladstone, *Mem. Chem. Soc.*, **3**, 480, 1848; H. Kühn, *Arch. Pharm.*, (2), **50**, 283, 1847; L. Grünhut, *Chem. Ztg.*, **18**, 447, 1894; E. Nihoul, *ib.*, **17**, 500, 1893; T. Graham, *Phil. Trans.*, **127**, 57, 1837; J. J. Berzelius, *Pogg. Ann.*, **1**, 28, 1824; J. P. Cooke, *The Principles of Chemical Philosophy*, Boston, 379, 1871; J. Habermann, *Sitzber. Akad. Wien*, **90**, 266, 1884; *Monatsh.*, **5**, 437, 1884; H. Soxhlet, *Zeit. Zuckerind.*, **28**, 373, 1878; K. A. Hofmann and E. C. Marburg, *Liebig's Ann.*, **305**, 191, 1899; E. Reindel, *Journ. prakt. Chem.*, (1), **100**, 1, 1867; A. Werner, *Ber.*, **40**, 4444, 1907.

§ 30. Copper Phosphates

No one has yet prepared *cuprous orthophosphate*, Cu_3PO_4 , although E. Péchard obtained what he regarded as *ammonium cuprous orthophosphate*, or *ammonium phosphato-cuprite*, by adding hydroxylamine to cupric sulphate until the soln. was decolorized, and then treating the mixture with a soln. of ammonium dihydrophosphate. V. Auger also claims to have made *cuprous metaphosphate* by adding metaphosphoric acid at a dull red heat to an excess of copper turnings contained in a platinum capsule provided with a lid and heated to a similar temp.; the copper dissolves with the evolution of hydrogen and the mass becomes brown. The latter is immediately oxidized by air, but if the mass is poured off from the unattacked copper into a platinum crucible and protected from air, on cooling it deposits lamellæ of copper in weight equal to that subsequently found in the residual mass in the form of cupric phosphate. The cuprous metaphosphate formed is thus stable at a red heat, but decomposes on cooling into cupric metaphosphate and copper. If the fused mass of cuprous metaphosphate dissolved in excess of metaphosphoric acid is allowed to fall in small drops into methyl chloride, transparent, vitreous, pale yellow beads of cuprous metaphosphate dissolved in excess of metaphosphoric acid are obtained. These can be kept in a sealed tube for some days, but gradually become reddish-brown and opaque. The change occurs immediately on warming.

E. Mitscherlich¹ obtained normal *cupric orthophosphate*, $\text{Cu}_3(\text{PO}_4)_2 \cdot 3\text{H}_2\text{O}$, as a bluish-green amorphous precipitate by adding an amount of diammonium, or dipotassium hydrophosphate, insufficient for complete precipitation, to the soln. of a cupric salt. J. Steinschneider used a great excess of cupric sulphate or nitrate. From the work of C. F. Rammelsberg and R. A. Metzner, the composition of the precipitate depends upon the proportions and conc. of the soln. employed.

J. Steinschneider found that in preparing cupric phosphate by the action of disodium hydrophosphate on cupric sulphate the following phosphates are formed: By employing an *excess of copper sulphate*, a double salt of the formula $3\text{Cu}_3\text{P}_2\text{O}_8 \cdot \text{Na}_2\text{H}_2\text{PO}_4$ is formed; if the copper sulphate be present in very large excess, C. F. Rammelsberg's normal phosphate, $\text{Cu}_3\text{P}_2\text{O}_8$, is formed. Both these salts, if subjected to protracted washing under press., are converted into the compound $4\text{CuO} \cdot \text{P}_2\text{O}_5$, already described by H. Debray, and C. Friedel and E. Sarasin. Sodium acetate precipitates the double salt $3\text{Cu}_3\text{P}_2\text{O}_8 \cdot \text{Na}_2\text{C}_2\text{H}_3\text{O}_2$ from the filtrate. By employing an *excess of sodium phosphate*, two double salts are formed, namely, $2\text{Cu}_3\text{P}_2\text{O}_8 \cdot \text{Na}_2\text{HPO}_4$ and $3\text{Cu}_3\text{P}_2\text{O}_8 \cdot \text{Na}_2\text{HPO}_4$; the former is formed first and is converted into the latter by continued washing. By the action of disodium hydrogen phosphate on cupric chloride, the following phosphates are formed: When an *excess of cupric chloride* is employed, the double salt $3\text{Cu}_3\text{P}_2\text{O}_8 \cdot 2\text{NaCl}$ is principally formed, although sometimes it is mixed with the phosphate, $4\text{CuO} \cdot \text{P}_2\text{O}_5$, and the oxychloride, $\text{CuO} \cdot \text{CuCl}_2$; in one case

the salt had the formula $5\text{Cu}_3\text{P}_2\text{O}_8 \cdot 3\text{NaCl}$. If an *excess of the sodium phosphate* is employed, the same phosphate, $3\text{Cu}_3\text{P}_2\text{O}_8 \cdot 2\text{NaCl}$, is formed as in the case of employing an excess of cupric chloride. By the action of the sodium phosphate on cupric nitrate, the following phosphates are obtained: By employing a slight *excess of the cupric nitrate*, the double salt $\text{Cu}_3\text{P}_2\text{O}_8 \cdot \text{NaH}_2\text{PO}_4$ is formed, whilst if the cupric nitrate is present in very large excess, the normal phosphate, $\text{Cu}_3\text{P}_2\text{O}_8$, together with a small quantity of basic cupric nitrate, is obtained. If an *excess of the sodium phosphate* is employed, a double salt of the formula $18\text{CuO} \cdot 3\text{Na}_2\text{O} \cdot 8\text{P}_2\text{O}_5$, is formed, which is decomposed by washing.

H. Rose said that if two mols of the disodium salt are used with three mols of cupric sulphate, the salt $2\text{CuHPO}_4 \cdot 3\text{H}_2\text{O}$ or $4\text{CuHPO}_4 \cdot \text{CuH}_4(\text{PO}_4)_2$ is precipitated, but the work of C. F. Rammelsberg renders this doubtful. J. Weineck's analysis makes the product a mixture and not a definite compound. A. Breithaupt and C. F. Plattner say that the emerald-green amorphous mineral *thrombolite* has the composition $2\text{CuHPO}_4 \cdot 3\text{H}_2\text{O}$, hardness 3 to 4, and sp. gr. 3.4; while A. Schrauf regards this mineral as an arsenate. H. Debray prepared the normal phosphate as a crystalline powder by dissolving the carbonate in dil. phosphoric acid, and heated the soln. to 70° ; he also heated cupric nitrate with calcium hydrophosphate below 100° . V. Augur heated cuprous chloride with phosphoric acid to 180° . It is questionable if the pure salt has yet been made.

According to H. Debray, the salt loses water and becomes brown when it is heated. According to A. Barillé, cupric phosphate is insoluble in water, but soluble in water with carbon dioxide in soln. R. M. Caven and A. Hill found that in washing the precipitate with water, the salt is hydrolyzed, and a marked hydrolysis occurs with hot water. H. Debray found the salt is rapidly hydrolyzed when heated with water in a sealed tube, forming basic phosphates several of which have been examined by J. Steinschneider, A. Reynoso, etc. According to J. Moser, cupric phosphate is soluble in nitric acid; according to H. Debray, in phosphoric acid, acetic acid, and, as B. W. Gerland also found, sulphurous acid, without forming cuprous oxide. C. Lory uses a soln. in hydrochloric acid in his process for determining bicarbonates; H. Debray also found the phosphate to be perceptibly soluble in soln. of ammonium salts; and R. M. Caven and A. Hill in soln. of cupric chloride or sulphate. It is also dissolved by a soln. of sodium thiosulphate. W. Skey and L. Grandeau obtained double phosphates by treating cupric phosphate with a soln. of potassium or ammonium magnesium phosphate. According to R. M. Caven and A. Hill, a cold soln. of potassium hydroxide produces no perceptible change, but on boiling, the precipitate becomes dark coloured, and is completely converted into cupric oxide. Cupric phosphate was found by H. Debray to be reduced to the phosphide when heated with carbon. H. N. Warren electrolyzed a soln. of cupric phosphate in phosphoric acid, and so obtained an acid of any desired sp. gr. The evaporation of a soln. of cupric phosphate furnishes a green sticky mass of uncertain composition, and labelled, according to the older chemistry books, "acid cupric phosphate," that is, *cupric hydrogen phosphate*. C. Luckow, and W. Borchers obtained a basic cupric phosphate of unknown composition by electrolyzing soln. of sodium phosphate between copper electrodes; and when the phosphate is precipitated electrolytically in a porous cell, H. N. Morse found it to form a semipermeable membrane. L. T. Wright found cupric phosphate absorbs hydrogen sulphide, and A. Colson found that the absorption by the dry salt at 0° is slow but continuous; the rate of absorption is reduced by lowering the press. and accelerated by raising the temp. J. Steinschneider found that cupric orthophosphate is decomposed quantitatively when boiled with a soln. of silver nitrate, forming cupric nitrate and silver phosphate.

It might be anticipated from the slow hydrolysis of cupric phosphate in contact with water, that many different *basic cupric phosphates* would have been reported by the early chemists who had no criterion other than analysis and the stoichio-metrical laws for recognizing chemical compounds. The phase rule test has not yet been applied. Hence, as might be anticipated, quite a number of basic cupric phosphates have been reported, and a number occur in nature as minerals, where the ratio $\text{CuO} : \text{P}_2\text{O}_5 : \text{H}_2\text{O}$ is 6 : 1 : 3; 5 : 1 : 2; 5 : 1 : 3; 4 : 1 : 1; 4 : 1 : 2; and 4 : 1 : 3.

Many are probably solid soln.; all are more or less hydrated. Perhaps the most important basic phosphate approximates in composition to **cupric hydroxyorthophosphate**, $4\text{CuO}\cdot\text{P}_2\text{O}_5\cdot\text{H}_2\text{O}$, or $\text{Cu}_3(\text{PO}_4)_2\cdot\text{Cu}(\text{OH})_2$, and its natural representative is the mineral *libethenite*. It was prepared by C. Friedel and E. Sarasin in octahedral crystals by heating cupric carbonate or cupric phosphate with dil. phosphoric acid in a sealed tube at 180° ; H. Debray heated cupric phosphate with water in a sealed tube; the formation of libethenite occurs at 100° if cupric nitrate or sulphate be also present—to get fine crystals, however, 150° is recommended—and a rather higher temp., 200° , is necessary if cupric chloride be used; and he found that libethenite is formed by heating a mixture of cupric nitrate and calcium hydrophosphate to 100° . J. Steinschneider, and R. M. Caven and A. Hill found that the same basic phosphate is obtained by boiling the normal phosphate with water, or by the prolonged washing of this salt with water at 100° until its composition is constant, and then drying the mass at 100° .

The crystals of libethenite are rhombic bipyramids, and the measurements of W. T. Schaller, and G. Melzer correspond with axial ratios $a : b : c = 0.9605 : 1 : 0.7020$. The analyses of C. F. Rammelsberg, H. Kühn, F. Field, R. Hermann, and C. Bergemann are in the main in agreement with the formula, $4\text{CuO}\cdot\text{P}_2\text{O}_5\cdot\text{H}_2\text{O}$, or $\text{Cu}_3(\text{PO}_4)_2\cdot\text{Cu}(\text{OH})_2$; which P. Groth reduces to $\text{Cu}(\text{CuOH})\text{PO}_4$, and thus regards libethenite as a basic cupric phosphate free from water. There are two more hydrated forms; one, which C. F. Rammelsberg designated *pseudo-libethenite*, has the composition $4\text{CuO}\cdot\text{P}_2\text{O}_5\cdot 2\text{H}_2\text{O}$, or $\text{Cu}_3(\text{PO}_4)_2\cdot\text{Cu}(\text{OH})_2\cdot\text{H}_2\text{O}$, in accord with the analyses of C. Berthier, and R. Rhodius. The other hydrate is called *tagilite*, and, according to A. Breithaupt, occurs in monoclinic crystals, and has the composition $4\text{CuO}\cdot\text{P}_2\text{O}_5\cdot 3\text{H}_2\text{O}$, or $\text{Cu}_3(\text{PO}_4)_2\cdot\text{Cu}(\text{OH})_2\cdot 2\text{H}_2\text{O}$, in accord with the analyses of R. Hermann and F. Field. R. Hermann found the sp. gr. of libethenite to range from 3.6 to 3.8, and that of tagilite to be 3.50; A. Breithaupt gave 4.076 for crystalline tagilite, and 3.5 for the amorphous mineral. The hardness of libethenite is 4, that of tagilite a little less. A. des Cloizeaux has measured the optical properties; the double refraction is negative. H. Debray found that water attacks the mineral with difficulty, and G. Rousseau and G. Tité that three days' heating in a sealed tube at 275° had no perceptible effect. R. M. Caven and A. Hill add that "the tenacity with which the single molecule of water remains in combination with the basic phosphate is remarkable, since a dull red heat is necessary for its elimination. The ignited precipitate, consisting of $\text{Cu}_3(\text{PO}_4)_2\cdot\text{CuO}$, was olive green in colour." It is soluble in acids and in aq. ammonia or ammonium carbonate, in a soln. of sodium hyposulphite. J. Steinschneider observed no alteration when the mineral is boiled with a soln. of silver nitrate.

There is a group of naturally occurring basic cupric phosphates called *lunnites*, which A. Schrauf has shown can all be regarded as containing varying proportions of one or more of the three minerals: *dihydrate*, $5\text{CuO}\cdot\text{P}_2\text{O}_5\cdot 2\text{H}_2\text{O}$; *ehlite*, $5\text{CuO}\cdot\text{P}_2\text{O}_5\cdot\text{H}_2\text{O}$; and *phosphochalcite*, $6\text{CuO}\cdot\text{P}_2\text{O}_5\cdot 3\text{H}_2\text{O}$. The formula for dihydrate is based on the analyses of R. Hermann, J. A. Arfvedson, H. Kühn, and A. Schrauf. The latter says the doubly refracting, dark green crystals are triclinic with axial ratios $a : b : c = 2.8252 : 1 : 1.53394$, and $\alpha = 89^\circ 29'$; $\beta = 91^\circ 0' 5'$; and $\gamma = 90^\circ 39'$; the hardness is approximately 5; the sp. gr. 4.4. The formula for ehilite is based on the analyses of A. Schrauf, who regards ehilite as a transformation product of dihydrate. The formula of phosphochalcite is based on the analyses of R. Hermann, H. Kühn, C. F. Rammelsberg, C. Bergemann, M. F. Heddle, A. H. Church, A. Schrauf, N. Story-Maskelyne and W. Flight, R. Rhodius, etc. The hardness is 4.5 to 5, and the sp. gr. 4.4. It loses no water at 200° . The variety called *pseudomalachite* has a sp. gr. 4.2, and suffers an appreciable loss of water at 200° . A. Hutchinson and A. M. Macgregor found the *cornetite* from Mkubwa (Rhodesia) has a composition approximating $\text{Cu}_3(\text{PO}_4)_2\cdot 3\text{Cu}(\text{OH})_2$. The rhombic crystals have the axial ratios $a : b : c = 0.9855 : 1 : 0.7591$; sp. gr. 4.10; and hardness 4 to 5. The optical properties agree with a mineral containing a

little cobalt (Co,Cu)(OH)(PO₄), named cornetite by H. Buttgenbach, and obtained from Katanga (Congo). G. Césaro found the axial ratios $a : b : c = 0.9844 : 1 : 0.7679$.

H. Schiff² found freshly precipitated and moist cupric phosphate dissolved slowly but completely in aq. ammonia, forming a dark blue liquid from which alcohol precipitates a dark blue syrup which soon forms greenish-blue anhydrous crystals of **cupric tetrammino-orthophosphate**, Cu₃(PO₄)₂.4NH₃. The salt can also be obtained directly by the use of alcoholic ammonia. Cupric tetrammino-orthophosphate is sparingly soluble in water; it dissolves in aqua ammonia, possibly forming, according to H. Schiff, a hexammino-complex, although only the tetrammino-salt has been isolated. R. A. Metzner obtained monoclinic prismatic crystals of a complex by similarly treating a sat. soln. of the basic phosphate in aqua ammonia. Analyses correspond with 2CuO.3P₂O₅.20NH₃.21H₂O. R. A. Metzner also obtained monoclinic crystals of the complex Cu(NH₄)₇(PO₄)₃(NH₃)₃.7H₂O by adding alcoholic ammonia to a soln. of an acid cupric phosphate in ammonia. E. J. Maumené claimed to have made 2CuO.P₂O₅.8NH₃ from an ammoniacal soln. of cupric phosphate.

According to J. Weineck,³ the well-washed precipitate obtained by mixing hot soln. of two mols of cupric sulphate with three of disodium hydrophosphate, when dried between 100° and 110°, has a composition corresponding with 2Na₂O.4P₂O₅.9CuO, and is probably a mixture of two or more salts. J. J. Berzelius and others have noted that beads of microcosmic salt, when sat. with various metallic salts, become opaque on cooling, owing to the separation of minute crystals of sodium phosphate and the metal phosphate. K. A. Wallroth has isolated these salts by dissolving metallic oxides in microcosmic salt or sodium metaphosphate at a bright red heat, and maintaining the glass in a fused condition until the crystals separate out. On cooling, the mass is digested with water, and then with dil. hydrochloric acid. With copper, a blue crystalline powder of **sodium phosphatocuprate**, or sodium cupric phosphate, is formed, Na₆Cu₃(PO₄)₄, or 2Na₃PO₄.Cu₃(PO₄)₂, which melts to a green transparent glass. L. Ouvrard obtained the same salt in dichroic prisms, probably monoclinic. If an excess of cupric oxide or sodium pyrophosphate be used, prismatic crystals of **sodium cupric phosphate**, NaCu(PO₄), with an oblique extinction, are formed. If sodium orthophosphate be employed as flux, a mixture of cupric and cuprous oxides, with some amorphous matter, is produced. C. Raspe also prepared a soluble double phosphate by melting disodium hydrophosphate with cupric and phosphoric oxides.

L. Ouvrard prepared what are said to be pale blue triclinic crystals of **potassium cupric phosphate**, KCuPO₄, by a method similar to that which he employed for the sodium salt. The crystals were similar to those of the sodium salt. L. Grandea also reported the formation of a bluish-green crystalline powder of the same compound made up of small plates, by melting cupric phosphate with an excess of dipotassium hydrophosphate. L. Ouvrard also made greenish-blue monoclinic lamellæ of **potassium triphosphatotetracuprate**, of KCuPO₄.Cu₃(PO₄)₂, by fusing cupric oxide or carbonate with potassium metaphosphate. As previously indicated, J. Steinschneider prepared salts with Cu₃(PO₄)₂:Na₂HPO₄ in the ratios 3:1, 2:1, and 1:1; and also two *sodium cupric chlorophosphates* with Cu₃(PO₄)₂:NaCl in the ratios 3:2 and 5:3, but there is nothing to show if these are really double salts, or mixed crystals (solid soln.).

Cupric pyrophosphates.—A. Schwarzenberg,⁴ A. Pahl, and J. H. Gladstone obtained blue amorphous cupric pyrophosphate—either Cu₂P₂O₇.2H₂O or Cu₂P₂O₇.2½H₂O—by adding an excess of sodium pyrophosphate to a soln. of a cupric salt; it becomes crystalline when boiled with sulphurous acid, or when precipitated from its soln. in aqua ammonia by the addition of sulphurous acid. No reduction occurs in either case. A. Pahl also precipitated the same salt from a soln. of the double sodium and cupric pyrophosphate by the addition of sulphuric or hydrochloric acid. The compound loses half its combined water at 150°, and when heated in a stream of hydrogen, it gives a sublimate of phosphorus trioxide,

and gives off phosphine and water. The residue is cupric phosphide. The salt is soluble in aqua ammonia, mineral acids, and in a soln. of sodium pyrophosphate. The deep blue colour of the ammoniacal soln. is bleached by grape sugar. According to A. Colson, the salt is decomposed by hydrogen sulphide liberating 50 Cals. of heat. A. Schwarzenberg found a boiling soln. of potassium hydroxide forms cupric oxide and potassium phosphate, while A. Stromeyer found a boiling soln. of disodium hydrophosphate forms sodium pyrophosphate and cupric orthophosphate. According to A. Pahl, if a soln. of this salt in sulphurous acid be evaporated over sulphuric acid, it forms blue crystals of the pentahydrate, $\text{Cu}_2\text{P}_2\text{O}_7 \cdot 5\text{H}_2\text{O}$; and, according to A. Wiesler, the same salt is made by mixing soln. of 15 grms. of pentahydrated cupric sulphate with one of 5 grms. sodium trimetaphosphate, evaporating in vacuo, and washing and drying the product. The salt is sparingly soluble in water, soluble in dil. acids, and when heated it becomes green without melting. According to F. W. Clarke and J. S. Diller, Mexican turquoises may be regarded as mixtures of different proportions of pentahydrated cupric pyrophosphate, $\text{Cu}_2\text{P}_2\text{O}_7 \cdot 5\text{H}_2\text{O}$, and aluminium phosphate, $2\text{Al}_2\text{O}_3 \cdot \text{P}_2\text{O}_5 \cdot 5\text{H}_2\text{O}$. J. H. Gladstone obtained evidence of the formation of an allotropic form. According to A. Schwarzenberg, when the hydrate is heated, it forms the anhydrous salt. G. Tammann also made the anhydrous salt by melting equi-molecular parts of cupric sulphate and microcosmic salt, or phosphoric acid and cupric sulphate. The pale blue salt is readily soluble in hot hydrochloric or nitric acid; and it is converted into sodium pyrophosphate and cupric sulphide by the action of a soln. of sodium sulphide.

A. Schwarzenberg found that when a soln. of cupric pyrophosphate in aqua ammonia is treated with alcohol, a **cupric ammino-pyrophosphate**, $8\text{CuO} \cdot 3\text{P}_2\text{O}_5 \cdot 8\text{NH}_3 \cdot 8\text{H}_2\text{O}$, is formed. The salt is slightly soluble in water, and when heated it becomes brown. According to H. Schiff, if a soln. of cupric pyrophosphate in aqua ammonia be exposed to the air, it gradually loses ammonia, and gives green crystals of the monohydrated **cupric tetramminopyrophosphate**, $2\text{CuO} \cdot \text{P}_2\text{O}_5 \cdot 4\text{NH}_3 \cdot \text{H}_2\text{O}$, that is, $\text{Cu}_2\text{P}_2\text{O}_7 \cdot 4\text{NH}_3 \cdot \text{H}_2\text{O}$, which, when heated, form a bluish-white mass easily soluble in acids and aqua ammonia. When further heated, it forms white anhydrous cupric pyrophosphate. T. Fleitmann and W. Henneberg digested cupric hydroxide with a soln. of sodium pyrophosphate in excess; and they also boiled freshly precipitated cupric pyrophosphate with a soln. of sodium pyrophosphate, filtered the hot soln., and cooled the mixture. The white crystals have a composition corresponding with $\text{Na}_4\text{P}_2\text{O}_7 \cdot 3\text{Cu}_2\text{P}_2\text{O}_7 \cdot 7\text{H}_2\text{O}$, that is, $\text{Na}_2\text{CuP}_2\text{O}_7 \cdot \text{Cu}_2\text{P}_2\text{O}_7 \cdot 3\frac{1}{2}\text{H}_2\text{O}$, **tricupric disodium dipyrophosphate**, $\text{Na}_2\text{Cu}_3(\text{P}_2\text{O}_7)_2 \cdot 3\frac{1}{2}\text{H}_2\text{O}$. The crystals are insoluble in water. A similar salt, $\text{Na}_2\text{CuP}_2\text{O}_7 \cdot \text{Cu}_2\text{P}_2\text{O}_7 \cdot 10\text{H}_2\text{O}$, or $\text{Na}_2\text{CuP}_2\text{O}_7 \cdot 3\text{Cu}_2\text{P}_2\text{O}_7 \cdot 20\text{H}_2\text{O}$, was prepared by M. Stange by mixing a soln. of sodium triphosphate with cupric sulphate until a permanent precipitate is obtained. The white crystalline powder is quite insoluble in water, and when heated, it becomes blue, green, and yellowish-green; it sinters at a high temp. After heating, it is still soluble in nitric and hydrochloric acids. A. Pahl had previously reported the preparation of minute pale blue rhombic plates of $\text{Na}_4\text{P}_2\text{O}_7 \cdot \text{Cu}_2\text{P}_2\text{O}_7 \cdot 10\frac{1}{2}\text{H}_2\text{O}$, or $\text{Na}_4\text{P}_2\text{O}_7 \cdot 3\text{Cu}_2\text{P}_2\text{O}_7 \cdot 21\text{H}_2\text{O}$. He said the salt melted when heated and freezes to a pale blue crystalline mass; and that it is soluble in a soln. of the salt, $3\text{Na}_4\text{P}_2\text{O}_7 \cdot \text{Cu}_2\text{P}_2\text{O}_7$. When this salt is heated to 100° , and then extracted with water, A. Pahl found that the soln. on evaporation furnished a bluish-green crystalline mass of the composition, $4\text{CuO} \cdot \text{P}_2\text{O}_5 \cdot 5\text{H}_2\text{O}$, or $2\text{Cu}(\text{OH})_2 \cdot \text{Cu}_2\text{P}_2\text{O}_7 \cdot 3\text{H}_2\text{O}$, **cupric hydroxypyrophosphate**. This basic salt melts when heated and forms on cooling a green glass. It is soluble in a soln. of sodium pyrophosphate, with the separation of cupric oxide.

When the mother liquid remaining after the preparation of the preceding salt is slowly evaporated, J. F. Persoz found that pale blue crystals of **cupric disodium dipyrophosphate**, $\text{CuNa}_2\text{P}_2\text{O}_7 \cdot 6\text{H}_2\text{O}$, or $\text{Na}_4\text{P}_2\text{O}_7 \cdot \text{Cu}_2\text{P}_2\text{O}_7 \cdot 12\text{H}_2\text{O}$, are formed. A. Pahl's and T. Fleitmann and W. Henneberg's analyses of the salt, crystallized respectively at 40° and 100° , correspond with $\text{Na}_4\text{P}_2\text{O}_7 \cdot \text{Cu}_2\text{P}_2\text{O}_7 \cdot 1\frac{1}{3}\text{H}_2\text{O}$. The

salt is sparingly soluble in water; melts when heated and freezes to a pale blue glass or, if slowly cooled, to a pale blue crystalline mass. T. Fleitmann and W. Henneberg and A. Pahl found that spontaneous evaporation of the syrupy mother liquid from the preparation of the preceding salt gives blue crystals of the composition: $3\text{Na}_4\text{P}_2\text{O}_7 \cdot \text{Cu}_2\text{P}_2\text{O}_7 \cdot 24$ (or 32) H_2O , that is, $\text{Na}_4\text{P}_2\text{O}_7 \cdot \text{Na}_2\text{CuP}_2\text{O}_7 \cdot 12$ (or 16) H_2O , corresponding with **hexasodium cupric dipyrophosphate**, $\text{Na}_6\text{Cu}(\text{P}_2\text{O}_7)_2 \cdot 12$ (or 16) H_2O . J. F. Persoz's analysis gave the lower proportion of water, A. Pahl's the higher; when dried at 100° , T. Fleitmann and W. Henneberg found the salt has the composition $\text{Na}_6\text{Cu}(\text{P}_2\text{O}_7)_2 \cdot 2\text{H}_2\text{O}$. The latter also stated that the crystals are triclinic prisms, easily soluble in water, which sinter about 100° , and melt when heated to a higher temp. The alkali cupric pyrophosphates want studying in the light of the phase rule. A. Pahl and J. F. Persoz obtained a pale blue mass of the composition **cupric dipotassium pyrophosphate**, $\text{K}_2\text{P}_2\text{O}_7 \cdot \text{Cu}_2\text{P}_2\text{O}_7 \cdot 1\frac{1}{2}\text{H}_2\text{O}$, or $\text{K}_2\text{CuP}_2\text{O}_7 \cdot \frac{3}{2}\text{H}_2\text{O}$. The salt melts when heated, and freezes to a glassy mass. The salt is very soluble in water; zinc does not precipitate the copper, but iron does so in a few days.

F. Schwarz prepared what he regarded as **cupric triphosphate**, $5\text{CuO} \cdot 3\text{P}_2\text{O}_5 \cdot 13\text{H}_2\text{O}$, by precipitation from the sodium salt soln. with a conc. soln. of cupric sulphate; but M. Stange expressed his doubts about the homogeneity of this product. F. Schwarz and M. Stange obtained prismatic crystals of **sodium cupric trimetaphosphate**, $\text{Na}_3\text{CuP}_3\text{O}_{10} \cdot 12\text{H}_2\text{O}$, from a not too dil. soln. of a gram of sodium triphosphate, $3\text{Na}_2\text{O} \cdot \text{P}_2\text{O}_5$, and 0.486 gm. of pentahydrated cupric sulphate. When heated the salt melts in its water of crystallization; when further heated, the water is expelled; and at a red heat, it melts to a yellow liquid, which on cooling forms a bluish-green glass. It is sparingly soluble in water, easily soluble in acids.

Copper metaphosphates.—T. Fleitmann,⁵ and R. Maddrell prepared anhydrous **cupric dimetaphosphate**, CuP_2O_6 , by mixing cupric nitrate with a dil. soln. of orthophosphoric acid, evaporating to dryness, and heating the product to 316° . F. Warschauer, and A. Glatzel prepared this salt by dissolving cupric oxide in phosphoric acid of sp. gr. 1.68 to 1.75 , so that the acid is about 5 per cent. in excess. The dissolution is assisted by heating first on a water-bath and then on a sand-bath gradually to 400° . The powdered mixture was washed with dil. nitric acid. According to G. Tammann, the insoluble form of sodium metaphosphate dissolves slowly in a conc. soln. of cupric sulphate. A rise of temp. hastens the rate of dissolution, and J. Müller obtained some copper metaphosphate from the soln. G. Tammann also obtained cupric dimetaphosphate by adding cupric sulphate to a soln. of silver metaphosphate; and he found ammonium metaphosphate swells up in a soln. of cupric sulphate, forming a mass soluble in excess; the soln. does not give a precipitate on dilution with water.

Cupric dimetaphosphate so prepared was regarded by F. Warschauer as a tetrametaphosphate. The salt is so sparingly soluble in water that R. Maddrell supposed it to be insoluble; T. Fleitmann found the salt to be almost insoluble in alkalis, easily soluble in aq. ammonia. According to A. Glatzel, some remains insoluble when the salt is extracted with boiling aqua ammonia. G. Gore says the salt is insoluble in liquid ammonia. A. Glatzel says the salt is almost insoluble in most acids. The salt was found by T. Fleitmann to be decomposed by soln. of alkali sulphides, but to be scarcely affected by hydrogen sulphide. T. Fleitmann obtained a dark blue crystalline powder of tetrahydrated salt, $\text{CuP}_2\text{O}_6 \cdot 4\text{H}_2\text{O}$, by the mixing soln. of cupric salts and alkali dimetaphosphates. The salt does not lose its water of crystallization at 100° , but it does so at a dull red heat with the simultaneous volatilization of phosphorus pentoxide. The salt melts when heated to a higher temp. and forms on slow cooling the tetrametaphosphate, $\text{Cu}_2\text{P}_4\text{O}_{12}$. T. Fleitmann said the salt is insoluble in water, but A. Glatzel found 100 parts of water dissolve 1.3 parts of the salt, and it is easily decomposed by hot. conc. sulphuric acid.

T. Fleitmann, and A. Glatzel obtained dark blue crystals of **ammonium**

cupric dimetaphosphate, $(\text{NH}_4)_2\text{Cu}(\text{P}_2\text{O}_6)_2 \cdot 4\text{H}_2\text{O}$, by mixing conc. soln. of two mols of ammonium dimetaphosphate with one mol of cupric chloride. By using a great excess of the former salt, T. Fleitmann found the dihydrated salt, $(\text{NH}_4)_2\text{Cu}(\text{P}_2\text{O}_6)_2 \cdot 2\text{H}_2\text{O}$, is formed, but A. Glatzel could not verify this. The compound dissolves sparingly in water, for 100 parts of water dissolve two parts of salt. All the water is expelled from the salt at 150° . Acids attack it with difficulty, it is readily decomposed by boiling conc. sulphuric acid.

G. Tammann obtained what was considered to be **cupric trimetaphosphate**, $\text{Cu}_3(\text{P}_3\text{O}_6)_2 \cdot 9\text{H}_2\text{O}$, by mixing soln. of the sodium salt and cupric sulphate. The precipitate separates with difficulty, and by mixing cupric sulphate with the barium salt, a liquid is obtained which does not crystallize. The salt is said to be sparingly soluble in water, 0.04 grm. dissolving in a litre at 20° ; the salt melts at a white heat. A. Wieslar and C. G. Lindboom obtained only cupric pyrosulphate by G. Tammann's process of preparation.

A. Glatzel obtained what he regarded as anhydrous **cupric tetrametaphosphate**, $\text{Cu}_2\text{P}_4\text{O}_{12}$, by the process indicated above for the dimetaphosphate (*q.v.*). The octahydrated salt, $\text{Cu}_2\text{P}_4\text{O}_{12} \cdot 8\text{H}_2\text{O}$, was also obtained by A. Glatzel in pale blue crystals by treating a dil. soln. of ammonium tetrametaphosphate with an excess of cupric sulphate. The water of crystallization can be all expelled by heat, and the anhydrous salt is formed when the mass fuses. The octahydrate is very sparingly soluble in water; acids, other than sulphuric acid, attack the salt with difficulty. T. Fleitmann, and A. Glatzel prepared anhydrous bluish-white crystalline **disodium cupric tetrametaphosphate**, $\text{Na}_2\text{CuP}_4\text{O}_{12}$, by mixing cupric dimetaphosphate with more than an equi-molecular part of sodium dimetaphosphate. The dried salt is heated to 300° . According to A. Glatzel, other metaphosphates are always present. The salt is decomposed by sodium sulphide soln., forming sodium tetrametaphosphate. A. Glatzel also prepared blue crystals of the tetrahydrate $\text{Na}_2\text{CuP}_4\text{O}_{12} \cdot 4\text{H}_2\text{O}$, by mixing conc. soln. of sodium dimetaphosphate and cupric chloride, and evaporating. The water of crystallization is expelled between 150° and 200° , and 100 parts of water dissolve 2.2 parts of the salt. A. Glatzel prepared tetrahydrated **dipotassium cupric tetrametaphosphate**, $\text{K}_2\text{CuP}_4\text{O}_{12} \cdot 4\text{H}_2\text{O}$, in a similar way. The properties of this salt resemble those of the sodium salt. 100 parts of water dissolve 1.72 parts of the salt. Conc. sulphuric acid readily decomposes the salt; boiling acids attack the salt particularly if it has been previously calcined. Alkali sulphide soln. decompose the salts.

G. Tammann reported the formation of **cupric pentametaphosphate**, $\text{Cu}_5(\text{P}_5\text{O}_{15})_2$ by mixing soln. of cupric sulphate and of ammonium pentametaphosphate. H. Lüdert precipitated bluish-white **cupric hexametaphosphate**, $\text{Cu}_3\text{P}_6\text{O}_{18}$, by mixing sat. soln. of cupric chloride, and sodium hexametaphosphate. The precipitate is soluble in an excess of either reagent. H. Rose says that no precipitate is obtained if cupric sulphate be used. The precipitate is sometimes a pale green oily liquid which dries on a glass plate to a brittle glass. The oil dries to a sticky mass at 100° . The salt is sparingly soluble in water, easily soluble in acids. H. Lüdert obtained evidence of the formation of **sodium cupric hexametaphosphate**, $\text{Na}_6\text{P}_6\text{O}_{18} \cdot \text{Cu}_3\text{P}_6\text{O}_{18}$, by adding alcohol to the soln. remaining after the separation of the preceding salt.

REFERENCES.

- ¹ E. Mitscherlich, *Pogg. Ann.*, 55. 95, 1841; J. Steinschneider, *Ueber die Phosphate des Kupfers*, Halle a. S., 1890; C. F. Rammelsberg, *Handbuch der Mineralchemie*, Leipzig, 2. 325, 1875; *Pogg. Ann.*, 68. 383, 1846; C. Bergemann, *ib.*, 104. 190, 1858; *Schweigger's Journ.*, 54. 305, 1828; J. Weineck, *Liebig's Ann.*, 156. 57, 1870; R. A. Metzner, *ib.*, 149. 67, 1869; H. Kühn, *ib.*, 34. 218, 1840; 51. 124, 1844; R. Rhodius, *ib.*, 62. 372, 1847; C. Bergemann and C. Bödecker, *ib.*, 94. 356, 1855; A. Breithaupt and C. F. Plattner, *Journ. prakt. Chem.*, (1), 15. 321, 1888; A. Breithaupt, *Berg. Hütt. Ztg.*, 24. 309, 1865; A. Schrauf, *Zeit. Kryst.*, 3. 19, 1879; 4. 1, 1830; 8. 231, 1884; G. Melzer, *ib.*, 32. 288, 1903; P. Berthier, *Ann. Mines*, (3), 8. 334, 1835; H. Debray, *Ann. Chim. Phys.*, (3), 61. 439, 1861; *Compt. Rend.*, 52. 44, 1861; G. Rousseau and G. Tité.

ib., 113. 193, 1891; V. Auger, *ib.*, 144. 199, 1907; A. Colson, *ib.*, 126. 1137, 1898; C. Lory, *ib.*, 67. 237, 1868; E. Péchard, *ib.*, 136. 506, 1903; L. Grandeau, *ib.*, 100. 1134, 1885; A. Reynoso, *ib.*, 34. 795, 1852; A. Gautier, *ib.*, 116. 1271, 1893; *Bull. Soc. Chim.*, (3), 9. 884, 1893; H. N. Warren, *Chem. News*, 68. 66, 1893; W. Skey, *ib.*, 22. 61, 1870; A. H. Church, *ib.* 10. 217, 1864; 24. 239, 1871; *Journ. Chem. Soc.*, 26. 107, 1873; N. Story-Maskelyne and W. Flight, *ib.*, 25. 1057, 1872; L. T. Wright, *ib.*, 43. 267, 1883; H. Müller, *ib.*, 11. 236, 1859; A. Barillé, *Journ. Pharm. Chim.*, (6), 19. 140, 1904; R. M. Caven and A. Hill, *Journ. Soc. Chem. Ind.*, 16. 29, 1897; J. Moser, *Zeit. anal. Chem.*, 45. 19, 1906; B. W. Gerland, *Journ. prakt. Chem.*, (2), 4. 97, 1871; R. Hermann, *ib.*, (1), 37. 175, 1858; C. Friedel and E. Sarasin, *Bull. Soc. Min.*, 2. 157, 1879; *Arch. Sciences Genève*, (3), 27. 10, 1892; W. T. Schaller, *Bull. U.S. Geol. Sur.*, 262. 121, 1905; F. Field, *Chem. Gaz.*, 17. 400, 1859; P. Groth, *Tabellarische Uebersicht der Mineralien*, Braunschweig, 90, 1898; J. A. Arfvedson, *Pogg. Ann.*, 1. 74, 1824; M. F. Heddle, *Phil. Mag.*, (4), 10. 39, 1855; A. Nordenskiöld, *Acta Soc. Fenn.*, 5. 335, 1858; C. Luckow, *German Pat. D.R.P.*, 91707, 1894; W. Borchers, *Zeit. Elektrochem.*, 3. 485, 1897; H. N. Morse, *Amer. Chem. Journ.*, 29. 173, 1903; A. Hutchinson and A. M. Macgregor, *Min. Mag.*, 19. 225, 1921; G. Césaro, *Bull. Soc. Geol. Belg.*, 39. 241, 1912; H. Buttgenbach, *Les minéraux et les roches*, Liège, 1916; A. des Cloizeaux, *Traité de minéralogie*, Paris, 2. 490, 1874

² H. Schiff, *Liebig's Ann.*, 123. 41, 1862; R. A. Metzner, *ib.*, 149. 66, 1869; E. J. Maumené, *Compt. Rend.*, 95. 226, 1882.

³ J. Weineck, *Liebig's Ann.*, 156. 57, 1870; K. A. Wallroth, *Bull. Soc. Chim.*, (2), 39. 316, 1883; L. Ouvrard, *Compt. Rend.*, 111. 177, 1890; C. Raspe, *German Pat.*, D.R.P. 78324, 1893; L. Grandeau, *Ann. Chim. Phys.*, (6), 8. 193, 1886; J. Steinschneider, *Ueber die Phosphate des Kupfers*, Halle a. S., 1890.

⁴ A. Schwarzenberg, *Untersuchungen über die pyrophosphorsauren Salze*, Göttingen, 1847; *Liebig's Ann.*, 65. 162, 1848; T. Fleitmann and W. Henneberg, *ib.*, 65. 387, 1848; H. Schiff, *ib.*, 123. 40, 1862; A. Wiesler, *Zeit. anorg. Chem.*, 28. 177, 1901; M. Stange, *ib.*, 12. 444, 1896; F. Schwarz, *ib.*, 9. 249, 1895; *Ueber eine neue Polyphosphorsäure*, Rostock, 1895; J. H. Gladstone, *Journ. Chem. Soc.*, 20. 435, 1867; J. F. Persoz, *Ann. Chim. Phys.*, (3), 20. 315, 1847; A. Stromeyer, *Schweigger's Journ.*, 58. 132, 1830; A. Pahl, *Oefvers. Vet. Förh.*, 7, 1873; A. Colson, *Compt. Rend.*, 126. 1327, 1898; F. W. Clarke and J. S. Diller, *Chem. News*, 56. 43, 1887; G. Tammann, *Journ. prakt. Chem.*, (2), 45. 469, 1892.

⁵ T. Fleitmann and W. Henneberg, *Liebig's Ann.*, 65. 304, 1848; T. Fleitmann, *Pogg. Ann.*, 78. 242, 1849; F. Warschauer, *Beiträge zur Kenntnis der Metaphosphate*, Berlin, 1903; *Zeit. anorg. Chem.*, 36. 137, 1903; H. Lüder, *ib.*, 5. 31, 1894; A. Glatzel, *Ueber dimetaphosphorsäure und tetrametaphosphorsäure Salze*, Würzburg, 1880; J. Müller, *Beiträge zur Kenntnis der Metaphosphate*, Berlin, 1906; G. Tammann, *Journ. prakt. Chem.*, (2), 45. 463, 1892; R. Maddrell, *Phil. Mag.*, (3), 30. 222, 1847; *Mem. Chem. Soc.*, 3. 273, 1847; V. Auger, *Compt. Rend.*, 144. 199, 1907; G. Gore, *Proc. Roy. Soc.*, 21. 140, 1873; C. G. Lindboom, *Ber.*, 8. 122, 1875; H. Rosc. *Pogg. Ann.*, 76. 1, 1849.

CHAPTER XXII

SILVER

§ 1. The History of Gold and Silver

No one ever yet has had so much silver as not to desire more ; and if people have a superabundance, they hoard it, and are not less delighted with so doing than with putting it to use.—XENOPHON (c. 353 B.C.).

PREHISTORIC man probably discovered silver some time after gold, and gold possibly before copper. Native silver is not nearly so common as gold, and it is not likely to have attracted attention so early. Pliny writes in his *Historia naturalis* (33. 31) that silver “is never found but in shafts sunk deep in the ground, and there are no shining spangles to raise hopes of its existence as in the case of gold.” Silver was not known to the Aryans before the linguistic separation, since the Latin, Greek, and Sanskrit names were formed independently. The philologists¹ tell us that the Latin *argentum* is derived from the Aryan root *radj* or *arg*, meaning white, bright, or shining ; the Greek term is *ἀργυρος*, and both the Greek and Sanskrit terms have the same root with a different suffix ; the Gothic *silubr*—Icelandic *silfr*, English *silver*, Hollandic *zilver*, Swedish *silfver*, Danish *sølv*, German *silber*—is believed to be a loan-word from the Assyrian *sarpu*, and to indicate that the term travelled to the Baltic nations from the Euxine along the trade route *viâ* the river Dnieper. The Celtic *argat* (Old Irish) shows that the Celts probably obtained the term when they invaded Italy about 390 B.C.

Silver occurs native in Spain and Armenia, and silver ornaments have been found in Spain in tombs of the early bronze age. The Phœnician traders probably carried silver from the Spanish mines to Greece between the twelfth and tenth centuries B.C., since the metal is not found in the oldest Phœnician style of tomb in Greece of the twelfth century, but is found in the more recent tombs at Mycenæ—earlier than the tenth century. Silver is not found in the Italian pile dwellings of the bronze age, but appears in those of a later date—400–500 B.C. There were mines in Persia, India, and China.

In his *Historia naturalis* (33. 31), Pliny gives an account of silver ore *quæ sequens insania est*—the next folly of mankind after gold ; and he describes a process of fusion and cupellation with lead for isolating the silver. Strabo, also, in his *Geographia* (3. 2) describes the process of extracting silver from the ore at Carthage. The ore was washed and sieved five times ; fused with lead ; and then cupelled for *argentum purum*.

Gold and copper were probably the first metals to be worked by primitive man and the evidence shows that both metals were known to the early Egyptians and Babylonians as far back as history goes. Both metals are fairly widely distributed, and the glittering yellow metal, gold, in the sandy beds of so many rivers, must have attracted man's attention at very early periods, and it is mentioned in the earliest writings of civilized man. Representations of quartz-crushing and gold-refining processes have been found on the rock carvings of Upper Egypt, the earliest of which is supposed to date back 2500 B.C.—*cf.* Fig. 1, Cap. I. In the code of Menes, who is supposed to have reigned in Egypt 3500 B.C.—about 200 years before Moses—it is decreed that gold is equal in value to two and a half parts of silver,

This code is probably related with the Hindu *Manu*, the Thibetan *Mani*, the Lydian *Manes*, the Phrygian *Manis*, and the Cretan *Minos*. It is accordingly thought to be probable that gold and silver were used as money in all countries between the Indus and the Nile many centuries before Christ—some estimate twenty-eight centuries B.C.² Silver coinage was probably used as early as that of gold. There are numerous references to these metals in the Pentateuch.³ According to W. Herapath,⁴ there is some evidence that the early Egyptians used argentine soln. for marking linen—*vide* nitric acid.

The absence of any common word for gold among the descendants of the Aryan peoples is taken to show that the Aryans paid no particular attention to this metal before the linguistic separation. The scholars say that the Greek term for gold, χρυσός, is a loan-word derived from the Semitic *chārutz*—Hebrew *tzanab*, to shine. The gold objects found at Attica, Thera, Mycenæ, etc., in tombs ornamented in the style of Phœnician art, are believed to date from about the twelfth century B.C.; and it is thought to be improbable that gold was known in Greece before it was brought there by the Phœnicians about this time. Similarly, gold was probably unknown in Italy before the eleventh century B.C., because neither gold nor silver has been found in the pile dwellings of Emilia, where bronze was plentiful. Gold was probably brought to Italy by the Phœnicians and Greeks about the ninth century B.C. The scholars⁵ also tell us that the Latin term for gold, *aurum*, and the earlier Sabine *ausum*, are words of Italian origin related to *aurora*, meaning the morning glow, or the shining dawn. The Celtic terms *ór* (Old Irish) and *awr* (Cymric) appear to have been borrowed from the Latin *aurum* about the time of the Gallic invasion of Italy—390 B.C. The old German *ausis* shows that the word was obtained from Italy before the change from *ausum* to *aurum*. The term *gold* is supposed to be derived from the Sanskrit *jvalita* derived from *jval*, to shine. The Teutonic *gulth*—the glowing or shining metal—was passed on to the Esthonians and Lapps, where it assumed the forms *kuld* and *golle* respectively. The terms for gold in the various Hindu and Iranian families are derived from the Sanskrit *hiranya*.

Most of the gold in ancient times was largely derived from Siberia (Bactria), Nubia, Greece, and India. Xenophon in his *Πόροι*, written about 353 B.C., says that “no one ever pretended from tradition or the earliest accounts of time, to determine when the Grecian mines began to be worked, and this is a proof of their antiquity.” The Nubian mines were worked extensively by the early Egyptians, and a kind of map showing the gold-mining region about 1350–1330 B.C. has been found in an Egyptian tomb. Diodorus’ account (c. 50 B.C.) of the African mines makes sorry reading:

On the confines of Egypt and the neighbouring countries there are parts full of gold mines, from whence, with the cost and pains of many labourers, much gold is dug. The soil is naturally black, but in the body of the earth there are many veins, shining with white marble, and glittering with all sorts of bright metals, out of which those appointed to be overseers cause the gold to be dug by the labour of a vast multitude of people. For the kings of Egypt condemn to these mines not only notorious criminals, captives taken in war, persons falsely accused, and those with whom the king is offended, but also all their kindred and relations. These are sent to this work either as punishment, or that the profit and gain of the king may be increased by their labours. There are thus infinite numbers thrust into these mines, all bound in fetters, kept at work day and night, and so strictly guarded that there is no possibility of their effecting an escape. They are guarded by mercenary soldiers of various barbarous nations, whose language is foreign to them and to each other, so that there are no means either of forming conspiracies or of corrupting those who are set to watch them; they are kept to incessant work by the nod of the overseer, who, besides, lashes them severely. Not the least care is taken of the bodies of these poor creatures; they have not a rag to cover their nakedness; and whoever sees them must compassionate their melancholy and deplorable condition, for though they may be sick, or maimed, or lame, no rest nor any intermission of labour is allowed them. Neither the weakness of old age nor the infirmities of females excuse any from that work to which all are driven by blows and cudgels, till at length, borne down by the intolerable weight of their misery, many fall dead in the midst of their insufferable labours. Thus these miserable creatures, being destitute of all hope, expect their future days to be worse than the present, and long for death as more desirable than life.

There are several accounts in the Bible of the quest for the precious metals in patriarchal days.⁶ The extravagant splendour of the royal palace and the holy temple erected by Solomon, is recorded in the first book of *Kings*, and the second book of *Chronicles*; while in the book of *Daniel* there is a description of an immense golden image erected by Nebuchadnezzar on the plain of Dura. The ancient historians—Herodotus and Diodorus—relate prodigies which, though they be exaggerations, yet indicate that a vast quantity of the precious metals had been collected in those early days. The wealth of Cræsus, who reigned as King of Lydia some 540 years before Christ, is proverbial. The profuse and lavish decoration of the palaces and temples of the cities of Tyre, Nineveh, and Babylon, over 1000 B.C., are but a few examples of the ornate display of the precious metals which history recounts, and which in this modern age seem almost fabulous. In any case, this ostentatious wealth displayed so gorgeously excited the cupidity of neighbouring nations, with disastrous results to the exhibitor in virtually every case.

There can be little doubt that the expeditions of Jason of Phœnicia, Darius of Persia, Alexander of Greece, Cæsar of Rome, Columbus of Genoa, as well as the marauds of the Huns, the Goths, and the Vandals, were little more than rapacious forays for gold, silver, or slaves. Plunder, not political supremacy, was the real object of these and many other ventures recorded in history. As W. Jacob puts it, the leaders of these historical expeditions “sought the precious metals not by exploring the bowels of the earth, but by the more summary process of conquest, tribute, and plunder.” In many cases they left behind a ghastly trail of cruel wickedness, inhuman lust, and wanton brutality. The letter of Ferdinand, King of Spain, to his colonists in Hispaniola (America), July 25, 1511, is thus paraphrased by A. Helps: ⁷ “Get gold; humanely if you can; but at all hazards get gold.” The greed of the Spaniards was so exorbitant that the natives of America were impressed with the idea that gold was the white man’s god, the god whom they sought and served. In the words of Timon of Athens: “Gold! yellow, glittering precious gold! . . . Much of this will make black, white; foul, fair; wrong, right; base, noble; old, young; coward, valiant.”

The circle was used by the early Egyptians as the symbol for divinity and perfection, and the same symbol was chosen by them for the sun; gold, the most perfect of metals, was also designated by the circle. The alchemists called gold *Sol* (the sun) or Apollo, and represented it by the symbol of perfection ☉, or by the sun (or Apollo) with a crown of rays, ☼, not altogether on account of its appearance, but because they considered it to be the most perfect of the then known noble metals—the *metallum rex*, the very king or Apollo of metals. Silver approaching nearest to gold was represented by the Egyptians by a semicircle, ☾. The alchemists termed silver *Luna* or *Diana*, and represented it by the symbol for the crescent moon ☾, possibly because of the pale silvery colour, which, the poets say, is characteristic of moonlight.

REFERENCES.

¹ O. Schrader, *Sprachvergleichungen und Urgeschichte*, Jena, 1883; E. O. Lippmann, *Entstehung und Ausbreitung der Alchemie*, Berlin, 1919.

² F. Lenormant, *La monnaie dans l'antiquité*, Paris, 1878-9; G. Wilkinson, *The Manners and Customs of the Ancient Egyptians*, London, 1837-41; H. Weissbach, *Das Gold in alten Aegypten*, Dresden, 1901.

³ *Genesis*, 13. 2; 20. 16; 23. 16; 24. 35, 53; 37. 28; etc.

⁴ W. Herapath, *Phil. Mag.*, (4), 3. 528, 1852; T. J. Herapath, *ib.*, (4), 5. 339, 1853; J. D. Smith, *ib.*, (4), 4. 142, 1852.

⁵ O. Schrader, *Sprachvergleichungen und Urgeschichte*, Jena, 1883.

⁶ J. Napier, *Manufacturing Arts in Ancient Times*, Paisley, 1879; B. White, *Silver, its History and Romance*, London, 1917.

⁷ W. Jacob, *An Historical Inquiry into the Production and Consumption of the Precious Metals*, Philadelphia, 1832; A. del Mar, *A History of the Precious Metals*, London, 1880; A. Helps, *The Spanish Conquest of America*, London, 1857; W. R. Ingalls, *Mineral Ind.*, 1. 225, 1892; J. Pelletier, *Ann. Chim. Phys.*, (2), 15. 5, 113, 1820.

§ 2. The Occurrence and Distribution of Silver

Silver is fairly widely distributed in various minerals in quantities less than one per cent. The disposition of the principal silver deposits are indicated on the map, Fig. 1. Few gold ores are quite free from silver, and silver is almost invariably found in the sulphide ores of lead, copper, and zinc. The lead-silver ores form an important class; and a comparatively large proportion of the world's silver

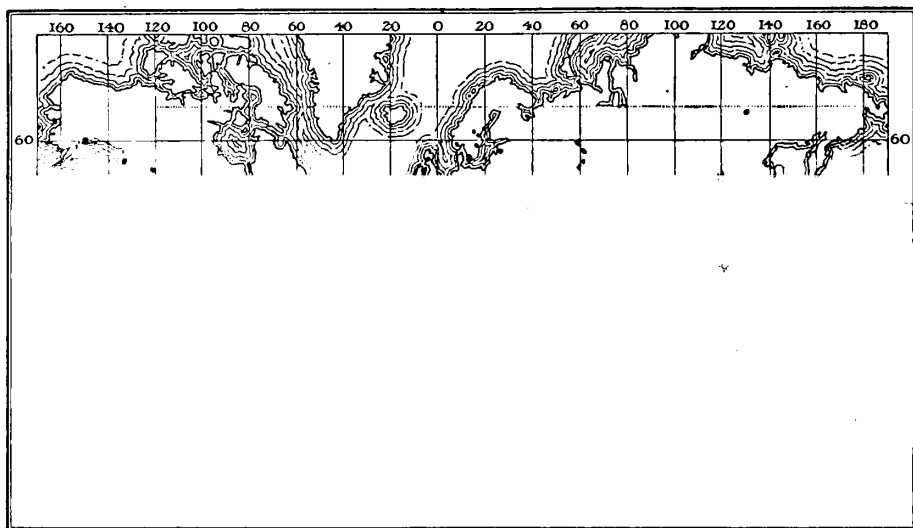

FIG. 1.—The Geographical Distribution of the Chief Deposits of Silver Ores.

is extracted from the base metals—lead and copper. Of 92 ores examined spectroscopically by W. N. Hartley and H. Ramage,¹ only four were found to be free from silver, and this element was detected in all manganese ores and bauxites examined. L. Wagoner estimated that granitic rocks contain on the average 6.15 parts of silver per million; sandstones, 0.44; and marble, 0.21 part per million. In 1787, J. L. Proust noted the occurrence of silver in sea-water, and it was estimated by F. J. Malaguti and J. Durocher, that sea-water contains one mgrm. of silver per 100 litres, and that the total quantity of silver in sea-water was two million tonnes. A. Liversidge estimated that sea-water contained one to two grains per ton; the water in the Christiania Fjord (Norway) is estimated to contain 0.005 part of silver per million; the water of the San Francisco Bay, 0.011; and the water in the depths of the Atlantic Ocean, 0.015 to 0.267 part per million.² According to F. Field, the copper sheathing of ships gradually becomes richer in silver. Of 54 samples of spring waters in France, J. Bardet found that 34 contained silver when examined spectroscopically. F. Field also detected silver in the ashes of seaweeds, *e.g.* the fucus serratus and the fucus ceranoïdes had 0.00001 per cent. F. J. Malaguti and co-workers found silver in the ashes of land plants; rock salt; coal ash; and in the blood of herbivora; G. Forchhammer found silver and lead in corals; J. W. Mallet reported silver in volcanic ash.

Most of the silver extracted in Europe is derived from galena or lead ores. In Great Britain, argentiferous ores have been obtained from Helston, Liskeard, Redmor, Tamor (Cornwall); Ochil Hills (Stirlingshire); Hilderstone Hills (Linlithgowshire), Leadhills and Wanlockhead; the Isle of Man; etc.; and at Wicklow, Ballycorn, etc., in Ireland. France obtained argentiferous ores, etc., from Pontgibaud (Pay-de-Dôme), Bormettes (Var), Peyre-brune (Tarn), and in the departments of Loire, Haute Saône, Isère, etc. The chief centres

furnishing silver in Germany are Nassau, Westphalia, Saxony, Hartz, Silesia, etc. The argentiferous copper of Rammelsberg, near Goslar, has been exploited for silver since 968 A.D. In Czecho-Slovakia, the chief centre is at Przibram in Bohemia. The silver mines at Joachimsthal (Bohemia) were flourishing at the beginning of the sixteenth century, and in 1516 employed nearly 8000 miners; the mines at Schneeberg (Saxony) were worked in 1471, and yielded about 160 tons of silver per annum in 1500. A concession to reopen the old mines at Przibram was granted in 1527. There are also argentiferous deposits at Erzgebirge, Kremnitz, Schemnitz, Tyrol, etc. In Spain silver ores are obtained in Gaudalaxara, Almeria, etc. The Spanish mines were exploited by the Phœnicians, and Pliny, *Historia naturalis* (33. 31), stated that silver was found in the mountains of nearly all the Roman provinces, and that the richest of all were to be found in Spain; Strabo, *Geographia* (3. 2), also notes the richness of the Spanish mines. Italy has centres in Tuscany, Sardinia, etc. Argentiferous ores are also obtained in the Laurium of Greece; Karassou (Ismidt) and Kassandra (Salonica) of Turkey; Fahlum and Sala, in Sweden; Kemi in Finland; and in the Urals of Russia. Native silver is mined in Kongsberg, Norway. In Asia, argentiferous minerals are obtained in Siberia; in Thibet; Kervan in Persia; the province of Fo-Kien in China; in Japan; Formosa; etc. Africa.—The old Egyptians obtained silver from Nubia and Ethiopia. The more important silver mines are in Algeria, Transvaal, Madagascar, etc. Australasia.—Silver is obtained from Broken Hill in New South Wales; Wilson's Reef in Victoria; Tasmania; Thames District, New Zealand; etc. In South America a great deal of silver has been obtained from mines in Chili, Bolivia, Peru, Argentine, etc. Native silver is obtained at Huantaya (Peru). Mexico in North America appears to be extraordinarily rich in silver ores. The Spaniards commenced silver mining at Tasco (Mexico) in 1522, and these mines, with those at Pachuca, are considered to be the oldest in Mexico, for they appear to have been worked by the Aztecs before the advent of the Spaniards. The more important sources of silver in the United States are in the Colorado, Montana, Utah, Idaho, Nevada, California, Texas, Washington, Dakota, New Mexico, Alaska, Oregon, Kansas, Michigan, Carolina, Tennessee, and Virginia. In Canada there are mines at Cobalt, Ontario; British Columbia; etc.

The world's production of silver³ was estimated in troy ozs. to be, in 1920:

	Troy ozs.		Troy ozs.
Mexico	66,200,000	Japan	4,500,000
United States	56,564,000	China	60,000
S. America	15,500,000	Dutch East Indies	1,300,000
Canada	13,500,000	Transvaal and Rhodesia	950,000
Central America	3,000,000	Rest of Africa	200,000
British India	180,000	Spain and rest of Europe	5,000,000
Burma	2,000,000	Australasia	3,500,000
Total	171,200,000	Troy ozs.	

and the totals for the years:

1493-1520	1601-1620	1701-1720	1801-1810	1876	1886	1908	1918
1,511,050	13,576,235	11,452,540	51,641,172	74,709,494	93,317,452	203,131,404	197,394,900

The minimum and maximum prices in 1909 were respectively $23\frac{1}{16}d.$ and $24d.$ per oz.; 1913, $25\frac{1}{16}d.$ and $29\frac{3}{8}d.$; in 1916, $26\frac{1}{16}d.$ and $37\frac{1}{8}d.$; in 1917, $35\frac{1}{16}d.$ and $55d.$; and in 1919, $47\frac{7}{8}d.$ and $79\frac{1}{8}d.$ The average in 1920 was $61\frac{9}{16}d.$; and in February, 1921, the price of silver had dropped to $35\frac{1}{2}d.$

Native silver occurs in crystals belonging to the cubic system—the largest crystals, cubes of 2·3 cms. side, come from Kongsberg (Norway); a mass of silver, weighing 697 kilograms, has been found in the same locality. The crystals are often twinned or distorted. The metal also occurs in dendritic masses, in filaments, and in sheets. Native silver is sometimes almost pure, but more usually it is alloyed with some copper, mercury, arsenic, antimony, tellurium, bismuth, iron, gold, or platinum. D. Forbes' analysis⁴ of a sample from Chuquiaguillo (Peru) gave: Silver, 97·98; gold, 0·22 per cent.—sp. gr. 10·77; G. Fordyce's analysis of a sample from Norway gave 28 per cent. of gold with the silver; and samples from the same country have been reported with but 0·0019 per cent. of gold. In some cases the analyses correspond by chance with chemical formulæ: AuAg₂, AuAg, etc., but there is no evidence of chemical combination—see electrum. P. Bcrthier⁵ reported a sample of silver from Curcy (France) with 10 per cent. of copper; H. J. Burkart one from Chilances (France) with 8 to 12 per cent. of antimony; and J. Domeyko one from Bolivia with 0·53 per cent. of antimony, and 0·015 per cent.

of arsenic. *Amalgam*, a native alloy of silver and mercury, crystallizes in the cubic system. The crystals are silvery-white; rather brittle; and with a bright metallic lustre. T. Scheerer reported a sample with 2 per cent. of mercury; F. Pisani, samples with 4.74 to 5.06 per cent.; and H. J. Burkart, samples with 18 to 26 per cent. Some specimens have a composition in agreement with chemical formulæ: Ag_2Hg_3 , AgHg , etc. A sample from Arqueros (Chili) corresponds with Ag_{12}Hg , and is called *acquerite*.

Besides occurring native, silver is found as sulphide, arsenide, antimonide, telluride, bismuthide, halides, and various sulpho-salts. *Argentite*, *glance ore*, or *silver glance*, in its purer forms contains the eq. of 12.9 per cent. of sulphur, and corresponds with the formula Ag_2S . It crystallizes in the cubic system; the colour varies from a leaden grey to black, and the surface becomes dull and acquires a sooty coating on exposure to air and light. The mineral is called by the Hungarian miners: *soft ore*; the old name *glass ore*—*Glaserz*—of Agricola is inappropriate since it has no resemblance to glass. *Argentite* is often contaminated with native silver. It is soluble in nitric acid. A variety with copper approaching $(\text{AgCu})_2\text{S}$ is called *jalpaite*. The so-called *ruby silvers* are of two kinds: (i) *Proustite*, or *light red silver ore*, or *arsenical silver blende*, approximates in composition with $3\text{Ag}_2\text{S} \cdot \text{As}_2\text{S}_3$, or Ag_3AsS_3 . It crystallizes in the rhombohedral system; it has a cochineal-red colour, and is slightly translucent. The rare mineral *xanthoconite* is a dimorphic variety which crystallizes in the monoclinic system. (ii) *Pyrrargyrite*, or *dark red silver ore* or *antimonial silver blende*, also crystallizes in the rhombohedral system. Its composition approximates with $3\text{Ag}_2\text{S} \cdot \text{Sb}_2\text{S}_3$, or Ag_3SbS_3 . This mineral has a dark red colour. There is a rare variety called *pyrostilpnite*, or *fire blende*, which crystallizes in the monoclinic system. The mineral *stephanite*, also called *black silver ore*, or *brittle silver ore*, approximates in composition with $5\text{Ag}_2\text{S} \cdot \text{Sb}_2\text{S}_3$. It crystallizes in the rhombic system, and is of a dark grey colour. *Polybasite* is a complex sulphide of copper, silver, antimony, and arsenic approximating in composition with $(\text{Ag}_2\text{S} \cdot \text{CuS})_2 \cdot \text{Sb}_2\text{S}_3 \cdot \text{As}_2\text{S}_3$, and crystallizing in the rhombic system. It is almost black in colour. *Argyrodite* is a rare mineral, almost black in colour, with a violet tinge. It crystallizes in the cubic system, and its composition approaches Ag_3GeS_8 . *Dyscrasite*, or *antimonial silver*, is a silver antimonide. The relative proportions of the two elements are variable—for instance, the silver may vary from 72 to 84 per cent., thus corresponding with Ag_3Sb contaminated with more or less silver. The mineral crystallizes in the rhombic system; and its colour is silver-white; on exposure to air and light, it acquires a dull grey or yellow colour. This is not an important ore of silver. *Hessite* approaches silver telluride, Ag_2Te , in composition. Its colour is steel-grey or lead-grey. A variety with gold is called *petzite* $(\text{AgAu})_2\text{Te}$ (*q.v.*). *Naumannite* approaches silver selenide, Ag_2Se , in composition. It is almost black in colour. A variety with copper, approximating $(\text{AgCu})_2\text{Se}$, is called *eucairite*; and one with sulphur, approximating $\text{Ag}_2(\text{SSe})$, is called *agularite*. A mineral corresponding with silver chloride is called *kerargyrite* or *cerargyrite*. This mineral is comparatively soft, and can be cut like horn, and resembles horn in lustre and colour—hence the name *horn silver*. *Cerargyrite* is pale grey—sometimes tinged blue or green—and on exposure to light, it becomes brown and dull. A piece of iron is silvered when rubbed with this mineral. Bromine or iodine is sometimes present. To distinguish the different halides, the chloride is sometimes called *chloroargyrite*; the bromide, *bromoargyrite*; the iodide, *iodoargyrite*; and the mixture of the chloride and bromide, *emboelite*.

REFERENCES.

- ¹ W. N. Hartley and H. Ramage, *Journ. Chem. Soc.*, 71. 533, 1897; L. Wagoner, *Trans. Amer. Inst. Min. Eng.*, 31. 808, 1901; 38. 704, 1907.
- ² J. L. Proust, *Journ. Phys.*, 30. 396, 1787; 49. 221, 1799; F. Field, *Chem. Gaz.*, 15. 93, 1857; F. J. Malaguti, J. Durocher, and M. Sarzeau, *Ann. Chim. Phys.*, (3), 28. 129, 1849; F. J. Malaguti and J. Durocher, *Recherches sur l'association de l'argent aux minéraux métalliques*, Paris, 94, 1850; G. Forchhammer, *Om Søvandets Bestanddele*, Copenhagen, 11, 1859; J. W. Mallet, *Proc. Roy. Soc.*, 47. 277, 1890; J. Bardet, *Compt. Rend.*, 157. 224, 1913; S. Bleekrode, *Pogg. Ann.*, 102. 478, 1857; A. Liviersidge, *Proc. Roy. Soc. New South Wales*, 29. 335, 350, 1895.
- ³ M. W. von Bernewitz, *Mineral Ind.*, 29. 241, 1921; L. H. Quin, *Metal Handbook and Statistics*, London, 276, 1921.
- ⁴ D. Forbes, *Phil. Mag.*, (4), 30. 143, 1865; S. B. Wight, *Eng. Min. Journ.*, 30. 153, 1880; G. Fordyce, *Phil. Trans.*, 66. 504, 1776; G. vom Rath, *Neues Jahrb. Min.*, 443, 1869; G. Küstel, *Berg. Hütt. Ztg.*, 25. 169, 1866.
- ⁵ P. Berthier, *Ann. Mines*, (1), 11. 72, 1825; H. J. Burkart, *Neues Jahrb. Min.*, 715, 1874; J. Domeyko, *Mineralojia*, Santiago, 353, 1879; T. Scheerer, *Berg. Hütt. Ztg.*, 6. 638, 1852; F. Pisani, *Compt. Rend.*, 75. 1274, 1872.

§ 3. The Extraction of Silver from its Ores

Of all the branches of metallurgy, that of which silver forms the subject is the most extensive, the most varied, and the most complicated.—J. PERCY (1880).

The extraction of silver from its ores¹ is usually effected by one of three processes: (1) An alloy of silver with lead or with copper is prepared in a smelting furnace, and the silver subsequently recovered from the base metal—*dry process*; (2) The silver is first amalgamated with mercury, and the mercury removed by distillation—*amalgamation process*; or (3) The ore, suitably prepared, is leached with a suitable solvent, and the silver subsequently precipitated—*wet process*. It will be observed that in all three processes, the silver is collected or extracted from its ore by a suitable solvent—lead, copper, mercury, cyanide-lye, brine, etc. In another variation of the wet process, the silver is converted into an insoluble form, and the copper into a form soluble in dil. sulphuric acid.

Dry processes for the extraction of silver.—The dry process is used where the silver ores contain enough lead to enable them to be smelted for the latter metal (*q.v.*); sufficient lead must be present to dissolve and retain in soln. the whole of the silver in the ore. The reaction is symbolized: $Ag_2S + nPb = PbS + [2Ag + (n-1)Pb]$. If the ore does not contain enough lead, either lead or galena, or a suitable plumbiferous mineral, is mixed with it, and the smelting is conducted as before. This process can be economically applied when cheap fuel is available. The resulting lead is subsequently desilvered by cupellation or otherwise. This process is sometimes called the **lead smelting process** in contradistinction to the **matte smelting process**, which is applied when the silver ore contains insufficient lead for the lead smelting process, and in districts where plumbiferous minerals are not prevalent, and where cupriferous minerals are abundant or where the silver ore is naturally mixed with enough cupriferous pyrites. The mixture of silver ore and cupriferous pyrites can then be smelted for matte as in the case of copper ores. The matte is bessemerized for copper, and the copper refined by electrolytic processes where the precious metals are obtained as a by-product. The Ziervogel leaching process (*vide infra*) was once used for extracting silver from the matte, but the electrolytic process gives better results. The copper matte acts like lead, in the lead smelting process, and collects the precious metals—silver and gold. A highly siliceous slag is desirable, and the amount of zinc impurity in the ore should be low. Under these conditions, there is very little loss of the precious metal in the slag. Argentiferous pyrites containing as low as 2 or 3 per cent. of copper can be profitably treated by this process under conditions where it would not pay to treat the ore for copper alone. Pyrites free from copper does not appear to collect the precious metals very well, but if as little as one-half or two-thirds of one per cent. of copper be present in the ore, the gold and silver are satisfactorily collected by the matte, and not lost in the slag.

The ancients extracted silver and gold from their ores by alloying them with lead, and oxidizing the product, when the precious metals remain alone unoxidized in the metallic state. The facts must have been known from very early times. The Jewish prophets Jeremiah (6. 29) and Ezekiel (22. 20–22), about 590 B.C., refer to the purification of the precious metals from the base metals by exposing mixtures of the two to a “trial by fire.” The base metals are alone “consumed” or drossed, while pure silver and gold pass unscathed through the ordeal. Diodorus Siculus (c. 50 B.C.), quoting from a lost book by Agarthides of Cnidos, says that gold was purified by mixing it with lead, salt, and some barley husks, enclosing the mixture in a crucible with a luted lid, and heating the crucible and contents for five days and nights in a furnace. On cooling, purified gold remained in the crucible. Gold purified by this operation was called *aurum obrizum* (obrizum or obrussum), and the operation itself *obrussa*—from the Greek *ὄβριζον*, meaning pure gold.

The base metals would be oxidized and absorbed by the pot; the silver would be chlorinated by the salt, and also absorbed into the pot as fused silver chloride; and the bran would prevent the base metals from being oxidized too rapidly. As previously indicated, near the beginning of the first century, both Pliny, in his *Historia naturalis* (33. 31), and Strabo, in his *Geographia* (3. 2), refer to the purification of silver by cupellation with lead. In the sixteenth century, V. Biringucci, in his *De la protecnica* (Venezia, 1540), stated that "if we had not lead, we should work in vain for the precious metals, for without its aid, silver and gold could not be extracted from the ores containing them." The method was also described by L. Erchcr in his book *Beschreibung aller fürnemsten mineralischen Ertzt und Berckwerksarten* (Prag, 1574);² and numerous later writers.

Cupellation.—In the modern operation, the alloy of lead with the precious metals to be cupelled is melted on the hearth of a reverberatory furnace. The hearth is made of bone-ash, calcareous clay (marl), magnesia, or other suitable earth which will resist the corrosive action of the lead oxide. The hearth is either covered by a movable hood, as in the so-called German cupellation furnace, or the hearth is movable and the hood is fixed as in the so-called English cupellation furnace. In both furnaces, a current of air impinges on the surface of the molten metal; litharge is formed, and the base metals simultaneously oxidized are dissolved in the litharge which accumulates about the edges of the metal and is removed periodically, or continuously. The first drawings of litharge consist largely of arseniates and antimonates of lead; a more pure litharge then commences to form; bismuth persistently remains unoxidized until near the end of the operation, when it, too, is attacked. Hence, in some works, with alloys containing appreciable amounts of bismuth, the litharge which is formed towards the end of the operation is collected separately and the bismuth recovered. Finally, the precious metals, sometimes as much as 99.7 or 99.8 per cent. purity, remain on the hearth unoxidized.

The **English cupellation furnace** has undergone more or less modification in different localities. It is virtually a reverberatory furnace with a firemouth very large

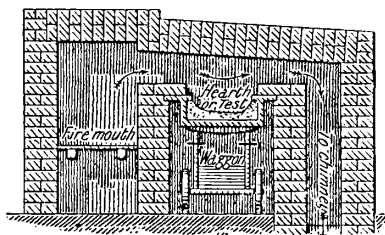

FIG. 2.—Diagrammatic Section of the English Cupellation Furnace.

in proportion to the size of the hearth, Fig. 2. The hearth or *test* is oval or oblong—about 4 ft. by 2½ ft.—and is supported on a carriage which can be removed. The pig-lead to be desilvered is charged into openings in the sides of the furnace; the litharge as it is formed is carried along by the blast, and runs over a notch in the hearth into a conical iron pot below. The silver is concentrated to 50–70 per cent. silver, and then ladelled or poured into moulds, and the furnace is re-charged. The molten metal is finished in another cupellation furnace. In

the **German cupellation furnace**, the hearth or test is built *in situ*, and is circular or elliptical, 9 to 11 ft. in diameter. The roof can be raised or lowered and luted to the body of the furnace with clay. The English furnace is used for the cupellation of alloys richer in lead than those usually treated in the German furnace. The litharge from the English furnace usually contains too much silver to be sold without further purification; the litharge from the German furnace is comparatively pure, and is ready for the market. The English furnace is continuous, and the German furnace is intermittent in that it is allowed to cool after each charge of ore has been treated.

Cupellation is now an auxiliary to the desilverization of lead or base-bullion—the name commonly applied to lead containing silver by Parkes' or Pattinson's process—though formerly all the silver extracted from lead was effected by the cupellation process. Cupellation is sometimes an independent process when litharge is to be manufactured, but in competition with Parkes' or Pattinson's

process cupellation is profitable only when the lead contains considerable amounts of silver. The final separation, however, whether Parkes' or Pattinson's process has been employed, is effected by cupellation.

Amalgamation process for the extraction of silver.—The use of mercury for the extraction of silver and gold is probably very old. True, the first known mention of mercury occurs in Theophrastus' *Περί Λιθῶν*, about 300 B.C., but neither he nor Diodorus the Sicilian, who wrote about 30 B.C., mentioned the use of mercury in this connection, although Diodorus wrote at some length on the process for the extraction of gold from quartz in Upper Egypt. Vitruvius, about 13 B.C., described the use of mercury for the recovery of gold from the cloth in which it was interwoven; and Pliny, in his *Historia naturalis* (30. 32), about 77 A.D., spoke of the amalgamation process as if it were very well known.

Everything excepting gold floats on quicksilver; gold alone is attracted by mercury, and therefore that metal is best cleansed by mercury, for the impurities are expelled from gold by repeatedly shaking it with mercury in earthen vessels. The product (gold amalgam) is poured into skins, which are then squeezed, the mercury exudes like sweat, and leaves behind the pure gold.

The gold is not pure, but is rather a solid amalgam. There is nothing in Pliny's account to show that silver could be so treated; his method would be effective only with simple gold-silver ores, but from this, a process was developed capable of extracting the metal from more complex ores. The early European process was described by V. Biringucci, in his *De la pirotecnica* (Venezia, 1540), as if it were a secret art, although it must have been used at an earlier date; it is mentioned by R. Theophilus, a writer of the eleventh century. In this early *European amalgamation process*, the ore was ground in a stone mill with water, mercury, salt, and some copper compound. It is sometimes said that the extraction of the precious metals by amalgamation was invented by the Spaniards in Mexico, about 1557, but, according to F. A. Schmid's edition (Freyberg, 1806) of G. Agricola's *Bermannus sive de re metallica* (Basil, 1530), the process was more probably introduced at Pachuca, in Mexico, by Bartolomé Medina, in 1552, who doubtless learned about it in Europe.³ According to F. Xavier de Sarria, and J. Garces y Eguia, the first printed treatise on the amalgamation process is A. A. Barba's *Arte de los metales* (Madrid, 1640). In B. Medina's *Mexican amalgamation process*—usually known as the **patio process**—the general principles of the European process were modified to suit the special conditions which prevailed in Mexico. In both processes, mercury is used in conjunction with common salt and a salt of copper, without the use of fuel except for expelling mercury from the solid amalgam. Horses and mules were introduced into Mexico about 1793 for mixing the *pulp*, mercury, etc. Previous to this time, the mixing was done by hand. It is said a saving of 757 per cent. on the cost of mixing was thereby effected. Very few improvements have been made on the original process during the 360 years it has been used in Mexico, but it is now almost entirely superseded by the cyanide process which is capable of giving a higher yield of the precious metal and at a less cost. Hence, the patio process promises very soon to be of little more than historical interest. The amalgamation process for extracting the previous metals from their ores soon travelled from Mexico to Peru, and in 1640, A. A. Barba described the *cazo process*—*cazo*, a small pan (*vide supra*). In this process, said to have been worked by Barba at Potosi (Bolivia) in 1590, the ground ore was stirred with water, mercury, and salt in copper cauldrons heated over a fireplace. The reaction is symbolized: $2AgCl + Cu + nHg = 2Ag + nHg + CuCl_2$; and $CuCl_2 + Cu = 2CuCl$. The *cazo process* was used in Mexico and South America for some years, and about 1800 it developed into the *fondon process*—*fondon*, ground—in which a larger vessel with a copper bottom and wooden sides was employed, and the stirring was done by mule power.

The Mexican ore contains metallic silver, silver sulphide, and silver chloride, etc., distributed in a large quantity of gangue. The ore is first crushed in stamp mills,

and ground to powder between porphyry blocks fixed on an axis turned by horses or mules. The work has to be done in a country where water for washing the ore is not available, while neither steam nor water power is practicable; the powdered ore, moistened with water, is thoroughly incorporated with a little sodium chloride. In about a day, mercury is added along with some roasted pyrites containing a mixture of iron and copper sulphates and oxides, and called *magistral*. The whole is most intimately mixed, and more mercury is added from time to time. The mixing is done on stone-paved areas—called *patios*—by being treaded by horses or mules as illustrated in Fig. 3. The mixture which is trodden by the mules or horses is called

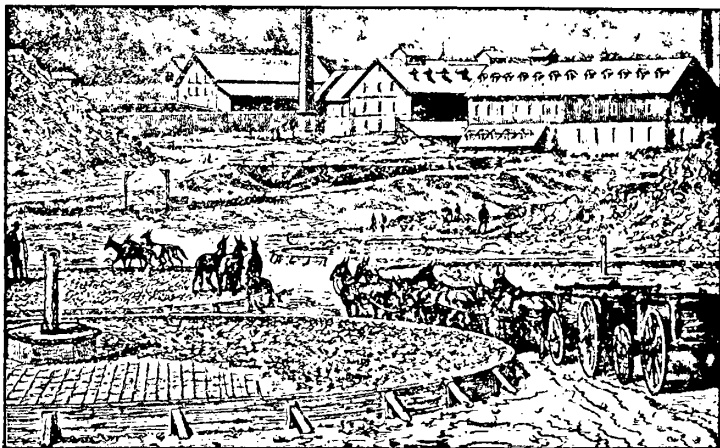

FIG. 3.—The Patio Process for the Extraction of Silver.

a *torta*, and a *torta* has to be treated from a fortnight to a month according to circumstances.

It is probable that cupric chloride is first formed: $2\text{NaCl} + \text{CuSO}_4 = \text{Na}_2\text{SO}_4 + \text{CuCl}_2$, and this reacts with the silver sulphide, forming cuprous and silver chlorides: $\text{CuCl}_2 + \text{Ag}_2\text{S} = 2\text{AgCl} + \text{CuS}$; $\text{CuCl}_2 + \text{CuS} = 2\text{CuCl} + \text{S}$; and $2\text{CuCl} + \text{Ag}_2\text{S} = 2\text{AgCl} + \text{Cu}_2\text{S}$. The complex sulphides are likewise decomposed: $2\text{Ag}_3\text{SbS}_3 + 3\text{CuCl}_2 = 6\text{AgCl} + 3\text{CuS} + \text{Sb}_2\text{S}_3$, and similarly with the arsenic compound Ag_3AsS_3 . Ferric chloride also reacts with the silver sulphide: $2\text{FeCl}_3 + \text{Ag}_2\text{S} = \text{S} + 2\text{AgCl} + 2\text{FeCl}_2$. The silver chloride dissolves in the brine, and it is then immediately reduced and dissolved by the mercury: $\text{AgCl} + \text{Hg} = \text{Ag} + \text{HgCl}$. There are many other side reactions: $\text{CuCl}_2 + \text{Hg} = \text{CuCl} + \text{HgCl}$, and $\text{CuCl}_2 + \text{Ag} = \text{CuCl} + \text{AgCl}$, but the loss of mercury as mercurous chloride, HgCl , which occurs in practice is not great enough to give these reactions any significance. The actual consumption of mercury is but 85 per cent. of that required by the equation: $\text{Hg} + \text{AgCl} = \text{Ag} + \text{HgCl}$.

The silver amalgam is separated from the mud by washing and settling; the excess of mercury is squeezed through canvas; the solid amalgam in the bags is pressed into cakes and heated in retorts—mercury distils over, and the silver which remains in the retort has a white frosted appearance and is called *plata pina*. The silver is then fused and cast into ingots. The mercury used in the amalgamation process is said to be more active if it has about one per cent. of sodium in soln.⁵

Various modifications of the amalgamation process have been tried in different localities. In the so-called *Boss process*, the ore passes continuously from the stampers through the amalgamating pans, and is not collected from the stamps and charged into the amalgamating pans at intervals. The chloridizing roast for silver ores was introduced by I. de Born⁶ in combination with the cazo process at Schemnitz (Hungary), and in conjunction with barrel amalgamation at Freiburg in 1790. The amalgamation was adapted to the special conditions in the Washoe district, U.S.A.,

in 1860, and it was called the *Washoe process*. In the Washoe process, the ore is usually crushed wet, and amalgamated in pans without previous roasting. The richer ores are roasted with salt and then amalgamated in barrels; the poorer ores are treated in the stamp mill and ground in cast-iron pans, with mercury and hot water—with or without the addition of salt and copper sulphate. The presence of copper sulphate is not so important as in the Mexican process because the ore contains more free silver, and under the influence of heat the mercury and iron are able to deal with the silver. After the amalgamation, the process is similar to the Mexican. Amalgamation in conjunction with cyanide soln.⁷ was tried successfully in 1911, in the so-called Batopilas and the Nipissing processes.

Wet processes for the extraction of silver.—Numerous wet processes have been proposed for the extraction of silver from its ores, copper mattes, speise, and metallic copper. There are four types of process:

I. The ore is roasted so that the copper is oxidized to cupric oxide and the silver sulphide is converted into metallic silver. The copper oxide is extracted with sulphuric acid, and crystallized from the soln. as copper sulphate or blue vitriol; the residue, containing silver and gold, is smelted with lead by the dry process. Any iron oxide which may be dissolved by the acid crystallizes, as an impurity, with the copper sulphate. The process⁸ is called the **Freiberg vitriolization process**, because it was developed at Freiberg in Saxony. In a modification, called the **Hofmann's vitriolization process**, the iron is separated by treating the hot neutral soln. of copper sulphate with roasted copper mattes—mainly cupric oxide—and forcing air through the liquid; ferric oxide is precipitated: $4\text{FeSO}_4 + \text{O}_2 + 4\text{CuO} = 2\text{Fe}_2\text{O}_3 + 4\text{CuSO}_4$. Basic copper sulphate may also be precipitated with the iron oxide, and recovered by treatment with 2.5 or 3 per cent. sulphuric acid, which dissolves the copper but not the iron.

II. The sulphide ores are fractionally roasted so as to convert most of the iron and copper sulphides into oxides, and the silver sulphide into silver sulphate. The mass is then leached with water. Silver and copper sulphates dissolve. The silver is precipitated from the soln. by scrap copper; the copper is afterwards precipitated by scrap iron—**Ziervogel's process**.⁹

III. The sulphide ores are roasted with salt whereby the silver sulphide is converted into chloride, and the mass is then leached with a suitable solvent.

(a) The chloride is extracted with a sat. soln. of sodium chloride at about 80°, and the silver precipitated by scrap copper—**Augustin's process**.¹⁰

(b) The chloride is extracted with sodium thiosulphate soln., the silver precipitated as sulphide, and reduced to the metal by calcination in a roasting furnace—**Patera's process**.

IV. The ore—which may or may not be calcined—is treated with a soln. of alkali cyanide—**cyanide process**. The cyanide reacts with the silver sulphide: $\text{Ag}_2\text{S} + 4\text{NaCy} = 2\text{NaAgCy}_2 + \text{Na}_2\text{S}$. The accumulation of sodium sulphide in the soln. stops the reaction. When the soln. is exposed to the air, however, the sodium sulphide is oxidized to sodium thiosulphate and sulphur. The reaction then progresses as indicated in the equation from left to right. Thus, the free access of air to the cyanide soln. is an important factor in promoting the dissolution of the silver. Silver and gold are also dissolved by the cyanide soln. as indicated in the discussion on the cyanide process under gold. The silver is recovered from the cyanide soln. by precipitation with zinc or aluminium.¹¹ The cyanide process has almost ousted the other lixiviation processes—*vide* gold. Augustin's process was used at Mansfield (Germany) between 1840 and 1842; at Freiberg between 1848 and 1862; and for a time at a few other places.¹² The failure of Augustin's process is mainly due to the comparatively low solubility of silver chloride in the brine which necessitates handling large volumes of liquid; and to the imperfect oxidation of silver in the presence of arsenic, antimony, and zinc.¹³ In the Patera process, the thiosulphate not only removes the silver chloride, but silver arseniate and antimoniate, and to some extent metallic silver and gold, are dissolved. Lead sulphate also, if present, is also

dissolved. Consequently, the precipitate from the thiosulphate soln. contains silver, gold, copper, lead, and small quantities of other metals. The use of sodium thiosulphate for the extraction of silver was indicated by A. Hauch in 1846, and by J. Percy in 1850. The solvent action is due to the formation of a soluble double thiosulphate of silver and sodium: $\text{Na}_2\text{S}_2\text{O}_3 \cdot \text{Ag}_2\text{S}_2\text{O}_3$. The process was applied industrially by A. Patera at Joachimsthal (Bohemia) in 1858, and the silver was precipitated by sodium or calcium sulphide: $\text{Ag}_2\text{S}_2\text{O}_3 \cdot \text{Na}_2\text{S}_2\text{O}_3 + \text{Na}_2\text{S} = \text{Ag}_2\text{S} + 2\text{Na}_2\text{S}_2\text{O}_3$, so that with sodium sulphide as precipitant, the thiosulphate can be used again. In 1860, M. Kiss proposed to substitute calcium thiosulphate for the sodium salt as the leaching liquid—**Kiss' process**; and if calcium sulphide is used as the precipitating agent, the calcium thiosulphate is regenerated. He claimed that the calcium salt is a more effective solvent—particularly for gold—than the sodium salt; but the claim has not been established. In 1884, E. H. Russell¹⁴ introduced a soln. of sodium cuprous thiosulphate which was claimed to exert a more energetic solvent action on metallic silver, silver sulphide, and the arsenical and antimonial sulphides, and other silver minerals. In **Russell's process**, the chloridized ore is leached first with sodium thiosulphate, and subsequently with sodium cuprous thiosulphate—the latter is called the *extra solution*—and it is supposed to extract an additional amount of silver which would otherwise escape in the tailings, and to require a less careful chloridizing roast. E. H. Russell also showed that lead can be removed from the thiosulphate extract by treatment with sodium carbonate; and the copper and silver in the remaining soln. precipitated as in the original thiosulphate process. The advantages claimed for the Russell process over the Patera process have not been generally established in that the extra cost is not always compensated by the increased yield of precious metal—particularly if the chloridizing roast be efficiently performed.

Roasting sulphide ores for sulphates—sulphatizing roast.—The sulphatizing roast has been mentioned in connection with the extraction of copper (*q.v.*). Suppose an ore containing iron, copper, and silver sulphides be roasted in a furnace where the temp. is gradually rising. The iron sulphide begins to oxidize just over 300° , and the sulphur di- and tri-oxides which are formed are swept along with the furnace gases. Ferric oxide is produced: $4\text{FeS}_2 + 11\text{O}_2 = 2\text{Fe}_2\text{O}_3 + 8\text{SO}_2$. The condition of equilibrium between the two sulphur oxides: $2\text{SO}_3 = 2\text{SO}_2 + \text{O}_2$, in the presence of the catalytic agent, ferric oxide, is discussed in connection with these gases. As the temp. rises, the partial press. of sulphur trioxide increases because the gases become more and more charged with sulphur oxide. The iron sulphate formed at a lower temp. begins to decompose between 550° and 600° ; and the copper sulphate begins to decompose slowly at about 650° , and the decomposition is complete at about 850° .

The relation between the partial press. and temp. of ferric and cupric oxides and sulphur trioxide, for equilibrium,¹⁵ is indicated in Table I.

TABLE I.—EQUILIBRIUM CONDITIONS FOR IRON AND COPPER SULPHATES.

$\text{Fe}_2(\text{SO}_4)_3 \rightleftharpoons \text{Fe}_2\text{O}_3 + 3\text{SO}_3$		$2\text{CuSO}_4 \rightleftharpoons 2\text{CuO} \cdot \text{SO}_3 + \text{SO}_2$		$2\text{CuO} \cdot \text{SO}_3 \rightleftharpoons 2\text{CuO} + \text{SO}_3$	
Temp.	Press., mm.	Temp.	Press., mm.	Temp.	Press., mm.
553	23	546	43	600	62
592	45	588	55	653	98
614	70	615	70	686	123
650	149	642	98	705	139
660	182	665	130	728	173
680	286	700	233	745	209
690	401	725	460	775	298
707	715	731	647	805	542

If the partial press. of the sulphur trioxide in the atm. of the furnace be greater than the equilibrium value for that temp. the corresponding sulphate will be formed;

and conversely, if less, sulphate will be decomposed. The partial press. of sulphur trioxide necessary for the formation of iron and copper sulphates are indicated in Table II.

TABLE II.—PARTIAL PRESSURES OF SULPHUR TRIOXIDE NECESSARY FOR THE FORMATION OF IRON AND COPPER SULPHATES.

Temp.	Partial press. of SO ₃ in mm. of mercury.		
	Fe ₂ (SO ₄) ₃	CuSO ₄ .	(CuO) ₂ SO ₃
550	12	27	—
600	22·5	29	29
650	61·5	40	33
700	244·0	99	35

At 650°, the partial press. of sulphur trioxide necessary for the formation of ferric sulphate is 61·5 mm.; and for copper sulphate, 40 mm. Consequently, if the stream of gases passing through the furnace has sulphur trioxide eq. to a partial press. of 50 mm., copper sulphate will be formed, and ferric sulphate decomposed. When the temp. rises still higher, and the partial press. of the sulphur trioxide required for the formation of copper sulphate is not high enough, copper sulphate will be decomposed. Silver oxide dissociates about 130°, but precisely similar relations obtain between silver or silver sulphide and sulphur trioxide as those between cupric oxide and the same gas. The dissociation¹⁶ of silver sulphate is very slow at 750°, and rapid at 917°. If the temp. of the furnace exceeds this limit, the sulphates are all decomposed into ferric and cupric oxides, and metallic silver; and if the temp. exceeds 1020°, or if reducing gases be present, some of the cupric oxide will be reduced to cuprous oxide, and ferric oxide to ferrosferric oxide, Fe₃O₄. The reactions are more complex still with natural ores; for instance, if arsenic and antimony are present, and have not been volatilized early, arsenate and antimoniate of silver will be formed, and thus introduce losses because these salts do not dissolve when the sulphate is extracted with water. The apparently simple operation of roasting, said W. C. Roberts-Austen,¹⁷ demands the exercise of the utmost skill, care, and patience. The main reactions begin at about 500° and end at about 700°, that is, within a range of 200°. "It would be difficult to appreciate too highly the delicacy of touch and sight which enables an operator to judge by the aid of rough tests, but mainly from the tint of the streak revealed when the mass is rabbled, whether any particular stage has or has not been reached."

Roasting sulphide ores for chlorides—chloridizing roast.—The aim of the chloridizing roast is to convert certain constituents of an ore into chlorides, and thus make them amenable to solvents. Certain volatile chlorides are incidentally formed, and these may or may not be recovered. The chloridizing roast is employed in W. Longmaid and W. Henderson's process for copper ores (*q.v.*); in Stahl's process for nickel ores; and in A. Patera's process for silver ores. In chloridizing roasting the crushed ore is usually mixed with about 10 per cent. of sodium chloride, and the mixture heated to 800° or 900° in a reverberatory furnace. The sulphates formed by the oxidation of the sulphides, react with the salt, forming chlorine and hydrogen chloride. These gases convert silver, silver sulphide, thioarsenides, and thioantimonides into silver chloride. The reactions are somewhat complicated. The salt may react directly with the sulphate, forming chlorine: $4\text{NaCl} + 4\text{FeSO}_4 + \text{O}_2 = 2\text{Na}_2\text{SO}_4 + 2\text{Fe}_2\text{O}_3 + 2\text{SO}_2 + 2\text{Cl}_2$; and simultaneously, the ferric and copper sulphates decompose, forming sulphur trioxide, which reacts with the salt, forming chlorine: $2\text{SO}_3 + 2\text{NaCl} = \text{SO}_2 + \text{Na}_2\text{SO}_4 + \text{Cl}_2$. In the main reaction, the chlorine acts directly on the silver compounds converting them into silver chloride: *e.g.* $\text{Ag}_2\text{S} + \text{O}_2 + \text{Cl}_2 = \text{SO}_2 + 2\text{AgCl}$. Hydrogen chloride is formed by the action of steam

and sulphur trioxide on sodium chloride: $2\text{NaCl} + \text{SO}_3 + \text{H}_2\text{O} = 2\text{HCl} + \text{Na}_2\text{SO}_4$, and by the silica present in the ores: $2\text{NaCl} + \text{SiO}_2 + \text{H}_2\text{O} = \text{Na}_2\text{SiO}_3 + 2\text{HCl}$. The hydrogen chloride acts on the oxidized silver ores converting them into silver chloride. Among the numerous side reactions which simultaneously occur: Copper sulphate is decomposed by sodium chloride, forming cupric chloride: $\text{CuSO}_4 + 2\text{NaCl} = \text{Na}_2\text{SO}_4 + \text{CuCl}_2$; and silver sulphate reacts similarly: $\text{Ag}_2\text{SO}_4 + 2\text{NaCl} = \text{Na}_2\text{SO}_4 + 2\text{AgCl}$. Silver sulphate—formed by the direct oxidation of the sulphide or by a reaction symbolized: $\text{Ag}_2\text{S} + 4\text{SO}_3 = \text{Ag}_2\text{SO}_4 + 4\text{SO}_2$ —may react with cupric chloride: $\text{Ag}_2\text{SO}_4 + \text{CuCl}_2 = 2\text{AgCl} + \text{CuSO}_4$. Some arsenic and antimony are volatilized in the oxidizing roast, and also as chlorides. If the temperature be too high, appreciable quantities of silver chloride may be volatilized.

Electrolytic processes for the extraction or refining of silver.—The electrolytic process employed in the refining of copper is used for the separation of silver from argentiferous copper, and it would be difficult to find a more remarkable application of the electric current than in the purification of metals by transferring the impure metal from the anode to pure metal at the cathode. In **Moebius' process**,¹⁸ the electrolyte is a mixture of silver and copper nitrates acidified with nitric acid. A slab of impure silver is used as anode, and a plate of pure silver as cathode. Silver and copper are dissolved at the anodes and the silver is deposited on the cathodes. The gold, if present, remains undissolved as slime below the anode. The anodes are sometimes enclosed in filter bags to facilitate the collection of the *anode mud*. The composition and concentration of the solution as well as the current density, are carefully regulated on account of the danger of depositing copper with the silver.

The preparation of highly purified silver.—Silver should be fairly pure when it is required for cupellation assays, volumetric analysis, etc., and such silver may be obtained by dissolving the metal in nitric acid, diluting the solution with water, and allowing the soln. to settle so that gold, tin and antimony oxides, basic bismuth nitrate, silver sulphide, etc., may coagulate, and permit the solution to be filtered. Silver chloride is precipitated from the filtered solution by the addition of hydrochloric acid. If sodium chloride be used for the precipitation, basic bismuth and antimony chlorides, if present, would be precipitated. The silver chloride is boiled with hydrochloric acid, and washed with hot distilled water until free from acid. The silver chloride can be reduced to metal by boiling it with invert sugar and sodium hydroxide; by the addition of an aqueous solution of formaldehyde, ammonium formate, etc. The precipitate in any case is thoroughly washed, and if desired, it can be fused to a button in a crucible under borax. The chloride can also be reduced by fusion with about half its weight of sodium carbonate and one-sixth its weight of potassium nitrate in a porcelain crucible. The so-called *molecular silver*,¹⁹ used in organic chemistry, is a grey powder which acquires a metallic lustre when rubbed under a burnisher, or heated to redness. It is prepared by washing silver chloride, precipitated in the cold, until it is nearly free from acid, and then bringing it in contact with a sheet of zinc for some hours. The silver chloride is reduced. The product is washed with dilute hydrochloric acid, then with water, and dried on paper in air, and finally heated to 140° or 150°.

It is a custom in atomic weight determinations to take the utmost precautions to eliminate every impurity. The materials used in preparing highly purified materials must themselves be of an exceptional degree of purity. The preparation of absolutely pure substances is an extremely difficult, if not an impossible task. Liquids, said T. W. Richards,²⁰ often attack the containing vessels and absorb gases, crystals include and occlude solvents, precipitates carry down polluting impurities, dried substances cling to water, and solids, even at high temperatures, often fail to discharge their imprisoned contaminations. Every substance, added T. W. Richards, must be assumed impure until proof to the contrary can be obtained.

J. S. Stas, in his celebrated investigation on the atomic weight of silver, prepared highly purified silver by boiling the chloride with sodium hydroxide and

sugar ; by reducing the nitrate with ammonium formate and acetate, although, as T. W. Richards has shown, the formate alone is better since it introduces less carbon as impurity in the pores of the crystals. J. S. Stas also reduced the silver with ammonium sulphite.

(1) *J. S. Stas' process*.—In one process, J. S. Stas started from samples of silver containing copper as the chief impurity. Dissolve the metal in dilute boiling nitric acid ; evaporate to dryness ; heat the residue until it fuses so as to decompose any platinum nitrate which may be present. Dissolve the cold mass in dilute ammonia, and after standing 24 hrs, filter through a double filter paper, and dilute the ammoniacal solution of silver and copper nitrates until it contains the equivalent of about 2 per cent. of silver. Add enough of a soln. of ammonium sulphite to precipitate the whole of the silver—the exact amount is determined by a preliminary trial by running the ammoniacal silver soln. from a burette into a definite volume of ammonium sulphite soln. until the liquid above the precipitate appears faintly blue. The ammoniacal copper nitrate solution appears blue only when the silver nitrate has been all reduced. About one-third of the total silver will be found to have precipitated when the liquid has stood 24 hrs. in a closed vessel. Decant the blue liquid from the precipitate and warm the soln. to about 60° or 70° when the whole of the silver will be precipitated. Wash the two portions of precipitated silver with ammoniacal water by decantation until the wash-liquid shows no trace of a blue colour on standing. After standing some days in contact with concentrated ammonia, wash the precipitate with water until all trace of ammonia has been removed. To convert the precipitated silver into bars, J. S. Stas mixed the precipitate with 5 per cent. of its weight of previously calcined borax, and 0·5 per cent. of sodium nitrate, and fused it in a porcelain crucible. The metal was cast in moulds made from a mixture of calcined and uncalcined china clay. The cold bars were cleaned with fine sand, and heated with purified potash lye in order to remove the last traces of clay from the bars. If the bars are cut with a chisel for use, the pieces must be warmed with concentrated hydrochloric acid, washed with ammonia, and then with water. J. S. Stas freed the silver from traces of absorbed gas by distilling the metal in an apparatus resembling Fig. 6.

(2) *T. W. Richards and R. C. Wells' process*.—According to T. W. Richards and R. C. Wells,²¹ Stas' silver was probably contaminated with occluded oxygen, alkalis, etc., derived from the vessels used in the operations. T. W. Richards and R. C. Wells, in consequence, used vessels of porcelain or quartz instead of glass. G. P. Baxter and co-workers have described modifications of the process.

A dilute soln. of recrystallized silver nitrate was precipitated as chloride by means of hydrochloric acid, and well washed. The silver chloride in a silver dish was converted into metallic silver by treatment with invert sugar and sodium hydroxide which had been previously purified by electrolysis until all the iron had been deposited. The precipitated silver was fused to a button on a block of lime while exposed to the reducing flame of a blast gas-blowpipe. This silver was found to be extremely pure for it contained but 0·001 per cent. of impurity derived from the sulphur and carbon of the coal gas flame, a trace of unreduced silver chloride, and possibly some cavities or pores holding gas. To purify further the silver, T. W. Richards and R. C. Wells placed the button of silver on a watch glass, and wholly submerged the two in a conc. soln. of silver nitrate prepared from the same silver. The button of silver was made the anode, and the cathode was a piece of highly purified silver. On electrolysis,²² a fine crystalline powder of electrolytic silver was obtained. In order to exclude contamination, no metal but silver was allowed to come in contact with the electrolyte. The crystals of silver were probably contaminated with the mother liquid from which they were deposited, and from which they were freed by fusion in an atmosphere of hydrogen on a boat of lime, heated to bright redness in a porcelain tube. Spectroscopic tests, capable of detecting 0·0001 per cent. of lime, failed to detect calcium in the metal. The silver was freed from adherent lime by scrubbing the piece with hard sand, and by successive treatment with dilute nitric acid, ammonia, and water. The little bars were finally dried at about 400° in vacuo.

For colloidal silver, *vide* gold.

REFERENCES.

- ¹ J. Percy, *Silver and Gold*, London, 1880 ; H. F. Collins, *The Metallurgy of Silver and Lead*, London, 1900 ; T. Egleston, *The Metallurgy of Silver, Gold, and Mercury*, New York, 1887 ; M. Eissler, *The Metallurgy of Silver*, London, 1896 ; H. C. H. Carpenter and C. G. Cullis, *Metal Ind.*, 16, 193, 1920 ; C. Roswag, *Métallurgie de l'argent*, Paris, 1885 ; *L'argent et l'or*, Paris, 1890 ;

L. de Launay, *L'argent—géologie, métallurgie, rôle économique*, Paris, 1896; C. Schnabel, *Handbook of Metallurgy*, London, 1. 578, 1905; H. O. Hofmann, *Hydrometallurgy of Silver*, New York, 1907; L. S. Austin, *Metallurgy of the Common Metals*, San Francisco, 1913; W. R. Crane, *Gold and Silver*, New York, 1908.

¹ J. Pettus, *Fleta Minor*, London, 218, 1686; T. K. Rose, *Trans. Inst. Min. Met.*, 10. 150. 1905.

² H. G. Ward, *Mexico*, 196, 199, 1829; M. V. Oretaga, *Trans. Amer. Inst. Min. Eng.*, 32. 276, 1901; T. Branckow, *Chem. News*, 1. 98, 1860; T. Egleston, *Pan Amalgamation of Silver Ores in Nevada and Colorado*, London, 1879; E. Tilmann, *Der Bergbau und das Amalgamations-Verfahren in dem Guanajuato in Mexico*, Münster, 73, 1866; J. Percy, *Silver and Gold*, London, 1. 560, 1880; F. Xavier de Sarria, *Essais de metalurgia*, Mexico, 1784; J. Garces y Eguia, *Nueva teórica y práctica de beneficio de los metales de oro y plata*, Mexico, 1802; J. Miers, *Travels in Chile and La Plata*, London, 2. 390, 1826.

³ J. B. J. D. Boussingault, *Ann. Chim. Phys.*, (2), 51. 337, 1832; C. F. Rammelsberg, *Berg. Hütt. Ztg.*, 50. 296, 1891; H. Schild, *ib.*, 47. 251, 1888; F. J. Malaguti and J. Durocher, *Ann. Mines*, (4), 17. 3, 245, 461, 1849; P. Laur, *ib.*, (6), 20. 259, 1871; L. Lemuhot, *ib.*, (5), 13. 447, 1858; A. Rivot, *ib.*, (6), 18. 1, 1870; M. V. Ortega, *Trans. Amer. Inst. Min. Eng.*, 32. 276, 1901; J. A. Poumarède, *Compt. Rend.*, 57. 95, 1863; C. J. B. Karsten, *Karsten's Archiv.*, 25. 174, 1852; O. W. Huntington, *Chem. News*, 46. 177, 1882; R. Fernandez, *Trans. Amer. Inst. Min. Eng.*, 29. 116, 1899; R. Vondracek, *Rev. Univ. Min. Mét.*, (4), 13. 145, 1908; *Rev. Mét.*, 678, 1908; L. Simonin, *L'or et l'argent*, Paris, 114, 1880 (I am indebted to Librairie Hatchette for the loan of Fig. 3).

⁴ W. Crookes, *Brit. Pat. No. 391*, 1865; *Chem. News*, 13. 153, 1866; E. Silliman, *ib.*, 13. 204, 1866; 14. 170, 1866; E. B. P. Vaughan, *ib.*, 13. 191, 1866; H. Wurtz, *ib.*, 13. 183, 195, 1866; *Amer. Journ. Scienc.*, (2), 41. 216, 1866; L. Eich, *Berg. Hütt. Ztg.*, 30. 29, 1871; P. Laur, *Compt. Rend.*, 95. 38, 1882; F. Hollick, *Dingler's Journ.*, 258. 168, 1855.

⁵ I. de Born, *Amalgamation des minerais d'or et d'argent*, Vienna, 1786; R. W. Raymond, *Mining Statistics West of the Rocky Mountains*, Washington, 733, 1870.

⁶ W. M. Brodie, *Mexican Min. Journ.*, 12. 21, 1911; R. B. Watson, *Eng. Min. Journ.*, 94. 1077, 1911.

⁷ C. Kuhlemann, *Berg. Hütt. Ztg.*, 31. 76, 1872; *Zeit. Berg. Hütt. Sal.*, 19. 180, 1871; O. Hofmann, *Min. Ind.*, 8. 189, 1899; 9. 222, 1900; 10. 230, 1901; *Hydrometallurgy of Silver*, New York, 259, 1907.

⁸ G. V. A. Steinbeck, *Die Veränderungen des Mansfelder Kupfersteins beim Rösten*, Halle, 1862.

⁹ A. Grützner, *Die Augustin'sche Silberextraktion, in ihrer Anwendung auf Hüttenprodukte und Erze*, Braunschweig, 1851.

¹⁰ E. Kühn, *Die chemischen Vorgänge bei der Cyanlaugung von Silbererzen*, Halle a. S., 1912.

¹¹ T. P. Holt, *Trans. Amer. Inst. Min. Eng.*, 49. 183, 1907.

¹² H. Hahn, *Trans. Amer. Inst. Min. Eng.*, 2. 99, 1874; *Eng. Min. Journ.*, 65. 434, 1898; J. Percy, *Chemist*, 1. 248, 1850; *Phil. Mag.*, (3), 36. 1, 1850.

¹³ E. H. Russell, *U.S. Pat. No. 295815*, 1887; C. A. Stetefeldt, *The Lixiviation of Silver Ores with Hyposulphite Solutions*, Freiberg, 1895; C. H. Aaron, *Leaching Gold and Silver Ores*, San Francisco, 1881.

¹⁴ L. Wöhler, W. Plüddemann, and P. Wöhler, *Ber.*, 41. 703, 1908; G. Keppeler, *Zeit. angew. Chem.*, 21. 532, 1908; R. Schenck, *Physikalische Chemie der Metalle*, Halle, 174, 1909.

¹⁵ H. O. Hofman and W. Wanjukow, *Trans. Amer. Inst. Min. Eng.*, 43. 423, 1912.

¹⁶ W. C. Roberts-Austen, *An Introduction to the Study of Metallurgy*, London, 10, 1902.

¹⁷ B. Moebius, *Brit. Pat. No. 16554*, 1884; *Eng. Min. Journ.*, 44. 447, 1885; 47. 324, 1888; 48. 25, 1888; 51. 556, 1891; 83. 802, 1907.

¹⁸ J. Wislicenus, *Liebig's Ann.*, 149. 220, 1869; M. Gombert and L. H. Cohne, *Ber.*, 39. 3287, 1906.

¹⁹ T. W. Richards, *Journ. Chem. Soc.*, 99. 1201, 1911; J. S. Stas, *Mém. Acad. Belg.*, 35. 1, 1865; *Œuvres complètes*, Bruxelles, 1. 451, 1894.

²⁰ T. W. Richards and R. C. Wells, *Journ. Amer. Chem. Soc.*, 27. 459, 1905; *A Revision of the Atomic Weights of Sodium and Chlorine*, Washington, 16, 1905; G. P. Baxter, *Journ. Amer. Chem. Soc.*, 28. 1329, 1906; 44. 591, 1922; G. P. Baxter and L. W. Parsons, *ib.*, 44. 577, 1922; G. P. Baxter, C. J. Moore, and A. C. Boylston, *ib.*, 34. 260, 1912; G. P. Baxter and H. Grover, *ib.*, 37. 1030, 1915.

²¹ J. L. H. Abrahall, *Journ. Chem. Soc.*, 61. 660, 1892; T. W. Richards and G. W. Heimrod, *Proc. Amer. Acad.*, 37. 415, 1902.

§ 4. The Desilverization of Lead

Galena usually contains a little silver, and most of the silver follows the lead during its extraction. In some cases, the silver is even more valuable than the lead itself—e.g. at Freiberg, Colorado, and Broken Hill. The lead from furnaces often

contains sufficient silver to pay for its extraction ; the lead at Freiberg, for instance, contains about 96.67 per cent. of lead and 0.55 per cent. of silver. The lead is usually desilverized by Pattinson's or Parkes' process, and in rarer cases, by cupellation or electrolysis. The choice of the process is determined by local conditions. Other things being equal, it is reported that at Ems : ¹

	Cupella- tion.	Pattinson's process.	Parkes' process.
Cost of treatment	3	1.5	1 unit.
Percentage recovery of silver and lead	0.94	0.98	0.99 unit.

The first operation in desilvering lead by Pattinson's or Parkes' process is to soften the so-called *hard-lead*—*Hartblei*—from the blast-furnace, by melting it in a reverberatory furnace with a shallow bed, and with the walls cooled by a water-jacket where they are most likely to be attacked by the metallic oxides formed in the operation. The metal is melted at a low heat and stirred ; most of the copper rises to the surface and is skimmed off as dross ; at a rather higher temp., much tin is removed ; and at a still higher temp., arsenic, antimony, and many other metal impurities are removed as oxides with some litharge. The hard-lead, thus freed by liquation and oxidation from the impurities which make it hard and brittle, is called *soft-lead*—*Weichblei*.

Pattinson's process for desilvering lead.—In 1833, H. L. Pattinson² noticed that on heating a bar of lead containing a small proportion of silver, the first drops which oozed out were richer in silver than the residual lead ; and conversely, with bars of lead with a relatively high proportion of silver, the first drops of metal which oozed out contained less silver than the residual lead. These phenomena were generalized only when the laws of soln. had been elucidated further than was the case in Pattinson's day ; but the facts sufficed for the development of a highly ingenious process for the desilverization of lead.

Molten lead and silver mix together in all proportions, and the m.p. of all possible alloys of the two metals, with less than 10 per cent. of silver, are indicated in Fig. 4. There is a eutectic temp. at 303°, when the molten lead contains 2.4 per cent. of silver. The part of the curve on the lead side of the eutectic is alone concerned in Pattinson's process. If a molten mixture of lead with, say, 50 per cent. of silver be allowed to cool, when the temp. reaches 648°, some silver (contaminated with a little lead) will separate from the soln. The remaining fluid is richer in lead than it was before, and consequently remains fluid, but as the temp. falls, more silver will separate from the soln. and the mother liquid will continually get poorer and poorer in silver until but 2.4 per cent. remains. The whole will then freeze *en bloc* at 303°. If the molten mass contains less than 2.4 per cent. of silver, it will freeze somewhere between 327° and 303°, and lead (contaminated with a little silver) will separate from the soln., and continue separating until the mother liquid has 2.4 per cent. of silver, when all the remaining silver and lead will freeze *en masse*. In Pattinson's process, the softened lead is melted, and the molten mixture, containing less than 2.4 per cent. of silver, is allowed to cool slowly. The crystals of lead which separate from the cooling soln. contain more lead than the original soln., and form a kind of mush. The crystals are ladled with perforated ladles into a neighbouring pot on the right until one-eighth to one-third of the liquid remains.³ The enriched alloy, remaining in the pot, is ladled to a pot on the left. The operations are repeated on both fractions time and again, until the enriched lead contains about 1 per cent. of silver, and the desilvered lead contains but 0.001–0.002 per cent. of silver—in practice, the desilvered lead has about

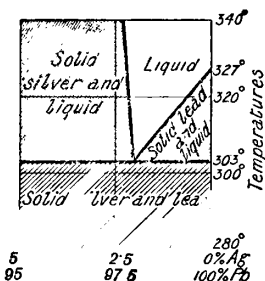

FIG. 4.—The Eutectic Portion of Freezing Curve of Silver-Lead Alloys.

10 dwts. or less of silver per ton. In practice, the enriched lead has 300–500 ozs. of silver per ton. When the lading from kettle to kettle is done by hand, there may be a row of eight to sixteen pots; the last pot on the right is the *market-pot*, and it contains the desilvered lead. The impurities, antimony, bismuth, and nickel, associated with the soft lead follow the silver, and at Freiberg, the bismuth is recovered from the litharge formed during the cupellation. Arsenic follows the lead, and the copper remains equally distributed with both fractions.⁴ The market lead produced by Pattinson's process is soft and fairly pure.

In a modification of Pattinson's process—called **Rozan's process**⁵—the base-bullion is melted in tilting kettles which discharge into a crystallizing kettle; steam is then blown through the latter until about two-thirds of the lead has crystallized, and the enriched portion is removed by tapping. The process is repeated until the lead is sufficiently desilverized.

Parkes' process for the desilverization of lead.—In 1842, C. J. B. Karsten⁶ discovered that argentiferous lead could be desilverized by means of zinc, but the process was not practicable until A. Parkes developed the subject about 1850. If 1 to 2 per cent. of zinc be stirred into argentiferous lead, just above its m.p., it appears as if the affinity of silver for zinc is greater than it is for lead, because the zinc deprives the lead of its silver and floats as an alloy on the molten lead. The surface crust of the zinc-silver alloy freezes before the lead, and the two can be separated by skimming the surface of the molten metal. In practice, the zinc added to the lead is kept between 0.8 and 1.5 per cent., and the composition of the zinc-silver crystals ladled off, is dependent upon the temp., and on the relative proportions of the two metals present. Gold in the argentiferous lead passes with the silver to the zinc; arsenic, antimony, and bismuth, for the main part, follow the lead; platinum, palladium, cobalt, and nickel follow the zinc.⁷ Consequently, the lead from Parkes' process is not freed from bismuth during the operation as is the case with Pattinson's process. To avoid an undue consumption of zinc, it is necessary to soften the lead by a preliminary purification as in the case of Pattinson's process. Usually, the zinking of the lead is performed two, three, or more times, the temp. being raised each time. Finally, the desilvered lead contains but 0.0005 per cent. of silver. The desilverization can be carried much further by this process than is practicable with Pattinson's. The mixture of zinc, lead, and the precious metals is liquated by heating it on an inclined surface hot enough to melt the lead, but not the zinc alloy; or else it is subjected to press. as it is lifted from the kettles containing the molten alloy. In either case, the lead flows away, and the enriched scum remains. The zinc can be separated from the silver, gold, and lead by distillation from plumbago retorts; the residue in the retort is cupelled, and, if necessary, parted, as described for gold. The solubility of lead in zinc varies considerably with temp. At 540°, silver is about 300 times more soluble in zinc than in lead, and at 358°, about 3000 times more soluble. Above 940°, the two metals are mutually soluble in all proportions, below that temp., the liquid separates into two layers—the lower layer represents a soln. of zinc in lead, and the upper layer a soln. of lead in zinc. The two solubility curves meet at about 940°, forming a closed curve as illustrated in Fig. 5. The temp. 940° is the critical soln. temp. If from 1 to 2 per cent. of zinc be stirred into molten lead, the liquid separates into two layers, the lighter zinciferous alloy floats on the surface of the heavier plumbiferous alloy. If silver be present in the lead, it will divide itself between the two layers so that a considerably larger proportion of the silver accumulates with the lighter layer. C. R. A. Wright and C. Thompson⁸ determined the composition of the two layers with varying proportions of the three

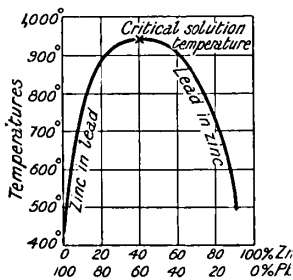

FIG. 5.—Mutual Solubility of Lead and Zinc.

accumulates with the lighter layer. C. R. A. Wright and C. Thompson⁸ determined the composition of the two layers with varying proportions of the three

metals after they had stood for 8 hrs. between 750° and 850°; a selection from their results is indicated in Table III. G. N. Potdar⁹ measured the partition coeff. of

TABLE III.—THE DISTRIBUTION OF SILVER BETWEEN ZINC AND LEAD.

Heavier layer.			Lighter layer.		
Silver.	Lead.	Zinc.	Silver.	Lead.	Zinc.
0	0·9870	0·0130	0	0·0157	0·9843
0·0002	0·9864	0·0134	0·0934	0·0251	0·8815
0·0025	0·9708	0·0267	0·2228	0·0756	0·7016
0·0226	0·9646	0·0128	0·4893	0·0382	0·4725
0·1075	0·8695	0·0230	0·6193	0·1028	0·2779

silver between the lead and zinc, but the numbers are not altogether satisfactory, although the partition coeff. was nearly constant for the more dil. soln. up to about 6 per cent. of silver, e.g.:

Silver in light layer	.	.	0·75	0·99	2·14	4·43	5·42	6·26
Silver in heavy layer	.	.	0·0030	0·0037	0·0096	0·0198	0·0169	0·0197
Partition coeff.	.	.	250	267	223	226	320	317

The many compounds of zinc and silver, contrasted with the failure of silver and lead to form any compound, show the greater affinity between zinc and silver, than between silver and lead; this may also have some connection with the fact, indicated above, that at about 540°, silver is 300 times more soluble in zinc than in lead. F. Rössler recommended the addition of 0·5 per cent. of aluminium to the zinc so as to give it a greater resistance to oxidation.

Electrolytic process for desilverization of lead.—Lead has also been desilvered electrolytically. Base-bullion is used for the anodes; sheets of highly purified lead are used for the cathodes; and a soln. of lead fluosilicate is used as electrolyte. Otherwise, the process is analogous with the refining of copper by electrolysis. Gold, silver, and bismuth are recovered from the anode slime.¹⁰

REFERENCES.

- ¹ H. F. Collins, *The Metallurgy of Lead*, London, 360, 1910.
- ² H. L. Pattinson, *Brit. Pat. No. 6487*, 1833; *Journ. prakt. Chem.*, (1), **10**, 321, 1837.
- ³ F. Reich, *Berg. Hütt. Ztg.*, **21**, 251, 1862; F. le Play, *Ann. Mines*, (3), **10**, 381, 1836; M. Röswag, *Métallurgie de la désargentation des plombs argentifères*, Paris, 1884.
- ⁴ C. A. Stetefeldt, *Berg. Hütt. Ztg.*, **22**, 64, 69, 77, 297, 381, 1863.
- ⁵ Anon., *Berg. Hütt. Ztg.*, **48**, 116, 1889; C. Rössler, *ib.*, **48**, 387, 1889.
- ⁶ L. Rozan, *Ann. Mines*, (7), **3**, 160, 1873; A. Zdráhal, *Oester. Jahrb.*, **38**, 1, 1890.
- ⁷ C. J. B. Karsten, *Karsten's Archiv.*, **16**, 597, 1829; **26**, 295, 1834; A. Parkes, *Brit. Pat. No. 13118*, 1850; **13997**, 1852; *Dingler's Journ.*, **119**, 466, 1851; **123**, 310, 1852; C. Schnabel, *ib.*, **228**, 186, 1878.
- ⁸ C. Kirchhoff, *Met. Rev.*, **1**, 224, 1878; *Dingler's Journ.*, **228**, 265, 1878; C. Heberlein, *Berg. Hütt. Ztg.*, **54**, 42, 1895; C. Schnabel, *Metalhüttenkunde*, Berlin, **1**, 530, 1901; H. O. Hofman, *The Metallurgy of Lead*, New York, 430, 1908.
- ⁹ C. R. A. Wright and C. Thompson, *Proc. Roy. Soc.*, **48**, 25, 1890.
- ¹⁰ G. N. Potdar, *Journ. Coll. Science, Tokyo*, **25**, 9, 1907; W. Spring and L. Romanoff, *Zeit. anorg. Chem.*, **13**, 29, 1897; B. Bogitsch, *Compt. Rend.*, **159**, 178, 1914; F. Rössler, *Brit. Pat. No. 64416*, 1892.

¹⁰ A. G. Betts, *Electrochem. Ind.*, **1**, 407, 1903; *Lead Refining by Electrolysis*, New York, 1908.

§ 5. The Purification of Silver ; and the Separation of the Metal from its Compounds

Commercial electrolytic silver may contain 0.5 per cent. of impurities, and silver prepared in the dry way is of a still lower degree of purity. The impurities which have been reported include lead, copper, gold, bismuth, antimony, arsenic, platinum, palladium, selenium, sulphur, etc. A common method of purifying the silver is to dissolve it in dil. nitric acid and precipitate the silver from the soln. of the nitrate, or precipitate the silver as chloride, and subsequently reduce the chloride to the metal. Silver is readily reduced from most of its compounds. V. Kohlschütter and E. Eydmann¹ reduced silver oxide, nitride, hyponitrite, nitrite, carbonate, and oxalate by the mere application of heat ; and also by warming the oxide in hydrogen or carbon monoxide. P. Laur found that hydrogen developed in a liquid in which silver sulphide, chloride, bromide, or iodide is suspended reduces these salts to the metal ; and A. Jaques that a soln. of silver acetate is reduced by hydrogen ; and H. Vogel that the same soln. is reduced slowly when boiled.

F. Mohr² reduced the chloride by mixing it with one-third its weight of resin, and gradually raising its temp. ; when the resin is burned away, some borax is added and the mixture heated to the m.p. of the metal. The process is very messy. G. C. Wittstein used wood charcoal in place of resin. The reduction is ascribed wholly to the hydrogen of the charcoal, for (a) no chlorine is evolved, but hydrogen chloride alone is given off, and (b) no reduction occurs if pure carbon be substituted for the charcoal. J. S. Stas recommended re-melting the metal with 5 per cent. of borax, and $\frac{1}{2}$ per cent. of soda nitre in an unglazed porcelain crucible. J. Thallwitz mixed wood charcoal and sodium dioxide with the silver chloride in a clay crucible. In a short time a vigorous reaction spontaneously occurs, and a button of silver is formed. J. L. Gay Lussac reduced silver chloride by heating it with a mixture of calcium oxide and charcoal ; but, according to J. B. Trommsdorff, and P. T. Meissner, the reaction is incomplete. J. E. F. Giese, E. Mohr, etc., fused silver chloride with alkali carbonate, but J. L. Proust found that the reaction is incomplete since some decomposed silver chloride remains as a residue when the silver is dissolved in nitric acid.

Silver chloride is reduced to the oxide when boiled with a conc. soln. of potassium or sodium hydroxide. The oxide is washed, and heated until it decomposes and melts ; if any undecomposed chloride is still present, a little alkali carbonate is added. According to W. Gregory,³ there is no fear of the loss of silver chloride by its sinking into the crucible, or spitting. Silver chloride is reduced to the metal when boiled with a soln. of alkali hydroxide or carbonate mixed with a suitable reducing agent. A. Levol, J. L. Casaseca, and F. Mohr used sugar ; H. Vogel and J. S. Stas used lactose ; P. A. Bolley used sugar, glycerin, or honey—it is probable that the reaction is not always complete ; R. Böttger and E. Brunner, and C. A. Müller used dextrose ; T. W. Richards and R. C. Wells, G. P. Baxter and H. C. Chapin, and W. Wicke used invert sugar ; L. Vanino, and V. Kohlschütter and E. Eydmann used formaldehyde ; G. D. Buckner and G. A. Hulett, ammonium formate. J. Guareschi reduced silver bromide by warming it with chromic anhydride ; E. H. Booth reduced an ammoniacal soln. of silver chloride with sodium dioxide ; F. Mawrow and G. Mollow found that silver chloride is slowly and quantitatively reduced by hypophosphorous acid.

Moist silver chloride is reduced to the metal when placed in contact with iron or zinc ; a little dil. sulphuric or hydrochloric acid hastens the reaction. The reduced silver is washed with dil. acid, then with the hot water, and dried. It then appears as a soft grey powder ; it is then mixed with borax and then a little nitre, and fused. According to F. Mohr, and W. Gregory, the reaction is incomplete, and the washing with acid does not remove all the zinc or iron from the silver. A. Gawalowsky also studied the reduction of silver chloride by zinc. M. Gräger reduced a soln. of the

silver chloride in aq. ammonia with zinc, and found that the silver is simultaneously separated from copper—if that element be present. The silver chloride can also be triturated with an excess of mercury; a silver amalgam is formed from which the mercury can be separated by distillation, as in the amalgamation process—*vide infra*. E. Vigouroux used aluminium in the presence of 10 per cent. hydrochloric acid; the acid can be replaced by ammonia, and the water by benzene, ether, or chloroform.

N. W. Fischer,⁴ and J. E. F. Giese placed silver chloride with water in a glass cylinder closed at one end by a membrane; the cylinder rested on a zinc plate immersed in water, and electrical connection with the water in the cylinder was made by means of a platinum or silver wire. The chloride was reduced in about a week's time. E. Brunner, F. Wandesleben, and O. Pfeiffer covered a platinum, silver, or copper dish with wax, leaving a round patch of the metal exposed on the bottom. The dish was placed on a disc of amalgamated zinc resting in a larger dish. Sulphuric acid was poured into the vessel so that the smaller dish containing silver chloride was wholly immersed. The silver chloride was reduced in about 24 hrs. Any of the halide not reduced was removed by washing with aqua ammonia. J. E. F. Giese, N. Gräger, W. Gregory, P. A. Bolley, R. Böttger, C. A. Müller, and O. Kühn have used modifications of the process. J. Nicklès, and J. S. Stas obtained silver of a high degree of purity by the electrolysis of a soln. of silver chloride in potassium cyanide. L. Kahlenberg electrolyzed a soln. of silver nitrate in pyridine. R. Lorenz and A. Helfenstein electrolyzed fused silver chloride; and T. W. Richards and W. N. Stull electrolyzed a soln. of silver nitrate in a molten mixture of sodium and potassium nitrates.

According to A. Vogel,⁵ *sulphurous acid* gives a white precipitate with soln. of silver salts which turns grey on boiling, the mother liquid retains silver, and it becomes turbid when allowed to stand for some time. A. Pleischl said that sulphurous acid gives white flakes which turn yellow, then brown, and then contain silver sulphide. He also found that *ammonium sulphite* precipitates white silver sulphite which becomes covered with a shining film of metal—slowly at ordinary temp., rapidly when heated. The reaction of *potassium sulphite*, said A. Pleischl, resembles that of sulphurous acid. H. Rose found *cuprous oxide* precipitates from silver nitrate soln. a grey-coloured mixture of silver and basic cupric nitrate, and a mechanical mixture of copper and cupric oxide was found to act in a similar manner. P. Sabatier found the reaction is exothermal, and with a mol of silver in two litres of water the precipitate has the composition $6\text{Ag} + 3\text{CuO} \cdot \text{Cu}(\text{NO}_3)_2 \cdot 3\text{H}_2\text{O}$. The precipitate from a boiling soln. has virtually the same composition. J. H. Gladstone, and A. Geuther observed that a warm soln. of silver nitrate dissolves cuprous oxide and at the same time crystals of silver are formed. R. Heumann and R. Schneider obtained a mixture of metallic silver and silver sulphide by the action of *cuprous sulphide* on a soln. of silver nitrate. K. Emszt obtained silver and silver chloride by acting on silver nitrate with *cuprous chloride*; N. A. E. Millon and A. Commaille reduced ammoniacal soln. of silver salts with an ammoniacal soln. of cuprous chloride; and J. S. Stas utilized the reaction in the preparation of silver from the ammoniacal soln. of a silver salt contaminated with copper. When ammonium sulphite is added, the copper is reduced to the cuprous form, and that reduces the silver to the metal which is precipitated in a finely-divided condition. A. Geuther mixed the soln. of silver with ammonium chloride and treated it with an alkaline soln. of *sodium hypophosphate*, whereupon silver is precipitated and any copper present remains in soln.

According to H. Rose, a soln. of *stannous chloride* in small quantity gives a white precipitate of silver chloride, while an excess of the tin salt gives a brownish-black precipitate of metallic silver. When the soln. of silver nitrate and stannous chloride are very dil., J. Percy obtained a rich yellowish-brown liquid, probably colloidal silver. The colour resembles that of glass stained with silver, for "the silver-stain of glass may be due to metallic silver in an extremely

fine state of division." H. Schulz obtained a colour analogous to that of purple of Cassius by stirring stannous hydroxide with water and a neutral soln. of silver nitrate and then gradually warming the mixture. Here again the colour of the *silver purple of Cassius* is probably a kind of lake in which stannic oxide is tinted with the finely-divided metal, just as M. Faraday could say, "I believe the purple of Cassius to be essentially finely-divided gold associated with more or less oxide of tin." H. Rose also found that a soln. of *stannous sulphate* produces a precipitate which is at first white, but soon becomes black or brownish-black, and retains this colour on boiling; and when this precipitate is heated with hydrochloric acid, metallic silver remains. F. Gutzkow, and L. Berlandt treated a hot soln. of silver nitrate or sulphate with one of *ferrous sulphate*, silver is precipitated, copper remains in soln. The reaction was noted by J. Keir, and, according to J. L. Proust and C. F. Bucholz, the precipitated silver may redissolve in the soln. of ferric sulphate when boiled. With silver nitrate the reaction is symbolized: $3\text{AgNO}_3 + 3\text{FeSO}_4 = \text{Fe}_2(\text{SO}_4)_3 + \text{Fe}(\text{NO}_3)_3 + 3\text{Ag}$. G. Wetzlar, J. E. F. Giese, and A. Vogel found that silver so obtained is contaminated with some iron, particularly if the soln. be dil., presumably owing to the simultaneous precipitation of a basic ferric salt. According to H. Rose, if the soln. of silver nitrate be mixed with ferrous chloride, the addition of ferrous sulphate precipitates silver chloride not the metal, and he added:

If moist oxide of silver be added in sufficient quantity to a soln. of ferrous sulphate, the former becomes deep black, but is still converted into silver after some time, and only acquires greater stability when the quantity of silver oxide is very predominant: the filtered liquid then contains no iron, but only silver sulphate. The black compound is obtained most readily and of the greatest stability, when a soln. of silver nitrate is mixed with so much ammonia that the small quantity of silver oxide separated is redissolved, and an excess of this soln. is dropped into a soln. of ferrous sulphate. A deep black precipitate is then formed immediately, which has so remarkably strong a colouring power that the smallest quantity of ferrous or argentic oxide may be thereby detected. In the first case, the slightly ammoniacal soln. of silver oxide is as sensitive a reagent as the soln. of potassium ferrocyanide and ammonium sulphide. The black precipitate is very stable, and undergoes no change in the air. At a dull red heat it only loses water, but it is not otherwise changed in composition; at a stronger red heat it is converted into silver and ferric oxide. By trituration in an agate mortar, it acquires a metallic lustre. It is changed by dil. hydrochloric acid into silver chloride, silver, and ferric chloride; but the quantity of silver separated is not very considerable: it is greater when the substance is treated with dil. acetic acid. By nitric acid, ferric oxide is first separated, whilst silver dissolves with evolution of gas; complete soln. takes place on the application of heat. When treated with a soln. of auric perchloride, silver chloride is formed and gold separated. The compound when variously prepared has the same composition: it consists of $\text{AgO} + 2\text{FeO} + \text{Fe}_2\text{O}_3$, where the ferric oxide acts as an acid towards the two bases. A compound of $\text{AgO} + \text{Fe}_2\text{O}_3$, without ferrous oxide, may be obtained by dissolving silver oxide in ammonia-water and adding thereto a soln. of ferrous sulphate, the former soln. being in great excess. When ferrous and silver oxides are combined with weak acids, the soln. of these neutral compounds form the black precipitate of silver oxide, without the addition of ammonia or any other base. If ferrous and silver acetates be used, the black compound is immediately produced, but under the influence of the free acids becomes white of itself in course of time, changing into silver. A far greater quantity of the compound of silver oxide is, however, produced when the free acids are sat. by a small quantity of a base.

J. Seymour showed that the reaction between ferrous sulphate and silver nitrate occurs in darkness as well as in light. The action of ferrous sulphate on silver salts has been also studied by V. Kohlschütter and E. Fischmann, H. Vogel, etc. L. Pissarjewsky obtained indications of what he regarded as two different modifications of silver by reduction with ferrous salts—*vide* allotropic and colloidal silver. F. Kessler reduced a neutral soln. of a silver salt with a mixture of sodium and *ferrous acetate*. C. Palmer and E. S. Bastin found some natural *sulphides* of copper, cobalt, and nickel precipitated silver from dil. soln. of the sulphate; pyrite and galena were inactive. J. M. Eder found potassium ferrous oxalate reduces silver nitrate to the metal. There is no decomposition when a soln. of manganous sulphate is added to one of silver nitrate, although a black precipitate may appear after a very long time; but, according to L. Schnaubert, and F. Wöhler, when alkalies are added to a mixed soln.

of a silver and a *manganous salt*, a black mixture of silver and manganese dioxide is precipitated. J. J. Ebelmen found *uranous oxide* decomposes silver nitrate without any evolution of gas producing metallic silver and uranic nitrate. According to R. A. Wawrinsky, when a mixed soln. of copper and silver nitrates is treated with *magnesium carbonate*, the copper carbonate is precipitated between 40° and 50°, and silver carbonate over 60°.

According to V. Kohlschütter and E. Fischmann, *hydrazine hydrate* precipitates silver from the ammoniacal soln. of a silver salt. R. Fresenius and H. Neubauer⁶ found a dil. soln. of silver nitrate is more rapidly reduced by *phosphorus* than a conc. soln. Finely-divided phosphorus, observed J. S. Stas, slowly reduces a 1 per cent. soln. of silver nitrate to the metal. With a conc. soln. of the nitrate and yellow phosphorus, T. Poleck and K. Thümmel obtained first a yellow liquid owing to the formation of $\text{Ag}_3\text{P}\cdot 3\text{AgNO}_3$, which is then reduced to silver phosphide, and W. Wicke found that a conc. soln. slowly deposits crystalline silver on the phosphorus. J. Phillip obtained silver phosphate as well as phosphoric and phosphorous acids by warming a nitric acid soln. of silver nitrate with phosphorus. J. B. Senderens represents the reaction with red phosphorus: $10\text{AgNO}_3 + 2\text{P} + 8\text{H}_2\text{O} = 10\text{Ag} + 2\text{H}_3\text{PO}_4 + 10\text{HNO}_3$. The reduction of silver nitrate soln. by phosphorus is utilized in electro-plating.

According to G. Shaw, the article to be plated is cleaned and dried, and then dipped in a soln. of phosphorus in twelve times its weight of carbon disulphide. As the solvent evaporates, a film of finely divided phosphorus remains on the surface. The article is then immersed in a soln. of silver nitrate. In this manner, the most delicate objects, such as lace, feathers, insects, and fruit, indeed, anything which will bear immersion in liquid, may be coated with a film of silver. Mrs. Fulhame used a similar process in 1794.

According to C. J. D. von Grotthuss, characters written on paper with a soln. of silver nitrate, and placed in a bottle containing phosphorus and atm. air, are blackened owing to the reduction of the nitrate to the metal. According to W. Herapath, the early Egyptians marked linen with a soln. of a silver salt. F. Mawrow and G. Mollow quantitatively reduced silver chloride to the metal by treating it with *hypophosphorous acid*. A. Wurtz reduced silver nitrate with the same agent. The brown precipitate produced by *phosphine* in a soln. of silver nitrate or sulphate consists of metallic silver, *vide* silver nitrate. P. Pascal found that *alkali ferroporphosphate*, $\text{M}_3\text{Fe}_2(\text{P}_2\text{O}_7)_3$, reduces silver nitrate to the metal. E. Soubeiran, and J. L. Lassaigne reduced dil. soln. of silver nitrate to the metal by treatment with *arsine*; with conc. soln. a double compound is formed. Z. Pozzi, and H. Reckleben and co-workers found arsine reduced ammoniacal soln. of silver salts. H. Reckleben and A. Güttich found *stibine* behaved like arsine. According to T. Poleck and K. Thümmel, when finely-divided *arsenic* is added to a neutral conc. soln. of silver nitrate, a yellow colour is developed, and the soln. reacts acid; nitric and arsenious acids are formed, and silver is precipitated. N. W. Fischer found that arsenic reduces aq. or alcoholic soln. of silver nitrate, forming, according to J. B. Senderens, arsenious oxide; *antimony* reduces the aq. nitrate or carbonate suspended in water, but it does not reduce the aq. sulphate or alcoholic nitrate; T. Poleck and K. Thümmel found that if precipitated antimony be added to a very conc. soln. of silver nitrate, a black precipitate of presumably silver antimonide is formed, and the soln. reacts acid; with the addition of more antimony a grey substance is precipitated, oxides of nitrogen are evolved, the soln. becomes warm, and the acidity disappears. The grey substance is presumably a mixture of antimony trioxide and silver. Black silver antimonide is precipitated from dil. soln. of silver nitrate (1 : 80) and the soln. becomes warm; J. B. Senderens says the precipitate is metallic silver; and R. Bartels, that a vigorous evolution of gas occurs. According to J. B. Senderens, no gas is developed with $\frac{1}{20}\text{N}$ - AgNO_3 , and the reduction is incomplete because a protective crust of antimony oxynitrate is formed, but from a $\frac{1}{2}\text{N}$ - or $\frac{1}{3}\text{N}$ -soln. the silver is quantitatively precipitated, some free nitric acid is formed and very little ammonium nitrite. According to N. W. Fischer, *bismuth* reduces the aq. or

alcoholic nitrate; and the carbonate suspended in water; but not the aq. sulphate. C. H. Palmer and E. S. Bastin found that the arsenides of copper, cobalt, and nickel reduce a dil. soln. of silver sulphate to the metal.

The metallic precipitation of silver.—In his memoir *Das Verhältniss der chemischen Verwandtschaft zur galvanischen Electricität, in Versuchen dargestellt* (Berlin, 1830), N. W. Fischer⁷ showed that silver is precipitated in the metallic state from aq. soln. of the nitrate by metallic lead, zinc, cadmium, mercury, tin, iron, copper, bismuth, antimony, and arsenic. The time required for the precipitation varies with the kind of metal employed. It is shortest with the first two elements, and the others require a longer and longer time and that in the order named. Excluding antimony, the reduction of silver from alcoholic soln. of silver nitrate is likewise affected by these metals. The metal is also reduced from the ammoniacal soln. of the nitrate quickly and completely by zinc, cadmium, copper, and arsenic; slowly by cobalt, mercury, and antimony; and not all by iron, manganese, nickel, or bismuth. Silver is also reduced from the molten nitrate by zinc, cadmium, tin, and copper, though not all, or very slowly, by certain other metals. J. B. Senderens studied metallic precipitation with the object of testing Richter's law, but he found that with silver nitrate, the law does not describe the facts because the displacement of the silver is always accompanied by a reduction of some of the nitric acid. According to A. Guntz and F. Martin, finely-divided manganese, nickel, cobalt, and copper, reduce silver nitrate dissolved in strongly ionizing, non-aqueous solvents. Thus, in liquid ammonia these metals form ammino-salts of the type $M(\text{NO}_3)_2 \cdot n\text{NH}_3$; similar remarks apply more or less to soln. in acetone and benzonitrile.

A. Chevallier found that dry silver nitrate is reduced to the metal by copper. As just indicated, N. W. Fischer found silver to be precipitated by copper from aq. or alcoholic soln. of the nitrate, and from the molten salt. According to J. L. Gay Lussac, the silver precipitated from aq. soln. of the nitrate is at first fairly pure but that later deposited is mixed with copper which dissolves out when the contaminated metal is immersed in a soln. of silver nitrate. J. B. Senderens found that only 65 to 68 per cent. of the silver can be displaced by copper from the nitrate; some ammonium nitrite is produced, and the presence of air leads to the deposition of some basic cupric salt. W. Hampe observed that with a cold soln. of silver nitrate, copper first gives nitric oxide and then forms some cupric oxide, which is decomposed by the excess of silver nitrate; the precipitated silver contains traces of copper. The phenomenon has been also studied by M. Lucas, and L. Vignon.

J. H. Gladstone and A. Tribe found that if a plate of copper be suspended in a soln. of silver nitrate, so that the suspended metal reaches neither to the top nor the bottom of the liquid, and if the percentage conc. of the salt C be expressed by series of powers of 2, the rate of chemical action V will be expressed by the corresponding powers of 3, such that for conc. represented by 1, 2, 4, 8, . . ., the rate of chemical action will be 1, 3, 9, 27, . . . The mathematical expression of what they called a new law in chemical dynamics, is: $V = k(\log 3 - \log 2)^c$, where k is a constant. Two currents are set up during the precipitation, a light blue ascending stream of silver and copper nitrates, and a deep blue descending stream of copper nitrate containing about three times as much nitric acid as the main soln. J. W. Langley showed that the true law of chemical action: "the rate of total chemical action varies directly as the mass of the reacting body in soln.," is here obscured by the effects of gravitation, for the access of fresh silver nitrate to the copper depends on the rate at which cupric nitrate soln. is removed from the copper plate, and this in turn depends on the density of the copper nitrate soln. Gladstone and Tribe's "2-3 law" is not therefore a general law of chemical dynamics, but a case where the law of mass action is obscured by the conditions of the experiment.

The action of silver on a conc. soln. of silver nitrate has already been described. According to N. W. Fischer, zinc reduces silver from aq. or alcoholic soln. of silver nitrate, and also from the fused salt; it also reduces aq. soln. of the sulphate, and suspensions of the carbonate or phosphate in water. According to G. Wetzlar, if zinc be placed in a slightly acidulated soln. of silver nitrate, from the beginning to the end of the precipitation, there is formed a black moss-like growth of silver

contaminated with zinc. The deposit assumes a lighter colour towards the edges, and portions detached from the mass part with the contained zinc and become white—the dark colour is restored by bringing a whitened portion in contact with the zinc. He added that with a neutral soln. of silver nitrate only the metal first precipitated is black, the metal subsequently deposited is white. N. W. Fischer, on the contrary, maintains that neutral soln. give alloys from the beginning to the end of the precipitation, while acidulated soln. give alloys only towards the end of the deposition. If the silver nitrate soln. contains some copper nitrate, N. W. Fischer observed that the silver is all precipitated before the deposition of copper begins. According to the last-named authority, **cadmium** behaves like zinc. J. B. Senderens says some cadmium nitrite is formed; and with the zinc reduction, nitric oxide, ammonia, and zinc hydroxide are formed. According to E. G. Bryant, **magnesium** acts very much like zinc, and J. W. Dodson obtained finely divided crystalline silver by the action of magnesium on a soln. of silver nitrate.

In the fifteenth century, P. Eck de Sultzbach, in his *Clavis philosophorum*, 1489, mentioned arborescent crystals of silver which are produced by the action of mercury on a soln. of silver nitrate. The product of the reaction was soon after called *arbor Dianæ*—or the tree of Diana—e.g. in J. B. Porta's *Magia naturalis* (Naples, 1558). The precipitation of silver by mercury was mentioned by R. Boyle in his paper *On the mechanical causes of chemical precipitation* (London, 1675), and in many later writings; by J. von Löwenstein Kunckel in his *Vollstantiges Laboratorium chymicum* (Berlin, 1767), etc. N. W. Fischer observed that when **mercury** is immersed in a soln. of silver nitrate, or sulphate, silver amalgam is formed, and a black powder said to contain silver suboxide is deposited from alcoholic soln.; mercury also exerts a slight action on silver phosphate and carbonate. According to A. Ogg, equilibrium in the reaction between mercury and a soln. of silver nitrate is attained between silver and mercurous nitrates and the amalgam. The conc. of the mercury may be regarded as constant, and if a be the eq. conc. of the silver nitrate, b that of mercurous nitrate, and c that of the silver in the amalgam, a/bc is a constant if the mercury ions are equivalent, and a/cb^2 if the mercury ions are bivalent. C. Barfoed found silver nitrate is reduced by the vapour of mercury.

N. W. Fischer found that black metallic silver is precipitated by **tin** from a soln. of silver nitrate or sulphate, a brown powder is formed at the same time, and the liquid is tinted brown. Tin precipitates but a little silver from an alcoholic soln. of the nitrate, and this only when the metal is first immersed. Tin also reduces dry silver nitrate, and the carbonate or phosphate when suspended in water. According to J. B. Senderens, the reduction of aq. soln. of the nitrate is attended by the formation of stannous oxide, and ammonium nitrate. N. W. Fischer found that **lead** precipitates silver from aq. soln. of the nitrate, and, with alcoholic soln., it behaves like tin. J. B. Senderens found that 2 gram-atoms of lead are required to displace the silver in two mols of silver nitrate, and that lead nitroso-nitrate, $\text{NO}_2\text{Pb}-\text{O}-\text{PbNO}_3$, is simultaneously formed. A soln. of silver nitrate was found by N. W. Fischer to be completely reduced by brass, and alloys of silver with zinc, tin, or lead; **manganese** exerts but a slight action, and **palladium** none. J. B. Senderens found **aluminium** to act very much like zinc, and the speed of the reduction increases with the conc. of the soln. N. W. Fischer says that **iron** causes no reduction either in an aq. or alcoholic soln. of silver nitrate, provided the soln. is perfectly neutral and there is no access of air; and none occurs so long as the metal is kept under the soln. If, on the contrary, the soln. is not neutral, but is diluted to a certain degree and contains free acid, or, if the iron projects out of the soln. and is exposed to atm. air, reduction always follows in a longer or shorter time which depends partly on the degree of dilution of the soln., as also upon the quantity of free acid, and partly upon the quality of the iron itself. However, under favourable conditions, complete reduction of the silver hardly occurs even after a very long time. According to H. Rose, and P. Sabatier, neutral soln. of above $\frac{1}{30}N\text{-AgNO}_3$ are not attacked by iron, but silver is deposited if the dilution be greater than is

represented by $\frac{1}{50}N\text{-AgNO}_3$. In acid soln. of silver nitrate, the iron becomes passive. F. Brandenberg stated that silver nitrate may be melted in iron vessels without change provided water be absent. According to J. B. Senderens, nickel has no action on soln. of silver nitrate, and cobalt acts like copper.

REFERENCES.

- ¹ V. Kohlschütter and E. Eydmann, *Liebig's Ann.*, 398. 5, 45, 1913; P. Laur, *Arch. Pharm.*, 221. 143, 1883; *Repert. Pharm.*, 10. 348, 1882; A. Jaques, *Trans. Faraday Soc.*, 5. 217, 1910, H. Vogel, *Pogg. Ann.*, 117. 321, 1862.
- ² F. Mohr, *Chem. Gaz.*, 3. 77, 1845; *Liebig's Ann.*, 3. 331, 1832; J. E. F. Giese, *ib.*, 3. 141, 1860; E. Mohr and A. P. J. du Ménil, *Arch. Pharm.*, (2), 62. 161, 1850; G. C. Wittstein, *Repert. Pharm.*, (3), 2. 1, 1848; *Chem. Gaz.*, 7. 354, 1849; J. S. Stas, *Bull. Acad. Belgique*, (2), 10. 208, 1860; *Mém. Acad. Belgique*, 35. 1, 1865; 93. 1, 1882; J. Thallwitz, *Zeit. phys. chem. Unterr.*, 17. 224, 1904; J. L. Gay Lussac, *Ann. Chim. Phys.*, (2), 14. 319, 1820; J. L. Proust, *Journ. Phys.*, 62. 211, 1806; J. B. Trommsdorff, *Neues Journ. Pharm.*, 5. 2, 437, 1821; P. T. Meissner, *Berlin Jahrb. Pharm.*, 19. 178, 1818.
- ³ W. Gregory, *Phil. Mag.*, (3), 22. 284, 1843; P. A. Bolley, *Journ. prakt. Chem.*, 18. 384, 1849; *Schweiz. polyt. Zeit.*, 3. 128, 1858; R. Böttger, *Dingler's Journ.*, 36. 158, 1855; E. Brunner, *ib.*, 171. 363, 1864; C. A. Miiller, *Arch. Pharm.*, (2), 118. 85, 1864; F. Mohr, *Liebig's Ann.*, 66. 65, 1848; L. Vanino, *Ber.*, 31. 1765, 1898; A. Levöl, *Rev. Scient.*, 19. 101, 1846; J. L. Casaseca, *Compt. Rend.*, 32. 686, 1851; J. S. Stas, *Bull. Acad. Belgique*, (2), 10. 208, 1860; *Mém. Acad. Belgique*, 35. 1, 1865; 93. 1, 1882; H. Vogel, *Pogg. Ann.*, 117. 321, 1862; G. P. Baxter and H. C. Chapin, *Zeit. anorg. Chem.*, 70. 19, 1911; T. W. Richards and R. C. Wells, *Journ. Amer. Chem. Soc.*, 27. 475, 1905; G. D. Buckner and G. A. Hulett, *Trans. Amer. Electrochem. Soc.*, 22. 372, 1912; J. Guareschi, *Atti Acad. Torino*, 48. 735, 1913; F. Mawrow and G. Mollow, *Zeit. anorg. Chem.*, 61. 96, 1909; E. H. Booth, *Chem. News*, 103. 288, 1911; A. Gawalowsky, *Oester. Chem. Ztg.*, 19. 150, 1916; E. Vigouroux, *Bull. Soc. Chim.*, (4), 1. 792, 1907; W. Wicke, *Liebig's Ann.*, 98. 143, 1856; V. Kohlschütter and E. Eydmann, *ib.*, 390, 346, 1912; M. Gräger, *Arch. Pharm.*, (3), 3. 85, 1873.
- ⁴ N. W. Fischer, *Schweigger's Journ.*, 20. 48, 1817; J. E. F. Giese, *Liebig's Ann.*, 3. 141, 1840; W. Gregory, *Phil. Mag.*, (3), 22. 284, 1843; N. Gräger, *Zeit. anal. Chem.*, 8. 64, 1869; *Dingler's Journ.*, 203. 111, 292, 1872; P. A. Bolley, *ib.*, 128. 301, 1853; *Schweiz. polyt. Zeit.*, 3. 128, 1858; R. Böttger, *Dingler's Journ.*, 136. 158, 1855; E. Brunner, *ib.*, 171. 363, 1864; C. A. Miiller, *Arch. Pharm.*, (2), 118. 85, 1864; O. Kühn, *Chem. Ztg.*, 22. 868, 1898; O. Pfeiffer, *ib.*, 22. 775, 1898; F. Wandeleben, *Jahrb. prakt. Pharm.*, 25. 102, 1852; J. Nicklès, *Journ. Pharm.*, (3), 41. 277, 1862; L. Kahlenberg, *Journ. Phys. Chem.*, 4. 349, 1900; E. Priwoznik, *Oesterr. Zeit. Berg. Hütt.*, 27. 418, 429, 1897; R. Lorenz and A. Helfenstein, *Zeit. anorg. Chem.*, 23. 97, 1900; T. W. Richards and W. N. Stull, *Zeit. phys. Chem.*, 42. 621, 1903; J. S. Stas, *Mém. Acad. Belg.*, 35. 1, 1865.
- ⁵ A. Vogel, *Journ. prakt. Chem.*, (1), 29. 279, 1843; R. Schneider, *Pogg. Ann.*, 152. 471, 1874; M. Vallety, *Ann. Chim. Anal. App.*, 10. 193, 1905; A. Pleischl, *Zeit. phys. Math.*, 3. 106, 1835; J. J. Ebelmen, *Ann. Chim. Phys.*, (2), 5. 219, 1817; N. A. E. Millon and A. Commaille, *Compt. Rend.*, 56. 309, 1863; P. Sabatier, *ib.*, 124. 363, 1897; J. S. Stas, *Bull. Acad. Belgique*, (2), 10. 233, 1860; M. Faraday, *Phil. Trans.*, 147. 170, 1857; J. E. F. Giese, *Liebig's Ann.*, 3. 141, 1840; V. Kohlschütter and E. Fischmann, *ib.*, 387. 100, 1912; A. Geuther, *ib.*, 114. 121, 1860; J. Seymour, *Pharm. Rundsch.*, 264, 1894; F. Gutzkow, *Monit. Scient.*, (2), 7. 128, 1870; L. Berlandt, *Dingler's Journ.*, 163. 237, 1862; R. A. Wawrinsky, *ib.*, 211. 244, 1874; J. Percy, *Silver and Gold*, London, 1. 92, 1880; H. Schulz, *Ueber eine dem Goldpurpur analoge Silberverbindungen*, Göttingen, 1857; H. Rose, *Sitzber. Akad. Berlin*, 311, 1857; *Chem. Gaz.*, 15. 344, 1857; 5. 2, 1847; *Ausführliches Handbuch der analytischen Chemie*, Braunschweig, 1. 172, 1851; F. Kessler, *Zeit. anal. Chem.*, 11. 258, 1872; 18. 8, 1879; L. Pissarjewsky, *Journ. Russ. Phys. Chem. Soc.*, 40. 367, 1908; H. Vogel, *Pogg. Ann.*, 117. 321, 1862; R. Schneider, *ib.*, 154. 295, 1874; N. W. Fischer, *ib.*, 6. 43, 1820; F. Wöhler, *ib.*, 41. 344, 1837; C. Palmer and E. S. Bastin, *Trans. Amer. Inst. Min. Eng.*, 45. 224, 1913; A. Vogel, *Journ. prakt. Chem.*, (1), 20. 362, 1840; G. Wetzlar, *Schweigger's Journ.*, 23. 94, 1828; J. L. Proust, *Journ. Phys.*, 62. 211, 1806; C. F. Buchholz, *Beiträge zur Erweiterung und Berücksichtigung der Chemie*, Erfurt, 2. 5, 1800; K. Emszt, *Zeit. anorg. Chem.*, 28. 346, 1901; J. Keir, *Phil. Trans.*, 80. 359, 1790; J. M. Eder, *Ber.*, 13. 500, 1880; R. Heumann, *ib.*, 8. 534, 1875; J. H. Gladstone, *ib.*, 5. 817, 1872; L. Schnaubert, *Untersuchung von der Verwandtschaft der Metalloxyde zu den Säuren*, Erfurt, 103-6, 1803; Mrs. Fulhame, *Essay on Combustion with a view to a new Art of Dying and Painting*, London, 1794.
- ⁶ J. B. Senderens, *Compt. Rend.*, 104. 504, 1887; *Bull. Soc. Chim.*, (3), 15. 218, 1896; A. Wurtz, *ib.*, 18. 702, 1844; *Liebig's Ann.*, 43. 318, 1842; 58. 49, 1846; R. Fresenius and H. Neubauer, *Zeit. anal. Chem.*, 1. 340, 1862; W. Wicke, *Liebig's Ann.*, 82. 145, 1852; T. Poleck and K. Thümmel, *Ber.*, 16. 2446, 1883; P. Pascal, *Compt. Rend.*, 146. 862, 1908; J. B. Senderens, *ib.*, 104, 175, 1887; C. J. D. von Grothuss, *Gilbert's Ann.*, 61. 60, 1819; *Schweigger's Journ.*, 28. 324, 1820; C. H. Palmer and E. S. Bastin, *Trans. Amer. Inst. Min. Eng.*, 843, 1913; E. Soubeiran, *Ann. Chim. Phys.*, (2), 43. 418, 1830; *Journ. Pharm.*, 16. 347, 1830; J. L. Lassaigue, *Journ. Chem.*

Méd., 16. 685, 1840; Z. Pozzi, *Ind. Chim.*, 6. 144, 1904; H. Reckleben, G. Lockemann, and A. Eckardt, *Zeit. anal. Chem.*, 46. 697, 1907; H. Reckleben and A. Güttich, *Ber.*, 42. 1458, 1909; J. Phillip, *ib.*, 16. 749, 1883; F. Mawrow and G. Mollow, *Zeit. anorg. Chem.*, 61. 96, 1909; G. Shaw, *A Manual of Electro-Metallurgy*, London, 91, 1844; H. Rose, *Pogg. Ann.*, 14. 184, 1828; 24. 318, 1832; N. W. Fischer, *ib.*, 6. 43, 1820; 8. 488, 1821; 10. 607, 1822; 12. 503, 1822; 16. 126, 1824; R. Bartels, *Ueber die Einwirkung des Antimonwasserstoffs auf Metallsalzlösungen*, Berlin, 1889; J. S. Stas, *Bull. Acad. Belgique*, (2), 10. 233, 1860; L. F. Böck, *De reductione metallorum via humida*, Tübingen, 1804; W. Herapath, *Phil. Mag.*, (4), 3. 528, 1852; Mrs. Fulhame, *Essay on Combustion with a view to a new Art of Dying and Painting*, London, 1794.

⁷ N. W. Fischer, *Pogg. Ann.*, 6. 43, 1826; 8. 488, 1826; 10. 607, 1827; 12. 503, 1828; 16. 126, 1829; *Gilbert's Ann.*, 72. 289, 1822; J. B. Senderens, *Bull. Soc. Chim.*, (3), 15. 208, 691, 1896; (3), 17. 271, 1897; *Compt. Rend.*, 104. 504, 1887; P. Sabatier, *ib.*, 124. 363, 1897; A. untz and F. Martin, *Bull. Soc. Chim.*, (4), 7. 313, 1910; M. Lucas, *ib.*, (3), 19. 795, 1898; L. Vignon, *ib.*, (3), 29. 515, 1903; E. G. Bryant, *Chem. News*, 79. 75, 1899; J. H. Gladstone and A. Tribe, *ib.*, 24. 4, 1871; *Proc. Roy. Soc.*, 19. 498, 1871; *Journ. Chem. Soc.*, 24. 1123, 1871; J. W. Langley, *ib.*, 45. 633, 1884; A. Tribe, *Ber.*, 5. 815, 1872; H. Rose, *Pogg. Ann.*, 101. 321, 1857; G. Wetzlar, *Schweigger's Journ.*, 50. 98, 1827; A. Ogg, *Zeit. phys. Chem.*, 22. 536, 1897; 27. 285, 1898; W. Hampe, *Zeit. Berg. Hütt. Sal.*, 21. 229, 241, 1873; *Berg. Hütt. Zig.*, 56. 145, 201, 297, 1897; *Zeit. anal. Chem.*, 13. 536, 1874; F. Brandenberg, *Ann. Gén. Sci. Phys.*, 1. 182, 1819; C. Barfoed, *Journ. prakt. Chem.*, (2), 38. 441, 1888; A. Chevallier, *Journ. Chem. Méd.*, 3. 131, 1827; J. L. Gay Lussac, *Ann. Chim. Phys.*, (1), 78. 91, 1811; *Gilbert's Ann.*, 72. 326, 1822; J. W. Dodgson, *Phot. Journ.*, 51. 265, 1911.

§ 6. The Physical Properties of Silver

Silver *en masse* is the whitest of metals, although the colour of some of the metals—*e.g.* tin, cadmium, indium, and lithium—approximates to that of silver. The silver reduced by the metals from the halides appears as a grey spongy mass, more or less granular and earth-like, but it immediately acquires the characteristic lustre of the metal when the burnisher is applied. Very thin layers of the metal on glass have a violet, blue, or bluish-green colour in transmitted light. According to F. Bothe,¹ a film of silver deposited on glass by J. von Liebig's process is so thin that when held up to bright sunlight it appears transparent and of a beautiful deep blue colour; L. Foucault showed that the blue colour is not due to porosity, but is an effect of the passage of light through the solid metal. A. K. Christomanos added that the colour of that portion of light transmitted by very thin layers of silver is bluish-green, and by somewhat thicker layers, yellow or yellowish-brown. H. Ambronn prepared films but a few millionths of a millimetre thick. The colloidal metal—*vide infra*—appears in various shades of red, yellow, green, blue, or violet. According to W. C. Roberts-Austen and J. N. Lockyer, "the vapour of silver when condensed into fine particles escaping into an atm. of hydrogen, is blue by reflected light." According to J. S. Stas, the vapour of silver produced by the oxyhydrogen flame has a pale blue colour, slightly inclining to purple, and is not green. The green tint which has been reported is due to the presence of a trace of copper.

J. B. L. Romé de l'Isle² first showed that the crystals of the metal belong to the cubic system, and they occur in the form of cubes, octahedra, hexahedra, dodecahedra, hexakis-octahedra, etc. R. J. Haüy, F. Mohs, G. Rose, etc., confirmed this observation, and J. F. L. Hausmann found sharply defined octahedra in the solidified silver hanging on the sides of a crucible from which the molten metal had been poured. V. Kohlschütter and E. Eydmann obtained well-defined crystals by heating the amorphous powder for some hours under molten silver nitrate; and E. Giurgea placed a copper rod in a soln. of silver nitrate in a porous cell, and obtained a crystalline deposit on the cell walls. G. W. A. Kahlbaum, K. Roth, and P. Siedler obtained microscopic octahedra and hexahedra by subliming the metal in vacuo. W. Haidinger obtained crystals by the fusion and slow cooling of the metal. Electrodeposited silver may appear as a black or dark grey powder in which six-sided stellate crystals can be recognized under the microscope. This subject has been studied by H. Dauber, G. vom Rath, M. Kirmis, U. Behn, R. C. Snowdon, etc. According to E. B. Rosa, G. W. Vinal and A. S. McDaniel, electrolytic silver

obtained from purified substances consists of microscopic cubes with sharp corners and angles. An acidulated electrolyte gives smaller and more numerous crystals—cupric nitrate or sulphate soln. act similarly. The presence of colloidal substances interferes with the formation of crystals. In general, the form of the deposit depends on the current density, the conc. of the soln., the voltage, etc. A. H. W. Aten and L. M. Boerlage have studied the crystallization of metals by electrical precipitation. M. Ettisch and co-workers say that the crystallites in soft wires are arranged irregularly, those in hard drawn wires, regularly. Z. Jeffries and R. S. Archer give 200° as the lowest temp. at which the recrystallization of the cold-worked metal has been observed. Filamentary and dendritic forms of silver occur in nature. **Filiform, moss, or hair silver** can be made artificially by reducing the sulphide in a current of steam; by reducing the sulphide, selenide, or telluride in a current of hydrogen—the sulphide at 400°. The temp. should suffice to agglutinate the sulphide, but be below the m.p. of the silver. J. Percy said :

This beautiful experiment may be made in a glass tube through which a current of the gas is passed. Long delicate fibres of silver may be seen protruding from minute rounded masses of the sulphide; and as they are produced while these masses are in a soft state and lying free in the tube, the idea that they result from the application of external mechanical press., in a similar manner to macaroni, can hardly be entertained. There seems to be some force in operation at the base of each filament, which causes the particles of silver at the moment of liberation to successively arrange themselves in one continuous fibre, or series of fibres; or, in other words, each filament grows, as it were, from a root embedded in sulphide of silver.

O. Ohmann made what he called *silver-wool*. Filiform silver has been studied by J. Margottet, C. Bischoff, H. Vogcl, W. M. Hutchings, A. Gurlt, A. Liversidge, C. Winkler, O. Mügge, K. Friedrich and A. Leroux, L. Opificius, and particularly by V. Kohlschütter and E. Eydmann, and A. Beutell. J. Percy said :

When natural or artificial silver sulphide is heated in an evacuated sealed tube for several days at a temp. of 350°–600° a certain amount of decomposition takes place. The small amount of silver formed seems to wander through the silver sulphide, appearing at the cooler end of the tube in the form of hair silver. A number of experiments which were made showed that neither silver-foil nor hair silver is attacked by sulphur vapour in a vacuum at 350°; the metal remained bright after forty-eight hours. Silver-foil heated alone in a vacuum for a long period at 450°–585° showed no trace of the growth of hair silver, but when silver foil and silver sulphide were heated together at 450° remarkable growths were obtained in a comparatively short time. To obtain these growths it is necessary for the silver and the silver sulphide to be actually in contact. Similar growths of copper were obtained by heating together copper and cuprous sulphide, but the process was much slower. When silver selenide or telluride was used in place of the sulphide, similar growths of silver were obtained, and hair copper was obtained to a certain extent with copper selenide and telluride. With gold, the best results were obtained when gold telluride containing silver was heated with silver-foil. After seven days' heating at 500°, growths of "moss" gold containing silver had appeared at the cooler end of the tube.

The phenomenon seems to be dependent on the breaking up of solid soln. of silver and silver sulphide. According to S. Kalischer, rolled silver is not crystalline, but it becomes so when heated to redness. A. H. W. Aten and L. M. Boerlage studied the rate of crystallization of silver in galvanic precipitation.

L. Vegard's **X-radiograms** of silver show that the crystal units are arranged as a simple face-centred cubic lattice with edge 4.060 Å., and the smallest distance apart of the atoms 2.876 Å. P. Sherrer gives 4.06×10^{-8} cm. for the dimensions of the elementary cube. N. Gross, and H. Bohlin also made observations on the structure of crystals of silver. S. Nishikawa and G. Asahara examined the X-radiogram of silver which has been rolled, and found that the metal anneals itself spontaneously after three weeks, for, instead of giving an ill-defined structure with a symmetry related to the direction of rolling, distinct crystals appear. K. F. Slotte estimated the edge of the molecular cube of liquid and solid silver to be 6.6×10^{-9} cm. M. Born and E. Bormann measured the mean **free-path** of silver atoms. W. L. Bragg showed that the radius of the at. spheres of silver in crystals of the metal is $0.177 \mu\mu$, or 1.77 Å. M. S. Saha made estimates of this magnitude. E. Beckmann

and O. Liesche found that in boiling mercury silver is present as monatomic mols.

In the Arabian *Book of the Best Things for the Knowledge of Mineral Substances*, by Abu-r-Raihan, written towards the end of the tenth century,³ the **specific gravity** of silver is stated to be 10·35, a value very close to that accepted at the present day. Another Arabian writer, Al-Khazini, in his *Book of the Balance of Wisdom*, written in the twelfth century, gives 10·30 for the value of this constant. A very large number of measurements of the sp. gr. of silver have been made since 1690, when R. Boyle⁴ gave 11·091 for this constant. D. G. Fahrenheit (1726) found its value to be 10·481. A. Matthiessen failed to get constant results in his determinations of this constant, for his numbers varied from 10·424 to 10·511 at 132°. According to C. Karmarsch, the densest silver, of sp. gr. 10·566, is obtained by slowly cooling the metal from a molten state; when suddenly chilled by pouring the molten metal into cold water, the sp. gr. fell to 9·632; when cast into rods, 10·105; and when melted and then cooled in a crucible, the sp. gr. varied from 9·998 to 10·474. The results thus depend on the previous history of the metal. The sp. gr. of chilled cast silver, for instance, has been reported as low as 8·7, and of the slowly cooled silver, 9·4. G. Wertheim and others have shown that cold work greatly influences the sp. gr. as it does the mechanical and physical properties of metals—elasticity, e.m.f., thermal and electric conductivity, etc. F. C. A. H. Lantsberry found the sp. gr. of annealed silver to be 10·4475, and of cold-worked silver, 10·4410. G. Rose, and V. Kohlschütter and E. Eydmann found that at 18° silver precipitated from a soln. of the nitrate by ferrous sulphate had a sp. gr. of 10·56 to 10·62; silver reduced from silver oxide by hydrogen at 144°, 10·352; and after heating two hours at 160°, 10·490; silver reduced from the oxide by carbon monoxide, 10·113; silver reduced from silver chloride by zinc and sulphuric acid, 10·307; and silver reduced by aldehyde, when the grain-size is 250 μ , 10·270. A. K. Christomanos found the sp. gr. of distilled silver to be 10·575; and G. W. A. Kahlbaum and co-workers found for the metal distilled in vacuo, a value 10·4923 (20°), and after compression at 10,000 atm., 10·5034 (20°). W. Spring found for annealed silver a sp. gr. 10·2696; for rolled silver, 10·2531; and for the metal which had been exposed to a great press., 10·2485. J. S. Stas obtained 10·4624 for the sp. gr. of the metal at 0°, and after compression and heating, the sp. gr. rose to 10·5023, but fell to 10·4894 when again heated to dull redness, and rose to 10·5104 when hammered. After re-heating to dull redness, and cooling in vacuo, the sp. gr. fell to 10·4977. J. S. Stas also found the sp. gr. of silver prepared in different ways ranged from 9·8688 to 10·5537, and he thought that the phenomenon was a secondary effect due to the occlusion of gases by the metal. It was assumed that the occlusion of gas diminished the sp. gr. The best representative value for the sp. gr. may be taken as 10·5. The **specific volume** of silver is therefore 0·0952; and the **atomic volume**, 10·3. According to W. C. Roberts and T. Wrightson, the sp. gr. of solid silver is 10·57, and of the liquid 9·46 to 9·51; according to A. Sieverts and J. Hagenacker, the sp. gr. of the solid at the m.p. is 10·0, and of the liquid 9·5, and at about 1120°, 9·453. According to T. M. Lowry, when silver is annealed at 100°, there is a contraction represented by an increase in sp. gr. of 0·0032 per cent.; at 180°, there is an expansion corresponding with a change of sp. gr. of 0·0020; and when annealed at a red heat there is a decrease in volume corresponding to an increase of sp. gr. of 0·0108. The annealing process thus involves three changes: a contraction at the lowest temp., and expansion at an intermediate temp., and a contraction at the highest temp. T. M. Lowry and R. G. Parker found that while the sp. gr. of silver *en masse* is 10·4960, that of the filings is 10·4786—*vide* allotropic silver and gold.

The **hardness** of silver on Mohs' scale varies between 2·5 and 3·0. Silver is harder than gold, and softer than copper. F. C. Calvert and R. Johnson⁵ found the hardness of gold, silver, and copper to be in the ratio 4 : 5 : 7·2; the ratio on J. R. Rydberg's scale is 2·5 : 2·7 : 3·0; on S. Bottone's scale, 979 : 963 : 1364; and on F. Auerbach's scale, 97 : 91 : 95. E. A. Smith and H. Turner found Brinell's

hardness of the cast and slowly cooled metal to be 38; C. A. Edwards gave 37.0. The increase in the hardness of cast sterling silver (7.5 per cent. copper) by progressive cold rolling:

Rolled to . . . —	0.500	0.365	0.250	0.125	0.076	0.042 in.
Brinell's hardness 60	135	145	157	170	177	183

A. Hanriot found that Brinell's hardness of silver increased from 19.0 to 36.0 after being subjected to a great hydrostatic press.—10,000 kgrms. per sq. mm. A. Kürth gave 29.3 for J. A. Brinell's hardness with a load of 400 kgrms. at 18°; and 27.1 at 200°. Z. Jeffries could detect no change in the microstructure of the compressed metal, and no substantial change in the physical properties. The hardness is increased by alloying the metal with, say, 10 per cent. of copper.

The **malleability** and **ductility** of silver are said to be exceeded only by gold. It is said that the metal may be hammered into leaves 0.00025 mm. or 0.00001 in. thick; and that a gram may be drawn into wire 1800 metres long, or that a grain may be drawn into wire 400 ft. long. The metal is hardened by hammering or rolling, but it recovers its malleability by annealing at a low red heat. G. Quincke's value for the **surface tension** at 1000°, $\sigma=782.4$ dynes per cm., and corresponding value for the **capillary constant**, $a^2=15.94$ sq. mm. T. Lohnstein computed rather larger values. A. Gradcnwitz gave $\sigma=751$, and $a^2=14.5$ sq. mm.; and S. W. Smith respectively 858 dynes per cm., and $a^2=18.52$ sq. mm. I. Traube gave for the **internal pressure** of the solid, 161,900 megabars. The **velocity of sound** is conveniently taken as 26.4×10^4 cm. per second. A. Masson⁶ found 2605.2 metres per sec. for soft silver between 15° and 20°; and 2674.4 metres per sec. for hard silver at 10°. A bar of silver gives a characteristic clear sound when struck, but C. J. B. Karsten said the sound is rather dull, so that the so-called "silver tone" and "silver voice" are poetic expressions with meanings different from what is literally implied. W. C. Roberts-Austen found the coeff. of **diffusion** of silver in molten tin at 500° to be $k=4.14$ per cm. per day. The **internal viscosity** of silver has been studied by C. E. Guye and co-workers from the logarithmic decrement of oscillating wires, and by M. Ishimoto, from tuning-forks and oscillating pendulums. K. Honda and S. Konno found the viscosity of hammered silver to be 2.8×10^8 at 15°; and that of the metal annealed at 400°, 2.24×10^8 at 15°. A. Einstein has calculated the wave-length of the elastic oscillations. A. Johnsen found the **plastic flow** of silver is diminished by cooling the metal in liquid air. O. Stern measured the **velocity of the molecules** of silver vapour, and showed that they are monatomic.

The fractional change in the volume caused by the application of unit press., *i.e.* the **compressibility**, of silver, is smaller than that of lead, tin, bismuth, aluminium, or zinc, and greater than that of copper, platinum, or palladium. According to T. W. Richards,⁷ the compressibility coeff. of silver at 20° is 1.01×10^{-6} per megabar or 10^6 dynes per sq. cm. between 100 and 500 megabars. L. H. Adams and co-workers give 0.97×10^{-6} , and they represent the change in vol. δv by a change of press. from p_0 to p by $\delta v=0.000055+0.00000968(p-p_0)$. The compressibility increases with a rise of temp., while the coeff. of expansion decreases with a rise of press. The greater the expansion with rise of temp. the greater the change in the compressibility. E. Grüneisen found the cubical compressibility of silver, at -191° , to be 0.709×10^{-6} ; at 16° , 0.763×10^{-6} ; at 134° , 0.844×10^{-6} ; and at 166° , 0.86×10^{-6} . A. Mallock also found 0.709×10^{-6} at -190° ; 0.768×10^{-6} at 17° ; and 0.820×10^{-6} at 100° .

The coeff. of resistance of silver to extension, the so-called **modulus of elasticity** or **Young's modulus**—*vide* copper—was found by G. Wertheim⁸ to be 7357 kgrms. per sq. mm. for drawn silver at 15°, and 7140 kgrms. per sq. mm. for the annealed metal also at 15°, and he gave 7274 and 6374 kgrms. per sq. mm. for the values at 100° and 200° respectively. W. Voigt represented Young's modulus by 7790 kgrms. per sq. mm. S. Katzenelsohn gave 7010 for drawn silver; and G. Angenheister, 7597 kgrm. per sq. mm. for cast silver; and other values have been obtained by

C. Schäfer, E. Grüneisen, A. Bock, etc. The best representative value at 15° may be taken as 7300 kgms. per sq. mm. for the drawn metal, and 7140 kgms. per sq. mm. for the annealed—when the extreme values range from 7010 to 8290 kgms. per sq. mm. The modulus of elasticity gradually decreases as the temp. rises up to the m.p. A. Mallock estimated the ratio of Young's modulus at -273° to its value at 0° to be 1.37. According to W. Sutherland, the variation with temp. is linear and approximately in accord with the empirical relation indicated in connection with copper (*q.v.*), where K. R. Koch and C. Dannecker's Fig. 10 shows the steady and gradual fall of the modulus of elasticity with rise of temp. C. Schäfer gives 7.65 for the temp. coeff. or the percentage increase of Young's modulus in passing from 20° to -186°. C. Schäfer plotted the temp. coeff. and the m.p. of a number of elements, and found that there is some relation between the two constants.

G. Tammann gave 86 kgms. per sq. cm. for the **elastic limit** of silver. An elastic body if subjected to a stress is deformed, and when the stress is removed, it wholly or partially recovers from the deformation. The recovery may take place immediately the stress is removed, or the recovery may proceed a certain way more or less rapidly and subsequently creep slowly back to its original state. Hence arises the so-called **elastic fatigue**, *elastische Nachwirkung*, etc. F. Rehküh, and E. Scholz have studied this phenomenon with silver wires.

The ratio of the lateral contraction to the longitudinal extension of silver, or **Poisson's ratio**, is 0.363, according to C. Schäfer; and 0.380 to 0.407, according to G. Angenheister; A. Bock⁹ found Poisson's ratio to be 0.337 at 20°; 0.352 at 50°; 0.372 at 100°; and 0.381 at 100°. C. Schäfer plotted the m.p. and Poisson's ratio for a number of elements, and showed that there is a close relation between them. The **volume elasticity**, cubic elasticity, or bulk modulus of silver is 10.9×10^{11} dynes per sq. cm. The resistance to shearing, or the **rigidity** or **torsion** or **shear modulus** of silver, is given by C. Schäfer as 2467 kgms. per sq. mm., W. Voigt gives 2960; M. Baumeister, 2650; G. F. C. Searle, 2816 for the hard-drawn metal. The mean value is 280×10^6 grms. per sq. cm. between 0° and 20°. When the maximum and minimum values are 331 and 257×10^6 grms. per sq. cm., the ratio of the value at 100° to that at absolute zero ranges from 0.956 to 0.962; and the corresponding ratio at 200° ranges from 0.858 to 0.898. W. Sutherland estimates the value of this constant to be 284×10^6 grms. per sq. cm. at absolute zero. G. Pisati gives for the rigidity of silver, n , at θ° , $n = n_0(1 - 0.000387\theta - 0.0638\theta^2 - 0.0811\theta^3)$ kgrm. per sq. mm., where $n_0 = 2566$, the value at 0°. F. Horton gives for the value of n at 15°, 2.67×10^{11} dynes per sq. cm., and at θ° , $n = n_{15}\{1 - 0.00048(\theta - 15)\}$ dynes per sq. cm.

A. and C. R. Aikin found a wire 0.1 in. in diameter supported a weight of about 240 lbs. without breaking; this is eq. to about 13.64 tons per sq. in. of sectional area. Silver, said A. Baudrimont is tougher than copper, and not so tough as palladium; others say silver is tougher than gold, but not so tough as copper. A. le Chatelier gave for the **tensile strength** of cast silver 7.50 kgms. per sq. mm.; 19.0 kgms. per sq. mm. for the annealed, hammered, or rolled metal; and 35.0 kgms. per sq. mm. for hard-drawn wire. A. Baudrimont¹⁰ found the tensile strength of silver wire 1 sq. mm. in sectional area, at 0°, 100°, and 200° to be respectively 28.324, 23.266, and 18.577 kgms. per sq. mm., or respectively 17.27, 14.19, and 11.33 tons per sq. in. G. Wertheim gave the results indicated in Table IV. J. Dewar

TABLE IV.—TENSILE STRENGTH OF SILVER WIRE.
(Kgms. per sq. mm.)

Silver wire.	10° to 15°.		100°.	200°.
	Rupture slow.	Rupture sudden.		
Drawn . . .	29.00	29.60	—	—
Annealed . . .	16.02	16.40	14.00	14.00

found the breaking stress of a silver wire 0.098 in. in diameter to be 330 lbs. at 15° and 420 lbs. at -182°. When the cooled wires regain their former temp., no change in the breaking stress can be detected. G. T. and H. N. Beilby also found the tensile strength of silver to be increased by lowering the temp. such that the tensile strength increases from 25.7 units at 15°, to 34 units at -182°. F. A. and C. A. Lindemann found the tensile strength of a wire 0.0513 mm. thick to decrease from 64.0 kgrms. per sq. mm. at -252.6°; 53.9 kgrms. per sq. mm. at -192°; and 27.8 kgrms. per sq. mm. at 17°. They add that although the tenacity increases the metal becomes very brittle at the low temp. of liquid hydrogen. According to C. A. Mebius, heating by a current has no effect other than that due to a rise of temp. E. A. Smith and H. Turner found silver cast in sand bears a rather lower maximum stress than silver cast in iron moulds; the reverse is true for standard coinage silver—with 7.5 per cent. of copper. Their results are shown in Table V expressed in tons per

TABLE V.—TENSILE AND COMPRESSION TESTS FOR SILVER.

		Silver alone.		Standard silver (7.5 per cent. copper).			
				Cadmium as deoxidizer.		Alone.	
		Iron mould.	Sand.	Iron mould.	Sand.	Iron mould.	Sand.
Tension	Elastic limit . . .	0.90	0.47	1.57	2.27	3.93	4.72
	Yield point . . .	2.07	1.615	5.66	6.3	8.51	8.15
	Max. stress . . .	6.90	6.87	8.42	13.8	10.92	14.12
	Elongation . . .	59.5	63	9	40	67	41
	Reduction of area % .	66.7	65.7	21.4	49.7	15.8	54.6
Compression	Yield point . . .	1.22	1.50	6.98	6.81	12.8	7.79
	Load for 5% reduction	3.99	3.66	11.59	11.08	17.42	12.58
	" 10% " "	7.29	6.45	15.10	14.4	21.2	16.32
	" 20% " "	12.98	11.85	23.30	24.30	26.1	23.7
	" 40% " "	22.4	21.5	38.20	32.88	34.0	31.7
	Energy of rupture . . .	2.74	—	2.74	2.44	2.21	1.81

sq. in.; the energy of rupture by the impact tests is expressed in kilogram-metres per sq. cm. J. Percy reported that the fractured surface of an ingot of silver showed a zone "consisting of a confused aggregate of imperfectly formed octahedral crystals while the rest of the fracture was largely fibrous or columnar."

Towards the end of the eighteenth century, A. L. Lavoisier and P. S. Laplace¹¹ measured the coefficient of thermal expansion, α , of cupelled silver between 0° and 100°, and found 0.000019074, a number which represents the increase per unit length per degree rise of temp. between the limits of temp. under observation. A. Matthiessen obtained $\alpha=0.00001943$, between 0° and 100°, and he represented the vol. at θ° by $v=v_0(1+0.00005246\theta+0.00000405\theta^2)$, where v_0 denotes the vol. at 0°. H. Fizeau obtained $\alpha=0.00001936$ between 0° and 100°. Hence the expansion from 0° to 100° is nearly 0.002, or $\frac{1}{50}$ th of its length. H. le Chatelier obtained $\alpha=0.0000205$ for the linear expansion up to 900°. W. Voigt found in the vicinity of 30°, the linear coeff. of expansion, α , to be $\alpha \times 10^6 = 19.25 + 0.043(\theta - 30)$. L. Holborn and A. L. Day gave for the length l of a bar of silver at θ° between 0° and 875° $l=l_0(1+0.00001827\theta+0.084793\theta^2)$, where its length at 0° is l_0 . W. C. Roberts-Austen found 0.00003721 for the mean linear expansion between atm. temp. and the m.p. of the metal, and for the mean cubical expansion 0.00011164. F. Hénning found the linear expansion of a metre rod to be -3.527 between 0° and -191°; 4.574 between 16° and 250°; 10.040 between 16° and 750°; and 19.362 between 16° and 875°. E. Grüneisen studied the effect of press. on the linear coeff. of expansion. He showed that between -190° and 17° $\alpha=17.12 \times 10^{-6}$ at one atm. press., and by raising the

press. to 1000 kgrms. per sq. cm., the value fell to 17.03×10^{-6} . Similarly between 17° and 100° , and one atm. press., $\alpha = 18.90 \times 10^{-6}$; and for 1000 kgrms. per sq. cm. press., $\alpha = 18.67 \times 10^{-6}$. F. A. Lindemann found between 81.5° K. and 291.7° K., $\alpha = 156 \times 10^{-6}$; between 82° K. and 90° K., $\alpha = 132 \times 10^{-6}$; and between 80° K. and 20.4° K., $\alpha = 98 \times 10^{-6}$. J. Disch made some observations at low temp.

K. Scheel gave for the expansion of silver in mm. per metre starting from 0° as zero:

	100°	200°	300°	400°	500°
Expansion	1.968	4.00	6.08	8.23	10.43

The thermal conductivity of silver for heat is greater than that of any other metal, and accordingly it is sometimes used as an arbitrary standard 12 100. G. Wiedemann and R. Franz gave the order:

Ag	Cu	Au	Zn	Sn	Fe	Pt	Pb	Bi
100	73.6	53.2	19.0	14.5	11.6	8.4	8.1	1.8

The absolute conductivity, measured by H. F. Weber, at 0° , is 1.0960; this number represents the amount of heat in cal. conducted per sec. across two planes one cm. apart, and a sq. cm. sectional area, when the difference of temp. of the two surfaces of the planes is 1° . W. Jäger and H. Diesselhorst found 1.006 at 18° , and 0.9919 at 100° ; and C. H. Lees, 0.974 at 18° , and 0.998 at -160° . For the thermal conducting capacity at 18° , W. Jäger and H. Diesselhorst found $a^2 = 1.74$, and at 100° , 1.67, where $a^2 = K/DC$, when K is the thermal conductivity; D , the sp. gr.; and C , the sp. ht. They also found that if K_0 be the thermal conductivity at 0° , the conductivity K at θ° is $K = K_0(1 + 0.00017\theta)$. E. H. Hall has studied this subject. For G. Wiedemann and R. Franz's comparison of the electrical and thermal conductivities, *vide* copper. P. W. Bridgman measured the effect of compression on the thermal conductivity of silver, and found the effect decreases linearly with press.

In 1818, P. L. Dulong and A. T. Petit¹³ measured the specific heat of silver and found it to be 0.0557 between 0° and 100° , and 0.0611 between 0° and 300° . The rise in the sp. ht. with rise of temp. may be regarded as evidence of a resistance offered by the metal to the raising of its temp. Other determinations have been made by H. Kopp, R. Bunsen, J. Pionchon, U. J. J. le Verrier, W. A. Tilden, T. S. Humpidge, etc. H. Schimpff gave 0.0557 for the sp. ht. at 0° ; J. N. Brönsted gave 0.05535 between 0° and 19° ; and H. Tomlinson 0.05684 between 0° and 100° . E. H. and E. Griffiths represented the sp. ht. C at θ° between 0° and 97.5° by $C = 0.05560(1 + 0.0003396\theta - 0.000000141\theta^2)$; or very approximately by $C = 4.804A\theta^{0.95}$, where A represents the at. wt. of the element. W. A. Tilden found the sp. ht. 0.0550 between -78° and 15° ; 0.0576 between 15° and 350° ; 0.0528 at 200° ; and 0.0590 at 700° ; U. J. J. le Verrier, 0.0565 between 0° and 260° ; 0.075 between 260° and 660° ; and 0.076 between 660° and 900° . He adds that the sp. ht. appears to undergo an abrupt change in the vicinity of 260° . J. Pionchon obtained 0.0748 for the solid at 800° , and for the liquid metal between the m.p. and 1100° , 0.0748. To summarize, the sp. ht. of silver above 0° may be taken as:

	0°	50°	100°	200°	400°	600°	961°
Sp. ht.	0.0560	0.0560	0.0564	0.0571	0.0592	0.0655	0.0730

The sp. ht. falls rapidly as the temp. drops, *e.g.* J. Dewar found the sp. ht. at -223° to be 0.0242; T. W. Richards and F. G. Jackson found at -188° , 0.0511; H. Bartschell, between -74° and -184° , 0.0492; U. Behn obtained 0.0544 for the sp. ht. between 18° and -79° ; and 0.0496 between -79° and -186° . W. Nernst and F. A. Lindemann found 0.556 for the sp. ht. of silver at 0° ; 0.03775 at -196° ; and 0.01465 at -238° ; and W. Nernst gives:

	0°	-40°	-73°	-189°	-209°	-238°	-253°
Sp. ht.	0.0550	0.0546	0.0530	0.0410	0.0336	0.0146	0.0036

From the sp. ht. data, it follows that the atomic heat of silver rises from 0.39 at -253°

to 6.0 at 0°, and to 7.88 for the solid at the m.p. According to A. Eucken, the sp. ht. of the liquid at the m.p. 961° is 0.0748, and the at. ht. C_r is accordingly 8.07; and the at. ht. C_p of the solid at the m.p. is 8.20. E. Grüneisen measured the effect of press. on the sp. ht. of silver and found for silver $dC_p/C_p dp = -0.0000038C_p$ kgrm. per sq. cm.

The melting point of silver was given by C. S. M. Pouillet¹⁴ in 1832 as 538°, but in 1856 he gave 1000°. J. Prinsep gave 999°; L. B. G. de Morveau, 1033.71°—where the numbers to the right of the decimal point may be correct, but those to the left are about 71° too high. The reported values for this constant are indeed somewhat discordant and range from 954° to 1223°. This might have been anticipated (i) from the unsatisfactory methods of estimating temp. which were available to the early observers, and (ii) from the failure of the early workers to recognize the great influence of impurities on the result; and (iii) from the failure to recognize that silver oxide may be introduced as an impurity when the metal is melted in air—thus L. Holborn and A. L. Day (1900) found that silver melts at 961.5° when air is excluded, and at 955° if exposed to air; C. F. Heycock and F. H. Neville (1896) also found that the m.p. of silver was lowered by 10° or 17° by fusing the metal in an atm. of oxygen; and H. Callendar (1892) obtained a lowering of 6.4° under similar conditions. A. C. Beequerel found 960° for the m.p. of silver, and he ascertained that silver did not actually melt at the temp. of the evolution of the vapour of zinc boiling under ordinary atm. press., though it became so much softened at that temp. as to cause separate pieces of the metal, in contact with each other, to stick together. J. Violle, and A. Potilitzin gave 954°; A. D. van Riemsdijk, 1040°; J. F. Daniell first gave 1223° and later 915°; L. Holborn and W. Wien, 968°; D. Berthelot gave 962°; L. Holborn and A. L. Day, G. I. Petrenko, and E. Quereigh, 961.5°; C. W. Waidner and G. K. Burgess, 960.9°, and in an atm. of carbon monoxide, 960.0°; K. Friedrich and A. Leroux, 962°; H. Callendar, F. Wüst and co-workers, and N. Baar, 961°; W. C. Roberts-Austen and T. K. Rose, 969°; S. F. Sehmte-sehusehny, 954°; G. Arrivaut, 950°; C. T. Heycock and F. H. Neville, 960.5°; S. W. Holman, R. R. Lawrence, and L. Barr, 960.5°; A. L. Day and J. K. Clement, 958.3° ± 5°; A. L. Day and R. B. Sosman, 960° ± 0.7°; E. Tiede and E. Birnbräuer, 968°; C. W. Waidner and G. K. Burgess, 960.88° ± 0.16°; and the best representative value of the later determinations of the m.p. of silver is 960.5°; in agreement with L. I. Dana and P. D. Foote, and K. Seheel—W. Guertler and M. Pirani round off the number to 961°. J. Johnston estimated that the m.p. of silver is depressed 0.12° per atm. rise of press., and that under a press. of 14,000 atm. silver would melt at the ordinary temp.—excluding, of course, the appearance of new forms of silver at high press. R. Wright and R. C. Smith found that very finely divided silver shows signs of sintering far below its m.p. C. T. Heycock and F. H. Neville measured the lowering of the f.p. of tin, lead, and bismuth by the dissolution of a gram-atom of silver in approximately 100 gram-atoms of the metal. With cadmium as solvent there was a rise in the f.p.

R. Emden emphasized the fact that silver retains its mirror-like surface when melted in air; indeed, molten silver has a brighter lustre than when in the solid state. According to J. Violle, the radiation of heat from molten silver, at a temp. above its m.p., measured from its effect on the thermopile steadily falls with the temp. and then begins to rise again owing to undercooling; the radiation remains constant during the process of solidification, and he recommended this as a convenient secondary standard for spectro-photometric measurements, etc. When all the metal has solidified the radiation rises again because the solid metal at the m.p. has a greater radiating power than the molten metal.

W. A. Lampadius¹⁵ noted the volatility of silver in 1839. J. L. Gay Lussac stated that the volatility of silver cannot be detected at temp. far exceeding its m.p. because purified silver can be cupelled without any appreciable loss, but W. A. Lampadius found that when heated in an open crucible at a white heat, it loses about one per cent. per hour even if the metal is covered with powdered chareoal. P. Berthier

also found that when silver is heated in a porcelain oven, it loses about 0.5 of its weight, and that, under similar conditions, copper loses rather more. A. D. van Riemsdijk observed that when silver begins to volatilize to a sensible degree when heated in a slow current of hydrogen to a temp. not much above the m.p. of copper. E. Tiede and E. Birnbrauer found volatilization occurs at 850° in vacuo. C. M. Despretz also said that silver wire can be rapidly volatilized at a temp. produced by the passage of the current from 600 Bunsen cells. W. Borehers, and H. Moissan have studied the volatilization of silver in electric furnaces. H. St. C. Deville and H. Debray observed that when silver is heated in a lime crucible by means of the oxyhydrogen flame, it boils like mercury, and volatilizes as silver oxide which condenses as a pale yellow sublimate. C. F. Plattner, H. St. C. Deville and H. Debray, and L. Troost and P. Hautefeuille, and W. A. Ross brought evidence to show that the volatility of silver is due to the formation of a volatile oxide stable only at a high temp.—*vide* the spitting or spewing of silver. J. S. Stas distilled silver in considerable quantities by means of the oxyhydrogen flame, in a little apparatus made of quicklime. His apparatus for the distillation of silver is illustrated in Fig. 6. A block of marble 25 to 30 cms. long, 10 cms. wide, and 10 cms. high has a circular cavity *A*—3 cms. diameter and 2 cms. deep—in communication with another similar cavity *B* by means of an inclined channel *C*. The blowpipe flame is directed on to about 50 grms. of silver in the cavity *A*, and the vapour condenses in the cavity *B* to molten silver. Vessels of quartz can be used for the distillation of the metal in vacuo.

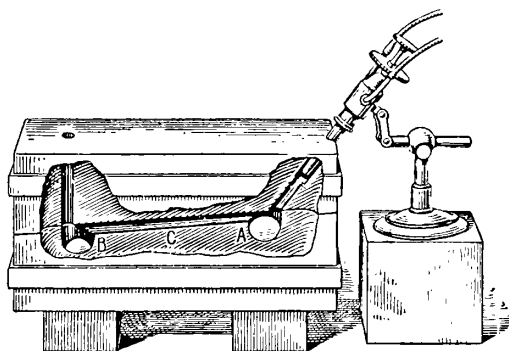

FIG. 6.—Apparatus for the Distillation of Silver.

According to A. Parkes, silver is easily volatilized when in connection with zinc or arsenic in a fused state, and he patented a process for separating silver from copper, copper regulus, etc., by heating the mixture in a reverberatory furnace, fitted with flues and chambers for collecting the volatile products, which were then to be cupelled for silver. The process has not been successful; F. J. Malaguti and J. Durocher heated a mixture of argentiferous blende and charcoal in a retort, and collected the zinc distillate which was found to contain only traces of silver. A. K. Christomanos studied the distillation of cupriferous silver. J. Napier, G. H. Makins, F. Elsner, J. W. Richards, etc., have made observations on the volatility of silver. T. Turner showed that volatilization can be detected in a stream of air at 700°, C. J. Hansen volatilized silver at 953° in vacuo; and H. von Wartenberg noted that the metal volatilizes more readily in an atm. of oxygen than in one of nitrogen. M. Knudsen found that the condensation of the vapour of silver on a clean glass or mica surface has a critical temp.—about 575°—below which the vapour is retained, and above which an appreciable fraction is repelled.

J. W. Richards estimated the vapour pressure of silver at different temp. to be :

	729°	913°	1169°	1500°	1867°	1977°	2040°
Vap. press.	0.0002	0.013	0.779	26.35	300	548	760 mm.

H. von Wartenberg found the vap. press. at 1178° to be 1.9×10^{-4} atm.; at 1316°, 1.8×10^{-3} atm.; at 1435°, 5.10×10^{-3} atm.; and at 2100°, 1 atm.; a change of temp. of 6° alters the vap. press. about 9 per cent. He also ascertained that the vapour density corresponds with a one-atom molecule. O. Ruff and B. Bergdahl observed 102 mm. at 1660°; 116 mm. at 1680°; 200 mm. at 1758°; 300 mm. at 1810°; and 744 mm. at 1940°. J. A. M. van Liempt represented the vap. press. p

in atm. by $\log_{10} p = 5.93 - 13150T^{-1}$. Trouton's constant = 27.15; A. Henglein compared the vap. press. formula of silver. The boiling point under 8 atm. press. is estimated to be 2747°; at 50 atm. press., 3298°; and at 162 atm. press., 3958°. F. Krafft and L. Bergfeld distilled silver in vacuo by exposing it to the green cathode light, and they found that under these conditions the metal evaporates at about 680°, and boils at about 1400°. C. J. Hansen gives for the b.p. of the metal 1660° at 103 mm.; 1780° at 263 mm.; and 2313° for the b.p. under normal press.; while H. C. Greenwood gives 1633° for the b.p. in vacuo, and 2313° at 760 mm.; and he later gave 1955° for the latter. H. von Wartenberg gave 2050° to 2100° for the b.p. of silver; O. Ruff and B. Bergdahl, and E. Tiede and E. Birnbräuer, 1950°; and J. A. M. van Liempt, 1944°.

According to J. Pionchon,¹⁶ the latent heat of fusion of silver is 24.7 cal. per gram, or 2.7 Cals. per gram-atom. G. G. Person found 21.07 cal. per grm. F. Wüst and co-workers give 26.01 cal. J. W. Richards estimates the latent heat of vaporization to be 397 cal. per grm., or 43 Cals. per gram-atom. H. von Wartenberg found that the internal latent heat of evaporation, calculated from his observations of the vap. press., is 54.6 Cals. per gram-atom between 1178° and 1316°; 67.0 Cals. between 1316° and 1435°; and 59.7 Cals. between 1435° and 2100°. The mean value is 60.8 Cals. If the b.p. be 10° too low, the latent heat of vaporization would have to be raised 0.8 Cal. By means of the formula $4.571 \log p = 25 - Q/T$, H. C. Greenwood has also calculated $Q = 55,800$ cal. for the heat of vaporization per gram-atom, when the vap. press. at the absolute temp. T is p . J. A. M. van Liempt gave 60,200 cal. for the heat of vaporization at the b.p. G. G. Person gave 2280 cal. for the heat of sublimation. R. de Forcrand calculated $Q = 56.07$ Cals. from Trouton's formula at the absolute temp. $T = 2228^\circ$. According to H. Buff, the heat of thermal expansion of silver is 2.378 cal. calculated from his relation $DC\alpha/\beta$, when $D = 10.3$; $C = 0.0577$; $\alpha = 0.0001401$; and $\beta = 0.0000573$.

The optical constants of silver, namely the refractive index μ , and the absorption index, k , as well as the extinction coefficient, μk , have been defined in connection with the optical constants of copper; similar remarks apply to the angle of principal incidence, ϕ , and the angle of principal azimuth, ψ , of polarized light. A selection¹⁷ of these constants is indicated in Table VI, along with the percentage reflecting

TABLE VI.—OPTICAL CONSTANTS OF SILVER.

λ	ϕ	ψ	μ	k	μk	R per cent.
226 $\mu\mu$	62° 41'	22° 16'	1.41	0.75	1.11	18
293 "	63° 14'	18° 56'	1.57	0.62	0.97	17
316 "	52° 28'	15° 38'	1.13	0.38	0.43	4
332 "	52° 1'	37° 2'	0.41	1.61	0.65	32
395 "	66° 36'	43° 6'	0.16	12.32	1.91	87
500 "	72° 31'	43° 29'	0.17	17.1	2.94	93
589 "	75° 35'	43° 47'	0.18	20.6	3.46	95
750 "	79° 26'	44° 6'	0.17	30.7	5.16	97
1000 "	82° 0'	44° 2'	0.24	29.0	6.96	98
1500 "	84° 42'	43° 48'	0.45	23.7	10.7	98
2250 "	86° 18'	43° 34'	0.77	19.9	15.4	99
3000 "	87° 10'	42° 40'	1.65	12.2	20.1	—
4500 "	88° 20'	41° 10'	4.49	7.42	33.3	—

power, R , in air, that is, the ratio of the intensity of the reflected ray to that of the incident ray for light of wave-length λ . J. Conroy, L. P. Wheeler, G. Quincke, and R. Sissingh have studied the reflecting power of silver in water, turpentine, or carbon tetrachloride. The index of refraction has been determined by A. Pfüger, L. R. Ingersoll, K. Fösterling and co-workers, H. L. Barvir, etc. The angles of principal incidence and principal azimuth by A. Beer, P. Drude, J. C. Jamin.

R. S. Minor, W. Voigt, A. L. Bernoulli, H. Knoblauch, K. Försterling and V. Fréedericksz, C. Stătescu, A. Galli and K. Försterling, etc. The index of absorption by A. L. Bernoulli, E. Hagen and H. Rubens, W. Wernicke, etc. The reflecting power has been determined by E. Hagen and H. Rubens, W. W. Coblentz, C. Zakrzewsky, etc. I. C. Gardner measured the reflection coeff. in Schumann's region of the spectrum. A. Kundt obtained $\mu=0\cdot27$ for the index of refraction of electrolytic silver for white light; and D. Shea $\mu=0\cdot27$ for $\lambda=431\mu\mu$; $\mu=0\cdot20$ for $\lambda=486\mu\mu$; $\mu=0\cdot25$ for $\lambda=656\mu\mu$. N. Galli and K. Försterling found the refraction and absorption indices for massive silver to be very different from those of silver films—*viz.* 12·2 and 7·42 for $\lambda=3\cdot00$ and $4\cdot50\mu\mu$ respectively. K. Schäfer studied the different values for silver for soln. of the salts on the assumption that the silver is ionized and also combined. The dispersion is small and it has been studied by A. Beer, J. C. Jamin, H. Rubens, A. Pfüger, W. Meier, W. Voigt, etc. F. Schön found the abnormal dispersion of the vapour is confined to the spectral lines of the principal series. J. H. Gladstone gave for the refraction equivalent of silver $(\mu-1)/D=0\cdot122$, and $A(\mu-1)D=13\cdot2$, where A represents the at. wt. of the metal. J. Kanonnikoff calculated 12·6 for the refraction eq. from the values for the silver salts of the oxy-acids.

According to G. K. Burgess and R. G. Waltenberg, the emissivity of a mass of silver by the same standard as that employed for copper, is, for red light of wave-length $0\cdot65\mu$, $0\cdot04$ for the solid, $0\cdot07$ for the liquid; and for light of wave-length $0\cdot55\mu$, the emissivity of the solid is $0\cdot35$, and likewise also $0\cdot35$ for the liquid. There is no marked temp. coeff. between 900° and 2000° . The emissive power of heated silver has been studied by H. Rubens and E. Hagen, F. Henning, and C. M. Stubbs. H. Knoblauch has measured the polarization angle and refractive index of the heat rays. P. Desains studied the reflection of heat rays from the vapour of silver. J. Violle recommended the vapour of silver as a light standard. M. Faraday noted the effect of thin films of silver on polarized light; he prepared them by electrically deflagrating a thin silver wire in air or hydrogen. B. Pogany measured the Faraday effect, that is, the rotation of the plane of polarization, of films of silver.

The photoelectric effect with silver has been studied by G. Reboul, W. Ramsay and J. F. Spencer, K. Herrmann, E. Ladenburg, R. A. Millikan and G. Winchester, etc. As a rule, the more electropositive a metal the greater is its photoelectric activity—*vide* copper. W. Hallwachs found a photoelectric effect could be obtained by ultra-violet light which has passed through a silvered quartz plate; and O. Stuhlmann showed that the photoelectric effect produced by the emergent beam of ultra-violet light is greater than that of the incident beam, and this the more the thinner the metal film until it attains a constant value 1·07 times greater. W. Frese found that the photoelectric sensitiveness of silver is not affected by treatment with water or alcohol.

W. D. Bancroft and H. B. Weiser¹⁸ reported:

When silver nitrate is introduced into the flame, it first melts to a bead and then decomposes. If care be taken, a silver mirror can be obtained, along the edge of which there is precipitated a considerable quantity of black or bluish-black silver oxide. If the flame is too hot or if it contains too much salt, spots or specks of metallic silver and also grey, pulverulent silver are obtained instead of a mirror. Since there is a good deal of free silver in the flame when silver nitrate is added, and since silver vapour is blue, it is not impossible that the blue colour of the flame is due in part to the vapour of metallic silver.

The emission spark spectrum and the spectrum of the oxyhydrogen flame of silver was stated by W. N. Hartley to be very similar to that of copper, and to resemble in some respects that of gold and of platinum. The brightest or most prominent lines in the emission spectrum of silver in the electric arc in vacuo have a wave-length of $328\cdot08$ and $338\cdot30\mu\mu$ in the ultra-violet; $405\cdot544$ and $421\cdot21\mu\mu$ in the violet; $466\cdot87\mu\mu$ in the blue; and $520\cdot925$, $546\cdot566$, $547\cdot172$, and $562\cdot35\mu\mu$ in the green. C. C. Hutchins and E. L. Holden found that three lines $447\cdot62$, $466\cdot80$,

and $487.43\mu\mu$ are also present in the solar spectrum. The arc spectrum has been studied by F. J. Kasper, J. Frings, W. Happers, etc.; the spark spectra by J. Frings, F. L. Wagner, J. M. Eder, W. M. Hicks, etc. A. C. Becquerel observed two intense lines $771-772\mu\mu$ and $825-829\mu\mu$ in the ultra-red. The ultra-red spectrum of silver has been explored by H. M. Randall, H. Lehmann, J. M. Eder and E. Valenta, F. J. Kasper, L. and E. Bloch, etc. According to A. de Gramont, the 328.08 and the $338.30\mu\mu$ lines in the ultra-violet are well defined in the spark spectrum of silver, and H. Könemann has explored the lines between 200 and $400\mu\mu$. J. M. Eder, F. L. Wagner, R. A. Millikan, and W. Happers have studied the ultra-violet spark spectrum of silver; F. M. Walters the ultra-red spectrum. B. de la Roche studied the effect of reducing gases on the spectrum of silver.

The series spectra of silver have been studied by H. Kayser and C. Runge, L. Janicki, F. J. Kasper, H. Oellers, W. M. Hicks, etc. The lines in the spectrum of silver present similar relations as are presented by those of copper, and the two spectra are said to be homologous. The spectral lines of copper, silver, and gold appear to be built on the same general plan. The formulæ for the pairs of lines in the first series are: $\lambda \times 10^8 = 30712.4 - 130621n^{-2} - 1093823n^{-4}$; $31633.2 - 130621n^{-2} - 1093823n^{-4}$, for $n=4, 5,$ and 6 as shown in Fig. 7; there is a second associated

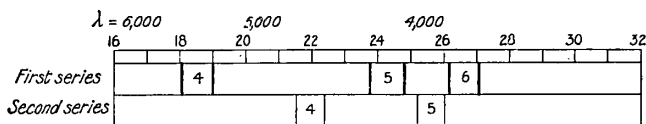

FIG. 7.—Series Spectra of Silver.

series: $\lambda \times 10^8 = 30696.2 - 123788n^{-2} - 394303n^{-4}$; $31617.0 - 123788n^{-2} - 394303n^{-4}$, for $n=4$ and 5 , Fig. 7. The value for $n=3$ gives the smallest positive value for these series, and this would correspond with lines in the ultra-red. A. C. Becquerel observed two silver lines, 8250 and $7710\mu\mu$, which may belong to the second of these sets, and E. P. Lewis gives the more accurate measurements, 8274.04 and 7688.4 . Besides these lines there are pairs with $\lambda=5545.86$ and 5276.4 ; $\lambda=4888.46$ and 4678.04 ; and $\lambda=3383.00$ and 3280.80 . The last pair is the strongest in the whole spectrum. The available data on the series line spectra of silver have been reviewed by A. Fowler.

The colour of light transmitted through silver has already been discussed. G. D. Liveing and J. Dewar measured the **absorption spectrum** and found that a thin layer of silver deposited on quartz is transparent for rays between 335.0 and $307.0\mu\mu$, and opaque on both sides of these limits. J. N. Lockyer and W. C. Roberts-Austen found a 60 -cm. column of silver vapour gave a channelled spectrum without absorption in the red, but with complete absorption in the blue. The optical properties of films have been studied by V. Kohlschütter and E. Fischmann, L. Houllevigue, N. Galli and K. Försterling, etc.

The effect of *pressure* on the spectral lines of silver has been investigated by W. G. Duffield; the effect of *hydrogen*, by J. Meunier; and the effect of *magnetism*, by J. R. Rydberg; H. Konen, and H. Finger examined the feeble continuous spectrum of the condenser discharge between silver electrodes under *water*. A. de Gramont has studied the spark spectra obtained with argentiferous minerals. W. N. Hartley and H. W. Moss have determined the smallest quantities of elements needed for the appearance of the ultimate lines in the flame and spark spectra of silver, and other metals. W. Schuler found 0.0001 mgrm. of silver could be detected by means of the spark spectrum.

The production of **Röntgen rays** by silver cathode, the passage of these rays through silver plates, and the reflection of these rays from silver, have been the subject of many investigations.¹⁹ E. Hjalmar, etc., studied the X-ray spectrum. According to W. H. Bragg, the stopping power s of a substance for the α -rays is

approximately proportional to the at. wt. A . For gold, $s=3.17$. H. R. von Traubenberg found the range of the α -particles in silver to be 19.2×10^{-4} cm. According to J. Crowther, the coeff. of absorption μ for the β -rays is approximately proportional to the sp. gr. D , and for gold, $\mu/D=8.3$. J. Chadwick measured the nuclear charge on the silver atom. M. N. Saha studied the ionizing potential of silver; and B. E. Moore, the excitation stages in the arc spectrum of that metal.

Silver is one of the best of conductors of electricity, and its conductivity is sometimes used as a standard of reference 100. H. F. Lenz's²⁰ values for the electrical conductivity are :

	Ag	Sn	Cu	Au	Zn	Fe	Pb
Electrical conductivity . . .	100	73.6	73.3	58.5	22.6	10.7	10.3

As indicated in connection with copper, G. Wiedemann and R. Franz emphasized the close relation between the thermal and electrical conductivities of the metals. The different values published for the electrical conductivity at 0° range from 60.8×10^4 to 68.12×10^4 reciprocal ohms, and the best representative value is near 67.0×10^4 reciprocal ohms. The measurements of A. C. Becquerel, W. Siemens, A. Matthiessen, etc., have shown that the electrical conductivity of a hard-drawn silver wire is less than that of an annealed wire. A. C. Becquerel gave the relation 100 : 107; W. Siemens, 100 : 108.8; and A. Matthiessen, 100 : 110. W. H. Preece gave 1.609 ohms for the electrical resistance, R , of silver at 14° ; and L. Weiller found that a silver wire, one mm. diameter, and one kilometre long, had a resistance of 19.37 ohms at 0° . The effect of an increase of temperature is to augment the resistance and lower the conductivity. G. Niccolai's value for low temp., in ohms per cm. cube, are :

	0°	-50°	-76.8°	-100°	-150°	-200°	-252.8	-258.6°
Ohms . . .	1.506	1.212	1.040	0.916	0.638	0.357	0.014	0.009

and E. F. Northrup's values for high temp. in microhms per c.c., are :

	100°	200°	400°	750°	960°	960°	1000°	1200°	1400°	1500°
R . . .	2.15	2.80	3.46	6.65	8.4	16.6	17.01	19.36	21.72	23.0
	Solid					Liquid				

A. Matthiessen and M. von Bose gave for the resistance, R , of silver, at θ° when the value at 0° is represented by R_0 is $R=R_0(1-0.0038287\theta+0.00000848\theta^2)$; J. Dewar and J. A. Fleming gave $R=R_0(1+0.00377\theta)$, and P. W. Bridgman found the temp. coeff. between 0° and 100° to be 0.00407; L. Holborn, 0.00410 per degree between 0° and 100° ; while W. Jäger and H. Diesselhorst found 0.00400 for silver 99.98 per cent. purity. According to H. K. Onnes, the ratio of the electrical resistance of silver at θ° and at 0° steadily falls as the temp. is reduced :

θ° . . .	0	-103.7°	-195.1°	252.8°	-259.1°
R_θ/R_0 . . .	1	0.581	0.197	0.009	0.007

so that the electrical resistance of silver probably vanishes towards absolute zero. A. L. Feild estimated the resistance of amorphous silver to be 5.29 micro-ohms per c.c. at 20° . P. W. Bridgman found the effect of pressure to be :

	0°	25°	50°	75°	100°
Resistance . . .	1.0000	1.1011	1.2024	1.3044	1.4074
Press. coeff. 0 kgrm. . .	-0.0_5308	-0.0_5363	-0.0_5362	-0.0_5359	-0.0_5355
Press. coeff. 12,000 kgrms. . .	-0.0_5308	-0.0_5311	-0.0_5313	-0.0_5315	-0.0_5318

The press. coeff. at 0° is -0.0_5308 ; E. Lisell found -0.0_535 with a sample containing 0.08 per cent. copper and traces of carbon. E. Lax has studied the effect of mechanical stresses on the resistance of silver wires. S. Pienkowsky found the electrical resistance of silver is not changed by illumination. L. Grunmach and F. Weidert ascertained that the increased resistance of silver in a magnetic field is

smaller than with bismuth, cadmium, or zinc, and greater than with gold, copper, tin, palladium, platinum, lead, or tantalum. According to S. Weber and E. Vosterhuis, a *thin film* of silver becomes conducting when it is over $6.5\mu\mu$ in thickness. A. Sieverts found the resistance is increased by the *occlusion of hydrogen*; and G. Szivessy, that it is increased 0.3 to 0.6 per cent. by the *occlusion of oxygen*. F. Credner found that the electrical resistance of a silver wire at a constant temp. diminishes, and this the more rapidly the higher the temp.; at 400° the resistance rises again. V. Kohlschütter with E. Fischmann, and with A. Noll, has investigated the conductivity of thin films of silver under various conditions. P. W. Bridgman found that the electrical resistance of thin films of silver, for high current densities, is greater than corresponds with Ohm's law. A. L. Bernoulli showed that the great increase in the resistance of silver by small proportions of impurities cannot be explained by a decrease in the number of conductivity electrons.

S. Kyropoulos²¹ showed that different parts of a piece of silver may have a different electric potential and thus exhibit different degrees of nobility. For instance, if a clean silver plate be scratched and immersed in a soln. of agar-agar containing potassium iodide and phenolphthalein, the scratches show up as black lines on a bright ground through the deposition of silver iodide on the less "noble" worked parts. According to C. E. Fawsitt, the potential difference of silver with a normal soln. of silver nitrate against a calomel electrode is 1.055 volt for brightly polished silver; 1.060 volt for the same silver annealed at a red heat; and 1.057 volt for annealed silver hammered until hard. Hence, annealed silver is more electro-positive than hardened silver. He also measured the electromotive force of cells with hardened and annealed silver electrodes in soln. of silver nitrate. V. Kohlschütter and co-workers studied the potential of silver films produced in various ways. According to F. M. G. Johnson and N. T. M. Wilmore, the potential difference of silver against a hydrogen electrode in 0.01*N*-, and 0.1*N*-AgNO₃ is -0.771 volt. I. M. Kolthoff gave -0.7887 volt. G. N. Lewis found the potential of the silver electrode against normal silver ion at 25° is -0.515 volt if that of the normal electrode be zero, or -1.079 volt if the normal electrode has a potential -0.560 volt at 18° or -0.564 volt at 25°. This agrees with the value found by A. A. Noyes and B. F. Brann. G. Maganini found the difference of potential in volts between zinc in a normal soln. of sulphuric acid and silver immersed in the given soln. containing *n* mols per litre. $\frac{1}{2}n$ -H₂SO₄, 1.213 volt; *n*-NaOH, 0.958 volt; *n*-KOH, 1.040 volt; $\frac{1}{2}n$ -Na₂SO₄, 1.209 volt; *n*-Na₂S₂O₃, 0.648 volt; *n*-KNO₃, 1.057 volt; *n*-NaNO₃, 1.148 volt; $\frac{1}{2}n$ -K₂CrO₄, 1.210 volt; $\frac{1}{2}n$ -K₂Cr₂O₇, 1.324 volt; $\frac{1}{2}n$ -K₂SO₄, 1.148 volt; $\frac{1}{2}n$ -(NH₄)₂SO₄, 1.257 volt; $\frac{1}{2}n$ -K₄FeCy₆, 0.878 volt; 0.167*n*-K₃FeCy₆, 1.249 volt; *n*-KCNS, 0.725 volt; *n*-NaNO₃, 1.15 volt; $\frac{1}{2}n$ -Sr(NO₃)₂, 1.193 volt; $\frac{1}{2}n$ -Ba(NO₃)₂, 1.215 volt; *n*-KNO₃, 1.150 volt; $\frac{1}{2}n$ -KClO₃, 1.209 volt; 0.167*n*-KBrO₃, 1.208 volt; *n*-NH₄Cl, 1.017 volt; *n*-KF, 0.615 volt; *n*-NaCl, 1.013 volt; *n*-KBr, 0.824 volt; *n*-KCl, 1.076 volt; $\frac{1}{2}n$ -Na₂SO₃, 1.037 volt; *n*-NaOBr with a quantity of bromine was used corresponding to NaOH=1, 0.997 volt; *n*-tartaric acid, 1.234 volt; $\frac{1}{2}n$ -tartaric acid, 1.257 volt; $\frac{1}{2}n$ -potassium sodium tartrate, 1.197 volt. U. Sborgi and A. Donati studied the potential of silver against various salt soln.; F. Jirsa, the effect of telluric acid on the depolarization of silver anodes; V. Kohlschütter and H. Stäzer, the anodic behaviour of silver in soln. of sodium sulphide; and G. Trümpler, the e.m.f. against the normal calomel electrode. P. Walden has made estimates of the **diameters and velocities of silver ions** in aq. and non-aq. solvents. W. P. Davey gave 0.85 A. for the at. radius of silver in the iodide, and 1.18 A. for the radius in the chloride and bromide.

G. Carrara and L. d'Agostini found that with a normal soln. of silver nitrate and a normal calomel electrode (-0.56 volt) the potential is -1.055 volt, and with a 0.01*N*-soln., -0.977 volt; with 0.527*N*- and 0.1*N*-soln. of silver chlorate, the potential is -1.055 and -1.024 volt respectively; and with *N*-silver acetate, -0.991 volt. In the latter case, A. Jaques showed that the result is greatly

influenced by the gases dissolved in the electrolyte, but not in soln. of silver nitrate or in soln. of lead nitrate or acetate. N. Isgarischeff found with an alkaline soln. of silver nitrate 0.910 volt. S. B. Christy found that in soln. of potassium cyanide the probable values are :

Per cent. KCy	6.5	0.65	0.065	0.0065	0.00065	0.000065	0.0000065	0
Volt . . .	+0.340	+0.195	+0.055	-0.310	-0.420	-0.460	-0.495	-0.570

F. Förster found that in conc. soln. of potassium cyanide, the cathode potential behaves normally with increasing current density.

H. J. S. Sand investigated the changes of the cathode potential during the electrolysis of silver nitrate. F. M. G. Johnson and N. T. M. Wilmore investigated the potential of silver against soln. of the nitrate and iodide in liquid ammonia. J. Neustadt and R. Abegg found that silver does not change its place in the electrochemical series against soln. of silver salts in water, methyl or ethyl alcohol, acetone, or pyridine. N. Isgarischeff, G. Carrara and L. d'Agostini, etc., studied soln. in methyl alcohol; L. Kahlenberg, soln. in methyl, ethyl, benzyl, or allyl alcohol, in glycol, glycerol, pyridine, or quinoline. P. Bechtereff, molten sodium hydroxide; O. Sackur, molten alkali chlorides; L. Poincaré, fused sodium nitrate; F. W. Küster and A. Thiel, soln. of mixed silver halides. The e.m.f. of silver in various combinations of galvanic cells has been also studied by W. Wolff, S. Lindeck, F. Exner and J. Tuma, G. Gore, C. R. A. Wright and C. Thompson, G. N. Lewis, R. Luther and F. Pokorny, F. M. G. Johnson and N. T. M. Wilmore, A. Lapworth and J. R. Partington, P. Bechtereff, F. Haber, R. Beutner, etc.

The polarization of the silver electrode in different electrolytes has been studied by F. Streintz, E. Pirani, A. Oberbeck, M. le Blanc, G. Grube, R. Kremann and F. Noss, F. Haber and J. Zawadsky, etc. P. Bechtereff found silver becomes *passive* in molten sodium hydroxide and has the cathode polarization at 500° for current density 0.25, 0.63, and 1.89 amp. per sq. dm., the respective voltages 0.026, 0.083, and 0.377. It is less than for platinum, iron, or nickel, and is diminished by sodium peroxide. W. Winter has studied the electrolytic value action of silver anodes.

G. T. Beilby²² found a **thermo-electric current** is produced by a thermo-couple with hardened and annealed silver wires. A. L. Bernoulli, and O. Sackur have studied the e.m.f. of *silver-copper* couples at different temp. :

	300°	550°	630°	675°	740°	775°	820°
Microvolts . . .	-14	-17	-10	0	+14	+20	+30

G. von Hevesy and E. Wolff of the *silver-nickel* couple :

	-80°-0°	0°-80°	0°-160°	0°-400°	0°-800°
Microvolts	22.1	23.7	26.9	20.0	35.0

J. Dewar and J. A. Fleming of the *silver-lead* couple :

	-205°	-105.8°	-6.5°	9.4°	24.2°	70.5°	100.1°
Microvolts	43.4	-26.15	-2.05	+2.21	+6.73	+22.1	+33.2

W. Jäger and H. Diesselhorst, J. Dewar and J. A. Fleming, K. Noll, W. H. Steele have measured the e.m.f. of the *silver-platinum* couple. L. Holborn and A. L. Day's values are :

	-185°	100°	200°	400°	600°	800°	1000°
Microvolt	-0.16	+0.74	+1.8	+4.5	+8.2	+13.2	+16.0

W. W. Coblentz found the *silver-bismuth* couple to have a thermo-e.m.f. of 89 microvolts per degree; N. A. Gesehus found the positive thermo-e.m.f. of silver is less than for antimony, cadmium, and zinc, and greater than for copper and brass. J. Monckman found the thermo-electric properties of silver were not influenced by the occlusion of oxygen. K. Noll found that for hardened and annealed silver, the

silver-mercury couple had respectively an e.m.f. of +710.3 and +671.5 microvolts between 0° and 100°. E. Sedström, and H. Jahn have studied the Peltier effect for combinations of silver with various metals—*e.g.* Ag-Cd, and Ag-Zn. The thermo-electric force of silver against lead at atm. press. and θ° is $E = (2.556\theta + 0.00432\theta^2) \times 10^{-6}$ volts; the Peltier effect is $P = (2.556 + 0.00864\theta)(\theta + 273) \times 10^{-6}$ volts; and the Thomson effect $\sigma = 0.00864(\theta + 273) \times 10^{-6}$ volts per degree. E. Lecher found that the Thomson effect between 123° and 525° could be represented by $(7.363 + 0.00887\theta)10^{-7}$ gram-cals. per coulomb. P. W. Bridgman observed the effect of press. between the compressed and uncompressed metal, and a selection of the results is indicated in Table VII. The Seebeck and Peltier effects are positive and

TABLE VII.—THE EFFECT OF PRESSURE ON THE SEEBECK, PELTIER, AND THOMSON EFFECTS.

Temp.	Seebeck effect. Volts $\times 10^6$.			Peltier effect. Joules per coulomb $\times 10^6$.			Thomson effect. Joules per coulomb $\times 10^6$.		
	Press. in kgrms. per sq. cm.			Press. in kgrms. per sq. cm.			Press. in kgrms. per sq. cm.		
	2000	6000	12000	2000	6000	12000	2000	6000	12000
0°	+0.15	+0.48	+ 0.94	+3.9	+12.9	+25.3	+2.2	+4.1	+7.1
40°	0.66	2.00	3.91	5.6	16.6	32.1	2.5	4.7	8.1
60°	1.03	3.10	6.02	6.5	18.8	36.0	2.7	5.0	8.7
100°	1.87	5.49	10.56	8.4	23.3	44.2	3.0	5.6	9.7

increase regularly with press. and temp. The Thomson effect is positive and increases with rising press., and any constant press. is proportional to the absolute temp. E. Wagner also measured the effect of press. on the Seebeck effect. G. Borelius and F. Gunneson found the Thomson effect, in microvolts per degree, to be 1.80 at 400° K., 1.31 at 300° K., 0.81 at 200° K., 0.55 at 150° K., 0.25 at 120° K., and -0.10 at 105° K. A. Cöhn and A. Lotz studied the contact electricity of silver against glass in vacuo.

A. Günther-Schulze²³ has found that silver exhibits the electrolytic value action with dil. hydrochloric, hydrobromic, or hydriodic acid. The formation of the electric arc, or sparking between silver poles, has been studied by F. J. Kasper, E. Täge, and D. Roschansky. The disintegration of the metal during sparking in vacuum tubes, etc., has been studied by W. Crookes,²⁴ H. B. Williams, V. Kohlschütter and T. Goldschmidt, etc. The tendency to disintegration is said to be greater with silver than with platinum, copper, nickel, iron, or aluminium; and to be smaller in air than in hydrogen. F. W. Aston found Crookes' dark space in vacuum tubes is thicker with silver than with aluminium, magnesium, iron, copper, zinc, tin, platinum, lead, carbon, or mercury. E. Weiss, and F. Ehrenheft have studied the character of the colloidal particles obtained by the disintegration of silver electrodes during sparking. W. G. Duffield, T. H. Burnham, and A. H. Davis studied the electric arc between silver electrodes; and V. L. Chrisler measured the potential gradient of the arc with silver electrodes.

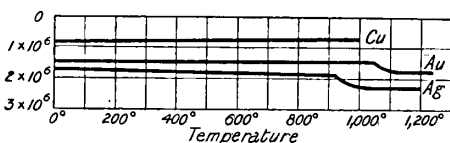

FIG. 8.—Magnetic Susceptibility of Copper, Silver, and Gold at different Temperatures.

P. Joubin²⁵ places silver among the magnetic metals, while it is usually regarded as diamagnetic, since it appeared in M. Faraday's list (1846) of diamagnetic metals: bismuth, antimony, . . . mercury, silver, copper—concerning which he said, "I cannot be sure that they are perfectly free, from magnetic metals." The magnetic susceptibility of silver has been determined by J. A. Fleming and J. Dewar, S. Meyer,

J. Königsberger, C. Chéneveau, etc. About 15° , the value is -1.3 to -1.7×10^{-6} volume units; and -0.2×10^{-6} mass units. The magnetic susceptibility increases during the melting of the metal. M. Owen found a numerical increase. K. Honda found very little change, e.g. he obtained -0.19×10^{-6} mass units at 18° , and -0.22×10^{-6} mass units at 1100° . There is, however, a discontinuity at the m.p. as illustrated in Fig. 8. W. Gerlach and O. Stern demonstrated the magnetic moment of silver atoms.

REFERENCES.

- ¹ L. Foucault, *Compt. Rend.*, **63**, 413, 1866; F. Bothe, *Journ. prakt. Chem.*, (1), **92**, 191, 1864; A. K. Christomanos, *Zeit. anal. Chem.*, **7**, 299, 1868; J. S. Stas, *Mém. Acad. Belgique*, **35**, 1, 1865; H. Ambronn, *Zeit. wiss. Mikroskop.*, **22**, 349, 1905; W. C. Roberts-Austen and J. N. Lockyer, *Proc. Roy. Soc.*, **23**, 344, 1875.
- ² J. B. L. Romé de l'Isle, *Crystallographie*, Paris, **3**, 432, 1783; R. J. Haiüy, *Traité de minéralogie*, Paris, **3**, 385, 1801; F. Mohs, *Grundriss der Mineralogie*, Dresden, **2**, 434, 1825; G. Rose, *Pogg. Ann.*, **23**, 202, 1831; **64**, 533, 1845; J. F. L. Hausmann, *Abhand. König. Ges. Wiss. Göttingen*, **4**, 1850; W. Haidinger, *Jahrb. geol. Reichsanst. Wien*, **1**, 150, 1850; H. Dauber, *Liebig's Ann.*, **78**, 68, 1851; V. Kohlschütter and E. Eydmann, *ib.*, **390**, 340, 1912; **398**, 14, 1913; G. vom Rath, *Zeit. Kryst.*, **12**, 545, 1887; M. Kirmis, *Pogg. Ann.*, **158**, 121, 1876; C. Bischoff, *ib.*, **60**, 287, 1843; R. C. Snowdon, *Journ. Phys. Chem.*, **9**, 392, 1905; H. Vogel, *Sitzber. Akad. Berlin*, **289**, 1862; *Pogg. Ann.*, **117**, 317, 1862; G. W. A. Kahlbaum, K. Roth, and P. Siedler, *Zeit. anorg. Chem.*, **29**, 177, 1902; E. Beckmann and O. Liesche, *ib.*, **89**, 171, 1914; W. L. Bragg, *Phil. Mag.*, (6), **40**, 169, 1920; H. Bohlin, *Ann. Physik*, (4), **61**, 434, 1920; S. Nishikawa and G. Asahara, *Phys. Rev.*, (2), **15**, 38, 1920; J. Margottet, *Ann. Ecole Norm.*, **8**, 362, 1879; *Compt. Rend.*, **85**, 1142, 1877; W. M. Hutchings, *Chem. News*, **35**, 117, 186, 1877; A. Liversidge, *ib.*, **35**, 68, 1877; A. Gurtl, *Uebersicht der pyrogeneten künstlichen Mineralien*, Freiberg, **10**, 1875; O. Mügge, *Neues Jahrb. Min.*, **ii**, **6**, 1913; S. Kalischer, *Ber.*, **15**, 702, 1882; L. Vegard, *Phil. Mag.*, (6), **31**, 83, 1916; P. Sherrer, *Phys. Zeit.*, **19**, 23, 1918; K. Friedrich and A. Leroux, *Met.*, **3**, 368, 1906; G. Winkler, *Chem. Ztg.*, **12**, 721, 1888; L. Opificius, *ib.*, **12**, 649, 1888; F. A. Moesta, *Ueber das Vorkommen der Chlor-, Brom-, und Jodverbindungen des Silbers in der Natur*, Marburg, 1870; W. C. Roberts-Austen and J. N. Lockyer, *Proc. Roy. Soc.*, **23**, 344, 1875; E. B. Rosa, M. Born, and E. Bormann, *Phys. Zeit.*, **21**, 578, 1920; S. O. Ohmann, *Ber.*, **45**, 2973, 1912; N. Gross, *Umschau*, **34**, 510, 1920; A. Beutell, *Centr. 14, Min.*, 1919; J. Percy, *Metallurgy of Copper, Zinc, and Brass*, London, 359, 1861; A. H. W. Aten and L. M. Boerlage, *Rec. Trav. Chim. Pays-Bas*, **39**, 720, 1920; K. F. Slotte, *Acta Soc. Fennicæ*, **40**, 3, 1911; G. W. Vinal and A. S. McDaniel, *Elect. World*, **60**, 1262, 1912; U. Behn, *Wied. Ann.*, **51**, 105, 1894; E. Giurgea, *Bull. Soc. Bucaresti*, **21**, 192, 1912; A. L. W. E. van der Veen, *Zeit. Kryst.*, **52**, 511, 1913; M. Ettisch, M. Polyani, and K. Weissenberg, *Zeit. phys. Chem.*, **99**, 332, 1921; Z. Jeffries and R. S. Archer, *Met. Chem. Eng.*, **26**, 343, 1922; M. W. Saha, *Nature*, **107**, 682, 1921.
- ³ J. J. C. Mullet, *Journ. Asiatique*, (5), **11**, 379, 1876; N. Kbanikoff, *Journ. Amer. Oriental Soc.*, **6**, 1, 1859; H. C. Bolton, *Quart. Journ. Science*, **13**, 494, 1876.
- ⁴ R. Boyle, *Hydrostatic Balance*, London, 1690; D. G. Fahrenheit, *Phil. Trans.*, **33**, 114, 1726; P. van Muschenbroek, *ib.*, **33**, 370, 1726; C. Hatchett, *ib.*, **93**, 88, 1803; M. Holzmann and A. Matthiessen, *ib.*, **150**, 85, 1860; *Chem. News*, **2**, 217, 1860; A. Matthiessen, *Pogg. Ann.*, **110**, 21, 1880; G. Quincke, *ib.*, **135**, 642, 1868; H. Vogel, *ib.*, **117**, 316, 1861; G. Rose, *ib.*, **73**, 1, 1848; *Chem. Gaz.*, **6**, 136, 1848; W. D. Helder mann, *Journ. Inst. Metals*, **16**, 84, 1916; S. W. Smith, *ib.*, **8**, 175, 1912; T. M. Lowry, *ib.*, **21**, 359, 1919; V. Kohlschütter and E. Eydmann, *Liebig's Ann.*, **398**, 26, 1913; W. Langsdorf, *ib.*, **85**, 155, 1853; G. W. A. Kahlbaum, K. Roth, and P. Siedler, *Zeit. anorg. Chem.*, **29**, 178, 1902; G. W. A. Kahlbaum and E. Sturm, *ib.*, **46**, 217, 1905; A. Sievert and J. Hagenacker, *Zeit. phys. Chem.*, **68**, 115, 1908; W. C. Roberts-Austen and T. Wrightson, *Nature*, **24**, 470, 1881; *Phil. Mag.*, (5), **11**, 295, 1881; (5), **13**, 360, 1882; W. C. Roberts-Austen, *Chem. News*, **31**, 143, 1875; *Proc. Roy. Soc.*, **23**, 349, 481, 1875; H. Tomlinson, *ib.*, **37**, 111, 1884; J. B. A. Dumas, *Chem. News*, **37**, 82, 1877; *Compt. Rend.*, **86**, 65, 1878; *Ann. Chim. Phys.*, (5), **14**, 289, 1878; G. Wertheim, *ib.*, (3), **12**, 415, 1844; A. Baudrimont, *ib.*, (3), **30**, 304, 1850; *Journ. prakt. Chem.*, (1), **7**, 287, 1836; C. Karmarsch, *ib.*, (1), **43**, 193, 1848; A. Breithaupt, *ib.*, (1), **11**, 151, 1837; C. J. B. Karsten, *Schweigger's Journ.*, **65**, 394, 1832; C. Zimmermann, *Ber.*, **15**, 850, 1882; L. Playfair and J. P. Joule, *Mem. Chem. Soc.*, **3**, 66, 1848; A. K. Christomanos, *Zeit. anal. Chem.*, **7**, 299, 1868; M. J. Brisson, *Pésanteur spécifiques des corps*, Paris, 1787; J. S. Stas, *Œuvres complètes*, Bruxelles, **3**, 126, 1894; *Mém. Acad. Belgique*, **35**, 103, 1865; W. Spring, *Bull. Acad. Belgique*, **1066**, 1903; J. J. Berzelius, *Traité de chimie*, Paris, **2**, 476, 1846; F. C. A. H. Lantsbery, *Proc. Birmingham Met. Soc.*, **5**, 101, 1913; T. M. Lowry and R. G. Parker, *Journ. Chem. Soc.*, **107**, 1005, 1915.
- ⁵ F. C. Calvert and R. Johnson, *Mem. Manchester Lit. Phil. Soc.*, (2), **15**, 113, 1853; *Phil. Mag.*, (4), **17**, 114, 1859; O. Stern, *Zeit. Physik*, **2**, 49, 1920; S. Bottone, *Chem. News*, **28**, 215, 1873; E. A. Smith and H. Turner, *Journ. Inst. Metals*, **22**, 149, 1919; C. A. Edwards, *Metal Ind.*, **17**, 221, 1921; F. Auerbach, *Wied. Ann.*, **43**, 61, 1891; **45**, 262, 1892; **53**, 1000, 1894; A. K. Christomanos, *Zeit. anal. Chem.*, **7**, 299, 1868; A. Kurth, *Phys. Zeit.*, **8**, 417, 1907; G. T. Beilby,

Proc. Roy. Soc., 79. A, 463, 1907; J. R. Rydberg, *Zeit. phys. Chem.*, 33. 353, 1900; W. R. Webster, *Rev. Mét.*, 10. 108, 1913; A. Hanriot, *Compt. Rend.*, 155. 713, 971, 1502, 1912; Z. Jeffries, *Journ. Inst. Metals*, 18. 243, 1917; G. Quincke, *Pogg. Ann.*, 134. 356, 1868; 135. 261, 1869; 138. 141, 1869; *Phil. Mag.*, (4), 36. 267, 1868; (4), 38. 78, 1869; *Wied. Ann.*, 61. 267, 1897; 52. 1, 1894; S. W. Smith, *Journ. Inst. Metals*, 12. 168, 1914; 17. 65, 1917; I. Traube, *Ber. deut. phys. Ges.*, 11. 231, 1909; *Ber.*, 42. 86, 1909; A. Gradenwitz, *Wied. Ann.*, 67. 467, 1899; T. Lohmstein, *Ann. Physik*, (4), 20. 266, 1906; W. C. Roberts-Austen, *Phil. Trans.*, 187. 383, 1896; *Proc. Roy. Soc.*, 59. 281, 1896; 67. 101, 1900; *Chem. News*, 74. 289, 1896; A. Kürth, *Zeit. Ver. deut. Ing.*, 53. 85, 209, 1909.

⁸ A. Masson, *Compt. Rend.*, 44. 464, 1857; *Pogg. Ann.*, 103. 272, 1858; *Cosmos*, 10. 425, 1858; G. Wertheim, *Ann. Chim. Phys.*, (3), 2. 385, 1844; A. Johnsen, *Centr. Min.*, 233, 1918; K. Honda and S. Konno, *Phil. Mag.*, (6), 42. 115, 1921; C. J. B. Karsten, *System der Metallurgie*, Berlin, 5. 467, 1831; C. E. Guye, *Journ. Phys.*, (5), 2. 620, 1912; C. E. Guye and S. Mintz, *Arch. Sciences Genève*, (4), 26. 263, 1908; C. E. Guye and V. Freedericksz, *Compt. Rend.*, 149. 1066, 1909; A. Einstein, *Ann. Physik*, (4), 34. 170, 1911; M. Ishimoto, *Proc. Math. Phys. Soc. Japan*, (3), 1. 267, 1919; W. C. Roberts-Austen, *Proc. Roy. Soc.*, 59. 281, 1896; 67. 101, 1900; *Phil. Trans.*, 187. 383, 1896; *Chem. News*, 74. 289, 1896; O. Stern, *Zeit. Physik*, 2. 49, 417, 1921.

⁷ T. W. Richards, *Journ. Amer. Chem. Soc.*, 37. 470, 1643, 1913; L. H. Adams, E. D. Williamson, and J. Johnston, *ib.*, 41. 12, 1919; T. W. Richards and G. Jones, *ib.*, 31. 158, 1909; J. Johnston, *ib.*, 34. 788, 1912; E. Grüneisen, *Ann. Physik*, (4), 3. 75, 1900; (4), 33. 1264, 1910; A. Mallock, *Proc. Roy. Soc.*, 74. 50, 1904.

⁶ G. Wertheim, *Ann. Chim. Phys.*, (3), 12. 385, 1844; W. Voigt, *Wied. Ann.*, 48. 674, 1893; E. Rehkuh, *ib.*, 35. 476, 1888; A. Bock, *ib.*, 52. 609, 1894; C. Schäfer, *Ann. Physik*, (4), 5. 233, 1901; E. Grüneisen, *ib.*, (4), 22. 801, 1907; (4), 33. 1262, 1910; G. Angenheister, *ib.*, (4), 3. 116, 1900; K. R. Koch and C. Dannecker, *ib.*, (4), 47. 197, 1915; W. Sutherland, *Phil. Mag.*, (5), 32. 31, 215, 524, 1891; S. Katzenelsohn, *Ueber den Einfluss der Temperatur auf die Elasticität der Metalle*, Berlin, 1887; G. Tammann, *Gött. Nachr.*, 181, 1911; A. Mallock, *Proc. Roy. Soc.*, 95. A, 429, 1919; G. Tammann, *Wied. Ann.*, 29. 214, 1886; E. Scholz, *Ueber den Einfluss der Temperatur auf die Torsionsnachwirkung*, Köln, 1902.

⁵ C. Schäfer, *Ann. Physik*, (4), 5. 233, 1901; G. Angenheister, *ib.*, (4), 3. 116, 1900; (4), 11. 188, 1903; G. F. C. Searle, *Phil. Mag.*, (5), 49. 193, 1900; W. Sutherland, *ib.*, (5), 32. 31, 1891; W. Voigt, *Wied. Ann.*, 48. 674, 1893; M. Baumeister, *ib.*, 18. 578, 1883; G. Pisati, *Nuovo Cimento*, (3), 5. 34, 135, 1879; S. Katzenelsohn, *Ueber den Einfluss der Temperatur auf die Elasticität der Metalle*, Berlin, 1887; H. Tomlinson, *Proc. Roy. Soc.*, 40. 343, 1886; A. T. Kupffer, *Mém. Acad. St. Petersburg*, (6), 5. 233, 1856; (6), 6. 397, 1867; A. W. Napiersky, *Pogg. Ann. Ergbd.*, 3. 351, 1853; F. Horton, *Phil. Trans.*, 204. A, 1, 1905; *Proc. Roy. Soc.*, 73. 334, 1904; 74. 401, 1905; J. Kiewiet, *Wied. Ann.*, 29. 650, 1886; E. Scholz, *Ueber den Einfluss der Temperatur auf die Torsionsnachwirkung*, Köln, 1902; A. Bock, *Wied. Ann.*, 52. 609, 1894.

⁴ A. le Chatelier, *Compt. Rend.*, 109. 24, 1889; A. Baudrimont, *ib.*, 31. 115, 1850; *Ann. Chim. Phys.*, (3), 30. 304, 1850; G. Wertheim, *ib.*, (3), 12. 385, 1844; G. T. and H. N. Beilby, *Proc. Roy. Soc.*, 76. 462, 1905; W. C. Roberts-Austen, *ib.*, 43. 425, 1888; *Chem. News*, 57. 133, 1888; A. and C. R. Aikin, *A Dictionary of Chemistry and Mineralogy*, London, 2. 311, 1807; F. A. and C. A. Lindemann, *Nernst's Festschrift*, 265, 1912; J. Dewar, *Chem. News*, 71. 200, 1895; J. Percy, *Silver and Gold*, London, 1. 3, 1880; E. A. Smith and H. Turner, *Journ. Inst. Metals*, 22. 149, 1919; F. C. Thompson, *Trans. Faraday Soc.*, 11. 104, 1915; C. A. Meibius, *Oefvers. Akad. Förh.*, 681, 1887.

³ A. L. Lavoisier and P. S. Laplace, *Recueil des mémoires de Lavoisier*, Paris, 1. 121, 1805; *Ostwald's Klassiker*, 40, 1892; A. Matthiessen, *Phil. Trans.*, 156. 231, 868, 1866; *Phil. Mag.*, (4), 31. 149, 1866; (4), 32. 472, 1866; H. Fizeau, *Ann. Chim. Phys.*, (4), 2. 143, 1864; (4), 8. 335, 1866; *Compt. Rend.*, 68. 1125, 1869; H. le Chatelier, *ib.*, 108. 1096, 1889; W. Voigt, *Wied. Ann.*, 49. 702, 1893; 48. 675, 1893; L. Holborn and A. L. Day, *Amer. Journ. Science*, (4), 11. 374, 1901; *Ann. Physik*, (4), 2. 505, 1900; (4), 4. 104, 1901; F. Hennig, *ib.*, (4), 22. 637, 1907; E. Grüneisen, *ib.*, (4), 33. 65, 1910; W. C. Roberts-Austen, *Proc. Roy. Soc.*, 23. 349, 481, 1875; C. L. Lindemann, *Phys. Zeit.*, 12. 1199, 1911; G. Wiedemann and R. Franz, *Pogg. Ann.*, 89. 497, 1853; K. Scheel, *Zeit. Physik*, 5. 167, 1921; J. Disch, *ib.*, 5. 173, 1921; P. W. Bridgman, *Phys. Rev.*, (2), 18. 115, 1921.

² G. Poloni, *Rend. Ist. Lombardi*, (3), 15. 15, 1882; H. F. Weber, *Zürich Vierteljahr.*, 25. 184, 1880; *Wied. Ann.*, 11. 345, 1880; W. Jäger and H. Diesselhorst, *Wiss. Abh. Phys. Tech. Reichsanst.*, 3. 269, 1900; G. Wiedemann and R. Franz, *Pogg. Ann.*, 89. 497, 1853; *Phil. Mag.*, (4), 7. 33, 1854; E. H. Hall, *Proc. Nat. Acad. Sciences*, 6. 613, 1920; C. H. Lecs, *Phil. Trans.*, 208. A. 381, 1908; J. H. Gray, *ib.*, 186. A, 165, 1895.

¹ P. L. Dulong and A. T. Petit, *Ann. Chim. Phys.*, (2), 7. 113, 1818; H. V. Regnault, *ib.*, (2), 73. 1, 1840; (3), 1. 129, 1841; (3), 9. 322, 1843; J. Pionchon, *ib.*, (6), 11. 106, 1887; *Compt. Rend.*, 102. 675, 1854, 1886; 103. 1122, 1886; U. J. J. le Verrier, *ib.*, 144. 907, 1892; H. E. Schmitz, *Proc. Roy. Soc.*, 72. 177, 1903; T. S. Humpidge, *ib.*, 35. 137, 1883; *Chem. News*, 47. 181, 1883; W. A. Tilden, *ib.*, 78. 16, 1898; *Proc. Roy. Soc.*, 71. 220, 1903; *Phil. Trans.*, 201. A. 37, 1903; 202. A, 139, 1904; E. H. and E. Griffiths, *ib.*, 214, A, 319, 1914; *Proc. Roy. Soc.*, 88. A, 549, 1913; J. Dewar, *ib.*, 89. A, 158, 1913; H. Tomlinson, *ib.*, 37. 111, 1884; H. Kopp, *Liebig's Ann. Suppl.*, 3. 290, 1864; R. Bunsen, *Pogg. Ann.*, 141. 1, 1870; H. Buff, *ib.*, 145. 626, 1872; *Phil. Mag.*, (4), 44. 544, 1872; A. Naccari, *Gazz. Chim. Ital.*, 18. 13, 1888; A. Bartoli and E. Stracciati.

ib., 25. i, 389, 1895; A. Eucken, *Ber. deut. phys. Ges.*, 18. 18, 1916; H. Schimpff, *Zeit. phys. Chem.* 71. 257, 1910; T. W. Richards and F. G. Jackson, *ib.*, 70. 414, 1910; J. N. Brönsted, *Zeit. Elektrochem.*, 18. 714, 1912; H. Barschell, *ib.*, 17. 344, 1911; W. Nernst and F. A. Lindemann, *ib.*, 17. 817, 1911; *Sitzber. Akad. Berlin*, 269, 308, 1910; 494, 1911; W. Nernst, *Zeit. Elektrochem.*, 17. 219, 1911; *Ann. Physik*, (4), 36. 410, 1911; P. Debye, *ib.*, (4), 49. 789, 1912; E. Grüneisen, *ib.*, (4), 33. 65, 1910; A. Magnus, *ib.*, (4), 31. 607, 1910; U. Behn, *ib.*, (4), 1. 257, 1900; F. Wüst, A. Meuthen, and R. Durrer, *Zeit. Instrumentenk.*, 39. 294, 1919; P. Schübel, *Zeit. anorg. Chem.*, 87. 81, 1914.

¹⁴ C. S. M. Pouillet, *Éléments de physique*, Paris, 1. 318, 1832; 1. 265, 1856; J. Prinsep, *Phil. Trans.*, 118. 94, 1828; L. B. G. de Morveau, *Ann. Chim. Phys.*, (1), 90. 236, 1814; L. I. Dana and P. D. Foote, *Trans. Faraday Soc.*, 15. 186, 1920; W. Guertler and M. Pirani, *Zeit. Metallkunde*, 11. I. 1919; C. W. Waidner and G. K. Burgess, *Bull. Bur. Standards*, 6. 166, 1909; L. Holborn and A. L. Day, *Ann. Physik*, (4), 2. 531, 1900; *Amer. Journ. Science*, (4), 11. 374, 1901; A. L. Day and J. K. Clement, *ib.*, (4), 26. 405, 1908; A. L. Day and R. B. Sosman, *ib.*, (4), 29. 93, 1910; C. T. Heycock and F. H. Neville, *Journ. Chem. Soc.*, 67. 1024, 1896; *Phil. Trans.*, 189. A, 37, 1897; H. Callendar, *Phil. Mag.*, (5), 33. 220, 1892; (5), 48. 519, 1899; J. Johnston, *Journ. Amer. Chem. Soc.*, 34. 788, 1912; J. F. Thomson and E. H. Miller, *ib.*, 28. 1115, 1906; D. Berthelot, *Compt. Rend.*, 126. 473, 1898; A. C. Becquerel, *ib.*, 55. 826, 1862; 57. 855, 1863; J. Violle, *ib.*, 89. 702, 1879; 96. 1033, 1883; 104. 111, 1887; 105. 163, 1887; *Phil. Mag.*, (5), 8. 501, 1879; S. W. Holman, R. R. Lawrence, and L. Barr, *ib.*, (5), 42. 37, 1896; L. Pissarjewsky, *Zeit. anorg. Chem.*, 58. 399, 1908; E. Quercign, *ib.*, 68. 302, 1910; G. I. Petrenko, *ib.*, 46. 53, 1905; 48. 351, 1906; 50. 138, 1906; 53. 213, 1907; 63. 303, 1910; R. Ruer, *ib.*, 51. 316, 1906; N. Paschin, *ib.*, 56. 8, 1908; G. Arrivaut, *ib.*, 60. 439, 1908; F. Dörncel, *ib.*, 54. 341, 1907; N. Baar, *ib.*, 70. 385, 1911; G. I. Petrenko and E. S. Fedoroff, *ib.*, 70. 161, 1911; G. Hindrichs, *ib.*, 59. 425, 1908; W. von Lepowsky, *ib.*, 59. 290, 1908; N. Kurnakoff, N. Puschin, and N. Senkowsky, *ib.*, 68. 123, 1910; S. F. Schemtschuschny, *ib.*, 49. 405, 1906; A. Ledebur, *Metallarbeiter*, 202, 1881; L. Holborn and W. Wien, *Wied. Ann.*, 47. 107, 1892; R. Emden, *ib.*, 36. 214, 1889; A. Potilitzin, *Journ. Russ. Phys. Chem. Soc.*, 24. i, 1892; R. Edler and R. Schuster, *Mitt. Tech. Gew. Mus.*, (2), 19. 143, 1910; E. H. Mathewson, *Internat. Zeit. Metallog.*, 1. 57, 1911; K. Friedrich, *Met.*, 3. 398, 1906; K. Friedrich and A. Leroux, *ib.*, 3. 365, 1906; F. Wüst, A. Meuthen, and R. Durrer, *Zeit. Instrumentenk.*, 39. 294, 1919; K. Scheel, *Zeit. angew. Chem.*, 32. 347, 1919; C. T. Heycock and F. H. Neville, *Journ. Chem. Soc.*, 61. 895, 1892; W. C. Roberts-Austen and T. K. Rose, *Chem. News*, 87. 2, 1903; A. D. van Riemdsdijk, *ib.*, 20. 32, 1869; J. F. Daniell, *Phil. Trans.*, 120. 257, 1830; 124. 443, 1831; *Phil. Mag.*, (3), 11. 191, 268, 350, 1830; R. Wright and R. C. Smith, *Journ. Chem. Soc.*, 119. 1683, 1921; E. Tiede and E. Birnbräuer, *Zeit. anorg. Chem.*, 87. 129, 1914.

¹⁵ H. St. C. Deville and H. Debray, *Ann. Chim. Phys.*, (3), 56. 385, 1859; H. Moissan, *ib.*, (7), 9. 133, 1896; J. L. Gay Lussac, *ib.*, (2), 45. 211, 1830; P. Berthier, *Traité des essais par la voie sèche*, Paris, 2. 776, 1848; A. K. Christomanos, *Zeit. anal. Chem.*, 7. 299, 1868; J. S. Stas, *Mém. Acad. Belgique*, 35. 1, 1865; *Œuvres complètes*, Bruxelles, 1. 456, 1894; J. Napier, *Journ. Chem. Soc.*, 10. 229, 1857; 11. 168, 1858; G. H. Makins, *ib.*, 13. 97, 1860; A. Parkes, *Brit. Pat. Nos.* 13118, 1850; 13997, 1852; *Chem. Gaz.*, 10. 219, 1852; A. D. van Riemdsdijk, *Arch. Neerl.*, 3. 357, 1868; *Chem. News*, 20. 32, 1869; W. A. Ross, *ib.*, 32. 83, 1875; J. W. Richards, *ib.*, 74. 2, 1896; *Metalurgical Calculations*, New York, 1. 70, 1906; 3. 588, 1908; F. J. Malaguti and J. Durocher, *Recherches sur l'association de l'argent aux minéraux métalliques*, Paris, 27, 1850; W. A. Lampadius, *Journ. prakt. Chem.*, (1), 16. 44, 204, 1839; C. M. Despretz, *Compt. Rend.*, 48. 362, 1858; J. Violle, *ib.*, 141. 1188, 1906; L. Troost and P. Hautefeuille, *ib.*, 84. 946, 1877; F. Elsner, *Chem. tech. Mitt.*, 36. 1858; W. Borchers, *Zeit. Elektrochem.*, 3. 85, 1896; C. F. Plattner, *Die metallurgischen Röstprozesse*, Freiberg, 113. 235, 1856; F. Krafft, *Ber.*, 36. 1690, 1903; J. Krafft and L. Bergfeld, *ib.*, 38. 254, 1905; C. J. Hansen, *ib.*, 42. 210, 1909; J. A. M. van Liempt, *ib.*, 114. 105, 1920; A. Henglein, *Zeit. Elektrochem.*, 26. 431, 1920; T. Turner, *Proc. Roy. Soc.*, 81. A, 301, 1908; H. C. Greenwood, *ib.*, 82. A, 396, 1909; 83. A, 483, 1910; *Zeit. phys. Chem.*, 76. 484, 1911; H. von Wartenberg, *Zeit. Elektrochem.*, 19. 485, 1913; *Zeit. anorg. Chem.*, 56. 335, 1907; E. Tiede and E. Birnbräuer, *ib.*, 87. 129, 1914; O. Ruff and B. Bergdahl, *ib.*, 106. 76, 1919; M. Knudsen, *Ann. Physik*, (4), 50. 472, 1916.

¹⁶ J. Pionchon, *Compt. Rend.*, 103. 1122, 1881; *Ann. Chim. Phys.*, (6), 11. 106, 1887; G. G. Person, *ib.*, (3), 24. 36, 156, 1848; *Pogg. Ann.*, 75. 462, 1848; H. Buff, *ib.*, 145. 626, 1872; W. Ledebur, *Metallarbeiter*, 202, 1881; J. W. Richards, *Metalurgical Calculations*, New York, 1. 70, 1906; 3. 588, 1908; H. von Wartenberg, *Zeit. Elektrochem.*, 19. 485, 1913; H. C. Greenwood, *Zeit. phys. Chem.*, 76. 484, 1911; R. de Forcrand, *Compt. Rend.*, 156. 1648, 1913; F. Wüst, A. Meuthen, and R. Durrer, *Zeit. Instrumentenk.*, 39. 294, 1919; J. A. M. van Liempt, *Zeit. anorg. Chem.*, 114. 105, 1920.

¹⁷ E. Hagen and H. Rubens, *Ber. deut. phys. Ges.*, 6. 710, 1910; *Phys. Zeit.*, 9. 874, 1908; *Sitzber. Akad. Berlin*, 478, 1909; *Ann. Physik*, (4), 1. 352, 1900; (4), 8. 1, 1902; (4), 11. 873, 1903; R. S. Minor, *ib.*, (4), 10. 581, 1903; K. Försterling and V. Fréedriczsk, *ib.*, (4), 40. 210, 1913; W. Meier, *ib.*, (4), 31. 1043, 1910; C. Statescu, *ib.*, (4), 33. 1032, 1910; C. Grimm, *ib.*, (4), 5. 478, 1901; P. Drude, *Wied. Ann.*, 39. 481, 1890; 64. 159, 1898; 42. 186, 1891; D. Shea, *ib.*, 47. 177, 1892; H. Knoblauch, *ib.*, 24. 260, 1885; A. Pfüger, *ib.*, 58. 495, 1896; W. Voigt, *ib.*, 23. 142, 1884; H. Rubens, *ib.*, 37. 249, 1889; A. Kundt, *ib.*, 34. 469, 1888; *Sitzber. Akad. Berlin*, 255, 1888; G. Quincke, *Pogg. Ann.*, 128. 541, 1866; J. Conroy, *Proc. Roy. Soc.*, 28

242, 1879; 31. 486, 1881; L. P. Wheeler, *Phil. Mag.*, (6), 22. 229, 1911; J. C. Jamin, *Ann. Chim. Phys.*, (3), 22. 311, 1848; L. R. Ingersoll, *Astrophys. Journ.*, 32. 265, 1910; H. L. Barvir, *Sitzber. Böhm. Ges.*, 2, 1906; A. Beer, *Pogg. Ann.*, 92. 417, 1834; J. Kanonnikoff, *Ber.*, 17. 157, 1884; W. Wernicke, *Pogg. Ann. Ergb.*, 8. 65, 1876; A. L. Bernoulli, *Zeit. Elektrochem.*, 15. 647, 1909; F. Schön, *Zeit. wiss. Phot.*, 5. 349, 1907; K. Schäfer, *ib.*, 8. 212, 257, 1910; W. W. Coblenz, *Bull. Bur. Standards*, 2. 471, 1906; C. M. Stubbs, *Proc. Roy. Soc.*, 88. A, 195, 1913; O. Stuhlmann, *Phil. Mag.*, (6), 22. 854, 1911; R. A. Millikan and G. Winchester, *ib.*, (6), 12. 558, 1903; W. Ramsay and J. F. Spencer, *ib.*, (6), 12. 397, 1906; K. Herrmann, *Beiträge zum Hallwachsseffekt*, Berlin, 1908; E. Ladenburg, *Ann. Physik*, (6), 12. 558, 1903; J. H. Gladstone, *Phil. Trans.*, 159. 13, 1869; G. K. Burgess and R. G. Waltenberg, *Phys. Rev.*, (2), 4. 546, 1914; C. Zakrzewsky, *Anz. Akad. Cracow*, 849, 1912; N. Gaili and K. Försterling, *Nachr. Gött.*, 58, 1911; W. Hallwachs, *Tagbd. Heid. Nat. Bcr.*, 24, 1890; P. Desains, *Compt. Rend.*, 74. 1102, 1185, 1896; J. Violle, *ib.*, 141. 1185, 1906; G. Reboul, *ib.*, 158. 477, 1914; W. Rathenau, *Die Absorption des Lichts in Metallen*, Berlin, 1889; R. Sissingh, *Mémoires de l'Académie des sciences de l'Institut des Pays-Bas*, 1892; F. Henning, *Jahrb. Rad. Electron.*, 17. 30, 1920; B. Pogany, *Ann. Physik*, (4), 64. 196, 1921; M. Faraday, *Phil. Trans.*, 147. 137, 1857; I. C. Gardner, *Astrophys. Journ.*, 45. 1, 1917; W. Frese, *Zeit. wiss. Photochem.*, 21. 37, 1921.

¹⁸ G. D. Liveing and J. Dewar, *Chem. News*, 47. 121, 1883; *Proc. Roy. Soc.*, 35. 71, 1883; J. N. Lockyer and W. C. Roberts-Austen, *ib.*, 23. 344, 1875; W. N. Hartley and W. E. Adeney, *ib.* 35. 148, 1883; W. N. Hartley and H. W. Moss, *ib.*, 87. A, 38, 1912; W. G. Duffield, *ib.*, 84. A, 118, 1910; W. N. Hartley, *ib.*, 79. A, 242, 1907; *Journ. Chem. Soc.*, 41. 84, 1882; H. Konen and H. Finger, *Zeit. Elektrochem.*, 15. 166, 1909; W. D. Bancroft and I. B. Weiser, *Journ. Phys. Chem.*, 18. 255, 1914; M. A. Catalan, *Anal. Soc. Espan. Fis. Quim.*, 15. 432, 438, 483, 1917; J. C. McLennan, J. F. T. Young, H. J. C. Ireton, *Proc. Roy. Soc.*, 98. A, 98, 1920; L. and E. Bloch, *Compt. Rend.*, 170. 320, 1920; B. de la Roche, *Bull. Soc. Chim.*, (4), 25. 305, 1919; J. R. Rydberg, *Svensk. Vet. Akad. Handl.*, 23. 11, 1890; C. C. Hutchins and E. L. Holden, *Amer. Journ. Science*, (3), 34. 451, 1887; *Phil. Mag.*, (5), 24. 325, 1887; V. Kohlschütter and E. Fischmann, *Liebigs Ann.*, 387. 125, 1912; J. Meunier, *ib.*, 152. 1760, 1911; L. Houllevigue, *ib.*, 149. 1368, 1909; A. Cornu, *ib.*, (4), 42. 237, 1871; *Compt. Rend.*, 73. 322, 1871; A. C. Becquerel, *ib.*, 97. 71, 1883; 99. 374, 1884; A. de Gramont, *ib.*, 144. 1101, 1907; 147. 307, 1908; 150. 308, 1910; *Bull. Soc. Min.*, 18. 212, 1895; R. Thalen, *Nova Acta Upsala*, 6, 1868; H. Kayser and C. Runge, *Wied. Ann.*, 46. 225, 1892; N. Gaili and K. Försterling, *Nachr. Gött.*, 67, 1911; J. M. Eder and E. Valenta, *Sitzber. Akad. Wien*, 118. 1091, 1909; J. M. Eder, *ib.*, 122. 625, 1913; W. Schuler, *Ann. Physik*, (4), 5. 931, 1901; H. M. Randall, *ib.*, (4), 33. 739, 1910; L. Janicki, *ib.*, (4), 29. 833, 1909; H. Lehmann, *ib.*, (4), 39. 75, 1912; E. P. Lewis, *Astrophys. Journ.*, 2. 1, 1895; R. A. Millikan, *ib.*, 52. 47, 1920; M. de Broglie and A. Dauvillier, *Compt. Rend.*, 171. 626, 1920; C. Fabry and A. Perot, *Ann. Chim. Phys.*, (7), 25. 91, 1902; (8), 1. 5, 1904; H. Köemann, *Zeit. wiss. Phot.*, 12. 65, 1913; F. J. Kasper, *ib.*, 10. 53, 1911; H. Oellers, *ib.*, 10. 374, 1912; H. Finger, *ib.*, 7. 329, 1909; W. Happers, *ib.*, 13. 46, 1914; F. L. Wagner, *ib.*, 10. 69, 1912; W. M. Hicks, *Phil. Mag.*, (6), 38. 1, 301, 1919; (6), 39. 457, 1920; *Phil. Trans.*, 217. A, 374, 1918; R. A. Millikan, *Proc. Nat. Acad. Sciences*, 7. 289, 1921; F. M. Walters, *Scient. Paper Bur. Standards*, 17. 161, 1921; B. E. Moore, *Astrophys. Journ.*, 54. 246, 1921; J. Frings, *ib.*, 15. 165, 1915; W. Happers, *ib.*, 13. 51, 1914; F. L. Wager, *ib.*, 10. 69, 1912; J. M. Eder, *ib.*, 13. 20, 1913; 14. 137, 1914; A. Fowler, *Report on Series in Line Spectra*, London, 111, 1922.

¹⁹ N. R. Campbell, *Phil. Mag.*, (6), 11. 206, 1906; C. W. Richardson and H. L. Cooke, *ib.*, (6), 21. 404, 1911; C. G. Barkla and A. J. Philpot, (6), 25. 832, 1913; E. Marsden and H. Richardson, *ib.*, (6), 25. 184, 1913; W. H. Bragg, *ib.*, (6), 11. 617, 1906; J. Crowther, *ib.*, (6), 12. 379, 1906; J. Chadwick, *ib.*, (6), 40. 734, 1920; H. R. von Traubenberg, *Zeit. Physik*, 2. 268, 1920; R. T. Beatty, *Proc. Cambridge Phil. Soc.*, 15. 416, 1910; R. Widdington, *ib.*, 17. 280, 1913; C. W. G. Kaye, *ib.*, 14. 236, 1907; J. C. Chapman, *Proc. Roy. Soc.*, 88. A, 24, 1913; P. D. Innes, *ib.*, 79. A, 442, 1907; J. A. Gray, *ib.*, 85. A, 131, 1911; 87. A, 89, 1912; W. P. Davey, *Journ. Franklin Inst.*, 171. 277, 1911; F. C. Miller, *ib.*, 171. 457, 1911; B. Walter, *Ann. Physik*, (4), 17. 561, 1905; W. Seitz, *ib.*, (4), 27. 301, 1908; W. Kaufmann, *Phys. Zeit.*, 14. 387, 1913; L. Meitner, *ib.*, 8. 489, 1907; C. D. Cooksey, *Amer. Journ. Science*, (4), 21. 285, 1907; L. Wertenstein, *Compt. Rend.*, 151. 469, 1910; F. K. Richtmyer, *Phys. Rev.*, (2), 18. 13, 1921; M. N. Saha, *Nature*, 107. 682, 1921; E. Hjalmar, *Zeit. Physik*, 7. 341, 1921.

²⁰ G. Wiedemann and R. Franz, *Pogg. Ann.*, 89. 497, 1853; W. Siemens, *ib.*, 110. 1, 1860; H. F. Lenz, *ib.*, 34. 418, 1835; 34. 105, 1858; A. Matthiessen and M. von Bose, *ib.*, 115. 353, 1862; A. Matthiessen, *ib.*, 103. 428, 1858; 110. 222, 1860; *Phil. Mag.*, (4), 21. 107, 1861; J. Dewar and J. A. Fleming, *ib.*, (5), 36. 271, 1893; W. Jäger and H. Diesselhorst, *Phys. Tech. Reichsanst.*, 3. 269, 1900; L. Cailletet and E. Bouty, *Compt. Rend.*, 100. 1188, 1885; A. Berget, *ib.*, 110. 76, 1890; W. Broniewski, *ib.*, 150. 1758, 1910; R. Benoit, *ib.*, 76. 342, 1873; *Phil. Mag.*, (4), 45. 314, 1873; V. Strouhal and C. Barus, *Abh. Böhm. Ges.*, 12. 15, 1884; H. F. Weber, *Sitzber. Akad. Berlin*, 457, 1880; P. W. Bridgman, *Proc. Amer. Acad.*, 52. 573, 1917; *Phys. Rev.*, (2), 9. 269, 1917; G. F. Fitzpatrick, *B. A. Rep.*, 131, 1894; W. H. Preece, *ib.*, 206, 1887; H. K. Onnes, *Versl. Akad. Amsterdam*, 19. 1187, 1911; *Comm. Phys. Lab. Leiden*, 10. 119, 1920, 1911; H. Ihle, *Jahrb. Gymn. Dresden-Neustadt*, 22. 3, 1896; G. Poloni, *Rend. Ist. Lombardi*, (2), 15. 15, 1882; G. Nicolai, *Atti Accad. Lincei*, (5), 16. 1, 757, 906, 1907; A. L. Bernoulli, *Zeit. Elektrochem.*, 15. 647, 1909; V. Kohlschütter and E. Fischmann, *Liebigs Ann.*, 387. 131,

1912; V. Kohlschütter and A. Noll, *Zeit. Elektrochem.*, 18. 419, 1912; E. Lax, *Ueber die Aenderung des Widerstandes in Drähten durch Dehnung*, Berlin, 1919; L. Holborn, *Ann. Physik*, (4), 59. 14, 1919; *Zeit. Physik*, 8. 58, 1921; G. W. A. Kahlbaum and E. Sturm, *Zeit. anorg. Chem.*, 46. 217, 1905; E. F. Northrup, *Journ. Franklin Inst.*, 178. 85, 1914; F. Auerbach, *Wied. Ann.*, 28. 604, 1886; G. Szivessy, *Ann. Physik*, (4), 23. 963, 1907; E. Lisell, *Om tryckets inflytande på det elektriska ledningsmotståndet hos metaller samt en ny metod att mäta höga tryck*, Upsala, 1902; F. Credner, *Zeit. phys. Chem.*, 82. 457, 1913; H. Hörig, *Phys. Zeit.*, 14. 446, 1913; K. P. Brooks, *ib.*, 11. 473, 1910; L. Grunmach and F. Weidert, *ib.*, 7. 729, 1906; *Ber. deut. phys. Ges.*, 4. 359, 1907; S. Pienkowsky, *Bull. Acad. Belgique*, 603, 1911; A. C. Becquerel, *Ann. Chim. Phys.*, (2), 32. 428, 1828; E. Becquerel, *ib.*, (3), 17. 261, 1846; A. Sieverts, *Internat. Zeit. Metallg.*, 3. 37, 1912; L. Weiller, *Zentr. Ztg. Opt. Mech.*, 6. 28, 1885; C. Onestig, *Nuovo Cimento*, (3), 16. 58, 1884; P. Cohn, *Wied. Ann.*, 41. 71, 1890; A. L. Feild, *Met. Chem. Eng.*, 21. 566, 1919; S. Weber and E. Vosterhuis, *Proc. Acad. Amsterdam*, 19. 597, 1917; P. W. Bridgman, *Proc. Nat. Acad. Sciences*, 7. 299, 1921.

²¹ C. E. Fawsitt, *Proc. Roy. Soc. Edin.*, 26. 2, 1906; *Journ. Soc. Chem. Ind.*, 25. 1133, 1907; G. Carrara and L. d'Agostini, *Gazz. Chim. Ital.*, 35. i, 132, 1905; G. von Hevesy, *ib.*, 18. 546, 1912; F. Förster, *ib.*, 13. 561, 1907; P. Bechtereff, *ib.*, 17. 860, 1911; *Proc. Polyt. Inst. St. Petersburg*, 15. 433, 1911; M. le Blanc, *Zeit. Elektrochem.*, 16. 33, 1910; G. Grube, *ib.*, 8. 193, 1912; A. Thiel, *ib.*, 7. 305, 1901; S. B. Christy, *Amer. Chem. Journ.*, 37. 345, 1902; F. M. G. Johnson and N. T. M. Wilmore, *Trans. Faraday Soc.*, 3. 77, 1907; A. Jaques, *ib.*, 5. 212, 1910; A. A. Noyes and B. F. Brann, *Journ. Amer. Chem. Soc.*, 34. 1016, 1912; G. N. Lewis, *ib.*, 28. 158, 1906; G. Gore, *Proc. Roy. Soc.*, 30. 32, 1720; C. R. A. Wright and C. Thompson, *Phil. Mag.*, (5), 19. 1, 102, 197, 1885; H. J. S. Sand, *ib.*, (6), 9. 20, 1905; W. Winter, *Phys. Zeit.*, 14. 823, 1913; O. Sackur, *Zeit. Elektrochem.*, 11. 387, 1905; *Zeit. phys. Chem.*, 83. 311, 1913; J. Neustadt and R. Abegg, *ib.*, 69. 486, 1909; F. Haber and J. Zawadzky, *ib.*, 78. 228, 1911; J. Tafel, *ib.*, 50. 641, 1905; N. Isgarisheff, *Chem. Ztg.*, 37. 652, 1913; *Zeit. Elektrochem.*, 18. 572, 1912; R. Beutner, *ib.*, 15. 433, 1909; *Neue galvanische Elemente*, Karlsruhe, 1908; L. Kahlenberg, *Journ. Phys. Chem.*, 3. 379, 1899; *Trans. Amer. Electrochem. Soc.*, 6. 61, 1904; V. Kohlschütter and E. Eydmann, *Liebig's Ann.*, 398. 27, 1913; V. Kohlschütter and E. Fischmann, *ib.*, 387. 130, 1912; W. Meier, *Ann. Physik*, (4), 31. 1049, 1910; F. Haber, *ib.*, (4), 26. 947, 1908; R. Kremann and F. Noss, *Monatsh.*, 34. 7, 1913; L. Poincaré, *Compt. Rend.*, 110. 950, 1890; P. Dutoit, *Bull. Soc. Chim.*, (4), 7. 1, 1910; R. Luther and F. Pokorny, *Zeit. anorg. Chem.*, 57. 310, 1908; P. Walden, *ib.*, 113. 113, 125, 1920; S. Kyropoulos, *ib.*, 114. 157, 1920; F. W. Küster and A. Thiel, *ib.*, 23. 25, 1900; A. Lapworth and J. R. Partington, *Journ. Chem. Soc.*, 99. 1417, 1911; S. Lindeck, *Wied. Ann.*, 35. 311, 1888; H. Jahn, *ib.*, 34. 755, 1888; A. Overbeck, *ib.*, 21. 139, 1884; E. Pirani, *ib.*, 21. 64, 1884; F. Streintz, *ib.*, 17. 841, 1882; 32. 116, 1887; *Sitzber. Akad. Wien*, 86. 216, 1882; F. Exner and J. Tuma, *ib.*, 97. 917, 1888; *Monatsh.*, 9. 903, 1888; W. Wolff, *Ueber Sauerstoffzellen*, Freiberg, 1888; G. Trümpler, *Zeit. phys. Chem.*, 99. 9, 1921; V. Kohlschütter and H. Stäzer, *Helvetica Chem. Acta*, 4. 821, 1921; G. Magnanini, *Rend. Accad. Lincei*, (4), 6. 182, 1890; *Gazz. Chim. Ital.*, 20. 308, 1890; U. Sborgi and A. Donati, *Nuovo Cimento*, (6), 21. 211, 1921; F. Jirsa, *Zeit. Elektrochem.*, 25. 146, 1919; I. M. Kolthoff, *Zeit. anorg. Chem.*, 119. 202, 1921; W. P. Davey, *Phys. Rev.*, (2), 19. 248, 1922.

²² L. Holborn and A. L. Day, *Sitzber. Akad. Berlin*, 691, 1899; *Ann. Physik*, (4), 2. 505, 1900; A. L. Bernoulli, *ib.*, (4), 33. 701, 1910; E. Sedström, *ib.*, (4), 59. 134, 1919; W. W. Coblenz, *Journ. Franklin Inst.*, 172. 559, 1911; W. Jäger and H. Diesselhorst, *Phys. Tech. Reichsanst.*, 3. 269, 1900; G. T. Bellby, *Proc. Roy. Soc.*, 79. A, 463, 1907; J. Dewar and J. A. Fleming, *Phil. Mag.*, (5), 40. 95, 1895; W. H. Steele, *ib.*, (5), 37. 218, 1894; K. Noll, *Wied. Ann.*, 53. 874, 1894; G. von Hevesy and E. Wolff, *Phys. Zeit.*, 11. 473, 1910; N. A. Gesehad, *Journ. Russ. Phys. Chem. Soc.*, 39. 1, 1907; B. Rosing, *ib.*, 30. 151, 1898; E. Lecher, *Sitzber. Akad. Wien*, 114. 1, 1905; P. W. Bridgman, *Proc. Amer. Acad.*, 53. 269, 1918; E. Wagner, *Ann. Physik*, (4), 27. 955, 1908; O. Sackur, *Zeit. phys. Chem.*, 83. 311, 1913; H. Jahn, *Wied. Ann.*, 34. 755, 1888; J. Monckman, *Proc. Roy. Soc.*, 44. 220, 1888; G. Borelius and F. Gunneson, *Ann. Physik*, (4), 65. 520, 1921; A. Cöhn and A. Lotz, *Zeit. Physik*, 5. 242, 1921.

²³ A. Günther-Schulze, *Ann. Physik*, (4), 26. 372, 1908; *Trans. Faraday Soc.*, 9. 266, 1913; F. J. Kasper, *Zeit. wiss. Phot.*, 10. 53, 1911; D. Roschansky, *Phys. Zeit.*, 11. 1177, 1910; E. Täge, *ib.*, 14. 1041, 1913; E. Weiss, *ib.*, 12. 630, 1911; F. Ehrenheft, *ib.*, 10. 308, 1909; 11. 619, 1910.

²⁴ F. W. Aston, *Proc. Roy. Soc.*, 87. A, 437, 1912; W. G. Duffield, T. H. Burnham, and A. H. Davis, *ib.*, 97. A, 326, 1920; W. Crookes, *ib.*, 50. 88, 1891; *Chem. News*, 63. 289, 1891; H. B. Williams, *Phys. Rev.*, (2), 2. 402, 1913; V. Kohlschütter and T. Goldschmidt, *Zeit. Elektrochem.*, 14. 221, 1908; F. Fischer and O. Hähnel, *ib.*, 14. 367, 433, 1908; V. Kohlschütter, *ib.*, 14. 417, 437, 1908; F. Fischer and F. Schröter, *Ber.*, 43. 1454, 1910; E. Weiss, *Phys. Zeit.*, 12. 630, 1911; F. Ehrenheft, *ib.*, 11. 619, 1910; V. L. Chrisler, *Astrophys. Journ.*, 54. 273, 1921.

²⁵ S. Meyer, *Wied. Ann.*, 68. 325, 1899; *Ann. Physik*, (4), 1. 664, 1900; K. Honda, *ib.*, (4), 32. 1027, 1910; M. Owen, *ib.*, (4), 37. 657, 1912; J. Königsberger, *ib.*, (4), 6. 506, 1901; *Wied. Ann.*, 66. 698, 1898; J. A. Fleming and J. Dewar, *Proc. Roy. Soc.*, 60. 283, 1896; 63. 311, 1898; C. Chéneveau, *Journ. Phys.*, 9. 163, 1910; P. Joubin, *Compt. Rend.*, 112. 93, 1891; M. Faraday, *Phil. Trans.*, 135. 1, 1846; W. Gerlach and O. Stern, *Zeit. Physik*, 8. 110, 1921; O. Stern, *ib.*, 7. 249, 1921.

§ 7. The Chemical Properties of Silver

Exposure to dry or moist air has no effect on silver if the air be free from extraneous constituents—ozone, hydrogen sulphide, etc.—which do attack the metal. Silver is not attacked by moist or dry oxygen at ordinary temp. and press., but J. L. Proust¹ early succeeded in oxidizing silver with the mouth-blowpipe. H. le Chatelier also found that at press. exceeding 15 atm., the metal is distinctly oxidized at about 300°; and, according to W. Manchot, silver is covered with a very thin film of oxide if it be heated to 200° in air. H. St. C. Deville and H. Debray, and L. Troost and P. Hautefeuille found that a mixture of silver oxide and silver is obtained when silver vapour, obtained by heating silver in the oxyhydrogen blowpipe, is rapidly cooled in air; the former also reported the presence of silver oxide in the condensed fumes from blast furnaces working *plomb argentifère*. H. von Wartenberg explained the more ready volatilization of silver in oxygen than in nitrogen by assuming the formation in oxygen of the more volatile silver oxide which can be detected in the condensed material. V. Kohlschütter and A. Noll found that silver disintegrated at the cathode in a tube containing oxygen or air at a low press., contains some silver oxide. It is also said that when silver is deflagrated by the electric discharge in air, the brown product which condenses from the vapour contains silver oxide. W. G. Duffield observed the formation of silver oxide by producing an electric light arc between silver electrodes. The oxide appeared as a black growth on a third cathode negatively charged to 50 volts and placed about 2 mm. above the horizontal arc.

It has long been known that when silver is melted in air, the metal is liable to spit and splutter during solidification. Suetonius, a Roman historian of the first century, referred to the blistered surface of silver, which has been melted in air, as *argentum pustulatum*. The cause of the **spitting of silver** was established by S. Lucas in 1819. He showed that the phenomenon was due to the absorption of oxygen when the molten metal is exposed to air, or to oxidizing substances like "some of the nitrates," and the subsequent evolution of the absorbed gas as the metal is quickly or slowly cooled. He stated that when silver, which has been melted in air so as to acquire oxygen, is left to cool gradually, for five minutes or longer, protuberances like miniature volcanic cones are thrown up here and there over the surface of the metal; if cooled rapidly, by being poured into water, the same phenomenon occurs, but the protuberances are smaller, and spread more equally over the surface. He collected a sample of the gas given off by the metal cooling under water, and John Dalton's analysis showed that it contained .86 or .87 per cent. of oxygen. In spite of precautions, some air must have been also collected with the oxygen. S. Lucas further ascertained that substances having a powerful affinity for oxygen, abstracted that gas from molten silver; for example, by spreading charcoal for a few moments on the surface of the metal, the whole of the oxygen was removed, and there was no emission of gas during the cooling—whether slowly or quickly conducted.

P. F. Chevillot showed that every gram of silver melted in air gave off, on solidification, 0.975 c.c. of oxygen; and J. L. Gay Lussac, that silver which had been melted under nitre gave off under the same conditions 22 times its volume of gas. H. Rose found that if silver be melted under a layer of potassium or sodium chloride, the metal solidifies with a bright surface, showing that oxygen had not been absorbed and afterwards emitted. If potassium or sodium nitrate be mixed with the saline covering later, spitting occurs. The silver obtained by the reduction of the chloride by fusion with sodium carbonate does not spit even though oxygen is evolved during the reduction: $4\text{AgCl} + 2\text{K}_2\text{CO}_3 = 4\text{Ag} + 4\text{KCl} + 2\text{CO}_2 + \text{O}_2$. The non-spitting of the silver is due to the evolution of the oxygen before the silver has melted. For the same reason, potassium chlorate does not cause spitting, while potassium chromate does; nor does silver spit when fused under a mixture

of sodium chloride and manganese dioxide. A. Sieverts and J. Hagenacker measured the amount of oxygen absorbed by two grams of silver at different temp. and found :

Temp.	923°	973°	1024°	1075°	1125°
Oxygen occluded	0.56	21.35	20.56	19.39	18.49 c.c.

The volume of oxygen was here reduced to 0° and 760 mm. press. The results computed for the volume of oxygen absorbed per unit volume of silver are plotted in Fig. 9.

J. W. Russell and A. Matthiessen, and C. T. Heycock and F. H. Neville found that hydrogen, nitrogen, carbon dioxide, and carbon monoxide do not cause spitting when bubbled through the molten silver; but the contrary is the case with oxygen and air. P. Hautefeuille and A. Perrey found that the metal spits if fused in an atm. of phosphorus vapour, and to a less extent in arsenic vapour. P. F. Chevillot found that silver with more than 15 per cent. of copper did not spit; J. L. Gay Lussac said that 5 per cent. of copper is effective, presumably because the copper unites with the oxygen which the silver absorbed. A. Levol found silver with one-third its weight of gold spits, but when the alloy has less silver than gold the phenomenon does not take place.

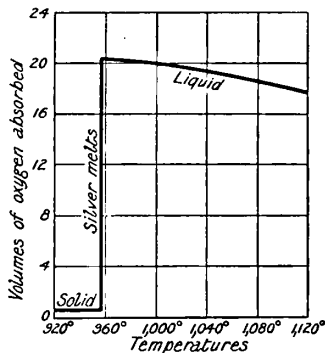

FIG. 9.—The Solubility of Oxygen in Silver.

Not all the absorbed oxygen is given off on freezing; a little oxygen is retained by the solid, and it can be abstracted by heating the metal to 400° or 500° in vacuo. In this way B. Brauner obtained 0.347 c.c. of oxygen from 100 grms. of the metal heated a little over 450°. J. B. A. Dumas suggested that in J. S. Stas' at. wt. determinations, the silver must have contained occluded oxygen because the metal was melted with borax and nitre, but J. S. Stas always heated the silver to a dull redness before a weighing was made, and the greater part of the occluded oxygen would thus be expelled. J. S. Stas' results have been examined in the light of these facts by L. Meyer and K. Seubert, J. van der Plaats, etc.

From experiments on the action of oxygen on silver, made by C. F. Plattner, in 1856, he concluded that at ordinary temp. solid silver has very little affinity for oxygen, but at a moderately high temp. silver is oxidized by gaseous oxygen, and the silver oxide which is formed at that temp. is volatile, while at a lower temp. the oxide is resolved into silver and oxygen. He further added that the phenomenon of spitting is due, not as generally believed to the simple absorption of uncombined oxygen and its subsequent liberation, but rather to the formation of silver oxide at a high temp., and its soln. in molten silver like that of cuprous oxide in molten copper; and to the subsequent resolution at a lower temp. into its elements—silver and oxygen.

There are three possible cases. The oxygen absorbed by the silver may be chemically combined with the metal, or dissolved either as diatomic molecules, O_2 , or monatomic molecules, O .

(1) If the gas be not chemically combined, and Henry's law of absorption be valid, the conc. of the dissolved oxygen will be proportional to the partial press. of this gas, provided the molecules have the same complexity in the liquid and gaseous states—*viz.* diatomic molecules. In that case, the partial press. of the free oxygen and the conc. C_{O_2} of the gas in soln. will be in equilibrium when $p = k_1 C_{O_2}$, where k_1 is a constant. Consequently, if the oxygen be in the same mol. state in soln. and gas, the ratio p/C_{O_2} will be a constant. This is not the case, and the hypothesis is therefore invalid.

(2) Next suppose that the dissolved gas is in the atomic condition, $O_2 \rightleftharpoons 2O$, by the law of mass action, $C_{O_2} = k_2 C_O^2$; but Henry's law is valid for the dissolved

diatomic molecules of oxygen, $p=k_1C_{O_2}$, or $p=kC_{O_2}^2$, where k is a constant eq. to the product k_1k_2 . Consequently if most of the dissolved oxygen is in the monatomic condition, its conc. C_0 will be proportional to the square root of the press. of the oxygen gas, or $C_0=k\sqrt{p}$, or the ratio \sqrt{p}/C_0 is constant. This is what A. Sieverts and J. Hagenacker actually observed within the limits of experimental error. Let p denote the partial press. of the oxygen in mm. of mercury; and C the number of c.c. of oxygen reduced to normal temp. and press., absorbed by 10·87 grms. of silver at 1075° :

$p =$	1203	760	488	346	209	150	39
$C =$	26·91	21·01	17·02	14·53	11·75	10·09	4·75
$\sqrt{p}/C =$	1·29	1·31	1·30	1·28	1·23	1·21	1·31

The constancy of the ratio \sqrt{p}/C is thus in agreement with the assumption that the dissolved gas is in the atomic condition; and the inconstancy of the ratio p/C is not in agreement with the assumption that the dissolved gas is in the same mol. state, O_2 , as the gas.

(3) If the oxygen in the molten metal is mainly in the form of oxide, Ag_2O , the equilibrium relations in the molten silver are $Ag_2O=2Ag+O$; and $O_2\rightleftharpoons 2O$; and for the small amount of mol. oxygen in the soln., by Henry's law, $p=k_1C_{O_2}$, as before, exactly the same result is obtained, namely, $C_0=k\times\sqrt{p}$. Consequently, as F. G. Donnan and T. W. A. Shaw have emphasized, measurements of the partial press. of the oxygen will not distinguish between dissolved oxygen in the atomic condition and oxygen chemically combined with the silver as Ag_2O . According to the latter hypothesis, silver melted in air or oxygen is a dil. soln. of silver oxide, and is accordingly stable in spite of the great dissociation press. of the oxide. As the metal solidifies, the silver oxide, virtually insoluble in solid silver, is rejected from the soln., and dissociates explosively causing the mass to splutter. The experimental evidence does not here answer the question: Is the dissolved oxygen in soln. as silver oxide, Ag_2O , or as free atomic oxygen? F. G. Donnan and T. W. A. Shaw add:

It is interesting to compare the solubilities of oxygen in molten copper, silver, and gold. In the case of copper the solid oxide Cu_2O can separate from the soln., since the dissociation press. of Cu_2O at the m.p. of copper is quite low. In the case of silver the solid phase Ag_2O cannot separate owing to its very great oxygen dissociation-press., although Ag_2O can probably exist in dil. soln. in molten silver. Finally, in the case of gold the affinity between this metal and oxygen has become so low that even a very dil. soln. of oxide of gold in molten gold would correspond to an oxygen press. many times greater than that of the atm. This comparison may perhaps lend some support to the view that the oxygen present in molten silver exists as dissolved silver monoxide.

According to T. Graham, silver can occlude 0·745 vol. of oxygen, which, "like the hydrogen in palladium, is permanently fixed in the metal at all temp. below an incipient red heat. It does not tarnish the bright metal surface of the silver, or produce any appearance suggestive of the oxidation of the metal." T. Graham found that a piece of silver wire absorbed 0·211 vol. of hydrogen at a red heat; G. P. Baxter, that fritted silver, reduced from the oxide, occluded very little hydrogen; G. Neumann and F. Streintz, and A. Sieverts and co-workers, that none was absorbd. M. Berthelot observed that silver heated to redness in a stream of hydrogen shows some signs of disintegration to dust. H. le Chatelier found that hydrogen is absorbed by silver at about 600°, and rejected about 30° from the m.p. The absorption of hydrogen by silver has also been studied by T. W. Richards, C. Chabrier, and H. T. Calvert. According to H. Hartley, during the absorption of gases and their catalytic combustion on a surface of silver, the metal acquires a negative charge. V. L. Chrisler, and W. Heald found that hydrogen is rapidly absorbed by a silver electrode when an electrical discharge passes through the attenuated gas. T. Graham also found a specimen of what he called "fritted silver" to occlude 0·938 vol. of hydrogen, 0·545 vol. of carbon dioxide, and 0·156 vol. of carbon

monoxide, but he remarks that this sample occluded hydrogen and carbon dioxide in larger proportions than former specimens he had examined. In another sample of silver he found 1.37 vols. of carbon dioxide, 0.20 vol. of **nitrogen**, and 0.04 vol. of carbon dioxide. P. A. Guye and F. E. E. Germann found hydrogen to be practically insoluble in silver, while carbon monoxide is appreciably soluble. A. Sieverts and M. Berthelot could detect no change when silver is heated in an atm. of nitrogen. A. Sieverts and E. Bergner found that **argon** is not absorbed by silver at 1120°. Red-hot silver is permeable to oxygen, but only traces of nitrogen, carbon dioxide, or carbon monoxide can pass through the metal. P. A. Guye, and G. P. Baxter and co-workers have measured the occlusion of gases by silver. The last-named found crude silver occluded 0.006 per cent. and refined silver 0.00063 per cent. under ordinary conditions. H. von Euler and A. H. Hedalius studied the adsorption of silver nitrate and potassium chloride from aq. soln. of these salts, by very finely divided silver.

C. Chabrier, and M. Berthelot² have discussed the possibility of forming a silver hydride, AgH. E. J. Bartlett and W. F. Rice added an excess of dil. hypophosphorous acid to a dil. soln. of silver nitrate, and obtained first a red and then a black soln. which could be filtered unchanged. The black soln. flocculated when allowed to stand a few minutes; the product was washed and dried to a constant weight at 60°. It has been suggested that the black residue is silver hydride because it loses from 0.53 to 0.96 per cent. when ignited—for silver hydride, AgH, the theoretical loss is 0.94 per cent. The alleged compound is not decomposed by water, and in the presence of hypophosphorous acid it gives no hydrogen. The evidence as to the individuality of the alleged hydride is very feeble. A. Sieverts and F. Lössner say that if the hypophosphorous acid is free from chlorine the precipitate is silver quite free from hydrogen.

C. F. Schönbein³ showed that silver reacts with **ozone**, forming a peroxide, but only when the gas is moist; and, according to H. Thiele, dried ozone has no action on the dry metal. If warm silver be allowed to cool while a stream of ozone impinges on the surface of the metal, a black film of silver oxide is produced. The maximum effect is obtained between 240° and 220°; there is no action at 450°—*vide* ozonc. According to R. J. Strutt, a single collision of an ozone molecule with silver suffices for its decomposition. Silver has a marked catalytic action on the decomposition of **hydrogen peroxide** (*q.v.*). O. P. Watts and N. D. Whipple studied the corrosion of silver by hydrochloric, perchloric, phosphoric, nitric, chromic, sulphuric, and acetic acids, by sodium hydroxide, and by a number of oxidizing agents—hydrogen peroxide; sodium arsenate and nitrate; ferric sulphate, and chloride; potassium dichromate, chlorate, permanganate, nitrate, bromide and iodide; and mercuric chloride.

Silver reduced by zinc from silver chloride retains water very tenaciously at 100°; and, according to A. Vogel,⁴ the water is only completely expelled by heating the metal to 210°. At ordinary temp. **water** has no perceptible action on silver either *en masse* or in a finely-divided state. M. Traube-Mengarini and G. Scala, K. Kahle, G. P. Merrill, and G. van Dijk, have reported that silver is slightly soluble in hot water; and that the solubility is rather smaller than copper and greater than platinum. A. Leduc, T. W. Richards, E. Collins, and G. W. Heimrod, and K. E. Guthe, showed that properly washed silver does not change at room temp. by a prolonged digestion with water. W. Skey stated that when silver is immersed in distilled water for a few hours, its surface is so modified that it will not amalgamate immediately afterwards; the effect was not produced by spring water or by rain water. The affected metal is again susceptible to amalgamation after it has been in contact with rain or spring water, a soln. of ferrous sulphate, acetic acid, or after it has been heated to 260°. W. Skey assumed that in distilled water oxide of silver is formed, and in spring water and rain water the oxide is converted to chloride. The chloride is readily amalgamated by mercury, and he assumes that the oxide is not, although F. J. Malaguti and J. Durocher say that silver oxide is easily reduced by mercury. According to H. V. Regnault, when steam is passed over silver at a

white heat, there is a notable disengagement of hydrogen; and, on subsequent cooling, the metal spits owing to the escape of the absorbed oxygen. In this experiment, H. St. C. Deville considers that the silver probably absorbed the oxygen gas from the products of the thermally decomposed steam.

H. Moissan⁵ observed that **fluorine** attacks silver very slowly in the cold; at 100°, the action is faster; and at a red heat, the action takes place with incandescence. R. Cowper found that dry **chlorine** has scarcely any action on dry silver, but if moisture be present silver chloride is formed without incandescence; and, according to V. von Cordier, the reaction is quicker in light than in darkness. J. S. Stas noted that chlorine water acts similarly. H. Gautier and G. Charpy also showed the reaction between dried chlorine or bromine and silver is very slow. The attack with chlorine is faster than with **bromine**. According to G. Reboul, dried chlorine, bromine, or iodine vapour attacks a piece of silver foil more vigorously where it has been bent than in the parts of less curvature. When silver is heated with **iodine**, silver iodide is formed. J. H. Kastle said that the reaction between chlorine, bromine, or iodine and finely-divided silver is quantitative. A. Galecky and L. Bruner found that when a soln. of bromine or iodine in nitrobenzene, not completely dried, is electrolyzed between silver electrodes, silver halide forms on the anode, and silver is deposited on the cathode. C. C. Perkins noted that iodine is removed from aq. soln. by finely-divided silver. According to R. G. van Name and G. Edgar, the rates of dissolution of mercury, cadmium, zinc, silver, and copper in aq. soln. of iodine and potassium iodide are nearly the same at 25°. L. Bruner and E. Bekin found that silver is rapidly attacked by **iodine chloride**, ICl, while **iodine bromide** attacks silver very little. G. Tammann has studied the formation of surface films by exposing the metal to iodine vapour, and obtained similar results as with copper (*q.v.*).

C. W. Scheele, and J. L. Gay Lussac and L. J. Thénard⁶ reported that aq. **hydrofluoric acid** does not act on silver. According to A. Jouniaux, dry hydrogen fluoride free from oxygen does not attack silver in light or darkness at ordinary temp. According to J. B. J. D. Boussingault, M. Berthelot, and A. Jouniaux, both **hydrogen chloride** and **hydrochloric acid** attack silver if air be simultaneously present. For the action of hydrogen chloride on silver, see silver chloride. According to J. L. Proust, when metallic silver is kept in hydrochloric acid, hydrogen is slowly evolved, and the reaction is more rapid if the acid be aerated. C. W. Scheele also showed that silver chloride is rapidly formed by the action of hydrochloric acid in the presence of various oxidizing substances such as manganese peroxide, arsenic acid, red lead, etc., and chlorine is at the same time evolved. N. W. Fischer also satisfied himself that silver does dissolve in hydrochloric acid and that the reaction is induced if another metal be present; indeed, M. Faraday and J. Stodart observed that in the analysis of their supposed alloy of silver and steel, the silver was attacked and dissolved by hydrochloric acid. G. Wetzlar, however, doubted whether the purified acid has any action on the purified metal. Silver derived by dissolving out the zinc from zinc-silver alloys by hydrochloric acid is stated by D. Palitsch to be an allotropic form of silver because it differs from ordinary silver in sp. gr., heat of soln. in mercury, and electrolytic potential. For the action of **hydrogen bromide** on silver, *vide* silver bromide; and for **hydrogen iodide**, *vide* silver iodide. M. Berthelot found silver is readily attacked by **hydrobromic acid** at ordinary temp., and the reaction is more marked than is the case with hydrochloric acid. **Hydriodic acid** is the most active of the halide acids. H. St. C. Deville and A. Potilitzin showed that the metal dissolves readily in the cold with the evolution of hydrogen, and when the acid is conc. the action is vigorous. The action continues until the liquid is sat. with silver iodide, and if the soln. be then heated the action is renewed. H. Dannecl showed that the reactions in soln. are reversible.

According to K. A. Winkler,⁷ silver easily decomposes **sodium chloride** at a red heat and with access of air, forming silver chloride, and this action is the more

pronounced the more finely divided the silver. H. Rose melted silver under common salt, so that air could get only a very limited access, and until the salt had in great part volatilized; the residue contained much silver chloride, and it was not in the least alkaline. He assumed that the sodium of the salt is evolved as sodium oxide or hydroxide, and that this combines with the clay of the crucible and is so removed from the sphere of the reaction, for, at the temp. of the experiment, sodium hydroxide readily reduces silver chloride to silver. The greater the heating the greater the loss of metal by conversion into chloride. He found that with coins containing copper the conversion was considerably reduced, and he stated that "copper prevents the formation of silver chloride and the consequent loss of silver." H. Rose also said that C. F. Plattner roasted a mixture of finely-divided silver and common salt with the addition of a large excess of cupric or ferric oxide, and found no more silver chloride was formed than without such addition.

According to G. Wetzlar,⁸ when silver is subject to an aq. soln. of sodium chloride with access of atm. air, silver chloride is formed, and the soln. acquires an alkaline reaction. H. St. C. Deville made a similar observation in 1859, for he found that silver dissolves with extreme rapidity though in small quantity in a conc. aq. soln. of sodium chloride, and the soln. turns red litmus blue owing to the formation of sodium hydroxide. In this way it is supposed that coins, etc., recovered from submerged wrecks, have been converted into silver chloride by long immersion in sea-water. Thus J. L. Proust found some silver piastres, recovered from a sunken Spanish ship after many years' immersion, had been almost wholly converted into chloride. Silver salt-cellars may become corroded by contact with table-salt, and in consequence such articles are sometimes gilded internally. J. Percy showed that "silver chloride is not formed when a soln. of sodium chloride is boiled in contact with silver, unless atm. oxygen has access."

Silver coins which have been long buried in the earth are almost always covered with a dark grey layer of soft silver chloride, *i.e.* horn silver, of varying thickness. If the silver contains a large proportion of copper, they show the green patina characteristic of bronzes. F. Rathgen, and A. Schertel say that there is a layer of silver subchloride, Ag_2Cl , between the surface layer of normal chloride and the metal, but this is probably a wrong inference. The outer layer of chloride can be removed by dissolution in ammonia-water, and a silver coin of Edward the Confessor's period is stated by J. Percy to have had the percentage composition:

Coin	AgCl	CuO	$3\text{Cu}(\text{OH})_2 \cdot \text{CuCl}_2$	Sulphates
88.36	10.50	0.73	0.41	trace

There is usually a layer in immediate contact with the metal consisting of cupric oxide, silver sulphide, gold (if the silver is auriferous), etc. The following is A. H. Church's analysis of the granular layer from an ancient tomb in Cyprus:

Ag	Au	Cu	Pb	Sb	As	Bi
94.69	0.41	3.43	0.28	0.21	trace	trace

Both the analyses of A. H. Church, and R. Warrington show that the composition of the unaltered ductile metal core is the same as that of the brittle granular layer; perhaps these facts are better expressed by saying that no difference in composition was revealed by the methods employed for the analysis. It was accordingly assumed that the change from the ductile to the brittle silver is purely physical, and is produced by "a molecular change, which in the course of ages had occurred throughout all the thinner parts of the piece of silver, but had left unchanged in the thickest part, a central fusiform core. A crypto-crystalline structure had been produced in the previously homogeneous alloy, which caused the peculiarly easy fracture of the metal." A. Schertel's explanation of the change is as follows:

The layer of chloride of silver shows plainly that the water percolating through the clay, and containing chlorides in soln., first changed the copper into cupric chloride, and that this formed, with the silver, argentous and cuprous chlorides. The cuprous chloride

was then reconverted into cupric chloride, and again attacked the silver. The clay surrounding the metal kept the liquid in contact with it for a long time; so that, with but little copper, much silver was converted into chloride. The clay retained the chloride of silver like a filter, so that a thick incrustation was formed upon the vessels.

M. Berthelot added :

Silver chloride is for the most part produced by the sodium chloride dissolved in subsoil water, which acts in conjunction with the oxygen and carbonic acid of the air : $4\text{Ag} + \text{O}_2 + 2(n+2)\text{NaCl} + \text{CO} = 2(2\text{AgCl} \cdot n\text{NaCl}) + 2\text{Na}_2\text{CO}_3$; but this reaction differs from that which takes place in the case of copper in that it does not proceed continuously except in the presence of a considerable quantity of salt-water, as, for instance, in the sea. In museums, the alteration goes no further than corresponds with the minute quantity of sodium chloride contained in the object. On the other hand, in an earth which contains salts, the continued presence of water can bring about a more or less marked change.

E. von Bibra adopted a similar explanation, and assumed that the reddish colour sometimes seen on silver near a fresh fracture is produced by cuprous oxide. The outer layer is also coloured reddish-brown either from the adhesion of minute quantities of earth, or from the products of the action of light on the silver chloride. There is no need to assume with A. Schertel that the presence of copper is a vital necessity, because, as J. Percy remarks, silver chloride alone can be formed under the conditions stated—*viz.*, the presence of atm. oxygen, and dissolved chlorides. This explanation does not include the layer of unattacked metal which has lost its malleability and toughness. A. Schertel did succeed in making a rolled silver coin brittle by digesting it six months in a soln. of sodium chloride, but, in this particular case, the brittleness was due to the abstraction of copper from the metal.

C. J. B. Karsten,⁹ and J. Percy found that, at a temp. between 12° and 20°, a soln. of **cupric chloride** alone reacts very slowly on silver : $\text{CuCl}_2 + \text{Ag} = \text{AgCl} + \text{CuCl}$, but the action is very rapid in the presence of sodium chloride. M. C. Lea prepared a purple photo chloride (colloidal silver) by the action of metallic silver on a soln. of cupric chloride. C. J. B. Karsten also reported that an ammoniacal soln. of cupric chloride does not act on silver. According to G. Wetzlar, metallic silver slowly reduces an aq. soln. of **ferric chloride** : $\text{FeCl}_3 + \text{Ag} = \text{FeCl}_2 + \text{AgCl}$, and J. J. Berzelius utilized the reaction in determining the relative proportions of ferric and ferrous oxides in substances soluble in hydrochloric acid. At a certain stage in the reduction of ferric chloride by silver, G. Wetzlar noted the formation of what he regarded as black silver subchloride which, by prolonged immersion in the soln. of iron chloride, is converted into white silver chloride. According to A. Vogel, and M. C. Lea, silver reduces an aq. soln. of **mercuric chloride** to mercurous and silver chlorides : $\text{Ag} + \text{HgCl}_2 = \text{HgCl} + \text{AgCl}$; C. Jones assumed a double salt, $\text{HgCl} \cdot \text{AgCl}$, is formed. According to G. Campani, if the action of finely-divided silver is allowed to continue for some hours, mercury is formed : $2\text{Ag} + \text{HgCl}_2 = 2\text{AgCl} + \text{Hg}$. When a dry mixture of finely-divided silver and mercuric chloride is heated, mercurous chloride sublimes, and silver chloride remains. A. Colson, and J. N. Brönsted have studied the reducing action of silver on **mercurous chloride**, where the action is reversible.

According to A. Ditte, silver is attacked by aq. soln. of **potassium iodide** forming a layer of silver iodide on the metal, with conc. soln. of potassium iodide a double salt, $\text{KI} \cdot \text{AgI} \cdot \frac{1}{2}\text{H}_2\text{O}$, may be formed. A. Seyewetz found finely divided silver forms silver iodide when treated with a sat. soln. of potassium iodide in *p*-benzoquinone; analogous results are obtained with a soln. of **potassium bromide**. G. Campani found that silver precipitates mercury completely from an aq. soln. of **mercuric iodide** and potassium iodide. According to A. J. Balard,¹⁰ **chlorine monoxide** and **hypochlorous acid**, as well as aq. soln. of the **hypochlorites** with finely-divided silver form silver chloride, and give off oxygen. W. S. Hendrixson found silver is attacked by **chloric acid**, **bromic acid**, and **iodic acid** (*q.v.*) in accord with the equation : $6\text{Ag} + 6\text{HClO}_3 = \text{AgCl} + 5\text{AgClO}_3 + 3\text{H}_2\text{O}$. C. Zenghelis found that silver foil is reduced by a soln. of **potassium chlorate**. O. P. Watts and N. D. Whipple investigated the action of **perchloric acid** on silver.

Silver is slowly attacked by contact with **sulphur** at ordinary temp. This is evidenced by rubbing a silver coin with a piece of sulphur, when a black stain of silver sulphide appears. Sulphur vapour reacts much more quickly, and W. Spring¹¹ reported that a mixture of sulphur and silver unite when compressed under high press. On the other hand, E. Obach found a soln. of sulphur in carbon disulphide to be almost without action on silver—*vide* silver sulphide. According to A. Orlowsky, the affinity of silver for sulphur is a little less than that of copper, but the affinity of selenium for silver is the greater. The affinity of silver for sulphur is also evidenced by its action on mercuric sulphide which, according to A. Colson, involves a reversible reaction. According to J. J. Berzelius, silver is blackened by the vapour of **selenium**, and the two elements unite when fused together; B. Brauner, and J. Margottet found similar remarks apply to the action of **tellurium** on silver. According to J. M. Cabell, purified and dried **hydrogen sulphide** does not attack silver at ordinary temp.; on the contrary, silver rapidly forms sulphide when the gas is admixed with air. The tarnish which silver acquires by exposure to the atm. contaminated with animal exhalations containing sulphur—possibly hydrogen sulphide—is due to the formation of a surface film of silver sulphide. The tarnish is most effectively removed by a dil. soln. of potassium cyanide. Not only does thoroughly dry hydrogen sulphide appear to be inert towards silver, but air or oxygen also appears to be necessary for the attack, because F. L. Hahn found that hydrogen sulphide may be bubbled through water in which silver has been placed, without blackening the metal. A trace of oxygen or hydrogen peroxide causes an immediate blackening. G. Rebol found that with a bent piece of silver, the attack by hydrogen sulphide is greatest where the curvature is greatest. Liquid hydrogen sulphide was found by E. Beckmann and P. Wöntig to have no action on silver. According to J. Percy, "the fading of some photographs, untuned by gold, is due to the transformation of silver or of a silver compound constituting the image into silver sulphide, which, in an extremely thin film, is yellowish-brown, just like incipient silver tarnish." M. Berthelot found hydrogen sulphide in the presence of silver decomposes at about 550°, forming silver sulphide. H. Pélabon has studied the reversible reaction: $2\text{Ag} + \text{H}_2\text{S} \rightleftharpoons \text{Ag}_2\text{S} + \text{H}_2$, at elevated temp. Silver is also attacked by **hydrogen selenide**, and the reversibility of the reaction, $2\text{Ag} + \text{H}_2\text{Se} \rightleftharpoons \text{Ag}_2\text{Se} + \text{H}_2$, has been studied by H. Pélabon.

E. Priwoznik found that silver is blackened by aq. soln. of the **alkali sulphides**, forming silver sulphide which dissolves in the excess. According to F. L. Hahn, air or oxygen is necessary for the attack on silver by alkali sulphides because, if air be vigorously excluded, silver may be boiled with a soln. of sodium sulphide without any blackening. A trace of oxygen or hydrogen peroxide causes an immediate blackening of the metal. A soln. of **ammonium polysulphide** acts on silver at ordinary temp., forming a bluish-grey film, which deepens with a more prolonged action, ultimately forming a crystalline crust of silver sulphide. G. Strüver has studied the action of the heavy **metal sulphides** on silver—hauerite, for example, forms a black layer of silver sulphide when placed in contact with the metal.

The so-called *oxydized silver* is silver whose surface has been rendered a lead-grey colour which is agreeably relieved by deeper tints in the depressed parts. The term is a misnomer in that sulphur, not oxygen, is the agent involved in its production. The effect is produced by immersing the articles in a hot soln. containing alkali sulphide until they acquire a sufficiently dark colour. They are afterwards brushed or wiped in the more prominent parts.

The spitting of silver which has been precipitated by iron sulphate has been attributed to the evolution of **sulphur dioxide** dissolved by the molten metal. W. Stahl¹² found that while sulphur dioxide is insoluble in the molten metal, yet, as J. Uhl has shown, when metallic silver is heated with dry sulphur dioxide, silver sulphide and sulphate are formed: $4\text{Ag} + 2\text{SO}_2 \rightleftharpoons \text{Ag}_2\text{SO}_4 + \text{Ag}_2\text{S}$; or, if oxygen be present: $4\text{Ag} + 2\text{SO}_2 + 2\text{O}_2 \rightleftharpoons 2\text{Ag}_2\text{SO}_4$. Silver sulphate does not dissociate below 1080°, so that when gently melted, the fused sulphate floats on the surface

as a slag. At higher temp., the sulphate dissociates, yielding sulphur dioxide and oxygen: $\text{Ag}_2\text{SO}_4 = 2\text{Ag} + \text{SO}_2 + \text{O}_2$, and it is this oxygen which dissolves in the silver and causes the spitting.

Granulated silver dissolves readily in hot sulphuric acid with the evolution of sulphur dioxide—*vide* copper: $2\text{Ag} + 2\text{H}_2\text{SO}_4 = \text{Ag}_2\text{SO}_4 + \text{SO}_2 + 2\text{H}_2\text{O}$, and the hot conc. acid can dissolve so much of the silver sulphate as to become a crystalline mass on cooling. The solvent action of sulphuric acid is utilized in the operation of parting gold from silver (*q.v.*). G. Wetzlar¹³ said that "dil. sulphuric acid, when left in contact for any length of time with powdered silver, does not dissolve a trace of the metal"; and, according to E. Pannain, boiling sulphuric acid attacks pure silver only when the sp. gr. of the acid is not less than 1.710; a more dil. acid attacks silver only when the metal is impure; pure silver is insoluble in dil. sulphuric acid. E. Harbeck found that silver, as anode in a cell, dissolves in sulphuric acid of sp. gr. over 1.53 in the presence of iron, lead, tin, and copper. A. Vogel stated that finely-divided silver dissolves in conc. sulphuric acid without the evolution of sulphur dioxide. M. C. Lea found that finely-divided silver dissolves in sulphuric acid diluted with four or five times its volume of water. A. Vogel, A. Ditte, and P. Braham have also studied the dissolution of silver in sulphuric acid. W. S. Hendrixson observed that the continued action of the acid exerted no influence on the amount of silver dissolved, and he was able to show that dil. sulphuric acid alone is incapable of dissolving finely-divided silver, and that the seeming solvent action is due to the oxygen of the air dissolved in the acid, to the superficial oxidation of the silver, or to oxygen derived from some external source. According to E. Salkowsky, the solvent action of sulphuric acid on silver is facilitated if hydrogen peroxide be mixed with the acid. O. von der Pfordten reported that a soln. of potassium permanganate in dil. sulphuric acid dissolves silver in the presence of air; but C. Friedheim found the last limitation is not necessary. J. Keir, in 1790, augmented the solvent action of sulphuric acid on silver by mixing it with one-tenth its weight of potassium nitrate, and he recommended this solvent for stripping silver from silver-plated articles. It scarcely affects copper, lead, or iron. The sulphuric acid, of course, liberates nitric acid from the potassium nitrate so that the effect is eq. to a mixture of sulphuric and nitric acids. R. G. van Name and D. U. Hill found that when silver dissolves in a soln. of chromic acid containing sulphuric acid, the velocity of soln. depends on the physical state of the metal, which indicates that the rate of dissolution of the metal is not entirely dependent on the diffusion. The rates of dissolution of different metals tend to become more nearly equal as the conc. of the sulphuric acid increases, but with silver and cadmium the relative rates of dissolution diverge as the conc. of the sulphuric acid increases. E. Divers and T. Shimidzu found that finely-divided silver is rapidly dissolved by **pyrosulphuric acid** without the evolution of a gas, and when the soln. is poured into water, silver sulphate and sulphur dioxide are formed. H. Marshall found silver to be converted by **persulphuric acid** into a mixture of silver sulphate and peroxide. According to V. Lenher, silver is attacked by warm **selenic acid**. According to H. B. North, **sulphuryl chloride**, SO_2Cl_2 , does not act on silver at 300°.

G. Wetzlar¹⁴ ascertained that silver is slightly soluble, at ordinary temp., in an aq. soln. of **ferric sulphate**, and this the more when free sulphuric acid is present; and he added: "When the red soln. of ferric sulphate is heated, it dissolves silver and becomes green ferrous sulphate, but, on cooling, the silver is deposited, and the soln. acquires its original colour." The precipitation is never complete, and the more free acid the soln. contains, the more difficult the precipitation of the silver by ferrous sulphate, and if sufficient free acid be present, no silver is precipitated. Dil. sulphuric acid does not dissolve silver, but if a drop of ferric sulphate be present, an appreciable amount of silver will be dissolved in the course of an hour. The explanation of G. Wetzlar, 1828, reduces the process to a catalytic cycle:

The ferric sulphate imparts oxygen to the silver and is thereby reduced to ferrous sulphate, but the latter immediately absorbs oxygen from the air and is brought back to its original state of ferric sulphate; and so these alternate reactions continue, the ferric sulphate acting as a vehicle for the transfer of oxygen from the air to the silver whereby silver oxide is produced, which combines with the sulphuric acid to form silver sulphate.

A. Vogel also found silver to dissolve readily in a boiling soln. of ferric sulphate, even though the soln. be made as neutral as possible by the addition of hydrated ferric oxide. F. Wöhler stated that a hot soln. of **ferrous sulphate** dissolves silver, which is subsequently precipitated as the soln. is cooled. Neither A. Vogel nor J. Percy could detect the least action when the metal is boiled with a soln. of ferrous sulphate, but if a trace of ferric sulphate be present, some silver will be dissolved by the boiling soln., and precipitated as metal when the soln. cools. M. C. Lea also found finely divided silver readily dissolves in a soln. of iron alum, *i.e.* **ferric ammonium sulphate**. K. Hopfgartner found that there is a state of equilibrium in the soln. $2\text{Ag} + \text{Fe}_2(\text{SO}_4)_3 \rightleftharpoons \text{Ag}_2\text{SO}_4 + 2\text{FeSO}_4$, or $\text{Ag} + \text{Fe}^{\cdot\cdot} \rightleftharpoons \text{Ag}^+ + \text{Fe}^{\cdot}$, such that $[\text{Ag}^+][\text{Fe}^{\cdot}] = K[\text{Fe}^{\cdot\cdot}]$, where the symbols in brackets represent conc. The value of K is 0.004, and it alters a little in soln. of different conc., and when iron alum is used in place of ferric sulphate. The reaction has been studied by V. Kohlschütter and E. Eydmann, and by A. A. Noyes and B. F. Brann. K. Hopfgartner also recommended the reduction of an acidulated soln. of a known amount of ferric ammonium sulphate by silver and subsequently titrating the product with a soln. of potassium permanganate to be standardized. H. N. Stokes reported that silver dissolves in a hot soln. of **cupric sulphate**, and is deposited as the soln. cools.

According to E. C. Franklin and C. A. Kraus, silver is insoluble in liquid **ammonia**. M. C. Lea,¹⁵ and C. Matignon and G. Desplantes found that finely-divided reduced silver is slightly soluble in aq. ammonia if air or oxygen be present, but if air or oxygen be excluded, it is probably insoluble. J. W. Turrentine found that when a very dil. soln. of silver in **hydrazoic acid** is electrolyzed with a silver anode, the anode efficiency exceeds 100 per cent. of the corrosion predicted by Faraday's law, and he explains the phenomenon by assuming that the metal dissolves or partially dissolves electrochemically at a valence lower than that usually ascribed to silver, forming compounds which are readily oxidized—he quotes the subhalides and suboxide in support of silver with a valence lower than unity. The phenomenon only occurs with very dil. soln., and if the electrolyte is stirred, the metal becomes passive.

The reports of the effects of nitrogen oxides on heated silver are not all consistent. According to W. Manchot, and A. Kurtenacker, **nitrous oxide** and **nitric oxide** are not changed, and, according to P. Sabatier and J. B. Senderens,¹⁶ silver is not attacked by nitric oxide at any temp.; on the other hand, silver at a bright red heat decomposes the oxide of nitrogen completely, according to F. Epstein and R. Dohrt, and E. Calberla, and incompletely, according to H. Hermann. G. Reboul found that dil. **nitrogen trioxide**, N_2O_3 , attacks a piece of bent silver most at the places of greatest curvature. W. Manchot found **nitrogen tetroxide**, NO_2 , does not attack silver at 240° , but at room temp. the metal is coloured yellow. M. Oswald says that nitrogen tetroxide, N_2O_4 , reacts with silver, forming silver nitrate and nitric oxide. Liquid nitrogen tetroxide was found by E. Divers and T. Shimidzu to convert finely-divided silver into silver nitrate and nitric oxide. J. J. Sudborough says that **nitrosyl chloride**, NOCl , produces on silver a thin superficial film of the chloride which protects the metal from further attack.

According to J. J. Berzelius,¹⁷ when silver is suspended in pure **nitric acid**, and the liquid is viewed by transmitted light, the metal appears to dissolve without the evolution of gas, and the denser soln. of silver nitrate to fall in striæ from the surface of the silver. The soln. gradually acquires a greenish tinge, owing to the reduction of the nitric acid to nitrous acid; but as the liquid becomes warm, and occasionally quite abruptly, the evolution of gas begins. In his *Recherches sur*

l'acide nitrique, N. A. E. Millon found that silver is not attacked by nitric acid of lower sp. gr. than 1.405, whose composition is represented by $4\text{HNO}_3 + 7\text{H}_2\text{O}$, so long as the temp. does not rise above 20° , and no soln. of silver nitrate is added. In pure conc. nitric acid, silver becomes coated with a grey or white film which protects the metal from further oxidization. J. W. Russell also showed that silver does not react with dil. nitric acid, because, when hydrogen is passed through silver nitrate, metallic silver is precipitated and nitric acid is formed. The amount of hydrogen absorbed is in excess of that required by the replacement of silver by hydrogen: $2\text{AgNO}_3 + \text{H}_2 = 2\text{HNO}_3 + 2\text{Ag}$, because some nitrous acid is simultaneously formed: $2\text{HNO}_3 + 2\text{H}_2 = 2\text{H}_2\text{O} + 2\text{HNO}_2$, and silver redissolves, forming silver nitrite when the passage of hydrogen is stopped. When silver dissolves in nitric acid, also, it does so as silver nitrite, not nitrate. This explanation of the action of nitric acid on silver is practically the same as that given by N. A. E. Millon to the dissolution of copper in nitric acid. These observations, coupled with those of V. H. Veley on the action of nitric acid on copper, show that the metal actively reacts with the acid only in the presence of nitrous acid, for the action of nitric acid on the metal is scarcely measurable unless, and until, a sensible quantity of nitrous acid is present. Silver cannot remain long in contact with nitric acid without reaction, but this is because the nitric acid is slowly dissociated into nitrous acid and oxygen, excepting perhaps when the acid is highly diluted. In any case, nitric acid of moderate conc. cannot be kept free from nitrous acid. Hence, nitric acid is considered to be the most important solvent for silver and, according to L. Marchlewsky, acid below one per cent. HNO_3 attacks the finely-divided metal. Neither E. Divers nor C. Montemartini could detect any signs of the formation of ammonia or hydroxylamine, but only nitric acid and nitrous acid. G. O. Higley and W. E. Davis used nitric acid varying from a sp. gr. 1.05 to 1.40. Neither nitrogen nor nitrous oxide was produced in any of the experiments; nitric peroxide is the principal reduction product with conc. acid, accounting for over 70 per cent. of the metal dissolved; the decrease of this gas and the complementary increase of nitric oxide as the acid is diluted is due to the decomposition of the nitric peroxide into nitric acid and nitric oxide by water.

According to V. H. Veley's hypothesis, the metal dissolves in the nitrous acid to form a nitrite and nitric oxide: $\text{Ag} + 2\text{HNO}_2 = \text{AgNO}_2 + \text{NO} + \text{H}_2\text{O}$; the nitrite is then decomposed by the excess of nitric acid to reform nitrous acid: $\text{AgNO}_2 + \text{HNO}_3 = \text{HNO}_2 + \text{AgNO}_3$. The nitric oxide formed by the reaction symbolized by the first of the equations reduces the nitric acid (or the nitrate) to produce a further quantity of nitrous acid: $\text{HNO}_3 + 2\text{NO} + \text{H}_2\text{O} = 3\text{HNO}_2$. When the conc. of nitrous acid has reached its equilibrium value, the reverse reaction occurs: $3\text{HNO}_2 = \text{HNO}_3 + 2\text{NO} + \text{H}_2\text{O}$, and nitric oxide is evolved from the liquid. E. Divers' hypothesis is that the silver reacts slowly with nitric acid, forming silver nitrite and nitrate: $2\text{Ag} + 2\text{HNO}_3 = \text{H}_2\text{O} + \text{AgNO}_2 + \text{AgNO}_3$, and that the presence of nitrous acid catalyzes this reaction. The silver nitrite so formed reacts with the nitric acid to form nitrous acid: $\text{AgNO}_2 + \text{HNO}_3 = \text{AgNO}_3 + \text{HNO}_2$, and the nitrous and nitric acids are consumed at the same rate by the reaction: $\text{HNO}_2 + \text{HNO}_3 + 2\text{Ag} = 2\text{AgNO}_2 + \text{H}_2\text{O}$. In the former hypothesis silver nitrate is a secondary product of the reaction; in the latter hypothesis, part of the silver nitrate is a primary product—*vide* action of nitric acid on copper. A soln. of **cupric nitrate** was found by M. C. Lca to have no action on finely-divided silver. According to W. R. E. Hodgkinson and A. H. Coote, molten **ammonium nitrate** acts on silver if it is strongly heated; aq. soln. acts very slightly or not at all. W. R. E. Hodgkinson also found **aniline** and **toluidine nitrates** behave like ammonium nitrate.

In 1792, B. Pelletier¹⁸ dropped **phosphorus** on silver heated to redness in a crucible, and found the metal instantly melted; he continued adding phosphorus until he believed the silver to be sat. The molten mass had a tranquil surface, but, on cooling, much phosphorus was emitted, and the surface became *toute mamelonnée* owing to the spitting of the silver as it rejected the phosphorus in soln.

It was estimated that the solid silver retained about 15 per cent. of phosphorus, and that it lost 10 per cent. in the act of solidification. J. Percy found a maximum of 0.293 per cent. to be retained by the solid metal. P. Hautefeuille and A. Perrey, and H. N. Warren confirmed these observations in a general way, and A. Granger found that silver at 400° absorbs phosphorus, which it rejects at about 500°, and takes up anew at 900°. O. Emmerling, A. Granger, and A. Schrötter prepared silver phosphides—AgP, Ag₂P₃, and AgP₂—by the action of phosphorus on the metal. A. Granger found that phosphorus trichloride is attacked by silver only at a high temp.; H. Goldschmidt, that phosphorus pentachloride reacts: $2\text{Ag} + \text{PCl}_5 = 2\text{AgCl} + \text{PCl}_3$; and B. Reinitzer and H. Goldschmidt, that phosphoryl chloride reacts at 250°, forming phosphorus trichloride, pyrophosphoryl tetrachloride, P₂O₃Cl₄; phosphorus pentoxide; silver chloride, phosphate, and pyrophosphate. O. P. Watts and N. D. Whipple studied the action of phosphoric acid on silver. J. J. Berzelius found that when ammonium sodium hydrophosphate, microcosmic salt, is fused with silver in an oxidizing flame, a yellow opalescent glass is formed.

T. Bergmann¹⁹ found that silver takes up one-fourteenth of its weight of arsenic, and thereby becomes yellow and brittle. A. F. Gehlen heated a mixture of equal parts of powdered silver and arsenic, and obtained what he called a compact, brittle, steel-grey, crystalline mass with about 16 per cent. of arsenic—possibly Ag₃As. The two elements unite without incandescence. P. Berthier described a similar alloy. J. Percy likewise obtained an alloy with 18.54 per cent. of arsenic—possibly Ag₃As. P. Hautefeuille and A. Perrey noted that as in the case of phosphorus, the molten alloy of silver and arsenic spits in the act of solidification, owing to the rejection of arsenic by the cooling metal. K. Friedrich and A. Leroux studied the f.p. curves and found evidence of the formation of silver arsenide, Ag₃As. A portion of the curve is shown in Fig. 10, for alloys with up to about 40 per cent. of arsenic. I refers to the mixed crystals of arsenic in silver, III refers to the alloy Ag₃As; the portion to the right has not been explored. W. Spring prepared alloys by compressing mixtures of the powdered elements at 6500 atm. C. W. Scheele reported that arsenic oxide does not act on silver, but when the two elements are melted together, arsenious oxide sublims, and silver arsenate, Ag₃AsO₄, is formed. A. F. Gehlen found arsenious oxide does not act on silver at a high temp. Alloys of silver and antimony are easily prepared. P. Berthier²⁰ said

that each of the two elements has *beaucoup d'affinité pour l'autre et se combinent en toutes proportions*. Their whiteness increases as the proportion of antimony increases; they are always brittle, and a very small proportion of antimony suffices to impart that quality to silver. The alloys are very fusible, and wholly decomposed by cupellation or fusion with nitre; *l'argent reste pur*. P. A. von Bonsdorff says that about one-tenth per cent. of antimony remains obstinately united with the silver when the alloy is cupelled. H. Rose found that by repeatedly heating the alloy with ammonium chloride, the proportion of antimony is gradually diminished. Portions of the constitutional diagram were worked out by H. Gautier, and C. T. Heycock, and completed by G. I. Petrenko. The diagram is illustrated in Fig. 11. The break at 559° corresponds with 27.07 per cent. of antimony and represents

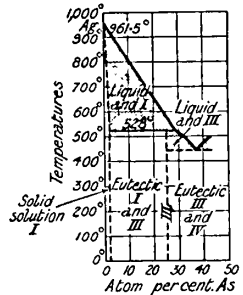

Fig. 10.—Freezing Point Curve of the Binary System Ag-As (K. Friedrich and A. Leroux).

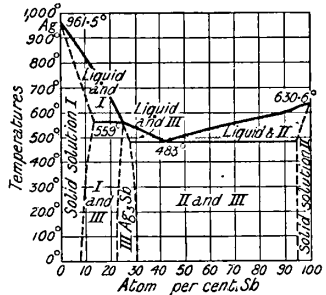

Fig. 11.—Freezing Point Curve of the Binary System Ag-Sb (G. I. Petrenko).

the formation of the antimonide, Ag_3Sb ; the eutectic at 483° corresponds with nearly 45 per cent. of antimony. The areas bounded by the liquidus and solidus curves are shaded in the diagram. I refers to solid soln. of antimony in silver; and II of silver in antimony; while III refers to the antimonide, Ag_3Sb . G. Charpy studied the microstructure of the alloys; E. Maey, the sp. gr.; N. A. Puschin, the electrochemical behaviour; E. Elsässer, the electrical conductivity; and W. Haken, the thermo-electric force.

According to P. Berthier,²¹ silver and bismuth easily fuse together, forming a brittle laminar alloy. A. Wright found homogeneous alloys can be obtained with all proportions of the two constituents. According to P. Berthier, silver is readily separated from the bismuth by cupellation. R. Schneider remarked that when impure bismuth—containing sulphur, arsenic, iron, nickel, cobalt, and silver—is fused and poured upon a cold plate, the globules of metal which are thrown up during solidification contain at least 99.5 per cent. of bismuth; and of the heavy metals, only silver remains in these globules, the copper remains with the mass.

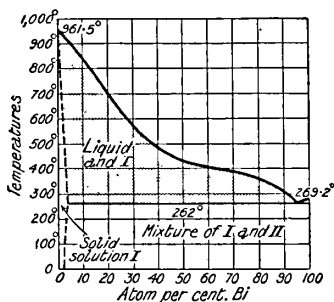

FIG. 12.—Freezing Point Curve of Silver-Bismuth Alloys (G. I. Petrenko).

He suggests this property might be advantageously employed for a preliminary purification of bismuth. The f.p. curves have been determined by G. I. Petrenko, and C. T. Heycock and F. H. Neville. The curves are shown in Fig. 12. The curve is the simple V-type with a eutectic at 262° and 2.5 per cent. of silver. The sp. gr. of the alloys has been investigated by P. von Muschenbrock, A. Matthiessen and M. Holzmann, and E. Maey; the thermo-electric properties by A. Batelli; and the e.m.f. by W. N. Lacey. The e.m.f. of the alloys is greater than that of bismuth; and the alloys are all formed with the absorption of heat. According to C. M. Marx, an alloy of equal parts of the two elements does not expand on solidifying, but an expansion does occur when the proportion of bismuth is double that of silver. According to H. Moissan, silver does not alloy with vanadium.

In 1835, J. L. Gay Lussac²² stated with respect to the action of carbon on silver:

I have sought to detect the presence of mercury in silver, by heating in a small crucible in a muffle, a gram of it with lamp-black in order to avoid the vaporization of the silver; but I have been deceived in my attempt; after heating the mixture for 45 mins., the weight of the silver had sensibly increased—in one experiment the excess of weight had risen to more than 3 per cent.

There are several possible explanations of the increase in weight—*e.g.* the increase may have been due to the sulphur not uncommonly present in the lamp-black of commerce. J. Percy has shown that there is, indeed, not the least ground for here suspecting that silver can take up the smallest quantity of carbon under the circumstances. O. Ruff and B. Bergdahl found that molten silver dissolves a little carbon. M. Berthelot, and B. Reinitzer and H. Goldschmidt could detect very little evidence of a reaction between silver and carbon monoxide; when heated in a sealed tube, carbon monoxide was found by M. Berthelot to begin to react at 300° , some carbon is formed, and carbon dioxide is produced. M. Berthelot did not find any signs of the combination of cyanogen with silver at any observed temp. For the solvent action of soln. of the alkali cyanides on silver, *vide* gold. In conformity with others' observations, A. Brochet and J. Petit found silver is attacked by potassium cyanide soln. in the presence of air. According to A. Hébert, the organic acids, in general, have no action on silver, and, in accord with this, M. C. Lea found that acetic acid does not act on finely-divided silver, but if hydrogen peroxide be also present, E. Salkowsky found that the metal is attacked by the

acid. O. P. Watts and N. D. Whipple also studied the action of acetic acid on silver. Silver was found by M. le Blanc and E. Plaschke,²³ and S. Foden to be not so active a catalytic agent as copper in the oxidation of, say, methyl alcohol vapour to formaldehyde. Silver is used with hydrogen for the reduction of nitro-compounds to the amines; and for the dechlorination of certain organic compounds.

J. J. Berzelius stated that it is easy for a small proportion of silicon to unite with silver, when heated strongly in a crucible; and when the malleable button of alloy is digested with nitric acid, the silver dissolves leaving a residuc of silica. J. Percy and C. Winkler did obtain a grey, brittle alloy, the former by fusing silver with sodium and potassium fluosilicates, and the latter by fusing a mixture of silica and silver under cryolite. H. Moissan found silicon readily dissolves in fused silver, and a part separates out in a crystalline state before freezing—*vide* silicon. H. Moissan and F. Siemens measured the solubility of silicon in silver at different temp. The results of G. Arrivaut's thermal study of the silicon-silver alloys is shown in Fig. 13. There are no compounds here revealed, and this agrees with J. Percy's observations. H. N. Warren, and G. J. L. de Chalmot alloyed the two elements, and F. Wöhler thought a compound was precipitated along with silver when silicon hydride is passed into a soln. of silver nitrate. E. Vigouroux noticed that when pulverulent silver is heated in the vapour of silicon tetrachloride, silver chloride is formed, but the silicon does not unite with the silver. H. Moissan found that when silver is fused at the high temp. of an electric furnace it dissolves boron;

and also boron carbide which separates in crystals as the soln. cools. J. J. Berzelius says that a borax bead with a silver salt in an oxidizing flame becomes opalescent or milk-colour, and in the reducing flame, grey owing to the reduction of the silver. According to V. Kohlschütter, when the borax bead is heated and removed from the flame, it is at first clear, the characteristic coloration appearing suddenly during the cooling. J. Donau, however, obtained borax bead coloured yellow by dissolved silver. It is well known, too, that certain compounds of silver impart a yellow colour to glass when the two are heated in contact. R. Wynn and others have studied the coloration of glass by silver. According to E. Warburg's theory, the quantity of silver which diffuses in glass is proportional to the product of the sq. root of the time, the conductivity of the glass and the absolute temp. G. Schulze found this applied with molten silver chloride or bromide. J. S. Stas thought a yellow silver silicate was formed, but, as J. C. M. Garnett showed, the coloration is more probably due to the diffusion of extremely finely-divided metallic silver in the glass, just as the ruby-red colour of glass is due to finely-divided gold, and red colour of the Chinese rouge flambé glazes is probably due to finely-divided copper—*vide* colloidal copper, silver, and gold. The adsorption of silver ions from soln. of silver sulphate or nitrate by silver has been studied by H. von Euler.

According to M. C. Lea,²⁴ silver dissolves but slowly in a dil. soln. of potassium permanganate. W. Foster, and H. B. Gilcs have shown that a neutral soln. of potassium permanganate is reduced by silver. R. Kremann and F. Noss found a soln. of chromic nitrate, $\text{Cr}(\text{NO}_3)_3$, dissolves silver in the cell $\text{Ag}|\text{Cr}(\text{NO}_3)_3|\text{C}$, and this the more the higher the temp.; as the soln. approaches saturation, some nitrogen oxides are given off. According to J. M. Eder, a cold soln. of potassium ferricyanide forms silver and potassium ferricyanide when treated with silver; G. McP. Smith found that a boiling soln. gives a dark green precipitate, and some of the silver forms the double cyanide, KAgCy_2 . O. Ruff and A. Heinzelmann found warm silver is slightly attacked by uranium hexafluoride, UF_6 ; and O. Ruff and F. W. Tschirch, that osmium octofluoride, OsU_8 , forms silver fluoride, osmium, and a lower osmium fluoride. Silver readily alloys with the metals, and the silver

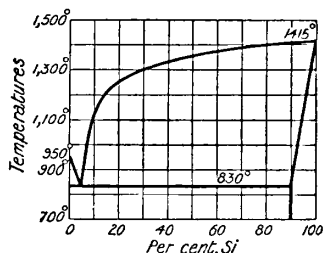

FIG. 13.—Fusion Curves of Alloys of Silver and Silicon.

alloys are discussed along with those of copper and gold. The alkali hydroxides can be fused in silver crucibles. According to W. Dittmar and D. Prentice,²⁵ the attack is more vigorous if the fusion be made in air than if air is excluded; and more vigorous with potassium hydroxide than with sodium hydroxide. W. L. Dudley found that molten **sodium peroxide** also rapidly attacks silver, and the grey product contains monoclinic prismatic crystals; it appears to be a mixture of silver with about 25 per cent. of silver oxide. N. N. Beketoff also found that a black body, thought to be *potassium argentate*, KOAg, is formed when **potassium tetroxide** is fused on a silver crucible. It is probably a mixture of silver and silver oxide. Silver is also stated to be less attacked than platinum when fused with **potassium nitrate** or hydroxide in air. A. Chodnew found that **potassium hydroxide** is coloured yellow when heated 10 mins. in a silver crucible, and when extracted with water there remains a black mixture of silver and silver oxide. O. P. Watts and N. D. Whipple studied the action of soln. of sodium hydroxide and of various salts on silver.

W. A. Lampadius heated a mixture of equal parts of silver and **barium oxide** with 10 per cent. of carbon and obtained a metal which disintegrated in air to silver and barium oxide. According to C. E. Wait, if silver be mixed with **manganese, barium, or lead dioxide, or lead monoxide**, and heated in an oxidizing atm. in a muffle, up to about 36 per cent. of the silver is oxidized to Ag_2O ; on the other hand, no oxidation occurs with bismuth, zinc, calcium, or cupric oxides.

Reactions of analytical interest.—An aq. soln. of silver nitrate is (*q.v.*) generally taken to represent the behaviour of soln. of silver salts. This soln. gives a brown precipitate of silver oxide, Ag_2O , when treated with **potassium hydroxide**. The same result is obtained with sodium hydroxide. The precipitate is insoluble in excess of the precipitant, but is readily soluble in nitric acid and in aq. ammonia. If a dil. soln. of silver nitrate contains dextrine, gum arabic, cane sugar, starch, or the like, the brown oxide remains in suspension so that the intensity of the coloration is proportional to the amount of silver in soln. Hence, G. S. Whitby²⁶ utilized the reaction for the colorimetric determination of the metal. The colour is so sensitive that in 50 c.c. of soln. one part of silver can be detected in 25,000,000 parts of soln. T. G. Wormley detected one part of silver in 125,000 of liquid by the sodium hydroxide reaction, and F. Jackson, 1 in 8000. P. Jolibois, R. Bossuet, and M. Chevy found that with a mixed soln. of copper and silver nitrates, sodium hydroxide first precipitates the whole of the copper as cupric hydroxide before any of the silver is precipitated as silver hydroxide.

When aq. **ammonia** is gradually added drop by drop to a neutral soln. of silver nitrate, the first few drops give a white precipitate, which quickly changes to the brown oxide, Ag_2O . Most of the silver, however, remains in the soln. as silver amino-nitrate, $\text{Ag}(\text{NH}_3)_n\text{NO}_3$, and the oxide is itself dissolved as silver amino-hydroxide, $\text{Ag}(\text{NO}_3)_n\text{OH}$, by an excess of ammonia. According to F. Jackson, the ammonia reaction will detect one part of silver in 800 of liquid. White silver carbonate is precipitated when **sodium carbonate** is added to a soln. of a silver salt, the precipitate becomes yellow if boiled with the mother liquid, owing to a slight decomposition of the carbonate into oxide: $\text{Ag}_2\text{CO}_3 \rightarrow \text{Ag}_2\text{O} + \text{CO}_2$. F. Jackson found the reaction to be sensitive to one part of silver in 32,000 of liquid. The same precipitate is produced with **ammonium carbonate**, but it is soluble in excess of the precipitant. **Hydrochloric acid** or aq. soln. of the chlorides precipitate silver chloride from aq. soln. of the silver salts—excepting the thiosulphate. The precipitate is curdy from conc. soln., but from very dil. soln. it shows itself as a white or bluish-white opalescence. According to G. J. Mulder, the opalescence appears with one part of silver in 1,000,000 parts of liquid; P. Harting gives 1 in 378,000; C. H. Pfaff gives 1 in 189,000; and F. Jackson, 1 in 64,000 when hydrochloric acid of sp. gr. 1.035 is used for the test, and 1 in 32,000 when a soln. of sodium chloride (1.20) is employed. According to J. L. Lassaigne, a soln. containing one of one part of silver in 200,000 parts of liquid gives a very slight turbidity

with hydrochloric acid or sodium chloride; with one in 400,000 soln. the opalescence is scarcely perceptible; and with one in 800,000 the opalescence appears in about 15 mins. The precipitated chloride is almost insoluble in nitric acid; it is slightly soluble in hydrochloric acid or in soln. of the alkali chlorides; it is readily soluble in aq. ammonia, and the chloride is re-precipitated when the ammoniacal soln. is neutralized with acid; it is readily soluble in a soln. of potassium cyanide; and, in the absence of an acid, it is readily soluble in a soln. of sodium thiosulphate, and the soln. when boiled does not precipitate silver sulphide. Potassium iodide gives a yellow curdy precipitate of silver iodide which is but sparingly soluble in ammonia, but readily soluble in soln. of potassium cyanide or sodium thiosulphate. According to P. Harting, one part of silver can be detected by the potassium iodide reaction in 47,250 parts of liquid, and F. Jackson gives one in 8000. J. S. Stas detected one part of silver as bromide when in 5,000,000 parts of water; and by suitably arranging the light, T. W. Richards detected one part of silver chloride in 30,000,000 parts of water. W. Böttger detected 0.00012 mgrm. of silver as chloride; and H. Behrens, 0.0001 mgrm. The solubilities of silver bromide, and iodide are respectively 0.3×10^{-6} , and 1.5×10^{-8} gm. per litre; and the sensitivenesses are respectively 0.3×10^{-6} , and 0.34×10^{-6} . W. Biltz detected 0.0042 mgrm. of silver ultramicroscopically as chloride, and 0.00036 mgrm. as bromide. M. Gorsky obtained the Tyndall effect with 0.0002 mgrm. of silver bromide using an eq. of potassium bromide, and 0.00014 mgrm. with an excess of that salt; with 0.0001 mgrm. of silver iodide using an eq. of potassium iodide; and 0.00007 mgrm. with an excess of that salt.

The precipitation of grey metallic silver by boiling a mixed soln. of **ferrous sulphate** and silver nitrate has already been discussed; so also has the precipitation of silver from neutral soln. by means of **zinc**. Neutral, acid, or ammoniacal soln. of silver salts give a precipitate of black silver sulphide when treated with **hydrogen sulphide**. According to F. Jackson, the reaction is sensitive to one part of silver in 64,000 of soln. The precipitate is insoluble in aq. ammonia, alkali sulphides, or dil. potassium cyanide soln., but it is appreciably soluble in a conc. soln. of potassium cyanide, so that if a considerable amount of the last-named salt be present, hydrogen sulphide may give no precipitate at first, but with an excess of hydrogen sulphide a precipitate of silver sulphide is gradually formed. Black silver sulphide is readily soluble in a hot dil. soln. of nitric acid with the separation of sulphur, and the formation of silver nitrate. A reddish-brown precipitate of silver dichromate is obtained by adding a soln. of **potassium dichromate** to one of silver nitrate. The precipitate is soluble in ammonia; the same remarks apply to the brownish-red precipitate of silver chromate which is formed by adding a soln. of **potassium chromate** to one of silver nitrate. According to F. Jackson, this reaction is sensitive to one part of silver in 8000 parts of soln. Neutral soln. of silver salts give a yellow precipitate of silver phosphate when treated with **sodium phosphate**: $3\text{AgNO}_3 + 2\text{Na}_2\text{HPO}_4 = 3\text{NaNO}_3 + \text{NaH}_2\text{PO}_4 + \text{Ag}_3\text{PO}_4$. F. Jackson says the reaction is sensitive to one part of silver in 8000 of liquid. The precipitate is soluble in nitric acid and aq. ammonia. The phosphate is reprecipitated if the ammoniacal soln. be neutralized with acid. **Potassium arsenite** gives an egg-yellow precipitate, which P. Harting found to be perceptible with one part of silver in 6000 parts of liquid, and to reach its limits with 1 in 20,000. **Oxalic acid** precipitates a white pulverulent silver oxalate; **potassium thiocyanate**, white silver thiocyanate; **potassium ferrocyanide**, white silver ferrocyanide; **potassium ferricyanide**, reddish-brown silver ferricyanide; and **potassium iodate** or **potassium bromate**, respectively white silver iodate or bromate. **Hydrocyanic acid** or **potassium cyanide** precipitates white silver cyanide which is curdy in conc. soln., C. W. Scheele, its discoverer, said that it had the consistency of cheese; it dissolves in an excess of potassium cyanide.

The uses of silver.—The word *silver* not only refers to the pure unalloyed metal, but to the alloy of silver with one-half, one-third, or other proportional

parts of copper.²⁷ The term *silver bullion* is applied to ingots and bars generally to silver in bulk, as distinguished from silver coin or plate. Silver with appreciable amounts of gold is called *doré silver*. The so-called *refined silver* usually contains from 99.75 to 99.9 per cent. of silver. Silver of a still higher degree of purity is called *fine silver*. Gold and silver are much used for ornaments, jewellery, coinage, etc. Fine silver is too soft to be sufficiently durable for coinage, and many other purposes; the pure metal is therefore alloyed with other hardening metals—usually copper. British coinage is very nearly 925 fine and contains 92.5 per cent. of silver, and 7.5 per cent. of another metal which is nearly always copper. This is the *standard silver* or *sterling silver* required by law for coinage and silver plate, so that sterling silver is 925 fine. This peculiar standard originated with the particular system of weights in use in the sixteenth century. From very early times, the fineness of silver coinage has been measured in terms of the division of the troy pound:

Pound.	Ounces.	Pennyweights (dwts.).	Grains.
1	12	240	5760
	1	20	480
		1	24

Consequently the so-called *standard* of sterling silver is 11 ozs. 2 dwts. or 5328 grains of silver, and 18 dwts. or 432 grains of the other metal. The English term *standard* is equivalent to the French *titre*, excepting that in France the unit of weight is the kgrm. or 1000 grms. British coin in France thus has the *titre* or standard 925. The chemist regards standard silver as an alloy of silver and copper; the bullion-dealer or assayer says that it is silver containing 18 dwts. of *alloy* per lb. troy. There are thus two meanings to the word *alloy*. The term *base metal* is also used synonymously with *alloy* when used in the last-named sense. S. Johnson, in his *Dictionary of the English Language* (London, 1805), said that “*alloy* or *alloy* is derived by some from *à la loi*, according to law; by others from *allier*, to unite; perhaps from *allocare*, to put together.”

Standard silver 925 fine was established for British silver coinage in the reign of Henry II., and it has so remained for 600 years, excepting a period of 20 years—from the end of the reign of Henry VIII. to the beginning of the reign of Elizabeth—when it was more or less debased. In the early accounts the standard of fineness is spoken of as the “old standard of England” or the “Easterling alloy.” The inhabitants of Eastern Germany in the twelfth and thirteenth centuries were called Easterlings, and their money was famous for its purity, and Henry II. imported some Easterling coins to improve the quality of the debased British currency. Hence, said J. Stow,²⁸ “The money of England was called of the workers thereof, and so the Easterling pence took their name of the Easterlings, which did first make this money in England in the reign of Henry II.” Hence arose the term *sterling* applied to the gold and silver.

A second legal standard introduced in 1696 allows 11 ozs. 10 dwts. of silver per pound troy, or 958.3 per thousand, but the alloy is seldom used because it is so much softer than sterling silver. It is known as *Britannia silver* because that stamped at Birmingham and Sheffield had a stamp with the figure of a woman commonly known as *Britannia*, instead of the lion passant stamp used for sterling silver. The same alloy stamped elsewhere had a stamp with a lion's head erased (*i.e.* without the body). The stamp includes also the initials of the maker; the heraldic representation of the assay office, and the year of assay by a letter which is changed every year. The payment of duty is represented by the Sovereign's head.²⁹ Most other countries use silver 900-fine for coinage, and foreign plate is usually 800 to 950 fine. The American dollar has 90 per cent. of silver. According to L. J. Chaudet,³⁰ the silver coin of France has 97 to 103 parts of copper in 1000 parts. The composition of the coins of the world is discussed in J. C. Nelkenbrecher's *Allgemeines Taschenbuch* (Berlin, 1858). J. A. Phillips found 5 to 8 per cent. of silver in some old Roman coins dated Claudius Sothicus, A.D. 268; and another Tacitus, A.D. 275. Silver ornaments made from standard silver can be heated in air to oxidize the copper near the surface of the metal, the resulting copper oxide

is removed by digestion with sulphuric acid leaving a superficial layer of silver. The effect so produced is called *frosted silver*.

Objects made of base metals or their alloys—copper, brass, German silver, etc.—can be silvered or gilded to give them the appearance of having been made of the more precious metal. If the coating of precious metal be thin, they are said to be *silvered* or *gilded*; and if thick, *gold-plated* or *silver-plated*. Many small articles can be silvered directly by a simple immersion in a warm soln. of silver chloride in sodium sulphite, sodium thiosulphate, cream of tartar, etc. Glass can be silvered by precipitating the silver while the vessel is immersed in an alkaline soln. of silver in the presence of a suitable reducing agent—milk-sugar,³¹ formaldehyde, etc.

V. Kohlschütter and T. Toropoff³² obtained *black silver* by the action of organic reducing agents on silver soln., by the action of zinc, copper, and cadmium on dil. soln. of silver salts; and electrolytically from dil. soln. by the use of comparatively high current densities. Black silver is considered to be silver in a condition between the colloidal and the crystalline states, for it appears crystalline microscopically, but it behaves as a colloid towards electrolytes. Black silver cannot be preserved, for it speedily changes into grey or white crystalline silver. If the current be stopped during its preparation by electrolysis, it begins to pass over into grey crystalline silver, as evidenced by the change in colour, and the apparent shrinkage of the mass. However, no real volume change occurs in the passage from coherent massive silver, to silver black, and then to grey crystalline silver. The formation of black silver is attributed to the lack of crystal centres, so that each discharged ion finds itself more or less isolated, and consequently deposits as such, and does not attach itself to a crystal centre with the formation of the grey, crystalline silver. The sudden change to grey silver on breaking the current is explained as an electro-surface tension phenomenon. The black silver with very large surface takes up the form of smallest surface on stopping the current, but while the current is flowing and it is negatively polarized the electrostatic repulsions of the charged particles overcome the tendency to a surface diminution.

The silvering of glass mirrors.—Add ammonia drop by drop to a beaker containing a soln. of 5 grms. of silver nitrate in 9 c.c. of distilled water until the precipitate just redissolves; make the soln. up to 125 c.c. with distilled water; pour this soln. into a beaker containing 5 c.c. of a 4 per cent. soln. of formalin; and at once pour the mixture into a dish containing the glass to be silvered; and rock the dish up and down for about two minutes, when the silvering should be complete. If a muddy deposit is formed, insufficient formalin has been added; and if the process takes place too quickly, too much formalin was used. It is of the greatest importance that the glass to be silvered be scrupulously cleaned, say, by rinsing it first with a sulphuric acid soln. of potassium bichromate, then with water under a tap, and then with distilled water. Dry the glass by rubbing it with a clean linen cloth, and finally rub it with a little absolute alcohol, and soft linen handkerchief. The silvered mirror is rinsed with tap water, and then with distilled water. When dry, polish the mirror with a little of finest rouge on a very soft chamois leather pad.

According to V. Kohlschütter, the film on silvered mirrors is colloidal and amorphous, and it gradually passes into normal silver. L. Hamburger has studied the properties of thin metal films deposited under different conditions. V. Kohlschütter and co-workers have also studied the effect of various conditions on the form of precipitated silver. A. Silvermann and R. M. Howe studied the conditions for the production of silver mirrors.

In *silver plating* a plate of silver is laid on the smooth clean surface of a copper ingot, and the two metals are bound together with wire. A sat. soln. of borax is painted round the edges so that when the compounded metals are heated the borax will melt, and prevent access of air to the surface of the copper, since a film of copper oxide between the silver and the copper would prevent their adhesion. The two metals are sweated together by hammering or rolling just below the m.p. of silver. The compound mass is finely rolled until it has the desired thickness.³³ *Gold plating* is done in a similar manner. The *electroplating of silver* was discovered in 1840 by J. Wright, O. W. Barrett, and A. Parkes—*vide* copper. J. Wright soon

afterwards developed a process in which a soln. of silver cyanide in potassium cyanide was used as electrolyte; and he obtained a thick coherent deposit of silver. This process was patented by G. R. and H. W. Elkington. To make the cyanide electrolyte: dissolve 10.75 grms. of silver nitrate in water, and carefully add a soln. of potassium cyanide so long as a precipitate forms—avoid an excess of the cyanide soln. Wash the precipitate by decantation, and add enough potassium cyanide soln. to dissolve the precipitate, and dilute the soln. to 500 c.c. The object to be silvered is connected with the cathode, and a silver plate is used as anode. For *electroplating gold* a similar process is employed, substituting gold in place of silver.

REFERENCES.

- ¹ J. L. Proust, *Journ. Phys.*, 62, 211, 1806; H. le Chatelier, *Zeit. phys. Chem.*, 1, 516, 1887; 8, 186, 1891; *Bull. Soc. Chim.*, (2), 48, 342, 1887; S. Lucas, *Mem. Manchester Lit. Phil. Soc.*, (2), 3, 271, 1819; *Ann. Chim. Phys.*, (2), 12, 402, 1819; P. F. Chevallot, *ib.*, (2), 13, 299, 1820; J. L. Gay Lussac, *ib.*, (2), 45, 211, 1830; H. St. C. Deville and H. Debray, *ib.*, (3), 56, 385, 1859; 80, 459, 1875; A. Levol, *ib.*, (3), 15, 60, 1845; (3), 39, 167, 1853; *Compt. Rend.*, 35, 63, 1852; M. Berthelot, *ib.*, 131, 1159, 1901; P. Hautefeuille and A. Perrey, *ib.*, 98, 1378, 1884; C. Chabrier, *ib.*, 75, 484, 1872; L. Troost and P. Hautefeuille, *ib.*, 84, 946, 1877; L. Troost, *ib.*, 98, 1427, 1884; J. van der Plaats, *Rec. Trav. Chim. Pays-Bas*, 5, 212, 1886; B. Brauner, *Bull. Acad. Belgique*, (3), 18, 81, 1889; L. Meyer and K. Seubert, *Ber.*, 18, 1098, 1885; W. Manchot, *ib.*, 42, 3942, 1909; G. Neumann, *Monatsh.*, 13, 40, 1893; G. Neumann and F. Streintz, *ib.*, 12, 642, 1891; J. W. Mallet, *Chem. News*, 41, 212, 1880; W. A. Ross, *ib.*, 32, 83, 1875; C. T. Heycock and F. H. Neville, *Journ. Chem. Soc.*, 67, 1024, 1896; T. Graham, *Phil. Trans.*, 156, 399, 1866; A. Sieverts and J. Hagenacker, *Wallach's Festschrift*, 631, 1909; *Zeit. phys. Chem.*, 68, 115, 1910; A. Sieverts and W. Krumbhaar, *ib.*, 74, 277, 1910; A. Sieverts, *ib.*, 60, 129, 1907; A. Sieverts and E. Bergner, *ib.*, 82, 257, 1913; *Ber.*, 45, 2576, 1912; P. A. Guye and F. E. E. Germann, *Journ. Chim. Phys.*, 14, 204, 1916; P. A. Guye, *ib.*, 14, 25, 55, 83, 195, 204, 1916; 15, 360, 405, 1917; 16, 46, 1918; G. H. Baxter, *Amer. Chem. Journ.*, 22, 351, 1899; G. P. Baxter and L. W. Parsons, *ib.*, 44, 577, 1922; H. T. Calvert, *ib.*, 22, 351, 1899; W. G. Duffield, *Phil. Mag.*, (6), 26, 333, 1913; A. Sieverts, *Zeit. Elektrochem.*, 16, 708, 1910; V. Kohlschütter and A. Noll, *ib.*, 18, 424, 1912; H. von Wartenberg, *ib.*, 489, 1913; F. G. Donnan and T. W. A. Shaw, *Journ. Soc. Chem. Ind.*, 29, 987, 1910; V. L. Chrisler, *Phys. Zeit.*, 10, 745, 1909; W. Heald, *ib.*, 8, 659, 1907; T. W. Richards, *Zeit. anorg. Chem.*, 47, 79, 1906; E. Jurisch, *Studien über die Löslichkeit von Gasen in festen Metallen und Legierungen*, Leipzig, 1912; H. Rose, *Pogg. Ann.*, 68, 283, 1846; *Chem. Gaz.*, 4, 484, 1846; C. F. Plattner, *Die metallurgischen Röstprozesse*, Freiberg, 161, 1856; R. Schenk, *Physikalische Chemie der Metalle*, Halle, 91, 116, 1909; J. W. Russell and A. Matthiessen, *Phil. Mag.*, (4), 23, 84, 1862; H. B. Hartley, *Proc. Roy. Soc.*, 90, A, 61, 1914; *Journ. Ind. Eng. Chem.*, 6, 694, 1914; H. von Euler and A. H. Hedalius, *Arkiv Kemi Min. Geol.*, 7, 31, 1920; J. S. Stas, *Mém. Acad. Belg.*, 65, 3, 1865; J. B. A. Dumas, *Ann. Chim. Phys.*, (6), 7, 513, 1886.
- ² E. J. Bartlett and W. F. Rice, *Amer. Chem. Journ.*, 19, 49, 1897; C. Chabrier, *Compt. Rend.*, 75, 484, 1872; M. Berthelot, *ib.*, 131, 1169, 1901; *Ann. Chim. Phys.*, (7), 22, 305, 1901; A. Sieverts, *Zeit. Elektrochem.*, 16, 710, 1910; A. Sieverts and F. Lössner, *Zeit. anorg. Chem.*, 76, 10, 1912.
- ³ C. F. Schönbein, *Journ. prakt. Chem.*, (1), 45, 469, 1866; A. Volta, *Gazz. Chim. Ital.*, 9, 521, 1879; J. C. G. de Marignac and A. de la Rive, *Compt. Rend.*, 20, 808, 1291, 1845; W. Manchot and W. Kampschulte, *Ber.*, 40, 2891, 1907; W. Manchot, *ib.*, 42, 3942, 1909; H. Thiele, *Zeit. öffentl. Chem.*, 12, 11, 1906; R. J. Strutt, *Proc. Roy. Soc.*, 87, A, 302, 1912; O. P. Watts and N. D. Whipple, *Trans. Amer. Electrochem. Soc.*, 32, 257, 1917.
- ⁴ W. Skey, *Chem. News*, 35, 203, 1877; H. St. C. Deville, *Leçons de chimie*, Paris, 309, 1865; F. J. Malaguti and J. Durocher, *Recherches sur l'association de l'argent aux minéraux métalliques*, Paris, 1850; H. V. Regnault, *Ann. Mines*, (3), 11, 33, 1837; A. Vogel, *Repert. Pharm.*, 23, 263, 1826; M. Traube-Mengarini and G. Scala, *Atti Acad. Lincei*, (5), 18, i, 542, 1909; (5), 18, ii, 111, 1909; K. Kahle, *Zeit. Instrum.*, 18, 233, 1898; G. van Dijk, *Arch. Néerl.*, 10, 287, 1905; T. W. Richards, E. Collins, and G. W. Heimrod, *Proc. Amer. Acad.*, 35, 139, 1899; A. Leduc, *Compt. Rend.*, 135, 24, 1902; G. P. Merrill, *Phys. Rev.*, (1), 10, 287, 1905; K. E. Guthe, *Bull. Bur. Standards*, 1, 24, 1905.
- ⁵ H. Moissan, *Bull. Soc. Chim.*, (3), 5, 880, 1891; L. Bruner and E. Bekin, *Zeit. Elektrochem.*, 18, 370, 1912; R. Cowper, *Journ. Chem. Soc.*, 43, 153, 1883; G. Tammann, *Gött. Nach.*, 225, 1919; V. von Cordier, *Monatsh.*, 21, 184, 655, 1900; 22, 707, 1901; J. S. Stas, *Bull. Acad. Belgique*, (2), 10, 239, 1860; H. Gautier and G. Charpy, *Compt. Rend.*, 113, 597, 1891; G. Reboul, *ib.*, 156, 548, 1913; R. G. van Name and G. Edgar, *Amer. Journ. Science*, (4), 29, 237, 1910; C. C. Perkins, *ib.*, (4), 29, 338, 1910; A. Galecky and L. Bruner, *Zeit. Elektrochem.*, 16, 204, 1910; J. H. Kastle, *Amer. Chem. Journ.*, 45, 396, 1911.

* J. L. Gay Lussac and L. J. Thénard, *Recherches physico-chimiques*, Paris, 2, 33, 1811; G. Wetzlar, *Schweigger's Journ.*, 52, 473, 1828; N. W. Fischer, *ib.*, 51, 193, 1827; J. L. Proust, *Journ. Phys.*, 62, 211, 1806; O. P. Watts and N. D. Whipple, *Trans. Amer. Electrochem. Soc.*, 32, 257, 1917; C. W. Scheele, *Examen chemicum fluoris mineralis ejusque acidi*, Upsala, 1771; *Chemical Essays*, London, 172, 1786; A. Jouniaux, *Compt. Rend.*, 129, 835, 1899; 132, 1558, 1901; H. St. C. Deville, *ib.*, 42, 894, 1856; 43, 970, 1856; M. Berthelot, *ib.*, 87, 619, 1878; *Bull. Soc. Chem.*, (2), 35, 487, 1881; J. B. J. D. Bousingault, *Ann. Chim. Phys.*, (2), 54, 253, 1833; J. Stodart and M. Faraday, *Quart. Journ. Science*, 9, 319, 1820; A. Potilitzin, *Journ. Russ Phys. Soc.*, 13, 415, 1881; H. Danneel, *Zeit. phys. Chem.*, 33, 415, 1900; D. Palitsch, *Bull. Acad. Belgique*, 5, 395, 1911.

* K. A. Winkler, *Europäische Amalgamation der Silbererze und silberhaltigen Hüttenprodukte*, Freiberg, 166, 1848; H. Rose, *Pogg. Ann.*, 68, 283, 1846; C. F. Plattner, *Die metallurgischen Röstprozesse*, Freiberg, 1856.

* R. Warington, *Mem. Chem. Soc.*, 2, 47, 1845; *Chem. News*, 23, 253, 1871; A. H. Church, *ib.*, 23, 243, 1871; J. Percy, *Silver and Gold*, London, 1, 67, 1880; A. Schertel, *Journ. prakt. Chem.*, (2), 3, 317, 1871; *Dingler's Journ.*, 201, 52, 1871; F. Rathgen, *The Preservation of Antiquities*, Cambridge, 1905; C. Mitzopoulos, *Berg. Hütt. Ztg.*, 37, 327, 1878; E. von Bibra, *Ueber alte Eisen- und Silberfunde*, Nürnberg, 14, 1873; F. Wieseler, *Der Hildesheimer Silberfunde*, Bonn, 1869; M. Berthelot, *J. de Morgan's Fouilles à Dahchour*, Vienna, 1895; *Ann. Chim. Phys.*, (7), 14, 205, 1898; G. Wetzlar, *Schweigger's Journ.*, 52, 473, 1828; H. St. C. Deville, *L'aluminium, ses propriétés, sa fabrication, et ses applications*, Paris, 33, 1859; J. L. Proust, *Journ. Phys.*, 62, 211, 1806.

* C. J. B. Karsten, *Archiv. Berg. Hütt.*, (2), 25, 175, 1852; J. Percy, *Silver and Gold*, London, 1, 71, 1880; M. C. Lea, *Amer. Journ. Science*, (3), 44, 444, 1892; G. Wetzlar, *Schweigger's Journ.*, 22, 474, 1828; A. Vogel, *Journ. prakt. Chem.*, (1), 8, 107, 1836; G. Campani, *Nuovo Cimento*, (2), 3, 73, 1870; A. Colson, *Compt. Rend.*, 129, 825, 1899; J. N. Brönsted, *Zeit. phys. Chem.*, 50, 481, 1905; C. Jones, *Journ. Soc. Chem. Ind.*, 12, 983, 1893; A. Ditte, *Compt. Rend.*, 93, 415, 1881; A. Seyewetz, *ib.*, 154, 355, 1912; *Bull. Soc. Chim.*, (4), 11, 450, 1912; J. J. Berzelius, *Lehrbuch der Chemie*, Dresden, 1841.

* A. J. Balard, *Ann. Chim. Phys.*, (2), 57, 225, 1834; W. S. Hendrixson, *Journ. Amer. Chem. Soc.*, 25, 637, 1903; C. Zenghelis, *Zeit. phys. Chem.*, 57, 90, 1906; O. P. Watts and N. D. Whipple, *Trans. Amer. Electrochem. Soc.*, 32, 257, 1917.

* W. Spring, *Bull. Acad. Belgique*, (3), 5, 229, 1883; *Ber.*, 16, 324, 1883; 17, 1218, 1884; E. Obach, *Journ. prakt. Chem.*, (2), 18, 258, 1878; J. J. Berzelius, *Pogg. Ann.*, 7, 242, 1826; 8, 423, 1826; B. Brauner, *Journ. Chem. Soc.*, 55, 382, 1889; *Monatsh.*, 10, 411, 1889; A. Orlovsky, *Journ. Russ. Phys. Chem. Soc.*, 13, 848, 1881; J. M. Cabell, *Chem. News*, 50, 208, 1884; H. Pélabon, *Bull. Soc. Chim.*, (3), 21, 402, 1899; *Ann. Chim. Phys.*, (7), 25, 378, 1902; M. Berthelot, *ib.*, (5), 16, 440, 1879; F. L. Hahn, *Zeit. anorg. Chem.*, 99, 118, 1917; E. Beckmann and P. Wäntig, *ib.*, 67, 58, 1910; J. Margottet, *Compt. Rend.*, 84, 1293, 1877; G. Reboul, *ib.*, 156, 548, 1913; E. Prioznik, *Liebig's Ann.*, 164, 46, 1872; G. Strüver, *Atti Accad. Lincei*, (5), 10, i, 233, 1901; *Centr. Min.*, 401, 1901; H. Landolt, *Zeit. phys. Chem.*, 68, 173, 1909; J. Percy, *Silver and Gold*, London, 1, 21, 1880; A. Colson, *Compt. Rend.*, 129, 825, 1899.

* J. Uhl, *Ber.*, 23, 2151, 1890; W. Stahl, *Metal Erz.*, 12, 501, 1916.

* A. Vogel, *Kastner's Archiv.*, 16, 108, 1829; G. Wetzlar, *Schweigger's Journ.*, 23, 94, 1828; P. Braham, *Chem. News*, 42, 163, 1880; J. Keir, *Phil. Trans.*, 80, 367, 1790; C. Friedheim, *Ber.*, 21, 312, 1888; H. Marshall, *Journ. Chem. Soc.*, 59, 775, 1891; E. Divers and T. Shimidzu, *ib.*, 47, 636, 1885; E. Salkowsky, *Chem. Ztg.*, 40, 448, 1916; E. Pannain, *Gazz. Chim. Ital.*, 39, ii, 234, 1909; E. Harbeck, *German Pat.*, D.R.P. 189876, 1906; H. B. North, *Bull. Soc. Chim.*, (4), 9, 646, 1911; R. G. van Name and D. U. Hill, *Amer. Journ. Science*, (4), 45, 54, 1918; O. von der Pfordten, *Ber.*, 20, 3375, 1887; C. Friedheim, *ib.*, 21, 307, 1888; A. Ditte, *Ann. Chim. Phys.*, (6), 19, 98, 1891; M. C. Lea, *Amer. Journ. Science*, (3), 44, 444, 1892; *Zeit. anorg. Chem.*, 3, 180, 1892; W. S. Hendrixson, *Journ. Amer. Chem. Soc.*, 25, 637, 1903; V. Lenher, *ib.*, 24, 354, 1902; O. P. Watts and N. D. Whipple, *Trans. Amer. Electrochem. Soc.*, 32, 257, 1917; J. S. Stas, *Bull. Acad. Belgique*, (2), 9, 322, 1860.

* G. Wetzlar, *Schweigger's Journ.*, 23, 94, 1828; A. Vogel, *Journ. prakt. Chem.*, (1), 20, 365, 1840; J. Percy, *Silver and Gold*, London, 1, 46, 1880; M. C. Lea, *Amer. Journ. Science*, (3), 44, 444, 1892; *Zeit. anorg. Chem.*, 3, 180, 1892; K. Hopfgartner, *Monatsh.*, 26, 469, 1905; H. N. Stokes, *Econ. Geol.*, 1, 644, 1908; *Neues Jahrb. Min.*, i, 248, 1908; V. Kohlschütter and E. Eydmann, *Liebig's Ann.*, 398, 26, 1913; A. A. Noyes and B. F. Brann, *Journ. Amer. Chem. Soc.*, 34, 1016, 1912; F. Wöhler, *Gott. Nachr.*, 97, 1860; *Liebig's Ann.*, 114, 119, 1860.

* M. C. Lea, *Amer. Journ. Science*, (3), 44, 444, 1892; *Zeit. anorg. Chem.*, 3, 180, 1892; J. W. Turrentine, *Journ. Amer. Chem. Soc.*, 33, 803, 1911; E. C. Franklin and C. A. Kraus, *Amer. Chem. Journ.*, 20, 828, 1898; C. Matignon and G. Desplantes, *Compt. Rend.*, 140, 853, 1905.

* P. Sabatier and J. B. Senderens, *Compt. Rend.*, 144, 1429, 1892; H. Hermann, *Zeit. anal. Chem.*, 44, 686, 1905; E. Divers and T. Shimidzu, *Journ. Chem. Soc.*, 47, 630, 1885; J. J. Sudborough, *ib.*, 59, 655, 1891; E. Calberla, *Journ. prakt. Chem.*, (1), 104, 232, 1868; W. Manchof, *Ber.*, 42, 3948, 1909; F. Epstein and R. Doht, *Zeit. anal. Chem.*, 46, 771, 1907; A. Kurtenacker, *ib.*, 51, 639, 1912; M. Oswald, *Compt. Rend.*, 152, 381, 1911; G. Reboul, *ib.*, 156, 548, 1913.

* J. J. Berzelius, *Traité de chimie*, Paris, 4, 274, 1845; N. A. E. Millon, *Ann. Chim. Phys.*,

(3), 6. 98, 1842; *Compt. Rend.*, 14. 904, 1842; J. W. Russell, *Journ. Chem. Soc.*, 27. 3, 1874; *Chem. News*, 28. 277, 1874; V. H. Veley, *Phil. Trans.*, 182. A, 279, 1891; *Proc. Roy. Soc.*, 48. 458, 1891; *Journ. Soc. Chem. Ind.*, 8. 858, 1889; 10. 204, 1891; E. Divers, *ib.*, 23. 1182, 1904; *Journ. Chem. Soc.*, 43. 443, 1883; J. H. Stansbie, *Journ. Soc. Chem. Ind.*, 25. 45, 1071, 1906; 32. 311, 1913; C. Montemartini, *Gazz. Chim. Ital.*, 22. i, 384, 397, 426, 1892; L. Marchlewsky, *Ber.*, 24. 2269, 1891; G. O. Higley, *Amer. Chem. Journ.*, 21. 377, 1899; G. O. Higley and W. E. Davis, *ib.*, 18. 587, 1896; M. C. Lea, *Amer. Journ. Science*, (3), 44. 444, 1892; *Zeit. anorg. Chem.*, 3. 180, 1892; T. C. Choudre, *Journ. Amer. Chem. Soc.*, 37. 2037, 1915; W. R. E. Hodgkinson and A. H. Coote, *B. A. Rep.*, 502, 1904; *Chem. News*, 90. 142, 1904; W. R. E. Hodgkinson, *Journ. Soc. Chem. Ind.*, 32. 519, 1913.

¹⁸ B. Pelletier, *Ann. Chim. Phys.*, (1), 13. 109, 1792; J. Percy, *Silver and Gold*, London, 1. 137, 1880; P. Hautefeuille and A. Perrey, *Compt. Rend.*, 98. 1378, 1884; A. Granger, *ib.*, 124. 896, 1897; O. Emmerring, *Ber.*, 12. 152, 1879; A. Schrötter, *Sitzber. Akad. Wien*, 3. 301, 1849; B. Reinitzer and H. Goldschmidt, *ib.*, 81. 820, 1880; H. Goldschmidt, *Chem. Centrbl.*, 489, 1881; H. N. Warren, *Chem. News*, 56. 113, 1886.

¹⁹ T. Bergmann, *De arsenico*, Stockholm, 1777; *Physical and Chemical Essays* (London, 2. 287, 1788), gives 25 per cent.; C. W. Scheele, *Acta Acad. Stockholm*, 1, 1775; J. Percy, *Silver and Gold*, London, 1. 139, 1880; P. Berthier, *Traité des essais par la voie sèche*, Liège, 2. 671, 1847; P. Hautefeuille and A. Perrey, *Compt. Rend.*, 98. 1378, 1884; W. Spring, *Bull. Acad. Belgique*, (3), 5. 229, 1883; *Ber.*, 16. 324, 1883; K. Friedrich and A. Leroux, *Mét.*, 3. 193, 1906; A. F. Gehlen, *Ann. Chim. Phys.*, 3. 135, 1816.

²⁰ P. Berthier, *Traité des essais par la voie sèche*, Liège, 2. 681, 1847; H. Rose, *Chem. Gaz.*, 6. 412, 1848; G. I. Petrenko, *Zeit. anorg. Chem.*, 50. 133, 1906; K. Endell and H. Hanemann, *ib.*, 83. 267, 1913; C. T. Heycock and F. H. Neville, *Phil. Trans.*, 189. A, 25, 1897; E. Maey, *Zeit. phys. Chem.*, 50. 203, 1905; P. A. von Bonsdorff, *Schweigger's Journ.*, 34. 225, 1822; P. Christoffe, *Recherches sur les combinaisons de l'antimoine avec les différents métaux*, Göttingen, 15, 1863; G. Charpy, *Contribution à l'étude des alliages*, Paris, 149, 1901; *Bull. Soc. d'Encour.*, (5), 2. 384, 1897; H. Gautier, *Contribution à l'étude des alliages*, Paris, 110, 1901; *Bull. Soc. d'Encour.*, (5), 1. 1309, 1896; N. A. Puschin, *Journ. Russ. Phys. Chem. Soc.*, 37. 382, 1905; A. Wright, *Journ. Soc. Chem. Ind.*, 13. 1016, 1894; W. Haken, *Ann. Physik*, (4), 32. 325, 1910; M. le Gris, *Rev. Mét.*, 8. 615, 1911; T. Liebisch, *Sitzber. Akad. Berlin*, 365, 1910; E. Elsässer, *Wied. Ann.*, 8. 455, 1879.

²¹ P. Berthier, *Traité des essais par la voie sèche*, Liège, 2. 682, 1847; R. Schneider, *Sitzber. Akad. Berlin*, 495, 1855; *Chem. Gaz.*, 13. 436, 1855; C. W. Kayser, *Ber.*, 2. 309, 1869; G. I. Petrenko, *Zeit. anorg. Chem.*, 50. 133, 1906; J. Scully, *Chem. News*, 56. 224, 232, 247, 1887; C. M. Marx, *Schweigger's Journ.*, 58. 471, 1830; A. Batelli, *Atti Ist. Veneto*, (6), 5. 19, 1888; E. Maey, *Zeit. phys. Chem.*, 38. 295, 1901; A. Matthiessen and M. Holzmann, *Pogg. Ann.*, 110. 21, 1860; P. von Muschenbrock, *Phil. Trans.*, 33. 370, 1726; A. Wright, *Journ. Soc. Chem. Ind.*, 13. 1016, 1894; C. T. Heycock and F. H. Neville, *Phil. Trans.*, 189. A, 54, 1897; *Journ. Chem. Soc.*, 61. 895, 1892; W. Gowland and Y. Koga, *ib.*, 51. 410, 1887; W. N. Lacey, *Chem. Ztg.*, 36. 1146, 1912.

²² J. L. Gay Lussac, *Ann. Chim. Phys.*, (2), 58. 218, 1835; J. Percy, *Silver and Gold*, London, 1. 129, 1880; M. Berthelot, *Compt. Rend.*, 89. 63, 1879; *Ann. Chim. Phys.*, (5), 18. 378, 1879; (7), 22. 289, 1901; *Bull. Soc. Chim.*, (2), 35. 487, 1881; A. Hébert, *ib.*, (3), 29. 320, 1903; B. Reinitzer and H. Goldschmidt, *Ber.*, 13. 845, 1880; M. C. Lea, *Amer. Journ. Science*, (3), 44. 444, 1892; *Zeit. anorg. Chem.*, 3. 180, 1892; O. Ruff and B. Bergdahl, *ib.*, 106. 76, 1919; E. Salkowsky, *Chem. Ztg.*, 40. 448, 1916; A. Brochet and J. Petit, *Bull. Soc. Chim.*, (3), 31. 359, 1255, 1904; *Chem. News*, 91. 67, 1905; O. P. Watts and N. D. Whipple, *Trans. Amer. Electrochem. Soc.*, 32. 257, 1917.

²³ J. J. Berzelius, *Pogg. Ann.*, 1. 220, 1824; J. Percy, *Silver and Gold*, London, 1. 131, 1880; R. Wynn, *Trans. Roy. Soc. Arts*, 35. 49, 1817; G. Arrivaut, *Zeit. anorg. Chem.*, 60. 439, 1908; *Compt. Rend.*, 147. 859, 1908; H. N. Warren, *Chem. News*, 60. 5, 1889; 67. 303, 1893; G. J. L. de Chalmot, *Amer. Chem. Journ.*, 18. 95, 1896; F. Stromeyer, *Gilbert's Ann.*, 38. 321, 1811; C. Winkler, *Journ. prakt. Chem.*, (1), 91. 193, 1864; V. Kohlschütter, *Zeit. Elektrochem.*, 14. 61, 1908; G. Schulze, *ib.*, 19. 122, 1913; *Ann. Physik*, (4), 40. 335, 1913; E. Warburg, *ib.*, (4), 40. 327, 1913; O. Sackur, *Ber.*, 41. 3356, 1908; H. Moissan, *Ann. Chim. Phys.*, (7), 8. 546, 1896; (7), 9. 272, 330, 1896; *Compt. Rend.*, 121. 621, 1898; E. Vigouroux, *ib.*, 144. 1214, 1907; H. Moissan and F. Siemens, *ib.*, 138. 1299, 1904; *Bull. Soc. Chim.*, (3), 31. 1015, 1904; J. Donau, *Monatsh.*, 25. 913, 1904; R. S. Marsden, *Proc. Roy. Soc.*, 11. 20, 1880; J. J. Berzelius, *Die Anwendung des Löthrohrs in der Chemie und Mineralogie*, Nürnberg, 1821; S. Foden, *Journ. Russ. Phys. Chem. Soc.*, 45. 286, 1913; M. le Blanc and E. Plaschke, *Zeit. Elektrochem.*, 17. 57, 1911; J. C. M. Garnett, *Proc. Roy. Soc.*, 76. A, 370, 1905; F. Wöhler, *Liebig's Ann.*, 137. 369, 1866; J. S. Stas, *Mém. Acad. Belg.*, 35. 3, 1865; H. von Euler, *Zeit. Elektrochem.*, 28. 2, 1922.

²⁴ M. C. Lea, *Amer. Journ. Science*, (3), 44. 444, 1892; *Zeit. anorg. Chem.*, 3. 180, 1893; R. Kremann and F. Noss, *Monatsh.*, 34. 7, 1913; J. M. Eder, *Journ. prakt. Chem.*, (2), 16. 211, 1877; G. McP. Smith, *Zeit. anorg. Chem.*, 82. 66, 1913; O. Ruff and A. Heinzelmann, *ib.*, 72. 63, 1911; O. Ruff and F. W. Tschirch, *Ber.*, 46. 943, 1913; O. P. Watts and N. D. Whipple, *Trans. Amer. Electrochem. Soc.*, 32. 257, 1917; W. Foster, *Chem. News*, 115. 73, 1917; H. B. Giles, *ib.*, 15. 204, 1867.

²⁵ C. E. Wait, *Amer. Chem. Journ.*, 10. 254, 1896; W. L. Dudley, *ib.*, 28. 59, 1902; W. A. Lampadius, *Schweigger's Journ.*, 15. 146, 1815; E. D. Clarke, *Ann. Phil.*, 8. 357, 1816; *Gilbert's Ann.*, 62. 373, 1819; W. E. Barlow, *Journ. Amer. Chem. Soc.*, 28. 1446, 1906; N. N. Beketoff, *Bull. Soc. Chim.*, (2), 37. 491, 1882; A. Chodnew, *Journ. prakt. Chem.*, (1), 22. 222, 1841; W. Dittmar, *Chem. Ztg.*, 15. 1521, 1580, 1891; W. Dittmar and D. Prentice, *ib.*, 12. 248, 1893; M. le Blanc and L. Bergmann, *Ber.*, 42. 4728, 1909; W. G. Mixer, *Amer. Journ. Science*, (4), 32. 202, 1911; P. Bechtereff, *Zeit. Elektrochem.*, 17. 859, 865, 1911; O. P. Watts and N. D. Whipple, *Trans. Amer. Electrochem. Soc.*, 32. 257, 1917.

²⁶ G. S. Whitby, *Ber. Internat. Congress App. Chem.*, 7. 12, 1910; T. W. Richards, *Proc. Amer. Acad.*, 29. 74, 1893; T. W. Richards and R. C. Wells, *Amer. Chem. Journ.*, 31. 233, 1904; *Journ. Amer. Chem. Soc.*, 27. 459, 1905; F. Jackson, *ib.*, 25. 992, 1903; P. Jolibois, R. Bossuet, and M. Chevry, *Compt. Rend.*, 172. 373, 1921; G. J. Mulder, *Die Silber-Probirmethode*, Leipzig, 1859; J. L. Lassaigue, *Journ. Chim. Méd.*, 8. 583, 1832; P. Harting, *Journ. prakt. Chem.*, (1), 22. 52, 1841; *Bull. Sciences Néerl.*, 2. 164, 1841; C. W. Scheele, *Chemical Essays*, London, 395, 1786; C. H. Pfaff, *Handbuch der analytischen Chemie*, Altona, 2. 283, 1821; R. Fresenius, *Anleitung zur qualitativen chemischen Analyse*, Braunschweig, 1843; T. G. Wormley, *Microchemistry of Poisons*, New York, 1879; B. Neumann, *Chem. Ztg.*, 20. 763, 1896; J. S. Stas, *Compt. Rend.*, 73. 998, 1870; *Bull. Acad. Belg.*, (2), 10. 239, 1860; W. Böttger, *Wallach's Festschrift*, 282, 1909; M. Gorsky, *Zeit. anorg. Chem.*, 81. 315, 1913; H. Behrens, *Anleitung zur mikrochemischen Analyse*, Hamburg, 1899; W. Biltz, *Zeit. phys. Chem.*, 53. 288, 1907.

²⁷ T. Snelling, *The Doctrine of Gold and Silver Computations*, London, 1, 1766.

²⁸ J. Stow, *A Survey of London*, London, 1603; E. A. Smith and H. Turner, *Journ. Inst. Metals*, 22. 149, 1919; A. Ryland, *The Assay of Gold and Silver Wares*, London, 2, 1852; *A New Touch-stone for Gold and Silver Wares*, London, 1679; J. Percy, *Silver and Gold*, London, 1. 160, 1880.

²⁹ G. F. Ansell, *A Treatise on Coining*, London, 1862.

³⁰ L. J. Chaudet, *L'art de l'assayeur*, Paris, 355, 1835; J. A. Phillips, *Journ. Chem. Soc.*, 4. 252, 1851.

³¹ R. Kayser, *Zeit. angew. Chem.*, 5. 541, 1890; F. L. O. Wadsworth, *ib.*, 9. 106, 1895; J. von Liebig, *Liebig's Ann.*, 98. 132, 1856; *Liebig's Ann. Suppl.*, 5. 257, 1867; T. Drayton, *Dingler's Journ.*, 92. 472, 1844; 93. 137, 1844; 96. 81, 1845; 98. 292, 458, 1845; H. Vohl, *ib.*, 112. 207, 1849; E. Reichardt, *ib.*, 176. 139, 1865; M. C. Lea, *ib.*, 182. 24, 1866; L. Bowring, *ib.*, 183. 147, 1867; A. Martin, *Compt. Rend.*, 56. 1044, 1863; *Ann. Chim. Phys.*, (4), 15. 94, 1868; C. Krippendorf, *Repert. Pharm.*, 7. 182, 484, 1871; J. E. Lenoir, *Bull. Soc. Enc.*, 75. 19, 1876; F. Bothe, *Journ. prakt. Chem.*, (1), 92. 191, 1864; E. von Furtenbach, *Wiesk's Gew. Ztg.*, 323, 1869; R. Finckh, *Polyt. Centr.*, 617, 1864; W. Siemens, *ib.*, 1097, 1872; R. Böttger, *Chem. Centr.*, 74, 1885; L. Palmieri, *Gazz. Chim. Ital.*, 12. 206, 1882; H. Vogel, *Journ. prakt. Chem.*, (1), 86. 321, 1862; A. B. Drautz, *German Pat.*, D.R.P. 56260, 1890; G. T. Morgan and M. G. Micklethwait, *Journ. Soc. Chem. Ind.*, 21. 1373, 1903; J. Stenhouse, *Mem. Chem. Soc.*, 2. 242, 1845; *Phil. Mag.*, (3), 26. 233, 1845; G. Tammann, *Zeit. anorg. Chem.*, 111. 78, 1920; L. R. Koller, *Phys. Rev.*, (2), 17. 231, 1921; G. W. Stewart, *ib.*, (2), 17. 232, 1921; G. R. Wait, *ib.*, (2), 17. 233, 1921; F. Cremer, *Ind. Blatt.*, 7, 1888.

³² V. Kohlschütter and E. Fischmann, *Liebig's Ann.*, 387. 86, 1912; C. Grimm, *Ann. Physik*, (4), 5. 478, 1901; V. Kohlschütter and T. Toropoff, *Zeit. Elektrochem.*, 19. 161, 1913; V. Kohlschütter, T. Toropoff, and W. Pfander, *ib.*, 19. 169, 1913; V. Kohlschütter and H. Schacht, *ib.*, 19. 172, 1913; V. Kohlschütter, *ib.*, 19. 181, 1913; V. Kohlschütter and A. Noll, *ib.*, 8. 422, 1912; T. Turner, *Proc. Roy. Soc.*, 81. A, 301, 1908; G. T. Beilby, *ib.*, 72. 218, 1902; *Journ. Soc. Chem. Ind.*, 22. 1166, 1903; *Electrochem. Met.*, 3. 806, 1904; R. Pohl and P. Pringsheim, *Ber. deut. phys. Ges.*, 14. 506, 546, 1912; L. Hamburger, *Zeit. Koll.*, 23. 177, 1918; H. Hauschild, *Ann. Physik*, (4), 63. 816, 1920; A. Silvermann and R. M. Howe, *Journ. Ind. Eng. Chem.*, 9. 1032, 1917; H. Lüdtke, *Ueber die Eigenschaften verschiedener Silber-modification*, Greifswald, 1893.

³³ G. B. Brook, *Metal Ind.*, 17. 447, 1920.

§ 8. The Atomic Weight and Valency of Silver

According to H. E. Roscoe and A. Harden,¹ in a notebook dated March, 1804, J. Dalton wrote 150 for the at. wt. of silver when that of oxygen is 5.5, and, later, in his *A New System of Chemical Philosophy* (Manchester, 2. 352, 1810), he gave 100 for the at. wt. if oxygen be 7; if oxygen be 16, Dalton's number becomes virtually 228. In 1817, J. J. G. Meinecke estimated the at. wt. to be 108; and in 1826, L. Gmelin estimated the eq. wt. to have the same numerical value. J. J. Berzelius first adopted a value approximately four times that employed to-day, and later used half his former value, by making the at. wt. of silver 215.94 or 2×107.97 —

with oxygen 16. Assuming as is done to-day that the at. wt. of silver approximates to 108, silver is univalent in the halides; possibly bivalent in the peroxide, Ag_2O_2 , or AgO ; and possibly trivalent in the perhalides, AgI_3 . The at. wt. approximating 108, is in harmony with Avogadro's hypothesis; with Dulong and Petit's rule; with Mitscherlich's rule; and with Mendeléeff's periodic law—*vide* copper.

H. von Wartenberg found the mol. wt. of silver vapour, calculated from vapour density determinations, to be between 107 and 111. The highest value obtained was 145. This leaves little room for doubting that the mol. of silver vapour is monatomic. J. Wislicenus showed that white silver generally behaves as a univalent element, the alleged existence of the suboxide and of the subsalts of this element shows that there is a possibility that silver may act as a bivalent element. M. Traube assumed that silver is bivalent, and wrote silver chloride, Cl.Ag.Ag.Cl , *i.e.* Ag_2Cl_2 . G. A. Barbieri supposed silver to be bivalent in the pernitrate, and in the pyridine complex with silver persulphate, $\text{AgS}_2\text{O}_8 \cdot 4\text{C}_5\text{H}_5\text{N}$, as well as in the mixed crystals of this salt with cupric persulphate. R. Luther and F. Pokorny, and G. A. Barbieri, assumed that silver may also exist as a trivalent element, for example, in the sesquioxide, Ag_2O_3 , and that it is bivalent in the dioxide, Ag_2O_2 . E. Bose and K. Jellinek also believe in the existence of a bivalent silver.

A number of ratios involving various salts containing silver, chlorine, bromine, iodine, sodium, or potassium have been employed to furnish fundamental values for the at. wt. of these elements. The at. wt. of oxygen arbitrarily selected as 16 is the primary standard for the modern table of at. wt., and the relation of the at. wt. of silver to that of oxygen is one of the most important of the secondary standards, since only a few at. wt. can be conveniently related directly with the at. wt. of oxygen, while many are related with that of silver either directly, or through silver with that of chlorine, bromine, or iodine. Consequently, the determination of the at. wt. of silver is of special importance. The at. wt. of silver is not conveniently determined directly from the $\text{Ag} : \text{O}$ ratio in silver oxide. A less direct relation between silver and oxygen is obtained by the analysis of the chlorates, bromates, and iodates, for the ratio $\text{RX} : 3\text{O}$, and when the ratio $\text{Ag} : \text{RX}$ is known, there follows $\text{Ag} : 3\text{O}$. The transformation of, say, potassium chlorate into chloride is susceptible to so many sources of error, that it was a long time before the reaction could be manipulated to furnish values of an acceptable degree of precision. Better results have been obtained by the synthesis of silver nitrate from silver for the ratio $\text{Ag} : \text{NO}_3$, since the relation of nitrogen to the primary standard, oxygen, has been directly determined with a high degree of precision. The subject has been discussed by L. Meyer and K. Seubert, F. W. Clarke, J. D. van der Plaats, B. Brauner, etc. P. A. Guye, and G. P. Baxter and L. W. Parsons have discussed the effect of errors due to the presence of occluded gases and an adherent pellicle of moisture on the at. wt. of silver; G. P. Baxter discussed the effect of solid impurities on the at. wt. determination.

Determination of the silver nitrate ratio.—F. Penny dissolved silver in nitric acid, evaporated the soln. to dryness, and weighed the product. He found for the ratio $\text{Ag} : \text{AgNO}_3 = 100 : 157.4417$; J. C. G. de Marignac obtained $100 : 157.4236$; J. S. Stas obtained in three series of experiments numbers ranging from $100 : 157.474$ to $100 : 157.486$; and T. W. Richards and G. S. Forbes, $100 : 157.479$. E. Turner and F. Penny measured the ratio $\text{AgNO}_3 : \text{AgCl}$, and the former found $100 : 84.373$, and the latter $100 : 84.3744$. J. C. G. de Marignac found the ratio $\text{AgNO}_3 : \text{KCl}$ to be $100 : 43.858$; and J. S. Stas, between $100 : 43.8697$ and $100 : 43.8823$.

The determination of the silver halide ratio.—Analyses of silver chloride were made by C. F. Wenzel, C. F. Bucholz, H. Davy, etc. Between 1811 and 1826, J. J. Berzelius synthesized silver chloride by dissolving silver in nitric acid, and precipitating silver chloride from the soln.; he obtained 83.7 per cent. of silver oxide and 18.7 per cent. of hydrochloric acid; and later 80.9034 and 19.0966. From his data involving two syntheses of silver chloride he got $\text{Ag} : \text{Cl} = 100 : 32.757$; E. Turner repeated Berzelius' work and obtained $100 : 32.832$;

F. Penny, 100 : 32·8363 ; and J. C. G. de Marignac, 100 : 32·839. In these experiments silver chloride was synthesized ; L. Maumené (1846) reduced silver chloride in hydrogen and obtained the ratio 100 : 32·7364. J. B. A. Dumas synthesized silver chloride and found 100 : 32·8755 ; and J. S. Stas synthesized silver chloride directly by heating silver in chlorine ; by passing hydrogen chloride into a soln. of silver nitrate ; and by adding hydrochloric acid to a soln. of silver nitrate he found 100 : 32·8445. T. W. Richards and R. C. Wells found J. S. Stas' result to be affected by errors due to the occlusion of oxygen and possibly also alkalis ; and they found that glass vessels were attacked by the soln. and changed in weight by the acids used in the operations. Hence, T. W. Richards and R. C. Wells worked in porcelain and quartz vessels, and, eliminating the occlusion errors, found the ratio $\text{Ag} : \text{Cl} = 100 : 32\cdot8668$.

The earlier analyses of silver bromide by A. J. Balard, J. von Leibig, J. J. Berzelius, and C. Löwig were made on preparations contaminated with chlorine ; and W. Wallace's specimens were contaminated with arsenic. J. C. G. de Marignac purified his bromine free from chlorine, precipitated silver bromide from a soln. of silver nitrate by potassium bromide, and obtained for the ratio $\text{Ag} : \text{Br} = 100 : 74\cdot077$; J. S. Stas precipitated silver bromide from a soln. of the sulphate and of the nitrate by hydrobromic acid. He obtained the ratio 100 : 74·084 ; O. W. Huntington analyzed silver bromide and found 100 : 74·071 ; T. W. Richards synthesized silver bromide and found 100 : 74·065 ; G. P. Baxter precipitated silver bromide from the nitrate with ammonium bromide, and fused the product in bromine vapour ; he found for the ratio $\text{Ag} : \text{Br}$, 100 : 74·0786. B. Brauner showed that some of J. S. Stas' processes resulted in his samples being contaminated with bromoform ; this made his results a little too high.

J. C. G. de Marignac precipitated silver iodide from a soln. of silver nitrate by means of potassium iodide and obtained for the ratio $\text{Ag} : \text{I}$, 100 : 117·5335 ; J. S. Stas precipitated the iodide with hydriodic acid, and synthesized silver iodide from known weights of iodine and silver ; he obtained 100 : 117·5344. J. C. G. de Marignac's and J. S. Stas' values of this ratio were based on a value for iodine which A. Ladenburg showed was about one-tenth of a unit too low ; and he obtained for the ratio $\text{Ag} : \text{I} = 100 : 117\cdot552$. A. Scott also obtained 100 : 117·6421 (vacuum weighings). P. Köthner and E. Aeuer avoided the error due to the occlusion of silver nitrate by silver iodide, when precipitated by adding hydriodic acid to a soln. of the nitrate ; they also synthesized the iodide by the action of iodine vapour on silver. The mean of the two sets is $\text{Ag} : \text{I} = 100 : 117\cdot6413$. G. P. Baxter precipitated silver iodide, from a soln. of the metal in nitric acid, by means of ammonium iodide in the presence of an excess of ammonia ; he found values for the ratio $\text{Ag} : \text{I}$ varying from 100 : 117·6314 to 100 : 117·6585. G. Gallo obtained for this ratio 100 : 117·5770.

J. C. G. de Marignac measured the ratio $\text{Ag} : \text{KCl}$ and found 100 : 69·062 (weighings in air). Between 1860 and 1882, J. S. Stas also made many series of determinations of this magnitude, and his values ranged from 100 : 69·1033 to 100 : 69·1230. T. W. Richards and E. H. Archibald found 100 : 69·1138 ; E. H. Archibald, 100 : 69·114 ; and T. W. Richards and A. Staehler, 100 : 69·1073. J. C. G. de Marignac found the ratio $\text{Ag} : \text{KBr}$ to be 100 : 110·343 ; and $\text{Ag} : \text{KI}$, 100 : 153·6994. J. S. Stas found for $\text{Ag} : \text{KBr}$, 100 : 110·3463 ; G. Dean, 100 : 110·313 ; and T. W. Richards and E. Mueller, 100 : 110·3190.

T. J. Pelouze found for the ratio $\text{Ag} : \text{NaCl}$, 100 : 54·141 ; J. B. A. Dumas, 100 : 54·172 ; J. S. Stas, 100 : 54·2078 and 100 : 54·20625 ; and T. W. Richards and R. C. Wells, 100 : 54·1854. J. S. Stas also found for the ratio $\text{Ag} : \text{NaBr}$, 100 : 95·4383 to 100 : 95·4426 ; and with a correction for the presence of silica in the alkali bromide, 100 : 95·4376.

The methods employed for determining the ratios $\text{Ag} : \text{NH}_4\text{Cl}$ and $\text{Ag} : \text{NH}_4\text{Br}$ are similar to those employed for the corresponding ratio with sodium and potassium halides. J. T. Pelouze found for $\text{Ag} : \text{NH}_4\text{Cl}$, 100 : 49·5365 ; J. C. G. de Marignac,

100 : 49·523 ; and A. Scott, 100 : 37·3234 ; J. S. Stas' values ranged from 100 : 49·589 to 100 : 49·597. For the ratio $\text{NH}_4\text{Cl} : \text{AgCl}$, T. W. Richards, P. Köthner, and E. Tiede found 100 : 37·32170 ; and A. Scott, 100 : 37·3218. For the ratio $\text{Ag} : \text{NH}_4\text{Br}$, J. S. Stas obtained 100 : 90·8297 ; and A. Scott, 100 : 90·7944. J. J. Berzelius obtained for the ratio $\text{Ag} : \text{KCl}$, 100 : 51·997 ; J. C. G. de Marignac, 100 : 52·011 ; L. Maumemé, 100 : 51·878 ; T. W. Richards, and E. H. Archibald, 100 : 52·0215 ; A. Thiel, 100 : 51·999 ; E. H. Archibald, 100 : 52·024 ; and T. W. Richards and A. Staehler, 100 : 52·0118. V. Rose first determined the ratio $\text{AgCl} : \text{NaCl}$, and J. J. Berzelius found $\text{Ag} : \text{NaCl} = 100 : 40·883$; W. Ramsay and E. Aston, 100 : 40·867 ; and T. W. Richards and R. C. Wells, 100 : 40·7797.

J. B. A. Dumas determined the ratio $\text{AgCl} : \text{AgBr}$ to be 100 : 131·030, while G. P. Baxter found 100 : 131·0173. Similarly J. J. Berzelius found for the ratio $\text{AgCl} : \text{AgI}$, 100 : 163·326 ; J. B. A. Dumas, 100 : 163·733 ; A. Ladenburg, 100 : 163·8257 ; P. Köthner, and E. Aeuer, 100 : 163·8070 ; and G. P. Baxter, 100 : 163·8131.

There are many other determinations in which a chloride has been balanced against silver, and the silver halide produced, weighed. These results were obtained in the determination of the at. wt. of other elements. Thus, V. Lenher converted silver selenite into silver chloride, and reduced the latter to the metal by heating in hydrogen ; W. C. Ebaugh obtained similar results with silver arsenate ; T. W. Richards and E. H. Archibald, with caesium chloride ; E. H. Archibald, rubidium chloride ; G. P. Baxter and F. B. Coffin, cobalt chloride ; G. P. Baxter and M. A. Hines, manganese chloride ; and G. P. Baxter and J. H. Wilson, with lead chloride. In another set of determinations the ratios $\text{RCl} : \text{Ag}$ and $\text{RCl} : \text{AgCl}$ (or the corresponding bromide) have been measured, and this permits a calculation of the ratio $\text{Ag} : \text{Cl}$. T. E. Thorpe's determination of the at. wt. of titanium ; T. E. Richards, barium ; T. W. Richards and H. G. Parker, magnesium ; G. P. Baxter, M. A. Hines, and H. L. Frevert, cadmium ; E. H. Archibald, platinum ; T. W. Richards and H. H. Willard, lithium ; T. E. Thorpe and A. G. Francis, strontium ; T. E. Thorpe and A. P. Laurie, gold ; T. W. Richards and A. S. Cushman, nickel ; T. W. Richards and G. P. Baxter, cobalt ; T. W. Richards and B. S. Merigold, uranium ; J. P. Cooke, antimony ; T. W. Richards and E. F. Rogers, zinc ; G. P. Baxter and A. Thiel, indium ; etc.

Determination of the chlorate, bromate, or iodate ratio.—From analyses of silver chlorate, J. C. G. de Marignac obtained for the ratio $\text{AgCl} : 3\text{O}$, 74·912 : 25·088 ; S. Stas, 74·920 : 25·180. J. S. Stas' analyses of silver bromate gave for the ratio $\text{AgBr} : 3\text{O}$, 79·651 : 20·349. Analyses of silver iodate made by N. A. E. Millon furnished the ratio $\text{AgI} : 3\text{O} = 82·953$; 17·047 ; and J. S. Stas found 83·0253 : 16·9747. G. P. Baxter and G. S. Tilley found the ratio between iodine pentoxide and silver to be $\text{I}_2\text{O}_5 : \text{Ag} = 100 : 64·2229$. The relations between silver and various compounds of carbon—organic acids, etc.—and between various sulphur or oxy-sulphur salts of silver—sulphide, sulphate, etc.—have been determined in connection with the at. wt. of carbon and sulphur. Similar remarks apply to many other elements.

The general result of the older determinations gave the value 107·93 for the at. wt. of silver. The determinations of J. S. Stas furnished the same value 107·93, and W. Ostwald obtained from Stas' results 107·9376 with a probable error $\pm 0·0037$. The deviations from the mean were in general smaller than the probable error calculated from the individual determinations, and consequently he inferred that "none of the five methods employed by J. S. Stas had a constant error." On the mathematical side, the calculation neglected to provide for facts which chemists subsequently found to invalidate the conclusion. As a result, J. S. Stas' value is now regarded as being too high, and what is assumed to be the best representative value is rather less, *viz.* 107·883, when that of oxygen is 16. F. W. Clarke obtained $107·88 \pm 0·00029$ as the best representative value calculated from twenty-nine values deducted from seventy-five different sets of determinations. The minimum was $107·666 \pm 0·029$, and the maximum $108·094 \pm 0·0540$. The modern value for the at. wt. is in close accord with 107·883 obtained by T. W. Richards and G. S. Forbes from the analysis of silver nitrate, and the result is but slightly affected by the small uncertainty in the at. wt. of nitrogen. The International Table for Atomic Weights for 1920 gives 107·88. The **atomic number** of silver is 47.

The electrochemical equivalent of silver.—Special attention has been paid² to the electrochemical eq. of silver because this method affords special facilities for an accurate determination, and for testing Faraday's law, "the quantity of a given metal deposited in an electrolytic cell, or dissolved in a battery cell when there is no local action, depends on the quantity of electricity that passes, and is independent of the time." The value for silver is taken as a basis for calculating the electrochemical eq. of many of the other elements. The reported numbers for the amount of silver deposited per sec. per ampère range from T. W. Richards, E. Collins, and G. W. Heimrod's 1.1172 mgrms. to H. Pellat and A. Potier's 1.1195 mgrms. The earlier determinations were often affected by errors due to the use of filter paper, and impurities—acid, alkali, colloidal matter, etc.—in the voltmeter. The best representative value of the older determinations is 1.1182 mgrms. per sec. per amp., and this makes the charge per ion to be 96540 ± 10 coulombs; and for the more recent measurements, the best representative value is taken to be 1.1175 mgrms. per sec. per amp. This makes the eq. charge, per ion, to be 96580 ± 10 coulombs. The method has also been applied to the determination of the amount of silver in a given quantity of a silver salt. Thus, W. L. Hardin dissolved silver in nitric acid, and the solid was evaporated, dried, and fused. The salt was then mixed with an excess of a soln. of potassium cyanide, and electrolyzed in a platinum dish. The results obtained gave for the ratio $\text{Ag} : \text{AgNO}_3 = 100 : 157.484$.

L. Naudin³ reported some unpublished experiments by P. Schützenberger in which lead freed from silver was found to contain traces of silver after conversion to chloride by chlorine gas followed by reduction with hydrogen, and he claimed that repetitions of the experiment confirmed the result.

REFERENCES.

- ¹ H. E. Roscoe and A. Harden, *A New View of the Origin of Dalton's Atomic Theory*, London, 1896; J. J. G. Meinecke, *Die chemische Messkunst*, Halle, 1817; L. Gmelin, *Handbuch der theoretischen Chemie*, Frankfurt a. M., 1827; E. Turner, *Phil. Trans.*, 119, 291, 1829; 123, 537, 1833; F. Penny, *ib.*, 129, 28, 1839; T. E. Thorpe and A. G. Francis, *Proc. Roy. Soc.*, 83, A, 277, 1910; J. B. A. Dumas, *Ann. Chim. Phys.*, (3), 55, 134, 162, 1859; *ib.*, (6), 7, 513, 1886; L. Maumené, *ib.*, (3), 18, 41, 1846; J. D. van der Plaats, *ib.*, (6), 7, 499, 1886; A. J. Balard, *ib.*, (2), 32, 337, 1826; N. A. E. Millon, *ib.*, (3), 9, 400, 1843; J. S. Stas, *Mém. Acad. Belgique*, 35, 3, 1865; *Œuvres complètes*, Bruxelles, 1894; T. W. Richards and A. Staehler, *Further Researches concerning Atomic Weights*, Washington, 1907; T. W. Richards and R. C. Wells, *A Revision of the Atomic Weights of Sodium and Chlorine*, Washington, 1905; C. Löwig, *Das Brom und seine chemischen Verhältnisse*, Heidelberg, 1829; J. von Liebig, *Schweigger's Journ.*, 48, 108, 1826; W. Ostwald, *Lehrbuch der allgemeinen Chemie*, Leipzig, 1, 41, 1885; T. J. Pelouze, *Compt. Rend.*, 15, 959, 1842; 20, 1047, 1845; P. A. Guye and G. Ter-Gazarian, *ib.*, 143, 411, 1907; J. B. A. Dumas, *ib.*, 86, 65, 1878; J. D. van der Plaats, *ib.*, 116, 1362, 1893; A. Leduc, *ib.*, 116, 383, 1893; W. L. Hardin, *ib.*, 123, 821, 1896; 125, 299, 1897; O. W. Huntington, *Proc. Amer. Acad.*, 17, 28, 1881; G. P. Baxter, *ib.*, 40, 419, 1904; 42, 201, 1906; 41, 73, 419, 1905; T. W. Richards and E. H. Archibald, *ib.*, 38, 443, 1902; T. W. Richards and G. P. Baxter, *ib.*, 33, 115, 1897; 34, 351, 1898; T. W. Richards and B. S. Merigold, *ib.*, 37, 393, 1901; T. W. Richards, *ib.*, 25, 195, 1888; 29, 55, 1891; 43, 116, 1907; T. W. Richards and A. S. Cushman, 33, 97, 1897; J. P. Cooke, *ib.*, 5, 13, 1877; B. Brauner, *Monatsh.*, 10, 422, 1889; A. Ladenburg, *Ber.*, 35, 2275, 1902; W. A. Noyes, *ib.*, 24, 238, 1891; P. Köthner and E. Aeufer, *ib.*, 37, 2536, 1904; *Liebig's Ann.*, 337, 124, 362, 1904; 338, 259, 1904; J. C. G. de Marignac, *Bibl. Univ.*, 40, 145, 1842; *Bibl. Univ. Arch.*, 3, 269, 1846; *Œuvres complètes*, Gêneve, 1, 52, 1902; E. H. Archibald, *Trans. Roy. Soc. Canada*, 3, 47, 1904; *Journ. Chem. Soc.*, 85, 786, 1904; G. Gallo, *Gazz. Chim. Ital.*, 36, 116, 1906; *Atti Accad. Lincei*, (5), 15, 24, 1906; J. J. Berzelius, *Gilbert's Ann.*, 38, 166, 287, 1811; *Schweigger's Journ.*, 23, 107, 1818; *Ann. Phil.*, 15, 89, 1820; *Pogg. Ann.*, 8, 1, 1826; *Journ. Pharm.*, (2), 2, 44, 1818; (1), 21, 87, 1812; *Ann. Chim. Phys.*, (2), 40, 430, 1829; 14, 556, 1828; W. Ramsay and E. Aston, *Journ. Chem. Soc.*, 63, 211, 1893; A. Scott, *ib.*, 79, 167, 1901; T. E. Thorpe, *ib.*, 47, 126, 1883; T. E. Thorpe and A. P. Laurie, *ib.*, 51, 565, 1887; G. Dean, *ib.*, 77, 177, 1900; G. P. Baxter and G. S. Tilley, *Journ. Amer. Chem. Soc.*, 31, 201, 1909; T. W. Richards and E. Mueller, *ib.*, 29, 639, 1907; V. Lenher, *ib.*, 20, 555, 1898; G. P. Baxter and M. A. Hines, *ib.*, 28, 1560, 1906; G. P. Baxter and J. H. Wilson, *ib.*, 30, 187, 1908; G. P. Baxter, *ib.*, 26, 1593, 1904; 27, 879, 1905; 28, 1322, 1906; 44, 577, 1922; G. P. Baxter, M. A. Hines, and H. L. Frevert, *ib.*, 28, 770, 1906; T. W. Richards, P. Köthner, and E. Tiede, *ib.*, 31, 6, 1909; T. W. Richards and G. S. Forbes, *ib.*, 29, 808, 1907; T. W. Richards and H. H. Willard, *ib.*, 32, 4, 1910; W. C. Ebaugh,

ib., 24. 489, 1902; G. P. Baxter and F. B. Coffin, *Zeit. anorg. Chem.*, 51. 171, 1906; A. Bilecki, *ib.*, 110. 339, 1920; A. Thiel, *ib.*, 40. 313, 1904; W. Wallace, *Phil. Mag.*, (4), 18. 279, 1859; W. N. Shaw, *ib.*, (5), 23. 138, 1887; F. W. Clarke, *ib.*, (5), 12. 101, 1881; *Amer. Chem. Journ.*, 3. 263, 1881; H. von Wartenberg, *Ber.*, 39. 381, 1906; J. Wislicenus, *ib.*, 4. 63, 1871; M. Traube, *ib.*, 19. 1117, 1886; G. A. Barbieri, *Atti Accad. Lincei*, (5), 15. i, 500, 1906; (5), 21. i, 561, 1912; *Atti Ist. Veneto*, 70. 899, 1910; *Gazz. Chim. Ital.*, 42. ii, 10, 1912; G. Bredig, *Zeit. Elektrochem.*, 18. 530, 1912; E. Bose, *ib.*, 13. 477, 1907; 14. 85, 314, 1908; R. Luther and F. Pokorny, *Zeit. anorg. Chem.*, 57. 309, 1908; K. Jellinek, *Zeit. phys. Chem.*, 71. 513, 1910; F. H. Loring, *Chem. News*, 108. 188, 1913; A. L. Bernoulli, *Zeit. Elektrochem.*, 13. 551, 1907; B. Berauner, *Chem. Ztg.*, 31. 483, 1907; *Abog's Handbuch der anorganischen Chemie*, Leipzig, 2. i, 177, 1908; P. A. Guye, *Bull. Soc. Chim.*, (3), 35. 1, 1906; *Journ. Chim. Phys.*, 4. 174, 1906; 10. 145, 1912; 11. 275, 1913; 15. 549, 1917; G. D. Hinrichs, *Monit. Scient.*, (4), 21. 733, 1907; (4), 22. 454, 1908; (4), 23. 383, 1909; *Compt. Rend.*, 147. 1302, 1908; 151. 513, 1910; 154. 211, 1912; L. Dubreuil, *ib.*, 147. 856, 1300, 1908; *Bull. Soc. Chim.*, (4), 5. 260, 341, 348, 513, 852, 1049, 1909; C. Scheurer, *Zeit. phys. Chem.*, 68. 575, 1909; T. W. Richards and M. W. Cox, *Chem. News*, 107. 267, 1913; G. P. Baxter, E. Mueller, and M. A. Hines, *Journ. Amer. Chem. Soc.*, 31. 529, 1909; G. P. Baxter and R. H. Jesse, *ib.*, 31. 541, 1909; G. P. Baxter and L. W. Parsons, *ib.*, 44. 577, 1922; C. F. Bucholz, *Beiträge zur Erweiterung und Berichtigung der Chemie*, Erfurt, 1802; C. F. Wenzel, *Lehre von der Verwandtschaft der Körper*, Dresden, 1777; T. W. Richards and E. F. Rogers, *Proc. Amer. Acad.*, 31. 158, 1895; *Chem. News*, 73, 226, 238, 250, 264, 1896; L. Meycr and K. Scubert, *Ber.*, 18. 1098, 1885.

* M. Faraday, *Phil. Trans.*, 123. 23, 1833; J. W. Rodger and W. Watson, *ib.*, 186. A, 631, 1895; A. N. Shaw and H. L. Callender, *ib.*, 214. A, 147, 1914; F. Kohlrausch, *Sitzber. Ges. Phys. Med. Würzburg*, 41, 1884; W. Weber and R. Kohlrausch, *Pogg. Ann.*, 99. 10, 1856; F. and W. Kohlrausch, *Wied. Ann.*, 27. 1, 1886; Lord Rayleigh and H. Sidgwick, *Chem. News*, 49. 171, 1884; *Phil. Trans.*, 179. A, 411, 1889; *Proc. Roy. Soc.*, 36. 448, 1884; 37. 142, 1884; R. T. Glazebrook and S. Skinner, *Phil. Trans.*, 182. A, 567, 1892; A. Schuster and A. W. Crossley, *ib.*, 50. 344, 1892; F. E. Smith, T. Mather, and T. M. Lowry, *ib.*, 80. A, 77, 1908; T. W. Richards, E. Collins, and G. W. Heimrod, *Proc. Amer. Acad.*, 35. 123, 1899; T. W. Richards and N. W. Stull, *ib.*, 38. 409, 1902; T. W. Richards and B. S. Lacy, *Journ. Amer. Chem. Soc.*, 27. 232, 1905; G. P. Baxter, *ib.*, 32. 1602, 1910; S. J. Bates, *ib.*, 34. 1515, 1912; E. W. Washburn and S. J. Bates, *ib.*, 34. 1341, 1912; L. H. Duschak and G. A. Hulett, *Trans. Amer. Electrochem. Soc.*, 12. 257, 1907; J. S. Laird and G. A. Hulett, *ib.*, 22. 345, 1912; G. D. Buckner and G. A. Hulcitt, *ib.*, 22. 374, 1912; E. Cohen, *Zeit. Elektrochem.*, 19. 133, 1913; P. Farup, *ib.*, 8. 569, 1902; W. G. Wilcox, *Journ. Phys. Chem.*, 13. 383, 1909; A. L. Bernoulli, *Zeit. phys. Chem.*, 65. 391, 1909; F. Förster, *ib.*, 66. 643, 1911; F. Laporte, *Ind. Elect.*, 19. 141, 1910; C. Fabry and A. Perot, *Ann. Sciences Marseilles*, 8. 201, 1898; T. M. Lowry, *Trans. Faraday Soc.*, 5. 223, 1910; T. Gray, *Phil. Mag.*, (5), 22. 389, 1886; H. Pellat and A. Leduc, *Compt. Rend.*, 136. 1649, 1903; A. Leduc, *ib.*, 135. 237, 1902; H. Pellat and A. Potier, *Journ. Phys.*, (2), 9. 381, 1890; E. Mascart, *ib.*, (2), 1. 109, 1883; (2), 3. 382, 1884; G. van Dijk, *Arch. Néerl.*, (2), 9. 442, 1905; (2), 10. 227, 1905; *Ann. Physik*, (4), 19. 249, 1906; (4), 21. 845, 1907; K. Kohlrausch, *ib.*, (4), 26. 580, 1908; G. van Dijk and J. Kunst, *ib.*, (4), 14. 569, 1904; K. E. Guthe, *ib.*, (4), 20. 429, 1906; *Bull. Bur. Standards*, 1. 36, 1905; E. B. Rosa, N. E. Dorsey, and J. M. Miller, *ib.*, 8. 369, 1912; E. B. Rosa, G. W. Vinal, and A. S. McDaniel, *ib.*, 8. 367, 1912; G. W. Patterson and K. E. Guthe, *Phys. Rev.*, (1), 7. 257, 1895; K. Kahle, *Wied. Ann.*, 67. 1, 1899; *Zeit. Instr.*, 17. 97, 143, 1896; 18. 276, 1896; H. Haga and J. Boerema, *Arch. Néerl.*, (3), 3. 324, 1914; W. L. Hardin, *Journ. Amer. Chem. Soc.*, 18. 996, 1896.

* L. Naudin, *Monit. Scient.*, (5), 10. 121, 1920.

§ 9. Silver Suboxide, or Silver Quadrantoxide, or Silver Tetratoxide

The well-established oxides of silver are silver oxide or silver monoxide, Ag_2O ; and silver peroxide, Ag_2O_2 . Silver suboxide or quadrantoxide, Ag_4O , is not generally recognized, although there is a score of reports of its formation. Silver tritetratoxide, Ag_4O_3 , and silver hemitrioxide or sesquioxide, Ag_2O_3 , are largely based on reports by M. Berthelot, and are probably non-existent. When silver oxide is dissolved in aq. ammonia, and the pale brownish soln. is exposed to the air in an open vessel, a brilliant pellicle forms on its surface, which, when removed, is succeeded by another, and another, until most of the metal has been separated. This phenomenon was observed by C. L. Berthollet¹ in 1789, and he stated that its production is dependent on the abstraction of ammonia by the atm. M. Faraday analyzed the product, which is an oxide of silver, and said that "there is every reason to believe that its composition is eq. to that of silver monoxide, but

containing about two-thirds the quantity of oxygen found in the common oxide," which makes its formula approximate Ag_3O . H. Vogel stated his belief that Faraday's oxide is a mixture of argentous and argentic oxides, and that the former resulted from the action of light. G. H. Bailey and G. J. Fowler repeated Faraday's experiment and obtained "suboctahedral masses of an iron-grey colour." It was always accompanied by a small quantity of fulminating silver which could not be separated, and by a yellow crystalline substance which appeared after exposing the first product to the air for some days. The analyses and properties agreed with the assumption that Faraday's suboxide is silver oxide modified by the presence of a small amount of fulminating silver.

In 1839, F. Wöhler² announced the formation of a silver suboxide having the composition, Ag_4O . He said that when silver oxalate, mellitate, or citrate is heated in a current of hydrogen to 100° , or thereabouts, mixtures of the free acid with yellow or brown sub-salts are formed, and half the oxygen is given off as water. He then extracted the free acid by washing the mixture with water until the runnings assumed a port wine-red colour; and found the residue in the case of silver citrate had a composition corresponding with that of silver subcitrate. When a soln. of the subcitrate is treated with potassium hydroxide, a black powder is obtained which he assumed without analysis to be a suboxide. From the repetition of F. Wöhler's experiments by S. B. Newbury, and of G. H. Bailey and G. J. Fowler, it appears (i) that considerable quantities of carbon dioxide are evolved during the preparation of the alleged sub-citrate owing to the decomposition of citric acid, so that the reaction is far more complex than F. Wöhler supposed; (ii) that the alleged subcitrate is not a chemical individual because when extracted with ether, it gives a tar-like mass containing much free citric acid; (iii) that the product is a complex mixture of itaconic and other organic acids, all reduction products of citric acid; (iv) that F. Wöhler interrupted the reduction of the citric acid at an arbitrarily selected stage where the less soluble products, by chance, happened to correspond with values approximating to the subcitrate; (v) that the port wine-red soln. of the alleged subcitrate is always turbid and grey by reflected light, and the coloration is due to finely divided silver and silver oxide. The conclusion is drawn that F. Wöhler's suboxide is "a mixture of metallic silver with silver oxide," probably, added W. Muthmann, in a more or less colloidal state.

F. Wöhler, and F. Rautenberg also concluded that a cold ammoniacal soln. of silver chromate, or a warm ammoniacal soln. of silver molybdate, or tungstate is reduced by hydrogen to the lower state of oxidation; but W. Muthmann has shown that it is more probable that the product of the reduction is rather a mixture of more or less colloidal silver with the ordinary silver salt. H. Rose³ reported that a soln. of silver nitrate furnishes black silver suboxide when treated with an alkaline soln. of stannous chloride; but W. Pillitz showed that the precipitate is a mixture of silver and stannic hydroxide. R. Bunsen likewise obtained the alleged black silver suboxide by the action of an alkaline soln. of antimony trioxide on an ammoniacal soln. of silver nitrate, but W. Pillitz showed that the precipitate is a variable mixture of silver, silver oxide, and antimony. A. Sänger obtained what he regarded as silver suboxide by the action of phosphorous acid on silver nitrate in neutral or feeble ammoniacal soln. at ordinary temp.: $8\text{AgNO}_3 + 2\text{H}_3\text{PO}_3 + \text{H}_2\text{O} + 8\text{NH}_3 = \text{Ag}_4\text{O} + \text{Ag}_4(\text{PO}_3)_2 + 8\text{NH}_4\text{NO}_3$. He added that the suboxide decomposes rapidly, particularly if the ammonia is in excess, or the soln. warm; the phosphite is then oxidized to phosphate. According to A. Sieverts, the reduction of ammoniacal soln. of silver salts, or of acidulated soln. of silver phosphate by phosphorous acid gives a black precipitate of silver, not silver suboxide. O. van der Pfordten, and C. F. Rammelsberg have studied this reaction. The former treated an alkali tartrate with silver nitrate and a little sodium hydroxide, and thought that a subsalt, probably subtartrate, is formed, which, with the further action of the alkali, gives a black precipitate of silver suboxide, and he later stated that the precipitate is

silver subhydroxide—possibly $\text{Ag}_4\text{H}_2\text{O}$; but C. Friedheim showed that the precipitate is a mixture of silver, silver oxide, and organic impurities. M. Berthelot found that when pure silver foil is heated to 500° or 550° in dry air or in oxygen, or in a sealed tube, the metal loses its lustre and disintegrates to a yellowish-white powder assumed to be silver suboxide, Ag_4O . The action was said to begin at about 200° ; and no such action is observed with steam, nitrogen, or carbon dioxide. He assumed that silver oxide, Ag_2O , was formed by the oxidation of silver, and that the loss in weight of the silver oxide was due to his sample containing moisture and carbon dioxide, or both, since it is quite difficult to keep silver oxide free from these impurities because they are both rapidly taken up from the air. Under the conditions of these experiments silver, silver oxide, silver suboxide, and oxygen could not all exist in the equilibrium. In the absence of the suboxide, the phase rule shows that equilibrium is possible between silver, silver oxide, and oxygen; while if silver oxide is present, the possible states of equilibrium are between oxygen and silver oxide and suboxide, and between silver suboxide, silver and oxygen. A. Guntz introduced enough potassium permanganate in a glass tube of known contents, to give at 358° a press. of 49 atm., and two side arms in the tube contained respectively silver and silver oxide. After heating three days at 358° , the silver oxide lost in weight 3.39 per cent.—theory for $4\text{Ag}_2\text{O} = 2\text{Ag}_4\text{O} + \text{O}_2$ requires a loss of 3.44 per cent. The metallic silver gained in weight 3.88 per cent.—theory for $8\text{Ag} + \text{O}_2 = 2\text{Ag}_4\text{O}$ requires an increase of 3.67 per cent. The product in both cases was pale brown. G. N. Lewis could only obtain a mixture of silver and silver oxide, and obtained no evidence of the formation of the alleged suboxide.

Many other reactions have been reported to furnish silver suboxide but without an adequate examination of the nature of the product. F. Wöhler,⁴ for instance, says that normal silver phosphate or arsenate is reduced by ferrous sulphate to a black powder which is a mixture of silver and silver suboxide; he also claimed to have made a similar product by boiling normal silver arsenite with a conc. aq. soln. of sodium hydroxide: $2\text{Ag}_3\text{AsO}_3 = \text{Ag}_4\text{O} + 2\text{Ag} + \text{As}_2\text{O}_5$. A. Geuther stated that black silver suboxide is formed when an aq. soln. of silver nitrate is treated with cuprous hydroxide; and H. Rose reported a similar product to be formed when an ammoniacal soln. of silver nitrate or sulphate is digested with ferrous, manganese, or cobaltous sulphate, A. Guntz prepared what he regarded as silver suboxide by the action of steam at 160° on silver subfluoride. F. Glaser reported the formation of silver suboxide when a stream of hydrogen is passed for 22 hrs. at about 34° , and the product does not change after another 15 hrs. action between 47° and 48° . E. Divers and T. Haga say that when a soln. of silver nitrate is treated with hydroxylamine, there is at first a black precipitate of silver suboxide. A. Leduc and M. Labrouste electrolyzed a clear soln. of silver oxide, obtained by the action of baryta on silver nitrate, between platinum electrodes at a press. of 10–12 volts, and noticed that a brown cloud is produced in the neighbourhood of the cathode, at the edges of which light filaments of silver are formed, while there is an abundant evolution of hydrogen. The brown cloud, it is said, “probably consists of silver suboxide.” E. A. Schneider believes that the so-called colloidal silver, prepared from silver nitrate and ferrous citrate, is really silver suboxide, because with hydrochloric acid it forms silver chloride without the escape of hydrogen. Although the alleged silver suboxide is resolved by heat into oxygen and silver, E. Lenssen says that it may be stabilized by the presence of other oxides, so that it can exist at a high temp., for, he added, on melting in a crucible a precipitate of the silver, zinc, and iron sulphides mixed with nitre and sodium carbonate, he found an olive-green crust above the button of silver, and on this rested a lilac-coloured powder containing ferric oxide, zinc oxide, and silver suboxide. According to C. Weltzien, when clean silver foil is dipped into a neutral soln. of hydrogen peroxide, it first becomes covered with bubbles of oxygen, then with a greyish-white film of what he regards as hydrated silver suboxide, $\text{Ag}_4\text{O} \cdot \text{H}_2\text{O}$. This oxide then dissolves, and a small quantity of a greyish-blue substance is precipitated;

when the soln. is exposed to the air, it becomes slightly turbid, and blue owing to the separation of finely-divided silver. Potassium hydroxide precipitates a brownish-black substance; and on evaporation a crystalline residue is formed from which water dissolves hydrated silver suboxide, and leaves translucent red crystals of silver.

This review shows that the evidence for the existence of alleged silver suboxide, Ag_4O , is very unsatisfactory. Where the reactions have been sceptically examined the conclusion is drawn that the suboxide is non-existent, and where they have been sympathetically examined, it is concluded that silver suboxide is a true chemical individual and its properties are described. It seems as if man cannot always balance evidence with a purely logical and unbiassed mind. Logic and temperament each plays its own part in forming his opinions or beliefs. Graphic formulæ have even been put forward. J. Wislicenus,⁵ and M. Traube favour the assumption that the silver atom in the suboxide is bivalent; J. F. Heyes that the oxygen atom is quadrivalent:

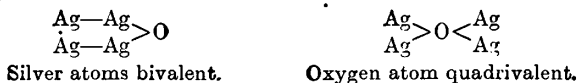

REFERENCES.

- ¹ M. Faraday, *Quart. Journ. Science*, 4, 268, 1818; *Ann. Chim. Phys.*, (2), 9, 107, 1818; C. L. Berthollet, *ib.*, (1), 1, 52, 1789; G. H. Bailey and G. J. Fowler, *Journ. Chem. Soc.*, 51, 416, 1887; H. Vogel, *Journ. prakt. Chem.*, (1), 87, 288, 1862.
- ² F. Wöhler, *Liebig's Ann.*, 30, 1, 1839; F. Rautenberg, *ib.*, 114, 120, 1860; S. B. Newbury, *Amer. Chem. Journ.*, 6, 407, 1885; 8, 196, 1886; G. H. Bailey and G. J. Fowler, *Journ. Chem. Soc.*, 51, 416, 1887; G. H. Bailey, *Chem. News*, 55, 263, 1887; W. Muthmann, *Ber.*, 20, 983, 1887; E. von Bibra, *Journ. prakt. Chem.*, (2), 12, 39, 1875.
- ³ G. Fricke, *Pogg. Ann.*, 12, 285, 1828; H. Rose, *ib.*, 101, 214, 321, 497, 1857; *Sitzber. Akad. Berlin*, 311, 1857; *Chem. Gaz.*, 15, 344, 1857; W. Pillitz, *Zeit. anal. Chem.*, 21, 27, 496, 1882; R. Bunsen, *Liebig's Ann.*, 106, 1, 1858; A. Sieverts, *Zeit. Elektrochem.*, 16, 710, 1910; O. van der Pfordten, *Ber.*, 18, 1407, 1885; 20, 1458, 1887; 21, 307, 1888; C. Friedheim, *ib.*, 21, 307, 1888; C. F. Rammelsberg, *Journ. Chem. Soc.*, 26, 1, 1873; G. H. Bailey, *Chem. News*, 55, 263, 1887; A. Guntz, *Compt. Rend.*, 128, 996, 1899; M. Berthelot, *ib.*, 131, 1159, 1901; G. N. Lewis, *Journ. Amer. Chem. Soc.*, 28, 139, 1906; H. le Chatelier, *Bull. Soc. Chim.*, (2), 48, 342, 1887; *Zeit. phys. Chem.*, 1, 516, 1887; A. Sängner, *Liebig's Ann.*, 232, 14, 1886.
- ⁴ F. Wöhler, *Liebig's Ann.*, 101, 363, 1857; A. Geuther, *ib.*, 114, 121, 1860; C. Weltzien, *ib.*, 138, 129, 1866; 142, 105, 1866; H. Rose, *Ausführliches Handbuch der analytischen Chemie*, Braunschweig, 1, 172, 243, 1851; *Sitzber. Akad. Berlin*, 311, 1857; *Chem. Gaz.*, 15, 344, 1857; A. Guntz, *Compt. Rend.*, 112, 861, 1891; A. Leduc and M. Labrouste, *ib.*, 145, 55, 1907; F. Glaser, *Zeit. anorg. Chem.*, 36, 9, 1903; E. Divers and T. Haga, *Journ. Chem. Soc.*, 47, 203, 1885; E. A. Schneider, *Ber.*, 24, 3370, 1891; E. Lenssen, *Journ. prakt. Chem.*, (1), 85, 96, 1862.
- ⁵ J. Wislicenus, *Ber.*, 4, 63, 1871; M. Traube, *ib.*, 19, 1117, 1886; J. F. Heyes, *Phil. Mag.*, (5), 25, 221, 1888.

§ 10. Silver Oxide

The formation of an oxide of silver when the metal is heated in air or oxygen has been discussed in connection with the action of the gases on the metal. H. le Chatelier¹ first showed that the oxidation of silver is probably a reaction of the balanced type: $2\text{Ag}_2\text{O} \rightleftharpoons 4\text{Ag} + \text{O}_2$, for he obtained a press. of 10 atm. by heating silver oxide in a closed tube at 300° ; and at a press. of 15 atm. in a sealed tube at the same temp., he observed the oxidation of the silver. Hence he placed the decomposition press. of silver oxide between 10 and 15 atm. A. Guntz argued that the observed decomposition press. at 308° is not that of silver oxide, but of silver suboxide. He tried to show that silver oxide first decomposes: $4\text{Ag}_2\text{O} = 2\text{Ag}_4\text{O} + \text{O}_2$, and that the suboxide then decomposes until equilibrium is attained: $2\text{Ag}_4\text{O} = 8\text{Ag} + \text{O}_2$. G. N. Lewis found the equilibrium press. for decomposing silver oxide at 302° to be 20.5 atm.; at

325°, 32 atm.; and at 445°, 207 atm. In no case was there any sign of the formation of any silver suboxide; and the condition of equilibrium is that represented by the equation: $2\text{Ag}_2\text{O} \rightleftharpoons 4\text{Ag} + \text{O}_2$.

Silver oxide was obtained by H. Rose² by heating silver carbonate to 100°. L. Joulin said the decomposition is complete at 225°, but a little of the oxide is simultaneously decomposed. Silver oxide is usually prepared by precipitation from a soln. of the nitrate by means of potassium, sodium, calcium, or barium hydroxide. Care must be taken that these precipitants are free from carbonates and chlorides. According to H. Rose, the washed precipitate should be dried at a temp. between 60° and 70°, and not exceeding 80°. There is some difference of opinion as to the temp. at which the material can be dried without danger of decomposition. According to M. C. Lea, the product retains some water after 20 hrs. drying at 100°, and, with longer drying, some oxygen is lost even at that temp. A. Colson said the temp. can be carried to 200° without decomposing the silver oxide, while H. Rose says a little oxygen is given off at 100°. V. Kohlschütter and E. Eydmann recommended drying the product in vacuo over calcium oxide; W. G. Mixer recommended drying the precipitate two days between 200° and 220°, and an hour at 280°. E. H. Madsen said that only 0.13 per cent. of water is retained at 85°, but only at 280° is all the water lost; at this temp., however, some oxygen is lost. W. L. Hardin said that all his attempts to make pure silver oxide free from water proved unavailing.

W. Gregory, and F. Mohr made silver oxide by boiling freshly precipitated silver chloride with a soln. of potassium hydroxide of sp. gr. 1.25 to 1.30, until a washed sample dissolved completely in nitric acid; if the reaction should not be completed in ten minutes, the lye is poured off, and the product triturated in a mortar, and again boiled with new or the old lye. The product is then washed with boiling water, then with cold water, and lastly dried on the filter paper. J. S. Stas emphasized the difficulty of washing out the alkali from silver oxide prepared by this process.

Pure silver oxide has not been made. If a conc. soln. of silver nitrate is treated with a dil. soln. of sodium hydroxide and the precipitate be washed with water free from carbon dioxide, and dried, a dark brown oxide with a violet tinge is obtained containing between 1 and 2 per cent. of silver hydroxide, and probably traces of silver carbonate. Some reduction of the oxide always occurs because the moist precipitate gives a white silver chloride with hydrochloric acid, while the dried product gives a red-coloured chloride, the colour of which is deeper the higher the drying temp. The oxide also dissociates when the attempt is made to drive off all the moisture.

G. W. Morse³ found that in the electrolysis of the best conductivity water between silver electrodes at 1.40–3.80 volts, with the electrodes 1 mm. apart, a faint brown cloud appears about the anode, and the liquid contains particles which exhibit the Brownian movement. From solubility observations, the particles are considered to be silver oxide. With higher voltages, the silver anode can be wholly converted into the oxide. F. Wöhler electrolyzed a soln. of potassium nitrate with a silver anode, silver oxide was formed, and remaining suspended in the electrolyte, coloured it brown. E. Müller and F. Spitzer also reported the anodic formation of silver oxide by the electrolysis of alkali cyanide or thiosulphate soln. of silver salts; J. S. Hughes and J. R. Withrow, by the electrolysis of silver nitrate which contained sulphuric acid or potassium fluoride, or perchloric acid with ammonia.

A. Lottemoser⁴ prepared colloidal solutions of silver oxide, or hydroxide by mixing $\frac{1}{40}N$ -soln. of silver nitrate and potassium hydroxide. C. Paal and F. Voos treated soln. of a silver protalbinat or lysalbinat with sodium hydroxide; L. Sensburg treated soln. of silver salts with aq. soln. of tannin or related products; and M. Kimura, and L. Wöhler heated silver to redness, and suddenly dipped it in cold water. According to V. Kohlschütter, the yellow coloration of the beads, obtained by fusing silver oxide or borax, is due to colloidal silver. V. Kohlschütter and

J. L. Tüscher prepared silver oxide dispersed in a gaseous medium by making the metal one electrode of an electric arc, and oxidizing the vapour.

H. Vogel added a soln. of 1.156 grms. purified sodium hydroxide in 20 grms. of water to a soln. containing a gram of silver nitrate in 15 grms. of water. He then added ammonia drop by drop until the precipitate dissolved. A violet skin of crystalline oxide forms on the surface of the liquid, and the crystals continue to form for a few weeks. W. Biltz and F. Zimmermann found that if the hydroxide of beryllium, aluminium, indium, zirconium, tin(ic), antimony, or bismuth be precipitated with ammonia, and thoroughly washed free from the precipitant, the product has no action on a $\frac{1}{10}N$ -soln. of silver nitrate; but with some other hydroxides, silver oxide is formed and absorbed; thus, magnesium hydroxide is coloured brownish-yellow; zinc hydroxide pale brown; cadmium hydroxide brownish-yellow; and lead hydroxide, violet-brown. The formation of silver oxide by the oxidation of silver with the dioxides of the metals, potassium nitrate, etc., is discussed in connection with the metal.

H. Rose⁵ said that the purest oxide he could prepare by precipitation was brown and that its colour readily darkens in sunlight. W. Gregory's product was bluish-black. The crystalline masses prepared by H. Vogel were in the form of 4- or 6-rayed stars, and the crystals appeared to belong to the cubic system, for he said that it forms "microscopic isotropic crystals which can be grown in small octahedra." According to W. P. Davey, the **X-radiogram** corresponds with the tetrahedral cubic lattice with the smallest distance apart of the atoms 2.03 Å. According to R. W. G. Wyckoff, the crystals have the same structure as those of cuprous oxide—*i.e.* a face-centred cubic lattice—and the length of the side of unit cube 476×10^{-8} cms.

The **specific gravity** of the oxide is given by T. Herapath⁶ as 7.143 (16.6°); by P. F. G. Boullay as 7.250; by C. J. B. Karsten, 8.2558; by L. Playfair and J. P. Joule, 7.147 (3.9°); and by H. G. F. Schröder as 7.521. The difference in the volume of two mols of silver oxide less four gram-atoms of silver is 20 c.c.

According to M. Berthelot, silver oxide is quite stable at ordinary temp. whether it be dry or moist. P. Berthier⁷ states that silver oxide is *très fusible*, but this statement must be a mistake. The decomposition of the salt during its drying has already been discussed. In addition, H. Rose said that silver oxide begins to decompose and lose oxygen at 250°. According to T. Carnelly and J. Walker, there is a rapid loss of water and a small quantity of oxygen between 100° and 180°, while silver oxide with a small quantity of silver is comparatively stable between 180° and 270°; there is a rapid reduction of silver oxide to metallic silver between 270° and 300°; and the reduction is complete between 300° and 340°. K. Frenzel, S. Fritz, and V. Meyer showed that in a current of air, decomposition begins at 250°. As previously indicated, M. C. Lea found decomposition occurs between 100° and 165°. E. H. Madsen found that there is always some reduction during the drying at 85°–98°, for while the moist precipitate yields a white chloride when treated with hydrochloric acid, the dried salt gives a red chloride, where the colour is deeper the higher the temp. of drying. According to P. Berthier, silver oxide is more stable when it is associated, or in combination, with the oxides of other elements—*e.g.* lead, copper, and manganese—when it is not reducible to the metal by heat alone. L. Joulin found that at 250° the dissociation press. is very feeble, and G. N. Lewis found the decomposition of the oxide at 340° was very slow; at this temp. thermal decomposition of the silver oxide commences very slowly, but proceeds very much more quickly as time goes on. Thus,

Time from commencement	. 10	13	14	16	18	20	21 hrs.
C.c. of oxygen per min.	. 0.017	0.037	0.055	0.25	2	1	0.28

The reaction thus steadily increased in velocity, and reached a maximum speed after about the eighteenth hour; the speed then steadily decreased as is typical of such reactions. The values obtained with silver, prepared in different ways, have a great influence on the speed of decomposition, and G. N. Lewis assumed that the *period of induction* in this reaction is due to the catalytic action of silver produced in the reaction—*autocatalysis* as the phenomenon is called. If silver is initially

mixed with the silver oxide, the decomposition commences at once, and the speed increases with the amount of silver added.

If x denotes the fractional portion of the oxide which has been decomposed at the time t , x is proportional to the quantity of silver present at the time t ; and $1-x$ is the fractional portion of the unchanged silver oxide. The velocity of the reaction was found to be proportional to the amount of silver oxide and silver present in the system, so that

$$\frac{dx}{dt} = kx(1-x); \text{ or } \log \frac{x}{1-x} = kt; \text{ or } \frac{x}{1-x} = e^{kt}$$

where k is a constant which G. N. Lewis found to be $k=4$. The integration is made on the assumption that zero time is calculated when the reaction has its greatest velocity, *i.e.* when $t=0$, $x=1-x$. Consequently, $dx/dt = ke^{kt}(1+ekt)^{-2}$.

Platinum and manganese dioxide act as catalytic agents, and stimulate the speed of decomposition of silver oxide. J. Kendall and F. J. Fuchs found that the addition of cupric oxide, manganese dioxide, ferric oxide, cerium dioxide, silica, and chromium trioxide to silver oxide, mercuric oxide, or barium peroxide increases in every case the rate of evolution of oxygen on heating and in most cases reduces the decomposition temp. The observed values of the **decomposition press.** of silver oxide are indicated above. F. G. Keyes and H. Hara found the press. in atm. are well represented by $\log_{10} p = -2859/T + 6.2853$, the value at 25° calculated from the calorimetric data is 5×10^{-4} , where the heat of decomposition, Q , is related with the change in the vap. press., p , and temp., T , as represented by Clausius' equation, $dp/dT = Q/T(v-V)$, where v is the vol. of oxygen at T° and press. p , and V is the total change in vol. of the solid system, *i.e.* the difference in vol. between 2 mols of silver oxide and 4 gram-atoms of silver. Q is the heat absorbed during the decomposition; if U denotes the internal energy, and $p(v-V)$ the work done during the change; then, if U varies with temp. T as $U = U_0 - aT$, where a is the decrease in the thermal capacity of the system during the decomposition of 2 mols of silver oxide, Clausius' equation becomes $dp/dT = \{U_0 - aT + p(v-V)\}/T(v-V)$. If V is not negligible but is a constant magnitude, integration furnishes:

$$\log \frac{p_1}{p_2} = \frac{U_0}{R} \left(\frac{1}{T_1} - \frac{1}{T_2} \right) + \frac{V}{R} \left(\frac{p_1}{T_1} - \frac{p_2}{T_2} \right) + \frac{R-c}{R} \log \frac{T_1^2}{T_2^2}$$

and with the observed dissociation press. the increase of internal energy accompanying the decomposition of 2 mols of silver oxide, U_0 , is very nearly 13.6 Cals., and at room temp. about 12.8 Cals., so that the **heat of formation** of silver oxide, at room temp., exclusive of external work, is half this value, or 6.4 Cals. J. Thomsen calculated the heat of formation ($2\text{Ag}_2\text{O}$) to be 5.9 Cals. from the observed heat of neutralization of silver oxide, and from the heat of the reaction between copper and silver nitrate; and M. Berthelot similarly obtained ($2\text{Ag}_2\text{O}$), 7.0 Cals.; while W. G. Mixer gives 5.4 Cals. F. G. Keyes and H. Hara give for the external heat of the reaction $Q = 6582p(v-20.7)/T$ cal. per mol of oxygen. The external and internal heats, $U = Q - pdv$, minimum values:

	25°	200°	300°	400°	500°	600°	700°	800°
Q	—	13083	13042	13046	13313	14071	14973	15349
U	12640	12142	11907	11712	11751	12204	12760	12840

H. von Wartenberg gives for the heat of formation in the gaseous state 9.8 Cals., calculated from a vap. press. of silver of 2.5×10^{-3} mm., and a vapour pressure of silver oxide of 6.5×10^{-3} at 1453° . The **heat of vaporization** is also calculated to be between -90.6 and -109 Cals. M. de K. Thompson calculated the **free energy** of formation to be 3.31 and also 3.9 Cals. (the total energy is 5.9 Cals.). J. Thomsen gives for the **heat of neutralization**, (Ag_2O , 2HCl aq.), 42.38 Cals.; for (Ag_2O , H_2SO_4 aq.), 14.49 Cals.; and for (Ag_2O , 2HNO_3 aq.), 10.88 Cals.

M. Berthelot gives (Ag_2O , $2\text{HNO}_3\text{aq.}$), $10\cdot4$ Cals.; for (Ag_2O , 2HBraq.), $51\cdot2$ Cals.; and for (Ag_2O , 2Hlaq.), $64\cdot2$ Cals.

The colour of silver oxide gradually deepens when exposed to light, and at the same time H. Rose⁸ found that the compound is decomposed with the evolution of oxygen. According to G. Wetzlar, also, the aq. soln. of silver oxide acquires a reddish colour when exposed to light. After exposure to light, the dry solid yields a red chloride when treated with hydrochloric acid.

The potential of $\text{Ag}_2\text{O}|\text{Ag}$ at 25° in a soln. of potassium hydroxide against a hydrogen electrode with the same electrolyte was found by R. Luther and F. Pokorný⁹ to be $1\cdot172$ volts, and to be independent of the conc. of the electrolyte. P. Bechtereff found that the presence of silver oxide raises the e.m.f. of the $\text{C}|\text{B}_2\text{O}_3\text{fused}|\text{Pt}$ cell less than do the oxides of iron, cobalt, nickel, or copper, because it acts on the platinum electrode by the deposition of silver. A. Leduc and M. Labrouste also studied the electrolysis of an aq. soln. of silver oxide. According to G. Tammann, when ignited zinc oxide is left in a soln. of silver nitrate or sulphate in subdued light, it remains white for a whole day, but in bright light it quickly becomes grey, and, after a quarter of an hour, black. Lead oxide blackens in the same manner, even in subdued light, but less rapidly than in sunlight, and ferric oxide, bismuth oxide, antimonite oxide, and yellow mercuric oxide change in colour more slowly. The blackening is due to the deposition of silver oxide. An ionic exchange is said to take place at the surface of the oxide, controlled, probably, by the electric potentials of the reacting substances. The velocity of the reaction is said to depend on the tendency of the silver oxide to crystallize in the lattice form appropriate to the medium in which the deposition takes place.

Silver oxide is sparingly soluble in water. J. L. Proust,¹⁰ and C. F. Bucholz noted that the aq. soln. has a metallic taste, and N. W. Fischer, and A. Vogel an alkaline reaction, for it turns red litmus blue, and turmeric brown like other strong bases, for, according to A. Bineau, the aq. soln. decomposes the metal halides and oxy-salts, setting free the base as oxide. According to A. Bineau, the solubility is such that 100 parts of water dissolve 33×10^{-3} parts of silver oxide; M. G. Levi gives $6\cdot5 \times 10^{-3}$; R. Böttger, $2\cdot14 \times 10^{-3}$ at $19\cdot96$; and $2\cdot51 \times 10^{-3}$ at $24\cdot94$; R. Abegg and A. J. Cox, $2\cdot1 \times 10^{-3}$ at 25° ; A. A. Noyes and D. A. Kohr, $2\cdot51 \times 10^{-3}$ at 25° . According to G. S. Whitby, the solubility of the oxide increases with time, becoming constant only after 14 days; at first it is $1\cdot72 \times 10^{-3}$ at 20° , and in 14 days it increases to $2\cdot15 \times 10^{-3}$. Silver oxide dissolves in an aq. soln. of *ammonia*, or *ammonium carbonate*; *sodium thiosulphate*; *sodium* or *potassium cyanide*; and the cyanides of the alkaline earths. It is not soluble in aq. soln. of *potassium*, *sodium*, or *barium hydroxide*. E. C. Franklin and C. A. Kraus found silver oxide to be insoluble in *liquid ammonia*; and M. Hamers, insoluble in pure and in sat. aq. soln. of *ethyl acetate* at 18° .

Cold silver oxide was found by A. Colson¹¹ to absorb hydrogen. According to F. Wöhler, and K. Frenzel, S. Fritz, and V. Meyer, silver oxide is reduced by **hydrogen** at 100° ; while F. Glaser said that at 34° silver oxide is reduced to the suboxide, and at 63° to the metal, but the former statement needs revision. S. Hauser gave about 25° for the temp. of reduction. I. W. Fay and A. F. Seeker found that the reduction occurs at 0° , but more slowly. In a sealed tube at 0° fitted with a mercury gauge, the mercury had moved $14\cdot9$ mm. in one day; $18\cdot3$ mm. in 2 days; 39 mm. in 4 days; and 107 mm. in 12 days. A. Colson says that in the reaction between hydrogen and silver oxide, some metal is volatilized. According to V. Kohlschütter, the perfectly dry substances do not react; in presence of a trace of moisture, the reaction takes place even at the ordinary temp. The presence of larger quantities of water retards the change, which always begins at the points of contact of silver oxide and glass. If a little silver oxide dust is distributed over the walls of a flask, which is then filled with hydrogen nearly sat. with aq. vap., minute drops of water can be caused to condense round the silver oxide particles by cooling

one side of the flask. The reduction takes place in these drops much more rapidly than in the dry particles, and, when the drops are evaporated, a film of silver is left on the glass. The film consists of colloidal silver; it does not conduct electricity at first, but soon passes into the ordinary form of the metal. When a suspension of silver oxide in pure water is reduced by hydrogen, the reaction takes place almost exclusively in the contact surface of glass and the soln., the solid oxide being unattacked; the reduced silver is obtained partly as a mirror and partly as a hydrosol. The rate of reduction of the silver oxide increases with the ratio (glass surface)/(vol. of soln.), whilst the ratio hydrosol/mirror diminishes. The nature of the hydrosol obtained depends on the kind of vessel used. Ordinary glass and quartz glass give yellowish-brown soln., Jena glass yields red, blue, or violet soln., whereas platinum gives no hydrosol, all the silver separating as a crystalline deposit on the platinum. The soln. contain dissolved silver hydroxide in addition to the colloidal silver.

According to M. Berthelot, the sesquioxide, Ag_4O_3 , is formed when **ozone** acts on moist silver oxide, or on silver. L. J. Thénard¹² noted that there is a vigorous reaction between **hydrogen peroxide** and silver oxide resulting in the liberation of oxygen, and the separation of silver. T. Bayleigh said that more oxygen is given off than corresponds with the passage of the hydrogen peroxide to water, but M. Berthelot, and E. Mulder maintained that dil. hydrogen peroxide in contact with silver oxide only gives off an amount of oxygen corresponding with the catalytic reduction of the peroxide, the silver oxide is not decomposed. They believed that in the reduction the silver oxide first forms an unstable dioxide, Ag_2O_2 , which acts as intermediate compound in the catalysis. A. von Beyer and V. Villiger, however, observed that all the silver oxide is reduced to the metal if sufficient hydrogen peroxide is present; and M. Berthelot explained this by assuming that in the second phase of the reaction: $2\text{Ag}_2\text{O} + 3\text{H}_2\text{O}_2 = \text{Ag}_4\text{O}_3 + \text{O}_2 + 3\text{H}_2\text{O}$, and that the oxide decomposes: $2\text{Ag}_4\text{O}_3 = 4\text{Ag}_2\text{O} + \text{O}_2$.

According to M. Berthelot, silver **tritetratoxide**, Ag_4O_3 —sometimes called silver sesquioxide—is formed during the catalytic action of hydrogen peroxide on silver or silver oxide in hydrated black flecks, which decompose when the attempt is made to dry them. With dil. acids, the corresponding salt of silver is formed with the evolution of oxygen. The same oxide is said to be formed during the action of ozone on silver or on freshly precipitated silver oxide. He gives for the heat of formation (4Ag, 3O) 21 Cals. A. von Beyer and V. Villiger maintained that M. Berthelot's alleged tetratritoxide does not exist, and that hydrogen dioxide with silver oxide produces metallic silver. The tetratritoxide may be a mixture of silver oxide and dioxide. E. R. Watson supposed it to be produced when ammonia acts on silver dioxide: $6\text{Ag}_2\text{O}_2 + 2\text{NH}_3 = 3\text{Ag}_4\text{O}_3 + \text{N}_2 + 3\text{H}_2\text{O}$. G. Baborovsky and B. Kuzma assumed that silver peroxynitrate or peroxysulphate respectively obtained in the electrolysis of soln. of silver nitrate or sulphate with platinum electrodes is fundamentally silver tetratritoxide, Ag_4O_3 .

J. S. Stas¹³ found moist silver oxide is attacked by **chlorine**, forming a mixture of silver chloride, hypochlorite, and chlorate, and some hypochlorous acid; and A. J. Balard showed that **hypochlorous acid** reacts with silver oxide, forming silver chloride, oxygen, and a little chlorine. L. Bruner and J. Sahbill found that the electrical conductivity of a soln. of **bromine** in nitrobenzene is very much reduced by the addition of silver oxide owing to the formation of complexes. The action was studied by C. W. B. Normand and A. C. Cumming. A. Naquet reported that when **iodine**, suspended in water, is treated with silver oxide, silver iodide and iodic acid are formed. G. L. Fowler and J. Grant, and W. R. Hodgkinson and F. K. S. Lowndes found **potassium chlorate** is oxidized by silver oxide to the perchlorate and silver without the evolution of oxygen.

R. Böttger¹⁴ found that when finely divided **sulphur** is tritreated with silver oxide, the mixture inflames. A. Geuther reported that flowers of sulphur is oxidized by silver oxide and water, forming a little acid silver sulphate; and J. B. Senderens, by heating the mixture in a sealed tube, obtained silver sulphide and sulphate. A. Geuther also found that **sodium pentasulphide** and freshly

precipitated silver oxide from sulphur, silver sulphide, sodium hydroxide, and a little silver sulphate but no dithionate. W. Vaubel, and A. Geuther also found that **sodium thiosulphate** reacts with silver oxide: $\text{Ag}_2\text{O} + \text{Na}_2\text{S}_2\text{O}_3 = \text{Ag}_2\text{S} + \text{Na}_2\text{SO}_4$. R. Böttger found that ignition takes place when silver oxide is triturated with various metal sulphides—**auric sulphide**, black **antimony trisulphide**, and **mercuric sulphide** (realgar or orpiment)—or **selenium**. A. Vogel also boiled **lead sulphide** with silver oxide and water and so obtained lead oxide; **arsenic trisulphide** when similarly treated suffered no change. A. Vogel found that **sulphur dioxide** reacts incompletely with warm silver oxide, forming silver and silver sulphate. It was found by H. B. North and A. M. Hageman that silver oxide in the cold does not attack **thionyl chloride**, but when heated in a sealed tube at 150° , a little silver chloride, etc., is formed.

S. Hauser¹⁵ said that silver oxide is reduced by **ammonia** gas at room temp. Silver oxide is insoluble in liquid ammonia; but it is soluble in aq. ammonia or an aq. soln. of **ammonium carbonate**—*vide infra*. G. Bruni and G. Levi reported the formation of **silver diammino-oxide**, $\text{Ag}_2(\text{NH}_3)_2\text{O}$. P. Sabatier and J. B. Senderens found that **nitric oxide** decomposes silver oxide at 170° . When silver oxide is heated to redness with **ammonium chloride**, a mixture of silver and silver chloride is formed. According to H. Rose, a portion of the silver oxide is reduced to silver, and this is not altered by the ammonium chloride which converts the remainder of the oxide to silver chloride. An alkaline soln. of **hydroxylamine** is vigorously oxidized by silver oxide with the liberation of nitrous oxide, and the formation of a little hyponitrous acid, $\text{H}_2\text{N}_2\text{O}_2$. R. Böttger found that when amorphous **phosphorus** is triturated with silver oxide, the mixture inflames. A. Vogel oxidized **phosphorous acid** with silver oxide. G. Wetzlar found that when a soln. of **sodium phosphate** is shaken with silver oxide until the colour is not changed, the soln. becomes very alkaline, but retains some phosphoric acid.

P. Bechtereff found that the presence of silver oxide stimulates the oxidation of **carbon**. According to A. Colson,¹⁶ **carbon monoxide** reduces silver oxide energetically at 10° , but at -21° there is very little reduction although sometimes the gas is absorbed or replaced by an equal vol. of carbon dioxide, with the formation of silver carbonate. I. W. Fay and A. F. Seeker found appreciable reduction occurs at 0° , and the reaction is more vigorous than with hydrogen. S. Hauser said that the reduction occurs at room temp. C. F. Schlagdenhauffen and M. Pagel found that carbon monoxide is completely converted to the dioxide in its passage over dry silver oxide at 60° . A. Colson found the velocity of the reaction varies with the previous history of the silver oxide. The reaction was also found to be influenced by its humidity. The gas dried by passing through conc. sulphuric acid begins to react at the temp. of a water-bath. K. Frenzel, S. Fritz, and V. Meyer found the heat liberated by the reaction when a current of carbon monoxide is passed over the oxide raised its temp. to 300° . H. Dejust observed that when carbon monoxide acts on dry silver oxide at the ordinary temp., a considerable amount of heat is developed and metallic silver is formed: $\text{Ag}_2\text{O} + \text{CO} = 2\text{Ag} + \text{CO}_2 + 61.2 \text{ Cals.}$ It is sometimes necessary to raise the temp. of the oxide to 40° – 50° before the reaction sets in. The gas also acts slowly on the oxide suspended in water; metallic silver is deposited and a yellowish-brown soln. is formed which also deposits silver. The reaction takes place much more rapidly in ammoniacal soln.; the colourless soln. turns brown, then black, and deposits silver. H. Dejust suggests the possibility of utilizing this reaction for the determination of the amount of carbon monoxide in air. According to A. Gautier, moist silver oxide slowly absorbs carbon monoxide, forming silver subcarbonate, Ag_4CO_3 , along with traces of formic and oxalic acids. N. W. Fischer found that freshly precipitated and moist silver oxide readily absorbs **carbon dioxide** from the atm., and G. N. Lewis shows the possibility of errors arising in analytical work owing to the absorption of moisture and carbon dioxide by silver oxide exposed to the air. G. Wetzlar observed that an aq. soln. of silver oxide is rendered turbid by the passage of a little carbon dioxide, but the soln. becomes

clear with the passage of more carbon dioxide. The property possessed by moist silver oxide of giving up its oxygen at a low temp. is utilized in organic chemistry—*e.g.* for the transformation of organic bromides and chlorides into alcohols. According to L. Vanino, **formaldehyde** reacts with silver oxide in the presence of sodium hydroxide forming sodium formate: $\text{Ag}_2\text{O} + \text{NaOH} + \text{CH}_2\text{O} = 2\text{Ag} + \text{H}_2\text{O} + \text{HCOONa}$, while, according to H. Wieland, dry formaldehyde is reduced to carbon dioxide; dry **acetaldehyde** does not react, but in the presence of moisture, the reaction is vigorous; **chloral** reacts very slowly if at all; **chloral hydrate** is readily oxidized. H. Vogel oxidized **lactose**; M. A. Gordon, **hydroquinone**; etc. A. Michael and A. Murphy observed that **carbon tetrachloride** reacts at 250° , while a soln. of chlorine in carbon tetrachloride reacts at ordinary temp., forming carbonyl chloride, COCl_2 . The chlorine acts as a catalytic agent.

According to N. W. Fischer,¹⁷ and H. Rose, silver oxide freed from all traces of silver salts—more especially the carbonate—and suspended in water, is completely reduced by the **metals** copper, zinc, cadmium, lead, and tin, while iron, cobalt, nickel, or the other metals which precipitate silver from soln. of the silver salts, are without action. F. J. Malaguti and J. Durocher found silver oxide is readily reduced by mercury and the resulting silver forms an amalgam. C. Winkler found that when a mixture of silver oxide and magnesium is heated in a sealed tube, the reaction proceeds with explosive violence. According to N. W. Fischer, an ammoniacal soln. of silver oxide is rapidly reduced by zinc, copper, and arsenic; more slowly by cadmium, mercury, tellurium, and lead; to a slight extent by manganese and antimony; and not at all by bismuth, tin, iron, and nickel, etc.

On account of its relative solubility, H. Rose found that silver is completely exchanged by the metals: beryllium, aluminium, chromium, gold, iron, cobalt, copper, zinc, bismuth, and mercury; and the replacement is only partial with salts of yttrium, manganese, nickel, cadmium, and lead; and but slight with the salts of calcium and magnesium—the halogen salts excepted. According to J. Persoz, also, boiling aq. soln. of cobalt, nickel, cerium, cadmium, magnesium, or copper dissolve silver oxide with the separation of the corresponding metal oxide. P. Sabatier has shown that with nitrate of copper, the silver is mixed with a basic cupric nitrate—similarly also with the sulphate, chlorate, and thiosulphate. D. Vitali found silver oxide completely decomposes mercurous, mercuric, ferrous, ferric, and cupric nitrates and auric and platonic chlorides; almost completely decomposes cobalt and nickel nitrates; partially decomposes cadmium, manganese, zinc, and aluminium sulphates; and very incompletely decomposes magnesium and calcium sulphates. Stannous chloride, when hot, gives a violet coloration; and a soln. of mercurous chloride, when boiled with silver oxide, gives a green mixture of mercuric oxide and silver subchloride. When chromic hydroxide is boiled in alkaline soln. with an alkali hydroxide and silver oxide, D. Meneghini found the corresponding alkali chromate is formed.

According to G. Wetzlar, and J. Percy, if at ordinary temp. moist silver oxide is added to an aq. soln. of sodium and potassium chlorides, so long as a white precipitate is formed, a soln. of the alkali hydroxide is obtained. The action, however, is not complete; while if the soln. be boiled the reaction reverses and silver oxide is formed as in the preparation of silver oxide by W. Gregory's and F. Mohr's processes (*q.v.*). Similar reactions occur with the alkaline earth chlorides. According to H. Rose, the reaction is complete with magnesium chloride in the cold. The bromides and iodides behave similarly. A. Kusminsky has studied the action of silver oxide on lithium chloride, bromide, and iodide. The alkali hydrocarbonates are converted into carbonates; alkali sulphates are not changed; and aq. soln. of the alkali nitrates dissolve some silver oxide. H. Rose also found calcium nitrate dissolves silver oxide copiously, but not a soln. of barium nitrate; and soln. of magnesium nitrate and sulphate are not changed, although A. Kormilitzine found the former is very slowly changed.

REFERENCES.

- ¹ H. le Chatelier, *Bull. Soc. Chim.*, (2), 48. 342, 1887; *Zeit. phys. Chem.*, 1. 516, 1887; G. N. Lewis, *ib.*, 52. 310, 1905; *Proc. Amer. Acad.*, 40. 719, 1905; *Journ. Amer. Chem. Soc.*, 28. 139, 1906; A. Guntz, *Compt. Rend.*, 128. 996, 1899.
- ² H. Rose, *Pogg. Ann.*, 85. 314, 1852; *Chem. Gazz.*, 10. 182, 1852; L. Joulin, *Ann. Chim. Phys.*, (4), 30. 260, 1873; *Bull. Soc. Chim.*, (2), 19. 349, 1873; A. Colson, *Compt. Rend.*, 127. 961, 1898; 130. 330, 1900; W. Gregory, *Phil. Mag.*, (3), 22. 284, 1839; F. Mohr, *Liebig's Ann.*, 66. 65, 1848; V. Kohlschütter and E. Eydmann, *ib.*, 398. 1, 1913; J. S. Stas, *Mém. Acad. Belgique*, 35. 103, 1865; H. Vogel, *Journ. prakt. Chem.*, (1), 87. 288, 1862; W. G. Mixer, *Amer. Journ. Science*, (4), 32. 203, 1911; M. C. Lea, (3), 44. 249, 1892; E. H. Madsen, *Zeit. anorg. Chem.*, 79. 200, 1913; W. L. Hardin, *Journ. Amer. Chem. Soc.*, 18. 994, 1898; *Compt. Rend.*, 123. 821, 1899.
- ³ F. Wöhler, *Liebig's Ann.*, 146. 264, 1868; E. Müller and F. Spitzer, *Zeit. anorg. Chem.*, 50. 321, 1906; J. S. Hughes and J. R. Withrow, *Journ. Amer. Chem. Soc.* 32. 1571, 1910; G. W. Morse, *Proc. Amer. Acad.*, 45. 371, 1910.
- ⁴ A. Lottermoser, *Journ. prakt. Chem.*, (2), 72. 39, 1905; C. Paal and F. Voos, *Ber.*, 37. 3862, 1904; M. Kimura, *Mem. Coll. Kyoto Univ.*, 5. 211, 1913; L. Wöhler, *Zeit. Koll.*, 11. 241, 1912; L. Cramer, *ib.*, 2. 171, 1907; *Jahrb. Phot.*, 39, 1903; L. Sensburg, *German Pat.*, D.R.P. 208189, 1907; Kalle & Co., *ib.*, 179980, 1900; V. Kohlschütter, *Zeit. Elektrochem.*, 14. 61, 1908; W. P. Davey, *Phys. Rev.* (2), 18. 102, 1921; H. Vogel, *Journ. prakt. Chem.*, (1), 87. 288, 1862; W. Biltz and F. Zimmermann, *Ber.*, 40. 4979, 1908; V. Kohlschütter and J. L. Tüschler, *Zeit. Elektrochem.*, 27. 225, 1921.
- ⁵ H. Rose, *Ausführliches Handbuch der analytischen Chemie*, Braunschweig, 1. 168. 1851; *Pogg. Ann.*, 85. 317, 1852; H. Vogel, *Journ. prakt. Chem.*, (1), 87. 288, 1862; *Pogg. Ann.*, 118. 145, 1863; R. W. G. Wyckoff, *Amer. Journ. Science*, (5), 3. 184, 1922; W. Gregory, *Phil. Mag.*, (3), 22. 284, 1839.
- ⁶ T. Herapath, *Phil. Mag.*, (2), 64. 321, 1824; P. F. G. Boullay, *Ann. Chim. Phys.*, (2), 43. 266, 1830; C. J. B. Karsten, *Schweigger's Journ.*, 65. 394, 1832; L. Playfair and J. P. Joule, *Mem. Chem. Soc.*, 3. 84, 1848; H. G. F. Schröder, *Dichtigkeitsmessungen*, Heidelberg, 3, 1873.
- ⁷ P. Berthier, *Traité des essais par la voie sèche*, Paris, 2. 666, 1834; H. Rose, *Pogg. Ann.*, 85. 317, 1852; L. Joulin, *Bull. Soc. Chim.*, (2), 19. 349, 1873; T. Carnelly and J. Walker, *Journ. Chem. Soc.*, 63. 59, 1888; H. von Wartenberg, *Zeit. Elektrochem.*, 19. 489, 1913; K. Frenzel, S. Fritz, and V. Meyer, *Ber.*, 30. 2515, 1897; M. C. Lea, *Amer. Journ. Science*, (3), 44. 247, 1892; W. G. Mixer, *ib.*, (4), 32. 204, 1911; G. N. Lewis, *Zeit. phys. Chem.*, 52. 310, 1905; 55. 465, 1906; *Journ. Amer. Chem. Soc.*, 28. 139, 1906; M. de K. Thompson, *ib.*, 28. 731, 1906; M. Berthelot, *Ann. Chim. Phys.*, (8), 6. 195, 1905; (5), 15. 185, 1878; (5), 16. 442, 1878; (4), 29. 271, 1873; *Compt. Rend.*, 78. 1177, 1874; J. Thomsen, *Bull. Soc. Chim.*, (2), 16. 63, 1871; *Pogg. Ann.*, 143. 354, 497, 1871; *Thermochemische Untersuchungen*, Leipzig, 3. 381, 1883; E. H. Madsen, *Zeit. anorg. Chem.*, 79. 195, 1913; J. Kendall and F. J. Fuchs, *Journ. Amer. Chem. Soc.*, 43. 2017, 1921; F. G. Keyes and H. Hara, *ib.*, 44. 479, 1922.
- ⁸ G. Wetzlar, *Schweigger's Journ.*, 53. 102, 1828; H. Rose, *Pogg. Ann.*, 85. 317, 1852; E. H. Madsen, *Zeit. anorg. Chem.*, 79. 200, 1913.
- ⁹ R. Luther and F. Pokorny, *Zeit. anorg. Chem.*, 57. 310, 1908; P. Bechtcreff, *Zeit. Elektrochem.*, 17. 869, 1911; A. Leduc and M. Labrouste, *Compt. Rend.*, 145. 55, 1907; G. Tamman, *Zeit. anorg. Chem.*, 114. 151, 1920.
- ¹⁰ J. L. Proust, *Journ. Phys.*, 62. 214, 1806; C. F. Bucholz, *Beiträge zur Erweiterung und Berichtigung der Chemie*, Erfurt, 2. 5, 1800; N. W. Fischer, *Kastner's Archiv.*, 9. 356, 1826; A. Vogel, *Repert. Pharm.*, 30. 93, 1871; A. Bineau, *Compt. Rend.*, 41. 509, 1855; M. G. Levi, *Gazz. Chim. Ital.*, 31. ii, 1, 1901; R. Böttger, *Zeit. phys. Chem.*, 46. 602, 1903; R. Abegg and A. J. Cox, *ib.*, 46. 11, 1903; A. A. Noyes and D. A. Kohr, *ib.*, 42. 342, 1903; G. S. Whitby, *Zeit. anorg. Chem.*, 67. 107, 1910; E. C. Franklin and C. A. Kraus, *Amer. Chem. Journ.*, 20. 828, 1898; M. Hamers, *Verhalten der Halogenverbindungen des Quecksilbers in reinem und in bei 18° mit Wasser gesättigtem Aethylacetat*, Giessen, 1906.
- ¹¹ F. Wöhler, *Liebig's Ann.*, 30. 4, 1839; V. Kohlschütter and E. Eydmann, *ib.*, 398. 8, 1913; V. Kohlschütter, *Zeit. Elektrochem.*, 14. 49, 1908; I. W. Fay and A. F. Seeker, *Journ. Amer. Chem. Soc.*, 25. 641, 1903; F. Glaser, *Zeit. anorg. Chem.*, 36. 1, 1903; K. Frenzel, S. Fritz, and V. Meyer, *Ber.*, 30. 2515, 1897; A. Colson, *Compt. Rend.*, 130. 330, 1900; 132. 467, 1901; S. Hauser, *Ueber Reduktion einiger Metalloxyde durch Gase*, Strassburg, 1907.
- ¹² M. Berthelot, *Bull. Chim. Soc.*, (2), 34. 135, 1880; *Compt. Rend.*, 90. 572, 1880; 132. 897, 1901; 133. 555, 1901; *Ann. Chim. Phys.*, (5), 21. 164, 1880; (7), 23. 52, 1901; (7), 25. 78, 1901; L. J. Thénard, *ib.*, (2), 9. 96, 1818; G. Baborovsky and B. Kuzma, *Zeit. phys. Chem.*, 67. 62, 1909; E. Mulder, *Rec. Trav. Chim. Pays-Bas*, 22. 388, 1904; E. Rieglar, *Bull. Soc. Bucarest*, 4. 78, 1895; T. Bayleigh, *Phil. Mag.*, (5), 7. 126, 1879; A. von Bayer and V. Villiger, *Ber.*, 34. 749, 2769, 1901; E. R. Watson, *Journ. Chem. Soc.*, 89. 578, 1906.
- ¹³ A. J. Balard, *Ann. Chim. Phys.*, (2), 57. 225, 1880; *Taylor's Scientific Memoirs*, 1. 269, 1837; J. S. Stas, *Mém. Acad. Belgique*, 35. 103, 1865; A. Naquet, *Bull. Soc. Chim.*, (1), 1. 126, 1860; W. R. Hodgkinson and F. K. S. Lowndes, *Chem. News*, 59. 63, 1889; G. L. Fowler and J. Grant, *Journ. Chem. Soc.*, 57. 272, 1890; L. Bruner and J. Sahbill, *Zeit. phys. Chem.*, 84. 558, 1913; C. W. B. Normand and A. C. Cumming, *Journ. Chem. Soc.*, 101. 1852, 1912.

¹⁴ A. Geuther, *Liebig's Ann.*, 226. 232, 1884; J. B. Senderens, *Compt. Rend.*, 104. 58, 1887; W. Vaubel, *Ber.*, 22. 1686, 1889; R. Böttger, *Jahrb. phys. Ver. Frankfurt*, 68, 1862; A. Vogel, *Journ. prakt. Chem.*, (1), 20. 362, 1840; H. B. North and A. M. Hageman, *Journ. Amer. Chem. Soc.*, 35. 352, 1913.

¹⁵ R. Böttger, *Jahrb. phys. Ver. Frankfurt*, 68, 1862; A. Vogel, *Journ. prakt. Chem.*, (1), 20. 362, 1840; G. Wetzlar, *Schweigger's Journ.*, 23. 99. 1828; H. Rose, *Chem. Gaz.*, 6. 412, 1848; P. Sabatier and J. B. Senderens, *Compt. Rend.*, 114. 1476, 1892; A. Thum, *Beiträge zur Kenntnis der untersalpitrigen Säure*, Bern, 39, 1893; G. Bruni and G. Levi, *Gazz. Chim. Ital.*, 46. ii, 17, 1916; S. Hauser, *Ueber Reduktion einiger Metalloxyde durch Gase*, Strassburg, 1907.

¹⁶ A. Colson, *Compt. Rend.*, 132. 467, 1901; H. Dejust, *ib.*, 140. 1250, 1905; A. Gautier, *ib.*, 126. 871, 1898; C. F. Schlagdenhauffen and M. Pagel, *ib.*, 128. 309, 1899; G. N. Lewis, *Journ. Amer. Chem. Soc.*, 28. 139, 1906; G. Wetzlar, *Schweigger's Journ.*, 53. 102, 1828; N. W. Fischer, *Kastner's Archiv.*, 9. 356, 1826; H. Rose, *Pogg. Ann.*, 85. 304, 1852; H. Vogel, *ib.*, 117. 333, 1862; K. Frenzel, S. Fritz, and V. Meyer, *Ber.*, 30. 2515, 1897; L. Vanino, *ib.*, 36. 3304, 1903; H. Wieland, *ib.*, 45. 2606, 1912; I. W. Fay and A. F. Seeker, *Journ. Amer. Chem. Soc.*, 25. 641, 1903; S. Hauser, *Ueber Reduktion einiger Metalloxyde durch Gase*, Strassburg, 1907; V. Kohlschütter and E. Eydmann, *Liebig's Ann.*, 398. 8, 1913; V. Kohlschütter, *Zeit. Elektrochem.*, 14. 49, 1908; P. Bechtereff, *ib.*, 17. 869, 1911; M. A. Gordon, *Journ. Phys. Chem.*, 17. 47, 1913; A. Michael and A. Murphy, *Amer. Chem. Journ.*, 44. 365, 1910.

¹⁷ N. W. Fischer, *Pogg. Ann.*, 10. 605, 1827; *Das Verhältniss der chemischen Verwandtschaft zur galvanischen Electricität*, Berlin, 1830; F. J. Malaguti and J. Durocher, *Recherches sur l'association de l'argent aux minéraux métalliques*, Paris, 474, 1850; C. Winkler, *Ber.*, 23. 44, 120, 772, 1890; H. Rose, *Pogg. Ann.*, 101. 321, 1857; *Sitzber. Akad. Berlin*, 245, 1857; *Chem. Gaz.*, 15. 344, 1857; P. Sabatier, *Compt. Rend.*, 125. 175, 1897; 129. 211, 1899; 132. 1538, 1901; J. Persoz, *Introduction à l'étude de la chimie moléculaire*, Paris, 364, 1839; G. Wetzlar, *Schweigger's Journ.*, 23. 99, 1828; J. Percy, *Silver and Gold*, London, 1. 10, 1880; A. Kusminsky, *Journ. Russ. Phys. Chem. Soc.*, 7. 53, 1875; A. Kormilitzine, *ib.*, 1. 488, 1890; D. Vitali, *L'Orosi*, 13. 335, 1891; D. Meneghini, *Gazz. Chim. Ital.*, 42. i, 134, 1912.

§ 11. Silver Hydroxide and Silver Ammino-Hydroxide

H. Rose¹ attempted to make silver hydroxide, AgOH, by the action of lime water on a soln. of silver nitrate, but the product was virtually free from water when dried at 100°; and it contained no hydroxide. It has often been assumed that the moist precipitate, obtained by the action of the hydroxides of the alkaline earths on soln. of silver salts, is silver oxide; thus T. Carnelly and J. Walker say that the product is stable up to 100°, but that it rapidly loses oxygen and water between 100° and 180°. D. Lance found that possibly silver hydroxide, or else silver oxide, is precipitated by heating soln. of the oxide or carbonate in amines, or mixed soln. of the amines and ammonia. J. D. Bruce has shown that dil. eq. soln. of silver nitrate and potassium hydroxide in 90 per cent. alcohol, at ordinary temp., give a granular brown precipitate of silver oxide; but at a low temp., say -45°, the precipitate is almost white, but it soon becomes coloured, and at -40° it is pale brown. The aq. soln. of silver oxide is assumed to contain silver hydroxide. According to V. Kohlschütter, the electrical conductivity of these soln. at 25° is:

$N \times 10^4$.	.	.	2.0	2.2	2.4	3.0	3.2	4.0	4.8	6.4
$k \times 10^6$.	.	.	25.8	27.9	29.3	34.0	39.25	49.6	57.8	73.0

From the electrical conductivity of the soln. containing a mol of the hydroxide in 1783 to 14,264 litres, M. G. Levi calculated the ionization constant to be 1.15×10^{-4} , indicating silver hydroxide to be a stronger base than ammonium hydroxide. The degrees of ionization: $\text{AgOH} \rightleftharpoons \text{Ag}^+ + \text{OH}^-$ are respectively 38.7 and 72.2 per cent. W. Biltz and F. Zimmermann estimate the ionic solubility to be between 2.2×10^{-4} and 3.02×10^{-4} mols per litre. S. Glixelli studied the electroösmosis of colloidal silver hydroxide.

According to A. Reychler, if a conc. aq. soln. of silver monammino-nitrate be dialyzed into water, white needles, whose composition, after washing with alcohol and ether, and drying at a low temp., approximates to silver monammino-hydroxide, are formed. The salt supposed to be silver monammino-nitrate is,

however, but a mixture of silver nitrate and diammino-nitrate. J. Kunckel, in his *Vollständiges Laboratorium chymicum* (Berlin, 1767), described how *fulmen præcipitatum* is obtained as a precipitate by adding *sal volatile urinæ* to a soln. of a silver salt; this product was later called *fulminating silver*—*Knallsilber* or *l'argent fulminant*. About twenty years later, C. L. Berthollet² prepared it by treating precipitated silver oxide with conc. aq. ammonia. The action was accompanied by a noise like that which attends the slaking of lime with water, and after 12 hrs. the film formed on the surface was dissolved by adding fresh aq. ammonia, the clear liquid decanted, and the fulminating silver, which collected at the bottom of the vessel, was dried in separate small portions, on pieces of filter paper. M. Faraday cautiously boiled precipitated silver oxide with an aq. soln. of potassium hydroxide and ammonia. The function of the potassium hydroxide is to remove any carbon dioxide which may have been absorbed by the silver oxide and would otherwise prevent the soln. of the oxide in the aq. ammonia. Another process which has been recommended is to add gradually purified potassium hydroxide to a soln. of silver chloride in conc. ammonia, until no effervescence occurs, when more alkali is added. The black turbid liquid is diluted with water, filtered, and the resulting black powder is washed on the filter and dried, in small portions at a time. Crystals of fulminating silver are also reported to have been obtained by J. L. Proust, B. Higgins, C. L. Berthollet, and J. L. Gay Lussac, as indicated below, by exposing colourless ammoniacal soln. of silver oxide to the air; in addition, F. Raschig by warming this same soln. on a water-bath, or by heating it with alcohol.

The term *fulminating silver* is also applied to *silver fulminate* prepared in 1798 by L. Brugnatelli, by pouring a soln. of one part of silver in 10 parts of nitric acid of sp. gr. 1.36 into 20 parts of 85–90 per cent. alcohol. It separates from the soln. in fine needles, and is regarded as the silver salt, $\text{Ag}_2\text{C}_2\text{N}_2\text{O}_2$, of fulminic acid, $\text{H}_2\text{C}_2\text{N}_2\text{O}_2$, which has not been isolated. The mercury and silver salts are employed in filling percussion caps.

Fulminating silver appears either as a black powder, or in black opaque crystals with a metallic lustre. B. Higgins, and M. H. Klaproth and F. Wolf assumed the crystals are pure fulminating silver, and the black powder a mixture of fulminating silver, metallic silver, and possibly Faraday's suboxide. Dry fulminating silver is instantly decomposed by slight disturbing causes—percussion, friction, heat, etc.; the decomposition is attended by a violent explosion which usually shatters the containing vessel. Thus, F. Raschig says that a drop of water falling directly on the moist product is attended by an explosion. The products of the decomposition are said to be silver, water, and nitrogen. The moist oxide is not so liable to explode as when dry. The composition of fulminating silver is unknown. It may be *silver nitride*, Ag_3N , or *silver imide*, Ag_2NH . F. Raschig's analyses corresponded in one case with Ag_3N ; and in two cases with Ag_2NH . He also observed that fulminating silver is slowly soluble in aq. ammonia; sulphuric acid converts it into silver and ammonium sulphates; and it dissolves in aq. soln. of potassium cyanide without the evolution of gas: $\text{Ag}_3\text{N} + 3\text{KCy} + 3\text{H}_2\text{O} = 3\text{AgCy} + 3\text{KOH} + \text{NH}_3$.

Many of the compounds of silver are dissolved by aqua ammonia, and, in some cases, powerfully detonating and dangerous substances are formed. For example, A. Stock tried to accelerate the dissolution of silver oxide in dil. aq. ammonia by warming, and a vigorous explosion resulted; C. Matignon, also, found an ammoniacal soln. of silver oxide exploded after standing 24 hrs., possibly owing to the drying of fulminating silver on the walls of the glass vessel. A. Sieverts has also emphasized the danger of violent explosions incurred in working with ammoniacal silver soln. Even clear soln., said he, may give rise to explosions.

According to M. Faraday, precipitated silver oxide dissolves completely in aq. ammonia, forming a pale brown soln. On the contrary, J. L. Gay Lussac said that there is always some residue which does not dissolve and which is identical with the so-called fulminating silver; but N. W. Fischer showed that the freshly precipitated oxide dissolves completely, while the dried oxide dissolves only partially.

W. R. Whitney and A. C. Melcher found that the solubility of silver oxide, expressed in C_{Ag} gram-atoms of silver per litre, in aq. ammonia soln., expressed in C_{NH_3} mols of ammonia per litre, at 25° , is

C_{NH_3}	.	.	0.214	0.469	0.720	0.827	0.899	0.999	1.522
C_{Ag}	.	.	0.0654	0.140	0.225	0.248	0.278	0.299	0.470
Ratio	.	.	3.272	3.361	3.196	3.336	3.237	3.344	3.235

So that the solubility in aq. ammonia at 25° is almost exactly proportional to the conc. of the latter between the investigated limits where the ratio $C_{NH_3} \div C_{Ag}$ is virtually constant. The ratio of the solubility eq. to the ammonia conc. is nearly as 1 : 3.31 at 25° ; and 2.53 at 0° . The solubility of silver oxide is thus much greater at 0° than it is at 25° , and the reverse is true for the solubility of the oxide in water. H. von Euler has also measured the solubility of silver oxide in methylamine and in ethylamine.

When the ammoniacal soln. of silver oxide is exposed to the air, or, according to J. L. Proust, when a soln. of silver chloride in aq. ammonia is exposed to the air, or still more readily by the application of heat, black opaque crystals of fulminating silver are deposited. These crystals were found by B. Higgins, M. H. Klaproth and F. Wolff to detonate violently with the slightest disturbance, even that which is produced by agitating the mother liquid in which they are being produced; *au contraire*, according to M. Faraday, the crystals which form at the surface of the soln. are silver suboxide (*q.v.*), while if the soln. be boiled for a few moments, the liquid becomes highly coloured, nitrogen is given off, and a black curdy precipitate of fulminating silver is formed which leaves the liquid colourless; when the colourless liquid is again heated, it is blackened, gives off nitrogen, and deposits a precipitate of silver oxide, not fulminating silver. Other crops of oxide may be obtained by repeating the operation. The liberation of nitrogen therefore does not belong exclusively to the formation of fulminating silver, but seems rather to depend on the production of oxide. When the soln. of silver oxide in ammonia is kept for three months in a closed vessel, oxygen gas is evolved, and the soln. deposits a layer of metallic silver, but no fulminating silver. The soln. gives white precipitates when treated with potassium hydroxide, ether, or alcohol; the precipitates soon change colour, and, after drying, detonate both by heat and by friction. M. Berthelot found that when the ammoniacal soln. is treated with hydrogen peroxide, crystalline silver is precipitated, and oxygen is liberated. N. W. Fischer found that when the soln. is treated with alkali phosphates, chromates, or chlorides, if too much ammonia be not present, the corresponding salt of silver is precipitated. Lead and copper reduce silver from the soln., tin and iron do not. A. Oppenheim found that phosphorus precipitated metallic silver from the boiling soln.; and H. Dejust found that carbon monoxide produced an analogous result.

G. Bruni and G. Levi prepared silver diammino-oxide, $Ag_2O \cdot 2NH_3$. Many investigations on the physical properties of ammoniacal soln. of the silver compounds point to the conclusion that the silver of these compounds exists in soln. as a complex cation, $Ag(NH_3)_2^+$, and in the case of soln. of the oxide, as silver diammino-hydroxide, $Ag(NH_3)_2OH$, or $AgOH \cdot 2NH_3$. For example, A. Reychler³ showed that the f.p. of silver nitrate or sulphate soln. is almost unaffected by the addition of ammonia until 2 mols have been added, when subsequent additions produce the normal lowering. D. Konowaloff, and W. Gaus found that the addition of silver chloride or nitrate to a soln. of ammonia reduced the partial press. of ammonia to a value equal to that of a soln. of ammonia of a conc. less by 2 mols of NH_3 per gram-atom of silver added. M. Berthelot and M. Delépine proved that on mixing dil. soln. of ammonia and of silver nitrate, no heat effect occurs with the addition of an excess of either component beyond that required for the ratio : $Ag : 2NH_3$. G. Bodländer and R. Fittig investigated the solubility relations of silver chloride or bromide in aq. ammonia containing either potassium chloride or silver nitrate, and assuming the mass law is applicable, it follows that the silver is present almost exclusively

as the cation $\text{Ag}(\text{NH}_3)_2^+$; and this conclusion was confirmed by e.m.f. measurements of conc. cells with silver electrodes and soln. containing the same conc. of silver nitrate or chloride, and different conc. of ammonia. The dissociation constant, K , for the breaking up of the complex ion $\text{Ag}(\text{NH}_3)_2$ into the components $[\text{Ag}][\text{NH}_3]_2 = K[\text{Ag}(\text{NH}_3)_2]$ was found to be small. $K=6.88 \times 10^{-8}$; H. von Euler found $K=4.1 \times 10^{-8}$; and A. A. Noyes and D. A. Kohr found $K=7.0 \times 10^{-8}$. W. Bonsdorff found that the strength of silver, cadmium, copper, nickel, and zinc ammino-hydroxides decreases in the order named, and that silver ammino-hydroxide is the strongest base of the series, being more strongly ionized than barium hydroxide, while zinc ammino-hydroxide is a very weak base. H. von Euler made similar investigations with methylamine and ethylamine soln., and found for the former $K=2.45 \times 10^{-7}$, indicating that the methylamine complex $\text{Ag}(\text{NH}_2\text{CH}_3)_2$ is five times less stable than the ammonia complex $\text{Ag}(\text{NH}_3)_2\text{OH}$. W. R. Whitney and A. C. Melcher studied the transport of the ion $\text{Ag}_n(\text{NH}_3)_{2n}$ into neutral soln. of sodium salts; they found the f.p. of ammonia soln. is not affected by the dissolution of the silver oxide; that the eq. conductivity changes so slowly with dilution as to show that the complex salt is completely ionized; and the greater solubility of silver oxide in aq. ammonia at 0° than at 25° , corresponds with the smaller tendency of the complex ion to dissociate into its components at the lower temp.

REFERENCES.

¹ H. Rose, *Pogg. Ann.*, 85. 304, 1852; J. D. Bruce, *Chem. News*, 50. 218, 1884; T. Carnelly and J. Walker, *Journ. Chem. Soc.*, 53. 59, 1888; M. G. Levi, *Gazz. Chim. Ital.*, 31. ii, 1, 1901; W. Biltz and F. Zimmermann, *Ber.*, 40. 4979, 1907; V. Kohlschütter, *Zeit. Elektrochem.*, 14. 54, 1908; V. Kohlschütter and E. Fischmann, *Liebig's Ann.*, 387. 114, 1912; A. Reyehler, *Ber.*, 16. 990, 1883; D. Lance, *German Pat.*, D.R.P. 188793, 1905; R. Lohnstein, *Phys. Zeit.*, 10. 672, 1909; S. Glixelli, *Anz. Acad. Cracow*, 102, 1917.

² C. L. Berthollet, *Ann. Chim. Phys.*, (1), 1. 52, 1789; L. Brugnatelli, *ib.*, (1), 2. 331, 1789; M. Faraday, *Quart. Journ. Science*, 4. 268, 1818; Anon., *Trommsdorff's Journ. Pharm.*, 13. 615, 1804; F. Raschig, *Liebig's Ann.*, 233. 93, 1886; J. L. Proust, *Ann. Phys.*, 62. 211, 1806; J. L. Gay Lussac, *Gilbert's Ann.*, 76. 421, 1823; N. W. Fischer, *Kastner's Archiv*, 9. 357, 1826; B. Higgins, *Minutes of the Society for Philosophical Experiments*, London, 1794; M. H. Klaproth and F. Wolff, *Chemisches Wörterbuch, Suppl.*, 2. 584, 1815; A. Stock, *Ber.*, 39. 1967, 1906; A. Oppenheim, *ib.*, 5. 979, 1872; H. von Euler, *ib.*, 36. 1854, 2878, 1903; W. Bonsdorff, *ib.*, 36. 2322, 1903; *Zeit. anorg. Chem.*, 41. 132, 1904; H. Dejust, *Compt. Rend.*, 140. 1240, 1905; W. R. Whitney and A. C. Melcher, *Journ. Amer. Chem. Soc.*, 25. 69, 1903; C. Matignon, *Bull. Soc. Chim.*, (4), 3. 618, 1908; A. Sieverts, *Zeit. angew. Chem.*, 22. 6, 1909.

³ W. R. Whitney and A. C. Melcher, *Journ. Amer. Chem. Soc.*, 25. 70, 1903; A. Reyehler, *Ber.*, 28. 555, 1895; G. Bodländer and R. Fittig, *Zeit. phys. Chem.*, 39. 597, 1901; A. A. Noyes and D. A. Kohr, *ib.*, 42. 336, 1903; M. Berthelot and M. Delépine, *Compt. Rend.*, 129. 326, 1899; W. Gaus, *Zeit. anorg. Chem.*, 25. 236, 1900; W. Bonsdorff, *ib.*, 41. 132, 1903; *Ber.*, 36. 2322, 1903; H. von Euler, *ib.*, 36. 1854, 2878, 1903; D. Konowaloff, *Journ. Russ. Phys. Chem. Soc.*, 30. 367, 1898; G. Bruni and G. Levi, *Gazz. Chim. Ital.*, 46. ii, 17, 1916.

§ 12. Silver Dioxide; or Silver Peroxide

According to C. F. Schönbein,¹ and J. C. G. de Marignac, ozone acts on silver, producing a black silver peroxide. A. Volta says that the action occurs only when moisture is present; no action occurs if ozone and metal be thoroughly dried. The reaction has been studied by W. Manchot and W. Kampschultze, and H. Thiele—*vide* ozone. J. Schiel says that silver oxide likewise yields silver peroxide when exposed to the action of ozone. H. Erdmann found a soln. of ozone in liquid oxygen immediately blackens the inside of a silver vessel; the coloration clears off rapidly at ordinary temp. It is assumed to be due to the formation of a silver peroxide. A. Mailfert obtained bluish-black silver peroxide by the action of ozone on a soln. of silver nitrate or sulphate; the product with the last-named soln. is the more stable. The peroxidation of silver chloride or cyanide is slow. E. Salkowsky

noted that in the presence of a small amount of alkali hydroxide, a little hydrogen dioxide gives a black precipitate which becomes grey when more hydrogen dioxide is added. The precipitate is considered to be a mixture of silver and silver oxide. According to H. Marshall, a mixture of potassium persulphate, or, according to L. Cramer, ammonium persulphate and silver nitrate, first forms silver persulphate, $\text{Ag}_2\text{S}_2\text{O}_8$, and this immediately decomposes producing black silver peroxide: $\text{Ag}_2\text{S}_2\text{O}_8 + 2\text{H}_2\text{O} = \text{Ag}_2\text{O}_2 + 2\text{H}_2\text{SO}_4$. M. G. Levi, E. Migliorini, and G. Ercolini represented the reaction: $2\text{Ag} + \text{K}_2\text{S}_2\text{O}_8 + \text{H}_2\text{O} \rightarrow \text{Ag}_2\text{O} + \text{K}_2\text{SO}_4 + \text{H}_2\text{SO}_4$, followed by $\text{Ag}_2\text{O} + \text{H}_2\text{SO}_4 = \text{H}_2\text{O} + \text{Ag}_2\text{SO}_4$. From the anodic decomposition curves of soln. of silver nitrate and sulphate, M. Bose concluded that the oxide is Ag_2O_2 . G. I. Higson regarded it as a mixture of peroxide and sulphate. N. Tarugi concluded that the product is the silver salt of Caro's acid: Ag_2SO_5 ; and P. C. Austin concluded that it is a mixture of silver peroxide and persulphate. The following method of preparation is given by P. C. Austin:

Ten grams of silver nitrate dissolved in 100 c.c. of distilled water were added to a soln. of 30 grms. of potassium persulphate in a litre of water, at the ordinary temp., in a large separating funnel, the mixture being thoroughly shaken. The formation of the black precipitate, although not immediate, quickly followed. Owing to the difficulty of filtering such a soln., since the persulphate attacks filter paper, it was kept for about an hour, by which time the bulk of the precipitate had settled and could be drawn off. It was immediately shaken with distilled water, washed three or four times by decantation, and finally filtered and washed again. It was then spread out on a watch-glass and dried in a vacuum desiccator over sulphuric acid. The drying was found to require several days. An analysis of the product showed that it contained 21 per cent. of silver persulphate; 77 per cent. of silver peroxide; and 2.5 per cent. of water.

H. Marshall and J. K. H. Inglis represent the reaction in terms of the ionic hypothesis: $2\text{Ag}^+ + \text{S}_2\text{O}_8^{2-} \rightleftharpoons 2\text{Ag}^{\cdot\cdot} + 2\text{SO}_4^{\cdot-}$. When the conc. of the silver salt and silver peroxide is small in comparison with that of the persulphate, the speed of the peroxidation may be represented by an equation characteristic of a unimolecular reaction, and therefore $dC/dt = kC$, where C denotes the conc. of the persulphate. In the absence of oxidizable substances, hydrolysis may occur with the formation of peroxyhydroxide, oxide, or a basic salt. Ammonia may be oxidized to a nitrate: $4\text{Ag}_2\text{O}_2 + \text{NH}_4^+ + 6\text{H}^+ = 8\text{Ag}^+ + \text{NO}_3^- + 5\text{H}_2\text{O}$. The reaction with ammonium persulphate is eight times as fast at 50° as at 25° ; and it is almost proportional to the conc. of the silver salt. Neutral salts retard the reaction, acids accelerate it—possibly in virtue of the consecutive reaction $2\text{Ag}_2\text{O}_2 + 4\text{H}^+ = 4\text{Ag}^+ + \text{O}_2 + 2\text{H}_2\text{O}$. G. A. Barbieri found that silver oxide in alkaline soln. is partially peroxidized by potassium permanganate—more rapidly hot than cold—in accord with the reversible action: $\text{Ag}_2\text{O} + 2\text{KMnO}_4 + 2\text{NaOH} \rightleftharpoons \text{Ag}_2\text{O}_2 + \text{K}_2\text{MnO}_4 + \text{Na}_2\text{MnO}_4 + \text{H}_2\text{O}$. E. Mulder, and E. R. Watson obtained it by heating silver peroxy-nitrate or peroxy-sulphate with water. According to R. Luther and F. Pokorny, when silver is oxidized in alkaline soln., say $N\text{-NaOH}$, with a small current-density, silver oxide, Ag_2O , is at first formed quantitatively and reversibly; on further oxidation, it is changed quantitatively and reversibly to a higher oxide, Ag_2O_2 . The change $\text{Ag} \rightarrow \text{Ag}_2\text{O}$ takes place at 1.72 volts (taking the hydrogen electrode as zero), the change $\text{Ag}_2\text{O} \rightarrow \text{Ag}_2\text{O}_2$ at 1.40 volts, both at 25° , and no higher peroxide could be obtained in alkaline soln. G. Grube obtained silver peroxide in the electrolysis of alkaline soln. of potassium ferro- and ferri-cyanides with a silver anode; G. W. Morse in the electrolysis of water with a press. exceeding 1.40 volts; and F. Wöhler, by the electrolysis of sulphuric acid or a soln. of sodium sulphate with a silver anode. *Vide* silver peroxy-nitrate.

According to G. A. Barbieri, a soln. of silver peroxide in conc. nitric acid does not reduce lead dioxide, manganese dioxide or potassium permanganate; nor does it give rise to hydrogen peroxide, and hence A. Piccini would regard it as a higher oxide of silver, but not a true peroxide. This view is confirmed by the observation that when silver oxide is treated with permanganate in alkaline soln., it undergoes partial oxidation to Ag_2O_2 by the reversible reaction just indicated. The oxide Ag_2O_2 is a weaker base than Ag_2O , and its soln. in conc. nitric acid is supposed to

contain argentic nitrate $\text{Ag}(\text{NO}_3)_2$, which is stable only in the presence of a large excess of nitric acid with which it forms a complex salt. Argentous nitrate, AgNO_3 , dissolved in conc. nitric acid, acts as if it were a reducing agent towards lead dioxide and bismuth tetroxide presumably because the argentous nitrate is oxidized to argentic nitrate. The oxidizability of silver salts in nitric acid soln. is supposed to explain the accelerating influence they exert upon certain oxidation processes.

The formula Ag_2O_2 is usually taken to represent silver peroxide, but G. A. Barbieri used the formula AgO ; and J. F. Heyes assumed that graphically the formula is $\text{Ag}\cdot\text{O}\cdot\text{O}\cdot\text{Ag}$, or if oxygen be tetravalent, $\text{Ag}_2 : \text{O} : \text{O}$. According to E. R. Watson, silver peroxide is a greyish-black powder, of sp. gr. 7.44, and it can be heated to 100° without decomposition, but it decomposes at higher temp. into its elements; P. C. Austin's product exploded at 110° . F. Streintz measured the electrical conductivity of silver dioxide. C. F. Schönbein and E. R. Watson found that the peroxide dissolved in conc. nitric acid to a dark brown liquid which was stable or decomposed very slowly in the cold, but gave off oxygen when heated and the soln. was decolorized; when the nitric acid soln. was diluted with water the silver peroxide was re-precipitated; the peroxide is scarcely affected by cold dil. nitric acid:

The brown soln. of silver peroxide in conc. nitric acid is assumed by G. A. Barbieri to contain *silver dinitrate*, $\text{Ag}(\text{NO}_3)_2$, with silver bivalent. The salt is readily hydrolyzed, and stable only in the presence of an excess of nitrate ions; he also showed that a 1 per cent. soln. of silver nitrate in nitric acid of sp. gr. 1.4 is oxidized at -10° by lead dioxide and more rapidly by bismuth tetroxide, Bi_2O_4 , to form silver dinitrate. E. R. Watson writes the formula $\text{Ag}_4(\text{NO}_3)_8$.

E. R. Watson found the peroxide dissolves in hot. dil. sulphuric acid, giving off oxygen, and forming silver sulphate; M. Traube likewise found it to dissolve in sulphuric acid with the formation of silver sulphate. E. C. Franklin and C. A. Kraus found silver peroxide is insoluble in liquid ammonia. E. R. Watson assumed the reaction with aq. ammonia is represented by the equation: $6\text{Ag}_2\text{O}_2 + 2\text{NH}_3 = 3\text{Ag}_4\text{O}_3 + \text{N}_2 + 3\text{H}_2\text{O}$. E. Mulder found silver peroxide catalytically decomposes hydrogen peroxide. L. Cramer, and E. Salkowsky, studied the action of silver peroxide on gum arabic, gelatine, etc. R. Kempf found silver peroxide to be an energetic oxidizing agent for organic substances; and it completely oxidizes ammonia to nitrogen very quickly.

M. Berthelot² assumed that *silver sesquioxide*, Ag_2O_3 , is formed as an intermediate product in the catalytic action of silver on hydrogen peroxide; and A. Loduc and M. Labrouste assumed that it is formed as a black dust on the silver anode, without the evolution of gas, during the electrolysis of a clear, freshly prepared soln. of silver oxide. R. Luther and F. Pokorny believe that F. Wöhler's peroxide, and E. Mulder's peroxynitrate (*q.v.*), are essentially silver sesquioxide, with more or less absorbed silver salts. These products were obtained with acid electrolytes; $2\text{Ag} \rightarrow \text{Ag}_2\text{O}_3$; if the electrolyte be alkaline, silver peroxide is formed: $\text{Ag}_2\text{O}_3 \rightarrow \text{Ag}_2\text{O}_2$ at 1.57 volts. In acid soln., the sesquioxide is decomposed directly into silver by electrolytic reduction; and conversely silver can be oxidized directly to the sesquioxide.

REFERENCES.

- ¹ C. F. Schönbein, *Journ. prakt. Chem.*, (1), 45. 469, 1866; (1), 74. 325, 1858; J. C. G. de Marignac and A. de la Rive, *Compt. Rend.*, 20. 808, 1291, 1845; J. Schiel, *Liebig's Ann.*, 132. 322, 1864; A. Volta, *Gazz. Chim. Ital.*, 9. 521, 1897; W. Manchot and W. Kampschultze, *Ber.*, 40. 2891, 1907; H. Erdmann, *ib.*, 37. 4739, 1904; H. Thiele, *Zeit. öffent. Chem.*, 12. 11, 1906; A. Mailfert, *Compt. Rend.*, 94. 860, 1882; H. Marshall, *Journ. Soc. Chem. Ind.*, 16. 396, 1907; *Proc. Roy. Soc. Edin.*, 24. 88, 1902; H. Marshall and J. K. H. Inglis, *ib.*, 24. 88, 1902; *Journ. Chem. Soc.*, 59. 775, 1891; E. R. Watson, *ib.*, 89. 578, 1906; P. C. Austin, *ib.*, 99. 262, 1911; F. Streintz, *Ann. Physik*, (4), 9. 854, 1902; E. Mulder, *Rec. Trav. Chim. Pays. Bas.*, 18. 19, 129, 1898; M. Traube, *Ber.*, 22. 1518, 1889; R. Kempf, *ib.*, 38. 3963, 1906; R. Kempf and E. Oehler, *ib.*, 41. 2576, 1908; E. C. Franklin and C. A. Kraus, *Amer. Chem. Journ.*, 20. 828, 1898; J. F. Heyes, *Phil. Mag.*, (5), 25. 221, 1888; L. Cramer, *Zeit. Koll.*, 2. 171, 1907; F. Wöhler, *Liebig's Ann.*, 146. 264, 1868; G. A. Barbieri, *Atti Accad. Lincei*, (5), 16. ii. 72, 1907; (5), 15. i. 500, 1906;

G. W. Morse, *Proc. Amer. Acad.*, **45**, 371, 1910; G. Grube, *Zeit. Elektrochem.*, **18**, 205, 1912; R. Luther and F. Pokorny, *Zeit. anorg. Chem.*, **57**, 309, 1908; A. Piccini, *ib.*, **12**, 169, 1896; G. Gore, *Chem. News*, **50**, 150, 1884; N. W. Fischer, *Kastner's Archiv.*, **16**, 215, 1842; *Journ. prakt. Chem.*, (1), **32**, 108, 1844; (1), **33**, 237, 1844; E. Salkowsky, *ib.*, (2), **102**, 194, 1921; M. Bose, *Zeit. anorg. Chem.*, **44**, 237, 1905, G. I. Higson, *Journ. Chem. Soc.*, **119**, 2048, 1921; W. L. Hardin, *Journ. Amer. Chem. Soc.*, **18**, 999, 1896; M. G. Levi, E. Migliorini, and G. Erco-
lini, *Gazz. Chim. Ital.*, **38**, i, 583, 1908; N. Tarugi, *ib.*, **32**, ii, 383, 1902.

² M. Berthelot, *Ann. Chim. Phys.*, (5), **21**, 164, 1880; *Compt. Rend.*, **90**, 572, 1880; A. Leduo and M. Labrouste, *ib.*, **145**, 55, 1907; R. Luther and F. Pokorny, *Zeit. anorg. Chem.*, **57**, 290, 1907.

§ 13. Silver Fluoride

A. Guntz prepared what he regarded as silver subfluoride, Ag_2F , by electrolyzing a sat. soln. of silver fluoride with silver electrodes and a strong current. If the liquid is allowed to become hot, silver is not deposited, but bronze plates are deposited at the cathode. These crystals, though mixed with some silver fluoride, contain less fluorine than normal silver fluoride. In dil. soln. with 6 volts and 2 amps., or with 24 volts and 5 amps. whereby the soln. is heated, or in conc. soln. with 6 volts and 5 amps., L. Vanino and P. Sachs¹ obtained silver deposits alone, but, says A. Guntz, a dil. soln. at all temp. furnishes silver alone, a conc. soln. over 50° is needed for the formation of silver subfluoride, and, adds K. Eisenreich, when 8*N*-soln. of silver fluoride are used the anode no longer dissolves, but becomes coated with silver subfluoride, Ag_2F . K. Eisenreich also observed the formation of silver subfluoride when the light from a mercury quartz lamp acts on soln. of silver fluoride. A. Guntz also found that if finely-divided silver be heated with a warm soln. of silver fluoride in a sealed tube, the liquid becomes yellow above 50° , and if the temp. does not exceed 90° , all the silver is converted into a crystalline powder resembling brass filings. H. Moissan also made the same salt by leaving silver foil in contact with an aq. soln. of silver fluoride. L. Wöhler and G. Rodewald prepare silver subfluoride in the following manner :

A soln. of 5 grms. of silver nitrate in 250 c.c. of water with slight excess of ammonia is treated with 2 or 3 c.c. of formalin with constant stirring. The metal is precipitated when the liquid is allowed to stand at the room temp.; it is washed cold, by decantation, and pressed between filter paper—about 3 grms. of silver are so obtained. Again, 17 grms. of silver nitrate in 100 c.c. of water is treated in the cold with sodium carbonate; in this way, the formation of sparingly soluble oxides is prevented. The precipitated carbonate is washed, and then dissolved in hydrofluoric acid, and the soln. conc. on a water-bath and filtered. The resulting liquid contains the eq. of about 4 grms. of silver, and it is mixed with the pressed silver previously prepared, and evaporated on a water-bath with constant stirring until the bronze-green crystals of silver fluoride and the yellowish-brown crust of silver fluoride begin to form. The liquid is filtered by suction through a filter tube, closed with a stopper fitted with a calcium chloride tube, and washed 4 or 5 times with 1 to 2 c.c. of absolute alcohol, then with absolute ether. The thin surface layer of solid is rejected, and the compound is dried in vacuo over sulphuric acid for a couple of hours, and then preserved in a sealed tube.

The octahedral crystals are a golden-yellow colour, and unlike the other silver halides, the crystals are not sensitive to direct light; a press. of 20,000 atm. is without influence. The crystals are decomposed by water with the development of heat: $\text{AgF} + \text{Aq.} = 3.4$ Cals.; and $\text{Ag}_2\text{F} + \text{Aq.} = \text{AgF}_{\text{aq.}} + \text{Ag} + 2.73$ Cals.; $2\text{Ag}_{\text{aq.}} + \text{F}_{\text{gas}} = \text{Ag}_2\text{F}_{\text{solid}} + 26.3$ Cals.; not 24.9 Cals. as A. Guntz stated, and therefore $\text{Ag}_{\text{aq.}} + \text{AgF}_{\text{aq.}} = \text{Ag}_2\text{F}_{\text{solid}} - 0.7$ Cal. The crystals do not alter in dry air, but in moist air they decompose. A little water continues decomposing the salt until the soln. contains 64.5 per cent. of silver fluoride. With sodium chloride, it is decomposed into silver and silver chloride and fluoride. L. Vanino and P. Sachs have expressed the opinion that the alleged silver subfluoride is a mixture of normal silver fluoride with silver or silver oxide in varying proportions, claiming that (i) under the microscope the former appears as a transparent mass, in which the latter is scattered in

black spots; (ii) after treatment with water, the ratio of soluble to insoluble silver is as 1 : 4 to 1 : 5, whereas silver fluoride requires a ratio 1 : 1; and (iii) the total silver in the alleged subfluoride varies in quantity. According to L. Wöhler and G. Rodewald, silver fluoride is very easily decomposed by water, and the influence of atm. moisture is the source of the difficulties which are found in accepting the evidence of the individuality of this product. If a little silver fluoride be placed on a filter paper supported on a clay triangle, over a glass dish with a few drops of water, and all be covered by a bell-jar, decomposition is evident after the elapse of 5 minutes, and all is completely decomposed in 25 minutes: $\text{Ag}_2\text{F}=\text{Ag}+\text{AgF}$. The transition point in an atm. of nitrogen or carbon monoxide for $\text{Ag}_2\text{F}\rightleftharpoons\text{AgF}+\text{Ag}$ is 90° , above this temp. the reaction passes as symbolized from left to right; and below 90° , from right to left. This reaction represents the case of a solid dissociating into two other solids; the decolorization which attends the transformation is completed in a few minutes at 110° – 115° ; the transition temp. in contact with a sat. soln. of silver fluoride also occurs at 90° . Unlike silver fluoride, silver subfluoride is insoluble in absolute alcohol and in absolute ether. It is virtually insoluble in acetone and xylene, while pyridine decomposes it into silver and silver fluoride.

The preparation of silver fluoride.—H. Moissan² showed in 1891 that metallic silver is but slowly attacked in the cold by fluorine gas; at 100° the attack is faster; and at a red heat, the two elements react with incandescence. J. L. Gay Lussac and L. J. Thénard reported in 1811 that silver is not attacked by hydrofluoric acid, and that silver fluoride is obtained when a soln. of silver oxide or carbonate in hydrofluoric acid is evaporated to dryness. J. J. Berzelius, and G. Gore prepared silver fluoride in this manner, but H. Moissan pointed out that the product always contains some reduced silver and silver oxide. He therefore recommended dissolving freshly precipitated silver carbonate in silicon-free hydrofluoric acid, and evaporating the liquid over a free flame until crystallization begins, and continuing the evaporation to dryness on a sand-bath with constant stirring. The black pulverulent mass is dissolved in water, filtered, and evaporated in darkness in a platinum dish, in vacuo, over conc. sulphuric acid. Dark brown crystals of the anhydrous salt form as a crust on the surface, while octahedral crystals of the hydrated salt form on the bottom of the dish. Good yields are obtained if the hydrofluoric acid is pure, and glass vessels are not employed since glass is attacked.

According to E. Frémy, the neutral or slightly alkaline soln. gives on evaporation in vacuo either small yellow cubes or colourless tetragonal pyramids of **hydrated silver fluoride**, $\text{AgF}\cdot\text{H}_2\text{O}$. J. C. G. de Marignac gives the axial ratio $a : c = 1 : 1.1366$ for $\text{AgF}\cdot\text{H}_2\text{O}$. The particular form of the crystals depends on the temp. According to A. and A. A. Guntz, on evaporating in a vacuum at 10° a neutral soln. containing 120 grms. of silver fluoride in 100 grms. of water and suitably seeding the liquid, colourless, transparent crystals of **tetrahydrated silver fluoride**, $\text{AgF}\cdot 4\text{H}_2\text{O}$, m.p. 18.5° , were obtained, having at 13° a heat of soln.—4.93 cal. Below 18.5° this is the only hydrate stable in neutral soln. A soln. containing 170 grms. of silver fluoride allowed to crystallize between 18° and 38° gives deliquescent prisms of **dihydrated silver fluoride**, $\text{AgF}\cdot 2\text{H}_2\text{O}$, m.p. 42° , decomposing to the anhydrous fluoride. Its heat of soln. is -1.5 cal. at 10° . The presence of hydrofluoric acid lowers the transition temp. of $\text{AgF}\cdot 4\text{H}_2\text{O}$ to $\text{AgF}\cdot 2\text{H}_2\text{O}$, 5.5 per cent. of acid lowering it to 0° . On evaporating a neutral, sat. soln. of silver fluoride at 26° – 36° , hard, highly refractive, slightly yellow, deliquescent crystals are obtained of a monohydrate, $\text{AgF}\cdot\text{H}_2\text{O}$. The heat of soln. of this hydrate is $+0.85$ cal. at 10° . By repeating this crystallization at the ordinary temp. there is formed round each nucleus of the monohydrate, voluminous, colourless rosettes of a hydrate, $2\text{AgF}\cdot 5\text{H}_2\text{O}$. Both the latter forms are unstable in the presence of crystals of $\text{AgF}\cdot 2\text{H}_2\text{O}$, giving this hydrate and anhydrous silver fluoride; if the conc. aq. soln. be allowed to stand some time colourless prismatic crystals of dihydrated silver fluoride, $\text{AgF}\cdot 2\text{H}_2\text{O}$, appear. The hydrates are very deliquescent, and all of them lose all their combined water in vacuo. According to E. Frémy, if the hydrated salt be dried in vacuo, the whole

of the water and some hydrofluoric acid is evolved, and the remaining yellow amorphous mass is contaminated with some oxyfluoride. A. and A. A. Guntz prepared the salt by evaporating a soln. of silver with 5 per cent. of hydrofluoric acid in vacuo. L. Pfaundler showed that by heating the hydrated salt to 327°, it loses about 0.5 per cent. of fluorine as hydrogen fluoride; and if heated in a covered crucible to its m.p. some hydrofluoric acid also escapes with the water, and no more is lost if the fluoride be heated up to 960°.

The properties of silver fluoride.—Silver fluoride forms a yellow or yellowish-brown mass. The various reports as to the colour of silver fluoride are not very consistent; the pure salt is probably colourless and the observed colours are due to admixtures of very small quantities of, possibly, colloidal silver, or silver oxide. The brown colour, say L. Vanino and P. Sachs,³ is due to the presence of silver oxide. The amorphous powder, which is yellow at 0°, becomes orange at 25°. Ruby-red cubes are obtained, according to A. and A. A. Guntz, by evaporating a soln. of silver fluoride in 5 per cent. hydrofluoric acid in vacuo. According to G. Gore, its sp. gr. is 5.852 (15.5°); and, according to H. Moissan, it melts at 435°, forming a black liquid which, according to O. Unverdorben, solidifies to a black horn-like mass when rapidly cooled, and a crystalline mass with slow cooling. The horn-like variety cannot be powdered by pulverization, but, says L. Pfaundler, it can be cut with the scissors. The molten fluoride attacks silver crucibles, and slightly attacks platinum. The heat of formation from its elements is, according to M. Guntz, $\text{Ag}_{\text{solid}} + \text{F}_{\text{gas}} = \text{AgF}_{\text{solid}} + 25.6$ Cals.; $\text{Ag}_2\text{O} + 2\text{HF}_{\text{gas}} = 2\text{AgF} + \text{H}_2\text{O}_{\text{liq.}} + 32.8$ Cals. Further, $\text{AgF} + 2\text{H}_2\text{O} = \text{AgF} \cdot 2\text{H}_2\text{O} + 4.9$ Cals.; $\text{AgCl} + \text{HF} = 12.9$ Cals.; and for $\frac{1}{2}\text{Ag}_2\text{SO}_4 + \text{HF} = 9.2$ Cals. The heat of hydration: $\text{AgF} + 2\text{H}_2\text{O} = 4.9$ Cals.; and the heat of soln. of dihydrated silver fluoride in a large quantity of water at 10° is 1.5 Cals., while for the anhydrous salt at 16°, the heat of soln. is +4.3 Cals. The molten salt conducts electricity like a metal without the development of a gas. According to L. Vanino and P. Sachs, the metallic conductivity is due to the presence of metallic silver formed during the melting of the salt. Silver fluoride is readily soluble in water—100 grms. of soln. at 15.5° has 64.8 grms. of salt, and the sp. gr. is 2.61. The great increase in the solubility of silver fluoride which L. Wöhler and G. Rodewald observed at about 50°, is probably due to the transition from the hydrate $\text{AgF} \cdot 2\text{H}_2\text{O}$ to the anhydrous salt. The aq. soln. has a neutral reaction. The comparatively high solubility of silver fluoride is in marked contrast with the low solubilities of the other three silver halides. Silver oxide dissolves in a soln. of silver fluoride probably forming complex ions, *viz.* $[\text{Ag}_2\text{OH}]$; together with the F'-ions. L. Pfaundler also noted the apparent formation of silver oxyfluoride, $\text{AgF} \cdot \text{AgOH}$, by the evaporation of neutral aq. soln., or by melting the salt in imperfectly dried vessels. These oxyfluorides are probably mixtures of silver fluoride with some oxidized salt. Under-cooled soln. are readily formed, and on electrolysis, silver is deposited on the cathode, and oxygen is evolved at the anode. S. Tanatar obtained what he regarded as silver peroxyfluoride, $4\text{Ag}_3\text{O}_4 \cdot 3\text{AgF}$, by the electrolysis of an aq. soln. of the fluoride; it decomposes when heated with the evolution of oxygen, and, when digested with water on a water-bath, and washed with hot water, furnishes another peroxyfluoride, $2\text{Ag}_3\text{O}_4 \cdot \text{AgF}$.

The electrical conductivities of aq. soln. of silver fluoride have been determined by R. Abegg and C. Immerwahr. For 1.21*N*-soln. the conductivity at 18° is $\lambda = 0.0539$, and α , the ionization, 53 per cent.; for 0.211*N*-soln., $\lambda = 0.0812$, and α , 80 per cent.; and for 0.0121*N*-soln., $\lambda = 0.0955$, $\alpha = 94$ per cent. The numbers are very close to the corresponding values for silver nitrate. The calculated value of λ_{∞} is 0.0116, but for very dil. soln.—0.00516*N*- to 0.000516*N*-—the conductivity is greater; this is taken to mean that the solute is hydrolyzed. A. Heydweiller gives the sp. gr. at 18° (water at 18° unity) for 0.1001*N*-soln., 1.01280; 0.2010*N*-, 1.02566; 0.4034*N*-, 1.05067; 0.8044*N*-, 1.10018; 1.584*N*-, 1.19604; and 3.136*N*-, 1.38206. He also gives the indices of refraction of soln. at 18° for sodium light for 0.1*N*-soln., $\mu = 1.33465$; dispersion for H_{γ} and $H_{\alpha} = 1.035$; *N*-soln., $\mu = 1.34583$, dispersion,

0.942; and for 3*N*-soln., $\mu=1.36703$, dispersion, 0.844. Silver fluoride, says G. Gore, does not dissolve in alcohol. According to E. Paterno and M. Cingolani, aq. soln. of silver fluoride are bactericides, and under the trade name *tachyol* they recommend it for disinfecting drinking water and, according to L. Pigorini, very dil. soln. exercise a toxic action on fish.

G. Gore reported that dry silver fluoride is not altered in dry air on exposure to light. Under the influence of the light from a mercury quartz lamp. soln. of silver fluoride are decomposed with the formation of silver subfluoride and silver peroxide. When fused, silver fluoride is attacked by moist air with the formation of silver; the vapour of water also reduces it at a dull red heat, $4\text{AgF} + 2\text{H}_2\text{O} = 4\text{Ag} + 4\text{HF} + \text{O}_2$. This reaction is taken to explain how silver fluoride prepared under ordinary conditions is contaminated with metallic silver. If hydrated silver fluoride, $\text{AgF} \cdot \text{H}_2\text{O}$, be dried in a vacuo or in a stream of dry air at ordinary press. until the salt becomes yellow, the residue contains silver oxyfluoride, $\text{AgF} \cdot \text{AgOH}$. Silver hydrofluoride is formed when a soln. of silver fluoride in hydrofluoric acid is cooled. The crystals have the composition of silver trihydrofluoride, $\text{AgF} \cdot 3\text{HF}$, or H_3AgF_4 , and they readily dissociate in air. G. Gore, and E. Frémy also noted the formation of acid fluorides, the latter by crystallization of a soln. of silver fluoride, in an excess of hydrofluoric acid; the former by the action of the gas on the dry fused salt at 13° . Hydrogen in the cold acts neither on the dry salt nor on aq. soln. in darkness or in light; but at a red heat, the fluoride is completely reduced. Many investigators—E. Frémy, H. Davy, G. Aimé, and C. J. and T. Knox—have attempted to prepare fluorine gas by the action of chlorine on silver fluoride. G. Gore found that between 15° and 110° , chlorine superficially attacks the fluoride very slowly, forming, in platinum or gold vessels, double salts of the chloride of these metals with silver fluoride—e.g. $\text{PtCl}_4 \cdot \text{AgF}$; with a graphite vessel, carbon fluoride is formed; vessels of glass, cryolite, or fluoride are attacked by molten silver fluoride. In soln., oxygen is evolved: $16\text{AgF} + 8\text{Cl}_2 + 8\text{H}_2\text{O} = 14\text{AgCl} + 2\text{AgClO}_3 + 16\text{HF} + \text{O}_2$. Bromine acts like chlorine, and the action of iodine has been studied by L. Pfaundler, H. Kammerer, and G. Gore—iodine pentachloride is formed. Dry hydrogen chloride also decomposes silver fluoride at a red heat; bromic or iodic acid gives a precipitate of silver bromate or iodate, but chloric acid has no action. Nitrosyl chloride, NOCl , was found by O. Ruff and K. Stäuber to form nitrosyl fluoride, NOF , at 200° – 250° . G. Gore and H. Moissan have shown that the vapour of sulphur chloride gives sulphur fluoride and silver chloride and sulphide; phosphorus pentachloride gives silver chloride and phosphorus pentafluoride; and phosphorus trichloride, phosphorus trifluoride; phosphorus oxychloride gives phosphorus oxyfluoride; the carbon chlorides at a red heat give silver chloride and carbon fluoride; silicon chloride gives silicon fluoride; boron trichloride gives boron trifluoride; sulphur at a red heat gives silver sulphide and sulphur fluoride; sulphur dioxide has no action. Fused silver fluoride at a red heat does not attack carbon, but it reacts explosively at ordinary temp. when triturated with boron—the mixture becomes incandescent. L. Pfaundler says silver fluoride has no action on boron. Silicon also reacts violently with silver fluoride, forming silicon fluoride, and silver; if the reaction takes place in a soln. of silver fluoride, the precipitated silver is crystalline. Silica and boric oxide reduce silver fluoride at a red heat. When heated in a current of coal gas silver fluoride gives silver, hydrofluoric acid, and carbon tetrafluoride; with carbon disulphide, silver sulphide and carbon tetrafluoride are formed; cyanogen reduces solid silver fluoride at a dark red heat, and a soln. of that salt is reduced by the same gas cold. Hydrogen cyanide behaves similarly. When triturated with calcium hydride, the mass becomes incandescent, forming silver and calcium fluoride. F. Valentiner and A. Schwarz found iodoform to be converted into fluoroform and silver iodide, or, according to M. Meslens, into a double compound, $\text{AgF} \cdot \text{AgI}$. G. Gore analyzed silver fluoride by heating a known weight with an excess of lime: $4\text{AgF} + 2\text{CaO} = 2\text{CaF}_2 + 4\text{Ag} + \text{O}_2$. According to G. Gore, dry silver fluoride absorbs 844 vols. of ammonia, hence the product very nearly corresponds with silver

amminofluoride, $\text{AgF}\cdot\text{NH}_3$. E. C. Franklin and C. A. Kraus found silver fluoride to be slightly soluble in liquid ammonia. G. Bruni and G. Levi prepared the silver ammino-fluoride, $\text{AgF}\cdot 2\text{NH}_3\cdot 2\text{H}_2\text{O}$ or $2\text{AgF}\cdot 4\text{NH}_3\cdot 5\text{H}_2\text{O}$. Molten silver fluoride is decomposed by ammonia gas. B. Grützner obtained white needle-like crystals of **hydrated diammonium argentofluoride**, $2\text{NH}_4\text{F}\cdot\text{AgF}\cdot\text{H}_2\text{O}$, or $(\text{NH}_4)_2\text{AgF}_3\cdot\text{H}_2\text{O}$, by cooling a soln. of freshly precipitated and moist silver oxide in a cold conc. aq. soln. of ammonium fluoride. E. Böhm, in his *Zur Kenntnis der Fluoride* (Giessen, 1906), also described the preparation of colourless needles of the complex salt $15\text{NH}_4\text{F}\cdot\text{AgF}\cdot 4\text{H}_2\text{O}$.

REFERENCES.

- ¹ A. Guntz, *Compt. Rend.*, 110. 1337, 1890; A. and A. A. Guntz, *ib.*, 157. 981, 1913; H. Moissan, *Bull. Soc. Chim.*, (3), 5. 456, 1891; L. Vanino and P. Sachs, *Zeit. anal. Chem.*, 50. 626, 1911; 53. 154, 1914; A. Guntz, *Bull. Soc. Chim.*, (4), 11. 845, 1912; L. Wöhler and G. Rodewald, *Zeit. phys. Chem.*, 61. 54, 1909; K. Eisenreich, *ib.*, 76. 643, 1911.
- ² H. Moissan, *Bull. Soc. Chim.*, (3), 5. 456, 880, 1891; J. J. Berzelius, *Pogg. Ann.*, 1. 35, 1824; G. Gore, *Proc. Roy. Soc.*, 13. 157, 1870; E. Frémy, *Ann. Chim. Phys.*, (3), 47. 39, 1856; L. Pfaundler, *Sitzber. Akad. Wien*, 46. 259, 1862; J. L. Gay Lussac and L. J. Thénard, *Recherches physico-chimiques*, Paris, 2. 33, 1811; J. C. G. de Marignac, *Ann. Mines*, (5), 12. 21, 1857; A. and A. A. Guntz, *Compt. Rend.*, 157. 981, 1913; L. Vanino and P. Sachs, *Zeit. anal. Chem.*, 50. 626, 1911; 53. 154, 1914.
- ³ G. Gore, *Proc. Roy. Soc.*, 13. 157, 1870; *Ber.*, 4. 131, 1871; H. Moissan, *Bull. Soc. Chim.*, (3), 5. 5, 880, 1891; A. Guntz, *ib.*, (3), 13. 114, 1895; O. Unverdorben, *Neues Journ. Pharm.*, 9. 1, 34, 1824; L. Pfaundler, *Sitzber. Akad. Wien*, 46. 269, 1863; M. Guntz, *Ann. Chim. Phys.*, (6), 3. 5, 1884; M. Meslens, *ib.*, (7), 1. 395, 1894; E. Frémy, *ib.*, (3), 47. 5, 1856; H. Davy, *ib.*, (1), 88. 271, 1813; G. Aimé, *ib.*, (2), 55. 443, 1834; C. J. and T. Knox, *Phil. Mag.*, (3), 9. 107, 1836; A. and A. A. Guntz, *Compt. Rend.*, 157. 981, 1913; R. Aebegg and C. Immerwahr, *Zeit. phys. Chem.*, 32. 142, 1900; H. Kammerer, *Journ. prakt. Chem.*, (1), 85. 452, 1862; O. Ruff and K. Stäuber, *Zeit. anorg. Chem.*, 47. 190, 1905; S. Tanatar, *ib.*, 28. 331, 1901; B. Grützner, *Arch. Pharm.*, 238. 1, 1900; E. Paterno and M. Cingolani, *Gazz. Chim. Ital.*, 37. i, 313, 1907; L. Pigorini, *Arch. Farm. Sperim.*, 6. 530, 1908; K. Eisenreich, *Zeit. phys. Chem.*, 76. 643, 1911; L. Wöhler and G. Rodewald, *Zeit. anorg. Chem.*, 61. 54, 1909; L. Vanino and P. Sachs, *Zeit. anal. Chem.*, 50. 154, 1914; E. C. Franklin and C. A. Kraus, *Amer. Chem. Journ.*, 20. 828, 1898; F. Valentiner and A. Schwarz, *German Pat.*, D.R.P.P. 105916, 106513, 1899; *Bull. Soc. Chim.*, (4), 5. 5, 1909; F. W. O. de Coninck, *ib.*, (4), 5. 62, 1909; A. Heydweiller, *Ann. Physik*, (4), 41. 504, 1903; (4), 37. 750, 1912; G. Bruni and G. Levi, *Gazz. Chim. Ital.*, 46. ii, 17, 1916.

§ 14. Silver Chloride

Small quantities of silver chloride occur in nature as *horn silver*, *chlorargyrite*, *occrargyrite*, or *kerargyrite*—from *képas*, horn—in various parts of the world notably in Chili and Peru; it has been reported in Nicaragua, Honduras, Norway, Alsace, Cornwall, Brittany, Freiberg, etc.¹ An earthy variety at Andreasburg (Harz) is called *Buttermilcherz*. It usually occurs in veins of clay slate, accompanying other silver ores; and also associated with iron and copper ores, calcite, barite, etc.

There can be little doubt that silver chloride was known in the time of Pliny for, in his *Historiæ naturalis* (33, 25), he refers to operations in which this compound must have been formed. Geber also, in his *Summa perfectionis magisterii*, describes its *color mirabilis*. W. Fabricius, in his *De rebus metallicis* (Tiguri, 1565), refers to the colour, translucency, and fusibility of the mineral horn silver, but there is nothing about the change of this compound in light. O. Croll, in his *Basilica chymica* (Frankfort, 1609), described the preparation of silver chloride. A. Libavius stated that the resulting chloride weighed less than the silver used in its formation, but both R. Boyle and J. Kunckel contradicted this assertion. The latter, in his *Vollständiges laboratorium chymicum* (Berlin, 1716), said that “in D cornea, 12 loth of D retain from common salt, 4 loth of terra and salt,” otherwise expressed: 12 parts of silver form 16 parts of common salt, a result which is very close to the best determinations of to-day. A. Libavius describes, in his *Alchemia* (Frankfurt, 1585), how he precipitated silver chloride by adding a soln. of salt to one of a silver

salt; and "Basil Valentine" said the same thing: "common salt precipitates D." J. B. Porta, in his *Magia naturalis* (Naples, 1549), mentions the fusibility of this compound. Mediæval chemists called the precipitated silver chloride *lac argenti*; the fused product was called *luna cornea* or *horn silver*. J. R. Glauber, in his *Furnis nova philosophicis* (Amstelodami, 1648), refers to its solubility in ammonia. R. Boyle specially commented on the blackening of white silver chloride by exposure to the air; and in his *Experiments and observations on colours* (London, 1663), he said:

Having dissolved good silver in *aqua fortis*, and precipitated it with spirit of salt, upon first decanting the liquor, the remaining matter was purely white; but, after it had lain awhile uncovered, the part of it that lay contiguous to the air, not only lost its whiteness, but appeared of a very dark, and almost blackish colour; but if the part that was contiguous to the air were gently taken off, the subjacent part of the same mass would appear very white; till that also having continued a while exposed to the air would likewise degenerate.

R. Boyle attributed the darkening to the presence of air; it required almost another century to find that light alone produces the effects observed by R. Boyle. J. H. Schulze² is regarded as the discoverer of the sensitiveness of silver salts to light, for, in a paper entitled: *Scotophorus pro phosphore inventus seu experimentum curiosum de effectu radiorum solarium*, he specially states that when a soln. of silver in nitric acid is treated with chalk, the precipitate is darkened on the side exposed to light, and he proved that this effect is produced by light, but not by heat. C. W. Scheele, also in his essay *Aëris atque ignis examen chemicum* (Upsala, 1777), further commented upon the darkening of silver chloride in light; and by exposing paper impregnated with silver chloride to different parts of the spectrum, he further proved that this compound is bleakened far more quickly by the violet rays than by the other coloured rays, and he attributed the phenomenon to the greater readiness with which the violet rays parted with their phlogiston.

Dry hydrogen chloride produces varying colours from violet-red to violet-black when it is passed over silver fluoride, and, according to A. Guntz,³ some silver subchloride, Ag_2Cl , is formed, but the transformation is incomplete; on the other hand, silver subfluoride is completely transformed into the subchloride by the action of silicon or carbon tetrachloride, or phosphorus trichloride. The violet product blackens in a few days without losing any appreciable amount of chlorine. H. Vogel also prepared it by the action of silver nitrate on cuprous chloride. The heat of the reaction is $2\text{Ag} + \text{Cl} = \text{Ag}_2\text{Cl} + 29.7$ Cals., while the reaction $\text{Ag} + \text{Cl} = \text{AgCl} + 29.2$ Cals. A similar difference is observed in the case of the two fluorides. It also follows that the hypothetical reaction: $2\text{AgCl} = \text{Ag}_2\text{Cl} + \text{Cl}$, absorbs 28.7 Cals. Silver subchloride is decomposed by heat into silver chloride and silver; dil. nitric acid has no action, but the conc. acid, especially if warm, gives silver chloride, AgCl , and a mixture of different colours. A soln. of potassium cyanide rapidly dissolves the subchloride, forming silver and silver cyanide: $\text{Ag}_2\text{Cl} + \text{KCyanide} = \text{Ag} + \text{AgCyanide} + \text{KCl}$. E. von Bibra reported the formation of a black powder of silver tetrachloride, Ag_4Cl_3 , by the action of hydrochloric acid upon silver subcitrate obtained by heating silver citrate to 100° in a stream of hydrogen until its weight was constant—7 to 8 hrs. According to S. B. Newbury, the supposed silver subcitrate is a mixture of metallic silver and unchanged silver citrate, and E. von Bibra's product is thought to be a mixture of silver chloride and silver.

The preparation of silver chloride.—Silver is slowly converted into the chloride when exposed to the action of chlorine gas or chlorine water. If chlorine gas be passed into a bottle loosely packed with silver foil, when the air is displaced, and the bottle is closed, the silver is quickly converted into chloride without shrinkage or changing its form. J. S. Stas⁴ prepared this salt by passing purified chlorine over the purified metal heated in a tube of hard glass. R. Cowper, and V. von Cordier showed that if the reagents be quite dry, there is no reaction. The reaction is faster in light than in darkness. Chlorine gas precipitates silver chloride from soln. of silver salts with the formation of some silver hypochlorite which decomposes immediately into silver chlorate and chloride. C. Weltzien⁵ found with silver nitrate,

five-sixths of the silver was precipitated as chloride, and one-sixth formed a soluble chlorate. Free chlorine, said J. J. Berzelius, displaces bromine or iodine from warm silver bromide or iodide respectively. L. Bruner and E. Bekier found iodine chloride, ICl , transforms metallic silver or silver iodide into the chloride. Dry hydrogen chloride converts silver into hydrogen and silver chloride, and conversely, silver chloride with hydrogen form silver and hydrogen chloride. J. B. J. D. Bous-singault showed that the reaction is reversible—Fig. 8, Cap. XVIII. According to A. Potilitzin, the reaction between silver and hydrogen chloride begins at 150° , and, according to A. Jouniaux, at 400° . If the gas be dried R. E. Hughes found very little action. J. L. Proust found that silver chloride is superficially attacked by hydrochloric acid and a small proportion dissolves, while M. C. Lea says the metal is not attacked by an acid of specific gravity 1.20. N. W. Fischer showed that if air acts simultaneously with the acid (sp. gr. 1.20) much silver is dissolved in, say, eight days, and the addition of water precipitates silver chloride from the soln. C. W. Scheele, and F. T. Sonneschmid also showed that the attack is much hastened if oxidizing agents—arsenious acid, manganese dioxide, or copper sulphate or chloride—be present. Silver oxide forms silver chloride when treated with hydrochloric acid, and G. Wetzlar found that soln. of the alkali chlorides convert silver oxide into silver chloride and alkali hydroxide. Hydrochloric acid also converts soluble silver salts and many insoluble silver salts into silver chloride, but not so with silver iodide or bromide. The usual method of preparation is to add hydrochloric acid or a soln. of sodium chloride to a soln. of silver nitrate, and well wash the precipitate away from violet light. If a few drops of a chloride be added to an ammoniacal soln. of silver nitrate, G. Carlo found that silver chloride free from ammonia is precipitated. B. Finzi also found that the precipitation of silver chloride by adding mercuric chloride to a soln. of a silver salt is not quantitative; a part of the silver remains in soln., as a complex silver-mercury salt.

The velocity of formation of silver chloride, when soln. of silver nitrate and sodium, potassium or ammonium chloride are allowed to mix by diffusion, has been investigated by K. Jablczynsky, B. L. Vanzetti, O. Scarpa, L. Rolla, and T. Paul; while T. W. Richards and R. C. Wells have shown how difficult it is to precipitate silver chloride without the occlusion of other substances which cannot be removed by washing. W. L. Hardin recommends for the preparation of highly purified silver chloride what is virtually the following process:

Purified silver is dissolved in hot dil. nitric acid, and the soln. evaporated to dryness, fused, and heated until nitrogen oxides commence to be evolved. The cold mass is dissolved in the smallest possible quantity of water, and allowed to stand 24 hrs. The soln. is then filtered through a double filter paper, and diluted with 30 times its volume of water. An excess of hydrochloric acid is added, and the precipitate after it has settled is washed by decantation first with dil. hydrochloric acid, and then with water. The precipitate is collected on a Buchner funnel, dried, finely powdered, and digested three days with aqua regia. The product is then thoroughly washed by decantation and dried.

According to H. Rose, silver is converted into chloride by the action of sodium chloride at a red heat, and this the more rapidly, the finer the state of subdivision of the metal. According to C. F. Plattner, the reaction is not hastened by the addition of ferric or cupric oxide; but, according to H. Rose, manganese dioxide does accelerate the reaction. The action of sodium chloride on a mixture of silver and gold is the basis of the so-called cementation process for the separation of these metals. Soln. of sodium chloride, exposed to air, slowly attack silver, forming silver chloride and sodium hydroxide, and J. L. Proust found that after some years' exposure to sea water, some silver coins were transformed into chloride. A. J. Balard found gaseous chlorine monoxide, or aq. soln. of hypochlorous acid, or the hypochlorites, transform silver into chloride; phosphorus pentachloride, says H. Goldschmidt, reacts $\text{PCl}_5 + 2\text{Ag} = 2\text{AgCl} + \text{PCl}_3$. When silver sulphide is heated in chlorine gas or roasted with sodium chloride, silver chloride is formed. With a soln. of cupric chloride, mixed with sodium chloride, silver and cuprous chlorides

are formed which remain in soln.; lead chloride forms lead sulphide and silver chloride. C. W. B. Normand and A. C. Cumming found silver thiocyanate to be incompletely converted into chloride by hydrogen chloride—ammonia, and sulphuric, and hydrocyanic acids were simultaneously formed. J. Kablukoff found the alkali halides convert molten silver nitrate almost completely into silver halide. Carbon tetrachloride reacts with silver at 250°, and a soln. of chlorine in carbon tetrachloride at ordinary temp. forms silver and carbonyl chlorides.

Colloidal silver chloride.—According to R. Ruer,⁶ if a 0.002*N*-HCl be treated with 0.1*N*-AgNO₃, no precipitate is formed, but a bluish opalescence appears; after standing half an hour, the soln. is turbid; and in 24 hrs. a precipitate has settled on the bottom of the vessel. A. Lottermoser and E. von Meyer obtained colloidal silver chloride by the action of a soluble chloride on colloidal silver. C. Paal and F. Voss made it by first precipitating colloidal silver oxide by mixing soln. of sodium hydroxide and silver nitrate, then treating the product with an alkali chloride soln.

Properties of silver chloride.—Precipitated silver chloride, dried at 100°, is a white, flocculent, or curdy, non-crystalline, anhydrous solid. F. Kuhlmann⁷ prepared an imitation of horn silver by filling a flask quite full with a soln. of silver nitrate, and closing the flask with a porous stopper, and placing the whole under hydrochloric acid. Masses of horn silver are slowly formed about the stopper. H. Debray obtained crystals of silver chloride by repeatedly heating and boiling silver chloride with a conc. soln. of silver nitrate or mercuric nitrate. According to P. Growth, the crystals are hexakisoctahedra, A. P. H. Trivelli and S. E. Sheppard say dyakisidodecahedra, belonging to the cubic system. The slow evaporation of the ammoniacal soln. in darkness furnishes white octahedral crystals. A. Ditte obtained the crystals by slowly cooling the soln. of the salt in hydrochloric acid. K. Haushofer, O. Lehmann, A. Streng, and H. Behrens studied the crystals of silver chloride. W. Reinders studied the precipitation of silver chloride in the presence of protective colloids. He showed that silver chloride crystallizing in the presence of various colloids—*e.g.* colloidal silver, gelatine, albumen, casein, etc.—has the capacity of taking up and homogeneously distributing these colloids in the crystals; with gelatine the effect was noticeable with conc. as low as a mgrm. of gelatine in 10 litres of water. P. Debye and P. Scherrer, A. W. Hull, and R. B. Wilsey have studied the **X-radiogram** of silver chloride. The lattice presents the simple cubic arrangement with a cube edge 2.78 Å., and the distance of the nearest atomic centres 2.78 Å.

The **specific gravity** determined by C. J. B. Karsten⁸ is 5.501 before fusion; 5.5671 after blackening in sunlight; and after fusion, 5.4582. G. F. Rodwell gave 5.505 (0°). The sp. gr. of the salt which has been fused ranges from J. L. Proust's 5.4548 to H. G. F. Schröder's 5.594. F. Mohr says the sp. gr. is the same after precipitation, after standing in the mother liquid for some time, and after heating to 100°. According to G. F. Rodwell, its sp. gr. steadily increases from its fusion point down to -60°. G. F. Rodwell gave the sp. gr. of the molten salt as 4.919 at 451°; and G. Quincke, 5.4. The mean of I. Domekkyo's values for native silver chloride, horn silver, is 5.37. P. Walden, and F. A. Henglein studied the mol. vol. of the silver halides.

The values reported for the **melting point** range from G. F. Rodwell's⁹ 450° to W. Ramsay and N. Eumorfopoulos' 460°. The best representative value is 455°. Before melting, the salt is yellow, after melting it forms a transparent viscid orange-yellow liquid, and when cooled, forms a colourless translucent horn-like mass. H. Stolzenberg and M. E. Huth have studied the formation of anisotropic liquids or liquid crystals during the freezing of molten silver chloride. C. Sandonnini found that the f.p. curves of mixtures of lithium and silver chlorides give mixed crystals of two kinds with a gap between 16 and 50 gram-mol. per cent. of silver chloride; with sodium and silver chlorides, C. Sandonnini and P. C. Aureggi found that there is a continuous variation in the f.p. from silver chloride to sodium chloride, showing that

an unbroken series of mixed crystals of the two salts is formed without a minimum in the freezing curves. E. Jänecke has followed the whole course of the "unmixing" of the mixed crystals when the molten mixtures are cooled. The crystals under the microscope appear to be homogeneous, and those crystals with up to 11 per cent. of silver chloride, as in the mineral *huantajayite*, dissolve in water, leaving a curdy residue. S. F. Schemtschuschny found silver and potassium chlorides form a typical V-curve with the eutectic at 306°, and 60 gram-mols. per cent. of silver chloride; a similar curve is obtained with silver and rubidium chlorides, and C. Sandonini and P. C. Aureggi give the eutectic at 251° with 60 gram-mols. per cent. of silver chloride. H. Stolzenberg and M. E. Huth have obtained liquid crystals of silver chloride during the cooling of fused silver chloride. According to I. Kablukoff, and G. Scarpa, there is a eutectic with mixtures of silver nitrate and chloride at 160° with 75 to 90 gram-mols. per cent. of silver nitrate. Silver chloride which has been fused forms a waxy or horn-like translucent mass, and when in thin flexible and transparent plates, which appear colourless although *en masse*, the colour is yellowish-grey. According to A. and C. R. Aikin, the fused chloride has been turned in a lathe, and ornaments have been made from it.

T. W. Richards and G. Jones¹⁰ value for the **compressibility** of silver chloride between 100 and 500 megabars is 0.0000222 megabar per sq. cm.; or 0.0000218 kilogrmm. per sq. cm.; or 0.0000225 atm. per sq. cm.; and the mol. compressibility is 0.000057 megabar per cm. N. Kurnakoff and S. F. Schemtschuschny's value for the *Fließdruck*, that is, the press. required to make precipitated silver chloride flow through a small opening is 65.2 kilogrms. per sq. mm.; for precipitated and compressed silver chloride, 34.7; and for precipitated silver chloride, 17.2. G. Quincke's value for the **surface tension** of molten silver chloride is $\sigma = \frac{1}{2}a^2Dg$ dynes per cm., where a is the difference in cms. between the height of the plane corresponding with the upper surface of the liquid and the plane of greatest diameter, g the acceleration of gravity, 980.6; and D , the sp. gr. of the liquid; but $D=5.3$, and $a=0.286$, accordingly $\sigma=210$ dynes per cm. A. Gradenwitz found $\sigma=212.7$; and for the specific cohesion a^2 , 8.18 sq. mm. A. Colson has investigated the **diffusion** of solid silver chloride into solid sodium chloride.

H. Fizeau's¹¹ value for the **coefficient of linear expansion** is 0.000032938; and for the mol. cubical expansion, 0.00255. The **heat of fusion** of silver chloride is 4.4 Cals. according to O. H. Weber. The **specific heat** C_p of silver chloride which has been fused is 0.0911 between 15° and 98° (H. V. Regnault), and 0.0978 between 160° and 380° (O. Ehrhardt). J. N. Brönsted gives 0.08775 between 0° and 19°; and the corresponding **molecular heat**, 12.58 Cals. The mol. ht. rises with the temp.; thus A. Magnus gives 13.01±0.06 from 15° to 100°; 13.60±0.01 from 16° to 250°; and 13.72±0.02 from 16° to 300°. A. Eucken likewise found the mol. ht. falls to 11.81 at -65.5°, and to 10.34 at -157°. W. Nernst gives for the mol. ht. 2.98 at -249.5°; 4.79 at -240.2°; 7.25 at -227.4°; and 9.79 at -187.7°. W. Nernst and F. Schwes give 2.78 at -250.5°, and 9.82 at -181.6°. Silver chloride commences to volatilize at about 260°, and at a red-heat the loss by volatilization is appreciable. At a rather higher temp. it volatilizes as a dense white vapour. F. J. Malaguti and J. Durocher say that "silver chloride *per se* requires a very high temp. for its volatilization, and it volatilizes very slowly in a closed vessel on account of the low press. of its vapour." The **vapour pressure** of silver chloride at 1000° is less than 5 mm., and at 1150° it is nearly 15 mm. It is less volatile than lead chloride. **Vapour density** determinations by A. Scott, and by H. Biltz and V. Meyer, show that at 1735° the vapour density is 5.698; the theoretical value for AgCl is 4.965, and accordingly some molecules of Ag₂Cl₂ still exist undissociated at this temp.

According to M. Berthelot,¹² the **heat of formation** is Ag+Cl=AgCl (amorphous or crystalline), 29.2 Cals.; or 114 kilojoules per mol; Ag₂O+2HCl_{aq}=41.8 Cals.; J. Thomsen's value for the heat of formation from its elements is 29.38 Cals. M. de K. Thompson found the **free energy** of formation with gaseous chlorine to be

25,600 cal., the **total energy**, 28,900 cal. The heat of formation calculated by J. N. Brönsted and F. Halla from the e.m.f. of the element $\text{HgCl}|\text{AgCl}$ is 29·939 Cals. U. Fischer gives 30·1 Cals. between 15° and 159°, and H. Braune and F. Koref, 30·410 Cals. For the formation of silver chloride from fused silver nitrate and potassium chloride, J. Kablukoff gives 14·51 Cals. M. Berthelot tried if the heats of dissolution of the different forms of silver chloride in potassium cyanide show any differences outside the range of the errors of experiment, but with negative results.

A. de Gramont says that kerargyrite is electrically non-conducting. W. Kohlrausch¹³ found the **electrical conductivity** of silver chloride at 20° to be less than 0·0000035 and to increase with a rise of temp. C. Tubandt and E. Lorenz also found it to gradually rise up to the m.p., when an abrupt increase occurs; there is no sign of a change corresponding with the formation of liquid crystals. The data are :

	250°	350°	450°	455°	457°	550°	600
Conductivity	0·00030	0·0065	0·112	melts	3·764	4·05	4·1

C. Tubandt said that the current in solid crystals of silver chloride is carried entirely by the positive silver ion; the velocity of the ion close to the m.p. was $0\cdot03 \times 10^{-3}$ cms. per sec. C. Sandonini gives the electrical conductivity of fused silver chloride at its m.p. 455° as 3·654 reciprocal ohms, and he investigated the electrical conductivities of fused mixtures of silver and thalious chlorides. J. C. Ghosh also measured the conductivity and calculated the **ionization**, α , of fused silver chloride at different temp. He found at 523° $\alpha=0\cdot26$, and at 723°, $\alpha=92\cdot92$ per cent. L. Grätz showed that under a press. of 4000 atm. the electrical resistance decreases between 0·002 and 0·001 per cent. of its initial value, and a rise of temp. between 220° and 230° produces a similar result. The degree of ionization of silver chloride at 461° is $1\cdot25 \times 10^{-3}$. E. Becquerel found that when a substance is used for the two poles of a voltmeter containing an electrolyte, there is a difference of potential when one plate is in darkness and the other plate is illuminated. H. Luggin studied the effect with silver halides. S. Arrhenius has studied the effect of light on the electrical conductivity of silver chloride. C. Tubandt studied the conductivity of the crystalline solid. G. Trümpler measured the e.m.f. of silver chloride against the normal calomel electrode. S. Meyer gave $-0\cdot28 \times 10^{-6}$ units of mass at 17° for the **magnetic susceptibility** of silver chloride; no discontinuity was observed, by T. Ishiware, when silver chloride is melted.

G. C. Schmidt obtained a marked **photoelectric effect** with silver chloride, bromide, and iodide. According to G. Dima, the order of magnitude is 200 : 430 : 750. C. Schell noticed that while silver iodide is a poor conductor of electricity in darkness, it becomes a much better conductor when illuminated; that rays of wavelength $0\cdot4226\mu$, $0\cdot3222\mu$, and $0\cdot2712\mu$ are most active in changing the conductivity; and that the absorption coeff. for photoelectrically active rays is 13,000; W. Wilson found 15,000. W. Wilson studied the photoelectric effect with silver iodide, and found this salt is ten times as active as an aluminium plate when illuminated by an arc light. The effect with violet light is 8 to 10 per cent. more than with ultra-violet light. W. Wilson explained this by the assumption that violet light causes the molecules to emit electrons of higher speed, and these are less easily liberated by an applied e.m.f., and so the conductivity suffers less change. The photoelectric effect of silver chloride, says G. Dima, is smaller than with silver bromide or silver iodide; in arbitrary units, under the influence of ultra-violet light, the respective ratio is 1 : 2·15 : 3·75. H. Jackson found purified silver chloride in a high vacuum was apparently unaffected by daylight, but it glowed with a green phosphorescence in the cathode rays. The silver chloride was darkened by the exposure, and the darkening was greatest where the glow was brightest.

P. Dutoit and G. von Weisse found the potential of silver chloride against $\frac{1}{10}N$ -silver nitrate is 0·226 volt at 25°, and M. Katayama found the e.m.f. of the cell

Ag|AgCl|Cl to be $1.130 + 0.0006(20 - \theta)$ volts at a temp. θ between 15° and 195° ; and for the cell Ag|AgCl|PbCl₂|Pb, $0.480 + 0.0001(60 - \theta)$ volt between 23° and 121° . A. de Cloizeaux¹⁴ found the **index of refraction** of native silver chloride for Na-light to be $\mu = 2.071$. L. Wernicke gives for $\lambda = 431$, $\mu = 2.135$; $\lambda = 486$, $\mu = 2.101$; and $\lambda = 656$, $\mu = 2.0473$. J. A. Wilkinson observed that the salt has a green fluorescence. H. Hertenstein noted that the spark spectrum is very like that of the metal with some lines missing. T. W. Richards and R. C. Wells have measured the opacity of suspensions of silver chloride in water; and C. Wissinger, the absorption spectrum. S. Procopiu found that a liquid with suspended particles of silver chloride depolarized polarized light.

The **solubility** of silver chloride in water is very small. C. H. Pfaff¹⁵ found the insolubility of silver chloride to be so great that water containing one part of hydrochloric acid in 113,000,000 parts of water is rendered turbid by the addition of silver nitrate, but the action is almost insensible with 1 in 227,000,000. G. J. Mulder, however, claimed that silver can be so detected in water containing at ordinary temp. one part of silver in 1,000,000 parts of water, but not in water with half that proportion of silver in soln. *Vide* analytical reactions of silver. According to C. Hoitsema, one part of silver chloride produces an appreciable turbidity in 3,000,000 to 5,000,000 parts of water. W. Böttger found the specific conductivity of aq. soln. at 100° to be 56.7×10^{-6} reciprocal ohms, and for infinite dilution, 373 reciprocal ohms; from this, he calculates the solubility to be 15.2×10^{-5} mols, or 0.0218 gm. per litre at 100° . From R. Abegg and A. J. Cox's value 0.015 volt for the cell Ag|AgCl against $\frac{1}{10}N$ -KCl, H. M. Goodwin calculated 1.25×10^{-5} at 25° , and A. Thiel, 1.41×10^{-5} . Collecting together the different data for the solubility of powdered amorphous silver chloride expressed in grams per litre:

	2°	10°	18°	25°	34°	42°	100°
AgCl	0.00076	0.00096	0.00156	0.00191	0.00303	0.00303	0.0218

The solubility depends to some extent on the grain-size; J. S. Stas found that freshly precipitated curdy silver chloride is more soluble than the powdered form. The larger grains are less soluble than the small ones, and therefore increase in size at the cost of the small ones. The heat of soln. Q , or negatively, the heat of precipitation, calculated from the solubilities S_1 and S_2 at temp. T_1 and T_2 calculated from $\log S_1 - \log S_2 = \frac{1}{2}Q(T_1^{-1} - T_2^{-1})/R$, is -16 Cals., and J. Thomsen's value, found calorimetrically, is -15.8 Cals.

In estimating silver by J. L. Gay Lussac's method, in which a soln. of silver nitrate is titrated with a soln. of an alkali chloride, a point is reached at which a slight precipitate is produced by the addition of a drop either of the alkali chloride or of the silver nitrate soln., indicating the presence of either free silver nitrate or alkali chloride in a state of equilibrium, either of which is precipitated by the other. This is sometimes called *Mulder's neutral point* after G. J. Mulder's study of the reaction in his *De essayeer-methode van het zilver scheikundig onderzocht* (Utrecht, 1857), where the phenomenon was attributed to the presence of alkali nitrate; but J. S. Stas showed that alkali nitrate is not the cause which determines the soln. of the silver chloride; rather is it due to the solubility of silver chloride in the soln. and to the reduction of the solubility by the addition of an excess of either silver nitrate or of a little sodium chloride. The use of an alkali bromide or iodide obviates the difficulty which arises owing to the solubility of silver chloride, because silver bromide or iodide is so much less soluble in cold water than the chloride. J. P. Cooke says that 0.1 gm. of silver nitrate per litre makes silver chloride quite insoluble in water, while the addition of some *hydrochloric acid* lowers the solubility one half. According to C. St. Pierre, a soln. of silver nitrate is added drop by drop to conc. hydrochloric acid, and the whole is rapidly stirred, the silver chloride which is first formed dissolves so rapidly that its formation can be perceived only with difficulty; the proportion of silver chloride thus dissolved may exceed 0.5 per cent. of the weight of acid employed. When water is added, the soln. becomes turbid. The

turbidity at first increases with the quantity of water added; but all the silver chloride cannot be precipitated by adding water.

The solubility of silver chloride in water is depressed when chlorine or silver ions are present in the soln. Since the solubility of silver chloride is approximately 10^{-5} mols per litre and the ionization is then complete, the solubility product is 10^{-10} , and therefore an excess of the ions of either chlorine or silver reduces the solubility very much. For instance, if the conc. of either of these ions be 10^{-3} , the solubility falls from 10^{-5} to 10^{-7} mols per litre. In many cases, however, complexes appear to be formed. A. A. Noyes and W. C. Bray¹⁶ suggested the complex ion is AgCl_2' ; G. Bodländer, AgCl_4''' . G. S. Forbes, however, obtained a little evidence of the formation of the complex ions AgCl_3'' , AgCl_4''' , and possibly of AgCl_5'''' , but not of AgCl_2' , in his study of silver chloride in soln. of various chlorides. With conc. *hydrochloric acid*, E. H. E. Reinsch showed that one part of silver nitrate in 15,000 parts of water becomes turbid when a little hydrochloric acid is added, and the turbidity clears up when more acid is present. Again, G. S. Whitby found that at 21°, 1 per cent. HCl dissolves 0.0002 gm. per litre; 5 per cent. acid, 0.0033 gm. per litre; and 10 per cent. acid, 0.0555 gm. per litre. C. St. Pierre also showed that while 100 grms. of conc. hydrochloric acid dissolve 0.5 gm. per litre, 100 c.c. of the same acid diluted with twice its weight of water, dissolve only 0.167 gm. of silver chloride. A. Vogel stated that with 100 c.c. of cold hydrochloric acid of sp. gr. 1.165, alone or diluted with :

Water.	.	.	0	100	200	300	500 c.c.
Silver chloride	.	.	0.298	0.056	0.018	0.0089	0.0035 gm. per 100 c.c.

Boiling hydrochloric acid diluted with its own vol. of water dissolved, under similar conditions, 0.56 gm. of silver chloride. O. L. Erdmann found that a hot mixture of alcohol and hydrochloric acid dissolves silver chloride, part of which separates out on cooling. E. H. Riesenfeld and H. Feld electrolyzed soln. of silver chloride in 35 per cent. hydrochloric acid, and they found that silver migrates to the anode as a complex **hydrochloroargentic acid**, HAgCl_2 . This conclusion is in agreement with G. S. Forbes and H. I. Cole's work on the solubility of silver chloride in hydrochloric acid, and also in soln. of the chlorides of sodium, ammonium, potassium, rubidium, calcium, strontium, and barium.

According to N. A. E. Millon and A. Commaille, silver chloride is not soluble in aq. soln. of *calcium or zinc chloride*; but this statement has not been confirmed by A. Vogel, H. C. Hahn, or G. S. Forbes, who investigated the solubility of this salt in aq. soln. of *sodium potassium, ammonium, barium, strontium, calcium, and magnesium chlorides*. The solubility of silver chloride is very nearly proportional to the conc. of the dissolved chloride through considerable ranges, and is nearly doubled in passing from 0° to 25°. On the basis of the theory of the solubility product, G. S. Forbes calculated that silver chloride ought to be most insoluble in $\frac{1}{10^9}N$ -soln. of the given chloride. H. C. Hahn says a sat. soln. of calcium chloride dissolves at 0°, 2.825 grms. of silver chloride per litre, and at 100°, 8.147 grms., while in magnesium chloride soln. the solubility is even greater. H. Debray, and J. Formáne say that the presence of mercuric chloride does not favour the solubility of silver chloride. A. Sauer says the presence of ferric chloride favours the solubility of silver chloride, while H. C. Hahn found a sat. soln. of *ferric chloride* at 24.5° dissolves 0.006 gm. of silver chloride per 100 grms. of soln.; *ferrous chloride*, 0.169 gm.; *cupric chloride*, 0.053 gm.; *manganese chloride*, 0.013 gm.; *zinc chloride*, 0.0134 gm.; a 27.32 per cent. soln. of *barium chloride*, 0.057 gm.; 41.26 per cent. of *calcium chloride*, 0.571 gm.; 36.35 per cent. *magnesium chloride*, 0.531 gm.; 2 per cent. *ammonium chloride*, 0.3397 gm.; 24.95 per cent. *potassium chloride*, 0.0776 gm. (19.6°); 25.95 per cent. *sodium chloride*, 0.105 gm. The solubility of silver chloride in soln. of sodium and potassium chloride at 15° show per 100 grms. of soln.—10 grms. KCl, 0.000 gm. AgCl; 20 KCl grms., 0.020 gm. AgCl; 25 grms. KCl, 0.084 gm. AgCl; and with 10 grms. NaCl, 0.0025 gm. AgCl;

21.98 grms. NaCl, 0.0439 gm. AgCl; and with 26.31 grms. NaCl, 0.127 gm. AgCl. A. C. and A. E. Becquerel found a litre of a sat. soln. of sodium chloride at ordinary temp. dissolved 0.807 gm. of silver chloride. J. Percy found the rate of dissolution of the salt in a cold sat. aq. soln. of calcium chloride to be, per 100 c.c. :

	2	5	10	21	60 days.
Grm. silver chloride	0.0538	0.0576	0.0753	0.1134	0.1426

According to P. A. Guye, the solubility of silver chloride in soln. of *potassium chlorate* is 0.0018 gm. per litre. G. J. Mulder says that the solubility of silver chloride in *nitric acid* of sp. gr. 1.3 is not greater than it is in the dil. acid—hot or cold, conc. or dil., but according to C. St. Pierre, when nitric acid is distilled with a small quantity of pulverulent silver chloride, the salt gradually dissolves. This is not a case of simple soln. because silver nitrate crystallizes from the cooling liquid. According to C. van Rossem, the solubility is not perceptibly influenced by $\frac{1}{10}N$ -soln. of *sodium or ammonium nitrate*; silver chloride is also slightly soluble in cold aq. soln. of sodium, potassium, calcium, magnesium, or ammonium nitrates, and more so in warm soln., inasmuch as "hot soln. which are perfectly clear become strongly clouded as they cool." He also showed that between 15° and 20°, a soln. containing 0.393 gm. of sodium nitrate dissolved 0.00096 gm. of silver chloride per 100 grms. of soln. and with 0.787 and 2.787 grms. of sodium nitrate respectively 0.00133 and 0.00253 gm. of silver nitrate. A conc. soln. of *silver nitrate*, at 25°, was found by G. S. Forbes to give a faint turbidity with 0.00003 gm.-eq. or 0.001 gm. of chlorine per litre. This is but one-tenth the solubility of silver chloride in a 2*N*-soln. of alkali chloride. W. Böttger also found the solubility of silver chloride in $\frac{1}{50}N$ -silver nitrate to be 0.15×10^{-7} . E. Reichert claims to have obtained what he thought to be a compound of silver chloride and nitrate, AgCl.AgNO₃. F.p. curves of silver chloride and nitrate have been examined by I. Kablukoff, and by G. Scarpa. There is a eutectic with 75 gram-mol. per cent. of silver nitrate at 160°. H. W. F. Wackenroder (1842), and J. von Liebig (1851) noticed that the silver halides dissolve comparatively easily in cold soln. of mercuric nitrate, and more so in hot soln.; while J. S. Stas measured some of the solubilities. J. T. Hewitt found that silver chloride suspended in nitric acid is dissolved when mercuric oxide is added. B. H. Buttle and J. T. Hewitt say the amount of silver in soln. rises from 0.00684 to 0.0187 gram-atom per litre as the conc. of the *mercuric nitrate* rises from 0.025 to 0.250 mol per litre. With a sufficiently great excess of mercuric nitrate, the addition of hydrochloric acid or silver nitrate results in the separation of an eq. amount of silver chloride. If the conc. of the nitric acid rises from 0.30 to 0.70 mol per litre, the amount of silver remaining in soln. falls from 0.00924 to 0.00862 gram-atom per litre. H. Morse found evidence of the formation of complexes of mercuric nitrate and silver chloride in the soln. R. Luther explains the phenomenon by assuming that when mercuric nitrate is added to the completely ionized soln. of silver chloride, some chlorine ions are discharged, by the formation, according to J. T. Hewitt, of a HgCl⁻ ion; and more silver chloride dissolves in order to preserve a constant solubility product for this salt. B. Finzi, and J. Barnes have studied the effect of mercuric salts on the solubility of silver chloride. A hot sat. soln. of silver chloride in one of mercuric nitrate deposits brilliant yellowish-white crystals of silver chloride on cooling. The addition of an excess of hydrochloric acid, sodium, or ammonium chloride, or nitric acid, precipitates all the silver as chloride; sodium acetate acts in a similar manner, forming mercuric acetate and sodium nitrate. Silver chloride precipitated with a small quantity of mercurous chloride, is stated by J. Spiller not to be blackened by light.

G. J. Mulder found silver chloride to be insoluble in dil. or conc. cold *sulphuric acid*, but it is decomposed by the boiling acid; and he also found silver chloride is not dissolved by cold or hot *sulphurous acid*. J. von Liebig, and H. Debray have studied the effect of *alkali acetates* on the solubility of silver chloride. E. Valenta found the solubility in *ammonium thiosulphate* soln. at 20°, to be per 100 grms.;

in soln. containing 1 : 100(NH₄)₂S₂O₃, 1.32 grms. AgCl ; with 1 : 10(NH₄)₂S₂O₃, 3.92 grms. AgCl. Again, with *sodium thiosulphate* soln. at 20°, the solubility per 100 grms. of soln. containing 1 : 100Na₂S₂O₃, 0.40 gm. AgCl ; 100Na₂S₂O₃, 2.00 grms. AgCl ; 10 : 100Na₂S₂O₃, 4.10 grms. AgCl ; and 20 : 100Na₂S₂O₃, 6.10 grms. AgCl ; T. W. Richards and H. B. Faber found a soln. with 200 grms. of sodium thiosulphate in litre at 35° dissolves 9.08 grms. of silver chloride per 100 grms. of soln. R. Luther and A. Leubner attributed the augmented solubility to the formation of complexes. A. Rosenheim and S. Steinhäuser isolated the complex 4(NH₄)₂S₂O₃.NH₄Cl.AgCl. Similar remarks apply to the augmented solubility of silver chloride in *sodium sulphite* soln., where E. Valetta showed that soln. with conc. 10 : 100 and 20 : 100 Na₂SO₃ respectively dissolve 0.44 and 0.95 gm. of silver chloride per 100 grms. of soln. E. Valenta also showed that a 5 : 100 soln. of *potassium cyanide*, at 25°, dissolves 2.75 grms. of silver chloride. Thiocyanates also augment the solubility of silver chloride. Thus, 5 : 100, 10 : 100, and 15 : 100 soln. of *ammonium thiocyanate*, at 20°, dissolve respectively 0.08, 0.54, and 2.88 grms. of silver chloride per 100 grms. of soln. With soln. of conc. 10 : 100, at 25°, the solubility with *potassium thiocyanate* is 0.11 gm. of silver chloride ; *calcium thiocyanate*, Ca(SCy)₂, 0.15 gm. ; *barium thiocyanate*, Ba(SCy)₂, 0.20 gm. ; Al(SCy)₃, 2.02 grms. ; *thiocarbamide*, 0.83 gm. ; and *thiosinamine*, 3.90 grms. G. J. Mulder found silver chloride to be perceptibly soluble in a warm aq. soln. of *tartaric acid*, and to a less extent in a cold soln. N. G. Chatterji and N. R. Dhar observed no signs of peptization when silver chloride is treated with a conc. soln. of *cane sugar*.

M. Faraday (1818), and E. C. Franklin and C. A. Kraus (1898) ¹⁷ reported that silver chloride is slightly soluble in *liquid ammonia* ; but it is very soluble in *aqueous ammonia* as was noted by J. R. Glauber in 1648. Many observations have been made on the phenomenon since that time. If an ammoniacal soln. of silver chloride is boiled, J. L. Proust showed that fulminating silver is deposited, but if slowly evaporated at a gentle heat, silver chloride may be deposited in cubes or octahedra, or in pearly scales. The silver chloride is precipitated from the ammoniacal silver chloride soln. by neutralizing the ammonia with an acid ; and P. Berthier showed that hydrogen sulphide or alkali sulphides precipitate silver sulphide from the ammoniacal soln. by neutralizing the ammonia with an acid, and when boiled with ammonium sulphate finely divided silver is precipitated. N. W. Fischer found that zinc and copper rapidly reduce grey spongy silver ; lead reduces the silver slowly and completely ; cadmium and antimony act slowly and incompletely ; and tin, iron, bismuth, and mercury are without action. G. Bodländer found an ammoniacal soln. of lead acetate precipitates lead chloride from an ammoniacal soln. of silver chloride. An ammoniacal soln. of silver chloride or bromide when heated with iodic acid up to nearly 200° gives a deposit of silver iodide and an evolution of a small amount of gas. It is supposed that the iodic acid oxidizes the ammonia, forming nitrogen, water, and ammonium iodide : NH₄IO₃+2NH₃=NH₄I+3H₂O+N₂, a reaction verified by heating the iodic acid with ammonia in a sealed tube ; no bromic or chloric acid is formed if silver bromide or chloride be also present. The ammonium iodide so formed reacts with the less soluble silver chloride or bromide giving silver iodide. Bromic acid acts similarly.

According to R. Jarry, at 0°, 100 grms. of the soln. hold :

NH ₃ . . .	1.45	5.60	11.77	28.16	30.19	34.56	37.48 grms.
AgCl . . .	0.49	3.44	4.68	6.59	7.25	4.77	3.90 „

When the soln. in a confined space is evacuated, at 0°, the manometer remains constant at 268 mm., and 10 to 15 c.c. of the soln. can give off more than 500 c.c. of ammonia without the press. changing. If evacuated further, the manometer falls to 15 mm. If an allowance be made for the water vapour, the partial press. of the ammonia in the two cases are 263 mm. and 12 mm. respectively ; these are the dissociation press. of the compounds AgCl.3NH₃ and 2AgCl.3NH₃ respectively. There are also two breaks in the solubility curves of silver chloride in aq. ammonia

which correspond with these two compounds as solid phases. G. Bodländer and R. Fittig's work on the solubility of silver chloride in aq. ammonia led to the inference that other ammino compounds are present—*e.g.* $\text{AgCl}\cdot 2\text{NH}_3$. J. Straub represents the relation between the silver $[\text{Ag}]$ and the ammonia $[\text{NH}_3]$ in soln. by $[\text{Ag}] = 0\cdot0218[\text{NH}_3]^2 + 0\cdot0550[\text{NH}_3]$.

M. Faraday noted in 1818 that when silver chloride is exposed to ammonia gas, a considerable proportion is absorbed, and the solid swells considerably and finally crumbles to powder. He also noted that when a conc. soln. of silver chloride in aq. ammonia is allowed to stand for some weeks it furnishes colourless transparent crystals. R. Jarry also obtained similar crystals by cooling to 0° a soln. of ammonia sat. with silver chloride at 20° . B. Gossner used an analogous mode of preparation. R. Kane also obtained these crystals by treating the soln. with alcohol. The product obtained by these different processes is **silver sesquiammino-chloride**, $2\text{AgCl}\cdot 3\text{NH}_3$. F. Isambert found this compound is also produced when silver chloride is exposed to a stream of ammonia at 20° . When exposed to air the crystals become opaque, ammonia is evolved, and silver chloride remains. Both F. Isambert and A. Horstmann have measured the dissociation press. at different temp.

6°	10°	20°	47°	$58\cdot5^\circ$	$69\cdot0^\circ$	$71\cdot5^\circ$	103°
22·0	28·2	52·6	268	528	786	946	4880 mm.

According to W. Biltz, the dissociation temp. for one atm. is 68° ; the compound melts at 103° , and F. Isambert's value for the heat of formation is $11\cdot58$ Cals. per mol of ammonia. W. Biltz and W. Stollenwerk also found evidence of silver monammino-chloride, $\text{Ag}(\text{NH}_3)\text{Cl}$, above 30° , the sesquiammine and the monammine form mixed crystals. The vap. press. p of the sesquiammine is given by $\log p = -14\cdot57T + 1\cdot75 \log T - 0\cdot0015T + 3\cdot3$, where the heat of formation Q is $10\cdot52$ Cals.; likewise for the monammine, $Q = 11\cdot11$ Cals., and the vap. press. p is given by $\log p = -Q/4\cdot57T + 1\cdot75 \log T - 0\cdot0015T + 3\cdot3$.

F. Isambert found that when the temp. of silver chloride is between 0° and 20° , a current of ammonia gas produces **silver triammino-chloride**, $\text{AgCl}\cdot 3\text{NH}_3$. A. Terreil prepared what he thought to be *silver diammino-chloride*, $\text{AgCl}\cdot 2\text{NH}_3$, by heating in a sealed tube on a water-bath silver chloride sat. with ammonia gas or with conc. aqua ammonia; on cooling, crystals of the salt in question separate out. The crystals may prove to be the partially dissociated triammino-salt. W. Biltz found the dissociation temp. of the triammino-salt to be 20° at one atm. press.; the dissociation press. are:

$0\cdot1^\circ$	$0\cdot6^\circ$	$16\cdot6^\circ$	$28\cdot8^\circ$	$32\cdot4^\circ$	$34\cdot2^\circ$	54°	57°
273	505	598·5	1355	1596	1713	4641	4880 mm.

Consequently, if silver chloride be placed in an excess of aqua ammonia at a press. of 760 mm., the compound $\text{AgCl}\cdot 3\text{NH}_3$ will be formed below 20° nearly; $2\text{AgCl}\cdot 3\text{NH}_3$ between 20° and 65° nearly; and above 65° silver chloride alone will exist. W. Biltz and W. Stollenwerk found the heat of formation $Q = 9\cdot16$ Cals., and the vap. press., p , is given by $\log p = -Q/4\cdot57T + 1\cdot75 \log T - 0\cdot0025T + 3\cdot3$.

Soln. of ammonium chloride at 15° , containing 10, 19·23, and 28·45 grms. of *ammonium chloride*, dissolve respectively 0·0050, 0·0577, and 0·340 gm. of silver chloride per 100 grms. of soln. The solubility of silver chloride in soln. with 26·31 grms. of ammonium chloride per 100 grms. of soln. rises from 0·276 at 15° to 1·053 at 110° . A. Vogel found that a hot sat. soln. of ammonium chloride dissolves silver chloride, and, as the soln. cools, it deposits needles of silver chloride; silver chloride is also precipitated if water be added to the soln. P. T. Austen¹⁸ found that an ammoniacal soln. of silver chloride can be acidified by hydrochloric acid without precipitation of silver chloride, and he assumes the soln. contains *ammonium silver chloride*. G. S. Forbes also studied the solubility of silver chloride in aq. soln. of ammonium chloride, and the formation of the complex salt. A soln. of *ammonium carbonate* (1 : 10) dissolves 0·05 gm. of silver chloride per 100 grms. of solvent.

Silver chloride is virtually insoluble in *ethyl alcohol*, and, according to G. Bodländer, J. Neustadt found the solubility in *methyl alcohol* to be 1.95×10^{-13} , and in ethyl alcohol, 1.8×10^{-14} . B. Wuth, and H. Euler have investigated the solubility of silver chloride in *methylamine* and in *ethylamine*. The salt is almost insoluble in *ether*. F. Mylius and G. Hüttner could find no sign of the extraction of any silver chloride by treating aq. or hydrochloric acid soln. with this menstruum. F. Bezold says it is insoluble in *methyl acetate*, and M. Hamers, in *ethyl acetate*. According to L. Kahlenberg and W. J. Wittich, the solubility in *pyridine* falls from 5.35 grms. per 100 grms. of pyridine at 0° to 0.12 gm. at 110°; between -1° and -22°, the solid phase is $\text{AgCl} \cdot \text{C}_5\text{H}_5\text{N}$; and between -22° and -57°, $\text{AgCl} \cdot 2\text{C}_5\text{H}_5\text{N}$.

Chemical properties of silver chloride.—D. Tommasi¹⁹ says that silver chloride is reduced by **hydrogen** under a high press. or at an elevated temp. The equilibrium reaction, $2\text{Ag} + 2\text{HCl} \rightleftharpoons 2\text{AgCl} + \text{H}_2$, has been previously discussed, and A. Jouniaux's values for the equilibrium constant $K[\text{HCl}]^2 = [\text{H}_2]$ are 0.1164 at 526°; 0.08912 at 605°; and 0.05728 at 705°. According to A. Jouniaux, silver chloride is reduced in **sunlight** at ordinary temp., and with time, the reaction is complete. H. Schulze observed no change when silver chloride is heated in oxygen. but A. Mailfert found it to be slowly peroxidized by **ozone**.

H. Rose²⁰ reported that when **phosphorus** is heated with silver chloride it forms phosphorus trichloride and silver; while at 400°, A. Granger obtained silver diphosphide. H. Rose also found that silver chloride is easily reduced by **phosphine**, forming phosphorus, silver, and hydrogen chloride. Silver chloride is not reduced when heated with **carbon**, but on charcoal in the blowpipe flame it is reduced to the metal. J. Thallwitz found an intimate mixture of silver chloride, charcoal, and sodium peroxide spontaneously inflamed in a short time, and produced a regulus of silver. According to F. Göbel, **carbon monoxide** reacts with silver chloride, forming phosgene, COCl_2 , but neither A. G. Bloxam nor C. Stammer could confirm this: carbon monoxide does not reduce red-hot silver chloride. N. D. Costeanu did not detect any action when *carbon dioxide* is passed over silver chloride at 835° and 1000°.

E. Filhol and J. B. Senderens²¹ say that silver chloride is not changed when boiled with **sulphur**; but P. Berthier states that a small proportion of silver chloride is decomposed when it is heated with sulphur, forming what he called a soft greyish-black *sulfo-chlorure*. C. F. Wenzel found that when silver chloride is heated with **mercuric sulphide**, silver sulphide and mercuric chloride are formed; A. Levallois obtained an analogous result with lead sulphide in a sealed tube at 160°.

F. J. Malaguti and J. Durocher made an elaborate study of the action of different metal sulphides and arsenides on silver chloride. They found that silver chloride is directly decomposed, at ordinary temp., by contact with various metallic sulphides when no liquid other than water is present. Thus by triturating a mixture of *cadmium sulphide* and silver chloride with water, the yellow sulphide becomes first bistre-coloured, and finally black; on filtering, cadmium chloride is found in the filtrate. With some sulphides the action is very slow—e.g. with copper pyrites the reaction is inappreciable in less than a month. *Stannic sulphide* becomes black, and the filtrate contains some free hydrochloric acid. *Cuprous sulphide*, according to C. J. B. Karsten, is converted by an ammoniacal soln. of silver chloride into copper chloride, and sulphide, and metallic silver: $2\text{AgCl} + \text{Cu}_2\text{S} = 2\text{Ag} + \text{CuCl}_2 + \text{CuS}$; F. J. Malaguti and J. Durocher represent the reaction: $4\text{AgCl} + \text{Cu}_2\text{S} = 2\text{Ag} + \text{Ag}_2\text{S} + 2\text{CuCl}_2$, and added: The reaction is as precise and almost as prompt as between two eq. proportions of liquid substances; but C. J. B. Karsten found no reaction occurs with cuprous sulphide and a soln. of silver chloride in sodium chloride. He also found *zinc sulphide* in the presence of aq. ammonia reacts with silver chloride, forming silver sulphide, but in the presence of an aq. soln. of sodium chloride, the reaction is retarded. F. J. Malaguti and J. Durocher represent the reaction with zinc blende in the presence of

aq. ammonia: $2\text{AgCl} + \text{ZnS} = \text{Ag}_2\text{S} + \text{ZnCl}_2$. No silver is found in the filtrate because silver sulphide is not soluble in that menstruum. C. J. B. Karsten stated that *lead sulphide* has as little action as *bismuth sulphide* on silver chloride whether aq. ammonia or a soln. of sodium chloride be the solvent. F. J. Malaguti and J. Durocher found that a soln. of silver chloride in ammonia water or in a soln. of sodium thiosulphate reacts: $2\text{AgCl} + \text{PbS} = \text{PbCl}_2 + \text{Ag}_2\text{S}$; *mercuric sulphide* also reacts in a similar manner: $2\text{AgCl} + \text{HgS} = \text{HgCl}_2 + \text{Ag}_2\text{S}$.

Representing what F. J. Malaguti and J. Durocher call the decomposing faculty of various sulphides, etc., on silver chloride by the number of parts by weight of silver chloride decomposed in 18 hrs. by 100 parts of the sulphide, etc., when 0.2 gm. of the sulphide, etc., is treated with 7 c.c. of an ammoniacal soln. of silver chloride containing 0.002 gm. of the salt per c.c., they obtained for the decomposing faculty of artificial galena, 5; Heulgoat galena, 5; galena very rich in silver from Freiberg, 7; seleniferous galena, with curved faces, from Beresow, 8; antimonical galena, with slightly curved faces, from Saint-Mandé, 10; arsenical galena, with the solid angles and the edges of the cube truncated, from Saxony, 13; seleniferous galena from Fahlun, 13; crystallized blende from Saxony, 1; sulphide of zinc, prepared in the dry way, 3; very pure blende from Königsberg, 3; cadmiferous blende from Prizbram, 4; fibrous blende from Pontpéan, 5; lamellar blende from Pontpéan, 5; black artificial blende, obtained by sublimation, 10; artificial sulphide of cadmium, 14; cubical iron-pyrites, 0.25; white or prismatic pyrites, 0.50; white globular pyrites, 1; sulphide of cobalt, prepared in the dry way, 6; sulphide of nickel, prepared in the dry way, 8; sulphide of bismuth, prepared in the dry way, 3.50; protosulphide of tin, prepared in the dry way, 0.33; bisulphide of tin, or mosaic gold, 31; sulphide of antimony, 0.002; sulphide of molybdenum, 0.001; native cinnabar, 0; sulphide of copper (cuprous sulphide) artificially prepared, 337; copper-pyrites of unknown locality, 10; bornite or purple copper-ore, $3\text{Cu}_2\text{S} + \text{Fe}_2\text{S}_3$, from Sweden, 10; bornite, of a lilac tint, from Tunaberg, 180; cupro-nickeliferous pyrites from Espedal in Norway, 2; stromeyerite, $\text{AgS} + \text{Cu}_2\text{S}(\text{Ag}_2\text{S} + \text{Cu}_2\text{S})$, 3.25; compact bourbonite, 11; smaltine, 170; kupfer-nickel, 470; mispickel, forming a fibrous mass, 0.5; crystallized mispickel from Utö, 17.5; and nickel-glance from Schneeberg, 440.

They found three types of reaction: (i) double decomposition: $\text{MS} + 2\text{AgCl} = \text{Ag}_2\text{S} + \text{MCl}_2$; (ii) reduction: $\text{MS}_2 + 2\text{AgCl} = \text{Ag}_2\text{S} + \text{MS} + \text{Cl}_2$; (iii) double decomposition and reduction: $\text{M}_2\text{S} + 4\text{AgCl} = 2\text{Ag} + \text{Ag}_2\text{S} + 2\text{MCl}_2$. The general conclusion is that the decomposing faculty of the sulphides may be modified by the state of purity, the density, the composition, the mol. state, the cohesion, the structure of the substance, and the crystalline form, even by modifications in crystals belonging to the same system of crystallization.

The metals which give hydrogen when treated with hydrochloric acid reduce silver chloride to metallic silver; zinc is frequently used for this purpose, and it does its work equally well in contact with silver chloride, or in a soln. of the chloride in aqua ammonia. K. Seubert and A. Schmidt²² found silver chloride to be reduced by heating it dry with magnesium. According to N. W. Fischer, the metals zinc, cadmium, mercury, copper, iron, arsenic, antimony, bismuth, lead, and tin when shaken with silver chloride suspended in water, or, better, in dil. hydrochloric or sulphuric acid, precipitate the silver, but they do not do so under alcohol or ether. D. Tommasi, U. Antoni and G. Turi, and J. Schnauss found copper and mercury reduce ammoniacal soln. of silver chloride. E. Vigouroux also reduced silver chloride by means of aluminium; and R. Escalles found that if powdered aluminium be mixed with silver chloride, the reaction once started proceeds with explosive violence unless an excess of aluminium be present. According to F. T. Sonneschmid, the presence of sodium chloride is necessary for the reduction with mercury. According to J. N. Brönsted, the heat of the reaction with mercury is $\text{AgCl} + \text{Hg} = \text{HgCl} + \text{Ag} + 1.4$ Cals., and with lead, 11 Cals. D. Tommasi says that sodium amalgam does not reduce silver chloride. J. H. Gladstone and A. Tribe found that a plate of silver dipping in molten silver chloride becomes covered with crystals of silver. A soln. of ferrous sulphate was found by R. Keir, H. Rose, G. Wetzlar, and J. Seymour not to reduce silver chloride in light or in darkness; as R. Keir puts it "luna cornea is not decomposed by martial vitriol." J. Seymour also found that stannous chloride does not reduce silver chloride, but alkali stannite soln. do. According

to G. Skutari, silver chloride is reduced by **sodium hyposulphite**, $\text{Na}_2\text{SO}_3 + 2\text{AgCl} = 2\text{Ag} + 2\text{NaCl} + \text{SO}_2$, and the same result is obtained if the silver chloride is in soln. in aq. ammonia or potassium cyanide. A. Vogel showed that cold **sulphurous acid** does not reduce silver chloride, but the salt becomes grey if this acid be warm; A. Geuther and P. Berthier found that boiling **alkali sulphite** in presence of ammonium chloride reduces silver chloride to metal. A. Rosenheim and S. Steinhäuser found cold soln. of the **alkali bisulphites** dissolve silver chloride, and, after standing a little while, deposit metallic silver. P. Jannasch found a hot soln. of **hydroxylamine hydrochloride** and sodium hydroxide dissolves the silver halides. E. Riegler found silver chloride to be reduced to the metal by **hydrazine sulphate** in alkaline soln.—nitrogen is at the same time evolved. According to F. Mawrow and G. Mollow, **hypophosphorous acid** reduces silver chloride slowly; and, according to M. C. Lea, a dil. soln. of **sodium hypophosphite** produces no visible effect with silver halides, but it brings these substances into the same condition as they exist in the latent photographic image; conc. soln. of the hypophosphite colour the silver halides purple-brown. J. Seymour says sodium hypophosphite reduces silver chloride to the metal. G. B. Bonino found **potassium ferrocyanide** converts silver chloride into insoluble potassium silver ferrocyanide, $\text{AgK}_3\text{FeCy}_6$ —silver bromide or iodide is not affected.

A. Vogel, and A. Sauer noted that cold **sulphuric acid** has no action on silver chloride; hot sulphuric acid dissolves some silver chloride and deposits it again on cooling; boiling sulphuric acid forms silver sulphate and hydrochloric acid. Native silver chloride is, however, attacked but slowly even by the boiling acid. G. J. Mulder found that if dil. sulphuric acid be distilled in darkness over silver chloride some hydrochloric acid will be found in the distillate. T. E. Thorpe, and C. S. Pierre noted that with **nitric acid** some silver nitrate is formed.

H. Moissan found that **fluorine** displaced the chlorine in silver chloride. J. J. Berzelius says that molten silver chloride absorbs chlorine gas and gives it up on cooling. The action of the other halogens on silver chloride has been much discussed. The heats of formation are AgCl , 29.44 Cals.; AgBr , 23.0 Cals.; and AgI , 14.66 Cals. Consequently, the formation of silver bromide or iodide by the action of the proper halogen on silver chloride should be an endothermic process, and therefore, by M. Berthelot's *le principe du travail maximum*, should not occur. P. Julius, however, showed that the chlorine can be completely displaced by bromine or iodine at a red heat if the action be prolonged. This, said M. Berthelot, is because the heats of formation of the silver halides are not the same at high as they are at ordinary temp. According to P. Julius,²³ air charged with **bromine** vapour converts silver chloride into bromide; but, says A. Potilitzin, at ordinary temp. the exchange is very slow. According to M. Berthelot, if silver chloride be suspended in water, it readily takes up bromine, which can be removed by the passage of a current of air. According to P. Julius, **iodine** vapour, and, according to N. N. Beketoff, a soln. of iodine in chloroform, slowly converts silver chloride into the iodide. According to C. Löwig, silver chloride is slightly soluble in hydrobromic acid, forming some silver bromide; and, according to H. St. C. Deville, hydriodic acid forms hydrochloric acid and silver iodide. Both reactions are exothermal, but conversely, hydrochloric acid displaces bromine from silver bromide. M. Berthelot tried to explain this by his principle of maximum work by supposing that hydrochloric acid forms *un chlorhydrate de chlorure d'argent*. The action of the metal bromides and iodides on silver chloride has been studied by F. Field, A. Potilitzin, and M. Berthelot. Further, A. Colson covered silver chloride with an alkali chloride, and he found that the latter diffused into the former when the mass was heated to a temp. below the m.p. of either; thus presenting an example of the diffusion of a solid. H. Baubigny found **iodic acid** at 200° produces silver iodide, and **ammonium iodate** and ammonia form ammonium iodide, which then reacts with silver chloride, forming the iodide. According to G. Mazzaron (1898), silver chloride gives chlorine, not chromyl chloride, when treated with potassium dichromate and

sulphuric acid. F. W. O. de Coninck showed that **iodoform** converts silver chloride into chloroform and silver iodide. A. Mailfert found that **ozone** acts but slowly on silver chloride.

According to P. Berthier,²⁴ silver chloride dissolves in all proportions in fused **lead oxide**, and when galena is added to the mixture, the silver chloride is all reduced to the metal by the lead set free in the reaction: $2\text{PbO} + \text{PbS} = \text{SO}_2 + 3\text{Pb}$. F. J. Malaguti and J. Durocher found cuprous oxide exerts no appreciable action on silver chloride in water at 100° , but if some alum, ferrous sulphate, or cupric sulphate is present, the silver chloride is reduced; but the action is less energetic than it is with iron or copper with or without these salts. P. Berthier found that boric acid decomposes silver chloride only when heated in the presence of water vapour. P. Berthier stated that fused borax or siliceous fluxes dissolve silver chloride, forming an opalescent mass—it is doubtful if this mixture is a true soln.

G. Wetzlar²⁵ first reported the formation of **sodium silver chloride**. A boiling conc. soln. of sodium chloride dissolves silver chloride, and on cooling deposits cubic crystals of the double salt; the same salt was made by adding silver nitrate to a boiling soln. of sodium chloride until some silver chloride remained undissolved. His analyses were too indecisive as to the composition of the double salt to be "worth communicating." He found that the double salt could exist only in a very conc. soln. of sodium chloride, and was decomposed by a more dil. soln. as well as by water into silver chloride which separates in numerous voluminous flocks, and the alkali chloride which remains in soln. The crystals of the double salt were stated to be unaffected by exposure to the most intense sunlight, and not to be reduced by adding ferrous sulphate to the soln. of sodium chloride containing the double salt. He also found that potassium, calcium, and other "electropositive metallic" chlorides combined with silver producing analogous double compounds. A. C. Becquerel prepared octahedra and tetrahedra of double salts of silver chloride with potassium and sodium chlorides by the method he employed for sodium cuprous chloride. The soln. have been examined by O. Sackur, F. Cornu, and G. S. Forbes, and, as already indicated, the crystalline solid is probably a solid soln., although complexes do exist in soln. J. B. J. D. Boussingault prepared a crystalline mass by cooling a soln. of silver chloride in fused sodium chloride. The mass is decomposed by water, and is coloured violet by exposure to light. As already indicated, the work of F. Cornu, W. Botta, and C. Sandonnini shows that fused mixtures of sodium and silver chlorides furnish a continuous series of mixed crystals. G. Tammann showed that when the mixed crystals are treated with water, the sodium chloride is completely extracted when the proportion of silver chloride falls below 0.625, but not when it exceeds 0.75.

As previously indicated, C. Sandonnini's thermal study of *lithium chloride* and silver chloride showed that two types of mixed crystals are produced with a gap between 16 and 60 mols per cent. of silver chloride. S. F. Schemtschuschny did not obtain evidence of a compound of silver chloride and *potassium chloride* on the f.p. curve. O. Sackur, and G. S. Forbes obtained evidence of the formation of complexes in soln. of silver chloride in potassium chloride soln. C. Sandonnini and P. C. Aureggi in their thermal analysis of mixtures of *rubidium chloride* and silver chloride obtained a V-eutectic curve at 253° with 60 mols per cent. of silver chloride; there was no definite indication of a compound. H. L. Wells and H. L. Wheeler obtained rhombic crystals of **cæsium silver chloride**, $2\text{CsCl} \cdot \text{AgCl}$, with axial ratios $a : b : c = 0.971 : 1 : 0.244$, by saturating a very conc. soln. of cæsium chloride with silver chloride; a compound of the composition $\text{CsCl} \cdot \text{AgCl}$ was obtained by C. Sandonnini and G. Scarpa in the f.p. curve of mixtures of the component salts. E. H. Ducloux also studied this salt. G. Poma and G. Gabbi found that silver chloride and *cuprous chloride* are completely miscible in the molten state, but in the solid state, P. de Cesaris found a gap between 7 and 10 and between 12 and 92 mols per cent. of cuprous chloride. According to C. Sandonnini, the m.p. curve falls from the m.p. of silver chloride to a eutectic at 260°

with 54.6 mols per cent. of cuprous chloride and then rises to the m.p. of cuprous chloride. According to G. Poma and G. Gabbi, the m.p. curve falls from the m.p. of cuprous chloride to 250° with 56 mols per cent. of silver chloride, and then rises to the m.p. of silver chloride.

REFERENCES.

- ¹ C. Gesner, *De omni rerum fossilium genere*, Tiguri, 1565; W. Fabricius, *De rebus metallicis*, Tiguri, 1565; I. Domekyo, *Elementos de mineralogia*, Serena, 1845; M. H. Klaproth, *Beiträge zur chemischen Kenntniss der Mineralkörper*, 1. 137, 1795.
- ² J. H. Schulze, *Acta Acad. Cæsareæ Leopoldino-Carolinæ*, 1. 528, 1727.
- ³ A. Guntz, *Compt. Rend.*, 112. 861, 1212, 1891; 113. 72, 1891; H. Vogel, *Phot. Mitt.*, 36. 344, 1900; E. von Bibra, *Journ. prakt. Chem.*, (2), 12. 52, 1875; S. B. Newbury, *Amer. Chem. Journ.*, 8. 186, 1886; *Chem. News*, 54. 57, 1886; F. Heyer, *Untersuchungen über das hypothetische Silbersubchlorid*, Leipzig, 1902.
- ⁴ J. S. Stas, *Bull. Acad. Belgique*, (2), 10. 239, 1860; R. Cowper, *Journ. Chem. Soc.*, 43. 154, 1883; V. von Cordier, *Monatsh.*, 21. 184, 665, 1900; H. Gautier and G. Charpy, *Compt. Rend.*, 113. 597, 1891; J. H. Kastle, *Amer. Chem. Journ.*, 45. 396, 1911.
- ⁵ J. B. J. D. Boussingault, *Ann. Chim. Phys.*, (2), 54. 260, 1833; M. Berthelot, *Compt. Rend.*, 87. 619, 1878; A. Jouniaux, *ib.*, 129. 883, 1900; A. Levallois, *ib.*, 96. 1666, 1883; *Actions des hydracides halogènes sur l'argent et réactions inverses*, Lille, 1901; A. Potilitzin, *Bull. Soc. Chim.*, (2), 31. 490, 1879; *Ber.*, 13. 2391, 1890; *Journ. Russ. Phys. Chem. Soc.*, 1. 183, 289, 415, 1881; J. Kablukoff, *ib.*, 39. 914, 1907; N. W. Fischer, *Schweigger's Journ.*, 51. 193, 1827; G. Wetzlar, *ib.*, 52. 473, 1828; H. Rose, *Pogg. Ann.*, 68. 283, 1846; M. Ribalkin, *Bull. Acad. St. Petersburg*, (2), 1. 279, 1888; M. C. Lea, *Zeit. anorg. Chem.*, 3. 180, 1893; F. T. Sonnenschmid, *Ann. Chim. Phys.*, (2), 51. 349, 1832; C. J. B. Karsten, *Schweigger's Journ.*, 65. 394, 1832; C. F. Plattner, *Pogg. Ann.*, 77. 134, 1849; K. A. Winkler, *Europäische Amalgamation der Silbererze*, Freiberg, 166, 1848; J. L. Proust, *Journ. Phys.*, 62. 211, 1806; A. J. Balard, *Ann. Chim. Phys.*, (2), 57. 241, 1834; R. E. Hughes, *Phil. Mag.*, (5), 35. 531, 1893; C. Weltzien, *Liebig's Ann.*, 91. 43, 1854; C. Hengen, *Rec. Trav. Chim. Pay-Bas*, 2. 124, 1863; K. Jablczynsky, *Zeit. phys. Chem.*, 82. 115, 1913; B. L. Vanzetti, *Atti Accad. Lincei*, (5), 16. ii, 696, 1907; L. Rolla, *ib.*, (5), 22. ii, 104, 1913; T. Paul, *Zeit. Elektrochem.*, 18. 521, 1912; O. Scarpa, *Gazz. Chim. Ital.*, 41. i, 113, 1911; T. W. Richards and R. C. Wells, *Journ. Amer. Chem. Soc.*, 27. 475, 1905; W. L. Hardin, *ib.*, 18. 992, 1896; H. Goldschmidt, *Chem. Centr.*, 489, 1881; C. W. B. Normand and A. C. Cumming, *Journ. Chem. Soc.*, 101. 1852, 1912; A. Michael and A. Murphy, *Amer. Chem. Journ.*, 44. 365, 1910; L. Bruner and E. Bekier, *Zeit. Elektrochem.*, 18. 372, 1912; G. Carlo, *Gazz. Chim. Ital.*, 40. ii, 476, 1910; B. Finzi, *ib.*, 41. ii, 538, 1911; C. W. Scheele, *Svenska Akad. Handl.*, 36. 265, 1775.
- ⁶ A. Lottermoser and E. von Meyer, *Journ. prakt. Chem.*, (2), 56. 241, 1898; (2), 57. 540, 1898; A. Lottermoser, *ib.*, (2), 72. 39, 1905; *Zeit. phys. Chem.*, 60. 451, 1907; R. Ruer, *Zeit. anorg. Chem.*, 43. 85, 1905; C. Paal and F. Voss, *Ber.*, 37. 3862, 1904; *Chem. Fab. Heyden, German Pat.*, D.R.P. 103406, 1897; Kalle and Co., *ib.*, 175794, 1906; F. Bayer and Co., *ib.*, 261875, 1912.
- ⁷ F. Kuhlmann, *Compt. Rend.*, 42. 374, 1856; H. Debray, *ib.*, 70. 995, 1870; A. Ditte, *Ann. Chim. Phys.*, (5), 22. 551, 1881; R. B. Wilscey, *Phil. Mag.*, (6), 42. 262, 1921; A. W. Hull, *Phys. Rev.*, (2), 10. 661, 1917; P. Debye and P. Scherrer, *Phys. Zeit.*, 17. 277, 1916; O. Lehmann, *Zeit. Kryst.*, 1. 453, 1877; A. Streng, *Neues Jahrb. Min.*, i, 51, 1886; K. Haushofer, *Mikroskopische Reaktionen*, Braunschweig, 1885; H. Behrens, *Anleitung zur mikrochemischen Analyse*, Leipzig, 1905; P. Groth, *Chemische Kristallographie*, Leipzig, 1. 200, 1906; A. P. H. Trivelli and S. E. Sheppard, *The Silver Bromide Grain of Photographic Emulsions*, New York, 97, 1921; W. Reinders, *Zeit. phys. Chem.*, 77. 213, 357, 677, 1911.
- ⁸ C. J. B. Karsten, *Schweigger's Journ.*, 65. 394, 1832; P. Walden, *Zeit. anorg. Chem.*, 115. 241, 1920; T. Herapath, *Phil. Mag.*, (1), 64. 321, 1824; P. A. Boullay, *Ann. Chim. Phys.*, (2), 48. 266, 1831; J. L. Proust, *Journ. Phys.*, 62. 211, 1806; H. Schiff, *Liebig's Ann.*, 108. 21, 1858; H. G. F. Schröder, *Pogg. Ann.*, 106. 226, 1859; F. Mohr, *ib.*, 113. 655, 1861; H. Fleck, *ib.*, 113. 160, 1861; G. Quaince, *ib.*, 135. 642, 1868; 138. 141, 1869; G. F. Rodwell, *Phil. Trans.*, 173. 125, 1882; *Proc. Roy. Soc.*, 31. 211, 1881; I. Domekyo, *Elementos de Mineralogia*, Serena, 1845; F. A. Henglein, *Zeit. anorg. Chem.*, 120. 77, 1921.
- ⁹ G. F. Rodwell, *Phil. Trans.*, 173. 1125, 1882; *Proc. Roy. Soc.*, 25. 291, 1876; T. Carnelley, *Journ. Chem. Soc.*, 29. 489, 1876; 33. 273, 1878; W. Ramsay and N. Eumorfopoulos, *Phil. Mag.*, (5), 41. 60, 1896; O. Ehrhardt, *Wied. Ann.*, 24. 215, 1885; F. Kohlrausch, *ib.*, 17. 642, 1882; A. Potilitzin, *Journ. Russian Phys. Chem. Soc.*, 24. 1, 1892; J. F. Persoz, *Introduction à l'étude de la chimie moléculaire*, Paris, 1839; C. Sandonnini, *Atti Accad. Lincei*, (5), 20. i, 457, 753, 1911; C. Sandonnini and P. C. Aureggi, *ib.*, (5), 20. ii, 588, 1911; S. F. Schemtschuschny, *Zeit. anorg. Chem.*, 57. 267, 1908; N. Kurnakoff and S. F. Schemtschuschny, *ib.*, 60. 1, 1908; W. Truthe, *ib.*, 76. 168, 1912; W. Botta, *Centr. Min.*, 123, 1911; H. Stolzenberg and M. E. Huth, *Zeit. phys. Chem.*, 71. 641, 1910; O. Sackur, *ib.*, 83. 300, 1913; E. Jänecke, *ib.*, 90. 296, 1915; O. Schott, *Beiträge zur Kenntniss der anorganischer Schmelzverbindungen*, Braunschweig, 1881; I. Kablukoff, *Journ.*

Russ. Phys. Chem. Soc., 39. 914, 1907; *Zeit. phys. Chem.*, 65. 125, 1909; G. Scarpa, *Atti Accad. Lincei*, (5), 22. ii, 452, 1913; F. J. Malaguti and J. Durocher, *Recherches sur l'association de l'argent aux minéraux métalliques*, Paris, 315, 1850; A. and C. R. Aikin, *A Dictionary of Chemistry and Mineralogy*, London, 2, 317, 1807.

¹⁰ T. W. Richards and G. Jones, *Journ. Amer. Chem. Soc.*, 31. 158, 1909; G. Jones, *ib.*, 31. 191, 1909; G. Quincke, *Pogg. Ann.*, 138. 141, 1869; A. Gradenwitz, *Wied. Ann.*, 67. 467, 1899; A. Colson, *Compt. Rend.*, 93. 1074, 1881; N. Kurnakoff and S. F. Schemtschuschny, *Zeit. anorg. Chem.*, 60. 1, 1908.

¹¹ O. H. Weber, *Zeit. anorg. Chem.*, 21. 305, 1899; O. Ehrhardt, *Wied. Ann.*, 24. 215, 1885; H. V. Regnault, *Ann. Chim. Phys.*, (3), 46. 278, 1858; F. J. Malaguti and J. Durocher, *Recherches sur l'association de l'argent aux minéraux métalliques*, Paris, 315, 1850; M. de K. Thompson, *Journ. Amer. Chem. Soc.*, 28. 762, 1906; H. Biltz and V. Meyer, *Zeit. phys. Chem.*, 4. 249, 1889; A. Scott, *Proc. Roy. Soc. Edin.*, 14. 410, 1887; J. N. Brönsted, *Zeit. Elektrochem.*, 18. 716, 1912; F. Potilitzin, *ib.*, 19. 517, 1913; A. Magnus, *Ann. Physik*, (4), 31. 607, 1910; W. Nernst, *ib.*, (4), 36. 420, 1911; A. Eucken, *Phys. Zeit.*, 10. 586, 1909; H. Fizeau, *Compt. Rend.*, 64. 314, 1867; *Pogg. Ann.*, 132. 292, 1867; W. Nernst and F. Schwerns, *Sitzber. Akad. Berlin*, 355, 1914.

¹² M. Berthelot, *Compt. Rend.*, 87. 619, 1878; 94. 917, 912, 1883; *Ann. Chim. Phys.*, (5), 16. 433, 1878; (5), 29. 241, 271, 1883; A. Guntz, *Compt. Rend.*, 113. 72, 1891; *Bull. Soc. Chim.*, (3), 6. 140, 1891; M. Ribalkin, *Bull. Acad. St. Petersburg*, 34. 165, 1891; F. Halla, *Zeit. Elektrochem.*, 14. 411, 1908; U. Fischer, *ib.*, 18. 287, 1912; *Zeit. anorg. Chem.*, 78. 41, 1912; J. N. Brönsted, *Zeit. phys. Chem.*, 56. 645, 1906; R. Lorenz and M. Katayama, *ib.*, 62. 119, 1908; M. de K. Thompson, *Journ. Amer. Chem. Soc.*, 28. 731, 1906; J. Kablukoff, *Journ. Russ. Phys. Chem. Soc.*, 39. 914, 1907; J. Thomsen, *Thermochemische Untersuchungen*, Leipzig, 3. 381, 1884; Anon., *Journ. Franklin Inst.*, 188. 142, 1919; H. Braune and F. Koref, *Zeit. anorg. Chem.*, 87. 175, 1914.

¹³ W. Kohlrausch, *Wied. Ann.*, 17. 642, 1882; 33. 42, 1888; L. Grätz, *ib.*, 29. 327, 1886; G. C. Schmidt, *ib.*, 64. 708, 1898; S. Meyer, *ib.*, 68. 325, 1899; 69. 236, 1899; *Ann. Physik*, (4), 1. 664, 1900; J. C. Ghosh, *Journ. Chem. Soc.*, 117. 823, 1920; T. Ishiware, *Rep. Science Tohoku Imp. Univ.*, 9. 233, 1920; P. Dutoit and G. von Weisse, *Journ. Chim. Phys.*, 9. 630, 1911; M. Katayama, *Zeit. phys. Chem.* 61. 566, 1908; R. Lorenz and M. Katayama, *ib.*, 62. 119, 1908; C. Tubandt and E. Lorenz, *W. Nernst's Festschrift*, Halle a. S., 450, 1912; M. le Blanc and F. Kerschbaum, *Zeit. Elektrochem.*, 16. 242. 680, 1910; K. Arndt and A. Gessler, *ib.*, 14. 663, 1908; R. Beutner, *ib.*, 15. 439, 1909; F. Haber, *Ann. Physik*, (4), 26. 927, 1908; W. Wilson, *ib.*, (4), 23. 107, 1907; C. Schell, *ib.*, (4), 16. 193, 417, 1905; E. Becquerel, *La lumière*, Paris, 2. 121, 1865; G. M. Minchin, *Phil. Mag.*, (5), 31. 207, 1891; H. Luggin, *Zeit. phys. Chem.*, 23. 577, 1897; G. Dima, *Compt. Rend.*, 157. 590, 736, 1913; A. de Gramont, *Bull. Soc. Min.*, 18. 385, 1895; S. Arrhenius, *Sitzber. Akad. Wien*, 96. 831, 1888; H. Jackson, *Journ. Chem. Soc.*, 65. 734, 1894; C. Tubandt, *Zeit. anorg. Chem.*, 115. 105, 1920; C. Sandonini, *Atti Accad. Lincei* (5), 24. i, 616, 1915; G. Trümpler, *Zeit. phys. Chem.*, 99. 9, 1921.

¹⁴ A. de Cloizeaux, *Bull. Soc. Min.*, 5. 143, 1882; J. A. Wilkinson, *Journ. Phys. Chem.*, 13. 723, 1909; H. Hertenstein, *Zeit. Wiss. Phot.*, 11. 69, 1912; H. Rubens and E. Aschkinas, *Wied. Ann.*, 65. 241, 1898; T. W. Richards and R. C. Wells, *Amer. Chem. Journ.*, 25. 99, 1906; C. Wissinger, *Bull. Acad. Belgique*, (3), 15. 390, 1888; L. Wernicke, *Pogg. Ann.*, 142. 565, 1871; S. Procopiu, *Compt. Rend.*, 173. 409, 1921.

¹⁵ C. H. Pfaff, *Handbuch der analytischen Chemie*, Altona, 2. 283, 1821; G. J. Mulder, *Die Silberprobiermethode*, Leipzig, 1859; F. Kohlrausch and F. Rose, *Wied. Ann.*, 50. 127, 1893; *Zeit. phys. Chem.*, 12. 242, 1893; F. Kohlrausch, *ib.*, 50. 355, 1905; 64. 129, 1908; C. Hoitsema, *ib.*, 20. 272, 1896; W. Böttger, *ib.*, 46. 602, 1903; 56. 83, 1906; H. M. Goodwin, *ib.*, 13. 645, 1894; A. F. Hollemann, *ib.*, 12. 132, 1893; A. A. Noyes and D. A. Kohr, *ib.*, 42. 336, 1903; R. Abegg and A. J. Cox, *ib.*, 46. 1, 1903; *Zeit. Elektrochem.*, 9. 892, 1903; A. Thiel, *Zeit. anorg. Chem.*, 24. 57, 1900; G. S. Whitby, *ib.*, 67. 107, 1910; A. Ditte, *Ann. Chim. Phys.*, (5), 22. 551, 1881; J. P. Cooke, *Amer. Journ. Science*, (3), 21. 220, 1881; *Chem. News*, 44. 234, 1881; J. S. Stas, *Compt. Rend.*, 73. 998, 1870; *Ann. Chim. Phys.*, (5), 3. 177, 1874; J. L. Gay Lussac, *ib.*, (2), 58. 218, 1835; A. C. Melcher, *Journ. Amer. Chem. Soc.*, 32. 54, 1910; C. van Rossem, *Chem. Weekb.*, 9. 203, 396, 1912; L. Rolla, *Atti Accad. Lincei*, (5), 22. ii, 104, 1913; C. St. Pierre, *Compt. Rend.*, 73. 1090, 1871.

¹⁶ C. St. Pierre, *Journ. Pharm. Chim.*, (3), 12. 237, 1848; *Compt. Rend.*, 73. 1090, 1871; H. Debray, *ib.*, 70. 849, 1870; F. Ruysen and E. Varenne, *ib.*, 92. 524, 1459, 1881; *Bull. Soc. Chim.*, (2), 36. 5, 1881; E. H. E. Reinsch, *Journ. prakt. Chem.*, (1), 13. 133, 1838; O. L. Erdmann, *ib.*, (1), 19. 341, 1840; J. P. Cooke, *Amer. Journ. Science*, (3), 21. 220, 1881; A. Ditte, *Ann. Chim. Phys.*, (5), 22. 551, 1881; A. Vogel, *Repert. Pharm.*, 23. 335, 1874; W. E. Barlow, *Journ. Amer. Chem. Soc.*, 28. 1446, 1906; A. A. Noyes and W. C. Bray, *ib.*, 29. 166, 1907; G. Bodländer, *Ber.*, 36. 2878, 1903; R. Abegg, *Zeit. anorg. Chem.*, 20. 453, 1899; G. S. Whitby, *Zeit. anorg. Chem.*, 67. 107, 1910; A. Rosenheim and S. Steinhäuser, *ib.*, 25. 103, 1905; R. H. Brett, *Phil. Mag.*, 10. 95, 1837; J. Formánek, *Listy Chem.*, 11. 87, 1887; H. C. Hahn, *Eng. Min. Journ.*, 65. 434, 1898; G. J. Mulder, *Die Silberprobiermethode*, Leipzig, 62, 1859; H. Morse, *Zeit. phys. Chem.*, 41. 709, 1902; R. Luther, *ib.*, 36. 402, 1901; J. T. Hewitt, *Proc. Chem. Soc.*, 23. 10. 1907; B. H. Buttle and J. T. Hewitt, *Journ. Chem. Soc.*, 93. 1405, 1908; J. Spiller, *Phil. Mag.*, (4), 19. 186, 1860; E. H. Riesenfeld and H. Feld, *Zeit. Elektrochem.*, 26. 286, 1920; A. C. and A. E. Becquerel, *Traité d'électricité et magnétisme*, Paris, 2. 372, 1855; J. Percy, *Gold and Silver*, London, 1. 59, 1880; I. Kablukoff, *Journ. Russ. Phys. Chem. Soc.*, 39. 914, 1907; *Zeit. phys. Chem.*, 65. 125.

- 1909; G. Scarpa, *Atti Accad. Lincei*, (5), 22. ii, 452, 1913; H. W. F. Wackenroder, *Liebig's Ann.*, 41. 317, 1842; J. von Liebig, *ib.*, 81. 128, 1851; J. S. Stas, *Ann. Chim. Phys.*, (5), 3. 179, 1874; A. Sauer, *Zeit. anal. Chem.*, 12. 176, 1873; J. Barnes, *Chem. News*, 51. 97, 1885; B. Finzi, *Gazz. Chim. Ital.*, 32. ii, 324, 1903; C. Schierholz, *Sitzber. Akad. Wien*, 101. 8, 1890; E. Valenta, *ib.*, 103. 191, 1894; *Monatsh.*, 15. 249, 1894; E. Reichert, *Journ. prakt. Chem.*, (1), 92. 237, 1864; P. A. Guye, *Journ. Chim. Phys.*, 10. 145, 1912; F. Meyer and A. Stähler, *Zeit. anorg. Chem.*, 77. 255, 1912; N. G. Chatterji and N. R. Dhar, *Chem. News*, 121. 253, 1920; C. van Rossem, *Chem. Weekb.*, 9. 203, 396, 1912; W. Böttger, *Zeit. phys. Chem.*, 46. 602, 1903; 56. 83, 1906; G. S. Forbes, *Journ. Amer. Chem. Soc.*, 33. 1946, 1911; G. S. Forbes and H. I. Cole, *ib.*, 43. 2492, 1921; N. A. E. Millon and A. Commaille, *Compt. Rend.*, 56. 309, 1863; H. C. Hahn, *Eng. Min. Journ.*, 65. 434, 1898; R. Luther and A. Leubner, *Zeit. anorg. Chem.*, 74. 389, 1912.
- ¹⁷ E. C. Franklin and A. C. Kraus, *Amer. Chem. Journ.*, 20. 828, 1898; J. R. Glauber, *Furnis novis philosophicis*, Amstelodami, 1650; W. Wallace, *B. A. Rep.*, ii, 88, 1859; *Chem. Gaz.*, 9. 387, 1851; N. W. Fischer, *Pogg. Ann.*, 6. 43, 1826; *Gilbert's Ann.*, 42. 230, 1812; R. Pohl, *Sitzber. Akad. Wien*, 41. 627, 1860; C. Schierholz, *ib.*, 101. 8, 1890; N. A. E. Millon and A. Commaille, *Compt. Rend.*, 56. 309, 1863; R. Jarry, *Recherches sur la dissociation de divers composés ammoniacaux au contact de l'eau*, Paris, 1899; *Compt. Rend.*, 124. 288, 1897; A. Terrell, *ib.*, 98. 1279, 1884; *Bull. Soc. Chim.*, (2), 41. 597, 1884; A. Senier, *Pharm. Journ.*, (3), 14. 1, 1883; W. R. Whitney and A. C. Melcher, *Journ. Amer. Chem. Soc.*, 25. 69, 1903; A. Longi, *Gazz. Chim. Ital.*, 13. 87, 1883; E. Valenta, *Monatsh.*, 15. 249, 1894; G. Bodländer, *Zeit. phys. Chem.*, 9. 730, 1892; G. Bodländer and R. Fittig, *ib.*, 39. 597, 1902; W. Biltz, *ib.*, 57. 561, 1909; W. Biltz and W. Stollenwerk, *Zeit. anorg. Chem.*, 114. 174, 1920; M. Faraday, *Quart. Journ. Science*, 5. 74, 1818; R. Kane, *Ann. Chim. Phys.*, (2), 72. 290, 1839; F. Isambert, *Ann. Ecole Norm.*, 5. 138, 1868; *Compt. Rend.*, 66. 1529, 1868; 86. 968, 1878; A. Horstmann, *Ber.*, 9. 749, 1876; B. Gossner, *Zeit. Kryst.*, 38. 133, 1904; D. W. Horn, *Amer. Chem. Journ.*, 37. 619, 1907; J. Straub, *Zeit. phys. Chem.*, 77. 331, 1911; H. Ley and G. Wiegner, *Zeit. Elektrochem.*, 11. 590, 1905; W. Peters, *Zeit. anorg. Chem.*, 77. 153, 1912; G. J. Mulder, *Die Silberprobiermethode*, Leipzig, 1859; P. Berthier, *Traité des essais par la voie sèche*, Paris, 2. 789, 1834; A. Vogel, *Repert. Pharm.*, 23. 335, 1874; H. C. Hahn, *Trans. Amer. Inst. Min. Eng.*, 2. 99, 1874; *Eng. Min. Journ.*, 65. 434, 1898; G. S. Forbes, *Journ. Amer. Chem. Soc.*, 33. 1946, 1911; J. L. Proust, *Journ. Phys.*, 62. 211, 1806.
- ¹⁸ J. Neustadt, *Zeit. Elektrochem.*, 16. 868, 1910; A. Vogel, *Journ. prakt. Chem.*, (1), 2. 197, 1834; P. T. Austen, *Amer. Chem. Journ.*, 11. 286, 1889; G. S. Forbes, *Journ. Amer. Chem. Soc.*, 33. 1946, 1911; H. Arnold, *Zeit. anal. Chem.*, 51. 554, 1912; G. Bodländer, *Zeit. phys. Chem.*, 9. 730, 1892; B. Wuth, *Ber.*, 35. 2415, 1902; H. Euler, *ib.*, 36. 2878, 1903; F. Mylius and G. Hüttner, *ib.*, 44. 1315, 1911; L. Kahlenberg and W. J. Wittich, *Journ. Phys. Chem.*, 13. 421, 1909; F. Bezold, *Das Verhalten chemischer Verbindungen in Methylacetat*, Giessen, 1906; M. Hamers, *Verhalten der Halogenverbindungen des Quecksilbers in reinem und in bei 18° mit Wasser gesättigtem Aethylacetat*, Giessen, 1906.
- ¹⁹ D. Tommasi, *Ber.*, 11. 1249, 1878; H. Schulze, *Journ. prakt. Chem.*, (2), 21. 407, 1880; A. Mailfert, *Compt. Rend.*, 94. 860, 1882; A. Jouniaux, *ib.*, 129. 883, 1899; 132. 1270, 1558, 1901.
- ²⁰ N. D. Costeau, *Étude de l'action du gaz carbonique sur les sulfures minéraux*, Paris, 1914; H. Rose, *Pogg. Ann.*, 24. 334, 1832; 27. 117, 1833; C. Stammer, *ib.*, 32. 135, 1835; A. Granger, *Compt. Rend.*, 124. 896, 1897; F. Göbel, *Journ. prakt. Chem.*, (1), 6. 388, 1835; A. G. Bloxam, *Chem. News*, 52. 183, 1885; J. Thallwitz, *Zeit. phys. chem. Unter.*, 17. 224, 1904.
- ²¹ E. Filhol and J. B. Senderens, *Compt. Rend.*, 93. 153, 1881; A. Levallois, *ib.*, 96. 1666, 1883; F. J. Malaguti and J. Durocher, *ib.*, 25. 160, 1848; *Recherches sur l'association de l'argent aux minéraux métalliques*, Paris, 352, 1850; C. J. B. Karsten, *Karsten's Archiv*, (2), 25. 183, 1852; C. F. Wenzel, *Lehre von der Verwandtschaft des Körper*, Dresden, 1777; P. Berthier, *Traité des essais par la voie sèche*, Paris, 2. 788, 1848.
- ²² R. Keir, *Phil. Trans.*, 80. 384, 1790; G. Wetzlar, *Schweigger's Journ.*, 21. 373, 1827; H. Rose, *Chem. Gaz.*, 5. 2, 1847; K. Seubert and A. Schmidt, *Liebig's Ann.*, 267. 218, 1892; A. Geuther, *ib.*, 114. 121, 1860; N. W. Fischer, *Pogg. Ann.*, 6. 43, 1826; *Gilbert's Ann.*, 42. 230, 1812; E. Vigouroux, *Bull. Soc. Chim.*, (4), 1. 792, 1907; D. Tommasi, *ib.*, (2), 38. 148, 1882; *Gazz. Chim. Ital.*, 8. 194, 1878; U. Antoni and G. Turi, *ib.*, 23. ii, 231, 1893; J. Schnauss, *Archiv. Pharm.*, (3), 6. 411, 1875; J. H. Gladstone and A. Tribe, *Phil. Mag.*, (5), 11. 508, 1881; F. Mawrow and G. Mollow, *Zeit. anorg. Chem.*, 61. 95, 1909; M. C. Lea, *Amer. Journ. Science*, (3), 33. 482, 1887; P. Jannasch, *Journ. prakt. Chem.*, (2), 78. 34, 1908; J. N. Brönsted, *Zeit. Elektrochem.*, 19. 766, 1913; W. Reinders, *Zeit. phys. Chem.*, 77. 677, 1911; R. Escales, *German Pat.*, D.R.P. 115014, 1899; F. T. Sonneschmid, *Ann. Chim. Phys.*, (2), 51. 349, 1832; P. Berthier, *ib.*, (3), 7. 826, 1843; G. Wetzlar, *ib.*, 51. 373, 1827; J. Seymour, *Pharm. Rundsch.*, 264, 1894; G. Skutari, *Gazz. Chim. Ital.*, 4. 28, 1874; A. Rosenheim and S. Steinhäuser, *Zeit. anorg. Chem.*, 25. 72, 1900; A. Sauer, *Zeit. anal. Chem.*, 12. 176, 1873; E. Riegler, *ib.*, 40. 633, 1901; G. J. Mulder, *Die Silberprobiermethode*, Leipzig, 1859; T. E. Thorpe, *Journ. Chem. Soc.*, 25. 453, 1872; C. St. Pierre, *Compt. Rend.*, 75. 1090, 1871; A. Vogel, *Journ. prakt. Chem.*, (1), 2. 197, 1834; H. Moissan, *Le fluor et ses composés*, Paris, 1900; J. J. Berzelius, *Pogg. Ann.*, 14. 558, 1828; *Lehrbuch der Chemie*, Dresden, 4. 626, 1836; G. B. Bonino, *Gazz. Chim. Ital.*, 51. ii, 261, 1921.
- ²³ P. Julius, *Zeit. anal. Chem.*, 22. 523, 1883; A. Potilitzin, *Bull. Soc. Chim.*, (2), 38. 258, 1882; *Ber.*, 15. 918, 1882; 16. 3051, 1883; 17. 1308, 1884; T. S. Humpidge, *ib.*, 17. 1838, 1884; N. N. Beketoff, *Journ. Russ. Phys. Chem. Soc.*, 1. 44, 1881; M. Berthelot, *Compt. Rend.*, 100. 761, 1885; *Ann. Chim. Phys.*, (5), 23. 94, 1881; (5), 29. 280, 1883; F. Field, *Journ. Chem.*

Soc., 10. 234, 1857; A. Colson, *Compt. Rend.*, **93**. 1074, 1881; A. Mailfert, *ib.*, **94**. 860, 1882; H. Baubigny, *ib.*, 146. 1097, 1908; F. W. O. de Coninck, *Bull. Soc. Chim.*, (4), **5**. 62, 1909; G. Mazzaron, *Atti Ist. Venezia*, (7), **7**. 1124, 1896; H. St. C. Deville, *Compt. Rend.*, **43**. 970, 1856; C. Löwig, *Das Brom und seine chemischen Verhältnisse*, Heidelberg, 1829.

²⁴ P. Berthier, *Traité des essais par la voie sèche*, Paris, **2**. 789, 1840; F. J. Malaguti and J. Durocher, *Recherches sur l'association de l'argent aux minéraux métalliques*. Paris, 388, 1850.

²⁵ G. Wetzlar, *Schweigger's Journ.*, **21**. 371, 1827; **23**. 97, 1828; J. Percy, *Silver and Gold*, London, **1**. 63, 1880; J. B. J. D. Boussingault, *Ann. Chim. Phys.*, (2), **54**. 261, 1833; A. C. Becquerel, *ib.*, (2), **41**. 33, 1829; *Traité de l'électricité et magnétisme*, Paris, **2**. 86, 1855; F. Cornu, *Neues Jahrb. Min.*, **1**, 25, 1908; W. Botta, *Centrb. Min.*, **138**, 1911; O. Schott, *Beiträge zur Kenntnis der anorganischer Schmelzverbindungen*, Braunschweig, 1881; C. Sandonni, *Atti Accad. Lincei*, (5), **20**. 459, 760, 1911; C. Sandonni and P. C. Aureggi, *ib.*, (5), **20**. ii, 592, 1911; C. Sandonni and G. Scarpa, *ib.*, (5), **21**. ii, 80, 1912; P. de Cesaris, *ib.*, (5), **20**. i, 597, 1911; G. Poma and G. Gabbi, *ib.*, (5), **20**. i, 466, 1911; *Gazz. Chim. Ital.*, **42**. ii, 78, 1912; G. S. Forbes, *Journ. Amer. Chem. Soc.*, **33**. 1039, 1911; S. F. Schemtschuschny, *Zeit. anorg. Chem.*, **57**. 267, 1908; H. L. Wells and H. L. Wheeler, *Amer. Journ. Science*, (3), **44**. 155, 1892; O. Sackur, *Zeit. phys. Chem.*, **83**. 302, 1913; G. Tammann, *Gött. Nachr.*, **296**, 1918; E. H. Ducloux, *Anal. Assoc. Quim. Argentina*, **9**. 215, 1921.

§ 15. Action of Light on Silver Halides

When silver chloride is exposed to light, it darkens, assumes a violet tint, which passes into brown, and finally turns black. This fact was made known by C. Gesner¹ in his *De omni rerum fossilium genere* (Tiguri, 1565), for he recorded that horn silver darkens when exposed to light; R. Boyle (1660) noted that horn silver blackens in air; and G. Suckow specially studied the action of light on chemical compounds—*vide* introduction to silver chloride. *Chlorine is evolved when white silver chloride is blackened in light.* If white silver chloride under water in a closed flask be exposed to sunlight, G. Wetzlar² noted that the contents of the flask furnished chlorine. This continues time after time, the amount becoming smaller and smaller until at last what little chlorine is given off is converted into hydrochloric acid and oxygen. Even then, the innermost part of the white silver chloride remains unchanged. The loss of weight which occurs is small—N. W. Fischer found 0.1473 per cent.; G. J. Mulder, 0.155 per cent.; R. Hitchcock, 8.57 per cent.; and A. Richardson, 8 per cent.; while E. von Bibra found no perceptible loss after five weeks' exposure; D. Tommasi could detect virtually no loss of chlorine; P. P. Koch and F. Schrader that with the light from an arc filtered through 80 cms. of a one per cent. soln. of cupric sulphate, the silver halides do not change more than 1 to 2 per cent. in weight. According to E. Sonstadt, some hydrogen peroxide is formed; and, according to W. R. Hodgkinson, ozone is formed.

P. P. Koch and F. Schrader also showed that if silver bromide is definitely darkened by a light of 3200 candle metre seconds, in 5 seconds, in the same time silver chloride is darkened by light of 940 candle metre seconds. Ten minutes' illumination of silver iodide by the same light only gave a weak greyish-black coloration.

According to C. F. A. Morren, chlorine water restores the white colour of blackened silver chloride so that the chlorine liberated during the blackening of silver chloride sets up a back reaction. Silver chloride, when sealed in a glass tube with chlorine water remains white so long as free chlorine is present, but it becomes brown when the chlorine has been all converted into hydrochloric acid. The white colour is restored when the tube with the brown chloride is placed in diffused daylight or in darkness. G. Wetzlar found the blackening is slower under a soln. of sodium or potassium chloride than under water. E. von Bibra says that white silver chloride is not blackened under aq. soln. of cupric or ferric chloride; nor, according to H. W. Vogel, is it blackened under mercuric chloride soln., but it is blackened under acetic acid, and the mineral acids. C. W. Scheele said that white silver chloride is not blackened under nitric acid, but F. Guthrie, G. Wetzlar, and

E. von Bibra said that it is blackened under dil. or conc. nitric acid, and G. C. Wittstein stated that under nitric acid of sp. gr. 1.23, it is coloured pale violet by two days' exposure to daylight: and dark violet by an hour's exposure to sunlight; while under nitric acid of sp. gr. 1.4 it remains white in diffused daylight, and is coloured pale violet by an hour's exposure and dark violet by 4 hours' exposure to sunlight. G. Wetzlar also found the white chloride to be discoloured under hydrochloric acid; while H. W. Vogel, and E. von Bibra found the blackening to be delayed under conc. sulphuric acid; H. Vogel noticed only a faint discoloration under aqua regia; and, according to G. Wetzlar, it is not blackened under a soln. of ferrous sulphate. H. Rose, and E. von Bibra found silver chloride is not blackened when mixed with mercurous chloride; and F. Field states that silver chloride crystallized from an aq. soln. of mercuric nitrate remains unchanged, and also if it is exposed in a moist condition to sunlight. J. J. Pohl found silver chloride, prepared at 60°–80°, and kept at this temp. in the liquid, is not blackened after many days' exposure to light; and the darkened silver chloride becomes paler when heated, but it does not become white. H. B. Baker found white silver chloride under dried benzene is blackened on exposure to light, and, according to M. C. Lea, also under carbon tetrachloride, but, according to H. B. Baker, not if the solvent be thoroughly dried and air be excluded. N. W. Fischer found the white chloride to be discoloured under alcohol, ether, and nut oil.

White silver chloride is not discoloured in darkness at temp. below 100°. Although G. J. Mulder³ stated that white silver chloride gradually turns grey when submerged in water, and protected from light. E. von Bibra could not detect the slightest discoloration when the chloride was kept for 8 days with light completely excluded, but when the temp. exceeded 100°, the chloride was soon discoloured. According to T. J. Seebeck,⁴ *the presence of moisture is necessary for the discoloration of white chloride in light*, for it is not decolorized in vacuo over sulphuric acid, and R. E. Hughes exposed thoroughly dried silver chloride to intense sunlight without discoloration, but directly ordinary (moist) air was introduced, the discoloration occurred. T. J. Seebeck also found that covering the white chloride with alcohol protected it from blackening for some time. According to J. J. Ackworth, silver chloride becomes insensitive to light if heated to 220°; this M. C. Lea attributes to the need for heating the chloride to this temp. to make sure the moisture is all removed, and not to the existence of a variety insensitive to light.

The early observers on the darkening of silver chloride in light assumed that the result is a simple decomposition of silver chloride into metallic silver⁵ and chlorine, but the fact that the darkening occurs under conc. nitric acid, or other solvents of silver, ousts the hypothesis that the darkening is due to the liberation of metallic silver. To get over this difficulty F. Guthrie supposed that the metallic silver which separates is in a special mol. or passive state.

In 1814, N. W. Fischer⁶ suggested that the darkening is due to the partial decomposition of silver chloride, resulting in the production of a subchloride; and A. Riche assigned to the supposed subchloride the formula Ag_3Cl_2 . M. C. Lea⁷ suggested that a compound of silver chloride and subchloride, $\text{AgCl} \cdot n\text{Ag}_2\text{Cl}$, is formed.

J. J. Berzelius⁸ stated that the blackened silver chloride is not attacked by nitric acid, but R. Hitchcock says that an amount of silver passes into soln. which is eq. to the chlorine which has been developed. H. B. Baker whitened the black chloride by boiling it with hydrochloric acid. C. F. Berthollet says that the blackened chloride dissolves without residue in aqua ammonia, but E. Mitscherlich and others have shown that a little changed chloride remains undissolved. M. C. Lea found that when the blackened chloride is digested with a soln. of sodium thio-sulphate, a little metallic silver remains undissolved. H. B. Baker states that blackened silver chloride dissolved in a conc. neutral soln. of potassium chloride, and the resulting soln. has an alkaline reaction.

According to H. W. Vogel,⁹ the dark product is an oxychloride identical with the black product obtained by L. Wöhler by the action of hydrochloric acid on silver

suboxide ; and if E. von Bibra's observation be correctly interpreted that the silver chloride suffers no appreciable change in weight although chlorine is lost, it would follow that the escape of chlorine is compensated by the absorption of some other substance. R. Hunt stated that the presence of oxygen is necessary for the blackening, and his demonstration that the decomposing chloride absorbs or combines with oxygen is as follows : Some pure chloride of silver was arranged in a bent tube closed at one end, and the other end immersed in a bottle of distilled water. In this state the chloride was exposed for many days to the action of sunshine, during which time it was frequently shaken, for the purpose of exposing the whole of the powder to its influence. As the chloride darkened the water rose into the tube, and it gave a precipitate of chloride of silver on the addition of the nitrate, thus appearing to prove the substitution of oxygen for chlorine under the agency of solar radiation. It was quite evident that some absorption of atm. air had taken place. R. Hunt's proof is not conclusive, but H. B. Baker repeated the experiment taking extreme precautions to ensure thorough desiccation, and he came to a similar conclusion. H. B. Baker showed that the blackening which occurs when white silver chloride under dried benzene is exposed to light, is not the normal type of blackening because the product is metallic silver removable by treatment with nitric acid. H. B. Baker suggested that an oxychloride with the ultimate composition Ag_2ClO is formed, which when kept in the dark absorbs more oxygen, forming a white oxychloride. W. R. Hodgkinson supposed the oxychloride is Ag_4OCl_2 , that is, $\text{AgCl}\cdot\text{Ag}\cdot\text{O}\cdot\text{Ag}\cdot\text{AgCl}$. M. C. Lea says the blackening cannot be due to the formation of an oxychloride because it occurs under naphtha where oxygen and moisture are excluded. The phenomenon may be here related with that observed by H. B. Baker with benzene. E. von Bibra supposed that the blackening is due to change of white silver chloride into a dark-coloured silver chloride in a different molecular or allotropic state.

As previously indicated, C. W. Scheele showed that violet light is more effective than light from the other parts of the spectrum in darkening silver chloride, and J. Senebier, in his *Mémoires physico-chimiques sur l'influence de la lumière solaire pour modifier les êtres des trois règnes de la nature* (Genève, 1782), states that when horn silver in a darkened room is exposed to light of various colours, the times required for darkening are as follows :

Violet.	Purple.	Blue.	Green.	Yellow.	Orange.	Red.
15	25	29	37	330	720	1200 secs.

There is nothing to show if the intensity of these different-coloured lights was the same. R. Bunsen and H. E. Roscoe found that the amount of silver chloride decomposed in a given time is not proportional to the intensity of the incident light, but diminishes with time. By exposing a thin layer of silver chloride to light, the initial colour is violet-red, which changes to black. The black product is soluble in dil. nitric acid. Three layers have been distinguished in a film of insolated silver chloride—(i) black metallic silver ; (ii) red silver chloride ; and (iii) white unaltered chloride. Coloured silver chloride was obtained chemically by G. Wetzlar by the action of soln. of ferric, cupric, or mercuric chloride, for a short time on metallic silver. The following illustrative experiment is due to G. Staats :

A plate of polished silver was immersed for 10 minutes in a 5 per cent. soln. of ferric chloride, by which the metal became covered with a slate-coloured film. The metal was then placed under a frame with strips of red, green, orange, and blue glass, and exposed to a bright light. The colours were reproduced on the metal plate.

The coloured products obtained by the action of light on silver chloride can be obtained by chemical processes. For example, J. Cavalier passed a stream of dry chlorine in darkness through an ammoniacal soln. of silver chloride, and obtained first a turbidity, and finally a black precipitate. Both E. von Bibra and F. P. Dulk

believed that J. Cavalier's black product is not identical with the black product obtained by the action of light on silver chloride. M. C. Lea called the coloured derivatives of the silver halides *photo-salts*—e.g. photochloride, photobromide, and photoiodide :

Of the three haloids, the chlorine salt is the most interesting, because of its relations to heliochromy ; it is also the most stable of the three compounds and exhibits perhaps a finer variety of coloration, though the bromide and iodide are also obtainable in very beautiful tints. The chloride shows all the warm shades from white to black through the following gradations : white, pale flesh colour, pale pink, rose colour, copper colour, red purple, dark chocolate, black. These compounds are obtained in an endless variety of ways : by chloridizing metallic silver ; by acting on the normal chloride with reducing agents ; by partly reducing silver oxide or silver carbonate by heat and treating with HCl ; by forming suboxide or a sub-salt of silver and treating with HCl followed by nitric acid ; by acting on subchloride with nitric acid or an alkaline hypochlorite, etc. ; by attacking almost any soluble salt of silver with ferrous, manganous, or chromous oxide, etc., followed by HCl ; by reducing silver citrate by hydrogen and treating it with HCl ; by treating a soluble silver salt or almost any silver soln. with potash or soda and almost any reducing agent, cane sugar, milk sugar, glucose, dextrine, aldehyde, alcohol, etc., and supersaturating with HCl ; there is no easily oxidizable organic substance that I have tried that has failed to give this reaction. Also almost any salt of silver exposed to light, treated with HCl, and then with hot strong nitric acid, yields it. Almost any of these classes represents a long range of reactions, each susceptible of endless variation. In fact, the more the matter is studied, the more extended the range of reactions is found to be that give rise to the formation of this substance. To show how slight an influence will lead to the production of red chloride instead of white ; if freshly precipitated argentic oxide is mixed for a few minutes with starch or tragacanth paste and is then treated with HCl, the result is not white, but pink silver chloride.

M. C. Lea seems to regard the photohalides as adsorption compounds of silver halide and subhalide. He says that just as alumina unites with certain colouring matters to form *lakes*, so may the silver halides unite with a certain proportion of its own subsalt, which by the union quite loses its characteristic instability and forms a compound of great permanence. All varieties of photochloride are destroyed by a prolonged treatment with hot conc. nitric acid, but in some cases it may require 25 hours' boiling to convert it into the white chloride ; the photochloride, also, may even resist boiling aqua regia for a time. Exposure to light changes the brighter shades to purple or purple-black. Black specimens at 100°, in a drying oven, become purple or chocolate ; a grey variety may become pink. R. Lorenz and K. Hiege also attribute the darkening of silver chloride or bromide to the formation of ultra-microscopic particles of silver, so small that the crystals appear optically clear even if coloured violet. If the slightly darkened crystals be removed from light and heated to 350°, the darkening continues, but if heated without previous illumination, there is no darkening. The latent photographic image, on this hypothesis, is a complex containing colloidal silver. F. Weigert and W. Schöller say that silver chloride in an emulsion is of itself not sensitive to light, but that the colloidal metallic silver which is present in small proportions as an impurity, is the only substance present which is sensitive to light.

The photohalides, says L. Cramer, are normal halides coloured by colloidal silver, and those obtained by chemical processes are quite similar in their properties to those prepared by the action of light on the normal halides. The different colours correspond with the differences in the grain size of the colloidal silver. A. P. H. Trivelli like M. C. Lea regards the photohalides as normal halides coloured with the subhalides not metallic silver. Either hypothesis can be defended, but not the one to the exclusion of the other. The colloidal silver hypothesis is the simpler and is therefore preferred. L. Schaum and H. Lang studied the relation between the colour of the photohalide and the colloidal character of the adsorbed silver.

Photography.—A celluloid sheet or a glass plate is coated on one side with a film of collodion or gelatine containing, say, silver bromide in suspension, and dried, so as to form a *photographic plate*. The plate is placed in the camera, and momentarily *exposed* by focusing the image of the object to be photographed on to the plate. The silver bromide is affected

in some way so that the most intense change occurs where the light is brightest, while the change is less intense in the shadows. No visible change is apparent until the plate is *developed*. The plate is developed by treating it with a reducing agent—ferrous sulphate, pyrogallol, or some special developer. The developer continues the change started by the light, but is without action on the unexposed parts of the plate. As a result, finely-divided silver is deposited on the parts of the plate illuminated by the light reflected from the object. The deposit is thickest where the light was most intense. Hence, the dark parts of the object appear lightest on the plate, and the light parts dark. The image is thus the reverse of the object, and the plate is accordingly called a *negative*. The silver salt which has not been affected by the light nor by the developer is now removed, and the image thus *fixed* on the plate by immersing the plate in a soln. of sodium thiosulphate. The plate is then washed and dried. A *print* is made by laying the negative upon sensitized paper—that is, paper prepared in a similar way to the negative—so that the light must pass through the negative before striking the paper. The negative absorbs the light in proportion to the thickness of the deposit of silver, so that the print has the same shading as the object. The paper is then treated with a soln. of sodium thiosulphate to fix the image. The print may be *toned* by immersing it in a soln. of gold chloride so that some of the silver is replaced by gold; this gives the print a warm reddish tone; if a platinum salt be used instead of gold, a steel-grey tone is produced. The image on the print will be the reverse of that on the negative, and will therefore correspond with the object. Hence the print may be called the *positive*.

It will be evident that although no visible change is apparent in the film of a photographic plate which has been exposed, the light must have produced a marked difference in the film on the exposed and unexposed portions of the plate because of effects subsequently produced by the developer. It is usual to say that the light has produced a *latent image* during the exposure. There can be no question, said R. Namais, that one of the most marvellous things in photography is the formation of the latent image. The latent image is destroyed by a great number of reagents—*e.g.* soln. of nitric acid; the halogens; cupric, mercuric, ferric, or auric chloride; hydrochloric acid; hydrobromic acid; potassium persulphate, permanganate, or ferricyanide; and by chromic acid—which attack the exposed more than the unexposed silver bromide. On the contrary, a soln. of sodium thiosulphate attacks the unexposed more rapidly than the exposed silver bromide, so also do soln. of ammonia, potassium cyanide, and ammonium bromide. The photographic developers in common use are able to reduce to metallic silver the so-called latent image, and yet do not reduce the silver halide which has not been modified by exposure to light.

The latent image may gradually disappear by a process which is regarded as a reversal of the effect produced by the exposure to light, and it seems as if a reversible reaction is involved. L. Baekeland calls this phenomenon *photo-retrogression*. In the so-called daguerreotype process the latent image persists a few hours; in some more modern process the latent image persists for years. Photo-retrogression is noticed more with under- than with over-exposed plates.

C. F. Brush has shown that there is a period of induction in the formation of the latent image:

Photographic action is slow in starting, involving considerable light energy which leaves no permanent record. If exposure is stopped at this stage, the starting action relapses almost wholly within a few minutes and is lost to further exposure. Once started, however, action increases rapidly to full activity and then remains substantially constant during further exposure. A relapse of sensitiveness follows exposure and is very marked at the end of a few hours. Photographic action, when fully excited, *continues many minutes after exposure*, gradually dying out. With the adopted period of exposure, this after action amounts to something like eight or ten per cent. of the whole. Within an hour or two after action has ceased, relapse sets in and amounts to about four per cent. in the first thirty hours, fully half of which occurs within the first four hours.

The reaction which is involved in the production of the latent image and in the photo-retrogression has been the subject of many hypotheses.

1. *The assumption that the halide is oxidized.*—J. von Tugolesoff assumed that the latent image is an oxidation product. He supposes that the silver salt is first oxidized to a higher valency, and subsequently decomposed into a subhalide or to

metallic silver. He attempted to demonstrate an increase in weight during the production of the latent image, when an unstable oxyhalide of silver is formed, say $\text{AgBr} \cdot \text{O} \cdot \text{AgBr}$, but L. Cramer was unable to establish the accuracy of J. von Tugolessoff's experiments on the oxidation of silver bromide by dil. soln. of hydrogen peroxide, sodium nitrite, etc., and he tried to show that oxygen is not necessary for the development of the latent image.

2. *The assumption that the halide suffers a physical modification.*—In this hypothesis it is assumed that the silver salt undergoes a physical change when the latent image is produced whereby the silver bromide remains silver bromide, but the nature of the combination into aggregates is modified. The product is then invested with the properties known to be possessed by the latent image, and the phenomenon is fully explained. For example, the silver halide after exposure to light is more prone to dissociation, and yields more quickly when reducing agents are present. R. Namais and C. Jones assume that the silver halide is polymerized by light and depolymerized during the photo-retrogression. F. Hurter and V. C. Driffield make the converse assumption, depolymerization in light, polymerization in darkness.

3. *The assumption that the halide forms a nucleus of silver.*—The old assumption that the latent image is due to the reduction of the halide to metallic silver has been revived by W. Ostwald, and R. Abegg in the assumption that the formation of the latent image is due to the precipitation of an infinitesimally small quantity of metallic silver which, acting as a germ or a nucleus, facilitates the reduction of the surrounding silver bromide. The latent image, however, shows none of the reactions of metallic silver, nor does it show the electrical potential of metallic silver; the hypothesis cannot be reconciled with the facts of development or of solarization in which longer exposure means more silver produced though the amount approaches a limit; more silver means a more rapid reduction of silver bromide, and not a less rapid reduction. L. Cramer has also shown that the latent image does not behave like a mixture of silver bromide and metallic silver. C. Jones found the behaviour of aqua ammonia also does not favour this hypothesis; and S. E. Sheppard and C. E. K. Mees found the hypothesis fails to account for the resistance of the latent image to oxidizing soln. of such potential as to destroy the metal silver.

4. *The assumption that a subhalide is formed.*—This hypothesis was suggested by C. Choiselat and M. Ratel in 1843 to explain the latent daguerreotype image. Taking the case of silver bromide, it is assumed that this salt decomposes into free bromine and silver sub-bromide, Ag_2Br , thus: $4\text{AgBr} \rightleftharpoons 2\text{Ag}_2\text{Br} + \text{Br}_2$. The bromine is presumably temporarily dissolved by the decomposed or undecomposed grain of silver bromide. The system is in equilibrium when the vap. press. of the bromine has reached a certain value. When the silver sub-bromide is exposed to the action of bromine gas in darkness, silver bromide, AgBr , is formed. The amount of silver bromide decomposed, for equilibrium, depends upon the intensity of the light. If bromine be removed from the sphere of the reaction, by, say, mixing the silver salt with a suitable organic compound which "binds" the bromine, the reaction proceeds to an end. The photochemical decomposition of silver bromide has been studied by R. Schwarz and H. Stock. Some early experiments by R. Luther pointed to the existence of definite compounds Ag_2Br or Ag_2Cl . He placed a weighed amount of powdered silver in a $\frac{1}{10}N$ -soln. of hydrochloric acid; added measured amounts of chlorine water; and, after shaking the vessel to bring about equilibrium, he placed a platinum electrode in the soln. and measured the potential against a silver-plated platinum electrode in $\frac{1}{10}N$ -hydrochloric acid containing an excess of silver halide. These measurements were made after each addition of chlorine water, and sharp breaks were observed corresponding with the composition Ag_2Cl and AgCl ; but subsequent experiments by E. Baur, by F. Heyer, and by H. Weisz have failed to confirm R. Luther's measurements because R. Luther did not measure the equilibrium conc. W. Reinders also failed to find satisfactory evidence of the existence of any stable compound of silver chloride at high or at low temp. The reactions of the latent image are not consistent with the existence of one compound, whatever

it be, and accordingly A. P. H. Trivelli gets over the difficulty by postulating the existence of four intermediate compounds with specific colours: $5\text{AgCl} \rightarrow \text{Ag}_5\text{Cl}_4$ (green) $\rightarrow \text{Ag}_5\text{Cl}_3$ (blue) $\rightarrow \text{Ag}_5\text{Cl}_2$ (yellow) $\rightarrow \text{Ag}_5\text{Cl}$ (red) $\rightarrow 5\text{Ag}$, but since there is no evidence of the existence of the alleged compounds, the hypothesis has not made much headway.

5. *The assumption that the latent image is a solid solution.*—Since the latent image is not a reduction product of silver halide—a definite subhalide, or free metallic silver—following M. C. Lea's suggestion, the latent image is considered to be a phase of variable composition with silver bromide as the end term. These solid soln. have been prepared by L. Cremer and by W. Reinders, and their properties are in harmony with observations. There is no means of distinguishing whether the latent image consists of a solid soln. of silver bromide and metallic silver, or silver bromide and silver subhalide; but the former hypothesis is simpler and fits in with the parallelism between the colours of the photohalides and those of colloidal silver. The arguments against the latent image being a reduction product are directed against the existence of free metallic silver or a definite free subhalide; they are invalid when directed against the solid soln. hypothesis. The properties of silver or a hypothetical subhalide absorbed in solid soln. by a large mass of silver bromide to form a phase of variable composition are quite different from the properties of a mixture. In the latent image, says C. Jones, "the amount of silver bromide which is decomposed must be exceedingly minute, small beyond imagination. The amount decomposed might be increased many thousand times before the product of decomposition would have accumulated in sufficient quantity for direct recognition," and the energy which is available during an ordinary exposure is quite inadequate to produce a material decomposition of silver bromide on the plate. F. Hurter and V. C. Driffield show that if all the energy available in a standard candle burning 0.0021 grm. per second be 0.016 Cal. per 100 sq. cms. of surface, a 10 seconds' exposure would then yield 0.16 cal. per 100 sq. cms. The amount of silver 0.0265 grm. which can be obtained by this exposure on the developed plate actually requires 5.6 cal. Hence, only 2.9 per cent. of the energy could be derived from the burning candle if all were converted into radiant energy; but, as a matter of fact, only a small fraction of the available heat is really converted into radiant energy. W. D. Bancroft adds that these difficulties, though very real, vanish entirely with the solid soln. theory because the difference in the energy content of the decomposed and undecomposed silver bromide can be theoretically made as small as we please; practically, the difference which can be detected depends upon the sensitiveness of the developer. The bromine set free by light is probably temporarily adsorbed on or in the grains of silver bromide, or on the parts of the silver bromide not exposed to light. This bromine may also pass into the air or it may react with gelatine, but if the conditions are favourable it may react with the silver in solid soln., and give the phenomenon of photo-retrogression. Hence, during photo-retrogression the latent image reacts with the halogen which comes mainly from the bromine adsorbed by the silver bromide; a small inappreciable amount may come from the decomposition of the gelatino-bromide of the film. In illustration, M. C. Lea showed how silver iodide may adsorb iodine, and how the silver halides generally can take up by adsorption many other foreign substances. For example, a dil. alcoholic soln. of iodine is quickly decolorized by silver iodide.

The so-called solarization, or reversal of the photographic image whereby the negative becomes positive, is primarily due to the silver halide and is independent of the nature of the associated materials it has obtained as a result of a prolonged exposure; by the antagonistic action of light of different colours; by an exposure to white light followed by treatment with an oxidizing soln. and subsequent exposure; by using white light during development; by very slowly developing an under-exposed plate; by very short and intense exposures followed by a short exposure to diffused light; by exposure to cathode rays followed by sunlight, etc. The latent image which gives rise to a negative under normal development consists

of silver bromide with an excess of from 0.002 to 0.1 per cent. of silver; when the excess rises above 0.1 per cent. a positive results. M. C. Lea obtained effects simulating the latent image by the action of acids, press. or heat—*e.g.* characters were drawn on bromide paper by means of a glass rod dipped into sulphuric acid (1 : 2), the acid was washed away with water containing a trace of ammonia. When the plate was developed, brown marks appeared on a white surface. The effect, however, is not like the normal latent image, but is due to the removal of gelatine from the grains of silver bromide.

In 1801, J. W. Ritter found that silver chloride which had been darkened by the violet rays of the spectrum became lighter or bleached when exposed to the yellow and infra-red rays. This was attributed to the deoxidizing action of the less refrangible rays (at the red end), and the reducing action of the more refrangible rays (at the violet end). Analogous observations were made by W. H. Wollaston in 1804, by T. J. Seebeck in 1810, by J. Herschel in 1840, and by J. W. Draper. If an under-exposed iodized silver photographic plate or printing-out paper be exposed to yellow or red light, the opposite effect occurs, for the action started by the violet light is continued, hence E. Becquerel (1840) called the violet rays the *rayons excitateurs*, and the yellow and red rays the *rayons continueurs*. Further investigations have shown that each colour of the spectrum can exert an oxidizing or a reducing effect which is determined by the nature of the substance sensitive to light. J. M. Eder adds :

Although the oxidizing action of the red rays cannot be sharply distinguished from the reducing action of the violet rays, in the majority of cases yet examined, red light has in general an oxidizing action on metallic compounds, while violet light usually has a reducing action. A case in which red light can act as a reducing agent on metallic compounds is especially noticeable in the photography of the spectrum using silver salts and developing the picture. Violet and blue light have the most effect on compounds of the metalloids, for instance, on hydrogen and chlorine mixtures, on nitric acid, on sulphurous acid, on hydriodic acid, etc. (Hydrogen sulphide, however, is decomposed more rapidly by red light.) The action of light is partly a reducing one, depending on the nature of the substance in question. On organic compounds (especially the colourless ones) violet light usually has the strongest oxidizing action; dyes are oxidized most strongly by those rays which are absorbed. In all cases, however, the chemical action of coloured light comes under the law that those rays are the most effective which are markedly adsorbed by the light-sensitive substances.

T. von Grothaus showed that only those rays of light which are absorbed can produce chemical action, and that the action of a ray of light is analogous to that of a galvanic cell. The similarity in the products obtained by the action of light on sensitive substances, and those obtained by electrolysis, is taken to confirm the hypothesis as to the justness of the analogy between the action of a ray of light and of a galvanic cell. The electromotive force of light is low, and therefore the decomposition voltage of a substance must be low if it is to be susceptible to the action of light; if otherwise, the light sensitive substance must be admixed with something conventionally called a *depolarizer* which will lower its decomposition voltage. Hence, adds H. W. Vogel, the compounds of the metals which are sensitive to light are divided into two classes—those which are decomposed by the action of light alone, and those which are decomposed only in the presence of a substance which combines with one of the decomposition products. The sensitiveness of all substances to light is augmented by a suitable depolarizer. For example, silver nitrate can react with silver iodide, and consequently silver iodide is more sensitive to light in the presence of this agent. Similarly with silver bromide in place of the iodide, but with the chloride, the effect is not so marked. The decomposition of chlorine or bromine water in light, as previously indicated, is accelerated in the presence of tartaric or citric acid, and both acids are likewise attacked by the halogen. In some cases the depolarizer changes the sensitiveness of the system towards certain rays. These depolarizers are called optical sensitizers. In 1873, H. W. Vogel showed that a photographic silver bromide plate, stained yellow with

the chemically inert aniline red, gave a maximum sensitiveness in the green not present when the aniline dye is absent. H. W. Vogel further showed that there is a relation between the sensitiveness of a silver bromide plate for certain wave-lengths and the absorption bands of the admixed dye. H. W. Vogel's results with silver

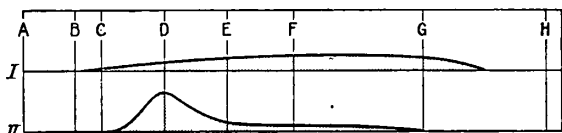

FIG. 14.—Action of different parts of the Spectrum on
I. Silver Chloride alone; II. Silver Chloride with Coralline.

chloride alone, and with silver chloride and coralline are indicated in Fig. 14. H. W. Vogel added: In order to make silver bromide sensitive to any desired colour, or to increase its existing sensitiveness for certain colours, it is necessary

only to add a substance which will promote the decomposition of silver bromide, and which absorbs the rays in question, letting the others pass.

T. Wedgwood¹⁰ is considered to have been the first to obtain light-pictures. In 1802 he gave an account of a method of copying paintings and obtaining profiles of leaves by allowing light to pass through a more or less transparent object on the white paper or leather which had been moistened with nitrate of silver. H. Davy also repeated these experiments and succeeded in preparing pictures of small objects which had been magnified by the solar microscope. About 1814, these pictures were not permanent in light and had to be examined by candle-light. J. N. Niépce tried to obtain permanent light pictures; and about 1826 L. J. M. Daguerre was independently working in the same direction. J. N. Niépce is now credited with having been the first to produce permanent photographs in a camera obscura. He coated a metallic surface with a layer of asphaltum, and exposed it to light in a camera for a whole day. The exposure rendered the asphaltum insoluble in Dippel's bone oil, while the soluble parts were removed by the oil. The pictures were lacking in detail. The metal if desired could be etched with acid. The parts protected by the insolated asphaltum were not affected by the acid. L. J. M. Daguerre was the first to employ silver iodide as a light-sensitive substance. In 1829 the two investigators joined forces in order as they said to develop "the discovery made by J. N. Niépce and improved by L. J. M. Daguerre." In L. J. M. Daguerre's process, the vapour of iodine is allowed to act on a well-polished surface of silver as so to form a film of silver iodide. The film of iodide is then exposed to light in the camera obscura. In a short time the light produces an action which is not visible on the plate, but which develops when the plate is exposed to the action of mercury vapour. The portions of the iodide not affected by light were removed by a hot soln. of sodium chloride. J. Herschel's discovery of the better solvent action of sodium thiosulphate in 1819 was later utilized by L. J. M. Daguerre. This process is called the *Daguerreotype process*. In 1839 F. Talbot obtained negatives by a process which was improved in 1841. Paper coated with a film of silver nitrate was exposed in the camera, and the invisible image developed with a soln. of silver nitrate in acetic and gallic acids. The negative was soaked in white wax to make it transparent, and a positive prepared by placing the waxed negative on paper moistened with silver chloride and exposed to light. This procedure was called the *Talbot process* or the *calotype process*. In 1851, T. S. Archer used a transparent film of iodized collodion spread on glass as a photographic plate instead of W. H. F. Talbot's iodized paper. As a result, greater precision in the reproduction of detail was attained. The results were still further surpassed by the modern dry plate process in which a glass plate coated with an emulsion of silver bromide in gelatin—possibly also with a little silver iodide—is employed as the photographic plate.

REFERENCES.

¹ M. Boruttan, *Zeit. angew. Chem.*, 31, i, 139, 1918; R. Boyle, *Experiments and Considerations on Colours*, London, 1663; G. Suckow, *Commentatio physica de lucis effectibus chemicis*, Jenæ, 1828.

² G. Wetzlar, *Schweigger's Journ.*, 52, 466, 1828; *Pogg. Ann.*, 9, 172, 1827; N. W. Fischer, *Ueber die Wirkung des Lichtes auf das Hornsilber*, Nürnberg, 1813; G. C. Wittstein, *Repert. Pharm.*, 63, 220, 1838; E. von Bibra, *Journ. prakt. Chem.*, (2), 12, 52, 1875; G. J. Mulder, *Die Silberprobiermethode*, Leipzig, 1859; D. Tommasi, *Ber.*, 11, 1249, 1878; R. Hitchcock, *Amer. Chem. Journ.*, 11, 474, 1889; 13, 273, 1891; A. Richardson, *Journ. Chem. Soc.*, 59, 356, 1891; H. B. Baker, *ib.*, 61, 728, 1892; F. Field, *ib.*, 10, 242, 1857; F. Guthrie, *ib.*, 10, 74, 1857; E. Sonstadt, *Proc. Chem. Soc.*, 15, 179, 1899; W. R. Hodgkinson, *R. Meldola's The Chemistry of Photography*, London, 56, 1891; C. F. A. Morren, *Journ. Pharm.*, (4), 6, 324, 1867; H. Vogel, *Pogg. Ann.*, 119, 497, 1863; A. Vogel, *Journ. prakt. Chem.*, (1), 20, 365, 1840; H. W. Vogel, *Ber.*,

16. 1170, 1883; M. C. Lea, *Amer. Journ. Science*, (3), 33. 349, 488, 1887; (3), 43. 527, 1892; H. Rose, *Pogg. Ann.*, 31. 583, 1834; C. W. Scheele, *Aëris aque ignis examen chemicum*, Upsala, 1777; J. J. Pohl, *Sitzber. Akad. Wien*, 6. 574, 1851; P. P. Koch and F. Schrader, *Zeit. Physik*, 6. 127, 1921; W. Ehlers and P. P. Koch, *ib.*, 3. 169, 1920.
- ³ G. J. Mulder, *Die Silberprobiermethode*, Leipzig, 1859; E. von Bibra, *Journ. prakt. Chem.*, (2), 12. 45, 1879.
- ⁴ T. J. Seebeck, *Pogg. Ann.*, 9. 172, 1827; R. E. Hughes, *Phil. Mag.*, (5), 35. 531, 1893; J. J. Ackworth, *Wied. Ann.*, 42. 371, 1891; M. C. Lea, *Amer. Journ. Science*, (3), 44. 446, 1892; R. Hitchcock, *Amer. Chem. Journ.*, 11. 474, 1889; H. B. Baker, *Journ. Chem. Soc.*, 61. 728, 1892; W. de W. Abney, *Chem. News*, 44. 184, 1881; E. Wiedmann, *Wied. Ann.*, 37. 177, 1889.
- ⁵ S. B. Newbury, *Amer. Chem. Journ.*, 6. 407, 1885; R. Hitchcock, *ib.*, 13. 273, 1891; F. Guthrie, *Journ. Chem. Soc.*, 10. 74, 1857.
- ⁶ N. W. Fischer, *Ueber die Wirkung des Lichtes auf das Hornsilber*, Nürnberg, 1813; A. Guntz, *Compt. Rend.*, 113. 72, 1891; A. Richardson, *Journ. Chem. Soc.*, 59. 536, 1892; A. Riche, *Chem. Centr.*, (3), 10. 600, 1879; *Compt. Rend.*, 86. 1502, 1878.
- ⁷ M. C. Lea, *Amer. Journ. Science*, (3), 15. 189, 1878; (3), 41. 259, 1891; (3), 44. 322, 1892.
- ⁸ J. J. Berzelius, *Lehrbuch der Chemie*, Dresden, 4. 626, 1836; M. C. Lea, *Amer. Journ. Science*, (3), 15. 189, 1878; H. B. Baker, *Journ. Chem. Soc.*, 61. 728, 1892; R. Hitchcock, *Amer. Chem. Journ.*, 13. 273, 1891; E. von Bibra, *Journ. prakt. Chem.*, (2), 12. 47, 1875; C. F. Berthollet, *Ann. Chim. Phys.*, 2. 233, 1834; E. Mitscherlich, *Lehrbuch der Chemie*, Berlin, 2. 275, 1840.
- ⁹ H. W. Vogel, *Pogg. Ann.*, 117. 333, 1862; 119. 497, 1863; R. Hunt, *Researches on Light*, London, 80, 1854; E. von Bibra, *Journ. prakt. Chem.*, (2), 12. 49, 1875; H. B. Baker, *Journ. Chem. Soc.*, 61. 728, 1892; G. Wetzlar, *Schweigger's Journ.*, 51. 373, 1827; K. Heydenreich, *Photo-elektromotorische Untersuchungen von Chlorsilber und Bromsilber*, München, 1911; M. Volmer, *Zeit. wiss. Phot.*, 7. 399, 1909; W. Haas, *Photochemische Untersuchungen über Bromsilber*, München, 1912; S. E. Sheppard and C. E. K. Mees, *Proc. Roy. Soc.*, 76. A, 217, 1905; 78. A, 461, 1907; *Investigations on the Theory of the Photographic Process*, London, 1907; F. Heyer, *Untersuchungen über das hypothetische Silbersubchlorid*, Leipzig, 1902; M. C. Lea, *Amer. Journ. Science*, (3), 33. 349, 384, 480, 1887; H. Siedentopf, *Verh. deut. phys. Ges.*, 12. 6, 1910; P. de Heen, *Bull. Acad. Belgique*, 680, 1913; V. Kohlschütter, *Zeit. Elektrochem.*, 19. 182, 1913; W. Scheffer, *ib.*, 14. 489, 1908; *Ber. deut. phys. Ges.*, 5. 490, 1907; W. Reinders and C. J. van Nieuwenburg, *Koll. Zeit.*, 10. 36, 1912; R. L. Liesegang, *ib.*, 4. 63, 1909; *Phot. Corresp.*, 581, 1909; F. Hurter and V. C. Driffield, *Phot. Journ.*, 22. 149, 1898; *Photographic Researches*, London, 1920; W. Ostwald, *Lehrbuch der allgemeinen Chemie*, Leipzig, 2. 1078, 1893; R. Namais, *Chimie photographique*, Paris, 113, 1902; *Phot. Corresp.*, 43. 155, 1905; C. Jones, *An Introduction to the Science and Practice of Photography*, London, 382, 1904; O. Flaschner, *Journ. Chem. Soc.*, 95. 327, 1909; S. E. Sheppard, *ib.*, 87. 1311, 1905; *Koll. Zeit.*, 5. 43, 1909; L. Baekeland, *Internat. Kongress angew. Chem. Berlin*, 4. 403, 1903; *Zeit. wiss. Phot.*, 3. 58, 1905; C. F. Brush, *Phys. Rev.*, (1), 31. 241, 1910; J. von Tugoleff, *Phot. Corresp.*, 40. 594, 1903; J. M. Eder, *Sitzber. Akad. Wien*, 90. 1097, 1885; 114. 1159, 1905; J. M. Eder and G. Pizzighelli, *ib.*, 83. 144, 1881; J. M. Eder, *Zeit. wiss. Phot.*, 3. 329, 1905; *Phot. Corresp.*, 44. 484, 1907; R. Luther, *Zeit. phys. Chem.*, 30. 680, 1900; *Arch. wiss. Phot.*, 1. 272, 1899; R. Abegg, *ib.*, 1. 268, 1899; G. Mercator, *ib.*, 1. 199, 1899; C. G. Barkla and G. H. Martyn, *Phil. Mag.*, (6), 25. 296, 1913; P. G. Nutting, (6), 26. 423, 1913; G. Staats, *Ber.*, 21. 2199, 1888; H. W. Vogel, *ib.*, 16. 1170, 1883; L. Wöhler and W. Krupko, *ib.*, 46. 2046, 1913; C. Otsuki, *Journ. Soc. Chem. Ind.*, 24. 583, 1905; C. Schultz-Sellak, *Pogg. Ann.*, 143. 439, 1871; R. Bunsen and H. E. Roscoe, *ib.*, 117. 529, 1862; A. Streissler, *Chem. Ztg.*, 32. 1185, 1908; J. Reynolds, *Chem. News*, 27. 33, 1873; W. de W. Abney, *Proc. Roy. Soc.*, 33. 164, 1882; S. Kinoshita, *ib.*, 83. A, 432, 1910; A. Werner, *Zeit. wiss. Phot.*, 6. 25, 1908; A. Becker and W. Werner, *ib.*, 5. 382, 1907; C. Winther, *ib.*, 8. 135, 1910; E. Legrady, *ib.*, 6. 60, 1908; E. Schlömann, *ib.*, 5. 183, 1907; A. and L. Lumière and A. Seyewetz, *ib.*, 5. 392, 1907; F. Wentzel, *ib.*, 7. 113, 1909; *Beiträge zur Sensibilisation in Chlorsilbergelatine*, Berlin, 1908; G. A. Perley, *Journ. Phys. Chem.*, 13. 630, 1909; 14. 685, 1910; B. Homolka, *ib.*, 13. 87, 1909; J. H. Mathews and L. E. Barmer, *ib.*, 17. 682, 1913; W. D. Bancroft, *ib.*, 13. 1, 1909; 14. 12, 97, 201, 620, 1910; 15. 313, 551, 1911; 16. 29, 89, 1912; 17. 93, 1913; A. P. H. Trivelli, *Chem. Weekb.*, 6. 358, 525, 1909; 7. 321, 350, 381, 404, 1910; 8. 101, 1911; 9. 2. 32, 248, 1912; *Zeit. wiss. Phot.*, 6. 197, 237, 273, 358, 438, 1908; 7. 394, 1909; 8. 17, 113, 1910; 9. 168, 185, 1911; *Arch. Néerl.*, (2), 14. 339, 1909; *Bemmelen's Gedenboek*, 13, 1910; W. H. Idzerda, *Zeit. wiss. Phot.*, 7. 392, 1909; K. Schaum, *ib.*, 7. 399, 1909; W. Reinders, *Chem. Weekb.*, 7. 961, 993, 1910; 8. 299, 1911; 9. 242, 1912; *Zeit. Koll.*, 9. 10, 1911; *Zeit. phys. Chem.*, 77. 213, 356, 677, 1911; H. Weisz, *ib.*, 54. 305, 1906; K. Sichling, *ib.*, 77. 1, 1911; E. Baur, *ib.*, 77. 58, 1911; E. Lehmann, *ib.*, 64. 89, 1908; R. Abegg, *ib.*, 54. 311, 1906; L. Cramer, *Zeit. Koll.*, 2. 103, 135, 360, 1908; 3. 33, 1908; 5. 103, 1909; 6. 168, 1910; 7. 99, 304, 1910; 8. 42, 97, 1911; 9. 116, 240, 1911; 10. 29, 182, 295, 1912; 11. 74, 1912; 12. 309, 1913; 13. 35, 1913; *Zeit. angew. Chem.*, 22. 2330, 1909; *Phot. Corresp.*, 44. 578, 1907; 43. 28, 1906; 46. 81, 1909; 47. 337, 527, 1910; L. Cramer and W. Scheffer, *Zeit. Koll.*, 6. 7, 1910; B. T. Brooks, *Philippine Journ. Science*, 4. 451, 1909; B. Walter, *Ann. Physik*, (4), 27. 83, 1908; A. and L. Lumière, *Monit. Scient.*, (4), 20. 174, 1906; V. Vojtech, *Jahrb. Phot.*, 19. 386, 1905; A. Guébbard, *Compt. Rend.*, 141. 559, 1905; A. G. de Monsetz, *ib.*, 148. 406, 1022, 1909; M. Chanoz, *ib.*, 146. 172, 1908; 152. 1576, 1905; J. Cavalier, *ib.*, 139. 284, 1904; C. Choiselet and M. Ratel, *ib.*, 16. 1436, 1843; 17. 1734, 1911

1843; E. Stenger, *Phys. Zeit.*, 12, 580, 1911; J. Precht and E. Stenger, *ib.*, 6, 332, 1905; G. Leimbach, *ib.*, 11, 313, 1910; G. Eberhard, *ib.*, 13, 288, 1912; M. Levin and R. Ruer, *ib.*, 9, 248, 1908; J. Königsberger and J. Kutschewsky, *ib.*, 11, 666, 1910; J. Stark, *ib.*, 9, 894, 1908; C. W. Scheele, *Aëris atque ignis examen chemicum*, Upsala, 62, 1777; F. P. Dulk, *De licibus effectibus chemicis*, Regimontii, 1843; J. W. Ritter, *Physikalisch-chemische Abhandlungen*, Leipzig, 1, 91, 1806; 2, 90, 1806; W. H. Wollaston, *Nicholson's Journ.*, (2), 8, 293, 1804; J. Herschel, *Phil. Trans.*, 130, 35, 1840; T. J. Seebeck, *Schweigger's Journ.*, 5, 233, 1812; J. M. Eder, *Ausführliches Handbuch der Photographie*, Halle a. S., 1, 180, 1892; W. R. Hodgkinson in R. Meldola, *The Chemistry of Photography*, London, 56, 1891; R. Lorenz and K. Hiege, *Zeit. anorg. Chem.*, 92, 27, 1915; L. Schaum and H. Lang, *Koll. Zeit.*, 28, 243, 1921; F. Weigert and W. Schöller, *Sitzber. Akad. Berlin*, 641, 1921; R. Schwarz and H. Stock, *Ber.*, 54, 2111, 1921; P. P. Koch and F. Schrader, *Zeit. Physik*, 6, 127, 1921; J. W. Draper, *Phil. Mag.*, (3), 19, 195, 1841; T. von Grothhus, *Jahresverh. kurland. Ges.*, 1, 119, 1819; *Ostwald's Klassiker*, 152, 1906; E. Becquerel, *La lumière: ses causes et ses effets*, Paris, 1867; H. Weisz, *Zeit. phys. Chem.*, 54, 305, 1906; F. Weigert, *Sitzber. Akad. Berlin*, 641, 1921; A. P. H. Trivelli and S. E. Sheppard, *The Silver Bromide Grain of Photographic Emulsions*, New York, 1921.

¹⁰ T. Wedgwood, *Journ. Roy. Inst.*, 1, 170, 1802; H. Davy, *Outlines of a Course of Lectures on Chemical Philosophy*, London, 1820; R. Meldola, *The Chemistry of Photography*, London, 1891; C. Jones, *An Introduction to the Science and Practice of Photography*, London, 1895; R. Namais, *Chimie photographique*, Paris, 1902; S. Fouqué, *La vérité sur l'invention de la photographie*, Paris, 1867; J. M. Eder, *Geschichte der Photochemie und Photographie von Alterthume bis in die Gegenwart*, Halle a. S., 1891; T. S. Archer, *Journ. Phot. Soc.*, 3, 266, 1855; J. Herschel, *Phil. Trans.*, 130, 35, 1840; L. J. M. Daguerre, *Historique et description des procédés du daguerréotype et du diorama*, Paris, 1839; J. N. Niépce, *Notice sur l'héliographie*, Paris, 1839; W. H. F. Talbot, *Phil. Mag.*, (3), 12, 258, 1838; (3), 14, 196, 1839; *B.A. Rep.*, 3, 1839.

§ 16. Silver Bromide

Silver bromide occurs in nature in cubes or octahedral crystals of *bromite* or *bromargyrite* of sp. gr. 5.8 to 6.0, and hardness 1 to 1½. It is usually associated with silver chloride in Chili, Mexico, Honduras, etc., forming the so-called mineral *emboquite*—*ἐμβόλιον*, an intermediate—in which the ratio Cl:Br varies indefinitely. The yellow and deep green varieties usually contain the largest proportion of bromine. From I. Domeyko's and P. Yorke's analyses of samples from Chili, emboquite contains from 51 to 81 per cent. of the chloride and 18 to 49 per cent. of the bromide. A. Breithaupt¹ called the varieties of emboquite with the larger proportion of bromine *megabromite*, and those with the smaller proportion *microbromite*. Silver bromide can be made by the action of bromine on silver, which, according to H. Gautier and G. Charpy,² is very slow, and which, according to V. von Cordier, progresses more rapidly in darkness than in light because of the decomposition of the resulting silver bromide. M. Berthelot says that silver is readily attacked by hydrobromic acid at ordinary temp., and A. Jouniaux has studied the equilibrium conditions in the reversible reaction, $2\text{Ag} + 2\text{HBr} \rightleftharpoons 2\text{AgBr} + \text{H}_2$, which represents phenomena similar to those observed in the corresponding reaction between hydrogen chloride and silver. Bromine also forms silver bromide when it acts on silver chloride or iodide. A. Potilitzin, and T. S. Humpidge have shown that the reaction is very slow with silver chloride. The thermochemistry of the process has been discussed in connection with silver chloride. P. Julius observed that the reaction is complete when bromine vapour is passed over the molten halide; and that more rapidly with silver iodide than silver chloride. When silver chloride or some other sparingly soluble salt of silver—not the iodide—is warmed with a soln. of potassium bromide, it is converted into silver bromide, $\text{AgCl} + \text{KBr} = \text{AgBr} + \text{KCl}$; if both silver bromide and chloride are present as solid phase, the system might be expected to be in equilibrium when the ratio KCl:KBr is equal to the ratio of the solubility product of the silver chloride and bromide; but there is a complication owing to the formation of a solid soln. of silver chloride and bromide, and the ratio of the chlorine and bromine ions in the soln. is dependent on the ratio of AgCl:AgBr in the precipitate, as was shown by F. W. Küster. The ratio $[\text{AgBr}]/[\text{AgCl}] : [\text{KBr}]/[\text{KCl}]$ between soln. and precipitate undergoes very little change. A. Thiel also showed that in a series of mixed soln.

of silver bromide and chloride, in equilibrium with a normal soln. of potassium chloride and bromide, the change of potential steadily increases as the proportion of silver bromide increases. Silver bromate was found by C. Löwig to be decomposed into the bromide and oxygen.

As A. J. Balard first showed, silver bromide separates as a white curdy precipitate when a soln. of a silver salt is treated with hydrobromic acid or a soluble bromide. In his work on the at. wt. of bromine, G. P. Baxter prepared silver bromide in the following manner :

Purified silver was dissolved in purified nitric acid, dil. with an equal volume of water, and heated until free from nitrous acid and the oxides of nitrogen. The soln. was still further diluted to a conc. of about a quarter normal and added slowly, with constant agitation, to a dil. soln. of an excess of purified ammonium bromide in a glass-stoppered precipitating flask, and the whole violently shaken to promote coagulation. By adding the silver soln. to the bromide, the occlusion of silver nitrate was almost wholly prevented. After standing about 24 hrs., the flask was again shaken, and allowed to stand until the supernatant liquid was clear. The precipitate was washed on a Gooch's crucible and dried for several hours at 130°, and finally for about 14 hrs. at 180°.

J. S. Stas tried to distinguish six different forms of silver bromide : (i) The white flocculent precipitate obtained by precipitation with an excess of silver salt ; (ii) the yellow flocculent precipitate obtained with an excess of hydrobromic acid or soluble bromide ; (iii) the pulverulent yellow salt obtained when the preceding product is agitated with water ; (iv) the yellowish-white product obtained by boiling the flocculent bromide with water ; (v) the white product obtained when the yellowish-white salt is boiled a long time ; and (vi) the yellow crystalline or fused salt. He showed that some of these forms have different solubilities, and different sensibilities to light. The precipitate with an excess of potassium bromide appears yellow owing to the adsorption of a little potassium bromide, which forms a yellow solid soln. When the flocculent precipitate is allowed to stand for some time, or when heated in boiling water, it forms a pulverulent mass—the action presumably depends on the smaller grain dissolving and reprecipitating on the larger less soluble grains. B. L. Vanzetti says that potassium bromide diffuses into soln. of silver nitrate as rapidly as potassium chloride or iodide ; and K. Jablezynsky, that the precipitate of silver bromide is formed twice as slowly as silver chloride. According to W. Böttger, a turbidity appears in a soln. containing 0.3×10^{-6} mol of silver bromide per litre ; and, according to L. Rolla, with potassium or sodium bromide and silver nitrate, with between 4 or 5×10^{-7} mol per litre. For the preparation of **colloidal silver bromide**, see the analogous colloidal silver chloride.

A. C. Becquerel³ obtained **crystals** of silver bromide by heating a mixture of hydrobromic acid and silver in a sealed tube. C. Löwig obtained octahedral crystals by evaporating a soln. of silver bromide in hydrobromic acid ; and H. Debray by cooling a warm soln. of the chloride in mercuric nitrate. A. P. H. Trivelli and S. E. Sheppard prepared crystals of silver bromide by allowing a mixture of aq. ammonia and silver bromide to stand in a bottle, with frequent shaking, at 20° for about a week. The ammoniacal soln. was then allowed to crystallize (i) by dilution with water, (ii) by evaporating off excess of ammonia, (iii) by cooling the soln. Crystals of an ammino-complex are yellow, those of silver bromide are white. V. Bellach described tetrahedral forms ; E. Baur, and J. V. Elsdon hexagonal forms ; F. W. T. Krohn, cubic crystals which crystallize as hexagons ; and F. F. Renwick, both hexagonal and cubic forms. P. Groth placed silver bromide in the hexakisoctahedral class of the cubic system ; and A. P. H. Trivelli and S. E. Sheppard, in the dyakisdodecahedral class because of the occurrence of pentagonal dodecahedra as in the case of stannic iodide, ferric disulphide, cobalt sulphoarsenide, caesia-alum, and trimethylammonia-alum. The evidence of the existence of a metastable hexagonal form is not sufficient to establish the dimorphism of silver bromide. G. I. Higson could find no evidence of the polarization of light by the crystals. The phenomenon, say A. P. H. Trivelli and

S. E. Sheppard, may be due to reflection and not to anisotropism. E. Banks, V. Bellach, P. P. Koch and V. du Prel, G. I. Higson, L. Cramer, and F. W. T. Krohn showed that much of the silver bromide in emulsions used for sensitive photographic plates is crystalline. For the adsorption of gelatine during the crystallization of silver bromide in the presence of the protective colloid gelatine, see silver chloride. A. P. H. Trivelli and S. E. Sheppard studied the **corrosion figures** of silver bromide by aq. ammonia. A. Thiel showed that there is a continuous change of potential with mixtures of silver chloride and bromide in agreement with the formation of solid soln. of the two salts in all proportions. The **X-radiogram** of silver bromide has been studied by P. Debye and P. Scherrer, A. W. Hull, and R. B. Wilsey. The lattice is a simple cube with sides 2·89 Å., and the distance of the nearest atomic centres, 2·89 Å. The **specific gravity** of silver bromide is 6·245 (0°) according to G. F. Rodwell;⁴ 6·215 (17°); according to F. W. Clarke the sp. gr. of the salt which has been fused is 6·473 (25°); and according to G. P. Baxter and M. A. Hines, 6·479. H. G. F. Schröder gave numbers ranging from 6·32 to 6·49. The sp. gr. of the molten salt at 427° is 5·595. G. Quincke gave 6·2. P. Walden, and F. A. Henglein studied the mol. vol.

T. W. Richards and G. Jones'⁵ value for the **compressibility** of silver bromide is 0·00000259 megabar per sq. cm. or 0·00000262 atm., or 0·00000254 kilogram per sq. cm. between 100 and 500 megabars, and the mol. compressibility is 0·000075. According to J. E. Meyers and F. Braun, if subjected to a press. of 3000–50,000 atm. precipitated silver bromide in layers 3–4 mm. thick gradually becomes translucent. The *Fließdruck*—that is, the press. required to make silver bromide flow through a small opening—is, according to N. Kurnakoff and S. F. Schemtschuschny, 18·6 kilograms per sq. mm. G. Quincke's value for the **surface tension** of molten silver bromide is 120 dynes per cm. when the sp. gr. is 6·2, and the **specific cohesion** $a^2=4$ sq. mm.

Silver bromide melts to a reddish liquid which on cooling forms a yellow horny translucent mass. The reported values for the **melting point** range from C. Sandonini's⁶ 419°, to K. Mönkemeyer's 422°, and to T. Carnelley's 434° ± 2°. According to K. Mönkemeyer, for a mixture of silver chloride, melting at 451°, and silver bromide, melting at 422°, containing about 65 mols per cent. of silver bromide, the m.p. is 413°. As O. Lehmann showed, the two salts form mixed crystals and the f.p. curve corresponds with H. W. B. Roozeboom's Type III curve. The results are in harmony with C. Sandonini's observations on the electrical conductivity of mixtures of the two salts. The mixed crystals correspond with the mineral *embolite*. N. Kurnakoff and S. F. Schemtschuschny measured the **hardness**, and also the press. required to make the mixed crystals flow. According to H. Stolzenberg and M. E. Huth, the pale greenish-yellow crystalline solid is anisotropic and at 259° forms greenish-orange liquid crystals which are isotropic, and at 398° forms an orange-red liquid, but C. Tubandt and E. Lorenz could detect no sign of the alleged transformation point at 259° by the electrical conductivity method.

According to J. H. van't Hoff, silver bromide dissociates at 60° in vacuo in the sense of the equation: $2\text{AgBr} \rightleftharpoons 2\text{Ag} + \text{Br}_2$, until the press. of the bromine vapour reaches the very minute press. $2·9 \times 10^{-53}$ mm. The value for silver chloride is $5·4 \times 10^{-73}$ mm. H. V. Regnault's value for the **specific heat** of fused silver bromide is $C_p=0·0739$ between 15° and 98°. According to G. F. Rodwell, the salt steadily contracts from its fusion temp. down to -60°, when it attains its maximum sp. gr. H. Fizeau's value for the linear coeff. of expansion is 0·0000347, the mol. cubical expansion 0·00302.

J. Thomsen's value for the **heat of formation** from its elements, $\text{Ag} + \text{Br}_{\text{liq.}} = \text{AgBr}_{\text{cryst.}} + 23·7$ Cals.; or 20·7 to 23·7 kilojoules. According to M. Berthelot,⁷ the heat of transformation AgBr (precipitated) to AgBr (crystalline) is 3·4 Cals. per mol. M. Berthelot also gives $\text{Ag}_2\text{O} + 2\text{HBr}_{\text{aq.}} = \text{AgBr} + 44·6$ Cals. to 51·2 Cals. The heat of precipitation in dil. soln. is 20·2 Cals. according to J. Thomsen. M. de K. Thompson found the **free energy of formation** of silver

bromide—halogen liquid—is 23,000 cals., and the **total energy** of formation 23,400 cals.

W. Kohlrausch⁸ found the **electrical conductivity** of silver bromide at 20° to be 0.35×10^{-5} reciprocal ohms, and K. Arndt and A. Gessler give for the conductivity at

150°	250°	350°	410°	418°	419°	500°	600°
0.00008	0.0044	0.11	0.722	melts	2.767	2.94	3.10

There is therefore a sharp break at the m.p.; and below the f.p. the conductivity rapidly decreases. C. Tubandt said that the current is carried entirely by the positive silver ion which, at 422°, has the velocity 0.15×10^{-3} cm. per sec. C. Sandonnini found the conductivity of fused silver bromide at its m.p. 422° to be 2.920 reciprocal ohms, and he investigated the electrical conductivities of fused mixtures of silver chloride and bromide. C. Tubandt studied the conductivity of the crystalline solid. J. C. Ghosh measured the conductivity, and calculated the **ionization**, α , of fused silver bromide at different temp., and found $\alpha=0.089$ per cent. at 473°, and 63.72 per cent. at 673°. L. Graetz has studied the influence of press., and S. Arrhenius that of light on the electrical conductivity of silver bromide. P. Dutoit and G. von Wiese's value for the potential against 0.1N-AgNO₃ at 25° is 0.296 volt; M. Katayama's value for the e.m.f. of the cell Ag | AgCl | AgBr | Ag is zero, and for the cell Ag | AgBr | PbBr₂ | Pb is 0.342 + 0.00025(20 - θ) volts between 20° and 145°, and AgBr + $\frac{1}{2}$ Pb = $\frac{1}{2}$ PbBr₂ + Ag + 9.6 Cals. J. A. Wilkinson⁹ reported that the salt has a bluish-violet fluorescence. For the **photoelectric effect**, see silver chloride. W. Wernicke gives for the **index of refraction**, for $\lambda=431$, $\mu=2.360$; $\lambda=486$, $\mu=2.303$; and $\lambda=656$, $\mu=2.2336$. S. Meyer¹⁰ gave -0.26×10^{-6} mass units for the **magnetic susceptibility** of silver bromide at 19°; and no discontinuity was observed by T. Ishiwara when silver bromide was melted.

Silver bromide is less soluble in water than silver chloride; according to F. Kohlrausch's calculation¹¹ from the electrical conductivity data, a litre of water at 21° dissolves 0.000107 grm. of silver bromide, or 0.00058 milligram-eq. I. M. Kolthoff gave 4.1×10^{-13} for the solubility product at 18°. According to A. E. Hill's calculation from the equilibrium condition $\text{AgSCy} + \text{KBr} \rightleftharpoons \text{AgBr} + \text{KSCy}$, a litre of water at 25° dissolves between 6.6×10^{-7} and 8.1×10^{-7} mols per litre when the solubility of silver chloride is 0.000016, and that of silver thiocyanate 0.735. According to A. F. Holleman, the effect of grain size on the solubility of the different forms of silver bromide has been discussed by J. S. Stas; and the electrical conductivities of soln. of silver bromide by F. Kohlrausch and F. Rose. According to W. Böttger, all three silver halides in sat. aq. soln. are completely ionized. C. Löwig noticed that silver bromide dissolves in conc. *hydrobromic and hydrochloric acids*—a mol of hydrogen bromide in conc. aq. soln. dissolves nearly a mol of silver bromide. The latter salt separates on dilution with water, and crystals of silver bromide are obtained on evaporation. According to M. Berthelot, the soln. contains a *bromhydrate de bromure d'argent*; with hydrochloric acid an analogous chlorohydrate is formed. Silver bromide also dissolves in soln. of alkali bromides forming double salts.

Silver bromide dissolves in soln. of *sodium thiosulphate*.¹² According to T. W. Richards and H. B. Faber, 5 c.c. of a soln. containing 100, 200, 300, 400 grms. of crystalline sodium thiosulphate per litre at 35° dissolve respectively 0.118, 0.224, 0.341, and 0.613 grm. of silver as silver bromide. E. Valenta found 100 grms. of sodium thiosulphate soln., at 25°, contain

Per cent. Na ₂ S ₂ O ₄	.	.	1	5	10	15	20
Grms. of AgBr	.	.	0.35	1.90	3.50	4.20	5.80

E. Valenta says that the solvent power of *ammonium thiosulphate* is nearly the same as for the sodium salt, but A. and L. Lumière and A. Seyewetz say that the action

of the ammonium salt is the faster. A. Rosenheim and S. Steinhäuser isolated tetragonal crystals of $4(\text{NH}_4)_2\text{S}_2\text{O}_3 \cdot \text{NH}_4\text{Br} \cdot \text{AgBr}$, analogous with those obtained with silver chloride. E. Valenta also found that 100 grms. of a 1:10 soln. of *potassium, calcium, or barium thiosulphate*, at 25° , dissolves 0.73, 0.03, or 0.02 grm. respectively of silver bromide; 100 grms. of 1:10 and 1:5 soln. of *sodium sulphite* dissolve respectively 0.04 and 0.08 grm. of silver bromide at 25° ; 100 grms. of 1:20 soln. of *potassium cyanide* dissolves 6.55 grms. of silver bromide; and 100 grms. of 1:20, 1:10, and 1:6 $\frac{2}{3}$ soln. of *ammonium thiocyanate* at 20° dissolve respectively 0.21, 2.04, and 5.30 grms. of silver bromide. K. Hellwig finds the solubility of silver bromide in soln. of *silver nitrate* is smaller than that of silver iodide. P. Kremers, H. Risse, and K. Hellwig obtained products which they thought to be compounds of silver bromide and nitrate. The needle-like crystals obtained by cooling a hot soln. of freshly precipitated silver bromide in one of conc. silver nitrate, have a composition corresponding with $\text{AgBr} \cdot \text{AgNO}_3$. I. Kablukoff, and G. Scarpa have investigated the f.p. curve of mixtures of silver nitrate and bromide and found a eutectic with 75 gram-mol. per cent. of silver nitrate at 155° . H. W. F. Wackenroder also found soln. of *mercuric nitrate* readily dissolve silver bromide.

According to E. C. Franklin and C. A. Kraus, silver bromide is soluble in liquid ammonia,¹³ and according to R. Jarry, and A. Joannis and M. Croizier, at -30° a white compound **silver triammino-bromide**, $\text{AgBr} \cdot 3\text{NH}_3$, can be obtained which, between 3.5° and 4.0° , passes into the sesquiammine $2\text{AgBr} \cdot 3\text{NH}_3$. R. Jarry also says the triammine is formed in aq. soln. if the water is sat. under a press. corresponding with the dissociation press. of the salt, namely—

-23°	-18°	-8°	0°	3.5°	8°	14°	20°	23°
140	195	360	605	745	920	1310	1820	2140 mm.

W. Biltz and W. Stollenwerk found the heat of formation, Q , of the triammine is 8.64 Cals., and the vap. press. is given by $\log p = -Q/4.57T + 1.75 \log T - 0.0028T + 3.3$. Silver bromide dissolves readily in conc. aq. soln. of *ammonia*; according to A. Longi, for conc. between 0.08 and 0.45 mol per litre, the solubility is proportional to the conc. of the ammonia; 100 c.c. of 0.5 per cent. aqua ammonia (sp. gr. 0.998) dissolve 0.0113 grm. of silver bromide, and of 10 per cent. ammonia (sp. gr. 0.96), 0.333 grm. J. J. Pohl says that freshly precipitated silver bromide is twice as soluble as the dried salt; this is probably a question of rate of soln. J. V. Elsdon noted the formation of a complex ammino-bromide. According to G. Bodländer and R. Fittig, the ammoniacal soln. contains complex ions. P. Berthier obtained a pale yellow powder by cooling a hot soln. of silver bromide in conc. aqua ammonia: when treated with water it gradually forms white silver bromide. According to R. Jarry, and A. Joannis and M. Croizier, **silver sesquiammino-bromide**, $2\text{AgBr} \cdot 3\text{NH}_3$, is obtained when the temp. of silver triammino-bromide is allowed to rise between 3.5° and 34° . Dry silver bromide in an atm. of ammonia slowly forms this same compound. G. Wiegner, and W. Peters say $\text{AgBr} \cdot 2\frac{1}{2}\text{NH}_3$ is formed. According to R. Auerbach, the addition of just enough ammonia to satisfy the reversible equation $\text{AgBr} + 2\text{NH}_3 \rightleftharpoons [\text{Ag}(\text{NH}_3)_2]\text{Br}$ does not cause either precipitation or re-soln. within five minutes. With slight but increasing excess amounts of ammonia, the coagulation speed transcends the soln. speed and then the reverse.

C. F. Rammelsberg said that silver bromide does not absorb ammonia gas, but, according to R. Jarry, he was misled by the slowness of the absorption. According to G. Bodländer, J. von Liebig obtained what was probably this compound in white crystals by allowing an ammoniacal soln. of silver bromide to stand some time. According to A. Terreil, if silver bromide sat. with gaseous ammonia is heated in a sealed tube, fusion occurs at 90° , and an explosion at 100° . The dissociation temp. of silver sesquiamminobromide is between 34° and 35° ; and the dissociation press.

0°	4°	10.4°	11.2°	14°	16.6°	28.6°	43.8°	53°
88	107	166	174	206	269	513	1225	1986 mm.

The ammino-bromide forms yellow crystals, which are not sensitive to light; they become turbid in ammonia-free water, and are opaque after heating to 70°. They show double refraction between crossed nicols. According to W. Biltz and W. Stollenwerk, Q for the sesquiammine, $\text{AgBr} \cdot 1\frac{1}{2}\text{NH}_3$, is 9.95 Cals., and $\log p = Q/4.57T + 1.75 \log T - 0.0020 T + 3.3$. When the temp. of silver sesqui-amminobromide lies between 34° and 51.5°, **silver ammino-bromide**, $\text{AgBr} \cdot \text{NH}_3$, is formed. Above 51.5° it decomposes into silver bromide and ammonia. W. Biltz and W. Stollenwerk found that the heat of formation, Q , of the monammine is $Q = 10.65$, and $\log p = -Q/4.57T + 1.75 \log T - 0.0015T + 3.3$. According to G. C. Wittstein, silver bromide is soluble in hot soln. of *ammonium chloride*, sparingly soluble in soln. of *ammonium carbonate*, *sulphate*, or *succinate*; and very sparingly soluble in soln. of *ammonium nitrate*. H. Euler,¹⁴ and B. Wuth have investigated the solubility of it in *ethylamine*. According to J. Neustadt, *methyl alcohol* dissolves 1.12×10^{-15} and *ethyl alcohol* 6.4×10^{-16} mol. of silver bromide per litre. F. Bezdold finds it insoluble in *methyl acetate* and M. Hamers in *ethyl acetate*.

Chemical properties of silver bromide.—The remarks on the photochlorides and subchlorides apply also to the photobromides and subbromides. H. W. Vogel¹⁵ prepared a grey precipitate which he regarded as **silver subbromide**, Ag_2Br , by the action of cuprous bromide on silver nitrate; but K. Emszt, and J. Waterhouse showed that the product is more likely to be a mixture of metal and normal bromide.

White silver bromide becomes violet in a few seconds when exposed to light. The phenomenon resembles that which occurs with silver chloride, and which has previously been discussed. The latent image with silver bromide photographic plates has also been discussed. W. Ehlers and P. P. Koch¹⁶ found that particles of colloidal silver bromide with an average diameter of 0.4μ , lose 6 per cent. of bromine when illuminated for 20 minutes by an arc lamp. B. Homolka assumed that because indoxyl or thioindoxyl developer is oxidized during the development of the exposed plate, a **silver perbromide**, AgBr_2 or AgBr_3 , is present in the latent image. As W. D. Bancroft has shown, this assumption is quite unnecessary, because as the silver bromide is reduced, the developer must be oxidized, and the oxidation will be greatest in those parts where the reduction of the silver bromide is greatest. L. Bruner and E. Bekier, however, obtained indications of the formation of silver perbromide during the electrolysis by means of a silver anode, of molten bromine iodide, BrI , containing an excess of bromine.

Several observers have suggested that **silver oxybromide** is formed during the development of the latent image on a photographic plate. Thus, E. Demole¹⁷ supposed AgBrO is formed by the action of potassium ferricyanide soln., and that this is reduced by hydroquinone. A. and L. Lumière and A. Seyewetz also supposed the oxybromide $\text{AgBr} \cdot \text{O} \cdot \text{AgBr}$ to be formed by the action of an aq. soln. of benzoquinone and potassium bromide on silver bromide paper. A. Seyewetz has also prepared crystals of what he regarded as an oxybromide $\text{Ag}_7\text{Br}_7\text{O}$, or $\text{Ag}_2\text{O} \cdot \text{Ag}_5\text{Br}_7$, by the action of a soln. of silver bromide in benzoquinone on finely divided silver.

Dry silver bromide, says J. S. Stas,¹⁸ suffers no appreciable change when heated to 100°, and, according to I. Guareschi, even when heated to its m.p., no bromine is given off; according to K. Arndt and A. Gessler, decomposition begins about 900°. The molten salt is slightly ionized. G. Schulze calculates the degree of ionization at 450° to be 2.34×10^{-4} , and **oxygen** likewise was found by M. Berthelot to have no action on hot silver bromide. A. P. H. Trivelli says that 30 per cent. **hydrogen peroxide** has no appreciable action on silver bromide alone, nor in the presence of colloidal silver. I. Guareschi found **chromic anhydride** gives off bromine and oxygen when heated with silver bromide, forming chromic oxide and silver; in some cases, chromyl bromide, CrO_2Br_2 , is formed: $2\text{AgBr} + \text{CrO}_3 = 2\text{Ag} + \text{O} + \text{CrO}_2\text{Br}_2$. With conc. soln. of chromic acid some silver chromate is formed. A. Potilitzin found it to be slowly reduced when heated in **hydrogen**. A. Seyewetz reduced molten silver bromide to spongy silver by hydrogen; and A. Jouniaux has studied the equilibrium conditions of the reaction $2\text{AgBr} + \text{H}_2 \rightleftharpoons 2\text{Ag} + 2\text{HBr}$.

D. Tommasi has proved that although nascent hydrogen from sodium amalgam does not reduce silver bromide, the reduction readily occurs with electrolytic hydrogen, and A. J. Balard found silver bromide to be readily reduced by zinc and sulphuric acid. J. S. Stas showed that grey or reddish-brown metallic silver is produced with white silver bromide, and white metallic silver with the yellow bromide. H. Vogel found that iron or zinc acts very slowly on dry silver bromide, more rapidly if moist, and more rapidly still in the presence of dil. acids. J. Seymour found silver bromide to be reduced by sodium hypophosphite (L. Cramer says not) or alkaline stannous chloride in light or when heated, but not by acid soln. of stannous chloride; ferrous sulphate in sunlight is without action.

H. Moissan found that the bromine in silver bromide is displaced by fluorine. P. Berthier also found that when suspended in water, silver bromide is completely converted by chlorine into silver chloride. According to J. J. Berzelius, silver bromide is transformed by chlorine into silver chloride more slowly than is the case with silver iodide. Iodine vapour also, according to P. Julius, converts silver bromide completely into the iodide. P. Hautefeuille found that dry hydrogen chloride converted silver bromide at 700° into the chloride: $\text{AgBr} + \text{HCl} = \text{AgCl} + \text{HBr}$, the analogous change which takes place in soln. is supposed by M. Berthelot to involve the intermediate formation of a bromohydrate. A. Potilitzin has investigated the action of soln. of the chlorides of the alkalis and alkaline earths on silver bromide whereby a partial interchange of the halogens occurs, and he obtained similar results with the alkali iodides. A. Senier precipitated silver bromide from its ammoniacal soln. by the addition of silver chloride. Aq. hypochlorous acid, said A. J. Balard, converts silver bromide into a mixture of silver chloride and bromate with the simultaneous evolution of chlorine and bromine. H. Baubigny found iodic acid acts on an ammoniacal soln. of silver bromide, forming silver iodide, ammonium iodide, iodine, ammonia, water, and nitrogen.

According to C. Sandonnini and G. Scarpa,¹⁹ lithium bromide gives a series of mixed crystals but no compound with silver bromide when mixtures of the two salts are thermally investigated. Similar results were obtained with sodium bromide. If silver bromide be dissolved in a hot sat. soln. of potassium bromide, and the soln. cooled, M. Berthelot found that crystals of potassium silver bromide, $3\text{KBr} \cdot \text{AgBr} \cdot \frac{1}{2}\text{H}_2\text{O}$, are formed, and he calculated the corresponding heat of formation. C. Sandonnini found the two salts are soluble in one another only when melted; and the f.p. curve shows a eutectic at 290° and 51 mol per cent. of silver chloride. He obtained neither a compound nor mixed crystals. He also found that the f.p. curve of mixtures of rubidium bromide and silver bromide exhibits a break at 265° with 55 mol per cent. of silver bromide, and at 228° with 68 mol per cent. there is a eutectic. The break corresponds with the formation of an unstable rubidium silver bromide—either $2\text{RbBr} \cdot \text{AgBr}$, or $\text{AgBr} \cdot \text{RbBr}$, which decomposes on melting.

According to A. J. Balard, boiling nitric acid has no influence on silver bromide. R. Auerbach found that when a silver bromide hydrosol is treated with aq. ammonia, coagulation and hydrolysis simultaneously occur. A. J. Balard found that boiling sulphuric acid decomposes silver bromide with the evolution of bromine. When fused with sodium carbonate, metallic silver and sodium bromide are formed; although at low temp. J. J. Berzelius noted that silver bromide can be melted in the presence of sodium carbonate without any appreciable change. According to L. Cramer, formaldehyde, gallic acid, or tannin in the presence of sodium carbonate; or citrate or tartrate of iron do not reduce the silver halides. M. A. Gordon calls the number of mols of silver which a mol of reducing agent or a developer separates, the silver equivalent of the reducing agent, e.g. the silver eq. of pyrogallol is 4.5.

REFERENCES.

- ¹ A. Breithaupt, *Pogg. Ann.*, 77, 134, 1849; P. Yorke, *Journ. Chem. Soc.*, 4, 149, 1852; F. Field, *ib.*, 10, 239, 1872; I. Domeyko, *Elementos de mineralogía*, Serena, 1845; C. F. Plattner, *Pogg. Ann.*, 77, 134, 1849; J. M. H. Munro, *Chem. News*, 53, 99, 1886; J. C. Welch, *ib.*, 54, 94,

162, 1886; G. T. Prior and L. J. Spencer, *Min. Mag.*, 13, 174, 1902; F. Cornu, *Centr. Min.*, 393, 1908.

³ H. Gautier and G. Charpy, *Compt. Rend.*, 113, 597, 1891; A. Jouniaux, *ib.*, 133, 228, 1901; H. Debray, *ib.*, 70, 995, 1870; M. Berthelot, *ib.*, 87, 619, 1878; *Ann. Chim. Phys.*, (5), 16, 433, 1878; A. J. Balard, *ib.*, (2), 57, 241, 1834; J. S. Stas, *ib.*, (5), 3, 145, 1874; *Mém. Acad. Belgique*, 35, 157, 1867; A. Potilitzin, *Ber.*, 13, 2044, 1881; 17, 1308, 1884; T. S. Humpidge, *ib.*, 17, 1838, 1884; C. F. Rammelsberg, *Pogg. Ann.*, 52, 94, 1851; P. Julius, *Zeit. anal. Chem.*, 22, 523, 1883; G. P. Baxter, *Proc. Amer. Acad.*, 42, 201, 1906; F. W. Küster, *Zeit. anorg. Chem.*, 19, 81, 1899; A. Thiel, *ib.*, 24, 1, 1900; W. Böttger, *Zeit. angew. Chem.*, 25, 1993, 1912; B. L. Vanzetti, *Atti Accad. Lincei*, (5), 16, ii, 696, 1907; L. Rolla, *ib.*, (5), 22, ii, 104, 1913; K. Jablonsky, *Zeit. phys. Chem.*, 82, 115, 1913; M. Górsky, *Zeit. anorg. Chem.*, 81, 315, 1913; C. Löwig, *Das Brom und seine chemischen Verhältnisse*, Heidelberg, 1829; V. von Cordier, *Monatsh.*, 21, 660, 1909.

⁵ E. Banks, *Phot. Journ.*, 22, 159, 1898; F. F. Renwick, *ib.*, 58, 195, 1918; F. W. T. Krohn, *ib.*, 58, 193, 1918; G. I. Higson, *ib.*, 60, 140, 1920; V. Bellach, *Die Struktur der photographischen Negative*, Halle a. S., 1903; L. Cramer, *Photographische Probleme*, Halle a. S., 1907; A. P. H. Trivelli and S. E. Sheppard, *The Silver Bromide Grain of Photographic Emulsions*, New York, 1921; E. Bauer in R. Abegg, *Handbuch der anorganischen Chemie*, Leipzig, 2, i, 684, 1903; J. V. Elsdon, *Phot. News*, 25, 174, 1881; P. P. Koch and V. du Prel, *Phys. Zeit.*, 17, 536, 1916; P. Groth, *Chemische Kristallographie*, Leipzig, 1, 200, 1906; A. Thiel, *Zeit. anorg. Chem.*, 24, 1, 1900; P. Debye and P. Scherrer, *Phys. Zeit.*, 17, 277, 1916; A. W. Hull, *Phys. Rev.*, (2), 10, 661, 1917; R. B. Wilsey, *Phil. Mag.*, (6), 42, 262, 1921; A. C. Becquerel, *Mém. Acad.*, 38, 141, 1873; *Compt. Rend.*, 44, 938, 1862; H. Debray, *ib.*, 42, 894, 1856; 70, 995, 1870; C. Löwig, *Das Brom und seine chemischen Verhältnisse*, Heidelberg, 1829.

⁴ G. F. Rodwell, *Phil. Trans.*, 173, 1125, 1882; F. W. Clarke, *Amer. Journ. Science*, (3), 13, 294, 1828; H. G. F. Schröder, *Pogg. Ann.*, 106, 226, 1859; G. Quincke, *ib.*, 138, 141, 1869; C. J. B. Karsten, *Schweigger's Journ.*, 65, 394, 1832; G. P. Baxter and M. A. Hines, *Journ. Amer. Chem. Soc.*, 28, 1560, 1906; P. Walden, *Zeit. anorg. Chem.*, 115, 241, 1920; F. A. Henglein, *ib.*, 120, 77, 1921.

⁵ T. W. Richards and G. Jones, *Journ. Amer. Chem. Soc.*, 31, 158, 1909; G. Jones, *ib.*, 31, 191, 1909; T. W. Richards and E. P. Bartlett, *ib.*, 37, 479, 1915; G. Quincke, *Pogg. Ann.*, 138, 141, 1869; J. E. Meyers and F. Braun, *Phil. Mag.*, (5), 44, 172, 1897; N. Kurnakoff and S. F. Schemtschuschny, *Zeit. anorg. Chem.*, 60, 1, 1908.

⁶ C. Sandonnini, *Atti Accad. Lincei*, (5), 21, ii, 197, 1912; *Gazz. Chim. Ital.*, 50, i, 289, 1920; C. Tubandt and E. Lorenz, *Nernst's Festschrift*, 453, 1912; K. Mönkemeyer, *Neues Jahrb. Min. B. B.*, 22, 28, 1906; T. Carnelley, *Journ. Chem. Soc.*, 29, 489, 1876; 33, 273, 1878; A. Potilitzin, *Journ. Russ. Phys. Chem. Soc.*, 24, 1, 1892; W. Ramsay and N. Eumorfopoulos, *Phil. Mag.*, (5), 41, 360, 1896; H. V. Regnault, *Ann. Chim. Phys.*, (3), 46, 278, 1858; O. Lehmann, *Zeit. Kryst.*, 10, 324, 1885; N. Kurnakoff and S. F. Schemtschuschny, *Zeit. anorg. Chem.*, 60, 1, 1908; J. H. van't Hoff, *Études de dynamique chimique*, Amsterdam, 208, 1884; G. F. Rodwell, *Phil. Trans.*, 173, 1125, 1882; *Proc. Roy. Soc.*, 25, 280, 1876; 31, 291, 1881; H. Fizeau, *Compt. Rend.*, 64, 314, 1867; H. Stolzenberg and M. E. Huth, *Zeit. phys. Chem.*, 71, 641, 1910.

⁷ M. Berthelot, *Ann. Chim. Phys.*, (5), 16, 433, 1878; (5), 29, 241, 271, 1883; *Compt. Rend.*, 94, 817, 1883; 87, 619, 1878; M. de K. Thompson, *Journ. Amer. Chem. Soc.*, 28, 731, 1906; J. Thomsen, *Thermochemische Untersuchungen*, Leipzig, 3, 381, 1884.

⁸ W. Kohlrausch, *Wied. Ann.*, 17, 642, 1882; L. Graetz, *ib.*, 29, 314, 1886; J. E. Meyer and F. Braun, *Phil. Mag.*, (5), 44, 172, 1897; S. Arrhenius, *Sitzber. Akad. Wien*, 96, 831, 1888; K. Arndt and A. Gessler, *Zeit. Elektrochem.*, 14, 663, 1908; C. Tubandt and E. Lorenz, *Nernst's Festschrift*, 446, 453, 1912; P. Dutoit and G. von Wiese, *Journ. Chem. Phys.*, 9, 630, 1911; M. Katayama, *Zeit. phys. Chem.*, 61, 566, 1908; R. Lorenz and M. Katayama, *ib.*, 62, 119, 1908; C. Sandonnini, *Atti Accad. Lincei*, (5), 24, i, 616, 1915; *Gazz. Chim. Ital.*, 50, i, 289, 1920; J. C. Ghosh, *Journ. Chem. Soc.*, 117, 823, 1920; C. Tubandt, *Zeit. anorg. Chem.*, 115, 105, 1921.

⁹ J. A. Wilkinson, *Journ. Phys. Chem.*, 13, 723, 1909; W. Wernicke, *Pogg. Ann.*, 155, 87, 1875.

¹⁰ S. Meyer, *Wied. Ann.*, 68, 325, 1899; 69, 236, 1899; *Ann. Physik*, (4), 1, 664, 1900; T. Ishiura, *Rep. Science Tohoku Imp. Univ.*, 9, 233, 1920.

¹¹ W. Böttger, *Zeit. phys. Chem.*, 46, 602, 1903; A. H. Holleman, *ib.*, 12, 132, 1893; F. Kohlrausch, *ib.*, 50, 355, 1905; 64, 129, 1908; F. Kohlrausch and F. Rose, *Wied. Ann.*, 50, 127, 1893; F. Kohlrausch and F. Dolezalek, *Sitzber. Akad. Berlin*, 1018, 1901; C. Löwig, *Das Brom und seine chemischen Verhältnisse*, Heidelberg, 1829; A. E. Hill, *Journ. Amer. Chem. Soc.*, 30, 68, 1908; W. R. Whitney and A. C. Melcher, *ib.*, 15, 69, 1903; M. Prud'homme, *Journ. Phys. Chem.*, 9, 519, 1911; J. S. Stas, *Ann. Chim. Phys.*, (5), 3, 145, 1874; M. Berthelot, *ib.*, (5), 23, 94, 1881; *Bull. Soc. Chim.*, (2), 36, 13, 1882; L. Rolla, *Atti Accad. Lincei*, (5), 22, ii, 1913; I. M. Kolthoff, *Zeit. anorg. Chem.*, 119, 202, 1921.

¹² F. Field, *Chem. News*, 3, 17, 1861; T. W. Richards and H. B. Faber, *Amer. Chem. Journ.*, 21, 167, 1899; E. Valenta, *Monatsh.*, 15, 249, 1894; H. Risse, *Liebig's Ann.*, 111, 39, 1859; P. Kremers, *Pogg. Ann.*, 92, 497, 1854; A. and L. Lumière and A. Seyewetz, *Rev. Gen. Chim. Pure App.*, 11, 300, 1908; K. Hellwig, *Zeit. anorg. Chem.*, 25, 157, 1900; H. W. F. Wackenroder, *Liebig's Ann.*, 41, 317, 1842; I. Kablukoff, *Journ. Russian Phys. Chem. Soc.*, 39, 914, 1907; *Zeit. phys. Chem.*, 65, 121, 1909; G. Scarpa, *Atti Accad. Lincei*, (5), 32, ii, 452, 1913; A. Rosenheim and S. Steinhäuser, *Zeit. anorg. Chem.*, 25, 103, 1900.

- ¹⁰ E. C. Franklin and C. A. Kraus, *Amer. Chem. Journ.*, 20, 829, 1898; J. J. Pohl, *Sitzber. Akad. Wien.*, 41, 627, 1860; A. Senier, *Pharm. Journ.*, (3), 14, 1, 1883; A. Longi, *Gazz. Chim. Ital.*, 13, 87, 1883; G. C. Wittstein, *Repert. Pharm.*, 63, 220, 1838; G. Bodländer and R. Fittig, *Zeit. phys. Chem.*, 39, 597, 1902; G. Bodländer, *ib.*, 9, 730, 1892; P. Berthier, *Ann. Chim. Phys.*, (1), 77, 417, 1811; C. F. Rammelsberg, *Pogg. Ann.*, 55, 248, 1842; J. von Liebig, *Schweigger's Journ.*, 48, 108, 1826; R. Jarry, *Recherches sur la dissociation de divers composés ammoniaux au contact de l'eau*, Paris, 1899; *Compt. Rend.*, 126, 1138, 1898; A. Joannis and M. Croizier, *ib.*, 118, 1149, 1894; A. Terrell, *ib.*, 98, 1279, 1884; W. Peters, *Zeit. anorg. Chem.*, 77, 153, 1912; W. Biltz and W. Stollenwerk, *ib.*, 114, 174, 1920; W. Biltz, *Zeit. phys. Chem.*, 67, 561, 1909; G. Wiegner, *Zeit. Elektrochem.*, 11, 590, 1905; J. V. Eلسden, *Phot. News*, 25, 174, 1881.
- ¹⁴ H. Euler, *Ber.*, 36, 2878, 1903; B. Wuth, *ib.*, 35, 2415, 1902; J. Neustadt, *Zeit. Elektrochem.*, 16, 868, 1810; F. Bezold, *Das Verhalten chemischer Verbindungen in Methylacetat*, Mainz, 1906; M. Hamers, *Verhalten der Halogenverbindungen des Quecksilbers in reinem und in bei 18° mit Wasser gesättigtem Aethylacetat*, Giessen, 1906.
- ¹⁵ H. W. Vogel, *Phot. Mitt.*, 36, 344, 1899; K. Emszt, *Zeit. anorg. Chem.*, 28, 346, 1901; J. Waterhouse, *Phot. Journ.*, 24, 156, 1900; L. Cramer, *Zeit. Koll.*, 2, 103, 1907; 8, 97, 1911; A. P. H. Trivelli, *Zeit. Wiss. Phot.*, 6, 273, 1908; *Chem. Weekb.*, 7, 525, 1909; 7, 350, 1910.
- ¹⁶ B. Homolka, *Phot. Corresp.*, 227, 1903; W. D. Bancroft, *Journ. Phys. Chem.*, 13, 554, 1909; L. Bruner and E. Bekier, *Zeit. Elektrochem.*, 18, 372, 1912; W. Ehlers and P. P. Koch, *Zeit. Physik*, 3, 169, 1920.
- ¹⁷ E. Demole, *Compt. Rend.*, 144, 565, 1907; A. and L. Lumière and A. Seyewetz, *ib.*, 151, 618, 1910; A. Seyewetz, *ib.*, 154, 355, 1912; *Bull. Soc. Chim.*, (4), 11, 450, 1912.
- ¹⁸ J. S. Stas, *Mém. Acad. Belgique*, 35, 157, 1867; *Ann. Chim. Phys.*, (5), 3, 145, 1874; A. Potilitzin, *Journ. Russian Phys. Chem. Soc.*, 13, 1, 183, 289, 415, 1881; *Ber.*, 12, 695, 1879; 13, 2044, 1880; 16, 3051, 1883; D. Tommasi, *Bull. Soc. Chim.*, (2), 38, 148, 1882; M. Berthelot, *ib.*, (2), 36, 13, 1881; P. Hautefeuille, *ib.*, (2), 7, 203, 1867; A. Scyewetz, *ib.*, (4), 11, 452, 1912; A. Jouniaux, *Journ. Chim. Phys.*, 1, 609, 1904; *Compt. Rend.*, 129, 883, 1899; 132, 1270, 1558, 1901; H. Baubigny, *ib.*, 146, 1097, 1908; M. Berthelot, *ib.*, 86, 628, 787, 859, 920, 1878; 87, 575, 667, 1878; 92, 488, 1881; *Ann. Chim. Phys.*, (5), 15, 185, 1878; (5), 16, 442, 1879; A. J. Balard, *ib.*, (2), 57, 225, 1834; M. Berthelot, *ib.*, (5), 23, 102, 1881; P. Berthier, *ib.*, (1), 77, 417, 1811; L. Cramer, *Zeit. Chem. Ind. Koll.*, 2, 360, 1908; M. A. Gordon, *Journ. Phys. Chem.*, 17, 47, 1913; A. P. H. Trivelli, *Chem. Weekb.*, 6, 525, 1909; 7, 351, 1910; J. J. Berzelius, *Pogg. Ann.*, 14, 565, 1828; H. Vogel, *ib.*, 117, 321, 1862; I. Guareschi, *Atti Accad. Torino*, 48, 735, 1913; A. Senier, *Pharm. Journ.*, (3), 14, 1, 1883; P. Julius, *Zeit. anal. Chem.*, 22, 523, 1883; J. Seymour, *Pharm. Rend.*, 264, 1894; G. Schulze, *Zeit. Elektrochem.*, 19, 122, 1913; K. Arndt and A. Gessler, *ib.*, 14, 663, 1908; R. Auerbach, *Koll. Zeit.*, 28, 124, 1921.
- ¹⁹ C. Sandonnini and G. Scarpa, *Atti Accad. Lincei*, (5), 22, ii, 517, 1913; C. Sandonnini, *ib.*, (5), 21, ii, 197, 1912; M. Berthelot, *Ann. Chim. Phys.*, (5), 29, 271, 1883; *Compt. Rend.*, 94, 912, 1883.

§ 17. Silver Iodide

Silver iodide occurs in Chili, Peru, Mexico, and Spain, as the mineral *iodite*, *iodargyrite*, or *iodyrite*, in hexagonal crystals, and also massive with a colour varying from citron or sulphur-yellow to a yellowish-green or brown. When the crystals are cubic, the mineral is called *miersite*. All three haloids occur in the mineral *iodobromite* reported by A. von Lasaulx¹ in cavities in the ferruginous quartzites of Dernbach (Nassau). In the *cuproiodargyrite* of Huantajava about half the silver is replaced by copper.

The preparation of silver iodide.—Silver iodide is formed when iodine vapour is passed over heated silver, and J. H. Kastle obtained a quantitative yield by warming iodine with finely-divided silver on a water-bath. Aq. hydriodic acid acts on silver in the cold; and, as H. St. C. Deville,² A. Potilitzin, and H. Danneel have shown, hydrogen is evolved until the liquid is sat. with silver iodide. When the mixture is warmed, more hydrogen is evolved, and, on cooling the soln., large colourless plates separate out. These crystals are probably a hydro-iodide since, on exposure to air, they decompose, giving off hydrogen iodide. A mixture of hydrochloric and hydriodic acids forms only the iodide. According to H. St. C. Deville, aq. soln. of potassium iodide gradually convert metallic silver into the iodide, and the soln. at the same time becomes alkaline; if the soln. of potassium iodide is very conc., the silver iodide dissolves as fast as it is formed. If air be excluded, these reactions do not occur; the same remark applies to the formation of silver iodide by the action of molten

potassium iodide on the metal. I. Kablukoff made silver iodide by melting together silver nitrate and potassium iodide, a reaction whose thermal value is 24.41 Cals. A. Vogel partly converted silver chloride or bromide into silver iodide by triturating a mixture of say silver chloride and powdered iodine, and subsequently washing out the excess of iodine with alcohol. F. Julius also found silver chloride or bromide is completely converted to the iodide by heating it in a stream of iodine vapour. C. W. B. Normand and A. C. Cumming made it by the action of iodine on a number of silver salts—sulphite, acetylide, cyanide, cyanate, and thiocyanate. H. St. C. Deville also converted silver chloride, bromide, or other insoluble salts into the iodide by digestion with a conc. soln. of alkali iodide; with conc. hydriodic acid and silver chloride, $\text{AgCl} + \text{HI} = \text{AgI} + \text{HCl}$. F. Field obtained fine crystals of silver iodide by boiling mercuric iodide with an excess of silver nitrate, and cooling the soln. L. Rolla places the visibility of the precipitate with potassium or sodium iodide and silver nitrate between 0.8×10^{-8} and 1×10^{-8} normality, and, according to W. Böttger, a turbidity is produced when 0.34×10^{-6} mol of silver iodide is present per litre. G. P. Baxter prepared pure silver iodide by precipitation from an ammoniacal soln. of silver nitrate with a soln. of ammonium iodide. The process is quite analogous to that employed for silver bromide (*q.v.*). The precipitate clots more rapidly in the ammoniacal soln. than in an acid soln. Precipitated silver iodide has a marked tendency to pass into the colloidal state when washed with water. J. S. Stas found that if the water be previously heated to 60°, and the precipitate allowed to settle at that temp., the tendency is lessened, but the precipitate is then inclined to adhere tenaciously to the walls of the precipitation vessel. G. P. Baxter recommends washing the precipitate with 1 per cent. nitric acid, when there is no tendency to pass into the colloidal state; but if the nitric acid be expelled by drying at a high temp., some silver iodide is decomposed by the acid, and the iodide acquires a dark colour.

The properties of silver iodide.—H. Hauschild,³ and G. Tammann studied the colour of thin films of silver iodide. While the crystals of silver chloride and bromide belong to the cubic system, silver iodide crystallizes in the hexagonal system, forming, according to V. von Zepharovich, dihexagonal pyramids with axial ratios $a : c = 1 : 0.8196$, although, according to F. Wallerant, these crystals belong to the cubic system, they imitate very closely the hexagonal crystals by the peculiar method of twinning. H. St. C. Deville, and H. Debray studied the crystallization of silver iodide. The X-radiogram has been investigated by P. Debye and P. Scherrer, A. W. Hull, and R. B. Wilsey. The lattice has the tetrahedral arrangement, with sides 6.53 Å., and the distance between nearest atomic centres 2.83 Å.

V. von Zepharovich noted that silver iodide changes from a yellow to an orange colour at about 138°, and O. Lehmann said that in the vicinity of this temp. this salt changes its crystalline form which passes from the hexagonal to the cubic system. G. F. Rodwell found that this change is attended by a contraction in volume, and hence it follows that the transition temp. should be depressed with increasing press. E. Mallard and H. le Chatelier examined the lowering of the transition point by raising the press. They found that at 20°, under 2500 atm. press., a variety of silver iodide with a mol. vol. 16 per cent. smaller than that of the hexagonal form, hence a denser variety must be formed with a sp. gr. approximately 6.8, and a mol. vol. 35. This denser variety is probably that which should be compared with the ordinary chloride and bromide. The subject was further investigated by G. Tammann, and P. W. Bridgman. Temp. ranging from 138° to 150° have been published for the transition point by W. Kohlrausch, G. F. Rodwell, M. Bellati and R. Romanese, W. Schwarz, etc. The best representative value is 147°. A. Steger found the transition point could be lowered from 147° to 135° by admixture with mercuric iodide. G. Tammann found with a press. of 340 kilograms per sq. cm. the transition point was lowered to 138.8°; and with 2948 kilograms, to 100.31°—curve *AB*, Fig. 15. It was also found that there are really three stable modifications: the yellow hexagonal form which is

identical with the so-called amorphous precipitate, and which G. Tammann calls form I, and K. Mönkemeyer, β -AgI; the red cubic modification, form II, or α -AgI; and a third variety stable above 2940 kilograms press.—form III—whose crystalline form is unknown. The volume decreases in passing from forms I to II to III. At the triple point— 99.4° , and 2810 kilograms per sq. cm. press.—the change of II to I is attended by a change in the sp. vol. of 0.01010 c.c. per gram; from II to III, 0.01402 c.c.; and I to III, 0.02412 c.c.; so that the high temp. forms II and III have the smaller volumes. This is not usual, although ice presents a parallel case. The values of dT/dp at the triple point are II to I, -0.01787 ; II to III, -0.0290 ; and I to III, -0.276 . The equilibrium press. and temp. are indicated in Fig. 15,

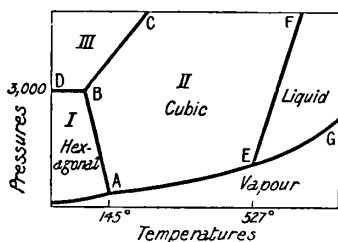

FIG. 15.—Equilibrium Diagram of Silver Iodide.

which represents the relation between the solid, liquid, and vapour, and is based on one by H. W. B. Roozeboom. The high temp. from II is cubic, and isomorphous with cubic silver chloride and bromide; it might, therefore, be anticipated that at low temp. silver bromide and chloride would undergo transformations, forming substances isomorphous with the low temp. form I of silver iodide. No such change has been observed. Similarly, at high press. and room temp., modifications of silver chloride and bromide analogous to form III of silver iodide might be expected; but none such has been yet observed. A. Thiel showed that the change in the potential of mixtures of silver bromide and iodide corresponds with the formation of solid soln. containing up to 30 molar per cent. of silver bromide. According to A. P. H. Trivelli and S. E. Sheppard, the mixed crystals of silver iodide and bromide are polarized between crossed nicols; and this effect is due to reflection as well as to mechanical strains in the crystals.

H. Stolzenberg and M. E. Huth say that hexagonal greenish-yellow silver iodide at 134° forms liquid crystals which are yellowish-red and isotropic, and which form an amorphous blood-red liquid at about 500° . C. Tubandt and E. Lorenz found no evidence of this in the change of the electrical conductivity of silver iodide with temp. The properties of the ordinary forms of silver chloride, bromide, and iodide are:

	AgCl	AgBr	AgI
Sp. gr.	5.45	6.40	5.674
Mol. vol.	25.79	29.01	24.40
Sp. compressibility $\times 10^6$ at 20°	2.2	2.6	3.9
Heat formation	39.2	23.7	13.8 Cals.
Sp. ht.	0.0911	0.0739	0.0616

The reported values for the **specific gravity** of silver iodide⁴ range from C. J. B. Karsten's 5.026 to H. St. C. Deville's 5.687, at 0° ; G. P. Baxter gives for the fused salt 5.674, at 25° (water 4°). A. Damour gives 5.669 (14°) for the crystallized salt, and 5.596 (14°) for the amorphous pressed variety. G. F. Rodwell says the density is a maximum at 142° . G. F. Rodwell gives the sp. gr. of the fused salt as 5.681 (0°), 5.771 (163°), and of the molten salt, 5.522 (527°). The sp. gr. of the mineral iodyrite ranges from 5.365 of J. L. Smith to 5.707 of A. Damour, P. Walden, and F. A. Henglein studied the mol. vol. During the formation of silver iodide from its elements there is an increase of nearly 15 per cent. in volume:

	Silver.	Iodine.	Silver Iodide.
Sp. gr.	10.49	4.993	5.674
Mol. vol.	10.28	25.73	41.38

indicating an increase of $41.38 - (10.28 + 25.73) = 5.37$ c.c. Most salts show a

decrease in volume during their formation. P. Walden studied the mol. vol. T. W. Richards and G. Jones' value for the compressibility of silver iodide at 20° between 100 and 500 megabars press. is 0.00000385 kilogram per sq. cm., 0.00000393 megabar, or 0.00000398 atm. per sq. cm. The press. required to make fused silver iodide flow through a small opening is, according to N. Kurnakoff and S. F. Schemtschuschny, 26.3 kilograms per sq. mm.

Silver iodide is an example of the very rare phenomenon of a substance contracting on a rising temp. The relation between the volume and temp. is illustrated in Fig. 16. H. Fizeau established this fact for three different varieties of this salt—precipitated, crystalline, and fused.

The other substances known to decrease in size with rise of temp. are water between 0° and 4°; liquid bismuth about 8° above its m.p. (C. Lüdeking); fused quartz below -80° (H. G. Dorsey and K. Scheel); silica between 575° and 870° (H. le Chatelier); a nickel steel (C. E. Guillaume); diamond below -42.3° (H. Fizeau); and copper oxide below -4.3° (H. Fizeau). Calcite and beryl were also shown by H. Fizeau to have a negative coeff. of expansion in the direction vertical to their principal axes, but positive in directions vertical to the chief axes, but the cubical expansion coeff. are positive.

H. Fizeau found the linear coefficient of expansion of large crystals at 40° to be -0.000003966 along the chief axis, and +0.00000647 vertical to that axis; or the average volume contraction is 0.000002307 c.c., and for the precipitated or amorphous salt, the linear coeff. of expansion is -0.00000137 at 40°, and the cubical expansion coeff. is therefore negative, being -0.00000414. H. Fizeau, and G. F. Rodwell both showed that the coeff. of expansion of silver iodide increases rapidly with rise of temp. The average coeff., according to G. F. Rodwell, is -0.00000718 between -18° and 0°; -0.00003297, between 0° and 21°; -0.00005570, between 21° and 67°; and -0.00000335, between 70° and 150°; while the mean expansion of form II between 150° and 450° is about 0.000005. G. Jones explains the phenomenon by assuming that the change in volume which occurs when a solid is heated is due (i) to a small increase in the intra-molecular free space; (ii) an increase in the volume of the molecules due to a decrease in cohesion; and (iii) a change in the volume of the atoms due to a change in the attractive force between the molecules. In the case of silver iodide, it is assumed that the attractive force increases with a rise of temp., and thereby produces an increased compression of the atoms great enough to outweigh the effects of the other two influences. The free energy F of formation of a compound is taken as an indication of the magnitude of this attractive force, and in accord with the relation $F - Q = TdF/dT$, where Q is the heat of formation in kilojoules, G. Jones finds

	F	Q	dF/dT	Coeff. Cub. expansion.
AgCl	111.8	114	-0.006	+0.0000988
AgBr	96.6	95	+0.005	+0.0001041
AgI	66.3	58	+0.028	-0.0000041

The marked increase in the free energy with rise of temp. is taken to support the hypothesis in question. W. Barlow and W. J. Pope explain the dimorphism by assuming the existence of alternate methods of close packing structural units which are dimensionally identical at the transition temp. They said:

It is evident that a passage from the ideal condition in which the spheres are all equal to one in which the two kinds of spheres show a minute difference in size, instead of producing a lowering of the symmetry, may merely cause a diminution in the number of equal press., some of those which in the ideal assemblage are equal becoming a little greater

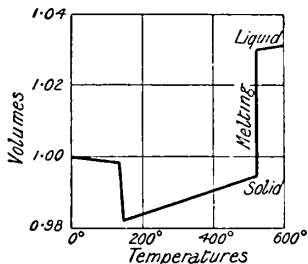

FIG. 16.—Relation between the Temperature and Volume of Silver Iodide.—(G. F. Rodwell.)

and the others a little smaller. Thus, considering a layer in which one-third of the spheres are a trifle smaller than the rest, the press. between the larger spheres would be slightly increased, and that between spheres of different sizes would be slightly diminished. And whilst an increase in size of both kinds of spheres will tend to expand the whole mass, if the increase proceeds at different rates for the two and in such a manner that the two kinds of spheres become more nearly equal, the closer approximation to equality of size will lead to a closer approximation to the closest-packed ideal assemblage, and will thus tend towards contraction of the mass as a whole. A very small increase of size of one kind of sphere and a much larger decrease of that of the other accompanying a rise of temp., can consequently lead to the observed negative coeff. of cubic thermal expansion of hexagonal silver iodide if the structure more nearly approaches the ideal closest-packed arrangement of equal spheres as the temp. rises. This kind of explanation is in harmony with the observation quoted above, namely, that the coeff. of linear expansion is large and negative in the direction of the principal axis and small and positive in directions perpendicular thereto.

Silver iodide melts at a dull red heat to a yellow, red, or reddish-brown fluid whose colour is determined by the temp.; and on cooling, it freezes to a dirty yellow, translucent solid. The melting point given by different investigators⁵ ranges from A. Steger's 526° to W. Ramsay and N. Eumorfopoulos' 556°. The best representative may be taken as 552°. According to O. Lehmann, and H. Stolzenberg and M. E. Huth, silver iodide, bromide, and chloride form anisotropic liquids or liquid crystals during their solidification. On the other hand, C. Tubandt and E. Lorenz showed that well-purified silver iodide is harder 2° below its m.p. than is yellow phosphorus at ordinary temp. If a little of another silver halide be present, ordinary silver iodide becomes much more plastic. Similar results were obtained with thallium halides and the other silver halides. Hence, these substances must be deleted from the list of substances furnishing liquid crystals. K. Mönkemeyer has studied the f.p. curves of mixtures of silver iodide with silver bromide and chloride. With the bromide, there is a U-shaped curve falling to a minimum at 377° with 25 gram-mol. per cent. of silver iodide; the transformation point of silver iodide is also lowered by additions of the other halide. For instance, with about 35 gram-mol. per cent. of silver bromide it

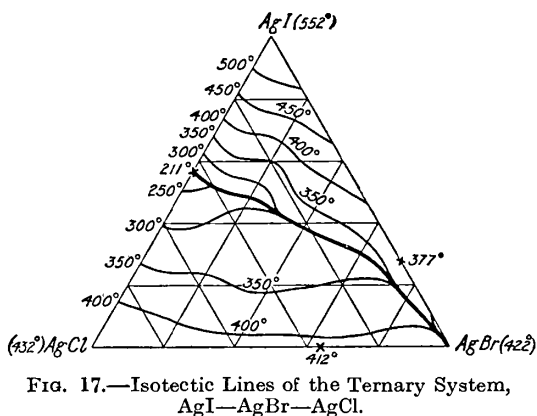

FIG. 17.—Isotectic Lines of the Ternary System, AgI—AgBr—AgCl.

are indicated in Fig. 17, showing the isotectic lines.

A. Vogel found silver iodide to be volatile at a white heat in closed vessels, and C. Antoine has measured the vapour pressure of silver iodide at different temp. J. Dewar and A. Scott measured the vapour density and obtained values in agreement with the molecule Ag_2I_2 . H. V. Regnault's value for the specific heat is $C_p = 0.0616$ between 15° and 98°; M. Bellati and R. Romanese's value for the I-variety is 0.0573 (14°–142°); and for the II-variety, 0.0577 (136°–264°). F. Koref found the sp. ht. from -191.1° to -81.6° to be 0.0488; and from -77.4° to 0° , 0.0532; A. Magnus' value of the mol. heat from 17° to 507° is 6.460 ± 0.003 ;

falls to 80°, and with 11 gram-mol. per cent. of silver chloride to 115°. The U-shaped curve with silver chloride and iodide has its minimum at 211° with about 57 gram-mols. per cent. of silver iodide. M. McLans, and V. Auger prepared what they regarded as silver fluo-iodide, $\text{AgI} \cdot \text{AgF}$, by the action of iodoform on silver fluoride, but there is nothing to show the chemical individuality of the alleged compound. The ternary system: AgI—AgBr—AgCl, has been studied by K. Mönkemeyer, and the results

W. Nernst and F. Schwers gave 3·287 at $-255\cdot2^\circ$, and 11·355 at $-156\cdot5^\circ$; while W. Nernst's values for the mol. heat are :

	-244°	-243°	$-242\cdot4^\circ$	$-197\cdot5^\circ$	$-193\cdot2^\circ$
Mol. heat	5·51	5·08	5·95	9·70	10·17

The mol. ht. of silver iodide is greater than the sum of the thermal capacities of the constituent atoms. This is unusual, but is related with the other anomalous properties of this salt.

M. Berthelot's ⁶ value for the **heat of formation** of silver iodide from its elements—iodide solid—is 13·8 Cals., according to J. Thomsen, or, according to M. Berthelot, $\text{Ag} + \text{I} = \text{AgI}_{\text{cryst.}} + 14\cdot3$ Cals.; $\text{Ag} + \text{I} = \text{AgI}_{\text{amorphous}} + 7\cdot7$ to 14·3 Cals. U. Fischer considers M. Berthelot's value is too small, and gives 15·169 Cals. at 15° . G. Jones and M. L. Hartmann give the **free energy** of formation of silver iodide from silver and solid iodine as 65·1 kilojoules at 0° , and 66·1 kilojoules at 25° ; or 26·300 Cals., and the total energy 14·570 Cals. According to F. Gerth, the difference between U. Fischer's and G. Jones and M. L. Hartmann's results is due to the difference in the silver electrodes used in measuring the e.m.f., and to the applied corrections. F. Gerth obtained 15·158 Cals.; and H. Braune and F. Koref, and H. S. Taylor and W. T. Anderson, 15·100. J. Thomsen's value for the heat of precipitation is 26·6 Cals.

The **electrical conductivity** of silver iodide has been measured by W. Kohlrausch,⁷ C. Tubandt and co-workers, K. Arndt and A. Gessler, etc. There is a marked change at the transition point: $\text{I-AgI} \rightleftharpoons \text{II-AgI}$, but not so marked a change at the m.p. Thus, the conductivities in reciprocal ohms at different temp. are :

	$142\cdot4^\circ$	145°	$146\cdot5^\circ$	150°	300°	547°	552°	554°	650°
Rec. ohms	0·000333	\longleftrightarrow	7·308	1·33	1·97	2·638	melts	2·362	2·47

C. Tubandt and S. Eggert found the maximum sp. conductivity of the hexagonal form stable below $144\cdot6^\circ$ to be 0·00034; while the cubic form, at the transition point, has the greater value 1·31, rising to 2·64 near the m.p. They also investigated the electrolysis of the fused salt. The conductivity with form II and with the molten salt is thought to be electrolytic. The increase in the conductivity in the formation of the II-form is explained by the considerable contraction which silver iodide suffers during the freezing of the molten salt; this raises the molecular concentration, while the ionization and ionic mobilities remain unchanged. Within a range of about 125° , the II-form conducts better than the melted salt, and the molten salt does not reach the maximum value which the II-form reaches at about 800° when the salt begins to dissociate. This phenomenon is unique with silver iodide. C. Tubandt found that the current is carried wholly by the silver ion whose velocity, at 145° , is about $0\cdot55 \times 10^{-3}$ cm. per sec., and at 552° , $1\cdot1 \times 10^{-3}$. With aq. soln., the ionic velocity at 18° is nearly 0·55 cm. per sec. C. Tubandt and F. Lorenz have measured the electrical conductivities of binary mixtures of silver chloride, bromide, and iodide. According to K. Bödeker, the conductivity is raised if the salt be exposed to iodine vapour. L. Graetz has studied the effect of press. on the conductivity of silver iodide.

H. Scholl and B. A. Dima the **photoelectric effect** of this salt—*vide* silver chloride. W. Wilson found the conductivity of silver iodide to be greater when illuminated. P. Dutoit and G. von Wiese found the potential towards $\frac{1}{10}N\text{-AgNO}_3$, at 25° , to be 0·701 volt. S. Iimori and T. Takebe have described photochemical cells with silver iodide electrodes. R. B. Archey discussed the sensitiveness of silver iodide to red light.

L. Wernicke gives for the **index of refraction** for $\lambda=431$, $\mu=2\cdot409$; $\lambda=486$, $\mu=2\cdot267$; and for $\lambda=656$, $\mu=2\cdot1531$. A. Kundt's value for white light is 2·31; and A. des Cloizeaux's ⁸ for yellow light, 2·23. According to C. Schell, the **absorption spectrum** shows maxima at $0\cdot4226\mu$, $0\cdot3222\mu$, and $0\cdot2712\mu$. J. A. Wilkinson

reports a bluish-violet fluorescence. S. Meyer found the magnetic susceptibility to be -0.29×10^{-6} mass units at 19° .

The solubility of silver iodide in water is very small, and the published results are not concordant. H. Danneel⁹ gives 0.00000133 grm. per litre at 13° ; F. Kohlrausch and E. Dolczalek, 0.00000353 grm. per litre at 20.8° ; H. M. Goodwin, 0.0000023 grm. per litre at 25° ; and A. Thiel, 0.0000025 grm. per litre at 25° . A. E. Hill gives the solubility as 0.97 to 1.05×10^{-8} mols per litre at 25° ; the corresponding value for silver bromide is $6.6-8.1 \times 10^{-7}$; and for silver chloride, $1.25-1.64 \times 10^{-5}$. If ϵ_1 and ϵ_2 be respectively the electrolytic potentials of iodine (0.540 volt) and of silver (0.784 volt), C the solubility of silver iodide, and F the free energy of the formation of silver iodide, then, according to G. Bodländer, for a binary salt from univalent ions $F = \epsilon_1 - \epsilon_2 - 2RT \log C$, and if in the first approximation the heat of formation be used in place of the free energy of formation, $Q = 23100(\epsilon_1 - \epsilon_2 - 2RT \log C)$, or $C = 6 \times 10^{-8}$ mols per litre at room temp. This is in agreement with the observed values.

H. St. C. Deville¹⁰ noted that silver iodide dissolves copiously in *hydriodic acid*, and, when the soln. is allowed to stand in air, crystals of *silver hydroiodide*, which M. Berthelot regards as $3AgI.HI.7H_2O$, are formed: $3AgI + HI_{gas} + 7H_2O_{liq.} = 21.6$ Cals. The mother liquid still contains some hydroiodide. The crystals become yellow on exposure to air and light; when heated, they decompose, forming silver iodide; they are decomposed by water into hydriodic acid, and silver iodide is precipitated. In his memoir, *Sur les iodures doubles*, P. A. Boullay showed that silver iodide dissolves readily in soln. of *potassium or sodium iodides*, forming double salts. F. Field noticed that silver iodide is but slightly soluble in soln. of the *alkali chlorides*. The solubility of the silver halides in the alkali halides is considered to be due to the formation of complexes. This tendency to form complexes increases in passing from the chloride to the iodide, and with the electropositive character of the alkali metal. K. Hellwig gives the solubility of silver iodide in soln. of potassium iodide when the conc. are expressed in mols per litre:

KI	0.33	0.586	1.008	1.018	1.406	1.482	1.6304	1.937
AgI	0.000363	0.00218	0.0141	0.0148	0.0535	0.0658	0.102	0.198

According to G. Bodländer and W. Eberlein, dil. soln. hold a complex with $2Ag$, possibly $K_2Ag_2I_4$, $K_3Ag_2I_5$, $K_4Ag_2I_6$, or $K_6Ag_2I_7$; and in conc. soln. of potassium iodide the complex has only one Ag—

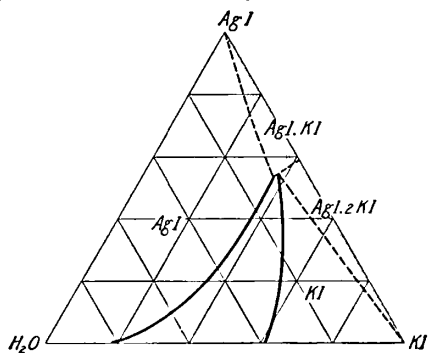

FIG. 18.—Equilibrium Curves in the Ternary System, AgI—KI—H₂O at 50°

$KAgI_2$, separate out; and, if the soln. is only partially sat. with silver iodide, colourless rhombic needle-like crystals of *potassium diargento-iodide*, KI_2AgI , or KAg_2I_3 , have been obtained by P. A. Boullay. H. L. Wells and H. L. Wheeler find the axial ratios of $2KI.AgI$ to be $a : b : c = 0.977 : 1 : 0.234$. J. E. Marsh and W. C. Rhymes also made the double salts, KI_3AgI and $KI.AgI$, by the cooling of acetone soln. of the component salts in mol. proportions. They also made KI_2AgI ;

the rubidium argento-iodides, $\text{RbI}\cdot 3\text{AgI}$; $\text{RbI}\cdot 2\text{AgI}$, and $\text{Rb}\cdot \text{Ag}_2\text{I}_3\cdot 2\text{C}_3\text{H}_6\text{O}$; $\text{RbI}\cdot \text{AgI}$; $\text{RbI}\cdot \text{AgI}_2\cdot \frac{1}{2}\text{H}_2\text{O}$; $2\text{RbI}\cdot \text{AgI}$; the cæsium argento-iodides, $\text{CsI}\cdot 2\text{AgI}$; $\text{CsI}\cdot \text{AgI}_2$; and the lithium argento-iodide, $\text{LiI}\cdot 2\text{AgI}$. J. E. Marsh reported $\text{LiI}\cdot \text{AgI}\cdot 3(\text{C}_2\text{H}_5)_2\text{O}$; but C. Sandonnini and G. Scarpa obtained only mixed crystals in their thermal study of mixtures of lithium and silver iodides. J. E. Marsh and W. C. Rhymes prepared crystals of sodium diargento-iodide, NaAg_2I_3 , and of sodium argento-iodide, NaAgI_2 , from acetone soln. of the component salts; and W. Krym obtained crystals of $\text{NaI}\cdot \text{AgI}\cdot 3\cdot 5\text{H}_2\text{O}$, as solid phase in soln. with the following proportions of the component salts in mols per 1000 mols of water:

$(\text{NaI})_2$.	.	35·63	94·25	107·25	117·96	134·40	135·83	133·81	117·11
$(\text{AgI})_2$.	.	8·14	47·79	57·52	51·70	46·82	46·36	43·03	11·93
			AgI		↔	$\text{AgI}\cdot \text{NaI}_3\cdot 5\text{H}_2\text{O}$		↔	NaI	

Neither N. S. Kurnakoff and P. S. Eiler, nor C. Sandonnini and G. Scarpa could detect any sign of chemical combination in the fusion curves of mixtures of potassium and silver iodides. W. Eberlein measured the e.m.f. of conc. cells of potassium silver iodide. According to A. Ditte, deliquescent crystals of tripotassium argento-iodide, $3\text{KI}\cdot \text{AgI} + \frac{1}{5}\text{H}_2\text{O}$, or $\text{K}_3\text{AgI}_4 + \frac{1}{2}\text{H}_2\text{O}$, are formed by evaporating the mother liquid. M. Berthelot obtained crystals of what he regarded as hydrated tripotassium diargento-iodide, $3\text{KI}\cdot 2\text{AgI}\cdot \text{H}_2\text{O}$, or $\text{K}_3\text{Ag}_2\text{I}_5\cdot \text{H}_2\text{O}$, by the evaporation of a soln. of silver in a very conc. soln. of potassium iodide in air. H. L. Wells and S. L. Penfield obtained white rhombic crystals of dirubidium argento-iodide, $2\text{RbI}\cdot \text{AgI}$, or Rb_2AgI_3 , with axial ratios $a : b : c = 0\cdot 977 : 1 : 0\cdot 236$; and likewise rhombic hair-like crystals of dicæsium argento-iodide, $2\text{CsI}\cdot \text{AgI}$, or Cs_2AgI_3 , with axial ratios $a : b : c = 0\cdot 971 : 1 : 0\cdot 244$ by cooling hot sat. soln. of silver iodide in conc. aq. potassium iodide. The three salts of the type M_2AgI_3 are isomorphous, and they do not conform with the now obsolete rule of I. Remsen, for they contain more halogen atoms belonging to the alkali nitrate than belonging to the silver. The tendency of the silver halides to form complexes increases in passing from chlorides to iodides, and from lithium to cæsium.

G. F. Rodwell¹¹ studied the sp. gr. of "alloys" of cuprous iodide and silver iodide; M. Bellati and R. Romanese, the thermal expansion and the sp. ht.; and G. F. Rodwell, and T. Carnelley and L. T. O'Shea, the m.p. G. T. Prior reported a mineral *miersite*, $\text{CuI}\cdot 4\text{AgI}$, sp. gr. 5·640, from Broken Hill; B. Gossner also studied the same mineral. H. Schulz's analyses of the Chilian mineral *cupro-iodargyrite* agreed with the formula $\text{CuI}\cdot \text{AgI}$.

According to J. Schnauss,¹² 100 parts of a solution of silver nitrate, sat. at 11°, dissolve 2·3 parts of silver iodide in the cold, and 12·3 parts when boiling. Silver iodide absorbs silver sulphate and silver nitrate. C. Stürenberg obtained crystals of what he regarded as silver iodonitrate, $\text{AgI}\cdot \text{AgNO}_3$, by cooling a hot. conc. soln. of silver nitrate sat. with silver iodide; and if the soln. is not completely sat. with the iodide, there are formed needle-like crystals of silver iododinitrate, $\text{AgI}\cdot 2\text{AgNO}_3$, belonging to the rhombic system with axial ratios $a : b : c = 0\cdot 6638 : 1 : 0\cdot 3123$. According to G. Scarpa, and J. Kablukoff, the f.p. curve of the two salts shows the existence of the silver iodosesquinitrate, $2\text{AgI}\cdot 3\text{AgNO}_3$. According to J. Preuss, soln. of mercuric nitrate, especially if warm, dissolve much silver iodide, and, according to H. Debray, on cooling, crystals of the salt separate unchanged. F. Field says that a soln. of sodium thiosulphate dissolves very little silver iodide. G. Fogh says none, but, according to E. Valenta, at 20°, 100 grms. of soln. containing 1, 5, 10, 15, and 20 of sodium thiosulphate in 100 of water dissolve respectively 0·03, 0·15, 0·30, 0·40, and 0·60 grm. of silver iodide. A. Rosenheim and S. Steinhäuser obtained crystals of $4(\text{NH}_4)_2\text{S}_2\text{O}_3\cdot \text{NH}_4\text{I}\cdot \text{AgI}$ by shaking silver iodide with a conc. soln. of ammonium thiosulphate. According to E. Valenta, also, 100 grms. of soln. containing 10 and 20 parts of sodium sulphite per 100 of water, at 25°, dissolve respectively 0·01 and 0·02 grm. of silver iodide; 100 grms. of soln. containing 5, 10,

and 15 grms. of *ammonium thiocyanate* per 100 grms. of water dissolve respectively, at 20°, 0·02, 0·08, and 0·13 grm. of silver iodide; 100 grms. of a 1:20 soln. of *potassium cyanide*, at 25°, dissolve 8·23 grms. of silver iodide; and 100 grms. of 1:10 soln. of *calcium or barium thiocyanate* dissolve respectively 0·03 and 0·02 grm. of silver iodide. J. Neustadt¹³ found the solubility of silver iodide in *methyl alcohol* to be $1·56 \times 10^{-18}$; in *ethyl alcohol*, $1·1 \times 10^{-19}$; and in *acetone*, about 5×10^{-24} ; and F. Benzold says it is insoluble in *methyl acetate*.

According to O. Ruff and E. Geisel,¹⁴ and E. C. Franklin and C. A. Kraus, silver iodide is soluble in *liquid ammonia*. If v represents the number of litres containing a mol of the salt, and ϕ the fluidity, and D the sp. gr. of the soln.:

$v \times 10^{-3}$	0·1377	0·2956	0·5040	1·182	4·960	15·63	27·75
D	2·2275	1·4250	1·1175	0·8588	0·7215	0·6840	0·6820
ϕ	10·12	108·6	195·9	284·8	355·9	375·3	376·4

According to E. C. Franklin and C. A. Kraus, the degree of ionization of soln. of silver iodide in liquid ammonia, at -33° , is 0·18 per cent. with a dilution of 100, and 0·43 per cent. with a dilution of 1000, values which are not so high as with other binary salts. At -33° the conductivity λ in reciprocal ohms is:

$v \times 10^{-3}$	0·1720	1·299	5·376	62·4	967·2	2881·0	15100·0	80000·0
λ	3·397	9·618	15·35	42·52	121·0	175·2	242·1	276·0

The solubility and fluidity of soln. of silver iodide in the substituted ammonias—*methylamine* and *ethylamine*—have been determined by F. F. Fitzgerald. The conc. soln. in these menstrua are very viscous. Silver iodide is slightly soluble in *aqua ammonia*, as shown by J. Martini, W. Wallace, H. Rose, A. Vogel, and H. Baubigny. A. Longi found 100 c.c. of 10 per cent. ammonia (sp. gr. 0·96) dissolves 0·0036 grm. of silver iodide; H. Baubigny, that 100 c.c. of ammonia of sp. gr. 0·926 dissolves 0·0167 grm. of silver iodide; and W. Wallace, that 100 c.c. of ammonia of sp. gr. 0·89 dissolves 0·04 grm. of silver iodide.

According to A. Joannis and M. Croizier,¹⁵ when silver iodide, cooled by a freezing mixture of ice and salt, is treated with ammonia gas, silver amino-iodide, $\text{AgI} \cdot \text{NH}_3$, is formed with a dissociation temp. of $3·5^\circ$ under normal press. According to A. Longi, the same compound is formed if silver iodide be digested with aq. ammonia; but on account of the low dissociation temp. this is not probable. W. Biltz and W. Stollenwerk gave $Q=8·56$ Cals. for the heat of formation of the monamine, and $\log p = -Q/4·57T + 1·75 \log T - 0·0030T + 3·3$. R. Jarry measured the dissociation press. of this compound. A. Vogel found aq. ammonia forms a compound, probably silver hemiammino-iodide, $2\text{AgI} \cdot \text{NH}_3$, which is not very stable, since on washing or exposure to the air it forms yellow silver iodide. According to C. F. Rammelsberg, the hemiammino-salt is formed when unfused silver iodide is exposed to ammonia gas; heat is developed, and a white compound is formed, $2\text{AgI} \cdot \text{NH}_3$. H. Ley and G. Wiegner found the same product was formed when silver iodide was confined with ammonia in a eudiometer; the eq. of half a mol of ammonia is rapidly absorbed. The compound slowly loses ammonia on exposure, and forms yellow silver iodide on exposure to air; the decomposition occupies about half an hour in vacuo. According to A. Joannis and M. Croizier, the dissociation temp. of this compound is 90° under ordinary press. According to F. Isambert, the dissociation press. are:

20°	34°	45°	53°	60·5°	63°	70°	76°
29	79	102	178	222	236	327	460 mm.

C. Antoine represented the vap. press in p mm., at θ° , by $\log p = 0·2373(14·4478 + 1000/t)$, when $t = \theta^\circ + 80$. W. Biltz and W. Stollenwerk gave $Q=11·59$ Cals. for the heat of formation of the hemi-amine, $\text{AgI} \cdot \frac{1}{2}\text{NH}_3$, and $\log p = -Q/4·57T + 1·75 \log T - 0·0010T + 3·3$. R. Jarry also measured the dissociation press. of this compound. If silver iodide sat. with ammonia is heated with aqua ammonia

in a sealed tube on a water-bath, a little of the solid is dissolved and the soln. deposits on cooling white mica-like crystals of **silver diammino-iodide**, $\text{AgI}\cdot 2\text{NH}_3$, which are rapidly coloured violet in light. They lose ammonia and form yellow silver iodide. W. Biltz and W. Stollenwerk gave $Q=7\cdot 05$ Cals. for the heat of formation of the diammine, and $\log p = -Q/4\cdot 57T + 1\cdot 75 \log T - 0\cdot 0050T + 3\cdot 3$. They also prepared **silver sesquiammino-iodide**, $2\text{AgI}\cdot 3\text{NH}_3$, whose heat of formation, Q , is $7\cdot 25$ Cals., and $\log p = -Q/4\cdot 57T + 1\cdot 75 \log T - 0\cdot 0050T + 3\cdot 3$; likewise also for silver triammino-iodide, $\text{AgI}\cdot 3\text{NH}_3$, the heat of formation, $Q=6\cdot 92$ Cals., and $\log p = -Q/4\cdot 57T + 1\cdot 75 \log T - 0\cdot 0050T + 3\cdot 3$. All the ammino-iodides form mixed crystals. From the temp. of dissociation, the stability of the silver ammino-halides is in the order: AgI , AgBr , AgCl .

According to J. S. Stas,¹⁶ pure silver iodide has a pale yellow colour; it is not decomposed in direct sunlight unless in the presence of traces of certain impurities—*e.g.* with traces of silver salts—when the iodide darkens. The photo-iodides are discussed in connection with the action of light on silver halides. A. Guntz claims to have prepared **silver subiodide**, Ag_2I , by the action of hydrogen iodide on silver subfluoride, when much heat is developed; H. W. Vogel also prepared a substance which he regarded as silver subiodide by the action of cuprous iodide on silver nitrate, but which K. Emszt regards as a mixture of silver and silver iodide. When heated strongly in air, A. Vogel found silver iodide is partially decomposed; it sublimes when heated in closed vessels. According to K. Arndt and A. Gessler decomposition begins when the salt is heated to about 800° . According to H. Schulze, it is not decomposed when heated in **oxygen**; and according to A. Vogel, it is only very incompletely reduced by **hydrogen** at a white heat; but, according to A. Jouniaux, it is not appreciably reduced by hydrogen at 700° . Electrolytic hydrogen, says H. Vogel, reduces silver iodide. H. Danneel found that the equilibrium conditions in the reaction $2\text{Ag} + 2\text{HI} = 2\text{AgI} + \text{H}_2$ are such that if the hydrogen is at atm. press. and the temp. 13° , the conc. of the hydrogen iodide is $0\cdot 043$ normal. In order that silver iodide may be completely reduced by hydrogen in aq. soln., $2\text{AgI} + \text{H}_2 = 2\text{HI} + 2\text{Ag}$, it is therefore necessary that the dissolved hydrogen have a greater conc. than $0\cdot 043$ normal. According to H. Rose, silver iodide is completely reduced by **iron** in the presence of water, or dil. acids, but with zinc the reduction is incomplete. A. Naquet found that **antimony** and **bismuth** do not reduce silver iodide suspended in boiling water; nor, according to D. Tommasi, does **sodium amalgam**, even in acidified soln. J. Seymour obtained no signs of reduction by **ferrous sulphate** in light; E. Rupp and F. Lehmann also say that **formaldehyde** does not attack silver iodide suspended in alkaline soln.

According to J. J. Berzelius,¹⁷ silver iodide absorbs **chlorine** at ordinary temp., but iodine is liberated only when the silver iodide is warmed. P. Julius converted it completely into silver bromide by passing over the molten iodide a stream of air laden with **bromine** vapour. Dry **hydrogen chloride** forms silver chloride and hydrogen iodide at about 700° . M. Berthelot has studied the action of hydrogen chloride and **hydrogen bromide** on silver iodide. According to F. W. Schmidt, when silver nitrate is added to an alcoholic soln. of potassium tri-iodide, the resulting dark brown precipitate is **silver tri-iodide**, AgI_3 . The same compound is formed when the white precipitate formed by the addition of iodine to ammoniacal silver nitrate is treated with an alcoholic soln. of iodine. It is stable only in the moist condition. J. S. Johnson obtained black deliquescent crystals of $4\text{KI}_3\cdot \text{AgI}\cdot 5\text{H}_2\text{O}$, or $\text{K}_4\text{AgI}_{13}\cdot 5\text{H}_2\text{O}$, by evaporating a soln. of potassium and silver iodides and iodine in these proportions. According to W. D Bancroft, silver iodide strongly adsorbs iodine, for M. C. Lea showed that freshly precipitated and still moist silver iodide quickly decolorizes the pale sherry-wine colour of an alcoholic soln. of iodine. F. E. E. Germann and R. N. Traxler showed that if the adsorbed silver nitrate be removed from the iodide no adsorption occurs above the limit $0\cdot 02$ millimol per gram of silver iodide. The phenomenon observed by M. C. Lea was probably due to a chemical reaction between the adsorbed silver nitrate and iodine.

According to R. Brandes, dil. nitric acid or phosphoric acid has no action on silver iodide; but, according to A. Naquet, hot conc. nitric acid converts it into silver nitrate; and, according to A. Ladenburg, sulphuric acid at 180° forms silver sulphate. H. Davy found that when silver iodide was "acted upon by fused hydrate of potassa, it was rapidly decomposed, and a solid substance having all the characters of oxide was formed. The matter soluble in water separated by a filter and acted upon by sulphuric acid, afforded the peculiar substance—iodine"; but, according to A. Vogel, the decomposition is incomplete, while boiling aq. soln. of potassium hydroxide turn silver iodide grey without appreciable decomposition; A. Naquet says alkali lye colours silver iodide brown, and that with boiling alkali lye the decomposition is incomplete; the alkali carbonates slightly discolour silver iodide, while the carbonates and oxides of the alkaline earths and magnesium are without action.

REFERENCES.

- ¹ I. Domeyko, *Elementos de mineralogia*, Serena, 1845; *Ann. Mines*, (4), 6. 153, 1844; A. Damour, *ib.*, (5), 4. 329, 1853; J. L. Smith, *Amer. Journ. Science*, (2), 18. 374, 1854; F. Field, *Journ. Chem. Soc.*, 10. 241, 1872; A. von Lasaulx, *Bull. Soc. Min.*, 1. 136, 1878; G. T. Prior and L. J. Spencer, *Min. Mag.*, 13. 174, 1902.
- ² H. St. C. Deville, *Compt. Rend.*, 42. 894, 1856; 43. 970, 1856; A. Ditte, *ib.*, 93. 415, 1881; P. Julius, *Zeit. anal. Chem.*, 22. 523, 1883; F. Field, *Journ. Chem. Soc.*, 10. 242, 1857; A. Potilitzin, *Journ. Russ. Phys. Chem. Soc.*, 13. 415, 1881; W. Pawloff and S. Schein, *ib.*, 39. 943, 1907; H. Dannehl, *Zeit. phys. Chem.*, 33. 415, 1900; I. Kablukoff, *ib.*, 65. 126, 1909; A. Vogel, *Neucs Repert. Pharm.*, 20. 129, 1871; G. P. Baxter, *Journ. Amer. Chem. Soc.*, 26. 1577, 1904; 27. 876, 1905; J. H. Kastle, *Amer. Chem. Journ.*, 45. 396, 1911; C. W. B. Normand and A. C. Cumming, *Journ. Chem. Soc.*, 101. 1852, 1912; W. Böttger, *Zeit. angew. Chem.*, 25. 1993, 1912; L. Rolla, *Atti Accad. Lincei*, (5). 22. ii, 104, 1913.
- ³ V. von Zepharovich, *Zeit. Kryst.*, 4. 119, 1880; O. Lehmann, *ib.*, 1. 492, 1877; L. J. Spencer, *Nature*, 57. 574, 1898; *Bull. Soc. Min.*, 21. 176, 1898; P. W. Bridgman, *Proc. Amer. Acad.*, 51. 97, 1915; 52. 91, 1916; F. Wallerant, *Cristallographie*, Paris, 275, 1909; L. von Werneke, *Pogg. Ann.*, 142. 560, 1871; G. F. Rodwell, *Phil. Trans.*, 173. 1125, 1883; *Proc. Roy. Soc.*, 25. 280, 1876; E. Mallard and H. le Chatelier, *Journ. Phys.*, (2), 4. 315, 1885; *Bull. Soc. Min.*, 6. 181, 1884; *Compt. Rend.*, 97. 102, 1883; P. Walden, *Zeit. anorg. Chem.*, 115. 241, 1920; G. Tammann, *ib.*, 111. 78, 1920; *Kristallisieren und Schmelzen*, Leipzig, 302, 1903; *Zeit. phys. Chem.*, 75. 733, 1910; *Wied. Ann.*, 68. 643, 1899; W. Kohlrausch, *ib.*, 17. 642, 1882; W. Schwarz, *Beiträge zur Kenntnis der umkehrbaren Umwandlungen polymorpher Körper*, Göttingen, 1892; A. Steger, *Zeit. phys. Chem.*, 43. 595, 1903; M. Bellati and R. Romanese, *Atti Ist. Veneto* 1. 1043, 1883; H. W. B. Roozeboom, *Die heterogenen Gleichgewichte*, Braunschweig, 1. 199, 1901; H. Stolzenberg and M. E. Huth, *Zeit. phys. Chem.*, 71. 641, 1910; C. Tubandt and E. Lorenz, *Nernst's Festschrift*, 446, 1912; H. Hauschild, *Ann. Physik*, (4), 63. 816, 1920; H. St. C. Deville, *Compt. Rend.*, 64. 323, 1867; H. Debray, *ib.*, 42. 824, 1856; 70. 995, 1870; P. Debye and P. Scherrer, *Phys. Zeit.*, 17. 277, 1916; A. W. Hull, *Phys. Rev.*, (2), 10. 661, 1917; R. B. Wilsey, *Phil. Mag.*, (6), 42. 262, 1921; K. Mönkemeyer, *Ueber die Bildung von Mischkristallen der Blei-, Silber-, Thallo-, und Cupro-halogene aus Schmelzfluss*, Göttingen, 1906; *Neues Jahrb. Min. B.B.*, 22. 28, 1906; A. P. H. Trivelli and S. E. Sheppard, *The Silver Bromide Grain of Photographic Emulsions*, New York, 121, 1921; A. Thiel, *Zeit. anorg. Chem.*, 24. 1, 1900.
- ⁴ P. A. Boullay, *Ann. Chim. Phys.*, (2), 43. 266, 1830; E. Filhol, *ib.*, (3), 21. 417, 1847; C. J. B. Karsten, *Schweigger's Journ.*, 65. 417, 1832; H. Schiff, *Liebig's Ann.*, 108. 21, 1858; H. G. F. Schröder, *ib.*, 192. 295, 1878; H. St. C. Deville, *Compt. Rend.*, 64. 325, 1867; G. P. Baxter, *Journ. Amer. Chem. Soc.*, 26. 1577, 1904; 27. 876, 1905; G. F. Rodwell, *Proc. Roy. Soc.*, 25. 280, 1877; *Phil. Trans.*, 173. 1125, 1882; H. Fizeau, *Ann. Chim. Phys.*, (4), 8. 335, 1865; *Compt. Rend.*, 62. 1101, 1133, 1866; 64. 314, 771, 1867; A. Damour, *ib.*, 64. 314, 1867; C. E. Guillaume, *ib.*, 136. 303, 1903; C. Lüdeking, *Wied. Ann.*, 34. 21, 1888; H. G. Dorsey, *Phys. Rev.*, 25. 101, 1907; K. Scheel, *Ber. deut. phys. Ges.*, 5. 718, 1907; G. Jones, *Journ. Amer. Chem. Soc.*, 31. 191, 1909; G. Jones and M. L. Hartmann, *ib.*, 37. 752, 1915; T. W. Richards and G. Jones, *ib.*, 31. 158, 1909; W. Barlow and W. J. Pope, *Journ. Chem. Soc.*, 91. 1177, 1907; 93. 1538, 1908; N. Kurnakoff and S. F. Schemtschuschny, *Zeit. anorg. Chem.*, 60. 1, 1908; P. Walden, *ib.*, 115. 241, 1920; F. A. Henglein, *ib.*, 120. 77, 1921; J. L. Smith, *Amer. Journ. Science*, (2), 18. 374, 1854; P. Walden, *Zeit. anorg. Chem.*, 115. 241, 1920; H. le Chatelier, *Bull. Soc. Min.*, 13. 112, 1890.
- ⁵ T. Carnelley, *Journ. Chem. Soc.*, 29. 489, 1876; 33. 273, 1878; W. Ramsay and N. Eumorfopoulos, *Phil. Mag.*, (5), 41. 360, 1896; A. Steger, *Zeit. phys. Chem.*, 43. 601, 1903; H. Stolzenberg and M. E. Huth, *ib.*, 71. 641, 1910; C. Sandonini, *Atti Accad. Lincei*, (5), 21. ii, 199, 1912;

M. Bellati and R. Romanese, *Atti Ist Veneto*, 1. 1043, 1883; K. Mönkemeyer, *Neues Jahrb. Min. B.B.*, 22. 28, 1906; F. Matthes, *ib.*, 31. 347, 1911; C. Tubandt and E. Lorenz, *Nernst's Festschrift*, 446, 1912; *Zeit. phys. Chem.*, 87. 527, 1914; A. Vogel, *Neues Repert. Pharm.*, 20. 129, 1871; C. Antoine, *Compt. Rend.*, 107. 836, 1888; J. Dewar and A. Scott, *B. A. Rep.*, 597, 1881; H. V. Regnault, *Ann. Chim. Phys.*, (3), 46. 278, 1858; M. Meslans, *ib.*, (7), 1. 395, 1894; V. Auger, *Bull. Soc. Chim.*, (4), 5. 7, 1909; A. Magnus, *Ann. Physik*, (4), 31. 608, 1910; F. Koref, *ib.*, (4), 36. 49, 1911; W. Nernst, *ib.*, (4), 36. 420, 1911; *Sitzber. Akad. Berlin*, 270, 1910; G. Jones and M. L. Hartmann, *Journ. Amer. Chem. Soc.*, 37. 752, 1914; G. Jones, *ib.*, 31. 191, 1909; P. W. Bridgman, *Proc. Amer. Acad.*, 51. 97, 1915; O. Lehmann, *Molekularphysik*, Leipzig, 1. 166, 1884; W. Nernst and F. Schwerns, *Sitzber. Akad. Berlin*, 355, 1914.

⁸ M. Berthelot, *Compt. Rend.*, 87. 619, 1878; 94. 912, 1883; *Ann. Chim. Phys.*, (5), 16. 433, 1878; (5), 29. 241, 1883; J. Thomsen, *Thermochemische Untersuchungen*, Leipzig, 3. 381, 1884; M. de K. Thompson, *Journ. Amer. Chem. Soc.*, 28. 731, 1906; G. Jones and M. L. Hartmann, *ib.*, 38. 752, 1915; U. Fischer, *Zeit. anorg. Chem.*, 78. 43, 1912; *Zeit. Elektrochem.*, 18. 283, 1912; O. Gerth, *ib.*, 27. 287, 1921; H. Braune and F. Koref, *Zeit. anorg. Chem.*, 87. 175, 1914; H. S. Taylor and W. T. Anderson, *Journ. Amer. Chem. Soc.*, 43. 2014, 1921.

⁷ W. Kohlrausch, *Wied. Ann.*, 17. 642, 1882; 33. 42, 1888; L. Graetz, *ib.*, 29. 314, 1886; O. Lehmann, *ib.*, 24. 1, 1885; 38. 396, 1889; K. Arndt and A. Gessler, *Zeit. Elektrochem.*, 14. 663, 1908; K. Bödeker, *ib.*, 18. 1080, 1912; C. Tubandt and E. Lorenz, *Nernst's Festschrift* 446, 1912; *Zeit. phys. Chem.*, 87. 543, 1914; C. Tubandt and S. Eggert, *Zeit. anorg. Chem.*, 110. 196, 1920; C. Tubandt, *ib.*, 115. 105, 1921; G. Bruni and G. Scarpa, *Atti Accad. Lincei*, (5), 22. i, 438, 1913; W. Wilson, *Ann. Physik*, (4), 23. 107, 1907; H. Scholl, *ib.*, (4), 16. 193, 1905; B. A. Dima, *Compt. Rend.*, 157. 590, 1913; P. Dutoit and G. von Wiese, *Journ. Chim. Phys.*, 9. 630, 1911; S. Iimori and T. Takebe, *Journ. Tokyo Chem. Soc.*, 41. 77, 1920; R. B. Archey, *Phot. Journ.*, 61. 235, 1921.

⁶ A. des Cloizcaux, *Mém. Acad.*, 18. 511, 1868; A. Kundt, *Wied. Ann.*, 34. 484, 1888; C. Schell, *Ann. Physik*, (4), 35. 726, 1911; J. Friedel, *ib.*, (4), 18. 1031, 1906; S. Meyer, *ib.*, (4), 1. 664, 1900; *Wied. Ann.*, 68. 325, 1899; 69. 236, 1899; E. Lehmann, *Zeit. phys. Chem.*, 64. 89, 1908; J. A. Wilkinson, *Journ. Phys. Chem.*, 13. 723, 1909; L. Wernicke, *Pogg. Ann.*, 142. 565, 1871.

⁵ F. Kohlrausch and F. Rose, *Wied. Ann.*, 50. 127, 1893; F. Kohlrausch and E. Dolezalek, *Sitzber. Akad. Berlin*, 1018, 1901; F. Kohlrausch, *Zeit. phys. Chem.*, 50. 355, 1905; 64. 129, 1908; H. Danneel, *ib.*, 33. 439, 1900; H. M. Goodwin, *ib.*, 13. 646, 1894; G. Bodländer, *ib.*, 27. 55, 1898; A. Thiel, *Zeit. anorg. Chem.*, 24. 57, 1900; L. Rolla, *Atti Accad. Lincei*, (5), 22. ii, 104, 1913; A. E. Hill, *Journ. Amer. Chem. Soc.*, 30. 68, 1908.

¹⁰ H. St. C. Deville, *Compt. Rend.*, 42. 895, 1856; M. Berthelot, *ib.*, 91. 1024, 1880; *Ann. Chim. Phys.*, (5), 23. 85, 1881; G. Fogh, *ib.*, (6), 21. 66, 1890; *Compt. Rend.*, 110. 711, 1890; F. Field, *Chem. News*, 3. 17, 1861; N. S. Kurnakoff and P. S. Eiler, *Chem. Ztg.*, 24. 60, 1900; J. Schnauss, *Arch. Pharm.*, (2), 82. 260, 1855; G. Bodländer, *Ber.*, 36. 3988, 1904; W. Eberlein, *Ueber einige komplexe Salze des Silbers, des Goldes, und des Quecksilbers*, Leipzig, 1904; E. Valenta, *Monatsh.*, 15. 249, 1894; J. Preuss, *Liebig's Ann.*, 29. 329, 1839; W. van Dam and A. D. Donk, *Chem. Weekb.*, 8. 846, 1911; C. Sandoninni, *Atti Accad. Lincei*, (5), 21. ii, 196, 1912; C. Sandoninni and G. Scarpa, *ib.*, (5), 22. ii, 517, 1913; J. E. Marsh and W. C. Rhymes, *Journ. Chem. Soc.*, 103. 783, 1913; J. E. Marsh, *ib.*, 97. 2308, 1910; W. Krym, *Journ. Russ. Phys. Chem. Soc.*, 41. 382, 1909; H. L. Wells and H. L. Wheeler, *Amer. Journ. Science*, (3), 44. 357, 1892; P. A. Boullay, *Ann. Chim. Phys.*, (2), 34. 377, 1829; M. Berthelot, *ib.*, (5), 29. 271, 1883; *Compt. Rend.*, 94. 912, 1882; A. Ditte, *ib.*, 93. 415, 1881; H. Debray, *ib.*, 70. 995, 1870; K. Hellwig, *Zeit. anorg. Chem.*, 25. 157, 1900; G. Bodländer and W. Eberlein, *ib.*, 39. 197, 1904; J. Remsen, *Amer. Chem. Journ.*, 11. 291, 1889; 14. 81, 1892—vide 2. 18, 15.

¹¹ G. F. Rodwell, *Proc. Roy. Soc.*, 33. 143, 1882; M. Bellati and R. Romanese, *ib.*, 34. 104, 1882; *Atti Ist. Veneto*, (6), 1. 1043, 1883; T. Carnelley and L. T. O'Shea, *Journ. Chem. Soc.*, 45. 409, 1884; G. T. Prior, *Min. Mag.*, 13. 186, 1902; B. Gossner, *Zeit. Kryst.*, 38. 129, 1904; H. Schulze, *Chem. Ztg.*, 16. 1953, 1892.

¹² G. P. Baxter and G. S. Tilley, *Journ. Amer. Chem. Soc.*, 31. 201, 1909; 32. 1591, 1910; C. Stürenberg, *Arch. Pharm.*, (2), 143. 18, 1870; J. Schnauss, *ib.*, (2), 82. 260, 1855; K. Hellwig, *Zeit. anorg. Chem.*, 25. 157, 1900; R. Fanto, *Monatsh.*, 24. 477, 1903; A. Kremer, *Journ. prakt. Chem.*, (1), 71. 54, 1857; H. Risse, *Liebig's Ann.*, 111. 39, 1859; C. Weltzien, *ib.*, 95. 127, 1855; A. Riche, *Journ. Pharm. Chim.*, (3), 33. 343, 1858; A. W. Hofmann, *Pharm. Journ.*, (2), 1. 29, 1859; F. Jäger, *Zeit. Kryst.*, 44. 169, 1908; G. Scarpa, *Atti Accad. Lincei*, (5), 22. ii, 452, 1913; J. Kablukoff, *Journ. Russ. Phys. Chem. Soc.*, 39. 914, 1907; *Zeit. phys. Chem.*, 55. 121, 1909; H. Debray, *Compt. Rend.*, 70. 995, 1870; J. Fogh, *ib.*, 110. 711, 1890; *Ann. Chim. Phys.*, (6), 21. 66, 1890; J. Preuss, *Liebig's Ann.*, 29. 328, 1839; A. Rosenheim and S. Steinhäuser, *Zeit. anorg. Chem.*, 25. 72, 1900; F. Field, *Journ. Chem. Soc.*, 10. 241, 1858; *Chem. News*, 3. 17, 1861; E. Valenta, *Monatsh.*, 15. 249, 1894.

¹³ J. Neustadt, *Zeit. Elektrochem.*, 16. 868, 1910; J. E. Marsh and W. C. Rhymes, *Journ. Chem. Soc.*, 103. 783, 1913; F. Benzold, *Das Verhalten chemischer Verbindungen in Methylacetat*, Giessen, 1906.

¹⁴ O. Ruff and E. Geisel, *Ber.*, 38. 2659, 1905; E. C. Franklin and C. A. Kraus, *Amer. Chem. Journ.*, 20. 228, 1898; 21. 1, 1899; 23. 290, 1900; *Journ. Amer. Chem. Soc.*, 27. 219, 1905; E. C. Franklin and H. D. Gibbs, *ib.*, 29. 1389, 1907; C. A. Kraus and W. C. Bray, *ib.*, 35. 1337,

1913; C. E. Franklin, *Zeit. phys. Chem.*, **69**, 289, 1909; F. M. G. Johnson and N. T. M. Wilsomere, *Trans. Faraday Soc.*, **3**, 77, 1907; *Zeit. Elektrochem.* **14**, 227, 1908; F. F. Fitzgerald, *Journ. Phys. Chem.*, **16**, 656, 1912; A. Vogel, *Neues Repert. Pharm.*, **5**, 53, 1856; H. Rose, *Pogg. Ann.*, **31**, 583, 1834; J. Martini, *Schweigger's Journ.*, **56**, 154, 1829; W. Wallace, *B. A. Rep.*, **88**, 1859; A. Longi, *Gazz. Chim. Ital.*, **13**, 87, 1883; H. Baubigny, *Compt. Rend.*, **146**, 1263, 1908; *Bull. Soc. Chim.*, (4), **3**, 722, 1908.

¹⁵ A. Joannis and M. Crozier, *Compt. Rend.*, **118**, 1149, 1894; A. Terreil, *ib.*, **98**, 1279, 1884; *Bull. Soc. Chim.*, (2), **41**, 597, 1884; A. Longi, *Gazz. Chim. Ital.*, **13**, 86, 1883; C. F. Rammelsberg, *Pogg. Ann.*, **48**, 170, 1839; A. Vogel, *Neues Repert. Pharm.*, **5**, 53, 1856; M. C. Lea, *Amer. Journ. Science*, (3), **15**, 379, 1878; F. Isambert, *Ann. École Norm.*, **5**, 143, 1868; H. Ley and G. Wiegner, *Zeit. Elektrochem.*, **11**, 590, 1905; W. Peters, *Zeit. anorg. Chem.*, **77**, 154, 1912; W. Biltz, *Zeit. phys. Chem.*, **67**, 561, 1909; W. Biltz and W. Stollenwerk, *Zeit. anorg. Chem.*, **114**, 174, 1920; C. Antoine, *Compt. Rend.*, **107**, 681, 778, 836, 1888; R. Jarry, *Recherches sur la dissociation de divers composés ammoniacaux au contact de l'eau*, Paris, 1899.

¹⁶ J. S. Stas, *Mém. Acad. Belgique*, **35**, 134, 1865; A. Vogel, *Neues Repert. Pharm.*, **20**, 129, 1871; H. Schulze, *Journ. prakt. Chem.*, (2), **21**, 407, 1880; A. Jouniaux, *Journ. Chim. Phys.*, **1**, 609, 1904; H. Danneel, *Zeit. phys. Chem.*, **33**, 415, 1900; H. Rose, *Pogg. Ann.*, **24**, 334, 1832; **27**, 117, 1833; A. Naquet, *Bull. Soc. Chim.*, (2), **1**, 126, 1860; H. Vogel, *Pogg. Ann.*, **117**, 321, 1862; D. Tommasi, *ib.*, (2), **38**, 148, 1882; J. Seymour, *Pharm. Rund.*, **264**, 1894; K. Arndt and A. Gessler, *Zeit. Elektrochem.*, **14**, 663, 1908; E. Rupp and F. Lehmann, *Chem. Ztg.*, **34**, 227, 1910; A. Guntz, *Compt. Rend.*, **112**, 861, 1891; H. W. Vogel, *Phot. Mitt.*, **36**, 344, 1899; K. Emszt, *Zeit. anorg. Chem.*, **28**, 346, 1901.

¹⁷ J. J. Berzelius, *Pogg. Ann.*, **14**, 558, 1828; P. Julius, *Zeit. anal. Chem.*, **22**, 523, 1883; A. Ladenburg, *Ber.*, **35**, 1256, 2275, 1902; P. Hautefeuille, *Bull. Soc. Chim.*, (2), **7**, 203, 1867; A. Naquet, *ib.*, (2), **1**, 126, 1860; M. Berthelot, *ib.*, (2), **36**, 13, 1881; *Ann. Chim. Phys.*, (5), **23**, 102, 1881; *Compt. Rend.*, **92**, 488, 1881; F. W. Schmidt, *Zeit. anorg. Chem.*, **9**, 418, 1895; J. S. Johnson, *Journ. Chem. Soc.*, **3**, 183, 1878; R. Brandes, *Schweigger's Journ.*, **61**, 255, 1831; H. Davy, *Phil. Trans.*, **104**, 487, 1814; A. Vogel, *Neues Repert. Pharm.*, **20**, 129, 1871; W. D. Bancroft, *Applied Colloidal Chemistry*, New York, **98**, 1921; M. C. Lea, *Amer. Journ. Science*, (3), **33**, 493, 1887; F. E. E. Germann and R. N. Traxler, *Journ. Amer. Chem. Soc.*, **44**, 460, 1922.

§ 18. Silver Sulphide

Silver sulphide occurs in nature in two forms—the common ore *argentite* which crystallizes in the cubic system, and the rare mineral *acanthite* which crystallizes in the rhombic system. The cubic variety of silver sulphide was described by G. Agricola¹ (1529) as *Glaserz*; by J. G. Wallerius (1750) as *Silberglas*; by J. B. L. Romé de l'Isle (1783) as *minera argenti vitrea*; by K. C. Leonhard (1821) as *Silberglanz* or *silver glance*; by F. S. Beudant (1832) as *argyrose* from *ἀργυρος*, silver; and by W. Haidinger (1845) as *argentite*. L. Erker (1598) showed that the mineral contained five-sixths of its weight of silver; J. F. Henkel (1725), that it contained sulphur; and B. G. Sage (1776) found that a sample he analyzed contained 16 per cent. of sulphur and 84 per cent. of silver. M. H. Klaproth obtained a similar result.

Silver sulphide is easily prepared, for silver has a strong affinity for sulphur, as was shown by A. Orłowsky, and by J. W. Langley. A. Colson found that silver is blackened when heated with sulphur to 100° in an evacuated tube. J. Margottet,² and J. B. A. Dumas prepared small crystals of the sulphide by passing the vapour of sulphur over silver at a low red heat. Silver sulphide was prepared by J. S. Stas by heating silver in the vapour of sulphur, and expelling the excess by heating the product in a stream of nitrogen or carbon dioxide free from oxygen or hydrogen chloride. F. Rössler crystallized silver sulphide from a soln. of sulphur in molten silver. H. Pélabon studied the fusion curve of mixtures of sulphur and silver, or of silver sulphide and silver. P. Berthier stated that silver sulphide and metallic silver *s'unissent par fusion en toutes proportions*, but J. Percy showed that this statement is wrong, for while 83.63 per cent. of silver, and 16.37 per cent. of silver sulphide can be melted so as to furnish a "homogeneous metallic product," other proportions gave a product with two distinct layers—the lower layer is a soln. of silver sulphide in silver, and the upper layer a soln. of silver in silver sulphide. K. Friedrich and A. Leroux, and F. M. Jäger and H. S. van Klooster have studied

a portion of the equilibrium diagram, which is not unlike that obtained with copper and cuprous sulphide, as illustrated in Fig. 19. By adding silver sulphide to silver, the m.p. is progressively lowered to 906° with about 3 per cent. of silver sulphide; the m.p. then remains stationary with further additions of sulphur, until, with 12 per cent. of silver sulphide, the m.p. falls and continues falling to a eutectic at 806° , with 23 at. per cent. of sulphur; with between 7 and 29 at. per cent. of sulphur, the liquid separates into two layers. According to G. G. Urazoff, molten silver sulphide dissolves up to 0.65 per cent. of silver; if any more passes into soln. the fluid separates into two layers—the upper layer freezes at about 800° , and the lower one at 900° . The cooling solid has a transition point at about 175° , corresponding with passage from rhombohedral to cubic silver sulphide. There are also other transition points—*vide infra*, cuprous silver sulphide—corresponding with *stromeyerite* and *jalpaite*. C. C. Bisset studied the binary system: silver and silver sulphide.

H. Vogel, A. C. Becquerel, and C. Geitner prepared amorphous silver sulphide by the joint action of silver, sulphur, and water in a sealed tube at 200° ; but E. Obach found that sulphur dissolved in carbon disulphide has no action on silver; but A. Colson found that silver is blackened when heated with a soln. of sulphur in benzene. J. B. Senderens found that silver oxide is slowly attacked by sulphur and water at ordinary temp.; the action occupies some hours at 90° ; but is faster at 100° ; and he represented the reaction: $4Ag_2O + 4S = 3Ag_2S + Ag_2SO_4$; followed by: $3Ag_2SO_4 + 4S + 4H_2O = 3Ag_2S + 4H_2SO_4$. When the mixture is heated in a sealed tube, silver sulphide and sulphate are formed. M. Raffo and A. Pieroni found colloidal sulphur acts in a similar way. E. Filhol and J. B. Senderens converted a soln. of silver sulphate into silver sulphide and sulphuric acid by boiling it with finely divided sulphur; similar results were obtained with silver nitrate, oxalate, acetate, and carbonate. G. Vortmann and C. Padberg found insoluble silver chloride, bromide, and iodide are either unaffected or only slightly blackened by boiling with sulphur and water. E. Weinschenk obtained crystals of silver sulphide by heating silver acetate with hydrogen sulphide under press., or by heating the same salt with a soln. of ammonium thiocyanate in a sealed tube at 180° —the active agent here is hydrogen sulphide formed by the decomposition of the thiocyanate. W. Spring claimed to have made silver sulphide by the union of a mixture of the two finely divided elements merely by compression under 6500 atm., but W. Hallock and J. Johnson and L. H. Adams have shown that this statement wants modifying—*vide* l. 18, 23.

J. M. Caball found that hydrogen sulphide, thoroughly dried, does not attack silver at ordinary temp., but under ordinary atm. conditions, the small amount of hydrogen sulphide sometimes present was found by J. L. Proust to blacken the surface of silver; and by heating silver in a stream of hydrogen sulphide J. S. Stas prepared silver sulphide. E. Obach also found that a soln. of hydrogen sulphide in carbon disulphide attacks silver if air be simultaneously present, but not if air be excluded. Silver sulphide is precipitated as a black powder when silver oxide, or an aq. soln. of a silver salt, is treated with hydrogen sulphide or a soluble alkaline sulphide. H. St. C. Deville and L. Troost made crystals of argentite by passing hydrogen sulphide over silver *chauffé au rouge*, and J. Durocher prepared crystals

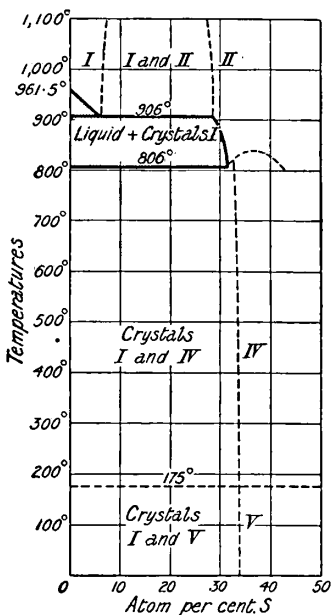

FIG. 19.—Equilibrium Curve of Binary Mixtures of Sulphur and Silver.

of silver sulphide by the action of hydrogen sulphide on silver chloride at a high temp. V. Kohlschütter and E. Eydmann found that with a neutral soln. of silver nitrate, the precipitate always contains free sulphur which cannot be removed with carbon disulphide; while F. M. Jäger and H. S. van Klooster could extract traces with toluene. L. Bruner and J. Zawadsky studied the equilibrium conditions of the reaction. I. Block and F. Höhn found that hydrogen persulphide, dropped on silver oxide, reacts with explosive violence, and inflames; when the combustion has ceased, greyish-black crystals of silver sulphide remain.

O. von der Pfordten claimed to have made silver subsulphide, Ag_4S , by the action of freshly-prepared ammonium hydrosulphide on silver suboxide; and A. Guntz, by the action of hydrogen sulphide on silver subfluoride. The product is black and amorphous; it is readily soluble in nitric acid and in conc. sulphuric acid without the separation of sulphur. It decomposes: $\text{Ag}_4\text{S} = \text{Ag}_2\text{S} + 2\text{Ag}$ on standing under water, or when it is dried.

E. Priwoznik obtained silver sulphide by melting silver with potassium pentasulphide and extracting the mass with water. A yellow soln. of ammonium sulphide slowly attacks silver, and in six weeks, a crystalline crust of the sulphide is formed on the metal. V. Stanek obtained crystals of silver sulphide by heating colourless ammonium sulphide with silver in a tube at $150^\circ\text{--}200^\circ$. K. Preis and B. Raymann found a soln. of sodium thioarsenite, Na_3AsS_3 , reacts with silver nitrate, forming silver sulphide and arsenious acid. A. Beutell, and G. Strüver found that hauerite, pyrite, marcasite, and pyrrhotite act on silver, forming silver sulphide, while cobaltite and arsenical pyrites have no action.

C. Geitner obtained crystals of silver sulphide by heating the metal with sulphurous acid in a sealed tube at 200° ; and he found that when silver sulphite is heated with water under similar conditions, a mixture of crystalline silver sulphide and crystalline silver is formed. When silver is heated with dry sulphur dioxide, J. Uhl found that silver sulphide and sulphate are formed. C. Geitner obtained microscopic crystals of silver sulphide by heating a mixture of silver nitrate and sulphurous acid in a sealed tube. According to W. Vaubel, silver oxide reacts quantitatively with sodium thiosulphate: $\text{Ag}_2\text{O} + \text{Na}_2\text{S}_2\text{O}_3 = \text{Ag}_2\text{S} + \text{Na}_2\text{SO}_4$; and, according to J. Fogh, and J. Girard, silver nitrate gives a precipitate of silver sulphide: $2\text{AgNO}_3 + \text{Na}_2\text{S}_2\text{O}_3 + \text{H}_2\text{O} = 2\text{NaNO}_3 + \text{Ag}_2\text{S} + \text{H}_2\text{SO}_4$, and if the thiosulphate be in great excess, the precipitate redissolves.

The physical properties of silver sulphide.—C. Paal and F. Voss³ prepared colloidal silver sulphide by treating silver lysalbinat with a dil. soln. of ammonium sulphide, and dialyzing the soln. to remove the compound last named. A. Lottermoser mixed $\frac{1}{40}N\text{-AgNO}_3$ with an excess of $\frac{1}{40}N\text{-Na}_2\text{S}$. J. Lefort and P. Thibault used a mixture of gum arabic and silver nitrate, and E. Stiasny used casein, albumin, dextrine, gelatine, or glue in place of gum arabic. A. Pieroni treated a dil. soln. of silver nitrate in pyridine with hydrogen sulphide. S. Odén mixed dil. soln. of silver nitrate and of sulphur hydrosol. H. Freundlich and A. Nathanson made silver sulphide sol by mixing sulphur sol with silver sol; and F. V. von Hahn, by bubbled hydrogen sulphide through $0\cdot002N\text{-AgNO}_3$. The so-called *silver hydrosulphide* of S. E. Linder and H. Picton is probably the colloidal sulphide. F. V. von Hahn found that silver hydrosols pass through a range of colours from yellow to green on adding increasing amounts of potassium chloride; the precipitate is invariably brown.

Argentite has a dark leaden-grey colour, and it occurs in **crystals** which are rude uneven cubes, or octahedra, but more usually it is scaly, earthy, or dendritic. H. Rose's analyses⁴ of fahlerz showed that silver and cuprous sulphides are closely related, and G. Rose emphasized the relationship by showing that cuprous sulphide, though rhombic in copper glance, does occur in a cubic form like argentite; and he added that "the isomorphism of these two sulphides is almost established by the occurrence of a rhombic stromeyerite (Cu, Ag)₂S, at Rudelstadt (Silesia); but the demonstration will not be completed until rhombic crystals of silver sulphide

have been discovered." In 1855, C. A. Kennigott was lucky enough to find the missing rhombic form of silver sulphide near Joachimsthal; and he called the new mineral *acanthite* from *ἀκανθα*, a thorn, in reference to the appearance of its acicular crystals—H. Dauber found the axial ratios to be $a : b : c = 0.6886 : 1 : 0.9944$. There is also the rhombic form of silver sulphide *daleminzite*, so named by A. Breithaupt after Dalminzien, the ancient name for Freiberg. The angle of the rhombic prism of daleminzite is 116° , and with acanthite, $110^\circ 54'$. The former is the variety isomorphous with cuprous sulphide.

The **specific gravity** of artificially prepared silver sulphide was found by C. J. B. Karsten to be 6.8501; H. Dauber found 7.269 and 7.317 for argentite; and for acanthite, 7.164 to 7.326; while C. A. Kennigott found 7.31 to 7.36; and A. Breithaupt gave 7.02 for daleminzite. The **hardness** is about 2. In illustration of the **malleability** of silver sulphide, J. J. Berzelius related that Augustus, King of Poland, caused pieces of native silver sulphide from the Saxony mines to be struck into medals. M. Bellati and S. Lussana found the **specific heat** between 75° and 220° to be 0.0891; and at 100° , 0.0786; A. Sella gave 0.0746; while W. A. Tilden found the sp. ht. between -182° and 15° to be 0.0568; between 15° and 100° , 0.0737; and between 15° and 324° , 0.0903. E. Madelung and R. Fuchs gave 3.00×10^{12} dynes per sq. cm. for the **compressibility** of argentite. H. Pélabon gave 825° for the **melting point** of silver sulphide; F. M. Jäger and H. S. van Klooster gave 842° ; W. Truthe, 834° ; G. G. Urazoff, 842° ; C. Sandonnini, 836° ; and the latter found the f.p. to be not much higher than 812° . The fusion curve is shown in Fig. 19. F. M. Jäger says that silver sulphide dissociated perceptibly at 950° . O. Mügge found an appreciable softening occurs when the silver sulphide is heated to 200° . K. Friedrich, and W. Truthe found the **transition point** from the rhombic to the cubic form is 175° , C. Sandonnini gave 178° ; F. M. Jäger and H. S. van Klooster, 179° . According to G. G. Urazoff, solid silver sulphide shows transition points at 576° , 175° , and 110° . The first modification forms solid soln. with up to 0.5 per cent. of silver, and this product breaks down, as the temp. is lowered, and passes through the other critical points. There is also a discontinuity in the electrical resistance at the transition point. P. W. Bridgman found that the transformation is accompanied by a very small change in vol.—less than 0.0002 c.c. per gm.

V. Kohlschütter and E. Eydmann say that silver sulphide does not sublime between 350° and 400° , but in sulphur vapour or in hydrogen sulphide the product rapidly re-crystallizes—*vide* moss silver.

The **heat of formation** of silver sulphide from the solid elements is $2\text{Ag} + \text{S} = \text{Ag}_2\text{S} + 3.0$ Cals. according to M. Berthelot, and 5.34 Cals. according to J. Thomsen.⁵ The former also gives $2\text{Ag}_{\text{solid}} + \text{H}_2\text{S}_{\text{gas}} = \text{Ag}_2\text{S} + \text{H}_{2\text{gas}} - 1.6$ Cals.; and $\text{Ag}_2\text{O} + \text{H}_2\text{S}_{\text{soln.}} = \text{Ag}_2\text{S} + \text{H}_2\text{O}_{\text{liq.}} + 27.9$ Cals. J. Thomsen found for $2\text{AgNO}_{3\text{aq.}} + \text{H}_2\text{S}_{\text{aq.}} = 47.63$ Cals., and P. A. Favre and J. T. Silbermann, 57.52 Cals. W. A. Felsing calculated the **free energy** decrease at the transition temp. 448°K. to be -630 cal.

A. de Gramont⁶ found the **spark spectrum** of argentite is characterized by the intensity of two green silver-lines, only comparable with the thallium-line, and stronger than the copper-line; there are also other silver lines present without special characteristics. There is also a group of sulphur-lines in the red, green, and blue parts of the spectrum; and diffuse and scarcely visible lines in the violet where they are mixed with iron-lines. Some zinc-lines are also visible. O. Rohde, and K. Herrmann have studied the **photoelectric effect** of silver sulphide. G. Chaperon and E. Mercadier, and H. Rigollot found that silver sulphide is sensitive to luminous or ultra-violet radiations, and it can serve as an *actinometre électrochimique*. Like selenium, it has a low electrical conductivity in the dark and a higher one in light. W. W. Coblenz and H. Kohler found a change in the electrical resistance of argentite when exposed to light, from 0.6μ in the visible spectrum to 3μ in the infra-red. G. Césaro said that argentite is a non-conductor, but others find it to be a conductor of electricity, but not so much as acanthite.

F. Beijerinck says that the decrease in the **electrical resistance** with decrease of temp. is more marked at a low temp. than at a higher temp.; at 180° the resistance is approximately a thousand times smaller than at 80°. K. Bädeker found that the passage of the current at room temp. is attended by decomposition and polarization, but not so at 220°; the sp. resistance at 200° is 0·0017 (when that of copper is 0·000017). There is a marked jump in the conductivity near the transition point 175°. V. Kohlschütter and H. Stäger studied the electrolysis of sulphide soln. with anodes of silver sulphide. C. Tubandt found solid silver sulphide conducts electrolytically above 180°, the silver ions carry the current with an ionic velocity of 0·11 cm. per sec. F. Streintz noted the high temp. coeff. of the conductivity of silver sulphide. W. Mönch made observations on this subject. S. von Laszcynsky and S. von Gorsky found that a soln. of silver sulphide in pyridine is a non-conductor. F. Streintz studied the unipolar conductivity of silver sulphide. C. Tubandt also measured the conductivity of the crystalline solid. A. A. Noyes and E. S. Freed, and G. Trümpler studied the e.m.f. of silver sulphide cells; and the last-named measured the e.m.f. against sodium sulphide.

According to R. Lucas,⁷ the **solubility** of silver sulphide in water is smaller than that of silver iodide. The solubility is so small that the estimates that have been made are not in agreement. O. Weigel estimated the constant to be $0\cdot552 \times 10^{-6}$ mol per litre at 18°; W. Biltz, $0\cdot8 \times 10^{-6}$ between 16° and 18°; and J. Knox, $2\cdot2 \times 10^{-17}$, at 25°, if complete ionization occurs, and $4\cdot3 \times 10^{-17}$ from the conc. of the silver ions in a sat. soln.

Chemical properties of silver sulphide.—Silver sulphide is permanent in a dry or moist atm. at ordinary temp. whether in light or in darkness; and J. Percy⁸ showed that this applies even when the silver sulphide is finely powdered. A. Beutell found that when natural or artificial silver sulphide is heated in an evacuated tube for several days between 350° and 600°, some decomposition occurs; and a little silver is formed which seems to wander through the silver sulphide, appearing at the cooler end of the tube as filiform silver (*q.v.*). Neither silver foil nor filiform silver is attacked by sulphur vapour in vacuo at 450° for 48 hrs. Silver foil alone in vacuo at 450°–585° showed no trace of the formation of filiform silver, but silver and silver sulphide heated together at 450° furnishes filiform silver. The action of heat on silver sulphide was studied by M. Wasjuchnowa. When silver sulphide is heated in atm. air, silver and sulphur dioxide are formed. D. Larranga, F. de la Garza, A. V. Ezpeleta and J. M. Peimger, and P. Berthier state that if roasted at a low temp. some silver sulphate is formed, but J. Percy failed to confirm this at the lowest temp. at which any change occurs.

F. Krafft and L. Merz found that in vacuo in the cathode light, silver sulphide decomposes at a low temp. into silver and sulphur. V. Kohlschütter ascertained that silver sulphide is reduced by exposure to canal rays, even when hydrogen is absent. K. Friedrich and A. Leroux did not detect any appreciable action when silver sulphide is exposed to the radiations from radium bromide, but O. Mügge said that there is a slight action. K. Friedrich and A. Leroux found argentite is decomposed by exposure to sun-light or the arc-light, and the decomposition is the more marked the more intense the light. O. Mügge also found polished surfaces of natural or artificial silver sulphide become covered with a fine dust when exposed to conc. solar light; but the attack is very slight in an indifferent atm. At the high temp. of an electric furnace, A. Mourlot found that silver sulphide melts and is readily reduced, and the condensed drops of volatilized metal contain traces of sulphur. According to A. de Gramont, when argentite is exposed to electric sparks, it acquires a black coating—possibly metallic silver.

H. Rose⁹ heated silver sulphide in a stream of **hydrogen** and observed that hydrogen sulphide is evolved, and that the silver separates in delicate hair-like fibres. S. Hauser gave 260°–276° for the temp. of the reaction. According to V. Kohlschütter and E. Eydmann, the evolution of hydrogen sulphide can be detected between 200° and 220°. H. Pélabon has studied the equilibrium

conditions in the reaction: $\text{H}_2 + \text{Ag}_2\text{S} \rightleftharpoons \text{H}_2\text{S} + 2\text{Ag}$ in sealed tubes at different temp. Equilibrium is attained the more quickly the higher the temp.; at 360° about 160 hrs. is needed, and at 580° a few moments suffice. The liberated silver occurs in filiform masses only when the temp. is below 580° ; the best samples were obtained by heating crystalline silver sulphide and hydrogen in a sealed tube at 440° . W. S. Felsing studied the equilibrium conditions in the reaction $\text{Ag}_2\text{S} + \text{H}_2 = 2\text{Ag} + \text{H}_2\text{S}$ between 750°K. and 890°K. , and found the equilibrium constant $K = v_{\text{H}_2\text{S}}/v_{\text{H}_2}$ has the value 0.3588 at 749.15°K. ; 0.3155 at 811.25°K. ; and 0.2780 at 889.63°K. The relation of the thermal value of the reaction to the temp. about 448°K. is $3471 - 7.20T$, or 245 cal. at 448°K. , and allowing for 1195 cal. for the increased heat content at the transition temp., the thermal value of the reaction near 298°K. is $3740 - 5.68T$, or 2047 cal. at 298°K. The change in the free energy of the reaction is -1527 cal. at 749.15°K. ; -1861 cal. at 811.25°K. ; and -2265 cal. at 889.63°K. ; and for the decrease in free energy between 448°K. and 890°K. , $-3471 - 7.20T \log_e T + 50.26T$; and from 298°K. to 448°K. , $-3740 - 5.68T \log_e T + 41.58T$. Silver sulphide is reduced by "nascent" hydrogen from iron or zinc and a dil. acid, and P. Laur reduced the sulphide by the action of tin amalgam and a dil. soln. of sodium hydroxide. According to A. Mailfert, silver sulphide is oxidized by **ozone** to free sulphuric acid, etc.

Silver sulphide undergoes no appreciable change in water at ordinary temp., but P. de Clermont and J. Frommel found that when boiled with water, some silver oxide and hydrogen sulphide are formed. According to O. Weigel, a litre of water at 18° dissolves 0.552×10^{-6} mol of silver sulphide. H. V. Regnault found that silver sulphide is reduced to the metal when heated to redness in steam, and there is a marked evolution of hydrogen sulphide. G. Bischof found the reduction occurs at a little below the m.p. of zinc (418°), and the silver is left in hair-like threads exactly resembling capillary or filiform silver. G. Bischof claimed that some sulphuric acid is produced in the reaction, possibly: $4\text{Ag}_2\text{S} + 4\text{H}_2\text{O} = 4\text{Ag}_2 + \text{H}_2\text{SO}_4 + 3\text{H}_2\text{S}$. F. A. Moesta showed that the products vary with the temp. of the reaction, and in his experiments, hydrogen sulphide, sulphur dioxide, and free sulphur escaped from the tube along with the excess of steam. Possibly the sulphur of the sulphide is simultaneously attacked by the water, simultaneously forming hydrogen sulphide and sulphur dioxide. B. Corenwinder found that the passage of sulphur vapour and steam over porous substances gave hydrogen sulphide, but he does not mention the production of sulphur dioxide. Artificial silver sulphide was found to be energetically reduced by steam at 100° , and by heating different parts of a tube of silver sulphide to different temp., it is easy to obtain silver in "tree-, moss-, and wire-like forms, and also in larger pieces." F. A. Moesta found a mixture of sodium chloride and silver sulphide is slowly converted into silver chloride by steam at 100° ; and rapidly if magnesium chloride be substituted for the sodium salt. The reactions are faster at a higher temp., and also if finely powdered iron pyrites be present. In the latter case the increased activity is attributed to the facility with which the sulphur of the pyrites is converted into sulphuric acid.

According to H. Rose,¹⁰ silver sulphide is not acted upon by **chlorine** at ordinary temp., and is attacked but slowly when heated in a stream of that gas, while C. J. B. Karsten stated that chlorine converts the sulphide into chloride at ordinary temp., and that the action takes place more quickly and completely when the sulphide is heated to redness in an atm. of the gas. L. R. von Fellenberg, and J. Percy also found that silver sulphide is changed by chloride into silver chloride, and the action is promoted by a rise of temp. Sulphur chloride is a product of the reaction. P. Jannasch proposed to decompose the argentiferous sulphides by dry air charged with **bromine** vapour. Chlorine water was also found by J. Percy to partially convert silver sulphide into chloride at ordinary temp., and in light; most of the sulphur is simultaneously oxidized to sulphuric acid. F. J. Malaguti and J. Durocher obtained a similar result in darkness. According to K. Heumann,

dil. hydrochloric acid has no appreciable action on old or freshly precipitated silver sulphide; but the conc. acid, particularly if aided by heat, gives off hydrogen sulphide and forms silver chloride, which in part dissolves and in part forms a coating over the sulphide, protecting or impeding further action. F. T. Sonnesehmid studied the combined action of aq. hydrochloric acid and mercury on the Mexican sulphide ores, and found that at ordinary temp. the silver sulphide is completely reduced and the whole of the silver amalgamates with the excess of mercury. Silver chloride is first formed, and this is reduced by the mercury. A. A. Noycs and E. S. Freed calculated the free energy of the reaction: $\text{Ag}_2\text{S} + 2\text{HI}_{\text{aq.}} = 2\text{AgI} + \text{H}_2\text{S}_{\text{aq.}}$, and they found 4070 cal. at 25°.

C. Schnabel found that silver sulphate is formed when silver sulphide is heated with sulphur trioxide. According to J. Percy, silver sulphide is said to be decomposed by conc. sulphuric acid with the formation of silver sulphate and free sulphur; but it is not acted on when boiled with sulphuric acid diluted with three or four times its vol. of water. According to T. Gross, when silver sulphide is brought into contact with a platinum cathode in dil. sulphuric acid, it is converted into a grey mass, the gas evolved from the cathode yields, with silver nitrate soln., a greyish-black precipitate consisting of glistening plates. A similar precipitate is obtained by treating silver nitrate with electrolyzed sulphuric acid. Both precipitates differ from silver sulphide, Ag_2S , in properties, but their compositions have not been determined. According to P. Berthier, and A. Guérout, silver sulphide is not soluble in sulphurous acid. A. Potilitzin found that when heated with an eq. quantity of selenium, between 600° and 700°, about 68 per cent. of the sulphur is displaced. According to H. Feigel, a benzene soln. of sulphur chloride converts silver sulphide into a mixture of silver chloride and sulphide.

J. Percy¹¹ has studied the formation of silver chloride from the sulphide, chiefly with the object of understanding the Mexican amalgamation process. When silver sulphide is treated with sodium chloride, air, and water at ordinary temp., no silver chloride is formed, but when silver sulphide is treated with cupric chloride, air, and water at ordinary temp., silver chloride and cupric oxychloride are formed, with the separation of free sulphur and sulphuric acid. It is assumed that the first reaction: $\text{Ag}_2\text{S} + 2\text{CuCl}_2 = 2\text{AgCl} + 2\text{CuCl} + \text{S}$, is followed by $2\text{Ag}_2\text{S} + 8\text{CuCl} + 3\text{O}_2 + 6\text{H}_2\text{O} = 4\text{AgCl} + 2\{\text{CuCl}_2 \cdot 3\text{Cu}(\text{OH})_2\} + 2\text{S}$. J. B. J. D. Boussingault believed an aq. soln. of cupric chloride has no action on silver sulphide, but immediately sodium chloride is added decomposition begins, and it continues until all the silver is converted into chloride. C. J. B. Karsten made a similar observation, and added that an ammoniacal soln. of cupric or cuprous chloride likewise has no action on silver sulphide, but a reaction does occur if sodium chloride be present. F. J. Malaguti and J. Durocher claimed, like J. Percy, that the presence of sodium chloride is not necessary for the reaction between silver sulphide and cupric chloride. J. Percy also found that when a conc. aq. soln. of cupric chloride in excess is boiled with silver sulphide, the latter is rapidly converted into chloride; the action is not appreciably accelerated if a stream of air is passed through the boiling liquid—sulphur is liberated during the reaction, and a little sulphuric acid is formed. If a mixture of silver sulphide and cuprous chloride is boiled, while a stream of air is passed through the mixture, only a little silver chloride is formed. This is explained by the insolubility of both substances in water. When silver sulphide is exposed to the action of cupric and sodium chlorides, air, and water at ordinary temp., silver chloride is formed and sulphur is set free. C. J. B. Karsten found a soln. of cupric and sodium chlorides decomposes stephanite, red silver ore, and fahlerz in the course of a few days—the last-named mineral is attacked the most slowly—cuprous and silver chlorides are formed. If cuprous chloride be substituted for cupric chloride, the silver sulphide behaves in a similar way—the cuprous chloride is soluble in the soln. of sodium chloride. If air be excluded, not a trace of silver chloride is formed, so that oxygen plays an essential part in the conversion of silver sulphide to the chloride by cuprous chloride and a soln. of sodium chloride. F. J. Malaguti and

J. Durocher state that in air some silver is formed. If cupric sulphate is substituted for cupric chloride similar results are obtained; cupric chloride and sodium sulphate are first produced, and the former then reacts with silver sulphide as before. Silver sulphide, basic ferric sulphate, sodium chloride, and water, react at ordinary temp., and silver chloride is formed. Air is not needed for the reaction. According to F. J. Malaguti and J. Durocher, ferric sulphate alone has no action on silver sulphide; while, according to J. Guillemin, ferric sulphate has been successfully used at Tetela del Ora as a substitute for cupric sulphate in the Mexican amalgamation process. If ferrous sulphate be employed in place of the basic ferric sulphate, silver chloride is produced only when atm. air has access.

According to F. J. Malaguti and J. Durocher, pyrargyrite behaves like silver sulphide with a soln. of cupric chloride; and when air is present, "sulphuric acid and a mixed deposit of silver chloride and cupric oxychloride are formed; the antimony passes into soln. from which it can be precipitated along with the copper by a plate of zinc." Proustite is less energetically attacked than pyrargyrite. The presence of sodium chloride does not promote the formation of silver chloride as it does in the case of the simple sulphide. Sodium chloride inhibits the reaction with proustite. Argentiferous galena, cuprous chloride, air, and water, form cupric oxychloride, lead chloride, and cupric sulphate--some silver chloride was produced at the end of three months' action. Similar experiments were made with argentiferous blende, and argentiferous iron, or copper pyrites.

Silver sulphide dissolves in the **alkali sulphides**—*vide infra* for the resulting double sulphides—and J. Knox¹² found that at 25° 0.1 mol of sodium sulphide in *N*-soln. contains 6.3×10^{-24} gram-ions of silver per litre when sat. with silver sulphide. The blackening of silver by hydrogen sulphide or soluble sulphides has been studied by F. H. Hahn—*vide silver*. J. Percy found silver sulphide to be insoluble in an aq. soln. of **sodium thiosulphate**. P. N. Gredy found silver sulphide dissolves in conc. **nitric acid**, with the separation of sulphur. H. Gruener found that the proportions of silver nitrate and sulphate formed during the reaction vary widely with the conc., temp., and time. Silver sulphide is rapidly dissolved by nitric acid when the conc. exceeds 5 per cent. Very conc. nitric acid yields silver sulphate alone, while acid of lower conc. forms some nitrate in proportion to its dilution: thus, 20–21 per cent. acid yields the maximum proportion of silver nitrate—about 95 per cent.—and a more dil. acid again results in a smaller percentage of nitrate. Heating the acid or prolonging its time of action is unfavourable to the formation of nitrate. According to P. N. Gredy, silver sulphide is not soluble in aq. soln. of **ammonia** or **ammonium carbonate**. P. N. Gredy found aq. ammonia dissolves some silver sulphide, if it has been simultaneously precipitated with silver chloride; and, according to E. C. Franklin and C. A. Kraus, silver sulphide is not soluble in liquid ammonia. N. D. Costeanu did not observe any reaction with **carbon dioxide**. F. H. Hahn found that silver sulphide dissolves in **hydrocyanic acid**, and the soln. gives a black precipitate when treated with an excess of potassium sulphide, a violet coloration with nitroprusside, and, with hydrochloric acid, silver chloride is precipitated. W. Skey found silver sulphide to be soluble in aq. soln. of **potassium cyanide**. R. Lucas represented the reaction: $\text{Ag}_2\text{S} + 6\text{KCy} + \text{H}_2\text{O} = \text{KSH} + \text{KOH} + 2\text{K}_2\text{AgCy}_3$; but E. Kühn found that more silver is dissolved than corresponds with this equation, and C. Göpner represented the reaction: $\text{Ag}_2\text{S} + 4\text{KCy} = \text{K}_2\text{S} + 2\text{KAgCy}_2$. J. Percy found that five-sixths of the silver is reduced by fusing silver sulphide with potassium cyanide, the remaining silver remains in combination with the resulting alkali sulphide.

According to J. Percy,¹³ silver sulphide is not affected by trituration with **iron** powder, dry, or in the presence of cold or hot water; but if hydrochloric acid be present, hydrogen sulphide and silver are liberated; similar results are obtained with **zinc**. F. J. Malaguti and J. Durocher reduced silver sulphide by iron in a soln. of alum, or of ferrous or cupric sulphate at 100°. In the last case the reaction must be complicated by the separation of copper. Iron completely reduces silver sulphide at a red heat, with the formation of iron sulphide; prolonged fusion, stirring, and an excess of iron are needed for the completion of the reaction. Iron

does not separate the silver completely from the double sulphide of copper and iron. Silver sulphide is not completely reduced when heated with an excess of copper; the regulus formed contains silver, and the silver alloys with the copper. J. Percy said that silver sulphide is reduced by shaking it with precipitated copper in water, but F. J. Malaguti and J. Durocher say that copper has no action on silver sulphide even in water at 100° provided the sulphide is thoroughly freed from acid; they also report that silver sulphide is more easily reduced by copper than by iron, in water containing alum, or cupric or ferrous sulphate at 100°. When cuprous oxide is used in place of copper, a smaller amount of silver is reduced in the case of alum and cupric sulphate, but a larger amount in the case of ferrous sulphate. Similar experiments were made on pyrrargyrite, and on proustite. Expressing the amount of silver reduced in hundredths of the amount of silver in the sulphide:

	Alum	CuSO ₄	FeSO ₄
Copper and argentite	83·39	83·39	28·44
Copper and pyrrargyrite	71·0	71·0	8·8
Cu ₂ O and proustite	22·0	43·0	17·8

Possibly an insoluble basic ferric sulphate was formed in the case of ferrous sulphate. Silver sulphide is not completely reduced when heated with lead in excess, since the regulus contains silver, and the silver which separates alloys with the excess of lead.

Silver sulphide is decomposed when triturated with mercury even at ordinary temp., and if the mercury be in excess, silver amalgam is formed: $\text{Ag}_2\text{S} + \text{Hg} = \text{HgS} + 2\text{Ag}$. F. J. Malaguti and J. Durocher reported that mercury reduces silver sulphide, native or artificial, more rapidly than the chloride. The presence of alum or of ferrous or cupric sulphate greatly promotes the reducing action of mercury on silver sulphide. With mercury alone unity, the relative proportions of silver extracted by mercury with the aid of these salts is:

	Alum	FeSO ₄	CuSO ₄
Mercury and silver sulphide	1·34	1·80	28·3

The action on pyrrargyrite and proustite is slower than in the case of argentite. There are some native sulphides which contain a considerable proportion of silver sulphide but from which no silver, or only a small proportion of the total, can be extracted by treatment with an excess of mercury. Thus, of ten samples of galena from different localities, that from Sala (Sweden), with 0·8 per cent. of silver, yielded about 18 per cent. of its silver; that from Giromagny, with 0·05 per cent. of silver, yielded about 17 per cent. even though the former is 16 times richer in silver than the latter; none of the other eight samples yielded any silver to the mercury during 960 hrs.' contact. Hence, added F. J. Malaguti and J. Durocher:

Il semble donc que les galènes dociles à l'amalgamation renferment l'argent sous forme de sulfure dont une partie au moins se trouve à l'état de mélange, tandis que les galènes qui ne cèdent rein au mercure renferment probablement le sulfure d'argent à l'état de combinaison.

Similar results were obtained with argentiferous blende, iron pyrites, and grey copper ore. R. Segura found the amalgamation occurs much more readily when the amount of water is just sufficient to make the mixture into a paste and is not in excess. V. Kohlschütter and E. Eydmann found mercury vapour passed in a stream of carbon dioxide over heated silver sulphide reduces it more slowly than hydrogen.

A boiling soln. of potassium hydroxide transforms silver sulphide into oxide. J. Percy found that the fusion of silver sulphide with four times its weight of potassium hydroxide reduced 88·7 per cent. of the silver, in about 30 mins. at dull redness; similar results were obtained by fusion with sodium carbonate. With a longer action and a higher temp. the yield was greater. Silver sulphide is not

soluble in an aq. soln. of sodium or potassium carbonate. No reaction is observed when silver sulphide is heated with **calcium oxide**. When silver sulphide is fused with **alkali chloride** in the presence of air, part is decomposed, forming silver chloride and sodium sulphate, and part is resolved into silver and sulphur dioxide. It is possible also that the alkali chloride acts on some of the metallic silver liberated during the reaction.

Silver sulphide is not soluble in aq. soln. of potassium or sodium chloride. When a mixture of silver sulphide and **silver oxide** is heated, the compounds are mutually reduced: $\text{Ag}_2\text{S} + 2\text{Ag}_2\text{O} = 6\text{Ag} + \text{SO}_2$; **lead oxide** behaved similarly and an alloy of lead and silver was produced. If the lead oxide be in large excess, no sulphate was detected in the products of the reaction. Similar results were obtained with **copper oxide**. When a mixture of **silver sulphate** and sulphide is fused, the reaction is symbolized: $\text{Ag}_2\text{S} + \text{Ag}_2\text{SO}_4 = 4\text{Ag} + 2\text{SO}_2$. J. Percy also found silver sulphide is not oxidized by heating it with **sodium sulphate**; **potassium nitrate** forms potassium sulphate and all the silver separates as metal; a violent reaction occurs with **potassium chlorate**, and about one-third of the sulphide is reduced to silver: $3\text{Ag}_2\text{S} + 4\text{KClO}_3 = 2\text{Ag} + 4\text{AgCl} + 2\text{K}_2\text{SO}_4 + \text{SO}_2 + \text{O}_2$. A boiling soln. of potassium chlorate has no action on silver sulphide. Silver sulphide dissolves in fused borax and in microcosmic salt, colouring the masses red. As previously indicated, C. J. B. Karsten found silver sulphide is not decomposed by a soln. of **cupric chloride**, but J. B. J. D. Boussingault observed that cupric sulphide and silver chloride are formed if the soln. of cupric chloride contains some sodium chloride. C. Schnabel reported that solid cupric chloride is reduced to cuprous chloride by silver sulphide. A. Levallois found that **lead chloride** decomposes silver sulphide: $\text{Ag}_2\text{S} + \text{PbCl}_2 = \text{PbS} + 2\text{AgCl}$. According to W. H. F. Wackenroder, silver sulphide is insoluble in a soln. of **mercuric nitrate**; and H. C. Bolton found that it dissolves in **citric acid** containing a little potassium nitrate.

Silver sulphide is stated by E. Waterton¹⁴ to have been used for the preparation of a black substance used in ancient times for inlaying silver and other jewels—*argenterie niellée*—in the so-called *niello* work described by Theophilus, and others.

J. J. Berzelius¹⁵ emphasized the basic character of silver sulphide, in that it forms a number of double salts with other sulphides. P. Berthier stated that silver sulphide is soluble in fused alkali sulphides in all proportions, and it combines *par voie sèche* with most of the metal sulphides. According to A. Ditte, silver sulphide changes its colour when kept in darkness in contact with a cold sat. soln. of sodium sulphide, Na_2S ; and if the liquid is warmed whereby its conc. increases, a stage is reached when a mass of red crystals suddenly appears. The crystals are rapidly filtered from the mother liquid, and dried on porous tiles. Their composition is then **silver sodium sulphide**, $\text{Na}_2\text{S} \cdot 3\text{Ag}_2\text{S} \cdot 2\text{H}_2\text{O}$. The crystals are immediately decomposed by water, or by a sat. soln. of sodium sulphide, with the formation of black silver sulphide. A. Ditte also prepared **potassium silver sulphide**, $\text{K}_2\text{S} \cdot 4\text{Ag}_2\text{S} \cdot \text{H}_2\text{O}$, in a similar way. A. C. Becquerel prepared crystals of a potassium silver sulphide of unknown composition by the galvanic decomposition of silver nitrate and potassium sulphide.

According to G. Rose, dark steel-grey rhombic crystals of *stromeyerite* with axial ratios $a : b : c = 0.5822 : 1 : 0.9668$ occur in nature. According to the analyses of F. Stromeyer, T. Sander, W. J. Taylor, and I. Domeyko, their composition corresponds with **cupric silver sulphide**, $(\text{Cu}, \text{Ag}_2)\text{S}$, up to half of the copper in chalcosine being replaced by silver. Their sp. gr. is 6.2–6.3; and hardness 2–3. Another variety of this salt occurs in cubical crystals of *jalpaite*, $(\text{Cu}, \text{Ag}_2)\text{S}$, with a sp. gr. 6.88–6.89, and hardness less than 3. They were analyzed by A. Breithaupt, and E. Bertrand. K. Friedrich's thermal analyses of mixtures of cuprous and silver sulphides do not show the existence of any compounds. The fusion curve is of the U-form, falling from the m.p. of cuprous sulphide at 1121° , to a minimum at 677° , rising again to 835° , the m.p. of silver sulphide.

Silver disulphide, Ag_2S_2 .—The rise in the f.p. of mixtures of silver sulphide with increasing proportions of sulphur, points to the existence of higher sulphides. A. Hantzsch¹⁶ prepared silver disulphide by adding a soln. of sulphur in carbon disulphide to a soln. of silver nitrate in benzonitrile; the precipitate, after remaining for 24 hrs. in a closed flask, is washed with benzonitrile and carbon disulphide, and then with alcohol and ether, and quickly dried on a porous plate. It is a brown amorphous powder which oxidizes very rapidly when damp, yields a soln. of silver sulphate when shaken with water, and does not lose sulphur when extracted with carbon disulphide; it melts to a red liquid when heated, and then gives off sulphur and sulphurous anhydride, leaving a residue of metallic silver. When treated with dil. hydrochloric acid, it yields sulphur, hydrogen sulphide, and silver chloride, whilst nitric acid dissolves it with liberation of sulphur. Silver disulphide can only be prepared from a soln. of benzonitrile; when other solvents are used, silver sulphide is obtained.

REFERENCES.

¹ G. Agriola, *Bermannus*, Basil, 438, 1529; 692, 1657; *Interpretatio Germanica*, Basil, 463, 1546; J. G. Wallerius, *Mineralogia*, Stockholm, 394, 1750; J. B. L. Romé de l'Isle, *Cristallographie*, Paris, 3, 440, 1783; K. C. Leonhard, *Handbuch der Oryktognosie*, Heidelberg, 196, 1821; F. S. Beudant, *Traité élémentaire de minéralogie*, Paris, 2, 392, 1832; W. Haidinger, *Handbuch der bestimmenden Mineralogie*, Wien, 565, 1845; L. Erker, *Probirkunst*, Frankfurt, 3, 1598; J. F. Henkel, *Pyritologia, oder Kiess-Historie*, Leipzig, 1725; B. G. Sage, *Ann. Chim. Phys.*, (1), 3, 250, 1779; M. H. Klaproth, *Beiträge zur chemischen Kenntniss der Mineralkörper*, Berlin, 1, 160, 1795.

² J. Margottet, *Compt. Rend.*, 85, 1142, 1877; H. St. C. Deville and L. Troost, *ib.*, 52, 920, 1861; A. C. Bequerel, *ib.*, 44, 938, 1857; H. Pélabon, *ib.*, 143, 294, 1906; J. Durocher, *ib.*, 32, 825, 1851; E. Filhol and J. B. Senderens, *ib.*, 93, 152, 1881; A. Colson, *ib.*, 148, 1183, 1909; J. Fogh, *ib.*, 110, 709, 1890; J. B. Senderens, *ib.*, 104, 58, 1887; *Bull. Soc. Chim.*, (3), 6, 800, 1891; K. Preis and B. Raymann, *ib.*, (2), 47, 892, 1887; J. S. Stas, *Bull. Acad. Belgique*, (2), 9, 253, 1860; W. Spring, *ib.*, (3), 5, 402, 1883; *Ber.*, 16, 324, 999, 1883; 17, 1218, 1884; W. Hallock, *Amer. Journ. Science*, (3), 34, 277, 1887; J. Johnson and L. H. Adams, *ib.*, (4), 35, 205, 1913; F. Rössler, *Zeit. anorg. Chem.*, 9, 31, 1895; V. Stanek, *ib.*, 17, 117, 1898; G. Strüver, *Atti Accad. Lincei*, (5), 10, i, 233, 1901; *Centr. Min.*, 401, 1901; A. Beutell, *ib.*, 758, 1913; E. Obaeh, *Journ. prakt. Chem.*, (2), 18, 258, 1875; (2), 26, 281, 1882; C. Geitner, *Liebig's Ann.*, 129, 358, 1864; A. Geuther, *ib.*, 226, 232, 1884; E. Priwoznik, *ib.*, 164, 46, 1872; K. Preis, *ib.*, 257, 178, 1890; V. Kohlshütter and E. Eydmann, *ib.*, 390, 347, 1912; L. Bruner and J. Zawadzsky, *Anz. Akad. Cracow*, 267, 1909; M. Raffo and A. Pironi, *Zeit. Koll.*, 7, 153, 1910; P. Berthier, *Traité des essais par la voie sèche*, Liège, 2, 668, 1847; J. Percy, *Silver and Gold*, London, 1, 25, 1880; W. Hampe, *Chem. Ztg.*, 17, 1693, 1893; F. M. Jäger, *Versl. Akad. Amsterdam*, 20, 497, 1911; F. M. Jäger and H. S. van Klooster, *Zeit. anorg. Chem.*, 78, 248, 1912; K. Friedrich and A. Leroux, *Mét.*, 3, 363, 1906; J. M. Caball, *Chem. News*, 50, 208, 1884; J. L. Proust, *Journ. Phys.*, 62, 211, 1806; J. B. A. Dumas, *Ann. Chim. Phys.*, (3), 55, 147, 1859; J. Uhl, *Ber.*, 23, 2151, 1890; W. Vaubel, *ib.*, 22, 1686, 1889; G. Vortmann and C. Padberg, *ib.*, 22, 2642, 1889; I. Block and F. Höhn, *ib.*, 41, 1971, 1908; A. Orłowsky, *ib.*, 14, 2823, 1881; E. Weinschenk, *Zeit. Kryst.*, 17, 497, 1890; J. Girard, *Ann. Chim. Anal. App.*, 5, 56, 1900; J. W. Langley, *Zeit. phys. Chem.*, 2, 83, 1888; F. Faktor, *Zeit. anal. Chem.*, 39, 345, 1900; G. G. Urazoff, *Ann. Inst. Polyt. St. Petersburg*, 23, 593, 1915; H. Vogel, *Neues Repert. Pharm.*, 12, 393, 1864; O. von der Pfordten, *Ber.*, 20, 1458, 1887; A. Guntz, *Compt. Rend.*, 112, 861, 1891; C. C. Bisset, *Journ. Chem. Soc.*, 105, 1223, 1914.

³ C. Paal and F. Voss, *Ber.*, 37, 3862, 1904; A. Lottermoser, *Journ. prakt. Chem.*, (2), 72, 39, 1905; C. Winssinger, *Bull. Acad. Belgique*, (3), 15, 390, 1888; S. Odén, *Nova Acta Upsala*, (4), 3, 4, 1913; J. Lefort and P. Thibault, *Journ. Pharm. Chim.*, (5), 6, 169, 1882; E. Stiasny, *Gerber*, 33, 124, 1907; A. Pironi, *Gazz. Chim. Ital.*, 43, i, 198, 1913; S. E. Linder and H. Pieton, *Journ. Chem. Soc.*, 61, 114, 1892; F. V. von Hahn, *Koll. Zeit.*, 27, 172, 1920; *ib.* 29, 139, 1921; H. Freundlich and A. Nathanson, *Koll. Zeit.*, 29, 16, 1921.

⁴ H. Rose, *Pogg. Ann.*, 15, 584, 1829; 28, 156, 1833; G. Rose, *Elemente der Krystallographie*, Berlin, 157, 1833; *Das krystallochemische Mineralsystem*, Leipzig, 48, 1852; C. A. Kennigott, *Sitzber. Akad. Wien*, 15, 238, 1855; H. Dauber, *ib.*, 39, 685, 1860; C. J. B. Karsten, *Schweigger's Journ.*, 65, 394, 1832; A. Breithaupt, *Berg. Hütt. Ztg.*, 21, 93, 1862; 22, 44, 1863; P. W. Bridgman, *Proc. Amer. Acad.*, 52, 91, 1916; E. Madelung and R. Fuchs, *Ann. Physik*, (4), 65, 299, 1921; H. Schröder, *Neues Jahrb. Min.*, 473, 1875; O. Mügge, *ib.*, ii, 9, 1913; K. Friedrich, *Mét.*, 5, 123, 1908; K. Friedrich and A. Leroux, *ib.*, 3, 363, 1906; C. Sándonnini, *Atti Accad. Lincei*, (5), 21, i, 480, 1912; W. Truthe, *Zeit. anorg. Chem.*, 76, 173, 1912; F. M. Jäger and H. S. van Klooster, *ib.*, 78, 248, 1912; F. M. Jäger, *Versl. Akad. Amsterdam*, 20, 497, 1911; V. Kohlshütter and E. Eydmann, *Liebig's Ann.*, 390, 347, 1912; H. Pélabon, *Compt. Rend.*,

137. 920, 1903; 143. 294, 1906; M. Bellati and S. Lussana, *Atti Ist. Veneto*, (6), 7. 1051, 1889; *Zeit. phys. Chem.*, 5. 282, 1890; W. A. Tilden, *Proc. Roy. Soc.*, 71. 220, 1903; *Phil. Trans.*, 201. A, 37, 1903; F. Streintz, *Boltzmann's Festschrift*, 196, 1904; A. Sella, *Gött. Nachr.*, 311, 1891; J. J. Berzelius, *Traité de chimie*, Paris, 2. 482, 1846; G. G. Urazoff, *Ann. Inst. Polyt. St. Petersburg*, 23. 593, 1915; A. Beutell, *Centr. Min.*, 14, 1919.
- ⁵ J. Thomsen, *Journ. prakt. Chem.*, (2), 19. 1. 1879; *Thermochemische Untersuchungen*, Leipzig, 3. 381, 1883; M. Berthelot, *Compt. Rend.*, 78. 1175, 1874; P. A. Favre and J. T. Silbermann, *Ann. Chim. Phys.*, (3), 37. 471, 1853; W. A. Felsing, *The Equilibrium of the Reaction: Ag₂S + H₂ = 2Ag + H₂S*, Massachusetts, 1918.
- ⁶ A. de Gramont, *Bull. Soc. Min.*, 18. 238, 1895; F. Beijerinck, *Neucs Jahrb. Min. B. B.*, 11. 439, 1897; O. Rohde, *Ann. Physik*, (4), 19. 935, 1906; K. Herrmann, *Beiträge zum Hallwachsseffekt*, Berlin, 1908; F. Streintz, *Boltzmann's Festschrift*, 196, 1904; *Phys. Zeit.*, 13. 673, 1912; 21. 367, 1920; K. Bädcker, *Ann. Physik*, (4), 22. 749, 1907; *Ueber die elektrische Leitfähigkeit und die thermoelastische Kraft einiger Schwermetallverbindungen*, Leipzig, 1906; W. Mönch, *Ueber die elektrische Leitfähigkeit von Kupfersulfür, Silber-, Blei-, und schwarzen Quecksilbersulfid*, Stuttgart, 1905; S. von Laszcynsky and S. von Gorsky, *Zeit. Elektrochem.*, 4. 290, 1897; W. W. Coblenz, *Journ. Amer. Opt. Soc.*, 4. 249, 1920; C. Tubandt, *Zeit. anorg. Chem.*, 115. 105, 1920; 117. 1, 48, 1921; G. Césaró, *Bull. Acad. Belgique*, 115, 1904; *Zeit. Kryst.*, 42. 200, 1907; W. W. Coblenz and H. Kohler, *Bull. Bur. Standards*, 15. 231, 1919; H. Rigollot, *Compt. Rend.*, 121. 164, 1895; G. Chaperon and E. Mercadier, *Compt. Rend.*, 106. 1595, 1888; A. A. Noyes and E. S. Freed, *Journ. Amer. Chem. Soc.*, 42. 476, 1920; G. Trümpler, *Zeit. phys. Chem.* 99. 9, 1921; V. Kohlschütter and H. Stäger, *Helvetica Chim. Acta*, 4. 821, 1921.
- ⁷ R. Lucas, *Zeit. anorg. Chem.*, 41. 193, 1904; W. Biltz, *Zeit. phys. Chem.*, 58. 288, 1907; O. Weigel, *ib.*, 58. 593, 1907; J. Knox, *Trans. Faraday Soc.*, 4. 48, 1908.
- ⁸ J. Percy, *Silver and Gold*, London, 1. 27, 1880; P. Berthier, *Traité des essais par la voie sèche*, Liège, 2. 668, 1847; D. Larranga, F. de la Garza, A. V. Ezpeleta, and J. M. Peiminger, *Gilbert's Ann.*, 22. 304, 1806; F. Krafft and L. Merz, *Ber.*, 40. 4775, 1908; A. Mourlot, *Compt. Rend.*, 124. 768, 1897; K. Friedrich and A. Leroux, *Met.*, 3. 363, 1906; V. Kohlschütter, *Zeit. Elektrochem.*, 17. 393, 1906; O. Mügge, *Neues Jahrb. Min.*, ii, 9, 1913; C. A. Münster, *ib.*, ii, 77, 1898; A. de Gramont, *Compt. Rend.*, 145. 231, 1907; A. Beutell, *Centr. Min.*, 14, 1919; M. Wasjuchnowa, *Das Gleichgewicht Cupri-Cuprosulfid*, Berlin, 1909.
- ⁹ V. Kohlschütter and E. Eydmann, *Liebig's Ann.*, 390. 347, 1912; H. Rose, *Pogg. Ann.*, 42. 540, 1837; H. Pélabon, *Compt. Rend.*, 126. 1864, 1898; *Bull. Soc. Chim.*, (3), 21. 402, 1898; H. V. Regnault, *Ann. Mines*, (3), 11. 49, 1837; G. Bischof, *Lehrbuch der chemischen und physikalischen Geologie*, Bonn, 2. 2067, 1855; *Pogg. Ann.*, 60. 287, 1843; F. G. Keyes and W. S. Felsing, *Journ. Amer. Chem. Soc.*, 42. 246, 1920; W. S. Felsing, *The Equilibrium of the Reaction: Ag₂S + H₂ = 2Ag + H₂S*, Massachusetts, 1918; S. Hauser, *Ueber Reduktion einiger Metalloxyde durch Gase*, Strassburg, 1907; O. Weigel, *Zeit. phys. Chem.*, 58. 294, 1907; F. C. Phillips, *Journ. Amer. Chem. Soc.*, 16. 700, 1894; W. M. Hutchings, *Chem. News*, 35. 117, 186, 1877; J. H. Collins, *ib.*, 35. 154, 1877; A. Liversidge, *ib.*, 35. 68, 1877; W. Skey, *ib.*, 23. 255, 1871; C. Winkler, *Chem. Ztg.*, 12. 721, 1888; L. Opificius, *ib.*, 12. 649, 1888; A. Gurlt, *Uebersicht der pyrogenen künstlichen Mineralien*, Freiburg, 1857; A. Mailfert, *Compt. Rend.*, 94. 1186, 1882; P. de Clermont and J. Frommel, *ib.*, 127. 330, 1898; *Bull. Soc. Chim.*, (2), 30. 145, 1898; *Ann. Chim. Phys.*, (5), 18. 189, 1878; J. Percy, *Silver and Gold*, London, 1. 28, 1880; B. Corenwinder, *Compt. Rend.*, 53. 140, 1861; P. Laur, *ib.*, 95. 38, 1882; F. A. Moesta, *Ueber das Vorkommen der Chlor-, Brom-, und Jodverbindungen des Silbers in der Natur*, Marburg, 1870.
- ¹⁰ H. Rose, *Pogg. Ann.*, 42. 540, 1837; L. R. von Fellenberg, *ib.*, 50. 72, 1840; C. J. B. Karsten, *System der Metallurgie*, Berlin, 5. 479, 1831; J. Percy, *Silver and Gold*, London, 1. 41, 1880; C. Schnabel, *Handbuch der Metallhüttenkunde*, Berlin, 1. 608, 1901; F. J. Malaguti and J. Durocher, *Recherches sur l'association de l'argent aux minéraux métalliques*, Paris, 247, 1850; F. T. Sonnenschmid, *Beschreibung der spanischen Amalgamation oder Verquickung des in der Erzen verborgenen Silber, so wie sie bey den Bergwerken in Mexiko gebräuchlich ist, mit ausführlicher Darstellung einer neuen Theorie, nach zwölfjährigen practischen Erfahrungen und auf specieller Befehl des General-Tribunals der Bergrwerke von Neuspanien*, Gotha, 332, 1810; P. Berthier, *Traité des essais par la voie sèche*, Liège, 2. 668, 1847; A. Guérout, *Compt. Rend.*, 75. 1276, 1872; N. P. Gerdy, *ib.*, 14. 757, 1842; N. D. Costeau, *ib.*, 156. 1985, 1913; H. Hahn, *Berg. Hütt. Ztg.*, 29. 66, 1870; W. Skey, *Chem. News*, 36. 36, 1877; R. Lucas, *Zeit. anorg. Chem.*, 41. 193, 1904; H. Gruener, *Journ. Amer. Chem. Soc.*, 32. 1030, 1910; A. A. Noyes and E. S. Freed, *ib.*, 42. 476, 1920; E. C. Franklin and C. A. Kraus, *Amer. Chem. Journ.*, 21. 1, 1899; E. Kühn, *Met.*, 8. 434, 464, 1911; C. Göpner, *ib.*, 6. 134, 1909; J. Knox, *Trans. Faraday Soc.*, 4. 48, 1908; T. Gross, *Elektrochem. Zeit.*, 1. 80, 1895; K. Heumann, *Ber.*, 13. 60, 1880; P. Jannasch, *Journ. prakt. Chem.*, (2), 40. 230, 1889; E. S. Freed, *A Thermodynamic Investigation of Reactions involving Silver Sulfide and Silver Iodide*, Massachusetts, 1918; H. Feigl, *Verhalten von Schwermetallverbindungen gegen Polysulfide und Chlorschwefel*, Erlangen, 1905; A. Potilitzin, *Ber.*, 12. 697, 1879.
- ¹¹ J. Percy, *Silver and Gold*, London, 1. 73, 1880; J. B. J. D. Boussingault, *Ann. Chim. Phys.*, (2), 51. 350, 1832; C. J. B. Karsten, *Karsten's Archiv*, (2), 25. 182, 1852; F. J. Malaguti and J. Durocher, *Recherches sur l'association de l'argent aux minéraux métalliques*, Paris, 405, 1850; J. Guillemin, *Bull. Soc. l'Ind. Min.*, 2. 310, 1857; F. L. Hahn, *Zeit. anorg. Chem.*, 99. 118, 1917.

¹² H. Gruener, *Journ. Amer. Chem. Soc.*, 32, 1030, 1910; J. Knox, *Trans. Faraday Soc.*, 4, 48, 1908; P. N. Gredy, *Compt. Rend.*, 14, 757, 1842; N. D. Costeanu, *ib.*, 156, 1985, 1913; E. C. Franklin and C. A. Kraus, *Amer. Chem. Journ.*, 21, 1, 1899; R. Lucas, *Zeit. anorg. Chem.*, 41, 193, 1904; E. Kühn, *Met.*, 8, 434, 464, 1911; C. Göpner, *ib.*, 6, 134, 1909; F. H. Hahn, *Berg. Hütt. Ztg.*, 29, 66, 1870; W. Skey, *Chem. News*, 36, 36, 1877; J. Percy, *Silver and Gold*, London, 1, 73, 1880.

¹³ F. J. Malaguti and J. Durocher, *Recherches sur l'association de l'argent aux minéraux métalliques*, Paris, 412, 1850; J. Percy, *Silver and Gold*, London, 1, 30, 1880; R. Segura, *Chem. News*, 36, 157, 1877; V. Kohlschütter and E. Eydmann, *Liebig's Ann.*, 390, 347, 1912; A. Levallois, *Compt. Rend.*, 96, 1666, 1883; J. B. J. D. Boussingault, *Ann. Chim. Phys.*, (2), 51, 350, 1832; C. J. B. Karsten, *System der Metallurgie*, Berlin, 1831; C. Schnabel, *Handbuch der Metallhüttenkunde*, Berlin, 1, 609, 1901; W. H. F. Wackenroder, *Liebig's Ann.*, 41, 317, 1842; H. C. Bolton, *Chem. News*, 37, 48, 1878.

¹⁴ R. Hendrie, *An Essay on the Various Arts, in three books by Theophilus also called Rugerus, Priest and Monk*, London, 237, 1847; P. Boué, *Traité d'orfèvererie, bijouterie, et joaillerie*, Paris, 1, 284, 1832; E. Waterton, *Trans. Arch. Inst.*, 19, 323, 1862; J. F. L. Hausmann, *Karsten's Archiv.*, 23, 432, 1850.

¹⁵ P. Berthier, *Traité des essais par la voie sèche*, Liège, 2, 668, 1847; J. J. Berzelius, *Liebig's Ann.*, 46, 254, 1843; *Pogg. Ann.*, 7, 150, 1826; A. C. Becquerel, *Compt. Rend.*, 44, 938, 1857; 120, 191, 1895; K. Friedrich, *Met.*, 4, 671, 1907; F. Stromeyer, *Schwigger's Journ.*, 19, 325, 1817; T. Sander, *Pogg. Ann.*, 40, 313, 1837; W. J. Taylor, *Amer. Journ. Science*, (2), 29, 308, 1860; I. Domeyko, *Ann. Mines*, (4), 3, 9, 1843; G. Rose, *Mineralogisch-geognostische Reise nach dem Ural*, Berlin, 1, 536, 1837; A. Breithaupt, *Berg. Hütt. Ztg.*, 17, 85, 1858; E. Bertrand, *Ann. Mines*, (7), 1, 413, 1872; A. Ditte, *Compt. Rend.*, 129, 91, 1895.

¹⁶ A. Hantzsch, *Zeit. anorg. Chem.*, 19, 104, 1898; K. Friedrich and A. Leroux, *Met.*, 3, 363, 1906; H. Pélabon, *Ann. Chim. Phys.*, (8), 17, 526, 1909.

§ 19. Silver Sulphate

The action of sulphuric acid on silver resulting in the formation of silver sulphate has already been discussed. P. Brahmin preferred dissolving silver foil in sulphuric acid containing a few drops of conc. nitric acid. J. S. Stas¹ prepared normal silver sulphate by treating finely divided reduced silver with conc. sulphuric acid, and subsequently expelling the sulphur dioxide by boiling. The salt was washed with water, and heated on a platinum dish to the b.p. of sulphuric acid. It can also be made by evaporating to dryness a soln. of silver nitrate with sulphuric acid; by dissolving silver carbonate in dil. sulphuric acid; or by adding sodium sulphate or sulphuric acid to an aq. soln. of silver nitrate, when silver sulphate is precipitated as a white crystalline powder. A. E. Hill and J. P. Simmons prepared the salt in this way, and dried the washed crystals at 100°; and the preparation of the salt of a high degree of purity is discussed by T. W. Richards and G. Jones. E. Mitscherlich found the finest crystals are obtained from a soln. of the salt in nitric acid, and C. Schultz obtained a mass of plates by cooling the soln. of the salt in sulphuric acid of sp. gr. less than 1.5.

According to E. Mitscherlich, and C. F. Rammelsberg, the prismatic crystals belong to the rhombic system and have axial ratios $a : b : c = 0.5712 : 1 : 1.2380$; and, according to J. W. Retgers, the rhombic pyramids are isomorphous with sodium sulphate and with sodium and silver selenates. The reported numbers for the specific gravity of the salt are: L. Playfair and J. P. Joule, 5.322 at 3.9°; C. J. B. Karsten, 5.341; E. Filhol, 5.410; O. Pettersson, 5.49 and 5.54 at 11°; H. G. F. Schröder, 5.425; and T. W. Richards and G. Jones, 5.45 at 29.2°. The last two determinations were made on the salt which had been fused. According to W. D. Harkins, the sp. gr. of a sat. soln. of the salt at 25° is 1.0052; W. D. Harkins has measured the sp. gr. of mixed soln. of silver sulphate with nitric acid, the nitrates of potassium, magnesium, and silver, and the sulphates of potassium and magnesium. B. L. Vanzetti found that if a layer of water be poured over a conc. aq. soln., sulphuric acid diffuses partially into the water.

According to J. S. Stas, silver sulphate decrepitates at about 300°, and when it melts at a dull red heat, there is scarcely any loss in weight, and it forms a pale

yellow liquid, which solidifies to a white crystalline mass. If the molten sulphate contains a trace of the sulphide, it melts to a dark orange-coloured liquid, and solidifies to a brownish-black crystalline mass. According to T. W. Richards and G. Jones, the fused salt acquires a darker colour as soon as it has slightly decomposed—even when the loss is but 0.0015 per cent. According to T. Carnelley, its melting point is $654^{\circ} \pm 2^{\circ}$; W. Ramsay and N. Eumorfopoulos gave 676° ; A. Potilitzin, 654° ; H. O. Hofman and W. Wanjukow, 656° ; R. Nacken, 651° ; and K. Friedrich, 660° . J. L. Gay Lussac, and R. II. Bradford found that at a higher temp. the salt decomposes giving off sulphur dioxide and oxygen, and leaving behind the metal; H. O. Hofman and W. Wanjukow say that the dissociation begins at 752° , and is rapid at 917° ; while K. Friedrich said that it decomposes into silver at 1085° . According to K. Friedrich, there is a transformation point at 410° ; H. O. Hofman and W. Wanjukow give 417° ; and R. Nacken gives 412° . According to the latter, α -silver sulphate is stable between 651° and 412° , and β -silver sulphate is the form stable below 412° . The heat of formation, according to J. Thomsen, is $(2\text{Ag}, \text{S}, 4\text{O})=167.28$ Cals.; $(2\text{Ag}, 2\text{O}, \text{SO}_2)=92.2$ Cals.; $(\text{Ag}_2\text{O}, \text{SO}_3)=58.14$ Cals.; and for $(\text{Ag}_2\text{O}, \text{SO}_{3\text{aq}})=14.49$ Cals. J. Thomsen's value for the heat of solution is -4.48 Cals., and M. Berthelot's, -4.40 Cals. The latter also gives for the heat of neutralization: $\text{Ag}_2\text{O} + \text{H}_2\text{SO}_{4\text{aq}} = \text{Ag}_2\text{SO}_{4\text{aq}} + \text{H}_2\text{O} + 14.4$ Cals.

Silver sulphate is not changed by exposure to sunlight. W. N. Hartley² found the absorption spectrum of a layer of a $\frac{1}{40}N$ -soln., 200 mm. thick, is continuous up to $\lambda^{-1}=4008$, and the transmitted rays extend beyond those of silver nitrate of the same conc., so that the specific absorption exerted by the silver does not limit the extent of the rays of the spectrum absorbed or transmitted by the nitrate soln.

The electrical conductivity λ of aq. soln. of silver sulphate has been measured by A. A. Noyes and K. G. Falk,³ S. J. Bates, G. Jäger, E. Bouty, W. D. Harkins and F. L. Hunt, etc. In the following data, by F. L. Hunt, the conc. C are expressed in millimols per litre:

	0	1	2	4	5	10	20	40
λ at 18°	. 112.5	116.3	113.6	109.85	108.4	102.9	96.1	88.0
λ at 25°	. 143.4	135.7	132.6	128.0	126.3	119.9	111.7	102.2

The corresponding percentage ionization, α calculated from λ/λ_{∞} are:

α at 18°	. . 100	95.0	92.7	89.5	88.5	84.0	78.4	71.8
α at 25°	. . 100	94.7	92.5	89.3	88.1	83.6	77.9	71.3

W. D. Harkins has also measured the conductivity of soln. of silver sulphate with potassium nitrate, magnesium nitrate, silver nitrate, potassium sulphate, or magnesium sulphate. J. Kendall and co-workers measured the conductivity of silver sulphate in anhydrous sulphuric acid. W. Hittorf's value for the transport number of the anions in 0.05N-soln. at 17° is 0.554. A. Chassy has also measured values for this constant. F. Streitz measured the electromotive force of cells with aq. soln. of silver and cupric sulphates; and J. Miesler of conc. cells. For the formation of silver peroxysulphate during the electrolysis of a soln. of silver sulphate, *vide* peroxyxynitrate.

The solubility of silver sulphate in water is small; according to K. Drucker,⁴ 100 parts of water at 25° dissolve 0.80 part of the salt; and, according to J. J. Berzelius, 100 parts of water at 100° dissolve 1.14 parts of the salt, which is deposited from the cooling soln. in small acicular crystals. The solubility of silver sulphate in water has been measured by C. F. Wenzel, P. Kremers, V. Rothmund, G. F. Rodwell, J. M. Eder, etc. At 17° , H. Euler found 0.770 grm. of silver sulphate was dissolved per 100 c.c.; at 18° , C. R. A. Wright and C. Thompson, 0.728 grm.; at 25° , K. Drucker found 0.801 grm. per 100 c.c., or 0.0257 mol per litre; C. M. Swan, 0.02699 mol per litre; and at 100° , C. F. Wenzel found 1.460 grms.

per 100 c.c. The composite results for the number of grams of salt in 100 grms. of soln. are :

	0°	10°	20°	30°	40°	60°	80°	100°
Ag ₂ SO ₄ . . .	0.57	0.69	0.79	0.88	0.97	1.14	1.28	1.39

A sat. soln. at 25° was found by W. D. Harkins to contain 0.02676 mol per litre ; this is about 4 per cent. greater than K. Drucker's 0.0257 mol per litre. Expressing conc. in grams per litre, K. Drucker found at 25°, with soln. of sulphuric acid :

H ₂ SO ₄	0.98	1.96	4.90	9.81
Ag ₂ SO ₄	8.11	8.23	8.45	8.58

The solubility still further increases by increasing the conc. of the acid. F. Bergius made some inaccurate observations on the solubility of silver sulphate in anhydrous acid. Sulphuric acid of sp. gr. 1.25 is a convenient solvent for silver sulphate. By cooling a soln. of the normal sulphate in dil. sulphuric acid, yellowish rhombic octahedra of a double salt, Ag₂SO₄.H₂SO₄, are obtained. According to C. Schultz, and J. W. Retgers, silver hydrosulphate, AgHSO₄, or Ag₂SO₄.H₂SO₄, crystallizes in pale yellowish prisms from a soln. of the normal sulphate in three times its weight of sulphuric acid. J. Kendall and A. W. Davidson say the colour is white, and that there are two forms : the α-salt occurs in thick prisms stable below 66°, and the β-salt occurs in fine needles stable above 66°. The m.p. by extrapolation is 125°, but the salt probably forms normal sulphate at 122.5°. C. Schultz showed that if a soln. of this salt be treated with 8–10 parts of sulphuric acid of sp. gr. 1.6 to 1.7, prismatic crystals of Ag₂SO₄.3H₂SO₄.2H₂O, or AgHSO₄.H₂SO₄.H₂O, are formed, and the same salt is obtained by dissolving the normal sulphate in from 6–10 parts of sulphuric acid, and allowing the soln. to become diluted by leaving it exposed to moist air. This salt begins to melt at 100°, it is quite liquid at 150°, and it solidifies on cooling into a foliated crystalline mass which gradually changes into small flat crystals. If the normal sulphate be dissolved in from 4–9 parts of sulphuric acid, sp. gr. 1.75, with the aid of heat, foliated plates are formed ; they have the composition 2Ag₂SO₄.3H₂SO₄.2H₂O, or 4AgHSO₄.H₂SO₄.2H₂O. J. Kendall and A. W. Davidson found that with anhydrous sulphuric acid the solid phase is H₂SO₄ between 10.4° and 2.4° with soln. containing up to 3.67 per cent. of silver sulphate ; Ag₂SO₄.2H₂SO₄ between –1.5° and 37.6° with between 5.69 and 12.38 per cent. of silver sulphate in soln. ; Ag₂SO₄.H₂SO₄ between 40.2° and 122.8° and 11.66 to 47.17 per cent. of silver sulphate in soln. ; and Ag₂SO₄ between 138.9° and 197.3° with between 47.17 and 48.69 per cent. of silver sulphate in soln. The transition between H₄Ag₂(SO₄)₃, or Ag₂SO₄.2H₂SO₄ and α-Ag₂SO₄.H₂SO₄ is 36°, and for β-Ag₂SO₄.H₂SO₄, 39°.

K. Drucker also found that the solubility of silver sulphate is gradually lowered by the addition of increasing proportions of *potassium sulphate*. Expressing solubilities in grams per litre, at 25° :

K ₂ SO ₄	1.74	3.49	8.72	17.44
Ag ₂ SO ₄	7.67	7.36	7.30	7.24

M. Barre also found the solubility of silver sulphate to increase regularly with the conc. of the soln. of potassium sulphate. W. D. Harkins, but not J. M. Eder, obtained a similar result with potassium sulphate. The presence of *potassium hydrosulphate* decreases the solubility of silver sulphate less than the addition of potassium sulphate. W. D. Harkins explains the effect of potassium sulphate in slightly decreasing the solubility, and of sulphuric acid in increasing the solubility of silver sulphate by assuming that the proportion of the intermediate ion HSO₄' present in the acid soln. is much larger than the proportion of the KSO₄'-ion present in the potassium sulphate soln. A. G. Betts has measured the solubility of silver sulphate in sulphuric acid of different conc. between 2° and 90°. J. M. Eder found the solubility of silver sulphate is augmented with increasing proportions of

sodium sulphate, and of *ammonium sulphate*. M. Barre obtained similar results. W. D. Harkins measured the effects of *potassium nitrate*, and *magnesium nitrate* on the solubility of silver sulphate, and he also found that the solubility is depressed with increasing proportions of *silver nitrate* or *magnesium sulphate*; the effect is less with the latter than with *potassium sulphate*. H. Euler found a litre of aq. soln. at 17° in contact with both silver sulphate and *silver acetate* contains 3.95 grms. of silver sulphate and 8.30 grms. of silver acetate—the sp. gr. of the soln. is 1.0094. L. Schnaubert, J. W. Retgers, and W. D. Harkins found that the solubility is increased by increasing proportions of *nitric acid* in the soln.

E. C. Franklin and his co-workers found silver sulphate to be insoluble in liquid *ammonia*, and in liquid *methylamine*. According to V. Rothmund, a litre of water at 25° dissolves 0.0267 gm. of silver sulphate, and a litre of a $\frac{1}{2}N$ -soln. of *methyl alcohol* dissolves 0.0249 gm.; *ethyl alcohol*, 0.0228 gm.; *propyl alcohol*, 0.0218 gm.; *tertiary amyl alcohol*, 0.0204 gm.; *acetone*, 0.0220 gm.; *ether*, 0.0206 gm.; *formaldehyde*, 0.0227 gm.; *glycol*, 0.0259 gm.; *glycerol*, 0.0263 gm.; *mannite*, 0.0297 gm.; *grape sugar*, 0.0283 gm.; *cane sugar*, 0.0270 gm.; *urea*, 0.0303 gm.; *dimethylpyrone*, 0.0216 gm.; *urethane*, 0.0227 gm.; *formamide*, 0.0270 gm.; *acetamide*, 0.0253 gm.; *acetonitrile*, 0.0525 gm.; *glyocol*, 0.0433 gm.; *acetic acid*, 0.0252 gm.; *phenol*, 0.0379 gm.; *chloral*, 0.0233 gm.; *methylal*, 0.0205 gm.; and *methyl acetate*, 0.0212 gm. F. Bezold found it to be insoluble in methyl acetate.

J. S. Stas⁵ reduced silver sulphate by heating it to a low temp. in a stream of **hydrogen** when the products are silver and sulphuric acid; at a higher temp., the first products are silver sulphide and water, and then silver and hydrogen sulphide. T. W. Richard and G. Jones obtained indications that J. S. Stas did not wholly reduce silver sulphate by hydrogen. According to A. Colson, gaseous hydrogen attacks silver sulphate at about 125°; the reaction is not reversible, because the reaction of sulphuric acid on the hydrogen sulphide changes the character of the products. N. N. Beketoff produced silver from a soln. of the sulphate by heating it under press. with hydrogen.

A. Mailfert found that with **ozone**, a black deposit of silver peroxide is produced, which is decomposed and redissolved on agitating the soln. According to J. Keutwig, **chlorine** does not act directly on silver sulphate, and only at a very high temp. above the m.p. is the salt attacked with the formation of silver chloride, sulphur dioxide, and oxygen. The heat of the reaction: $Ag_2SO_4 + Cl_2 = 2AgCl + SO_2 + O_2 - 37.44$ Cals. According to C. Hensgen, and A. Colson, a mol of silver sulphate absorbs 2 mols of **hydrogen chloride** at ordinary temp. with the evolution of heat, and the salt changes *complètement* into chloride; at 300° the inverse reaction observed with cupric sulphate does not occur, but the sulphuric acid is completely expelled by a current of air. The thermal data indicate that, with the salts investigated, silver sulphate changes into the chloride with the greatest evolution of heat: $Ag_2SO_4 + 2HCl_{gas} = 2AgCl + H_2SO_{4liquid} + 40.4$ Cals., or 170 kilojoules as calculated by T. W. Richards and G. Jones from J. Thomsen's observations; they found that the reaction is complete, and it was used in the determination of the at. wt. of sulphur. A. B. Prescott found that if a gram of silver sulphate be evaporated to dryness with 4.035 grms. of aq. hydrochloric acid containing 1.251 grms. of HCl, all is changed into chloride. According to C. W. B. Normand and A. C. Cumming, **bromine** at 0° forms hypobromous acid: $Ag_2SO_4 + 2Br_2 + 2H_2O = 2AgBr + H_2SO_4 + 2HBrO$; and at a higher temp., $5Ag_2SO_4 + 6Br_2 + 6H_2O = 10AgBr + 5H_2SO_4 + 2HBrO_3$. C. Geitner found that silver sulphate is converted to the sulphide when a soln. is boiled with **sulphur**. R. Webcr, and H. Schulze converted silver sulphate into the pyrosulphate by the action of **sulphur trioxide**. O. Sackur found **silver sulphide** reacts with the sulphate at 300°, giving off sulphur dioxide and separating silver. The equilibrium press. is over 10 atm. at 327°. J. Camus has studied the action of native **sulphides** and **arsenides** on silver salts.

T. Poleck and K. Thümmel prepared an amorphous red powder with a composition corresponding with **silver sulphato-sulphide**, $Ag_2SO_4 \cdot Ag_2S$, by the action of sulphur on a warm conc.

soln. of silver nitrate : $4\text{AgNO}_3 + 2\text{S} = 4\text{NO}_2 + \text{Ag}_2\text{SO}_4 \cdot \text{Ag}_2\text{S}$; or by treating silver sulphide with nitric acid of sp. gr. 1.18. The product is soluble in nitric acid, and is decomposed by water into its component salts. Cold hydrochloric acid converts it into silver chloride and sulphide. The product is stable up to 180° , but it decomposes on calcination, furnishing silver and sulphur dioxide.

E. Divers found **sulphuryl bromide** converted silver sulphate into silver bromide and sulphur trioxide ; J. Girard found that with **sodium thiosulphate** silver sulphide is formed ; J. Seymour, that a neutral soln. of silver sulphate is reduced to the metal by **ferrous sulphate**. According to L. Pissarjewsky, the heat effect obtained by mixing soln. of silver and ferrous sulphates in various solvents, varies with the conditions under which the reaction occurs ; similar variations occur in the constant of the reaction : $\text{Ag}_2\text{SO}_4 + 2\text{FeSO}_4 \rightleftharpoons 2\text{Ag} + \text{Fe}_2(\text{SO}_4)_3$. Hence, it is inferred that a mixture of probably two different modifications of ordinary grey silver—*allotropic silver*—is precipitated.

W. R. Hodgkinson and C. C. Trench found silver sulphate is reduced when heated in a stream of **ammonia**. H. Rose found that dry silver sulphate slowly absorbs up to 11.82 per cent. of ammonia gas with scarcely any perceptible rise of temp. The theoretical absorption for **silver diammino-sulphate**, $\text{Ag}_2(\text{NH}_3)_2\text{SO}_4$, is 10.9 per cent. When heated, the product gives off ammonia and ammonium sulphate, and it is completely soluble in water. According to C. G. and E. Mitscherlich, clear crystals of **silver tetrammino-sulphate**, $\text{Ag}_2(\text{NH}_3)_4\text{SO}_4$, are deposited when a sat. soln. of silver sulphate is poured into a warm soln. of ammonia and cooled. C. F. Rammelsberg, and E. Mitscherlich found the tetragonal crystals have the axial ratio $a : c = 1 : 0.5328$. They are stable in air in darkness, and blacken in light. They are soluble in water, or aq. ammonia, and can be recrystallized unchanged. A soln. of potassium hydroxide precipitates Berthollet's fulminating silver. A. Reyehler studied the lowering of the f.p. and the electrical conductivity of aq. soln. of this salt. N. W. Fischer precipitated silver from the soln. by means of indium, cadmium, lead, copper, antimony, and arsenic ; but not by tin, bismuth, iron, or mercury.

J. L. Gay Lussac completely reduced silver sulphate mixed with **charcoal** by heating it to dull redness—equal vols. of carbon and sulphur dioxides are evolved. O. Boudouard gives the equation : $\text{Ag}_2\text{SO}_4 + \text{C} = \text{CO}_2 + \text{SO}_2 + 2\text{Ag}$. K. Stammer also reduced the salt to the metal by heating it with **carbon monoxide**. According to N. W. Fischer, **copper** precipitates the whole of the silver, as a bulky, spongy, crystalline mass, when immersed in a sulphuric acid soln. of the sulphate ; **iron**, **zinc**, **tin**, and **lead** (but not antimony) also precipitate the silver. G. Goldschmidt added **cobalt** to N. W. Fischer's list—*vide supra*, the metallic reduction of silver. H. Rose found **cuprous oxide** precipitates silver from a soln. of the sulphate ; the precipitate is mixed with some basic cupric sulphate, and cupric sulphate remains in soln. C. Sandonnini and P. C. Aureggi found molten **stannous chloride** reduces silver sulphate to silver sulphide, and the metal—*vide* the metallic precipitation of silver.

R. Nacken⁶ has studied the binary systems of the dimorphous lithium, sodium, and potassium sulphates with dimorphous silver sulphates. The transition and fusion temp. are indicated in the diagrams, Figs. 20 to 22. The lower sets of curves show the transition points, the upper sets represent the liquidus and solidus curves. The existence of the compounds $2\text{Li}_2\text{SO}_4 \cdot 3\text{Ag}_2\text{SO}_4$ and of $\text{K}_2\text{SO}_4 \cdot 3\text{Ag}_2\text{SO}_4$ has been established, and there is no sign of a complex sodium salt, Fig. 21 ; according to J. W. Retgers, sodium and silver sulphates probably form mixed crystals in all proportions. They have been studied by M. Barré. The first-named salt, **lithium silver sulphate**, $2\text{Li}_2\text{SO}_4 \cdot 3\text{Ag}_2\text{SO}_4$, is capable of existence only between 572° and 420° , so that the compound breaks up as the temp. falls below 420° ; and the transition point curve shows a discontinuity at a conc. corresponding with the composition of the double salt. The region of stability of **potassium silver sulphate**, $\text{K}_2\text{SO}_4 \cdot 3\text{Ag}_2\text{SO}_4$, is shown in the diagram. H. Rose reported in 1825 that when

potassium and silver sulphates are fused together they freeze to a crystalline mass, but no definite compound was isolated.

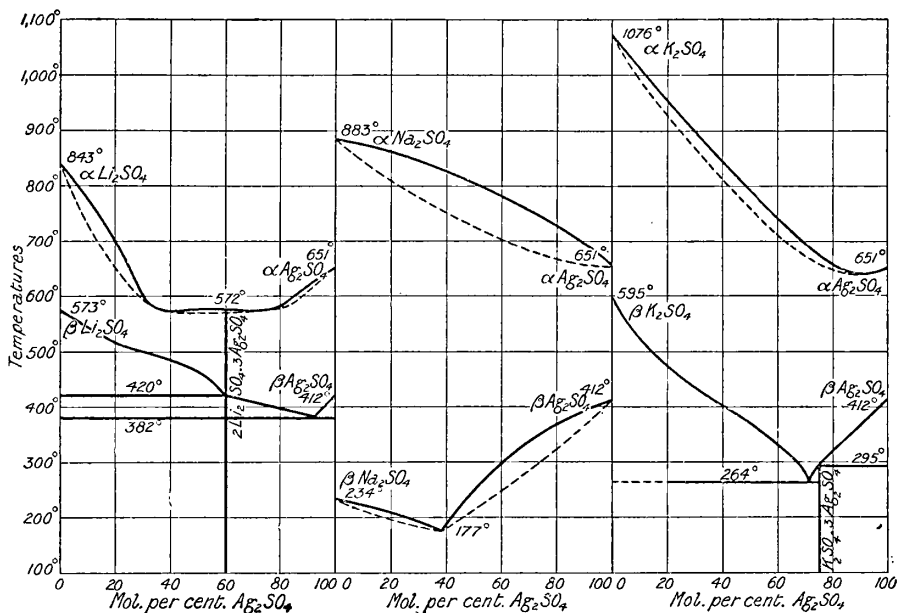

FIG. 20.—Binary System
 Li_2SO_4 — Ag_2SO_4 .

FIG. 21.—Binary System
 Na_2SO_4 — Ag_2SO_4 .

FIG. 22.—Binary System
 K_2SO_4 — Ag_2SO_4 .

REFERENCES.

- ¹ J. S. Stas, *Bull. Acad. Belgique*, (2), 9, 322, 1860; P. Brahmin, *Chem. News*, 42, 163, 1880; E. Mitscherlich, *Pogg. Ann.*, 9, 414, 1827; 12, 138, 1828; 25, 301, 1832; C. Schultz, *ib.*, 133, 137, 1868; H. G. F. Schröder, *ib.*, 106, 245, 1859; C. F. Rammelsberg, *Handbuch der krystallographisch-physikalischen Chemie*, Leipzig, 1, 411, 1881; A. E. Hill and J. P. Simmons, *Journ. Amer. Chem. Soc.*, 31, 828, 1909; J. W. Retgers, *Zeit. phys. Chem.*, 8, 51, 1891; C. J. B. Karsten, *Schweigger's Journ.*, 65, 394, 1832; L. Playfair and J. P. Joule, *Mem. Chem. Soc.*, 2, 401, 1845; E. Filhol, *Ann. Chim. Phys.*, (3), 21, 415, 1847; O. Pettersson, *Novo Acta Upsala*, (3), 9, 35, 1874; T. W. Richards and G. Jones, *Journ. Amer. Chem. Soc.*, 29, 826, 1907; W. D. Harkins, *ib.*, 33, 1813, 1911; B. L. Vanzetti, *Zeit. Koll.*, 9, 54, 1911; T. Carnelley, *Journ. Chem. Soc.*, 33, 273, 1878; W. Ramsay and N. Eumorphopoulos, *Phil. Mag.*, (5), 41, 360, 1896; A. Potilitzin, *Journ. Russ. Phys. Chem. Soc.*, 24, 1, 1892; H. O. Hofman and W. Wanjukow, *Trans. Amer. Inst. Min. Eng.*, 43, 523, 1912; K. Friedrich, *Met.*, 7, 323, 1910; R. Nacken, *Neues Jahrb. Min. B.B.*, 24, 1, 1907; J. Thomsen, *Thermochemische Untersuchungen*, Leipzig, 3, 382, 1883; *Journ. prakt. Chem.*, (2), 17, 165, 1878; M. Berthelot, *Thermochemie*, Paris, 2, 372, 1897; J. L. Gay Lussac, *Journ. Mines*, 22, 325, 1807; *Nicholson's Journ.*, 33, 44, 1812; *Ann. Chim. Phys.*, (1), 63, 431, 1836; R. H. Bradford, *Trans. Amer. Inst. Min. Eng.*, 33, 50, 1902.
- ² W. N. Hartley, *Journ. Chem. Soc.*, 101, 820, 1902.
- ³ F. L. Hunt, *Journ. Amer. Chem. Soc.*, 33, 795, 1911; A. A. Noyes and K. G. Falk, *ib.*, 34, 454, 1912; W. D. Harkins and F. L. Hunt, *ib.*, 33, 1820, 1911; S. J. Bates, *ib.*, 35, 532, 1913; W. D. Harkins, *ib.*, 33, 1812, 1911; G. Jäger, *Sitzber. Akad. Wien*, 96, 317, 1887; *Monatsh.*, 8, 721, 1887; J. Miesler, *ib.*, 8, 193, 1887; F. Streintz, *Phil. Mag.*, (5), 5, 219, 1878; E. Bouty, *Compt. Rend.*, 98, 140, 1884; *Ann. Chim. Phys.*, (6), 3, 433, 1884; A. Chassy, *ib.*, (6), 21, 241, 1890; W. Hittorf, *Pogg. Ann.*, 89, 177, 1853; J. Kendall, H. Adler, and A. W. Davidson, *Journ. Amer. Chem. Soc.*, 43, 1846, 1921.
- ⁴ J. M. Eder, *Journ. prakt. Chem.*, (2), 17, 44, 1878; E. C. Franklin and C. A. Kraus, *Amer. Chem. Journ.*, 20, 829, 1898; C. F. Wenzel, *Lehre von der Verwandtschaft der Körper*, Dresden, 1777; P. Kremers, *ib.*, 92, 497, 1854; H. Euler, *Zeit. phys. Chem.*, 49, 314, 1904; V. Rothmund, *ib.*, 69, 537, 1909; J. W. Retgers, *ib.*, 8, 32, 1891; K. Drucker, *Zeit. anorg. Chem.*, 28, 361, 1901; C. R. A. Wright and C. Thompson, *Phil. Mag.*, (5), 17, 288, 1884; (5), 19, 11, 1885; W. D. Harkins, *Journ. Amer. Chem. Soc.*, 33, 1813, 1911; A. E. Hill and J. P. Simmons, *ib.*, 31, 828, 1909; E. C. Franklin and H. D. Gibb, *ib.*, 28, 1420, 1906; J. Kendall and A. W. Davidson, *ib.*, 43,

979, 1921; F. Bergius, *Zeit. phys. Chem.*, 72. 354, 1914; M. Barre, *Ann. Chim. Phys.*, (8), 24. 204, 1911; *Compt. Rend.*, 150. 1321, 1910; A. G. Betts, *Elektrochem. Zeit.*, 13. 25, 1906; L. Schnaubert, *Untersuchung der Verwandtschaft der Metalloxyde zu dem Säuren*, Erfurt, 65, 1803; F. Bezold, *Das Verhalten chemischer Verbindungen in Methylacetat*, Giessen, 8, 1906; J. J. Berzelius, *Traité de chimie*, Paris, 4. 270, 1846; G. F. Rodwell, *Chem. News*, 11. 50, 1865; C. M. Swan, *The Investigation of the Dissociation of Sulphuric Acid and its Salts*, Cambridge, Mass., 1899; C. Schultz, *Pogg. Ann.*, 133. 137, 1868.

⁵ N. N. Beketoff, *Compt. Rend.*, 48. 442, 1859; *Zeit. Chem.*, 8. 376, 1865; J. S. Stas, *Bull. Acad. Belgique*, (2), 9. 322, 1860; W. R. Hodgkinson and C. C. Trench, *Chem. News*, 66. 223, 1892; J. L. Gay Lussac, *Journ. prakt. Chem.*, (1). 11. 70, 1837; K. Stammer, *Pogg. Ann.*, 82. 136, 1851; C. Schultz, *ib.*, 133. 137, 1868; J. Keutwig, *Ber.*, 14. 506, 1881; R. Weber, *ib.*, 17. 2503, 1884; H. Schulze, *ib.*, 17. 2705, 1884; O. Sackur, *ib.*, 41. 3356, 1908; T. Poleck and K. Thümmel, *ib.*, 16. 2435, 1883; A. Reychler, *ib.*, 28. 555, 1895; A. Mailfert, *Compt. Rend.*, 94. 860, 1882; J. Camus, *ib.*, 155. 310, 1912; A. Colson, *ib.*, 127. 961, 1898; 125. 945, 1897; *Rev. Chim. Pure App.*, 8. 109, 1905; E. Divers, *Journ. Chem. Soc.*, 49. 584, 1886; C. W. B. Normand and A. C. Cumming, *ib.*, 101. 1855, 1912; J. Girard, *Ann. Chim. Anal. App.*, 5. 56, 1900; C. Geitner, *Liebig's Ann.*, 129. 350, 1864; J. Scymour, *Pharm. Rund.*, 264, 1894; N. W. Fischer, *Das Verhältniss der chemischen Verwandtschaft zur galvanischen Electricität, in Versuchen dargestellt*, Berlin, 1830; C. Goldschmidt, *Chem. Ztg.*, 29. 424, 1905; C. Hensgen, *Rec. Trav. Chim. Pays-Bas*, 2. 124, 1883; T. W. Richards and G. Jones, *Journ. Amer. Chem. Soc.*, 29. 826, 1907; C. Sandonini and P. C. Aureggi, *Gazz. Chim. Ital.*, 42. i, 227, 1912; O. Boudouard, *Bull. Soc. Chim.*, (3). 25. 294, 1901; H. Rose, *Sitzber. Akad. Berlin*, 311, 1857; *Chem. Gaz.*, 15. 344, 1857; *Pogg. Ann.*, 20. 153, 1830; C. G. and E. Mitscherlich, *ib.*, 9. 414, 1827; E. Mitscherlich, *ib.*, 12. 141, 1828; C. F. Rammelsberg, *Handbuch der krystallographisch-physikalischen Chemie*, Leipzig, 1. 411, 1881; J. W. Retgers, *Zeit. phys. Chem.*, 8. 6, 1891; L. Pissarjewsky, *Journ. Russ. Phys. Chem. Soc.*, 35. 1204, 1903; 40. 367, 1908; *Zeit. anorg. Chem.*, 58. 399, 1908; A. B. Prescott, *Chem. News*, 36. 178, 1877.

⁶ R. Nacken, *Neues Jahrb. Min. B.B.*, 24. 1, 1907; H. Rose, *Pogg. Ann.*, 5. 463, 1825; J. W. Retgers, *Zeit. phys. Chem.*, 8. 51, 1891; M. Barre, *Compt. Rend.*, 150. 1321, 1910.

§ 20. Silver Carbonate

According to N. W. Fischer, and H. Rose,¹ silver carbonate is formed when moist silver oxide is exposed to the atm.; and, according to L. Joulin, when silver oxide is suspended in an aq. soln. of sodium hydrocarbonate. J. Setterberg could not make *silver hydrocarbonate*, AgHCO₃, by treating silver nitrate with potassium hydrocarbonate under various conditions, and the salt in question has not been isolated. G. Wetzlar precipitated normal silver carbonate as a white powder by adding an aq. soln. of an alkali carbonate or hydrocarbonate to a soln. of silver nitrate; and E. Bohlrig recommended mixing soln. of eq. amounts of silver nitrate and potassium carbonate. H. Rose observed:

It is remarkable that silver oxide exhibits considerable affinity for carbon dioxide, and none at all for water. When a soln. of an eq. of a normal salt of silver is decomposed by a normal alkali carbonate, normal silver carbonate is obtained, without water, whether the soln. be conc. or dil., cold or hot.

J. F. Spencer and M. le Pla recommended slowly pouring a very dil. soln. of sodium hydrocarbonate, or the normal carbonate, with constant stirring, into a conc. soln. of silver nitrate. The precipitate is washed many times with water. According to V. Kohlschütter and E. Eydmann, a little decomposition occurs when the carbonate is allowed to stand under cold water for any time, and also when dried at 110°. The composition of silver carbonate is affected by conc. of the soln., the temp., and the relative proportions of the salts used in its preparation. This subject has been studied by L. Joulin. If equi-molecular parts of silver nitrate and alkali carbonate are employed at a dilution not exceeding 0.0025 molar part per litre, the precipitate is wholly normal silver carbonate; if the soln. be more dil., silver oxide will also be formed, and this the more the more dil. the soln.; with a dilution of 0.0003 molar part per litre, the oxide is wholly precipitated. If an excess of alkali carbonate be used the precipitate is a mixture of silver carbonate and oxide, with the oxide in greater proportion the greater the excess of alkali

carbonate. If the silver nitrate be in excess the precipitate will be white, free from oxide, and coloured superficially violet, and it will be coloured yellow by washing. These relations were obtained at ordinary temp. At 0°, the precipitate will be free from oxide even with a large excess of sodium carbonate, and at 100° the precipitate will contain oxide, even with equi-molecular proportions of silver nitrate and alkali carbonate, and at least five eq. of silver nitrate are required for one of sodium carbonate if the precipitate is to be free from oxide. G. S. Johnson obtained crystals of the salt by passing carbon dioxide into water with silver carbonate in suspension, and allowing the soln. to stand. H. Vogel also exposed to air a mixture of an ammoniacal soln. of silver nitrate and sodium hydroxide; after some weeks, silver oxide is precipitated, and thereafter lemon-yellow needle-shaped crystals of silver carbonate are deposited. A. Lottermoser prepared **colloidal silver carbonate** by mixing $\frac{1}{40}N$ -AgNO₃ and $\frac{1}{40}N$ -Na₂CO₃, so that the latter is in excess. C. Paal and F. Voss treated a soln. of sodium carbonate with silver protalbinat or lysalbinat.

Precipitated silver carbonate is a white powder, which becomes yellow by the aggregation of its particles, an effect which is immediately produced by heat. The lemon-yellow acicular **crystals** prepared by H. Vogel were doubly refracting, and were thought to be hexagonal. C. J. B. Karsten gave 6.0766 for the **specific gravity**, and P. Kremers, 6.0 at 17.5°. A. Colson gives for the **heat of formation** from its elements (2Ag, C, 3O)=120.8 Cals. M. Berthelot gives 120.4 Cals. and J. Thomsen gives 122.92 Cals.; for (2Ag, O₂, CO)=93.92 Cals.; for (2Ag, O, CO₂)=25.96 Cals.; and for (Ag₂O, CO_{2(gas)})=20.06 Cals.; M. Berthelot gives 18.6 Cals.; and for (Ag₂O, CO_{2(aq.)}), 13.80 Cals. J. Thomsen has also studied the heat of the reaction between silver nitrate and sodium carbonate.

According to N. W. Fischer, silver carbonate blackens when exposed to light or when heated. H. Rose found that it loses carbon dioxide at 200°, and A. Colson found that silver carbonate is less stable than lead carbonate, and it is completely decomposed at 220°, L. Joulin said 225°, and added that only a little or no carbon dioxide is taken up on cooling. V. Kohlschütter and E. Eydmann say that silver carbonate begins to give off gas between 150° and 160°, and the rate of decomposition is faster at the higher temp.; at 216° the speed of decomposition is quite rapid, and silver oxide is formed. If the decomposition occurs in vacuo, some silver is formed. A. Colson found the **dissociation pressure** to be 6 mm. at 132°; 99 mm. at 167°; 173 mm. at 167°; 173 mm. at 182° (173 mm. with the dry gas); 547 mm. at 210°; and 752 mm. at 218°; he also showed that in moist air, even at a comparatively low temp., there is a reversible reaction, Ag₂CO₃⇌Ag₂O+CO₂—a similar result is obtained when moisture is excluded, but in that case, although there is a definite dissociation press. for a given temp., the reaction is not reversible because carbon dioxide is not taken up by the silver oxide; but he found that at a high press. the reaction is reversible. Neither moist freshly precipitated silver carbonate nor the dry salt is decomposed by cold **water**, but boiling water transforms it into silver oxide. L. Joulin obtained a port wine-red fluid by pouring two litres of boiling water on a gram of silver carbonate. H. Rose obtained basic silver carbonate, or silver oxycarbonate: 3Ag₂O.2CO₂, or 2Ag₂CO₃.Ag₂O, by boiling a soln. of silver nitrate with an excess of sodium carbonate; and E. Bohlig, by pouring silver nitrate into an excess of a soln. of potassium carbonate. The black precipitate dries at 100° to a dark brown mass, which, according to E. Bohlig, contains granular particles mixed with fine needle-like crystals, and is probably a mixture of the oxide and carbonate. P. Kremers said that the **solubility** is such that 100 parts of water dissolve 0.00325 part silver carbonate at 15°, A. Abegg and J. Cox found the solubility of silver carbonate in water at 25° to be about 1.2×10⁻⁴ gram-atoms per litre, and J. F. Spencer and M. le Pla found 1.16×10⁻⁴ mols per litre. The last-named also found that in aq. soln. the salt is almost completely—96.6 per cent.—hydrolyzed, consequently the soln. reacts alkaline to litmus and methyl orange. According to J. L. Lassaigne, 100 parts of water sat. with carbon dioxide dissolve

0.104 part of silver carbonate; and, according to J. J. Berzelius, it is soluble in aq. ammonia, ammonium carbonate, sodium thiosulphate, and potassium cyanide. W. O. de Coninck reported that silver carbonate is somewhat soluble in an aq. soln. of sodium nitrate; E. C. Franklin and C. A. Kraus, that it is insoluble in liquid ammonia; insoluble in methyl acetate; and M. Hamers, insoluble in ethyl acetate. According to A. von Baeyer and V. Villiger, hydrogen peroxide is decomposed by silver carbonate without the decomposition of the latter, while E. Mulder maintained some carbon dioxide is given off with the oxygen.

S. Kern added absolute alcohol to a soln. of silver carbonate in aq. ammonia, and obtained a grey powder which darkened when dried. It dissolved in aq. ammonia and, on evaporation, the soln. furnished irregular needle-like crystals, possibly silver tetrammino-carbonate, $\text{Ag}_2\text{CO}_3 \cdot 4\text{NH}_3$, which began to lose ammonia at 80° , and lost all this gas at 100° . M. Dervin and M. Olmar obtained crystals of hydrated tetrammino-carbonate, $\text{Ag}_2\text{CO}_3 \cdot 4\text{NH}_3 \cdot \text{H}_2\text{O}$, by repeatedly evaporating in air, ammoniacal soln. of silver oxide. On exposure to air the crystals lose ammonia and water; they are blackened by sunlight.

C. Wittstein found silver carbonate is slightly soluble in a cold aq. soln. of potassium carbonate, and when the soln. is warmed, a precipitate is obtained which is blackened by the organic matter of filter paper. A. de Schulten observed that when a soln. of silver nitrate is added to an excess of potassium carbonate containing some hydrocarbonate, a white precipitate is formed which changes to microscopic crystals with a composition corresponding with potassium silver carbonate, AgKCO_3 . He recommended the following process:

Dissolve 150 grms. of potassium carbonate in 150 c.c. of water, cool the soln., and agitate it with 15 grms. of potassium hydrocarbonate. When the liquid is sat. with the latter salt, filter, and mix the filtrate with a gram of silver nitrate dissolved in 25 c.c. of water. To obtain large crystals, the liquid containing the precipitate is heated with continued agitation. The precipitate dissolves, and, on cooling, deposits long transparent prisms with a brilliant lustre.

The crystals have a sp. gr. 3.769; they do not blacken when exposed to light except in the presence of organic matter, and when treated with water, the silver carbonate which remains retains the form of the original crystals. When heated, the compound loses carbonic anhydride, and at a higher temp. the silver oxide which is formed gives off oxygen. The crystals are microscopic, rectangular lamellæ with a terminal angle closely approaching 90° . The double refraction is almost identical with that of apatite; the extinction of parallel polarized light is straight; twinning plane parallel with the plane of the optical axes; sign of elongation positive; the maximum birefringence approximately 0.0216. The compound is decomposed by water, with removal of the potassium carbonate and formation of yellow silver carbonate. A. de Schulten also obtained a crystalline double salt, possibly sodium silver carbonate, by substituting sodium for the potassium salt. The product, however, was not examined further.

REFERENCES.

- ¹ H. Rose, *Pogg. Ann.*, 85. 314, 1852; P. Krcmers, *ib.*, 85. 43, 1852; N. W. Fischer, *Kastner's Archiv.*, 9. 356, 1826; G. Wetzlar, *Schweigger's Journ.*, 53. 100, 1823; C. J. B. Karsten, *ib.*, 65. 394, 1832; E. Bohlig, *Arch. Pharm.*, (3), 23. 381, 1885; G. S. Johnson, *Chem. News*, 54. 75, 1886; S. Kern, *ib.*, 31. 231, 1875; H. Vogel, *Sitzber. Akad. Berlin*, 545, 1862; A. Colson, *Compt. Rend.*, 132. 467, 1901; 140. 865, 1905; 148. 837, 1909; A. de Schulten, *ib.*, 105. 811, 1887; A. von Baeyer and V. Villiger, *Ber.*, 34. 2769, 1901; C. Paal and F. Voss, *ib.*, 37. 3862, 1904; E. Mulder, *Rec. Trav. Chim. Pay-Bas*, 22. 388, 1904; L. Joulin, *Ann. Chim. Phys.*, (4), 30. 260, 1873; A. Lottermoser, *Journ. prakt. Chem.*, (2), 72. 39, 1905; H. Vogel, *ib.*, (1), 87. 288, 1862; J. Thomsen, *ib.*, (2), 21. 38, 1880; *Thermochemische Untersuchungen*, Leipzig, (3), 382, 1883; *Ber.*, 12. 2031, 1879; R. Abegg and A. J. Cox, *Zeit. phys. Chem.*, 46. 1, 1904; J. L. Lassaigne, *Journ. Chim. Méd.*, 4. 312, 1848; J. Setterberg, *Oefver. Vet. Akad. Förh.*, 3. 25, 1846; V. Kohlschütter and E. Eydmann, *Liebig's Ann.*, 398. 5, 1913; J. F. Spencer and M. le Pla, *Zeit. anorg. Chem.*, 65. 11, 1909; F. Bezdold, *Das Verhalten chemischer Verbindungen in Methylacetat*, Giessen,

1906; M. Hamers, *Verhalten der Halogenverbindungen des Quecksilbers in reinem und in bei 18° mit Wasser gesättigtem Aethylacetat*, Giessen, 1906; J. J. Berzelius, *Traité de chimie*, Paris, 4. 282, 1846; C. Wittstein, *Repert. Pharm.*, 81. 145, 1852; M. Dervin and M. Olmar, *Compt. Rend.*, 172. 1662, 1921; M. Berthelot, *Thermochimie*, Paris, 2. 372, 1897; E. C. Franklin and C. A. Kraus, *Amer. Chem. Journ.*, 20. 828, 1898; 23. 290, 1900; *Journ. Amer. Chem. Soc.*, 27. 197, 1905; W. O. de Coninck, *Bull. Acad. Belg.*, 333, 1909.

§ 21. Silver Nitrate

The twelfth or thirteenth-century writer, Geber, in his *De inventione ventatis*, described the preparation of silver nitrate by dissolving the metal in nitric acid, and evaporating the soln. for crystallization. Albertus Magnus, about the same period, in his *Compositum de compositis*, said the soln. blackened the skin, and that the stain was difficult to remove. In the seventeenth century, A. Sala, in his *Septem planetarum terrestrium spagyrica recensio*, called the salt *crystalli Dianæ*; N. Lemery (1675)¹ called it *vitriol de Luna*; and H. Boerhaave (1732), *vitriolum argenti*. This shows that the term *vitriol* was of more general application than it is to-day; its use is now confined to a specific group of sulphates. Silver nitrate has been called *silver-saltpetre*; and, after fusion, the mediæval alchemists also called it *lapis infernalis*, or *lunar caustic*.

As shown by Geber, silver nitrate is prepared by crystallization from a soln. of the metal in dil. nitric acid. H. Greuner² studied the preparation of silver nitrate from silver sulphide by digestion of that compound with dil. nitric acid. F. Laporte and P. de la Gorce found that if the soln. of silver nitrate during evaporation be not protected, it may absorb impurities from the air. Similar remarks apply during the washing and drying of the crystals. If the metal contains copper, the two metals are separated by precipitating the silver as sparingly soluble chloride, reducing the chloride as previously indicated, and then dissolving the product in nitric acid. N. J. B. G. Guibourt, R. Palm, C. J. H. Warden, etc., separated the two elements by fractional crystallization from a soln. strongly acidified with nitric acid, in which silver nitrate is far less soluble than the cupric salt. F. Nölle extracted the salt with boiling alcohol, most of the silver nitrate remained undissolved, and most of that which dissolved separated out on cooling, while the cupric nitrate remained in soln. F. Brandenburg, J. B. Trautwein, and F. W. C. Martius heated the molten mixture so that the cupric nitrate decomposed while the silver nitrate remained unchanged; the latter was then leached from the cupric oxide. M. Gräger treated a part of the mixed soln. with potassium hydroxide, and digested the washed precipitate with the remaining soln. Provided no excess of acid is present, he found that cupric oxide was precipitated and silver oxide passed into soln. Organic impurities are removed by recrystallization. In the last-named operation advantage is taken of the low solubility of the salt in soln. strongly acidified with nitric acid. T. W. Richards and G. S. Forbes, W. L. Hardin, G. P. Baxter and G. Jones, and G. D. Buckner and G. A. Hulett have prepared silver nitrate of the highest degree of purity for at. wt. determinations. G. P. Baxter and G. Jones proceeded as follows:

Crude silver nitrate was reduced with ammonium formate, made by passing ammonia gas into redistilled formic acid. The reduced silver was washed with the purest water, until the wash-waters no longer gave a test for ammonia with Nessler's reagent, and was fused on sugar charcoal. The buttons were then scrubbed with sea-sand and thoroughly cleansed with ammonia and nitric acid. They were then dissolved in redistilled nitric acid, in a platinum dish. After the silver nitrate soln. had been evaporated on a steam bath until sat., an equal volume of redistilled nitric acid was added and the soln. was cooled. The precipitated silver nitrate was very completely drained in a centrifugal machine, provided with platinum Gooch crucibles to retain the salt. A similar recrystallization followed. The final product was preserved in Jena glass vessels under a bell-jar.

G. D. Buckner and G. A. Hulett used quartz vessels; and they melted the

salt until the last trace of nitric acid was expelled. E. B. Rosa, G. W. Vinal, and A. S. McDaniel say the salt then contains but one or two parts of acid per 100,000 parts of salt.

The physical properties of silver nitrate.—Silver nitrate forms rhombic crystals which, according to H. J. Brooke,³ have the axial ratios $a : b : c = 0.9430 : 1 : 1.3697$. A. Scacchi, F. M. Jäger, C. F. Rammelsberg, etc., have studied the crystallography of the salt. While M. L. Frankenheim observed no change of form when the salt is heated up to its temp. of decomposition, O. Lehmann found it to exist in two modifications; the form stable below 159.4° is rhombic, and above that temp. the salt exists in rhombohedra belonging to the trigonal system. The rhombic form is the one obtained by crystallization at ordinary temp.; the trigonal was obtained by the crystallization of the molten salt. According to B. Gossner, the form stable at the higher temp. is isomorphous with trigonal sodium nitrate. It does not crystallize isomorphously with the nitrate of ammonium, potassium, rubidium, caesium, or thallium, but, according to J. W. Retgers, it is isodimorphous with sodium nitrate since mixed soln. of the two salts furnish trigonal mixed crystals with up to 52.57 per cent. of silver nitrate, and rhombic crystals with up to 0.8 per cent. of sodium nitrate—*vide infra*.

The reported values for the **transition temperature** are 159° by J. Guinehant,⁴ 159.2° to 159.8° by W. Schwarz, 159.4° by P. W. Bridgman, and 159.8° by D. J. Hissink. P. W. Bridgman measured the effect of press. on the transition temp. and found the phase diagram, Fig. 23, to be quite different in character from those of the nitrates of ammonium, potassium, rubidium, caesium, or thallium. P. W. Bridgman was unable to trace the sudden increase of curvature with press. beyond 6000 kgms. per sq. em. for press. up to 22,000 kgms. per sq. cm., at room temp. or at 200° . E. Jänecke measured the transition points on the heating and cooling curves from the changes in press., and found that in the former case the transition occurred between 159.2° and 159.8° , and in the latter case

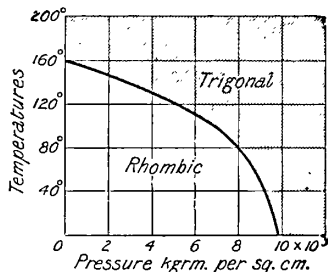

FIG. 23.—Effect of Pressure on the Transition Point of Silver Nitrate.

about 16° lower.

The **specific gravity** of silver nitrate by C. J. B. Karsten⁵ is 4.3554; L. Playfair and J. P. Joule gave 4.336 (3.9°); and H. Schröder gave numbers ranging from 4.238 to 4.328. L. Poincaré gave 3.9 for the sp. gr. of the molten salt at 350° ; G. Schulze also gave the same numbers for the molten salt. If molten silver nitrate be allowed to cool in a test-tube, the sudden expansion of the solid, which occurs about 160° , breaks the tube. The expansion—about 0.6 per cent.—is due to the transformation of the trigonal to the rhombic form. According to J. W. Retgers, the sp. gr. of the stable form of silver nitrate is 4.35 at 19.4° ; and for the labile trigonal form, 4.19. He also gave 39.1 for the **molecular volume** of the salt. The ratios of the **specific solution volume** of a 25-millinormal soln. of silver nitrate at 156° and 218° , were respectively 1.096 and 1.185; of a 50-millinormal soln. at 306° , 1.425; and of a 100-millinormal soln. at 156° and 218° , 1.095 and 1.182. The sp. gr. of soln. of silver nitrate has been determined by F. Kohrausch, H. Jahn, C. Chéneveau, A. J. Rabinowitsch, and R. Wagner. The first named gives for the sp. gr. *D* of soln. containing upwards of 5 per cent. silver nitrate, and the second named for the soln. below 5 per cent. conc., all at 18° :

<i>p</i>	0.080	0.565	5	10	20	30	40	50	60
<i>D</i>	0.9968	1.0074	1.0422	1.0893	1.1958	1.3213	1.4773	1.6745	1.9158

F. F. Fitzgerald has measured the sp. gr. of soln. in liquid ammonia, in methylamine, in ethylamine, and in quinoline.

According to J. Wagner,⁶ the specific viscosity of soln. of silver nitrate at 25° is :

Viscosity	Water	$\frac{1}{2}N$	$\frac{1}{3}N$	$\frac{1}{4}N$	N -soln.
	1.0000	1.0114	1.0240	1.0491	1.1150

A. J. Rabinowitsch measured the viscosities of these soln. According to A. Scachanoff, the coeff. of viscosity of soln. with 1.403, 2.788, 4.852, and 8.460 mols per litre is 0.00990, 0.01134, 0.01451, and 0.02439 respectively. He also measured the viscosity in very conc. quinoline soln. F. F. Fitzgerald has measured the viscosity of soln. of silver nitrate in liquid ammonia, and in methylamine, ethylamine, and quinoline. G. Zemplen measured the surface tension of soln. of silver nitrate. According to J. Thover, the coefficients of diffusion at 12° for soln. containing 0.02, 0.1, 0.9, and 3.9 mol per litre are respectively 1.035, 0.985, 0.88, and 0.535. J. C. G. de Marignac and J. D. R. Scheffer also obtained values for this constant.

E. Madelung and R. Fuchs⁷ found the compressibility of silver nitrate to be 3.67×10^{-12} dynes per sq. cm. P. W. Bridgman measured the compressibility of the two modifications of silver nitrate. At low press. (high temp.) the form with the larger vol. is the more compressible, but, passing along the transition curve to higher press. and lower temp., the difference becomes less and less, finally reversing its sign near the region of rapid curvature. Below 70° the modification stable at the higher temp. is the more compressible. The differences in the thermal expansions $\delta\alpha$, the compressibilities $\delta\beta$, and the sp. hts. at constant press. δC_p in kgrm.-cm. per grm., for press., p , expressed in kgrm. per sq. cm., are :

	1	2000	4000	6000	8000	9000
$\delta\beta$	-0.0 ₈ 45	-0.0 ₈ 35	-0.0 ₈ 25	-0.0 ₈ 15	-0.0.2	+0.0.7
$\delta\alpha$	-0.0 ₄ 55	-0.0 ₄ 37	-0.0 ₄ 22	-0.0 ₅ 6	+0.0 ₅ 5	+0.0 ₅ 5
δC_p	0.35	0.21	0.11	0.13	0.13	0.08

The change in sign of $\delta\alpha$ occurs at a lower press. than $\delta\beta$. The cause of the changes in sign is not known, "it may be a compacting together under press. of the crystal framework of the low temp. form which makes it less responsive to changes of temp. and press." Silver nitrate readily fuses without loss of weight, and it solidifies, on cooling, to a white crystalline mass which is called *lunar caustic*. In his study, *Sur la décomposition du nitrate argentique sous l'influence de la chalcure*, J. F. Persoz found that while in tranquil fusion, below 500°, bubbles of oxygen are evolved, and this is soon followed by red nitrous fumes. The product obtained by heating 15 grms. until 300 c.c. of oxygen had collected, was slightly yellow, and when extracted with boiling water gave a slight residue of silver. The crystallization of the soln. furnished long fine needles of silver nitrite, and the mother liquid contained undecomposed silver nitrate. The nitrite was formed during the heating of the salt, and not by the action of the reduced silver on the boiling soln. of the nitrate. The nitrate is stabilized by the presence of the nitrite. As indicated above, silver nitrate resists a temp. at which the cupric salt is decomposed, so that if a mixture of the two salts be heated until the effervescence due to the decomposition of the cupric nitrate has ceased, silver nitrate can be leached from the cold mass, and insoluble cupric oxide remains undissolved. Silver nitrate is also much more stable than lead nitrate; but it can be wholly reduced to metallic silver by heating it to dull redness—nitrogen, oxygen, and nitrogen oxide gases are evolved. According to E. Divers, there is an intermediate formation of silver nitrite, and the salt begins to decompose "close to the m.p. of sulphur (444°)," for if the yellow liquid be cooled, some nitrite can be detected. The aq. soln. of silver nitrate has a neutral reaction, but if the salt has been previously fused before it is dissolved in water, H. Pellat, and A. Vogel found that the soln. reacts alkaline owing to the presence of silver oxide. According to G. Scarpa, not 2 per cent. of the salt is decomposed by heating it slowly to its m.p., and A. Colson says that it can be heated

to 350° in a 2 mm. vacuum without appreciable decomposition. E. B. Rosa, G. W. Vinal, and A. S. McDaniel say that the decomposition on melting is less dependent on the temp. than on the amount of free acid present. As the last trace of acid is removed, the molten salt begins to decompose into silver oxide and colloidal silver; the presence of so little as one or two parts of acid in 100,000 parts of the solid salt hinders its decomposition. The reported melting point data range from J. J. Pohl's 198° to J. W. Retgers' 224°. The mean of the more recently published values is 212°.

J. Guinchant⁸ found the coefficient of thermal expansion between 20° and 150° is 0·000077; the contraction with rise of temp. at 159° is 0·17 per cent., and the expansion on cooling is 0·22 to 0·25 per cent. This is eq. to about 0·00047 c.c. per gm. if the sp. gr. be 4·3; P. W. Bridgman found 0·00250 c.c. per gm. at one atm. press., showing that the change in vol. during the transition does not take place equally in all directions. He also found a change in vol. of 0·00330 c.c. per gm. during the transition at a press. of 9770 kgrms. per sq. cm. P. W. Bridgman's measurements of the change in the expansion of the two forms of silver nitrate are indicated above. The difference in the expansion at different press. runs parallel with the difference of compressibility. At the low press. end of the curve, the high temp. phase is the less expansible, but at the other end of the curve it becomes more expansible. H. V. Regnault⁹ found the specific heat of silver nitrate to be 0·1435 between 15° and 99°. J. Guinchant gives 0·1411 for the rhombic form between 0° and 137°; 0·1490 for the trigonal form between 0° and 188°; and 0·187 for the liquid between 208° and 281°. The high temp. phase has the greater sp. ht. The difference in sp. ht. between the rhombic and trigonal forms of silver nitrate was found by J. Guinchant to be 0·008 cal. per gm., and P. W. Bridgman obtained a similar result at atm. press., when calculated from the values of $\delta\alpha$ and $\delta\beta$ —*vide supra*. The difference decreases at higher press., but no change of sign was observed. J. Guinchant gives 17·6 to 17·9 cal. per gm. or 2·99 Cals. per mol for the heat of fusion; H. M. Goodwin and H. T. Kalmus gave 15·2 cal. per gm. and 2·58 Cals. per mol. P. W. Bridgman found 4·9 cal. per gm. for the heat of transition from the rhombic to the trigonal form. J. Guinchant found 3·4 cal. The former also found the latent heat of the transformation at atm. press. to be 1·422 kgrmmetres. per gm., and at 5000 and 9000 kgrms. per sq. cm. press., respectively 1·228 and 0·254 kgrmmetres. per gm. M. Berthelot¹⁰ gives for the heat of formation of the salt from its elements (Ag, 30, N)=28·7 Cals.; J. Thomsen, 30·74 Cals.; and A. Colson, 28·7 Cals. J. Thomsen also gave $\text{Ag}_2\text{O} + 2\text{HNO}_{3\text{aq.}} = 2\text{AgNO}_3 + \text{H}_2\text{O} + 10·881$ Cals. M. Berthelot gives -5·7 Cals. for the heat of solution of silver nitrate in water between 10° and 15° for a mol of the salt in 470 to 940 mols of water. J. Thomsen found the heat of soln. at ordinary temp. to be -5·54 Cals. G. Bruni and G. Levi give -5·30 Cals. for the heat of soln. of a mol in 1000 mols. of water, or -5·70 Cals. for a mol in 1600 mols. of water.

According to W. Meyerhoffer,¹¹ the vapour pressure curve of a sat. soln. of silver nitrate has a maximum while the vap. press. at the two ends of the solubility curve—the cryohydrate and the m.p.—approximate to zero:

	121°	135°	150°	160°	167°	170°	185°	191°
Vap. press.	760	800	960	1000	1015	1010	900	760 mm.

There are therefore two sat. soln. which boil at atm. press.—one at 121° and the other at 191°. If the soln. at the second b.p. is cooled, the vap. press. rises, and salt crystallizes out; in this region, the heat of soln. is positive; it then passes through zero, and at a lower temp. it is negative. W. Meyerhoffer's diagrammatic curve of the vap. press. of soln. of silver nitrate is shown in Fig. 24. *AC* is the vap. press. of ice; *BMD*, the vap. press. of a soln. sat. with the rhombic salt; *DENF*, of a soln. sat. with the trigonal salt; *GH*, that of the rhombic salt; *HF*, that of the trigonal salt; *FJ*, that of the molten salt; and *HOD*, that of the rhombic and trigonal salts, and water vapour. F. M. Raoult¹² found the difference between the vap. press.

of water vapour, and that of a soln. containing one part of silver nitrate in 100 parts of water to be 0.160×7.6 mm. According to P. Kremers, a sat. soln. of silver nitrate boils at 125° . A. Smits, and L. Kahlenberg found that soln. with w grms. of salt per 100 grms. of water had boiling points corresponding with :

w	0.8040	1.542	7.4949	35.08	86.43	136.36
Raising b.p.	0.044°	0.087°	0.332°	1.526°	3.143°	4.415°
Mol. raising	0.93°	0.90°	0.87°	0.739°	0.618°	0.550°

The mol. raising of the b.p. thus gradually decreases as the conc. of the soln. increases. F. M. Raoult found the difference between the freezing point of water and of soln. containing one part of salt in 100 parts of water to be 0.145° . W. A. Roth has measured the lowering of the f.p. of soln. containing N mols of salt per litre :

N	0.01050	0.02826	0.04046	0.05346	0.08119	0.1369
Lowering f.p.	0.0375°	0.0991°	0.1407°	0.1840°	0.2702°	0.4474°
Mol. lowering	3.57	3.51	3.48	3.385	3.33	3.265

The mol. lowering of the f.p. thus gradually decreases as the conc. of the soln. increases.

J. Guinchant found the cryoscopic constant to be 264; and that with soln. of the nitrates of lithium, potassium, thallium, and lead; silver sulphate; and with silver fluoride, chloride, iodide, and iodate in molten silver nitrate, the molecular lowering is about normal.

P. Werner and M. Stephani¹³ found silver nitrate dissolved in benzonitrile has a molecular weight 176 corresponding with the formula AgNO_3 ; N. Castoro likewise found 173 for soln. in urethane; G. Schülze, L. Kahlenberg, and W. Schmujiloff found the mol. wt. in pyridine soln. to be normal; while P. Walden found the salt to be polymerized in pyridine, aniline, liquid ammonia, and liquid sulphur dioxide, but the mol. wt. becomes approximately normal with increasing dilution. Silver nitrate blackens when exposed to light, but not if organic matter be rigorously excluded. The crystals of silver nitrate have a positive double refraction. The index of refraction μ of aq. soln. of silver nitrate was studied by E. Forster,¹⁴ and P. Barbier and L. Roux. At 17.5° , B. Wagner gave for soln. with p per cent. of salt :

p	1	5	10	15	20	25
μ	1.33426	1.33868	1.34393	1.34882	1.35353	1.36669

K. Schaefer reports the selective absorption spectrum in the ultra-violet spectrum is independent of the degree of ionization; and W. N. Hartley that the specific absorption of silver does not influence that due to the nitrate-ions.

W. N. Hartley, and K. Schaefer found that soln. of silver nitrate do not conform to Beer's law since conc. soln. have a proportionately greater absorption. For layers of liquid of depth l and conc. C , the spectrum is continuous to λ_1^{-1} , and there is an absorption band between λ_1^{-1} and λ_2^{-1} :

l	10	10	50	200	200	200	200	200
C	N	N	N	$\frac{1}{2}N$	$\frac{1}{2}N$	$\frac{1}{2}N$	$\frac{1}{5}N$	$\frac{1}{10}N$
λ_1^{-1}	3004	3002	3069	3069	3067	3069	3148	3150
λ_2^{-1}	—	—	3535	—	—	3579	3579	3531
								3504

W. N. Hartley found that the absorption spectrum of soln. of silver nitrate, unlike that of nitric acid or potassium nitrate, is not the same for soln. containing the same quantity of nitrate in soln. of different thickness (conc. variable) for the more dil. soln. transmit rays more freely—20 to 50 times as great as soln. of normal conc.

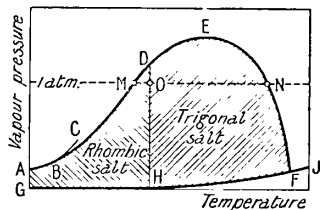

FIG. 24.—Meyerhoffer's Vapour Pressure Curves of Solutions of Silver Nitrate. (Diagrammatic.)

although the same quantity of nitrate is contained in each corresponding soln. This difference is possibly due to the action of light on the soln.

According to L. Poincaré,¹⁵ the eq. **electrical conductivity** of molten silver nitrate is 0.0537 at 300° ; and the specific conductivity of the molten salt at θ° is $1.220\{1+0.00272(\theta-350)\}$. A. Leduc has studied the changes which occur in the electrolysis of a soln. of AgNO_3 . The eq. conductivity, λ , of aq. soln. has been measured by very many observers. H. C. Jones' data for soln. with a mol. of the salt in v litres of water are :

0°	$\left\{ \begin{array}{l} v \\ \lambda \\ \alpha \end{array} \right.$	$\begin{array}{l} . \\ . \\ . \end{array}$	$\begin{array}{l} 4 \\ 51.43 \\ 72.4 \end{array}$	$\begin{array}{l} 8 \\ 56.01 \\ 78.8 \end{array}$	$\begin{array}{l} 32 \\ 61.80 \\ 87.0 \end{array}$	$\begin{array}{l} 128 \\ 65.79 \\ 92.6 \end{array}$	$\begin{array}{l} 512 \\ 69.24 \\ 97.4 \end{array}$	$\begin{array}{l} 2048 \\ 69.83 \\ 98.3 \end{array}$	$\begin{array}{l} 4096 \\ 71.03 \\ 100.00 \end{array}$	
	12.5°	$\left\{ \begin{array}{l} \lambda \\ \alpha \\ \kappa_{0-1.25} \end{array} \right.$	$\begin{array}{l} . \\ . \\ 1 \end{array}$	$\begin{array}{l} 70.55 \\ 71.3 \\ 1.65 \end{array}$	$\begin{array}{l} 76.68 \\ 77.4 \\ 1.65 \end{array}$	$\begin{array}{l} 85.30 \\ 86.2 \\ 1.88 \end{array}$	$\begin{array}{l} 91.06 \\ 92.0 \\ 2.02 \end{array}$	$\begin{array}{l} 94.99 \\ 95.9 \\ 2.06 \end{array}$	$\begin{array}{l} 96.67 \\ 97.6 \\ 2.15 \end{array}$	$\begin{array}{l} 99.03 \\ 100.00 \\ 2.24 \end{array}$

where κ represents the **temperature coefficient** of the conductivity. H. Herwig found that increasing the *pressure* on soln. of silver nitrate did not affect the resistance; nor could E. Coehn detect any variation in the application of Faraday's law in the electrolysis of silver nitrate under press. ranging from 1 to 1500 atm. According to J. Johnston, the eq. conductivity at infinite dilution at 18° is 116.1 ; at 100° , 367 ; and at 156° , 570 . According to R. Abegg and C. Immerwahr, a normal soln. of silver nitrate is 58 per cent. ionized. The **percentage degree of ionization** is represented above by α . W. A. Roth calculated a series of values for the **ionization constant** from the lowering of the f.p., and found 0.11 , 0.23 , and 0.32 respectively for $0.0105N$ -, $0.05214N$ -, and $0.1369N$ -soln. J. H. van't Hoff found that the value of the ratio $\alpha = \lambda_v / \lambda_\infty$ can be represented by $\alpha^3 / (1-\alpha)^2 v = 1.11$ at 25° . The subject has been studied by G. N. Lewis and co-workers. M. Rudolphi found the **heat of ionization** for a mol. of the salt in 32 litres of water at 25° to be -1.878 cal., and in 512 litres of water, -1.725 cal. A. J. Rabinowitsch studied the anomalous ionization of soln. of silver nitrate. W. J. Mather found the **transport number** for the anions of silver nitrate to be respectively 0.538 and 0.525 for $0.025N$ -soln. at 0° and 45° ; M. Löb and W. Nernst gave 0.541 for $0.1N$ -soln. at 0° ; and W. Hittorf, for $2.3N$ -soln. at 15° , 0.473 . H. Jahn found 0.482 for the transport number of the cations of silver nitrate at 30° ; A. A. Noyes and co-workers found for $0.02N$ -soln. 0.461 at 0° ; for 0.01 to $0.1N$ -soln. at 18° , 0.471 ; for 0.01 to $0.05N$ -soln. at 25° , 0.477 ; for 0.005 to $0.5N$ -soln. at 30° , 0.481 . A. Leduc studied the electrolysis of soln. of silver nitrate.

The electrical conductivities of soln. of silver nitrate in methyl and ethyl alcohols and in acetone have been studied by H. C. Jones, and he found that the ionization increases with dilution more rapidly than in water. The soln. in ethyl alcohol is positive when tested against an aq. soln., the soln. in methyl alcohol is weaker, and in acetone weaker still. A soln. in ethyl alcohol is negative towards one in methyl alcohol. The degree of ionization in alcoholic soln. is less than in aq. soln., so that it is assumed the soln. press. of silver in alcohol is less than in water, and B. Vollmer estimates that the soln. press. is 42-48 times as great in water as in alcohol. A. Roshdestwensky and W. C. McC. Lewis measured the eq. conductivity of soln. of silver nitrate in acetone, and found the transport number of the anions to be $0.58-0.60$ at 90° for $0.02N$ - to $0.007N$ -soln., and 0.56 for soln. of less conc. C. A. Kraus and W. C. Bray, and A. Ssachanoff have studied soln. in aniline; L. Kahlenberg and O. E. Rüdorff, in amylamine; E. C. Franklin and H. D. Gibbs, F. F. Fitzgerald, and E. C. Franklin and C. A. Kraus, soln. in methylamine; G. Bodländer and W. Eberlein, soln. in methylamine and ethylamine; A. Ssachanoff, in dimethylamine; A. Ssachanoff and J. Prscheborowsky in *o*-toluidine and benzylamine; A. T. Lincoln in pyridine, piperidine, quinoline, benzonitrile, and methyl and ethyl cyanoacetates; and L. Kahlenberg, in acetonitrile and methyl thiocyanate. E. C. Franklin and co-workers measured the conductivity, the degree of ionization, and the transport numbers of soln. of silver nitrate in liquid ammonia.

F. Strcintz measured the **electromotive force** of soln. of silver and cupric nitrates. The e.m.f. of conc. cells $\text{Ag} | \text{AgNO}_{3\text{soln.}} | \text{AgNO}_{3\text{soln.}} | \text{Ag}$ have been measured by

J. Miesler, W. Nernst, W. Negbauer, A. C. Cumming and R. Abegg, N. Cybulsky and J. Dunin-Borkowsky, A. A. Noyes and B. F. Brann, etc. J. M. Bell and A. L. Field found that the e.m.f. of conc. cells with aq. soln. at 25° are in agreement with Nernst's formula with dil. soln. $E = \{2v/(v+v')\} (RT/nF) \log (C_1/C_2)$, where C_1 and C_2 refer to the conc. of silver ions; and v and v' to the migration ratios of Ag⁺ and NO₃⁻. With conc. soln., however, the calculated values are too great owing to the lowered velocities of the ions. E. Bichal and R. Blondlot found that the e.m.f. of the cell Pt | AgNO₃ soln. | Ag was changed about 0.5 millivolt per 100 atm. press. W. K. Lewis investigated the e.m.f. of conc. cells. J. H. Wilson studied the e.m.f. of conc. cells Ag | $\frac{1}{10}N$ -AgNO₃ in alcohol | $\frac{1}{100}N$ -AgNO₃ in alcohol | Ag for methyl and ethyl alcohols. A. Roshdestwensky and W. C. McC. Lewis found the e.m.f. of conc. cells of silver nitrate dissolved in acetone. L. R. Ferguson could not confirm F. L. Hunt's observation that only in darkness does silver separate in a cell Pt | KI, AgNO₃ | Pt. G. von Elissaff studied the electrolytic valve action of aq. soln. and the fused salt. A. E. Oxley found soln. of silver nitrate show the Hall effect.

Silver nitrate is very soluble in water; the solubility has been determined by P. Kremers,¹⁶ W. Middelberg, A. Étard, W. A. Tilden, W. A. Shenstone, J. Schnauss, etc. The average data for the weights of silver nitrate in grms. per 100 grms. of soln. are when the solid phase is the rhombic form:

	0°	10°	20°	30°	40°	50°	60°	80°	100°	130°
S	53	62	68	73.5	77	80	82.5	86.7	90.1	98.5

According to D. J. Hissink, with ice as the solid phase the solubility is 34.2 per cent. at -5.6°; and, according to W. Middelberg, the eutectic is at -7.3° with a solubility of 7.1 per cent. The solubility at the m.p. is infinite, for the salt and water then mix together in all proportions. The addition of *nitric acid* to an aq. soln. of silver nitrate lowers the solubility as noted by L. Schweigger-Seidal, C. J. H. Warden, etc. C. Schultz found that 100 grms. of conc. nitric acid dissolved 0.2 gm. of silver nitrate, and an acid 2HNO₃+3H₂O dissolved 3.33 grms. at 20°, and 16.6 grms. at 100°. J. I. O. Masson found that if D denotes the sp. gr. of the soln., a the number of mols of nitric acid per litre of soln., and b the number of mols of silver nitrate per litre of soln.—all at 30°:

D	2.3921	2.2754	2.1243	1.9402	1.7052	1.4980	1.4195	1.3818	1.3976
a	0.0000	0.4042	0.962	1.698	2.834	4.497	5.992	8.84	12.53
b	10.31	9.36	8.08	6.54	4.526	2.590	1.698	0.843	0.347

R. Engel's empirical rule, that the introduction of an acid into a sat. soln. of a salt precipitates a chemically eq. quantity of salt, holds approximately for some acids of moderate conc., but it fails completely in other cases. J. I. O. Masson represents the results by:

$$-\frac{da}{db} = 0.40 + 0.46 \frac{a}{b}; \text{ or } \frac{a}{b} = \frac{0.40}{1.46} \left\{ \left(\frac{B}{b} \right)^{1.46} - 1 \right\}$$

where B is the value of b when a is zero. Silver nitrate is readily soluble in alcohol. According to C. A. L. de Bruyn, 100 parts of absolute *methyl alcohol* at 19° dissolve 3.72 parts of silver nitrate; and *ethyl alcohol*, 3.1 parts of the salt; J. M. Eder gives for the solubility S in grms. of the salt per 100 grms. of p per cent. alcohol at 15°:

Alcohol, p	8.5	24.7	33.4	42.5	52.5	62.5	73.6
AgNO ₃ , S	158	73.7	56.4	35.8	30.5	12.1	10.3

He also gives data at 50° and at 75°—*e.g.* the solubilities in 16.3 per cent. alcohol at 15°, 50°, and 75° are respectively 107, 214, and 340; and in 92.5 per cent. alcohol, respectively 3.8, 7.3, and 18.3. W. Kuriloff has also investigated the same subject, and F. A. H. Schreinemakers studied the ternary system: water—alcohol—silver

nitrate. D. J. Hissinck studied the mutual solubility of silver nitrate and *sodium nitrate* in aq. soln. of alcohol. In addition to finding silver nitrate to be soluble in methyl and ethyl alcohols, W. G. Wilcox found it to dissolve readily in *isobutyl alcohol*.

S. von Lazczynsky found 100 parts of absolute *acetone* both at 14° and at 59° dissolve 0.35 part of the salt; W. G. Wilcox also found this salt to be soluble in acetone, *chloroform*, and *carbon tetrachloride*. A. Naumann says 0.44 part at 18°. C. E. Linebarger found 100 parts of *benzene* at 35° dissolves 0.22 part of salt, and 0.44 at 40.5°. P. Werner says the salt is surprisingly soluble in *benzonitrile*; R. Scholl and W. Steinkopf find it to be soluble in *acetonitrile*; F. L. Shinn, and F. F. Fitzgerald found silver nitrate dissolves in *methylamine* and *ethylamine*, with the development of heat, forming clear colourless soln. H. D. Gibbs found that the very high solubility of the salt in this menstruum is connected with the formation of a double salt $\text{AgNO}_3 \cdot 4\text{CH}_3\text{NH}_2$. F. F. Fitzgerald found that a soln. with 69.2 grms. of the salt in 100 c.c. is not sat. between -33° and 15°, and the smallest trace of moisture leads to the separation of a black precipitate. It is also soluble in *amylamine*. E. C. Franklin and C. A. Kraus, and F. M. G. Johnson and N. T. M. Wilsmore studied the solubility in *liquid ammonia*, but its solubility is not as great as might have been anticipated from its solubility in water and in ethylamine. According to E. H. Büchner, silver nitrate is insoluble in liquid carbon dioxide; F. Bezold found the salt to be insoluble in methyl acetate.

The chemical properties of silver nitrate.—J. R. Glauber¹⁷ noted that a soln. of silver nitrate blackens in contact with organic matter. A soln. of silver nitrate gradually decomposes on exposure to light. According to F. Liebert, the reaction continues until all the organic matter has reacted, for if the soln. be then filtered through asbestos, a stable soln. is obtained which was kept for more than a year in a clear glass bottle in full daylight without change. In 1794, Mrs. Fulhame noted the reduction of silver nitrate when a piece of silk wetted with a soln. of that salt is exposed to the action of **hydrogen** gas in the dark. If, however, moisture is excluded the salt is not reduced. C. Brunner reported that he obtained a light grey precipitate by passing purified hydrogen gas through an aq. soln. of that salt for several hours; but the greater part of the salt remained unchanged after a week's exposure to the action of the gas. B. Renault, *au contraire*, maintained that the observed reduction is due to the contamination of the hydrogen with small quantities of silicane, stibine, arsine, or phosphine, although Swedish filter paper moistened with a soln. of the salt is immediately blackened. J. W. Russell, again, maintained that although no action appears when purified hydrogen is passed into a conc. soln. of the salt, after the lapse of about half an hour, metallic silver is precipitated which acts upon the liberated acid: $2\text{AgNO}_3 + \text{H}_2 = 2\text{Ag} + 2\text{HNO}_3$, forming silver nitrite; but with a very dil. soln. of the salt, metallic silver is obtained because the resulting acid is not sufficiently conc. to act on the metal. H. Pellet contradicted Russell's statement that silver nitrite is formed, and claimed that that salt cannot exist in the presence of nitric acid especially in a hot soln. H. Pellet continued that hydrogen, purified by scrubbing with soln. of sodium hydroxide and silver nitrate (1 : 33), has no action on a neutral soln. of silver nitrate at ordinary temp., a light grey precipitate is formed when hydrogen is first introduced at 80°, and after filtration no further change occurs. He also found that a cold or hot soln. of fused silver nitrate, which has an alkaline reaction owing to the presence of a little silver oxide, is attacked by hydrogen only so far as to reduce the oxide of silver in soln.; if the soln. be acidulated with nitric acid, no silver is precipitated. N. N. Beketoff found that silver is precipitated from a neutral soln. of silver nitrate only when the operation is continued for a long time; that the silver precipitated is eq. to the hydrogen absorbed, and the soln. then has an acid reaction. A. R. Leeds found a soln. of silver nitrate becomes acid and is reduced to silver and silver nitrite by the action of hydrogen scrubbed with an acid soln. of ferrous sulphate, conc. sulphuric acid, solid potassium hydroxide, and a 20-ft. column of pumice-stone and asbestos soaked with a soln. of silver nitrate. M. Paucke also says that crystals of this salt, as well as neutral and acid soln., are reduced to the metal by hydrogen gas, but that an ammoniacal soln. of the salt is not reduced. T. Poleck and K. Thümmel say that acid soln. are not reduced and that in very conc. soln., ammonia is formed.

The evidence as to the action of hydrogen at ordinary press. and temp. on a soln. of silver nitrate, is therefore somewhat discordant. J. B. Senderens found that a boiling soln. of silver nitrate is readily reduced by hydrogen, and this the more the more conc. the soln. N. N. Beketoff also found that hydrogen under press. produces a film of silver on a soln. of silver nitrate. J. Donau says that a flame of hydrogen is coloured yellow by playing on a soln. of silver nitrate.

As indicated previously, silver nitrate, prepared by crystallization from its aq. soln., has a neutral reaction, and hence there is no evidence of hydrolysis, but E. B. Rosa,¹⁸ G. W. Vinal, and A. S. McDaniel claim that by the repeated crystallization of the salt from aq. soln., a *basic silver nitrate* is formed. Judging from the early observations of C. H. Pfaff, and A. Vogel, **water vapour** exerts a reducing action on soln. of silver nitrate. According to A. Mailfert, **ozone** with a soln. of silver nitrate gives a bluish-black flocculent precipitate of silver peroxide, and when the soln. is agitated, silver nitrate is again formed. E. Mulder found that silver nitrate accelerates the decomposition of **hydrogen peroxide**, without undergoing any change. H. Kwasnik reduced a soln. of silver nitrate to the metal by the action of **barium dioxide**. F. Wöhler¹⁹ found that when silver is immersed in a conc. soln. of silver nitrate overlaid with water, metallic silver of dendritic form grows from a few scattered points on the surface of the metal. It is assumed that silver dissolves in the soln. of silver nitrate, and is re-deposited therefrom. According to E. Bose, a warm aq. soln. of silver nitrate dissolves metallic silver, forming **silver subnitrate**; the metal is precipitated again when the soln. cools. K. Eisenreich also obtained a soln. of the subnitrate by the electrolysis of a soln. of silver nitrate with a silver anode.

According to H. Moissan,²⁰ **fluorine** does not attack cold silver nitrate, but at a dull red heat, yellow silver fluoride is formed. H. St. C. Deville found that when dried **chlorine** is passed over dried silver nitrate, between 55° and 60°, silver chloride, nitric anhydride, and oxygen gas are formed. M. Odet and M. Vignon say the reaction occurs in two phases, first the formation of nitroxyl chloride, NO_2Cl , which then reacts with silver nitrate. According to A. J. Balard and A. Naquet, when chlorine gas is passed into an aq. soln. of silver nitrate, silver chloride and hypochlorous acid are formed, whereas C. Weltzien found that with chlorine water, silver chloride and chlorate are formed. W. Dancer utilized the action of **bromine** on silver nitrate to prepare hypobromous acid. R. E. Hughes found that if moisture be excluded, **hydrogen chloride** has no action on dry silver nitrate. The action of **hydrochloric acid** and of the soluble **chlorides** on soln. of silver salts has been previously described. Similar results are obtained with **hydrobromic acid** and the soluble **bromides**, or with **hydriodic acid** and the soluble **iodides**.

According to E. C. Franklin and C. A. Kraus, slightly soluble silver chloride is precipitated by **ammonium chloride**, from a soln. of silver nitrate in liquid ammonia; very little bromide is precipitated by **ammonium bromide**; and no iodide by **ammonium iodide**. J. Preuss found that when dry silver nitrate is triturated with **iodine**, silver iodide, periodic acid, and nitric acid are formed. According to W. Pawloff and S. Schein, iodine acts on an excess of silver nitrate as symbolized by the equation: $6\text{AgNO}_3 + 3\text{I}_2 + 3\text{H}_2\text{O} = 5\text{AgI} + \text{AgIO}_3 + 6\text{HNO}_3$; and if the iodine be in excess: $5\text{AgNO}_3 + 3\text{I}_2 + 3\text{H}_2\text{O} = 5\text{AgI} + 5\text{HNO}_3 + \text{HIO}_3$. In alcoholic soln. C. Weltzien found iodine to react in accord with the first of these two equations.

According to J. Kablukoff,²¹ if an alkali halide be dissolved in molten silver nitrate: $\text{AgNO}_3 + \text{K} \rightleftharpoons \text{Ag} + \text{KNO}_3$. The homogeneous mass gradually separates into two layers; the lower layer is silver halide. The m.p. of silver nitrate was depressed with increasing proportions of silver chloride from 207.2° for the pure salt down to 179.8° when 14.99 per cent. of silver chloride had been added. With mixtures of silver bromide and nitrate there is a eutectic near 163.5° with 20.2 per cent. AgBr. With mixtures of silver iodide and nitrate G. Scarpa obtained a eutectic at 80° with 55 per cent. AgI. According to J. Schnauss, P. Kremers, H. Risse, and H. Debray, silver chloride dissolves in hot soln. of silver nitrate and

crystallizes out again on cooling. K. Hellwig found that 100 c.c. of a 3*N*-soln. of silver nitrate dissolves 0.08 grm. of silver chloride; and when the soln. is diluted, the solubility sinks very rapidly. No double salt could be made from the soln. of silver chloride in the nitrate. G. Peichert claimed to have made **silver chloronitrate**, $\text{AgCl} \cdot \text{AgNO}_3$, by dissolving the chloride in nitric acid. The colourless prismatic crystals which separated from the soln. were washed with equal parts of alcohol and ether. The crystals are only slowly blackened in light; they melt at 160° ; and are decomposed rapidly in water, slowly by commercial alcohol, and are not affected by a mixture of alcohol and ether.

The solubility of the bromide decreases rapidly as the soln. of silver nitrate is diluted. H. Risse, and K. Hellwig found that fine acicular crystals of **silver bromonitrate**, $\text{AgBr} \cdot \text{AgNO}_3$, separate out on cooling the soln. of silver bromide in a hot conc. soln. of the silver nitrate. P. Kremers and J. Schnauss failed to make the salt by the wet process, but P. Kremers prepared the double salt by fusing eq. amounts of the component salts; the double salt prepared by the dry process melts at 182° ; the salt obtained by the wet process melts at 172° . The crystals are decomposed by water or alcohol. Silver iodide is far more soluble than either of the other two halides in an aq. soln. of silver nitrate. K. Hellwig found at 25° :

AgNO_3	.	.	0.20	0.40	0.70	1.215	2.54	3.75	5.9	mols per litre.
AgI	.	.	0.068	0.167	0.85	3.08	16.1	33.2	85.0	grms. ,,

The results are indicated in Fig. 25 along with the three solid phases. The solubility is augmented by raising the temp. J. Schnauss found a cold soln. of silver nitrate sat. at 11° , dissolves 2.3 parts of silver iodide, and 12.3 parts when boiling.

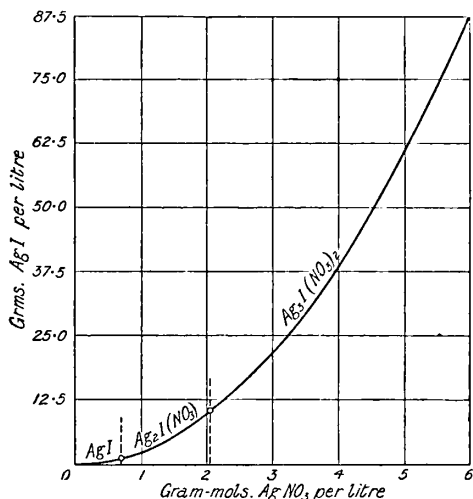

FIG. 25.—Solubility of Silver Iodide in Solutions of Silver Nitrate.

without decomposition, but they are decomposed with a larger proportion of water. J. Schnauss says that silver iodide is formed when the crystals are treated with water, and C. Stürenberg added that the silver iodide is dissolved when the soln. is heated, and on cooling, crystals of **silver iododinitrate**, $\text{AgI} \cdot 2\text{AgNO}_3$, appear. According to J. Schnauss, $\text{AgI} \cdot \text{AgNO}_3$ is not decomposed nor dissolved by hot alcohol. C. Stürenberg prepared the iododinitrate by cooling a hot conc. soln. of silver nitrate which was not completely sat. with the iodide, and by adding alcohol to a soln. of $\text{AgI} \cdot \text{AgNO}_3$ in silver nitrate. H. Risse melted proportions of the component salts, and boiled the cold cake with water. The soln. deposited crystals of iododinitrate on slow cooling. R. Fanto prepared the salt by passing carbon dioxide charged with vapour of methyl iodide into a soln. of silver nitrate. A. Riehe, C. Weltzien, and K. Hellwig also

J. Preuss (1839) observed that a crystalline compound of silver iodide and nitrate is deposited from a soln. of silver iodide in a conc. soln. of silver nitrate, or from a soln. of silver iodide and oxide in nitric acid. The product is **silver iodonitrate**, $\text{AgI} \cdot \text{AgNO}_3$, and it was prepared by C. Stürenberg by cooling a boiling conc. soln. of silver nitrate sat. with silver iodide. K. Hellwig used a similar process. The clear acicular crystals are said to belong to the cubic system, and to melt at 72° ; P. P. von Weimarn says 95° . J. Schnauss says the compound rapidly blackens in daylight. P. Kremers says it is almost insensitive to light. According to P. Kremers, the crystals dissolve in a little water

prepared the salt. It forms colourless needle-like crystals which F. M. Jäger found to be rhombic bipyramids with axial ratios $a : b : c = 0.6638 : 1 : 0.3123$. H. Risse says the crystals blacken rapidly in light, while R. Fanto found the blackening only occurs in moist air; in dry air, the crystals are almost insensitive to light. H. Risse found the salt melts at 105° , and exhibits under-cooling phenomena. R. Fanto gives 119° for the m.p., and F. M. Jäger, 119.1° . The crystals are decomposed with water and alcohol, but, according to H. Risse, a protective skin of silver iodide may be produced by the treatment, so that decomposition appears to be incomplete, otherwise the decomposition by water is complete. K. Hellwig found that the b.p. determinations correspond with the existence of complex salts in aq. soln.; the salt is soluble in a conc. soln. of silver nitrate with ionization; during electrolysis, the silver iodide collects at the cathode; the ionization of silver iododinitrate, $\text{Ag}_3\text{I}(\text{NO}_3)_2$, is not $\text{Ag}_3\text{I}(\text{NO}_3)_2 \rightleftharpoons \text{Ag}_3\text{I}^+ + 2\text{NO}_3^-$; but rather $\text{Ag}_3\text{I}(\text{NO}_3)_2 \rightleftharpoons \text{Ag}_3\text{I}(\text{NO}_3)^+ + \text{NO}_3^-$; and $\text{Ag}_3\text{I}(\text{NO}_3)^+ = \text{Ag}_3\text{I}^+ + \text{NO}_3^-$; and $\text{Ag}_3\text{I}^+ = 2\text{Ag}^+ + \text{AgI}$; as well as $\text{Ag}_3\text{I}(\text{NO}_3)^+ = \text{AgI} + \text{Ag}^+ + \text{AgNO}_3$. The salt also dissolves sparingly in boiling water. K. Hellwig obtained evidence of still higher nitrates—*e.g.* silver iodotetranitrate, AgI.4AgNO_3 . A. W. Hofmann, and P. Kremers also obtained products with higher proportions than $\text{AgI} : \text{AgNO}_3 = 1 : 2$, but the 1:2-compound may have been contaminated with silver nitrate. G. Scarpa obtained evidence of the formation of $3\text{AgNO}_3.2\text{AgI}$. K. Hellwig also prepared silver cyanodinitrate, $\text{Ag}_3\text{Cy}(\text{NO}_3)_2$; and silver thiocyanatodinitrate, $\text{Ag}_3\text{CyS}(\text{NO}_3)_2$; and C. Stürenberg triple salts of lead and silver nitrates and silver iodide.

N. W. Fischer²² found a mixture of silver nitrate and sulphur detonates slightly when struck with a hammer. If a warm conc. soln. of silver nitrate be digested with sulphur, T. Poleck and K. Thümmel found that the salt is decomposed and a carmine-red amorphous powder, $\text{Ag}_2\text{S.AgSO}_4$, is formed. According to R. Fanto, the first stage in the action of hydrogen sulphide on a soln. of silver nitrate is the formation of silver thionitrate, $\text{Ag}_2\text{S.AgNO}_3$, and with the continued action of the gas, silver sulphide is formed. T. Poleck and K. Thümmel prepared silver thionitrate as a greenish-yellow precipitate by passing hydrogen sulphide into a conc. soln. of silver nitrate; and also by treating silver sulphide with fuming nitric acid. The product blackens when washed with water or alcohol, owing to its decomposition: $\text{Ag}_2\text{S.AgNO}_3 \rightarrow \text{Ag}_2\text{S} + \text{AgNO}_3$, but it is not changed by dil. nitric acid. The air-dried product loses very little in weight when heated to 180° ; but when heated to redness, it gives off sulphur dioxide, etc., and leaves metallic silver. It is sensitive to light. Galena, copper pyrites, and the lower iron and copper sulphides were found by W. Skey to precipitate metallic silver; the reduction of ammoniacal soln. by cuprous sulphide occurs only when warm. R. Schneider also found that silver is precipitated by cuprous sulphide: $\text{Cu}_2\text{S} + 4\text{AgNO}_3 = 2\text{Cu}(\text{NO}_3)_2 + \text{Ag}_2\text{S} + 2\text{Ag}$. J. Myers found that when crystals of silver nitrate are in contact with a soln. of potassium sulphide, a crust of silver sulphide is formed and underneath this a thin film of metallic silver. According to E. C. Franklin and C. A. Kraus, ammonium sulphide gives a precipitate in a soln. of silver nitrate in liquid ammonia. According to H. Rose, and S. Kern, sulphur dioxide precipitates silver sulphite completely from an aq. soln. of silver nitrate, and while the precipitate is insoluble in aq. sulphurous acid, it is soluble in aq. ammonia or alkali sulphite. C. Geitner found that by heating silver or silver nitrate with sulphurous acid in a sealed tube at 200° , microscopic crystals of silver sulphide are formed resembling the native sulphide. According to H. Baubigny, an excess of sodium sulphite, at 100° , forms over 95 per cent. of sodium dithionate, $\text{Na}_2\text{S}_2\text{O}_8$, with the separation of silver; for the action of potassium and ammonium sulphites, see the precipitation of silver from the soln. of its salts.

Silver nitrate was found by H. Marshall to be slowly converted by potassium persulphate into black silver peroxide, etc.; J. Girard found sodium thiosulphate converts silver nitrate into the sulphide with the evolution of 23 Cals. when an eq. of each salt is dissolved in 2 litres of water at 15° . J. Fogh showed that silver

thiosulphate is first formed with the development of 2.6 Cals. T. E. Thorpe found **sulphuryl chloride**, SO_2Cl_2 , is without action on silver nitrate, indeed, the former can be distilled from the latter without perceptible decomposition; **thionyl chloride**, SOCl_2 , reacts rapidly with silver nitrate forming silver chloride and nitrosulphuric chloride, $\text{Cl}\cdot\text{SO}_2\cdot\text{NO}_2$; and **chlorosulphonic acid**, $\text{Cl}\cdot\text{SO}_2\cdot\text{OH}$, acts violently, forming silver chloride and nitrosulphuric acid, $\text{HO}\cdot\text{SO}_2\cdot\text{NO}_2$. E. Bamberger obtained ozonized oxygen by heating **persulphuric acid** with silver nitrate.

T. Parkman found that red selenium is blackened in a soln. of silver nitrate, flakes of selenious acid are formed as well as a black powder, probably a compound of selenium and silver, Ag_2Se , from analogy with analysis on the corresponding reaction with cupric nitrate. R. D. Hall and V. Lenher have shown that the "flakes of selenious acid" were probably silver selenite. J. B. Senderens found that **selenium** reacts readily with a boiling dil. or conc. soln. of silver nitrate, forming silver selenide and selenious acid: $4\text{AgNO}_3 + 3\text{Se} + 3\text{H}_2\text{O} = 2\text{Ag}_2\text{Se} + \text{H}_2\text{SeO}_3 + 4\text{HNO}_3$; if the mixture be heated in a sealed tube some silver selenite, Ag_2SeO_3 , is formed. N. W. Fischer observed that tellurium acts on a soln. of silver nitrate producing a black compound of tellurium and silver which does not acquire a metallic lustre under press., but he obtained no reduction with selenium. T. Parkman regarded the black powder as having the composition Ag_2Te , from analogy with analysis on the corresponding compound with copper nitrate. According to J. B. Senderens, at 100° the reaction $4\text{AgNO}_3 + 3\text{Te} + 3\text{H}_2\text{O} = 2\text{Ag}_2\text{Te} + \text{H}_2\text{TeO}_3 + 4\text{HNO}_3$ is faster than with the analogue selenium, and the reaction with both elements proceeds slowly but completely at ordinary temp. R. D. Hall and V. Lenher represents the reaction $4\text{AgNO}_3 + 3\text{Te} = 2\text{Ag}_2\text{Te} + \text{Te}(\text{NO}_3)_4$.

According to E. Divers,²³ silver nitrate decomposes at a much lower temp. in an atm. of **nitric oxide** than when heated in air. The decomposition is marked at the m.p. of the salt, and at the b.p. of mercury the decomposition is slow but complete. At first, the products are silver nitrite and nitric peroxide, $\text{AgNO}_3 + \text{NO} = \text{AgNO}_2 + \text{NO}_2$, but very little silver is liberated, the nitrite being almost wholly preserved for a long time, through combination with the undecomposed nitrate. But when, as the nitrate becomes decomposed, the nitrite is no longer protected, it suffers decomposition, as usual, into silver and nitric peroxide; finally nothing but silver remains. Theoretically it is quite probable that nitric oxide does not, after all, act directly on silver nitrate. Assuming the first action is $2\text{AgNO}_3 \rightarrow 2\text{AgNO}_2 + \text{O}_2$, and that the nitric oxide reacts with the oxygen to form nitrogen tetroxide, silver nitrate is not actually decomposed by nitric oxide, but only decomposes more rapidly in its presence in consequence of its interaction with one of the products of decomposition. E. Divers and T. Haga say that **hydroxylamine** gives a black precipitate of silver oxide when it reacts with a soln. of silver nitrate. The action of **ammonia** is treated in the next section. According to N. W. Fischer,²⁴ a mixture of silver nitrate and **phosphorus** detonates violently when struck with a hammer. M. Mauder also stated that a mixture of sublimed **arsenic** triturated with ten times its weight of silver nitrate takes fire immediately when shaken out on paper. The action of phosphorus, arsenic, and **antimony** have been discussed in connection with the metallic precipitation of silver.

According to H. Rose,²⁵ **phosphine** produces a brown precipitate in soln. of silver nitrate. D. Vitali showed that the first action results in the formation of **silver nitratophosphide**, $\text{Ag}_3\text{P}\cdot 3\text{AgNO}_3$, an unstable yellow compound studied by T. Poleck and K. Thümmel. This compound is very unstable and soon decomposes, and if the soln. of silver nitrate is dil., it is only formed momentarily: $6\text{AgNO}_3 + \text{PH}_3 = \text{P}\cdot\text{Ag}_3\cdot 3\text{AgNO}_3 + 3\text{HNO}_3$. When the nitratophosphide is treated with water, or when formed in dil. soln., it gives off nitrogen tetroxide and black silver phosphide, Ag_3P , and this then decomposes into silver and phosphorous acid: $\text{Ag}_3\text{P}\cdot 3\text{AgNO}_3 + 3\text{H}_2\text{O} = 6\text{Ag} + 3\text{HNO}_3 + \text{H}_3\text{PO}_3$. The nitric acid formed during the latter reaction transforms the phosphorous acid into phosphoric acid. Hence, silver, silver phosphide,

and silver nitratophosphide may be produced by the action of phosphine on silver nitrate soln., the proportions depend on the conc. of the silver nitrate. Hence, T. Thomson, and G. Landgrebe could say that silver phosphide is formed by the action of phosphine on silver nitrate; P. Kulisch, a mixture of silver and silver phosphide; and H. Rose, that metallic silver is formed which, according to R. Fresenius and H. Neubauer, contains phosphorus. If purified phosphine is passed into a conc. soln. of silver nitrate, each bubble of gas is attended by inflammation; indeed, D. Vitali obtained an explosion by passing the purified gas rapidly into a conc. soln. of silver nitrate. It is therefore best to dilute the gas with carbon dioxide. E. Soubeiran observed the deposition of elemental silver when arsine is passed into an aq. soln. of silver nitrate. J. L. Lassaigne showed that the precipitated silver contains a little arsenic which can be removed by allowing the precipitate to stand in contact with the acidulated liquid. According to E. Reichardt, arsenious and arsenic acids, H_3AsO_3 and H_3AsO_4 , are formed. J. L. Lassaigne gives the equation: $2\text{AsH}_3 + 12\text{AgNO}_3 + 3\text{H}_2\text{O} = \text{As}_2\text{O}_3 + 12\text{Ag} + 12\text{HNO}_3$. L. Marchlewsky's objection that J. L. Lassaigne's equation cannot be right because finely-divided silver is attacked by 0.4 per cent. nitric acid—a product of the reaction—is invalid, since T. Poleck and K. Thümmel have pointed out that silver is not dissolved by nitric acid when no nitrous acid is present. According to G. Lockemann and H. Reckleben, the reaction does not always furnish end-products in accord with the equation since in acidified soln. too little silver is produced; only in alkaline soln. is the theoretical proportion obtained. The reaction has also been studied by J. A. Wanklyn, J. B. Senderens, D. Vitali, J. F. Simon, A. W. Hofmann, etc. K. Preis and B. Rayman say that in neutral soln., arsenious oxide (or silver arsenite) is produced, and in ammoniacal soln., arsenic oxide. J. L. Lassaigne stated that in a soln. of silver acetate, a bubble of arsine produces black flecks of silver, and some yellow silver arsenite which is decomposed by further contact with the gas. According to T. Poleck and K. Thümmel, the reaction is quite analogous to that which obtained with phosphine. Silver nitrate which has been fused is coloured by arsine first yellow and then black. A soln. of silver nitrate, in less than twice its weight of water, gives a citron-yellow coloration, and becomes acidic when treated with hydrogen mixed with a little arsine. The yellow liquid may be mixed with a little nitric acid, and it can be kept one or two days. Silver then separates out, arsenious and arsenic oxides are formed; the liquid becomes turbid and loses its colour. If the soln. be diluted, warmed, or treated with an excess of arsine, the changes occur more quickly. When the conc. soln., cooled below 0° , is treated with a rapid current of gas, it forms an egg-yellow crystalline mass, which rapidly blackens with the separation of silver when the temp. is allowed to rise. If the aq. soln. of silver nitrate be mixed with one-fourth its vol. of absolute alcohol, yellow crystals are formed during the passage of the arsine; these crystals decompose when pressed and dried. The yellow substance obtained with conc. soln. of silver nitrate is **silver nitratoarsenide**, $\text{Ag}_3\text{As} \cdot 3\text{AgNO}_3$, which is decomposed by water into nitric acid, silver, and arsenious oxide. The first stage of the reaction is then represented: $\text{AsH}_3 + 6\text{AgNO}_3 = \text{AsAg}_3 \cdot 3\text{AgNO}_3 + 3\text{HNO}_3$, and in dil. soln. the yellow nitratoarsenide is immediately decomposed: $2(\text{Ag}_3\text{As} \cdot 3\text{AgNO}_3) + 3\text{H}_2\text{O} = 12\text{Ag} + \text{As}_2\text{O}_3 + 6\text{HNO}_3$. According to Z. Pozzi, and H. Reckleben, G. Lockemann, and A. Eckardt the action is more complex than T. Poleck and K. Thümmel suppose, for besides the reaction represented by J. L. Lassaigne's equation, there occurs in neutral soln.: $\text{AsH}_3 + 3\text{AgNO}_3 = \text{Ag}_3\text{As} + 3\text{HNO}_3$, and this the more conc. the soln. The silver arsenide so formed reacts: $\text{Ag}_3\text{As} + 3\text{AgNO}_3 = \text{Ag}_3\text{As} \cdot 3\text{AgNO}_3$, or else: $\text{Ag}_3\text{As} + 3\text{AgNO}_3 + 3\text{H}_2\text{O} = 6\text{Ag} + \text{As}(\text{OH})_3 + 3\text{HNO}_3$ —all depends on the conc. of the soln. and the duration of the action. In alkaline soln., in addition, there is the reaction: $\text{As}(\text{OH})_3 + 2\text{AgNO}_3 + \text{H}_2\text{O} = 2\text{Ag} + \text{H}_3\text{AsO}_4 + 2\text{HNO}_3$; or $\text{AsH}_3 + 6\text{AgNO}_3 + 3\text{H}_2\text{O} = 6\text{Ag} + \text{H}_3\text{AsO}_3 + 6\text{HNO}_3$ or $\text{AsH}_3 + 8\text{AgNO}_3 + 4\text{H}_2\text{O} = 8\text{Ag} + \text{H}_3\text{AsO}_4 + 8\text{HNO}_3$. The reaction last symbolized is completed when the liquid is boiled. In ammoniacal soln. therefore: $\text{AsH}_3 + 8\text{AgNO}_3 + 11\text{NH}_3 + 4\text{H}_2\text{O} = (\text{NH}_4)_3\text{AsO}_4 + 8\text{Ag} + 8\text{NH}_4\text{NO}_3$.

The reaction between arsine and silver nitrate has been recommended as a test by H. Hager, etc., and H. Gutzeit's test is based on the formation of the yellow nitratophosphide. This test has been studied by E. Dowzard, F. C. J. Bird, H. Strauss, A. H. Gottlieb, etc. A piece of filter paper, spotted with a soln. of silver nitrate, and exposed to arsine, gives a citron-yellow spot with a brown or black periphery which slowly broadens towards the centre until the whole spot is blackened. When the yellow spot is wetted with water, it blackens all over—0.005 mgrm. may be so detected in 15–20 mins. Stibine under similar conditions gives a grey or uncoloured spot with brownish-red or black edges. The yellow spots with phosphine or hydrogen sulphide may be distinguished, the former by oxidation with chlorine or bromine, the latter by iodine. The action of silver nitrate on arsine has also been utilized for removing the latter from gaseous mixtures. According to E. Reichardt, the absorption of arsine from a current of the gas mixed with much hydrogen, by a neutral or ammoniacal soln. of silver nitrate, is incomplete, but if the silver nitrate soln. be acidified with nitric acid—say one part of silver nitrate dissolved in 24 parts of water; mixed with an equal vol. of nitric acid of sp. gr. 1.20; and the whole diluted with 4–5 times its vol. of water—the arsine is completely absorbed.

When stibine is passed into a *dilute* soln. of silver nitrate, the gas is completely decomposed, and a black precipitate is formed which rapidly settles. The supernatant liquid has an acid reaction, and contains very little antimony. The reaction has been investigated by C. H. Pfaff, A. Houzeau, T. Humpert, J. W. Russell, E. Schobig, etc. The black precipitate was supposed by J. L. Lassaigne to be silver antimonide, Ag_3Sb , or a mixture of this compound with silver. T. Poleck and K. Thümmel, R. Bartels and F. Jones obtained a ratio nearer $\text{Sb} : \text{Ag} = 1 : 6$. The reducing effect of any hydrogen accompanying the stibine has been shown by R. Bartels, and T. Poleck and K. Thümmel to be negligibly small. D. Vitali represents the reaction: $6\text{AgNO}_3 + 2\text{SbH}_3 = 2\text{SbAg}_3 + 6\text{HNO}_3$. J. F. Simon, and R. Bartels have shown that the product of the reaction is but slightly attacked by cold hydrochloric acid, the hot acid forms silver and antimonious chlorides; it is slowly dissolved by nitric acid; when boiled with a soln. of nickel, cobalt, or manganous chloride, antimony passes into soln. and the residue is free from nickel, cobalt, or manganese; and a boiling soln. of silver nitrate dissolves some of the antimony. F. Jones found that both silver and antimony are dissolved when the precipitate is digested with a conc. soln. of sodium chloride. A. W. Hofmann dissolved all the antimony from the precipitate by means of tartaric acid. With a *concentrated* soln. of silver nitrate, say one part of the salt to 0.7 part of water, a greenish-yellow coloration is developed and the soln. reacts acid; if the stibine is diluted with a large excess of hydrogen, the greenish-yellow colour does not appear, or it becomes grey owing to the formation of metallic silver. R. Bartels believes that the yellow compound has a similar constitution to silver monamminochloride, $\text{Ag}(\text{NH}_3)\text{Cl}$, and represents it as an addition product: $\text{SbH}_3 + \text{AgNO}_3 = \text{Ag}(\text{SbH}_3)\text{NO}_3$, and he says that it acts as a reducing agent on the excess of silver nitrate present in the soln.: $\text{Ag}(\text{SbH}_3)\text{NO}_3 + 5\text{AgNO}_3 + 3\text{H}_2\text{O} = \text{H}_3\text{SbO}_3 + 6\text{Ag} + 6\text{HNO}_3$. The yellow compound cannot be isolated; and from T. Poleck and K. Thümmel's analyses, its composition agrees with that of silver nitratantimonide, $\text{SbAg}_3 \cdot 3\text{AgNO}_3$, and its mode of formation and properties resemble those of the corresponding products obtained with arsine and phosphine, $\text{SbH}_3 + 6\text{AgNO}_3 = \text{Ag}_3\text{Sb} \cdot 3\text{AgNO}_3 + 3\text{HNO}_3$, followed by $\text{SbAg}_3 \cdot 3\text{AgNO}_3 + 3\text{H}_2\text{O} = \text{H}_3\text{SbO}_3 + 6\text{Ag} + 3\text{HNO}_3$.

According to A. Wurtz,²⁶ hypophosphorous acid, H_3PO_2 , reduces silver nitrate soln. in the cold, without the evolution of hydrogen; and E. J. Bartlett and W. F. Rice said that if the acid be in excess, *silver hydride* is formed; C. F. Rammelsberg symbolized the reaction with barium hypophosphite: $\text{Ba}(\text{H}_2\text{PO}_2)_2 + 6\text{AgNO}_3 + 4\text{H}_2\text{O} \rightarrow 2\text{H}_3\text{PO}_4 + 4\text{HNO}_3 + \text{Ba}(\text{NO}_3)_2 + \text{H}_2 + 6\text{Ag}$, and he represented the action of phosphorous acid on silver nitrate by the equation: $2\text{H}_3\text{PO}_3 + 2\text{AgNO}_3 + 2\text{H}_2\text{O} \rightarrow 2\text{H}_3\text{PO}_4 + 2\text{HNO}_3 + 2\text{Ag} + \text{H}_2$; while H. Rose observed that dil. phosphorous acid does not at first render silver nitrate turbid, but forms first a brown then a black precipitate of *silver suboxide*; the reaction proceeds more rapidly when heated, and silver may then be deposited. According to A. Sanger, hypophosphoric acid is formed when ammonia and silver nitrate are added to a cold soln. of phosphorous

acid, but the silver oxide which results from this reaction oxidizes some of the hypophosphoric acid to orthophosphoric acid. The white crystalline precipitate which is produced on the addition of silver nitrate to phosphorous acid has the composition Ag_2HPO_3 , silver phosphite. U. J. J. le Verrier obtained a mixture of silver phosphate and phosphide by the action of **phosphorous suboxide** on silver nitrate. T. E. Thorpe and S. Dyson found that **thiophosphoryl chloride**, PSCl_3 , reacts with silver nitrate in the cold: $4\text{AgNO}_3 + \text{PSCl}_3 \rightarrow \text{Ag}_3\text{PO}_4 + \text{AgCl} + \text{SO}_2 + 2\text{NOCl} + \text{N}_2\text{O}_4$. Liquid **phosphorous sulphide** with silver nitrate gives an olive-green non-metallic powder. The action of soln. of **ammonium arsenite** on ammoniacal silver nitrate was studied by H. Reckleben, G. Lockemann, and A. Eckardt; and of **sodium thioarsenate**, Na_3AsS_4 , by K. Preis and B. Rayman.

H. Moissan²⁷ found that **boron** precipitates crystals of silver from a soln. of silver nitrate; C. Winkler, and P. Sabatier obtained a brown precipitate by the action of **boron hydride**. G. Buchner, and T. Poleck and K. Thümmel, found **silicon hydride**— SiH_4 or Si_2H_6 —precipitates silver from a soln. of silver nitrate. N. W. Fischer²⁸ found that a mixture of **charcoal** and silver nitrate takes fire without detonation when struck with a hammer. If a piece of charcoal be allowed to stand in an aq. soln. of silver nitrate for a long time, its surface becomes studded with bright spangles of silver. J. Percy, M. Lazowsky, C. F. Chandler, said that the reduction is probably due to the hydrogen of the charcoal, for when the charcoal has been strongly heated, there is but a slight separation of the metal. M. Lazowsky added: "The parts of the charcoal on which certain metals are preferentially deposited are the extremities, whilst other metals cover equally all the surface of the reducing body; at other times the metal appears in very brilliant crystals disseminated on the periphery of the charcoal." L. F. Böck says that **coal** does not precipitate silver from boiling soln. of silver nitrate. G. Gore could detect no reaction when a mixture of **carbon monoxide** and **carbon dioxide** is passed into a soln. of silver nitrate, but **coal gas** gives a precipitate after acting about 14 days, and, according to A. Vogel and C. Reischauer, the minute crystals which are deposited behave like silver acetylide (*q.v.*).

The action of the **metals** on soln. of silver nitrate has been discussed in connection with the metallic precipitation of silver; likewise also the action of cuprous, ferrous, stannous, and manganous salts; cuprous oxide and sulphide; brown silver oxide is precipitated from soln. of silver nitrate by **potassium and sodium hydroxide**: $2\text{AgNO}_3 + 2\text{KOH} = 2\text{KNO}_3 + \text{H}_2\text{O} + \text{Ag}_2\text{O}$; the precipitate is insoluble in an excess of the precipitant, but readily soluble in nitric acid and ammonia. The ammoniacal soln., on standing, deposits black fulminating silver, $\text{Ag}_2(\text{NH}_3)_2\text{O}$. According to W. Biltz and F. Zimmerman,²⁹ the freshly prepared **hydroxides of beryllium, aluminium, indium, zirconium, tin(ic), antimony, and bismuth** have no action on $\frac{1}{10}N\text{-AgNO}_3$; while **magnesium hydroxide** is coloured brownish-yellow, **zinc hydroxide**, dark brown, **cadmium hydroxide**, brownish-yellow, and **lead hydroxide**, violet-brown, owing to the absorption of silver oxide, Ag_2O . According to G. Tammann, and V. Kohlschütter and A. d'Almeida, a soln. of silver nitrate acidified with acetic acid deposits a film of silver in contact with **zinc oxide, mercuric oxide, bismuth oxide, lead oxide**, but not with acidic oxides, like **silica or stannic oxide**.

White silver carbonate is precipitated when **sodium carbonate** is added to a soln. of silver nitrate: $2\text{AgNO}_3 + \text{Na}_2\text{CO}_3 = 2\text{NaNO}_3 + \text{Ag}_2\text{CO}_3$; and when the mixture is boiled the silver carbonate becomes yellow owing to a slight decomposition: $\text{Ag}_2\text{CO}_3 = \text{Ag}_2\text{O} + \text{CO}_2$; **ammonium carbonate** produces the same precipitate which is soluble in an excess of the precipitant. According to M. Gräger, the addition of a cream-like slip of **calcium carbonate** to an aq. soln. of silver and cupric nitrates so long as effervescence ensues, at 70° , results in the precipitation of the whole of the copper as green carbonate while the silver remains in soln. R. Griessbach studied the equilibria between silver nitrate and **sodium, barium, or lanthanum acetate**.

According to C. de Filière,³⁰ crystals of silver nitrate wrapped up in **paper** are

gradually reduced to silver. N. W. Fischer found that alcohol under the influence of light slowly reduces silver nitrate; sugar reduces it more rapidly; starch and gum act in a similar way. A. Vogel found sugar gives a mixture of silver and silver oxide. E. Salkowsky says that cane sugar does not reduce aq. or ammoniacal soln., but it does readily if some alkali hydroxide be present. Count Rumford found that ether and volatile oils reduce silver nitrate rapidly in light, or at the boiling temp. R. Brandes and L. Reimann have studied the oxidizing action of silver nitrate on organic compounds; R. E. Liesegang, the action of silver nitrate on photographic developers; and A. Naumann, the reactions of silver nitrate in non-aq. soln.—pyridine, acetone, etc. Silver nitrate forms complexes with ammonia (*g.v.*), asparagine, carbamide, urethane, leucine, and other ammino-derivatives (N. Castoro); with aldehyde (A. Reychler); etc. According to N. Dhar, silver nitrate undergoes "practically no reduction" when boiled with organic acids—malic, tartaric, citric, malonic, and lactic acid—but in the presence of an oxidizing agent like potassium permanganate reduction quickly occurs.

Silver nitrate has a bitter metallic taste. Dil. soln. of the salt have an antiseptic action.⁸¹ Under the designation, *lunar caustic*, silver nitrate has long been used as one of the best caustics where a limited action is required on any particular part, and an extensive deep action is not required—*e.g.* warts, bites, etc. A dil. aq. soln. is also used as a lotion on account of its combining an irritant stimulating effect with an astringent action. It is not used so much for internal application as was formerly the case, although it is used in checking severe diarrhoea. Long-continued use may cause blackening of the lips, inside the cheeks, gums, nostrils, eyelids, and later the skin-argyria. The coloration is thought to be due to the deposition of minute granules of metallic silver in the parts affected. Chronic silver poisoning is accompanied by many of the symptoms characteristic of lead poisoning. Acute silver poisoning is accompanied by severe vomiting and convulsions.⁸²

REFERENCES.

¹ N. Lemery, *Cours de chimie*, Paris, 1675; H. Boerhaave, *Elementa chemiæ*, Lugduni Bataavorum, 1732.

² N. J. B. G. Guibourt, *Journ. Chim. Méd.*, 7, 536, 1831; R. Palm, *Russ. Pharm. Journ.*, 8, 461, 1869; F. Nölle, *Liebig's Ann.*, 2, 92, 1832; M. Gräger, *Arch. Pharm.*, (2), 118, 228, 1864; F. W. C. Martius, *Repert. Pharm.*, 9, 319, 1820; J. B. Trautwein, *ib.*, 12, 153, 1821; F. Brandenburg, *Scherer's Ann.*, 2, 125, 1819; *Ann. Gen. Sci. Phys.*, 1, 182, 1819; C. J. H. Warden, *Pharm. Journ.*, (4), 4, 61, 1897; T. W. Richards and G. S. Forbes, *Journ. Amer. Chem. Soc.*, 29, 808, 1907; W. L. Hardin, *ib.*, 18, 995, 1896; G. P. Baxter and G. Jones, *ib.*, 32, 298, 1910; H. D. Greuner, *ib.*, 32, 1030, 1910; F. Laporte and P. de la Gorce, *Compt. Rend.*, 150, 278, 1910; G. G. Buckner and G. A. Hulett, *Trans. Amer. Electrochem. Soc.*, 22, 373, 1912; E. B. Rosa, G. W. Vinal, and A. S. McDaniel, *Elect. World*, 61, 85, 1913.

³ H. J. Brooke, *Ann. Phil.*, 23, 162, 1824; C. F. Rammelsberg, *Handbuch der krystallographisch-physikalischen Chemie*, Leipzig, 1, 352, 1881; O. Lehmann, *Wied. Ann.*, 24, 11, 1885; *Molekularphysik*, Leipzig, 1, 164, 1888; *Zeit. Kryst.*, 1, 110, 1877; 10, 323, 1885; A. Foek, *ib.*, 28, 405, 1897; F. M. Jäger, *ib.*, 37, 343, 1903; W. Schwarz, *Zur Kenntniss der umkehrbaren Umwandlungen polymorpher Körper*, Göttingen, 1897; B. Gossner, *Zeit. Kryst.*, 38, 146, 1904; W. Schwarz, *ib.*, 25, 614, 1896; S. Kreutz, *Tschermak's Mitt.*, (2), 28, 488, 1910; J. W. Retgers, *Zeit. phys. Chem.*, 4, 593, 1889; D. J. Hissink, *ib.*, 32, 537, 1900; M. L. Frankenheim, *Pogg. Ann.*, 40, 447, 1837; 92, 354, 1854; H. Rose, *ib.*, 102, 437, 1857; 106, 1320, 1859; A. Scacchi, *Nuovo Cimento*, 1, 169, 1855; V. von Lang, *Sitzber. Akad. Wien*, 31, 102, 1859; A. des Cloizeaux, *Ann. Mines*, (5), 11, 305, 1857; A. Ditte, *Ann. Chim. Phys.*, (6), 8, 418, 1886.

⁴ D. J. Hissink, *Zeit. phys. Chem.*, 32, 537, 1900; E. Jänecke, *ib.*, 90, 280, 1915; J. Guinchant, *Compt. Rend.*, 145, 320, 1907; 149, 569, 1909; W. Schwarz, *Zur Kenntniss der umkehrbaren Umwandlungen polymorpher Körper*, Göttingen, 1897; P. W. Bridgman, *Proc. Amer. Acad.*, 51, 581, 1916.

⁵ C. J. B. Karsten, *Schweigger's Journ.*, 65, 394, 1832; H. Schröder, *Pogg. Ann.*, 107, 113, 1859; J. W. Retgers, *Zeit. phys. Chem.*, 4, 593, 1889; L. Poincaré, *Compt. Rend.*, 108, 138, 1889; G. Schulze, *Zeit. Elektrochem.*, 17, 512, 1911; L. Playfair and J. P. Joule, *Mem. Chem. Soc.*, 2, 401, 1845; F. F. Fitzgerald, *Journ. Phys. Chem.*, 16, 629, 1912; C. Chénaveau, *Ann. Chim. Phys.*, (8), 12, 145, 1907; H. Jahn, *Zeit. phys. Chem.*, 37, 679, 1901; R. Wagner, *ib.*, 5, 31, 1890; F. Kohlrausch, *Wied. Ann.*, 6, 1, 145, 1879; A. A. Noyes, *The Electrical Conductivity of Aqueous Solutions*, Washington, 82, 1907; A. J. Rabinowitsch, *Zeit. phys. Chem.*, 99, 338, 417, 434, 1921

⁶ J. Wagner, *Zeit. phys. Chem.*, 5, 31, 1890; F. M. Raoult, *Compt. Rend.*, 87, 167, 1878; G. Zemplén, *Ann. Physik*, (4), 20, 798, 1906; A. Scachanoff, *Zeit. Elektrochem.*, 19, 588, 1913;

Journ. Russ. Phys. Chem. Soc., 45. 102, 1913; *Zeit. phys. Chem.*, 83. 141, 1913; J. D. R. Scheffer, *ib.*, 2. 397, 1888; *Ber.*, 16. 1903, 1883; F. F. Fitzgerald, *Journ. Phys. Chem.*, 16. 629, 1912; J. Thovert, *Compt. Rend.*, 134. 594, 1902; J. C. G. de Marignac, *Arch. Sciences Genève*, 50. 89, 1874; N. I. Morosoff, *Journ. Russ. Phys. Chem. Soc.*, 47. 783, 1915; A. J. Rabinowitsch, *Zeit. phys. Chem.*, 99. 338, 417, 434, 1921.

⁷ J. J. Pohl, *Sitzber. Akad. Wien*, 6. 587, 1851; E. Madelung and R. Fuchs, *Ann. Physik*, (4), 65. 289, 1921; P. W. Bridgman, *Proc. Amer. Acad.*, 51. 581, 1916; T. Carnclley, *Journ. Chem. Soc.*, 29. 489, 1876; 33. 273, 1878; G. Scarpa, *Atti Accad. Lincei*, (5), 22. ii, 452, 1913; J. W. Retgers, *Zeit. phys. Chem.*, 4. 593, 1899; D. J. Hissink, *ib.*, 32. 557, 1900; J. Kablukoff, *Journ. Russ. Phys. Chem. Soc.*, 39. 914, 1907; E. B. Rosa, G. W. Vinal, and A. S. McDaniel, *Elect. World*, 61. 84, 1913; A. Colson, *Compt. Rend.*, 148. 837, 1909; J. F. Persoz, *Ann. Chim. Phys.*, (3), 23. 48, 1859; H. Pellat, *Compt. Rend.*, 78. 1132, 1874; A. Vogel, *Repert. Pharm.*, 20. 93, 1871; E. Divers, *Journ. Chem. Soc.*, 75. 83, 1899.

⁸ J. Guinchant, *Compt. Rend.*, 149. 569, 1909; P. W. Bridgman, *Proc. Amer. Acad.*, 51. 581, 1916.

⁹ H. V. Regnault, *Ann. Chim. Phys.*, (3), 1. 129, 1841; J. Guinchant, *Compt. Rend.*, 145. 320, 1907; H. M. Goodwin and H. T. Kalmus, *Phys. Rev.*, (1), 28. 1, 1909; P. W. Bridgman, *Proc. Amer. Acad.*, 51. 581, 1916.

¹⁰ M. Berthelot, *Ann. Chim. Phys.*, (5), 4. 101, 1875; (5), 20. 255, 1880; *Compt. Rend.*, 78. 99, 1874; A. Colson, *ib.*, 148. 837, 1909; J. Thomsen, *Ber.*, 12. 2065, 1879; *Journ. prakt. Chem.*, (2), 17. 165, 1878; (2), 12. 293, 1875; *Thermochemische Untersuchungen*, Leipzig, 3. 378, 382, 1881; G. Bruni and G. Levi, *Gazz. Chim. Ital.*, 47. i, 259, 1917.

¹¹ H. W. B. Roozeboom, *Proc. Acad. Amsterdam*, 4. 371, 1902; W. Meyerhoffer, *Landolt and Bornstein's Physikalisch-chemische Tabellen*, Berlin, 1905.

¹² F. M. Raoult, *Compt. Rend.*, 87. 167, 1878; J. Guinchant, *ib.*, 149. 569, 1909; P. Kremers, *Pogg. Ann.*, 92. 497, 1854; A. Smits, *Zeit. phys. Chem.*, 39. 418, 1902; W. A. Roth, *ib.*, 79. 612, 1912; L. Kahlenberg, *Journ. Phys. Chem.*, 5. 369, 1901.

¹³ P. Werner and M. Stephani, *Zeit. anorg. Chem.*, 15. 32, 1897; W. Schmujiloff, *ib.*, 15. 23, 1897; N. Castoro, *Gazz. Chim. Ital.*, 28. ii, 319, 1899; G. Schulze, *Zeit. Elektrochem.*, 17. 512, 1911; L. Kahlenberg, *Journ. Phys. Chem.*, 3. 379, 1899; P. Walden, *Bull. Acad. St. Petersburg*, 45. 1075, 1913.

¹⁴ E. Forster, *Untersuchungen über die Beziehungen die zwischen dem spezifischen Brechungsvermögen und der Concentration der Salzlösungen bestehen*, Bern, 38, 1878; *Arch. Sciences Genève*, (3), 4. 621, 1881; P. Barbier and L. Roux, *Compt. Rend.*, 110. 457, 527, 1071, 1890; 111. 180, 235, 1890; K. Schaefer, *Zeit. wiss. Phot.*, 8. 212, 257, 1910; W. N. Hartley, *Journ. Chem. Soc.*, 81. 556, 1902; 101. 822, 1912; B. Wagner, *Tabellen zum Eintauchrefraktometer*, Londershausen, 1907.

¹⁵ L. Poincaré, *Compt. Rend.* 108. 138, 1889; A. Leduc, *ib.*, 135. 23, 1902; A. Leduc and M. Labrouste, *ib.*, 145. 55, 1907; P. T. Muller and R. Romann, *ib.*, 157. 400, 1913; G. Carrara, *Gazz. Chim. Ital.*, 33. i, 241, 1903; N. Cybulsky and J. Dunin-Borkowsky, *Anz. Akad. Cracov*, 660, 1909; W. Campetti, *Nuovo Cimento*, (3), 35. 225, 1894; G. Heydweiller, *Ann. Physik*, (4), 41. 514, 1913; (4), 37. 750, 1912; A. A. Noyes and B. F. Brann, *Journ. Amer. Chem. Soc.*, 34. 1016, 1912; A. Roshdestwensky and W. C. McC. Lewis, *Journ. Chem. Soc.*, 99. 2138, 1911; 101. 2094, 1913; G. von Elissafoff, *ib.*, 79. 385, 1912; A. Saschanoff and J. Prscheborowsky, *Zeit. Elektrochem.*, 20. 40, 1914; A. T. Lincoln, *ib.*, 6. 384, 1900; A. C. Cumming and R. Abegg, *ib.*, 13. 18, 1907; G. Schulze, *ib.*, 17. 509, 1911; *Ann. Physik*, (4), 34. 657, 1911; C. Dempwolff, *ib.*, 11. 124, 1904; A. Saschanoff, *Journ. Russ. Phys. Chem. Soc.*, 42. 683, 1910; A. E. Oxley, *Proc. Roy. Soc.*, 88. A. 588, 1913; H. C. Jones, *The electrical conductivity, dissociation, and temperature coefficients of conductivity for aqueous solutions*, Washington, 1912; W. C. D. Whetham, *Phil. Trans.*, 186. A, 507, 1895; B. D. Steele, *ib.*, 198. A, 105, 1902; *Journ. Chem. Soc.*, 79. 414, 1902; E. Bouty, *Compt. Rend.*, 98. 140, 1884; *Ann. Chim. Phys.*, (6), 3. 433, 1884; A. Chessy, *ib.*, (6), 21. 241, 1890; H. C. Jones and H. P. Basset, *Amer. Chem. Journ.*, 32. 409, 1905; H. C. Jones and C. A. Rouiller, *ib.*, 36. 427, 1907; A. M. Clover and H. C. Jones, *ib.*, 43. 187, 1910; L. G. Winston and H. C. Jones, *ib.*, 46. 399, 1911; E. C. Franklin and C. A. Kraus, *ib.*, 23. 277, 1900; J. H. Wilson, *ib.*, 35. 78, 1906; W. J. Mather, *ib.*, 26. 473, 1901; *Johns Hopkins Univ. Bull.*, 16. 45, 1901; S. Arrhenius, *Recherches sur la conductibilité galvanique des électrolytes*, Stockholm, 1884; *B. A. Rep.*, 357, 1886; O. J. Lodge, *ib.*, 389, 1886; G. Jäger, *Monatsh.*, 8. 721, 1887; L. Boltzmann, *ib.*, 8. 230, 1887; J. Miesler, *ib.*, 8. 193, 1887; B. Vollmer, *Zeit. phys. Chem.*, 10. 668, 1892; E. Franke, *ib.*, 16. 463, 1895; W. Kistiakowsky, *ib.*, 6. 97, 1890; W. Bein, *ib.*, 27. 1, 1898; H. Hoffmeister, *ib.*, 27. 345, 1898; H. Jahn, *ib.*, 37. 673, 1901; 38. 127, 1901; B. D. Steele, *ib.*, 40. 689, 1902; W. Böttger, *ib.*, 56. 83, 1906; M. Löb and W. Nernst, *ib.*, 2. 948, 1888; H. Jahn, *ib.*, 58. 641, 1907; A. Benrath, *ib.*, 64. 697, 1912; E. C. Franklin, *ib.*, 69. 290, 1909; W. K. Lewis, *ib.*, 63. 171, 1908; L. Kahlenberg, *ib.*, 46. 64, 1903; W. A. Roth, *ib.*, 79. 612, 1912; R. Abegg and C. Immerwahr, *ib.*, 32. 142, 1900; M. Rudolphi, *ib.*, 17. 277, 1895; E. Coehn, *ib.*, 84. 83, 1913; W. Nernst, *ib.*, 4. 155, 1889; J. Neustadt and W. Nernst, *ib.*, 69. 486, 1909; J. H. van't Hoff, *ib.*, 18. 300, 1895; R. Lohnstein, *Wied. Ann.*, 47. 299, 1892; W. Bein, *ib.*, 46. 29, 1892; W. Negbaur, *ib.*, 44. 737, 1891; C. Deguise, *ib.*, 52. 604, 1894; F. Kohrausch, *ib.*, 6. 1, 145, 1879; 26. 161, 1885; E. Bichal and R. Blondlot, *Journ. Phys.*, (2), 2. 503, 1883; H. Jäger, *Sitzber. Akad. Wien*, 96. 317, 1888; F. Kohrausch and H. Steinwehr, *Sitzber. Akad. Berlin*, 581, 1902; R. Abegg and A. C. Cumming, *Trans. Faraday Soc.*, 2. 213, 1906; G. Wiedemann, *Pogg. Ann.*, 99. 193, 1856;

W. Hittorf, *ib.*, 89. 177, 1853; H. Herwig, *ib.*, 160. 110, 1877; H. J. S. Sand, *Phil. Mag.*, (6), 9. 20, 1905; F. Streintz, *ib.*, (5), 5. 219, 1878; G. Bodländer and W. Eberlein, *Ber.*, 36. 3945, 1903; J. A. Wilkinson and H. W. Gillet, *Journ. Phys. Chem.*, 11. 382, 1907; L. Kahlenberg and O. E. Rüdorff, *ib.*, 7. 254, 1903; L. Kahlenberg, *ib.*, 3. 379, 1899; 5. 339, 1901; A. T. Lincoln, *ib.*, 3. 457, 1899; L. R. Ferguson, *ib.*, 13. 262, 1909; H. Schmidt, *ib.*, 6. 259, 1902; A. A. Noyes, *The Electrical Conductivity of Aqueous Solutions*, Washington, 1908; *Journ. Chim. Phys.*, 6. 505, 1908; G. Vincenti, *Atti Accad. Torino*, 20. 869, 1885; A. A. Noyes and K. G. Falk, *Journ. Amer. Chem. Soc.*, 34. 474, 1912; G. N. Lewis, *ib.*, 34. 1641, 1912; G. N. Lewis and M. Randall, *ib.*, 43. 1112, 1921; A. Heydweiller, *Zeit. anorg. Chem.*, 116. 42, 1921; W. H. Sloan, *ib.*, 32. 946, 1910; W. D. Harkins and F. L. Hunt, *ib.*, 33. 1819, 1911; J. Johnston, *ib.*, 31. 1012, 1909; S. J. Bates, *ib.*, 35. 532, 1913; E. C. Franklin and H. D. Gibbs, *ib.*, 29. 1389, 1907; E. C. Franklin and H. P. Cady, *ib.*, 26. 499, 1904; E. C. Franklin and C. A. Kraus, *ib.*, 27. 219, 1905; J. M. Bell and A. L. Field, *ib.*, 35. 715, 1913; C. A. Kraus and W. C. Bray, *ib.*, 35. 1337, 1913; A. Ungerer, *Phys. Zeit.*, 14. 685, 1913; C. Dempf, *ib.*, 5. 637, 1904; A. Leduc, *Electrolyse de l'azotate d'argent*, Tours, 1902; A. J. Rabinowitsch, *Zeit. phys. Chem.*, 99. 338, 417, 434, 1921; F. F. Fitzgerald, *Journ. Phys. Chem.*, 16. 629, 634, 1912

¹⁶ P. Kremers, *Pogg. Ann.*, 92. 499, 1854; W. Middelberg, *Zeit. phys. Chem.*, 43. 313, 1893; *Evenwichter in het Stelsel Barnsteenzuurnitrid, Zilvernitryaat*, Water, Leiden, 1902; W. A. Tilden and W. A. Shenstone, *Phil. Trans.*, 175. 23, 1884; A. Étard, *Ann. Chim. Phys.*, (7), 2. 526, 1894; J. Schnauss, *Arch. Pharm.*, (2), 82. 260, 1855; J. M. Eder, *Journ. prakt. Chem.*, (2), 17. 45, 1878; D. J. Hissink, *Zeit. phys. Chem.*, 32. 557, 1900; W. Schwarz, *Zur Kenntniss der umkehrbaren Umwandlungen polymorpher Körper*, Göttingen, 1897; C. Schultz, *Zeit. Chem.*, (2), 5. 531, 1869; E. C. Franklin and C. A. Kraus, *Amer. Chem. Journ.*, 20. 828, 1898; E. C. Franklin, *Zeit. phys. Chem.*, 69. 288, 1909; E. H. Büchner, *ib.*, 54. 665, 1906; F. A. H. Schreinemakers, *ib.*, 65. 571, 1909; F. Rüdorff, *Pogg. Ann.*, 145. 606, 1872; F. Bezold, *Das Verhalten chemischen Verbindungen in Methylacetat*, Giessen, 1906; L. Kahlenberg, *Journ. Phys. Chem.*, 10. 141, 1906; W. G. Wilcox, *ib.*, 14. 591, 1910; F. F. Fitzgerald, *ib.*, 16. 629, 1912; F. L. Shinn, *ib.*, 11. 537, 1908; J. I. O. Masson, *Journ. Chem. Soc.*, 99. 1132, 1911; H. D. Gibbs, *Journ. Amer. Chem. Soc.*, 28. 1420, 1906; F. M. G. Johnson and N. T. M. Wilsmore, *Trans. Faraday Soc.*, 3. 77, 1907; *Zeit. Elektrochem.*, 14. 227, 1908; C. Schweigger-Seidal, *Schweigger's Journ.*, 64. 127, 1882; C. J. H. Warden, *Pharm. Journ.*, (4), 4. 61, 1897; C. A. L. de Bruyn, *Rec. Trav. Chim. Pays-Bas*, 11. 156, 1892; W. Kuriloff, *Bull. Acad. St. Petersburg*, 17. 149, 1903; S. von Lazczynsky, *Ber.*, 27. 2285, 1894; A. Naumann, *ib.*, 37. 4332, 1904; R. Scholl and W. Steinkopf, *ib.*, 39. 4393, 1906; C. E. Linebarger, *Amer. Journ. Science*, (4), 49. 52, 1895; R. Engel, *Compt. Rend.*, 102. 619, 1886; 104. 433, 1887; *Ann. Chim. Phys.*, (6), 13. 132, 1888; A. Werner, *Zeit. anorg. Chem.*, 15. 7, 1897.

¹⁷ J. R. Glauber, *Furnis nova philosophicis*, Amstelodami, 1648; Mrs. Fulhame, *An Essay on Combustion*, London, 21, 1794; N. N. Beketoff, *Compt. Rend.*, 48. 442, 1859; B. Renault, *ib.*, 76. 384, 1873; H. Pellet, *ib.*, 78. 1132, 1874; C. Brunner, *Pogg. Ann.*, 122. 153, 1864; J. Donau, *Sitzber. Akad. Wien*, 122. 335, 1913; *Monatsh.*, 34. 949, 1913; J. W. Russell, *Journ. Chem. Soc.*, 27. 3, 1874; *Chem. News*, 28. 1132, 1874; A. R. Leeds, *Ber.*, 9. 1456, 1876; T. Poleck and K. Thümmel, *ib.*, 16. 2435, 1883; J. B. Senderens, *Bull. Soc. Chim.*, (3), 15. 991, 1891; M. Paucke, *Beiträge zum Nachweis von Arsen*, Leipzig, 1908; R. Böttger, *Chem. Gaz.*, 17. 264, 1869; F. Liebert, *Chem. Weekbl.*, 16. 74, 1919.

¹⁸ C. H. Pfaff, *Schweigger's Journ.*, 36. 68, 1822; 52. 314, 1828; A. Vogel, *Gilbert's Ann.*, 72. 335, 1822; A. Mailfert, *Compt. Rend.*, 94. 860, 1852; E. Mulder, *Rec. Trav. Chim. Pays-Bas*, 22. 388, 1904; E. B. Rosa, G. W. Vinal, and A. S. McDaniel, *Elect. World*, 61. 84, 1913; H. Kwasnik, *Ber.*, 25. 67, 1892.

¹⁹ E. Bose, *Zeit. Elektrochem.*, 13. 477, 1907; K. Eisenreich, *Zeit. phys. Chem.*, 76. 643, 1911; F. Wöhler, *Chem. Gaz.*, 12. 49, 1854.

²⁰ A. Naquet, *Bull. Soc. Chim.*, (2), 1. 126, 1860; *Repert. Chim.*, 126, 1860; C. Weltzien, *Liebig's Ann.*, 91. 43, 1854; H. St. C. Deville, *Ann. Chim. Phys.*, (3), 28. 241, 1850; A. J. Balard, *ib.*, (2), 57. 241, 1834; R. E. Hughes, *Phil. Mag.*, (5), 35. 531, 1893; M. Odet and M. Vignon, *Compt. Rend.*, 69. 1142, 1869; E. C. Franklin and C. A. Kraus, *Amer. Chem. Journ.*, 21. 1, 1899; W. Pawloff and S. Schein, *Journ. Russ. Phys. Chem. Soc.*, 39. 943, 1908; J. Kablukoff, *ib.*, 37. 355, 1905; 39. 914, 1907; A. Hantzsch, *Ber.*, 40. 3798, 1907; J. Preuss, *Liebig's Ann.*, 29. 324, 1839; H. Moissan, *Le fluor et ses composés*, Paris, 1900; W. Dancer, *Journ. Chem. Soc.*, 15. 477, 1862.

²¹ H. Debray, *Compt. Rend.*, 70. 995, 1870; G. Reichert, *Journ. prakt. Chem.*, (1), 92. 237, 1864; P. Kremers, *ib.*, (1), 71. 54, 1857; *Pogg. Ann.*, 92. 497, 1854; H. Risse, *Liebig's Ann.*, 111. 39, 1859; C. Weltzien, *ib.*, 95. 127, 1855; J. Preuss, *ib.*, 29. 329, 1839; K. Hellwig, *Zeit. anorg. Chem.*, 25. 157, 1900; J. Schnauss, *Arch. Pharm.*, (2), 82. 260, 1855; C. Stürenberg, *ib.*, (2), 143. 12, 1870; R. Fanto, *Monatsh.*, 24. 477, 1903; A. Riche, *Journ. Pharm.*, (2), 33. 343, 1858; A. W. Hofmann, *ib.*, (3), 1. 29, 1859; F. M. Jäger, *Zeit. Kryst.*, 44. 169, 1908; J. Kablukoff, *Journ. Russ. Phys. Chem. Soc.*, 39. 914, 1907; *Zeit. phys. Chem.*, 65. 121, 1909; G. Scarpa, *Atti Accad. Lincei*, (5), 22. ii, 452, 1913; P. P. von Weimarn, *Zeit. Koll.*, 28. 97, 1921.

²² N. W. Fischer, *Das Verhältniss der chemischen Verwandtschaft*, Berlin, 1830; *Pogg. Ann.*, 12. 502, 1828; T. Poleck and K. Thümmel, *Ber.*, 16. 2435, 1883; R. Fanto, *Monatsh.*, 24. 477, 1903; S. Kern, *Chem. News*, 33. 35, 1876; W. Skey, *ib.*, 23. 232, 1871; H. Marshall, *Journ. Chem. Soc.*, 59. 771, 1891; T. E. Thorpe, *ib.*, 41. 297, 1882; R. D. Hall and V. Lenher, *Journ. Amer. Chem.*

Soc., **24**, 918, 1902; J. Girard, *Ann. Chim. Anal. App.*, **5**, 56, 1900; J. B. Sendereus, *Compt. Rend.*, **104**, 175, 1887; J. Fogh, *ib.*, **110**, 709, 1890; *Ann. Chim. Phys.*, (6), **21**, 61, 1890; H. Baubigny, *ib.*, (8), **20**, 8, 1910; *Compt. Rend.*, **149**, 735, 1910; *Bull. Soc. Chim.*, (4), **7**, 4, 1910; J. Myers, *Ber.*, **6**, 440, 1873; R. Schneider, *Pogg. Ann.*, **152**, 471, 1874; C. Geitner, *Liebig's Ann.*, **129**, 350, 1864; H. Rose, *Pogg. Ann.*, **102**, 436, 1857; **106**, 320, 1859; *Sitzber. Akad. Berlin*, 474, 1857; *Chem. Gaz.*, **15**, 344, 1857; T. Parkman, *Amer. Journ. Science*, (2), **33**, 328, 1864; E. C. Franklin and C. A. Kraus, *Amer. Chem. Journ.*, **21**, 1, 1899; E. Bamberger, *Ber.*, **33**, 1959, 1900.

²³ E. Divers, *Journ. Chem. Soc.*, **75**, 83, 1899; E. Divers and T. Haga, *ib.*, **47**, 203, 1885.

²⁴ N. W. Fischer, *Pogg. Ann.*, **6**, 43, 1820; **8**, 488, 1821; **10**, 607, 1822; **12**, 503, 1822; **16**, 126, 1824; M. Mauder, *Almanach für Schiedekunstler*, **1**, 36, 1780.

²⁵ H. Rose, *Pogg. Ann.*, **14**, 184, 1828; **24**, 318, 1832; J. F. Simon, *ib.*, **42**, 563, 1837; C. H. Pfaff, *ib.*, **42**, 339, 1837; T. Poleck and K. Thümmel, *Ber.*, **16**, 2435, 1883; *Arch. Pharm.*, (3), **22**, 1, 1884; R. Otto, *ib.*, (3), **21**, 583, 1883; E. Reichardt, *ib.*, (3), **17**, 1, 1880; (3), **21**, 590, 1883; J. L. Lassaigne, *Journ. Chim. Méd.*, **16**, 685, 1839; **17**, 440, 1840; A. W. Hofmann, *Liebig's Ann.*, **115**, 287, 1860; P. Kulisch, *ib.*, **231**, 327, 1885; J. A. Wanklyn, *Chem. News*, **85**, 181, 1902; H. Hager, *Zeit. anal. Chem.*, **11**, 82, 478, 1872; R. Fresenius and H. Neubauer, *ib.*, **1**, 340, 1862; H. Reckleben, G. Lockemann, and A. Eckardt, *ib.*, **46**, 697, 1907; J. B. Sendereus, *Compt. Rend.*, **104**, 175, 1887; A. Houzeau, *ib.*, **75**, 1823, 1872; Z. Pozzi, *Ind. Chim.*, **6**, 144, 1914; G. Lockemann and H. Reckleben, *Zeit. angew. Chem.*, **19**, 275, 1906; G. Landgrebe, *Schweigger's Journ.*, **60**, 128, 1830; L. Marchlewsky, *Ber.*, **24**, 2269, 1891; D. Vitali, *L'Orosi*, **15**, 397, 1892; **16**, 10, 1893; K. Preis and B. Rayman, *Listy's Chemické*, **11**, 34, 1887; H. Gutzeit, *Pharm. Ztg.*, **24**, 263, 1873; E. Doward, *Journ. Chem. Soc.*, **79**, 715, 1901; J. W. Russell, *ib.*, **28**, 3, 1874; F. Jones, *ib.*, **29**, 641, 1876; **33**, 95, 1878; F. C. J. Bird, *Analyst*, **26**, 181, 1901; II. Strauss, *Chem. Ztg.*, **29**, 51, 1905; A. H. Gotthelf, *Journ. Soc. Chem. Ind.*, **22**, 191, 1903; J. A. Goode and F. M. Perkin, *ib.*, **25**, 507, 1906; R. Bartels, *Ueber die Einwirkung des Antimonwasserstoffs auf Metallsalzlösungen*, Berlin, 1889; R. Fanto, *Monatsh.*, **24**, 477, 1903; T. Thomson, *Phil. Mag.*, (3), **10**, 353, 1837; T. Humpert, *Journ. prakt. Chem.*, (1), **94**, 398, 1865; E. Schobig, *ib.*, (2), **14**, 299, 1876; E. Soubeiran, *Ann. Chim. Phys.*, (2), **43**, 418, 1830; *Journ. Pharm.*, **16**, 347, 1830; G. Landgrebe, *Schweigger's Journ.*, **55**, 96, 1829.

²⁶ A. Wurtz, *Compt. Rend.*, **18**, 702, 1844; *Liebig's Ann.*, **43**, 158, 1842; **58**, 49, 1846; H. Rose, *Pogg. Ann.*, **8**, 205, 1826; **9**, 33, 215, 1827; C. F. Rammelsberg, *Journ. Chem. Soc.*, **26**, 1, 1873; T. E. Thorpe and S. Dyson, *ib.*, **41**, 297, 1882; E. J. Bartlett and W. F. Rice, *Amer. Chem. Journ.*, **19**, 49, 1897; A. Sängler, *Liebig's Ann.*, **232**, 14, 1886; L. F. Böck, *Dissertatis inauguralis de reductione metallorum via humida*, Tübingen, 1804; U. J. J. le Verrier, *Ann. Chim. Phys.*, (2), **60**, 174, 1835; (2), **65**, 257, 1837; H. Reckleben, G. Lockemann, and A. Eckardt, *Zeit. anal. Chem.*, **46**, 671, 1908; K. Preis and B. Rayman, *Bull. Soc. Chim.*, (2), **47**, 892, 1887.

²⁷ H. Moissan, *Compt. Rend.*, **114**, 617, 1892; P. Sabatier, *ib.*, **112**, 865, 1891; C. Winkler, *Ber.*, **23**, 780, 1890; G. Buchner, *ib.*, **18**, 317, 1885; T. Poleck and K. Thümmel, *ib.*, **16**, 2435, 1883.

²⁸ J. Percy, *Silver and Gold*, London, **1**, 123, 1880; C. F. Chandler, *Chem. News*, **24**, 76, 1871; M. Lazowsky, *Journ. Chim. Méd.*, (3), **3**, 629, 1847; *Chem. Gaz.*, **6**, 43, 1848; G. Gore, *ib.*, **48**, 298, 1883; A. Vogel and C. Reischauer, *Jahresber.*, **208**, 1858; N. W. Fischer, *Das Verhältniss der chemischen Verwandtschaft zur galvanischen Electricität dargestellt*, Berlin, 1830; L. F. Böck, *De reductione metallorum via humida ope combustibilium stricte sic dictorum perficiendo*, Tübingensis, 1804.

²⁹ W. Biltz and F. Zimmermann, *Ber.*, **40**, 4979, 1907; M. Gröger, *Polyt. Notizb.*, **27**, 1, 17, 1872; G. Tammann, *Zeit. anorg. Chem.*, **114**, 151, 1920; V. Kohlschütter and A. d'Almeida, *Ber.*, **54**, 1961, 1921; R. Griessbach, *Zeit. phys. Chem.*, **97**, 22, 1921.

³⁰ C. de Filière, *Ann. Chim. Phys.*, (2), **42**, 335, 1829; N. W. Fischer, *Kastner's Archiv*, **9**, 349, 1826; A. Vogel, *Gilbert's Ann.*, **72**, 335, 1822; Count Rumford (B. Thompson), *Essays*, London, **2**, 350, 1798; E. Salkowsky, *Zeit. physiol. Chem.*, **4**, 133, 1880; R. E. Liesegang, *Phot. Arch.*, **177**, 1895; R. Brandes and L. Reimann, *Neues Journ. Pharm.*, **12**, 100, 1826; A. Naumann, *Ber.*, **32**, 999, 1899; N. Castoro, *Gazz. Chim. Ital.*, **37**, i, 310, 1907; A. Reychler, *Ber.*, **16**, 990, 1883; N. Dhar, *Journ. Chem. Soc.*, **111**, 690, 1917.

³¹ T. Bokhorny, *Pharm. Centr.*, **47**, 121, 1906; M. Chamberland, *Journ. Pharm. Chim.*, (5), **16**, 126, 1887; W. Kopaczewsky, *Biochem. Zeit.*, **44**, 349, 1912; A. Lumière and J. Chevrotier, *Bull. Gén. Therap.*, **165**, 959, 1913; P. Miquel, *Monit. Scient.*, (3), **14**, 170, 1884.

³² L. Pigorni, *Atti Accad. Lincei*, (5), **16**, i, 359, 1907.

§ 22. Silver Ammino-nitrates : Double or Complex Nitrates

Three silver ammino-nitrates have been reported with $\text{AgNO}_3 : \text{NH}_3$ as 1 : 1, 1 : 2, and 1 : 3. The existence of *silver monammino-nitrate* was reported by A. Reychler¹ in 1883 as being obtained by treating a soln. of silver nitrate with aq. ammonia

until a precipitate appeared, and evaporating the filtrate on a water-bath. A. Joannis and M. Croizier also reported the formation of this salt, but W. Kuriloff showed that Reychler's salt is a solid soln. of silver nitrate and diammino-nitrate. This view was later accepted by A. Reychler. According to H. Rose, dry silver nitrate rapidly absorbs ammonia gas, at the same time the rise of temp. may suffice to fuse the salt. The analysis of the white mass so obtained corresponded approximately with that required for *silver triammino-nitrate*, $\text{AgNO}_3 \cdot 3\text{NH}_3$. H. Ley and G. Wiegner, and W. Peters studied this reaction. The product is completely soluble in water. When heated to a higher temp., ammonia is given off. According to A. Joannis and M. Croizier, the salt dissociates at about 63° under normal press. ; and it is very soluble in liquid ammonia below -10° .

C. G. Mitscherlich found that crystals of an ammino-salt are readily separated from an aq. soln. of silver nitrate supersaturated with ammonia ; their analysis corresponded with **silver diammino-nitrate**, $\text{Ag}(\text{NH}_3)_2\text{NO}_3$. G. Wetzlar showed that the first drop of ammonia added to a soln. of silver nitrate produces no precipitate, but it renders the liquid alkaline, without imparting to it the smell of ammonia. A soln. supersaturated with ammonia gives off the excess on evaporation and deposits crystals of this salt ; and he obtained the same compound by dissolving silver oxide in a soln. of ammonium nitrate, or, according to H. N. Draper, in an ammoniacal soln. of ammonia nitrate. N. Castoro obtained crystals of the salt by adding absolute alcohol to a conc. ammoniacal soln. of silver nitrate, or an amorphous precipitate by adding ether. A. Hantzsch precipitated silver diammino-nitrate by passing ammonia into a benzonitrile soln. of silver nitrate.

According to J. C. G. de Marignac, and C. F. Rammelsberg, the crystals belong to the rhombic system, and they have the axial ratios $a : b : c = 0.7567 : 1 : 0.5945$. C. G. Mitscherlich noticed the crystals blacken in light. H. N. Draper said that the crystals are stable in air, while N. Castoro found them to turn brown rapidly when exposed to air, owing to the separation of silver, but if suspended in alcohol, they can be preserved some days. According to R. Kane, and H. N. Draper, the salt melts when heated, losing nitrogen, ammonia, and ammonium nitrate, and leaving behind metallic silver. J. C. G. de Marignac said the crystals do not lose in weight when heated to 100° , but A. Joannis and M. Croizier found them to dissociate irregularly at about 170° . M. Berthelot and M. Delépine found the heat of formation from a mol of silver nitrate in two litres of water and two mols of ammonia in two litres, forming $\text{AgNO}_3 \cdot 2\text{NH}_3$ aq. is 12.25 Cals. G. Bruni and G. Levi gave the heat of formation $(\text{AgNO}_3 \cdot 2\text{NH}_3) = 33.64$ Cals., in soln., 12.68 Cals. ; and the heat of soln. per mol as -9.05 Cals. As C. G. Mitscherlich first observed, the crystals are soluble in water. A. Reychler investigated the electrical conductivity and lowering of the f.p. of ammoniacal soln. of silver nitrate—*vide* silver hydroxide. V. Kohlschütter and E. Fischmann measured the potential difference of ammoniacal soln. against aq. soln. of silver nitrate. A. A. Blanchard measured the viscosity of these soln. D. Konowaloff found the solubility of ammonia in aq. soln. of silver nitrate, and A. B. Prescott noted that approximately two mols of ammonia are required for the soln. of a mol of silver nitrate in aq. ammonia, and W. Herz studied the same reaction. W. Kuriloff reported alcohol dissolves 0.0383 mol of silver diammino-nitrate per litre.

The aq. soln. of silver diammino-nitrate was reported by G. Wetzlar to have an alkaline reaction. C. Weltzien found hydrogen peroxide reduces a conc. soln. of the salt, forming white granular silver. The complex silver diammino-nitrate dissociates to some extent in aq. soln., and accordingly it was found by N. Castoro to give a white precipitate of silver chloride with chlorides, and also Nessler's reaction. F. W. Schmidt found that a very dil. aq. soln. of iodine gives a white flocculent precipitate of silver hypoiodite, which when dried becomes yellow owing to the formation of silver iodide ; an alcoholic soln. of iodine forms silver tri-iodide. According to H. Debus, the pentathionates give an intense brown coloration and silver sulphide is slowly precipitated ; the trithionates and tetrathionates, dil. soln.

of ammonium sulphite, or potassium thiosulphate have no action. J. J. Berzelius found phosphorous sulphide precipitated silver sulphide. N. W. Fischer found that silver is quickly and completely reduced from the ammoniacal soln. of the nitrate by zinc, cadmium, copper, and arsenic; slowly by cobalt, mercury, and antimony; and not at all by iron, manganese, nickel, or bismuth. H. Reckleben, G. Lockemann, and A. Eckhardt found that when boiled with arsenic, silver is quantitatively precipitated; the action of arsine on ammoniacal soln. of silver nitrate has been previously discussed. Wool and silk were found by L. Cramer to be stained a deep brown by ammoniacal soln. of silver nitrate. Ethyl iodide was found by A. Reyhler to react: $\text{Ag}(\text{NH}_3)_2\text{NO}_3 + \text{C}_2\text{H}_5\text{I} = \text{AgI} + \text{C}_2\text{H}_5\text{NO}_3 + 2\text{NH}_3$, and this behaviour is said to be incompatible with the view that the diammino-nitrate is an argentoammonium nitrate. G. Bruni and G. Levi prepared silver triammino-nitrate, $\text{Ag}(\text{NH}_3)_3\text{NO}_3$, and found the heat of formation $(\text{AgNO}_3, 3\text{NH}_3) = 42.94$ Cals., and the mol. heat of soln., -10.44 Cals. It is assumed that only the diammines exist in soln., and that the triammines, which exhibit considerable heats of formation in the solid state, are completely decomposed in soln. into the corresponding diammines and ammonia. Measurements of the e.m.f. indicate the existence in soln. of the complex $\text{Ag}(\text{NH}_3)_2$, and of this alone.

W. J. Russell and N. S. Maskelyne² prepared crystals of ammonium silver nitrate, $\text{NH}_4\text{NO}_3 \cdot \text{AgNO}_3$, by evaporating a soln. containing eq. proportions of the component salts. A. Ditte also made the crystals in an analogous manner. J. W. Retgers says the rectangular or six-sided plates so formed are biaxial, and probably belong to the rhombic system. The crystals are very hygroscopic, and fuse at 97° . J. von Zawadsky, and F. Flawitzky have studied the f.p. curves of mixtures of the two salts. The results are shown in Fig. 26.

The transition points of the four different forms of ammonium nitrate complicate the diagram. The region of stability of the double salts is represented by the portion AB. F. A. H. Schreinemakers and W. C. de Baat studied the ternary systems $\text{H}_2\text{O} - \text{NH}_4\text{NO}_3 - \text{AgNO}_3$, and $\text{C}_2\text{H}_5\text{OH} - \text{NH}_4\text{NO}_3 - \text{AgNO}_3$, as well as the quaternary system, $\text{H}_2\text{O} - \text{C}_2\text{H}_5\text{OH} - \text{AgNO}_3 - \text{NH}_4\text{NO}_3$; and J. W. Retgers investigated mixed crystals of the component salts. F. A. H. Schreinemakers and W. C. de Baat's diagram is shown in Fig. 27. The region HMZ includes cubic ammonium nitrate; GLSMH, rhombohedral ammonium nitrate; FKLK and ACKF respectively, α -rhombic and β -rhombic ammonium nitrate; CKLSRD, the double-salt $\text{AgNO}_3 \cdot \text{NH}_4\text{NO}_3$; PNX, rhombohedral silver nitrate; and BDRPN, rhombic silver nitrate. The lines represent the corresponding two-phase system, and the points of intersection of three curves represent three-phase systems. The curve BDCA is a solubility curve at 30° , the other regions are diagrammatic for temp. ranging up to the m.p. of the respective salts.

Neither A. Ditte³ nor W. J. Russell and N. S. Maskelyne could obtain crystals of a lithium silver nitrate by the evaporation of mixed soln. of the component salts. The mixed crystals show isodimorphism. H. Rose evaporated a mixed soln. of sodium and silver nitrates and obtained first rhombic crystals of the latter and then

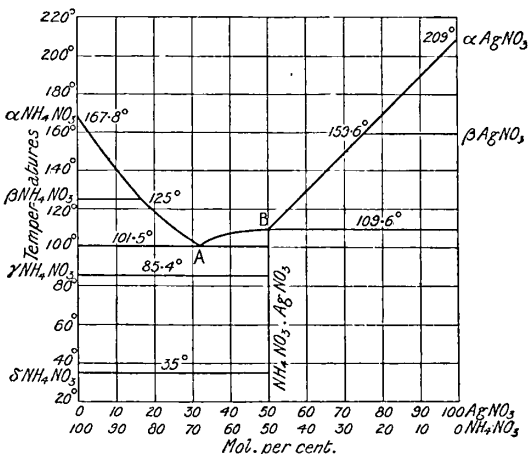

Fig. 26.—Fusion Curves of the Binary System, $\text{AgNO}_3 - \text{NH}_4\text{NO}_3$ (J. von Zawadsky).

rhombic crystals of the sodium salt. Mixed crystals of the two salts can be formed but no double salt, *sodium silver nitrate*. According to G. Tammann, mixed crystals of silver and sodium nitrates, prepared by slow cooling of the molten salts, give up more silver nitrate to a sat. soln. of sodium nitrate than mixed crystals prepared by slowly cooling a soln. of the two salts in aq. alcohol. W. J. Russell and N. S. Maskelyne, J. W. Retgers, A. Ditte, and E. Mauméne have also studied the subject.

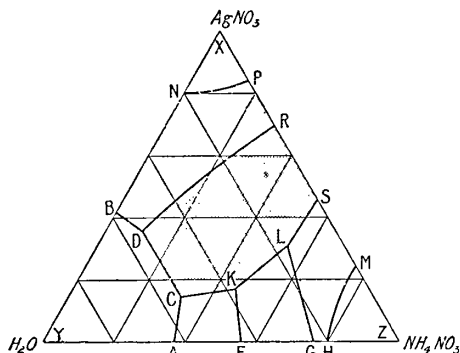

FIG. 27.—Ternary System, $\text{NH}_4\text{NO}_3\text{—AgNO}_3\text{—H}_2\text{O}$ (Diagrammatic).

boom's type IV. N. S. Kurnakoff and P. P. Eiler⁴ have studied the f.p. of mixtures of the two salts. A. Benrath investigated the electrical conductivity of the mixtures.

According to H. Rose, silver and potassium nitrates crystallize together from aq. soln. in all proportions; if but a small proportion of silver nitrate is present,

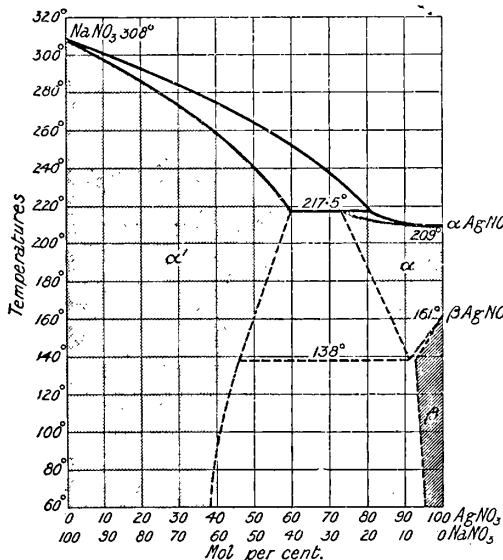

FIG. 28.—Fusion Curves of the Binary System, $\text{NaNO}_3\text{—AgNO}_3$ (D. J. Hissink).

pure potassium nitrate separates from the soln.; if a large proportion of the silver salt is present, crystals of the form of potassium nitrate containing the silver salt are obtained. J. W. Retgers, however, did not succeed in getting mixed crystals of the two salts in all proportions—up to 0.3 per cent. of potassium nitrate from mixed crystals of the potassium nitrate type; and up to 0.5 per cent. of silver nitrate from crystals of the silver nitrate type. By evaporating soln. with an excess of silver nitrate, W. J. Russell and N. S. Maskelyne obtained crystals of the double salt, **potassium silver nitrate**, $\text{KNO}_3\cdot\text{AgNO}_3$; if the soln. contains equi-molecular proportions of the component salts, potassium nitrate alone crystallizes out; and, according to A. Ditte, when the soln. has 3 mols of silver nitrate to one of the potassium salt, the double salt is obtained. P. Friedlander, and J. W. Retgers found the crystals of the double salt belong to the monoclinic system, with axial ratios $a : b : c = 0.8200 : 1 : 0.6963$, and $\beta = 97^\circ 47'$. J. W. Retgers gives 3.219 for

D. J. Hissink found the m.p. of mixtures of the two salts steadily rise from that of pure silver nitrate to that of sodium nitrate, as illustrated by the curves, Fig. 28. There are two series of mixed crystals. The series with silver nitrate predominating have a transition temp. from hexagonal (higher temp.) to rhombic (lower temp.) between 161° and 138° ; the series with the sodium salt predominant are rhombohedral. Mixed crystals α and β with predominating silver nitrate and α' with sodium nitrate predominating occur as shown in the diagram. The region between the liquidus and solidus curves corresponds with Roozeboom's type IV.

the sp. gr.; and at 125° for the m.p., but A. Ussoff says the double salt has not a well-defined m.p. J. G. L. Stern found silver nitrate to be but feebly ionized in soln. in molten potassium nitrate. N. S. Kurnakoff and P. P. Eiler, and A. Ussoff studied the f.p. of mixtures of the component salts; E. Mauméne the m.p.; L. Poincaré, the electrical conductivity; and L. J. Spencer, B. Gossner, and J. W. Retgers, the crystallographic relations of the mixed crystals. A. Ussoff's curves are shown in Fig. 29, where AD is the m.p. curve of silver nitrate with additions of increasing amounts of potassium nitrate; at G , α - AgNO_3 passes on cooling to the β -salt; DE is the m.p. curve of the double salt but there is no hylotropic m.p.; E upwards is the m.p. curve of potassium nitrate with decreasing proportions of the silver salt. E is a transformation point; D is a eutectic. F. A. H. Schreinemakers has studied the ternary systems, KNO_3 - AgNO_3 - H_2O at 30° ; and KNO_3 - AgNO_3 - $\text{C}_2\text{H}_5\text{OH}$ at 30° ; as well as the quaternary system, KNO_3 - AgNO_3 - H_2O - $\text{C}_2\text{H}_5\text{OH}$ at the same temp.

A. Ditte prepared fine crystals of rubidium silver nitrate, $\text{RbNO}_3 \cdot \text{AgNO}_3$, and of caesium silver nitrate, $\text{CsNO}_3 \cdot \text{AgNO}_3$, analogous to the corresponding potassium salt. P. Sabatier reported the formation of microscopic needles of a basic cupric silver nitrate, $3\text{CuO} \cdot \text{Ag}_2\text{O} \cdot \text{N}_2\text{O}_5 \cdot 3\text{H}_2\text{O}$, or $3\text{Cu}(\text{OH})_2 \cdot 2\text{AgNO}_3$, by the action of silver oxide on a soln. of cupric nitrate, or of cupric hydroxide on a soln. of silver nitrate.

REFERENCES.

¹ A. Reychler, *Ber.*, 16. 990, 2421, 1883; 28. 555, 1895; *Journ. Chim. Phys.*, 1. 345, 1903; W. Kuriloff, *Bull. Acad. St. Petersburg*, 17. 149, 1903; H. Rose, *Pogg. Ann.*, 20. 153, 1830; C. G. Mitscherlich, *ib.*, 9. 413, 1827; F. A. H. Schreinemakers and W. C. de Baat, *Chem. Weekbl.*, 7. 259, 1910; W. C. de Baat, *ib.*, 15. 463, 1918; A. Joannis and M. Croizier, *Compt. Rend.*, 118. 1149, 1894; M. Berthelot and M. Delépine, *ib.*, 129. 326, 1899; A. B. Prescott, *Chem. News*, 42. 31, 1880; H. N. Draper, *Pharm. Journ.*, (3), 17. 487, 1886; N. Castoro, *Gazz. Chim. Ital.*, 37. i, 310, 1907; A. Hantzsch, *Zeit. anorg. Chem.*, 19. 104, 1899; F. W. Schmidt, *ib.*, 9. 418, 1895; W. Herz, *ib.*, 67. 248, 1910; W. Peters, *ib.*, 77. 154, 1912; *Ber.*, 42. 4826, 1909; J. C. G. de Marignac, *Ann. Mines*, (5), 12. 24, 1857; C. F. Rammelsberg, *Handbuch der Kristallographisch-physikalischen Chemie*, Leipzig, 1. 373, 1881; A. A. Blanchard, *Journ. Amer. Chem. Soc.*, 26. 1315, 1904; D. Konowaloff, *Journ. Russ. Phys. Chem. Soc.*, 30. 367, 1898; F. Flawitzky, *ib.*, 41. 739, 1910; G. Bruni and G. Levi, *Gazz. Chim. Ital.*, 47. i, 259, 1917; C. Weltzien, *Liebigs Ann.*, 138. 129, 1866; J. J. Berzelius, *ib.*, 46. 140, 1843; H. Debus, *ib.*, 244. 76, 1888; V. Kohlschütter and E. Fischmann, *ib.*, 387. 93, 1912; N. W. Fischer, *Das Verhältniss der chemischen Verwandtschaft zur galvanischen Electricität dargestellt*, Berlin, 118, 1830; H. Reckleben, G. Lockeman, and A. Eckardt, *Zeit. anal. Chem.*, 46. 700, 1907; L. Cramér, *Zeit. Koll.*, 8. 42, 1911; R. Kane, *Ann. Chim. Phys.*, (2), 72. 282, 1839; H. Ley and G. Wiegner, *Zeit. Elektrochem.*, 11. 590, 1905; G. Wetzlar, *Schweigger's Journ.*, 53. 103, 1828.

² W. J. Russell and N. S. Maskelyne, *Proc. Roy. Soc.*, 26. 357, 1877; A. Ditte, *Compt. Rend.*, 101. 878, 1885; J. W. Retgers, *Zeit. phys. Chem.*, 4. 616, 1889; 5. 451, 1890; 6. 616, 1890; J. von Zawadsky, *ib.*, 47. 721, 1904; F. A. H. Schreinemakers, *ib.*, 65. 572, 1909; F. A. H. Schreinemakers and W. C. de Baat, *Arch. Néerl.*, (2), 15. 411, 1911; *Chem. Weekb.*, 7. 6, 259, 333, 1910; W. C. de Baat, *ib.*, 15. 463, 1918; F. Flawitzky, *Journ. Russ. Phys. Chem. Soc.*, 41. 739, 1909; G. Bruni and G. Levi, *Gazz. Chim. Ital.*, 47. ii, 259, 1917; *ib.*, 46. ii, 17, 235, 1916.

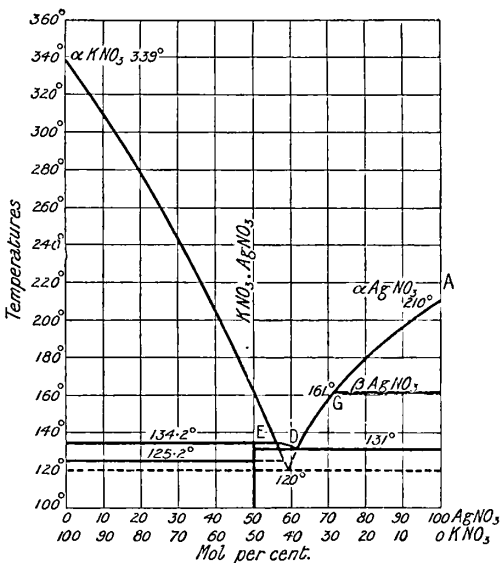

FIG. 29.—Fusion Curves of the Binary System, KNO_3 - AgNO_3 (A. Ussoff).

³ H. Rose, *Pogg. Ann.*, 102. 436, 1857; 106. 321, 1859; W. J. Russell and N. S. Maskelyne, *Proc. Roy. Soc.*, 26. 357, 1877; A. Ditte, *Compt. Rend.*, 101. 878, 1885; E. Mauméne, *ib.*, 97. 45, 1215, 1883; D. J. Hissink, *Zeit. phys. Chem.*, 32. 537, 1900; J. W. Retgers, *ib.*, 4. 593, 1889; A. Benlath, *ib.*, 64. 702, 1908; O. Lehmann, *Molekularphysik*, Leipzig, 1. 465, 754, 790, 1888; *Wied. Ann.*, 24. 14, 1885; *Zeit. Kryst.*, 1. 110, 1877; T. V. Barker, *ib.*, 45. 1, 1908; N. S. Kurnakoff and P. P. Eiler, *Journ. Russ. Phys. Chem. Soc.*, 31. 974, 1899; G. Tammann, *Gött. Nachr.*, 296, 1918.

⁴ H. Rose, *Pogg. Ann.*, 106. 320, 1859; J. W. Retgers, *Zeit. phys. Chem.*, 4. 608, 1889; J. G. L. Stern, *ib.*, 65. 687, 1909; F. A. H. Schreinemakers, *ib.*, 65. 576, 1909; W. J. Russell and N. S. Maskelyne, *Proc. Roy. Soc.*, 26. 257, 1877; A. Ditte, *Compt. Rend.*, 101. 878, 1885; *Ann. Chim. Phys.*, (6), 8. 418, 1886; P. Friedlander, *Zeit. Kryst.*, 3. 215, 1879; B. Gossner, *ib.*, 38. 145, 1904; L. J. Spencer, *Min. Mag.*, 14. 308, 1908; A. Ussoff, *Zeit. anorg. Chem.*, 38. 419, 1904; E. Mauméne, *Compt. Rend.*, 97. 45, 1215, 1883; P. Sabatier, *ib.*, 125. 175, 1897; L. Poincaré, *ib.*, 108. 138, 1889; O. Lehmann, *Wied. Ann.*, 24. 10, 1885; *Zeit. Kryst.*, 1. 110, 1877; *Molekularphysik*, Leipzig, 1. 756, 1888; N. S. Kurnakoff and P. P. Eiler, *Journ. Russ. Phys. Chem. Soc.*, 31. 974, 1899.

§ 23. Silver Peroxynitrate and Peroxysulphate

In 1804, J. W. Ritter¹ observed that a black crystalline deposit is formed on the anode when an aq. soln. of silver nitrate is electrolyzed between platinum electrodes. A silver cathode and platinum anode may be used. During the electrolysis, silver is deposited on the cathode and the black crystals on the anode, and there is a simultaneous formation of nitric acid. Both solid deposits are crystalline, and grow rapidly towards one another in arborescent crystals, so that the anode deposit, as F. Mahla, and M. J. Brown have observed, is a good electrical conductor.

O. Sulz recommended using a platinum dish as cathode and as anode a piece of platinum foil cut in the form of a comb and rolled up. A 15 per cent. soln. of silver nitrate was used as electrolyte, with a current of 0.06 amp. and a current density at the cathode of 0.0033 amp. per sq. cm. The electrolysis continued 3-4 hrs. when the soln. became contaminated with about 4 per cent. of free nitric acid. The electrolyte was then renewed, and the electrolysis continued. The crystalline deposit on the anode was brushed off with a glass rod, and washed with water until the runnings gave no opalescence with hydrochloric acid. The product was dried over calcium chloride.

M. J. Brown showed that the losses due to the decomposition of the black crystals breaking away from the anode is avoided if the crystals are kept in electrical contact with the anode, for the crystals are not then attacked by the nitric acid simultaneously formed; E. Mulder and J. Heringa, and E. R. Watson found that the product is the same when soln. of different conc. (5 to 15 per cent.) are electrolyzed, and when the current varies from 0.13 to 1.12 amp., and the current density varies from 0.015 to 0.14 amp. per sq. cm. V. Novak, O. Kühling, S. Tanatar, R. Böttger, and others have likewise prepared the same product. According to H. C. P. Weber, the soln. of silver nitrate being electrolyzed contains 15-25 per cent. of nitric acid, there is no deposit, but a brown soln. is formed. According to E. Wallquist, the deposit forms black octohedra united in a series of prisms and needles, and, according to C. J. D. von Grothaus, the crystals are tetrahedra. According to F. Mahla, the sp. gr. of the crystals is 5.474, and according to O. Sulz, 5.65.

The black deposit was thought to be a peroxide, Ag_2O_2 , and E. Wallquist's analyses (1842) corresponded with this assumption. N. W. Fischer, however, showed that the product always contains nitric acid, and that the analogous product obtained by the electrolysis of silver sulphate also contains sulphuric acid; while the electrolysis of silver hypophosphate, or of silver acetate, does not yield the peroxidized product. N. W. Fischer's analysis (1842) corresponded with $\text{Ag}_5\text{O}_5 \cdot \text{AgNO}_3$, or with $2\text{Ag}_2\text{O}_2 \cdot \text{AgNO}_3 \cdot \text{H}_2\text{O}$; F. Mahla's (1852) with $5\text{Ag}_2\text{O}_2 \cdot 2\text{AgNO}_3 \cdot \text{H}_2\text{O}$; M. Berthelot's (1881) with $4\text{Ag}_2\text{O}_3 \cdot 2\text{AgNO}_3 \cdot \text{H}_2\text{O}$; W. Hampe's (1890) with $\text{Ag}_2\text{O}_3 \cdot 2\text{AgNO}_3$; and O. Sulz's (1896), $3\text{Ag}_4\text{O}_5 \cdot 2\text{AgNO}_3$. E. Mulder and J. Heringa's analysis

(1896) gave $3\text{Ag}_2\text{O}_2 \cdot \text{AgNO}_3$, or $2\text{Ag}_3\text{O}_4 \cdot \text{AgNO}_3$, which is eq. to $\text{Ag}_7\text{NO}_{11}$; S. Tanatar (1901), O. Sulc (1900), E. R. Watson (1906), M. J. Brown (1916), obtained similar results.

While these workers consider that silver nitrate is an essential constituent of the product, others like E. Wallquist believe that silver nitrate is either adsorbed or in solid soln. with silver peroxide. Indeed, M. Bose made no analysis of her products because she considered it impossible to get accurate results, and added :

When one remembers how many chemically prepared compounds can be washed free from the adhering mother liquid only with great difficulty, and how often crystals contain enclosed mother liquid, it is not surprising that the crystals, formed by electrolysis and precipitated very rapidly, should contain some of the soln. in which they grew.

She obtained only one break in the current-voltage curve for a soln. of silver nitrate or silver sulphate—in the former case 1.573 volts, and 1.53 in the latter—and considered that the two values are the same, and hence concluded that the precipitate is the same and consequently cannot contain either silver nitrate or silver sulphate. As a matter of fact, the difference between 1.573 and 1.53 volts is nothing like as large as the changes found by J. A. Wilkinson and H. W. Gillett in the decomposition voltage of soln. of silver nitrate of varying conc. and with varying amounts of nitric acid. R. Luther and F. Pokorny also determined the voltage-current curve of a silver anode in soln. of sodium hydroxide, and they obtained one break corresponding with silver oxide, Ag_2O , and another with silver peroxide, Ag_2O_2 . They prepared E. Mulder's peroxy-nitrate and peroxy-sulphate, washed them with a dil. soln. of sodium hydroxide, and reduced them at constant current in *N*-NaOH soln. They obtained three definite potentials, 1.57, 1.41, and 1.17 volts, and they believe that these correspond respectively with Ag_2O_3 , Ag_2O_2 , and Ag_2O . Similar results were obtained with both the peroxy-nitrates and peroxy-sulphates, and hence the same conclusion was drawn that neither silver sulphate nor silver nitrate is an integral part of the compound, which is therefore an impure silver oxide, Ag_2O_3 . B. Brauner and B. Kuzma (1907) likewise believe the compound to be silver peroxide, Ag_4O_4 or $\text{Ag}_2\text{O} \cdot \text{Ag}_2\text{O}_3$; and G. Baborovsky and B. Kuzma (1909), Ag_3O_4 .

O. Sulc's investigations on the action of heat and oxidizing properties (*vide infra*); E. R. Watson's observation that a definite crystalline product is obtained by varying the current density and conc. of the soln.; and M. J. Brown's work on the coulometer ratio of the compound to copper, show that the deposit is probably impure $(\text{Ag}_3\text{O}_4)_2\text{AgNO}_3$. In the latter case it was found that no silver peroxide or hydrated oxide can give the observed ratio of silver contents of anode deposit to copper deposited in the coulometer. The values calculated for $(\text{Ag}_3\text{O}_4)_2\text{AgNO}_3$ agree with the observed. It required ten farads to precipitate a mol of $\text{Ag}_7\text{NO}_{11}$. For some soln. the low values of the coulometer ratio may be explained by the possible presence of $\text{Ag}_2\text{O}_3 \cdot \text{AgNO}_3$ or $(\text{Ag}_3\text{O}_4)_2 \cdot \text{H}_2\text{O}$; or to the dissolution of the anode deposit. H. C. P. Weber suggested two probable formulæ for the oxide part of the salt— Ag_2AgO_4 analogous to red lead, and $\text{Ag}(\text{AgO}_2)_2$ analogous to magnetic oxide of iron—but transference experiments show that one-third the silver is cathodic and bivalent, and two-thirds is anodic and trivalent. This leads to the formula $\text{Ag}(\text{AgO}_2)_2$, making the oxide portion of the peroxy-nitrate to be the silver salt of an unstable **argentic acid**, HAgO_2 .

According to E. Wallquist, the product decrepitates in the flame of a candle; and, according to N. W. Fischer, the product obtained with silver sulphate does not decrepitate in the flame of a candle. When the dried product is heated gently in a flask, it gives off nitrous fumes, and cold water extracts silver nitrate from the residue. According to F. Mahla, it loses oxygen at 110° , leaving a residue of silver and silver nitrate; M. Schucht says that the crystals detonate feebly at 110° with the evolution of oxygen. The speed of decomposition is moderate at 50° , but rapid between 90° and 100° . W. Hampe also records the spontaneous explosion of a sealed tube containing this product. At 150° - 160° , O. Sulc found that oxygen is given off

and a dark brown voluminous powder is formed; when heated to redness, reddish-brown fumes are evolved, and metallic silver remains. M. Berthelot says that the crystals are not stable at ordinary temp., but O. Sulc found them to be fairly stable in air, and to decompose only after keeping them some months. E. Mulder and J. Heringa, E. R. Watson, and O. Sulc found oxygen to be evolved in the proportion corresponding to the equation: $2\text{Ag}_7\text{NO}_{11} = 2(3\text{Ag}_2\text{O} \cdot \text{AgNO}_3) + 5\text{O}_2$. They believed that three out of the five atoms of oxygen liberated per mol of $\text{Ag}_7\text{NO}_{11}$ are different from the other two because only these three take part in the reaction with ammonia and probably oxalic acid; and it is probably these three atoms which give the substance the properties of a peroxide as evidenced by the energetic oxidizing properties. The powdered crystals are slowly decomposed when in contact with water at ordinary temp. with the evolution of oxygen. The change is completed in an hour when the water is boiled, and a greyish-black powder of silver peroxide, Ag_2O_2 , of sp. gr. 7.44, remains: $\text{Ag}_7\text{NO}_{11} = \text{AgNO}_3 + 3\text{Ag}_2\text{O}_2 + \text{O}_2$. According to O. Sulc, the salt is decomposed very slowly by water at ordinary temp. and silver nitrate passes into soln.; but when boiled with water for about 36 hrs. silver is deposited as a mirror on the flask.

F. Mahla observed no action when **hydrogen** is passed over the cold salt, but when heated, a feeble explosion occurs and the salt is reduced. R. Böttger also noted that **hydrogen sulphide** is inflamed by the salt; and when triturated with **antimony pentasulphide** inflammation occurs. C. J. D. von Grotthus says that the compound detonates when struck in contact with **sulphur** or **phosphorus**. According to H. Rose, and E. R. Watson, conc. **sulphuric acid** forms a greenish-black or olive-green soln. which slowly decomposes at ordinary temp., and the oxygen which is evolved smells of ozone; N. W. Fischer, E. Wallquist, and F. Mahla also noted that oxygen is evolved when the salt is treated with sulphuric acid, and likewise also with **phosphoric acid**—with syrupy phosphoric acid, H. Rose noted that the product is not dissolved at ordinary temp., but when warmed a colourless liquid is formed with the evolution of oxygen. N. W. Fischer said that the salt dissolves unchanged in **nitric acid**; and F. Mahla obtained a port-wine coloured liquid with nitric acid of a sp. gr. 1.2, and the soln. became colourless with the evolution of oxygen when warmed. With cold conc. nitric acid, E. R. Watson obtained a brown soln., which cannot be distinguished from the soln. obtained similarly with silver peroxide. It is assumed that the coloured soln. contains *silver peroxy-nitrate* in the case of nitric acid, and *silver peroxy-sulphate* in the case of sulphuric acid. The presence of salts is the cause of the coloration. These peroxy-salts gradually decompose at ordinary temp., more quickly when heated; or when diluted with water. No hydrogen peroxide has been detected during the decomposition. E. R. Watson found the rate of decomposition of the coloured nitric acid soln. is proportional to the conc. x of the coloured salt, or $dx/dt = kx$. This does not agree with the assumption that the coloured compound is $\text{Ag}(\text{NO}_3)_2$, although the formula $[\text{Ag}(\text{NO}_3)_2]_4$ satisfies the condition that the decomposition is a unimolecular reaction: $\text{Ag}_4(\text{NO}_3)_8 + 2\text{H}_2\text{O} = 4\text{AgNO}_3 + 4\text{NH}_3 + \text{O}_2$; the same condition is satisfied by $\text{Ag}_2(\text{NO}_4)_2 = 2\text{AgNO}_3 + \text{O}_2$. Attempts to isolate the peroxy-salts have not been successful. G. A. Barbieri believes the brown nitric acid soln. of silver peroxy-nitrate, like that of silver peroxide, contains *silver dinitrate*, $\text{Ag}(\text{NO}_3)_2$, with silver bivalent.

Silver peroxy-nitrate, said J. W. Ritter, is converted by **hydrochloric acid** into silver chloride with the evolution of chlorine; A. J. Balard found that with **hypochlorous acid**, silver chloride, oxygen, and a little chlorine are formed. N. W. Fischer and S. Tanatar say that a cold soln. of **sodium chloride** has no action, but a boiling soln. gives off a gas, and forms silver chloride and sodium hydroxide; the last-named also found that a soln. of **potassium iodide** forms silver iodide and potassium iodate. N. W. Fischer also found that with **ammonium chloride** soln., a gas is evolved and silver chloride is formed—partly in soln. and partly precipitated. H. Rose said that if the nitric acid soln. be poured into a dil soln. of **potassium hydroxide**, an alkali peroxide and yellowish-brown silver oxide are formed; with

sodium carbonate, sodium phosphate, or potassium chromate, precipitates of silver carbonate, phosphate, or chromate are respectively produced. O. Kühling found that **manganous salts** are converted into permanganates. According to C. J. D. von Grothhuss, and O. Sulc, the salt dissolves in aq. **ammonia** and is completely decomposed with the evolution of nitrogen, and the formation of silver ammino-oxide; and, according to O. Sulc, two mols of ammonia are oxidized by three of the oxygen atoms of the peroxy-nitrate, $\text{Ag}_7\text{NO}_{11}$. H. Rose says that when the nitric acid soln. of the salt is dropped into very dil. aq. ammonia, a peroxide is first formed, and this soon passes into soln. R. Kempf has shown that silver peroxy-nitrate acts as an oxidizing agent on organic compounds. F. Mahla and O. Sulc found that it is completely decomposed by **oxalic acid** with the evolution of carbon dioxide; **alcohol** is converted into aldehyde with the simultaneous deposition of a silver mirror; **oil of cloves**, and similar compounds, are inflamed (R. Böttger), and it is decomposed by filter **paper** (E. R. Watson).

REFERENCES.

¹ J. W. Ritter, *Gehlen's Journ.*, 3. 561, 1804; C. J. D. von Grothhuss, *Gilbert's Ann.*, 61. 60, 1819; *Schweigger's Journ.*, 28. 324, 1820; N. W. Fischer, *Kastner's Archiv.*, 16. 215, 1812; *Journ. prakt. Chem.*, (1), 32. 108, 1844; (1), 33. 237, 1844; E. Wallquist, *ib.*, (1), 31. 179, 1842; M. Berthelot, *Compt. Rend.*, 90. 653, 1880; *Bull. Soc. Chem.*, (2), 34. 138, 1880; *Ann. Chim. Phys.*, (5), 21. 172, 1880; A. J. Balard, *ib.*, (2), 57. 225, 1834; *Taylor's Scientific Memoirs*, 1. 269, 1837; E. Mulder, *Rec. Trav. Chim. Pays-Bas*, 16. 57, 1897; 17. 57, 1898; 18. 91, 1899; 19. 115, 1899; 22. 385, 1904; E. Mulder and J. Heringa, *ib.*, 151. 236, 1896; V. Novak, *Abh. böhm. Akad. Prag.*, 21, 1892; *Rozpravy Ceske Akad.*, 5. 6, 1896; B. Kuzma, *ib.*, 19. 11, 1905; E. R. Watson, *Proc. Chem. Soc.*, 21, 297, 1906; *Journ. Chem. Soc.*, 89. 578, 1906; F. Mahla, *Liebig's Ann.*, 82. 289, 1852; *Ueber das Silbersuperoxyd und über die Bildung von Schwefelsäure aus schwefeliger Säure und Sauerstoffgas*, Göttingen, 1852; W. Hampe, *Chem., Ztg.*, 14. 1779, 1890; J. A. Wilkinson and H. W. Gillett, *Journ. Phys. Chem.*, 11. 382, 1907; B. Brauner and B. Kuzma, *Ber.*, 40. 3371, 1907; R. Kempf, *ib.*, 38. 3963, 1905; S. Tanatar, *ib.*, 42. 1516, 1909; R. Böttger, *ib.*, 6. 1396, 1873; *Zeit. Chem.*, 13. 82, 1870; *Repert. Pharm.*, 24. 563, 1875; G. Baborovsky and B. Kuzma, *Zeit. phys. Chem.*, 67. 48, 1909; M. Bose, *ib.*, 68. 383, 1909; *Zeit. anorg. Chem.*, 44. 237, 262, 1907; O. Sulc, *ib.*, 12. 89, 180, 1896; 25. 305, 1900; S. Tanatar, *ib.*, 28. 331, 1901; R. Luther and F. Pokorny, *ib.*, 57. 290, 1908; M. J. Brown, *Journ. Phys. Chem.*, 20. 680, 1916; *Frans. Amer. Electrochem. Soc.*, 30. 326, 1916; H. C. P. Weber, *ib.*, 32. 391, 1917; O. Kühling, *Zeit. angew. Chem.*, 16. 1145, 1904; G. A. Barbieri, *Gazz. Chim. Ital.*, 42. ii, 7, 1912; M. Schucht, *Zeit. anal. Chem.*, 22. 485, 1883; H. Rose, *Ausführliches Handbuch der analytischen Chemie*, Leipzig, 1. 347, 1867; G. I. Higson, *Journ. Chem. Soc.*, 119. 2048, 1921.

§ 24. Silver Phosphates

According to G. Wetzlar,¹ silver oxide reacts with an aq. soln. of phosphoric acid or disodium hydrophosphate, forming **normal silver orthophosphate**, Ag_3PO_4 ; and, according to J. J. Berzelius and E. Mitscherlich, the same salt is precipitated when diammonium, dipotassium, or disodium hydrophosphate is added to a soln. of silver nitrate, and the supernatant liquid contains free nitric acid; but, according to T. Graham, the liquor is neutral if normal sodium orthophosphate be employed as precipitant: $\text{Na}_3\text{PO}_4 + 3\text{AgNO}_3 = 3\text{NaNO}_3 + \text{Ag}_3\text{PO}_4$. In all cases also, T. Graham found that the precipitate carries down a little silver nitrate which cannot be completely removed by washing, and consequently nitrous fumes are evolved when the salt is heated. It was also remarked that sparingly soluble orthophosphates—e.g. the calcium or magnesium salts—are coloured yellow when moistened with a soln. of silver nitrate owing to the formation of silver phosphate. It is not feasible to purify normal silver orthophosphate by recrystallization, and the conditions of precipitation must be so chosen that a pure product is obtained at once. G. P. Baxter and G. Jones did not obtain satisfactory results with disodium ammonium phosphate or with trisodium phosphate as precipitant, but the

precipitates with disodium hydrophosphate, disodium ammonium phosphate, and sodium ammonium hydrophosphate had very nearly the same composition.

A 0.3*N*-soln. of one of these salts was slowly poured into a 0.3*N*-soln. of silver nitrate; the precipitate was washed by decantation with water and allowed to stand in contact with water for 24 hrs. in order to allow all soluble matters to be leached out. The precipitate was drained in a centrifugal machine, and then dried in a current of air for several hours, first at 90° and then at 100°. All the operations were conducted in a dark room. The excess of silver in soln. prevents the conc. of the phosphate from exceeding a small value, and the soln. can neither become alkaline by hydrolysis, nor dissolve an appreciable amount of acid phosphate. The addition also prevents the formation or occlusion of acid phosphates.

F. Stromeyer found the salt contained no water, J. J. Berzelius observed about half per cent., and G. P. Baxter and G. Jones ascertained that the salt can be completely dried, without fusion, by heating it to about 400° in a current of dry air for about 7 hrs.

The reaction between disodium orthophosphate and silver nitrate is usually represented: $\text{Na}_2\text{HPO}_4 + 3\text{AgNO}_3 = \text{Ag}_3\text{PO}_4 + 2\text{NaNO}_3 + \text{HNO}_3$, but W. Ostwald gave $2\text{Na}_2\text{HPO}_4 + 3\text{AgNO}_3 = \text{Ag}_3\text{PO}_4 + \text{NaH}_2\text{PO}_4 + 3\text{NaNO}_3$ as more in accord with observations, but added that "it no doubt fails to express all that goes on." W. R. Lang and W. P. Kaufmann have shown that the reaction takes place in several distinct stages: $\text{Na}_2\text{HPO}_4 + \text{AgNO}_3 + \text{HNO}_3 = 2\text{NaNO}_3 + \text{AgH}_2\text{PO}_4$; $\text{AgH}_2\text{PO}_4 + \text{AgNO}_3 = \text{Ag}_2\text{HPO}_4 + \text{HNO}_3$; and $\text{Ag}_2\text{HPO}_4 + \text{AgNO}_3 = \text{Ag}_3\text{PO}_4 + \text{HNO}_3$. The filtrate contains both phosphoric and nitric acids, and this is accounted for by the equation, $4\text{Na}_2\text{HPO}_4 + 9\text{AgNO}_3 = 3\text{Ag}_3\text{PO}_4 + 8\text{NaNO}_3 + \text{HNO}_3 + \text{H}_3\text{PO}_4$. The composition of the precipitate approaches that of Ag_3PO_4 , but more usually is nearer $\text{Ag}_5\text{H}(\text{PO}_4)_2$, or $\text{Ag}_3\text{PO}_4 + \text{Ag}_2\text{HPO}_4$. According to M. Berthelot, when disodium hydrophosphate is employed as precipitant, the normal silver phosphate is contaminated with the disilver orthophosphate, and a double silver disodium orthophosphate. The relative quantities of these three salts in the precipitate is determined by the composition of the mother liquid, and the equilibrium conditions have been studied by Y. Osaka.

A. Lottermoser² prepared colloidal silver orthophosphate by mixing 0.05*N*- AgNO_3 with an excess of 0.05*N*-normal sodium phosphate, or disodium hydrophosphate. C. Paal and F. Voss added silver nitrate to a soln. of disodium hydrophosphate and sodium lysalbinat or protalbinat.

Precipitated silver orthophosphate is a yellow amorphous powder which J. J. Berzelius, and A. Joly found can be recrystallized from orthophosphoric acid (38 per cent. P_2O_5). H. Dufet says the crystals belong to the cubic system, F. Stromeyer found the specific gravity to be 7.321 at 7.5°; G. P. Baxter and G. Jones, 6.37 at 25°/4°. The salt becomes reddish-brown when heated, and, according to J. J. Berzelius, it melts like silver chloride at a red heat. T. Carnelley places the melting point at about 849°. According to F. Stromeyer, the molten salt is coloured dark brown, and, on cooling, solidifies to a yellow mass; if the salt be kept fused for a long time, it is partly reduced, and becomes paler and more fusible, owing to the formation of the pyrophosphate. The salt blackens on exposure to light. Silver orthophosphate is sparingly soluble in water; R. Böttger found the solubility in water at 19.3° to be 6.5×10^{-3} grms. per litre. According to J. F. H. Suersen, the salt dissolves readily in an aq. orthophosphoric acid. A. Joly observed that the soln. of the salt in phosphoric acid with less than 80 per cent. P_2O_5 , sat. at 80°, deposits pale yellow crystals of normal silver phosphate, Ag_3PO_4 , on cooling, but if the soln. contains about 40 per cent. P_2O_5 , colourless crystals of disilver hydrophosphate, Ag_2HPO_4 , are produced. According to J. F. H. Suersen, normal silver phosphate is readily soluble in nitric acid. The soln. in nitric acid yields crystals of silver nitrate. J. F. H. Suersen also found silver phosphate to be readily soluble in acetic acid, and, according to W. Skey, crystals of the normal phosphate separate from the

soln. J. F. H. Suerscn also found the normal phosphate to dissolve readily in aq. *ammonia* or *ammonium carbonate*; it is less readily soluble in an aq. soln. of *ammonium nitrate* or *ammonium succinate*; and still less soluble in an aq. soln. of *ammonium sulphate*.

E. C. Franklin and C. A. Kraus ascertained that normal silver phosphate is insoluble in liquid *ammonia*; F. Bezold, that it is insoluble in *methyl acetate*, and M. Hamers, in *ethyl acetate*.

A. Colson found that **hydrogen** reduces normal silver phosphate by an irreversible reaction, and the speed of absorption is accelerated by a rise of temp. or press. J. B. Senderens observed that when boiled with **sulphur** and water, silver sulphide and phosphoric and sulphuric acids are formed. J. L. Lassaigne found that freshly prepared silver phosphate is decomposed when digested with a soln. of **sodium, calcium, or magnesium chloride**, silver chloride being produced. A soln. of **calcium or magnesium nitrate** is not decomposed.

O. Widmann found that if ammonia gas be passed over dry normal silver phosphate, until the solid has a constant weight, the eq. of three mols of ammonia are absorbed per mol of silver phosphate, and A. Reychler found between 3 and 4 mols of gas are absorbed. O. Widmann also reported that if a soln. of normal silver phosphate in aq. ammonia be conc. in a desiccator, over quicklime mixed with ammonium chloride, colourless prismatic needles of **silver tetrammino-orthophosphate**, $\text{Ag}_3\text{PO}_4 \cdot 4\text{NH}_3$, are formed. O. Widmann found the crystals are rapidly coloured yellow on exposure to air, and lose all their ammonia in a desiccator over sulphuric acid. Neither A. Reychler nor A. Terreil could get a product of constant composition by this procedure. The latter reported that the soln. rapidly becomes brown, and finally deposits a brownish-black substance resembling silver fulminate.

Disilver hydrophosphate, Ag_2HPO_4 .—J. J. Berzelius found that the evaporation of a soln. of normal silver phosphate in phosphoric acid at first deposits the same salt, but as the soln. is allowed to evaporate spontaneously, white feathery crystals assumed to be disilver hydrophosphate are formed. Similar results were obtained by L. Hurtzig and A. Geuther, and A. Joly—*vide supra*—who ascertained the conditions under which each salt is produced. J. J. Berzelius also obtained crystals of this salt by evaporating at a gentle heat, a mixture of silver nitrate with a large excess of orthophosphoric acid. A. Schwarzenberg did not succeed in preparing crystals of this salt by Berzelius' process, but he evaporated the soln. of silver phosphate in phosphoric acid to a syrupy consistence, and mixed it with ether, much heat was evolved, and a white crystalline powder was obtained which after washing with absolute alcohol to remove as much adherent phosphoric acid as possible, and drying at 100° , had a composition corresponding with disilver hydrophosphate. A. Joly found that the salt is not altered by washing with ether, and the excess of phosphoric acid can be washed from the crystals by that menstruum. According to H. Dufet, and O. Mügge, the colourless prismatic crystals of this salt belong to the hexagonal or trigonal system, and have the axial ratio $a : c = 1 : 0.7297$. They are quickly reduced by exposure to light. A. Schwarzenberg found the crystals lost no water at 100° , but at 170° , 2.87 per cent. of water was given off, and silver pyrophosphate was formed—A. Joly reported that the last-named change occurs between 110° and 150° . The crystals are blackened on exposure to light, and are immediately converted into the normal silver phosphate and free phosphoric acid by contact with water. Alcohol and ether have no action on the salt. The primary salt, *silver dihydrophosphate*, AgH_2PO_4 , has not been isolated.

Normal silver pyrophosphate, $\text{Ag}_4\text{P}_2\text{O}_7$.—T. Clark³ prepared this salt, in 1827, by precipitation when a soln. of sodium pyrophosphate is added to one of silver nitrate; the filtrate from the white precipitate is neutral. F. Stromeier observed that if a soln. of silver nitrate be added to a mixture of sodium orthophosphate and pyrophosphate, yellow normal silver orthophosphate is first precipitated, and afterwards the white pyrophosphate; and he added that at the first instant of the precipitation, white silver pyrophosphate appears to be hydrated but soon parts

with the combined water. A. Joly's and A. Schwarzenberg's production of this salt by heating disodium hydro-orthophosphate has already been indicated.

According to F. Stromeier, the white pulverulent normal silver pyrophosphate has a sp. gr. 5.306, and it fuses below a red heat, without decomposition, forming a dark-brown liquid, which on cooling solidifies to a white mass of radiating crystals. T. Carnelley gave 585° for the m.p. F. Stromeier added that the salt acquires a reddish tint on exposure to light. When silver pyrophosphate is boiled with a soln. of disodium hydrophosphate, it is decomposed into yellow normal silver orthophosphate, and a soln. of sodium pyrophosphate. The salt is soluble in cold dil. nitric acid, but when boiled with either nitric acid or sulphuric acid, it is converted into ordinary silver phosphate which is precipitated when the acid is neutralized with the alkalis or ammonia; it is converted by hydrochloric acid into silver chloride and free phosphoric acid. It readily dissolves in aq. ammonia, and is re-precipitated by acids; it is insoluble in acetic acid, and is not affected by boiling water. A. Schwarzenberg continued that the salt is slightly soluble in a soln. of silver nitrate, and insoluble in a soln. of the pyrophosphates.

Disilver dihydropyrophosphate, $\text{Ag}_2\text{H}_2\text{P}_2\text{O}_7$.—This salt was prepared in 1859 by L. Hurtzig and A. Geuther, by heating a soln. of normal silver pyrophosphate to 180° for 14 days. The crystals are washed free from the syrupy mother liquid first with ether, and then with alcohol. J. Cavalier heated a mixture of 40 grms. of normal silver pyrophosphate with 200 grms. of pyrophosphoric acid until the liquid was clear; it was then dissolved in half a litre of water at 0°, and precipitated by the addition of alcohol or ether.

The white crystalline powder softens at 150°; melts at 235°; and decomposes at 240°. L. Hurtzig and A. Geuther say that the salt loses 2.19 per cent. of water at 225° when it melts to a dirty green glass; and at a red heat, 1.95 per cent. more water is given off. A. Cavalier found the salt is decomposed by cold water, forming pyrophosphoric acid and normal silver pyrophosphate; it reacts with a soln. of disodium hydrophosphate to form normal silver phosphate and pyrophosphoric acid; and it reacts with alkali iodides to form silver iodide, and the alkyl esters of pyrophosphoric acid. L. Hurtzig and A. Geuther believed that they also obtained a compound of silver dihydropyrophosphate with metaphosphoric acid, *viz.*, $2\text{Ag}_2\text{H}_2\text{P}_2\text{O}_7 \cdot \text{HPO}_3$.

M. Stange reported the formation of **sodium trisilver pyrophosphate**, $\text{NaAg}_3\text{P}_2\text{O}_7$, with about 0.4 mol part of water by gradually mixing in darkness a cold sat. soln. of 20 parts of normal sodium pyrophosphate, and 50 c.c. of a 2.5 per cent. soln. of silver nitrate. The white crystals are washed, and dried on a porous tile. They are changed in light, and when heated to drive off the water, the crystals blacken, and when heated more strongly they decompose into normal silver phosphate and sodium metaphosphate.

Silver dimetaphosphate, $\text{Ag}_2\text{P}_2\text{O}_6$.—T. Fleitmann⁴ added an excess of silver nitrate to a conc. soln. of alkali dimetaphosphate, and obtained a crystalline precipitate; the crystals which separate when a dil. soln. is allowed to stand for some time are similar to silver trimetaphosphate, but are much less soluble in water. F. Warschauer dropped a soln. of sodium tetrametaphosphate into a 10 per cent. soln. of silver nitrate, and J. Müller stirred sodium metaphosphate with a conc. soln. of silver nitrate at 50°. Silver dimetaphosphate is gradually formed. K. Langheld emphasized that these methods of preparation are not free from objections. The crystals melt at an incipient red heat, forming a clear glass insoluble in water, and which cannot be distinguished from the hexametaphosphate. The air-dried salt does not lose any noteworthy quantity of water when heated to redness. The salt is sparingly soluble in water. G. Tammann obtained *monohydrated silver dimetaphosphate*, $\text{Ag}_2\text{P}_2\text{O}_6 \cdot \text{H}_2\text{O}$, by adding lithium disodium metaphosphate or potassium disodium metaphosphate to a soln. of silver nitrate; the same salt was obtained by adding a soln. in hot water of freshly precipitated ammonium metaphosphate to an excess of a soln. of silver nitrate. K. Langheld, F. Oppmann,

and E. Meyer dissolved 35 grms. of silver nitrate in a little water and poured the soln. into one of 20 grms. of sodium dimetaphosphate. The crystallization of the salt begins after some time. The octahedral crystals lose their water when exposed in vacuo to 150°.

Silver trimetaphosphate, $\text{Ag}_3\text{P}_3\text{O}_9$.—T. Fleitmann and W. Henneberg, and C. G. Lindböm obtained the anhydrous salt by heating disilver dihydropyrophosphate to its m.p.; and *monohydrated silver trimetaphosphate*: $\text{Ag}_3\text{P}_3\text{O}_9 \cdot \text{H}_2\text{O}$, by mixing the conc. soln. of sodium trimetaphosphate with silver nitrate. Crystallization sets in immediately, and continues some days. C. G. Lindböm recommended a great excess of sodium trimetaphosphate, and A. Weisler used 5 grms. of sodium trimetaphosphate and 15 grms. of silver nitrate. The crystals are probably monoclinic. If an excess of the sodium salt is used, the crystals are much larger than if an excess of the silver salt is used, but they are then contaminated with up to about 0.3 per cent. of soda. The crystals do not lose weight when confined over sulphuric acid. The solid does not alter very much in daylight. The hydrated salt loses about half its combined water at 100°; the product absorbs over 3 per cent. of moisture from the atm., and this is not lost by re-heating the salt to 100°. When the hydrated salt is melted, the loss of water is attended by bubbling. C. G. Lindböm found that the clear glass ultimately obtained by fusion is easily soluble in nitric acid; 100 parts of cold water dissolve 1.67 parts of the salt. C. G. Lindböm found the aq. soln. changes when warmed. The salt is easily soluble in nitric acid, and crystallizes from soln. in conc. nitric acid.

Silver hexametaphosphate, $\text{Ag}_6\text{P}_6\text{O}_{18}$.—J. J. Berzelius made this salt by mixing silver nitrate with an aq. soln. of freshly ignited phosphoric acid in ice-cold water. The salt separates out in white gelatinous flakes. T. Graham obtained it by adding silver nitrate to a soln. of sodium hexametaphosphate—the filtrate was noticed by H. Rose to have an acid reaction. According to H. Lüder, it is best made by pouring a soln. of the sodium salt slowly and with constant stirring into a soln. of silver nitrate containing four times the calculated quantity of that salt. The mixture is rapidly washed with a small quantity of cold water, and dried on a porous tile. G. Tammann used a similar process. T. Fleitmann melted silver oxide with an excess of phosphoric acid so as to form a clear glass, and found shining crystalline scales of this same salt separate as the mixture cools.

The white powder prepared by J. J. Berzelius became soft and viscid at 100°; and at a rather higher temp., it fused to a transparent colourless liquid which on cooling formed a crystalline mass which shattered to fragments; cold water extracted part of the acid, and boiling water resolved it into an acid soln. and silver tetraphosphate, $6\text{Ag}_2\text{O} \cdot 4\text{P}_2\text{O}_5$ or $\text{Ag}_6\text{P}_4\text{O}_{13}$. T. Graham's product dissolved in aq. ammonia, in nitric acid, and in a large excess of a soln. of the sodium salt. When boiled with water it fuses to a grey viscid mass capable of being drawn out into threads. T. Fleitmann's crystals are insoluble in water, and when treated with sodium sulphide, they yield ordinary deliquescent sodium hexametaphosphate.

G. Tammann prepared crystals of **sodium pentasilver hexametaphosphate**, $\text{NaAg}_5(\text{PO}_3)_6$, and **disodium tetrasilver hexametaphosphate**, $\text{Na}_2\text{Ag}_4(\text{PO}_3)_6$, by the action of silver nitrate on sodium hexametaphosphate. He also obtained **dipotassium tetrasilver hexametaphosphate**, $\text{K}_2\text{Ag}_4(\text{PO}_3)_6$, in a similar manner. G. Tammann believed that he could prepare **silver decametaphosphate**, $\text{Ag}_{10}\text{P}_{10}\text{O}_{30} \cdot 8\text{H}_2\text{O}$, by the action of silver nitrate on T. Fleitmann's sparingly soluble sodium dimetaphosphate.

According to J. J. Berzelius, if freshly precipitated and moist silver hexametaphosphate is introduced into cold water which is gradually raised to the b.p., the salt melts into a grey viscid mass capable of being drawn out into threads. The hot water when poured out and evaporated, gives silver hexametaphosphate, and the solid can be washed with cold water. Some silver hexametaphosphate in the interior of the mass remains undecomposed. T. Fleitmann and W. Henneberg consider this salt to be **silver tetraphosphate**, $6\text{Ag}_2\text{O} \cdot 4\text{P}_2\text{O}_5$, or $\text{Ag}_6\text{P}_4\text{O}_{13}$, or *silver*

pyrometaphosphate, $\text{Ag}_4\text{P}_2\text{O}_7 \cdot \text{Ag}_2\text{P}_3\text{O}_6$, identical with that made by the action of silver nitrate on the sodium salt; if the latter be in excess, the precipitate will be contaminated therewith. The salt rapidly prepared and dried at 100° contains very little water. The salt is decomposed by the prolonged action of boiling water, and phosphoric is set free. Hence H. Uelsmann's analysis of the salt is rather high in silver oxide, owing to his preparations having been partially decomposed by washing. T. Fleitmann prepared what he regarded as **silver decaphosphate**, $6\text{Ag}_2\text{O} \cdot 5\text{P}_2\text{O}_5$, or $\text{Ag}_{12}\text{P}_{10}\text{O}_{31}$, by the action of silver nitrate on the corresponding sodium salt. The product is soluble in an excess of the last-named salt.

In normal silver metaphosphate, the ratio $\text{Ag}_2\text{O} : \text{P}_2\text{O}_5$ is 1 : 1. A. V. Kroll has reported a series of what he calls **silver ultraphosphates** with the ratio $\text{Ag}_2\text{O} : \text{P}_2\text{O}_5 = 1 : 2$ and 1 : 3. Silver triphosphate, $\text{Ag}_2\text{O} \cdot 3\text{P}_2\text{O}_5$, was obtained by the action of phosphorus pentoxide on silver at a high temp. when a yellow glass is formed which dissolves in water to a ruby-red soln., containing colloidal silver. If the glass is somewhat overheated, a silver ruby glass is obtained. This has not yet been found to occur with silicates or phosphates. The fused product is almost colourless, but yields the red colloidal soln. with water. The aq. soln. contains an acid silver metaphosphate. It yields a brown precipitate with sodium orthophosphate.

Hydrated silver diphosphate, $\text{Ag}_2\text{O} \cdot 2\text{P}_2\text{O}_5 \cdot \text{H}_2\text{O}$, was obtained by the action of an excess of metaphosphoric acid on $\text{Ag}_2\text{O} \cdot 3\text{P}_2\text{O}_5$.

REFERENCES.

- ¹ G. Wetzlar, *Schweigger's Journ.*, 53. 100, 1828; F. Stromeyer, *ib.*, 58. 126, 1830; J. F. H. Suersen, *Scherer's Journ.*, 8. 120, 1802; J. J. Berzelius, *Gilbert's Ann.*, 53. 393, 1816; 54. 31, 1816; *Pogg. Ann.*, 2. 163, 1824; *Ann. Chim. Phys.*, (2), 2. 151, 217, 329, 1816; (2), 10. 278, 1819; M. Berthelot, *ib.*, (7), 25. 164, 1902; E. Mitscherlich, *ib.*, (2), 19. 350, 1821; Y. Osaka, *Mem. Coll. Science, Kyoto*, 1. 188, 1905; T. Graham, *Phil. Trans.*, 123. 253, 1833; W. R. Lang and W. P. Kaufmann, *Journ. Amer. Chem. Soc.*, 27. 1515, 1906; G. P. Baxter and G. Jones, *ib.*, 32. 298, 1910; W. Ostwald, *Scientifical Foundations of Analytical Chemistry*, London, 204, 1900.
- ² A. Joly, *Compt. Rend.*, 103. 1071, 1886; A. Colson, *ib.*, 127. 961, 1898; A. Terreil, *ib.*, 98. 1279, 1884; *Bull. Soc. Chim.*, (2), 41. 597, 1884; J. B. Senderens, *ib.*, (3), 7. 511, 1892; W. Skey, *Chem. News*, 22. 61, 1870; H. Dufet, *Bull. Soc. Min.*, 9. 274, 1886; F. Stromeyer, *Schweigger's Journ.*, 58. 126, 1830; J. F. H. Suersen, *Scherer's Journ.*, 8. 120, 1802; J. J. Berzelius, *Ann. Chim. Phys.*, (2), 2. 151, 1816; G. P. Baxter and G. Jones, *Journ. Amer. Chem. Soc.*, 32. 298, 1910; T. Carnelley, *Journ. Chem. Soc.*, 33. 273, 1878; R. Böttger, *Zeit. phys. Chem.*, 46. 602, 1903; J. L. Lassaigne, *Journ. Pharm. Chim.*, (3), 16. 398, 1849; C. Paal and F. Voss, *Ber.*, 37. 3862, 1904; O. Widmann, *ib.*, 17. 2284, 1884; A. Reychler, *ib.*, 17. 1840, 1884; A. Lottermoser, *Journ. prakt. Chem.*, (2), 72. 39, 1905; E. C. Franklin and C. A. Kraus, *Amer. Chem. Journ.*, 20. 828, 1898; M. Hamers, *Verhalten der Halogen-verbindungen des Quecksilbers in reinem und in bei 18° mit Wasser gesättigte Äthylacetat*, Giessen, 1906; F. Bezold, *Das Verhalten chemischer Verbindungen in Methyacetat*, Giessen, 1906; L. Hurtzig and A. Geuther, *Liebigs Ann.*, 111. 160, 1859; A. Schwarzenberg, *ib.*, 65. 162, 1848; *Untersuchungen über die pyrophosphorsauren Salze*, Göttingen, 1847.
- ³ T. Clark, *Edin. Journ. Science*, 7. 298, 1827; F. Stromeyer, *Schweigger's Journ.*, 58. 126, 1830; A. Joly, *Compt. Rend.*, 103. 1071, 1886; J. Cavalier, *ib.*, 139. 284, 1904; A. Schwarzenberg, *Untersuchungen über die pyrophosphorsauren Salze*, Göttingen, 1847; *Liebigs Ann.*, 65. 162, 1848; L. Hurtzig and A. Geuther, *ib.*, 111. 159, 1859; T. Carnelley, *Ber.*, 17. 1357, 1884; A. Weisler, *Zeit. anorg. Chem.*, 28. 177, 1901; O. Mügge, *Centr. Min.*, 636, 1909; M. Stange, *Ueber einige Metallverbindungen der Triphosphorsäure*, Rostock, 1896.
- ⁴ T. Fleitmann, *Pogg. Ann.*, 78. 253, 359, 1849; T. Fleitmann and W. Henneberg, *Liebigs Ann.*, 65. 304, 1848; H. Uelsmann, *ib.*, 118. 101, 1861; T. Graham, *Phil. Trans.*, 123. 253, 1833; H. Lüder, *Zeit. anorg. Chem.*, 5. 15, 1893; A. Weisler, *ib.*, 28. 177, 1901; *Beiträge zur Kenntniss der Metaphosphate*, Berlin, 1901; G. Tammann, *Journ. prakt. Chem.*, (2), 45. 417, 1892; *Zeit. phys. Chem.*, 6. 122, 1892; J. J. Berzelius, *Gilbert's Ann.*, 53. 393, 1816; 54. 31, 1816; *Ann. Chim. Phys.*, (2), 2. 151, 217, 329, 1816; (2), 10. 278, 1819; *Pogg. Ann.*, 19. 331, 1830; H. Rose, *Traité complet de chimie analytique*, Paris, 1. 534, 1859; F. Warschauer, *Beiträge zur Kenntniss der Metaphosphate*, Berlin, 1903; J. Müller, *Beiträge zur Kenntniss der Metaphosphate*, Berlin, 1906; K. Langheld, *Chem. Ztg.*, 35. 1099, 1911; *Ber.*, 44. 2076, 1911; K. Langheld, F. Oppmann, and E. Meyer, *ib.*, 45. 3760, 1912; C. G. Lindböm, *Acta Lund.*, 10. 7, 1844; A. V. Kroll, *Ueber Ultraphosphate*, Berlin, 1912; *Zeit. anorg. Chem.*, 76. 408, 1912.

CHAPTER XXIII

GOLD

§ 1. The Occurrences and Distribution of Gold

Gold occurs in the bowels of the earth native, possessing a complete metallic form although in general the small particles of it are so interspersed with various matrices that they are entirely invisible.—T. BERGMAN (1780).

GOLD is rather widely distributed in nature, generally in quantities too small to be profitably extracted. Deep sea water from the Atlantic Ocean has 0·015 to 0·267 part of gold per million of liquid; water from the Christiania Fjord, Norway, 0·005 to 0·006; from the coast of New South Wales, 0·032 to 0·065; and from the coast of New Zealand, 0·005 part of metal per million parts of liquid.¹ According to L. Wagoner, granites from California and Nevada had about 0·37 part of gold per million; sandstone, 0·03; and limestones, 0·007 part per million. Gold also occurs in small quantities in clays, coal, rock salt, pyrites, and in almost all silver, copper, bismuth, lead, tellurium, zinc, and antimony ores.² Gravels which need not be crushed can sometimes be profitably treated for gold—alluvial gold—if but 2 to 3 grains per ton be present, that is, about one part of gold per million parts of worthless material. The mean of the returns for the Rand is something less than half an ounce of gold per ton of material treated. The gold and silver in copper and lead ores can usually be profitably extracted, indeed, a comparatively large proportion of the world's output of gold is obtained as a kind of by-product from lead and copper ores.

Gold is found native in irregular masses, sometimes of microscopic size, in crystals, in veins of quartz or quartzite in rocks—**reef gold**—in metalliferous veins along with metal sulphides—chiefly iron pyrites; and in alluvial gravels and sands as **alluvial or placer gold**. The alluvial drifts represent the *débris* from the weathering of auriferous rocks which has been washed into river beds, etc. Large nuggets are occasionally found—one in California weighed over 190 lbs., and one in Victoria, 183 lbs. The presence of large well-formed crystals of gold with unworn edges, sometimes found in alluvial drifts, is quoted in support of the hypothesis that gold can grow *in situ* in these deposits—presumably carried in soln. by percolating waters. As N. Lemery³ expressed it in 1675: “Seeing that gold as well as silver is drawn from mines surrounded with waters, it is very probable that these waters bring along with them some saline principles that congeal and mix with earths of a particular composition.” The largest and most perfect crystals have been found in alluvial deposits; and the finest specimens hitherto recorded are from the gravels of Victoria. *Filiform gold*, gold filaments or *wire gold*, and other dendritic forms represent incipient stages of crystallization. The gold disseminated in quartz rocks is also supposed to have been introduced by percolating soln. along with silica, for gold is soluble in alkali silicate soln.;⁴ in alkali sulphides,⁵ and possibly also in alkali tellurides.⁶ J. R. Don showed that in the rocks in the neighbourhood of Ballarat, the gold occurs in the vicinity of pyrites; where the sulphide is abundant, gold is abundant, and where a small quantity of pyrites is present, there is a paucity of gold.⁷ Gold is also soluble in ferric chloride soln. and in waters containing free chlorine.⁸

There is rather an extensive literature on the geographical distribution of gold.⁹ Fig. 1 gives a general idea of the leading gold fields.

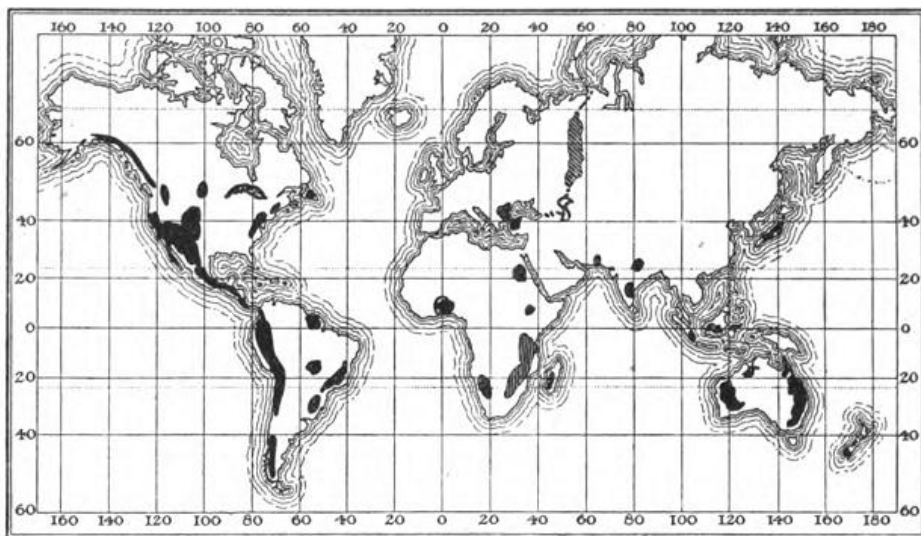

FIG. 1.—The General Distribution of the Auriferous Provinces.

In Europe, the principal gold mines are along the inner arc of the Carpathian Mountains in Hungary, and Transylvania. Gold mining at Schemnitz has been traced back to the pre-Christian era. The gold at Bosnia was also mined by the Romans. Most of the gold extracted in Germany is derived from metallic ores—galena, pyrites, zinc blende, etc. Gold has been obtained in Bavaria, Thuringia, and Silesia. Most of the Rhine workable gold was exhausted long ago. Gold has been worked in the British Isles on a small scale from the time of the Romans, and probably earlier, since gold ornaments were worn by the ancient Britons. Small quantities were once obtained in Cornwall, Devon, North Wales, Lanarkshire (Lead hills), Sutherland, Perthshire, and Wicklow in Ireland. The Phœnicians and the Romans obtained gold from Spain, but the supply seems now to be almost exhausted. In Pliny's time, the gold mines of Austria were considered to be the richest in the world. In France, the streams in the departments of Ariège, Garonne, Tarn, Hérault, Ardennes, and Meurthe-et-Moselle have gold-bearing sands, but they are not of much importance. Pliny mentions the gold mines of Northern Piedmont in Italy, and these mines are also mentioned by Strabo. Most of the tributaries of the Po have auriferous sands, and there are also auriferous veins on the Western Alps. Norway, Sweden, Finland, the Ural Mountains of Russia, and the streams of the Caucasus—the land of the golden fleece of the Argonaut expedition—have some auriferous deposits. In Asia gold is obtained from Siberia—east and west. There are gold fields in Borneo, Sumatra, and several of the East Indian Islands; in New Guinea, the Philippines, and the Malay peninsula. Gold is also obtained from China, Corea, Japan, Colar (Mysore), and the presidencies of Madras and Bombay. Gold is widely distributed in Africa—Egypt, Soudan, Abyssinia, the Gold Coast, Madagascar, and Rhodesia. The discovery of the auriferous conglomerates in the De Kaap district of the Transvaal in 1884, has converted that district into one of the most important of the gold-producing countries. The United States, America, is one of the world's largest producers of gold. Marshall's discovery of gold at Coloma (Cal.) on January 19, 1848, started the rush of gold-seekers to the Pacific coast of America, and numerous deposits were discovered in various American States shortly afterwards. Quartz mining commenced in the States about 1850. The most important gold fields are in Colorado, California, Alaska, South Dakota, Montana, Arizona, Utah, Nevada, Idaho, Oregon, Washington, New Mexico, and some of the smaller amounts from a number of other States. The more important Canadian gold fields are in Klondyke (Yukon), British Columbia, Nova Scotia, and Ontario. Gold is also found in Mexico, various smaller States of Central America, Brazil, Chili, Peru, Bolivia, etc. Gold is found in all the colonies of Australasia. Kalgoorlie (Western Australia) is perhaps the most prolific, and there are mines at Kimberley, Pilbarra, Murchison, Coolgardie, etc., in Western Australia; at Teetulpa, Mount Pleasant, etc., in South Australia; Mount Morgan, Charters Towers, Gympie, Croeyden, etc., in Queensland; Clarence, Richmond, Bathurst, Albert, Mudgee, etc., in New South Wales; Bendigo, Ballarat, Castlemaine, Maryborough, Ararat, Gippsland,

etc., in Victoria; Beaconsfield, Waterhouse, etc., in Tasmania; Otaga, Westland, Nelson, and Auckland, in New Zealand. Count Strzelecki¹⁰ is said to have discovered gold in New South Wales in 1839, but the discovery was kept secret in deference to the wishes of the Governor of the then penal colony. It is possible that a surveyor named O'Brien discovered the metal sixteen years earlier, but there are doubts as to whether or not O'Brien's samples were mica or pyrites, and not gold. The gold was rediscovered in the colony by W. Clark in 1841, and the value of the deposits was not realized until again discovered by E. H. Hargreaves in 1851. The Thames gold field in Auckland was discovered in 1867.

The world's production of gold¹¹ in troy ozs. has been estimated as :

1493-1520	1601-1620	1710-1720	1801-1810	1876-1886	1896-1906
186,470	263,918	422,163	560,572	5,364,685	5,135,673

The values for 1918 were :

	Troy oza.		Troy oza.
Austria-Hungary	8,700	Brazil	135,400
France	129	Colombia	235,410
Italy	1,100	Ecuador	38,700
Russian countries	830,000	Peru	57,645
Sweden	482	Uruguay	484
Belgian Congo	123,649	Venezuela	22,890
French W. Africa	2,000	Dutch Guiana	15,590
Madagascar	22,000	French Guiana	45,781
Portuguese E. Africa	5,592	China	174,000
Central America	164,500	Japan	431,806
Mexico	813,799	Dutch East Indies	95,518
United States and Colonies	3,320,784	Australasia	10,000,000
Argentina	194	South Africa	1,053,200
Chile	38,449		

On the whole, the world's output is still increasing, although only a small advance has been made in recent years. The expansion is attributed to the increased attention to the gold-mining industry. The output of the principal gold-producing countries in 1920 were: South Africa, about 47 per cent. of the world's supply; the United States, 16·5 per cent.; Australasia, 8 per cent.; and Russia, 2 per cent. The price of gold is roughly inversely equivalent to the measure of the adverse exchange against that country; and the price of gold fluctuates accordingly. Some European countries accumulated large debts in the United States while the severest stages of the Great War were being fought, and large stocks of gold were accordingly transferred to the United States from those countries. As a result it is estimated that the United States holds about 35 per cent. of the world's total. A curious feature occurred in 1920 when the Soviet Government of Russia made earnest but largely ineffectual attempts to dispose of the so-called *Soviet gold* which had formerly figured in the reserves of the Russian State. "Accustomed as the London market has always been to deal in gold by the ounce, the offer of gold in terms of a dozen tons at a time was regarded as a quaint innovation."

Native gold nearly always contains silver. Gold from Schnabrowsky has 0·16 per cent. of silver, and a sample from Siranowsk, 38·38 per cent.,¹² and there are numerous intermediate proportions in samples from different parts of the world. According to H. van Furman, a sample from Cripple Creek (Colorado) contained 99·9 per cent. of gold, and represents the purest native gold which has been found. Gold from the Californian placer deposits assayed 88·4 per cent. of gold; Australian gold averages 95·0 per cent.; Japanese placer gold, 62·0 to 90·4 per cent.; and Japanese vein gold, 56·6 to 92·6 per cent. gold. Native gold also contains a little copper, and occasionally iron. Palladium has been found in Brazilian gold; rhodium in Mexican gold; and bismuth in Victorian gold. Although some of the native binary alloys of gold with other metals have been stated as if they were real chemical compounds, their chemical individuality is not accepted on the results of chemical analysis alone. Pliny's *electrum*, named from *ἤλεκτρον*, which in Homer's time was the term used for amber, was a native alloy of gold and silver

of the same yellow colour as amber, and which contained one-fifth of its weight of silver—*ubicunque quinta argenti portio est, electrum vocatur*. The term is now sometimes used for the alloys with other proportions of silver and which range in colour from white to pale yellow. The sp. gr. ranges from 12·5 to 15·5 according to the proportion of silver. Mol. proportions of the two elements are sometimes present, and J. B. J. D. Boussingault¹³ thought these proportions corresponded with 2, 3, 5, 6, 8, and 12 gram-atoms of gold per gram-atom of silver, but G. Rose said that *eine Verbindung von Gold und Silber nach bestimmten Proportionen gar nicht zu denken sei*, otherwise expressed, there is nothing to justify the assumption that a chemical compound is formed. The two elements form a series of isomorphous mixtures.

An alloy of bismuth and gold containing from 34 to 35·5 per cent. of bismuth was discovered by G. H. F. Uhlrich,¹⁴ and called maldonite from Maldon (Victoria), where it was found. C. U. Shepard also reported what he called bismuthaurite, in some palladium grains of North Carolina; the sp. gr. is stated to be 12·44 to 12·90. Some consider that a mistake has been made and that the alleged bismuthaurite is an artificial product. Similar remarks apply to the rhodite of M. Adam,¹⁵ which is supposed to be a rhodium-gold alloy described by A. del Rio in 1825 as *un alliage d'or* obtained from the mint at Apartado (Mexico). A native alloy of palladium and gold containing 5 to 10 per cent. of the latter metal has been named propezeite. There is nothing to show that a compound Au_2Pd is formed as was once supposed, for the two metals form a continuous series of mixed crystals. A sample of the mineral from Taguaril (Brazil) had 8·21 per cent. of palladium. Specimens have been obtained from Minas Geraes province (Brazil) and in the Caucasus near Batoum.¹⁶ Gold amalgam is an alloy of gold with varying amounts of mercury; a sample from Mariposa (California) contained 61 per cent. of mercury, and one from Columbia, 57·4 per cent.¹⁷ Some amalgams are of secondary origin, and are thought to be derived from the mercury lost by the old miners. The so-called gold tellurides form a group of minerals the first specimen of which—from Zalathna (Transylvania)—was described by M. H. Klaproth¹⁸ in 1802, and many varieties from other localities have been described. The tellurium deposits at Cripple Creek (Colorado), and at Kalgoorlie (Western Australia) are the most important from an economic point of view. The telluride ores seem to have been deposited from aq. soln. in zones or belts. The mineral calaverite from Calaveras County (Cal.) was described by F. A. Genth¹⁹ in 1868; and large deposits occur at Cripple Creek and Kalgoorlie. Analysts have reported from 57·3 to 60·3 per cent. of tellurium, 33·9 to 42·0 per cent. of gold, and up to 5 per cent. of silver, with smaller amounts of copper, zinc, iron, nickel, lead, sulphur, and selenium. Calaverite is supposed to be a compound with the formula $AuTe_2$, and the supposition is probably correct. Calaverite has a pale bronze colour. A related telluride with silver as well as gold contains from 59·7 to 62·0 per cent. of tellurium, 26·1 to 28·6 per cent. of gold, and 9·7 to 13·9 per cent. of silver, with smaller quantities of copper, lead, iron, nickel, antimony, selenium, and sulphur. This mineral has been represented by the formula $AuTe_2 \cdot AgTe_2$, or $AuAgTe_4$, and called sylvanite, or *graphic tellurium*,²⁰ because the crystals are sometimes arranged in a manner which recalls written characters. Sylvanite occurs in monoclinic crystals varying from a steel-grey to a silver-white or brass-yellow. Another variety called müllerine has crystals varying from a brass-yellow to white in colour, and it contains larger proportions of antimony and lead than sylvanite proper.²¹ Krennerite is similar to sylvanite,²² but crystallizes in the rhombic system. When massive, the two forms are said to be indistinguishable. Another telluride of silver and gold, called petzite, does not occur in crystals. Its colour is steel or iron-grey. Its composition corresponds approximately with Ag_3AuTe_3 . A silver telluride called hessite, Ag_2Te , crystallizes in the cubic system, and it may contain up to 25·5 per cent. of gold. Kalgoorlie and coolgardite are different names for a variety found at Kalgoorlie. The mineral is almost black in colour, and it may contain 4 to 10 per cent. of mercury. It has been regarded as a mixture of coloradoite (mercury telluride, $HgTe$) and petzite—may be with calaverite and sylvanite as well.²³ Nagyagite is a telluride of lead and gold with more or less sulphides. Samples have been reported with from 17·5 to 30·5 per cent. of tellurium, 8·0 to 12·3 per cent. of sulphur, 3·8 to 7·5 per cent. of antimony, 50·3 to 60·3 per cent. of lead, and 5·9 to 9·6 per cent. of gold with smaller quantities of silver, copper, selenium, and iron. It crystallizes in the rhombic system. It has been called *foliated tellurium* because it also occurs foliated like graphite. The so-called nobilité and Phyllinglanz are varieties. There are no definite gold sulphide, selenide, chloride, or silicate minerals, although many gold minerals contain sulphur, selenium, and chlorino.

REFERENCES.

- ¹ E. Sonstadt, *Chem. News*, 25, 196, 231, 1872; A. Liversidge, *ib.*, 74, 146, 160, 166, 1897; C. A. Münster, *Norsk Tek. Tids.*, 10, 1, 1892; L. Wagoner, *Trans. Amer. Inst. Min. Eng.*, 31.

806, 1901; 33. 704, 1907; A. Weisler, *Zeit. angew. Chem.*, 18. 1795, 1906; H. Koch, *Koll. Zeit.*, 22. 1, 1918.

² J. R. Eckfeldt and W. E. Dubois, *Rép. Chim. Appl.*, 3. 447, 1861; J. Percy and R. Smith, *Phil. Mag.*, (4), 7. 126, 1854; R. W. Stone, *Bull. U.S. Geol. Sur.*, 499. 63, 1912; F. W. Clarke, *ib.*, 616. 642, 1916; A. Liversidge, *Journ. Chem. Soc.*, 71. 298, 1897; F. Laur, *Compt. Rend.*, 142. 1409, 1906; G. P. Merrill, *Amer. Journ. Science*, (4), 1. 309, 1896; W. Möricke, *Tschermak's Mitt.*, (2), 12. 195, 1891; O. Schiebe, *Zeit. deut. geol. Ges.*, 40. 611, 1888.

³ N. Lemery, *Cours de chimie*, Paris, 1675; London, 56, 1685.

⁴ C. Doelter, *Tschermak's Mitt.*, 11. 329, 1896; G. Bischof, *Lehrbuch der chemischen und physikalischen Geologie*, Bonn, 3. 843, 1871; A. Liversidge, *Proc. Roy. Soc. New South Wales*, 27. 303, 1893.

⁵ W. Skey, *Trans. New Zealand Inst.*, 3. 216, 1870; 5. 382, 1872; T. Egleston, *Trans. Amer. Inst. Min. Eng.*, 9. 639, 1881; G. F. Becker, *Amer. Journ. Science*, (3), 33. 307, 1887; A. Liversidge, *Proc. Roy. Soc. New South Wales*, 27. 303, 1893.

⁶ V. Lenher and R. D. Hall, *Journ. Amer. Chem. Soc.*, 24. 918, 1902.

⁷ J. R. Don, *Trans. Amer. Inst. Min. Eng.*, 27. 564, 1897; L. Wagoner, *ib.*, 31. 808, 1901; J. Posephny, *ib.*, 23. 205, 1893; W. H. Weed, *ib.*, 33. 715, 1903; J. E. Spurr, *ib.*, 33. 288, 1903; J. F. Kemp, *ib.*, 31. 169, 1901; 33. 599, 1903; W. Lindgren, *ib.*, 30. 578, 1900; H. N. Stokes, *Econ. Geol.*, 1. 650, 1906.

⁸ T. Egleston, *Trans. Amer. Inst. Min. Eng.*, 8. 451, 1880; J. R. Don, *ib.*, 27. 564, 1897; R. Pearce, *ib.*, 23. 739, 1893; T. A. Rickard, *ib.*, 26. 978, 1896.

⁹ J. M. Maclaren, *Gold: its Geological Occurrence, and Geographical Distribution*, London, 1908; J. H. Curle, *The Gold Mines of the World*, London 1899; C. Hintze, *Handbuch der Mineralogie*, Leipzig, 1. i, 244, 1904; E. Cumenge and M. Robellaz, *L'Or dans la Nature*, Paris, 1898; G. P. Proust, *L'Or—prospection, gisement, extraction*, Paris, 1919.

¹⁰ W. R. Ingalls, *Mineral Ind.*, 1. 225, 1892; J. M. Maclaren, *Gold: its Geological Occurrence and Geographical Distribution*, London, 349, 1908.

¹¹ M. W. von Bernewitz, *Mineral Ind.*, 29. 241, 1921; Bull. Imp. Mineral Resources Bureau, *Gold*, London, 1922.

¹² G. Rose, *Pogg. Ann.*, 23. 117, 1862; H. van Furman, *Colliery Manager*, 89, 1896.

¹³ J. B. J. D. Boussingault, *Ann. Chim. Phys.*, (2), 34. 408, 1827; A. Levot, *ib.*, (3), 27. 310, 1849; G. Rose, *Pogg. Ann.*, 23. 164, 1831.

¹⁴ G. H. F. Ulrich, *Contributions to the Mineralogy of Victoria*, Melbourne, 4, 1840; R. W. E. McIvor, *Chem. News*, 55. 191, 1887; C. U. Shepard, *Amer. Journ. Science*, (2), 4. 280, 1849; (2), 24. 112, 281, 1857.

¹⁵ M. Adam, *Tableau minéralogique*, Paris, 1869; *Ann. Mines*, 15. 405, 1869; A. del Rio, *Ann. Chim. Phys.*, (2), 29. 137, 1825; *Ann. Mines*, 12. 323, 1826.

¹⁶ W. Haidinger, *Handbuch der bestimmenden Mineralogie*, Wien, 558, 1845; W. H. Seamon, *Chem. News*, 46. 216, 1882; T. Wilm, *Zeit. anorg. Chem.*, 4. 300, 1893; J. C. Cloud, *Gilbert's Ann.*, 36. 310, 1810; J. J. Berzelius, *Journ. prakt. Chem.*, (1), 11. 309, 1837.

¹⁷ G. H. F. Ulrich, *Contributions to the Mineralogy of Victoria*, Melbourne, 82, 1866; *Berg. Hütt. Ztg.*, 18. 221, 1859; F. L. Sonneschein, *Zeit. deut. geol. Ges.*, 6. 243, 1848; R. Schneider, *Journ. prakt. Chem.*, (1), 43. 317, 1848.

¹⁸ M. H. Klaproth, *Beiträge zur chemischen Kenntniss der Mineralkörper*, Berlin, 3. 20, 1802; T. A. Richard, *Trans. Amer. Inst. Min. Eng.*, 30. 713, 1900; F. B. Allen, *Trans. Australian Inst. Min. Eng.*, 7. 95, 1901; B. Brauner, *Journ. Chem. Soc.*, 55. 391, 1889; V. Lenher, *Journ. Amer. Chem. Soc.*, 24. 358, 1902; R. D. Hall and V. Lenher, *ib.*, 24. 919, 1902; T. K. Rose, *Trans. Inst. Min. Met.*, 17. 285, 1908; G. Pellini and E. Quercigh, *Rend. Accad. Lincci*, (5), 19. 445, 1910.

¹⁹ F. A. Genth, *Amer. Journ. Science*, (2), 45. 314, 1868; L. J. Spencer, *Min. Mag.*, 13. 270, 1903.

²⁰ F. C. Smith, *Journ. prakt. Chem.*, (2), 6. 67, 1898.

²¹ W. H. Hobbs, *Amer. Journ. Science*, (4), 7. 357, 1899; C. Palache, *ib.*, (4), 10. 426, 1900.

²² G. vom Rath, *Zeit. Kryst.*, 1. 614, 1877; H. A. Miers, *Min. Mag.*, 9. 184, 1890; L. J. Spencer, *ib.*, 13. 262, 1902.

²³ E. F. Pittmann, *Records Geol. Sur. New South Wales*, 5. 203, 1898; A. Carnot, *Compt. Rend.*, 132. 1298, 1901; T. A. Richards, *Trans. Amer. Inst. Min. Eng.*, 30. 715, 1900; L. J. Spencer, *Min. Mag.*, 13. 283, 1903.

§ 2. The Mining and Extraction of Gold—Amalgamation Process

The amount of gold in a ton of ore is usually so small that even if the ore be conc. by washing, there is a loss of the finer particles of gold, and it is generally quite impracticable to smelt the ore so as to collect the precious metal in lead or copper, and afterwards remove the base metal by cupellation or some other process. The cost in fuel and fluxes is usually too great.¹ When gold occurs scattered as grains

or nuggets in alluvial sand or gravel, hand picking, dry-blowing, winnowing, or simple sifting may suffice to separate much of the precious metal. The melting of the collected fragments together is a comparatively simple operation. The sand may also be washed over smooth sloping rocks by running water, when the particles of gold have a tendency to sink to the bottom of the stream owing to their high density. The rock carvings of Upper Egypt give several pictorial representations of the art of washing auriferous sands by stirring them up with water in hollow stone basins, followed by the melting of the gold in simple furnaces heated by mouth blowpipes, as shown in Fig. 4, Cap. I. The oldest of these carvings dates back about 2500 B.C.² In his *Geographia* (3. 2), written near the beginning of the Christian era, the old historian Strabo says that the ancients washed gold from the hills by torrents of water, and the gold was caught and entangled in the hair on the skins of animals spread on the rocks over which the water flowed. In some of the primitive mines even to-day, a similar plan is employed, although woollen blankets or pieces of plush are generally preferred. The legend of the quest of the golden fleece, by the Argonauts under Jason, is considered to describe a piratical expedition to Armenia to steal the gold obtained by the natives from streams of water by the aid of sheepskins.

The so-called **placer deposits** comprise sands, gravels, and earthy beds containing gold. The shallow or recent deposits are usually near river-beds, and have not been covered by much *débris*, while the deep-seated or ancient placer beds were formed by rivers which have since been deflected into other channels by more or less extensive changes in the physical geography of the district, and they are usually covered by more or less compact *débris*. In **panning** or **pan washing**, the auriferous sand or gravel is agitated with water in pans, troughs, or *cradles* of various forms, and the rocky matters are floated off, while the free particles of gold remain on the bottoms of the cradle or pan as gold-dust. The primitive methods of extracting gold by individual workers, more or less on the principle of hit or miss, are successful in dealing with comparatively rich beds, and with them, gold-mining is more or less a gambler's lottery. To-day, with large companies, gold-mining is a carefully organized industry with approximately the same output from day to day.

In the simplest form of **placer mining**, the sand or gravel is shovelled into a *sluice*, Fig. 2, that is, in long a flume or trough with transverse cleets, riffles, or obstructions along the bottom, and through which a stream of water flows. The water sweeps along the sand, and the heavier gold collects in the crevices on the bottoms of the sluice.³ Dredging is also used to convey auriferous sands, etc., on river bottoms into the sluices. In **hydraulic mining**, water under high press. is directed against the earth containing the gold. The water is conveyed from a reservoir in the hills across the country, by means of flumes or aqueducts, to a large wooden tank near the placer deposit. The tank is provided with valves and thick iron pipes which lead to a cast-iron chamber, with valved apertures at the sides to which a number of flexible hose-pipes can be attached by means of union joints. The opposite end of a hose-pipe terminates in a bronze nozzle which enables a powerful jet of water to be directed against the bank of auriferous earth and gravel. As a result the bank is rapidly disintegrated and washed into sluices. Some idea of the method will be obtained from the sketch, Fig. 3. The head of water is sometimes up to 500 ft., and the nozzles are sometimes up to 11 ins. in diameter. The sluices with both placer or hydraulic mining may have wooden or stone riffles or obstructions of various kinds charged with mercury which amalgamates with the gold. Blankets or pieces of plush may be spread in the sluices to catch the lighter spangles of the precious metal. When a *clean-up* is desired, the riffles are taken out, and clean water is run along the sluices. The mercury amalgam is washed down to some convenient spot, and ladled into bags of canvas or leather. The amalgam in the bags is squeezed so that the excess of mercury, as Pliny expressed it about 77 A.D.—*per quas sudoris vice defluit*—exudes through the bags as a kind of perspiration. The pasty amalgam containing about one-third of its weight of gold is

heated in suitable retorts. The mercury distils over, and the gold remains behind. This is then fused and cast into ingots to be subsequently refined.⁴



FIG. 2.—Simple Form of Placer Mining.

It will be observed that the process of separating the gold from sands is dependent upon two principles—(i) the greater density of the precious metal; and (ii) the attraction which mercury has for gold, which, as Pliny said about 77 A.D., enables the mercury to attract the gold to itself, and to reject the associated impurities. The gold is miscible with mercury in all proportions, and the small particles of the liquid amalgam in the sluices coalesce into larger globules which collect in the inequalities in the bottom of the sluices.

When the richest of the placer deposits have been worked out in a country, attention is naturally directed to the extraction of gold from quartz rocks. In *vein or reef mining*, the auriferous quartz is mined by blasting. Holes are bored in the *face* of quartz up to the depth of four feet, into which sticks of gelignite or other explosives are placed and fired. The quartz is thus loosened and conveyed to the batteries where the conveyor trucks are tipped into a series of *crushers*, the quartz is broken into fragments about the size of a hen's egg. An endless belt carries the quartz which drops from the crushers to the stamps. Each stamp is a block of steel weighing say 1200 lbs., worked up and down by two-toothed cogs. About 300 stamps will pulverize 500 tons of quartz per day. The powder from the *stamper mill* is screened through a 40-mesh sieve; agitated with water; and elevated to a series of conduits, where it is conveyed to the so-called *tube or ball mills*—that is, in revolving cylinders lined with quartz, and containing lumps



FIG. 3.—The Hydraulic Mining of Placer Gold.

of quartz, flint pebbles, or steel balls—where it is ground still finer. The powder is floated with water as *pulp* in a thin stream, about a quarter of an inch deep, over slightly inclined plates amalgamated with mercury, and kept in a gentle pulsating motion—*amalgam tables*. The fine particles of gold amalgamate with the mercury. After some time, the plates are scraped, the excess of mercury squeezed from the scrapings, and the gold is separated from the mercury by distillation, as indicated above. Instead of the amalgam table, a *pulsator table* about 10×4 ft. is covered with linoleum, and rills, or narrow strips of wood, are tacked length-wise. The table is set on rollers arranged so that it can be set at any angle, and given a gentle sea-saw motion. The supply pipe sends a stream of water and pulp over the top of the table, and the heavy gold is caught by the rills. The pulp with which a little lime is mixed to facilitate the sedimentation of the gold—is washed over the upper edge of the table. The “muddy” water still containing recoverable gold is run along conduits or *flumes* to the settling tanks. The “free gold” from the rills is conveyed to the concentrate tube mills and ground still finer, whence it is transported to the cyanide tanks. The auriferous mud from the roller tables, after settling, is freed from the excess of water and also conveyed to the cyanide tanks.

Diodorus (*vide supra*) described the Egyptian process for mining quartz for gold. The rock was crushed to a coarse powder, and finely ground in hand mills. The further treatment of the ore resembled the process employed for washing auriferous sand. It is thought that P. Grommesterrer⁵ first used the stamp mill in 1519, and in his *De re metallica* (Basel, 1556), G. Agricola described the treatment of auriferous quartz in Germany, and it is virtually the very process which is employed in Transylvania and Tyrol at the present day. A considerable number of improvements in the mechanical preparation of auriferous quartz have been introduced since Agricola's time. The amalgamated copper plates were used in California in 1856, although the actual date of their introduction is unknown.⁶ The process was probably suggested as a result of experience derived from the working of the Cazo process for the extraction of the precious metals. It was noticed, even as early as 1786,⁷ that the thickness of the layer of amalgam on the inside of the copper kettle daily increases by slow and gradual apposition, and ultimately becomes so thick that the crust often falls off by its own weight.

J. A. Edman counted over 300 particles of gold, varying from $\frac{1}{1000}$ th to $\frac{1}{12000}$ th of an inch in size, by the examination of a piece of auriferous quartz $\frac{1}{50}$ th of an inch in size, and magnified about 50 diameters. A still greater number of particles of gold were counted under a higher magnification. The gold in this extremely fine state of subdivision is apt to float away with the tailings and escape the amalgamated copper plates, particularly when the gold is intimately associated with metal sulphides which prevent the particles amalgamating with the mercury; the mercury is also apt to *flour* or *sicken* by contact with the sulphides of arsenic, antimony, copper, zinc, lead, and bismuth, and it then fails to adhere to the amalgamation plates. Indeed, many ores are not worked by the amalgamation process because so little gold is recovered from the ores, and this even with comparatively rich ores. Ores which yield up their gold to the amalgamation process are called *free milling ores*; and those in which gold does not amalgamate with the mercury are called *refractory ores*. Even with free milling ores, the tailings from the amalgamation process usually contain one-third, often one-half, their total gold content. Tailings from the amalgamation process, and refractory ores, can usually be profitably treated by the chlorination or cyanide process.

REFERENCES.

- ¹ M. Eissler, *The Metallurgy of Gold*, London, 1900; T. K. Rose, *The Metallurgy of Gold*, London, 1916; J. Percy, *The Metallurgy of Gold and Silver*, London, 1880; C. C. Longridge, *Hydraulic Mining*, London, 1903; *Gold Dredging*, London, 1905; T. A. Rickard, *The Stamp Milling of Gold Ores*, New York, 1901; C. G. W. Lock, *Gold Milling: Principles and Practice*,

London, 1901; W. R. Crane, *Gold and Silver*, New York, 1908; B. Paulin, *Chem. Ztg.*, 45, 285, 1921.

² G. Wilkinson, *The Manners and Customs of the Ancient Egyptians*, London, 2, 137, 1874.

³ L. Simonin, *L'or et l'argent*, Paris, 1880. I am indebted to Librairie Hachette for the loan of Fig. 2.

⁴ J. Beckmann, *Beiträge zur Geschichte der Erfindungen*, Leipzig, 1780-1805; H. C. and L. H. Hoover's edition of G. Agricola's *De re metallica*, London, 279, 1912.

⁵ H. C. and L. H. Hoover's edition of G. Agricola's *De re metallica*, London, 281, 1912.

⁶ G. H. Clevenger, *Met. Chem. Eng.*, 14, 203, 1916.

⁷ I. de Born, *Amalgamation des minerais d'or et d'argent*, Vienna, 1786.

§ 3. The Chlorination and Cyanide Processes for the Extraction of Gold

Chlorine, or rather chlorine water slowly, attacks gold, and in 1848, J. Percy¹ attempted to apply this agent for the extraction of gold from its ores, and simultaneously, C. F. Plattner proposed the method for treating the residues obtained after the ore at Reichenstein had been treated for arsenic. A. Duflos investigated Plattner's proposal, and he obtained the same experimental results by allowing chlorine water to percolate through the ore in a stationary vat, and by the agitation of the ore with chlorine water in a barrel. V. von Lange followed up the work and found that better results could be obtained by acting on the moist ore with chlorine gas than by leaching it with chlorine water. Chlorine has a vigorous action on sulphides, and to avoid the great waste of gas which would be involved by the presence of sulphides in the ore, the ore is first roasted.

The chlorination process is applied on a large scale in one of three different ways: (1) The moist ore is treated with chlorine gas in closed vats for a couple of days. The actual solvent is a sat. soln. of chlorine water. The soluble salts are washed away from the ore by water, the tailings are rejected, and the gold is precipitated from soln. by ferrous sulphide, hydrogen sulphide, or other suitable agent. The particles of precious metal are allowed to settle, and then dried and melted down. (2) In order to prevent local action and to ensure that every particle of the ore is exposed equally to the action of chlorine, a revolving barrel containing a super-saturated soln. of chlorine in water is used in place of the stationary vat. The gas is kept in soln. by keeping the press. inside the barrel a few pounds per sq. in.² (3) W. Munktell leached the roasted ore with hot dil. hydrochloric or sulphuric acid to remove iron and copper, and then treated the residue in a vat with a 0.6 to 0.7 per cent. soln. of chloride of lime mixed with an equal volume of dil. sulphuric or hydrochloric acid (sp. gr. 1.002-1.003). A. Étard³ recommended treating the ore with a soln. containing about 45 lbs. of commercial hydrochloric acid and 12 ozs. of potassium permanganate. In H. R. Cassel's process a soln. of common salt is electrolyzed, and the chlorine which is generated attacks the gold in the ore. The soln. of gold chloride so obtained is simultaneously decomposed, and the metal is deposited on the cathode.

Bromine has been recommended in place of chlorine. It is claimed that bromine acts more rapidly on gold; gives a higher percentage extraction with a less proportion of base metals; and is more readily handled.⁴ Both the bromination and chlorination processes fail to deal with the silver of gold-silver ores, and attempts to extract, say, the silver chloride by subsequently leaching the tailing from the chlorine process with sodium hyposulphate soln. have not been satisfactory. The chlorination process has been gradually displaced by the cyanide process of extraction. The latter was first used to supplement the recovery of gold from the tailings of the plate amalgamation process; but with the introduction of improved grinding, and filtration, it has become so formidable a rival that the chlorination process is almost obsolete.

The alchemists of the eighteenth century knew that gold is soluble in an aq. soln. of potassium cyanide, and the early jewellers probably utilized the fact in

gilding. C. W. Scheele, in his memoir, *De materia tingente cærulei Berolinensis* (1783), noted the solvent action of aq. soln. of the alkali cyanides on gold, silver, copper, etc. In 1843, P. Bagnation⁵ showed that gold—*metallorum rex*—which resists attack by the strongest acids, dissolves quietly and quickly in an alkaline soln. of potassium or sodium cyanide, and less rapidly in soln. of alkali ferrocyanides. He also noticed that the action is more rapid in warm soln., and that the free circulation of air accelerated the speed of dissolution.

The facts are illustrated by placing a fragment of gold-leaf in each of two vessels containing a one per cent. soln. of potassium cyanide. Agitate one by stirring with a glass rod, and bubble a current of air through the other soln. In about 15 minutes, the gold in the latter vessel will be dissolved, and scarcely attacked in the other. A piece of gold-leaf submerged in dil. soln. of potassium cyanide also dissolves less rapidly than a *similar piece* of gold-leaf floating on the surface of the soln.

The solubility of metals, etc., in aqueous potassium cyanide.—Other metals are dissolved by the potassium cyanide soln.—mercury and platinum are attacked very slowly if at all. Silver sulphide, arsenate, antimoniate, and chloride are dissolved by the menstruum. According to G. Gore's experiments, the amount of metal, expressed in mgrm., dissolved per sq. cm. of surface by a 1.86 per cent. soln. of potassium cyanide, is indicated in Table I. This shows that the rate of disso-

TABLE I.—THE DISSOLUTION OF METALS IN AQUEOUS SOLUTIONS OF POTASSIUM CYANIDE

Metal.	Milligram dissolved per sq. cm. of surface.	
	15.6°	71°
Aluminium	0.096	4.510
Zinc	0.054	0.552
Copper	0.053	1.263
Silver	0.016	0.069
Cadmium	0.014	0.031
Gold	0.009	0.229
Tin	0.006	0.042
Nickel	0.005	0.027
Iron	trace	0.010
Platinum	nil	nil
Lead	—	0.031

lution of gold is increased nearly twenty-five-fold by raising the temp. about 55°. The numbers for aluminium are probably rather high—possibly owing to the potassium cyanide being contaminated with some potassium hydroxide. W. A. Caldecott⁶ found that the cyanide soln. is more active in light than in darkness, and M. Berthelot showed that this is probably due to the increasing rate at which oxygen is absorbed by potassium cyanide soln. exposed to light.

In 1846, L. Elsner⁷ showed that the presence of oxygen—either free or in soln.—is necessary for the dissolution of gold in potassium cyanide soln., and the reaction is said to occur in accord with the equation: $4\text{Au} + 8\text{KCy} + \text{O}_2 + 2\text{H}_2\text{O} = 4\text{KAuCy}_2 + 4\text{KOH}$. L. Elsner also obtained colourless octahedral crystals of potassium aurocyanide, KAuCy_2 , by the evaporation of the soln. The necessary oxygen was stated by L. Elsner to be obtained from the water by the metals iron, copper, zinc, and nickel, and hydrogen was liberated; while the metals gold, silver, and cadmium were stated to get the required oxygen from the air, and to dissolve only when oxygen had access to the soln. W. A. Dixon gave a similar equation to that employed by L. Elsner. In confirmation of L. Elsner's equation, W. Skey, and J. S. Maclaurin proved that for every 130 parts of potassium cyanide, 8 parts of oxygen suffice for the dissolution of 196.8 parts of gold; and therefore, the amount of oxygen normally dissolved in liquids, and adhering to the surface of a solid, is sufficient for the

dissolution of relatively large amounts of gold. J. S. Macarthur cited experiments to show that gold can be dissolved by the alkali cyanide in the absence of oxygen—*e.g.* if the crushed ore contains basic ferric sulphates which can form ferricyanide—and it has been suggested by L. Janin that the reaction should accordingly be represented by the equation: $2\text{H}_2\text{O} + 2\text{Au} + 4\text{KCy} = 2\text{KAuCy}_2 + 2\text{KOH} + \text{H}_2$; but it is very doubtful if this equation can be correct because free hydrogen has not been detected, although it might be formed and immediately unite with the oxygen in soln. producing hydrogen peroxide. According to G. Bodländer, the chemical action should be represented by the equation: $2\text{H}_2\text{O} + 2\text{Au} + 4\text{KCy} + \text{O}_2 = 2\text{KAuCy}_2 + 2\text{KOH} + \text{H}_2\text{O}_2$, and he was able to detect as much as 72.3 per cent. of a substance acting like hydrogen peroxide as an intermediate product when gold is rapidly dissolved in aerated cyanide lye. The hydrogen peroxide leads to the dissolution of more gold by a reaction symbolized: $4\text{KCy} + \text{H}_2\text{O}_2 + 2\text{Au} = 2\text{KAuCy}_2 + 2\text{KOH}$. The result of these two reactions is eq. to the one represented by L. Elsner's equation. W. Bettel considers that potassium auricyanide, KAuCy_4 , not hydrogen peroxide, is the intermediate product, and he represents the reaction: $2\text{H}_2\text{O} + 2\text{Au} + \text{O}_2 + 6\text{KCy} = \text{KAuCy}_2 + \text{KAuCy}_4 + 4\text{KOH}$, followed by $\text{KAuCy}_4 + 2\text{Au} + 2\text{KCy} = 3\text{KAuCy}_2$. The equation given by J. S. Macarthur and R. W. and W. Forrest: $\text{Au} + 4\text{KCy} + 2\text{H}_2\text{O} = \text{K}_2\text{AuCy}_4 + 2\text{KOH} + \text{H}_2$, cannot be right because no hydrogen is evolved during the reaction, and the fundamental part played by oxygen is not explained. D. Reichinstein assumed that the oxygen slowly unites with the gold, and the cyanide ions then react quickly on the product.

The action of cyanide lye on pyrites is rather complex. According to W. A. Caldecott, the roasted pyrites contains undecomposed pyrites, FeS_2 ; ferrous sulphide, FeS , and sulphur; ferrous sulphate, FeSO_4 , and sulphuric acid, H_2SO_4 ; ferric sulphate, $\text{Fe}_2(\text{SO}_4)_3$, or basic ferric sulphates; and ferric oxide, Fe_2O_3 . The sulphuric acid liberates hydrogen cyanide, $2\text{KCy} + \text{H}_2\text{SO}_4 = \text{K}_2\text{SO}_4 + 2\text{HCy}$; the ferrous sulphate forms ferrous cyanide, FeCy_2 , which reacts with potassium cyanide, forming potassium ferrocyanide, K_4FeCy_6 , and this may react with more ferrous sulphate, forming a pale blue precipitate, $\text{K}_2\text{Fe}_2\text{Cy}_6$, which is oxidized by air to Prussian blue, $3\text{FeCy}_2 \cdot 4\text{FeCy}_3$ —both these precipitates are decomposed by potash, forming potassium ferrocyanide and ferrous hydroxide, $\text{Fe}(\text{OH})_2$, in the former case, and ferric hydroxide, $\text{Fe}(\text{OH})_3$, in the latter. The ferric sulphates are decomposed by potassium cyanide, forming hydrogen cyanide and ferric hydroxide. Ferrous hydroxide, not ferric hydroxide, is decomposed by potassium cyanide: $\text{Fe}(\text{OH})_2 + 6\text{KCy} = \text{K}_4\text{FeCy}_6 + 2\text{KOH}$. With roasted cupriferrous pyrites, copper sulphate forms cuprous cyanide, CuCy , a precipitate soluble in excess of potassium cyanide, forming an unstable compound, $\text{K}_2\text{Cu}_2\text{Cy}_4$.

Application to the extraction of gold and silver from their ores.—The solvent action of potassium or sodium cyanide has been skilfully applied by metallurgists to the extraction of finely divided gold or silver from their ores. It has been stated⁸ that A. Parkes applied for a patent in 1840 for “the separation of gold or silver from their ores by digestion with a 3 to 6 per cent. soln. of cyanide of sodium, potassium, or ammonium for 3 days at 150° F. to 180° F.” It was proposed to recover the gold by fusing the residue obtained by the evaporation of the soln. This process would involve the loss of a large proportion of the cyanide soln., and the recovery of the gold would be expensive. J. H. Rae,⁹ in 1867, patented a process for extracting gold and silver from their ores by digestion with suitable chemicals, such as potassium cyanide, and simultaneously precipitating the dissolved gold on copper plates by means of an electric current; J. W. Simpson patented a process for removing gold, silver, and copper from their ores by leaching them with an aq. soln. containing 3 per cent. of potassium cyanide, and 0.19 per cent. of ammonium carbonate. The gold was subsequently precipitated by metallic zinc. J. W. Simpson appears to have believed that the cyanide soln. in J. H. Rae's process did its work only when stimulated by the electric current, and that the addition of ammonium carbonate rendered the electric current

unnecessary. Neither J. H. Rae's nor J. W. Simpson's process appears to have been employed on a large scale. Several other patents were obtained by inventors working along similar lines, but it is entirely due to the enterprise and skill of J. S. Macarthur and R. W. and W. Forrest of Glasgow that the practical success of the cyanide process for extracting gold from its ores was assured. J. S. Macarthur and R. W. and W. Forrest did not like the chlorine process because of the preferential action of chlorine on the sulphides of the base metals, and its unsuitability for the extraction of silver. They tried a number of solvents—ferric chloride, ferric bromide, etc.—and finally decided that a dil. soln. of potassium cyanide possessed advantages over all the other solvents because it exercises "a selective action" on gold and silver in preference to sulphides and other compounds of the base metals. They emphasized the use of a very dil. cyanide soln., "containing cyanogen in the proportion not exceeding 8 parts of cyanogen to 1000 parts of water," because the solvent action is then confined more to the precious metals; conc. soln. act also in the base metals. J. S. Maclaurin (1893) and J. J. Andrejeff (1908) showed that the rate of dissolution of gold increases with decreasing conc. to a maximum rate with a 0.25 per cent. soln., and thereafter decreases with decreasing conc. According to S. B. Christy, the solvent action of potassium cyanide in 0.00065 per cent. soln. is virtually nil, and for all practical purposes ceases when the conc. falls below 0.001 per cent. of potassium cyanide.

The precipitation of gold from cyanide solutions.—Some time after J. S. Macarthur and R. W. and W. Forrest's patent was issued, further patents were issued to them for the use of zinc, preferably filiform or thread-like, as a precipitating agent; and for the use of caustic alkalies or lime for neutralizing ores containing acids or acid salts which caused undue losses by the decomposition of the cyanide. It is said that a patent is very easy to obtain, but very difficult to retain if a powerful company wants to appropriate an idea, and the validity of the Macarthur-Forrest patents has been the subject of much litigation. J. S. Macarthur once quoted sympathetically Isaac Newton's remark:

If I get free of this present business, I will resolutely bid adieu to it eternally, except what I do for my private satisfaction or leave to come out after me; for I see a man must either resolve to put out nothing new or to become a slave to defend it.

A. P. Price (1883), and J. W. Simpson (1885) had previously used zinc as a precipitation agent, but J. S. Macarthur and R. W. and W. Forrest found that sheet zinc is not nearly so efficient as zinc filaments or lead in conjunction with zinc—the lead zinc couple. The zinc precipitation is represented by the equation: $2\text{KAuCy}_2 + \text{Zn} = \text{K}_2\text{ZnCy}_4 + 2\text{Au}$. There are also side reactions due to the direct action of the cyanide soln. on the zinc, resulting in the evolution of hydrogen and the formation of potassium zincate. If an excess of potassium cyanide be not present, a layer of zinc cyanide, zinc hydroxide, or potassium zinc ferrocyanide may be formed on the surface of the metal preventing further action.¹⁰ Zinc-dust or zinc fume has been recommended by H. L. Sulman and used for the purpose in some plants.¹¹ Instead of precipitating the gold from the cyanide soln. by zinc, E. W. von Siemens and J. G. Halske¹² recommended electrolysis; W. Moldenhauer, aluminium; and W. D. Johnston, charcoal. According to G. Gore,¹³ the voltaic order of the metals in aq. soln. of potassium cyanide is that indicated in Table II. The position of the metals in the table represents their relative tendency to dissolve under the conditions of the experiments; and when two metals are in contact, the metal on the negative side accelerates the soln. of the more positive metal, and is itself protected from dissolution by the latter. A metal tends to precipitate from soln. another metal which is on the negative side, and to replace it in soln.

According to C. Engler and J. Weissberg,¹⁴ the dissolution of the gold is attended by the formation of gold peroxide as an intermediate product. Feebly ozonized oxygen was found by J. J. Andrejeff to increase the speed of the dissolution, and this from about one and a quarter to one and three-quarter times the observed

rates in air. Increasing the proportion of ozone in the air accelerated the action. The gold plate gradually acquires a brick-red film which slows down the solvent action of the cyanide. Hydrogen peroxide was found to act in a similar manner. Lead or manganese dioxide exert very little influence on the speed of the action, but they favour the action of hydrogen peroxide. J. Michajlenko and M. Meschtscherjakoff found that oxidation agents accelerate the rate of dissolution of the gold, and that OH⁻ ions retard, and H⁺ ions stop the action. Among the accelerating agents he includes potassium perchlorate, periodate, permanganate, sulphate, ferricyanide, and carbonate; sodium sulphate and peroxide; ammonium sulphate; and bromine—the most marked action occurs with potassium or sodium sulphate, sodium peroxide, and potassium ferricyanide. The speed of dissolution increases with increasing conc. of the oxidizing agent up to a certain limiting value. Scarcely any acceleration was observed with potassium chlorate, bromate, or iodate, or sodium stannate; while no appreciable change occurs with sodium, cobalt, cupric chloride, or with mercuric cyanide. E. Noelting and G. Forel also noted that ammonium persulphate accelerates the action, while potassium nitrite and ammonium vanadate

TABLE II.—VOLTAIC ORDER OF THE METALS IN AQUEOUS SOLUTIONS OF POTASSIUM CYANIDE.

0.625 per cent. soln.		30 per cent. soln.	
10°	38°	10°	38°
+Al	+Mg	+Mg	+Mg
Mg	Zn	Zn	Al
Zn	Cd	Cu	Zn
Cu	Al	Al	Cu
Cd	Co	Cd	Cd
Sn	Cu	Au	Sn
Co	Ni	Ag	Au
Ni	Sn	Ni	Ag
Ag	Au	Sn	Ni
Au	Ag	Hg	Hg
Hg	Pb	Pb	Pb
Pb	Hg	Co	Co
Fe	Sb	Sb	Sb
Pt	Bi	Te	Te
Sb	Fe	Bi	Bi
Bi	Te	Fe	Fe
Te	Pt	Pt	Pt
-C	-C	-C	-C

are indifferent; they found that many organic substances with oxidizing properties raise the solvent action of alkali cyanide on gold—*e.g.* nitroso- β -naphthol, nitrobenzene, *o*-nitrophenol, or picric acid.

A. Parkes patented a mixture of bromine or a bromide with potassium cyanide, potassium dichromate, and sulphuric acid; W. H. Gaze and W. E. Field patented a haloid cyanide; and H. L. Sulman and F. L. Teed patented the use of a small quantity of a haloid cyanide, say, cyanogen bromide, BrCy, with the soln. of potassium cyanide in order to give greater activity to the solvent, and to reduce the loss due to the decomposition of the cyanide. It is supposed that the reaction was symbolized: $3\text{KCy} + 2\text{Au} + \text{BrCy} = 2\text{KAuCy}_2 + \text{KBr}$. The haloid cyanide acts as a mild oxidizing agent possibly: $2\text{BrCy} + 3\text{KC}_y + 2\text{H}_2\text{O} = 2\text{KBr} + \text{KOC}_y + 4\text{HC}_y + \text{O}$, and hence accelerates the cyanidation of ores. It therefore offers advantages with sulpho-tellurides and certain other ores where a rapid dissolution of the gold is necessary in order that other associated minerals may not have time to destroy the solvent. In most cases, however, the improvements which have attended the development of cheap and efficient processes for roasting of otherwise refractory

ores, mechanical agitation and aëration, and fine grinding of raw ores, have eliminated the need for special accelerators. Several attempts have been made to hasten the rate of dissolution of the gold by the addition of oxidizing agents. J. Michajlenko and M. Meschtscherjakoff recommended ozone; J. C. Montgomerie, and J. H. Burfeind, sodium peroxide; E. Schering, and W. Görlich and A. Wichmann, persulphates; W. H. James and co-workers, S. B. Christy, and G. Göpner, hydrogen peroxide; and W. Moldenhauer, chromates, permanganates, ferricyanides, chlorine, bromine, or iodine. Artificial oxidation, however, is employed only when some substance—*e.g.* soluble sulphide—is present in the ore or in the water and which acts as a reducing agent by the absorption of oxygen. It was formerly supposed that oxygen and potassium cyanide could not remain together in soln. without the immediate formation of potassium cyanate; observations have shown that the oxidation of cyanide to cyanate is a relatively slow process.

The work of a cyanide plant.—The application of the cyanide process comprises in general four operations although there are numerous modifications¹⁵ at various stages of the process. A diagrammatic sketch of the process is given in Fig. 4; the dissolving and solution tanks *A* and *B* for preparing the cyanide lye of the

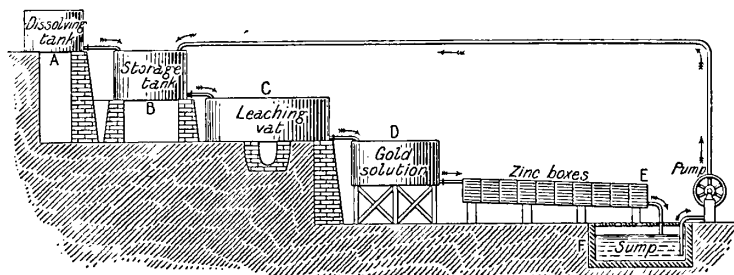

FIG. 4.—Diagrammatic Representation of Cyanide Plant.

required conc., are, if practicable placed so that the liquid runs by gravitation through the leaching vat *C* provided with false bottoms, and containing the ore to be treated; from the leaching or percolating vat to the settling tank *D* for the soln. of gold in the cyanide, the zinc extractors *E*, and thence to a sump *F* below the floor level, whence the lye is pumped back either to the storage tanks or directly into the leaching vats. If the plant has to be built on level ground more pumping and elevating appliances are needed than when the soln. can circulate in one direction wholly by gravity.

(1) *The preparation of the ore.*—The tailings from the amalgamation process may be treated directly. If the ore is not already crushed fine enough, it must be reduced to a fine enough state of subdivision. If the particles of gold are coarse, they would occupy too long a period to dissolve in the cyanide lye, and a preliminary amalgamation may be advisable. Ores containing tellurides, arsenides, or antimonides may require a preliminary roasting; acidic ores are mixed with lime; and ores containing reducing agents are treated with oxidizing agents—potassium ferricyanide or permanganate, peroxides, bromine, etc. The object is to prevent losses in the cyanide by secondary reactions. The consumption of cyanide with ores containing sulphide, oxide, or carbonate of copper is so great that even if but a small proportion is present, the process may be impracticable. The ore for the leaching vats is sometimes washed with alkali lye and water to remove organic matters, acid salts, etc.

(2) *The leaching of the prepared ore with the cyanide lye.*—The ore is first leached with a 0.15 to 0.05 per cent. soln. followed by a 0.05 to 0.10 per cent. lye repeated as often as may be economically necessary. In one plant, the leaching of the ore with the more conc. soln. occupies 8 to 16 hrs., and each of four leachings with the

dil. soln. occupies about 4 hrs. The ore is then washed with water—8 hrs. The object of using the dil. soln. and water is to make sure that no dissolved gold is left in the vat. The soln. of gold in the cyanide lye is run into vats, and allowed to settle. The clear liquid is decanted or filtered. The filtration is effected by lowering canvas-covered wire frames into the lye, and when suction is applied, the mud is sucked free from the cyanide soln., which passes to the storage tank. The frame is then raised from the tank, and the suction is continued until the cake is dry. The cake soon breaks up and falls into the vat, where it is sluiced by water from a discharge door in the side of the vat, and the vats are recharged with ore. The cyanide lye is then run to the zinc boxes.

(3) *The precipitation of the dissolved gold.*—The zinc boxes are wooden or iron vats capable of treating 50 to 150 tons of soln. *per diem*; the zinc boxes are divided into about ten compartments by partitions; eight of the compartments are packed with trays containing zinc shavings, or lead-coated zinc shavings—lead-zinc couple—and so arranged that the soln. flows upwards through the shavings. The first and last compartments have a sand filter to clarify the soln. on entering and leaving the “precipitation boxes.” The conc. and dil. soln. are treated separately. As the cyanide lyes percolate through the masses of zinc shavings or filaments, the gold is precipitated as a fine powder. The soln. pass into the sumps and a large proportion of their cyanide is available for more extractions. A clean-up of the black mud (precipitated gold) in the zinc boxes is made every week, fortnight, or month. A current of water is passed through the zinc extractors to remove the cyanide soln. The coarse fragments of zinc are picked out, and the residual slime is pumped into filter presses.

(4) *The conversion of the precipitated gold into bullion.*—The solid residue is finally collected and roasted at a red heat. It is then treated with hydrochloric acid to dissolve the zinc, washed, dried, and mixed with a flux—say, a mixture of sodium carbonate, glass, borax, fluorspar, and sand—and fused in a graphite crucible. The metal is re-melted, and cast into ingots of about 1000 ozs. each. The bullion so obtained is sold to the refiners. In P. S. Tavener’s process,¹⁶ the slimes are mixed with fluxes and litharge, and smelted in a reverberatory furnace. The product is cupelled, melted in graphite crucibles, and cast into ingots.

A. Goerz estimated that in the Transvaal, prior to the introduction of the cyanide process, 50 per cent. of the theoretical yield of gold was obtained by the amalgamation process, 5 to 10 per cent. was recovered by treating the tailings by Plattner’s chlorination process, and the remaining 40 per cent. was lost in the tailings. No economical process for extracting the gold was then known. To-day, the cyanide process enables at least 90 per cent. of the gold to be profitably extracted from the tailings. J. S. Macarthur estimated that the cyanide process has directly added 20 per cent. to the world’s output of gold, and indirectly enabled gold mining and amalgamation to be carried on under conditions where without this auxiliary they would not have yielded enough profit to stand alone.

REFERENCES.

- ¹ J. Percy, *B. A. Rep.*, 57, 1848; *Phil. Mag.*, (4), 36, 1, 1853; C. F. Plattner, *Die Proberkunst mit dem Löhrohre*, Leipzig, 570, 1853; A. Duflos, *Journ. prakt. Chem.*, (1), 48, 65, 1849; V. von Lange, *Karsten’s Archiv.*, 24, 396, 1851.
- ² J. E. Rothwell, *Mineral Ind.*, 1, 233, 1892; W. Munktell, *Dingler’s Journ.*, 269, 578, 1888; J. C. Newbery and C. T. J. Vautin, *Ber.*, 21, 279, 1888; E. W. Nardin, *Proc. Inst. Civ. Eng.*, 142, 297, 1900.
- ³ A. Étard, *Brit. Pat. No.* 880, 1897; E. Harris, *Trans. Inst. Min. Met.*, 14, 219, 1904.
- ⁴ C. McIlhiney, *Journ. Amer. Chem. Soc.*, 18, 451, 1896; R. W. Lodge, *Tech. Quart.*, 8, 378, 1895; H. R. Cassel and B. C. Hinman, *Brit. Pat. No.* 7555, 1897; H. R. Cassel, *ib.*, 8574, 1885.
- ⁵ P. Bagnaton, *Bull. Imp. Acad. Sciences, St. Petersburg*, 11, 136, 1843; *Journ. prakt. Chem.*, (1), 31, 367, 1844; J. Napier, *Phil. Mag.*, (3), 25, 64, 1844; M. Faraday, *Proc. Roy. Inst.*, 2, 308, 1857; G. Gore, *Proc. Roy. Soc.*, 37, 283, 1884; E. B. Wilson, *The Chlorination Process*, New York, 1908.

- ⁶ W. A. Caldecott, *Proc. Chem. Soc.*, 20. 199, 1905; M. Berthelot, *Compt. Rend.*, 139. 169, 1904.
- ⁷ L. Elsner, *Journ. prakt. Chem.*, (1), 37. 441, 1846; W. Skey, *N.Z. Mines Report*, Wellington, 1892; J. S. MacLaurin, *Journ. Chem. Soc.*, 63. 724, 1893; J. S. Macarthur, *Journ. Soc. Chem. Ind.*, 9. 267, 1890; J. S. Macarthur and R. W. and W. Forrest, *Brit. Pat. Nos.* 14174, 1887; 10223, 1888; G. Bodländer, *Zeit. angew. Chem.*, 9. 583, 1896; W. Ecttel, *South African Min. Journ.*, 2. 8, 1898; L. Janin, *Min. Ind.*, 1. 239, 1892; *Eng. Min. Journ.*, 548, 1886; S. B. Christy, *Trans. Amer. Inst. Min. Eng.*, 26. 735, 1896; W. A. Caldecott, *Proc. Chem. Soc.*, 12. 100, 1897; W. A. Dixon, *Chem. News*, 76. 281, 1897; G. A. Goyer, *ib.*, 69. 262, 268, 280, 1894; 72. 80, 95, 1895; D. Reichstein, *Zeit. Elektrochem.*, 19. 674, 1913; C. Butters and J. E. Clennell, *Eng. Min. Journ.*, 54. 341, 365, 1892; C. H. Aaron, *Leaching Gold and Silver Ores*, San Francisco, 1881; A. Brochet and J. Petit, *Bull. Soc. Chim.*, (3), 31, 359, 1255, 1904; *Chem. News*, 91. 67, 1905.
- ⁸ J. W. Richards, *Journ. Franklin Inst.*, 163. 96, 1897; A. Parkes, *Brit. Pat. No.* 8905, 1841.
- ⁹ J. H. Rae, *U.S. Pat. No.* 61866, 1867; J. W. Simpson, *ib.*, 323222, 1885; L. Janin, *Min. Ind.*, 1. 239, 1892; *Eng. Min. Journ.*, 41. 548, 1886; J. S. Macarthur and R. W. and W. Forrest, *Brit. Pat. No.* 10223, 1888; J. S. MacLaurin, *Journ. Chem. Soc.*, 63. 724, 1893; J. J. Andrejeff, *Proc. Polyt. Inst. St. Petersburg*, 9. 447, 1908; *Zeit. Elektrochem.*, 19. 668, 1913; A. P. Price, *Brit. Pat. No.* 5407, 1883; J. S. Macarthur, *ib.*, 28184, 1894; C. L. Jacobsen, *Ueber das elektrochemische Verhalten des Goldes und seine Passivität*, Leipzig, 1907; S. B. Christy, *Trans. Amer. Inst. Min. Eng.*, 26. 735, 1897; 30. 1, 1901; *Amer. Chem. Journ.*, 27. 354, 1902.
- ¹⁰ A. Prister, *Journ. Chem. Met. Soc. South Africa*, 5. 62, 1904; A. Prister and B. Bay, *ib.*, 5. 75, 1904.
- ¹¹ H. L. Sulman, *Trans. Inst. Min. Met.*, 3. 60, 1895; *Brit. Pat. Nos.* 18003, 1894; 18146, 1894.
- ¹² E. W. von Siemens and J. G. Halske, *Zeit. Elektrochem.*, 1. 532, 1895; W. Moldenhauer, *German Pat., D.R.P.P.* 74532, 1893; 77392, 1894; A. von Gernet, *Proc. Chem. Met. Soc. South Africa*, 1. 28, 1894; W. D. Johnston, *U.S. Pat. No.* 522260, 1894; J. T. Lowles, *Trans. Inst. Min. Met.*, 3. 190, 1899; S. B. Christy, *Trans. Amer. Inst. Min. Eng.*, 30. 1, 1899; *Amer. Chem. Journ.*, 27. 354, 1902.
- ¹³ G. Gore, *Proc. Roy. Soc.*, 30. 38, 1880.
- ¹⁴ C. Engler and J. Weissberg, *Kritische Studien über die Vorgänge der Autoxydation*, Braunschweig, 100, 1904; E. Noeltling and G. Forel, *Bull. Soc. Ind. Mulhouse*, 69. 28, 1899; J. J. Andrejeff, *Proc. Polyt. Inst. St. Petersburg*, 9. 477, 1908; *Zeit. Elektrochem.*, 19. 668, 1913; A. Coehn and C. L. Jacobsen, *Zeit. anorg. Chem.*, 55. 321, 1907; J. Michajlenko and M. Meschtscherjakoff, *Journ. Russ. Phys. Chem. Soc.*, 44. 567, 1912; H. L. Sulman and F. L. Teed, *Journ. Soc. Chem. Ind.*, 16. 961, 1897; *West Australia Pat. No.* 601, 1894; *Brit. Pat. No.* 18592, 1894; A. Parkes, *ib.*, 17033, 1887; A. E. Morgans, *ib.*, 18279, 1894; J. C. Montgomerie, *ib.*, 12641, 1892; C. A. Mulholland, *Eng. Min. Journ.*, 59. 510, 1896; W. H. James, *ib.*, 63. 399, 1897; W. H. James and C. J. Norris, *Electrochem. Ind.*, 1. 60, 1897; G. Göpner, *Met.*, 5. 41, 1908; W. Moldenhauer, *Ber.*, 26. 340, 1893; S. B. Christy, *Trans. Amer. Inst. Min. Eng.*, 26. 735, 1896; J. H. Burfeind, *Eng. Min. Journ.*, 63. 399, 1897; T. B. Stevens and C. E. Blackett, *Trans. Inst. Min. Met.*, 29. 250, 1920; H. Knutsen, *ib.*, 12. 1, 1902; W. H. Gaze and W. E. Field, *Victoria (Australia) Pat. No.* 11538, 1894; E. Schering, *Zeit. Elektrochem.*, 2. 507, 1896; *German Pat., D.R.P.* 85244, 1895; W. Görlich and A. Wichmann, *ib.*, 88201, 1895; P. A. Robbins and H. Hanson, *Eng. Min. Journ.*, 109. 194, 1920; H. K. Picard, *Trans. Inst. Min. Met.*, 28. 14, 1919.
- ¹⁵ H. F. Julian and E. Smart, *Cyaniding Gold and Silver Ores*, London, 1904; E. B. Wilson, *The Cyanide Process*, New York, 1903; M. Eissler, *The Cyanide Process*, London, 1902; J. Park, *The Cyanide Process of Gold Extraction*, London, 1913; T. K. Rose, *The Metallurgy of Gold*, London, 285, 1916; A. S. Miller, *Introduction to the Cyanide Process*, New York, 1906; M. Uslar and G. Erlwein, *Cyanid-Prozesse sur Goldgewinnung*, Halle, 1903; J. E. Clennell, *The Cyanide Handbook*, New York, 1910; *The Chemistry of Cyanide Solutions resulting from the Treatment of Ores*, New York, 1904; H. A. Megraw, *Practical Data for the Cyanide Plant*, New York, 1911; H. W. MacFarren, *Textbook of Cyanide Practice*, New York, 1912; T. A. Rickard, *Recent Cyanide Practice*, New York, 1907; H. F. Bain, *More Recent Cyanide Practice*, New York, 1910; R. Robine and M. Lenglen, *Cyanide Industry, theoretically and practically considered*, New York, 1906; F. L. Bosqui, *Practical Notes on the Cyanide Process*, New York, 1904; W. H. Gaze, *A Practical Handbook of Cyanide Operations*, London, 1898; A. James, *Cyanide Practice*, London, 1903; E. Viktor, *Die Cyankalium-Laugung von Goldcrzen*, Wien, 1902; R. Borchers, *Fortschritte der Edelmetallurgie während der letzten Jahrzehnte*, Halle, 19. 1913; S. B. Christy, *Electrodeposition of Gold and Silver from Cyanide Solutions*, Washington, 1919.
- ¹⁶ P. S. Tavener, *Journ. Chem. Met. Soc. South Africa*, 3. 70, 1902; J. S. Macarthur, *Brit. Pat. No.* 8184, 1894; A. Goerz, *Zeit. angew. Chem.*, 1. 63, 1888

§ 4. The Purification and Refining of Gold

The crude bullion is not commonly suited for use in the arts, and the bullion is therefore refined to bring it up to the standard degree of purity. Gold retorted from the amalgamation process contains 2 or 3 per cent. of copper, iron, mercury, and other base metals. More or less silver may also be present. Most gold is brittle before it is refined, and in refineries, the removal of impurities from gold and silver is called *toughening* the metal, and the term *refining* is reserved for the *parting* or separation of gold from silver. When cupellation is not practised, the bullion may be toughened by a preliminary treatment to remove the base metals. A large proportion of the more volatile metals can be removed by merely melting the bullion, and this the more the higher the temp., and the longer the time the metal is heated. Traces of the volatile metals, however, still remain after this treatment.

Refining by oxidation.—A large proportion of the base metals can be oxidized, say, by directing a blast of air over or below the surface of the bullion melted in a crucible; the oxidized metals form a scum on the surface, and can be skimmed off. Other oxidizing agents have been used—nitre, manganese dioxide, cupric oxide, potassium permanganate, etc.¹

Refining by sulphurization.—The base metals have also been sulphurized instead of oxidized—particularly when iron is the chief impurity. This is done by sprinkling sulphur on the surface of the metal melted in a graphite crucible, and then stirring with a graphite rod. The gold is not affected, iron and silver form sulphides, and can be separated as matte when the contents of the crucible are allowed to cool. The silver does not sulphurize very much until the iron has all been converted into sulphide. Stirring the molten metal with an iron rod for a few minutes has been recommended to remove arsenic, antimony, sulphur, etc., since arsenides, antimonides, sulphides, etc., are formed, and these can be removed by skimming. Melting the metal under charcoal removes oxygen.

Refining by cupellation.—In refining by cupellation, the bullion is alloyed with an easily oxidizable metal like lead. The alloy of lead and gold is heated in a stream of air in a furnace with a shallow hearth made of bone ash. The lead is oxidized to litharge, PbO, and the base metal impurities are simultaneously oxidized. The oxides are then partly blown from the surface of the molten metal, and partly absorbed by the bone ash. Finally, when the gold appears as a bright disc, the operation is stopped, and the gold removed. If silver be present, the two metals remain alloyed after the cupellation, and they must be parted by some other process.

Refining by chlorination—In 1838, L. Thompson² stated that “it has long been known to chemists that not only has gold no affinity for chlorine at a red heat, but it actually parts with it at that temp. although previously combined. This is not the case with those metals with which it is usually alloyed. . . . It therefore offers at once an easy and certain means of separation.” About thirty years later, 1870, F. B. Miller applied this property of chlorine to the separation of gold and silver on a large scale at the Sydney Mint; the process was well suited to the local conditions—high price of sulphuric acid, and the absence of auriferous silver suited for parting. The gold is melted in crucibles, and chlorine (from liquid chlorine in cylinders or otherwise prepared) is forced through clay tubes dipping in the molten metal. The gas is absorbed by the base metals and silver, their chlorides rise to the surface and are skimmed off. These chlorides are not appreciably decomposed at this temp. The process yields gold of a high degree of purity—99·5 per cent. gold. Instead of chlorine gas, alternate additions of nitre and sal ammoniac have been used in former times; and in another old process, frequent additions of corrosive sublimate, HgCl₂, were made in small quantities at a time.

The electrolytic process of refining.—The anode is the alloy to be purified; the electrolyte a soln. of gold chloride in hydrochloric acid; and the cathode, a sheet of pure gold. On electrolysis fairly pure gold is deposited on the cathode.

silver forms silver chloride which remains as a deposit about the anode. This process was brought out by E. Wohlwill,³ in 1874. If the gold has a large proportion of silver, B. Mobius' process by electrolysis with silver nitrate as the electrolyte is used. The main objection to the electrolytic process is the length of time required for the treatment, and this involves interest on the metal lying idle. The advantages are: absence of acid fumes, platinum and palladium are easily recovered from the anode mud. The working cost of the process is said to be about 1*d.* or 1½*d.* per ounce of gold. Metal to the value of about £15,000,000 is said to be treated annually by electrolysis.

The separation or parting of gold and silver.—During the operation, the base metals are removed from both the precious metals, but to avoid the waste of acids, etc., the base metals are first removed by refining or toughening. In Pliny's time, the granulated metal was heated with a mixture of salt and brick dust for about 36 hours. The alloy was not melted. The silver was converted into chloride. The silver chloride, brick-dust, etc., were separated from the gold by washing, and the silver recovered by amalgamation. This method of parting is sometimes called the *cementation process*. Melting the alloy of silver and gold with sulphur or antimony sulphide are old and obsolete methods called *sulphurization processes*. In both cases, silver sulphide is formed as a scum; with antimony sulphide an alloy of antimony and gold is simultaneously formed, and the antimony subsequently removed by oxidation. The chlorine and electrolytic processes of refining can also be used for parting.

In the thirteenth century, Albertus Magnus mentioned the parting of silver and gold by *nitric acid*, and the process was described by V. Biringuccio in his *De la pirotecnica* (Venice, 1540), and by G. Agricola in his *De re metallica* (Basil, 1556). It was used in the Paris mint about 1514, and in the London mint about 1594. Silver is soluble in nitric acid, gold is not. If an alloy of silver and gold be digested in nitric acid, silver and not gold is dissolved, provided that at least twice as much silver as gold be present, and the acid has a sp. gr. of not less than 1.26. In parting silver and gold, it is necessary to alloy the gold with up to about 75 per cent. of silver, if this proportion be not already present. The operation is called *inquartation*. The alloy is then treated with nitric acid free from chlorides. The silver dissolves as silver nitrate, and the gold remains behind as a brown powder.

J. Kunckel used *sulphuric acid*⁴ in place of nitric acid, about 1760; the process was mentioned by H. T. Scheffer in his *Historie vom Scheiden*, in 1753, and parting with sulphuric acid was used in the Paris mint by C. d'Arcet, nephew of J. P. F. d'Arcet, in 1802; the process is now comparatively common, because it is cheaper. Here the alloy is boiled with sulphuric acid and then with nitric acid. The gold is not appreciably attacked, and remains behind as a brown porous mass. This is washed, dried, and fused into a compact mass with sodium carbonate and charcoal. Any copper present is dissolved with the silver. The mixture of copper and silver sulphates is subsequently treated with scrap copper, when silver is precipitated: $\text{Ag}_2\text{SO}_4 + \text{Cu} = \text{CuSO}_4 + 2\text{Ag}$; the copper sulphate is electrolyzed for copper, or crystallized and sold as *bluestone*. The sulphuric acid process is said to furnish a less pure metal than either the chlorine or the electrolytic process; the alloy may contain lead and tellurium, while the platinum and palladium, if present, are not recovered. With care, the method gives satisfactory results in most cases, and metal to the value of about £70,000,000 is refined annually by this process. Allowing for the sale of the copper sulphate obtained as a by-product, the operation is said to cost from 3*d.* to 4*d.* per ounce of gold.

The same principle is applied in assaying gold ores. A weighed portion of the ores is fluxed along with borax, and lead oxide and a little charcoal. Some metallic lead is reduced. This lead gathers the gold and silver in the ores and collects as a button at the bottom of the crucible. The button is cupelled and the bead of silver and gold is weighed. The bead is inquarted with silver and parted with nitric acid. The resulting gold is weighed. These data—weight of ore, weight of contained gold and silver, and weight of gold—enable an estimate to be made of the gold and silver in the ore.

The preparation of highly purified gold.—In 1887, G. Krüss⁵ prepared highly purified samples of gold by the following process: Commercially refined gold is heated with hydrochloric acid in a flask on a sand-bath, and conc. nitric acid dropped into the liquid, in small quantities at a time. When all the metal is dissolved, the soln. is evaporated in a porcelain dish over a water-bath until a drop of the red liquid solidifies to a solid mass on cooling. The soln. must be protected from dust during the evaporation or some gold will be reduced from the soln. Distilled water is added and the silver chloride filtered off. The soln. is then treated with an excess of ferrous chloride soln. and the brown precipitate allowed to settle. The clear liquid is decanted off and the residue washed with dil. hydrochloric acid, and finally with water until all the iron is removed. If much platinum be present the precipitation is best made with oxalic acid; and if palladium be present, with sulphurous acid. The washed precipitate of gold is dried between 170° and 180°, and heated with conc. sulphuric acid in a platinum dish until the acid begins to give off dense white fumes. The object of this treatment is to remove traces of silver. In his work on the at. wt. of gold, G. Krüss repeated the digestion with sulphuric acid. The mixture, when cold, is poured into an excess of water, washed, dried, and fused with potassium bisulphate in order to remove any traces of palladium. The product is washed with water, dried, and fused with nitre in order to remove any platinum or iridium. If the cold flux be colourless, it may be assumed that these metals are absent. G. Krüss further dissolved the product in aqua regia, and precipitated the gold with sulphurous acid; and yet again dissolved the product in aqua regia, and precipitated the gold with oxalic acid.

REFERENCES.

- ¹ T. K. Rose, *The Metallurgy of Gold*, London, 1916.
² L. Thompson, *Journ. Roy. Soc. Arts*, 53, 17, 1838; F. B. Miller, *Journ. Chem. Soc.*, 21, 506, 1868; *Chem. News*, 21, 229, 241, 1870; A. Leibius, *ib.*, 27, 121, 1873; E. Dumas, *Bull. Soc. d'Enc.*, (2), 19, 443, 1872; H. Debray, *Monit. Scient.*, (3), 2, 367, 1877; S. B. Christy, *Trans. Amer. Inst. Min. Eng.*, 17, 3, 1888; R. R. Kahan, *Trans. Inst. Min. Met.*, 23, 25, 1919.
³ E. Wohlwill, *Zeit. Elektrochem.*, 4, 379, 402, 421, 1898.
⁴ T. Ulke, *Mineral Ind.*, 4, 343, 1895; T. Egleston, *Treatment of Gold and Silver in the United States Mint*, London, 1889; S. Gumbinner, *Rep. Cal. State Min.*, 9, 62, 1889; M. J. J. Dizé, *Journ. Phys.*, 55, 437, 1802; J. P. F. d'Arcet, *Seconde Instruction relative à l'art de l'affinage*, Paris, 6, 1828; H. T. Scheffer, *Abhand. Swedish. Akad.*, 15, 7, 1753; J. Kunckel, *Vollständiges Laboratorium Chymicum*, Berlin, 288, 1767.
⁵ G. Krüss, *Liebig's Ann.*, 238, 30, 1887.

§ 5. The Physical Properties of Gold

Gold in mass is yellow; it appears red if the light be reflected from the surface of the metal many times before it reaches the eye. According to M. Faraday,¹ gold-leaf 0.00009 mm. thick is yellow by reflected light and green or bluish-green in transmitted light; this is best seen by placing a sheet of leaf-gold between two sheets of glass, holding it up to the light, and viewing it through a magnifying lens. L. Houllevigne produced films almost colourless by reflected light, and in transmitted light they varied in colour from rose to violet. H. L. Barvir produced films which appeared red when very thin, and bluish or greenish when thicker. The hard and soft states of a metal are regarded by G. T. Beilby as two phases—the former is amorphous, the latter crystalline. The different mechanical, optical, electrical, and thermoelectric properties indicate that there is a transition temp.—amorphous gold began to soften at 250°, and was quite soft at 280°. According to J. W. Mallet, the maximum thickness for translucency is 0.20 mm.; G. Quincke gives 0.00816 mm.; and C. G. Ehrenberg, 0.00109 mm. H. L. Barvir produced thin mirror-like films on glass by slowly evaporating two or three drops of auric chloride,

moistening the residue with clove oil, and warming; N. Castoro produced films by reducing neutral dil. soln. with acrolein; C. Schuyten warmed a soln. of auric chloride with one of mercuric bromide containing some antipyrine; C. Statescu electrolyzed with 2.5 to 30 milliamps. for a few seconds a soln. of 15 grms. each of potassium ferrocyanide and sodium carbonate with 2 grms. of gold as chloride in a litre of water; H. L. Barvir heated a thin layer of a gold compound with ammonium chloride; etc. G. Rümelin, and W. Beetz studied the formation of mirrors by the disintegration of gold and silver electrodes in vacuum tubes. The properties of thin films have been studied by J. C. Chapman and H. L. Porter, L. P. Wheeler, etc. M. Faraday showed that when a film is heated, it breaks up into beads; and H. Schottky observed that films 0.087μ thick begin to break up when heated in air or hydrogen over 400° . According to T. Turner, gold-leaf does not undergo any change at 500° , but rapidly becomes transparent at 550° ; microscopic examination showed that the film, originally translucent, becomes aggregated to opaque masses with clear spaces between. Soft gold, which has not been mechanically strained, does not show this sudden change of properties. G. Tammann found the recrystallization temp. of gold to be 750° – 800° . Gold precipitated in a fine state of subdivision, varies in tint from red to dark brown; very thin films of gold are crimson or purple in transmitted light—*vide* colloidal gold.

J. B. L. Romé de l'Isle (1783), and R. J. Haüy (1801)² showed that the crystals of gold belong to the cubic system; it occurs in nature in the form of cubes, octahedra, rhombic dodecahedra, trapezohedra. The crystals are rarely isolated and detached, but rather in the form of branching, dendritic masses composed of microscopic octahedra. The isolated crystals occur in drift deposits, or in cavities left by the removal of iron pyrites or other soft materials from the quartz rocks, or they are found in the upper ferruginous or argillaceous crust of the reef. The gold which is embedded in massive quartz does not usually show any marked signs of crystallization. A. Liversidge obtained Widmanstätten's figures, by etching the sliced and polished surface of gold nuggets. The surface of a slowly cooling mass of gold sometimes shows the faces and angles of octahedral crystals. G. W. A. Kahlbaum and co-workers obtained octahedral crystals by sublimation; L. Knaffl prepared good crystals by heating an amalgam with 95 per cent. of mercury to 80° for some time and removing the excess of mercury with nitric acid of sp. gr. 1.35; F. Rinne, by crystallization from a gold-lead alloy; N. Averkieff also obtained hexahedral crystals by reducing gold chloride with formaldehyde, or, according to L. Knaffl, amyl or methyl alcohol. The gold appears mostly in cubes and octahedra. J. M. Maclaren studied the effect of organic matter on the gold crystals; A. Ditte found that on placing a piece of quartz in a soln. of gold in molten sodium thiosulphate, the gold was deposited on the edges and corners of the mineral. Feathery crystalline flakes were obtained by C. G. Lindböm by the electrolysis of a soln. of ammonium aurichloride. Z. Jeffries and R. S. Archer give 200° as the lowest temp. at which the recrystallization of the cold-worked metal has been observed. According to A. Liversidge, it is no uncommon thing to find natural gold in the form of capillary threads—**moss, filiform, or hair gold**—which are often interlaced and twisted into beautiful and fantastic shapes; also as thin plates or scales, having a more or less fibrous surface, and at times in scales so exceedingly thin that they are not thicker than ordinary gold-leaf. A. Liversidge obtained moss gold by roasting auriferous mispickel ores in a muffle—*vide* moss silver. **X-radiograms** of crystals³ of native gold show that the structural units are arranged after the pattern of a face-centred cubic lattice, with sides 4.08 \AA ., and the closest approach of the atoms 2.88 \AA . P. Sherrer's measurements give $4.06 \times 10^{-8} \text{ cm}$. for the length of the edge of the elementary cube. N. Gross also described the structure of gold crystals. K. F. Slotte estimated the edge of the elementary cube of liquid and solid gold to be $6.6 \times 10^{-9} \text{ cm}$. E. Beckmann and O. Liesche found that gold dissolves in boiling mercury as monatomic mols. M. N. Saha made estimates of the at. radius.

In the *Arabian Book of the Best Things for the Knowledge of Mineral Substances*, by Abu-r-Raikān, written towards the end of the tenth century, the **specific gravity** of gold is stated to be 19·05, a number very close to the value accepted at the present time; another Arabian writer, Al-Khazini, in his *Book on the Balance of Wisdom*, written in the twelfth century, gives this same number for the sp. gr. of gold. R. Boyle,⁴ in 1690, gave 19·64 for the sp. gr. of gold. D. G. Fahrenheit (1725) gave 19·081; G. Rose gave numbers between 19·2689 and 19·3336 (17·5) for sixteen samples of cast and pressed gold. M. Holzmann, 19·265 (13°); W. C. Roberts-Austen, 19·2945 for gold before rolling, 19·2982 for gold after once rolling. According to W. A. Tilden, hammered or rolled gold has a slightly greater sp. gr. than cast gold—cast gold at 18° has a sp. gr. 19·227, and hammered or compressed gold between 19·30 and 19·34; G. W. A. Kahlbaum and others have found similar results; according to the latter, cast gold has a sp. gr. 18·8840 at 20°, and hammered or compressed gold 19·2685. F. C. A. H. Lantsberry found that cold work affects the mechanical and physical properties of metals generally, and that the sp. gr. of annealed gold is 19·2601, that of cold-worked gold is 19·2504. According to T. M. Lowry, when gold is annealed at different temp. rising to 100°, it changes in volume, there is a small initial contraction followed by an expansion so that the original volume is restored; and T. M. Lowry and R. G. Parker found that while the sp. gr. of gold *en masse* is 19·2818, that of the filings is 19·2169. According to N. Averkieff, gold precipitated by formaldehyde has a sp. gr. 19·43095 at 20°, and, according to G. Rose, gold precipitated by ferrous sulphate has a sp. gr. 19·55 to 20·72; and with oxalic acid, 19·49. The best representative value of the sp. gr. of gold is 19·3. According to G. Quincke, the sp. gr. of liquid gold at 1120° is 18·38.

The **hardness** of gold lies between that of zinc and tin or between 2·5 and 3 on Mohs' scale; if the hardness of steel be 100, that of fine gold is 27; and, according to B. Kerl,⁵ iridium and osmiridium augment the hardness of gold. The Brinell hardness of cast and slowly cooled gold is 44·5, but, according to A. Hanriot, the value is too high; C. A. Edwards gave 33·01. C. Calvert and R. Johnson found the hardness of gold as related to that of silver and copper is 4 : 5 : 7·2; the ratio on J. R. Rydberg's scale is 2·5 : 2·7 : 3·0; on F. Auerbach's scale, 97 : 91 : 95; and on S. Bottone's scale, 979 : 990 : 1360.

The **malleability** and **ductility** of gold are very high. Pliny was wrong in stating in his *Historia naturalis* (33. 19) that these qualities with gold are inferior to those of lead, and he seems to contradict this later by saying that "gold possesses above all other metals the property of being spun and woven into garments like wool." According to J. W. Mallet, thin sheets can be made 0·08 μ to 0·12 μ thick. According to J. Fournet,⁶ it has been made into sheets nearly 0·00001 mm. thick, and drawn into wire so thin that a gram of metal is extended to 2000 metres. A film of gold 0·23 \times 10⁻⁸ mm. thick appears under the microscope as a continuous film. Pulverulent gold may be welded like platinum, and rolled into sheets. S. Kalischer stated that rolled gold is not crystalline, but becomes so when heated to redness. These qualities are greatly influenced by the presence of foreign metals. Lead, for example, was found by F. Mylius to make gold very brittle, while, according to E. Vigouroux, small quantities of copper, lead, arsenic, antimony, or bismuth considerably diminish the malleability of gold, while zinc, nickel, tin, and platinum behave similarly, but to a smaller degree. Less than 0·015 per cent. of silicon makes gold very soft. According to F. A. and C. L. Lindemann, gold is brittle at the temp. of liquid hydrogen or liquid air.

According to G. Quincke,⁷ the **surface tension**, σ , of gold is 581 dynes per cm.; A. Heydweiller gives for the surface tension of gold at 1070°, 612·2 dynes per cm., and for the **capillary constant**, a^2 , 6·90 sq. mm. at 1120°; S. W. Smith gives respectively $\sigma=1018$ dynes per cm. and $a^2=11·29$ sq. mm. He also shows that the surface tensions and capillary constants of the metals fit in with the periodic law. I. Traube gives for the **intrinsic pressure** of the solid 178,500 megabars. A. Masson⁸

gives 20.816×10^4 cms. per sec. for the **velocity of sound** in gold; and G. Wertheim gives for annealed gold, 17.413×10^4 cms. per sec. between 15° and 20° , and 21.122×10^4 cms. per sec. for annealed gold at 10° . C. E. Guye and co-workers have calculated the internal **viscosity** of metals from the logarithmic decrement of oscillating wires, and M. Ishimoto from tuning-forks and oscillating pendulums. A. Johnsen found the **plastic flow** of gold is diminished by cooling the metal in liquid air. W. C. Roberts-Austen found that the **diffusion coefficient** of gold in molten lead corresponds with 3 cms. in one day at 492° , or 0.023 cm. per day at 251° ; and he estimated that at 18° , it would diffuse 7 mm. in four years. C. E. van Orstrand and F. P. Dewey found that if k represents the coeff. of diffusion, v_0 the initial conc. of gold in solid lead, then, at 100° , $k=0.0002$, when $v_0=0.0023$ per cent.; at 150° , $k=0.004$, when $v_0=0.0074$ to 0.0123 ; and at 197° , $k=0.0068$, when v_0 ranges from 0.0155 to 0.0223 ; they also found at 150° , with v_0 ranging from 0.006 to 0.012 , $k=0.005$ when the press. p is one atm. per sq. in.; $k=0.011$, when $p=1.65$ atm. per sq. in. W. C. Roberts-Austen found that the coeff. of diffusion, k , in calcs. per cm. cube per day, for gold in mercury is 0.72 at 11° ; for gold in bismuth, 4.52 at 500° ; and for gold in tin at 500° , 4.65 . W. Fraenkel and H. Houben found the coeff. of diffusion of gold in silver at 870° , *i.e.* 100° below the m.p. of silver, to be 0.000037 per sq. cm. per day.

According to T. W. Richards,⁹ the **compressibility** of gold is 0.64×10^{-6} at 20° , *i.e.* 0.64×10^{-6} is the average fractional change of the original vol. caused by a press. of one megabar, or 10^6 dynes per sq. cm., between 100 and 500 megabars. L. H. Adams, E. D. Williamson, and J. Johnston give 0.57×10^{-6} , and they represent the change in vol. between the press. p_0 and p by $-0.000005 + 0.000000568(p - p_0)$. J. Y. Buchanan gave 0.260×10^{-6} per atm. for the linear compressibility.

According to G. Wertheim, the coeff. of resistance of gold to extension, *i.e.* the **modulus of elasticity**, or **Young's modulus** for drawn wires, is 81.31 kgrms. per sq. mm., and for the annealed metal 55.84 kgrms. per sq. mm. S. Katzenelsohn¹⁰ gave 98.00 kgrms. per sq. mm., and G. S. Meyer, 86.30 kgrms. per sq. mm. for the drawn wire, while W. Voigt gave 75.80 kgrms. per sq. mm. for cast gold. The usually accepted value is 8.0×10^{11} dynes per sq. cm., or 760 grms. per sq. cm. at 15° , with a maximum 980 and a minimum 559 grms. per sq. cm. The values at different temp. have been determined by G. Wertheim, who obtained 55.84 , 54.08 , and 54.82 respectively for the metal at 15° , 100° , and 200° , and S. Katzenelsohn obtained 2.92 for the percentage decrease between 0° and 100° . A. Wassmuth obtained a temp. coeff. 4.09 . K. R. Koch and C. Dannecker found that the fall in the modulus of elasticity is gradual and uniform with rise of temp. A. Mallock obtained 1.32 for the ratio of Young's modulus at 0° K. to its value at 273° K. N. S. Kurnakoff and S. F. Schemtschuschny have measured the *pressure of plastic flow* and shown that gold, along with other metals, behaves like liquids with high internal friction under slow deformation, and like elastic brittle solids under rapid deformation. G. Tammann gave 49 kgrms. per sq. cm. for the **elastic limit** of gold. The ratio of the lateral contraction to the longitudinal extension, or **Poisson's ratio** for gold, is 0.422 . The **volume elasticity**, cubic elasticity, or bulk modulus of gold is 16.6 dynes per sq. cm. The resistance to shearing, or the **rigidity** or **torsion** or **shear modulus** of gold, is 2.77×10^{11} dynes per sq. cm. S. Katzenelsohn gave 3950 kgrms. per sq. mm.; W. Voigt gives 2850 , and F. Horton, 2495 kgrms. per sq. mm. F. Horton gives 2445 kgrms. per sq. mm. at 15° ; 2430 kgrms. per sq. mm. at 34° ; 2400 kgrms. per sq. mm. at 75° ; and 2386 kgrms. per sq. mm. at 98° . He also gives 3.069 for the temp. coeff., or the rigidity n at θ° is $n=n_{15}\{1-2.45(\theta-15)\} \times 10^{11}$ dynes per cm. C. Schäfer gives -3.01 for the temp. coeff. between atm. temp and low temp.

A. Baudrimont¹¹ found the **tensile strength** of cast gold to be 14.45 kgrms. per sq. mm., 20.35 kgrms. per sq. mm. for the hard-drawn wire, and 17.10 to 18.80 kgrms. per sq. mm. for the annealed metal. The tensile strength of a gold wire, one mm. thickness before and after annealing, was as $1:0.69$, and at 0° the

tensile strength is 19 kgrms. per sq. mm.; at 100°, 15·8 kgrms.; and at 200°, 13·1 kgrms. per sq. mm. G. T. and G. N. Beilby gave 15·6 tons per sq. in. as the maximum tensile strength of gold at ordinary temp. F. A. and C. L. Lindemann found the tensile strength of a 0·0513 mm. thick wire to be 134 kgrms. per sq. mm. at -192°, and 98·6 kgrms. per sq. mm. at 170°. J. Dewar found the breaking stress of a gold wire 0·098 in. in diameter, to be 255 lbs. at 15°, and 340 lbs. at -182°. W. C. Roberts-Austen measured the tensile strength of gold alloyed with about 0·2 per cent. of various metals, and found that elements with a higher at. vol. than gold lower the tenacity very considerably, while elements with a similar or lower at. vol. than gold increase the tenacity. Silver, with nearly the same at. vol. as gold, has very little influence on the tenacity. W. C. Roberts-Austen's results are shown in Table III, where the tensile strength of the purified metal is 7 tons per sq. in.

TABLE III.—INFLUENCE OF IMPURITIES ON THE TENSILE STRENGTH OF GOLD.

Impurity.			Tensile strength in tons per sq. inch.
Element.	Per cent.	At. vol.	
Potassium . . .	Below 0·2	45·1	Below 0·5
Bismuth . . .	0·210	20·9	Nearly 0·5
Tellurium . . .	0·186	20·5	3·88
Lead . . .	0·240	18·0	4·17
Thallium . . .	0·193	17·2	6·21
Tin . . .	0·196	16·2	6·21
Antimony . . .	0·203	17·9	Nearly 6
Cadmium . . .	0·202	12·9	6·88
Silver . . .	0·200	10·1	7·10
Palladium . . .	0·205	9·4	7·10
Zinc . . .	0·205	9·1	7·54
Rhodium . . .	0·2 (nearly)	8·4	7·76
Manganese . . .	0·207	6·8	7·99
Indium . . .	0·290	15·3	7·99
Copper . . .	0·193	7·0	8·22
Lithium . . .	0·201	11·8	8·87
Aluminium . . .	0·186	10·6	8·87

A. L. Lavoisier and P. S. Laplace,¹² in 1782, made the first exact measurements of the coeff. of expansion of gold, and found between 0° and 100°, 0·00001466 for fine gold; 0·00001552 for gold not annealed, and 0·00001514 for the annealed metal. According to H. Fizeau, the coeff. of linear expansion of gold between 0° and 100° is 0·00001451; A. Matthiessen gave 0·00001403 at 20°; W. Voigt, 0·00001390 at 30°; according to A. Müller, the coeff. of linear expansion α , at θ , is $\alpha=0·000014157+0·000000215\theta$ between 0° and 520°; W. Voigt gave $\alpha=0·00001414+0·00000239-(\theta-30)$, and, according to A. Matthiessen, the volume v of gold at θ is $v=v_0(1+0·00004075\theta+0·0000000336\theta^2)$, where v_0 is the volume at 0°, or the coeff. of cubical expansion is about 0·000043 at 20°. E. Grüneisen found the mean coeff. of linear expansion between -191° and 17°, $\theta=0·00001316$; between -18·3° and 16·4°, $\alpha=0·00001320$; between 16·1° and 100·6°, $\alpha=0·00001434$; between 15·9° and 100·5°, $\alpha=0·00001429$; and between 17·7° and 100·3°, $\alpha=0·00001430$. J. C. Chapman and H. L. Porter suspended a piece of gold wire with a light load and found that when heated to 184°, the expansion is regular, and the length then remains constant up to 340°, whereafter there is an abrupt contraction. H. F. Wiebe found that the relation $\alpha A/D=0·000121$ for copper, 0·000197 for silver, and 0·00047 for gold, when α denotes the coeff. of expansion, D the sp. gr., and A the at. wt. of the element.

According to G. Wiedemann and R. Franz,¹³ the thermal conductivity of gold

is about half as great as that of silver (*q.v.*). J. H. Gray found for the mean conductivity of copper, between 10° and 97°, numbers between 0.96 and 0.32 cal. per degree difference of temp. per cm. per sec.—the exact value depends on the purity of the metal; for silver and gold the respective values were 0.9628 and 0.7464. W. Jäger and H. Diesselhorst found for pure gold at 18°, 0.7003, and at 100°, 0.7027, which represents a temp. coeff. or an increase of about 0.03 per cent. For 99.8 per cent. metal 0.4278 at 18° and 0.4708 at 100°. E. H. Hall has studied this subject.

H. V. Regnault found the **specific heat** of gold between 12° and 98° to be 0.03244; J. Violle¹⁴ found between 0° and 100°, 0.0316; G. W. A. Kahlbaum, K. Roth, and P. Siedler found a sp. ht. of 0.0309 for gold with 0.1 per cent. of impurity, and 0.03087 for the same metal after compression; W. A. Tilden found 0.03035 between 0° and 100°; H. Schimpff found 0.0302 at 0°; W. Voigt gave 0.0303 for a nearly pure sample between 18° and 99°; P. Nordmeyer and A. Bernoulli, 0.0348 between -185° and 20°; T. W. Richards and F. G. Jackson, 0.0297 at -188°; and J. Dewar, 0.0160 at about -223°. Below 0° the sp. ht. is:

	0°	-23°	-73°	-123°	-173°	-223°
Sp. ht. .	0.0302	0.0298	0.0288	0.0277	0.0260	0.0160

and above 0°:

	50°	100°	200°	600°	1000°	1063.5°
Sp. ht. .	0.03042	0.03065	0.03110	0.03288	0.03466	0.0349

Consequently, the **atomic heat** rises from 3.16 at -223° to 5.96 at 0°, and to 6.88 at 1063.5°.

According to T. K. Rose, when rolled gold is heated, the metal softens and, after passing through a pasty stage, it melts at a *cerise clair* heat just below the m.p. of copper, and above that of silver. The temp. at which the softening occurs is higher when impurities are present, *e.g.* 0.002 per cent. of hydrogen raises it from 150° to 300°; and 0.005 per cent. of copper raises it to 250°. Numbers between the 1035° of J. Violle¹⁵ and the 1421° of L. B. G. de Morveau have been given for the **melting point** of gold. C. T. Heycock and F. H. Neville gave 1061.7°; A. Jaquerod and F. L. Perrot gave 1067° at 200 mm. press.; L. Holborn and A. L. Day gave 1063.9°; E. Tiede and E. Birnbräuer, 1060°; H. Callendar, 1061°; A. L. Day and J. K. Clement gave 1059.3° ± 1°; A. L. Day and R. B. Sosman gave 1062.4° + 0.8°; W. C. Roberts-Austen and T. K. Rose, L. I. Dana and P. D. Foote, W. Guertler and M. Pirani, and K. Scheel gave 1063°, which happens to coincide with the best representative value deduced from the best of the modern determinations. According to L. Holborn and A. L. Day, the absorption of oxygen by gold had very little influence on the m.p., and does not exceed the error of experiment. C. S. M. Pouillet showed that there is a considerable expansion during the melting of gold, and, conversely, in freezing there is a large contraction, so that this metal is not suitable for casting in moulds. C. T. Heycock and F. H. Neville measured the lowering of the f.p. of sodium, cadmium, lead, and bismuth by the soln. of a gram-atom of gold in approximately 100 gram-atoms of the solvent. With tin as solvent there was a rise in the f.p.

Up to the beginning of the eighteenth century no one had noticed any signs of the **volatilization** of gold at a high temp. In 1709, W. Homberg¹⁶ gilded a silver plate by holding it over gold strongly heated in the focus of a burning lens; and in 1802, R. Hare observed the rapid volatilization of gold heated by the ordinary blowpipe, and he found that in a few seconds the vapour stained violet a bone-ash cupel. H. St. C. Deville and H. Debray volatilized and condensed gold when melting it with platinum. E. Tiede and E. Birnbräuer noted volatilization begins at 970° in vacuo. J. Napier, W. Fuchs, C. F. Plattner, S. B. Christy, G. H. Makins, T. K. Rose, K. Friedrich, L. Elsner, W. Lampadius, etc., have studied the losses due to the volatilization of gold in the oxidizing and chloridizing

roasting of ores, and in the cupellation of gold or of gold alloys. The loss of gold by volatilization during the melting of its alloys is the common experience of mints. T. K. Rose found the loss with pure gold is probably nil at the m.p.; it is insignificant at 1075°, being 0.09 part per 1000 per hour; at 1125°, the loss was 1.00 per 1000 per hour; and at 1250°, the loss was 2.60 per 1000 per hour—that is, the loss is about four times as great at 1250° as at 1100°. T. K. Rose further observed that the loss by volatilization is probably independent of the nature of the atm. provided it remains unchanged. There are, however, losses which appear to depend on the nature of the atm., thus, the loss appears to be twice as great in an atm. of carbon monoxide and six times as great in an atm. of coal gas as it is in air. Hence, a protective layer of charcoal on the surface of the molten metal increases the loss by volatilization. The losses in a reducing atm. are due to spirting where showers of globules of metal of all sizes are thrown up, and the smaller ones, especially those less than 0.001 mm. in diameter, are carried away by a draught, however slight, and are difficult to recover. They can be recovered by such a filter as cotton wool. It is this action which causes the unrecovered losses in the crucible melting of gold alloys without a covering of slag. It is therefore difficult to judge from published reports of the volatilization of gold which are due to true vaporization, and which are due to the mechanical transport of fine gold spray. The rate of volatilization was found by T. K. Rose to be augmented by the presence of metal impurities—even a non-volatile metal like platinum slightly accelerates the rate of volatilization; lead also has a slight effect; copper and zinc, a greater effect; while antimony and mercury are still more active. With 0.5 grm. of thin foil, 999.6 fine, containing 0.025 grm. of impurity, T. K. Rose found the loss of gold per 1000 was with the fine gold 0.12, and with gold alloyed with

	Pb	Ni	As	Sb	Bi	Hg	Cd	Zn	Cu	Pt
Loss . . .	0.30	0.30	0.80	1.00	0.50	0.90	0.55	1.60	0.55	0.23

The loss with tellurium was between 3 and 4 per cent. According to J. H. Niemann, selenium also favours the volatilization of gold. T. K. Rose showed that tellurium does not cause the volatilization of gold at temp. below 1100°, and that the observed losses in roasting telluride ores are due to the mechanical transport of fine dust or absorption by the furnace bottoms. The metals most effective in reducing the surface tension of the molten gold increase the volatility in the greatest degree. The loss is greater when the liquid is thrown into waves by heating the metal in a jet of gas of considerable velocity such as occurs when the metal is heated by the blast blowpipe—probably some of the gold here passes off as spray. H. Moissan vaporized 60 grms. of gold in six minutes in his electric furnace, and he showed that when the vapour is condensed in a cold tube, small cubic crystals or filiform gold are produced. The vapour is yellowish-green. A. Schuller found that when gold is heated in a quartz tube in vacuo, it commences to vaporize at 1070°. W. Mostowitsch and W. Pletneff did not detect any volatilization when pure gold is heated between 1100° and 1400° for 25 mins. in air, oxygen, nitrogen, or in carbon monoxide or dioxide, but the volatility is noticeable in hydrogen at 1250°, thus:

	1250°	1300°	1350°	1400°
Percentage volatilized . . .	0.055	0.090	0.105	0.250

The quartz boat was also coloured an intense red when heated in hydrogen, but not in other gases. It has been suggested that possibly *gold hydride* is formed, and that this breaks down immediately into hydrogen and gold; it is also possible that the evolution of occluded gas carries some of the metal mechanically as spray. J. W. Richards calculated the vapour pressure of gold in mm. of mercury to be:

	942°	1165°	1467°	1877°	2322°	2455°	2530°
Vap press. . .	0.0002	0.013	0.0779	26.35	300	548	760 mm.

O. Ruff and B. Bergdahl observed 130 mm. at 2315°; 296 mm. at 2450°; 332 mm. at 2480°; 400 mm. at 2500°; and 760 mm. at 2600°. J. A. M. van Liempt represented the vap. press. p atm. by $\log_{10} p = 7.20 - 20760T^{-1}$. F. Krafft and L. Bergfeld found the b.p. of gold in vacuo is 1800°, and they observed *d'un façon générale* that the difference between the temp. of commencement of vaporization and the b.p. in vacuo is the same as that which exists between the b.p. in vacuo and in atm. air. This makes the **boiling point** of gold 2530° at atm. press.; 3167° at 8 atm. press.; 4057° at 50 atm. press.; and 4858° at 162 atm. press. O. Ruff and B. Bergdahl give 2600° for the b.p. at atm. press.; E. Tiede and E. Bimbräuer, 2100° in vacuo; and J. A. M. van Liempt, 2611° at atm. press. J. W. Richards' estimate for the **latent heat of fusion** of gold is 16.3 cal. per gram. F. Wüst and co-workers found 15.87 cal., and J. W. Richards estimated the **latent heat of vaporization** of gold is 64.47 Cals. per mol, or 32.7 cal. per gram; J. A. M. van Liempt gave 95,060 cal. at the b.p. G. N. Lewis and co-workers give 11.0 for the **entropy** of gold at 25° and atm. press.

Gold, like copper, selectively emits a greenish or bluish light at a high temp. According to Kirchhoff's radiation law, the selective emission and selective reflectivity of these metals at ordinary temp. gives rise to the colour. If E denotes the emissivity of a surface at a temp. T° , and E_0 be the emissivity of a black body at the same temp., the absorptivity A is connected therewith by the relation $E/E_0 = A$; the ratio E/E_0 , called the **relative emissivity**, has been measured for gold by C. M. Stubbs and E. B. R. Prideaux,¹⁷ and a selection from their results is shown in Table IV. There is a sharp discontinuity on passing from the solid

TABLE IV.—THE RELATIVE EMISSIVITY OF SOLID AND LIQUID GOLD.

λ	Solid gold.				Liquid gold.			
	949°	1040°	1061°	Mean.	1067°	1083°	1177°	Mean.
0.7014 μ	0.164	0.134	0.103	0.103	0.202	—	0.174	0.184
0.6409 μ	0.169	0.144	0.143	0.1435	0.226	0.226	0.226	0.232
0.5895 μ	0.241	0.229	0.221	0.229	0.303	0.294	0.309	0.304
0.5418 μ	0.379	0.371	0.366	0.371	0.393	0.381	0.388	0.390
0.4961 μ	0.520	0.465	—	0.4945	0.485	0.418	0.490	0.473
0.4750 μ	0.595	0.492	—	0.531	—	—	0.547	0.503

to the liquid state, so that the relative emissivity of solid gold for the red and yellow rays is weaker, and for the extreme blue rays stronger than for the molten metal. L. Holborn and F. Henning state that there is no change in the emissivity at the m.p., and that the emitted light was so uniform that the difference in the two phases could be perceived only by shaking the crucible. Hence, the solid phase is evident by its having a deeper blue colour. C. E. Mendenhall and L. R. Ingersoll also found that gold and other metals show a marked increase of radiation on melting. The shapes of the curves with different wave-lengths are different; the curve for solid gold at high temp. is similar to that obtained from absorptivity at low temp., but whether the two are identical, and whether $E/E_0 = A$, has not been determined on account of the change of structure which a polished surface undergoes on heating. A. G. Worthing has also studied this subject.

The optical constants of gold, namely, the **refractive index**, μ , and the **absorption index**, k , as well as the **extinction coefficient**, μk , have been defined in connection with the optical constants of copper; similar remarks apply to the **angle of principal incidence**, ϕ , and the **angle of principal azimuth**, ψ , of polarized light. A selection of these constants by K. Försterling and V. Fréedericksz¹⁸ is indicated in Table V. The index of refraction has been studied by W. Meier, II. Rubens, P. Drude, G. Quincke, A. Kundt, A. Pflüger, II. du Bois and H. Rubens,

TABLE V.—OPTICAL CONSTANTS OF GOLD.

λ	ϕ	ψ	μ	k	μk
1.00 μ	81° 45'	44° 00'	0.24	28.0	6.7
2.00 μ	85° 30'	43° 56'	0.47	26.7	12.5
3.00 μ	87° 05'	43° 50'	0.80	24.5	19.6
5.00 μ	88° 15'	43° 25'	1.81	18.1	33.0

etc. D. Shea found for the α -Li-line, $\mu=0.29$ (A. Pfüger gave 0.20); for the D -line, 0.66 (A. Kundt gave 0.58); for the F -line, 0.82 (A. Pfüger gave 1.04); and for the G -line, 0.93 (A. Kundt gave 1.03). W. Meier's values for the index of refraction, absorption index, and extinction coeff., are:

λ	.	0.2573	0.2981	0.3611	0.4413	0.5080	0.5893	0.6680 μ
μ	.	0.918	1.100	1.300	1.175	0.908	0.469	0.355
k	.	1.243	1.239	1.346	1.572	2.574	6.030	9.034
μk	.	1.420	1.374	1.750	1.846	2.075	2.826	3.206

E. Hagen and H. Rubens give for the reflecting power (per cent.), *i.e.* the percentage reflecting power, R , of gold in air, that is, the ratio of the intensity of the reflected ray to that of the incident ray for light of wave-length λ :

$\lambda=0.251\mu$	0.305 μ	0.357 μ	0.385 μ	0.420 μ	0.500 μ	0.600 μ	0.800 μ	1.00 μ	1.50 μ
$R=38.8$	31.8	27.9	27.1	29.3	47.0	84.4	94.9	97.1	97.3

The reflectivity and other optical constants of gold were shown by J. Königsberger, A. Pfüger, and P. Drude to have no appreciable temp. coeff. in the visible spectrum. J. Conroy, and L. P. Wheeler have studied the reflecting power of gold in water and in carbon disulphide; and F. Henning has investigated the emissivity of gold. I. C. Gardner measured the reflection coeff. for Schumann's region of the spectrum. H. Knoblauch has measured the polarization angle of the heat rays—66°50'. The angle of principal incidence has been observed by C. Stasescu, etc.; the angle of principal azimuth by K. Försterling and V. Fréedericksz, etc.; H. Knoblauch, and F. Schön have studied the anomalous dispersion. J. H. Gladstone gave for the refraction equivalent of gold $A(\mu-1)/D=23.1$, when A denotes the at. wt. of the metal, D the sp. gr., and μ the index of refraction. M. Faraday noted the action of thin films of gold on polarized light. Y. Björnsthäl found that the colloidal particles of gold sol are magnetically anisotropic, while the crystals of gold are isotropic, hence it is concluded that the two forms of gold belong to different crystal systems.

According to L. de Boisbaudran,¹⁹ gold chloride imparts a greenish colour to the Bunsen's flame, and the flame spectrum is indicated in Fig. 5. It consists of a series of lines stretching from the yellow to the bluish-green.

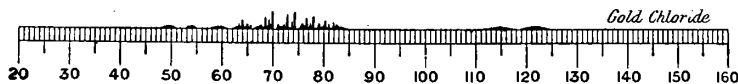

FIG. 5.—Flame Spectrum of Gold Chloride.

The spectrum is clearer if the auric chloride is volatilized in hydrogen. Hydrogen chloride is needed for the production of this spectrum, which is therefore regarded as due to the gold chloride, and not to gold alone. W. N. Hartley and H. W. Moss have studied the spark and the oxy-hydrogen flame spectrum. The spark spectrum of gold chloride, shown in Fig. 6, has some bands corresponding with the flame spectrum, and, in addition, there are brilliant sharp lines due to gold itself. B. de la Roche studied the effect of reducing gases—

hydrogen and coal gas—on the spectrum of gold. According to H. W. Vogel, the spectrum is clearer when the spark gap is large. W. Huggins, R. Thalen, G. Kirchhoff, A. de Gramont, F. Exner and E. Hasehek, H. Kayser and C. Runge, F. M. Walters, and G. Krüss, have measured parts of the spark spectrum. The



FIG. 6.—Spark Spectrum of Gold Chloride.

more prominent lines are 2932·3, 3029·3, and 3122·6 in the ultra-violet; 3898·0 and 4065·2 in the violet; 4437·4 and 4792·8 in the blue; 5064·7 in the green; 5656·0 and 5837·6 in the yellow; and 5957·2 and 6278·4 in the orange or red. J. M. Eder and E. Valenta have located 660 lines. H. Lehmann found the line $\lambda=7509\cdot8$ to be the most intense of those in the ultra-red emission spectrum, and $\lambda=10982\cdot3$ to be the weakest, while $\lambda=9208\cdot0$ is intermediate in intensity. J. M. Eder found $\lambda=2340\cdot22$ to be the most intense line in the ultra-violet spectrum. L. and E. Block studied the spectrum between $\lambda=1850$ and $\lambda=1401$ in the extreme ultra-violet. According to P. G. Nutting, the single and simple lines of the spark spectrum are broadened by increasing the intensity of the source of light. The arc spectrum has been studied by M. Quincke, etc. A. G. Leonard and P. Whelan have studied the spark spectra of dil. soln. of gold chloride with a view of detecting small quantities of the element. W. Hartmann, W. Michelson, and J. E. Purvis have studied the influence of a strong *magnetic field*—the Zeeman effect—on the spectral lines. W. G. Duffield found the lines are broadened by an increasing *pressure*. J. W. Mallet investigated the **absorption spectrum** of colloidal hydrosols of gold and ruby-coloured glass.

According to W. M. Hicks, the series spectra of copper, silver, and gold furnish clear evidence of being built on the same plan, although they seem defective in representatives of the ordinary series lines, and show some apparent deviations from relations exhibited by other groups. According to H. Kayser and C. Runge, there are two pairs of lines with a constant difference in the vibration frequency: the first pair of wave-lengths, 2676·05 and 2428·06, and the second pair, 6278·37 and 5064·75; the differences in the vibration frequencies are in both cases nearly the same. The first named corresponds with the isolated pair in the spectra of silver and gold, and was therefore regarded by J. R. Rydberg as the first member of a principal series. The second pair is possibly a member of a subordinate series. W. M. Hicks has shown the existence of a series in the ultra-red and one in the ultra-violet. The available data have been reviewed by A. Fowler.

According to B. C. Cobb,²⁰ gold becomes photographically active after it has been exposed to the discharge of a Ruhmkorff coil. For the radioactivity, see N. R. Campbell. For the action of α -rays, see H. A. Bumstead and A. G. McGougan, N. R. Campbell, H. Geiger, E. Marsden and co-workers, J. A. Gray, etc. According to W. H. Bragg, the stopping power s of substances for the α -rays is approximately proportional to the sq. root of the at. wt., A , and for gold, $s=4\cdot45$, and $\sqrt{A}=3\cdot70$. E. Rutherford and J. Chadwick found little if any evidence of the emission of long-range α -particles, charged hydrogen atoms, when gold is exposed to α -rays from radium-C. H. R. von Traubenberg found the range of α -rays in gold to be 140×10^{-4} cms. J. Crowther found the coeff. of absorption μ for the β -rays is approximately proportional to the sp. gr. D , and for gold, $\mu/D=9\cdot5$. For the heat developed during the absorption of radiations, see C. W. Richardson and H. L. Cooke. On the characteristics of the **X-rays** emitted by various metals, see C. G. Barkla and C. A. Sadler. The high frequency or X-ray spectrum has been investigated by D. Coster, A. Dauvillier, etc. E. Hjalmar, M. de Broglie,

and W. Duane and co-workers measured the absorption of X-rays by gold. The photoelectric effect with gold has been measured by W. Ramsay and J. F. Spencer,²¹ who arrange the copper family in the order Au, Cu, Ag; K. Herrmann gives the order Cu, Ag, Au; E. Ladenburg, and R. A. Millikan and G. Winchester give the order Cu, Au, Ag. W. Frese found that the photoelectric sensitiveness of gold is not affected by treatment with water or alcohol. E. Ladenburg²² showed that a photoelectric effect can be obtained by passing ultra-violet light through a film of gold, and O. Stuhlmann found that the effect produced by the emergent beam is in general greater than that produced by the incident beam. M. N. Saha studied the ionizing potential of gold.

The electrical conductivity, λ , of gold has been the subject of many measurements. A. Mattheissen and A. von Bose²³ found that if the conductivity of mercury be unity at 0°, the conductivity of hard-drawn gold is 47.07; and of softencd gold, 47.92; otherwise expressed, the specific conductivities in reciprocal ohms of hard and soft gold are respectively 46.8×10^4 and 47.6×10^4 . If λ be the conductivity at θ between 0° and 100°, λ_0 the conductivity at 0°, $\lambda = \lambda_0(1 - 0.0036745\theta + 0.00008442\theta^2)$. W. Jäger and H. Diesselhorst give for the conductivity of hard-drawn gold 41.28×10^4 rec. ohms at 18°, and 32.13×10^4 at 100°; the conductivity is much reduced when the metal is impure, thus gold containing 0.1 per cent. of tellurium and 0.1 per cent. of copper had a specific conductivity of 24.68×10^4 rec. ohms at 18°, and 21.24×10^4 rec. ohms at 100°. J. Dewar and J. A. Fleming found that for gold 999-fine:

λ	-183°	-100.5°	0°	90.4°	194.5°
	146.8×10^4	73.2×10^4	45.5×10^4	34.0×10^4	26.5×10^4 rec. ohms

G. Niccolai also found the electrical conductivity decreases with a rise of *temperature*, and increases as the temp. is lowered. Conversely, J. Dewar and J. A. Fleming found the electrical resistance, R , to fall from 2197×10^{-9} ohms at 0° to 1849×10^{-9} ohms at 44°; 1548.5×10^{-9} ohms at -81.9°; to 1366.8×10^{-9} ohms at -106.1°; and to 681.3×10^{-9} at 197.1°. The temp. coeff. between 0° and 100° is $\alpha = 0.00377$ in $R = R_0(1 - \alpha\theta)$. L. Holborn gave 0.00400 for the temp. coeff. of the resistance per degree between 0° and 100°. E. F. Northrup measured the electrical resistance of gold in micro-ohms per c.c. between 20° and 1500°, and found:

R	20°	300°	500°	800°	1000°	1063°	1063°	1200°	1300°	1500°
	2.316	4.72	6.62	9.94	12.45	13.50	30.83	31.76	34.17	37.00
	Solid.					Liquid.				

The change in the resistance of molten gold with rise of temp. is linear, and almost linear with the solid metal; the ratio of the resistance of the solid at 20° and 1063° is 1:5.827, and at the m.p. the ratio of the resistance of the solid to that of the liquid is 1:2.28. According to H. K. Onnes, for still lower temp. if the ratio of the resistance at θ° to that at 0° steadily falls:

θ°	0°	-103.7°	-195.1°	-252.8°	-259.1°	-268.7
R_θ/R_0	1	0.593	0.219	0.008	0.003	0.002

Consequently, the electrical resistance of gold at the b.p. of helium in vacuo is less than the experimental error involved in the measurement, and therefore the electrical resistance of pure gold probably vanishes towards absolute zero, -273°. A. L. Feild estimated the resistance of *amorphous gold* to be 16.09 micro-ohms per c.c. at 20°. P. W. Bridgman found the general effect of *pressure* on the resistance of gold has the same general character as with silver. P. W. Bridgman found

R		0°	25°	50°	75°	100°
Press. coeff. 0 kgm.		1.0000	1.0977	1.1963	1.2960	1.3968
Press. coeff. 12,000 kgms. per sq. cm.		-0.0,312	-0.0,310	-0.0,380	-0.0,305	-0.0,304
		-0.0,276	-0.0,275	-0.0,276	-0.0,279	-0.0,282

The initial press. coeff. at 0° is -0.053117 . B. Beekman found -0.05527 . S. Pienkowsky found the electrical resistance of a thin sheet of gold is not perceptibly altered by *illumination*. G. Szivessy found the electrical conductivity is not altered by heating the metal in *oxygen*. F. Streinz and A. Welliek measured the electrical resistance at the limiting surface between gold and arsenical pyrites or galene. L. Grunmach and F. Weidert measured the increase of resistance in a *magnetic field*—*vide* silver. F. Credner observed a similar change in the resistance of a gold wire as was obtained with a silver wire, but the increase in resistance occurred at 300°. P. W. Bridgman found that the resistance of thin films of gold, at high current densities, is rather greater than corresponds with Ohm's law.

According to J. Thomsen,²⁴ three **allotropes of gold** are obtained by reducing auric chloride, hydrobromauric acid, and aurous bromide with sulphur dioxide. E. Petersen confirmed this observation. The observed differences were :

	Source.	Specific gravity.	Atomic volume.	Heat of oxidation.
α -Au . .	AuCl ₃	19.39 (19.31–19.45)	10.17	139.9 Cals.
β -Au . .	HAuBr ₄	19.44 (19.40–19.50)	10.14	67.7
γ -Au . .	AuBr	19.72 (19.64–19.83)	10.00	37.9

J. W. van Heteren, however, does not agree with this conclusion, since the different modifications do not show any difference of potential, and he inferred that all three varieties are identical. C. E. Fawsitt, however, showed that if a portion of a rod of silver, gold, or platinum be softened by annealing, and the other portion of the rod of the same metal be hardened by polishing or hammering, there is a difference of potential when the two rods are placed in a soln. of an electrolyte—the hardened rod becomes the negative pole. Hammered gold has an electrode potential of 1.422 volts; polished gold, 1.446 volts; and the same specimen after annealing, 1.454 volts.

The **electrode potential of gold** in molten sodium hydroxide was found by P. Beehtereff²⁵ to rise from 0.328 volt at 386° to 0.537 at 620°, and the value is reduced if the metal has traces of selenium. F. H. Campbell found that the potential of gold in *N*-AuCl₃ against a normal electrode is 1.5 volts. S. B. Christy gives for the e.m.f. in soln. of potassium cyanide :

Per cent. KCy	6.5	0.65	0.065	0.0065	0.0.65	0.0.65	0.0.65	0
E.m.f. volts	+0.420	+0.265	+0.090	+0.340	-0.450	-0.565	-0.620	-0.720

L. Kahlenberg studied the potential in pyridine soln. of lithium chloride. J. Guyot, in soln. of alkali chlorides, cupric salts, and silver nitrate. P. Beehtereff found the cell $C | NaOH_{\text{fused}} | Au$ between 361° and 643° has an e.m.f. of 0.609 to 0.846 volt.

The so-called **electrolytic valve action** prevents the passage of the current in the direction of the flow so long as the applied potential does not reach a certain minimum value. G. Schulze²⁶ finds that the minimum potential of tantalum is 1.51 times that of aluminium when both metals have been prepared at the same potential. F. Giraud found that if two copper strips in electrical communication be dipped in a soln. of gold chloride and one of the strips be twisted or vibrated, it acquires a positive charge, the resting strip, a negative charge.

The hydrogen over-voltage with a gold cathode was found by J. N. Pring²⁷ to be greater than with platinum, and smaller than with zinc, copper, tin, nickel, or lead. G. Just and W. Berezowsky reported that gold electrodes are more readily polarized than those made of platinum, and that the previous history of the electrode is of great influence; treatment with potassium ferrocyanide increases and treatment with potassium ferrieyanide decreases the polarizability; while G. Grube found an anode of gold in neutral or alkaline soln. of a mixture of the two last-named salts in the proportion 1 : 3 at 19° is not polarizable. A. Coehn and C. L. Jacobsen electrolyzed a soln. of auric chloride when gold is deposited at the cathode, and plotted the potentials against the current with a soln. of potassium gold cyanide. There is one break in the curve at -0.2 volt representing the discharge of Au⁻ ions at the cathode; but there are several breaks with a soln. of auric chloride, thus

above -0.905 volt only Au^{+++} -ions are discharged; in fresh soln. containing no aurous salt, the break at -1.1 volt indicated the change of Au^{+++} to Au^{+} -ions; and between -0.985 and -0.905 volt both Au^{+} - and Au^{+++} -ions are discharged from soln. containing aurous and auric chloride. The gold anode is dissolved as a univalent metal in pure potassium cyanide soln., and does not become passive even in conc. soln. of the salt. In soln. of the commercial cyanide, however, it rapidly becomes passive, this being due to the presence of sodium salt as impurity. The passivity is attributed to the formation of a film of comparatively insoluble sodium gold cyanide on the anode. It is said that the passivation of the anode by sodium can be used to detect this metal in the presence of an excess of potassium. H. Kochan found that a gold anode polarized in dil. sulphuric acid is sensible to light of the visible spectrum, to ultra-red light, and to X-rays. W. Winter has studied the **electrolytic valve action** of gold anodes.

According to E. Wohlwill, soln. of gold in potassium cyanide cannot be utilized in electrolytic gold refining, because silver and copper are deposited along with the gold; with neutral soln. of auric chloride or hydrochloroauric acid, chlorine is evolved, and the gold anode is not attacked; and with hydrochloric acid alone, or acidified soln. of hydrochloroauric acid, no chlorine is evolved and the gold anode is dissolved—the alkali chlorides have the same effect as hydrochloric acid. Hence, in order that the gold anode shall dissolve it is necessary that the conditions permit the formation of AuCl_4^{-} -ions. E. Wohlwill also studied the conditions which favour the dissolution of the anode, and the cathodic deposition of the gold. If only trivalent gold exists in the soln. 2.45 grms. of gold should be deposited per amp. hour; in practice more nearly 3 grms. are deposited; this is attributed to the presence of aurous chloride in the soln. The loss at the anode is greater than the gain at the cathode, because there is a loss due to the separation of fine particles of gold, most of which is found in the anode mud; part of the gold dissolved in the aurous state at the anode is decomposed into metallic gold and aurous chloride in the soln., and never reaches the cathode.

The reported values for the **thermoelectric force** of gold against platinum at 100° range from J. Dewar and J. A. Fleming's 0.56 volt to E. Wagner's 0.78 volt; the best representative value is 0.74 volt. L. Holborn and A. L. Day²⁸ give for the *gold-platinum* couple:

	-185°	-80°	100°	200°	400°	600°	800°	1000°
E.m.f.	-0.15	-0.31	$+0.74$	$+1.8$	$+4.5$	$+7.9$	$+12.0$	$+16.8$ volts

K. Noll obtained for *gold-mercury* couple between 0° and 100° , $+713.2$ microvolts for hardened gold, and $+713.4$ for annealed gold. According to P. W. Bridgman, the thermoelectric force of gold against lead, at atm. press. and θ° , is $E=(2.899\theta + 0.00467\theta^2 - 0.00000166\theta^3) \times 10^{-6}$ volts; the **Peltier effect** is $P=(2.899 + 0.00934\theta - 0.00000398\theta^2)(\theta + 273) \times 10^{-6}$ volts; and the **Thomson effect**, $\sigma=(0.00934\theta - 0.00000996\theta)(\theta + 273) \times 10^{-6}$ volts per degree. Table VI contains a selection

TABLE VI.—THE EFFECT OF PRESSURE ON THE SEEBECK, PELTIER, AND THOMSON EFFECTS.

Temp.	Seebeck effect. Volts $\times 10^6$.			Peltier effect. Joules per coulomb $\times 10^6$.			Thomson effect. Joules per coulomb $\times 10^6$.		
	Press. in kgrms. per sq. cm.			Press. in kgrms. per sq. cm.			Press. in kgrms. per sq. cm.		
	2000	6000	12,000	2000	6000	12,000	2000	6000	12,000
10°	+0.080	+0.242	+0.485	+2.1	+6.4	+13.0	+1.5	+3.7	+5.5
40°	+0.354	+1.049	+2.061	+3.1	+9.1	+17.4	+1.7	+4.25	+6.3
60°	+0.564	+1.655	+3.213	+3.7	+10.5	+19.8	+1.8	+4.5	+6.7
100°	+1.052	+3.029	+5.760	+4.9	+13.8	+25.2	+2.0	+5.1	+7.6

from P. W. Bridgman's observations on the effect of press. on couples with compressed and uncompressed gold. All three effects are positive and increase regularly with temp. and press. E. Wagner also made some observations on the effect of temp. E. Sédström has studied the Peltier effect for couples of gold with silver, copper, cadmium, or zinc. G. Borelius and F. Gunneson found the Thomson effect, in microvolts per degree, to be 2.05 at 400° K., 1.61 at 300° K., 1.18 at 200° K., 0.71 at 130° K., and 0.29 at 100° K. A. Cöln and A. Lotz studied the contact electricity of gold against glass in vacuo.

Gold is diamagnetic. According to J. Königsberger,²⁹ the magnetic susceptibility of gold is -3.1×10^{-6} vol. units; and, according to K. Honda, -0.15×10^{-6} mass units between 18° and 1064°; so that, as M. Owen showed, the value is not dependent on the temp. There is a discontinuity at the m.p., as shown in Fig. 8, Cap. XXII. According to M. Hanriot, ordinary yellow α -gold is more strongly diamagnetic than brown β -gold. The magnetization coeff. varies from -0.16×10^{-6} to -0.23×10^{-6} . The change in the magnetization coeff. with temp. exhibits a break between 300° and 400° owing to the transformation of brown into yellow gold. H. Altherthum, and H. K. Onnes and B. Beekmann have studied the Hall effect with gold; and M. Owen, the thermomagnetic behaviour of this metal.

REFERENCES.

¹ C. G. Ehrenberg, *Pogg. Ann.*, 24. 40, 1832; G. Quincke, *ib.*, 136. 642, 1868; G. Rümelin, *Phys. Zeit.*, 13. 1222, 1912; J. W. Mallet, *Phil. Trans.*, 203. 43, 1904; M. Faraday, *ib.*, 147. 145, 1857; H. Ambronn, *Zeit. wiss. Phot.*, 22. 349, 1905; *Ber. Sächs. Ges.*, 48. 618, 1896; W. Beetz, *Ann. Physik*, (4), 18. 590, 1905; C. Stasescu, *ib.*, (4), 33. 1042, 1910; C. Maurin, *Compt. Rend.*, 142. 870, 1906; L. Houlléville, *ib.*, 149. 1368, 1909; H. Schottky, *Nernst's Festschrift*, 438, 1912; H. L. Barvir, *Sitzber. Böhm. Ges.*, 2, 1906; *Neues Jahrb. Min.*, ii, 170, 1908; C. Schuyten, *Bull. Acad. Belgique*, (3), 33. 829, 1897; J. C. Chapman and H. L. Porter, *Proc. Roy. Soc.*, 83. A, 65, 1910; T. Turner, *ib.*, 81. A, 301, 1908; G. T. Beilby, *ib.*, 79. A, 463, 1907; G. T. and H. N. Beilby, 76. A, 426, 1906; G. Tamman, *Gött. Nachr.*, 181, 1911; N. Castoro, *Zeit. Koll.*, 6. 284, 1910; L. P. Wheeler, *Amer. Journ. Science*, (4), 35. 491, 1913.

² J. B. L. Romé de l'Isle, *Cristallographie*, Paris, 3. 476, 1783; R. J. Haüy, *Traité de Minéralogie*, Paris, 3. 376, 1801; F. Mohs, *Grundriss der Mineralogie*, Dresden, 2. 510, 1824; A. Liversidge, *Journ. Roy. Soc. New South Wales*, 27. 299, 1893; *Journ. Chem. Soc.*, 71. 1125, 1897; *Chem. News*, 35. 68, 1877; 49. 264, 1884; 50. 224, 1884; 69. 152, 1894; 70. 199, 1894; W. P. Blake, *The Precious Metals of the United States*, Washington, 573, 1884; G. Rose, *Pogg. Ann.*, 23. 196, 1831; C. F. Neumann, *ib.*, 24. 385, 1832; G. vom Rath, *Neues Jahrb. Min.*, 876, 1876; F. Rinne, *ib.*, ii, 129, 1909; *Zeit. Kryst.*, 1. 1, 1877; K. Martin, *ib.*, 29. 278, 1898; R. Helmhaecker, *ib.*, 1. 511, 1877; K. Koch, *ib.*, 17. 506, 1890; P. Jereimejef, *ib.*, 13. 202, 1888; 29. 278, 1898; J. E. Pougé, *ib.*, 49. 225, 1911; E. S. Dana, *Amer. Journ. Science*, (3), 32. 136, 1886; A. H. Chester, *ib.*, (3), 16. 29, 1878; A. Ditte, *Ann. Chim. Phys.*, (8), 12. 275, 1907; *Compt. Rend.*, 131. 143, 1900; H. Hirschi, *Zeit. prakt. Geol.*, 19. 213, 1911; J. M. MacLaren, *Trans. New Zealand Inst.*, 31. 492, 1899; *B.A. Rep.*, 652, 1901; A. Beutell, *Centr. Min.*, 14, 1919; W. L. Bragg, *Phil. Mag.*, (6), 40. 169, 1920; F. Hesselberg, *Mineralogische Notizen*, Frankfurt, 4. 39, 1870; V. von Lang, *Phil. Mag.*, (4), 25. 435, 1863; W. J. Lewis, *ib.*, (5), 3. 456, 1877; C. G. Lindböm, *Bull. Soc. Chim.*, (2), 29. 416, 1878; C. W. C. Fuchs, *Die künstlich dargestellten Mineralien*, Haarlem, 17, 1872; E. S. von Federoff, *Proc. Russ. Min. Soc.* 30. 455, 1893; G. W. A. Kahlbaum, K. Roth, and P. Siedler, *Zeit. anorg. Chem.*, 29. 178, 1902; N. Averkieff, *ib.*, 35. 329, 1903; 61. 5, 1907; R. Dykes, *Chem. News*, 91. 180, 1904; L. Knaffl, *Dingler's Journ.*, 168. 282, 1863; Z. Jeffries and R. S. Archer, *Mct. Chem. Eng.*, 26. 343, 1922.

³ L. Vegard, *Phil. Mag.*, (6), 32. 65, 1916; P. Sherrer, *Phys. Zeit.*, 19. 23, 1918; N. Gross, *Umschau*, 34. 510, 1920; K. F. Slotte, *Acta Soc. Fennica*, 40. 3, 1911; E. Beekmann and O. Liesche, *Zeit. anorg. Chem.*, 89. 171, 1914; M. N. Saha, *Nature*, 107. 682, 1921.

⁴ J. C. Mullet, *Journ. Asiatique*, (5), 11. 379, 1876; N. Khanikoff, *Journ. Amer. Oriental Soc.*, 6. 1, 1859; H. C. Bolton, *Quart. Journ. Science*, 13. 494, 1876; D. G. Fahrenheit, *Phil. Trans.*, 33. 114, 1726; G. Rose, *Pogg. Ann.*, 73. 1, 1848; 75. 403, 1848; G. Quincke, *ib.*, 135. 642, 1868; F. C. A. H. Lantsberry, *Proc. Birmingham Met. Soc.*, 5. 101, 1913; R. Boyle, *Hydrostatic Balance*, London, 1690; W. C. Roberts-Austen, *Journ. Chem. Soc.*, 27. 197, 1874; C. Hatchett, *Phil. Trans.*, 93. 88, 1803; M. Holzmann and A. Matthiessen, *ib.*, 150. 85, 1860; *Chem. News*, 2. 217, 1860; T. M. Lowry, *Journ. Inst. Metals*, 21. 359, 1919; M. J. Brissou, *Pesanteur spécifiques des corps*, Paris, 1787; G. W. A. Kahlbaum, K. Roth, and P. Siedler, *Zeit. anorg. Chem.*, 29. 178, 1902; N. Averkieff, *ib.*, 35. 329, 1903; W. A. Tilden, *Chem. News*, 78. 16, 1898; T. M. Lowry and R. G. Parker, *Journ. Chem. Soc.*, 107. 1005, 1915.

⁵ B. Kerl, *Handbuch der metallurgischen Hüttenkunde*, Freiberg, 428, 1865; A. Hanriot, *Compt. Rend.*, 155. 713, 1912; C. Calvert and R. Johnson, *Mem. Manchester Lit. Phil. Soc.*, (2), 15. 113, 1858; *Phil. Mag.*, (4), 17. 114, 1859; F. Auerbach, *Wied. Ann.*, 43. 61, 1891; J. R. Rydberg, *Zeit. phys. Chem.*, 33. 353, 1900; S. Bottone, *Chem. News*, 28. 215, 1873; T. Turner, *Journ. I. S. Inst.*, 75. 1, 434, 1909; C. A. Edwards, *Metal Ind.*, 17. 221, 1921.

⁶ J. Fournet, *Ann. Chim. Phys.*, (2), 75. 435, 1840; E. Vigouroux, *ib.*, (7), 12. 170, 1897; S. Kalischer, *Ber.*, 15. 702, 1882; F. Mylius, *Zeit. anorg. Chem.*, 70. 231, 1911; J. W. Mallet, *Phil. Trans.*, 203. 43, 1904; F. A. and C. L. Lindemann, *Nernst's Festschrift*, 265, 1912.

⁷ A. Heydweiller, *Wied. Ann.*, 62. 694, 1897; 65. 311, 1898; G. Quincke, *ib.*, 61. 267, 1897; 52. 1, 1894; *Pogg. Ann.*, 134. 354, 1868; 135. 261, 1869; *Phil. Mag.*, (4), 36. 267, 1868; (4), 38. 78, 1869; A. Gradewitz, *Ueber eine neue Methode zur Bestimmung von Kapillarkonstanten verdünnter Salzlösungen*, Breslau, 1902; L. Grunmach, *Ann. Physik*, (4), 1. 660, 1900; S. W. Smith, *Journ. Inst. Metals*, 12. 168, 1914; 17. 65, 1917; I. Traube, *Ber. deut. phys. Ges.*, 11. 231, 1909; *Ber.*, 42. 86, 1909.

⁸ A. Masson, *Compt. Rend.*, 44. 464, 1857; *Phil. Mag.*, (4), 13. 533, 1857; G. Wertheim, *Ann. Chim. Phys.*, (3), 12. 385, 1844; C. E. Guye and H. Schapper, *Compt. Rend.*, 160. 962, 1910; C. E. Guye, *ib.*, 149. 1066, 1909; C. E. Guye and S. Mintz, *Arch. Sciences Genève*, (4), 26. 163, 1908; C. E. Guye, *Journ. Phys.*, (5), 2. 620, 1912; M. Ishimoto, *Proc. Math. Phys. Soc. Japan*, (3), 1. 267, 1919; W. C. Roberts-Austen, *Phil. Trans.*, 187. A, 383, 1896; *Proc. Roy. Soc.*, 67. 101, 1900; C. E. van Orstrand and F. P. Dewey, *Prof. Paper, U.S. Geol. Sur.*, 95. 83, 1915; A. Johnsen, *Centr. Min.*, 233, 1918; E. Keller, *Trans. Amer. Inst. Min. Eng.*, 60. 698, 1920; W. Fraenkel and H. Houben, *Zeit. anorg. Chem.*, 116. 1, 1921.

⁹ T. W. Richards, *Journ. Amer. Chem. Soc.*, 37. 470, 1643, 1915; L. H. Adams, E. D. Williamson, and J. Johnston, *ib.*, 41. 12, 1919; J. Y. Buchanan, *Proc. Roy. Soc.*, 73. 296, 1904.

¹⁰ W. Voigt, *Wied. Ann.*, 48. 774, 1893; G. S. Meyer, *ib.*, 59. 668, 1896; G. Wertheim, *Ann. Chim. Phys.*, (3), 23. 52, 1849; S. Katzenelsohn, *Ueber den Einfluss der Temperatur auf die Elasticität der Metalle*, Berlin, 1887; E. Grüneisen, *Ann. Physik*, (4), 22. 801, 1907; (4), 33. 1262, 1910; K. R. Koch and C. Dannecker, *ib.*, (4), 47. 197, 1915; A. Wassmuth, *ib.*, (4), 13. 182, 1904; *Phys. Zeit.*, 6. 755, 1904; *Sitzber. Akad. Wien.*, 115. 223, 1906; C. Schäfer, *ib.*, (4), 5. 233, 1901; G. Tammann, *Gött. Nachr.*, 181, 1911; A. Mallock, *Proc. Roy. Soc.*, 95. A, 429, 1919; W. Sutherland, *Phil. Mag.*, (5), 32. 31, 215, 524, 1891; F. Horton, *Phil. Trans.*, 204. A, 1, 1905; *Proc. Roy. Soc.*, 73. 334, 1904; 74. 401, 1905; N. S. Kurnakoff and S. F. Schemtschuschny, *Journ. Russ. Phys. Chem. Soc.*, 45. 1004, 1913.

¹¹ A. Baudrimont, *Ann. Chim. Phys.*, (3), 12. 385, 1844; F. A. and C. L. Lindemann, *Nernst's Festschrift*, 264, 1912; G. T. and G. N. Beilby, *Proc. Roy. Soc.*, 76. A, 426, 1906; W. C. Roberts-Austen, *ib.*, 43. 425, 1888; A. Mallock, *ib.*, 95. A, 429, 1919; J. Dewar, *Chem. News*, 71. 200, 1895.

¹² H. Fizeau, *Compt. Rend.*, 68. 1125, 1869; A. Matthiessen, *Phil. Mag.*, (4), 32. 472, 1866; *Pogg. Ann.*, 130. 50, 1867; W. Voigt, *Gött. Nachr.*, 177, 1893; A. Müller, *Phys. Zeit.*, 17. 29, 1916; J. C. Chapman, and H. L. Porter, *Proc. Roy. Soc.*, 83. 65, 1910; E. Grüneisen, *Ann. Physik*, (4), 33. 51, 1910; H. F. Wiebe, *Ber.*, 11. 610, 1878; 12. 788, 1761, 1879; A. L. Lavoisier and P. S. Laplace, *Recueil des mémoires de Lavoisier*, Paris, 1. 121, 1805; *Ostwald's Klassiker*, 40, 1892.

¹³ G. Wiedemann and R. Franz, *Pogg. Ann.*, 89. 497, 1853; *Phil. Mag.*, (4), 7. 33, 1854; J. H. Gray, *Phil. Trans.*, 186. A, 165, 1895; W. Jäger and H. Diesselhorst, *Wiss. Abh. Phys. Tech. Reichsanst.*, 3. 269, 1900; E. H. Hall, *Proc. Nat. Acad. Sciences*, 6. 613, 1920; E. Grüneisen, *Ann. Physik*, (4), 33. 33, 65, 1910.

¹⁴ J. Violle, *Compt. Rend.*, 89. 703, 1879; H. V. Regnault, *Ann. Chim. Phys.*, (2), 73. 5, 1840; (3), 1. 129, 1841; (3), 9. 322, 1843; G. W. A. Kahlbaum, K. Roth, and P. Siedler, *Zeit. anorg. Chem.*, 29. 178, 1902; P. Nordmeyer and A. Bernoulli, *Ber. deut. phys. Ges.*, 5. 175, 1907; W. Voigt, *Gött. Nachr.*, 6, 1893; E. Grüneisen, *Ann. Physik*, (4), 33. 65, 1910; T. W. Richards and F. G. Jackson, *Zeit. phys. Chem.*, 70. 414, 1910; H. Schimpff, *ib.*, 71. 259, 1910; J. Dewar, *Proc. Roy. Soc.*, 89. A, 158, 1913; W. A. Tilden, *ib.*, 66. 244, 1900.

¹⁵ C. S. M. Pouillet, *Éléments de physique*, Paris, 1. 318, 1832; 1. 265, 1856; L. B. G. de Morveau, *Ann. Chim. Phys.*, (1), 90. 236, 1914; A. C. Becquerel, *Compt. Rend.*, 57. 855, 1865; J. Violle, *ib.*, 89. 702, 1879; H. le Chatelier, *ib.*, 121. 325, 1895; D. Berthelot, *ib.*, 126. 473, 1898; 138. 1153, 1904; A. D. van Riemsdyk, *Chem. News*, 20. 32, 1869; *Arch. Néerl.*, 3. 357, 1869; C. T. Heycock and F. H. Neville, *Journ. Chem. Soc.*, 61. 895, 1892; 67. 160, 1895; *Phil. Trans.*, 189. A, 37, 1897; L. I. Dana and P. D. Foote, *Trans. Faraday Soc.*, 15. 186, 1920; W. Guertler and M. Pirani, *Zeit. Metallkunde*, 11. 1, 1919; H. V. D. Weyde, *Ber.*, 12. 441, 1879; C. Barus, *Amer. Journ. Science*, (3), 48. 332, 1894; A. L. Day and R. B. Sosman, *ib.*, (4), 29. 93, 1910; A. L. Day and J. K. Clement, *ib.*, (4), 26. 405, 1898; L. Holborn and F. Perrot, *Compt. Rend.*, 138. 1032, 1904; L. Holborn and A. L. Day, *Ann. Physik*, (4), 4. 101, 1901; O. Ruff and O. Göcke, *Zeit. angew. Chem.*, 24. 1459, 1911; L. Holborn and W. Wien, *Wied. Ann.*, 56. 360, 1895; E. Jänecke, *Zeit. phys. Chem.*, 67. 670, 1909; W. C. Roberts-Austen and T. K. Rose, *Proc. Roy. Soc.*, 67. 105, 1901; *Chem. News*, 87. 2, 1903; A. Jaquerod and F. L. Perrot, *Arch. Sciences Genève*, (4), 20. 506, 1906; F. Wüst, A. Meuthen, and R. Durrer, *Zeit. Instrumentenk.*, 39. 294, 1919; J. Prinsop, *Phil. Trans.*, 118. 94, 1828; J. F. Daniell, *ib.*, 120. 257, 1830; 121. 443, 1831; *Phil. Mag.*, (3), 11. 191, 268, 350, 1830; H. Callendar, *ib.*, (5), 33. 220, 1892; (5), 48. 519, 1899; T. K. Rose, *Journ. Inst. Metals*, 10. 150, 1913; K. Scheel, *Zeit. angew. Chem.*, 32. 347, 1919.

¹⁶ W. Homberg, *Mém. Acad.*, 106, 1709; R. Hare, *Tilloch's Phil. Mag.*, 14, 238, 298, 1802; *Memoir of the Supply and Application of the Blowpipe*, Philadelphia, 1802; J. Napier, *Journ. Chem. Soc.*, 10, 229, 1857; 11, 168, 1858; G. H. Makins, *ib.*, 13, 97, 1860; T. K. Rose, *ib.*, 63, 714, 1893; *The Metallurgy of Gold*, London, 6, 1906; *B.A. Rep.*, 623, 1897; *Trans. Inst. Min. Met.*, 174, 1919; W. Fuchs, *Sitzber. Akad. Wien*, 4, 270, 1850; S. B. Christy, *Trans. Amer. Inst. Min. Eng.*, 17, 3, 1888; A. D. van Riemsdijk, *Chem. News*, 20, 32, 1869; *Arch. Néer.*, 3, 357, 1858; C. F. Plattner, *Die metallurgischen Röstprozesse*, Freiberg, 1856; H. St. C. Deville and H. Debray, *Ann. Chim. Phys.*, (3), 56, 385, 1859; K. Friedrich, *Zeit. angew. Chem.*, 16, 269, 1903; H. Moissan, *Compt. Rend.*, 116, 1429, 1893; 141, 853, 977, 1905; F. Krafft and L. Bergfeld, *Ber.*, 36, 1690, 1903; 38, 254, 1905; A. Schuller, *Zeit. anorg. Chem.*, 37, 69, 1904; O. Ruff and B. Bergdahl, *ib.*, 106, 76, 1919; J. A. M. van Liempst, *ib.*, 114, 105, 1920; E. Tiedce and E. Birnbräuer, *ib.*, 87, 129, 1914; 88, 364, 1914; E. F. Kern and A. A. Heimrod, *School Mines Quart.*, 33, 34, 1911; T. K. Rose, *Trans. Inst. Min. Met.*, 14, 378, 1904; W. Mostowitsch and W. Plctneff, *Journ. Russ. Met. Soc.*, 3, 410, 1915; *Met. Chem. Eng.*, 16, 153, 1917; W. A. Lampadius, *Journ. prakt. Chem.*, (1), 16, 204, 1839; L. Elsner, *ib.*, (1), 99, 257, 1866; J. W. Richards, *Metallurgical Calculations*, New York, 3, 588, 1908; J. H. Niemann, *Min. Scient. Press.*, 107, 943, 1913; W. Crookes, *Chem. News*, 63, 287, 1891; F. Ehrenhaft, *Phys. Zeit.*, 11, 619, 1910; F. Fischer and F. Schröter, *Ber.*, 43, 1454, 1910; F. Fischer and O. Hähnel, *Zeit. Elektrochem.*, 14, 437, 1908; V. Kohlschütter and T. Goldschmidt, *ib.*, 14, 221, 1908; C. A. Skinner, *Phil. Mag.*, (6), 8, 387, 1904; F. Wüst, A. Meuthen, and R. Durrer, *Zeit. Instrumentenb.*, 39, 294, 1919; G. N. Lewis and G. E. Gibson, *Journ. Amer. Chem. Soc.*, 39, 2554, 1917; G. N. Lewis, G. E. Gibson, and W. M. Latimer, *ib.*, 44, 1008, 1922.

¹⁷ C. M. Stubbs and E. B. R. Prideaux, *Proc. Roy. Soc.*, 87, A, 451, 1912; L. Holborn and F. Henning, *Sitzber. Akad. Berlin*, 311, 1905; C. E. Mendenhall and L. R. Ingersoll, *Phys. Rev.*, (1), 25, 1, 1907; A. G. Worthing, *Journ. Franklin Inst.*, 192, 112, 1921.

¹⁸ D. Shea, *Wied. Ann.*, 47, 177, 1892; A. Kundt, *ib.*, 27, 61, 1886; 34, 477, 1888; 36, 824, 1889; A. Pflüger, *ib.*, 58, 495, 1896; P. Drude, *ib.*, 36, 548, 1889; 39, 537, 1890; H. Rubens, *ib.*, 37, 249, 1889; H. Knoblauch, *ib.*, 24, 260, 1885; H. du Bois and H. Rubens, *ib.*, 41, 507, 1890; G. Quincke, *Pogg. Ann. Jubelbd.*, 336, 1874; F. Henning, *Jahrb. Rad. Elektronik.*, 17, 30, 1920; W. Meier, *Ann. Physik.*, (4), 31, 1018, 1910; C. Statescu, *io.*, (4), 33, 1057, 1910; K. Försterling and V. Fréedericksz, *ib.*, (4), 40, 201, 1913; E. Hagen and H. Rubens, *ib.*, (4), 1, 373, 1900; (4), 8, 16, 1902; (4), 11, 881, 1903; *Sitzber. Akad. Berlin*, 269, 410, 1903; *Phys. Zeit.*, 4, 727, 1903; *Ann. Chim. Phys.*, (8), 1, 185, 1904; F. Schön, *Zeit. wiss. Phot.*, 5, 349, 1907; M. Laue and F. F. Martens, *Verh. deut. phys. Ges.*, 9, 522, 1907; *Phys. Zeit.*, 8, 833, 1907; J. H. Gladstone, *Phil. Trans.*, 159, 13, 1869; J. Königsberger, *Verh. deut. phys. Ges.*, 1, 247, 1899; W. Rathenau, *Die Absorption des Lichts in Metallen*, Berlin, 1889; J. Conroy, *Proc. Roy. Soc.*, 28, 242, 1879; 31, 486, 1881; L. P. Wheeler, *Phil. Mag.*, (6), 22, 229, 1911; M. Faraday, *Phil. Trans.*, 147, 137, 1857; I. C. Gardner, *Astrophys. Journ.*, 45, 1, 1917; Y. Björnsthäl, *Phil. Mag.*, (6), 42, 352, 1921.

¹⁹ J. M. Eder and E. Valenta, *Sitzber. Akad. Wien*, 63, 189, 1871; 118, 1085, 1909; J. M. Eder, *ib.*, 122, 622, 1913; *Zeit. wiss. Phot.*, 13, 20, 1914; F. Exner and E. Haschek, *ib.*, 106, 1127, 1897; H. Kayser and C. Runge, *Wied. Ann.*, 46, 225, 1892; H. Lehmann, *Ann. Physik.*, (4), 39, 75, 1912; O. Lüttich and W. Hartmann, *ib.*, (4), 38, 53, 1912; W. Michelson, *Nature*, 59, 440, 1899; J. E. Purvis, *Proc. Cambridge Phil. Soc.*, 14, 217, 1907; 13, 82, 1906; W. Hartmann, *Das Zeemannphänomen in sichtbarem Spektrum von Kupfer, Eisen, Gold, und Chrom*, Halle, 1907; W. M. Hicks, *Phil. Mag.*, (6), 31, 171, 1916; (6), 38, 1, 1919; J. R. Rydberg, *ib.*, (5), 29, 331, 1890; *Zeit. phys. Chem.*, 5, 227, 1890; *Compt. Rend.*, 110, 394, 1890; *Astrophys. Journ.*, 6, 239, 1897; Figs. 5 and 6 are kindly loaned from W. M. Watts' *An Introduction to the Study of Spectrum Analysis*, London, 1904; A. de Gramont, *Compt. Rend.*, 144, 1101, 1907; 151, 308, 1910; *Bull. Soc. Min.*, 18, 21, 1895; P. G. Nutting, *Astrophys. Journ.*, 23, 64, 1906; H. W. Morse, *ib.*, 21, 223, 1905; W. N. Hartley and H. W. Moss, *Proc. Roy. Soc.*, 87, A, 38, 1912; W. N. Hartley, *ib.*, 79, A, 242, 1907; W. G. Duffield, *ib.*, 84, A, 118, 1910; J. W. Mallet, *Phil. Trans.*, 203, 43, 1904; W. Huggins, *ib.*, 154, 139, 1864; A. G. Leonard and P. Whelan, *Proc. Roy. Soc. Dublin*, (2), 15, 273, 1918; L. and E. Bloch, *Compt. Rend.*, 172, 803, 962, 1921; D. Coster, *Zeit. Physik*, 4, 178, 1921; B. de la Roche, *Bull. Soc. Chim.*, (4), 25, 305, 1919; H. W. Vogel, *Die praktische Spektralanalyse irischer Stoffe*, Berlin, 1889; G. Krüss, *Liebig's Ann.*, 238, 30, 1887; L. de Boisbaudran, *Spectres lumineux*, Paris, 1894; R. Thalen, *Om spectralanalyse*, Upsala, 1866; *Nova Acta Upsala*, 6, 3, 1868; G. Kirchhoff, *Sitzber. Akad. Berlin*, 63, 1861; 227, 1863; L. and E. Block, *Compt. Rend.*, 172, 962, 1921; F. M. Walters, *Scient. Paper Bur. Standards*, 17, 161, 1921; M. Quincke, *Zeit. wiss. Photo.*, 14, 249, 1915; A. Fowler, *Report on Series in Line Spectra*, London, 113, 1922.

²⁰ W. H. Bragg, *Phil. Mag.*, (6), 11, 617, 1906; J. Crowther, *ib.*, (6), 12, 397, 1906; N. R. Campbell, *ib.*, (6), 11, 206, 1906; (6), 24, 527, 1912; C. W. Richardson and H. L. Cooke, *ib.*, (6), 21, 404, 1911; H. A. Bumstead and A. G. McGougan, *ib.*, (6), 24, 462, 1912; *Amer. Journ. Science*, (4), 34, 309, 1912; H. A. Bumstead, *ib.*, (4), 32, 403, 1911; *Phil. Mag.*, (6), 22, 907, 1911; E. Marsden and H. Richardson, *ib.*, (6), 25, 184, 1913; C. G. Barkla and C. A. Sadler, *ib.*, (6), 17, 739, 1909; E. C. Cobb, *Chem. News*, 99, 209, 1909; M. de Broglie, *Journ. Phys.*, (5), 6, 161, 1916; E. Rutherford and J. Chadwick, *Nature*, 107, 41, 1921; W. Duane, H. Fricke, and W. Stenström, *Proc. Nat. Acad. Science*, 6, 607, 1920; H. R. von Traubenberg, *Zeit. Physik*, 2, 268, 1920; R. Whiddington, *Proc. Roy. Soc.*, 86, A, 360, 1912; J. C. Chapman, *ib.*, 86, A,

439, 1912; H. Geiger, *ib.*, 81. A, 174, 1908; 83. A, 492, 1910; E. Marsden and T. S. Taylor, *ib.*, 88. A, 443, 1913; J. A. Gray, *ib.*, 85. A, 131, 1911; P. D. Innes, *ib.*, 79. A, 442, 1907; D. Coster, *Zeit. Physik*, 6, 185, 1921; *Phys. Rev.*, (2), 19, 20, 1922; A. Dauvillier, *Compt. Rend.*, 173, 647, 1921; E. Hjalmar, *Zeit. Physik*, 7, 341, 1921.

²¹ W. Ramsay and J. F. Spencer, *Phil. Mag.*, (6), 12, 397, 1906; R. A. Millikan and G. Winchster, *ib.*, (6), 14, 188, 1907; K. Herrmann, *Beiträge zum Hallwackseffekt*, Berlin, 1908; E. Ladenburg, *Ann. Physik*, (4), 12, 558, 1903; L. de Broglie, *Compt. Rend.*, 170, 585, 1920; G. Reoul, *ib.*, 158, 477, 1914; W. Frese, *Zeit. Wiss. Photo.*, 21, 37, 1921.

²² E. Ladenburg, *Verh. deut. phys. Ges.*, 9, 24, 1907; O. Stuhlmann, *Phil. Mag.*, (6), 20, 331, 1910; (6), 22, 845, 1911; M. N. Saha, *Nature*, 107, 682, 1921.

²³ J. Dewar and J. A. Fleming, *Phil. Mag.*, (5), 36, 271, 1893; W. Jäger and H. Diesselhorst, *Abhand. Phys. Tech. Reichsanst.*, 3, 269, 1900; A. Mattheissen and A. von Bose, *Pogg. Ann.*, 115, 353, 1862; *Proc. Roy. Soc.*, 11, 516, 1862; *Phil. Trans.*, 152, 1, 1862; E. F. Northrup, *Journ. Franklin Inst.*, 177, 287, 1914; L. Holborn, *Ann. Physik*, (4), 59, 14, 1919; *Zeit. Physik*, 8, 58, 1921; H. K. Onnes, *Rev. Mét.*, 8, 593, 1911; *Comm. Phys. Lab. Leiden*, 10, 119, 120b, 1911; *Versl. Akad. Amsterdam*, 19, 1187, 1911; R. Benoît, *Compt. Rend.*, 76, 342, 1873; H. Dickson, *ib.*, (5), 45, 525, 1898; H. Ihle, *Jahrb. Gymn. Dresden Neustadt*, 22, 3, 1896; V. Strouhal and C. Barus, *Abh. Böhm. Ges.*, 12, 15, 1884; H. Diesselhorst, *Ann. Physik*, (4), 11, 891, 1903; G. Szivessy, *ib.*, (4), 23, 963, 1907; F. Credner, *Zeit. phys. Chem.*, 82, 457, 1913; S. Pienkowsky, *Bull. Acad. Belgique*, 603, 1911; F. Streintz and A. Welliek, *Phys. Zeit.*, 12, 845, 1911; L. Grunmach and F. Weidert, *ib.*, 7, 729, 1906; *Ber. deut. phys. Ges.*, 4, 359, 1907; R. Abegg, *Zeit. Elektrochem.*, 13, 440, 1907; G. Nicolai, *Atti Accad. Lincei*, (5), 16, i, 1906; 17, ii, 185, 1907; P. W. Bridgman, *Proc. Amer. Acad.*, 52, 573, 1917; *Proc. Nat. Acad. Sciences*, 7, 299, 1921; B. Beckman, *Ann. Physik*, (4), 46, 481, 931, 1915; *Ark. Mat. Astr. Fys.*, 7, 42, 1912; P. Cohn, *Wied. Ann.*, 41, 71, 1890; A. L. Feild, *Mét. Chem. Eng.*, 21, 566, 1919.

²⁴ J. Thomsen, *Journ. prakt. Chem.*, (2), 13, 365, 1876; *Thermochemische Untersuchungen*, Leipzig, 3, 398, 1883; E. Petersen, *Zeit. phys. Chem.*, 8, 601, 1891; J. W. van Heteren, *Chem. Weekb.*, 2, 47, 1905; E. Cohen and J. W. van Heteren, *Zeit. Elektrochem.*, 12, 589, 1906; C. E. Fawsitt, *Proc. Roy. Soc. Edin.*, 26, 2, 1906; *Journ. Soc. Chem. Ind.*, 25, 1133, 1907.

²⁵ P. Bechtereff, *Zeit. Elektrochem.*, 17, 860, 1911; F. H. Campbell, *Chem. News*, 96, 26, 1907; S. B. Christy, *Amer. Chem. Journ.*, 37, 345, 1902; L. Kahlenberg, *Trans. Amer. Elektrochem. Soc.*, 6, 61, 1904; J. Guyot, *Compt. Rend.*, 153, 867, 1911; 156, 220, 1913; P. Dutoit, *Bull. Soc. Chim.*, (4), 7, 1, 1910.

²⁶ G. Schulze, *Ann. Physik*, (4), 41, 593, 1913; F. Giraud, *Compt. Rend.*, 157, 586, 1913.

²⁷ J. N. Pring, *Zeit. Elektrochem.*, 19, 255, 1913; G. Just and W. Berezowsky, *ib.*, 15, 297, 1909; E. Wohlwill, *ib.*, 4, 397, 402, 421, 1898; G. Grube, *ib.*, 18, 192, 1912; A. Coehn and C. L. Jacobsen, *Zeit. anorg. Chem.*, 55, 321, 1907; H. Koehan, *Beiträge zur Kenntnis der anodisch polarisierten lichtempfindlichen Goldelektrode*, Breslau, 1902; C. L. Jacobsen, *Ueber das elektrochemische Verhalten des Goldes und seine Passivität*, Leipzig, 1907; W. Winter, *Phys. Zeit.*, 14, 823, 1913.

²⁸ L. Holborn and A. L. Day, *Ann. Physik*, (4), 2, 505, 1900; E. Wagner, *ib.*, (4), 27, 955, 1908; E. Sedström, *ib.*, (4), 59, 134, 1919; G. T. Beilby, *Proc. Roy. Soc.*, 79, A, 463, 1907; W. Jäger and H. Diesselhorst, *Wiss. Abh. Phys. Tech. Reichsanst.*, 3, 269, 1900; J. Dewar and J. A. Fleming, *Phil. Mag.*, (5), 40, 95, 1895; W. H. Steile, *ib.*, (5), 37, 218, 1894; K. Noll, *Wied. Ann.*, 53, 874, 1894; P. W. Bridgman, *Proc. Amer. Acad.*, 53, 269, 1918; G. Borelius and F. Gunneson, *Ann. Physik*, (4), 65, 520, 1921; A. Cöhn and A. Lotz, *Zeit. Physik*, 5, 242, 1921.

²⁹ J. Königsberger, *Wied. Ann.*, 66, 698, 1898; M. Hanriot and F. Raoult, *Compt. Rend.*, 153, 182, 1911; *Bull. Soc. Chim.*, (4), 9, 1052, 1911; K. Honda, *Ann. Physik*, (4), 32, 1027, 1910; M. Owen, *ib.*, (4), 37, 657, 1912; H. Altherthum, *ib.*, (4), 39, 937, 1912; (4), 40, 391, 1913; H. K. Onnes and B. Beckmann, *Comm. Phys. Lab. Leiden*, 11, 129, 1912.

§ 6. The Chemical Properties of Gold

The general chemical behaviour of gold is connected with its relatively small affinity for the other elements. At the time Pliny's *Historia naturalis* was written, gold was considered to be "the only substance in nature that suffers no loss by the action of fire; because it passes unscathed through the flames of the funeral pyre." Indeed, continued Pliny, "the oftener gold is subject to the action of fire, the more refined becomes the quality." Testing the goodness of gold by fire was known as *obrussa—obryza*, or *obrizza*, from *ὄβρυζον*, pure gold.

Gold is not attacked by air or oxygen—moist or dry, hot or cold. Hence, the alchemists called gold a *noble metal* in contrast with the *base metals*—like lead, copper, tin, iron, etc.—which are oxidized and lose their metallic characters when

heated in air. The fact that Moses (*Exod.*, 32. 20) was able to reduce Aaron's "golden calf" to ashes by fire led some of the early chemists to make conjectures as to what Moses actually did.¹ G. E. Stahl suggested that the gold was dissolved in a soln. of alkali sulphide; and W. Herapath that the metal was dissolved in aqua regia; J. D. Smith supposed that the idol was fused with an alloy which made the gold so brittle that it could be ground to powder, otherwise expressed, the gold of Aaron and his religious brethren was a kind of brass alloyed with some gold. Many other suggestions have been made, but in the absence of essential details, nothing is gained by prolonging the old discussion. The result, however, is a good illustration of the *influence of temperament on inquiry*. Two men may be presented with the same phenomenon and they may draw opposite conclusions, both of which are based on the different aspects of the phenomenon to which the men directed their attention. Still more is this the case when but a meagre report of a supposed phenomenon is available. Instinctive or acquired tendencies, temperament, and thought are so inseparably mingled that there is often a very real difficulty in applying purely logical reasoning. In such cases Socrates' advice is invaluable:

What is the good of talking about something if you do not know clearly what it is, for all your observations may have been concerned with something different? but you would be as unable to know this as a man who set out to find something without knowing what it was, would never be able to tell when he had found it.

J. Prinsep² found an increase in weight occurred when an alloy of gold and platinum is melted in a forge fire, although no residue of carbon appears when the alloy was dissolved in aqua regia. T. Graham found that gold cornets when strongly heated in vacuo gave up 0.2 per 1000 of their weight, or 2.12 times their volume of gas, the bulk of which was carbon monoxide, as shown by the analysis:

CO	CO ₂	H ₂	N ₂	O ₂
65.4	14.6	15.4	4.3	0.3 per cent.

T. K. Rose also showed that furnace gases are always absorbed by the molten metal, the amount varying in weight from 0.25 per 1000 in the case of gold heated to 1215° in air, to 7.8 parts per 1000 of gold heated to the same temp. in coal gas. T. Graham further observed that when gold was heated and cooled in a stream of air, the occluded gas amounted to 0.22 vol. per volume of gold, and contained 86.3 per cent. of nitrogen, 8.4 per cent. of carbon dioxide, and 5.3 per cent. of oxygen. The occluded gas was principally nitrogen, and, said T. Graham, "the indifference of gold to oxygen is remarkable and contrasts with the power of silver to occlude this same gas." G. Neumann found that gold can absorb about 32.78 to 48.49 times its vol. of oxygen. A. Sieverts and E. Bergner found that liquid gold at 1220° does not absorb helium. A. Sieverts also stated that hydrogen and nitrogen are not absorbed by solid or melted gold. T. Graham further showed that gold can absorb 0.3 vol. of carbon monoxide, 0.2 vol. of carbon dioxide, and 0.48 vol. of hydrogen. J. Trowbridge found gold absorbs 37.31 to 46.32 times its vol. of hydrogen, and G. Neumann, that molten gold can absorb 37.31 to 46.32 times its vol. of that gas.

Attempts by A. Sieverts, M. Major, and M. Thoma to make gold hydride have proved nugatory. The treatment of soln. of gold salts with hypophosphorous and phosphorous acids give precipitates of metallic gold.

According to H. Hartley, a gold surface acquires a negative charge during the catalytic combustion of gases in contact with it. The electrical effect is probably antecedent to combustion, and primarily due to occlusion. The occlusion of hydrogen or carbon monoxide results in the metal getting a negative charge; with oxygen the charge is positive.

According to H. Moissan,³ gold is slowly attacked by fluorine at a red heat,

but there is no appreciable action at ordinary temp. O. Ruff and A. Heinzelmann found that **uranium hexafluoride**, UF_6 , has very little action on gold even when warmed; and O. Ruff and F. W. Tschirch found that when heated with **osmium octofluoride**, OsF_8 , a protective black film is formed on the surface of the gold. Thoroughly dried **chlorine** does not act on gold at ordinary temp. G. Krüss found that at 140° to 150° dry powdered gold is transformed by chlorine into aurosoauric chloride; at 180° to 190° into aurous chloride; and a little volatile auric chloride, while over 300° the metal is not attacked—*vide* gold chloride. S. B. Christy studied the volatility of gold in air containing chlorine. J. Percy found that no reaction occurs when dry chlorine is introduced into molten gold. Liquid chlorine was found by F. Meyer to act but slowly on gold at ordinary temp., but the reaction is vigorous at 100° . E. J. Reynolds, J. Spiller, and A. H. Allen studied the dissolution of gold by chlorine water at ordinary temp. G. Krüss found **bromine** gas attacks gold superficially, forming a black film on the surface; while liquid bromine forms auric bromide. On the other hand, J. Thomsen and E. Petersen found aurosoauric bromide to be produced under these conditions, the discrepancy in the two statements was explained by G. Krüss and F. W. Schmidt by showing that the auric bromide is much decomposed at 60° . F. Meyer found that in a sealed tube a gram-atom of precipitated gold with two of bromine forms a crust of auric bromide which hinders further action, but after 12 hrs.' shaking, all the bromine forms auric bromide. T. Döring found that gold is soluble in an ether soln. of bromine; and in a mixture of bromine and hydrobromic acid. F. Meyer found that dry **iodine** does not react with gold at ordinary temp., but between 50° and the m.p. of iodine, aurous iodide is formed. J. Nicklès showed that nascent iodine unites with gold, and also in the presence of ether or in sunlight. At ordinary press. a soln. of iodine in water does not attack gold, but in a sealed tube a reaction does occur. T. Döring says that iodine does not react with gold—when the two elements are rubbed up with water, alcohol, or ether. T. Döring found that a 10–15 per cent. soln. of iodine in potassium or ammonium iodide readily dissolves gold; the action is much slower with a 5 per cent. soln., and exceedingly slow in more dil. soln.

C. W. Scheele found that **hydrofluoric acid**, either alone or mixed with nitric acid, will not dissolve gold. M. Harriot and F. Raoult found powdered gold to be very slightly soluble in conc. **hydrochloric acid**—100 c.c. of acid dissolved 0.008 grm. of the metal. If access of air be excluded, hydrochloric acid has no action on gold. M. Berthelot said that fuming hydrochloric acid of sp. gr. 1.178 attacks gold when exposed to light, and particularly if certain salts—*e.g.* manganous chloride, $MnCl_2$ —be present. No reactions in either case occurs in darkness. According to W. Spring, gold is dissolved when it is heated with conc. hydrochloric acid to 150° in a sealed tube; and the soln. seems to be reduced by the resulting hydrogen, for minute crystals are deposited on the walls of the tube. N. Auerkiefé showed that precipitated gold is attacked by the conc. acid of sp. gr. 1.19, and particularly in the presence of many organic substances—*e.g.* various alcohols, cane sugar, formaldehyde, chloroform, etc. A. Bornträger also found a mixture of equal parts of conc. hydrochloric and nitrosulphuric acid is a good solvent for gold; and T. Fairley found a mixture of hydrogen peroxide and hydrochloric acid dissolves gold. O. P. Watts and N. D. Whipple studied the action of hydrochloric acid in the presence of soln. of various salts. The most convenient solvent for gold is usually **aqua regia**. The product of the action of aqua regia on gold was found by J. P. Prat to be dependent on the ratio of nitric to hydrochloric acid—an excess of the hydrochloric acid forms chloronitric acid, an excess of nitric acid acts on the chloride; to avoid the formation of chloronitric acid, the aqua regia should be diluted with an equal vol. of water. According to E. Priwoznik, a mixture of 200 c.c. of hydrochloric acid (sp. gr. 1.1946), 45 c.c. of nitric acid (sp. gr. 1.4), diluted with 245 c.c. of water, is the best solvent—one part of gold is dissolved by 4.3 parts of the mixture; and he represents the reaction: $Au + HNO_3 + 4HCl = HAuCl_4$

+NO+2H₂O. The alchemists were wont to represent the dissolution of gold in aqua regia by an animal devouring the sun or Apollo—*vide* Fig. 1, Cap. I. According to J. Nicklès, an ethereal soln. of **hydrobromic acid** does not dissolve gold; nor does **hydriodic acid** alone attack gold appreciably, but in presence of manganese dioxide, it does dissolve gold—the higher oxides of bismuth and other metals act similarly to manganese dioxide. An ethereal soln. of hydriodic acid dissolves gold. T. Döring also found gold to be readily soluble in hydriodic acid. According to J. P. Prat, **iodic acid** attacks gold slowly, and V. Lenher showed that if sulphuric acid be present, and the temp. 300°, the reaction is much faster; **periodic acid** also dissolves gold in the presence of sulphuric acid. O. P. Watts and N. D. Whipple studied the action of **perchloric acid** and of various acids and oxidizing agents on gold.

Gold is dissolved by mixtures containing **chlorides**, **bromides**, or **iodides** if they can generate the nascent halogens. For example, gold is dissolved by mixtures containing chloride, nitrates, and sulphuric acid or acid sulphates. A mixture of sodium chloride, nitre, and alum was the *menstruum sine strepitu* of the alchemists. Again, mixtures of hydrochloric acid with oxidizing agents like the nitrates; chlorates; permanganates; peroxides; with bleaching powder and an acid; and as J. Nicklès showed, with the easily decomposable **perchlorides**, **perbromides**, or **periodides** act similarly. C. Lossen also found that gold is dissolved by the products of the electrolysis of the alkali halide soln. According to T. Egleston, a soln. of **potassium chloride** or of **ammonium chloride**, has no action on finely divided gold when heated in a sealed tube for eight months or 5 hrs. at 150°–200°, **potassium bromide** under similar conditions gave a reaction. A. Hanriot and F. Raoult found that 100 c.c. of 25 per cent. hydrochloric acid containing 30 grms. of **auric chloride** dissolved 0.170 gm. of yellow and 0.745 gm. of brown gold. H. H. Morris made a similar observation and stated that aurous chloride is formed. F. Mylius found fuming hydrochloric acid containing some **cupric chloride** dissolves gold. W. J. McCaughey found that raising the conc. of the acid raises the speed of the action more than raising the conc. of the cupric chloride. The amount of gold dissolved seems to increase proportionately with the time of action without attaining a limit. Raising the temp. from about 40° to about 105° increases the speed of dissolution of the metal about 32 times. Doubling the conc. of the acid at about 40° increases the solvent action seven-fold, and at 105°, five-fold. Possibly the reaction of the cupric chloride is catalytic in the sense of the cuprous chloride in Deacon's process for chlorine, $2\text{CuCl}_2 \rightarrow 2\text{CuCl} + \text{Cl}_2$, and the cuprous chloride is oxidized by air and hydrochloric acid back to cupric chloride. The soln. of gold in the cupric chloride soln. at about 105° on cooling, and standing for about five days, does not deposit gold. According to P. C. Mellhiney, a boiling soln. of ferric chloride attacks gold in the presence of hydrochloric acid and air, but not if air be excluded. H. N. Stokes has also studied the solvent action of a soln. of ferric chloride and sulphate on gold. A hydrochloric acid soln. of a ferric salt—iron alum—was also found by W. J. McCaughey to dissolve gold, and the rate of soln. is increased more by raising the conc. of the acid than by raising the conc. of the salt. The rate of soln. is increased about eleven-fold by raising the temp. from about 40° to about 105°. The solvent action of the ferric salt occurs even when a ferrous salt is present, and decreases by increasing the conc. of the latter. Consequently, the precipitation of gold by ferrous sulphate can be complete only with a considerable excess of the latter. With an increasing conc. of the ferric salt a state approaching a balanced reaction may appear since, unlike the case with cupric chloride, the conc. of the dissolved gold approaches a limit. A soln. of gold obtained by boiling the alum soln. for two days with gold does not give evidence of the formation of a ferrous salt, when tested with potassium ferricyanide, but spangles of gold are deposited when the soln. cools. J. Nicklès found that ethereal soln. of **titanous chloride**, **TiCl₃**, **titanous bromide**, **manganic**, **cobaltic**, **nickelic chloride** or **bromide**, **ferric bromide**, and **plumbic chloride** dissolve gold;

so also does an ethereal soln. of **ferrous or ferric iodide**—on a water-bath or under the influence of light.

According to J. J. Berzelius, gold does not unite directly with **sulphur** or with **selenium**; but, according to H. Pélabon, at a temp. just below its m.p. selenium dissolves some gold. J. Margottet⁴ found that the vapour of tellurium attacks gold, forming gold telluride, and, according to H. Pélabon, molten tellurium dissolves gold, forming the same compound. It has long been known that soln. of the **alkali sulphides** dissolve gold—*vide* gold sulphides. According to G. F. Becker, one part of gold dissolves in 843 parts of sodium sulphide, Na_2S , at ordinary temp. A. Ditte observed no action when gold was sealed in a tube for 18 months in the presence of an alkali sulphide sat. with sulphur. C. A. Stetefeldt and T. Egleston observed that soln. of potassium or sodium sulphide dissolve gold in the cold, and **ammonium sulphide** at 145° to 180° . C. A. Stetefeldt and E. H. Russell found gold to be soluble in a soln. of **sodium thiosulphate** and other thiosulphates of the alkalies and alkaline earths. The action takes place in the cold, but more readily if heated—a gold sulphide is probably first formed, and this is dissolved by the alkaline soln. J. Moir found gold to be dissolved by acid soln. of **thiocarbamide**, particularly in the presence of oxidizing agents. J. Uhl found that **sulphur dioxide** does not attack gold when heated therewith, but it is converted into sulphur trioxide and sulphur. Gold is not attacked by **sulphuric acid**, but, according to A. H. Allen, V. Lenher, H. Pélabon, and J. Pelletier, the metal is attacked if an oxidizing agent is dissolved in the acid—*e.g.* the higher oxides of manganese or lead, nitric acid, permanganates, periodic acids or periodates, iodic acid or iodates, chromium or nickel sesquioxide, chromic anhydride, telluric acid, lead or copper nitrates, etc. O. P. Watts and N. D. Whipple also studied the action of sulphuric acid in the presence of soln. of various salts on gold. E. Sulkowsky says dil. sulphuric acid, mixed with hydrogen peroxide, does not attack gold. V. Lenher and G. Kemmerer said a hot mixture of nitric and sulphuric acid dissolves gold far better than does a soln. of potassium cyanide. M. E. Chevreul suggested that ozone is formed, but M. Berthelot and V. Lenher found that neither oxygen nor ozone attacks gold-leaf suspended in conc. sulphuric acid when these two gases are bubbled through the liquid, but gold is dissolved in the presence of nascent oxygen liberated when oxidizing agents are heated with sulphuric acid. According to C. J. T. von Grothuss, M. Berthelot, etc., gold is also dissolved at the anode when conc. sulphuric acid is electrolyzed with a gold anode; with dil. sulphuric acid, the anode is covered with a film of oxide. According to F. H. Jeffery, gold is also dissolved from the anode in sulphuric acid in the form of complex ions, but by the time the yellowish-brown stage is reached there is an appreciable formation of gold cations. These may possibly arise from the reduction of the anions by hydrogen. The anode soln. yields auric hydroxide with little of the aurous compound on dilution with water. According to E. Harbeck, M. Margules, and W. G. Mixer, a $\frac{1}{10}N$ -soln. of sulphuric acid behaves like nitric acid towards a gold anode. Similar results were obtained with **alkali bisulphates**. T. Egleston found a soln. of **ammonium sulphate** exerted no action on spongy gold when kept in a sealed tube for 8 months, or heated between 150° and 200° for 5 hrs.; but W. G. Mixer found a soln. of **potassium sulphate** and V. Lenher and G. Kemmerer a soln. of potassium sulphate, **potassium hydro-sulphate** or **sodium sulphate** attacks a gold anode during electrolysis. According to E. Mitscherlich and V. Lenher, conc. **selenic acid** in the cold does not attack gold appreciably, the action begins at about 230° , and proceeds more quickly at about 300° , when selenium dioxide is evolved, and gold selenate, $\text{Au}_2(\text{SeO}_4)_3$, passes into soln. According to V. Lenher, **telluric acid** attacks gold in the presence of sulphuric acid. According to M. Berthelot, **persulphuric acid** has no action on gold. H. B. North found that an excess of **sulphuryl chloride**, SO_2Cl_2 , in a sealed tube at 160° , slowly dissolves the metal, forming anhydrous auric chloride; while **thionyl chloride**, SOCl_2 , at 150° , has no appreciable action, but after heating the

mixture ten days at 200°, gold is dissolved. According to A. Ditte, **pyrosulphuryl chloride** attacks gold.

According to J. J. Sudborough,⁵ **nitrosyl chloride**, NOCl, does not attack gold after many hours' exposure to that metal at 100°. In 1748, G. Brandt showed that gold is slightly soluble in **nitric acid**, but the soln. readily deposits the gold. T. Bergmann discussed the phenomenon from the point of view of the phlogiston theory. In 1780, however, M. Tillet said that while it is true that nitric acid attacks gold, it does not really dissolve it, but keeps it mechanically in suspension, and he claimed that these suspended particles are visible under the microscope. T. Bergmann pointed out that this proved only that particles of gold may be suspended in the acid and not that gold cannot be truly dissolved. According to F. P. Dewey, gold is slightly soluble in highly purified nitric acid, and the yellow soln. deposits gold on standing for a few days; while M. Hanriot and F. Raoult found that when finely divided gold is boiled with nitric acid of sp. gr. 1.180, 0.002 gm. is dissolved; with acid of sp. gr. 1.285, 0.0119 gm. is dissolved; with acid of sp. gr. 1.332, 0.028 gm.; and with the monohydrated acid, 0.076 gm. G. J. Mulder found that nitric acid dissolves an appreciable quantity of gold (or platinum) when that metal is alloyed with a large proportion of silver. G. H. Makins attributed the action to the presence of nitrous acid. In any case, there is a small loss of gold during the parting of gold and silver by the nitric acid process. T. K. Rose found that the spent acid used in parting during the assay of gold at the Royal Mint contained 1.2 mgrms. of gold per litre. According to M. Margules, C. J. T. von Grotthuss, M. Berthelot, and W. G. Mixter, gold is readily attacked when used as anode in the electrolysis of nitric acid. The yellowish-green soln. thus obtained is reduced by hydrogen, forming a brown precipitate. According to F. H. Jeffery, if a porous pot be used in the electrolysis of nitric acid (1 : 2) the cathode cell remains clear, and the soln. in the anode cell passes from green to yellowish-brown, and if evaporated in vacuo over sulphuric acid and sodium hydroxide, yellow crystals of **hydroauric nitric acid**, $\text{HAu}(\text{NO}_3)_4 \cdot 3\text{H}_2\text{O}$, are formed. If the soln. of this acid be diluted with water, auric oxide accompanied by some aurous oxide is deposited. The more dil. the acid electrolyte, the less the amount of aurous oxide formed. If precautions are not taken to prevent the accumulation of ammonium nitrate formed in the anode cell with dil. acid (1 : 20), an explosive compound is formed at the anode. V. Lenher and G. Kemmerer found that a gold anode is attacked during the electrolysis of neutral soln. of **potassium nitrate** or **sodium nitrate**.

According to P. Hautefeuille and A. Perrey, melted gold absorbs **phosphorus** vapour, and gives it out again, with spitting, on the solidification of the metal. A. Granger found that phosphorus vapour does not attack finely divided gold at low temp., but a reaction occurs at 400°, and gold phosphide is formed. When gold is heated in a sealed tube with **phosphorus pentachloride** at 180° to 200°, L. Lindet observed the formation of aurous chloride, phosphorus trichloride, and a double compound, $\text{AuCl}_2 \cdot \text{PCl}_5$; with **phosphorus trichloride**, under similar conditions aurous chloride and phosphorus are formed. V. Lenher and G. Kemmerer found gold is readily dissolved by **phosphoric acid** in the presence of oxidizing agents. O. P. Watts and N. D. Whipple also studied the action of phosphoric acid on gold. According to F. H. Jeffery, the electrolysis of 15 per cent. phosphoric acid with a gold anode results in the formation of soluble gold complex anions, but not cations. When the resulting soln. is diluted with water, auric and aurous chlorides are formed, so that the soln. contains **gold phosphate**. According to A. Sieverts and M. Major, a boiling soln. of **sodium hypophosphate** is catalytically transformed into sodium phosphite by precipitated gold.

T. Bergmann, in his *De arsenico* (Upsala, 1777), showed that molten gold takes up scarcely $\frac{1}{60}$ th of its weight of arsenic. According to A. Hatchett, **arsenic** does not combine readily with gold in open vessels, but the vapour readily alloys with gold at a red heat, forming a grey fusible mass which does not give off all its arsenic when fused for two hours in an open crucible. A. Liversidge found that if arsenic

vapour be passed over heated gold, the latter readily melts and, when cooling, the mass spits, and ultimately furnishes yellow spangles of gold arsenide. The affinity between gold and arsenic, however, is not very great. A. P. Schleicher has worked out that portion of the equilibrium diagram which is possible by the ordinary thermal methods, and it includes alloys with between 100 and 74.53 atomic per cent. of gold. The m.p. of gold is lowered by arsenic down to what appears to be a eutectic with about 46 and 47 atomic per cent. of arsenic at 665°. On cooling, the evolution of arsenic occurs suddenly at the eutectic. V. Lenher and G. Kemmerer found that **arsenic acid** dissolves gold in the presence of oxidizing agents, but the action is much slower than with sulphuric acid. According to C. Hatchett, gold unites with **antimony** when the two elements are fused together, and likewise when the vapour is passed over the red-hot metal. Antimony makes gold brittle, even so little as 0.052 per cent. making gold lose its malleability. The antimony gradually oxidizes and volatilizes when it is fused for some time in an open crucible. The m.p. curve by R. Vogel is shown in Fig. 7; it explains itself; an unstable gold diantimonide, AuSb_2 , is formed. These alloys were also studied by W. C. Roberts-Austen. Alloys of gold with **bismuth** were also prepared by C. Hatchett; he found gold is rendered brittle when alloyed with but 0.052 per cent. of bismuth. A natural alloy of gold and bismuth with a little adherent mercury was found in Rutherford County (U.S.A.), sp. gr. 12.4–12.9. Its composition corresponds with

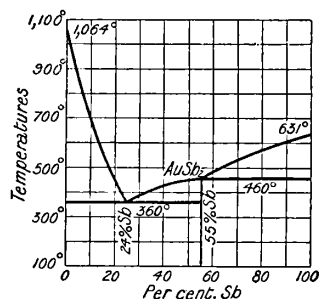

FIG. 7.—Fusion Curves of Mixtures of Gold and Antimony.

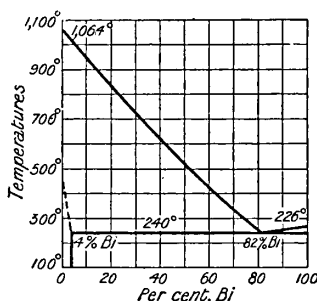

FIG. 8.—Fusion Curves of Mixtures of Gold and Bismuth.

AuBi , and it has been called *bismuthaurite*. From R. W. E. McIvor's analysis, G. H. F. Ulrich's *maldonite* found at Maldon (Victoria) has the composition Au_2Bi ; it has been also called *black gold*. It was investigated by C. U. Shepard, and W. Vernadsky. C. T. Heycock and F. H. Neville studied the lowering of the f.p. of gold by bismuth; E. Maey the sp. vol. of the alloys; and R. Vogel has worked out the fusion curve shown in Fig. 8, which is self-explanatory. It recalls the corresponding curve for silver. W. C. Roberts-Austen and F. Osmond also made some observations on these alloys.

O. Ruff and B. Bergdahl⁶ found that molten gold can dissolve only traces of **carbon**. H. N. Warren found that **silicon** at the moment of its formation, so to speak, unites with gold much more readily than ordinary silicon, and a 5 per cent. alloy is best made by heating sodium and gold with potassium fluosilicate at a high temp. C. Winkler also made gold-silicon alloys and noted their brittleness. H. Moissan found that molten gold dissolves **carbon**, and rejects it as graphite on cooling. For gold acetylide, see acetylene. According to W. Muthmann and A. Schaidhauf, gold in the electrodes does not influence the decomposition of **carbon dioxide** in the electric arc. The solubility of gold in soln. of **alkali cyanides** has been previously discussed. C. L. Jacobsen has discussed the passivity of gold in soln. of alkali cyanides. The electrolysis of amido-compounds, etc., which produce cyanides, also dissolve gold when they are electrolyzed. E. Beutel, and G. McP. Smith have studied the solubility of gold in soln. of **potassium ferrocyanide**.

The action is slow, but it is accelerated by heat. E. Beutel represented the reaction: $3\text{Au} + \text{K}_4\text{FeCy}_6 + 2\text{H}_2\text{O} + \text{O}_2 = 3\text{KAuCy}_2 + \text{Fe}(\text{OH})_3 + \text{KOH}$. Soln. of the **thiocyanates** and many double cyanides also dissolve gold. According to W. Foster, and H. B. Giles, a neutral soln. of **potassium permanganate** is reduced by gold. H. H. Morris found gold is dissolved by soln. of **auric chloride** forming aurous chloride. H. von Euler studied the adsorption of silver ions from soln. of **silver nitrate and sulphate** by gold.

According to W. Dittmar,⁷ fused **alkali hydroxide** does not attack gold to any appreciable extent, even when **alkali chlorate** is present, but the metal is attacked if an **alkali nitrate** be present. M. le Blanc and O. Weyl found that attack with dry potassium hydroxide begins below 670° , and small flecks of gold appear in the matrix. M. le Blanc and L. Bergmann found that in an atm. of nitrogen sodium hydroxide attacks gold but slightly. P. Bechtereff noticed that the molten sodium hydroxide is coloured yellow on account of oxidation. According to F. Meyer and W. L. Dudley, fused **alkali peroxide** readily attacks gold, forming the alkali aurate; **barium peroxide** attacks the metal to a less extent. The heat of the reaction with one gram of gold was found by W. G. Mixter to be 77 Cals., and for 2 grms., 30,400 cals. A Schiel, J. Spiller, M. Margules, and V. Lenher and G. Kemmerer found that a little gold is dissolved when soln. of the alkali hydroxides are electrolyzed with a gold anode; neutral salt soln. under similar conditions form a film of oxide on the anode. O. P. Watts and N. D. Whipple studied the action of soln. of sodium hydroxide and of various salts on gold; and also of **acetic acid** in the presence of oxidizing agents. A. Korczynsky studied the halogenation of aromatic hydrocarbons with gold as catalytic agent.

Reactions of analytical interest.—A soln. of gold trichloride acidified with hydrochloric acid is usually employed as a type to represent the gold salts. The action of potassium hydroxide, aqua ammonia, and of hydrogen sulphide are involved, and they are discussed in connection with auric chloride. The most important reactions depend on the ready reduction of auric salts to metallic gold, otherwise expressed, the auric salts are strong oxidizing agents—*e.g.* oxalic acid; ferrous sulphate; sulphurous acid; hydrogen peroxide; zinc with arsenic acid and ferric chloride; stannous chloride are oxidized. According to H. Rose,⁸ stannous chloride produces a pale rose coloration with a dilution of 1:1,000,000; and the coloration is still recognizable with a dilution of 1:4,000,000. A. Stähler and F. Bachran found a drop of titanium trichloride colours a soln. of auric chloride an intense violet, and the reaction is almost as sensitive as the purple of Cassius' reaction. G. Armani and J. Barboni say that the coloration produced by formaldehyde in warm alkaline soln. is sensitive to 1:100,000. J. E. Saul found a $\frac{1}{10}$ per cent. soln. of *p*-phenylenediamine colours 10 vols. of a 0.005 per cent. soln. of auric chloride greenish-yellow. Several other organic compounds have been suggested as tests for gold.

Uses of gold.—Gold is largely employed in the manufacture of ornamental jewellery. The extensive use of this metal, said H. Sowerby,⁹ wherever gorgeous ornament is required, as well as in the simplest designs of art—from the glittering crown of an emperor to the neat little wedding ring of the village maid—imparts to gold an interest in our eyes that other metals have failed to acquire. Gold alone is too soft to withstand wear and tear, and it is therefore alloyed with hardening metals like copper. Copper imparts a reddish tinge to gold, and this alloy was once called *red carat gold*. The term **carat** refers to a fractional part of 24, and is now used in stating the fineness of gold—*e.g.* pure gold is 24 carat; gold of 22-carats or 22-carat gold has 22 parts of gold and 2 parts of other metals. 22-carat gold is thus eq. to an alloy with 91.6 per cent. of gold and 8.3 per cent. of other metals. The British *gold coinage* is 22-carat gold. This alloy is termed *sterling or standard gold*. Brazil, Portugal, Turkey, India, Peru, Chili have the same standard; while America, France, Greece, Russia, Japan, and most other countries have a standard 90 per cent. of gold and 10 per cent. of baser metal, and this is

therefore 21·6-carat gold. The gold coinage of the Sydney mint has the same amount of gold as the British, but silver is used in place of copper, so that the Sydney sovereign appears greenish-yellow beside that of Great Britain. The standard gold alloys recognized in the United Kingdom are 22-, 18-, 15-, 12-, and 9-carat. The percentage composition of these different standards is commonly :

	Gold.	Silver.	Base metals (mainly copper).
22-carat gold	91·6	2·0	6·3
18-carat gold	75·0	12·5	12·5
15-carat gold	62·5	10·0	27·5
12-carat gold	50·0	10·0	40·0
9-carat gold	37·5	10·0	52·5

Articles made from these standard alloys can be *hall-marked*, or stamped with the imprimature of certain Government offices to show that the metal is up to the standard claimed. 22-carat gold is mainly used for wedding rings; the best jewellery is made from 18- or 15-carat gold; and 9-carat gold is used for cheap jewellery which can be hall-marked. Much cheap jewellery is made from less than 9-carat gold, but it is not hall-marked. For gilding, gold-plating, and electroplating—see copper. The electrolyte for the electro-deposition of gold is made by dissolving 2·34 grms. of gold in aqua regia; evaporating the soln. on a water-bath to drive off the excess of acid; adding potassium cyanide soln. so long as a precipitate forms—avoiding an excess; washing the lemon-yellow precipitate by decantation; dissolving the precipitate in a soln. of potassium cyanide; and making the liquid up to about 500 c.c. For the properties of thin metal films—*vide* silver. W. Theobald has described the preparation of gold-leaf and thin metal films.

REFERENCES.

- ¹ H. Kopp, *Beiträge zur Geschichte der Chemie*, Braunschweig, 2. 398, 1869; G. E. Stahl, *Opusculum chymico-physico-medicum*, Magdeburgicæ, 585, 1715; W. Herapath, *Phil. Mag.*, (4), 3. 528, 1852; J. D. Smith, *ib.*, (4), 4. 142, 1852; W. Napier, *Manufacturing Arts in Ancient Times*, Paisley, 77. 1879; C. E. M. Joad, *Essays in Common Sense Philosophy*, London, 219, 1919.
- ² J. Prinsep, *Phil. Trans.*, 118. 71, 1828; T. Graham, *ib.*, 156. 399, 1866; G. Neumann, *Monatsh.*, 13. 40, 1892; G. Neumann and F. Streintz, *ib.*, 12. 642, 1891; W. Hampe, *Chem. Ztg.*, 14. 1777, 1890; T. K. Rose, *Journ. Chem. Soc.*, 73. 714. 1890; A. Sieverts and E. Bergner, *Ber.*, 45. 2576, 1912; A. Sieverts, *Zeit. Elektrochem.*, 16. 708, 1910; A. Sieverts and M. Major, *Zeit. anorg. Chem.*, 64. 36, 1909; M. Major, *Zur Kenntnis der phosphorigen und unter-phosphorigen Säure*, Leipzig, 1908; M. Thoma, *Zeit. phys. Chem.*, 3. 93, 1889; H. Hartley, *Proc. Roy. Soc.*, 90. A, 61, 1914; *Journ. Ind. Eng. Chem.*, 6. 694, 1914; *Journ. Gas Lightg.*, 126. 879, 1914; J. Trowbridge, *Amer. Journ. Science*, (4), 27. 245, 1909.
- ³ C. W. Schcelc, *Examen chemicum fluoris mineralis ejusque acidi*, Upsala, 1771; O. P. Watts and N. D. Whipple, *Trans. Amer. Electrochem. Soc.*, 32. 257, 1917; H. Moissan, *Ann. Chim. Phys.*, (6), 24. 224, 1891; T. Fairley, *Journ. Chem. Soc.*, 31. 1, 1877; C. Lossen, *Ber.*, 27. 2726, 1894; G. Krüss, *ib.*, 20. 211, 1887; *Licbig's Ann.*, 238. 241, 1887; M. Margules, *Wied. Ann.*, 66. 540, 1898; F. Meyer, *Compt. Rend.*, 133. 815, 1901; 139. 733, 1905; 148. 347, 1909; M. Berthelot, *ib.*, 138. 1297, 1904; J. P. Prat, *ib.*, 70. 840, 1870; M. Hanriot and F. Raoult, *ib.*, 155. 1085, 1912; *Bull. Soc. Chim.*, (4), 13. 261, 1913; J. Percy, *Silver and Gold*, London, 1880; T. Döring, *Berg. Hütt. Ztg.*, 59. 49, 1900; P. C. McIlhiney, *Amer. Journ. Science*, (4), 2. 10, 293, 1896; S. B. Christy, *Trans. Amer. Inst. Min. Eng.*, 17. 3, 1888; E. J. Reynolds, *Chem. News*, 9. 70, 1864; J. Spiller, *ib.*, 10. 173, 1864; A. H. Allen, *ib.*, 25. 85, 1872; E. Petersen, *Journ. prakt. Chem.*, (2), 46. 328, 1892; J. Thomsen, *ib.*, (2), 13. 337, 1876; E. Bose, *Zeit. Elektrochem.*, 14. 85, 1908; G. Krüss and F. W. Schmidt, *Zeit. anorg. Chem.*, 3. 421, 1893; O. Ruff and A. Heinzelmann, *ib.*, 72. 63, 1911; W. Spring, *ib.*, 1. 240, 1893; O. Ruff and F. W. Tschirch, *Ber.*, 46. 943, 1913; N. Awerkieff, *ib.*, 61. 3, 1909; *Journ. Russ. Phys. Chem. Soc.*, 40. 840, 1908; T. Egleston, *The Metallurgy of Silver, Gold, and Mercury in the United States*, New York, 2. 65, 1887; A. Bornträger, *Rep. anal. Chem.*, 741, 1887; J. Nicklès, *Ann. Chim. Phys.*, (4), 10. 318, 1867; *Pharm. Centrbl.*, 264, 1866; 480, 1867; E. Priwoznik, *Oester. Zeit. Berg. Hütt.*, 58. 549, 1910; W. J. McCaughey, *Journ. Amer. Chem. Soc.*, 31. 1261, 1909; H. H. Morris, *ib.*, 40. 917, 1918; H. N. Stokes, *Econ. Geol.*, 1. 644, 1908; V. Lenher, *Journ. Amer. Chem. Soc.*, 24. 354, 1902; 26. 550, 1904; F. Mylius, *Zeit. anorg. Chem.*, 70. 205, 1911.

⁴ J. Uhl, *Ber.*, 23. 2151, 1890; J. Pelletier, *Ann. Chim. Phys.*, (2), 15. 12, 1820; V. Lenher, *Journ. Amer. Chem. Soc.*, 24. 354, 1902; 26. 550, 1904; W. G. Mixer, *ib.*, 33. 688, 1911; V. Lenher and G. Kemmerer, *ib.*, 26. 551, 1904; J. P. Prat, *Compt. Rend.*, 70. 840, 1870; A. Ditte, *ib.*, 131. 143, 1900; M. Berthelot, *ib.*, 89. 683, 1879; O. P. Watts and N. D. Whipple, *Trans. Amer. Electrochem. Soc.*, 32. 257, 1917; A. Sieverts and E. Bergner, *Zeit. phys. Chem.*, 82. 257, 1913; E. Sulkowsky, *Chem. Ztg.*, 40. 448, 1916; M. Hanriot and F. Raoult, *Compt. Rend.*, 155. 1085, 1912; E. Mitscherlich, *Pogg. Ann.*, 9. 623, 1827; J. Margottet, *Ann. École Norm.*, (2), 8. 247, 1879; J. Moir, *Proc. Chem. Soc.*, 22. 105, 1906; *Journ. Chem. Soc.*, 89. 1345, 1906; H. Pélabon, *Compt. Rend.*, 148. 1176, 1909; 174. 391, 1922; *Ann. Chim. Phys.*, (8), 17. 564, 1909; A. Ditte, *ib.*, (8), 12. 275, 1907; C. J. T. von Grothuss, *ib.*, (1), 59. 62, 1806; E. Harbeck, *German Pat.*, D.R.P. 189876, 1906; F. H. Jeffery, *Trans. Faraday Soc.*, 11. 172, 1916; H. B. North, *Bull. Soc. Chim.*, (4), 9. 647, 1911; H. B. North and A. M. Hagemann, *Journ. Amer. Chem. Soc.*, 34. 892, 1912; G. F. Becker, *Amer. Journ. Science*, (3), 33. 199, 1887; T. Egleston, *The Metallurgy of Silver, Gold, and Mercury in the United States*, New York, 2. 65, 1887; C. A. Stetefeldt, *The Lixiviation of Silver Ores with Hyposulphite Solutions*, New York, 15. 38, 1895; E. H. Russell, *U.S. Pat. No.* 295815, 1887; M. E. Chevreul, *Mus. Hist. Nat. Paris*, 12. 367, 1825; J. J. Berzelius, *Schweigger's Journ.*, 23. 309, 430, 1826; 34. 79, 1826; *Pogg. Ann.*, 7. 242, 1826; 8. 423, 1826; M. Margules, *Wied. Ann.*, 66. 540, 1898; A. H. Allen, *Chem. News*, 25. 85, 1872; M. Margules, *Wied. Ann.*, 66. 540, 1898.

⁵ J. J. Sudborough, *Journ. Chem. Soc.*, 59. 655, 1891; G. H. Makins, *ib.*, 13. 77, 1860; T. K. Rose, *ib.*, 63. 710, 1893; A. Granger, *Compt. Rend.*, 124. 498, 1897; L. Lindet, *ib.*, 98. 1382, 1884; P. Hautefeuille and A. Perrey, *ib.*, 98. 1387, 1884; A. Hanriot and F. Raoult, *ib.*, 155. 1085, 1912; *Bull. Soc. Chim.*, (4), 13. 261, 1913; F. P. Dewey, *Journ. Amer. Chem. Soc.*, 32. 318, 1910; W. G. Mixer, *ib.*, 33. 688, 1911; V. Lenher and G. Kemmerer, *ib.*, 26. 551, 1904; A. H. Allen, *Chem. News*, 25. 85, 1872; C. W. Elliot and F. H. Storer, *ib.*, 3. 318, 343, 1861; A. Liversidge, *ib.*, 69. 152, 1894; R. W. E. MeIvor, *ib.*, 55. 191, 1887; O. P. Watts and N. D. Whipple, *Trans. Amer. Electrochem. Soc.*, 32. 257, 1917; A. P. Schliefer, *Internat. Zeit. Met.*, 6. 18, 1914; M. Margules, *Wied. Ann.*, 66. 540, 1898; G. J. Mulder, *Die Silber-Probir-methode*, Leipzig, 159, 1859; F. H. Jeffery, *Trans. Faraday Soc.*, 11. 172, 1916; J. L. Gay Lussac, *Ann. Chim. Phys.*, (2), 63. 334, 1836; C. J. T. von Grothuss, *ib.*, (1), 59. 62, 1806; R. Vogel, *Zeit. anorg. Chem.*, 50. 147, 1906; C. Hatehett, *Phil. Trans.*, 93. 43, 1803; W. C. Roberts-Austen, *ib.*, 179. A, 433, 1888; W. C. Roberts-Austen and F. Osmond, *Bull. Soc. d'Enc.*, (5), 1. 1137, 1896; C. A. Stetefeldt, *The Lixiviation of Silver Ores with Hyposulphite Solutions*, New York, 1895; C. U. Shepard, *Amer. Journ. Science*, (2), 4. 280, 1847; E. Maey, *Zeit. phys. Chem.*, 38. 297, 1901; C. T. Heycock and F. H. Neville, *Journ. Chem. Soc.*, 61. 897, 1892; W. Vernadsky, *Centr. Min.*, 760, 1912; *Bull. Acad. St. Petersburg*, 1. 27, 1907; A. Sieverts and M. Major, *Zeit. anorg. Chem.*, 64. 36, 1909; M. Major, *Zur Kenntnis der phosphorigen und unterphosphorigen Säure*, Leipzig, 1908; M. Berthelot, *Compt. Rend.*, 89. 683, 1879; G. Brandt, *Acta Acad. Upsala*, 33, 1748; T. Bergmann, *De attractionibus electivis*, Upsala, 1775; London, 115, 330, 1785; M. Tillet, *Mém. Acad.*, 241, 1780; G. H. F. Ulrich, *Contributions to the Mineralogy of Victoria*, Melbourne, 4, 1870; *Mineralogy of Victoria*, Melbourne, 41, 1866.

⁶ H. N. Warren, *Chem. News*, 60. 5, 1889; 67. 303, 1893; C. Winkler, *Journ. prakt. Chem.*, (1), 91. 203, 1864; C. L. Jacobsen, *Ueber das elektrochemische Verhalten des Goldes und seine Passivität*, Leipzig, 1907; W. Foster, *Chem. News*, 115. 73, 1917; H. B. Giles, *ib.*, 15. 204, 1867; O. Ruff and B. Bergdahl, *Zeit. anorg. Chem.*, 106. 76, 1919; H. Moissan, *Compt. Rend.*, 141. 977, 1905; H. T. Lambert, *Min. Mag.*, 10. 138, 1914; E. Beutel, *Sitzber. Akad. Wien*, 119. 700, 1910; *Monatsh.*, 31. 887, 1910; *Zeit. anorg. Chem.*, 75. 154, 1912; G. MeP. Smith, *ib.*, 82. 63, 1913; G. Just and W. Berezowsky, *Zeit. Elektrochem.*, 15. 297, 1909; W. Muthmann and A. Schaidhauf, *ib.*, 17. 497, 1911; J. C. Claney, *Chem. Ztg.*, 35. 441, 1911; H. H. Morris, *Journ. Amer. Chem. Soc.*, 40. 917, 1918; E. Beutel, *Monatsh.*, 31. 887, 1910; H. von Euler, *Zeit. Electrochem.*, 28. 2, 1922.

⁷ J. Spiller, *Chem. News*, 10. 173, 1864; M. Margules, *Wied. Ann.*, 66. 540, 1898; A. Schiel, *Pogg. Ann.*, 159. 489, 1876; F. Meyer, *Compt. Rend.*, 145. 805, 1908; M. le Blanc and O. Weyl, *Ber.*, 45. 2300, 1912; M. le Blanc and L. Bergmann, *ib.*, 42. 4733, 1909; W. Dittmar, *Journ. Soc. Chem. Ind.*, 3. 303, 1884; P. Bechtereff, *Zeit. Elektrochem.*, 17. 859, 1911; V. Lenher and G. Kemmerer, *Journ. Amer. Chem. Soc.*, 26. 551, 1904; W. G. Mixer, *Amer. Journ. Science*, (4), 32. 205, 1911; W. L. Dudley, *Amer. Chem. Journ.*, 28. 61, 1902; O. P. Watts and N. D. Whipple, *Trans. Amer. Electrochem. Soc.*, 32. 257, 1917; A. Korczynsky, *Bull. Soc. Chim.*, (4), 29. 283, 1921.

⁸ H. Rose, *Zeit. anal. Chem.*, 41. 301, 1902; *Chem. News*, 66. 271, 1892; L. Vannino and L. Seemann, *Ber.*, 32. 1968, 1899; A. Carnot, *Compt. Rend.*, 97. 105, 169, 1883; G. Armani and J. Barboni, *Zeit. Koll.*, 6. 290, 1910; J. E. Saul, *Analyst*, 38. 54, 1913; A. Stähler and F. Baehran, *Ber.*, 44. 2906, 1911.

⁹ W. Theobald, *Metal Ind.*, 14. 321, 341, 1919; H. Sowerby, *Popular Mineralogy*, London, 289, 1850.

§ 7. The Atomic Weight of Gold

The early analyses of J. B. Richter,¹ J. L. Proust, A. Oberkampf, L. N. Vauquelin, and C. F. Bucholz gave rather discrepant results for the ratio by weight of gold to oxygen in the oxide of that metal. Of these, the analysis of A. Oberkampf comes nearest to that recognized at the present day. On the assumption that the at. wt. of oxygen is 5.5, J. Dalton wrote 105 for that of gold, and in his *A New System of Chemical Philosophy* (Manchester, 2. 219, 1818), he wrote the at. wt. of gold 140, on the assumption that that of oxygen is 7. J. J. Berzelius assumed, in 1813, that the ratio of the atoms of gold to those of oxygen in gold oxide is 1 : 3, and he later regarded the ratio as being 2 : 3; he also discovered aurous oxide in which the ratio was taken to be 1 : 1. He obtained 2486 for the at. wt. of gold with oxygen 100 as standard; with oxygen 16, this number becomes 2×198.8 ; and if the ratios of the atoms of gold in aurous and auric oxides be respectively 2 : 1 and 2 : 3, the at. wt. of gold is 198.8. J. J. G. Meinelke assumed the value to be 200; and L. Gmelin gave 66 for the eq. weight, which makes the at. wt. 198 when the formulæ of the two chlorides are AuCl and AuCl₃, and of the two oxides, Au₂O and Au₂O₃. The validity of the latter assumption was confirmed by the rule of Dulong and Petit; by Mitscherlich's isomorphous law; by J. H. van't Hoff's modification of Avogadro's rule; and by Mendeléef's periodic rule, whether gold be placed in the 11th series of the first group, or in the 10th series of the eighth group.

In 1813, J. J. Berzelius obtained the value 196.98 (assuming the at. wt. of mercury as 200.6), which is remarkably close to 197.2, the value accepted at the present day; he obtained this result by weighing the gold precipitated by mercury from a soln. containing a known weight of auric chloride. In order to emphasize how far J. J. Berzelius was in advance of the chemists of his day, it may be mentioned that in 1819 J. Pelletier obtained 238, by weighing the gold remaining after a known weight of aurous iodide was calcined; that in 1821, J. Javal obtained 201 by the analysis of gold oxide, and 208 by the analysis of potassium chloroaurate; and that in 1823, L. G. Figuier obtained 179, by the analysis of sodium chloroaurate. J. J. Berzelius, also in 1824, analyzed potassium chloroaurate, and calculating his result to present-day standards, he obtained 196.708 for the at. wt. of gold—a result not so good as his earlier determinations. In 1850, A. Levöl reduced a soln. of auric chloride with sulphur dioxide, and determined the resulting sulphuric acid as barium sulphate. A gram of gold gave 1.782 grms. BaSO₄, which makes the at. wt. of gold 196.55. In 1876, J. Thomsen determined the ratio Au : 4Br = 32.11 : 50 in hydrobromoauric acid, H₂AuBr₄.5H₂O, and this furnishes 197.48 for the at. wt. of gold.

In 1886, G. Krüss again opened up the subject in his memoir *Untersuchungen über das Atomgewicht des Goldes* (München, 1886). This memoir is often regarded as inaugurating the modern determinations of this constant. Hence the determinations of the at. wt. of gold may be conveniently grouped in three periods: (1) The inexact value obtained prior to J. J. Berzelius's investigations; (2) the values obtained in the Berzelian era, which give as a best representative value 197.29; and (3) the modern era commencing with the work of G. Krüss. G. Krüss first determined the ratios AuCl₃ : Au : 3AgCl, and obtained for the at. wt. of gold, 197.14; and in the remainder of his work he employed potassium bromoaurate from which five ratios were derived. In one set, the gold was reduced either by hydrogen or by sulphur dioxide and the consequent ratio KAuBr₄ : Au gave 197.125 for the at. wt. of this element. In another set the bromine liberated during the sulphur dioxide reduction was determined as silver bromide and the resulting ratio Au : 4AgBr gave 197.156 for the at. wt. The weighing of the residue Au + KBr obtained after the hydrogen reduction gave the ratio Au : 3Br which furnishes the at. wt. 197.040; and when the resulting KBr in the residue was determined, the ratio Au : KBr enabled the at. wt. to be computed—the result was 197.077. The

general mean of all G. Krüss's thirty measurements was 197.13. Independently of G. Krüss and partly overlapping, T. E. Thorpe and A. P. Laurie reduced the same compound by ignition, and the gold was determined by washing out the undecomposed bromide, and weighing the residue. This gave the ratio Au : KBr. The potassium bromide was also determined volumetrically by titration with a soln. of the silver salt for the ratio Au : Ag ; and also gravimetrically as silver bromide for the ratio Au : AgBr. These three ratios furnish the mean 197.25 for the at. wt. of gold.

In 1889, J. W. Mallet made seven series of determinations of the at. wt. of gold : (1) He analyzed auric chloride and obtained the ratio Au : 3Ag ; (2) likewise the bromide for Au : 3Ag ; (3) potassium bromoaurate, KAuBr_4 , was then analyzed for the ratio KAuBr_4 : Au : 4Ag ; (4) he also decomposed thermally the double salt trimethylammonium chloroaurate, $\text{NH}(\text{CH}_3)_3\text{AuCl}_4$, for the ratio $\text{NH}(\text{CH}_3)_3\text{AuCl}_4$: Au ; (5) he then electrolyzed potassium cyanoaurate, KAuCy_2 , and potassium cyanoargentate, KAgCy_2 , in the same circuit, and obtained the ratio Au : Ag ; (6) he also electrolyzed potassium cyanoaurate in circuit with the hydrogen voltameter for the ratio Au : H ; and finally, (7) he determined the hydrogen eq. of a given amount of zinc, and found the amount of gold this amount of zinc would reduce from a soln. of auric chloride or bromide. He thus obtained the ratio Au : 3H. The means in the different series were :

(1)	(2)	(3)	(4)	(5)	(6)	(7)
197.13	197.18	197.16	197.73	197.22	196.972	196.713

These results combined with the preceding give the general mean 196.722 ± 0.0129 . The best representative value for all the determinations is 197.20 and the International value is 197.2. The atomic number of gold is 79.

REFERENCES.

- ¹ J. B. Richter, *Aufangsgründe der Stöchiometrie*, Breslau, 1794 ; A. Oberkampf, *Ann. Chim. Phys.*, (1), 56. 30, 1806 ; L. G. Figuier, *ib.*, (2), 19. 177, 1823 ; L. N. Vauquelin, *ib.*, (1), 77. 321, 1811 ; J. Javal, *ib.*, (2), 17. 337, 347, 1821 ; J. Pelletier, *ib.*, (2), 15. 5, 1819 ; A. Levol, *ib.*, (3), 30. 59, 1850 ; J. L. Proust, *Gehlen's Journ.*, 1. 1, 487, 1806 ; H. E. Roscoe and A. Harden, *A New View of the Origin of Dalton's Atomic Theory*, London, 1896 ; J. J. G. Meinecke, *Die chemische Messkunst*, Halle, 1817 ; L. Gmelin, *Handbuch der theoretischen Chemie*, Frankfurt a. M., 1827 ; J. J. Berzelius, *Schweigger's Journ.*, 7. 47, 1813 ; *Lehrbuch der Chemie*, Dresden, 3. 1212, 1845 ; J. Thomsen, *Journ. prakt. Chem.*, (1), 13. 345, 1876 ; G. Krüss, *Ber.*, 20. 205, 2365, 1887 ; 21. 126, 1888 ; *Liebig's Ann.*, 238. 30, 241, 1887 ; T. E. Thorpe and A. P. Laurie, *Journ. Chem. Soc.*, 51. 565, 866, 1887 ; J. W. Mallet, *Proc. Roy. Soc.*, 46. 71, 1889 ; *Phil. Trans.*, 180. 395, 1889 ; *Amer. Chem. Journ.*, 12. 73, 182, 1889 ; *Chem. News*, 56. 132, 1887 ; 61. 70, 79, 102, 115, 127, 137, 151, 164, 1889 ; T. Thomsen, *An Attempt to Establish the First Principles of Chemistry by Experiment*, London, 1. 440, 1825 ; F. Weigand, *Zeit. angew. Chem.*, 19. 139, 1906 ; E. Priwoznik, *Octser. Zeit. Berg. Hütt.*, 59. 391, 1911 ; C. F. Bucholz, *Beiträge zur Erweiterung und Berichtigung der Chemie*, Erfurt, 1802.

§ 8. The Flocculation and Deflocculation of Colloidal Solutions

Adsorption by a liquid or solid is essentially specific, for the amount adsorbed necessarily varies with the nature of the adsorbing agent, the liquid, and the substance to be adsorbed. W. D. Bancroft¹ has compiled a large number of examples in his *Outlines of Colloidal Chemistry*, from which many of the following are selected. In illustration of selective adsorption L. and P. Wöhler and W. Pluddeman² found that charcoal and ferric oxide adsorb benzoic acid about ten times as strongly as acetic acid, while chromic oxide absorbs the two about equally well, and platinum black adsorbs acetic acid a little, and benzoic acid not at all. Salts generally have a tendency to adsorb their own ions—silver bromide adsorbs silver nitrate or potassium bromide, but not potassium nitrate ; charcoal adsorbs acid and basic

dyes; alumina adsorbs acid dyes readily but not so with basic dyes; silica and tannin adsorb basic dyes the more readily; and wool adsorbs many dyes strongly without a mordant, while cotton adsorbs relatively few. G. T. Davis found that the order of adsorption of iodine from soln. of different substances was not the same with different kinds of charcoal.

A. Müller and H. Weiske have shown that filter paper adsorbs so much barium, strontium, or calcium hydroxide from dil. soln. as to interfere with the use of filter paper for certain quantitative work. T. Bayley, J. U. Lloyd, M. A. Gordon, L. H. Skraup, etc., have studied the adsorption of salts by filter paper. The general results show: (1) filter paper shows selective adsorption for water and for each constituent of the soln.; (2) if the solute is adsorbed relatively faster than the water there will be formed a water-ring; (3) if the water is adsorbed relatively faster than the solute, the latter will concentrate in the outer zone.

If a substance adsorbs a base more strongly than an acid, there will be a tendency for that salt to hydrolyze in soln. Similar remarks apply if the acid be adsorbed the more strongly. For instance, there is no doubt a slight hydrolysis of sodium chloride in aq. soln.: $\text{NaCl} + \text{H}_2\text{O} \rightleftharpoons \text{NaOH} + \text{HCl}$, but the action is so slight that it cannot be detected under ordinary conditions and the soln. appears neutral. If one product of the hydrolysis be removed from the system, say, the sodium hydroxide, the hydrolysis can go further, and the soln. will become acid. F. K. Cameron showed that if fuller's earth be shaken with water, the filtrate remains neutral to litmus or to phenolphthalein, proving that no soluble acid or alkali is present; but if the fuller's earth be shaken with a soln. of sodium chloride, the filtrate is acid to litmus and phenolphthalein. Moist fuller's earth will remove alkali from slightly reddened phenolphthalein, and the colour disappears; moist fuller's earth acts similarly when pressed against litmus paper, the paper is reddened by the earth adsorbing the base from neutral litmus.

J. E. Harris found that sandy loams, and china clay which had been treated with an acid, and the soluble acid removed by washing, adsorb the base from soln. of sodium acetate, potassium nitrate, or sodium chloride. L. Liebermann reported that animal charcoal will not remove the base from a soln. of sodium chloride, but that it will do so from soln. of sodium acetate or phosphate. Cupric or ferric hydroxides, so called, adsorb the acid; and boneblack adsorbs unchanged calcium or barium chloride from the aq. soln. P. Yorke also observed that filter paper adsorbs lead oxide from a soln. of lead oxide in lime water. L. H. Skraup noted that lead acetate soln. loses lead oxide and becomes more acid when passed through filter paper; L. Vignon obtained an analogous result by the action of cotton wool on soln. of mercuric chloride.

G. C. Schmidt found that in the simultaneous adsorption of iodine and acetic acid by charcoal from soln. of iodine in water and in ethyl acetate, less of each substance was adsorbed than if the other had been absent. H. Freundlich and M. Masius obtained similar results with pairs of organic acids, and they also found that the acid which is adsorbed the more is displaced the less when the two acids are present in soln.

H. Lachs and L. Michælis found sodium hydroxide reduced the adsorption of potassium chloride from water, while the presence of sulphuric acid increased the adsorption in agreement with Y. Osaka's observation that potassium chloride is adsorbed more than potassium sulphate, and sodium chloride more than sodium sulphate. W. Skey also found that charcoal will remove traces of nitric acid from dil. but not from conc. sulphuric acid—otherwise expressed, with an increase in the conc. of the sulphuric acid there is an increasing displacement of nitric acid from the charcoal, so that less is adsorbed from the conc. acid. H. Freundlich and H. Kämpfer found that the presence of thorium salts reduce the adsorption of uranium salts by charcoal; P. Rona and L. Michælis, that acetone and acetic acid decrease the adsorption of glucose by charcoal; and D. B. Lake, that albumin and acetone have no effect each on the other.

H. Freundlich³ assumes that adsorption by colloids is accompanied by a lowering of the surface tension of the absorbing phase. He bases his reasons on J. W. Gibbs' well-known formula $\mu = -(C/RT)(d\sigma/dC)$, but as W. D. Bancroft has shown this

is a *mal*-application, because J. W. Gibbs' deduction refers to true soln., and not to suspensions. H. Freundlich's conclusion, however, is a valid empirical generalization, and it therefore follows that any substance A which is adsorbed by a second substance B lowers the surface tension of B, and will therefore tend to disintegrate it so as to form a colloidal soln. The term *peptization*— $\pi\acute{\epsilon}\psi\iota\varsigma$, digestion—was coined by T. Graham to denote the disintegration or deflocculation of a colloid so as to form a colloidal soln.; the converse coagulation or flocculation was also called *pectization*— $\pi\eta\kappa\tau\acute{o}\varsigma$, curdled. The assumption now made is that every adsorbed substance tends to peptize the adsorbing substance.

W. D. Bancroft⁴ has collected together a mass of evidence in support of this hypothesis from which the following examples are selected: We may have peptization by a liquid, by a non-electrolyte, by an adsorbed ion, by a salt, or by a peptized colloid. When a liquid is adsorbed by a solid, it will tend to peptize it, and in some cases will do so. Water peptizes tannin, amyl acetate peptizes pyroxylin, and fused salts peptize metals. At higher temp. the peptizing action increases, and we may get glass peptized by water or vulcanized rubber by various organic liquids. Gelatine is not peptized by cold water, but is by warm water. J. Weisberg found calcium silicate seems to dissolve in a sugar soln. What really happens is that it is peptized by the sugar soln. A conc. soln. of sugar in water will prevent the precipitation of calcium silicate. C. A. L. de Bruyn found that silver chromate and silver chloride are peptized by sugar; also T. Graham noted that lime is held in apparent soln. in the presence of sugar, and E. Riffard noted that sugar prevents the precipitation of the hydrous oxides of copper and iron by ammonia; and E. Grimaux noted that glycerol prevents the precipitation of hydrous ferric oxide by potassium hydroxide.

A. Lottermoser found that by adding a slight excess of $\frac{1}{20}N$ -potassium chloride, bromide, or iodide to $\frac{1}{50}N$ -silver nitrate, the silver halide remained in soln. Freshly precipitated silver chloride is peptized by silver nitrate or potassium bromide, and in each case the silver or bromide ions are adsorbed, and, as L. Cramer has shown, the peptization of silver iodide and silver bromide gels by the corresponding halogen ion takes place in a striking manner in the presence of gelatine. J. M. Eder said:

If we precipitate silver bromide from a cold aq. soln. containing no gelatine or other similar substance, we get a coarse, compact precipitate which can easily be washed on a filter. If we pour this precipitate into a warm soln. of gelatine and shake, the silver bromide disintegrates and forms a fine emulsion. Under these circumstances the silver bromide behaves differently, depending on whether it has been precipitated in presence of an excess of bromide or of silver salt. This difference is noticeable no matter how carefully the silver bromide is washed.

A. Müller peptized thorium hydroxide by a soln. of thorium nitrate, and zirconium hydroxide by zirconium nitrate; while B. Szilard peptized the rare earth hydroxides by soln. of the chlorides or nitrates of the same elements. C. F. Nagel showed that the apparent soln. of hydrated chromic oxide in chromic chloride soln. is a case of peptization. H. W. Fischer and W. Herz, and C. F. Nagel found the apparent soln. of chromic oxide in an excess of potassium hydroxide soln. is a case of peptization; A. Hantzsch found the apparent soln. of beryllium hydroxide in potassium hydroxide comes in the same category, so also O. Loew's and H. W. Fischer's observations of the action of caustic alkali on hydrated copper oxide, and C. Tubandt's on hydrated cobalt oxide with the same menstruum. Freshly precipitated zinc hydroxide was found by W. D. Bancroft to be peptized by caustic alkali, but the soln. is so unstable that it coagulates in half an hour, and the relatively small amount of zinc remaining in soln. is present as alkali zincate. This explains the results of A. Hantzsch, H. W. Fischer and W. Herz, and O. Klein with the same reagents. According to E. G. Mahin, D. C. Ingraham, and O. J. Stewart, alumina is peptized by alkali-lye, but the work of W. Herz, A. Hantzsch, J. Rubenbauer, M. H. Fischer, R. E. Slade, and F. Blum show that it goes into soln. mainly as sodium aluminate. T. Graham showed that gelatinous silicic or stannic acid is peptized by sodium hydroxide. A. Müller prepared colloidal soln. of aluminium, iron, cobalt, thorium, and yttrium oxides by peptization with $\frac{1}{20}N$ -HCl; W. B. Bentley and R. P. Rose peptized alumina with 8 per cent. acetic acid.

Sulphides are peptized by hydrogen sulphide, for S. E. Linder and H. Picton found an excess of the last-named agent was necessary for the preparation of stable colloidal arsenious sulphide, and S. W. Young and W. R. Goddard showed that such sulphides can be repeatedly precipitated and peptized by removing or adding hydrogen sulphide, so that flocculation by electrolytes is not always an irreversible process. W. Spring found that copper sulphide prepared from a dil. ammoniacal soln. of the sulphate, and free from ammonium salts is peptized to a brown soln. by hydrogen sulphide soln. J. N. Mukherjee and N. N. Sen made some observations in the same direction. E. Prost peptized cadmium sulphide in

a similar manner. C. Winssinger prepared a colloidal soln. of zinc sulphide by the action of a soln. of hydrogen sulphide on freshly precipitated zinc sulphide.

J. Lefort and P. Thibault found that mercuric sulphide precipitates rapidly if mercuric chloride be added to the sulphur springs of Bagnères de Luchin, but no precipitation occurs if soln. of gum arabic, albumin, and other decoctions be present. Experiments with sulphides of lead, silver, iron, manganese, mercury, copper, zinc, antimony, and arsenic give similar results if the soln. of the salts be sufficiently dil. and enough gum arabic is added; metallic hydroxides behaved similarly. The formation of many other precipitates was also prevented by gum arabic. M. Lachaud found dextrine prevents the precipitation of ferric hydroxide by ammonia. C. Schiaparelli found saponin peptizes lead sulphate, barium carbonate, and other salts; W. Spring says soap peptizes rouge, charcoal, etc. These substances are often called *protective colloids* because they prevent the agglomeration and settling of finely divided precipitates. Casein is not peptized by water, but is peptized by acids and alkalis, and then acts as a protecting colloid. C. F. Nagel, and A. B. Northcote and A. H. Church found that hydrous chromic oxide is peptized by caustic potash and can then prevent the precipitation of hydrous ferric oxide, etc. If too much ferric oxide is present, all the chromic oxide is carried down by it. M. Prud'homme found that colloidal copper oxide peptized by ammonia causes the peptization of chromic oxide by ammonia.

The particles in suspension in colloidal soln. are electrically charged, and in the majority of cases, if water be the dispersion medium, the charge is negative in agreement with A. Cöhn's rule⁵ that when two substances are electrified by friction, the substance with the higher dielectric constant takes on the positive charge while the other substance takes the negative charge. Water has a relatively high dielectric constant, and hence, if the particles are charged by a process analogous to frictional electricity, the probability is, that they will be electrified with a negative charge. On the other hand, the dielectric constant is low, and G. Quincke found that with the exception of sulphur all the substances he tried were positive in this menstruum. E. F. Burton's experiments are also in agreement with the rule.

The electric change on colloidal particles can be conveniently demonstrated by S. E. Linder and H. Picton's experiment in which the liquid was placed in a U-tube fitted with electrodes charged to a high potential—say 110 to 220 volts. It was found that suspended particles of shellac, starch, sulphur, gold, silver, platinum, cadmium, metallic chlorides and sulphides, Prussian blue, silicic acid, stannic acid, clay, molybdenum blue, aniline blue, etc., travel to the anode, and therefore the particles are presumably charged negatively; on the other hand, particles of various metal hydroxides—*e.g.* ferric, chromic, aluminium, cadmium, zinc, thorium, zirconium, and cerium hydroxides—titanic acid; the metals lead, bismuth, and iron; methylene blue, etc., migrate to the cathode and presumably carry a positive charge.

W. B. Hardy showed that albumin in an alkaline soln. is negatively charged; in an acid soln., positively charged; and in a neutral soln. it is neutral; and J. Billitzer found that colloidal platinum in chloroform is positively charged, and in water negatively charged; and H. B. Weiser obtained colloidal soln. of positively and negatively charged barium sulphate. W. Pauli obtained similar results with proteids; J. Perrin, with many suspended powders and hydrosols; and F. Powis with ferric hydroxide. A. Cöhn observed that sugar migrates to the anode in dil. alkali soln., and to the cathode in dil. acid soln.

F. F. Reuss, in 1808, discovered the transport of both liquid and solid in a system composed of a liquid with a finely divided solid:

He inserted into a lump of moist clay two vertical glass tubes, filled them with water and dipped an electrode into each. On establishing a potential gradient between the electrodes, F. F. Reuss noticed to his surprise that the liquid rose in one tube and sank in the other, and that furthermore a decided turbidity developed in that tube in which the water-level sank. There had occurred, in short, a transfer of liquid to the cathode through the more or less porous clay diaphragm and, besides this, a simultaneous migration of some of the detached clay particles, the effects taking place in opposite directions.

H. Freundlich classified the electro-kinetic effects in a two-phase system of liquid and solid as follows :

(1) A difference of potential sending a current through the system may produce a relative displacement of the phases : (a) if the solid is fixed in the form of a porous diaphragm the liquid may move through the diaphragm (*electrical endosmose*) ; (b) if the solid is in the form of a suspension and is free to move, the solid may migrate through the liquid (*cata-phoresis*). (2) A relative displacement of the phases may produce a difference of potential and consequently an electric current through the system : (a) if the solid is fixed in the form of a porous diaphragm through which liquid is forced, a difference of potential and an electric current may be established between the extremes of the diaphragm (*G. Quincke's diaphragm currents*) ; (b) if the finely divided solid is dropped through the liquid, a difference of potential and a current may be set up between the upper and lower liquid strata (*J. Billitzer's experiments*).

The velocity of migration V of the disperse phase with a fall of potential E volts per cm., when the potential difference of the double layer is ϵ , and the dielectric constant and viscosity of the liquid are respectively K and η , is obtained from $V = \frac{1}{4} \epsilon EK / \pi \eta$. For glass and water with a fall of one volt per cm., M. von Smolouchowsky⁶ calculated a velocity of migration of 34×10^{-5} cms. per second. Various measurements have been made by S. E. Linder and H. Picton, W. R. Whitney and J. C. Blake, E. F. Burton, A. Cotton and H. Mouton, etc., and the results for arsenious sulphide, quartz, gold, platinum, silver, iron, and ferric oxide range from 19 to 40×10^{-5} cms. per second with a fall of potential of one volt per cm. This means that the velocity is nearly independent of the size and form of the particles. The velocity of migration of the suspensoid is nearly the same as that of an average slowly moving ion—thus, for Li^+ , the velocity is 36×10^{-5} cms. per second with a fall of potential of one volt per cm. E. F. Burton estimated the magnitude of the charge on particles of gold and silver soln. and found for silver soln. 2.8×10^{-2} electrostatic units, so that the charge on a gram-eq. of colloidal silver is about 4 per cent. of the charge on a silver ion, Ag^+ . Calculations have also been made by W. C. McC. Lewis, by H. Lamb, and by H. Freundlich. The charge e on a particle is $e = 6\pi\eta r V / E$, where r denotes the radius. The charge on a particle of colloidal platinum of radius $50 \mu\mu$ and velocity 2μ is 297×10^{-10} electrostatic units, a quantity nearly eq. to that of 99 chloride ions.

In 1870, W. S. Jevons⁷ assumed that the minute particles in a colloidal soln. acquire their electric charge by friction against the solvent as a dielectric, and he also supposed that the mutual repulsion of like charges prevented the coalescence of the particles. A. Cotton and H. Mouton, H. Lamb, and others interpreted this in terms of H. von Helmholtz's theory of the double electric layer formed by friction,

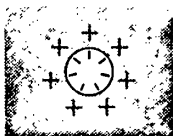

FIG. 9.

so that the charged particle, with an opposing charge of opposite sign in the surrounding dispersion medium acts as a spherical condenser with oppositely charged concentric plates, Fig. 9. It is necessary to assume that there is a slip between the two coatings, for if they were fixed the particles would remain motionless in the electric field. This hypothesis may explain the origin of the electric charge in non-conducting soln., but in other cases the trend of opinion is that the disperse phase absorbs electrically charged ions from the soln., and, in the case of colloidal soln. of the metals formed by G. Bredig's process of sparking the metals under water, H. T. Beans and H. E. Eastlack believe that an oxide of the metal is formed and adsorbed during the sparking. The negatively charged platinum, gold, etc., are much more stable if chlorides, bromides, iodides, or hydroxides be present.

The electrical conductivity of colloidal soln. is very small, and is so little different from the liquid medium that it is not easy to decide what part of the conductivity is due to the medium, and what to the sol, or to the adsorbed impurities which cannot be removed from the colloid by washing or dialysis. For example :

		Specific conductivity in mhos.
		Sol. Medium.
Gold	1.4×10^{-6} 0.81×10^{-6}
Ferric hydroxide	35.7×10^{-6} 2.00×10^{-6}

W. R. Whitney and J. C. Blake⁸ found the conductivity of gold hydrosol to diminish with repeated electrolysis, and finally approached a limiting value approximately that of the medium itself. When a soln. is placed in a U-tube, Fig. 10, fitted with suitable electrodes, during electrolysis, the suspended particles move through the liquid towards one electrode, and away from the other. The suspended particles move in the direction which reduces the electrical stress when a difference of potential is established in the liquid. This motion of the solid through the liquid is often called *cataphoresis* or *kalaphoresis* (κατὰ φορά, a bringing down).

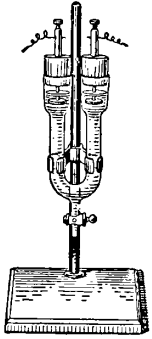

FIG. 10. — The Migration of Suspensoids during Electrolysis.

A. Cotton and H. Mouton have designed a neat apparatus. Two strips of platinum foil *PP*, Fig. 11, to serve as electrodes, are cemented to a glass slip *AA*. These strips of foil are gripped by a pair of terminals *TT*. A drop of the liquid under examination is placed on the slide so that it touches both electrodes, and the cover glass *BB* is placed in position

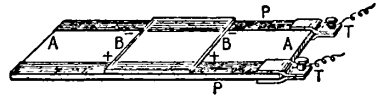

FIG. 11.—Microscopic Slide for observing the Migration of Colloids during Electrolysis.

The preparation is then examined under the microscope. The movements of the particles towards one electrode and away from the other electrode can be readily observed.

Suspensoids can be ranged in two groups according as they migrate towards the anode or the cathode. S. E. Linder and H. Picton (1892) noticed that colloidal arsenious sulphide travelled towards the anode, and ferric hydroxide towards the cathode. It is therefore inferred that the particles in some sols are positively charged, and others negatively charged.⁹

Positively charged sols (to cathode).

- Metal hydroxides
- Titanic acid
- Lead } are
- Iron } probably
- Bismuth } hydroxide sols
- Magdala red
- Methyl violet
- Methylene blue
- Albumen, agar-agar, hæmoglobin

Negatively charged sols (to anode).

- Metals and their salts
- Sulphur, selenium, iodine
- Vanadium pentoxide
- Clay, quartz, felspar, asbestos
- Starch, shellac, amber
- Aniline blue, fuchsin, tungsten blue
- Gambose, mastic, caramel
- Silicic and stannic acids

The solvents make a difference ; thus most of those substances which move towards the anode when suspended in water, travel in the opposite direction in turpentine.¹⁰ The magnitude of the charge can be estimated from the rate of transit of the particles and the strength of the electric field. The velocity is independent of the size and shape of the particles, and is found to be of the same order of magnitude as the migration velocities of slowly moving ions, and is not far from 34×10^{-5} cms. per second with a difference of one volt in the fall of potential. The actual numbers are :

Silver.	Gold.	Platinum.	Arsenious sulphide.	Ferric hydroxide.
19 to 33×10^{-5}	21 to 40×10^{-5}	20 to 30×10^{-5}	22×10^{-5}	30×10^{-5} cms. per second

The extraordinary sensitiveness of colloids to chemical reagents attracted attention very early,¹¹ In 1824, for example, J. J. Berzelius noted that colloidal boron is precipitated by acids and salts ; in 1846, H. W. F. Wackenroder noticed

that colloidal sulphur was precipitated by the addition of an acid to a soln. of a polythionate; E. Frémy marked the precipitation of soln. of silicic acid by soluble alkalis; H. B. Weiser, the precipitation of some colloids by mixed electrolytes; W. Crum, the coagulation of colloidal alumina by salts and acids; T. Scheerer, the clarification of turbid soln. by strong acids and their salts. M. Faraday also noticed that his gold sols changed colour when treated by a salt; and T. Graham, discussing this very action, said:

The colloid, although often dissolved in a large proportion of its solvent, is held in soln. by a singularly feeble force. Hence, colloids are generally displaced or precipitated by the addition to their soln. of any substance from the other class (crystalloids).

In general, the clarification of turbid soln., due to very small suspended particles which settle very slowly, if at all, is promoted by the addition of soluble electrolytes; non-electrolytes do not act in this manner. Thus, T. Schlösing found that the addition of 0.0001 or 0.00001 part of calcium or magnesium salts will clear water from suspended clay. This is supposed to explain the marked clarity of hard waters. A turbid suspension of clay which does not clear after standing for months will be clarified in half an hour after the addition of a trace of sodium chloride, or a drop of sulphuric acid. This partially explains the precipitation of mud at the mouths of fresh-water streams where they come in contact with the salt of the sea.

The susceptibility of colloids to the influence of electrolytes varies very much; some require large amounts of certain salts to effect precipitation, and are not affected by other salts. W. S. Jevons noticed, in 1870, the addition of acids, alkalis, or salts, independently of their constitution, stilled the Brownian movements, and coagulated the suspension. R. Zsigmondy thus described the effect of adding an electrolyte to a colloidal soln. with ultramicroscopic particles in suspension, as it appears under the ultramicroscope:

The light cone first becomes visible; wavy nebulae appear; the clouds thicken; and tiny individual particles with an active Brownian movement come into view. Where the particles unite, they turn about their common centre of gravity, and the Brownian movement begins again, but more sluggishly than before.

When the particles have settled, the Brownian movement ceases owing to the large size of the aggregates. The gradual discharge of the disperse phase has been followed by E. F. Burton, and T. Svedberg, and the latter showed that the amplitude of the Brownian movement was the same whether colloidal silver was neutral or charged positively or negatively, thus showing that the Brownian movement is not due to electrical causes.

A definite concentration of the electrolyte is necessary for the complete precipitation of the colloid, smaller or larger amounts may cause partial precipitation, or none at all. For example, H. Freundlich found that the addition of 1.219 and of 2.428 milligram-molecules of potassium chloride to a soln. containing 11.272 milligram-molecules of arsenious sulphide in suspension, produced very little result at the end of 340 days—about 1.8 milligram-molecules of the sulphide, at most, were precipitated—but with 3.9 milligram-molecules of potassium chloride, nearly the whole of the sulphide was precipitated. W. B. Hardy, H. Freundlich, E. F. Burton, J. Duclaux, A. Lottermoser, F. Powis, H. R. Kruyt and co-workers, etc., have studied the effect of traces of electrolytes on the stability of colloidal soln. W. B. Hardy showed that the flocculation of a colloidal soln. occurs exactly at that conc. of the electrolyte which can stop cataphoresis, but later observations have shown that this hypothesis requires modification. It is a curious fact that if the precipitating agent be added slowly, in small portions at a time, a larger amount is required for complete precipitation than if the reagent be added quickly. The difference is greater the slower the reagent is added. Thus, 2 c.c. of a soln. of barium chloride flocculated colloidal arsenious sulphide immediately when added at once, but if added to an equivalent soln. slowly, drop by drop, only a relatively small part of the colloid was precipitated in 45 days.¹² Using metaphorical language,

it has been said that the sol becomes acclimatized to the reagent when the latter is added slowly.

It has been a favourite assumption¹³ that the stability of a sol colloid is due to the formation of a chemical complex. For example, silver hydrosol has been regarded as $xAg.yAgOH$; arsenious sulphide as $xAs_2S_3.yH_2S$; etc.; and T. Graham has said that "the basis of colloidality may really be the composite character of the molecule." However this may be, V. Henri and A. Mayer consider that it is somewhat doubtful if the precipitating agent unites chemically with the sol colloid, because the amount of salt associated with the colloid varies with the conc. of the salt in the liquid, in agreement with the general law of adsorption of substances by colloids.

According to W. B. Hardy,¹⁴ the ion which is active in coagulating a given colloidal sol has a charge of opposite sign to that of the colloid; consequently, the precipitating power of an electrolyte depends upon the valency of the ion whose electric charge is of opposite sign to that of the colloid. H. Freundlich calls this **Hardy's rule**, and it has been confirmed by the work of H. Freundlich, H. Picton and S. E. Linder, J. Perrin, and others. In 1882, H. Schulze showed that the precipitating power of an electrolyte for a given colloidal solution depends upon either the anion or the cation, but never on both, and it increases rapidly with the valency of the active ion. This has been called *Schulze's law*. The precipitating power of electrolytes falls into groups according to the valency of the active ion. Thus, with arsenious sulphide, which is a negative sol, the electrolytes with a univalent cation—H⁺, Na⁺, K⁺, . . .—fall into one group with the smallest precipitating power; the bivalent cations—Ca²⁺, Ba²⁺, Mg²⁺, Zn²⁺, . . .—fall into a second group; and the trivalent cations—Al³⁺, Fe³⁺, . . .—fall into a third group with the greatest precipitating power. Table VII shows the minimum conc. of the given salts required to coagulate the negative colloid in a sol containing 14.71 milligram-molecules of arsenious sulphide per litre. In this particular case, therefore, the precipitating power of ter-, bi-, and uni-valent cations is approximately as 1 : 8 : 500. N. Bach found the coagulating power of the alkali ions is in the order Cs⁺ > Rb⁺ > NH₄⁺ > K⁺ > Na⁺ > Li⁺; and the halogen ions, Cl⁻ > Br⁻ > I⁻. A. Westgren found that the coagulating power of an electrolyte to be independent of the size of colloidal gold particles; and that the velocity of coagulation is greater, the greater the migration velocity of the anion. O. Herstad showed that soln. of mercuric chloride with a comparatively small degree of ionization have a much greater coagulating power on gold hydrosols than most salts of the heavy metals, more strongly ionized. The coagulation is inhibited by hydrochloric acid. He supposes a film of mercury oxide is formed about the colloidal particles of gold which transform the negative colloid into a positive one. W. C. D. Whetham recast Schulze's law in the form:

The coagulating power or the reciprocal of the minimal conc. of a series of ions of the same sign is proportional to a constant raised to the power representing the valency of each ion, so that if P_1 , P_2 , and P_3 represent the coagulating powers of a uni-, bi-, or tri-valent radicle, $P_1 : P_2 : P_3 = K : K^2 : K^3$, where K is a constant.

TABLE VII.—THE PRECIPITATING POWER OF ELECTROLYTES ON ARSENIOS SULPHIDE

Univalent cations.		Bivalent cations.		Tervalent cations.	
Salt.	Mgram. mols. per litre.	Salt.	Mgram. mols. per litre.	Salt.	Mgram. mols. per litre.
KI	67.1	BaCl ₂	0.94	AlCl ₃	0.13
KCl	69.1	BeSO ₄	1.13	Al(NO ₃) ₃	0.14
KNO ₃	69.8	MgCl ₂	1.00	$\frac{1}{2}Ce_2(SO_4)_3$	0.13
LiCl	81.5	CaCl ₂	0.905	—	—
HCl	42.9	Ca(NO ₃) ₂	0.945	—	—
NH ₄ Cl	59.1	ZnCl ₂	0.956	—	—

H. B. Weiser and E. B. Middleton noted that in the precipitation of colloidal aluminium hydroxide, the most readily adsorbed ion precipitates in the lowest conc. and conversely. The order of adsorption deduced from the precipitation values, expressed in eq., is ferrocyanide, thiosulphate, ferricyanide, citrate, sulphate, oxalate, phosphate, chromate, dithionate, dichromate, chloride, nitrate, bromide, and iodide. H. R. Kruyt and co-workers have studied the flocculation of gold sols by thorium nitrate, by colloidal thorium oxide, and by potassium, barium, and aluminium salts; H. D. Murray, of colloidal sulphur; N. Bach, of colloidal arsenic sulphide and ferric hydroxide by the alkali halides; J. N. Mukherjee and N. N. Sen,¹⁵ and J. Mukhopadhyaya, the effect of dilution and temp. on arsenic sulphide. H. D. Murray tried to get a general expression for the precipitating action of ions on colloids, and found, for univalent cations with the same anion, for negatively charged colloids $C=K.N^n$, where C is the minimum conc. for colloidal precipitation; N , the at. number of the cation; n , is a constant for the colloid at a given conc.; and K is a constant dependent upon the nature of the colloid, and on the anion.

W. D. Bancroft has emphasized the fact that the disperse phase in a colloidal soln. is electrically charged by the preferential or specific absorption of some ion; so long as all the particles are charged positively or negatively, they will repel one another and not coalesce. Neutralization of the charge causes precipitation through adsorption, and that in all probability the neutralization of an adsorbed ion is another case of specific adsorption. The precipitating power of an electrolyte depends on the degree of its adsorption by the disperse phase. According to this hypothesis, H. Schulze's law means that trivalent ions are adsorbed more strongly than bivalent ions, and bivalent ions more strongly than univalent ions. This is the usual state of things, but Y. Osaka has shown that charcoal adsorbs potassium salts in the following order: $KI > KNO_3 > KBr > KCl > K_2SO_4$ for eq. conc., therefore, the sulphate ion is adsorbed least of all. If selective adsorption be the cause of the action, it may be predicted that some univalent ions will be adsorbed by some substances more than some bi- or ter-valent ions. This is shown to be the case with S. Odén's experiments on the influence of different salts on the coagulation of colloidal soln. of sulphur. The eq. precipitating power of caesium chloride is nearly five times as great as that of cadmium nitrate, zinc sulphate, or nickel nitrate, and greater than magnesium sulphate, manganese nitrate, or copper sulphate. H. Freundlich found bivalent lead has nearly the same precipitating power on colloidal platinum as trivalent aluminium; and mercurous nitrate, $HgNO_3$, a greater coagulating power on mastic than zinc sulphate, calcium chloride, or barium chloride. There are also exceptions to Schulze's rule to be observed in the work of N. Pappada, on Prussian blue and copper ferrocyanide; of H. Freundlich and H. Schucht, on arsenious sulphide and hydrated ferric oxide; of J. N. Mukherjee and N. N. Sen on the coagulation of sulphide soln. where adsorption of the electrolyte does not take place to any marked extent. W. D. Bancroft further showed that in the case of albumin there is not even a suggestion of Schulze's law in the observed results. Instead of the cations being alone effective in the coagulation of negatively charged sols, and anions in the coagulation of positively charged sols, W. D. Bancroft shows that in virtue of the preferential adsorption, the nature of both ions must be taken into consideration. Schulze's law is to be regarded as a first approximation because the precipitating power of an ion depends on its adsorption by the disperse phase, and that the higher valent ions are adsorbed more than those of lower valency and have accordingly a greater coagulating power.

T. Graham, H. Picton and S. E. Linder,¹⁶ and A. Lottemoser have noted the mutual precipitation of colloidal sols having opposite charges, and that if the charges be alike no precipitation occurs. W. Biltz showed that it is necessary for the admixture to be made in proper proportions, for if either one is in excess, there may be no precipitation, as in a case recorded by W. Spring. Thus, with 2 c.c. of a soln. of 0.56 mgrm. antimony trisulphide, and 13 c.c. of a soln. of ferric oxide,

the product was turbid and homogeneous with 30.8 to 12.8 mgrms. Fe_2O_3 ; slow precipitation occurred with 8.0 mgrms. Fe_2O_3 ; complete precipitation with 6.4 mgrms. Fe_2O_3 ; and a yellow soln. with flocks with 4.8 and 3.2 mgrms. Fe_2O_3 ; and a yellow turbid soln. with no flocks with 0.3 mgrm. Fe_2O_3 per 13 c.c. of liquid. This conclusion was confirmed by H. Bechhold, M. Neisser and U. Friedemann, and V. Henri. W. D. Bancroft has emphasized the fact that adsorption may occur when two sols with charges of the same sign are mixed. "Since complete neutralization takes place only when one sol has adsorbed the amount of the sol carrying an equivalent amount of the ion having the opposite charge, it follows that the amount of one sol necessary to precipitate a given amount of another sol will vary with the degree of adsorption; it will therefore be a specific property and not an additive one," and he shows that the data of W. Biltz on the precipitation of colloidal gold, colloidal antimony, or arsenic sulphide fit in with this conclusion.

T. Graham observed that a rise of temp. of 1° occurred during the coagulation of a 5 per cent. soln. of gelatine; J. Thomsen could detect no measurable heat change during the coagulation of silicic acid, but E. Wiedemann and C. Lüdeking found 11.3 to 12.2 cal. per gram; and H. Picton and S. E. Linder reported that no measurable heat change attends the coagulation of ferric oxide or of arsenic or arsenious sulphides. According to F. Dörinckel, the heat of coagulation of silicic acid and of ferric oxide is always positive, and is not a linear function of the conc. of the colloid. The heat of coagulation is greater per gram of iron oxide in dil. soln. than it is in conc. soln. F. Dörinckel also found the heat of coagulation of colloidal silver with a protective colloid to be about 19 cal. per gram of the disperse phase; while J. A. Prange obtained with pure colloidal silver, 126.7 to 250.9 cal. per gram.

S. E. Linder and H. Picton noticed that during the coagulation and precipitation of a colloidal soln., the sol carries down with it part of the reagent—mainly the ion whose charge is of opposite sign to itself and the soln. becomes more acid or alkaline. Thus, when colloidal arsenious sulphide is precipitated with barium chloride, barium appears with the precipitate, and the supernatant liquid is acid with hydrochloric acid. The precipitate cannot be cleaned by washing. The ion with a charge of the same sign as the colloid, exerts an influence opposite to precipitation, and tends to make the suspension more stable—thus, G. Bredig's metal colloids become more stable when the medium contains a trace of alkali.

When an insoluble precipitate is formed in the absence of electrolytes by a reaction between two chemical compounds, it is almost always in the colloidal condition. Thus if aq. hydrogen sulphide be added to a soln. of arsenious acid, a turbid yellow soln. of colloidal arsenious sulphide is formed: $2\text{H}_3\text{AsO}_3 + 3\text{H}_2\text{S} \rightleftharpoons \text{As}_2\text{S}_3 + 6\text{H}_2\text{O}$. If the precipitate be made by adding an aq. hydrogen sulphide to a soln. of arsenious chloride, a coagulated precipitate of arsenious sulphide is formed. In the latter case, hydrochloric acid is produced by the reaction: $2\text{AsCl}_3 + 3\text{H}_2\text{S} \rightleftharpoons \text{As}_2\text{S}_3 + 6\text{HCl}$. If some hydrochloric acid be added to colloidal arsenious sulphide formed as just indicated, the suspended colloid is at once coagulated and precipitated. These facts illustrate a principle of great importance in quantitative analysis where successful work depends upon the formation of an insoluble precipitate which can be easily washed free from adsorbed mother liquid. When a colloid is precipitated by an electrolyte, as when aluminium and ferric hydroxides are precipitated by ammonia in the presence of ammonium chloride, the salt, ammonium chloride, coagulates the colloidal hydroxides into the gel condition. During the washing of the gel precipitate, the gel passes into the sol condition, because the coagulating salt is removed by washing. Hence a soln. of ammonium nitrate is used for washing aluminium and ferric hydroxide precipitates in order to keep the colloid in the coagulated or gel condition. The ammonium nitrate is driven off during the ignition of the hydroxides prior to weighing. Gel colloids are said to be reversible colloids when they can be converted into the sol condition by restoring the original conditions, e.g. by washing out the coagulating electrolyte from precipitated aluminium

hydroxide; M. C. Lea's soluble silver; etc. On the other hand, irreversible colloids cannot be reconverted into the sol condition once they have passed into the gel condition, e.g. stannic hydroxide, gold, etc. Some colloids are reversible when freshly precipitated, but become irreversible on standing.

Soln. must have a definite conc. in order that a precipitate may be formed in a given time. Certain conc. favour the formation of crystalline precipitates and with greater or less conc., the formation of crystals becomes less and less distinct until the crystalline structure cannot be recognized at all. When the conc. of the soln. decreases below that which favours the formation of a crystalline precipitate, the magnitude of the crystals decreases with increasing dilution, until colloidal suspensions are produced. There is no evidence of a discontinuity, and it is consequently inferred that the smallest particles have a crystalline character. According to P. P. von Weimarn's analysis of the phenomenon,¹⁷ the earliest or initial stage in the separation or condensation of a solid from a soln. is the formation of nuclei or particles approaching molecular dimensions. These particles increase in size in two ways: (1) By aggregation as when two particles approach close enough to unite and form a larger particle—this P. P. von Weimarn calls *Aggregations-Kristallisation*; or (2) by abstracting molecules of the solute from the surrounding soln.—this P. P. von Weimarn calls *molekularen Kristallisation*. Consequently, the stability of a system will depend upon at least two factors: (i) the rate at which the nuclear particles separate from the soln.; and (ii) on the rate at which the particles can grow. In order that precipitation may occur, an amount P of the solute must be present in excess of that required for the saturation of the soln. P. P. von Weimarn calls this excess the *Kondensationsdruck*—that is, the condensation press. of the soln. Working against this factor is what P. P. von Weimarn calls the *Kondensationswiderstand*, or the resistance of the soln. to condensation; this varies with the nature of the solute and solvent. If C denotes the actual conc. of the supersaturated soln., and S the solubility or conc. of the sat. soln., $C-S=P$, the condensation press. For a given value of P , a few crystals of a very soluble solute (with S large) will be slowly formed under conditions where, for the same value of P with a very sparingly soluble solute (S small), a large precipitate will be immediately formed. Hence, it can be assumed that the resistance of the soln. to condensation is inversely proportional to the solubility S of the solute; the rate of condensation or separation of the nuclear particles will be equal to kP/S , where k is a constant; and the *spezifische Uebersättigung*, or the relative supersaturation of the soln. at the moment of condensation, will be P/S .

The behaviour of the system will be different according as the value of P/S is determined by a large value of P , or a small value of S . In the former case, a gel is likely to be formed, and in the latter case, a sol. Other things being equal, the duration of the phase of the initial condensation will depend on the magnitude of the supersaturation of the soln., and the smaller the value of P the slower the growth of the particles. The solubility of barium sulphate, approximately 0.0002 gm. per 100 c.c., is small in comparison with that of a soln. of barium chloride or nitrate, and of the ordinary sulphate precipitate in the laboratory, for on mixing such soln., $C-S$ or P for the resulting barium sulphate is not large enough to give large values of P/S , and an immediate precipitation occurs as is desired in the operations of analytical chemistry. By using soln. of barium thiocyanate, $\text{Ba}(\text{SCy})_2 \cdot 3\text{H}_2\text{O}$, and manganese sulphate, $\text{MnSO}_4 \cdot 4\text{H}_2\text{O}$, P. P. von Weimarn was able to obtain a wide range of values of P/S for the formation of barium sulphate— $\text{MnSO}_4 + \text{Ba}(\text{SCy})_2 = \text{BaSO}_4 + \text{Mn}(\text{SCy})_2$. The time required for the opalescence of barium sulphate to appear when soln. with different conc. of $\text{Ba}(\text{SCy})_2 \cdot 3\text{H}_2\text{O}$ and $\text{MnSO}_4 \cdot 4\text{H}_2\text{O}$ are mixed: $\text{MnSO}_4 + \text{Ba}(\text{SCy})_2 = \text{Mn}(\text{SCy})_2 + \text{BaSO}_4$, is indicated in Table VIII; and P. P. von Weimarn's results showing the nature of the precipitate are indicated in Table IX.

For very soluble substances, where S is large, the suspensoid stage is developed for large values of P/S , and the conc. suspensoid forms a gel. When P/S is small,

the suspensoid stage is recognized with difficulty. For example, a test tube containing a sat. soln. of manganous sulphate, $MnSO_4$, when dipped in liquid air, forms a clear solid jelly or glass. For sparingly soluble substances, where S is small, the suspensoid stage is developed with both large and small values of P/S , but with large values of P/S , the suspensoid is a gel, and with small values of P/S a sol. Example, the formation of barium sulphate in aq. soln. For substances which are virtually insoluble, S is very small, and the suspensoid stage is recognizable only with large values of P/S ; and P/S must be extremely large if a gel is to be obtained. Example, the formation of aluminium hydroxide by reactions in aq. soln. at room temp.

TABLE VIII.—THE TIME REQUIRED FOR THE PRECIPITATION OF BARIUM SULPHATE.

Conc. of the reacting soln.—normality.	Time required for the appearance of a marked opalescence after the mixing of the reagents.	Time required for the precipitation of most of the barium sulphate after the mixing of the reagents.
0.002	Some seconds	0.5 to 1 hr.
0.001	3 to 5 minutes	2 to 3 hrs.
0.0005	2 to 3 minutes	10 to 12 hrs.
0.0003	6 to 8 minutes	24 hrs.
0.0002	The opalescence and the appearance of the precipitate were not distinguishable	In about 30 days the formation of a precipitate on the walls of the vessel was noticed.

P. P. von Weimarn further states that however small the solubility of a substance, a crystalline precipitate is obtained if the volume of the sol and the interval of time are sufficiently great. Examples: the formation of crystalline minerals of sparingly soluble substances in nature; and artificial processes for the synthesis of minerals. Again, every disperse system obtained by cooling a soln., by replacing one solvent by another, by reduction, oxidation, hydrolysis, or other chemical process, tends to diminish its dispersivity because the smallest particles are more soluble than the larger particles, and therefore the larger particles grow at the expense of the smaller. E. H. Buchner and J. Kalfi hold that P. P. von Weimarn's theory is not confirmed by quantitative experiments.

F. W. Lüdersdorff (1833),¹⁸ and M. Faraday (1857) found that the coloured soln. of gold are more stable in gummy gelatinous liquids. M. Faraday said that on evaporating such a mixture, the red did not change colour; and A. Lottermoser found that the presence of albumin prevented the precipitation of silver sols by electrolytes, and stated: When the hydrosol of silver is mixed with a stable colloid—like albumin, gelatine, agar-agar, or gum arabic—the addition of an electrolyte does not precipitate the silver until all the stable colloid has been gelatinized. The less stable hydrosol of silver is thus protected by the more stable colloid against the electrolyte. The silver hydrosol when protected by the stable colloid is itself stable. Hence, as previously indicated, those colloids which have the power of preventing or retarding the coagulation of suspensoid particles are called **protective colloids**, or *Schutzkolloide*. According to H. Bechhold,¹⁹ each particle of the suspensoid (silver hydrosol) surrounds itself with a film of the emulsoid (albumin), and then possesses the electrical properties of the latter. R. Zsigmondy considers that the relatively small dimensions of the particles of gold in comparison with those of gelatine or albumin molecules established by C. A. L. de Bruyn does not support this hypothesis; and he favours the assumption that the gold particle either unites with many particles of the protective colloid, or that a particle of the protective colloid unites with many particles of gold. R. Zsigmondy determined the quantity of colloid which just fails to prevent 10 c.c. of a red gold hydrosol changing violet on the addition of 1 c.c. of a 10 per cent. soln. of sodium chloride. The numbers so obtained are called *Goldzahlen*, or the **gold numbers**, or gold figures

of the protective colloid. The following gold numbers are selected from R. Zsigmondy's table :

Gelatine.	Egg-albumin.	Gum arabic.	Gum tragacanth.	Potato starch.	Sugar.
0.005—0.01	0.15—0.25	0.1—0.4	c. 2.0	c. 25	8

R. A. Gortner²⁰ has determined the gold numbers of protoalbic and lysalbic acids to be respectively 0.15—0.20, and 0.10—0.125; and for sodium oleate, 2—4. F. Küsspert found that gold and silver hydrosols are protected by silicic acid; W. Biltz, by zirconium hydroxide; and R. Zsigmondy, by alumina, and stannic oxide. According to M. Beyer, colloidal silver protected by albuminous matters

TABLE IX.—THE INFLUENCE OF CONCENTRATION ON THE PRECIPITATION OF BARIUM SULPHATE.

Cone. of the reagents (normality <i>N</i>).	<i>P</i> The degree of supersaturation of BaSO ₄ (grams per 100 c.c.).	<i>P/S</i> The relative supersaturation of BaSO ₄ (<i>S</i> =0.002 grm. per 100 c.c.).	Nature of the precipitate.
0.00005 to 0.00014	0 to 0.0006	0 to 3	No precipitate formed in a year, but theoretically a precipitate can be expected in a few years with a large volume of solution.
0.00014 to 0.0017	0.0006 to 0.0096	3 to 48	It is probable that for <i>P/S</i> =3, over a year is needed for the formation of a suspensoid; for <i>P/S</i> =48, a precipitate forms in a few seconds.
0.0017 to 0.75	0.0096 to 4.38	48 to 21,900	A precipitate is formed in a few seconds when <i>P/S</i> =48; after this, precipitation is instantaneous, and the precipitate consists of crystal skeletons and needles. The nearer the concentration approaches 0.0017, the smaller the number of crystal skeletons.
0.75 to 3	4.38 to 17.51	21,900 to 87,500	There is an immediate precipitation of an amorphous precipitate which appears under the microscope to consist of spherical particles.
3 to 7	17.51 to 40.9	87,500 to 204,500	Clear jelly which changes in about 24 hours into a voluminous flocculent mass.

is found in commerce under the name *collargol*. It is employed in medicine as an antiseptic, but its power as a bactericide is rather feeble. E. Zung has studied the protective action of the albumoses; L. Lichtwitz, H. H. Salkowsky, E. Rählmann, and H. Much, the protective action of urine albumin; A. Gutbier and co-workers, the protective action of cetraria islandica (Irish moss), and of saponin; H. Freundlich and E. Löning, albumen; and T. Iredale, the protective action of soaps on colloidal gold. In purple of Cassius the gold is protected by stannic oxide; and finely divided chromic oxide forms a crimson lake with the stannic oxide.

W. D. Bancroft identifies the so-called protective action of colloids with peptization. He supposes that the *Schutzkolloide* is absorbed, and, by lowering the

surface tension, tends to disintegrate the precipitate, or prevent it forming. Consequently, the protective action is but a special case of peptization. Several examples have been previously discussed. For instance, the influence of sugar, gums, etc., in preventing the precipitation of, say hydrated ferric oxide from soln. of ferric salts by ammonia or potassium hydroxide; of gums in preventing the precipitation of mercuric and other sulphides; etc.

M. von Smoluchowsky, O. Klein, A. Westgren, etc., have discussed the mathematical theory of coagulation. The first named said :

Perhaps the most simple view to adopt is, that the particles attract one another by capillary forces when they are sufficiently close together. The fact that no union takes place under normal circumstances, is to be attributed to the protective action of the electrical double layer, which can be likened to a kind of elastic cushion. The addition of an electrolyte, causes a partial or a complete destruction of the double layer through the absorption of ions as pointed out by H. Freundlich, so that at a certain conc. this protection is no longer sufficient to prevent the collision and adhesion of the particles. There is still a third factor to be considered, which favours the collision and hinders the permanent union of the particles. This is the mol. agitation which reveals itself in the Brownian movement; but, as taught by the statistic mechanics, this factor depends only on the temp., and, consequently, cannot be made answerable for the coagulation which follows the addition of an electrolyte.

REFERENCES.

¹ W. D. Bancroft, *Journ. Phys. Chem.*, 19. 363, 1915; *Journ. Franklin Inst.*, 185. 29, 199, 373, 1918; *Applied Colloidal Chemistry*, New York, 1921.

² F. K. Cameron, *Journ. Phys. Chem.*, 14. 400, 1910; J. E. Harris, *ib.*, 18. 355, 1914; D. B. Lake, *ib.*, 20. 761, 1916; W. D. Bancroft, *ib.*, 19. 363, 1915; *Journ. Franklin Inst.*, 185. 29, 199, 373, 1918; L. Liebermann, *Sitzber. Akad. Wien*, 74. 331, 1878; P. Yorke, *Mem. Chem. Soc.*, 2. 399, 1845; C. G. Schwalbe, *Die Chemie der Cellulose*, Berlin, 80, 1911; L. H. Skraup, *Sitzber. Akad. Wien*, 118. 564, 1909; L. Vignon, *Compt. Rend.*, 116. 517, 584, 645, 1893; A. Müller, *Journ. prakt. Chem.*, (1), 83. 384, 1861; H. Schulze, *ib.*, (2), 25. 43, 1882; (2), 27. 320, 1884; H. Weiske, *Journ. Chem. Soc.*, 30. 662, 1876; G. T. Davis, *ib.*, 91. 1682, 1907; T. Bayley, *ib.*, 33. 304, 1878; J. U. Lloyd, *Chem. News*, 51. 51, 1885; W. Skey, *ib.*, 17. 160, 217, 1868; L. Wöhler, W. Pluddeman, and P. Wöhler, *Zeit. phys. Chem.*, 62. 664, 1908; H. Freundlich and H. Kämpfer, *ib.*, 90. 681, 1915; G. C. Schmidt, *ib.*, 74. 730, 1910; H. Lachs and L. Michælis, *Zeit. Elektrochem.*, 17. 1, 1911; P. Rona and L. Michælis, *Biochem. Zeit.*, 16. 499, 1909; Y. Osaka, *Mem. Coll. Science Kyoto*, 1. 267, 1915; H. Freundlich and M. Masius, *Bemmelen's Gedenksboek*, Helder, 88, 1910; M. A. Gordon, *Journ. Phys. Chem.*, 18. 337, 1914.

³ H. Freundlich, *Zeit. phys. Chem.*, 57. 424, 1907; *Kapillarchemie*, Leipzig, 1909; W. D. Bancroft, *Journ. Phys. Chem.*, 20. 85, 1916; *Journ. Franklin Inst.*, 185. 29, 199, 373, 1918; T. Graham, *Journ. Chem. Soc.*, 17. 325, 1864.

⁴ C. Barus, *Amer. Journ. Science*, (3), 38. 408, 1889; (3), 41. 110, 1891; (3), 42. 359, 1891; (4), 6. 270, 1898; (4), 7. 1, 1899; *Phil. Mag.*, (5), 47. 104, 461, 1899; S. W. Young, *Journ. Phys. Chem.*, 21. 1, 1917; C. F. Nagel, *ib.*, 19. 331, 1915; A. B. Northcote and A. H. Church, *Journ. Chem. Soc.*, 6. 54, 1854; J. Weisberg, *Bull. Soc. Chim.*, (3), 15. 1097, 1896; T. Graham, *Journ. Chem. Soc.*, 15. 253, 1861; 17. 324, 1864; E. Riffard, *Compt. Rend.*, 77. 1103, 1873; E. Grimaux, *ib.*, 98. 1485, 1540, 1884; A. Lottermoser, *Journ. prakt. Chem.*, (2), 68. 341, 1903; (2), 72. 39, 1905; (7), 73. 374, 1906; *Zeit. phys. Chem.*, 62. 371, 1908; A. Müller, *Ber.*, 39. 2857, 1906; *Zeit. anorg. Chem.*, 52. 316, 1907; M. H. Fischer, *ib.*, 40. 39, 1904; W. Fischer and W. Herz, *ib.*, 31. 352, 1902; W. Herz, *ib.*, 25. 155, 1900; A. Hantzsch, *ib.*, 30. 289, 1902; 75. 371, 1912; O. Klein, *ib.*, 74. 157, 1912; C. Tubandt, *ib.*, 45. 368, 1905; J. Rubenbauer, *ib.*, 30. 331, 1902; W. Mecklenburg, *ib.*, 74. 260, 1912; B. Szilard, *Journ. Chim. Phys.*, 5. 488, 635, 1907; C. F. Nagel, *Journ. Phys. Chem.*, 19. 331, 1915; S. W. Young and W. R. Goddard, *ib.*, 21. 1, 1917; J. Meunier, *ib.*, 124. 1151, 1897; E. Prost, *Bull. Acad. Belgique*, (3), 14. 312, 1887; O. Loew, *Zeit. anal. Chem.*, 8. 463, 1869; R. E. Slade, *Zeit. anorg. Chem.*, 77. 457, 1912; *Trans. Faraday Soc.*, 10. 150, 1914; *Journ. Chem. Soc.*, 193. 421, 1908; E. Prost, *ib.*, 54. 653, 1888; J. Lefort and P. Thibault, *Journ. Pharm. Chim.*, (5), 6. 169, 1882; C. Schiaparelli, *Gazz. Chim. Ital.*, 13. 422, 1884; J. N. Mukherjee and N. N. Sen, *Journ. Chem. Soc.*, 115. 461, 1919; M. Prud'homme, *ib.*, 25. 672, 1872; F. Blum, *Journ. Amer. Chem. Soc.*, 35. 1499, 1913; E. G. Mahin, D. C. Ingraham, and O. J. Stewart, *ib.*, 35. 30, 1913; W. B. Bentley and R. P. Rose, *ib.*, 35. 1490, 1913; J. A. Wilson, 38. 1982, 1916; W. Spring, *Ber.*, 16. 1142, 1883; C. Winssinger, *Bull. Soc. Chim.*, (3), 49. 452, 1888; M. Lachaud, *ib.*, (4), 15. 1105, 1896; J. M. Eder, *Handbuch der Photographie*, Halle, 3. 28, 1902; L. Cramer, *Phot. Corresp.*, 44. 578, 1907; W. Spring, *Zeit. Koll.*, 4. 161, 1909; 6. 11, 164, 1910; S. E. Linder and H. Picton, *Journ.*

Chem. Soc., 61. 116, 1892; N. G. Chatterji and N. R. Dhar, *Trans. Faraday Soc.*, 16. 122, 1921; H. D. Murray, *Chem. News*, 123. 277, 1921; C. A. L. de Bruyn, *Ber.*, 35. 3079, 1902; W. D. Bancroft, *Applied Colloid Chemistry*, New York, 1921.

⁵ F. F. Reuss, *Mém. Soc. Moscow*, 2. 327, 1809; R. Porret, *Gilbert's Ann.*, 66. 272, 1916; G. Wiedemann, *Pogg. Ann.*, 87. 321, 1852; 99. 177, 1856; G. Quincke, *ib.*, 107. 1, 1859; 110. 38, 1860; 113. 513, 1861; M. Faraday, *Phil. Trans.*, 128, 125, 1838; J. F. Daniell, *ib.*, 129. 97, 1839; E. du Bois Reymond, *Sitzber. Akad. Berlin*, 1885, 1860; H. B. Weiser, *Journ. Phys. Chem.*, 21. 314, 1917; T. R. Briggs, *ib.*, 21. 198, 1917; W. B. Hardy, *Journ. Physiol.*, 24. 288, 1899; J. Billitzer, *Zeit. Koll.*, 1. 226, 1906; E. F. Burton, *Phil. Mag.*, (6), 11. 425, 1906; (6), 12. 472, 1906; H. Lamb, *ib.*, (5), 25. 52, 1888; W. G. Armstrong, *ib.*, (3), 23. 194, 1843; H. von Helmholtz, *Wied. Ann.*, 7. 337, 1879; H. Freundlich, *Kapillarchemie*, Leipzig, 223, 1909; S. E. Linder and H. Picton, *Journ. Chem. Soc.*, 61. 148, 1892; F. Powis, *ib.*, 107. 818, 1915; A. Cöhn, *Wied. Ann.*, 64. 217, 1898; *Zeit. Elektrochem.*, 15. 652, 1909; A. Cöhn and U. Raydt, *Ann. Physik*, (4), 30. 777, 1909; J. Perrin, *Compt. Rend.*, 136. 1388, 1903; 137. 513, 564, 1903; W. Pauli, *Hofmeister's Beiträge*, 7. 531, 1906.

⁶ M. von Smoluchowsky, *Bull. Acad. Cracow*, 182, 1903; W. C. McC. Lewis, *Zeit. Koll.*, 4. 209, 1909; H. Freundlich, *Kapillarchemie*, Leipzig, 243, 1909; J. Billitzer, *Zeit. phys. Chem.*, 51. 129, 1905; A. von Galecky, *Zeit. anorg. Chem.*, 74. 174, 1912; W. R. Whitney and J. C. Blake, *Journ. Amer. Chem. Soc.*, 26. 1339, 1904; A. Mustscheller, *ib.*, 42. 2142, 1920; E. F. Burton, *Phil. Mag.*, (6), 11. 425, 1904; (6), 12. 472, 1905; H. Lamb, *ib.*, (5), 25. 52, 1888; S. E. Linder and H. Picton, *Journ. Chem. Soc.*, 71. 508, 1897; A. Cotton and H. Mouton, *Journ. Chim. Phys.*, 4. 363, 1906.

⁷ W. S. Jevons, *Proc. Manchester Lit. Phil. Soc.*, 9. 78, 1870; *Chem. News*, 21. 66, 1870; A. Cotton and H. Mouton, *Les ultramicroscopes et les objets ultramicroscopiques*, Paris, 1906; E. Jordis, *Ber. phys. med. Soc. Erlangen*, 36. 43, 1904; H. von Helmholtz, *Wied. Ann.*, 7. 337, 1879; H. Lamb, *Phil. Mag.*, (5), 25. 52, 1888; H. T. Beans and H. E. Eastlack, *Journ. Amer. Chem. Soc.*, 37. 3667, 1915.

⁸ E. Malfitano, *Compt. Rend.*, 139. 1221, 1904; S. E. Linder and H. Picton, *Journ. Chem. Soc.*, 61. 148, 1892; W. R. Whitney and J. C. Blake, *Journ. Amer. Chem. Soc.*, 26. 1339, 1904; G. Bredig, *Ber. Internat. Kongress angew. Chem.*, 5. iv, 643, 1904; A. Cotton and H. Mouton, *Les ultramicroscopes et les objets ultramicroscopiques*, Paris, 144, 1906.

⁹ W. Spring, *Bull. Acad. Roy. Belg.*, (3), 35. 780, 1898; W. Biltz, *Ber.*, 37. 1095, 1904; A. Lottermoser, *Ueber anorganische Colloide*, Stuttgart, 76, 1901.

¹⁰ A. Winkelmann, *Handbuch der Physik*, Leipzig, 4. 949, 1905.

¹¹ H. W. F. Wackenroder, *Liebig's Ann.*, 60. 189, 1846; A. Sobrero and F. Selmi, *Ann. Chim. Phys.*, (3), 28. 210, 1850; E. Frémy, *ib.*, (3), 38. 312, 1853; T. Scheerer, *Pogg. Ann.*, 82. 419, 1852; T. Graham, *Phil. Trans.*, 151. 163, 1861; *Proc. Roy. Soc.*, 13. 335, 1861; W. S. Jevons, *Proc. Manchester Lit. Phil. Soc.*, 9. 78, 1870; *Chem. News*, 21. 66, 1870; W. Skey, *ib.*, 17. 160, 1868; G. Gouy, *Journ. Phys.*, 7. 561, 1888; W. Crum, *Journ. Chem. Soc.*, 4. 216, 1853; *Compt. Rend.*, 109. 102, 1889; T. Schlösing, *ib.*, 70. 1345, 1870; G. Bodländer, *Gött. Nach.*, 267, 1893; *Jahrb. Min.*, ii, 147, 1893; R. Zsigmondy, *Zur Erkenntnis der Kolloide*, Jena, 115, 1905; J. Sting and T. Morawsky, *Journ. prakt. Chem.*, (2), 20. 76, 1879; E. F. Burton, *Phil. Mag.*, (6), 11. 424, 1906; (6), 12. 472, 1906; (6), 17. 583, 1909; T. Svedberg, *Studien zur Lehre von den kolloiden Lösungen*, Upsala, 1907; O. Herstad, *Koll. Beih.*, 8. 399, 1916; H. R. Kruyt and J. van der Spek, *Koll. Zeit.*, 25. 1, 1919; H. R. Kruyt and H. G. van Arkel-Adriani, *Rec. Trav. Chim. Pays-Bas*, 39. 609, 1920; H. R. Kruyt and A. E. van Arkel-Adriani, *ib.*, 39. 615, 1920; M. Faraday, *Phil. Trans.*, 147. 145, 1857; J. J. Berzelius, *Pogg. Ann.*, 2. 113, 1824; 34. 560, 1835; H. B. Weiser, *Journ. Phys. Chem.*, 25. 665, 1921; H. B. Weiser and O. Nicholas, *ib.*, 25. 742, 1921; W. B. Hardy, *Proc. Roy. Soc.*, 66. 110, 1900; *Journ. Physiol.*, 29. 26, 1899; J. Duclaux, *Journ. Chim. Phys.*, 5. 1, 1907; A. Lottermoser, *Zeit. phys. Chem.*, 60. 451, 1907; F. Powis, *ib.*, 89. 91, 1914; H. D. Murray, *Chem. News*, 123. 277, 1921; H. R. Kruyt, *Chem. Weekbl.*, 18. 475, 1921; *Rec. Trav. Chim. Pays-Bas*, 39. 618, 1920; *Versl. Akad. Amsterdam*, 23. 260, 1914; H. Freundlich, *Zeit. phys. Chem.*, 44. 129, 1903; *Koll. Zeit.*, 23. 163, 1918.

¹² W. Spring, *Bull. Acad. Roy. Belg.*, (3), 38. 493, 1900; H. Freundlich, *Zeit. phys. Chem.*, 44. 129, 1903; H. Bechhold, *ib.*, 48. 385, 1904.

¹³ P. Nicolardot, *Recherches sur le sesquioxide de fer*, Paris, 1905; R. Ruer, *Zeit. anorg. Chem.*, 43. 283, 1905; E. Jordis, *ib.*, 35. 16, 1903; S. E. Linder and H. Picton, *Journ. Chem. Soc.*, 61. 114, 1892; G. N. Wyruboff, *Bull. Soc. Chim.*, (3), 21. 137, 1899; J. Duclaux, *Compt. Rend.*, 138. 144, 809, 1904; 140. 1468, 1844, 1905; A. Lottermoser, *Journ. prakt. Chem.*, (2), 72. 39, 1905; (2), 73. 374, 1906; W. Steubing, *Ann. Phys.*, (4), 26. 335, 1908; V. Henri and A. Mayer, *Compt. Rend.*, 139. 924, 1904.

¹⁴ W. B. Hardy, *Proc. Roy. Soc.*, 66. 95, 1900; *Zeit. phys. Chem.*, 44. 129, 1900; S. E. Linder and H. Picton, *Journ. Chem. Soc.*, 61. 114, 137, 148, 1892; 67. 63, 1895; 71. 568, 1897; 87. 1903, 1905; J. Perin, *Journ. Chim. Phys.*, 3. 50, 1905; N. Bach, *ib.*, 18. 46, 1920; A. Westgren, *Arkiv. Chem. Min. Geol.*, 7. 1, 1918; R. Höber and D. Gordon, *Beiträge zur Chem. Physiol.*, 5. 432, 1904; H. R. Kruyt and H. G. van Arkel-Adriani, *Rec. Trav. Chim. Pays-Bas*, 39. 609, 1920; H. R. Kruyt and A. E. van Arkel-Adriani, *ib.*, 39. 615, 1920; H. R. Kruyt, *ib.*, 39. 618, 1920; H. D. Murray, *Phil. Mag.*, (6), 40. 578, 1920; E. F. Burton and E. Bishop, *Journ. Phys. Chem.*, 24. 701, 1920; W. C. D. Whetham, *Phil. Mag.*, (5), 48. 474, 1889; O. Herstad, *Koll. Beih.*, 8. 399, 1916; H. Schulze, *Journ. prakt. Chem.*, (2), 25. 431, 1882; (2), 27. 320, 1883; (2), 32. 390, 1884;

W. D. Bancroft, *Journ. Phys. Chem.*, 19, 363, 1915; H. B. Weiser and E. B. Middleton, *ib.*, 24, 630, 1920; A. Gutbier, J. Huber, and R. Haug, *Koll. Zeit.*, 29, 25, 1921.

¹⁵ W. D. Bancroft, *Journ. Phys. Chem.*, 19, 349, 363, 1915; S. Odén, *Der kolloide Schwefel*, Upsala, 1913; N. Pappada, *Gazz. Chim. Ital.*, 42, i, 263, 1912; *Zeit. Koll.*, 6, 83, 1910; 9, 136, 233, 1911; H. Freundlich, *Kapillarchemie*, Leipzig, 1909; *Zeit. phys. Chem.*, 44, 129, 1903; 73, 385, 1910; 83, 97, 1913; 85, 398, 641, 1913; H. Freundlich and H. Schucht, *Zeit. phys. Chem.*, 80, 564, 1912; Y. Osaka, *Mem. Coll. Science Kyoto*, 1, 267, 1915; P. P. von Weimarn, *Ann. School Mines Urals*, 1, 14, 1919; H. R. Kruyt and J. van der Spek, *Proc. Akad. Amsterdam*, 17, 1158, 1915; J. N. Mukherjee and N. N. Sen, *Journ. Chem. Soc.*, 115, 461, 1919; 117, 350, 1920; J. Mukhopadhyaya, *Journ. Amer. Chem. Soc.*, 37, 2024, 1915; H. D. Murray, *Phil. Mag.*, (6), 40, 578, 1920.

¹⁶ E. Wiedemann and C. Lüdeking, *Wied. Ann.*, 25, 145, 1885; J. Thomsen, *Thermochemische Untersuchungen*, Leipzig, 1, 211, 1882; H. Picton and S. E. Linder, *Journ. Chem. Soc.*, 61, 114, 137, 148, 1892; T. Graham, *ib.*, 17, 325, 1864; F. Dörinckel, *Zeit. anorg. Chem.*, 66, 20, 1910; 67, 161, 1910; J. A. Prange, *Rec. Trav. Chim. Pays-Bas*, 9, 121, 1890; H. B. Weiser, *Journ. Phys. Chem.*, 20, 640, 1916; 21, 314, 1917; W. Clayton, *Koll. Zeit.*, 28, 233, 1921; W. Biltz, *Ber.*, 35, 4431, 1902; W. Spring, *Bull. Acad. Roy. Belg.*, (3), 38, 493, 1900; H. Bechhold, *Zeit. phys. Chem.*, 48, 385, 1904; M. Niesser and U. Friedemann, *Münchener med. Woch.*, 51, 465, 827, 1903; W. D. Bancroft, *Journ. Phys. Chem.*, 19, 363, 1915; V. Henri, *Compt. Rend. Biol. Soc.*, 55, 1666, 1904; A. Lottermoser, *Journ. prakt. Chem.*, (2), 68, 341, 1903; (2), 72, 39, 1905; (2), 73, 374, 1906.

¹⁷ P. P. von Weimarn, *Grundzüge der Dispersoidchemie*, Dresden, 1911; *Zur Lehre von den Zuständen der Materie*, Dresden, 1914; E. H. Buchner and J. Kalf, *Rec. Trav. Chim. Pays-Bas*, 39, 135, 1920; S. Odén, *Svensk. Kem. Tidnkr.*, 32, 90, 1920; *Arkiv Kemi Min. Geol.*, 7, 26, 1921.

¹⁸ F. W. Lüdersdorff, *Verh. Ver. Beförd. Gewerb. Preussen*, 228, 1833; M. Faraday, *Phil. Trans.*, 147, 154, 1857; E. von Mayer and A. Lottermoser, *Ueber anorganische Colloide*, Stuttgart, 1901; C. A. L. de Bruyn, *Rec. Trav. Chim. Pays-Bas*, 19, 236, 1900.

¹⁹ H. Bechhold, *Zeit. phys. Chem.*, 48, 385, 1904; G. Quincke, *Ann. Physik*, (4), 7, 95, 1902; M. Niesser and U. Friedemann, *Münchener med. Woch.*, 51, 465, 827, 1903; M. Lecoq, *Compt. Rend.*, 150, 700, 1910; R. Zsigmondy, *Zur Kenntniss der Kolloide*, Jena, 117, 1905; *Zeit. phys. Chem.*, 92, 600, 1918; *Zeit. anal. Chem.*, 40, 697, 1901; F. N. Schulz and R. Zsigmondy, *Beitr. Chem. Physiol. Pathol.*, 3, 137, 1902; A. Müller and P. Artmann, *Oester. Chem. Ztg.*, 7, 149, 1904; A. Müller, *Ber.*, 37, 11, 1904; C. A. L. de Bruyn, *Rec. Trav. Chim. Pays-Bas*, 19, 236, 1900.

²⁰ F. Küsspert, *Ber.*, 35, 2815, 4066, 1902; W. Biltz, *Ber.*, 35, 4431, 1902; R. Zsigmondy, *Verh. Ges. deut. Nat. Hamburg*, 172, 1901; M. Beyer, *München Med. Woch.*, 49, 331, 1902; C. Paal, *Ber.*, 39, 1436, 1906; 35, 2195, 1902; C. Paal and A. Amberger, *ib.*, 37, 124, 1904; 38, 1398, 1905; 40, 1392, 1907; C. Paal and W. Leuze, *ib.*, 39, 1545, 1550, 1906; W. D. Bancroft, *Journ. Phys. Chem.*, 19, 363, 1915; 20, 85, 1916; M. von Smoluchowsky, *Zeit. phys. Chem.*, 92, 129, 1917; W. Merz, *ib.*, 66, 129, 1909; A. Gutbier, A. Irion, and E. Sauer, *Koll. Zeit.*, 18, 1, 1916; A. Gutbier, J. Huber, and E. Huhn, *ib.*, 18, 57, 1916; A. Gutbier and E. Sauer, *ib.*, 25, 145, 1919; A. Gutbier, J. Huber, and R. Haug, *ib.*, 29, 25, 1921; H. Freundlich and E. Löning, *Festschrift Kaiser Wilhelm Ges. Förd.*, 82, 1921; R. A. Gortner, *Journ. Amer. Chem. Soc.*, 42, 595, 1920; T. Iredale, *Journ. Chem. Soc.*, 119, 625, 1921; E. Zung, *Archiv. Internat. Physiol.*, 1, 427, 1904; 5, 111, 245, 1907; *Bull. Soc. Roy. Sciences, Med. Nat.*, 64, 174, 187, 1906; L. Lichtwitz and O. Rosenbach, *Zeit. physiol. Chem.*, 61, 112, 1909; L. Lichtwitz, *ib.*, 64, 144, 1910; 72, 215, 1911; H. H. Salkowsky, *Berlin Klin. Woch.*, 51, 52, 1905; E. Rählmann, *Münchener Med. Woch.*, 48, 1903; H. Much, P. Römer, and C. Siebert, *Zeit. diät. Therapie*, 8, 19, 94, 1905; A. Westgren, *Arkiv Math. Astron. Fysik Svenska*, 13, 14, 1918; O. Klein, *ib.*, 16, 5, 1921.

§ 9. The Preparation of Colloidal Solutions

In the preparation of colloidal soln. a finely divided, peptized, dispersed, or deflocculated phase is kept from coalescing, coagulating, or flocculating into aggregates. In his *Outlines of Colloid Chemistry*, W. D. Bancroft¹ divides the available methods into two groups—condensation and dispersion—and he gives a long list of examples from which the following are selected. In the condensation methods there is a strong adsorption of some agent by the colloid, or a protective colloid is used, or else the conc. of the agglomerating agent is kept down by the use of suitable reagents or by dilution.

In illustration of the preparation of colloidal soln. in the presence of a strongly adsorbed substance, all the metals and many other substances can be kept in colloidal soln. by sodium protalbinat or lysalbinat.

Other examples are T. Svedberg's reduction of palladium salt soln. by hydrazine in the presence of gum arabic ; J. Hausmann, sulphide soln. with gum arabic ; silver chloride or bromide or Prussian blue in the presence of gelatin ; E. Grimaux, ferric oxide with glycerol ; T. Svedberg, cadmium sulphide, and H. Ritthausen, copper oxide with casein ; T. Svedberg, mercurous chloride by albumen ; C. Schiaparelli, lead sulphide by saponin ; O. Gengou, alumina or barium sulphate with sodium citrate ; T. Svedberg and E. Riffard, silver chromate, copper hydroxide, or ferric hydroxide by cane sugar or better invert sugar ; M. C. Lea, silver by ferrous citrate or tartrate ; C. Amberger, silver by wool-fat ; A. Gutbier and E. Weingärtner, gold and silver by starch ; P. Schöttlander, mercury and bismuth by stannic oxide, and gold by ceria ; T. Svedberg and S. Odén, sulphur in acid soln. by sodium sulphate (not the potassium salt).

Precipitates obtained by coagulation from colloidal soln. owing to the use of an excess of the precipitating agent may reform colloidal soln. when the excess of the flocculating agent is removed by washing, etc. For example, when precipitated silver halide is washed, the salt is apt to run through the filter when the excess of precipitant is removed ; zinc sulphide was found by J. Donau to form a colloidal soln. when the ammonium salt is washed out ; and E. G. Berkeley and J. Hartley made a similar observation with respect to the washing of copper sulphate from precipitated copper ferrocyanide. If the coagulating agent cannot be removed by washing, or if the agglomeration has gone too far, the precipitate is not dispersed. The phenomenon is frequently observed in the washing of precipitates in analysis, and sometimes the precipitate is washed with a flocculating medium in order to prevent deflocculation. The flocculating medium employed is volatilized in a subsequent operation—*e.g.* alumina and rare earth precipitates are washed with a dil. soln. of ammonium nitrate ; stannic oxide is washed with dil. nitric acid ; etc. Instead of washing out the precipitating agent, a peptizing agent may be added—*e.g.* W. Skey found ammonia keeps clay in suspension, similar remarks apply to dil. soln. of the caustic alkalis.

T. Graham noted caustic hydroxide peptizes silicic acid, S. W. Young found hydrogen sulphide deflocculates the sulphides. A large excess of the peptizing agent may be required, *e.g.* W. Fischer and W. Herz, and C. F. Nagel found that with chromic oxide a large excess of potassium hydroxide is needed to produce a green colloidal soln. F. Fischer found hydrated copper oxide ; A. Hantzsch, cobalt oxide, and beryllium oxide are peptized by alkali ; W. D. Bancroft found zinc oxide is partially peptized by alkali ; E. Grimaux reported that similar remarks apply to the presence of an excess of ammonia on a soln. of a copper salt. The production of metal fogs in baths of fused metals, studied by R. Lorenz, is a case of peptization.

A. B. Northcote and A. H. Church say that the presence of chromic oxide with the oxides of iron, cobalt, nickel, and manganese makes them soluble in caustic alkali ; M. Prud'homme made a similar observation with respect to chromic oxide in the presence of a copper salt ; C. Lépéz and L. Storch, stannic oxide enables iron oxide to form a colloidal soln. with ammonia. F. R. M. Hitchcock, and L. Wöhler report molybdic acid is not precipitated by uranyl salts but is precipitated in the presence of tungstic acid. A. Müller found hydrochloric acid readily peptizes freshly precipitated oxides of alumina, iron, cobalt, thorium, and yttrium ; T. Graham found soln. of their chlorides act similarly upon the oxide. H. W. Fischer and B. Szilárd, also give evidence showing that most oxides can be more or less peptized by soln. of their chlorides or nitrates. E. A. Schneider reported that ferric oxide is peptized by aluminium chloride ; W. B. Bentley and R. P. Rose, that precipitated alumina is peptized by 8 per cent. acetic acid ; and Prussian blue is peptized by oxalic acid or potassium oxalate.

Hence, adds W. D. Bancroft, "any substance will carry another into soln. when in sufficient conc. provided it is adsorbed by the second, but there is no direct experimental evidence of this."

Colloidal soln. are formed in reactions involving reduction processes.

T. Svedberg reduced silver oxide suspended in water at 50° by hydrogen ; and dil. soln. of gold salts by carbon monoxide, sulphur dioxide, formaldehyde, etc. ; A. Rasenfosse, a sulphuric acid soln. of copper sulphate by alcohol ; T. Svedberg and A. Liversidge, gold by *aspergillus oryzae* ; J. Donau, reduction in flames. The reduction may be affected by electrolysis—*e.g.* T. Svedberg electrolyzed dil. soln. of gold, silver, and mercury salts ; J. Billitzer, electrolyzed dil. soln. of the less noble metals ; M. Lecoq, a dil. soln. of sodium arsenite ; and A. Samsonoff, a soln. of uranyl chloride. T. Svedberg, and F. Hartwagner

reduced gold sols by exposure to light; A. Wigand, sulphur; J. Amann, soln. of ferro- and ferri-cyanide; and A. Galecki, by the action of X-rays.

Colloidal soln. may be produced by metathetical reactions.

H. Picton and S. E. Linder passed hydrogen sulphide through a soln. of arsenious acid and obtained colloidal arsenic sulphide; T. Svedberg similarly acted on mercuric cyanide with hydrogen sulphide. Again, colloidal soln. of silicic acid can be made from sodium silicate and hydrochloric acid; stannic acid from stannic chloride; metastannic acid from sodium stannate; and tungstic acid from sodium tungstate. T. Svedberg obtained colloidal sodium chloride from sodium malonic ester and chloroacetic ester in ligroin; A. Lottermoser obtained colloidal silver halides by the action of $\frac{1}{100}N$ -silver nitrate on $\frac{1}{10}N$ -soln. of potassium chloride, bromide, or iodide. Similarly reactions involving oxidations may furnish colloidal soln. e.g. A. Himmelbaur oxidized hydrogen sulphide in the presence of gelatine; L. Wöhler and W. Witzmann, sodium iridichloride. L. Vanino and L. Rössler, aurous chloride; and G. Bredig and A. Marck treated permanganates by hydrogen peroxide.

Colloidal soln. are also produced by hydrolytic reactions.

L. T. Wright boiled aq. soln. of ferric chloride; and generally soln. of acetates, nitrates or chlorides can be hydrolyzed to form colloidal oxides but not usually sulphates, although the chromosulphuric acids, according to H. G. Denham, are colloidal. T. Svedberg hydrolyzed silicon sulphide, ferric ethylate, and copper succinamide.

G. Wegelin found that some metals can be mechanically ground so as to form a colloidal soln., and the presence of a little gelatine is said to make disintegration easier. Quartz reduced to an impalpable powder by long grinding may form colloidal hydrated silica merely by boiling with water.

G. Bredig's and T. Svedberg's methods of forming colloidal soln. of the metals are cases of electrical disintegration by forming an electrical arc under water.

C. J. Reed, G. Bredig and F. Haber, M. Lecoq, and F. Haber and M. Sack report that cathodes of lead, tin, bismuth, antimony, arsenic, thallium, or mercury are disintegrated in soln. of sodium hydroxide when the current density exceeds a certain critical value. The soln. may be coloured as black as ink by the fine particles of metal. A. Müller similarly obtained colloidal soln. of tellurium; and F. Fischer obtained indications that colloidal copper may be formed by a high current density with a copper anode in sulphuric acid.

The disintegration of all electrodes by alternating currents of high density is attributed by F. Haber and R. G. van Name to the transient formation of a hydride or metal alloy.

REFERENCES.

- ¹ W. D. Bancroft, *Journ. Franklin Inst.*, 185. 373, 1918; C. J. Reed, *ib.*, 139. 283, 1895; T. Svedberg, *Die Methoden zur Herstellung kolloider Lösungen anorganischer Stoffe*, Dresden, 1909; J. Hausmann, *Zeit. anorg. Chem.*, 40. 121, 1904; L. Wöhler and W. Witzmann, *ib.*, 57. 328, 1908; H. G. Denham, *ib.*, 57. 378, 1908; W. Fischer and W. Herz, *ib.*, 31. 352, 1902; H. W. Fischer, *ib.*, 40. 40, 1904; A. Hantzsch, *ib.*, 30. 289, 1902; F. R. M. Hitchcock, *ib.*, 8. 235, 1895; A. Müller, *ib.*, 57. 311, 1908; 52. 316, 1907; R. Lorenz and W. Eitel, *ib.*, 91. 46, 1915; M. Sack, *ib.*, 34. 286, 1903; F. Haber and G. von Oordt, *ib.*, 38. 377, 1904; O. Gengou, *Zeit. Koll.*, 9. 88, 1911; C. Amberger, *ib.*, 11. 99, 1912; J. Donau, *ib.*, 16. 81, 1915; A. Samsonoff, *ib.*, 8. 96, 1911; A. Himmelbaur, *ib.*, 4. 307, 1909; E. Paternò and F. Medigreanu, *ib.*, 12. 65, 1913; L. Vanino and L. Rössler, *ib.*, 6. 289, 1910; K. Drucker, *ib.*, 4. 216, 1909; P. P. von Weimarn, *ib.*, 7. 92, 1910; 8. 216, 1911; 11. 651, 1912; T. Svedberg, *ib.*, 6. 238, 1910; J. Amann, *ib.*, 8. 197, 1911; A. Galecki, *ib.*, 10. 149, 1912; F. Hartwagner, *ib.*, 16. 79, 1915; R. Abegg and P. von Schroeder, *ib.*, 2. 85, 1907; W. Spring, *ib.*, 4. 161, 1909; 6. 11, 109, 164, 1909; R. P. Rose, *ib.*, 15. 1, 1914; G. Wegelin, *ib.*, 14. 65, 1914; W. B. Bentley and R. P. Rose, *Journ. Amer. Chem. Soc.*, 35. 1490, 1913; J. Lefort and P. Thibault, *Journ. Pharm. Chim.*, (5), 6. 169, 1882; R. Böttger, *Jahresb. physik. Ver. Frankfurt*, 16. 1876; T. Svedberg, *Chem. Met. Ind.*, 24. 23, 1921; S. Odén, *Der kolloide Schwefel*, Upsala, 1913; H. Ritthausen, *Journ. prakt. Chem.*, (2), 8. 215, 1873; (2), 7. 361, 1874; A. Lottermoser, *ib.*, (2), 68. 341, 1903; (2), 72. 38, 1905; (2), 73. 374, 1906; A. Gutbier and E. Weingärtner, *Koll. Beihefte*, 5. 211, 244, 1913; C. Winssinger, *Bull. Soc. Chim.*, 49. 452, 1883; H. L. Doyle, *Journ. Phys. Chem.*, 17. 390, 1913; S. W. Young, *ib.*, 21. 1, 14, 1917; C. F. Nagel, *ib.*, 19. 331, 1915; W. D. Bancroft, *ib.*, 20. 98,

1916; G. D. Kratz, *ib.*, 16. 126, 1912; A. Rasenfosse, *Bull. Acad. Belgique*, 738, 1910; F. Soxhlet, *Landw. Versuchs. Stat.*, 19. 118, 1876; P. Schottländer, *Verh. Vers. deut. Aerzte*, 73, 1895; J. Billitzer, *Ber.*, 35. 1929, 1902; A. Müller, *ib.*, 39. 2857, 1906; G. Bredig and F. Haber, *ib.*, 31. 2741, 1898; E. A. Schneider, *ib.*, 23. 1349, 1890; *Liebig's Ann.*, 257. 359, 1890; F. Haber, *Trans. Amer. Elektrochem. Soc.*, 2. 192, 1902; *Zeit. Elektrochem.*, 8. 511, 1902; L. Wöhler, *ib.*, 16. 693, 1910; G. Bredig, *ib.*, 4. 514, 1898; F. Haber and M. Saek, *ib.*, 8. 245, 1902; E. Müller, *ib.*, 11. 521, 701, 1905; R. G. van Name, *ib.*, 10. 303, 1904; F. Haber, *ib.*, 11. 660, 827, 1905; F. Fischer, *ib.*, 9. 507, 1903; M. Lecoq, *Compt. Rend.*, 150. 700, 1910; W. W. Strong, *ib.*, 150. 1172, 1910; E. Grimaux, *ib.*, 98. 1434, 1485, 1540, 1884; E. Riffard, *ib.*, 77. 1103, 1873; M. Prud'homme, *Journ. Chem. Soc.*, 25. 672, 1872; G. Bredig and A. Marck, *Bemmelen's Gedenkboek*, Helder, 342, 1910; A. Müller, *ib.*, 416, 1910; R. Lorenz, *ib.*, 395, 1910; L. T. Wright, *Journ. Chem. Soc.*, 43. 156, 1883; T. Graham, *ib.*, 17. 324, 1864; H. Picton and S. E. Linder, *ib.*, 67. 63, 1895; A. B. Northcote and A. H. Chureh, *ib.*, 6. 54, 1854; A. Pieroni, *Gazz. Chim. Ital.*, 43. i, 197, 1913; C. Schiaparelli, *ib.*, 13. 422, 1884; P. Donnici, *ib.*, 24. i, 219, 1894; A. Wigand, *Zeit. phys. Chem.*, 77. 423, 1911; G. Bredig, *ib.*, 31. 258, 1899; E. G. Berkeley and J. Hartley, *Phil. Trans.*, 206. A, 486, 1906; W. Skey, *Chem. News*, 17. 164, 1868; 22. 236, 1870; 34. 142, 1876; A. Liversidge, 62. 277, 1891; C. Lépéz and L. Storeh, *Monatsh.*, 10. 283, 1889; B. Szilárd, *Journ. Chim. Phys.*, 5. 488, 636, 1907.

§ 10. Colloidal Gold, Silver, and Copper

Soln. of gold salts are readily reduced to the metal by the mildest of reducing agents. The chemical inactivity of gold corresponds with the fact that it is precipitated from its salts by most of the metals, the metal sulphides, ferrous salts, and numerous organic compounds—oxalic acid, cane sugar, chloral hydrate, etc. Gold is also precipitated by many oxidizing agents, thus hydrogen peroxide precipitates the metal from its salts, and oxygen is evolved at the same time. Many of the peroxides reduce gold from alkaline soln.—e.g. manganese dioxide, peroxides of the alkaline earths, lead peroxide, ceric oxide, many of the manganiferous minerals, and even manganesc carbonate, in alkaline soln., precipitate the metal. If a soln. containing 0.01 to 0.001 per cent. of gold chloride be made slightly alkaline by the addition of magnesia, and then a few drops of a dil. soln. of formaldehyde as reducing agent be added, the liquid will probably acquire a red or purple colour. A red solution of gold hydrosol is also obtained by mixing 4 c.c. of a one per cent. soln. of gold chloride with 100 c.c. of water, and stirring this up with an equal volume of a two per cent. soln. of tannin; and a blue solution is obtained by mixing the gold soln. with three times its volume of the tannin soln. The main fact has been known for a long time, and was mentioned by J. Juncker in 1730, by P. J. Macquer in 1789, and by J. B. Richter in 1802,¹ before M. Faraday took up the subject in 1857. The liquid contains metallic gold in the form of minute particles which do not settle under the influence of gravity, but remain in suspension an indefinite time; the soln. can be filtered through paper unchanged. The liquid is sometimes called **Faraday's gold** because of his early work on the subject in 1857. The suspended gold is in the colloidal condition; the clear liquid may or may not appear opalescent by Tyndall's optical test; and the particles can be perceived by the ultramicroscope. A. Connejo has surveyed the history of colloidal gold.

The *aurum potabile*—potable gold—of the alchemists was probably a hydrosol of gold.² This liquid was obtained by treating a soln. of gold in aqua regia with ether or ethereal oils. Fabulous medicinal virtues were attributed to this liquid; it would cure "an infinity of diseases." The power of this medicine was explained somewhat as follows: "Gold receives its influence from the sun, which is, as it were, the heart of the world, and by communicating those influences to the air, it serves to fortify and cleanse it from all impurities." Mrs. Fulhame, in *An Essay on Combustion* (London, 1794), described the production of red and purple colours on silk by dipping the fabric in soln. of gold salts, and subsequently precipitating the metal with hydrogen or a soln. of phosphorus in ether, and Mrs. Fulhame's method was patented nearly a century later.³ The early book also described the

production of red soln. of gold by reducing the chloride with phosphine, metallic tin, etc.

R. Zsigmondy's method ⁴ for preparing a red sol of colloidal gold.—25 c.c. of a soln. of hydrochloroauric acid, containing 6 grms. of the solid $\text{HAuCl}_4 \cdot 3\text{H}_2\text{O}$ per litre, is dil. with 100 to 150 c.c. of distilled water (prepared by the re-distillation of distilled water, with say, a silver condenser), and made alkaline by adding 2 to 4 c.c. of a one-fifth normal soln. of potassium carbonate. The soln. is heated to boiling, and 4 c.c. of a soln. of one part of freshly distilled formaldehyde in 100 parts of water are gradually added to the boiling hot gold soln. In a short time, the liquid darkens, and acquires a dark red colour which does not change on boiling, or on standing for some months. Variations from these proportions give differently coloured soln.—purple, violet, or bluish-black turbid soln. may be obtained. The red liquid can be evaporated to half its volume without change, but further conc. causes the gold to precipitate as a black powder—possibly owing to the accumulation of salts in the soln. causing a precipitation of the metal. If the soln. be purified by dialysis at 40° to 50°, it can be conc. to one-twentieth of its volume—that is, a 0.12 per cent. soln.—in a few days. Further conc. leads to the precipitation of metallic gold.

A very great variety of other reducing agents have been recommended. M. Faraday ⁵ used yellow phosphorus, and also a soln. of phosphorus in carbon disulphide; J. Reitstötter, and others have employed a soln. of phosphorus in ether, alcohol, or other menstrua. F. Doerinckel, and T. Svedberg and K. Inouye used hydrogen peroxide; A. Gutbier, R. Zsigmondy, J. Reitstötter, T. Svedberg, and E. Pozzi-Escot, hydrazine hydrate (1 : 2000); A. Gutbier and F. Resenschek, phenylhydrazine hydrochloride; A. Gutbier, R. Zsigmondy, and J. Reitstötter, hydroxylamine hydrochloride; O. Brunck, sodium hyposulphite; M. C. Lea, sodium hypophosphite; A. Stähler, and F. Backran, titanous chloride; C. Winkler, E. Hatschek and A. L. Simon, sulphur dioxide; J. Donau, and E. Hatschek and A. L. Simon, carbon monoxide; J. C. Blake, W. R. Whitney, and E. Hatschek and A. L. Simon, acetylene; A. L. de Bruyn, V. Kohlschütter, T. Svedberg, and W. Taylor, oxalic acid; L. Vanino, anhydro-methylenecitric acid (*i.e.* citarin); and E. K. Lenz, acetaldehyde, chloralhydrate, arsenic hydride, terephthalaldehyde, benzaldehyde, and cinnamaldehyde.

A. Gutbier's process for red, blue, and violet gold sols.—Dissolve a gram of gold chloride in 1000 c.c. of purified distilled water, and exactly neutralize the soln. with very dil.—say 0.18N-potassium carbonate. Then add a cold dil. soln. (1 : 4000) of hydrazine hydrate—say 1 c.c. of a 50 per cent. soln. in 2000 c.c. of water—drop by drop. The resulting sol is clear and stable, and is deep blue by reflected and transmitted light; but if too much reducer is added, the sol is not clear and sedimentation occurs. The colour readily depends upon the nature of the sol, for, according to W. W. Taylor, if the soln. is faintly acid the sol is bright blue; if almost neutral, violet or purple; and a brilliant red if alkaline. Thus, 100 c.c. water, 1 c.c. of one per cent. gold soln., 1 to 1½ c.c. of 0.18N-potassium carbonate, and 1 to 2 c.c. of hydrazine hydrate soln. (1 : 4000), gives a bright blue sol; if 2 c.c. of the potassium carbonate soln. are used, the gold sol is violet; and with 2.5 c.c. of the alkali carbonate and 3 c.c. of the hydrazine hydrate soln., the gold sol is bright scarlet. These sols are all very stable and easily reproduced.

The following is a demonstration experiment :

Dil. 5 c.c. of the 0.1 per cent. gold soln. with 300 c.c. of water, and run in from a burette, 0.2 to 0.5 c.c. of a freshly prepared 0.4 per cent. soln. of phenylhydrazine hydrate. When the liquid is stirred it becomes deep red. Now add more reducer drop by drop, when the colour changes to violet; after adding 5 c.c., the colour is violet blue, and a further quantity changes the colour to blue, and, finally, when 12 c.c. have been added, the colour is deep blue.

The reduction of a soln. of silver oxide by hydrogen seems to take place mainly on the walls of the vessel without there being any question of the solubility of the glass because the same results are obtained in the different glass vessels if an aq. soln. derived from ordinary ground glass is used instead of water in the different vessels. Walls of soft glass or quartz give yellowish-brown hydrosols; Jena glass, red, reddish-brown, violet, or blue sols; and with platinum, no sol formation occurs, but crystalline silver is formed. Hence, the surface of the vessel plays an important rôle in the form and size of the particles.

V. Kohlschütter's process for colloidal silver.—Hydrogen gas is bubbled through a sat. soln. of silver oxide contained in a round-bottom glass flask warmed between 50° and 60°; an excess of solid silver oxide is present in order to keep up the conc. A silver mirror is formed on the walls of the glass vessel simultaneously with the hydrosol. In 8 to 10 hrs. between half and one litre of intensely coloured sol is obtained. At temp. below 50° reduction is too slow; above 60°, the sol is unstable. The sol contains a little undecomposed silver oxide. This can be removed by passing hydrogen through a tube with a platinum tip, into 80 c.c. of silver hydrosol contained in a blackened platinum basin protected from air by a bell-jar. In about 12 hrs. the silver oxide is reduced to crystals of silver firmly adherent to the basin; at the same time the conductivity falls to between 4 and 8×10^{-6} reciprocal ohms—one-tenth its former value. The purification of hydrogen is useful because dialysis is liable to coagulate the sol. If carbon monoxide be used in place of hydrogen V. Kohlschütter found the resulting sol is not very stable.

Various organic substances ⁶ have been employed in the preparation of gold sols. Thus, according to L. Vanino, terpenes, alcohols, and carbohydrates for gold hydrosols; he also found that a little sodium anhydro-methylenecitrate gives colloidal solutions of gold, silver, etc., when added to soln. of salts of the respective metals—the gold sols are red. N. Castoro used acrolein, for colloidal gold, platinum, palladium, osmium, and ruthenium; and M. Müller used glycerol. C. Paal prepared hydrosols of selenium, copper, iridium, platinum, palladium, gold, silver, or silver oxide with protalates or lysalates as protective agents, and hydrazine, hydrogen, or sodium amalgam as reducing agent. F. Henrich used polyphenols as protective agents in preparing colloidal gold, platinum, silver, or mercury; L. Garbowsky used phenolic acids for gold, silver, and platinum; M. C. Lea, iron citrate for silver sols; A. Gutbier and co-workers, Irish moss; and A. Lottemoser, stannous salts for mercury, bismuth, or copper sols.

C. Paal's method for preparing solid colloidal gold and silver.—A soln. containing 8 parts of gold chloride are added to an aq. soln. of 10 parts of sodium lysalbate containing a great excess of sodium hydroxide. The pale yellow soln. is clear, it contains gold in the ordinary condition, and passes unchanged through a dialyser. If the soln. be treated with formaldehyde or other reducing agent, or gradually warmed with frequent stirring until a drop no longer reacts with hydrazine hydrate, the product is ruby red, and contains colloidal gold. A dark violet sediment may appear; the supernatant liquid can be washed by dialysis, and evaporated on a water-bath so as to furnish a lustrous dark brown powder resembling iron pyrites, and it contains about 90 per cent. of colloidal gold. The mass passes into the sol condition when treated with water or dil. alkaline lye. Sodium protalbate can be used instead of the lysalbate. Colloidal silver was prepared in a similar manner, and the sol is more stable than the commercial *collargol*, the soln. of which can be neither evaporated nor frozen without reversion to ordinary silver.

The early workers on electrical discharges noticed that metals were dispersed as an extremely fine dust from the cathode during an electrical discharge. M. van Marum,⁷ for instance, mentioned the fact in 1787, and in 1857, M. Faraday obtained deposits ranging from a dark violet to a ruby-red colour by sparking gold terminals, and it is well known that when electrodes are used in vacuum tubes, the particles of gold which are shot from the cathode and deposited on the glass, form a film shading from red to purple according to its thickness. H. Davy also confirmed J. W. Ritter's observation (1808).

When tellurium is made the negative surface in water, the voltaic power being from a battery composed of a number of plates exceeding 300, a purple fluid is seen to separate from it, and diffuse itself through the water; the water gradually becomes opaque and turbid, and at last deposits a brown powder.

H. Davy supposed the purple fluid to be "a soln. of a compound of tellurium and hydrogen in water," and the brown powder to be a solid tellurium hydride. While thus early the metal sols formed by cathodic reduction were assumed to be metal hydrides, R. L. Ruhland, in 1815, and J. C. Poggendorf, in 1848, considered them to be metals in a very fine state of subdivision.⁸ E. Müller and R. Lucas, however, showed that the purple liquid is a sol of tellurium; and G. Bredig⁹ has employed the same fact in preparing sols of many of the metals—gold, silver, platinum, etc.

He made a direct current arc between the desired metals under water, and as in the case of tellurium, a hydrosol of the desired metal was formed.

G. Bredig's method of preparing colloidal metals by electrical dispersion.—Two wires of the metal, one millimetre thick and 6 to 8 cms. long, are dipped into water. For convenience in handling the wires, they are protected by narrow glass tubes. An electrical current of 5 to 10 amperes and 30 to 40 volts is passed through the wires, and the tips of the wires are separated 1 or 2 mm. so as to form a tiny electric arc about 1 or 2 cms. below the surface of the water. The arc is not easy to form at first but later on there is no difficulty in maintaining the arc for several seconds at a time. The arrangement will be evident from Fig. 12. While the arc is being maintained, dark clouds stream from the arc, and diffuse into the liquid. After a time, the liquid passes through various shades of colour, and finally in the case of platinum it assumes a brownish-black colour; with gold wires, the liquid appears reddish-purple; and with silver wires, yellowish-green. The liquid can be filtered to remove the larger particles, and the filtrate has all the properties of a colloidal soln.; or hydrosol of the given metal. During the experiment, very fine particles of the cathode metal appear to be torn from the wire and dispersed in the liquid. A trace of alkali in the water causes the formation of finer particles, presumably owing to a stabilizing action of the hydroxyl ions. Colloidal soln. of platinum, iridium, palladium, gold, silver, and cadmium are obtained in this way.

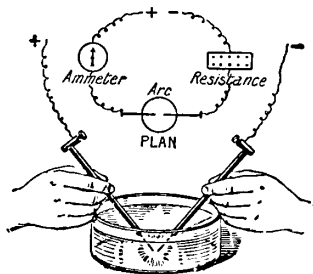

FIG. 12.—G. Bredig's Method of making Metal Sols by the Direct Current Arc.

G. Bredig's method does not give satisfactory results with organic liquids because too much liquid is decomposed. T. Svedberg found empirically that if the current density be made as small as possible this decomposition could be considerably reduced, and he therefore passed a current of high voltage (say 110 volts) and very low amperage between the electrodes placed between sheets of the required metal suspended in parallel or in series in the required medium. He obtained the best results with a large capacity, small self-induction, low resistance, and short arc. T. Svedberg also used oscillatory discharges in place of Bredig's direct current arc. The decomposition of the medium is not then so troublesome when organic liquids are substituted for water.

In one form of T. Svedberg's apparatus, the secondary terminals of a large induction coil (12–15 cm. sparks) were connected in parallel with a glass condenser 225 sq. cms. surface and the electrodes. The latter dipped in a porcelain basin of the required liquid, and small grains and fragments of the metal under investigation were spread on the bottom of the basin. The arrangement will be clear from Fig. 13. There is a vigorous sparking between the metal particles, and the required organosol is formed in a few minutes. Most of the metals—some 45 in fact—have been converted into colloidal soln. Liquid methane, ether, and isobutyl alcohol at a low temp. were especially satisfactory media for the metals of the alkalis and alkaline earths. The order of dispersion of some of the metals under similar conditions was found to be iron, copper, silver, aluminium, calcium, platinum, gold, zinc, tin, cadmium, antimony, thallium, bismuth, and lead, where the first member in the list was least rapidly dispersed, and the last member most rapidly. There is no perceptible relation between the order of the boiling points or the order of disintegration by cathode or canal rays and the dispersion in the organic liquid by T. Svedberg's process.

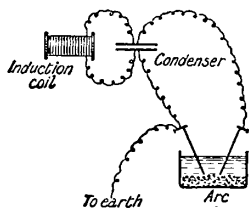

FIG. 13.—T. Svedberg's Method of making Colloidal Metals by the Oscillatory Discharge.

V. Kohlshütter also prepared colloidal metals by what he calls *discharge electrolysis* in which water is electrolyzed with either direct or alternating current combined with a condenser circuit.

The properties of gold hydrosols.—The particles of gold in suspension are assumed to be negatively charged because they migrate to the anode during electrolysis, and the liquid about the cathode becomes colourless while the liquid

about the anode becomes darker and darker in colour, and finally almost black. A black film of gold deposits on the anode. If the two electrodes are separated by a membrane, the gold, like a true colloid, does not pass through the partition, but is deposited on the negative side. The behaviour of gold sols under the influence of a fall of potential has been studied by A. von Galecky,¹⁰ J. Billitzer, J. C. Blake, and T. Svedberg. The adsorption of gold sol by dissolved dyestuffs depends less on the surface than on the number and size of particles, *i.e.* on the grain-size of the gold. The subject has been studied by R. Zsigmondy, W. Biltz, and L. Vanino. The gold can be removed from the colloidal sol by shaking it with precipitated aluminium hydroxide, stannic hydroxide, barium sulphate, animal charcoal, etc. The phenomenon resembles the decoloration of coloured soln. by shaking them with recently ignited charcoal. The gold is adsorbed by the precipitating agent. According to R. Zsigmondy (1898), a well-dialyzed and conc. gold hydrosol suffers no perceptible change after two or three days' shaking with mercury; and after a few weeks' shaking, there is often a slight change in the shade of the soln., and an increased turbidity. Probably the mercury dissolves a little, forming an electrolyte which partially coagulates the hydrosol; if mercury be boiled with the gold sol, the soln. is decolorized very slightly, and the precipitated powder amalgamates very slowly with the mercury. The addition of electrolytes—acids, salts, and bases—changes the red colour to blue, then violet, and then almost black. This is due to the coagulation of the suspensoidal gold into clots. The clotted gold settles to the bottom of the liquid in 8 or 9 hours as a bluish-black powder. With potassium ferrocyanide the colour changes to green, and in 24 hours the sol becomes yellow, but no gold is precipitated. Ammonia has no appreciable action; alcohol in excess changes the colour to a dark violet and then precipitates the gold completely, but the precipitate still retains its property of re-forming a sol when treated with water. H. R. Kruyt and co-workers, and others have studied the coagulation of gold sols. E. Hatschek measured the velocity of coagulation of gold sols. The gold is precipitated by freezing and thawing the liquid; and also by shaking in a centrifuge at 4000 revolutions per minute. The smaller the particles of colloidal gold, the more they incline to red, and the larger the particles, the more they incline to purple. When a few drops of a very dil. soln. of sodium hyposulphite,¹¹ $\text{Na}_2\text{S}_2\text{O}_4$, are added to hydrosols of gold of different conc., O. Brunck obtained the results shown in the first three columns of Table X. To these is

TABLE X.—THE EFFECT OF THE GRAIN-SIZE OF GOLD ON ITS COLOUR.

Conc. of gold sol.	Colour of liquid.	Opacity.	Average size of grain.
1 : 1,000	Deep purple-red	Opaque in thin layers	75 $\mu\mu$
1 : 10,000	Purple-red	Opaque in 14 cm. layers	38 $\mu\mu$
1 : 100,000	Rose-red	Perceptible in 1 cm. layer	10 $\mu\mu$
1 : 200,000	Very pale rose	14 cm. layers rose colour	6 $\mu\mu$
1 : 500,000	Scarcely perceptible	14 cm. layers perceptible	—
1 : 1,000,000	Colourless	Colourless	—

added R. Zsigmondy's estimate of the size of the particles of suspended gold in sols of different colours. J. N. Mukherjee and B. C. Papaconstantinou¹² studied the effect of temp. on the coagulation of gold hydrosols by electrolytes. C. Bergholm and Y. Björnstaahl found sols of vanadium pentoxide, gold, or silver are doubly refracting under the influence of an alternating electrical field. This is taken to imply that the particles of the sol are not spherical and do not possess spherical symmetry.

The colour of gold sols in transmitted light may be red, violet, or blue and occasionally yellowish-brown; the submicrons of red soln. are green; of the blue

soln., yellow or reddish-brown; and violet soln. contain submicrons of both colours. According to R. Zsigmondy, the blue obtained by the reduction of gold chloride soln. may be attributed to three causes:

First, the reduction may be incomplete and colloidal gold oxide be formed instead of gold. Further reduction, perhaps at higher temp., might cause the blue to change to red. This condition has not been taken cognizance of up to the present time. Secondly, the reduction may be complete and the blue colour be attributed to the flocculent union of particles already spoken of; or perhaps to the irregular growth, so that, instead of flakes or needles, husk-shaped bodies are called into being. These of course may be submicroscopic. Finally, the liquid may contain large massive gold particles that, according to the theory of G. Mie, would account for the blue colour.

As a rule, the larger particles are yellow or brown, and the smaller particles are green, but both green and brown particles may have all possible dimensions from a micronic dimension to over $120\mu\mu$. R. Fürth studied the colour and Brownian movement of colloidal gold; and B. Arakatsu and M. Fukuda, the limiting size of particles for the Brownian movement; H. Freundlich and A. Nathansohn attributed the various colours to the formation of complexes, and W. Pauli has adopted a similar view.

F. Ehrenhaft explained the colour of gold sols by the optical resonance of the particles; M. Garnett calculated the absorption spectra of gold hydrosols and

ruby glass, and the theory has been extended by G. Mie, and the polarization, absorption spectrum, and the dispersion of light all are in agreement. W. Steubing found that the dispersion of light is only a fraction of the absorption, and the former is smaller as the size of the particles decreases, as shown in Fig. 14, per c.c. for a 0.0025 per cent. red gold sol with particles of different sizes. The absorption for liquids with submicrons of $20\mu\mu$ and $36\mu\mu$, is nearly the same, but there is a marked difference in the intensity of the radiation. The radiation is small for particles of $20\mu\mu$, and immeasurably small for particles 2 to $4\mu\mu$. Light reflected from the side is polarized by the submicrons, and this the more the smaller the particles. The polarization is linear, not elliptical or circular. According to G. Mie's theory, particles of gold of diameter $40\mu\mu$ are green; the theory is based on the assumption that the particle is spherical and a compact mass of metallic gold. The divergence from the theory probably means that these conditions are not fulfilled. When the small particles are brown this may mean that the shape is not spherical, that the entire space occupied by the submicron is not filled with metallic gold, or that an allotropic modification of gold is in question. The last assumption is unnecessary, and leads to contradictions. The assumed sphericity of the particles is made solely for convenience in the calculations, and is probably wrong because of the independence of the colour on the diameter. The submicrons are not isodimensional in their contour, and T. Svedberg believes that the dichroism of gold gelatine films show that the distance between the particles in the two directions is different, and it is assumed the particles are long and flat, or leaf-shaped. H. Siedentopf believes that the colours of the submicrons is determined by their shape, since the colour of gold and silver submicrons changed from green to brown when pressed between the cover glass and the platform of the microscope. The observations of H. Ambronn and

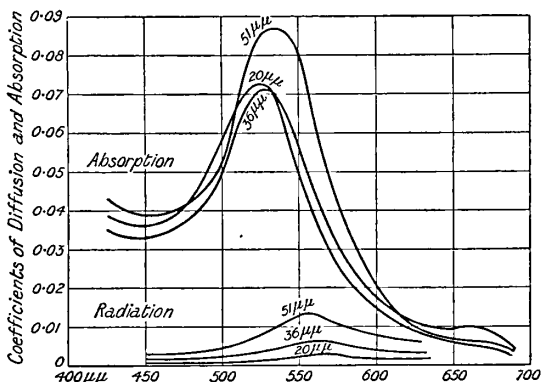

FIG. 14.—The Absorption and Radiation of Light.

The radiation is small for particles of $20\mu\mu$, and immeasurably small for particles 2 to $4\mu\mu$. Light reflected from the side is polarized by the submicrons, and this the more the smaller the particles. The polarization is linear, not elliptical or circular. According to G. Mie's theory, particles of gold of diameter $40\mu\mu$ are green; the theory is based on the assumption that the particle is spherical and a compact mass of metallic gold. The divergence from the theory probably means that these conditions are not fulfilled. When the small particles are brown this may mean that the shape is not spherical, that the entire space occupied by the submicron is not filled with metallic gold, or that an allotropic modification of gold is in question. The last assumption is unnecessary, and leads to contradictions. The assumed sphericity of the particles is made solely for convenience in the calculations, and is probably wrong because of the independence of the colour on the diameter. The submicrons are not isodimensional in their contour, and T. Svedberg believes that the dichroism of gold gelatine films show that the distance between the particles in the two directions is different, and it is assumed the particles are long and flat, or leaf-shaped. H. Siedentopf believes that the colours of the submicrons is determined by their shape, since the colour of gold and silver submicrons changed from green to brown when pressed between the cover glass and the platform of the microscope. The observations of H. Ambronn and

R. Zsigmondy showed that if the metal flakes are similarly oriented by spreading out the gelatine to form gold or silver gelatine films, the colour will be blue if the vibrations of the transmitted light are parallel to the direction of the distention of the gelatine; and red if the vibrations are at right angles to the distention. Hence G. Mie's theory must be adapted to include ellipsoidal particles.

The optical theory of metal colloids has not yet been completed, for it does not explain the colour change during coagulation. F. Kirchner supposes the particles act as resonators which, on coming into close contact with one another, displace the absorption maximum. G. Mie has raised objections to this hypothesis. The fact is that red gold sol changes to blue during coagulation, so that if a red colloidal gold sol with a very small amount of gelatine be evaporated, the dried residue is blue, and it becomes red when moistened. There is probably a flocculation of the particles during coagulation, but there is no relation between the size and colour because it occurs regardless of whether a micron or submicron unite. H. Siedentopf attributes the change to a change in the form of the particles rather than on their distance apart. The reversible change of colour indicates that an orientation of the particles parallel to the surface is more likely to occur than a change of form; and the distance apart of the particles also plays a part. The small amount of oxygen found on analyzing the gold precipitated by the addition of sodium chloride is not derived from aurous oxide, but is rather due to the condensation of air when the finely divided precipitate is dried—an eq. amount of nitrogen is simultaneously obtained.

The evidence that the gold is in the colloidal but elementary state is derived from: (i) The analysis; (ii) gold with a metallic lustre is deposited on slow evaporation, and there is no evidence of the decomposition of a compound; (iii) the red sol can be formed in a boiling hot soln. with a strong reducing agent where the probability is that aurous oxide would be decomposed; (iv) the colour of the gold sol resembles the colour of thin layers of gold viewed by transmitted light, and also that of ruby glass coloured with gold. The absorption spectra of the red gold sol, red film of metallic gold, and ruby glass; and of the blue and violet sols with blue and violet films of metallic gold, are almost identical.

Colloidal silver.—F. Wöhler¹³ reduced silver citrate in a current of hydrogen at 100°, and obtained a product which gave a deep claret-red coloured liquid when treated with water. F. Wöhler assumed that he had prepared a subcitrate of silver, but W. Muthmann (1887) showed that the red liquid contains elementary silver, which is precipitated as black metallic silver when the liquid is treated with sodium sulphate, potassium nitrate, and other salts. H. Vogel also prepared amber-coloured soln. of silver in water by chemical processes. If F. Wöhler's subcitrate be treated with very dil. aq. ammonia, the liquid is green, but otherwise it behaves like the red soln. Both soln. are decolorized by charcoal, and if mixed with gum, and treated with alcohol, the colouring agent is precipitated with the gum. After freezing and thawing an opaque black liquid is obtained. The coloured liquid remains on the dialyzer, and ammonia and silver salts pass through the dialyzer. Colloidal silver can be obtained in an analogous manner to colloidal gold. For example, add ammonia to 5 c.c. of a one per cent. soln. of silver nitrate until the precipitate just disappears, and then add 100 c.c. of water. Mix this soln. with an equal volume of a 2 per cent. aq. soln. of tannin. The resulting hydrosol of silver forms a clear liquid—brown by transmitted light, and greenish-blue by reflected light. M. C. Lea¹⁴ made an important contribution to the subject 1889-1891. It seemed remarkable that a metal so obviously insoluble in water should be produced in such a form that it could be dissolved in that menstruum, and hence M. C. Lea believed that the silver is in an allotropic form, and even to-day, M. C. Lea's hypothesis cannot be proved wrong. Indeed, on W. Ostwald's hypothesis that in the formation of a substance the unstable allotropic form appears first, it might be well argued that M. C. Lea's products are colloidal metals even though he never got them more than 97-98 per cent. purity. The assumption of allotropy, as C. Barus and

E. A. Schneider (1891) showed, is unnecessary and not so probable as the hypothesis that the metal is in a very fine state of subdivision. The reversibility of the silver sol and gel is explained by the formation of a protective colloid in M. C. Lea's process simultaneously with the production of the colloidal metal.

M. C. Lea's method of preparing colloidal silver.—Mix 200 c.c. of a 10 per cent. soln. of silver nitrate with a mixture of 200 c.c. of a 20 per cent. soln. of ferrous sulphate, 200 c.c. of a 40 per cent. soln. of sodium citrate, and 50 c.c. of a 10 per cent. soln. of sodium hydroxide. The resulting precipitate is a fine lilac colour; when filtered, it turns blue and does not become insoluble. It can be washed with ammonium nitrate, and it immediately forms a *blood-red solution* with highly purified water. It is precipitated by adding 5 to 10 per cent. of the same ammonium salt. It is purified by repeated re-solution, and re-precipitation, and finally washed with 95 per cent. alcohol. The precipitate contains about 97.2 per cent. of silver, and the remainder is iron oxide and citric acid. In another process, 40 grms. of sodium hydroxide and the same amount of ordinary brown dextrine are dissolved in 2 litres of water, and a soln. of 28 grms. of silver nitrate in a little water is gradually added. The resulting liquid is clear and black, although it contains less than one per cent. of silver. On dilution, the soln. becomes red, and with further dilution it forms a *yellow solution*. An insoluble *golden-yellow variety* is made by adding a freshly prepared mixture of 107 c.c. of a 30 per cent. soln. of ferrous sulphate, 200 c.c. of a 20 per cent. soln. of Rochelle salt, and 800 c.c. of distilled water, with constant stirring to a mixture of 200 c.c. of a 10 per cent. soln. of silver nitrate; 200 c.c. of a 20 per cent. soln. of Rochelle salt; and 800 c.c. of water. The red glittering precipitate soon becomes black, but looks like bronze on the filter paper. It is washed and then dried on a watch glass. The product has the colour of gold. If dried on glass it forms a beautiful gold mirror; if dried on glazed paper it looks like gold leaf. If washed too long it acquires the appearance of bronze. The product contains 99 per cent. silver.

J. A. Prange repeated M. C. Lea's experiments, and found that good silver hydrosols do not show the Tyndall effect, and K. Stöckl and L. Vanino therefore argued that the polarization of light by the silver sol is circular, but R. Zsigmondy showed that the polarization is always linear, never circular or elliptical. S. Odén showed that, like some gold hydrosols, silver hydrosols can be obtained optically homogeneous in Tyndall's beam. E. A. Schneider repeated M. C. Lea's experiments and used alcohol for the precipitation of the colloid, and he prepared the alcocol and glycerocol. The alcocols gave wine-red and green sols. Some non-electrolytes, like isopropyl alcohol, primary and secondary butyl alcohol, trimethyl alcohol, heptyl alcohol, octane, and formaldehyde precipitated the alcocol at once; but no coagulation occurred with propyl or isobutyl alcohols, a soln. of cetyl alcohol in alcohol, or glycerol.

The properties of silver sols.—The colloidal soln. of silver resemble in many of their properties the corresponding colloidal soln. of gold. The silver hydrosols prepared by precipitation with alkali sulphates, nitrates, and citrates are soluble, while the precipitates with iron, nickel, or manganese sulphate, and with barium or silver nitrate, are insoluble. The insoluble form can sometimes be peptized with borax or ammonium sulphate. The sols are decolorized by acids, bases, and salts, and, according to J. A. Prange, by indifferent bodies like quartz and graphite. Dialysis does not interfere with the colour, but a trace of a silver salt may pass through the membrane. Silver sols absorb light to a marked degree, and they become turbid on exposure—particularly to sunlight. Boiling and freezing and thawing decolorize the sols. Alcohol or ether precipitates the metal, but the precipitate again forms a sol with water, and hence the product was thought to be an allotropic water soluble form of silver before the colloidal nature of the product was established. Besides reducing silver nitrate with dextrine, and with a mixture of ferrous sulphate and sodium citrate, M. C. Lea also used a mixture of ferrous sulphate and Rochelle salt (*i.e.* sodium potassium tartrate). Golden-yellow colloidal silver is insoluble in water; it gives beautiful interference colours with oxidizing agents, alkali sulphates, and dil. potassium ferricyanide. Press. changes it to normal silver with the characteristic silver colour. Prolonged exposure to light, electricity, or shaking produces a similar result to press.—a sample tightly packed with cotton wool travelled 2000 miles without change, but a sample

loosely packed turned to white silver *en route*. These properties, and H. Ambronn's observations on the spontaneous crystallization of silver sols, are in favour of allotropy. The impure form is sometimes black, which becomes lighter coloured on warming. The unpurified red sol furnished a crystalline precipitate—short black needles and thin prisms after standing some weeks. Water changed the crystals without peptization, and on drying a green mass remained. W. R. Blake considered that M. C. Lea's experiments proved the existence of at least three, and possibly four, allotropic forms of silver—white, blue, red, and possibly yellow—but F. E. Gallagher¹⁵ showed that all the colours—blue, red, green, purple, gold, brown, black—can be easily prepared from one set of reagents by simply varying the conditions, and the thickness of the soln. By dipping a glass plate in the dark reddish-brown liquid obtained by Lea's dextrine process (without precipitating or washing the product), allowing the film to dry, and dipping again so as to get a series of films, one superposed on the other, the result showed that with

Number of films	1	2	3	4	5	6	7
Colour	Blue	Blue	Green	Yellow and red	Yellowish-brown and red	Red	Red

The colours can be reversed by washing away the films showing that the change from blue to green, yellow, and red is not due to the further coagulation of the silver. F. E. Gallagher, therefore, concludes that the different colours of colloidal silver are due to variations in the thickness of the films under observation, or to a difference in the size of the suspended particles. The effect of light on the soln. is either to coagulate the suspensoid and thus increase the size of the particles, or else it affects the conc. of the particles in the sol by reducing to colloidal silver any silver nitrate which remains. R. Fürth studied the colour and Brownian movement of silver sols; and B. Arakatsu and M. Fukuda the limiting size of particles for the Brownian movement. N. I. Morosoff measured the viscosity of silver sols; and P. P. von Weimarn and co-workers, the reversible solubility of colloidal silver.

Colloidal copper.—A. Gutbier, and J. Meyer found brown hydrosols of copper are obtained when dil. soln. of copper sulphate or ammoniacal copper sulphate are reduced by hydrazine hydrate, hypophosphorous acid, or sodium hydrosulphite.¹⁶ A. Lottermoser found that when a soln. of copper chloride in sodium citrate or tartrate is warmed with an alkaline soln. of stannous chloride, a white turbidity followed by a yellow, red, and black coloration is obtained; a precipitate may also be formed and a hydrosol of copper remains in the liquid which appears blue in transmitted light and red by reflected light. F. Fischer obtained metallic copper in a soln. with a high current density and a copper anode in sulphuric acid—cuprous sulphate is formed, which breaks down to metallic copper and cupric sulphate—colloidal copper has not been so obtained, but W. D. Bancroft says that this probably could be done with a suitable protecting colloid. The disintegration of all electrodes by an alternating current with a high current density is attributed by F. Haber, and R. G. van Name to the temporary formation and subsequent breaking down of a hydrogen or metallic alloy. J. Billitzer prepared colloidal soln. of the less noble metals by the electrolysis of some of their salts, but F. Haber suggests the dispersed phase is probably the oxide, not the metal. Colloidal copper has also been obtained by forming an electric arc under water, using an iron wire dipped in copper sulphate as cathode. C. Paal and W. Leuze prepared a deep bluish-violet hydrosol of copper hydroxide by adding an alkali hydroxide to a suspension of copper protalbate or lysalbate, and if a conc. soln. be treated with hydrazine, an unstable blue hydrosol of copper is formed in cold soln., and in warm soln., containing not more than 25 per cent. of copper and a small amount of ammonia, a stable liquid hydrosol of copper is formed which appears red by transmitted light and black by reflected light. On evaporation of the liquid a solid red hydrosol is formed, which is stable in the absence of air, but rapidly acquires green, orange, and blue colorations when exposed to air. The red hydrosol is similar in tint to ruby glass obtained with copper as the tinctorial agent. A blue hydrogel

is formed by adding an electrolyte to the red hydrosol. Red colloidal copper is formed by reducing colloidal copper oxide in the presence of sodium protalbate or lysalbate by hydrogen at 200°. For example :

Mix 20 grms. of powdered egg albumen and 20 c.c. of a 15 per cent. soln. of sodium hydroxide in water and dil. to 1 litre. Heat to boiling and filter. Boil again and add a 1 per cent. soln. of copper sulphate, drop by drop. The liquid turns red, then violet, then red-brown, and a precipitate settles. It is best to stop adding copper sulphate just before this precipitate forms. Dialyse the red-brown sol and filter. This sol of copper albuminate is almost neutral. Evaporate to dryness on the water-bath and dry further in a vacuum desiccator over sulphuric acid. Red-brown scales are left. They dissolve sparingly in water. Gold albuminate is made in similar manner.

The coloured varieties of colloidal copper are: brown (J. Billitzer); reddish-brown (A. Lottermoser); blue (A. Gutbier); olive-green (F. Ehrenhaft); green (C. Paal and W. Leuze); and C. Paal and H. Steyer describes two varieties of a ruby-red variety. B. Arakatsu and M. Fukuda studied the limiting sizes of particles of colloidal copper for the Brownian movement.

REFERENCES

- ¹ J. Juncker, *Conspectus chemiæ theoreticopracticæ*, Magdeburg, 1. 882, 1730; P. J. Macquer, *Dictionnaire de chymie*, Paris, 1778; J. B. Richter, *Ueber die neueren Gegenstände der Chymie*, Breslau, 1802; W. Ostwald, *Zeit. Koll.*, 4. 5, 1909; M. Faraday, *Phil. Trans.*, 147. 154, 1857; A. Connejo, *Koll. Zeit.*, 12. 1, 1913.
- ² A. Libavius, *Alchemia*, Francofurti, 1595; A. Neri, *L'arte vetraria*, Firenze, 1612; J. R. Glauber, *De auri tinctura sive auro potabili vero*, Amstelodami, 1646.
- ³ E. Odernheimer, *German Pat.*, D.R.P. 63842, 1890.
- ⁴ R. Zsigmondy, *Liebigs Ann.*, 301. 29, 361, 1898; *Zeit. anal. Chem.*, 40. 697, 1901; F. Küspert, *Ber.*, 35. 470, 1902; A. Gutbier, *Zeit. anorg. Chem.*, 31. 448, 1902; R. Zsigmondy, *ib.*, 99. 105, 1917; K. Hiege, *Ueber die Einwirkung von Fremdstoffen bei der Darstellung kolloidaler Goldlösungen nach der Formalmethode von Zsigmondy*, Göttingen, 1914.
- ⁵ J. Reitstötter, *Koll. Beihefte*, 9. 221, 1918; M. Faraday, *Phil. Trans.*, 147. 154, 1857; *Phil. Mag.*, (4), 14. 401, 512, 1857; W. B. Hardy, *Proc. Roy. Soc.*, 66. 111, 1900; T. Svedberg and N. Pihlblad, *Zeit. phys. Chem.*, 74. 529, 1910; A. von Galecky, *Zeit. Koll.*, 11. 106, 1912; F. Doerinckel, *Zeit. anorg. Chem.*, 63. 344, 1909; A. Westgren, *ib.*, 94. 193, 1916; R. Zsigmondy, *ib.*, 99. 105, 1917; E. K. Lenz, *Koll. Zeit.*, 28. 149, 1921; L. Vanino, *ib.*, 20. 122, 1917; T. Svedberg and K. Inouye, *Zeit. phys. Chem.*, 77. 150, 1911; A. Gutbier, *Zeit. anorg. Chem.*, 31. 448, 1902; *Zeit. Koll.*, 9. 177, 1911; T. Svedberg, *Zeit. phys. Chem.*, 65. 628, 1909; E. Pozzi Escot, *Ann. Chim. Anal.*, 12. 90, 1907; A. Gutbier and F. Resenschek, *Zeit. anorg. Chem.*, 39. 112, 1904; A. Gutbier, *Zeit. anorg. Chem.*, 32. 51, 91, 106, 347, 1902; 45. 77, 1905; *Journ. prakt. Chem.*, (2), 71. 358, 452, 1905; O. Brunck, *Liebigs Ann.*, 327. 250, 1903; M. C. Lea, *Zeit. anorg. Chem.*, 13. 447, 1897; C. Winkler, *Ber.*, 32. 893, 1889; E. Hatschek and A. L. Simon, *Zeit. Koll.*, 10. 265, 1912; J. Donau, *Monatsh.*, 26. 525, 1905; J. C. Blake, *Amer. Journ. Science*, (4), 16. 381, 1903; W. R. Whitney and J. C. Blake, *Journ. Amer. Chem. Soc.*, 26. 1339, 1904; A. L. de Bruyn, *Rec. Trav. Chim. Pays-Bas*, (2), 4. 240, 1900; V. Kohlschütter, *Zeit. Elektrochem.*, 14. 49, 1908; T. Svedberg, *Die Methoden zur Herstellung kolloider Lösungen anorganischer Stoffe*, Upsala, 1907; W. W. Taylor, *The Chemistry of Colloids*, London, 183, 1915; A. Stähler and F. Backran, *Ber.*, 44. 2914, 1911; K. Hiege, *Ueber die Einwirkung von Fremdstoffen bei der Darstellung kolloidaler Goldlösungen nach der Formalmethode von Zsigmondy*, Göttingen, 1914.
- ⁶ N. Castoro, *Zeit. anorg. Chem.*, 41. 126, 1904; F. Henrich, *Ber.*, 36. 609, 1903; L. Garbowsky, *Ber.*, 36. 1215, 1915; *Journ. Amer. Chem. Soc.*, 29. 385, 1903; M. Hanriot, *Compt. Rend.*, 138. 1044, 1904; L. Vanino, *Zeit. Koll.*, 20. 122, 1917; *Ber.*, 38. 463, 1905; M. Müller, *Journ. prakt. Chem.*, (2), 30. 278, 1884; L. Vanino and F. Hartl, *Ber.*, 39. 1696, 1906; C. Paal, *Ber.*, 35. 2204, 2206, 2236, 1902; 37. 124, 1904; 39. 1545, 1550, 1906; 38. 526, 534, 1905; F. Henrich, *ib.*, 36. 609, 1215, 1903; A. Lottermoser, *Zeit. anorg. Chem.*, 32. 179, 1902; A. Gutbier and J. Huber, *Koll. Zeit.*, 30. 20, 1922; A. Gutbier, A. Wolf, and A. Kiess, *ib.*, 30. 31, 1922; M. C. Lea, *Amer. Journ. Science*, (3), 33. 349, 489, 1887.
- ⁷ M. van Marum, *Verhand. Uitgezogte Teyler's Genootsch.*, 4, 1787; M. Faraday, *Phil. Trans.*, 147. 154, 1857; H. Davy, *ib.*, 100. 27, 1810; J. W. Ritter, *Journ. Phys.*, 66. 237, 323, 1808.
- ⁸ R. L. Ruhland, *Schweigger's Journ.*, 15. 411, 1815; J. C. Poggendorf, *Sitzber. Akad. Berlin*, 249, 1848.
- ⁹ G. Bredig, *Anorganische Fermente*, Leipzig, 1901; *Zeit. Elektrochem.*, 4. 514, 547, 1898; V. Kohlschütter, *ib.*, 25. 309, 1919; G. Bredig and W. Reinders, *Zeit. phys. Chem.*, 37. 323, 1901; A. Schiel, *Pogg. Ann.*, 159. 489, 1876; F. Ehrenhaft, *Sitzber. Akad. Wien*, 112. 182, 1903; W. Betz, *Ann. Phys.*, (4), 18. 590, 1906; C. Dölter, *Koll. Zeit.*, 4. 188, 1909; T. Svedberg, *ib.*, 1. 229, 257, 1907; 2. 29, 1908; *Med. Vet. Nobelinst.*, 5. 1, 1919; *Ber.*, 38. 3616, 1905; 39. 1705, 1906;

Methoden zur Herstellung kolloider Lösungen, Dresden, 1909; J. Billitzer, *Ber.*, 35 1929, 1902; E. F. Burton, *Phil. Mag.*, (6), 11. 425, 1906; F. Dezeine, *Journ. Pharm. Belg.*, 2. 238, 257, 281, 305, 329, 349, 389, 433, 1920; D. Zavriff, *Zeit. phys. Chem.*, 87. 507, 1914.

¹⁰ A. von Galocky, *Zeit. anorg. Chem.*, 74. 174, 1912; A. Westgren, *ib.*, 94. 193, 1916; J. C. Blake, *ib.*, 39. 72, 1904; T. Svedberg, *Studien zur Lehre von den kolloiden Lösungen*, Upsala, 1907; J. Billitzer, *Zeit. phys. Chem.*, 45. 307, 1903; R. Zsigmondy, *Liebig's Ann.*, 301. 36, 1898; *Verh. Ges. Naturf. Aertze*, 171, 1901; W. Biltz, *Gött. Nachr.*, 18, 1904; *Ber.*, 37. 1095, 1904; L. Vanino, *ib.*, 35. 662, 1902; O. Herstad, *Koll. Beihefte*, 8. 399, 1916; H. R. Kruyt and H. G. van Arkel-Adriani, *Rec. Trav. Chim. Phys.-Bas*, 39. 609, 1920; H. R. Kruyt and A. E. van Arkel-Adriani, *ib.*, 39. 615, 1920; E. Hatschek, *Trans. Faraday Soc.*, 16. 35, 1921.

¹¹ O. Brunck, *Liebig's Ann.*, 327. 250, 1903.

¹² C. Bergholm and Y. Björnstahl, *Phys. Zeit.*, 21. 137, 1920; J. N. Mukherjee and B. C. Papaconstantinou, *Journ. Chem. Soc.*, 117. 1563, 1920; R. Zsigmondy, *Zur Erkenntnis der Kolloide*, 114. 133, 1905; M. Garnett, *Phil. Trans.*, 203. A, 385, 1904; 205. A, 237, 1905; F. Ehrenhaft, *Sitzber. Akad. Wien*, 112. 181, 1903; 114. 1115, 1905; F. Hasenoehrl, *ib.*, 111. 1229, 1902; F. Kirchner and R. Zsigmondy, *Ann. Physik*, (4), 15. 573, 1904; W. Steubing, *ib.*, (4), 26. 329, 1908; G. Mie, *ib.*, (4), 25. 429, 1908; *Zeit. Koll.*, 2. 129, 1907; L. Lorenz, *Wied. Ann.*, 11. 70, 1880; T. Svedberg, *Arkiv Kemi*, 4. 19, 1911; *Zeit. phys. Chem.*, 65. 624, 1909; 66. 752, 1909; 67. 249, 1909; 74. 513, 1910; H. Siedentopf, *Verh. deut. phys. Ges.*, 12. 6, 1910; R. Zsigmondy, *Kolloidchemie*, Leipzig, 1912; H. Ambronn, *Zeit. wiss. Mikros.*, 22. 349, 1905; *Ber. Sächs. Ges. Wiss.*, 613, 1896; F. Kirchner, *ib.*, 261, 1902; O. Wiener, *Phys. Zeit.*, 5. 332, 1904; R. Fürth, *ib.*, 33. 80, 1921; B. Arakatsu and M. Fukuda, *Mem. Kyoto Coll. Science*, 4. 179, 1920; H. Freundlich and A. Nathansohn, *Koll. Zeit.*, 29. 16, 1921; W. Pauli, *ib.*, 28. 49, 1921.

¹³ F. Wöhler, *Liebig's Ann.*, 30. 1, 1839; W. Muthmann, *Ber.*, 20. 983, 1887; H. Vogel, *Pogg. Ann.*, 117. 316, 1861.

¹⁴ M. C. Lea, *Amer. Journ. Science*, (3), 37. 476, 1889; (3), 41. 179, 259, 482, 1891; *Phil. Mag.*, (5), 31. 238, 320, 497, 1891; (5), 32. 337, 1891; *Kolloides Silber und die Photohaloide*, Dresden, 1908; J. C. Blake, *Amer. Journ. Science*, (4), 16. 282, 1903; A. Gutbier and G. Hofmeier, *Zeit. anorg. Chem.*, 45. 77, 1905; K. Stöckl and L. Vanino, *Zeit. phys. Chem.*, 30. 98, 1899; C. Barus and E. A. Schneider, *ib.*, 8. 278, 1891; S. Odén, *ib.*, 78. 682, 1912; E. A. Schneider, *Ber.*, 25. 1281, 1892; *Zeit. anorg. Chem.*, 7. 339, 1894; R. Zsigmondy, *ib.*, 99. 105, 1917; J. Reitstötter, *Koll. Beihefte*, 9. 221, 1917; J. A. Prange, *Rec. Trav. Chim. Pays-Bas*, 9. 121, 1890; H. Ambronn, *Zeit. wiss. Mikros.*, 22. 349, 1905; R. Zsigmondy, *Kolloidchemie*, Leipzig, 1912.

¹⁵ F. E. Gallagher, *Journ. Phys. Chem.*, 10. 700, 1906; J. C. M. Garnett, *Phil. Trans.*, 203. A, 385, 1904; 205. A, 237, 1905; R. Lorenz and K. Hiege, *Zeit. anorg. Chem.*, 92. 27, 1915; N. I. Morosoff, *Journ. Russ. Phys. Chem. Soc.*, 47. 783, 1915; P. P. von Weimarn, N. I. Morosoff, and V. J. Anossoff, *ib.*, 47. 782, 1915; 48. 197, 1916; R. Fürth, *Phys. Zeit.*, 33. 80, 1921; B. Arakatsu and M. Fukuda, *Mem. Kyoto Coll. Science*, 4. 179, 1920.

¹⁶ A. Gutbier, *Zeit. anorg. Chem.*, 32. 355, 1902; 44. 227, 1905; J. Meyer, *ib.*, 34. 50, 1903; A. Lottemoser, *Ueber anorganische Colloide*, Stuttgart, 1901; *Journ. prakt. Chem.*, (2), 59. 489, 1899; J. Billitzer, *Ber.*, 35. 1929, 1902; T. Svedberg, *ib.*, 38. 3620, 1905; 39. 1712, 1906; B. Arakatsu and M. Fukuda, *Mem. Kyoto Coll. Science*, 4. 179, 1920; R. G. van Name, *Zeit. Elektrochem.*, 10. 303, 1904; F. Fischer, *ib.*, 9. 507, 1903; F. Haber, *ib.*, 8. 551, 1902; *Trans. Amer. Electrochem. Soc.*, 2. 192, 1902; C. Paal and W. Leuze, *Ber.*, 39. 1545, 1906; C. Paal and H. Steyer, *Koll. Zeit.*, 30. 88, 1922; F. Ehrenhaft, *Anz. Akad. Wien*, 39. 241, 1902; W. D. Bancroft, *Journ. Franklin Inst.*, 185. 387, 1918.

§ 11. Purple of Cassius, and Ruby Glass

I believe the purple of Cassius to be essentially finely divided gold associated with more or less oxide of tin.—M. FARADAY (1857).

If a soln. of stannous chloride be added to a very dil. soln. of gold chloride, hydrated stannic oxide is precipitated, and the gold is reduced, colouring the precipitate various shades of brown, purple, blue, green, yellow, or red. The precipitate is called **purple of Cassius**, and the tint depends upon the conc. and composition of the soln.—*e.g.* the proportion of stannous and stannic chloride and on the rapidity of admixture. The production of the colour is an extremely delicate test for gold. In making the test,¹ the soln. of gold chloride is heated to boiling, and poured into a beaker containing 5 to 10 c.c. of a sat. soln. of stannous chloride, and the mixture agitated to secure perfect admixture. A precipitate is at once produced which settles quickly. It will be purplish-red or blackish-purple if but one part of gold

is present in 5,000,000 parts of water, and T. K. Rose has shown that the presence of one part of gold in 100,000,000 parts of water—that is, one grain of gold in 6 tons of water—can be detected by this means. The purple has long been used as a colouring agent for enamels, glasses, etc. The methods for making the finest and richest gold-red tints for porcelain and glass decoration are supposed to be trade secrets, although there is no difficulty in making colours to satisfy the less severe standards. One part of gold will tint about 100,000 parts of glass a rose-red colour; and about half this amount of glass, a ruby-red.

The manuscript No. 3661 in the Sloane collection of the British Museum purports to have been copied by John Elyot in 1572 “out of an old cōpye by William Belyngslye which seemeth to be above 200 yers old;” it contains a recipe for colouring glass garnet by means of gold oxide, and for colouring glass ruby by means of copper oxide. The deep carmine-red glass called *Gallien glass* was also coloured by copper as described by Eraclius in his *De artibus romanorum*, written in the tenth century. The term Gallien applied to red glass may have been derived from *καλός*, beauty, or from the Roman Galienus under whose reign the arabesque and other architectural ornaments were introduced into Rome.

Towards the end of the sixteenth century, A. Libavius, in his *Alchemia* (Frankfurt, 1585), referred to the production of a hyacinth-red glass by using a mixture *ex utraque Martis et terrea Solis*; a little later, A. Neri, in his *L'arte vetraria* (Firenze, 1612), mentioned the coloration of glass by mixing the ingredients with the residue obtained by the evaporation of a soln. of gold in aqua regia; J. R. Glauber, in his *Furnis novis philosophicis* (Amstelodami, 1648),² described how he prepared a ruby-red precipitate by treating a soln. of gold chloride with water-glass; and in his *De prosperitate germanicæ* (1659), he mentioned the precipitation of a purple powder by the action of tin in a soln. of gold in aqua regia. In 1668, O. Tachen stated, in a tract called *De morborum principe*, that a purple colour is produced when glass is melted with fulminating gold; and, in 1684, R. Boyle noticed that the bottom of a glass flask in which gold amalgam had been heated was stained ruby-red. The alchemists of this period speak of “the purple gold-soul,” “the purple mantel of the king,”³ etc., without indicating their mode of preparation. About 1684, A. Cassius wrote a pamphlet entitled *De Auro* (Leiden, 1685), describing, for the first time, though somewhat incompletely, the preparation of the gold-tin purple colour, by mixing the chlorides of tin and gold. About the same time, J. C. Orschall, in his *Solis sine veste* (Augsburg, 1684), mentioned the use of Cassius' purple for colouring artificial stones and glass. In 1716, J. Kunckel⁴ referred to the *præcipitatio Solis cum Jove*, prepared by Cassius, and stated that artificial rubies could be made by colouring crystal glass with gold precipitated from its soln. in aqua regia. He claimed to be able to make a colour *so schön das es schöner nicht sein kann*. About this time, the precipitate obtained by Cassius' process came to be called *purpura mineralis Cassii*; and finally, *purple of Cassius*.

J. Kunckel stated that when attempts were made to colour glass by means of Cassius' purple, the product was often quite colourless, but when warmed in the blowpipe flame, the finest ruby-red tint was developed. There are, indeed, two types of ruby glass: the tint of the one is developed directly during fusion, and the tint of the other is developed when the glass is annealed below its fusion point. If the tint of the latter type be developed during the first fusion, it appears liver-coloured, and altogether lacks the fiery brilliance of the tint developed by the annealing process. The last-named phenomenon is very curious, and it can be illustrated by the following experiment:

A glass is made by fusing together an intimate mixture of quartz, 48; red lead, 80; nitre, 10; potassium carbonate, 10; crystallized borax, 30, for some hours. The product is ground, thoroughly mixed with stannic oxide, and antimony oxide, and moistened with a soln. of gold chloride containing the eq. of 0.0150 part of gold. The mass is dried, and fused so that when quickly cooled, the product has a pale yellow colour which turns ruby-red when warmed over the Bunsen flame.

It is supposed that the clear glass contains a soln. of gold, and on re-heating, the gold is reduced and surface tension brings the molecules of metal together and the aggregates separate from the soln. in the form of small particles; just as a film of metal on glass, at 300° or 400°, forms a number of minute spheroids without the metal melting. Coloured glasses have been prepared with copper or silver in place of gold. Methods of preparing ruby glasses, etc., industrially have been given by Arclais de Montamy in 1765, and by N. de Milly in 1771, by many others in later years.⁵

R. Zsigmoudy's process for making purple of Cassius.⁶—300 c.c. of gold chloride containing the eq. of 3 grms. of gold per litre are mixed with 250 c.c. of a soln. of stannous chloride containing the eq. of 3 grms. of tin per litre, and a small excess of hydrochloric acid, and added to 4 litres of water with vigorous agitation. After standing three days, a dark violet-red powder collects as a sediment while the supernatant liquid is clear and colourless, for it contains no gold or tin. The precipitate is washed free from chlorides first by decantation, and then by suction on a filter. If the solid be treated with a warm soln. of dil. ammonia, a clear hydrosol of the purple of Cassius is obtained which can be re-precipitated by the addition of a little sulphuric acid.

When purple of Cassius is formed it is assumed that on the addition of stannous chloride to a dil. soln. of gold chloride the latter is reduced, and stannic chloride is formed: $2\text{AuCl}_3 + 3\text{SnCl}_2 = 2\text{Au} + 3\text{SnCl}_4$. The stannic chloride is hydrolyzed into hydrochloric acid and colloidal stannic acid, and this prevents the aggregation of the gold particles. The hydrosol of stannic acid in soln. gradually changes into a hydrogel under the influence of the hydrochloric acid. A transformation from the soluble to the insoluble acid takes place at once on heating. The liquid usually becomes red, but the purple is not precipitated for some days unless the soln. is boiled.

The manufacture of special tints of purple of Cassius is attended by some uncertainty because the beauty of the tint depends upon details in manipulation not clearly understood. According to C. Buisson,⁷ one cause of uncertainty in the results is due to the use of a mixture of stannic and stannous chlorides in indefinite proportions. Stannic chloride alone does not reduce the gold chloride, and C. Buisson considered that a mixture of one part of stannic chloride with three parts of stannous chloride is best for the reprecipitation of one part of gold. P. A. Bolley⁸ used a soln. of 10 parts of ammonium chlorostannate, $2\text{NH}_4\text{Cl} \cdot \text{SnCl}_4$, with 40 parts of water and 1.07 part of tin-foil, for reducing the gold chloride; and J. N. von Fuchs recommended the addition of a soln. of one part of ferric chloride liquor (sp. gr. 1.54) with three of water to a soln. of one part of stannous chloride in six parts of water until the product has a green tint. This, when diluted with six parts of water, was added to the soln. of gold chloride as nearly neutral as possible. W. A. Lampadius,⁹ and J. Pelletier recommended a rod of tin or tin shavings as reducing agent. Colours analogous to the calcined purple of Cassius have been made by precipitating gold on the hydroxides of magnesium, calcium, barium, aluminium, antimony, bismuth, or zirconium; barium or lead sulphate; or on china clay, and calcining the product.¹⁰ Purple of Cassius remains as a residue when alloys of gold and tin with a large excess of silver are treated with nitric acid;¹¹ and when a gold-tin alloy is vaporized in air, the tin burns to stannic oxide, and it is at the same time stained by the condensation of the vapour of metallic gold.¹² The silver¹³ and platinum¹⁴ analogues of purple of Cassius have been prepared. The platinum product has all the properties of a colloid; if it be prepared in a conc. soln. of hydrochloric acid, it will be soluble, or rather peptized, in ether or ethyl acetate; and the purple can be extracted from the acid soln. by one of these menstrua, and a water soluble jelly is left behind.

Prior to 1894, two views as to the chemical nature of purple of Cassius were rife, and in spite of the many investigations, no generally accepted decision had been reached. Analytical results ranging from gold 27 to 38 per cent., tin oxide from 48 to 64 per cent., and water from 7 to 15 per cent. have been reported. Formulæ

based on the analyses have been suggested, but with no satisfactory result, because chemical analysis cannot decide whether a substance is a chemical compound or a mixture. One view, held by J. J. Berzelius (1831) and others,¹⁵ assumes purple of Cassius to be a chemical compound of a gold oxide with tin oxide, possibly with some stannic acid in excess; and the other view, advocated by J. B. Richter (1802) and others,¹⁶ regards purple of Cassius as a mixture of stannic oxide with metallic gold. While recognizing with M. Macquer that *les faits prouvent que cette couleur est naturelle à l'or toutes les fois qu'il est extrêmement divisé*, certain difficulties were encountered, for the behaviour of the purple towards certain reagents was not like their behaviour with gold. Thus, J. J. Berzelius¹⁷ argued that the solubility of purple of Cassius in ammonia, and the failure of mercury to extract the gold, favours the view that the gold is not present in the metallic state. By oxidizing stannous chloride, and allowing the dil. soln. to stand until a hydrogel of stannic acid separates, the addition of ammonia brings the product into soln. just as is the case with purple of Cassius, and there is therefore no sign of the formation of a salt. E. A. Schneider¹⁸ considers that the ammoniacal soln. contains the hydrogels of gold and stannic acid, and R. Zsigmondy has shown that he is probably correct. A substance identical with purple of Cassius can be made by mixing the hydrosols of stannic acid and gold, and subsequently precipitating them by the addition of acids. The purple so synthesized has the same colour as the gold hydrosol from which it was prepared, and it is not probable that so inert a substance as gold would unite with stannic oxide under these conditions. The ultramicroscope shows that there is no essential difference between the gold particles in the synthesized hydrosol of purple of Cassius and the particles of the gold hydrosol. Neither the absorption spectrum nor the colour of the hydrosol of gold is changed in the least when it is converted into purple of Cassius, and this is not likely to be the case if the two components unite chemically. Purple of Cassius behaves like a typical colloid towards the electric current, and on dialysis; and in this respect it resembles the hydrogel of stannic acid. Hence, R. Zsigmondy argues that **purple of Cassius is a mixture of the hydrosols of gold and stannic acid** in which the latter imparts to the metallic gold the property of being dispersed in alkaline liquids. **Calcined purple of Cassius is a mixture of stannic oxide and finely divided gold; and ruby glass owes its colour to particles of extremely finely divided gold.** Still further, the properties of purple of Cassius depend upon the properties of the protective colloidal—stannic acid—which makes the gold play a passive rôle towards reagents. If the stannic acid is soluble in conc. hydrochloric acid,*so is the purple; in the same manner, the solubility in ammonia and dil. alkalies depends upon the character of the stannic acid present. Generally, the great variations in the properties of the different varieties of stannic acid explain the many contradictions in literature with respect to the properties of purple of Cassius.

Instead of crystals being optically clear on solidification from a fused state, they are sometimes fogged.¹⁹ An ultramicroscopic examination of the fogged crystals of the chlorides of lead, silver, and of thallium, and the bromides of silver and of thallium has shown that the fog is produced by metal particles so that the crystals have the character of ruby glass. If the fogged crystals of lead or silver chloride be fused in a stream of chlorine and hydrogen chloride gases, they solidify optically clear—thallous chloride has not yet been obtained in quite clear crystals.

REFERENCES.

- ¹ T. K. Rose, *Chem. News*, 66. 271, 1892.
- ² J. R. Glauber, *Opera*, Amstelodami, 1650-70; R. Boyle, *Experiments and Considerations about the Porosity of Bodies*, London, 1684.
- ³ Basilius Valentinus, *Von der grossen Stein der Uhrallen daran so viel tausend Meister anfangs der Welt hero gemacht haben*, Strassburg, 1651.
- ⁴ J. von Löwenstein Kunckel, *Vollständiges laboratorium chymicum*, Berlin, 1716.
- ⁵ N. de Milly, *Mémoire sur la porcelaine de Saxe*, Paris, 1771; Arclais de Montamy, *Traité des couleurs pour la peinture en émail et sur la porcelaine*, Paris, 1865.

- ⁶ R. Zsigmondy, *Liebig's Ann.*, 301. 365, 1898; G. Besseyre, *Ann. Chim. Phys.*, (2), 54. 40, 1833.
- ⁷ C. Buisson, *Journ. Pharm.*, 16. 629, 1830.
- ⁸ P. A. Bolley, *Liebig's Ann.*, 39. 244, 1841; J. N. von Fuchs, *Journ. prakt. Chem.*, (1), 5. 318, 1835; C. F. K. Capaun, *ib.*, (1), 22. 152, 1841.
- ⁹ W. A. Lampadius, *Journ. tech. ökon. Chem.*, 16. 347, 1833; J. Pelletier, *Ann. Chim. Phys.*, (2), 15. 5, 113, 1820.
- ¹⁰ M. Müller, *Journ. prakt. Chem.*, (2), 30. 252, 1884; W. Biltz, *Ber.*, 37. 1102, 1904; H. Debray, *Compt. Rend.*, 75. 1025, 1872; E. Desmarest, *Journ. Pharm.*, 17. 219, 1831; A. Berge, *Sprechsaal*, 45. 419, 1912; E. Wedekind, *Zeit. Elektrochem.*, 9. 630, 1903.
- ¹¹ W. Wächter, *Liebig's Ann.*, 68. 115, 1848; E. A. Schneider, *Zeit. anorg. Chem.*, 5. 80, 1894.
- ¹² H. Moissan, *Compt. Rend.*, 141. 977, 1905; *Bull. Soc. Chim.*, (3), 35. 265, 1906.
- ¹³ A. Ditte, *Ann. Chim. Phys.*, (5), 27. 145, 1882; H. Schulz, *Ueber eine dem Goldpurpur analoge Silberverbindungen*, Göttingen, 1857; A. Lottermoser, *Ueber anorganische Colloide*, Stuttgart, 93, 1901.
- ¹⁴ L. Wöhler, *Zeit. Koll.*, 7. 248, 1910.
- ¹⁵ A. G. L. Lentin, *Scherer's Journ.*, 3. 30, 1790; N. W. Fischer, *ib.*, 56. 360, 1829; J. S. C. Schwigger-Seidel, *ib.*, 65. 265, 1832; J. N. Fuchs, *ib.*, 65. 267, 1832; *Pogg. Ann.*, 25. 630, 1832; 27. 634, 1833; J. J. Berzelius, *ib.*, 22. 306, 1831; J. A. Buchner, *Repert. Pharm.*, 29. 1, 1825; E. D. Clarke, *Ann. Phil.*, (2), 1. 393, 1821; E. Desmarest, *Journ. Pharm.*, 27. 219, 1841; M. Robiquet, *ib.*, 16. 693, 1830; L. G. Figuier, *Ann. Chim. Phys.*, (3), 11. 336, 1844; A. Oberkampf, *ib.*, (1), 80. 140, 1811; A. Strecker, *Lehrbuch der Chemie*, Braunschweig, 1. 637, 1861; W. Stein, *Journ. prakt. Chem.*, (2), 6. 172, 1873.
- ¹⁶ J. B. Richter, *Ueber die neueren Gegenstände der Chymie*, Breslau, 1802; W. Ostwald, *Zeit. Koll.*, 4. 5, 1909; M. Macquer, *Dictionnaire de chymie*, Paris, 3. 269, 1778; J. L. Gay Lussac, *Ann. Chim. Phys.*, (2), 34. 396, 1827; M. Marcadieu, *ib.*, (2), 34. 147, 1827; M. Sarzeau, *Journ. Pharm.*, (2), 3. 373, 1844; L. Knaffl, *Dingler's Journ.*, 168. 191, 1863; J. C. Fischer, *ib.*, 182. 31, 129, 1866; H. Debray, *Compt. Rend.*, 75. 1025, 1872; M. Müller, *Journ. prakt. Chem.*, (2), 252, 1884; A. Wächter, *Liebig's Ann.*, 68. 115, 1848; R. Zsigmondy, *ib.*, 301. 361, 1898; E. A. Schneider, *Zeit. anorg. Chem.*, 5. 80, 1894; M. Faraday, *Phil. Trans.*, 147. 170, 1857.
- ¹⁷ J. J. Berzelius, *Lehrbuch der Chemie*, Dresden, 2. 244, 1823.
- ¹⁸ E. A. Schneider, *Zeit. anorg. Chem.*, 5. 80, 1894; R. Zsigmondy, *Liebig's Ann.*, 301. 29, 1898.
- ¹⁹ R. Lorenz, *Zeit. Elektrochem.*, 7. 277, 1900; *Die Elektrolyse geschmolzener Salze*, Halle, 2. 40, 1905; R. Lorenz and W. Eitel, *Zeit. anorg. Chem.*, 91. 46, 57, 1915.

§ 12. Allotropic Modifications of Gold and Silver

Gold is precipitated as a brown powder from its salt soln. by means of a stannous chloride, ferrous chloride, or sulphate, or by arsenious or antimonious acid; with oxalic acid and conc. potassium carbonate, gold is precipitated from boiling soln. as a soft yellow spongy mass. The more dil. the soln. the finer the state of the subdivision of the precipitate, and under certain conditions, red or purple soln. of colloidal gold are obtained without any precipitation of the metal. With conc. soln. the gold is often precipitated in flakes with a metallic lustre. J. Thomsen¹ found that pale yellow powdered gold is precipitated from neutral soln. of auric chloride by sulphur dioxide gas, and he symbolized this form of gold by the symbol Au; the same agent precipitates a fine dark powder from auric bromide, and J. Thomsen symbolized this form of gold by Au α or α -gold; and gold with a metallic lustre is precipitated by the same agent from aurous halides, or by hydrogen chloride or bromide from aurous halides, and he designated this form of gold Au β or β -gold. J. Thomsen assumed that these three precipitates represented allotropic modifications of gold, and he found that the heats of the reactions corresponded with the relations Au α =Au+3.21 Cals.; and Au β =Au+4.7 Cals. During the action of sulphur dioxide on auric bromide, J. Thomsen said that the bromide is reduced to aurous bromide, and then to Au α ; but he also said that aurous bromide is reduced to Au β by the same agent, so that the two statements are not in accord. F. Cohen and J. W. van Heteren² found no difference of potential at 0° or 25° between these different varieties of gold, and concluded that there is a difference only in the state of subdivision of the precipitates. It is, therefore, inferred that the three allotropic modifications of gold postulated by J. Thomsen do not exist.

In studying the double refraction of gold, Y. Björnstähl found indications that gold crystals and particles of colloidal gold belong to different crystal systems—*vide supra*.

M. C. Lea, and J. C. Blake postulated different allotropic forms of silver for what are now regarded as colloidal forms of the metal. When A. J. A. Prage³ observed a similar difference in the heats developed during the precipitation of colloidal silver from soln. of different conc. and in the conversion of colloidal silver to the metallic form: $Ag_{\text{colloidal}} = Ag_{\text{metal}} + (6.48 \times 10^8)$ Cals., he, like J. Thomsen with gold, assumed that colloidal silver is an allotropic modification of that metal. C. Barus and E. A. Schneider, however, showed that work, or heat eq. to work, is necessary to transform a quantity of finely divided metal into a still finer state of subdivision, and heat is liberated during the converse process—the coagulation of the particles into larger grains. The energy difference between colloidal and finely divided silver is greater, per gram-atom, than between the allotropic modifications of phosphorus, sulphur, carbon, etc. *The development of heat during the transformation of a finely divided metal into more coarse-grained aggregates, is not conclusive evidence of the simultaneous conversion of one allotropic modification of an element into another.*

Attempts have likewise been made by M. Berthelot⁴ to show that the differences in the heats of soln. of different forms of silver in mercury correspond with four *états allotropiques de l'argent*. Silver rolled into thin sheets gave a heat of soln. of 2.03 Cals. per gram-atom, and if heated to dull redness for 20 hours in oxygen, 0.47 Cal.; electrolytic crystalline silver from a 10 per cent. soln. of silver nitrate gave 0.10 Cal.; silver precipitated from a dil. soln. of silver nitrate gave 1.19 Cals. if dried at the room temp., and 0.76 Cal. if dried at 120°, or 0.08 Cal. if heated to dull redness. Even if M. Berthelot's assumption that these differences are due to allotropes of silver were correct, there would be no need to postulate four varieties, since various mixtures of two varieties of silver would explain the facts. E. Cohen and J. W. van Heteren, however, likewise failed to detect any difference in the potential difference of these different forms of silver, and they considered that M. Berthelot's allotropes to be *Silber nur in einer Form*, or identically the same form of silver. A. Matthiessen⁵ said that "with silver it was not possible to get constant results for the sp. gr. although the metal was melted under borax, sodium chloride, and charcoal. The value 10.486 at 13.2° is the mean of thirteen different determinations varied between 10.424 and 10.511." W. D. Helder mann expressed the opinion that these differences cannot be ascribed to experimental error, but are rather due to changes in the metal itself, *i.e.* to different **allotropic forms of silver**. J. S. Stas obtained different values—9.8688 to 10.5537—for the sp. gr. of silver subjected to different treatment, and W. D. Helder mann also believed that different proportions of allotropic forms of the metal were present. He found the sp. gr. of silver, at 25°/4°, treated in different ways, varied from 10.3257 to 10.4978. He also found that when kept in contact with a soln. of potassium sulphate for different periods of time (days) at 25° the sp. gr. rose

	5	6	15	28
Specific gravity . . .	10.4774	10.4867	10.486	10.4870

When kept for 6 days at 400° in contact with a molten mixture of sodium and potassium nitrates, and then chilled in cold water, the sp. gr. fell to 10.21608 at 25°/40°. The e.m.f. of different varieties in contact with a 10 per cent. soln. of silver nitrate ranged from 0.0000187 to 0.0000748 volt. Experiment showed that if silver be heated in a dilatometer with a soln. of silver nitrate, the rate of expansion of the system is comparatively slow between 76° and 78°, and the metal which has been heated with the soln. above 76° has a smaller sp. gr. than the metal which has not been heated to so high a temp. Accordingly, W. H. Helder mann concluded that silver exists in at least two allotropic modifications and that there is a transition temp. in the vicinity of 77°. Ordinary silver is therefore

assumed to be in a metastable condition because the allotropic forms are not in a state of equilibrium. The physical constants excluding at. wt. refer to indefinite mixtures of the different allotropes, and hence must vary according to the proportions present in a given sample. It has been suggested, however, that the evidence is not decisive because the variations in the sp. gr. of silver observed by A. Matthiessen, and the movement of the liquid in W. D. Helder's dilatometer may be really due to the soln. permeating the pores of the metal; and the observed variation in the sp. gr. of the metal heated above and below 77° , due to a decrease in the apparent sp. gr. of the liquid confined in the pores of the metal—*vide* allotropic copper. Others have obtained evidence of allotropic modifications of silver. Thus, H. Lüdke found that the electrical resistance of silver films increased with time. E. Jänecke⁶ plotted the press. temp. curves of silver compressed to 20,000 kilograms per sq. cm. in steel cylinders on a rising and falling temp., and he found a break near 120° (at 118° on the cooling curve, and 120° on the heating curve), which he considered to represent the allotropic change. L. Pissarjewsky⁷ could not get a constant value for the equilibrium constant in the reaction, $\text{Ag}_2\text{SO}_4 + 2\text{FeSO}_4 = \text{Fe}_2(\text{SO}_4)_3 + 2\text{Ag}$; he found that the thermal values of the reaction in various solvents—water, normal sulphuric acid, 10 per cent. mannitol, or 24 per cent. glycerol—varied between 7.05 and 14.52 cal. per gram-atom of silver; and he also found that there is a difference of potential between the different precipitates in the reaction under consideration. Consequently, L. Pissarjewsky assumed that the precipitates are mixtures of at least two different modifications of silver. These results may be due to a difference in the state of subdivision of the different precipitates. Again, the curve showing the relation between the electromotive force of the silver-nickel thermocouple and the temp. coeff. between -80° and 920° shows a maximum value between 180° and 220° , and a minimum at about 370° . G. von Hevesy and E. Wolff⁸ attribute the latter to an allotropic change in the nickel, and E. Jänecke attributes the former to an allotropic change in the silver.

According to D. Palitsch,⁹ silver obtained by dissolving zinc from zinc-silver alloys by hydrochloric acid differs from ordinary silver in sp. gr., heat of soln. in mercury, and electrolytic potential, and is therefore considered to be an allotropic modification of ordinary silver. M. Hanriot studied the action of nitric acid on gold-silver alloys containing about 20 per cent. of gold, and he found that the residual gold always contained a little silver and much nitric acid; the latter is lost at 175° – 200° , and on further heating, the product changes colour, and undergoes contraction; at 900° , a gas is evolved; and the residue melts at 1040° . He assumed that the residual brown gold is an allotropic β -form of gold, and, according to M. Hanriot and F. Raoult, the proportion of β -gold increases as the proportion of silver in the alloy increases. The last named measured the coeff. of magnetization and found -0.181×10^{-6} for brown or β -gold, and -0.234×10^{-6} for yellow or α -gold. The former begins to pass into the latter at about 350° , and the change is completed in about 2 hours at 400° . They found that nitric acid attacks both forms of gold, and that the best solvent for β -gold is a hot soln. of auric chloride containing hydrochloric acid. On cooling the soln. the dissolved gold crystallizes out in the metallic state, and a determination of its magnetization coeff. shows that, in this form, it consists almost entirely of the β -variety. This solvent has a much more marked action on the brown than the yellow gold, and it is the β -variety which passes into soln., thus leaving the insoluble residue enriched with the α -variety.

REFERENCES.

- ¹ J. Thomsen, *Thermochemische Untersuchungen*, Leipzig, 3, 400, 1883.
- ² E. Cohen and J. W. van Heteren, *Zeit. Elektrochem.*, 12, 589, 1906; Y. Björnstähl, *Phil. Mag.*, (6), 42, 352, 1921.
- ³ A. J. A. Prage, *Rec. Trav. Chim. Pays-Bas*, 9, 121, 1890; C. Barus and E. A. Schneider,

Zeit. phys. Chem., 8, 278, 1891; R. Zsigmondy, *Zur Erkenntnis der Kolloide*, Jena, 14, 1905; M. C. Lea, *Phil. Mag.*, (5), 31, 238, 320, 497, 1891; (5), 32, 337, 1891; J. C. Blake, *Zeit. anorg. Chem.*, 37, 243, 1903.

⁴ M. Berthelot, *Ann. Chim. Phys.*, (7), 22, 289, 1901; E. Cohen and J. W. van Heteren, *Zeit. Electrochem.*, 12, 589, 1906.

⁵ W. D. Helder mann, *Journ. Inst. Metals*, 16, 84, 1916; A. Matthiessen, *Pogg. Ann.*, 110, 21, 1860; H. Lüdkte, *Ueber die Eigenschaften verschiedener Silbermodification*, Greifswald, 1893; J. S. Stas, *Mém. Acad. Belg.*, 35, 103, 1865.

⁶ E. Jänecke, *Zeit. phys. Chem.*, 90, 313, 1915.

⁷ L. Pissarjewsky, *Journ. Russ. Phys. Chem. Soc.*, 40, 367, 1908; *Zeit. anorg. Chem.*, 58, 399, 1908.

⁸ G. von Hevesy and E. Wolff, *Phys. Zeit.*, 11, 473, 1910; E. Jänecke, *Zeit. phys. Chem.*, 90, 313, 1915.

⁹ D. Palitsch, *Bull. Acad. Belgique*, 5, 395, 1911; M. Hanriot, *Compt. Rend.*, 151, 1355, 1910; 152, 138, 369, 704, 1911; M. Hanriot and F. Raoult, *ib.*, 153, 182, 1911; 155, 1085, 1912.

§ 13. Alloys of Gold, Silver, and Copper

H. Davy¹ said that when potassium "is heated with gold, or silver, or copper in a close vessel of pure glass, it rapidly acts upon them; and when the compounds are thrown in water, this fluid is decomposed, potash is formed, and the metals appear to be separated unaltered." G. S. Sérullas did not obtain any alloy of potassium with silver by igniting the metal with crude tartar. C. J. B. Karsten mentions a **sodium-copper alloy** with 0.13 per cent. of sodium, and H. Behrens made a **copper-potassium alloy**. There is some doubt about these statements, because molten sodium appears to be insoluble in copper at 500°, although when heated to the b.p. of sodium, copper absorbs a little sodium. According to E. Quercigh, and C. H. Mathewson, molten sodium and silver are miscible in all proportions, and the f.p. curve (Fig. 15) of the **sodium-silver alloys** has a single branch, although it is not certain if somewhere between 67 and 88 per cent. of silver there is not a separation into two liquid layers. There is probably a eutectic con-

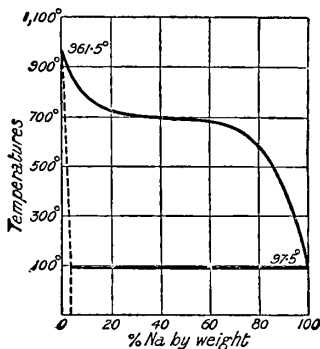

FIG. 15.—Freezing-point Curve of Sodium-Silver Alloys.

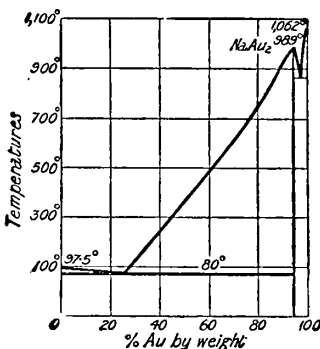

FIG. 16.—Freezing-point Curve of Sodium-Gold Alloys.

taining about 0.3 per cent. of silver, since G. Tammann found that the addition of this amount of silver lowered the f.p. of sodium 0.09°. This is represented in Fig. 15 by the area to the left of the dotted line. The little sodium which has been reported to be dissolved by silver in the crystalline state may be sodium which has been eutectically separated with the silver. Sodium dissolves virtually no silver in the solid state, for on cooling soln. of silver in sodium, octahedral crystals of silver are obtained. The equilibrium curve of **sodium-gold alloys** was found by C. H. Mathewson to show two eutectics (Fig. 16). The first eutectic with nearly 3.6 atomic per cent. of gold and f.p. at 80°; the second eutectic has a f.p. at about

970°; and there is a maximum in the f.p. curve at 989° corresponding with the formation of **sodium diauride**, NaAu_2 . C. Vickers studied the use of sodium as a deoxidizer for copper.

According to P. Berthier,² native silver may contain up to 10 per cent. of copper; and F. Field found the native copper of Coquimbo contained up to 7.6 per cent. of silver. W. Vernadsky also studied the native alloys of copper and silver. A. Levol, in his *Mémoires sur les alliages considérés sous le rapport de leur composition chimique*, stated that the two metals may be alloyed in all proportions, but only the alloy corresponding with Ag_3Cu is microscopically homogeneous; but F. Osmond showed that even *Levol's alloy* is not homogeneous, but a polished surface rather has the pearlitic structure characteristic of eutectics; alloys with more copper show copper crystals imbedded in the pearlitic mass under similar conditions, and alloys with more silver show crystals of that metal imbedded in the pearlitic mass. The segregation of these alloys was also noted by A. D. van Riemdyk, H. Hahn, W. von Lepkowsky, K. Bornemann, and A. Bock. Standard silver (7.5 per cent. copper) containing more silver than the eutectic becomes on solidification richer in silver in the interior than on the outside. The difference does not usually exceed one or two parts per 1000, and does not usually cause trouble. Attempts by G. Jars, W. C. Roberts-Austen, and F. Matthey to cast uniform ingots of standard silver have proved abortive. To impart soundness, and deoxidize any copper or silver oxide, it is customary to add about 0.5 per cent. of cadmium after the alloy is melted. The cadmium is nearly all eliminated before the metal is cast. T. K. Rose, F. Pannain, G. Tammann, and W. H. Walker studied the microstructure of coinage silver during annealing. The standard alloy is annealed rapidly at 670°, and T. K. Rose showed that softening begins about 230°; at 500° softening is completed in about half an hour; and in less than a minute at 600°. It melts at 890°. When a strip of copper is immersed in a soln. of silver nitrate F. Mylius and O. Fromm observed that a dark-coloured alloy of copper and silver is first deposited, and this soon decomposes, and finally a layer of crystalline silver is formed. S. Field studied the electro-deposition of a copper and silver alloy from a mixed soln. of potassium cyanocuprite, and cyanoargentite; G. Masing, the formation of alloys by compressing a mixture of the powdered metals at 4000 atm. press. W. Fränkel and H. Houben studied the diffusion of gold in a gold-silver alloy and found it to be 0.000037 sq. cm. per day at 870°.

The equilibrium curve of **copper-silver alloys** has been explored by C. T. Heycock and F. H. Neville, W. C. Roberts-Austen, W. von Lepkowsky, K. Friedrich

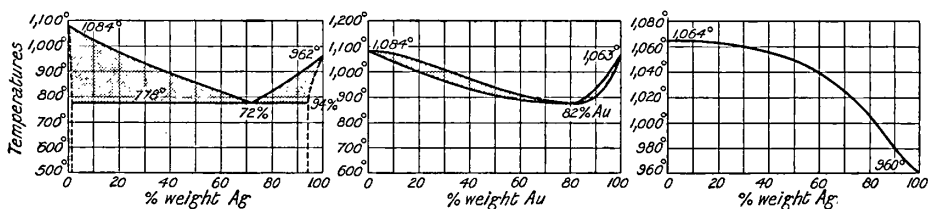

FIG. 17.—Freezing-point Curves of Copper-Silver Alloys. FIG. 18.—Freezing-point Curves of Copper-Gold Alloys. FIG. 19.—Freezing-point Curve of Gold-Silver Alloys.

and A. Leroux, and N. S. Kurnakoff. There is a eutectic with about 28.11 per cent. of copper at 778°–779°, and solid soln. are formed, as indicated in Fig. 17, represented respectively at the left and right of the dotted lines. F. C. Thompson and F. Sinkinson showed that the colour of the alloys is a linear function of the composition. K. Karmarsch studied the hardening and toughening of silver by alloying it with copper; N. S. Kurnakoff, N. Puschin, and N. Senkowsky, and T. K. Rose studied the hardness of the copper-silver alloys. According to E. A. Smith and H. Turner, the addition of copper to silver renders it harder and

better able to resist wear without sensibly impairing the malleability or ductility so that standard silver lends itself readily to rolling, stamping, spinning, and other mechanical operations employed in the manipulation of the metal in the arts. The plastic flow of a metal under press. is exemplified in the striking of coins whereby the metal is made to flow into the sunken portions of the die and so produce sharply defined impressions. T. K. Rose measured the hardness of standard silver at the successive stages of coinage. W. C. Roberts-Austen, and E. A. Smith and H. Turner measured some mechanical properties of some Cu-Ag alloys, including the tensile strength, compression, impact, and alternating bend test, see Table V, Cap. XXI. K. Karmarsch, and W. C. Roberts-Austen measured the sp. gr. of these alloys; E. Maey, the sp. vol.; the latter and also L. Weiller, N. S. Kurnakoff, N. Puschin, and N. Senkowsky, A. Matthiessen, and V. Strouhal and C. Barus, the electrical conductivity; and W. Meier, the refractive index, absorption coeff., extinction coeff., and the reflecting power. L. K. Oppitz also measured the optical properties of silver-copper alloys. D. Reichenstein showed that a silvered copper anode plate, in a conc. soln. of $KAgCy_2$, is not so readily polarized as a plate of amalgamated copper. When heated, A. Steinmann found that the surface is enriched in silver, and a film of copper oxide is formed which W. H. Walker showed can be avoided by heating the alloy in an inert gas. A. Sieverts showed that the absorption power of copper for hydrogen is scarcely influenced by alloying it with silver; and A. Sieverts and E. Bergner that the Cu-Ag alloy dissolves less sulphur dioxide than copper alone, and more than copper-gold or copper-platinum alloys. E. Pannain showed that an alloy of silver with one-sixth of copper is insoluble in dil. sulphuric acid. H. Moissan and T. Watanabe found that when the silver-copper alloy is heated in the electric furnace all but about 3 per cent. of the silver can be distilled from the copper. According to H. Rose, when the alloy is heated in air, only a small part of the copper is oxidized, but if a large excess of lead be added, the whole of the copper is oxidized by the cupel; and when fused with sodium chloride, cuprous chloride, but not silver chloride, is formed. According to W. R. Grove, nitric acid dissolves both metals, while a mixture of nitric acid with sulphuric acid acts slowly on copper, and serves to separate it from the silver. C. J. B. Karsten found that an alloy containing over 78 per cent. of silver has no action on silver nitrate, but if less silver be present, the silver nitrate is reduced, and this more rapidly as the proportion of copper increases. Curiously enough, not only is the excess of copper simultaneously dissolved during the precipitation, but the reaction continues even after the proportion of silver in the alloy exceeds 78 per cent.

Gold and copper readily form alloys which are redder, harder, and generally more fusible than the gold alone. C. Hatchett found that pure copper does not injure the ductility of gold, but that the gold becomes brittle if alloyed with copper containing lead or antimony. According to G. Bruni and D. Meneghini, the two elements unite to form a solid soln. if a gold wire is heated with copper below the m.p.; and M. le Blanc and L. Bergmann obtained the same result by heating the two elements under fused sodium hydroxide below the m.p. A. Levol stated that only certain **copper-gold alloys** can be obtained homogeneous, Au_3Cu , Au_4Cu , Au_2Cu , $AuCu$, and $AuCu_5$. R. Pearce³ reported the formation of compounds of the two elements, but the f.p. curves by E. Rudolf, E. Jänecke, N. S. Kurnakoff and S. F. Schemtschuschny, and C. T. Heycock and F. H. Neville give no evidence of chemical combination. These are typical U-shaped liquidus and solidus curves as indicated in Fig. 18, with the minimum near 883° with 82.9 per cent. of gold by weight. The British sovereign has 91.66 per cent. of gold, 7.48 per cent. of copper, and a small amount of silver. The electrical conductivity or electrical resistance, and the hardness curves of the alloys of gold and copper, if rapidly cooled by quenching, confirm, fairly well, the results deduced from the f.p. curve, but the case is altogether different when the results are made on annealed or slowly cooled alloys. The electrical conductivity (or resistance) curve shows sharp cusps corresponding with definite **copper aurides**, Cu_3Au and $CuAu$ —Table XI. Similar conclusions are

drawn from the curve representing the hardness of slowly cooled alloys—Table XI. It is therefore inferred that definite compounds are formed by the decomposition of an isomorphous mixture or solid soln. of the two elements. There are indications of similar transformations taking place in solidified amorphous mixture of iron and nickel, manganese and nickel, copper and manganese, manganese and cadmium, etc. The sp. gr. of cast alloys of gold and copper have been determined by C. Hatchett, W. C. Roberts-Austen, and C. Hoitsema :

Gold	100	91·7	75·0	58·3	25·0	0	per cent.
Sp. gr.	19·31	17·35	14·74	12·69	10·03	8·7	„

If the alloy has been worked by rolling or hammering, the sp. gr. is greater. The mixture of the two metals contracts on alloying.

TABLE XI.—HARDNESS AND ELECTRICAL CONDUCTIVITY OF GOLD-COPPER ALLOYS.

Atomic per cent.	Electrical $K \times 10^{-4}$.		Brinell's Hardness.	
	Quenched.	Annealed.	Quenched.	Annealed.
0	58·83	58·83	35·30	35·3
10	13·51	13·80	54·50	51·9
20	8·55	9·26	54·35	60·1
25	8·07	17·66	60·45	44·2
35	6·33	6·75	64·52	109·5
50	6·61	17·75	115·40	126·3
70	7·06	6·65	83·10	81·1
100	31·81	31·81	18·64	18·6

P. van Muschenbroeck, C. Hatchett, N. Kurnakoff and S. F. Schemtschuschny have determined the hardness of these alloys ; A. Portevin and J. Durand found the Brinell hardness rises to a maximum, and the force required to break a notched bar falls to a minimum with an alloy containing 20 per cent. of copper. The brittleness disappears on tempering at 400° owing to a transformation accompanied by an abrupt expansion. An alloy with 25·2 per cent. of copper, annealed at 700°, contracts when heated, and suddenly expands near 400°, it again contracts up to about 600°. An inverse curve is obtained by cooling, but the sudden change occurs at 350° when the heating and cooling curves intersect. W. C. Roberts-Austen and F. Osmond have measured the tensile strength and elongation of a few alloys ; E. Nernst and F. A. Lindemann, and L. Rolla, the sp. ht. ; and A. Matthiessen and E. Rudolphi, and A. L. Feild, the electrical conductivity. A. Sieverts found gold lowered the absorptive power of copper for hydrogen. Similarly, A. Sieverts and E. Bergner found gold-copper alloys dissolve less sulphur dioxide than copper or copper-silver alloys, and more than platinum-copper alloys. G. Tammann has also studied the galvanic polarization and the action of reagents on gold-copper alloys. R. Lorenz and co-workers studied the discharge potentials of the alloys. According to H. Moissan, copper first distills from the gold when the alloy is heated in the electric furnace. Copper cannot be completely separated from the alloy by calcining it in air, nor by cupellation with a large proportion of lead ; when a triple weight of silver and a 24-fold excess of lead are simultaneously added to the gold-copper alloy, the whole of the copper can be absorbed by the cupel as copper and lead oxide. According to J. MacCulloch, copper may be superficially dissolved from the alloy by heating it with aq. ammonia ; and alloys tarnished with cupric oxide may be cleansed by this reagent. G. Tammann studied the electrochemical behaviour of gold-copper alloys ; he found that rolled or hammered alloys are more chemically active than annealed alloys.

Gold readily alloys with silver in all proportions, and the resulting products

are harder, more fusible, and more sonorous than gold. As the proportion of silver increases, the colour of the alloy passes quickly through a pale greenish-yellow to white. J. Fournet⁴ welded gold and silver powders by Wollaston's process for platinum, and obtained a damasked metal, with a true alloy at the surfaces of contact, thus showing that the metals are capable of uniting at a temp. below their m.p. Alloys were made by M. le Blanc and L. Bergmann, and by G. Bruni and D. Meneghini by a method similar to that employed for copper-gold alloys, and at a temp. below the m.p. of either component. A. Bock noted that if a bar be broken, the interior is paler than the exterior, showing that gold tends to segregate and accumulate near the exterior. Native **gold-silver alloys** are represented by auriferous silver, argentiferous gold, and electrum. The proportions are very variable, and the native alloys are therefore very diverse in colour and sp. gr.; but they have the same crystalline form as the parent metals. J. B. J. D. Boussingault assumed that the two elements occur in definite stoichiometrical proportions in his analysis of Columbian ores, but G. Rose has shown that this assumption is not in accord with facts. Analyses have been reported of specimens from different parts of the world made by many workers. S. Field studied the electro-deposition of gold-silver alloys.

Determinations of the f.p. have been made by W. C. Roberts-Austen and T. K. Rose,⁵ C. T. Heycock and F. H. Neville, E. Jänecke, G. Bruni and D. Meneghini, U. Raydt, C. H. Mathews, A. Gautier, and T. Erhard and A. Schertel. The f.p. curve of silver-gold alloys lies entirely between the f.p. of the pure metals, Fig. 19. There is a continuous curve with what might prove to be an ill-defined minimum representing a continuous series of mixed crystals, but no compound. The m.p. of an alloy with less than 5 per cent. of silver is virtually the same as that of pure gold; further additions up to 35 per cent. of silver have very little effect, since the 35 per cent. alloy melts but 3° below the temp. of melting gold; with further additions of silver there is a more rapid decrease in the m.p. of the alloy. G. Tammann has studied the space lattice of mixed crystals of gold and silver. C. Hatchett showed that the sp. gr. of silver-gold alloys differs very little from the values calculated from the sp. gr. of the constituent elements. The sp. gr. of alloys of these two metals has been determined by W. C. Roberts-Austen, and C. Hoitsema:

Gold	.	.	100	91.6	75.0	50.0	25.0	16.7	0	per cent.
Sp. gr.	.	.	19.31	18.04	16.03	13.60	11.78	11.28	10.47	„

The sp. vol. of the silver-gold alloys was determined by E. Maey and C. Hoitsema; by W. C. Roberts-Austen and F. Osmond, the tensile strength and elongation; the hardness, by C. Hatchett, P. von Muschenbroeck, N. S. Kurnakoff and S. F. Schemtschuschny, and E. Rudolf; by W. Nernst and F. A. Lindemann, and L. Rolla, the sp. ht.; by A. Matthiessen, V. Strouhal and C. Barus, E. Rudolf, A. L. Feild, and N. S. Kurnakoff and S. F. Schemtschuschny, the electrical conductivity; by G. Tammann, the galvanic polarization; and by E. Rudolf, the e.m.f. of the thermo-electric couple. Again, A. Sieverts found the solubility of oxygen in any particular alloy decreases with temp.; and for any given temp., it decreases with increasing proportions of gold. G. Rose and A. Levol noted the spitting of alloys with a preponderating proportion of silver. G. Tammann found that rolled and hammered alloys are more chemically active than annealed alloys. According to M. Hanriot, nitric acid dissolves all the silver from alloys with over 60 per cent. of silver, and gold with about 0.1 per cent. of silver remains behind; alloys with less than 60 per cent. of silver have a residue with a greater amount of this metal. Alloys with less than 50 per cent. of silver are difficult to dissolve in nitric acid and should be melted with more silver if they are to be parted with this acid—*vide* allotropic gold. W. B. Pollard has investigated the action of aqua regia on gold-silver alloys in the presence of ammonium salts and obtained indications of the formation of purple-brown crystals, $3\text{AgCl}\cdot 4\text{AuCl}_3\cdot 8\text{NH}_4\text{Cl}$, which decompose when water is added. G. Tammann has studied the action of reagents on gold-silver alloys. Alloys of

silver and gold have long been used for jewellery and coins. The pale-coloured *electrum* has from 15 to 35 per cent. of silver. Coins of *electrum* were struck about 720 B.C. in Ægina, and a little later in Lydia; these coins were supposed to be three-quarters the value of pure gold coins.

Gold and *electrum* coins were hardened by the addition of copper a few years before the Christian era. C. Hatchett⁶ made some observations on the ternary gold-silver-copper alloys. E. Jänecke studied the thermal properties of the same alloys, and his results are shown in Fig. 20, arranged in isothermic lines. The curve *CBD* indicates the region where mixed crystals are formed; within that region two layers are formed. There is a minimum line passing from that of the binary eutectic of copper and gold, to the binary eutectic of copper and silver. The eutectic line passes from *E* to *A* in the diagram. The point *A* (42.5Cu, 36.5Ag, 21.0Au) represents a liquid mixture which is in equilibrium with a definite solid mixture, which is represented by *B* (42.5Cu, 33.5Ag, 24.0Au). The alloys were also studied microscopically.

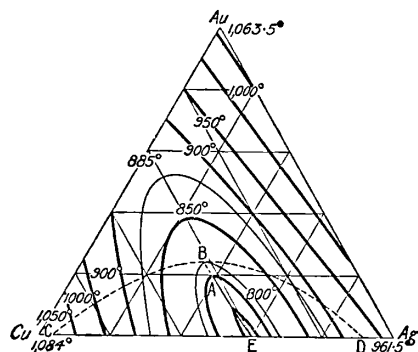

FIG. 20.—Isothermic Lines of Ternary Alloys of Copper-Silver-Gold.

resents a liquid mixture which is in equilibrium with a definite solid mixture, which is represented by *B* (42.5Cu, 33.5Ag, 24.0Au). The alloys were also studied microscopically.

REFERENCES.

- ¹ H. Davy, *Phil. Trans.*, **98**, 1, 333, 1808; C. J. B. Karsten, *System der Metallurgie*, Berlin, 1831; G. S. Sérullas, *Ann. Chim. Phys.*, (2), **21**, 199, 1822; H. Behrens, *Das mikroskopische Gefüge der Metalle und Legierungen*, Hamburg, 1894; C. H. Mathewson, *Internat. Journ. Metallog.*, **1**, 51, 81, 1911; E. Quercigh, *Zeit. anorg. Chem.*, **68**, 301, 1908; G. Tammann, *Zeit. phys. Chem.*, **3**, 441, 1839; C. Vickers, *Trans. Amer. Electrochem. Soc.*, **40**, 1921.
- ² W. Vernadsky, *Centr. Min.*, **760**, 1912; P. Berthier, *Ann. Mines*, (1), **11**, 72, 1825; *Traité des essais par la voie sèche*, Liège, **2**, 680, 1847; F. Field, *Journ. Chem. Soc.*, **3**, 29, 1851; A. Levöl, *Ann. Chim. Phys.*, (3), **36**, 193, 1852; (3), **39**, 163, 1853; F. Osmond, *Compt. Rend.*, **124**, 1094, 1234, 1897; A. D. van Riemsdyk, *Arch. Néerl.*, **3**, 357, 1868; *Chem. News*, **20**, 32, 1869; A. Bock, *Chem. Ztg.*, **29**, 1199, 1906; H. Hahn, *Berg. Hütt. Ztg.*, **29**, 65, 1870; F. Mylius and O. Fromm, *Ber.*, **27**, 630, 1894; K. Karmarsch, *Dingler's Journ.*, **226**, 335, 1877; L. Weiller, *ib.*, **253**, 134, 1884; E. Maey, *Zeit. phys. Chem.*, **38**, 295, 1901; A. Sieverts and E. Bergner, *ib.*, **82**, 257, 1913; C. Barus and V. Strouhal, *Abh. Böhm. Ges.*, **12**, 15, 1884; E. Pannain, *Atti Accad. Lincei*, (5), **13**, i, 523, 700, 1909; N. S. Kurnakoff, N. Puschin, and N. Senkowsky, *Journ. Russ. Phys. Chem. Soc.*, **42**, 733, 1910; *Zeit. anorg. Chem.*, **68**, 136, 1910; G. Tammann, *Gött. Natur.*, **181**, 1911; K. Bornemann, *Met.*, **6**, 246, 1909; W. Meier, *Ann. Physik*, (4), **31**, 1034, 1910; A. Steinmann, *Ann. Chim. Anal.*, **16**, 165, 1911; D. Reichenstein, *Zeit. Elektrochem.*, **19**, 528, 1913; A. Sieverts, *ib.*, **16**, 711, 1919; S. Field, *ib.*, **17**, 61, 1911; *Trans. Faraday Soc.*, **6**, 5, 1910; W. H. Walker, *Journ. Amer. Chem. Soc.*, **29**, 1198, 1907; C. T. Heycock and F. H. Neville, *Phil. Trans.*, **189**, A, 25, 1897; K. Friedrich and A. Leroux, *Met.*, **4**, 297, 1907; W. von Lepkowsky, *Zeit. anorg. Chem.*, **59**, 289, 1908; G. Masing, *ib.*, **62**, 270, 1909; N. S. Kurnakoff, *ib.*, **68**, 123, 1910; E. A. Smith and H. Turner, *Journ. Inst. Metals*, **22**, 149, 1909; T. K. Rose, *ib.*, **8**, 86, 1912; *Rep. Roy. Mint*, **42**, 107, 1911; **33**, 68, 1902; L. K. Oppitz, *Phys. Rev.*, (2), **10**, 156, 1917; A. Matthiessen, *Phil. Trans.*, **150**, 161, 1860; W. C. Roberts-Austen, *Rep. Roy. Mint*, **4**, 38, 1873; **13**, 69, 1899; *Proc. Mech. Eng.*, **555**, 1891; E. Matthey, *Proc. Roy. Soc.*, **55**, 265, 1894; **73**, 124, 1904; G. Jars, *Voyages métallurgiques*, Paris, **3**, 269, 1781; R. A. Hill and W. C. Roberts-Austen, *Rep. Roy. Mint*, **14**, 45, 1883; H. Rose, *Pogg. Ann.*, **68**, 290, 1846; F. C. Thompson and E. Sinkinson, *Chem. World*, **3**, 132, 1914; H. Moissan and T. Watanabe, *Compt. Rend.*, **144**, 16, 1907; W. R. Grove, *Phil. Mag.*, (3), **15**, 292, 1839; C. J. B. Karsten, *Journ. prakt. Chem.*, (1), **16**, 379, 1839; W. Fränkel and H. Houben, *Zeit. anorg. Chem.*, **116**, 1, 1921; T. K. Rose, *Journ. Inst. Metals*, **8**, 86, 1912.
- ³ R. Pearce, *Trans. Amer. Inst. Min. Eng.*, **13**, 738, 1884-5; N. S. Kurnakoff and S. F. Sehmetschusehny, *Zeit. anorg. Chem.*, **54**, 149, 1907; **60**, 13, 1908; N. S. Kurnakoff, N. Puschin, and N. Senkowsky, *Journ. Russ. Phys. Chem. Soc.*, **42**, 733, 1910; *Zeit. anorg. Chem.*, **68**, 136, 1910; E. Rudolf, *ib.*, **67**, 88, 1910; C. Hoitsemä, *ib.*, **41**, 63, 1904; N. S. Kurnakoff, S. F. Sehmetschusehny, and M. Schaschateleff, *Journ. Inst. Metals*, **15**, 305, 1916; E. Jänecke, *Met.*, **8**, 597, 1911; A. Levöl, *Ann. Chim. Phys.*, (3), **36**, 193, 1852; (3), **39**, 163, 1853; W. C. Roberts-Austen and T. K. Rose, *Chem. News*, **87**, 2, 1903; *Proc. Roy. S. c.*, **67**, 105, 1901;

W. C. Roberts-Austen, *ib.*, 23. 481, 1873; *Ann. Chim. Phys.*, (5), 13. 118, 1878; *Phil. Trans.*, 179. A, 344, 1888; W. C. Roberts-Austen and F. Osmond, *Bull. Soc. d'Enc.*, (5), 1. 1137, 1896; J. MacCulloch, *Edin. Journ. Science*, 1. 75, 1824; A. Portevin and J. Durand, *Rev. Mét.*, 16. 149, 1919; *Compt. Rend.*, 172. 325, 1921; A. Matthiessen, *Pogg. Ann.*, 110. 190, 1860; H. Moissan, *Compt. Rend.*, 141. 977, 1905; P. van Muschenbroeck, *Phil. Trans.*, 33. 370, 1726; C. Hatchett, *ib.*, 93. 43, 1803; E. Maey, *Zeit. phys. Chem.*, 38. 295, 1901; A. Sieverts and E. Bergner, *ib.*, 82. 257, 1913; A. Sieverts, *Zeit. Elektrochem.*, 16. 711, 1910; W. Nernst and F. A. Lindemann, *ib.*, 17. 817, 1911; L. Rolla, *Atti Accad. Lincei*, (5), 23. i, 616, 1914; G. Bruni and D. Meneghini, *ib.*, (5), 20. i, 928, 1911; *Internat. Zeit. Metallog.*, 2. 26, 1911; M. le Blanc and L. Bergmann, *Ber.*, 42. 4728, 1909; G. Tammann, *Gött. Nachr.*, 199, 1916; 351, 1918; *Zeit. anorg. Chem.*, 107. 1, 1919; 112. 233, 1920; 118. 48, 1921; R. Lorenz, W. Fränkel, and M. Wormser, *ib.*, 118. 231, 1921; A. L. Feild, *Met. Chem. Eng.*, 21. 566, 1919

* J. B. J. D. Boussingault, *Ann. Chim. Phys.*, (2), 34. 408, 1823; A. Levoll, *ib.*, (2), 27. 310, 1824; J. Fournet, *ib.*, (1), 75. 435, 1810; G. Tammann, *Zeit. anorg. Chem.*, 112. 233, 1920; *Gött. Nachr.*, 351, 1918; G. Bruni and D. Meneghini, *Atti Accad. Lincei*, (5), 20. i, 616, 1914; *Internat. Zeit. Metallog.*, 2. 26, 1911; T. Hiortdahl, *Compt. Rend.*, 67. 722, 1868; A. Terreil, *ib.*, 59. 1047, 1864; L. E. Rivot, *Ann. Mines*, (4), 14. 67, 1848; M. Avdeeff, *Pogg. Ann.*, 53. 153, 1841; G. Rose, *ib.*, 23. 161, 1831; D. Forbes, *Phil. Mag.*, (4), 29. 129, 1865; (4), 30. 142, 1865; (4), 34. 340, 1867; (4), 37. 321, 1869; A. B. Northcote, *ib.*, (4), 6. 390, 1853; A. D. Thomas, (4), 1. 261, 1851; W. Mallet, *Phil. Mag.*, 37. 393, 1850; E. T. Teschemacher, *Journ. Chem. Soc.*, 2. 193, 1849; G. Fordyce, *Phil. Trans.*, 66. 523, 1776; A. W. Hofmann, *Liebig's Ann.*, 70. 255, 1849; F. A. Genth, *Amer. Journ. Science*, (2), 45. 31, 1868; T. S. Hunt, *ib.*, (2), 20. 448, 1855; O. C. Marsh, *ib.*, (2), 33. 190, 1862; H. Ludwig, *Arch. Pharm.*, (2), 98. 142, 1859; W. B. Clarke, *Researches in the Southern Gold Fields of New South Wales*, Sydney, 276, 1860; F. J. Williams, *Chem. News*, 21. 84, 1870; T. L. Phipson, *ib.*, 24. 99, 1871; B. Kerl, *Berg. Hütt. Ztg.*, 12. 38, 1853; F. W. Clarke, *Bull. U.S. Geol. Sur.*, 419. 241, 1910; J. Ssamoiloff, *Neues Jahrb. Min.*, ii, 353, 1907; W. Vernadsky, *Centr. Min.*, 760, 1912; S. Field, *Metal Ind.*, 17. 502, 1920; A. L. Feild, *Met. Chem. Eng.*, 21. 566, 1919; A. Bock, *Chem. Ztg.*, 29. 1199, 1905.

* W. C. Roberts-Austen, *Phil. Mag.*, (5), 8. 57, 551, 1879; *Phil. Trans.*, 179. A, 344, 1888; W. C. Roberts-Austen and F. Osmond, *Bull. Soc. d'Enc.*, (5), 1. 1137, 1896; W. C. Roberts-Austen and T. K. Rose, *Chem. News*, 87. 1, 1903; C. T. Heycock and F. H. Neville, *Phil. Trans.*, 189. A, 69, 1897; U. Raydt, *Zeit. anorg. Chem.*, 75. 60, 1912; L. Rudolff, *ib.*, 67. 88, 1910; C. Hoitsema, *ib.*, 41. 63, 1904; N. S. Kurnakoff and S. F. Schemtschuschny, *ib.*, 60. 1, 1908; L. Rolla, *Atti Accad. Lincei*, (5), 23. i, 616, 1914; G. Bruni and D. Meneghini, *ib.*, (5), 20. i, 928, 1911; E. Jänecke, *Zeit. angew. Chem.*, 25. 937, 1912; *Met.*, 8. 599, 1911; *Zeit. phys. Chem.*, 67. 669, 1909; E. Maey, *ib.*, 68. 295, 1910; T. Erhard and A. Schertel, *Jahrb. Sachsen*, 164, 1879; A. Gautier, *Bull. Soc. d'Enc.*, (5), 1. 1318, 1896; W. Nernst and F. A. Lindemann, *Zeit. Elektrochem.*, 17. 817, 1911; A. Sieverts, *ib.*, 16. 710, 1910; M. Hanriot, *Compt. Rend.*, 151. 1355, 1910; *Bull. Soc. Chim.*, (4), 9. 140, 1911; M. le Blanc and L. Bergmann, *Ber.*, 42. 4728, 1909; A. Levoll, *Compt. Rend.*, 35. 63, 1852; *Ann. Chim. Phys.*, (3), 39. 163, 1853; J. Fournet, *ib.*, (1), 75. 435, 1810; V. Strouhal and C. Barus, *Abh. Böhm. Ges.*, 12. 14, 1885; A. Matthiessen, *Pogg. Ann.*, 110. 21, 1860; 112. 107, 1861; *Phil. Mag.*, (4), 21. 107, 1861; A. Bock, *Chem. Ztg.*, 29. 1199, 1905; G. Rose, *Pogg. Ann.*, 23. 181, 1831; P. von Muschenbroeck, *Phil. Trans.*, 33. 370, 1726; C. Hatchett, *ib.*, 93. 43, 1803; C. H. Mathews, *Internat. Journ. Metallog.*, 1. 51, 81, 1911; G. Tammann, *Gött. Nachr.*, 199, 1916; 265, 385, 1917; 190, 1918; *Zeit. anorg. Chem.*, 107. 1, 1919; 112. 233, 1920; 114. 281, 1920; W. B. Pollard, *Journ. Chem. Soc.*, 117. 99, 1920.

* C. Hatchett, *Phil. Trans.*, 93. 45, 1803; E. Jänecke, *Met.*, 8. 597, 1911.

§ 14. The Oxides and Hydroxides of Gold

Gold does not unite directly with oxygen. There are two well-recognized oxides of gold—aurous oxide, or gold monoxide, Au_2O , and auric oxide, or gold trioxide, Au_2O_3 , which are derived from the corresponding halogen salts; and another, auroso-auric oxide, or gold dioxide, $(\text{AuO})_n$, is generally regarded as a chemical individual although the evidence is not so satisfactory. It is possible that gold is a monad in aurous oxide; a dyad in aurosoauric oxide; and a triad in auric oxide. The distinction between the hydroxides and the anhydrous oxides in the published records is by no means always clear. Aurous oxide acts as a weak basic oxide, forming aurous salts, and possibly also as a very weak acidic oxide, forming aurites, MAuO . Auric oxide acts as an acidic oxide towards the strong bases, forming a series of salts—called aurates, MAuO_2 ; it also acts as a weak basic oxide, forming auric salts with the acids. It is doubtful if gold tetroxide, Au_2O_4 , or the "gold dioxide" of J. P. Prat, and gold pentoxide, Au_2O_5 , or the "perauric acid" of L. G. Figuier, can

be regarded as homogeneous compounds. What was formerly known as *purple oxide of gold* has proved to be nothing more than finely divided gold—*vide* colloidal gold.

Gold monoxide or aurous oxide, Au₂O.—J. J. Berzelius¹ first prepared this oxide in 1811, by the action of a cold dil. soln. of potassium hydroxide on the aurous chloride, which he had discovered. It was called *gold suboxide* and *protoxyde d'or*. G. Krüss warmed aurous bromide with potassium hydroxide and obtained a dark violet precipitate of *aurous hydroxide*, AuOH. According to L. G. Figuier, the product is contaminated with a comparatively large amount of metal, if, as prescribed by J. J. Berzelius, the aurous chloride is prepared at 210°; but if the latter be prepared at 150°, the aurous oxide is pure. L. G. Figuier also precipitated aurous oxide by treating a neutral dil. soln. of gold trichloride with mercurous nitrate: $2\text{AuCl}_3 + 4\text{HgNO}_3 + \text{H}_2\text{O} = \text{Au}_2\text{O} + 3\text{HgCl}_2 + \text{Hg}(\text{NO}_3)_2 + 2\text{HNO}_3$; if an excess of the precipitant is employed, the precipitate is contaminated with mercurous chloride. Aurous oxide was also obtained by mixing auric chloride with an excess of potassium hydroxide, and boiling the soln. with alkali tartrate, citrate, acetate, or other organic salt. If the soln. is neutral or acidic, metallic gold is precipitated. L. G. Figuier reduced auric chloride to aurous oxide by boiling the soln. for a long time with alkali hydroxide, alkali carbonate, or hydrocarbonate or with acetic acid. The non-evolution of oxygen led L. G. Figuier to suggest that a higher gold oxide is simultaneously formed. He also obtained aurous oxide by the prolonged boiling of a soln. of potassium aurate; and F. Meyer heated a soln. of alkali aurate. According to E. Frémy, the black product with alkali hydroxide is not aurous oxide at all, but rather the finely divided metal, and its formation arises from the accidental presence of organic substances, or more generally from the decomposition of a certain quantity of aurous chloride which is mixed with the trichloride, and is converted by the action of the alkali into metallic gold and the alkali aurate. J. P. Prat, and P. Schottländer obtained what they regarded as *aurous hydroxide*, the former by warming a soln. of gold chloride with potassium hydroxide, the latter by decomposing the sulphate, AuSO₄, with water and drying at 100°. G. Krüss' preparation, and the product obtained by L. G. Figuier by the mercurous nitrate process, were regarded as hydroxides.

The analyses of L. G. Figuier, and G. Krüss correspond with what is required for Au₂O. According to the latter, the moist precipitate is dark violet, the dry powder is greyish-violet, and it loses water not oxygen when heated up to 200°. The evolution of oxygen begins between 205° and 210°, and is complete at 250°. According to L. G. Figuier, the dried product is insoluble and stable towards water and alcohol, while G. Krüss said the freshly precipitated oxide is "soluble" in water, forming an indigo-blue soln. with a brown fluorescence, which, according to L. Vanino, is *colloidal aurous oxide*. When the colloidal soln. is boiled, or treated with a salt, or allowed to stand for many days, the dark violet oxide is re-precipitated. H. Vogel and G. Krüss measured the absorption spectrum of the indigo-blue soln., and found the maximum absorption between $\lambda = 586.5$ and 587.5 . J. J. Berzelius found the oxide to be slightly soluble in a soln. of potassium hydroxide, and he considered that the soln. contained *potassium aurate*, AuOK. J. J. Berzelius also said the oxide he prepared was decomposed by long contact with a soln. of potassium hydroxide, forming dark brown auric oxide and metallic gold which gilded the vessel; he also said that his oxide did not combine with acids; L. G. Figuier said his oxide did combine with acids and also with the alkalies. Hence, it is obvious that two investigators worked with different products—J. J. Berzelius' oxide was probably a mixture of metallic gold and aurous oxide. According to E. Frémy, when the alkaline soln. is conc. it decomposes into gold and alkali aurate. L. G. Figuier found that hydrochloric or hydrobromic acids convert the oxide respectively into hydrochloroauric or hydrobromoauric acid; hydriodic acid forms aurous iodide, and when the soln. is boiled, gold and iodine separate. Aqua regia readily dissolves aurous oxide, forming auric chloride; but the oxide is not acted on by sulphuric,

nitric, or acetic acid. According to F. Raschig, when aurous oxide is triturated with aq. ammonia a violet product is obtained which is less explosive than fulminating gold; it has the composition $\text{NAu}_3\text{.NH}_3$, and is not very explosive.

Gold dioxide or aurosaucic oxide, Au_2O_2 , or $(\text{AuO})_n$.—A hydrated product was obtained by J. P. Prat by dissolving gold in a quantity of aqua regia insufficient for its complete dissolution, and containing an excess of hydrochloric acid; the soln. was then heated with potassium hydrocarbonate until the precipitate first formed redissolved. When the orange-yellow filtrate is heated to 55° , it begins to appear turbid, at 60° it becomes pale green, and at 65° – 95° a dark olive-green hydrate separates. The product loses its water in air and becomes almost black; it is completely decomposed when heated to 250° . It dissolves in hydrochloric acid, forming a dark green soln.; dil. hydrofluoric acid gives an insoluble mass; and conc. sulphuric acid unites with aurosaucic oxide especially when heated. According to F. Raschig, aq. ammonia forms a compound with the composition $\text{Au}_3\text{N}_2\text{.5H}_2\text{O}$, related to fulminating gold. G. Krüss prepared an oxide of the same composition, by gradually heating pure auric hydroxide up to 160° until the weight remained constant. It is a fine dark yellowish-brown, is very hygroscopic, and can be kept only over phosphoric anhydride. When heated above 173° , it gives off oxygen. W. L. Dudley prepared this oxide by heating auric oxide, Au_2O_3 , to 160° . W. G. Mixer was unable to verify these results. P. Schottländer obtained *hydrated aurosaucic oxide*, $3\text{Au}_2\text{O}_2\text{.2H}_2\text{O}$, or $\text{Au}_3\text{O}_2(\text{OH})_2$, or $3\text{AuO.H}_2\text{O}$, by the decomposition of the sulphate AuSO_4 by water. The properties of this hydrate do not agree with those of J. P. Prat's oxide. It forms a crystalline black powder, which is not acted on by boiling potash soln., whilst hydrochloric acid or nitric acid decomposes it into metallic gold and trioxide, the latter dissolving and forming a salt. Mercury removes no gold from this oxide. P. Schottländer is of the opinion that the gold acts as a true dyad, analogous to mercury, and is not to be regarded as a combination of monadic and triadic gold. If this hypothesis be correct, the inadequacy of the nomenclature is at once apparent, and a modification is necessary—possibly on the lines indicated by A. Werner.

J. P. Prat claimed to have made what was called *gold dioxide*, Au_2O_4 , that is *gold tetroxide*, by dissolving gold in aqua regia containing an excess of nitric acid, and saturating the liquid with potassium hydrocarbonate. When the liquid is warmed an orange-yellow powder is precipitated. This is stable in light, but when heated towards 200° , it loses its oxygen. G. Krüss assumes that J. P. Prat here made auryl hydroxide, and not the alleged dioxide.

L. G. Figuier prepared a soln. of what he called *acide peraurique*, or *gold pentoxide*, Au_2O_5 , by boiling auric oxide for a long time with a soln. of potassium hydroxide, whereby aurous oxide is precipitated, without the evolution of a gas, and potassium peraurate with a little aurate is formed. If sulphuric or nitric acid is added, some auric oxide is precipitated; there is an evolution of a little carbon dioxide, but not of oxygen. The bright yellow filtered liquid is decomposed in a few seconds at 60° – 65° , becoming green and turbid, and depositing gold accompanied with the evolution of a little gas. L. G. Figuier added further that if a neutral soln. of auric chloride be boiled with an excess of potassium hydroxide until a considerable proportion of aurous oxide has separated, and then mixed first with barium chloride and then with baryta water, a yellow precipitate is first deposited, and afterwards a green one. If the latter be treated with sulphuric acid, auric oxide mixed with barium sulphate remains, and the liquid contains *acide peraurique*, J. J. Berzelius made this comment: "The verity of Figuier's results depends on whether or not he worked with alkali absolutely free from organic matter." G. Krüss could not confirm L. G. Figuier's results.

Gold trioxide or auric oxide, Au_2O_3 .—It was known to the mediæval alchemists that a precipitate called the *calx of gold*, is obtained when a soln. of gold in aqua regia is treated with sodium hydroxide. The precipitation was described by T. Bergmann at the end of the eighteenth century in his memoir *De præcipitatis metallicis*; while J. L. Proust,² and L. N. Vauquelin also prepared an oxide in a similar way; and A. Oberkampf showed that the product is *un peroxyd d'or*, Au_2O_3 . The product obtained by precipitation is **auric hydroxide**, $\text{Au}(\text{OH})_3$, or $\text{Au}_2\text{O}_3\text{.3H}_2\text{O}$;

and, according to G. C. Wittstein, when this is dried over calcium chloride at 100° , or, according to P. Schottländer, when it is heated to 205° , the water is expelled, and the anhydrous oxide, Au_2O_3 , is formed—*vide infra*. G. Krüss says that the intermediate hydrate, $Au_2O_3 \cdot H_2O$, or $Au_2O_3(OH)_2$, or $AuO \cdot OH$, *auryl hydroxide*, is formed by drying the normal hydroxide, $Au(OH)_3$, for a week over phosphorus pentoxide. P. Schottländer also found nitric acid of sp. gr. 1.4 transformed the aurosoauric hydroxide, $Au_3O_2(OH)_2$, into gold and auryl hydroxide, $AuO(OH)$. While in aurous oxide, gold acts as a monad, and in auric oxide as a triad.

A. Oberkampf mixed a neutral soln. of auric chloride with less than an eq. of alkali hydroxide, and obtained a yellow precipitate which he regarded as *basic auric chloride*, since it formed a chloride with potassium hydroxide, and was thereby converted into black auric oxide; but J. Pelletier showed that A. Oberkampf's basic oxide was really auric oxide contaminated with auric chloride, since the latter may be washed out by boiling water and nitric acid. L. N. Vauquelin obtained a reddish-yellow precipitate by treating a soln. of gold in aqua regia with potassium hydroxide or carbonate; and J. Pelletier also regarded this as a mixture of auric oxide mixed possibly with potassium aurate. When an excess of potassium hydroxide was used for the precipitation of a hot neutral soln. of auric chloride, A. Oberkampf obtained brownish-black auric oxide, contaminated, according to J. Pelletier, with a little alkali. J. Thomsen mixed a soln. of one mol of auric chloride with three mols of sodium hydroxide and added some sodium sulphate to hasten the sedimentation of the precipitate. P. Schottländer showed that the resulting precipitate is contaminated with alkali which cannot be removed by washing. L. G. Figuier boiled a neutral soln. of auric chloride sat. with sodium carbonate so long as a precipitate was formed. To decolorize the filtrate completely, it was supersaturated with sodium carbonate and neutralized with hot sulphuric acid. L. G. Figuier added potassium hydroxide to a neutral soln. of auric chloride until the liquid was strongly alkaline; he then added barium chloride until the yellow precipitate of barium aurate acquired a whitish colour. The barium aurate was then decomposed with nitric acid, which removed the barium; the residue was well washed and dried in the dark. J. B. A. Dumas employed a somewhat similar process, but boiled the auric chloride with baryta water. J. Pelletier remarked on the difficulty of removing all the barium from the precipitated barium aurate, and he recommended the use of an excess of magnesia or zinc oxide instead of baryta water. C. Wittstein, G. Krüss, and V. Lenher recommended the magnesia process. E. Frémy recommended the following process:

By adding to the soln. of auric chloride a sufficient quantity of potassium hydroxide to redissolve the precipitate first produced, boiling for a quarter of an hour, whereupon the liquid which is at first dark brown, gradually assumes a yellow tint—then adding sulphuric acid in slight excess—collecting the resulting precipitate on a filter, and washing it with water, till the wash-water no longer gives a precipitate with barium salts, auric oxide is formed. The first addition of the potassium hydroxide converts the auric chloride into an oxychloride, which then forms a soluble compound with the potassium hydroxide; if the soln. be treated with an acid without previous boiling, a precipitate is obtained consisting of the oxychloride, which may be distinguished from the auric oxide by dissolving slowly, but completely, in pure water. It is only by continued boiling that the compound of the oxychloride with potassium hydroxide is converted into the aurate of potassium, the conversion being attended with the change of colour above noticed. The auric oxide obtained in the manner just described is not quite free from potassium hydroxide, even after long-continued washing. It may be purified completely by treating it with very strong nitric acid, which dissolves it readily—mixing the soln. with water, which immediately precipitates the auric oxide—and washing the precipitate thoroughly with pure water.

P. Schottländer obtained auric oxide by the action on auryl nitrate or sulphate; and by dissolving gold in sulphuric acid mixed with manganese dioxide at 250° and decomposing the cold soln. with water. A good method of preparing auric oxide is to electrolyze a dil. soln. of nitric acid with a gold anode in a porous cell. The yellow liquid is decomposed with water as indicated in describing the action

of nitric acid on gold. F. Meyer added precipitated gold to sodium peroxide melted in a nickel crucible, and raised the temp. to bright redness for ten minutes; leached the cold mass with water; filtered off the nickel oxide and the excess of gold; treated the green filtrate, a soln. of sodium aurate with dil. sulphuric acid, and dried the washed product in vacuo in darkness. In the electrolysis of dil. sulphuric acid with gold electrodes, A. Rundspaden found that the anode was covered with a thick yellowish-red crust of auric hydroxide. W. G. Mixer also prepared auric oxide by making gold the anode in an electrolyte—with potassium sulphate as an electrolyte, the auric hydroxide retains some potassium presumably as aurate; and with sulphuric acid as electrolyte, the deposit contains some basic sulphate which is not removed by cold water.

Auric hydroxide is a brownish-black powder, and, according to L. G. Figuiet, that which is precipitated by conc. acid from potassium aurate is olive-green inclining to black, while that precipitated by acids of medium conc. is dark yellow, and he found that when dried under reduced press. or in dry air, it contained 24 per cent. of water—when $\text{Au}_2\text{O}_3 \cdot 8\text{H}_2\text{O}$ corresponds with 24.6 per cent.; while G. C. Wittstein found that the hydrate precipitated by baryta water contained 11.1 per cent. of water, when dried over calcium chloride in vacuo—the theoretical value for $\text{Au}_2\text{O}_3 \cdot 3\text{H}_2\text{O}$ is 10.9 per cent. L. G. Figuiet found that a little oxygen is lost along with water in the drying of samples at 100° , and W. L. Dudley also found oxygen to be evolved at 110° , and at 160° the residue has a composition corresponding with Au_2O_2 . W. G. Mixer also found oxygen is given off before all the water is expelled from auric hydroxide, that the decomposition is complete at 245° . W. G. Mixer heated 3.6907 grms. of auric hydroxide in a bulb 4 hrs. at 135° , and found its weight reduced to 3.6127 grms.; 18 hrs., 135° – 148° , and found 3.5615 grms.; 20 hrs., 161° – 168° , and found 3.5507 grms.; 24 hrs., 180° – 204° , and found 3.504 grms.; $2\frac{1}{2}$ hrs., 200° – 215° , and found 3.497 grms.; 2 hrs., 218° – 231° , and found 3.479 grms.; 2 hrs., 235° – 244° , and found 3.417 grms.; 3 hrs., 240° – 260° , and found 3.251 grms.; $2\frac{1}{2}$ hrs., 250° – 295° , and found 3.126 grms.; and above 360° , 3.083 grms. The loss with 80 hrs. heating from 135° – 213° was 5.7 per cent., which is practically the same as the amount of water in the original substance. The hydroxide is decomposed by light. J. Thomsen found the heat of formation of auric hydroxide, $2\text{Au} + 3\text{O} + \text{aq.} = \text{Au}_2\text{O}_3\text{aq.} - 11.5$ Cals. W. G. Mixer gave -12.3 Cals. for the heat of formation of auric oxide from its elements.

The hydroxide is readily reduced when warmed in a stream of **hydrogen**, and the gas first burns with a green, then a red flame. I. W. Fay and A. F. Seeker found an appreciable reduction occurs at 0° when the oxide is treated with hydrogen and with **carbon monoxide**. According to H. H. Morris, when gold hydroxide in a steel bomb is treated with **water** at 322° , metallic gold is formed; the presence of sodium or magnesium chloride favours the decomposition, while calcium chloride hinders the change. W. G. Mixer found auric hydroxide is reduced to the metal by **hydrogen peroxide** or a soln. of **sodium peroxide**. According to J. Pelletier and E. Frémy, auric hydroxide is easily soluble in **hydrochloric acid** and **hydrobromic acid**, but J. P. Prat found it to be insoluble in **hydrofluoric acid**, and this, added V. Lenher, even after digestion for a week in the presence of nitric acid. When warmed with **water** and **iodine**, it forms a turbid liquid from which a pale yellow powder settles—L. G. Figuiet believed the product was a higher iodide, J. J. Berzelius an iodate. J. Pelletier found that with aq. **hydriodic acid**, aurous iodide and iodine are formed and the mixture deposits gold when warmed. Cold **alcohol** has no action on hydroxide, but with boiling alcohol some gold separates out. Auric hydroxide unites with the **alkali hydroxides** and with several other metal oxides, forming aurates—*vide infra*. According to J. Pelletier, when the hydroxide is treated with an aq. soln. of potassium hydroxide, part is reduced to the metallic state, and part is precipitated as black oxide. L. G. Figuiet found the freshly precipitated hydroxide to be almost insoluble in a conc. soln. of potassium hydroxide, and it dissolves when heated, forming potassium aurate and some aurous oxide. J. Pelletier found that

with an alcoholic soln. of potassium hydroxide it is reduced to hard shining gold scales, once used in painting miniatures. H. Rose found it to be insoluble in a soln. of alkali bicarbonates; and J. Pelletier found it to be sparingly soluble in boiling aq. soln. of potassium, sodium, or barium chloride, forming a yellow alkaline fluid.

The hydroxide, even when freshly precipitated, is very sparingly soluble in most acids; it is somewhat soluble in conc. sulphuric acid, but the oxide is re-precipitated by diluting the soln. J. L. Proust and E. Frémy noted the ready solubility of the hydroxide in nitric acid, and when the soln. is diluted with water, gold is quantitatively precipitated. H. Rose noted that fuming nitric acid dissolves very little hydroxide, and at the same time exerts a reducing action in virtue of the contained nitrous acid; orthophosphoric acid has very little action on the hydroxide; oxalic acid reduces it to the aurous oxide and gold; and of all the oxy-acids, acetic acid dissolves the hydroxides most readily, and the deep yellowish-brown soln. deposits some gold and some of the hydroxide on standing, and when the acetic soln. is boiled it deposits auric hydroxide again. In general, the organic acids reduce the hydroxide, and consequently do not form gold salts. Nor does auric hydroxide unite with carbonic acid or boric acid. According to E. Beutell, auric hydroxide dissolves in an aq. soln. of potassium ferrocyanide at ordinary temp., and rapidly when the soln. is boiled. Potassium cyanoaurate, KAuCy_2 , is formed, and some ferric hydroxide is precipitated if the soln. is alkaline.

The action of ammonia on gold oxide or of alkali on an ammoniacal soln. of a salt of gold attracted much attention from the alchemists of the Middle Ages. In virtue of the fact that when rubbed, struck, heated, or exposed to an electrical spark, it detonates with a loud, sharp report, and a faint light, led to its being called **fulminating gold**. The anonymous writer, Basil Valentine,³ in the seventeenth century, described its precipitation by the action of *sal tartari* on a soln. of gold in a mixture of nitric acid and ammonium chloride; and he added that the powder is so explosive that "when exposed to a little warmth, it ignites and does a great damage, for it then explodes with such great power and might that no man can withstand." It was called *aurum fulminans* by J. Begiun (1608); *aurum volatile* by O. Croll (1609); *pulvis pyrius aureus* by A. Kircher (1641); *aurum scolopetans* by J. Schröder (1641); *saffran d'or* or *or fulminant* by N. Lemery (1675); and various other names were assigned to it, for example, *magisterium ccaunochryson*, *pulvis chrysoceraunius*, etc. Observations on fulminating gold were also made by T. Willis (1659), A. Sala (1620), J. R. Glauber (1648), G. E. Stahl (1702), F. Hoffmann (1722), J. Juncker (1730), A. S. Marggraf (1745), J. Black (1755), A. Baumé (1763), J. F. Meyer (1764), etc. They thought the explosiveness was due to the evolution of fixed air. J. Kunckel (1716) first observed that *aurum fulminans* contained ammonia as an essential constituent. The compound was further investigated by T. Bergmann in his dissertation *De calce auri fulminante* (Upsala, 1769), and by C. W. Scheele in his *Chemische Abhandlung von der Luft und Feuer* (Upsala, 1777), and confirming J. von Löwenstein-Kunckel's observation, fulminating gold was found to be a compound of gold calx and ammonia, and the French chemists accordingly called it *oxide d'or ammoniacal*.

According to T. Bergmann, and C. W. Scheele, auric hydroxide is converted into fulminating gold by immersion in aq. ammonia, or in a soln. of ammonium chloride, sulphate, or nitrate; and he found a gain of 23.3 per cent. in weight in aq. ammonia, and T. Bergmann a gain of 20 per cent. in weight in the other soln., and at the same time, the liquid acquires an acid reaction. The auric hydroxide prepared by J. B. A. Dumas' process⁴ yields green fulminating gold when immersed 24 hrs. in conc. aq. ammonia, and washed and dried at 100°. T. Bergmann also precipitated fulminating gold by adding aq. ammonia or ammonium carbonate to a soln. of auric chloride; and he observed that the greater the quantity of free acid in the gold soln. or a soln. of auric hydroxide in nitric or sulphuric acid, and the larger the excess of ammonia employed, the less the quantity of gold precipitated. The

more completely the precipitated *aurum fulminans* is washed, the more readily and violently does it detonate; the detonating power is likewise increased by boiling the product with a soln. of potassium hydroxide or carbonate, and thoroughly washing it with water. The wash-water was found by J. B. A. Dumas still to give a turbidity with silver nitrate, even after three days' washing. J. J. Berzelius pointed out that the last traces of absorbed auric chloride can be removed by washing with hot water containing ammonia. W. G. Mixter found that when a soln. of ammonium carbonate is electrolyzed with gold electrodes, fulminating gold is deposited on the anode.

J. B. A. Dumas' analyses of fulminating gold can be represented by $\text{Au}_2\text{O}_3 \cdot 4\text{NH}_3$, *gold tetrammino-oxide*, or $\text{AuN} \cdot \text{NH}_3 \cdot 1\frac{1}{2}\text{H}_2\text{O}$, or, according to F. Raschig, $\text{HN} : \text{Au} \cdot \text{NH}_2$, *auric imidoamide*. If aq. ammonia is added to a soln. of auric chloride a mixture of fulminating gold and yellow *auric imidochloride*, NHAuCl , is formed, and the chlorine cannot be all removed by a prolonged digestion with aqua ammonia. Fulminating gold is resolved by detonation into gold, nitrogen, ammonia, and water, and, said T. Bergmann, silver or copper supports are gilded by the explosion. T. Bergmann obtained 11 c.c. of nitrogen from 0.625 grm. of fulminating gold; and C. W. Scheele obtained a volume of nitrogen gas equal in bulk to 1875 grms. of water from 0.06 grm. of fulminating gold. According to J. B. A. Dumas, when fulminating gold is kept for some hours at 100° , it becomes so sensitive that it can scarcely be touched without exploding. T. Bergmann found that the moist product does not detonate by heat until it becomes dry, and then not violently all at once, but in separate portions as they give off their water; it acquires a blackish tint when the temp. is raised just below the temp. of explosion, which J. B. A. Dumas places at 143° . Both T. Bergmann and J. B. A. Dumas noted that if care be taken to avoid friction, fulminating gold can be heated nearly to the explosion temp., then cooled a little, and more strongly heated, again cooled, and again still more strongly heated; it can finally be heated to redness without exploding, and all the gold remains behind in the metallic state. The explosion of fulminating gold is very violent, and T. Bergmann reports the bursting of the doors and windows of an apartment in which a mass exploded, and A. Baumé says that a dram of fulminating gold in a bottle, exploded while the stopper was being turned round, so that "the operator's two eyes were irrecoverably destroyed by the projected fragments of glass." A mixture of fulminating gold with finely divided salts of the alkalies or alkaline earths may be heated without explosion; and J. B. A. Dumas obtained nitrogen gas but no nitric oxide by heating a mixture of fulminating gold and copper oxide. A mixture of the explosive with one or two times its weight of sulphur does not explode, and T. Bergmann added fulminating gold in small portions at a time to molten sulphur without explosion. Basil Valentine first found that fulminating gold loses its explosiveness when heated with sulphur. Hydrogen sulphide and also stannic chloride were found by J. L. Proust to decompose fulminating gold without explosion. T. Bergmann found that fulminating gold can be gently heated with sulphuric acid without change, and at the b.p. of the acid, it is decomposed into metallic gold, etc., without explosion. It also forms an explosive sulphate, $4(\text{HN} : \text{Au} \cdot \text{NH}_2)\text{H}_2\text{SO}_4$. It can be boiled with dil. sulphuric or nitric acid without decomposition. Boiling hydrochloric acid dissolves a little fulminating gold, $\text{AuNH} \cdot \text{NH}_2 + 5\text{HCl} = \text{AuCl}_3 + 2\text{NH}_4\text{Cl}$; and potassium hydroxide precipitates fulminating gold from the soln., copper precipitates gold, and C. W. Scheele found the remaining liquid yields ammonium carbonate when distilled with potassium carbonate. Aq. alkalies, most acids, and alcohol, hot or cold, have no action on fulminating gold, but it is dissolved by a soln. of potassium cyanide, forming potassium hydroxide, ammonia, and ammonium cyanoaurate, NH_4AuCy_2 . E. Beutell has studied the action of a dil. soln. of potassium ferrocyanide on fulminating gold, and found that at ordinary temp. hydrocyanic acid is formed; and when the mixture is boiled ferric hydroxide is precipitated, and all the gold forms potassium cyanoaurate, KAuCy_2 .

Auric acid and the aurates.—Gold hydroxide unites with bases to form aurates. A soln. of gold hydroxide in soln. of alkali hydroxides or chlorides contains the corresponding aurate. J. J. Berzelius⁵ noted that when aurous oxide is treated with an aq. soln. of potassium hydroxide it decomposes into metallic gold and potassium aurate; S. Tennant noted that when potassium nitrate is melted in a gold vessel, and the cold cake leached with water, a yellow soln. is obtained from which gold can be precipitated by potassium nitrite; J. Pelletier digested auric hydroxide in potassium hydroxide, and obtained a soln. of potassium aurate, which E. Frémy found, on evaporation in vacuo, furnished pale yellow masses and needle-like crystals of trihydrated **potassium aurate**, $K_2O \cdot Au_2O_3 \cdot 6H_2O$, or $KAuO_2 \cdot 3H_2O$. F. Meyer represents its composition by $KAuO_2 \cdot 2H_2O$. According to E. Frémy, potassium aurate is readily soluble in water, forming a pale yellow liquid with a feeble alkaline reaction indicative of hydrolysis, and on evaporation of the soln., much of the gold separates out. F. Meyer made potassium aurate by adding potassium sulphate to a soln. of barium aurate. H. Elkington, and E. L. Sehubarth used the soln. of gold hydroxide in potassium hydroxide for gilding copper, brass, and bronze. E. Frémy found copper precipitated black pulverulent gold from a warm soln. of potassium aurate. Most metallic salts were found to give precipitates with potassium aurate, forming sparingly soluble metal aurates, although many redissolve in an excess of the precipitant. For example, calcium chloride precipitates *calcium aurate*, which is soluble in an excess of calcium chloride. Potassium aurate is decomposed by almost all organic substances, with the separation of gold.

F. Meyer prepared a green soln. of **sodium aurate** in connection with the preparation of auric hydroxide. He also digested auric hydroxide with an aq. soln. of sodium hydroxide, excluding access of atm. carbon dioxide, and evaporated the soln. in vacuo in darkness. The product was rapidly washed with alcohol. He also obtained a soln. of the same salt by adding sodium sulphate to a soln. of barium aurate, and filtering. The acicular crystals obtained by evaporating the aq. soln. are pale green; and are assumed to have a composition $NaAuO_2 \cdot 2H_2O$. They detonate when heated with organic substances—*e.g.* paper. They are insoluble in alcohol. The aq. soln. is decomposed by heat and light; the soln. is reduced by sulphur dioxide. Alcohol furnishes gold and aldehyde. Hydrochloric acid converts the soln. into auric chloride. Dil. sulphuric or nitric acid converts the salt soln. into one containing **auric acid**, $HAuO_2$. According to W. G. Mixer, the heat of formation is $Au_2O_3 + 3Na_2O = 100.9$ Cals., and $2Au + 3O + 3Na_2O = 88.6$ Cals.

J. Pelletier obtained **barium aurate** by mixing a neutral soln. of auric chloride with baryta water. The precipitate dissolves in acetic acid, and the soln. furnishes crystals of the double acetate of gold and barium. F. Weigand said the filtrate from the preceding precipitate furnishes small green rhombic crystals of the composition $Ba(AuO_2)_2 \cdot 5H_2O$. F. Meyer regarded the pale green powder which he obtained by adding baryta water to a soln. of sodium or potassium aurate, washing the gelatinous precipitate with water, and drying in vacuo in darkness, as having composition $Ba(AuO_2)_2 \cdot 6H_2O$. The pale green powder gradually loses water in vacuo; it is decomposed by light; and is rather more soluble in water than the alkali aurate. E. Frémy prepared **calcium aurate** as indicated above, and F. Meyer also obtained a product, $Ca(AuO_2)_2 \cdot 6H_2O$, analogous with the barium salt. J. Pelletier obtained **magnesium aurate** by a method analogous to that employed for the barium salt.

REFERENCES.

- ¹ J. J. Berzelius, *Jahresber.*, 25. 199, 1846; *Schweigger's Journ.*, 7. 43, 1813; 34. 81, 1822; *Ann. Chim. Phys.*, (2), 18. 146, 1821; L. G. Figuier, *ib.*, (2), 47. 167, 1829; (3), 11. 336, 1844; E. Frémy, *ib.*, (3), 31. 481, 1850; G. Krüss, *Liebig's Ann.*, 237. 274, 1887; *Ber.*, 19. 2541, 1886; L. Vanino, *ib.*, 38. 462, 1905; W. L. Dudley, *Amer. Chem. Journ.*, 28. 61, 1902; F. H. Campbell, *Chem. News*, 96. 25, 1907; F. Raschig, *Liebig's Ann.*, 235. 341, 1886; F. Meyer, *Compt. Rend.*,

145. 807, 1907; J. P. Prat, *ib.*, 70. 842, 1870; P. Sehöttlander, *Ueber das Salzpetersäure-Goldnitrat und einige neue Derivate desselben*, Würzburg, 1884; *Liebig's Ann.*, 217. 312, 1883; H. W. Vogel, *Die praktische Spectralanalyse irdischer Stoffe*, Berlin, 1. 489, 1889; W. G. Mixer, *Journ. Amer. Chem. Soc.*, 33. 688, 1911.

² J. L. Proust, *Journ. Phys.*, 62. 131, 1806; A. Oberkampf, *Ann. Chim. Phys.*, (1), 80. 140, 1811; J. Pelletier, *Ann. Chim. Phys.*, (2), 15. 5, 113, 1820; L. N. Vauquelin, *ib.*, (1), 77. 321, 1811; J. B. A. Dumas, *ib.*, (2), 44. 179, 1830; E. Frémy, *ib.*, (3), 31. 480, 1850; F. H. Jeffery, *Trans. Faraday Soc.*, 11. 172, 1916; L. G. Figuier, *Journ. Pharm. Chim.*, (3), 11. 336, 1844; (3), 12. 401, 1847; *Compt. Rend.*, 18. 813, 1844; J. P. Prat, *ib.*, 70. 843, 1870; F. Meyer, *ib.*, 145. 807, 1907; C. Wittstein, *Pharm. Vierteljahr.*, 15. 21, 1866; J. Thomsen, *Journ. prakt. Chem.*, (2), 13. 337, 1876; P. Sehöttländer, *Ueber des Salzpetersäure-Goldnitrat und einige neue Derivate desselben*, Würzburg, 1884; *Liebig's Ann.*, 217. 312, 1883; G. Krüss, *ib.*, 237. 274, 1887; *Ber.*, 19. 2541, 1886; E. Beutel, *Sitzber. Akad. Wien*, 119. 700, 1910; *Monatsh.*, 31. 883, 1910; *Zeit. anorg. Chem.*, 78. 152, 1912; V. Lenher, *Journ. Amer. Chem. Soc.*, 25. 1137, 1903; H. H. Morris, *ib.*, 40. 917, 1918; I. W. Fay and A. F. Seeker, *ib.*, 25. 647, 1903; W. G. Mixer, *ib.*, 33. 688, 1911; *Amer. Journ. Science*, (4), 32. 206, 1911; A. Rundspaden, *Ueber Elektrolyse des Wassers*, Göttingen, 62. 1869; W. L. Dudley, *Amer. Chem. Journ.*, 28. 61, 1902; H. Rose, *Sitzber. Akad. Berlin*, 387, 1847; H. H. Morris, *Journ. Amer. Chem. Soc.*, 40. 917, 1918.

³ H. Kopp, *Geschichte der Chemie*, Braunschweig, 4. 212, 1847; Basil Valentine, *Letztes Testament*, Strassburg, 1751; J. Begium, *Tirocinium chymicum*, Paris, 1608; O. Croll, *Basilica chymica*, Frankfurt, 1609; A. Kireher, *Magnes sive de arte magnetica*, Romæ, 1641; J. Schröder, *Pharmacopœia medicæ-chymica*, Ulm, 1641; N. Lemery, *Cours de chymie*, Paris, 1675; T. Willis, *Diatribe de fermentatione*, Londini, 1659; A. Sala, *Descriptio brevis antidoti preciosæ*, Marpurge, 1620; J. R. Glauber, *Furnis novis philosophicis*, Amstelodami, 1648; G. E. Stahl, *Specimen Becherianum*, Lipsiæ, 1702; F. Hoffmann, *Observationum physico-chymicarum selectiorum*, Halæ, 1722; J. Juneker, *Conspectus chemiæ theoretico-practiciæ*, Halæ, Magdeburgiæ, 1730; J. Black, *Experiments upon Magnesia Alba*, *Quick-lime*, and other Alcaline Substances, Edinburgh, 1755; *Alembic Club Reprints*, 1. 19, 1893; A. Baumé, *Manuel de chymie*, Paris, 1763; J. F. Meyer, *Chymische Versuche zur näheren Erkenntniss des ungelöschten Kalchs*, Hannover, 1764; J. Kunekel, *Vollständiges Laboratorium chymicum*, Berlin, 1730; A. S. Marggraf, *Mém. Acad. Berlin*, 61, 1745.

⁴ W. G. Mixer, *Journ. Amer. Chem. Soc.*, 33. 688, 1911; J. B. A. Dumas, *Ann. Chim. Phys.*, (2), 44. 167, 1830; F. Rasehig, *Liebig's Ann.*, 235. 341, 1886; E. Beutel, *Sitzber. Akad. Wien*, 119. 700, 1912; *Monatsh.*, 31. 883, 1910; *Zeit. anorg. Chem.*, 78. 152, 1912.

⁵ S. Tennant, *Scherer's Journ.*, 1. 306, 1799; J. J. Berzelius, *Schweigger's Journ.*, 7. 43, 1813; *Ann. Chim. Phys.*, (2), 18. 146, 1821; E. Frémy, *ib.*, (3), 31. 483, 1850; J. Pelletier, *ib.*, (2), 15. 5, 113, 1820; H. Elkington and F. A. H. F. de Ruolz, *Compt. Rend.*, 13. 998, 1841; E. L. Sehubarth, *Journ. prakt. Chem.*, (1), 11. 339, 1837; F. Meyer, *Compt. Rend.*, 145. 805, 1907; W. G. Mixer, *Amer. Journ. Science*, (4), 32. 206, 1911; F. Weigand, *Zeit. angew. Chem.*, 19. 139, 1906.

§ 15. Gold Fluoride

Gold does occur associated with fluorspar, particularly in telluride deposits, but gold fluoride itself does not appear to be capable of existence in the presence of water, nor under the ordinary conditions which obtain in nature. The gold halides are fairly well defined. Tervalent gold forms a relatively stable chloride, while the bromide and iodide are not so stable and are liable to break down into univalent gold halides. As a rule, the elements form halides whose stability is inversely as the at. wt. of the combined halogen. Fluorine is the most chemically active of all the halogens—if not of all the elements—and yet it appears to have but little affinity for gold. This might not be expected from a comparison of the relative stability of the other gold halides with the at. wt. of the halide, although the known properties of other fluorides have made chemists rather cautious in predicting the properties of the fluorides by extrapolation so to speak with the properties of the other halides. For example, contrast the solubility of the chlorides, bromides, and iodides of the alkaline earths with the insolubility of the fluorides; and the solubility of the thallium and silver fluorides with the insolubility of the chlorides, bromides, and iodides. H. Moissan¹ states that gold is not attacked by fluorine at ordinary temp., but when gold wire is heated to dull redness in a stream of fluorine, a crust of reddish-yellow powder is formed on the metal. This powder attracts moisture from the air with great avidity; it is volatile at a temp. a little higher than that at

which it is formed, and decomposes into fluorine gas and the metal. J. P. Prat seems to have obtained a kind of basic fluoride, possibly a mixture of fluoride and oxide, as an insoluble product of the action of hydrofluoric acid upon gold sesquioxide; but V. Lenher says that this oxide is not attacked by digesting it for a week in nitrohydrofluoric acid. According to O. Ruff, similar remarks apply to gold dichloride when heated up to the temp. of its decomposition with hydrogen fluoride; or up to 280° with potassium hydrogen fluoride; V. Lenher adds that when a soln. of silver fluoride is heated with auric chloride or hydroxide, if the double decomposition: $\text{AuCl}_3 + 3\text{AgF} = \text{AuF}_3 + 3\text{AgCl}$ does occur, the gold fluoride is immediately hydrolyzed by water, for gold hydroxide is quantitatively precipitated: $\text{AuCl}_3 + 3\text{AgF} + 3\text{H}_2\text{O} = 3\text{AgCl} + \text{Au}(\text{OH})_3 + 3\text{HF}$. Many other processes were tried but without success; nor was he able to find a non-aqueous solvent which dissolved both gold chloride and silver fluoride without decomposition.

REFERENCES.

¹ H. Moissan, *Compt. Rend.*, 109. 807, 1889; *Ann. Chim. Phys.*, (6), 24. 224, 282, 1891; *Le fluor et ses composés*, Paris, 1900; J. P. Prat, *Compt. Rend.*, 70. 842, 1870; V. Lenher, *Journ. Amer. Chem. Soc.*, 25. 1136, 1903; O. Ruff, *Ber.*, 46. 922, 1913.

§ 16. Gold Chlorides

The solvent action of aqua regia on gold is mentioned in Geber's *De inventione veritatis*, for he says that the addition of sal ammoniac accentuates the solvent action of *aqua dissolutiva* (nitric acid) because it then dissolves gold. The soln. of gold in aqua regia was known to all the succeeding alchemists, and called by them potable gold, to which many medicinal virtues were ascribed; it was regarded as the elixir of life. Roger Bacon, in urging this terrestrial hippocrene to the attention of Pope Nicholas IV, related:

An old man, when ploughing a field in Sicily, one day found some of the yellow potable gold in a golden phial, and, supposing it to be dew, drank up the liquor. He was thereupon transformed into a hale, robust, and highly accomplished youth. The youth was thereafter received into the service of the Sicilian king, where he served some eighty years.

There are relics of the mediæval ideas regarding the virtues of yellow golden water in some present-day quack medicines. Basil Valentine,¹ Robert Boyle, and O. Tachen refer to colour effects obtained by the soln. of gold with various reagents. Basil Valentine reported that mercury forms gold amalgam when mixed with the gold soln., and that the gold remains as a purple powder when the mercury is distilled off. R. Boyle, J. R. Glauber, J. Kunckel, and J. C. Orschall refer to the reduction of gold from its soln. in aqua regia by means of organic matters, mercury nitrate, and ferrous sulphate.

There are two well-defined gold chlorides—aurous chloride, AuCl ; and auric chloride, AuCl_3 . Several investigators claim to have made an *intermediate chloride*. J. P. Prat stated that finely divided gold, or aurous chloride dissolves with the evolution of heat in a soln. of auric chloride, possibly with the formation of a compound of aurous and auric chlorides; he also said that a *higher chloride* than the trichloride is produced when chlorine is passed over auric chloride. According to J. Thomsen,² if dry chlorine be passed over dried and finely divided gold, the mixture becomes heated, without the application of external heat, and **aurousauric chloride**, or **gold dichloride**, Au_2Cl_4 , is formed. This may be regarded as **aurous chloroaurate**, $\text{Au}.\text{AuCl}_4$. According to J. Thomsen, aurousauric chloride is a dark red hygroscopic solid which decomposes at 250°. T. K. Rose says the sp. gr. is 5.1. Its heat of formation was measured by E. Petersen. J. Thomsen shows that the

product is decomposed by water or by alcohol into aurous and auric chlorides. A. Meillet claims to have made a double sodium and aurosoauric chloride—*vide supra*.

According to G. Krüss, when finely divided gold is heated to 140° in dry chlorine, aurosoauric chloride is formed, which decomposes into aurous and auric chlorides at 180°–190°. At 220°–230°, some auric chloride is formed, and the aurous chloride decomposes; above this temp. the gold is not attacked by chlorine. On cooling these changes are said to be reversed. In a subsequent memoir, G. Krüss and F. W. Schmidt say that the only products of the reaction of chlorine on gold are the two chlorides, AuCl and AuCl₃, and they maintain that the alleged compound, Au₂Cl₄, does not exist, for when made under different conditions, the product has a variable composition, never that of Au₂Cl₄; the ultimate product of the action is auric trichloride, and the alleged compound represents the product of a reaction arrested before it is completed, and is a mixture of auric chloride and unaltered gold. E. Petersen claims that G. Krüss and F. W. Schmidt washed their product with water and ether, and this is inadmissible, because J. Thomsen showed that it is decomposed by this menstruum. Even with alcohol at –20°, there is some decomposition. E. Petersen concludes from his synthetic and calorimetric experiments that this compound is a real chemical individual. G. Krüss and F. W. Schmidt repeated E. Petersen's experiments and again confirm their former conclusion.

Aurous chloride, or gold monochloride, AuCl.—J. C. Leuchs recommended heating the auric chloride, AuCl₃, between 230° and 300°; J. J. Berzelius³ to the m.p. of tin, that is between 228° and 230°; L. Vanino and L. Rössler, to about 200°; J. Thomsen, to 185°; F. W. Schmidt, and F. Lengfeld, in a paraffin bath at 175°, for several days; L. G. Figuier, between 120° and 150°; and J. Löwe, in a thin dish at the temp. of a boiling water-bath for some days. The liquid should be protected from dust during the evaporation, otherwise some of the salt may be reduced to the metal. The auric chloride first acquires a reddish-brown colour, then dirty brown, yellowish-brown, greenish-yellow, and finally yellow. F. H. Campbell also claims to have made aurous chloride by heating auric chloride in vacuo to 170°, and washing the product with ether until the washings were no longer coloured by auric chloride.

F. Lengfeld showed that at 185° auric chloride slowly dissociates into gold and chlorine, and below 175° some auric salt escapes decomposition; and M. E. Diemer, that when ordinary auric chloride—in reality hydrochloroauric acid, HAuCl₄—is heated there appears to be no intermediate stage between auric chloride and metallic gold, and in consequence the formation of aurous chloride might be questioned. If, however, the auric chloride be prepared quite free from hydrochloric acid and water, it shows no loss in weight and not the slightest sign of decomposition at 100°; but if heated in an atm. of hydrogen chloride at 190° chlorine is evolved and the product assumes a yellowish-white colour and undergoes no further change when heated at this temp. for a long time. The curve showing the loss in weight at different intervals of time indicates a definite break about the point where the auric chloride is converted to the aurous salt. This indicates that aurous chloride is probably a definite compound, and not a mixture of auric chloride and gold. The important factor in the preparation of aurous chloride is the exclusion of water. If heated in dry air, the product is contaminated with metallic gold; and this dissociation is prevented by heating the auric chloride in an atm. of hydrogen chloride.

V. Lenher showed that not only can auric chloride be reduced to aurous chloride by heat, but in the presence of sodium, potassium, magnesium, zinc, and cadmium chlorides, the auric salt is reduced to the aurous condition by sulphur dioxide: $\text{AuCl}_3 \cdot n\text{MCl}_2 + \text{SO}_2 + 2\text{H}_2\text{O} = \text{AuCl} \cdot n\text{MCl}_2 + \text{H}_2\text{SO}_4 + 2\text{HCl}$; and by arsenites: $\text{AuCl}_3 \cdot n\text{MCl}_2 + \text{Na}_2\text{HAsO}_3 + \text{H}_2\text{O} = \text{AuCl} \cdot n\text{MCl}_2 + 2\text{NaCl} + \text{H}_3\text{AsO}_4$. M. E. Diemer also showed that a soln. of auric chloride or hydrochloroauric acid is bleached by sulphur dioxide before metallic gold begins to separate, and this is particularly the

case in the presence of potassium, sodium, ammonium, or magnesium chlorides. When the soln. becomes colourless the electrode potential reaches a maximum, and there is a decided break at a point corresponding with the formation of aurous chloride, and this is the only break between auric chloride and the complete reduction to the metal. These soln. are more stable than those of auric chloride, and it is supposed that compounds of the type $\text{NaCl} \cdot \text{AuCl}$ are formed.

J. Nicklès prepared the salt by J. Pelletier's process and also by the action of manganese perchloride on the metal. He recommended separating aurous from auric chloride by treatment with ether which removes the auric chloride. J. C. Leuchs says that he obtained aurous chloride by heating auric chloride with conc. sulphuric acid, to 210° —decomposition begins at 170° . E. Bose has shown that in the presence of metallic gold, there is a state of equilibrium in aq. soln. of gold chloride: $2\text{Au} + \text{AuCl}_3 \rightleftharpoons 3\text{AuCl}$, which is displaced in favour of the aurous chloride by a rise of temp.; and E. Wohlwill found evidence of the formation of aurous chloride during the electrolysis of soln. of auric chloride with varying anodic current densities. Owing to the accumulation and decomposition of aurous chloride at the anode the loss at the anode is in excess of the gain at the cathode. The formation of aurous chloride decreases as the current density increases.

According to F. H. Campbell, aurous chloride is a dark red crystalline solid; and, according to M. E. Diemer, the colour is yellowish-white—possibly the difference is due to the former being contaminated with a minute quantity of very finely divided gold. T. K. Rose gives the sp. gr. as 7.4, and the mol. vol. 32. J. Thomsen gives the heat of formation from its elements as 5.81 Cals. F. Lengfeld says aurous chloride decomposes above 175° into the auric salt, and F. Meyer, that the dissociation begins at about 170° , and F. W. Schmidt, at about 210° . The dry salt, says M. E. Diemer, can be heated to 190° to 200° in an atm. of hydrogen chloride. F. Meyer says the dissociation press. at 207° is 65 mm., and F. Ephraim gave 289.5° for the dissociation temp. at atm. press.

F. Lengfeld says aurous chloride is insoluble in water, but, according to M. E. Diemer, it is immediately decomposed by water, even moist air quickly causes the separation of metallic gold: $3\text{AuCl} \rightleftharpoons 2\text{Au} + \text{AuCl}_3$; and the liquid becomes yellow owing to the formation of auric chloride. J. J. Berzelius and J. C. Leuchs say that in darkness, and in the cold, the decomposition is slow; but faster in light and when heated, and complete with boiling water. Aurous chloride is decomposed by alcohol, and, according to E. Petersen, the decomposition is slower with alcohol than with water; F. Lengfeld also says that this salt is slowly decomposed by acetone and by ether. F. H. Campbell found that dry chlorine converted it into auric chloride. M. E. Diemer says aurous chloride is decomposed when heated in an atm. of nitric oxide or carbon monoxide, forming metallic gold; with carbon monoxide, phosgene is formed; aurous chloride is slowly decomposed by sulphur dioxide. F. Lengfeld says that this salt is insoluble in dil. nitric acid, but decomposed, by conc. nitric acid—an auric salt passes into soln., and some gold remains as a residue. Aurous chloride dissolves in hydrochloric and hydrobromic acids, and in the alkali chlorides and bromides with decomposition; the decomposition is faster with bromides than with chlorides. J. Thomsen found aurous chloride to react with hydrochloric acid: $3\text{AuCl}_{\text{solid}} + \text{HCl}_{\text{aq.}} = \text{HAuCl}_{4\text{aq.}} + 2\text{Au} + 4.98$ Cals. According to F. Lengfeld, if aurous chloride be added to a soln. of potassium bromide, the resulting brownish-red liquid contains both potassium aurichloride and aurobromide: $4\text{KBr} + 12\text{AuCl} = \text{KAuBr}_4 + 3\text{KAuCl}_4 + 8\text{Au}$; aurous chloride also dissolves slowly in soln. of potassium chloride. According to M. E. Diemer, soln. of potassium, sodium, ammonium, magnesium, and calcium aurous chlorides can be made by adding sulphur dioxide to a soln. containing one mol. of aurous chloride to one of the other chlorides until the soln. is decolorized—some gold is precipitated at the same time—with calcium chloride, however, an excess of about 40 mols is needed. The soln. in each case probably contain complex ions.

J. J. Berzelius obtained what is regarded as potassium auro-chloride, $\text{KCl} \cdot \text{AuCl}$,

or KAuCl_2 , by melting potassium auri-chloride, $\text{AuCl}_3 \cdot \text{KCl}$, or KAuCl_4 . The molten salt is brownish-black, and after cooling, yellow. It does not decompose when heated to redness in open vessels, but in water or hydrochloric acid, it forms gold, potassium, and potassium auri-chloride; it is decomposed by **potassium hydroxide** into aurous oxide and potassium chloride. By dropping an acid soln. of auric chloride into sodium thiosulphate, and evaporating the soln. over quicklime, in addition to sodium chloride, sulphate, and thiosulphate, fine colourless needles are formed which A. Meillet thought were **sodium auro-aurichloride**, $4\text{NaCl} \cdot \text{AuCl} \cdot \text{AuCl}_3$, or $4\text{NaCl} \cdot \text{Au}_2\text{Cl}_4$. The crystals are separated by washing out the sodium aurochloride with alcohol, and recrystallizing. The product is soluble in alcohol and insoluble in water, and it is thought to be **sodium aurochloride**, $\text{NaCl} \cdot \text{AuCl}$. F. Lengfeld says a soln. of sodium chloride dissolves aurous chloride with little decomposition, forming a colourless soln.—possibly sodium aurochloride—which is unstable, for on standing gold is deposited and the soln. becomes yellow, and then contains sodium chloroaurate, NaAuCl_4 . The aurochlorides can also be called **chloroaurites**.

M. E. Diemer says that aurous chloride dissolves in aqua *ammonia* like silver chloride, and when the soln. is acidified with hydrochloric acid, a white crystalline precipitate is formed so unstable that it decomposes when dried—its analysis corresponds with **aurous ammino-chloride**, $\text{AuCl} \cdot \text{NH}_3$. The same compound is precipitated when an ammoniacal soln. of one of the double aurous chlorides is acidified with hydrochloric acid. When the ammoniacal soln. of aurous chloride is treated with a conc. soln. of sodium or potassium hydroxide, there is deposited a white flocculent precipitate which is very unstable and darkens in a few minutes; the partially decomposed substance explodes if heated gently. F. Lengfeld also says a white curdy precipitate resembling silver chloride is formed when nitric acid is added to the ammoniacal soln. of aurous chloride; the precipitate during washing decomposes into auric chloride and gold. F. Herrmann also prepared aurous ammino-chloride, $\text{AuCl} \cdot \text{NH}_3$, by the action of aqua ammonia or auro dibenzylsulphine chloride, $\text{AuS}(\text{C}_7\text{H}_7)_2\text{Cl}$, and extracting the soln. with ether. The evaporation of the aq. layer over sulphuric acid gives the salt in question. Aurous ammino-chloride decomposes at 150° – 200° without melting. It is soluble in aqua ammonia, insoluble in water. According to F. Ephraim, **aurous diammino-chloride** has a dissociation temp. of 113.5° . N. S. Kurnakoff studied the constitution. F. Meyer prepared **aurous dodec-ammino-chloride**, $\text{AuCl} \cdot 12\text{NH}_3$, by the action of ammonia on aurous chloride at -28° ; by gradually raising the temp., it passes into **aurous triammino-chloride**, $\text{AuCl} \cdot 3\text{NH}_3$, which is a white powder, stable up to 180° , but at higher temp. it decomposes into gold, ammonium chloride, etc.; it is decomposed by water; dil. acids transform it into the corresponding ammonium salt and a white curdy substance resembling silver chloride, which is unstable, and is slightly soluble in hydrochloric acid and in aqua regia; conc. sulphuric acid first dissolves and then decomposes the white substance. Aurous triammino-chloride is decomposed by potassium hydroxide, forming a brown explosive substance and ammonia.

According to L. Lindet, 100 grms. of phosphorus trichloride dissolves a gram of aurous chloride at 15° , and about 12.5 grms. at 120° ; he also obtained **aurous phosphoro-chloride**, $\text{PCl}_3 \cdot \text{AuCl}$ or AuPCl_4 , by heating aurous chloride with an excess of phosphorous chloride in a sealed tube between 110° and 120° ; prismatic crystals separate when the liquid cools. The salt is virtually insoluble in water, and the assumption that the ions are Au^+ and PCl_4^- is based on R. Abegg's valency theory—the positive valencies of phosphorus are balanced by the positive contra-valencies of chlorine. The compound has the characteristics of a derivative of phosphorous acid—e.g. it furnishes this acid when decomposed by water and the ester *aurous phosphoro-triethoxychloride*, $\text{AuP}(\text{OC}_2\text{H}_5)_3\text{Cl}$, when treated with alcohol.

Auric chloride, gold trichloride, AuCl_3 .—J. Thomsen made auric chloride by treating finely divided gold at 200° with chlorine gas; H. Debray conducted the

operation at 300°, and obtained sublimed auric chloride in red needle-like crystals. According to G. Krüss, H. Debray's estimate, 300°, is too high, for at that temp. he found the gold remains unchanged in a current of chlorine; and G. Krüss' description modified by T. K. Rose of the action of a continuous current of dry chlorine on gold at different temp. is as follows:

As the temp. rises to 140°, a small quantity of a reddish-brown vapour is formed; this condenses to a yellowish-red sublimate; if the temp. be maintained constant, the sublimation soon ceases, and the gold is converted into a mixture of aurous and auric chloride. When the temp. is raised to 180°–190°, this product decomposes, chlorine is evolved, green aurous chloride and a small quantity of auric chloride volatilize. As the temp. rises higher, the sublimed crystals form more rapidly in the cool part of the tube, and the part being heated darkens in colour, until, at 270°, it is almost black, and consists of lustrous crystals of auric chloride. At 285° there are signs of decomposition, but even at 300°, the rate of dissociation is slow. At 1100°, gold chloride distils slowly, when a current of chlorine is passed over metallic gold—the sublimation begins at 1000°, although gold chloride is completely decomposed at a much lower temp.

The excess of chlorine is removed from auric chloride, prepared by the action of chlorine on finely divided gold, by exposing the product for a day or two in a stream of air dried by sulphuric acid and phosphorus pentoxide, and allowing it to stand for several weeks over frequently renewed soda lime. C. Winkler removed the excess of chlorine by allowing the product to stand several days over potassium hydroxide contained in a desiccator. The aq. soln. forms a neutral soln. with water. According to F. Meyer, liquid chlorine converts gold completely into auric chloride. Finely divided gold dissolves in aqua regia, and L. N. Vauquelin recommended a mixture of two volumes of hydrochloric acid and one of nitric acid as a rapid solvent for the metal. According to J. J. Berzelius, the excess of acid cannot be all removed from the soln. in aqua regia by evaporation without transforming some of the auric into aurous chloride; a neutral soln. can therefore be obtained only by boiling the residue with water and filtering off the aurous chloride. The product of the action of aqua regia on gold is hydrochloroauric acid, HAuCl_4 ; M. E. Diemer converted this product into anhydrous gold chloride, by heating it to 200° in a stream of dry chlorine for half an hour. An ordinary soln. of gold chloride containing hydrochloric acid is gradually decomposed when heated to 100°, and the metal is formed; but if a soln. of gold in aqua regia be evaporated to dryness, and the residue heated to 200° in a stream of chlorine, auric chloride is formed free from hydrochloric acid.

In manufacturing gold chloride, fine gold is treated with aqua regia until the evolution of nitrogen oxides has ceased; and the soln. conc. to a syrup on a water-bath. It is then taken up with about five volumes of water, and allowed to stand 24 hrs., when a little silver chloride is deposited. The liquid is filtered and again evaporated on the water-bath, until a drop of the liquid solidifies to a mass of yellow crystals. The crystals which separate from the cooling soln. are sealed up for sale in "gram or five-gram tubes," and called "chloride of gold." The composition is not uniform since the crystals contain a variable amount of adsorbed water: $\text{HAuCl}_4 \cdot 3\text{H}_2\text{O} + \text{Aq}$.

G. Krüss recommended dissolving the gold in chlorine water. C. Winkler passed a slow current of chlorine through water with gold, precipitated by sulphur dioxide, in suspension; the soln. was evaporated in darkness on a water-bath, taken up again with water, and filtered from the undissolved gold. Other mixtures which give off chlorine can be employed, thus, J. Nicklès⁴ used aq. or ethereal soln. of manganese, cobalt, and nickel perchlorides; A. Baudrimont used phosphorus pentachloride and precipitated gold; L. Lindet heated finely divided gold with antimony pentachloride in a sealed tube at 200°. H. B. North heated the finely divided gold with an excess of thionyl chloride, SO_2Cl_2 , for many hours at 160° on an oil-bath.

According to W. J. Pope,⁵ auric chloride, AuCl_3 , forms small prismatic crystals which are deep claret red by reflected light, with no pleochroism; but H. Ambronn says that conc. soln. between glass plates furnish double refracting crystals with a claret-red and bluish-green pleochroism. The crystals are deliquescent, or, as

Robert Boyle expressed it, they "run in air *per deliquium*." T. K. Rose gives the **specific gravity** 3.9 for the volatilized chloride, and he calculated 4.3 for the fused chloride, and the mol. vol. is 70; he also found the **melting point** to be 288° in chlorine at 2 atm. press., and that the presence of aurous chloride does not have much influence on this constant since a mixture of one mol. of aurous chloride with four of auric chloride, melted at 287°; and at 286° under a press. of 1.81 atm. of chlorine. Robert Boyle noted the **volatility** of gold chloride and obtained "a yellow and reddish sublimate" in the neck of a retort containing gold chloride heated on a sand-bath; and he added, "sometimes we had the neck of the retort enriched with numerous large, thin, red crystals, very like rubies, and glorious to behold." L. Thompson, F. B. Miller, and S. B. Christy noted the losses which occur in chloridizing gold owing to the volatility of the chloride. J. P. Prat, H. Debray, G. Krüss, L. Lindet, and T. K. Rose have investigated the volatilization and dissociation of gold chloride. If p denotes the partial press. of dissociated chlorine, and p' the vap. press. of the gold chloride, the press. $P=p+p'$ at different temp. is:

	70°	74°	115°	200°	248°	251°	258°	278°
$p+p'$	0	2.05	9.0	138	682	755	893	1354 mm.

at 286° the press. was 1.81 atm., the chloride was molten and bubbling; and at 332° the press. was 4.1 atm. From the relation $\log P = -\frac{1}{2}Q/T + \text{constant}$, where Q denotes the heat of vaporization, or dissociation, and P the press. of vaporization or dissociation respectively, then if at 248°, $p=165$ mm. and $p'=538$ mm., and at 251°, $p=178$ mm. and $p'=577$ mm. M. Pellaton found the dissociation press. increases from 4.5 mm. at 140° to 931 mm. at 260°, and the results can be represented by $\log p = 51.6852 - bT^{-1} - c \log T$, where $\log b = 3.841148$, and $\log c = 1.117057$. F. A. Henglein gave $p = -13.2076T^{-1.6375} + 4.6222$ atm. between 5.2 (415.6° K.) mm., and 992.3 (534.6° K.) mm. At atm. press. the dissociation temp. is 254°. F. Ephraim gave 256.5°, and added that if the salt be left under about 100 mm. press. at 225°, it acquires a pale yellow colour, and is changed into aurous chloride; and if the product be heated further in the atm. of chlorine, the vap. press. reaches one atm. at 289.5°. Hence, aurous chloride is stable in an atm. of chlorine only over the range of 33°. H. H. Morris found gold chloride may be heated to the critical temp. 370° before metallic gold appears; the presence of sodium, magnesium, or calcium chloride increases the stability, for the metal does not then appear until the temp. reaches 450°–460°. The increased stability is attributed to the formation of double chlorides. W. Biltz discussed the dissociation of auric chloride.

The **heat of vaporization** of gold chloride is 13.8 Cals., and the **heat of dissociation**, 12.7 Cals. By subtracting J. Thomsen's value for the heat of formation of aurous chloride (5.81 Cals.) from that of auric chloride (22.82 Cals.) the heat of dissociation is 17.01 Cals. The calculated value is obtained on the assumption that the heat of dissociation is constant and independent of the temp. T. K. Rose showed that auric chloride is formed and volatilized at all temp. above 180° up to, and probably far beyond, 1100°. G. Krüss stated that both J. P. Prat, and H. Debray were mistaken in stating that gold chloride is volatilized at moderate temp. because he observed no action between chlorine and gold between 220° and 300°, and at these temp. gold chloride is completely decomposed, while a reaction begins at 1000°, and is marked at 1100°. G. Krüss' observations do not agree with those of T. K. Rose, and the latter showed that the contradiction arises from the faulty method employed by G. Krüss. T. K. Rose showed that, like mercury, carefully dried gold is attacked by chlorine, but the presence of moisture accelerates the speed of dissociation, for with the dried chloride equilibrium between 191° and 204° is attained only after heating several hours while with undried chloride, less than an hour suffices. The amount of auric chloride volatilized in half an hour rises from 0.007 per cent. at 180° to 0.35 per cent. at 230°, to a maximum of 2.32 at 200°; it then falls to a minimum of about 0.58 near 590°, and rises again to 1.93 at 1100°. These

results are taken to mean that the heat of formation of auric chloride changes from positive to negative between 800° and 1000°, and consequently exhibits a less tendency to dissociate as the temp. rises in accord with the rule that a rising temp. favours the system formed with an absorption of heat. J. Thomsen found the **heat of formation**: $\text{Au} + 3\text{Cl} = \text{AuCl}_3 + 22.82$ Cals.; the calculated values for the heat of formation, $\text{AuCl}_3 + \text{HCl} + 3\text{H}_2\text{O} = -3.55$ Cals., and for $\text{AuCl}_3 + \text{HCl} + 4\text{H}_2\text{O} = -5.83$ Cals.; the **heat of solution**, 4.45 Cals., or $\text{AuCl}_3\text{aq.} + \text{HClaq.} = \text{AuCl}_3.\text{HClaq.} - 4.53$ Cals.

L. Lindet says 100 grms. of water dissolve 68 grms. of auric chloride. The conc. soln. is brownish-red, and the dil. soln. is reddish-yellow. The crust which forms on the surface of a neutral soln. of auric chloride, contains, according to J. Thomsen, dark orange crystals of **dihydrated auric chloride**, $\text{AuCl}_3.2\text{H}_2\text{O}$. The water of crystallization is lost over conc. sulphuric acid. According to W. Hittorf and H. Salkowsky,⁶ the soln. contains the dibasic acid complex, $\text{AuCl}_3.\text{H}_2\text{O}$, i.e. H_2AuOCl_3 ; this acid forms with silver carbonate the silver salt, $\text{Ag}_2\text{AuOCl}_3$. The **transport number** of the anions for a soln. of approximately one mol per litre is 0.2316; for a soln. with 0.42 mol per litre, 0.233; and for one with 0.068 mols per litre, 0.227. It is therefore assumed that with conc. soln. the ionization is: $\text{H}_2\text{AuOCl}_3 \rightleftharpoons \text{H}^+ + \text{HOAuCl}_3'$, and with dil. soln.: $\text{H}_2\text{AuOCl}_3 \rightleftharpoons 2\text{H}^+ + \text{AuOCl}_3''$. This assumption has been also suggested as an explanation of the change of colour with increasing dilution. The **degree of ionization** is in any case small; for $\frac{1}{15}N$ -soln. F. Kohlrausch found the **equivalent conductivity** at 18°, $\lambda = 128$ on the assumption that the acid is dibasic; while if the acid is monobasic, the conc. is $\frac{1}{35}N$, and $\lambda = 256$, and for a soln. a 100 times more dil., viz. $\frac{1}{500}N$, $\lambda = 315$, which in 10 hrs. rises to $\lambda = 570$. F. Kohlrausch explains these high values—higher than hydrochloric acid—by assuming that the gold chloride becomes completely hydrolyzed.

According to L. Lindet,⁷ both *arsenic trichloride* and *antimony trichloride* dissolve about 2.5 per cent. of auric chloride at 15°, and 22 per cent. at 160°; *stannous chloride* dissolves about 4 per cent. of auric chloride at 160°, and a trace at 0°; the solubility in *titanous chloride*, TiCl_3 , is also small. According to E. C. Franklin and C. A. Kraus, auric chloride is slightly soluble in liquid *ammonia*; and, according to H. B. North, it is soluble in *sulphuryl chloride*, SO_2Cl_2 , and in a mixture of that compound with liquid *sulphur dioxide*. According to F. W. Schmidt, auric chloride is soluble in *alcohol*, *ether*, and *volatile oils*, but in these solvents it slowly decomposes with the reduction and separation of gold. V. Lenher found it to be insoluble in or decomposed by alcohol, ether, *carbon disulphide*, *turpentine*, *pentane*, *hexane*, *chloroform*, *carbon tetrachloride*, *ethyl nitrate*, *benzene*, *nitrobenzene*, *ethyl acetate*, *ethyl propionate*, and *pyridine*. F. Mylius, M. Frank, and R. Willstätter are not all in agreement as to the solubility of auric chloride in ether; according to W. Hampe, when auric chloride is warmed with ether, a yellow gelatinous mass, soluble in water, is formed, and the gold is reduced to aurous chloride and gold. H. H. Morris found that gold chloride may be heated with water in a sealed tube up to the critical temp., 370°, before metallic gold appears. In presence of small quantities of sodium, magnesium, or calcium chloride, gold chloride is more stable, and the reduction to the metal is not observed until the temp. is raised to 450°–460°. The increased stability is attributed to the formation of double chlorides. Calcite and magnesite become plated with gold when heated with gold chloride soln. up to 310°. Sodium, magnesium, and calcium chlorides prevent this action from taking place until the temp. is raised to about 500°. Magnesium hydrocarbonate acts like the normal carbonate, but calcium hydrocarbonate appears to have no influence on the stability of a gold chloride soln. It was also found that gold dissolves in hot hydrochloric acid containing auric chloride; and aurous chloride is formed. D. Avery studied the precipitation of gold from soln. of auric chloride, by charcoal: $4\text{AuCl}_3 + 6\text{H}_2\text{O} + 3\text{C} = 4\text{Au} + 12\text{HCl} + 3\text{CO}_2$.

If a neutral soln. of auric chloride be acidified with hydrochloric acid, or if gold is dissolved in aqua regia, a citron yellow soln. with a slight orange tinge is formed.

The soln. is supposed to contain **hydrochloroauric acid**, HAuCl_4 . Whenever a soln. of auric chloride in the presence of hydrochloric acid, is conc. by evaporation, and allowed to stand over quicklime, long, yellow, deliquescent needles are deposited. According to F. Lengfeld,⁸ P. Schottländer, and R. Weber, these crystals have a composition corresponding with hydrochloroauric acid, $\text{AuCl}_3 \cdot \text{HCl} \cdot 3\text{H}_2\text{O}$ or $\text{HAuCl}_4 \cdot 3\text{H}_2\text{O}$; on the other hand, J. Thomsen's analyses correspond with $\text{AuCl}_3 \cdot \text{HCl} \cdot 4\text{H}_2\text{O}$, and he regards the trihydrated salt as partially effloresced tetrahydrated salt. The eq. conductivity of an approximately normal soln. of hydrochloroauric acid, HAuCl_4 , is $\lambda=410$ at 18° , while for hydrochloric acid $\lambda=301$; and for $\frac{1}{100}N\text{-HAuCl}_3$, $\lambda=560$, and for $\frac{1}{100}N\text{-HCl}$, $\lambda=370$. The temp. coeff. of the conductivity is 0.016 in agreement with the values for other monobasic acids. Hydrochloroauric acid behaves as a monobasic acid and forms a series of well-defined salts—**chloroaurates**. In the electrolysis of the aq. soln. of the chloroaurates, say the potassium salt, the gold accumulates about the anode, the potassium about the cathode; hence the ions are taken to be K^+ and AuCl_4^- .

The chloroaurates.—The alkali chloroaurates are obtained by adding an eq. quantity of the alkali chloride to the solution of hydrochloroauric acid. The rubidium and cesium salts are so sparingly soluble that they form precipitates in moderately conc. soln.; it is not material whether the soln. are acid or neutral, or whether the gold or alkali halide is in excess. The lithium salt is least stable and most soluble; the stability increases, and the solubility decreases with increasing at. wt. of the alkali metal in passing from potassium to cesium. Citron-yellow deliquescent crystals of **dihydrated lithium chloroaurate**, $\text{LiAuCl}_4 \cdot 2\text{H}_2\text{O}$, were obtained by U. Antony and A. Lucchesi⁹ in 1890. The crystals lose their water at 90° , and decompose between 100° and 105° . **Tetrahydrated lithium chloroaurate**, $\text{LiAuCl}_4 \cdot 4\text{H}_2\text{O}$, was obtained by R. Fasbender by adding ether to a soln. of gold and lithium chlorides. T. Rosenblad's determinations of the solubilities of the alkali chloroaurates expressed in grams of the anhydrous salt per 100 grms. of soln. are as follows:

	10°	20°	30°	40°	60°	80°	100°
LiAuCl_4	53.1	57.7	62.5	67.3	76.4	85.7	—
NaAuCl_4	58.2	60.2	64.0	69.4	90.0	—	—
KAuCl_4	27.7	38.2	48.7	59.2	80.2	—	—
RbAuCl_4	4.6	9.0	13.4	17.7	26.6	35.3	44.2
CsAuCl_4	0.5	0.8	1.7	3.2	8.2	16.3	27.5

According to F. Mylius and G. Hüttner, and R. Fasbender, the sodium salt is soluble in alcohol and ether, but the sodium salt cannot be extracted from its aq. soln. by shaking out with ether; 100 parts of 98 per cent. alcohol dissolve 25 parts of the potassium salt, but the potassium salt is insoluble in ether which has been warmed to 100° – 110° to expel the free acid. H. L. Wells and H. L. Wheeler find the rubidium and cesium salts to be insoluble in ether, and soluble in alcohol. R. Fasbender says 100 parts of 98 per cent. alcohol dissolve 1.852 parts of rubidium chloroaurate. L. G. Figuier obtained large orange-yellow rhombic crystals of **dihydrated sodium chloroaurate**, $\text{NaAuCl}_4 \cdot 2\text{H}_2\text{O}$, by evaporating the aq. soln. J. C. G. de Marignac gives the axial ratios $a : b : c = 0.7002 : 1 : 0.5462$. The crystals are stable in air and lose their water of crystallization with difficulty. J. J. Berzelius, and J. F. W. Johnston found only 1.12 per cent. of water was lost at the m.p. At a red heat chlorine is given off. G. Krüss obtained a citron-yellow hygroscopic powder, which he thought to be $\text{NaAuCl}_4 \cdot \frac{1}{2}\text{H}_2\text{O}$, by drying the dihydrated salt for a week over phosphorus pentoxide. This may be a mixture of the anhydrous salt with a little dihydrated salt.

J. Javal made pale yellow rhombic crystals of **dihydrated potassium chloroaurate**, $\text{KAuCl}_4 \cdot 2\text{H}_2\text{O}$, by the spontaneous evaporation of the aq. soln. H. Topsøe gives the axial ratios $a : b : c = 0.8586 : 1 : ?$. According to J. J. Berzelius, the salt effloresces at ordinary temp. in air, forming a sulphur-yellow powder, and at 100° , all the water of crystallization is expelled; the salt melts at a higher temp. and gives

off chlorine. There is also a hemihydrate, $\text{KAuCl}_4 \cdot \frac{1}{2}\text{H}_2\text{O}$, analogous to the sodium salt, which is probably the anhydrous salt with a little of the dihydrate. H. L. Wells and H. L. Wheeler prepared the anhydrous **rubidium chloroaurate** and **cæsium chloroaurate**—the former in yellowish-red, the latter in golden yellow, monoclinic prisms; they also made golden yellow thin rhombic plates of **hemihydrated cæsium chloroaurate**, $\text{CsAuCl}_4 \cdot \frac{1}{2}\text{H}_2\text{O}$, by using an excess of the gold salt—say four mols of auric chloride to one of cæsium chloride—with not much free acid. The rhombic crystals of the hemihydrated cæsium salt have the axial ratios $a : b : c = 0.625 : 1 : 0.24$. On exposure to dry air the crystals lose water and change to monoclinic prisms of the anhydrous salt. H. L. Wells and H. L. Wheeler say the “rearrangement is a beautiful sight when studied under the microscope in polarized light.”

The crystals at first show a uniform action on polarized light; then from different parts of the surface the rearrangement, which is marked by aggregate polarization, commences. It advances, shooting out in various directions in a manner resembling the growth of ammonium chloride crystals under the microscope, until the whole field is covered and light is finally no longer transmitted.

The axial ratios of the monoclinic prisms of potassium chloroaurate are $a : b : c = 1.9180 : 1 : 1.3610$ and $\beta = 95^\circ 24\frac{1}{2}'$; the rubidium salt $1.1954 : 1 : 0.7385$ and $\beta = 75^\circ 22'$; and of the cæsium salt, $1.1255 : 1 : 0.7228$ and $\beta = 71^\circ 36'$. In these salts the replacement of one metal by another has a considerable influence on their form, particularly in the relation of the a -axis to the other axes, and in the angles β , while the replacement of cæsium and rubidium in the trihalides has very little influence on the crystal form. W. Hittorf has investigated the electrolysis of soln. of potassium chloroaurate. According to F. Ephraim, potassium chloroaurate melts at about 357° , but the cæsium salt melts at a rather higher temp. At 440° , however, both salts have vap. press. of about 350 mm. E. H. Duclaux studied the cæsium salts.

H. Ley and G. Wiegner, and W. Peters found that potassium chloroaurate, KAuCl_4 , slowly absorbs the eq. of three mol. parts of ammonia, forming orange **potassium triammino-chloroaurate**, $\text{KAuCl}_4 \cdot 3\text{NH}_3$. The compound loses the ammonia in vacuo. According to F. Ephraim, a mol of pale yellow potassium chloroaurate unites with about twelve mols of ammonia at -18° , forming a dark orange-red ammine which effervesces in water with the evolution of free nitrogen. The similarity in the behaviour of the alkali chloroaurates and auric chloride towards ammonia led F. Ephraim to suggest that they are dissociated by ammonia into their component halides. F. Emich, and E. Bayer have described a mixed **rubidium silver chloroaurate**, obtained by mixing a soln. of auric chloride with silver chloride and rubidium chloride; it appears in the form of blood-red prisms and plates, while **cæsium silver chloroaurate** forms non-transparent cubes and stars. This reaction is proposed as a microchemical test for cæsium and rubidium. The formulæ are of the type $\text{Ag}_n\text{Au}_{2-\frac{1}{2}n}\text{Cl}_6\text{3RbCl}$.

Ammonium chloroaurates, NH_4AuCl_3 , with $2\frac{1}{2}$ and $1\frac{1}{4}$ molecules of water, have been made—the former by the spontaneous evaporation or by cooling of aq. soln. of the two components, and the latter by using soln. with a large excess of acid. L. Darmstädter gave the formula for the first-named salt, $\text{NH}_4\text{Cl} \cdot \text{AuCl}_3 \cdot 3\text{H}_2\text{O}$, and he supposes the pale yellow plates are rhombic with axial ratios, $a : b : c = 0.5059 : 1 : ?$ while the latter salt, according to H. Topsöe, forms pale yellow monoclinic plates with axial ratios $a : b : c = 1.2190 : 1 : 1.2492$ and $\beta = 102^\circ 33'$. Both salts lose water at 100° . According to J. F. W. Johnston, the soln. of the yellow ammonium salts in aqua regia is almost blood-red, and on evaporation gives dark red or purple needle-like crystals. With alcohol, ammonium chloride and greenish-yellow particles of gold separate, and a red soln. is formed which on evaporation gives reddish-yellow prisms which melt when heated and on cooling give a mass of minute cubes. G. K. C. Storr has described a purple sublimate which is formed when a mixture of 15 parts of gold-leaf is heated. These substances have not been closely investigated.

Owing to the insolubility of silver chloride, attempts to make a *silver chloroaurate* by the action of silver carbonate or nitrate and gold chloride have been made. In both cases it was anticipated that the salt, AgAuCl_4 , would be formed, but P. Schottländer, E. Wohlwill, F. Herrmann, F. W. Schmidt, and F. Lengfeld were not successful since the products of the reaction appear to be mixtures of gold oxide and silver chloride. W. B. Pollard¹⁰ sat. a soln. of gold in aqua regia with ammonium chloride, and added silver nitrate. More ammonium chloride was added, and the silver chloride at once began to form brown crystals. When the mixture was heated silver chloride again appeared, but the brown crystals reappeared on cooling. The composition of his crystals corresponded with **ammonium silver auric chloride**, $3\text{AgCl}\cdot 4\text{AuCl}_3\cdot 8\text{NH}_4\text{Cl}$; they were holohedral and rhombic and had axial ratios $a : b : c = 0.5376 : 1 : 0.3210$. The refractive index was 1.74. H. L. Wells modified the method of preparation, and the analysis of his product corresponded with $(\text{NH}_4)_6\text{Ag}_2\text{Au}_3\text{Cl}_{17}$; he failed to make the potassium salt, but he made several complex **cæsium silver auric chlorides**.

P. A. von Bonsdorff prepared the chloroaurates of the alkaline earths by mixing soln. of the component salts in eq. proportions; on evaporation yellow rhombic crystals are obtained which are stable in dry air, and deliquesce in ordinary air—*e.g.* **hexahydrated calcium chloroaurate**, $\text{Ca}(\text{AuCl}_4)_2\cdot 6\text{H}_2\text{O}$; **hexahydrated strontium chloroaurate**, $\text{Sr}(\text{AuCl}_4)_2\cdot 6\text{H}_2\text{O}$; and **hexahydrated barium chloroaurate**, $\text{Ba}(\text{AuCl}_4)_2\cdot 6\text{H}_2\text{O}$. The amount of water in the two last-named salts has been fixed rather by analogy with the calcium salt than by analysis. W. Crookes prepared **thallium chloroaurate**, and also **scandium chloroaurate**, $3\text{ScCl}_3\cdot 2\text{AuCl}_3$. S. Jolin, and M. Holzmann made **cerous chloroaurate**, $\text{CeCl}_3\cdot \text{AuCl}_3\cdot 13\text{H}_2\text{O}$; F. Frerichs and F. Smith, **lanthanum chloroaurate**, $2\text{LaCl}_3\cdot 3\text{AuCl}_3\cdot 21\text{H}_2\text{O}$; and E. Alén, $\text{LaCl}_3\cdot \text{AuCl}_3\cdot 10\text{H}_2\text{O}$; C. A. Matignon, yellow crystals of **praseodymium chloroaurate**, $\text{PrCl}_3\cdot \text{AuCl}_3\cdot 10\text{H}_2\text{O}$, soluble in water; P. T. Cleve, and C. A. Matignon, orange prisms of **samarium chloroaurate**, $\text{SaCl}_3\cdot \text{AuCl}_3\cdot 10\text{H}_2\text{O}$; C. Benedicks, yellow tablets of **gadolinium chloroaurate**, $\text{GdCl}_3\cdot \text{AuCl}_3\cdot 10\text{H}_2\text{O}$; and P. T. Cleve, **yttrium chloroaurate**, $\text{YCl}_3\cdot \text{AuCl}_3\cdot 16\text{H}_2\text{O}$. P. A. von Bonsdorff also prepared dark brown crystals of **magnesium chloroaurate**, $\text{Mg}(\text{AuCl}_4)_2\cdot 12\text{H}_2\text{O}$; **zinc chloroaurate**, $\text{Zn}(\text{AuCl}_4)_2\cdot 12\text{H}_2\text{O}$; dark yellow **cadmium chloroaurate**, $\text{Cd}(\text{AuCl}_4)_2(12\text{H}_2\text{O}?)$; **manganese chloroaurate**, $\text{Mn}(\text{AuCl}_4)_2\cdot 12\text{H}_2\text{O}$; and dark yellow cobalt and nickel chloroaurates. H. Topsøe, however, made crystals of the chloroaurates of these salts of the type $\text{M}''(\text{AuCl}_4)\cdot 8\text{H}_2\text{O}$, as well as **cobalt chloroaurate**, $\text{Co}(\text{AuCl}_4)_2\cdot 8\text{H}_2\text{O}$, and **nickel chloroaurate**, $\text{Ni}(\text{AuCl}_4)_2\cdot 8\text{H}_2\text{O}$. The octahydrated salts of magnesium, nickel, and zinc are monoclinic and isomorphous, with axial ratios $\text{Mg}(\text{AuCl}_4)_2\cdot 8\text{H}_2\text{O}$, $a : b : c = 1.3441 : 1 : 1.7517$ and $\beta = 96^\circ 1'$; $\text{Ni}(\text{AuCl}_4)_2\cdot 8\text{H}_2\text{O}$, $a : b : c = 1.3411 : 1 : 1.7562$ and $\beta = 95^\circ 42'$; and $\text{Zn}(\text{AuCl}_4)_2\cdot 8\text{H}_2\text{O}$, which resemble the magnesium salt, but the crystals are too deliquescent to permit of exact measurement. The crystals of octahydrated manganese chloroaurate are triclinic and isomorphous with those of the corresponding cobalt salt, but are too deliquescent for exact measurement; the axial ratios of $\text{Co}(\text{AuCl}_4)_2\cdot 8\text{H}_2\text{O}$ are $a : b : c = 0.9238 : 1 : 0.9112$, and $\alpha = 101^\circ 25'$, $\beta = 103^\circ 23'$, and $\gamma = 92^\circ 5'$.

W. Gibbs and F. A. Genth prepared crystals of double salts of auric chloride with luteo- and xantho-cobalt chlorides. The former precipitates as a yellow salt sparingly soluble in water, soluble in hydrochloric acid, and with a composition $[\text{Co}(\text{NH}_3)_6]\text{Cl}_3\cdot \text{AuCl}_3$; the latter is obtained in brownish-yellow prismatic crystals by evaporation of a mixed soln. of the component salts. They have the composition $[\text{Co}(\text{NH}_3)_5\text{NO}_3]\text{Cl}_2\cdot \text{AuCl}_3$. Double salts of auric chloride with phosphorus pentachloride, $\text{AuCl}_3\cdot \text{PCl}_5$, have been made by L. Lindet; R. H. Pickard and J. Kenyon made double salts of the type $2\text{R}_3\text{PO}_4\cdot \text{HAuCl}_4$, where R denotes the organic radicles CH_3 , C_2H_5 , C_3H_7 , C_6H_5 , and C_7H_7 . L. Lindet made a double salt with sulphur tetrachloride, $\text{AuCl}_3\cdot \text{SCl}_4$; selenium tetrachloride, $\text{AuCl}_3\cdot \text{SeCl}_4$; silicon tetrachloride, antimony pentachloride, tin chloride, and titanium chloride; and J. J. Sudborough, $\text{AuCl}_3\cdot \text{NOCl}$. Numerous compounds of auric chloride with organic radicles are known.

The properties of acid and neutral solutions of auric chloride.—G. Massol and

A. Faucon¹¹ have measured the ultra-violet absorption spectrum of soln. of hydrochloroauric acid, and found the rays of the shortest wave length are absorbed; there is an absorption band between $\lambda=2900$ and $\lambda=3250$; and the transparency is a maximum between $\lambda=2600$ and $\lambda=2700$. T. Svedberg and N. Pihlblad observed that the maximum absorption with very dil. soln. of hydrochloroauric acid mixed with a soln. of phosphorus in ether, is at first displaced a little towards the ultra-violet, and then as time goes on the maximum absorption is slowly and continuously displaced towards the visible spectrum. There is a continuous change from gold soln. with a known degree of dispersion (size of particle) and absorption in the visible spectrum to hydrochloroauric acid which has maximum absorption in the ultra-violet. According to G. Besseyre, the neutral soln. gradually deposits flecks of metallic gold when it is allowed to stand in a closed vessel in the shade, but the acid soln. remains unchanged. According to E. Sonstadt, light decomposes very dil. aq. soln. of auric chloride with the separation of gold, and the formation of hydrogen peroxide. T. Svedberg says that prolonged illumination decomposes the soln., and that ultra-violet light reduces hydrochloroauric acid to colloidal gold at a speed proportional to the intensity of the light. E. P. Perman finds radium bromide reduces soln. of gold chloride to the metal. N. W. Fischer observed similar results in a closed vessel with an atm. of nitrogen. Soln. of gold chloride are very susceptible to reducing agents, some of which reduce the soln. to metallic gold, some to gold oxide, others to colloidal gold. A. Oberkampf reported that a neutral soln. of gold chloride is coloured purple-red by hydrogen without forming a precipitate. There are, however, other contradictory reports—J. L. Proust, and C. Schweigger-Seidel obtained neither a coloration nor precipitation; C. Buisson and L. G. Figuiet, and W. J. Russell obtained a brown precipitate. F. Emich and J. Donau reduced the dil. hydrochloroauric acid by allowing a hydrogen flame to play upon it; E. Hatschek and A. L. Simon reduced a soln. of auric chloride in silicic acid by hydrogen and coal gas. E. Hatschek and A. L. Simon, and J. Donau obtained a red or violet colloidal soln. of gold by passing carbon monoxide into a 0.002–0.04 per cent. soln. of auric chloride. M. E. Diemer reduced the warm chloride to the metal with this gas.

L. Vanino and L. Seemann found that **hydrogen peroxide** in alkaline soln. rapidly precipitates the metal completely: $2\text{AuCl}_3 + 3\text{H}_2\text{O}_2 + 6\text{KOH} = 2\text{Au} + 6\text{KCl} + 6\text{H}_2\text{O} + 3\text{O}_2$. The precipitate appears bluish-black by reflected and bluish-green by transmitted light; 0.00003 grm. of gold in 10 c.c. of soln. gives a bluish-red coloration by this reaction. According to E. Knövenagel and E. Ebler, the precipitation is not complete in ammoniacal or acid soln.; and L. Rössler, the action in acid soln. is slow, but rapid and complete in the presence of lithium or potassium carbonates. F. Doerincckel, and T. Svedberg and K. Inouye prepared colloidal gold soln. by treatment with hydrogen peroxide. According to N. Dhar, auric chloride reacts more readily with reducing agents when an oxidizing agent is present, e.g. the reduction with hydrogen peroxide is effected in a few seconds if a few drops of a soln. of potassium permanganate be added. The action of a soln. of an **alkali percarbonate** is likewise affected by the permanganate.

N. W. Fischer found that **sulphur** is without action on soln. of gold chloride, but if hot some gold is precipitated. W. Skey reported that gold is precipitated from soln. of gold chloride as a thin skin of the metal on the **sulphides** of copper, gold, zinc, mercury, arsenic, bismuth, lead, tin, molybdenum, iron, and platinum; and P. V. Gladkoff found gold is precipitated by the addition of copper pyrites to soln. of auric chloride, and with dil. soln., iron replaces the gold in the soln. C. Palmer and E. S. Bastin noted that natural sulphides, **arsenides** and **antimonides**—e.g. pyrites stibnite, millerite, lead glance—precipitate gold from auric chloride soln. with very different velocities. A. Cossa has studied the action of molybdenum glance; V. Lenher, of calaverite, sylvanite, coloradoite, calgoorlite, and nagyagite. C. H. Pfaff found that **hydrogen sulphide** precipitates brown flakes of auric sulphide at ordinary temp. from soln. of auric chloride; with one part of gold in 10,000

parts of liquid, a brown coloration is produced ; the colour is fainter with 1 : 20,000 to 1 : 40,000 ; and scarcely perceptible with 1 : 80,000. When hydrogen or steam containing a very small trace of hydrogen sulphide is passed into a soln. of auric chloride, a purple-brown colour is first produced, then a purple-red, and finally a violet colour. According to A. Levot, and U. Antony and A. Lucchesi, aurosoauric sulphide is precipitated from cold soln., and metallic gold from hot soln. According to A. Ditte, hydrogen sulphide precipitates auric sulphide, Au_2S_3 , only from acid soln. ; in neutral soln., the first few bubbles of hydrogen sulphide give a brown coloration and the sat. liquid is transparent and can be filtered without changing the colour, but after standing 24 hrs. in a closed vessel, the particles coagulate. The addition of hydrochloric acid to the brown liquid precipitates gold as a black powder. In general, hydrogen sulphide precipitates brown metallic gold from hot soln. of gold chloride : $8\text{AuCl}_3 + 3\text{H}_2\text{S} + 12\text{H}_2\text{O} = 24\text{HCl} + 3\text{H}_2\text{SO}_4 + 8\text{Au}$; and, according to J. L. Lassaigne, black gold sulphide is precipitated from cold soln. : $8\text{AuCl}_3 + 9\text{H}_2\text{S} + 4\text{H}_2\text{O} = 24\text{HCl} + \text{H}_2\text{SO}_4 + 4\text{Au}_2\text{S}_2$; the disulphide is sparingly soluble in acids, but dissolves in aqua regia ; it is sparingly soluble in ammonium sulphide, but soluble in soln. of potassium sulphide, forming a soluble sulpho-salt, KAuS_2 , from which hydrochloric acid precipitates yellowish-brown sulphide, Au_2S_3 . **Ammonium sulphide** gives a black or brown precipitate of auric sulphide which is soluble in an excess—especially on warming ; **sodium thiosulphate**, said H. Fizeau, precipitates auric sulphide, Au_2S_3 , from soln. of auric chloride. According to P. Berthier, and C. Winkler, **sulphur dioxide** reduces neutral or acid soln. of gold chloride, $2\text{AuCl}_3 + 3\text{H}_2\text{SO}_3 + 3\text{H}_2\text{O} = 3\text{H}_2\text{SO}_4 + 6\text{HCl} + 2\text{Au}$, so that the liquid in light appears to have a bluish opalescence ; on boiling, gold is deposited as a brown powder. H. Rose said that in the cold very dil. soln. are only decolorized, and when heated they are reduced ; and H. W. F. Wackenroder added that if very dil., and a great excess of hydrochloric acid is present, the soln. remains quite clear, and gold is precipitated when the soln. is diluted, or the acid neutralized with ammonia. M. E. Demier and V. Lenher showed that with many chlorides, aurous chloride is an intermediate stage in the reduction. N. Dhar found that the reduction of auric chloride by sulphurous acid is accelerated by potassium permanganate. According to A. Haase, if a conc. soln. of gold chloride, sat. with ammonia, is treated with sulphur dioxide, a voluminous flesh-coloured precipitate of **ammonium aurosulphite** is formed. P. Berthier said that **alkali sulphites** act like sulphurous acid ; and H. Rose, that the reduction occurs only with a prolonged boiling and if the soln. is sat. with hydrochloric acid. E. Hatschek and A. L. Simon prepared a gold sol by reduction of dil. auric chloride with sulphur dioxide. O. Brunck used **sodium hyposulphite** as a reducing agent in the preparation of colloidal soln. of gold. N. W. Fischer found **selenium** acts on gold only when the soln. is hot, while R. Hall and V. Lenher found that **tellurium** reduced cold soln. ; and V. Lenher, that **hydrogen telluride** reduces the salt to metal.

Aq. **ammonia** or **ammonium carbonate** precipitates most of the metal as dirty yellow fulminating gold, $[\text{Au}(\text{NH}_3)_2(\text{OH})_2]\text{OH}$, which is the more soluble the greater the acidity of the soln. : $\text{HAuCl}_4 + 6\text{NH}_3 + 3\text{H}_2\text{O} = 4\text{NH}_4\text{Cl} + [\text{Au}(\text{NH}_3)_2(\text{OH})_2]\text{OH}$, the precipitate explodes when warmed or by concussion. H. Rose found that many organic substances—gum, glucose, cane sugar, etc.—retard the precipitation. According to C. Winkler, A. Lainer, and E. Knövenagel and E. Ebler, **hydroxylamine** or **hydrazine** in alkaline ammoniacal or acid soln. reduce auric chloride to metallic gold. A. Gutbier and F. Resenscheck used **phenylhydrazine** for the preparation of gold hydrosols. A. Gutbier obtained blue, very stable gold hydrosol by adding a dil. soln. of hydroxylamine or hydrazine hydrate (1 : 2000) to a neutral soln. of auric chloride (1 : 1000), avoiding an excess of the reducing agent. The reduction by hydrazine has also been studied by T. Svedberg and K. Inouye, and E. Pozzi-Escot. N. W. Fischer found that **nitric oxide** or the fumes of nitric acid reduce neutral and acid soln. to gold. M. E. Diemer reduced auric chloride to the metal by warming it in a stream of **nitric oxide**. N. W. Fischer, and P. E. Jameson

observed that **potassium nitrite** precipitates the gold from auric chloride soln. rapidly and completely; and, according to E. Frémy, **nitrous acid** or **arsenic acid** gives a precipitate with conc. soln. of gold chloride, and at 150° the mixture gives off chlorine, and forms aurous chloride and the metal; on account of its volatility **nitric acid** does not act in the same way. J. Juncker and P. J. Macquer observed that **phosphorus** precipitates gold, as also do **phosphorous acid** and **hypophosphorous acid**; the reactions were studied by A. Sieverts, and M. Major. M. C. Lea added 15 c.c. of a 10 per cent. soln. of **sodium hypophosphite** to 1 c.c. of auric chloride (0.1 grm. of gold), and a drop of sulphuric acid, and in 2–4 min., as the soln. darkens in colour, 30 c.c. of water. The resulting hydrosol of gold is first green and then blue. According to H. Rose, **phosphine** precipitates metallic gold, and he contradicts the statement of A. Oberkampf that if an excess of phosphine is used some gold phosphide is formed. P. Pascal found that the alkali **ferropyrophosphates**—e.g. $K_8Fe_2(P_2O_7)_3$ —reduce gold salts in the cold, and with dil. soln. of the gold salt, the metal remains in the colloidal condition. E. Soubeiran, and V. A. Jacquelin say that **arsine** precipitates the gold after forming arsenious acid: $2AuCl_3 + AsH_3 + 3H_2O = As(OH)_3 + 6HCl + 2Au$; with **stibine**, the reaction is represented: $2AuCl_3 + SbH_3 = SbCl_3 + 3HCl + 2Au$. A. Levol said that *arsenious oxide* in a soln. of hydrochloric acid precipitates gold slowly in the cold, rapidly when heated; and E. Rupp represented the reaction, $3As_2O_3 + 4AuCl_3 + 6H_2O = 3As_2O_5 + 12HCl + 4Au$. According to A. Carnot, if a few drops of a dil. soln. of gold chloride be treated with a drop of arsenic acid, a few drops of ferric chloride, and two or three drops of hydrochloric acid, and then dil. to 100 c.c. and a piece of zinc dropped in the liquid, the soln. around the zinc will assume a purple colour. The zinc should be moved about so as to disseminate the colour; 0.00003 grm. of gold in 10 c.c. of liquid can be readily detected in this way—with phosphoric acid in place of arsenic acid—the coloration is blue to violet. V. Lenher found that in the presence of **sodium chloride**, **manganous chloride**, etc., yellow soln. of auric chloride are reduced to a colourless soln. of a double salt of aurous chloride. **Antimonious chloride** precipitates a gold-coloured powder from dil. soln. of auric chloride, but a soln. of antimonious oxide in hydrochloric acid does not reduce the gold chloride. A soln. of **antimonic oxide** in hydrochloric acid does not reduce gold chloride soln. of **potassium** or **sodium hydroxide** gives a black precipitate which does not change on boiling. A. Stähler reduced a conc. soln. of auric chloride by adding a few drops of a soln. of **titanous chloride** and obtained a violet powder of titanic oxide coloured with colloidal gold.

From the position of gold in the electrochemical series it might be anticipated that most of the metals will displace the gold from soln. of auric chloride, and this is in accord with the behaviour of the base metals; even mercury, silver, palladium, and platinum precipitate the metal as a brown powder or as a surface gilding. According to V. Lenher, active metals like magnesium, aluminium, zinc, and iron, precipitate gold directly; while the inactive metals like antimony, bismuth, cadmium, lead, copper, and mercury, act more slowly, probably with the intermediate formation of aurous chloride. C. Boussin studied the precipitation of gold by **magnesium**; N. W. Fischer noted that **zinc** rapidly precipitates gold as a brown powder; **cadmium**, slowly; **mercury**, slowly with the formation of gold amalgam. N. W. Fischer also noted that **arsenic** precipitates gold rapidly; **antimony** and **bismuth**, slowly—with the two latter, gilding occurs. G. L. Lesage says that gold salts give a purple coloration with arsenic, antimony, or bismuth. N. W. Fischer and J. Pelletier say that **tin** precipitates metallic gold or purple of Cassius or both, and, according to N. W. Fischer, **lead** rapidly precipitates dendritic gold. According to M. Dauvé, **aluminium** forms colloidal gold. N. W. Fischer also noted that **manganese** reduces gold salts rather feebly; **iron** and **cobalt** rapidly precipitate gold as a brown powder; and **nickel** behaves similarly, but more slowly. C. Winkler found that spongy or strongly heated nickel or cobalt do not precipitate eq. amounts of gold, for the gold always contains some nickel or cobalt. Reguline cobalt or nickel which has been

fused in the oxy-coal-gas flame, precipitates in 12 to 24 hrs. virtually pure gold, while if the nickel or cobalt contains iron, ferric chloride passes into soln., and if the soln. is warm, some basic ferric chloride may be formed, and the precipitated gold is contaminated with iron. N. W. Fischer found that **copper, silver, and palladium** precipitate gold, **platinum** reduces gold from neutral soln. and from soln. of sodium chloroaurate, but not from acid soln. ; and he also found that the platinum is active after it has been boiled with hydrochloric or nitric acid or aqua regia, but not after boiling with sulphuric acid. E. F. Smith found finely divided **molybdenum** precipitates gold from soln. of gold chloride, and that finely divided **tungsten** acts slowly, but rapidly in alkaline soln. M. Lazowsky found soln. of auric chloride to be reduced by charcoal, and the gold is deposited on the **carbon**. The reduction has also been studied by A. Liversidge, W. O. de Coninck, A. Tingle, S. Brussoff, G. A. Koenig, D. Avery, M. Green, etc. H. Koch has shown that the gold is adsorbed by the various forms of charcoal when the quantities of gold in soln. are extremely small. The results with dil. soln. of sodium chloroaurate are in accord with the ordinary adsorption formula. This property of charcoal was employed by H. Koch to estimate the quantity of gold in sea-waters.

H. Rose, in his *Ausführliches Handbuch der analytischen Chemie* (Braunschweig, 1851), stated that **potassium ferrocyanide** gives an emerald green coloration with soln. of gold chloride and **potassium ferricyanide** gives no precipitate ; E. Frémy also said that no precipitate is formed, and E. Jordis, in his *Electrolyse wässeriger Metall-salzlösungen* (Halle a. S., 1901), gave the theoretical equation : $4\text{AuCl}_3 + 3\text{K}_4\text{FeCy}_6 = \text{Au}_4(\text{FeCy}_6)_3 + 12\text{KCl}$. According to E. Beutel's study, the nature of the reaction between hydrochloroauric acid and potassium ferrocyanide is dependent upon the relative proportions of the reacting constituents. The colours produced—yellow, brown, blue, or green—are at first clear, and become turbid on exposure to light, and if the mixture be allowed to stand long enough, a precipitate is always formed. Direct sunlight accelerates the speed of the reaction in a very marked way. E. Beutel made up soln. *A* with 10 grms. of hydrochloroauric acid per litre, and soln. *B* with 10 grms. of potassium ferrocyanide per litre. Mixtures ranging from $25A$ to $3A+B$ give mainly aurous cyanide ; with $A+B$, the soln. gradually changes from light green to dark brown ; and it remains in this state a long time in diffused daylight without forming a precipitate, but on exposure to sunlight the colour changes to emerald green, dark blue, and finally deposits a blue precipitate. The emerald green soln. obtained with $A+2B$ gradually deposits blue ferric ferrocyanide, leaving a yellow liquid containing an excess of the ferrocyanide ; the reaction is hastened by warming. Similar results were obtained with $A+3B$ to $5B$, but the blue precipitate takes longer to form. Green soln. were obtained with $A+10B$ to $25B$, and these deposit small amounts of ferric hydroxide on exposure to sunlight leaving a yellow soln. of potassium ferro- and ferri-cyanide. The reaction with ferricyanide seems to be similar, but it has not been studied in detail. According to G. Mazzaron (1898), gold chloride gives chlorine not chromyl chloride when treated with potassium dichromate and sulphuric acid.

When **potassium or sodium hydroxide** is added to a conc. soln. of gold chloride, a reddish-brown precipitate of auric hydroxide is deposited : $\text{AuCl}_3 + 3\text{KOH} = 3\text{KCl} + \text{Au}(\text{OH})_3$. This precipitate looks like a ferric hydroxide precipitate ; and it is soluble in an excess of the alkali lye as alkali aurate—*e.g.* K_2AuO_2 . Dil. soln. of gold give no precipitate with alkali lye because the amount of alkali added suffices for the formation of the soluble aurate. According to A. Oberkampf, and J. Pelletier, **barium, strontium, calcium, or magnesium oxide** precipitates yellow auric oxychloride or, according to J. B. A. Dumas, auric hydroxide ; the precipitate is contaminated with the alkaline earth. According to L. G. Figuier, and A. S. Duportal and J. Pelletier, cold soln. of the alkali carbonates or bicarbonates do not precipitate gold from soln. of auric chloride, but when boiled, L. G. Figuier found a precipitate of gold hydroxide. E. Desmarest found that when **calcium carbonate** (marble) is moistened with a soln. of gold chloride

there are no signs of a reaction in daylight, but in sunlight, or when warmed, a purple colour appears. According to H. H. Morris, calcite and magnesite become plated with gold when heated with gold chloride to 310°; the presence of sodium, magnesium, and calcium chlorides prevent the action taking place until the temp. reaches 500°. Magnesium hydrocarbonate acts like the normal carbonate, but calcium hydrocarbonate appears to have no influence on the stability of a soln. of auric chloride. H. Rose found neither **barium carbonate** nor **sodium phosphate** is affected by gold chloride soln. According to H. H. Morris, a soln. of gold chloride is decomposed when heated in a steel bomb to about 365°, the critical temp. of water, but if sodium or magnesium chloride be present, the decomposition temp. is raised to 450°–460°. If heated in the presence of calcite or magnesite, the minerals become plated with octahedral dendritic crystals of gold. **Sodium orthophosphate** does not give a precipitate with soln. of auric chloride, and, according to J. F. Persoz, the latter soln. remains quite clear if it is mixed with **sodium pyrophosphate**, but the mixture is decolorized when heated. Alcohol precipitates sodium chloride, and, when the soln. is evaporated under conditions where organic matters are excluded, crystals of sodium chloride first separate, then sodium pyrophosphate, and finally a syrup is obtained containing sodium, gold, and pyrophosphoric acid in the proportions 26 : 92 : 75, possibly $\text{Na}_3\text{Au}_4(\text{P}_2\text{O}_7)_5$, *sodium pyrophosphato-aurate*. According to W. Gibbs, if this soln. is treated with aq. ammonia, a white precipitate appears which rapidly becomes yellow and crystalline. Its composition is given as $3\text{Na}_2\text{O} \cdot 14\text{Au}_2\text{O}_3 \cdot 6\text{P}_2\text{O}_5 \cdot 14\text{NH}_3 \cdot 24\text{H}_2\text{O}$ —*sodium ammino-pyrophosphato-aurate*. It is stable at ordinary temp., but explodes vigorously when heated to 170°. If a soln. of sodium aurate is poured into one of **sodium silicate**, P. P. von Weimarn found that after some minutes the yellow colour disappears, and a 0.1 per cent. soln. remains clear for some days. The reaction is here regarded as involving the *Selbstreduktion von Aurichlorid*.

According to V. Lenher, organic reducing agents—formic acid, formaldehyde, etc.—as a rule, reduce auric chloride to the metal, and not to aurous chloride; while the inorganic reducing agents—sulphurous and arsenious acids—reduce auric to aurous chloride, although some carry the reduction to the metal stage. Gold chloride soln. are reduced to metallic or colloidal gold by many organic substances. N. Dhar found that the reduction of auric chloride by organic acids—**oxalic, tartaric, citric, and malonic acids**—is hastened in the presence of an oxidizing agent like potassium permanganate. J. Pelletier and E. Priwoznik found oxalic acid, $(\text{COOH})_2$ or **ammonium oxalate**, completely precipitates gold from neutral or acid soln., slowly in darkness, rapidly in light or when warm: $2\text{AuCl}_3 + 3(\text{COOH})_2 = 6\text{HCl} + 6\text{CO}_2 + 2\text{Au}$, according to H. Rose, a large excess of hydrochloric acid or alkali chlorides hinders the precipitation. C. A. L. de Bruyn prepared colloidal soln. of gold by using a dil. soln. of gold chloride, gelatine, and oxalic acid. According to B. Morin and V. Lenher, **formic acid** and **potassium formate** do not precipitate all the gold from dil. soln.; and even if boiled with an excess of the potassium salt, about one-third of the gold escapes precipitation. V. Lenher noted that in acid soln. metallic gold is precipitated by formic acid only after long standing, while in alkaline soln. the action is quicker, but even then it is slow. Lactic, acrylic, pyracemic, and phenylacetic acids behave similarly. J. J. Berzelius found that pyracemic acid precipitates gold completely from hot soln. J. Pelletier found that **potassium tartrate, acetate, or citrate** precipitates metallic gold without the evolution of carbon dioxide; but, added R. Phillips, sodium tartrate requires heat to start the precipitation which then proceeds rapidly. N. Awerkieff, and J. Pelletier showed that the presence of an excess of hydrochloric acid retards the action of all these reagents. According to H. C. Neish, *m*-**nitrobenzoic acid** does not precipitate gold from a soln. of auric chloride. V. Lenher found that with acid soln. of gold chloride **formaldehyde** is without appreciable action even after the mixture had stood for some months, but with alkaline soln., gold is precipitated at once. R. Zsigmondy, F. N. Schulz, C. Thomae, F. Küssert, and A. Gutbier have prepared

gold hydrosols by means of this reagent. According to G. Armani and J. Barboni, the violet coloration with formaldehyde is produced if one part of gold is present in 100,000 parts of liquid. Similar results were obtained with other aldehydes. For instance, F. Hartwagner found that **acetaldehyde** reduces acid and alkaline soln. of auric chloride, forming colloidal soln., and N. Castoro used **acrolein** for the same purpose. According to V. Lenher, **valeric, anisic, benzylic, salicylic, and cinnamic aldehydes** are immiscible in water, and they extract the auric chloride from its aq. soln. as much as ether or carbon disulphide extracts bromine or iodine. The **ketones** behave like the aldehydes in acid and alkaline soln. and the immiscible ketones—**acetone, methyl-ethyl-ketone, methyl-butyl-ketone, acetylacetone, acetophenone, and pulegone**—extract gold chloride from its aq. soln. Some of the insoluble esters—**ethyl, isopropyl, butyl, and isobutyl acetates, diethyl oxalate, amyl formate, ethyl malonate, succinate, malate, or acetoalate**—also extract gold chloride from its aq. acidified soln.; but with mixed esters—**methyl, ethyl, or amyl benzoates**; and **methyl or ethyl salicylate**—no extraction occurs. The immiscible alcohols—**butyl, isobutyl, capryl, amyl, tertiary amyl, benzyl, or valeryl alcohol**—extract auric chloride from its aq. acidified soln., with soln. of gold chloride. The partially miscible alcohols—**propyl, isopropyl, secondary butyl, or allyl alcohol**—which, on the addition of magnesium or sodium chloride separate into two layers, the gold salt collects in the alcohol layer. According to N. Castoro, allyl alcohol gives a pale red coloration with acid soln. of gold chloride. M. Müller used **glycerol** as reducing agent for gold hydrosols. L. Vanino prepared colloidal soln. of gold with **methyl alcohol** as reducing agent. L. Garbowsky, A. Hanriot, and F. Henrich found that the **phenols—hydroquinone, resorcin, paracresol, etc.**—quickly precipitate gold from acid or alkali soln. No reduction or extraction occurs with **methylene dichloride, methyl iodide, chloroform, carbon tetrachloride, amyl bromide, acetylene tetrachloride, or tetrabromide, monobromobenzene, benzoyl chloride, or benzyl chloride.** Carbon disulphide does not extract gold from its aq. soln.; **thiophene** does. K. Lederer obtained a feeble turbidity with **diphenyl selenide**. According to V. Lenher, the immiscible cyanides—**methyl, ethyl, or benzyl cyanide, or benzonitrile**—extract gold from its aq. soln., but they exert no appreciable reducing action. The aliphatic amines have not a pronounced reducing action, but the aromatic amines—**aniline, naphthylamine, dimethylaniline, ethyl-aniline, o- or m-toluidine**—precipitate gold from acid or alkaline soln. **Pyridine, piperidine, and picoline**, with sodium chloride or hydroxide, form two layers with aq. soln. of gold chloride, and the organic solvent retains the gold salt. According to J. E. Saul, a 0.1 per cent. soln. of **p-phenylenediamine** coloured a 0.0001 per cent. soln. of auric chloride greenish-yellow, and, according to R. J. Carney, **tetramethyldiaminodiphenylmethane** gave a purple colour in the presence of 0.0001 grm. of gold.

All the sat. **hydrocarbons** which have been tried exert no appreciable reducing or extracting powers on soln. of auric chloride. According to H. Erdmann and P. Köthner, **acetylene** colours soln. of auric chloride dark reddish-violet, and a black precipitate is formed which when heated gives a smell of aldehyde or paraldehyde; J. C. Blake obtained a colloidal soln. with acetylene as precipitant, and the same reducing agent was utilized by W. R. Whitney and J. P. Blake, and by E. Hatschek and A. L. Simoni.

C. H. Pfaff found that **gallic acid**, and H. Rose that **pyrogallol** colour a soln. of auric chloride yellow, then brown, and finally precipitate the gold. According to Count Rumford, **ether and volatile oils** precipitate gold only in sunlight or when warmed, say to 100°. F. Mylius found that ether extracts over 90 per cent. of hydrochloroauric acid from its aq. soln. if at least 2 per cent. of hydrochloric acid is present. The solubility of auric chloride in the presence of copper is depressed; according to F. Mylius and C. Hüttner, this is due to the formation of $2\text{AuCl}_3 \cdot \text{CuCl}_2$. According to J. L. Proust, **sugar, mannite**, and decoctions of various dye-woods, form reddish-purple precipitates of gold.

According to B. Morin, at ordinary temp., **ferrous salts** completely precipitate the gold as a brown powder from neutral or acid soln.: $\text{AuCl}_3 + 3\text{FeSO}_4 = \text{Fe}_2(\text{SO}_4)_3 + \text{FeCl}_3 + \text{Au}$. According to J. L. Lassaigne, a soln. with one part of auric chloride in 40,000 parts of liquid gives a brown coloration; with 1:80,000, a sky-blue coloration; with 1:160,000, a pale violet, even by reflected light; with 1:320,000, a pale violet; and 1:640,000 produces a scarcely perceptible violet tinge; and, according to B. Morin, hydrochloric acid favours the action, while in hot soln. the gold is coagulated. According to H. Rose, a very few ferrous salts reduce gold chloride soln. in the presence of alkali chlorides, and the addition of ferrous sulphate to a soln. of gold chloride in alkali lye gives a black precipitate of ferric aurous oxide; with very dil. soln. a purple colour is produced rivalling in sensitiveness that produced by stannous chloride. H. Rose also stated that **manganese, nickel, and cobalt sulphates** produce similar results. A. D. Brockaw (1913) observed that **manganous chloride** precipitated gold, while L. L. de Koninck (1881) showed that manganous sulphate or chloride reduces gold soln. rapidly in sunlight, slowly in darkness. W. O. de Coninck found that light or heat has very little influence on the reduction of gold salts by manganous sulphate, and that heat has very little action on the reduction with manganous chloride. **Stannous chloride** precipitates finely divided gold from dil. or conc. acid or neutral soln. of gold chloride. The precipitate—purple of Cassius—is at first reddish-purple and then changes to brown; the brown becomes purple again if nitric acid be added. Purple of Cassius is a mixture of tin oxide with very finely divided gold: $2\text{AuCl}_3 + 3\text{SnCl}_2 = 3\text{SnCl}_4 + 2\text{Au}$. According to J. L. Lassaigne, a soln. with one part of gold in 10,000 parts of liquid gives a red precipitate; with 20,000 to 40,000 parts of liquid a claret-red coloration; with 80,000 parts of liquid a brownish-red coloration; with 160,000 to 320,000 parts of liquid a pale brown coloration; and with 640,000 parts of liquid a scarcely perceptible coloration. According to C. Buisson, a mixture of auric chloride with antimony trichloride, or bismuth chloride and hydrochloric acid, gives a purple precipitate with ferrous sulphate or mercurous nitrate; but E. D. Desmarest says that a precipitate is produced, but no purple coloration. According to J. L. Proust, a soln. of **cuprous chloride** in hydrochloric acid, and, according to C. Löwig, a soln. of **cuprous bromide** in hydrobromic acid, precipitate gold—the former reagent was used by W. O. de Coninck for preparing a colloidal gold soln. J. L. Proust also stated that **mercurous nitrate** gives a dark blue flocculent precipitate, which, after calcination, is bluish-black gold powder containing gold, mercury, and chlorine; according to N. W. Fischer, mercuric oxide and red auric oxide; and, according to L. G. Figuier, aurous oxide. J. L. Proust also stated that the precipitate produced by **mercuric nitrate** is a mixture of auric oxide, mercurous chloride, mercuric oxide, and water. J. Pelletier noted that **silver nitrate** or **silver sulphate** precipitates a yellowish-brown mixture of auric oxide and silver chloride from neutral soln. of gold chloride. According to J. Jacobsen, the pale brown precipitate is $4\text{AgCl} \cdot \text{Au}(\text{OH})_3$. L. Vanino and L. Rössler reduced auric chloride to aurous chloride by heating it to about 200° ; when a soln. of 0.055 grm. of auric chloride in a litre of water or acetone is heated on a water-bath for about half a day, a mirror of gold is formed by what is called the *Selbstoxydation von Aurochlorid*. J. Pelletier found **potassium iodide** precipitates yellow gold iodide, and A. Pleisch obtained a similar precipitate four hours after the addition of hydriodic acid to auric chloride. **Potassium cyanide** gives a yellow precipitate soluble in excess; **mercuric cyanide** gives no precipitate with aq. soln., but H. Rose said that a yellow precipitate is formed if mercuric cyanide be added to a soln. of auric chloride in aq. alcohol.

According to V. Lenher, the photographic developers—pyrogallol, hydroquinone, eikonogen, metaquinone, edinol, ortol, glycine, dianol, metol, adurol, and amidol—either acid or alkaline, instantly precipitate gold from auric chloride soln. V. Lenher further found that **ethylcyano-acetic ester, epichlorhydrin, acetic anhydride, paraldehyde, citral, guaiacol, acetone cyanhydrin, and amyl**

nitrate extract gold chloride from its aq. soln., while *amyl nitrate*, *nitrobenzene* partially extract gold chloride from its aq. soln.; and *ethyl dichloroacetate*, *ethyl trichloroacetone*, *ethyl chlorocarbonate*, *nitromethane*, *ethyl nitrate*, *nitrotoluene*, *allyl mustard oil*, *phenetole*, and *anethole*, are without extractive power; *tributyryl* distributes the gold chloride in two layers; while *pyrrol*, *anisidine*, *phenetidine*, β -*benzaldoxime*, and *phloroglucinol* more or less quickly reduce auric chloride soln. to metallic gold; and *vanillin*, *methylvanillin*, and *coumarin* precipitate gold from alkaline soln., but in acid soln. *vanillin* alone gives a reddish-brown precipitate which is insoluble in water and in dil. acid. K. A. Hofmann and D. Storm observed that *triformaltrisazine* reduces alkaline soln. of gold chloride. M. Wunder and V. Thüringer found *dimethylglyoxime* precipitates gold quantitatively from acid soln. of the chloride. A. Levof found that *chloral hydrate* precipitates gold quantitatively in alkaline soln., but, according to F. Hartwagner, reduction occurs in acid soln. G. Malatesta and E. di Nola say that a soln. of a gram of *benzidine* in 10 c.c. of acetic acid and 50 c.c. of water gives a deep blue coloration with dil. soln. of gold chloride, and that the colour gradually turns violet. M. Rogier and M. Fiore say that *sodium glycerophosphate* gives no precipitate with gold chloride.

REFERENCES.

- ¹ B. Valentine, *Offenbarung der verborgenen Handgriffe*, Erfurth, 1624; R. Boyle, *Experiments and Observations on Colours*, London, 1663; *Experimenta et observationes physicae*, London, 1691; O. Tachen, *Hippocrates chymicus*, Venice, 1666; J. R. Glauber, *Furnis novis philosophicis*, Amsterdam, 1648; J. von Löwenstein-Kunckel, *Philosophia chemica experimentis confirmata*, Amstelodami, 1677; *Vollständiges Laboratorium chymicum*, Berlin, 1730; J. C. Orschall, *Sol sine veste*, Augsburg, 1684.
- ² J. Thomsen, *Journ. prakt. Chem.*, (2), 13. 337, 1876; E. Petersen, *ib.*, (2), 46. 328, 1892; (2), 48. 88, 1893; G. Krüss and F. W. Schmidt, *ib.*, (2), 38. 77, 1888; *Zeit. anorg. Chem.*, 3. 42, 1893; *Ber.*, 20. 2640, 1887; G. Krüss, *ib.*, 20. 211, 1887; F. W. Schmidt, *Beiträge zur Kenntnis der Gold-Halogenverbindungen*, München, 1887; J. P. Prat, *Compt. Rend.*, 70. 840, 1870; T. K. Rose, *Journ. Chem. Soc.*, 67. 905, 1895; A. Meillet, *Journ. Pharm.*, 3. 447, 1845.
- ³ J. J. Berzelius, *Lehrbuch der Chemie*, Dresden, 3. 1011, 1827; L. G. Figuier, *Journ. Pharm. Chem.*, 6. 84, 1820; 8. 157, 1822; A. Meillet, *Journ. Pharm.*, 3. 447, 1845; F. W. Schmidt, *Chem. Ztg.*, 20. 483, 1896; F. Herrmann, *Ber.*, 38. 2819, 1905; J. Pelletier, *Ann. Chim. Phys.*, (2), 15. 5, 1820; E. Frémy, *ib.*, (3), 33. 478, 1851; J. Nicklès, *ib.*, (4), 10. 318, 1867; N. S. Kurnakoff, *Journ. prakt. Chem.*, (2), 52. 528, 1895; T. K. Rose, *Journ. Chem. Soc.*, 67. 905, 1895; J. Thomsen, *Journ. prakt. Chem.*, (2), 13. 337, 1876; J. C. Leuchs, *ib.*, (2), 6. 156, 1873; F. Lengfeld, *Amer. Chem. Journ.*, 26. 324, 1901; J. Löwe, *Dingler's Journ.*, 279. 167, 1891; G. Krüss, *Liebig's Ann.*, 237. 276, 1887; L. Vanino and L. Rössler, *Zeit. Koll.*, 6. 290, 1910; F. Ephraim, *Ber.*, 52. B, 241, 1919; F. H. Campbell, *Chem. News*, 96. 17, 1907; M. E. Diemer, *Journ. Amer. Chem. Soc.*, 35. 555, 1913; V. Lenher, *ib.*, 35. 546, 1913; E. Bose, *Zeit. Elektrochem.*, 14. 85, 1908; E. Wohlwill, *ib.*, 4. 379, 402, 421, 1899; F. Meyer, *Compt. Rend.*, 133. 815, 1901; L. Lindet, *ib.*, 98. 1382, 1884; 103. 1014, 1886; *Sur les combinaisons des chlorures et bromures acides avec les chlorures et bromures d'or*, Paris, 1886.
- ⁴ L. N. Vauquelin, *Ann. Chim. Phys.*, (1), 77. 321, 1811; J. Nicklès, *ib.*, (4), 10. 318, 1867; A. Baudrimont, *ib.*, (4), 2. 16, 1864; L. Lindet, *ib.*, (6), 11. 202, 1887; *Sur les combinaisons des chlorures et bromures acides avec les chlorures et bromures d'or*, Paris, 1886; H. Debray, *Compt. Rend.*, 75. 1025, 1872; F. Meyer, *ib.*, 133. 815, 1901; H. B. North, *Bull. Soc. Chim.*, (4), 9. 447, 1911; W. Hampe, *Chem. Ztg.*, 11. 816, 1887; G. Krüss, *Ber.*, 20. 205, 211, 1887; C. Winkler, *ib.*, 22. 892, 1889; J. Thomsen, *Journ. prakt. Chem.*, (2), 37. 105, 1888; J. J. Berzelius, *Lehrbuch der Chemie*, Dresden, 3. 1011, 1843; M. E. Diemer, *Journ. Amer. Chem. Soc.*, 35. 550, 1913; T. K. Rose, *Journ. Chem. Soc.*, 67. 881, 1895.
- ⁵ W. J. Pope, *Journ. Chem. Soc.*, 67. 906, 1895; T. K. Rose, *ib.*, 67. 881, 905, 1895; F. B. Miller, *ib.*, 6. 506, 1868; H. Ambronn, *Zeit. Wiss. Mikros.*, 22. 349, 1905; R. Boyle, *The origin of forms and qualities*, Oxford, 1666; L. Thompson, *Journ. Soc. Arts*, 53. 16, 1840; J. P. Prat, *Compt. Rend.*, 70. 840, 1870; H. Debray, *ib.*, 69. 984, 1869; G. Krüss, *Ber.*, 20. 211, 2641, 1887; L. Lindet, *Bull. Soc. Chim.*, (1), 49. 450, 1888; S. B. Christy, *Trans. Amer. Inst. Min. Eng.*, 17. 3, 1888; J. Thomsen, *Journ. prakt. Chem.*, (2), 13. 348, 1876; (3), 16. 329, 1877; *Ber.*, 16. 1585, 1883; *Thermochemische Untersuchungen*, Leipzig, 3. 407, 1884; M. Pellaton, *Journ. Chim. Phys.*, 13. 426, 1915; H. H. Morris, *Journ. Amer. Chem. Soc.*, 40. 917, 1918; W. Biltz, *Zeit. anorg. Chem.*, 109. 132, 1919; F. A. Henglein, *Zeit. phys. Chem.*, 98. 1, 1921; F. Ephraim, *Ber.*, 52. B, 241, 1919.

- ⁶ W. Hittorf and H. Salkowsky, *Zeit. phys. Chem.*, **28**, 546, 1899; F. Kohlrausch, *ib.*, **33**, 257, 1900.
- ⁷ L. Lindet, *Bull. Soc. Chim.*, (2), **45**, 149, 1886; F. W. Schmidt, *Chem. Ztg.*, **20**, 483, 1896; W. Hampe, *ib.*, **11**, 816, 1887; V. Lenher, *Journ. Amer. Chem. Soc.*, **25**, 1138, 1903; R. Willstätter, *Ber.*, **36**, 1830, 1903; M. Frank, *Schweiz. Wochs. Pharm.*, **51**, 386, 1913; E. C. Franklin and C. A. Kraus, *Amer. Chem. Journ.*, **20**, 829, 1898; F. Mylius, *Zeit. anorg. Chem.*, **70**, 207, 1911; J. P. Prat, *Compt. Rend.*, **70**, 842, 1870; H. B. North, *Bull. Soc. Chim.*, (4), **9**, 647, 1911; H. H. Morris, *Journ. Amer. Chem. Soc.*, **40**, 917, 1918; D. Avery, *Journ. Soc. Chem. Ind.*, **27**, 255, 1908.
- ⁸ R. Weber, *Pogg. Ann.*, **131**, 445, 1865; P. Schottländer, *Liebig's Ann.*, **217**, 312, 1883; J. Thomsen, *Ber.*, **16**, 1585, 1883; E. Schmidt, *Apoth. Ztg.*, **21**, 661, 1906; F. Lengfeld, *Amer. Chem. Journ.*, **26**, 328, 1901; J. Jacobsen, *Compt. Rend.*, **146**, 1214, 1908; F. Kohlrausch, *Zeit. phys. Chem.*, **33**, 257, 1900.
- ⁹ H. Topsøe, *Sitzber. Akad. Wien*, **69**, 261, 1874; A. Lainer, *ib.*, **99**, 247, 1890; *Monatsh.*, **11**, 220, 1890; P. Groth, *Chemische Krystallographie*, Leipzig, **1**, 451, 1906; J. F. W. Johnston, *New Edin. Journ. Scienc.*, **3**, 131, 290, 1821; L. Darmstädter, *Liebig's Ann. Suppl.*, **5**, 127, 1867; J. J. Berzelius, *Pogg. Ann.*, **18**, 599, 1830; W. Hittorf, *ib.*, **106**, 523, 1859; R. Weber, *ib.*, **131**, 445, 1867; J. C. G. de Marignac, *Mém. Sciences Genève*, **14**, 221, 1855; L. G. Figuier, *Journ. Pharm. Chim.*, **6**, 64, 1820; **8**, 157, 1822; J. Javal, *Ann. Chim. Phys.*, (2), **17**, 337, 1821; G. K. C. Storr, *Crell's Die neuesten Entdeckungen in der Chemie*, **2**, **41**, 1781; T. Rosenblatt, *Ber.*, **19**, 2535, 1886; F. Mylius and G. Hüttner, *ib.*, **44**, 1315, 1911; F. Ephraim, *ib.*, **52**, **B**, 241, 1919; C. Winkler, *ib.*, **22**, 895, 1889; W. Peters, *ib.*, **41**, 3182, 1908; *Zeit. anorg. Chem.*, **77**, 155, 1914; R. Fasbender, *Neder. Tijdschr. Pharm.*, **6**, **1**, 227, 1894; H. L. Wells and L. W. Wheeler, *Amer. Journ. Science*, (3), **44**, 157, 1892; U. Antony and A. Lucchesi, *Gazz. Chim. Ital.*, **20**, 601, 1890; G. Krüss, *Liebig's Ann.*, **238**, 241, 1887; C. Himly, *ib.*, **42**, 157, 1846; P. Schottländer, *ib.*, **217**, 312, 1883; M. E. Diemer, *Journ. Amer. Chem. Soc.*, **35**, 555, 1913; F. Emich, *Monatsh.*, **39**, 775, 1918; **41**, 243, 1920; E. Bayer, *ib.*, **41**, 223, 1920; H. Ley and G. Wiegner, *Zeit. Elektrochem.*, **11**, 590, 1905; L. F. Kebler, *Amer. Journ. Pharm.*, **72**, 325, 1900; L. H. Bernegau, *ib.*, **80**, 221, 1908; V. Coblentz and O. B. May, *Pharm. Journ.*, (4), **27**, 108, 1908; C. F. O. Glassford and J. Napier, *Phil. Mag.*, (1), **25**, 56, 1806; F. W. Schmidt, *Chem. Ztg.*, **20**, 483, 1896; F. Lengfeld, *Amer. Chem. Journ.*, **26**, 324, 1901; E. Wohlwill, *Zeit. Elektrochem.*, **4**, 379, 402, 421, 1898; F. Herrmann, *Ber.*, **38**, 2819, 1905; E. H. Duclaux, *Anal. Assoe. Quim. Argentina*, **9**, 215, 1921.
- ¹⁰ P. A. von Bonsdorff, *Pogg. Ann.*, **17**, 261, 1829; **33**, 64, 1834; H. Topsøe, *Sitzber. Akad. Wien*, **69**, 261, 1874; W. Gibbs and F. A. Genth, *Amer. Journ. Science*, (2), **23**, 330, 1857; (2), **24**, 86, 1857; W. Crookes, *Phil. Trans.*, **210**, A, 359, 1910; L. Lindet, *Compt. Rend.*, **98**, 1382, 1884; **101**, 1492, 1885; R. H. Pickard and J. Kenyon, *Journ. Chem. Soc.*, **89**, 262, 1906; J. J. Sudborough, *ib.*, **59**, 73, 270, 1891; W. B. Pollard, *ib.*, **117**, 99, 1920; S. Jolin, *Bull. Soc. Chim.*, (2), **21**, 533, 1874; E. Alén, *ib.*, (2), **27**, 365, 1876; P. T. Cleve, *ib.*, (2), **21**, 344, 1874; M. Holzmann, *Journ. prakt. Chem.*, (1), **84**, 76, 1861; F. Frerichs and F. Smith, *Liebig's Ann.*, **191**, 331, 1878; C. A. Matignon, *Compt. Rend.*, **134**, 427, 1308, 1902; *Ann. Chim. Phys.*, (8), **8**, 364, 403, 1906; C. Benedicks, *Zeit. anorg. Chem.*, **22**, 393, 1900; H. C. Wells, *Amer. Journ. Science*, (5), **3**, 257, 1922.
- ¹¹ G. Besseyre, *Ann. Chim. Phys.*, (2), **54**, 46, 1833; E. Soubeiran, *ib.*, (2), **43**, 407, 1830; P. Berthier, *ib.*, (3), **7**, 82, 1843; A. Levol, *ib.*, (2), **76**, 505, 1841; A. Oberkampf, *ib.*, (1), **80**, 140, 1811; J. B. A. Dumas, *ib.*, (2), **44**, 179, 1830; A. S. Duportal and J. Pelletier, *ib.*, (1), **78**, 47, 1811; J. J. Berzelius, *ib.*, (2), **14**, 376, 1820; A. Ditte, *ib.*, (8), **12**, 273, 1907; M. Dauvé, *Journ. Pharm. Chim.*, (6), **29**, 241, 1909; A. Pleischl, *Schweigger's Journ.*, **43**, 387, 1825; N. W. Fischer, *ib.*, **56**, 363, 1829; *Pogg. Ann.*, **9**, 255, 1827; **10**, 607, 1827; **12**, 505, 1828; **16**, 124, 1829; **17**, 137, 480, 1829; H. Rose, *ib.*, **14**, 184, 1828; J. J. Berzelius, *ib.*, **36**, 29, 1835; A. Sieverts, *Zeit. anorg. Chem.*, **64**, 36, 1909; E. F. Smith, *ib.*, **1**, 360, 1892; F. Mylius, *ib.*, **70**, 211, 1911; J. Juncker, *Conspectus chemiæ theoretico-practicæ, Halæ Magdæburgicæ*, **1**, 882, 1806; P. J. Macquer, *Chymisches Wörterbuch*, Leipzig, 1809; M. Faraday, *Phil. Mag.*, (4), **14**, 401, 512, 1857; *Phil. Trans.*, **147**, 154, 1857; L. Vanino, *Journ. prakt. Chem.*, (2), **73**, 575, 1906; L. Vanino and F. Hartl, *Ber.*, **37**, 3620, 1904; R. Zsigmondy, *Zur Erkenntnis der Kolloide*, Jena, **100**, 1905; J. Donau, *Monatsh.*, **26**, 525, 1905; Count Rumford (B. Thompson), *Essays*, London, **2**, 350, 1798; *Scherer's Journ.*, **2**, **3**, 1799; C. Schweigger-Seidel, *Schweigger's Journ.*, **65**, 268, 1832; C. H. Pfaff, *ib.*, **52**, 318, 1828; P. V. Gladkoff, *Berg. Hütt. Ztg.*, **58**, 497, 1899; E. Sonstadt, *Proc. Chem. Soc.*, **15**, 179, 1899; T. Svedberg, *Zeit. Koll.*, **6**, 239, 1910; O. Brunck, *Liebig's Ann.*, **327**, 250, 1903; W. J. Russell, *Chem. News*, **28**, 277, 1873; W. Skey, *ib.*, **23**, 232, 1871; A. Cossa, *Atti Accad. Lincei*, (3), **1**, 33, 1877; M. Major, *Kenntnis der phosphorigen und unterphosphorigen Säure*, Leipzig, 1908; C. Palmer and E. S. Bastin, *Bull. Amer. Inst. Min. Eng.*, **843**, 1913; A. Haase, *Ueber einige Produkte der Einwirkung von schwefliger Säure auf Goldchlorid*, Rostock, 1869; C. Winkler, *Ber.*, **22**, 890, 1889; E. Knövenagel and E. Ebler, *ib.*, **35**, 3055, 1902; L. Vanino and L. Secman, *ib.*, **32**, 1868, 1899; E. Rupp, *ib.*, **35**, 2011, 1902; C. Winkler, *ib.*, **22**, 892, 1889; K. Hofmann and D. Storm, *ib.*, **45**, 1725, 1912; K. Lederer, *ib.*, **47**, 277, 1914; F. Mylius and C. Hüttner, *ib.*, **44**, 1315, 1911; U. Antony and A. Lucchesi, *Gazz. Chim. Ital.*, **19**, 545, 1889; C. Buisson, *Journ. Pharm.*, **16**, 638, 1830; E. Desmarest, *ib.*, **17**, 219, 1831; B. Morin, *ib.*, **26**, 104, 1840; A. Lainer, *Sitzber. Akad. Wien*, **99**, 247, 1890; *Monatsh.*, **11**, 220, 1890; E. Beutel, *ib.*, **31**, 871, 1910; *Zeit. anorg. Chem.*, **72**, 141, 1912; N. Awerkieff, *ib.*, **61**, 11, 1909; H. Erdmann

and P. Köthner, *ib.*, 18. 53, 1898; A. Gutbier, *ib.*, 31. 448, 1902; *Zeit. Koll.*, 9. 177, 1911; J. L. Lassaigne, *Journ. Chim. Méd.*, 8. 586, 1832; G. Malatesta and E. di Nola, *Boll. Chim. Pharm.*, 52. 461, 1913; E. Frémy, *Compt. Rend.*, 70. 61, 1870; P. Pascal, *ib.*, 146. 862, 1908; V. A. Jacquelin, *ib.*, 16. 31, 1843; A. Carnot, *ib.*, 97. 105, 1883; F. Giraud, *ib.*, 157. 586, 1913; J. Jacobsen, *ib.*, 146. 1213, 1908; G. Massol and A. Faucon, *ib.*, 157. 332, 1913; J. F. Persoz, *Ann. Chim. Phys.*, (3), 20. 315, 1847; W. Gibbs, *Amer. Chem. Journ.*, 17. 167, 1895; M. C. Lea, *Amer. Journ. Science*, (4), 3. 64, 1897; J. C. Blake, *ib.*, (4), 16. 381, 1903; A. D. Brockaw, *Journ. Ind. Eng. Chem.*, 5. 560, 1913; P. E. Jameson, *Journ. Amer. Chem. Soc.*, 27. 1444, 1905; V. Lenher, *ib.*, 24. 357, 1902; 35. 550, 1913; M. E. Diemer, *ib.*, 35. 553, 1913; R. Hall and V. Lenher, *ib.*, 24. 918, 1902; R. J. Carney, *ib.*, 34. 32, 1912; T. Svedberg and N. Pihlblad, *Zeit. phys. Chem.*, 74. 530, 1910; E. P. Perman, *Journ. Chem. Soc.*, 24. 214, 1908; R. Phillips, *Phil. Mag.*, (2) 2. 95, 1827; C. Lucknow, *Chem. Zig.*, 16. 837, 1892; L. Rössler, *Zeit. anal. Chem.*, 49. 739, 1910; F. Hartwagner, *ib.*, 52. 19, 1913; M. Wunder and V. Thüringer, *ib.*, 52. 660, 1913; W. O. de Coninck, *Bull. Acad. Belgique*, 317, 1902; L. L. de Koninck, *ib.*, (3), 2. 316, 1881; J. E. Saul, *Analyst*, 38. 54, 1913; H. W. F. Wackenroder, *Journ. prakt. Chem.*, (1), 18. 295, 1839; G. Schulze, *Ann. Physik*, (4), 41. 593, 1913; *Trans. Faraday Soc.*, 9. 266, 1913; N. Castoro, *Zeit. Koll.*, 6. 289, 1910; G. Armani and J. Barboni, *ib.*, 6. 290, 1910; M. Rogier and M. Fiore, *Bull. Sci. Pharmacol.*, 20. 7, 1913; E. Priwoznik, *Oester. Zeit. Berg. Hütt.*, 59. 639, 1911; C. A. L. de Bruyn, *Rec. Trav. Chim. Pays-Bas*, (2), 4. 240, 1900; M. Lazowsky, *Journ. Chim. Méd.*, (3), 3. 627, 1847; *Chem. Gaz.*, 6. 43, 1848; M. Green, *Min. Eng. World*, 39. 873, 1913; S. Brussoff, *Zeit. Koll.*, 5. 137, 1909; G. A. Koenig, *Chem. News*, 45. 215, 1882; A. Liversidge, *ib.*, 69. 303, 1894; W. O. de Coninck, *Compt. Rend.*, 130. 1551, 1900; A. Tingle, *Journ. Amer. Chem. Soc.*, 31. 461, 1909; W. R. Whitney and J. P. Blake, *ib.*, 26. 1339, 1904; L. Garbowsky, *ib.*, 29. 383, 1901; H. C. Neish, *ib.*, 26. 787, 1904; H. H. Morris, *ib.*, 40. 917, 1918; D. Avery, *Journ. Soc. Chem. Ind.*, 27. 255, 1908; A. Hanriot, *Compt. Rend.*, 138. 1044, 1904; J. Donau, *Sitzber. Akad. Wien*, 122. 335, 1913; *Monatsh.*, 34. 949, 1913; F. Emich and J. Donau, *ib.*, 28. 825, 1907; E. Hatschek and A. L. Simon, *Zeit. Koll.*, 10. 265, 1912; G. L. Lesage, *Essay de chimie mécanique*, Rouen, 1758; W. B. Hardy, *Proc. Roy. Soc.*, 66. 111, 1900; A. Galecki, *Zeit. Koll.*, 11. 106, 1912; T. Svedberg and K. Inouye, *Zeit. phys. Chem.*, 77. 150, 1911; F. Doerinczel, *Zeit. anorg. Chem.*, 63. 344, 1909; A. Gutbier, *ib.*, 31. 448, 1902; N. Castoro, *ib.*, 41. 126, 1904; *Zeit. Koll.*, 6. 289, 1910; T. Svedberg, *Zeit. phys. Chem.*, 67. 252, 1909; E. Pozzi-Escot, *Ann. Chim. Anal.*, 12. 90, 1907; A. Stähler, *Ber.*, 44. 2914, 1911; E. Küspert, *ib.*, 35. 4070, 1902; F. Henrich, *ib.*, 36. 609, 1903; R. Zsigmondy, *Liebig's Ann.*, 301. 29, 1898; *Zeit. Elektrochem.*, 4. 546, 1898; *Zeit. anal. Chem.*, 40. 711, 1901; C. Thomae, *Journ. prakt. Chem.*, (2), 79. 519, 1909; M. Muller, *ib.*, (2), 30. 278, 1884; F. N. Schulz and R. Zsigmondy, *Beiträg. Chem. Physiol. Path.*, 3. 137, 1902; A. Gutbier and F. Resenschek, *Zeit. anorg. Chem.*, 39. 112, 1904; P. P. von Weimarn, *Zeit. Koll.*, 11. 283, 1912; L. Vanino and L. Rössler, *ib.*, 6. 289, 1910; H. Koch, *Koll. Zeit.*, 22. 1, 1918; N. Dhar, *Journ. Chem. Soc.*, 111. 690, 1917; G. Mazzaron, *Atti Ist. Venezia*, (7), 7. 1124, 1896.

§ 17. Gold Bromides

Gold forms two bromides, aurous bromide, AuBr, and auric bromide, AuBr₃, which are analogous in many respects with the corresponding chlorides. There is also an aurosaucic bromide, or gold dibromide, Au₂Br₄, or AuBr₂, or aurous bromoaurate, Au(AuBr₄), which resembles the corresponding aurosaucic chloride, and concerning the individuality of which there is some doubt. J. Thomsen¹ claims to have made black or steel blue aurosaucic bromide by the action of bromine on finely divided gold, and subsequently evaporating off the excess of bromine. F. Lengfeld's directions are:

Gold is first prepared by precipitation with ferrous sulphate, washing, and drying in vacuo over phosphorus pentoxide for two weeks. 6.1286 grms. of this gold are treated with an excess of bromine in a covered crucible, and the excess of bromine afterwards expelled by a stream of dry air. The product is kept over phosphorus pentoxide, in vacuo, until its weight is constant. The operation is repeated.

According to E. Petersen, aurosaucic bromide decomposes at 115° into bromine and aurous bromide, its heat of formation from aurous and auric chloride is -3.86 Cals.; it is decomposed by water, first into auric and aurous bromide, and the latter is then decomposed into gold and auric bromide; a similar result is obtained by the action of dry ether, according to F. Lengfeld; at 0° the attack by ether is

slow, and it is readily decomposed by many organic solvents. F. Meyer denies the existence of aurosoauric bromide, and G. Krüss and F. W. Schmidt regard it as a mixture of auric bromide and undissolved gold. E. Petersen thinks that the thermochemical data do not support the view that it is a mixture of $\text{Au}+2\text{AuBr}_3$ or of $\text{AuBr}+\text{AuBr}_3$.

Aurous bromide or gold monobromide, AuBr .—J. Thomsen² prepared aurous bromide by heating hydrobromoaauric acid up to the m.p., and after cooling, again raising the temp. to 200° ; and F. Lengfeld heated hydrobromoaauric acid for 3 hrs. on a water-bath, and then 12 hrs. at 105° ; no auric salt is left, but usually a little gold remains. F. W. Schmidt obtained the same compound, by heating auric bromide with conc. sulphuric acid up to 200° —*vide* aurous chloride. Aurous bromide is a yellowish-grey crystalline powder which, according to F. W. Schmidt, decomposes when heated to 165° , or, according to J. Thomsen, 115° . F. Meyer says the dissociation temp. is 211° to 270° ; and that it volatilizes at 270° , collecting on the cooler parts of the tube in fine needles. The heat of formation, according to J. Thomsen, is $\text{Au}+\text{Br}_{\text{liq.}}=\text{AuBr}-30$ cal. Aurous bromide is insoluble in water. The action of water on aurous bromide is similar to its action on aurous chloride. According to F. Lengfeld, gold bromide dissolves in soln. of potassium bromide, forming complex ions—possibly AuBr_2 —and finally gold and potassium bromoaurate. The alkali chlorides act similarly. Aurous bromide is insoluble in nitric acid and sulphuric acid. It is soluble in aqua ammonia with partial decomposition and the ammoniacal soln. gives an unstable partially soluble precipitate when treated with nitric acid; with hydrobromic acid it forms gold and auric bromide, and, according to J. Thomsen: $3\text{AuBr}+\text{HBr}_{\text{aq.}}=\text{HAuBr}_4+2\text{Au}+3\cdot65$ Cals. aurous bromide and hydrochloric acid form gold, auric chloride, etc. Sulphurous acid reduces it to metallic gold and, according to J. Thomsen: $2\text{AuBr}+\text{H}_2\text{SO}_{3\text{soln}}+\text{H}_2\text{O}=2\text{Au}+2\text{HBr}+\text{H}_2\text{SO}_4+42\cdot76$ Cals. The product dissolves in potassium cyanide soln. without decomposition; and is slowly decomposed by alcohol, ether, acetone, and moist chloroform. According to F. Meyer, when ammonia is liquefied over aurous bromide, at -40° , gold and ammonium bromide are formed, while if ammonia gas is passed over aurous bromide, gold, ammonium bromide, and nitrogen are formed with the evolution of much heat. If the temp. be maintained at 18° , **aurous diammino-bromide, $\text{AuBr}\cdot 2\text{NH}_3$** , is formed as a white powder which is decomposed by water, moist air, or heat. It is dissolved by aqua regia, and hydrochloric acid converts it into ammonium chloride and halogeno-auric acid. L. Lindet prepared colourless crystals of **aurous phosphino-bromide, $\text{AuBr}\cdot \text{PBr}_3$** , by heating auric bromide and phosphorous bromide in a sealed tube to 140° or 150° ; and similarly, with aurous bromide and phosphorous chloride, colourless crystals of **aurous phosphorochlorobromide, $\text{AuBr}\cdot \text{PCl}_3$** .

Auric bromide, or gold tribromide, AuBr_3 .—In 1826, A. J. Balard³ noticed that gold dissolved slowly in an aq. soln. of bromine, forming a liquid which colours the skin violet, and when evaporated forms yellow gold bromide, which when heated decomposes into bromine and gold. The compound was studied by W. A. Lampadius and by J. Nickles and the latter prepared auric bromide by dissolving gold in ethereal and aq. soln. of the higher bromides of iron, manganese, or cobalt. G. Wilson obtained a dark red soln. of auric bromide by the action of hydrobromic acid on auric chloride: $3\text{HBr}+\text{AuCl}_3=3\text{HCl}+\text{AuBr}_3$, hydrochloric acid was evaporated, and the auric bromide extracted with ether. F. Meyer made it by heating precipitated gold with bromine to 100° , and repeating the treatment on the product for a number of times.

Auric bromide forms crystals of a brown colour. J. Thomsen gives its heat of formation as $\text{Au}+3\text{Br}_{\text{liquid}}=\text{AuBr}_3+8\cdot85$ Cals. According to F. H. Campbell, it decomposes at ordinary temp. into aurous bromide and bromine. F. Meyer says the dissociation temp. is 165° – 220° ; F. Ephraim, 181° , and the products are aurous bromide, etc., and the salt volatilizes in atm. of bromine at 300° . According to F. W. Schmidt, auric bromide passes into aurous bromide at 160° ; and in conc. sulphuric acid it begins to give off bromine at 155° , and at 200° forms aurous bromide.

L. Lindet says that auric bromide dissolves slowly in water, and rapidly in ether, and it can be readily crystallized from its soln. in arsenious, antimonious, titanous, or stannous bromide. The conc. aq. soln. is almost black, and even dil. soln. have a viscous character and froth strongly when shaken. The aq. soln. of auric bromide is less stable than one of auric chloride, and on boiling is partially reduced. Auric bromide, says F. Meyer, is fairly soluble in bromine. F. Ephraim found dark brown auric bromide becomes brownish-yellow in an atm. of ammonia, and absorbs about 9 mols of the gas at ordinary temp., and about 23 mols when cooled by a freezing mixture. According to W. J. Pope and C. S. Gibson, ethyl magnesium bromide converts auric bromide into **auric diethylbromide**, $\text{Au}(\text{C}_2\text{H}_5)_2\text{Br}$.

If a conc. aq. soln. containing a mol of auric bromide and a mol of hydrogen bromide be cooled, dark scarlet crystals of **hydrobromauric acid**, $\text{HAuBr}_4 \cdot n\text{H}_2\text{O}$, are obtained which melt in their own water of crystallization at 27° . J. Thomsen supposed the crystals were $\text{HAuBr}_4 \cdot 5\text{H}_2\text{O}$, but F. Lengfeld considers that they are really $\text{HAuBr}_4 \cdot 6\text{H}_2\text{O}$, and that J. Thomsen's $\text{HAuBr}_4 \cdot 5\text{H}_2\text{O}$ is an effloresced product. J. Huber prepared an aq. soln. of this acid by dissolving 10 grms. of brown commercial gold chloride in about 100 c.c. of conc. hydrobromic acid (sp. gr. 1.78), and concentrating the soln. by evaporation to about 50 c.c. The crystals of hydrobromauric acid can be recrystallized from ether or chloroform. Hydrobromauric acid is reduced by sulphur dioxide to the metal, and, as F. W. Schmidt has shown, decomposed at 155° by conc. sulphuric acid into aurous bromide and bromine. F. Lengfeld found that if the hexahydrated acid be exposed in a desiccator over phosphorus pentoxide, sulphuric acid, or calcium chloride, or crystallized from dry ether, the trihydrated acid, $\text{HAuBr}_4 \cdot 3\text{H}_2\text{O}$, is formed. This takes up moisture from the air, re-forming the hexahydrated salt. The trihydrated salt loses water when heated, but simultaneously decomposes.

A. Gutbier and J. Huber prepared a dark red crystalline precipitate of **ammonium bromoaurate**, NH_4AuBr_4 , from a conc. soln. of the component salts; recrystallization from the mother liquid acidified with hydrobromic acid, furnishes large bluish-black prismatic crystals. The corresponding **dihydrated potassium bromoaurate**, $\text{KAuBr}_4 \cdot 2\text{H}_2\text{O}$, was obtained by P. A. von Bonsdorff by crystallization from aq. soln. of the component salts. P. Schottländer found the rhombic crystals had the axial ratios $a : b : c = 0.7969 : 1 : 0.3510$, $\beta = 94^\circ 26'$; and, according to W. Muthmann, the pleochroism is carmine red and dark brown. The crystals are soluble in water, forming a reddish-brown soln.; they are also readily soluble in alcohol. P. A. von Bonsdorff also obtained the anhydrous **potassium bromoaurate**, KAuBr_4 , by heating the dihydrated salt at 60° , and crystallizing from absolute alcohol, and G. Krüss by drying the dihydrated salt 14 days over phosphorus pentoxide. P. A. von Bonsdorff, and J. C. Leuchs prepared **dihydrated sodium bromoaurate**, $\text{NaAuBr}_4 \cdot 2\text{H}_2\text{O}$, in a similar manner. H. L. Wells and H. L. Wheeler, and A. Gutbier and J. Huber likewise made large black monoclinic prismatic crystals of **rubidium bromoaurate**, RbAuBr_4 , with axial ratios $a : b : c = 1.1951 : 1 : 0.7256$, and $\beta = 76^\circ 53\frac{1}{2}'$, and of **cæsium bromoaurate**, CsAuBr_4 , with axial ratios $a : b : c = 1.1359 : 1 : 0.7411$, and $\beta = 70^\circ 24\frac{1}{2}'$; and, added S. L. Penfield, "there seems to be no regularity in the influence of the replacement of chlorine by bromine in these gold salts, for in the cæsium compound the chloride has a slightly shorter c -axis and a greater angle β than the bromide, while with the rubidium salts exactly the reverse is true in both cases." The potassium salt is alone hydrated; the rubidium and cæsium salts are anhydrous. The crystals are slightly soluble in water, and in alcohol, and insoluble in ether. According to F. Ephraim, cæsium bromoaurate behaves towards ammonia very like auric bromide. The similarity in the behaviour of the alkali bromoaurates and of auric bromide towards ammonia led F. Ephraim to suggest that they are dissociated by ammonia into their component haloids. P. A. von Bonsdorff prepared the **barium, zinc, and manganese bromoaurates**; J. C. Leuch, **magnesium bromoaurate**; S. Jolin, **cerous bromoaurate**, $\text{CeBr}_3 \cdot \text{AuBr}_3 \cdot 8\text{H}_2\text{O}$; P. T. Cleve, **lanthanum bromoaurate**, $\text{LaBr}_3 \cdot \text{AuBr}_3 \cdot 9\text{H}_2\text{O}$;

and samarium bromoaurate, $\text{SaBr}_3 \cdot \text{AuBr}_3 \cdot 10\text{H}_2\text{O}$. L. Lindet obtained dark red crystals of auric phosphobromide, $\text{AuBr}_3 \cdot \text{PBr}_5$, by heating the components in a sealed tube at 150° . A. Gutbier and J. Huber have prepared a large number of organic bromoaurates.

REFERENCES.

- ¹ J. Thomsen, *Journ. prakt. Chem.*, (2), 13, 337, 1876; E. Petersen, *ib.*, (2), 46, 328, 1892; (2), 48, 90, 1893; G. Krüss and F. W. Schmidt, *ib.*, (2), 38, 83, 1888; *Ber.*, 20, 2641, 1887; F. Meyer, *Compt. Rend.*, 148, 348, 1909; F. Lengfeld, *Amer. Chem. Journ.*, 26, 324, 1901.
- ² J. Thomsen, *Journ. prakt. Chem.*, (2), 13, 337, 1876; F. Lengfeld, *Amer. Chem. Journ.*, 26, 324, 1901; F. Meyer, *Compt. Rend.*, 148, 348, 1909; F. W. Schmidt, *Chem. Ztg.*, 20, 483, 1896; F. H. Campbell, *Chem. News*, 96, 17, 1907.
- ³ A. J. Balard, *Ann. Chim. Phys.*, (2), 33, 362, 1826; J. Nicklès, *ib.*, (4), 10, 318, 1866; W. A. Lampadius, *Schweigger's Journ.*, 50, 377, 1827; G. Wilson, *Athenæum*, 674, 1839; J. Thomsen, *Journ. prakt. Chem.*, (2), 13, 337, 1876; F. W. Schmidt, *Chem. Ztg.*, 20, 483, 1896; L. Lindet, *Sur les combinaisons des chlorures et bromures acides avec les chlorures et bromures d'or*, Paris, 1886; F. Meyer, *Compt. Rend.*, 148, 348, 1909; F. Lengfeld, *Amer. Chem. Journ.*, 26, 324, 1901; F. H. Campbell, *Chem. News*, 96, 17, 1907; W. J. Pope and C. S. Gibson, *Journ. Chem. Soc.*, 91, 2061, 1907; J. Huber, *Studien über Gold Tetrabromoaurates*, Leipzig, 1914; F. Ephraim, *Ber.*, 52, B, 241, 1919; A. Gutbier and J. Huber, *Zeit. anorg. Chem.*, 85, 358, 1914; P. A. von Bonsdorff, *Pogg. Ann.*, 19, 346, 1830; 33, 64, 1834; P. Schöttländer, *Liebigs Ann.*, 217, 312, 1883; G. Krüss, *ib.*, 238, 241, 1887; W. Muthmann, *Zeit. Kryst.*, 15, 388, 1889; H. L. Wells and H. L. Wheeler, *Amer. Journ. Science*, (3), 44, 157, 1892; J. C. Leuchs, *Journ. prakt. Chem.*, (2), 6, 156, 1873; S. Jolin, *Bull. Soc. Chim.*, (2), 21, 533, 1874; P. T. Cleve, *ib.*, (2), 21, 196, 1874.

§ 18. Gold Iodides

Aurous iodide, gold monoiodide.—According to J. Nicklès (1867),¹ gold is not attacked by iodine at ordinary temp., but leaf-gold is slowly attacked when heated with iodine in a sealed tube at 50° ; a soln. of iodine in ether attacks gold in direct sunlight at ordinary press. F. Meyer (1904) synthesized aurous iodide from its elements by shaking precipitated gold with an aq. soln. of iodine in potassium iodide for 16–24 hrs., and by the action of gold on iodine—the action is very slow at 50° , but is completed in a few hours at 100° . F. H. Campbell agitated finely divided gold with a soln. of iodine in carbon tetrachloride. J. Pelletier first prepared aurous iodide by the action of hydriodic acid on auric oxide: $\text{Au}_2\text{O}_3 + 6\text{HI} = 2\text{AuI} + 3\text{H}_2\text{O} + 2\text{I}_2$; J. P. Prat used potassium iodide and auric oxide. J. Pelletier also made aurous iodide by the action of a hot mixture of hydriodic and nitric acids on powdered gold, and also by treating a neutral soln. of auric chloride with an aq. soln. of hydriodic acid, potassium iodide, or ferrous iodide: $\text{AuCl}_3 + 3\text{KI} = \text{AuI} + 3\text{KCl} + \text{I}_2$; if an excess of these reagents be employed some gold iodide passes into soln. The precipitate is washed by decantation with water, and freed from admixed iodine by warming it to about 35° . A. Meillet used ammonium iodide for the precipitation, and washed with alcohol; F. Gramp used iodine: $\text{AuCl}_3 + 2\text{I}_2 = 3\text{ICl} + \text{AuI}$; and F. H. Campbell, a soln. of potassium iodide in carbon tetrachloride. If hot water or alcohol be used for the washing, aurous iodide is decomposed. M. J. Fordos prepared this salt in an analogous manner in 1841. J. F. W. Johnston heated a soln. of a gold salt with a soln. of potassium iodide; on cooling, golden-yellow spangles of aurous iodide separated out. J. Thomsen treated auric bromide with potassium iodide. According to J. Nicklès, the higher iodides of many of the metals—iron, manganese, bismuth—attack leaf-gold, forming aurous iodide and a mixture of the oxide and iodide of the metal.

Aurous iodide forms a lemon-yellow crystalline powder or mica-like plates. A. Meillet obtained it as a white powder, and it is therefore possible that the yellow colour is due to the presence of a trace of iodine. When kept in a glass vessel, it acquires a greenish-yellow colour, owing to its slow decomposition into iodine and

gold. F. Meyer says it dissociates slowly at 50° in vacuo, and the decomposition is complete at 190°. Aurous iodide, according to F. Meyer, is decomposed by moist air, and this the faster the more readily the iodine can escape; in the presence of iodine it is not decomposed by moist air; and it is stable in a sealed tube in the presence of water. The dissociation press. of aurous iodide is rather smaller than that of pure iodine at ordinary temp., otherwise it would not be possible to combine these two elements. When the two elements are in contact they will unite until the vap. press. of the iodine reaches the equilibrium value $2\text{Au} + \text{I}_2 \rightleftharpoons 2\text{AuI}$, and conversely aurous iodide will decompose so long as the press. of the iodine is less than the equilibrium value. The system $2\text{AuI} \rightleftharpoons 2\text{Au} + \text{I}_2$ is univariant, consisting of two solid phases, and a vapour phase. The vap. press. of the iodine is the only variable, and it is dependent on the temp. F. H. Campbell found that a soln. of 0.1088 mol of iodine in a litre of carbon tetrachloride soln. is in equilibrium with gold and aurous iodide at 25°. A sat. soln. contains 0.1156 mol of iodine, so that the press. of gaseous iodine in equilibrium with aurous iodide and gold is $0.1088/0.1156 = 0.943$ of that of pure iodine. Hence, any soln. of iodine is or is not able to act on gold according to whether it is or is not sat.; and the dissociation press. of aurous iodide at 25° is nearly 95 per cent. of the vap. press. of iodine. J. Thomsen gives the heat of formation: $\text{Au} + \text{I} = \text{AuI} + 55$ Cals. It has not yet been determined whether the heat of formation becomes endothermal at higher temp., or whether the iodide then becomes more stable.

Warm water, or dil. sulphuric, hydrochloric, or nitric acid decomposes aurous iodide, but this salt is more stable towards these agents than the corresponding chloride or bromide. This is explained by the lower solubility of the iodide in these menstrua than is the case with the chloride or bromide. From the observations of J. Pelletier, and M. J. Fordos, chlorine water has no action, but bromine and chlorine respectively oxidize aurous iodide to auric bromide and chloride. Hydriodic acid forms hydriodoauric acid, HAuI_4 , with the separation of gold; potassium and ferrous iodide similarly form gold and iodoaurates. The solubility of aurous iodide in water is not known, but F. H. Campbell found the solubilities in potassium iodide soln. to be approximately proportional to the conc. of that salt. Expressing conc. in mols of potassium iodide and gram-atoms of gold per litre:

KI	.	.	.	0.1009	0.2508	0.4038	1.0096 mol
Au	.	.	.	0.0096	0.0293	0.538	0.1170 gram-atoms

The aurous iodide is present in the soln. in the form of complex anions AuI_2' or AuI_4''' —probably the former. Iron in the presence of water and aurous iodide forms ferrous iodide and gold. The dissociation tension of aurous iodide makes it behave like free iodine; e.g. with potassium hydroxide it forms gold and a mixture of the alkali iodide and iodate. Many organic solvents also decompose the iodide, ether more quickly than alcohol. Gum retards the spontaneous decomposition of aurous iodide.

According to F. Meyer, **aurous hexammino-iodide**, $\text{AuI} \cdot 6\text{NH}_3$, is formed by the action of liquid ammonia on dry aurous iodide; when the excess of ammonia has evaporated off, white crystals of the hexammino-salt remain. It is also formed as an amorphous powder by the action of ammonia gas on aurous iodide at -28° . The dissociation press. at -28° is 760 mm. Between -28° and -15° it loses two molecules of ammonia, at -10° a third molecule, and at 20° it forms **aurous ammino-iodide**, $\text{AuI} \cdot \text{NH}_3$. When heated, this salt loses ammonia and iodine; with water or moist air it forms gold and ammonium iodide, with dilute acids it forms aurous and ammonium iodides; it is dissolved by aqua regia; and with potash-lye it forms a black powder which burns with a hissing noise when heated by a flame.

Auric iodide, gold triiodide, AuI_3 .—J. P. Prat² found that a soln. of aurous iodide with a sat. soln. of iodine in hydriodic acid furnished on evaporation small

rhombohedral crystals of auric iodide. According to F. W. Schmidt, if aq. potassium iodide be gradually added to a neutral soln. of auric chloride, the liquid becomes dark green, and forms a dark green precipitate of auric iodide which dissolves when the liquid is agitated, forming soluble potassium iodoaurate: $\text{AuCl}_3 + 4\text{KI} = 3\text{KCl} + \text{KAuI}_4$. If auric chloride be added to the soln. containing $\text{AuCl}_3 : \text{KI} = 1 : 4$, the potassium iodoaurate is decomposed, and auric iodide is precipitated: $3\text{KAuI}_4 + \text{AuCl}_3 = 3\text{KCl} + 4\text{AuI}_3$. The precipitate can be washed without much decomposition, but it loses iodine when dried. It also decomposes slowly in air, forming yellow aurous iodide, which in turn decomposes as previously indicated. Auric iodide is decomposed by alkali and alkaline earth hydroxides. J. F. W. Johnston showed, in 1836, that auric iodide forms double salts with hydriodic acid and with metallic iodides. The soln. of auric iodide in hydriodic acid gives a dark brown precipitate when an excess of aqua ammonia is added, and with an excess of the gold soln. a black precipitate resembling fulminating gold. J. F. W. Johnston also obtained black prismatic crystals of ammonium iodoaurate by evaporating a soln. of auric iodide in aq. ammonium iodide. The evaporation of the dark reddish-brown soln. of finely divided gold in aq. potassium iodide and iodine (J. Pelletier), auric iodide (J. F. W. Johnston), or aurous iodide (M. J. Fordos), gives black crystals of what is considered to be hydriodoauric acid, HAuI_4 . J. F. W. Johnston also prepared black crystals of sodium iodoaurate, and barium iodoaurate, in an analogous manner.

REFERENCES.

- ¹ J. Nicklès, *Ann. Chim. Phys.*, (4), 10, 318, 1867; J. Pelletier, *ib.*, (2), 15, 116, 1820; M. J. Fordos, *Journ. Pharm. Chim.*, (2), 27, 653, 1841; A. Meillet, *ib.*, (2), 27, 665, 1841; G. Wilson, *Athenaeum*, 674, 1839; F. Meyer, *Compt. Rend.*, 139, 733, 1904; 143, 280, 1906; J. P. Prat, *ib.*, 70, 842, 1870; P. Schottländer, *Liebig's Ann.*, 217, 312, 1883; J. F. W. Johnston, *Phil. Mag.*, (3), 9, 266, 1836; F. Gramp, *Ber.*, 7, 1723, 1874; J. Thomsen, *Thermochemische Untersuchungen*, Leipzig, 3, 393, 1884; F. H. Campbell, *Chem. News*, 96, 15, 1907.
- ² J. P. Prat, *Compt. Rend.*, 70, 842, 1870; F. W. Schmidt, *Chem. Ztg.*, 20, 483, 1896; J. F. W. Johnston, *Phil. Mag.*, (3), 9, 266, 1836; J. Pelletier, *Ann. Chim. Phys.*, (2), 15, 116, 1820; M. J. Fordos, *Journ. Pharm. Chim.*, (2), 27, 653, 1841.

§ 19. The Sulphides of Gold

Gold does not unite with sulphur when the two elements are fused together. From J. R. Glauber's *De natura salium* (Amstelodami, 1658) it would appear that he found that the liver of sulphur, which he made by extracting with water a calcined mixture of sodium sulphate with carbon, had a solvent action on gold; and G. E. Stahl (1697) remarked on the solvent action of a boiling mixture of sulphur and potassium monosulphide, hydrosulphide, or carbonate on gold. U. Antony and A. Lucchesi found that the gold thiosalts obtained by treating auric chloride with soln. of alkali sulphides are very unstable, and cannot be obtained in the solid state. Gold is dissolved by molten alkali polysulphides. According to W. Skey,¹ gold is superficially attacked by a soln. of ammonium sulphide, by moist hydrogen sulphide, or by boiling with sulphur and water, whereby a film of gold sulphide is formed which prevents the metal amalgamating with mercury and which can be removed by calcination, by treatment with potassium cyanide, chromic anhydride, or nitric acid.

Gold monosulphide, or aurous sulphide, Au_2S .—J. J. Berzelius said that a brownish-black powder, gold monosulphide or aurous sulphide, is formed by passing hydrogen sulphide into a boiling soln. of auric chloride, part of the sulphur is at the same time converted into sulphuric acid. A. Levöl said the precipitate is not gold sulphide, but rather metallic gold; the amount of sulphuric acid produced

in the reaction corresponds with the equation: $8\text{AuCl}_3 + 3\text{H}_2\text{S} + 12\text{H}_2\text{O} = 8\text{Au} + 24\text{HCl} + 3\text{H}_2\text{SO}_4$. G. Krüss claimed that J. J. Berzelius' product is a mixture of sulphur and gold. This also is the conclusion of A. Schrötter and E. Priwoznik, V. A. Jacquelin, L. R. von Fellenberg, and of U. Antony and A. Lucchesi. The last-named worked with 1 per cent. soln. of gold chloride at 90° – 100° . Further, they found that a 1 to 3 per cent. soln. at ordinary temp., about 8° , yields a black precipitate of auroauric sulphide, Au_2S_2 . The temp. of the soln. continually rises during the precipitation proportionally to the strength of the soln., and if at any time the temp. approaches 40° , metallic gold is precipitated along with the sulphide. If the soln. is not fully precipitated and the sulphide is allowed to remain in contact with the soln. of auric chloride, these salts react according to the equation: $4\text{AuCl}_3 + \text{Au}_2\text{S}_2 + 8\text{H}_2\text{O} = 6\text{Au} + 12\text{HCl} + 2\text{H}_2\text{SO}_4$, metallic gold being formed. L. Hoffmann and G. Krüss also found that metallic gold is precipitated at 100° , and at lower temp. variable proportions of combined sulphur, but no definite compound, are precipitated. The free sulphur is retained very tenaciously by the precipitate, and cannot be removed by washing on a filter; they removed the sulphur by washing first with water, then successively with alcohol, ether, and carbon disulphide. They obtained no appreciable change when hydrogen sulphide was passed through a soln. of potassium cyanoaurate, but when an excess of hydrochloric acid was present and the whole heated, a steel-grey precipitate of aurous sulphide was precipitated; this was washed with dil. hydrochloric acid, alcohol, ether, etc., as previously indicated in order to remove free sulphur. When freshly precipitated, aurous sulphide is peptized by water to form a brown colloidal soln., hence the need for washing with dil. acid. A. Oberkampf said that aurous sulphide is precipitated when an acid is added to the reddish-yellow soln. obtained by dissolving finely divided gold in a boiling soln. of potassium sulphide, or carbonate and sulphur. From soln. of aurous sodium thiosulphate, hydrogen sulphide precipitates mixtures of gold, sulphur, and aurous sulphide which always vary in composition. A. Gutbier and E. Dürrwächter could not find the right conditions for making this sulphide. According to E. A. Schneider, **colloidal aurous sulphide** can be prepared by saturating a soln. of aurous cyanide in potassium cyanide with hydrogen sulphide, warming carefully with hydrochloric acid until a brown turbidity is produced, and then submitting the whole to dialysis; there remains in the dialyzer a deep brown, colloidal soln. of aurous sulphide which can be separated from the undissolved portions by decantation and filtration. The most conc. soln. that can be obtained in this way contains 1.74 grms. of the sulphide per litre. When the colloidal soln. is heated at 200° to 230° , sulphuric acid is formed, and gold is deposited; when the soln. is frozen and melted again, the aurous sulphide is precipitated.

P. Yorke prepared tetrahydrated **sodium thioaurite**, $\text{NaAuS}_4\text{H}_2\text{O}$, by heating to bright redness a mixture of one gram-atom of gold, 6 gram-atoms of sulphur, and two mols of sodium monosulphide; extracting the fused mass with water; and concentrating the filtered soln. in vacuo over sulphuric acid. The yellow crystals so obtained are colourless when purified by re-crystallization. He also obtained similar crystals by crystallization of a soln. of one of the gold sulphides in an aq. soln. of sodium monosulphide. According to P. Yorke, the crystals have the composition $\text{NaAuS}_4\text{H}_2\text{O}$, but A. Ditte's crystals obtained by evaporating in vacuo a yellow soln. of aurous sulphide in the least possible quantity of sodium monosulphide, are said to have had the composition $\text{NaAuS}_5\text{H}_2\text{O}$. The crystals obtained by P. Yorke were six-sided prisms, with trilateral or quadrilateral apices, and belonged to the monoclinic system. They rapidly turned brown in air, and when heated, first gave off water, and then sulphur. The crystals dissolve in water and alcohol, and when the aq. soln. is treated with acids, a yellowish-brown precipitate with $\text{Au} : \text{S} = 1 : 1$ or 2 is deposited, and hydrogen sulphide evolved. The aq. soln. also decomposed slowly when exposed to air. The potassium salt treated under similar conditions furnishes a mass of indistinct crystals whose composition

was not definitely established, but which were thought to be potassium thioaurite, $K_2S \cdot Au_2S \cdot nH_2O$, or $KAuS \cdot nH_2O$.

According to P. Yorke, when gold sulphide is digested with sodium hydrosulphide, only a small quantity dissolves at ordinary temp., and on heating the soln., the gold sulphide is reduced. A. Ditte found aurous sulphide gradually dissolves in a soln. of sodium hydrosulphide, forming an orange-coloured soln. which, when evaporated in vacuo, deposits colourless needles, $2Na_2S \cdot Au_2S \cdot 20H_2O$, or $Na_4Au_2S_3 \cdot 20H_2O$, **tetrasodium trithioaurite**. These crystals are superficially blackened if organic matter be present.

U. Antony and A. Lucchesi dissolved finely powdered aurous sulphide in a soln. of sodium hydrosulphide of sp. gr. 1.021 or 1.029, and found the reddish-brown soln. to be rapidly decolorized, on the addition of absolute alcohol, owing to the formation of crystals of **trisodium dithioaurite**, Na_3AuS_2 , or $3Na_2S \cdot Au_2S$. It is suggested that unstable *trisodium trithioaurite*, Na_3AuS_3 , is first formed, and this immediately decomposes into the more stable Na_3AuS_2 ; the corresponding **tripotassium dithioaurite**, $3K_2S \cdot Au_2S$, or K_3AuS_2 , was prepared in a similar manner. A. Ditte made yellow hygroscopic needle-like crystals of the composition, $4K_2S \cdot Au_2S \cdot 12H_2O$, by evaporating in vacuo a soln. of auric sulphide in a small excess of potassium monosulphide. The crystals are coloured superficially grey by exposure to light. The crystals readily dissolve in water, forming a yellow soln. Silver nitrate precipitates **silver thioaurite**, Ag_3AuS_2 , from soln. of the potassium salt.

Gold disulphide or aurosoauric sulphide, Au_2S_2 , or $(AuS)_n$.—A. Levol² precipitated this product by treating a cold aq. soln. of auric chloride with hydrogen sulphide or an alkaline sulphide, and he represented the reaction: $8AuCl_3 + 9H_2S + 4H_2O = 4Au_2S_2 + 24HCl + H_2SO_4$, and this was confirmed by G. Krüss and L. Hoffmann. According to U. Antony and A. Lucchesi, the best conc. of the auric chloride soln. is between 1 and 3 per cent., and the temp. ought not to exceed 35° or 40° , otherwise some metallic gold is deposited. If the auric chloride is treated with ammonium hydrosulphide or an excess of yellow ammonium polysulphide, metallic gold is precipitated. They also made aurosoauric sulphide by adding a soln. of auric chloride to an aq. soln. of sodium aurous thiosulphate, and washing and drying the product. The preparation of this salt was also investigated by A. Oberkampf and by A. Schrötter and E. Priwoznik. A. Ditte made aurosoauric sulphide by passing hydrogen sulphide into an acid soln. of auric chloride. S. Odén prepared a colloidal hydrosol of auric sulphide by the action of a hydrosol of sulphur on an aq. soln. of auric chloride. A. Gutbier and E. Dürrwächter could not find the right conditions for making this sulphide.

Dried aurous sulphide is a brownish-black powder, and, once the precipitate has been dried, it is no longer peptized by water. A. Beutell has studied the formation of filiform gold by heating gold sulphide in vacuo, and obtained results like those obtained with silver sulphide under similar conditions (*q.v.*). It is not decomposed when boiled with dil. hydrochloric or sulphuric acids. Ozone was found by A. Mailfert to oxidize gold sulphide to the metal and free sulphuric acid. According to G. Krüss, aqua regia, chlorous oxide, and other oxidizing agents oxidize it easily. Bromine water slowly dissolves it with the formation of aurous bromide and sulphuric acid. Alkaline monosulphides dissolve it but slowly and slightly, polysulphides rapidly and completely, with the formation of green soln. of thio-salts. A soln. of potassium hydroxide does not attack it even at 100° , whereas the compound Au_2S_2 is, under like conditions, decomposed into gold, potassium gold sulphide, and potassium gold oxide. Potassium cyanide dissolves it readily, and the sulphide is reprecipitated by boiling the soln. with excess of hydrochloric acid. This reaction gives a good means of purifying the sulphide from free sulphur, as a slightly warmed soln. of potassium cyanide dissolves the former but not the latter. When heated in a tube, part of the sulphur distils off, and part passes off as sulphurous anhydride. The compound is completely

decomposed at 240°, and ignites in oxygen at a low temp. When heated in a stream of hydrogen, hydrogen sulphide is formed, but in a stream of hydrogen chloride the sulphur sublimes without the formation of any hydrogen sulphide, and pure gold is left. The existence of a soluble aurous sulphide and a soluble aurous oxide is regarded by G. Krüss as evidence in favour of placing gold in the alkali group rather than in the platinum group.

K. A. Hoffmann and F. Höchtlen formed yellow rhombic crystals of ammonium trithioaurate, NH_4AuS_3 , by shaking aurous chloride with a soln. of ammonium polysulphide, and allowing the mixture to stand some days at 5°. Aurosoauric sulphide is a reddish-brown or brownish-black powder, which, according to A. Oberkampf and A. Levol, begins to decompose at 140°, and the decomposition is complete at 250°–270°. When heated in hydrogen, G. Krüss found it to be reduced to gold. V. A. Jacquelin noticed that when kept for two days under an excess of the gold soln. in which it was formed, the precipitate decomposes, producing gold and sulphuric acid. A. Levol observed that although aurosoauric sulphide can be boiled in the liquid in which it was made, it cannot be prepared from boiling soln. When freshly prepared, E. A. Schneider, and C. Winssinger found it to form a colloidal soln. with water such that a litre of water may hold up to 0.8 grm. of the sulphide, but it was found by A. Levol to be converted by chlorine into sulphur chloride and auric chloride. According to G. Krüss, bromine water converts aurosoauric sulphide into auric bromide and sulphuric acid. It is insoluble in acids, but is dissolved by aqua regia. Soln. of the alkali monosulphides dissolve it sparingly in the cold, but when heated it first forms a brown and then a yellowish-green soln. According to A. Ditte, an excess of alkali monosulphide soln. forms an alkaithioaurite, while with an excess of aurosoauric sulphide, crystals of gold are formed. A very small excess of potassium monosulphide in the cold or at 30°–40° gives a residue of metallic gold. According to H. Hahn, soln. of the alkali polysulphides dissolve it easily in the cold, forming first a brown, then a green soln. A. Ditte says that it is insoluble in a soln. of sodium monosulphide sat. with sulphur; and sulphur gradually precipitates gold as black sulphide from aq. soln. of aurosoauric sulphide in aq. sodium monosulphide. Potassium hydroxide lye does not attack aurosoauric sulphide in the cold, but when heated a part is dissolved and part reduced to gold. Potassium cyanide rapidly dissolves aurosoauric sulphide, forming a colourless soln. E. A. Schneider found a soln. of auric chloride converts it into gold, slowly if cold, rapidly if heated.

Gold trisulphide or auric sulphide, Au_2S_3 .—J. J. Berzelius³ melted an excess of gold with potassium pentasulphide; extracted the cold mass with water; and precipitated by adding an acid, dark green flocculent auric sulphide which dried to a brown mass. According to G. Krüss, J. J. Berzelius' product was a mixture of sulphur and auric sulphide. K. A. Hoffmann and F. Höchtlen prepared auric sulphide by passing hydrogen sulphide into a soln. of auric chloride in anhydrous ether. U. Antony and A. Lucchesi prepared auric sulphide by passing hydrogen sulphide over dry lithium tetrachloaurate, $\text{LiCl}\cdot\text{AuCl}_3$, or the hydrated salt, $\text{LiCl}\cdot\text{AuCl}_3\cdot 2\text{H}_2\text{O}$, at –10°. The resulting brown mass was extracted with alcohol, and washed successively with carbon disulphide, alcohol, and finally ether; the product was dried at 70° in alcohol vapour until the weight was constant. U. Antony and A. Lucchesi, and A. Gutbier and E. Dürrwächter found that auric sulphide is decomposed by soln. of auric chloride, say: $\text{Au}_2\text{S}_3 + 6\text{HAuCl}_4 + 12\text{H}_2\text{O} = 8\text{Au} + 3\text{H}_2\text{SO}_4 + 24\text{HCl}$.

U. Antony and A. Lucchesi reported that auric sulphide was a black amorphous powder with a sp. gr. 8.754; it decomposes into its constituents between 197° and 200°. Neither fuming hydrochloric acid nor moderately conc. nitric acid attack auric sulphide, but conc. nitric acid (sp. gr. 1.370) oxidizes the sulphur and leaves the gold. Aqua regia attacks it slightly. A hot soln. of potassium or sodium hydroxide (1:6) gradually dissolves the sulphur, forming alkali sulphide, thio-sulphate, and gold. Warm aq. ammonia acts extremely slowly. Auric sulphide

readily dissolves in a soln. of potassium cyanide: $Au_2S_3 + 6KCy = 2KAuCy_2 + K_2S + 2KCyS$; a soln. of auric sulphide in a hot 25 per cent. soln. of potassium cyanide, furnishes crystals of potassium cyanoaurite, $KAuCy_2$. Dil. acids precipitate gold sulphide and cyanide from a soln. of auric sulphide in one of potassium cyanide; while dil. acids precipitate aurous or aurosoauric sulphide unchanged from a soln. of the respective salt in the same menstruum. A cold soln. of ammonium hydro-sulphide or monosulphide extracts sulphur from auric sulphide, and leaves the gold; the action is rapid with warm soln. A soln. of the alkali sulphides and polysulphides dissolve auric sulphide with difficulty, and the latter salt is partially decomposed; cold soln. of the alkali hydrosulphides readily dissolve auric sulphide, forming a brown soln., which when warmed becomes pale yellow, and when boiled the soln. deposits gold; when an acid is added to the soln., a pale yellow flocculent precipitate is formed and hydrogen sulphide is given off, and the precipitate becomes brown owing to the separation of auric sulphide.

Although sulphur vapour has very little action on gold, the case is different when that metal is alloyed with copper or silver, since what have been regarded as double cuprous thioaurites and silver thioaurites are formed. M. M. P. Muir's analysis, $5Ag_2S.2Au_2S_3$, of a product of the action of sulphur vapour on an alloy of gold and silver showed that the gold and silver are attacked, and a native sulphide of gold and silver is known. J. S. Maclaurin⁴ confirmed M. M. P. Muir's observation and prepared a number of such alloys of gold and silver sulphides, but gave no evidence as to which were compounds and which were mixtures. J. S. Maclaurin made what he regarded as silver thioaurite, $Ag_2S.Au_2S$, or $AgAuS$. U. Antony and A. Lucchesi also prepared what they regarded as *trisilver dithioaurite*, $3Ag_2S.Au_2S$, or Ag_3AuS_2 , by the action of silver nitrate on trisodium dithioaurite; Na_3AuS_2 . Similar observations were made with respect to silver and cuprous sulphides.

REFERENCES.

¹ L. Hoffmann, *Untersuchungen über das Gold*, Erlangen, 1887; K. A. Hoffmann and F. Höchtlen, *Ber.*, 37, 245, 1904; G. Krüss, *Untersuchungen über das Atomgewicht des Goldes*, München, 1885; W. Skey, *Chem. News*, 22, 282, 1870; 23, 277, 1871; A. Levöl, *Ann. Chim. Phys.*, (3), 30, 356, 1850; A. Oberkampf, *ib.*, (1), 80, 140, 1811; A. Schrötter and E. Priwoznik, *Anz. Akad. Wien*, 165, 1874; U. Antony and A. Lucchesi, *Gazz. Chim. Ital.*, 19, 545, 1889; 20, 601, 1890; 21, ii, 212, 1891; 26, ii, 350, 1896; E. A. Schneider, *Ber.*, 24, 2241, 1891; G. Krüss and L. Hoffmann, *ib.*, 20, 2369, 2704, 1887; J. J. Berzelius, *Pogg. Ann.*, 7, 30, 150, 277, 288, 1826; P. Yorke, *Journ. Chem. Soc.*, 1, 236, 1848; A. Ditte, *Compt. Rend.*, 120, 320, 1895; *Ann. Chim. Phys.*, (8), 12, 276, 1907; G. E. Stahl, *Observationum chymico-physico-mediarum curiosarum*, Francofurti, 1697; G. Gutbier and E. Dürrwächter, *Zeit. anorg. Chem.*, 121, 267, 1922; L. R. von Fellenberg, *Pogg. Ann.*, 50, 71, 1840; V. A. Jacquelin, *Compt. Rend.*, 14, 642, 1842.

² A. Levöl, *Ann. Chim. Phys.*, (3), 30, 356, 1850; A. Oberkampf, *ib.*, (1), 80, 140, 1811; A. Ditte, *ib.*, (8), 12, 273, 1907; U. Antony and A. Lucchesi, *Gazz. Chim. Ital.*, 19, 552, 1889; 20, 601, 1890; 21, ii, 212, 1891; 26, ii, 350, 1896; A. Schrötter and E. Priwoznik, *Anz. Akad. Wien*, 165, 1874; L. R. von Fellenberg, *Pogg. Ann.*, 50, 71, 1840; V. A. Jacquelin, *Compt. Rend.*, 14, 642, 1842; A. Mailfert, *ib.*, 94, 1186, 1882; A. Beutell, *Centr. Min.*, 14, 1919; G. Krüss and L. Hoffmann, *Ber.*, 20, 2369, 2704, 1887; E. A. Schneider, *ib.*, 24, 2241, 1891; H. Hahn, *Berg. Hütt. Ztg.*, 29, 66, 1870; G. Krüss, *Untersuchungen über das Atomgewicht des Goldes*, München, 1885; C. Winssinger, *Bull. Soc. Chim.*, (1), 49, 452, 1888; A. Gutbier and E. Dürrwächter, *Zeit. anorg. Chem.*, 121, 267, 1922.

³ K. A. Hoffmann and F. Höchtlen, *Ber.*, 37, 245, 1904; F. Höchtlen, *Ueber kristallisierte Polysulfide und Thiokarbonate von Schwermetallen*, München, 1904; J. J. Berzelius, *Pogg. Ann.* 7, 30, 150, 277, 288, 1826; U. Antony and A. Lucchesi, *Gazz. Chim. Ital.*, 19, 552, 1889; 20, 601, 1890; 21, ii, 212, 1891; 26, i, 350, 1896; S. Odén, *Nova Acta Upsala*, (4), 3, 4, 1913; G. Krüss, *Untersuchungen über das Atomgewicht des Goldes*, München, 1885; G. Krüss and L. Hoffmann, *Ber.*, 20, 2369, 2704, 1887; A. Gutbier and E. Dürrwächter, *Zeit. anorg. Chem.*, 121, 266, 1922.

⁴ J. S. Maclaurin, *Journ. Chem. Soc.*, 69, 1269, 1896; M. M. P. Muir, *Proc. Glasgow Phil. Soc.*, 8, 184, 1872; *Ber.*, 5, 537, 1872; J. J. Berzelius, *Pogg. Ann.* 7, 277, 1826; U. Antony and A. Lucchesi, *Gazz. Chim. Ital.*, 26, ii, 352, 1896.

§ 20. Gold Sulphates

J. P. Prat¹ prepared what is regarded as **aurosoauric sulphates**, AuSO_4 , by heating finely divided gold with sulphato-iodic acid, $3\text{H}_2\text{SO}_4 \cdot 2\text{HIO}_3$, to 300° until the mixture acquired a dark orange-yellow colour; he dissolved the mass in fuming nitric acid, dil. with water, and boiled. The brown precipitate was washed, dried, and preserved out of contact with light. P. Schottländer prepared what appears to be the same product by evaporating a soln. of auryl sulphate at 250° as rapidly as possible. The red hygroscopic prismatic crystals so obtained were blackened when treated with water, owing to the separation of auric hydroxide, and with a small quantity of moisture they formed a yellow substance. They are insoluble in cold conc. sulphuric acid, and with hot conc. sulphuric acid they are decomposed into gold and a soln. of auric sulphate.

J. Pelletier found that auric oxide is sparingly soluble in cold sulphuric acid, forming a yellow strongly acid liquid which, when gently heated or when mixed with water, deposits metallic gold. The acid liquid is thought to contain a soln. of **auric sulphate**, $\text{Au}_2(\text{SO}_4)_3$. J. P. Prat says the soln. crystallizes with difficulty, and that the dry crystals are purple-red, very hygroscopic, and decompose when treated with water into an insoluble aurous salt and a soluble auric salt. A. H. Allen obtained a similar liquid to that obtained by J. Pelletier, but he worked with hot soln. The soln. reacts with ferrous sulphate, oxalic acid, or stannous chloride like ordinary soln. of gold salts. A. Reynolds made similar observations, but he employed hot conc. sulphuric mixed with a little nitric acid for dissolving the auric oxide. A. H. Allen employed a mixture of chlorine-free potassium permanganate and conc. sulphuric acid as a solvent. J. Spiller obtained a soln. of auric sulphate by the electrolysis of a mixture of sulphuric acid with 10 per cent. of nitric acid with a gold anode and platinum cathode. The resulting soln. contains auric sulphate which is converted into auric chloride by hydrochloric acids or metal chlorides.

P. Schottländer heated auryl nitrate with conc. sulphuric acid to about 200° and obtained yellow, hygroscopic octahedra of **auryl hydrosulphate**, $\text{AuO} \cdot \text{HSO}_4$. They form a yellowish-red soln. with 95 per cent. sulphuric acid which becomes almost black when heated. Boiling nitric acid does not appreciably affect the compound; hydrochloric acid forms auric chloride and sulphuric acid; and water immediately decomposes the salt into auric oxide and sulphuric acid.

According to J. P. Prat, an aq. soln. of gold sulphate unites with alkali sulphates to form a salt which crystallizes in octahedra resembling alum; and, according to P. Schottländer, a soln. of one part of potassium hydrosulphate with ten parts of auryl sulphate on evaporation at 200° furnishes pale yellow rhombic plates of **potassium disulphatoaurate**, $\text{KAu}(\text{SO}_4)_2$. These slowly turn brown on exposure to air, and when treated with cold water furnish auric oxide, potassium sulphate, and sulphuric acid. The corresponding **silver disulphatoaurate**, $\text{AgAu}(\text{SO}_4)_2$, was made in a similar way.

REFERENCES.

¹ J. P. Prat, *Compt. Rend.*, 70. 840, 1870; J. Pelletier, *Ann. Chim. Phys.*, (2), 15. 5, 1820; P. Schottländer, *Liebig's Ann.*, 217. 312, 1883; A. Reynolds, *Chem. News*, 10. 277, 1864; J. Spiller, *ib.*, 10. 173, 1864; A. H. Allen, *ib.*, 25. 85, 1872.

§ 21. The Gold Nitrates

According to T. Bergmann,¹ freshly precipitated gold dissolves in conc. nitric acid, but separates from it again when the liquid is agitated. S. Tennant also observed the formation of an orange-coloured soln, when finely divided gold is digested with fuming nitric acid, and found that the soln. deposits auric oxide

when shaken up with water, while if an excess of fuming nitric acid is present, or if the water contains some potassium nitrate, metallic gold is precipitated. According to A. H. Allen, the aq. soln. decomposes slowly in the cold, and rapidly when heated. L. N. Vauquelin, J. Pelletier, E. Frémy, and A. H. Allen studied the yellowish-brown soln. obtained when auric oxide or hydroxide is digested with conc. nitric acid. On evaporation, the soln. deposits first auric oxide, and then a black mixture of gold and auric oxide. In the absence of hydrochloric acid, the addition of water precipitates auric hydroxide from the soln. of gold in conc. nitric acid; the soln. behaves towards reagents in a way which is characteristic of auric salts. It is generally assumed that the soln. contains **auric nitrate**, which is stable only in very conc. soln. of nitric acid. A. Hanriot and F. M. Raoult dissolved brown precipitated gold in nitric acid free from nitric fumes, and concentrated the soln. in vacuo, over calcium chloride, in darkness, first aided by heat, and then while cooling the soln. The residue was extracted with boiling dried acetone, and the soln., on evaporation, furnished needle-like crystals of the composition $\text{Au}(\text{NO}_3)_3 \cdot n\text{H}_2\text{O}$. They are decomposed by exposure to light and air, and this renders the determination of the water of crystallization impracticable. The crystals are soluble in boiling acetone, and are decomposed by water into nitric acid and brown auric oxide.

F. M. Campbell prepared **aurous nitrate**, AuNO_3 , by shaking aurous oxide with nitric acid. He estimated that the solubility product, $[\text{Au}][\text{OH}]$, of the hydrolyzed aurous nitrate is 0.52×10^{-19} with $9.13N\text{-HNO}_3$, and 0.86×10^{-19} with $11.6N\text{-nitric acid}$. The discharge potential of Au^+ -ions is 1.5 volt. According to P. Schottländer, auric hydroxide is soluble in nitric acid of sp. gr. 1.40, when heated on a water-bath, and the soln. when evaporated in vacuo over calcium chloride and sodium hydroxide gives a dark reddish-brown gum-like mass of **auryl nitrate**, $\text{AuO} \cdot \text{NO}_3 \cdot \frac{1}{5}\text{H}_2\text{O}$, or $5\text{Au}_2\text{O}_3 \cdot 5\text{N}_2\text{O}_5 \cdot 2\text{H}_2\text{O}$. If hydronitratouric acid (*vide infra*) is dried on a water-bath at 98° , a reddish-brown amorphous powder is formed, whose composition corresponds with a basic auryl nitrate or **auryl oxynitrate**, $2\text{Au}_2\text{O}_3 \cdot \text{N}_2\text{O}_5 \cdot 2\text{H}_2\text{O}$, or $\text{Au}_2\text{O}_3 \cdot 2\text{AuO}(\text{NO}_3) \cdot 2\text{H}_2\text{O}$. It is very slowly soluble without residue in nitric acid of sp. gr. 1.40, even at 100° . According to P. Schottländer, when a soln. of one part of auric hydroxide in 3.67 parts of nitric acid of sp. gr. 1.492 is cooled by a freezing mixture, it furnishes golden-yellow triclinic crystals of sp. gr. 2.84, and whose composition corresponds with **auric hydronitrate**, or **hydronitratouric acid**, $\text{HAu}(\text{NO}_3)_4 \cdot 3\text{H}_2\text{O}$, or $\text{Au}(\text{NO}_3)_3 \cdot \text{HNO}_3 \cdot 3\text{H}_2\text{O}$. For F. H. Jeffery's preparation of yellow crystals of hydroaurinitric acid, $\text{HAu}(\text{NO}_3)_4 \cdot 3\text{H}_2\text{O}$, see the action of nitric acid on gold. The crystals effloresce in dry air, and deliquesce in moist air. When warmed at $72^\circ\text{--}73^\circ$, nitric acid is given off, and a brownish-black liquid is obtained. At 215° decomposition is complete. If a soln. of hydronitratouric acid and ammonium nitrate in colourless conc. nitric acid, of sp. gr. 1.4–1.5, be evaporated in a desiccator, yellow prismatic crystals of **ammonium nitratourate**, $\text{NH}_4\text{NO}_3 \cdot \text{Au}(\text{NO}_3)_3$, or $\text{NH}_4\text{Au}(\text{NO}_3)_4$, are formed. The crystals are fairly stable when heated, but decompose as the temp. approaches 140° . P. Schottländer also evaporated in a desiccator a warm soln. of seven parts of ammonium nitrate and ten of hydronitratouric acid in 25 parts of colourless nitric acid of sp. gr. 1.5. The yellow rhombic plates had the composition corresponding with $2\text{NH}_4\text{NO}_3 \cdot \text{Au}(\text{NO}_3)_3 \cdot \text{HNO}_3$, or $\text{NH}_4\text{Au}(\text{NO}_3)_4 \cdot \text{NH}_4\text{NO}_3 \cdot \text{HNO}_3$. They are decomposed by nitric acid of sp. gr. less than 1.4 and over 1.5. Corresponding salts—**potassium nitratourate**, $\text{KAu}(\text{NO}_3)_4$, and **rubidium nitratourate**, $\text{RbAu}(\text{NO}_3)_4$ —were prepared by P. Schottländer.

REFERENCES.

- ¹ T. Bergmann, *Opuscula physica et chemica*, Holmiæ, 3. 356, 1790; S. Tennant, *Scherer's Journ.*, 1. 307, 1798; L. N. Vauquelin, *Ann. Chim. Phys.*, (1), 77. 321, 1811; E. Frémy, *ib.* (3), 31. 478, 1850; J. Pelletier, *ib.*, (2), 15. 5, 113, 1820; A. H. Allen, *Chem. News*, 25. 85, 1872;

F. H. Campbell, *ib.*, 96. 26, 1907; P. Schöttländer, *Ueber das Salzpetersäure—Goldnitrat und einige neue Derivate desselben*, Würzburg, 1884; *Liebig's Ann.*, 217. 312, 1883; A. Harriot and F. M. Raoult, *Compt. Rend.*, 155. 1086, 1912; *Bull. Soc. Chim.*, (4), 13. 261, 1913; F. H. Jeffery, *Trans. Faraday Soc.*, 11. 172, 1916.

§ 22. The Family Relationship of Copper, Silver, and Gold

These three elements are generally classed together in so-called "systematic chemistry," and they are furthermore considered to be related to the alkali metals. The copper group of elements is generally linked with the alkali metals by the scheme indicated in the margin, which starts with the elements with the lowest atomic weights. The fault with the scheme is that it makes the relationship appear far closer than is indicated by known facts. If we recall the relationship between the members of, say, the alkali metals, and the halogen families, the relationship between the individual members of this so-called family and with the alkali metals is strikingly obscure. The student might well inquire why these elements are grouped together at all, and cogent reasons might be urged for grouping gold with platinum, silver with palladium, and copper with mercury. The reason why this is not done will appear when we take a general survey of *all* the elements. Returning to the elements copper, silver, and gold, the physical properties may be tabulated:

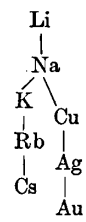

TABLE XII.—PHYSICAL PROPERTIES OF COPPER, SILVER, AND GOLD.

	Copper.	Silver.	Gold.
Atomic weight	63.6	107.88	197.2
Specific gravity	8.93	10.49	19.265
Atomic volume	7.07	10.29	10.11
Melting point	1082.6°	960.0°	1062.4°
Boiling point	2310°	1955°	2200°
Latent heat of fusion (cals.)	43	24.35	16.3
Specific heat	0.086	0.055	0.030

In malleability, ductility, and tenacity, silver is intermediate between copper and gold. While the large atomic volume of the alkali metals is associated with great chemical activity and affinity for oxygen, the low atomic volume of these elements is related with their weak affinity for oxygen, etc. Copper, for instance, is alone oxidized in air. The oxides of copper, silver, and gold are easily reduced, while the oxides of the alkali metals are reduced with great difficulty. The reduction of copper, silver, and gold by magnesium is the more energetic the greater the atomic weight of the metal—cuprous oxide reduces easily; silver oxide reduces with explosive violence, and gold oxide breaks down into its constituents below the ignition point of magnesium. Silver appears to be uni-, bi-, and ter-valent, but copper is both uni- and bi-valent, and gold is uni- and ter-valent. Hence these three elements have univalency in common with the alkali metals. Cupric salts are isomorphous with iron, cobalt, and nickel. The isomorphism of the silver and sodium sulphates and selenates indicates a relationship of some kind between silver and sodium. The alkali halides, like silver chloride and bromide, crystallize in the cubic system—silver iodide crystallizes in the hexagonal system and the crystals pass into the cubic system at about 146°—on cooling the reverse change takes place—sometimes with explosive violence. Silver seems to be related with copper through argentic oxide, Ag₂O, where silver appears to be bi-valent; silver pyridine persulphate, Ag₂S₂O₈.4Py, is isomorphous with the analogous copper pyridine persulphate, CuS₂O₈.4Py; with gold, through silver sesquioxide, Ag₂O₃; and with the alkalis

through argentous oxide, Ag_2O , and with the magnesium family through mercury. The more salient differences between copper and the alkali metals are : (1) The elements of the alkali metals have a small density, the other metals have a large density ; (2) the alkali metals do not occur free ; (3) the elements of the alkali metals are chemically active, the others not so ; (4) the haloids of the alkalies are all soluble in water, and are not hydrolyzed by water ; copper and silver form sparingly soluble haloids, and the haloids of copper and gold, not silver, are hydrolyzed by water. (5) The oxides and hydroxides of the alkalies are strongly basic ; the oxides and hydroxides of copper and gold are feebly basic, and they accordingly form basic salts. (6) The alkali metals do not form complex salts, whereas copper, silver, and gold form many complex salts.

R. F. Heath ¹ reported a radioactive element of monad valency, at. wt. 204.6, belonging to the first group in the periodic table. It was found in the uranite and monazite sand of Montana, U.S.A. The element itself is brownish-grey in colour, and it unites at a high temp. with the halogens, nitrogen, oxygen, and hydrogen ; the compounds and salts are white. It was named *wilsonium* after the then President of the United States. The results have not been confirmed.

REFERENCES.

¹ R. F. Heath. *Bull. Western Met. Chem. Soc.*, 43, 1917; *Bull. Internat. Met. Chem Soc*, 10. 46, 1917.

CHAPTER XXIV

THE ALKALINE EARTHS

§ 1. The History of Calcium, Strontium, and Barium

THE early chemists applied the term *earth* to those non-metallic substances which were virtually insoluble in water, and did not change when exposed to a high temp. When it was found that some of the earths resembled the alkalis in that they neutralized the acids, and gave an alkaline reaction when moistened with water, they were subdivided so as to form a class termed *terra alkalina*. The alkaline earths at first comprised magnesia and lime; baryta and strontia were afterwards included. It was subsequently found that the chemical properties of magnesia more nearly resembled those of zinc and cadmium oxides than those of the other three alkaline earths, and it was consequently removed to another sub-group so that this family now includes the three oxides—lime, strontia, and baryta. Radium has been included in the family of the alkaline earths.

Lime must have been long known, since it has been employed in making mortar from prehistoric times. Theophrastus (300 B.C.) mentioned in his *Περὶ Λίθων*, that the calcination of γύψος, gypsum, furnishes a product which has more the nature of a rock than an earth, and which develops heat and sets to a hard mass when wetted with water. He also stated that gypsum seems to have the nature of lime. Dioscorides (75 A.D.) described the preparation of caustic lime—ἄσβεστος, unslaked, as he called it—by calcining mussel-shells, limestone, or marble at a white heat. Contemporaneous with Dioscorides, the elder Pliny, in his *Historia naturali*, described the processes of burning and slaking lime.

G. E. Stahl¹ regarded salts as products of the combination of an earthy element with an aqueous element. N. Lemery said :

Quicklime is a stone whose moisture has been dried up by fire and replaced by a great many igneous particles; the igneous particles can be driven from quicklime by the addition of a little water. . . . I am not of the opinion of those who suppose quicklime to contain an acid which is drawn out by water, and, meeting an alkali, effervesces when in the presence of water.

C. F. Dufay evaporated lime-water and obtained what he called *le sel de la chaux*. M. Malouin assumed that the *crème de chaux*, which formed as a film on the surface of lime-water exposed to air, contained vitriolic acid united with a particular earth. In 1747, H. L. Duhamel du Monceau prepared many *combinaisons de la chaux avec plusieurs acides*. The changes which occur during the conversion of limestone into caustic lime were not understood until J. Black published his thesis, *Experiments upon Magnesia Alba, Quicklime, and other Alkaline Substances* (Edinburgh, 1777).

Near the beginning of the seventeenth century, about 1602 or 1603, the mineral heavy spar, found in the secondary strata of the Monte Paterno, attracted the attention of V. Casciorolus or V. Casciarolus who dabbled in alchemy; he suspected from the weight and lustre of the stone that it contained a heavy metal; he therefore subjected the mineral to fire and was amazed to find the product glowed with a red light when viewed in a dark room. Hence the stone was called *lapis solaris*, and, owing to its having been first prepared at Bologna, it was called *Bolognian or Bononian stone*. It was mentioned by A. J. C. de Galla² in 1612, and in his *Andegavensis pharmacopœa*

spagyrica (Coloniæ, 1625), P. Poterius described the method of making the phosphorescent stones. In 1748, F. M. Zanottus stated that in 1719 it had been demonstrated by J. B. Beccari and others that the Bolognian stone contained sulphur and an alkali.

The mineral from which the *lapis solaris* was made was also called the *Bologna stone* or *Bologna spar*. J. G. Wallerius regarded Bologna spar as a kind of gypsum, and he called it *gypsum spatiosum*; and A. F. Cronstedt considered it a distinct species and called it *marmor metallicum*. In 1750, A. S. Marggraf found that this mineral contained sulphuric acid, but he regarded it as a compound of sulphuric acid with lime. About 1760, J. H. G. von Justi, commenting on the obscure nature of the mineral, said :

Our analysis has here reached its limits, we know of no smelting operation which will enable anything to be obtained from the spar. Many skilled chemists and assayers have here tried their art in vain.

C. W. Scheele's investigation, *De magnesia nigra* (Stockholm, 1774), revealed the presence in manganese oxide of "an earth differing from all earths hitherto known," whose soln. in phosphoric, tartaric, or hydrofluoric acid gave an insoluble white precipitate with sulphuric acid; and in his *De arsenico ejusque acido* (Stockholm, 1775), C. W. Scheele made further observations on this new earth which he called *terra ponderosa*, and stated that he had been informed by I. G. Gahn that the new earth is the basis of heavy or ponderous spar. C. W. Scheele made a special *Examen chemicum de terra ponderosa* in 1779, and it was soon identified with the Bologna spar.

T. Bergmann, in his *Sciagraphia regni mineralis* (London, 1783), assumed that a carbonate of *terra ponderosa* would occur in nature, and this was discovered in 1783 by W. Withering, at Leadhills (Scotland). A. G. Werner called the mineral *witherite*. A. F. de Fourcroy and L. N. Vauquelin (1797) prepared *terra ponderosa* by calcining the nitrate. L. B. Guyton de Morveau recommended the term *barote*—from βαρύς, heavy—in place of *terra ponderosa*, and this term was later changed into *baryta* in conformity with A. L. Lavoisier's nomenclature, and the metal was called *barium*. E. D. Clarke proposed calling the metal *plutonium*, but the suggestion was never adopted.

A mineral resembling heavy spar, found associated with the ore in the lead mines of Strontian in Argyleshire, attracted the attention of T. C. Hope.³ In 1790, A. Crawford, basing his opinion on the experiments of his assistant, W. Cruickshank, emphasized the conspicuous difference in the form of the crystals of the chloride derived from this mineral, and from barytes; and on the difference in the solubilities of the two chlorides; and he conjectured that the mineral from Strontian differed from aerated barytes in containing a peculiar and hitherto unknown kind of earth. B. Pelletier reported that a sample of the Strontian mineral had been transmitted to a French chemist of note, who did not publish the result of his analysis because *elle ne m'avoit fourni rien de particulier*. T. C. Hope reported the results of his first experiments in 1792, and in 1793 he gave *An account of a mineral from Strontian and of a peculiar species of earth which it contains*. He added :

Considering it as a peculiar earth, I thought it necessary to give it a name. I have called it *strontites*, from the place where it was found; a mode of derivation, in my opinion, fully as proper as any quality it may possess, which is the present fashion.

In 1793, also, M. H. Klaproth compared the peculiarities of the two earths, and concluded from (i) the smaller sp. gr. of the strontian earth; (ii) the difference in the crystals of the carbonates; (iii) the difference in the crystalline form of the nitrates, acetates, and chlorides; (iv) the difference in the water of crystallization; and (v) the red colour imparted by the strontian earth to a flame, that strontian earth is *eine selbständige einfache Erde*. T. Bergmann believed that baryta is precipitated from soln. of its salt by potassium ferrocyanide, and this reagent was afterwards suggested as a means of distinguishing baryta from strontia; but F. Meyer showed

in 1786 that T. Bergmann's ferrocyanide must have been contaminated with sulphate, because the purified salt gives no precipitate with barium salts, and this was confirmed by M. H. Klaproth. R. Kirwan also investigated the properties of strontian earth. J. T. Lowitz found that strontian earth accompanied baryta in witherite.

The ideas of J. J. Becher, G. E. Stahl, and R. Boyle⁴ on the relation of earthy substances to the metals were founded on the alchemical hypothesis that the metals were compounds of an earth with some igneous principle or phlogiston. About 1755, C. Neumann made some unsuccessful experiments to obtain a metal from quicklime. T. Bergmann suspected *terra ponderosa* to be a metallic calx from its high sp. gr.; and A. L. Lavoisier extended the hypothesis to all the metallic oxides:

Il seroit possible à la rigueur que toutes les substances auxquelles nous donnons le nom de terre, ne fussent que des oxides métalliques, irréductibles par les moyens que nous employons.

M. Tondi and M. de Ruprecht stated that the earths can be reduced to metals by charcoal, but A. M. Savaresi, and M. H. Klaproth proved that the products were in reality mixtures containing phosphide of iron derived from the bone-ash and other materials used in the experiment. Consequently, the latter concluded: *la prétendue réduction des terres en métaux n'est qu'une pure illusion.*

H. Davy's decomposition of the fixed alkalis⁵ led him to say:

From analogy alone it is reasonable to expect that the alkaline earths are compounds of a similar nature to the fixed alkalis, peculiar highly combustible bases united to oxygen. I have tried some experiments on barytes and strontites; and they go far towards proving that this must be the case. When barytes and strontites, moistened with water, were acted upon by the power of the battery, there was a vivid action and a brilliant light at both points of communication, and an inflammation at the negative point.

H. Davy attempted to deoxidize the earths by heating them with potassium in glass tubes; he also modified the procedure employed in the deoxidation of the fixed alkalis, but was not very successful. While engaged on these experiments, H. Davy heard by letter from J. J. Berzelius that barytes and lime could be decomposed by negatively electrifying mercury in contact with them, whereby amalgams of the metals of these earths were obtained. Consequently, H. Davy repeated these experiments with barytes, strontites, and lime; and with perfect success. The resulting amalgams when thrown into water, disengaged hydrogen, mercury was set free, and an aq. soln. of the alkaline earth was obtained. H. Davy found the yield was improved by mixing mercuric oxide with the base. He then distilled the amalgams in sealed glass tubes filled with petroleum vapour, and found, as also did J. L. Gay Lussac and L. J. Thénard (1811), that it is very difficult to drive off the mercury. Although in some cases H. Davy obtained white metals, he never felt certain that a minute portion of mercury was not present. However, he claimed:

The evidence for the composition of the alkaline earths is of the same kind as that for the composition of the common metallic oxides, and the principles of the decomposition are precisely similar. . . . On the same principles as I have named the bases of the fixed alkalis, potassium and sodium, I shall venture to denominate the metals of the alkaline earths, barium, strontium, and calcium.

T. J. Seebeck showed in March, 1808, that lime, baryta, magnesia, and alumina when electrolyzed in contact with mercury, furnished amalgams of the basic elements which behave with water like sodium amalgam; and when distilled in the vapour of petroleum furnished a metallic powder. About the same time, J. B. Trommsdorff verified these results; and J. F. A. Göttling obtained metal spherules by the electrolysis of barium carbonate, but calcium or magnesium carbonate did not yield the same result. Coherent masses of these different metals were obtained later—*vide infra*.

REFERENCES.

¹ G. E. Stahl, *Specimen Becherianum*, Lipsiæ, 1703; *De salibus metallicis*, Halæ Magdcburgiæ, 1708; C. F. Dufay, *Mém. Acad.*, 88, 1724; M. Malouin, *ib.*, 93, 1745; N. Lemery, *Cours de chimie*, Paris, 1675; H. L. Duhamel du Monceau, *Mém. Acad.*, 59, 1747.

² A. J. C. de Galla, *De phenomenis in orbe lunæ novi telescopii*, Venetiis, 1612; F. M. Zanottus, *Comment. Bonon.*, 1. 181, 1748; J. B. Beccari, *ib.*, 1. 274, 1748; C. W. Scheele, *Beschaefigungen der berlinischen Gesellschaft naturforschender Freunde*, 4. 1, 1779; A. S. Marggraf, *Hist. l'Acad. Berlin*, 5. 56, 1749; 6. 114, 1750; *Chymische Schriften*, Berlin, 2. 113, 135, 1767; L. B. G. de Morveau, *Journ. Phys.*, 13. 90, 1779; J. G. Wallerius, *Systema mineralogicum*, Vindobonæ, 1773; A. F. Cronstedt, *Versuch einer Mineralogie*, Copenhagen, 1770; W. Withering, *Phil. Trans.*, 74. 293, 1784; J. Watt, *Mem. Manchester Lit. Phil. Soc.*, 3. 598, 1790; A. G. Werner, *Berg. Journ.*, 2. 225, 1790; A. F. de Fourcroy and L. N. Vauquelin, *Ann. Chim. Phys.*, (1), 21. 276, 1797; (1), 24. 276, 1797; E. D. Clarke, *Ann. Phil.*, 8. 357, 1816; J. H. G. von Justi, *Gründriss des gesamen Mineralreiches*, Göttingen, 1757; P. Poterius, *Andegavensis pharuaropœa spagyrica*, Coloniae, 1625.

³ A. Crawford, *London Med. Comm.*, 2. 301, 1790; T. C. Hope, *Trans. Roy. Soc. Edin.*, 4. 3, 1798; B. Pelletier, *Ann. Chim. Phys.*, (1), 10. 186, 1791; J. G. Schmaisser, *Phil. Trans.*, 84. 1, 1794; M. H. Klaproth, *Beiträge zur chemischen Kenntniss der Mineralkörper*, Berlin, 1. 260, 1794; 2. 84, 1797; *Crell's Ann.*, ii, 189, 1793; i, 99, 1794; J. T. Lowitz, *ib.*, i, 110, 1795; R. Kirwan and B. Higgins, *ib.*, ii, 119, 205, 1795; R. Kirwan, *Trans. Irish Acad.*, 5. 243, 1794; A. F. de Fourcroy, *Ann. Chim. Phys.*, (1), 1. 34, 1789; (1), 8. 9, 1791.

⁴ *Vide* 1. 1, 15. C. Neumann, *Chymia medica, dogmatico-experimentalis*, Züllichai, 1755; London, 1. 15, 1773; T. Bergmann, *Sciagraphia regni mineralis*, London, 1783; A. L. Lavoisier, *Traité élémentaire de chimie*, Paris, 1. 174, 1793; M. Tondi and M. de Ruprecht, *Ann. Chim. Phys.*, (1), 8. 1, 1791; A. M. Savaresi, *ib.*, (1), 10. 257, 1791; M. H. Klaproth, *ib.*, (1), 8. 275, 1791.

⁵ H. Davy, *Phil. Trans.*, 98. 1, 333, 1808; T. J. Seebeck, *Gehlen's Journ.*, 5. 482, 1805; J. B. Trommsdorff, *ib.*, 5. 483, 1808; J. F. A. Götting, *Phil. Mag.*, (1), 22. 218, 1805; J. J. Berzelius, *Gilbert's Ann.*, 35. 269, 1810; 36. 255, 1810; J. L. Gay Lussac and L. J. Thénard, *Recherches physico-chimiques*, Paris, 1. 50, 1811.

§ 2. The Occurrence of the Alkaline Earths

The metals of the alkaline earths do not occur free in nature. F. W. Clarke's estimate¹ of the relative abundance of these elements in the lithosphere or half-mile crust of the earth, is

	Calcium.	Strontium.	Barium.
Per cent.	3·47	0·02	0·08

The sea contains 0·05 per cent. of calcium; this makes an average of 3·22 per cent. in the earth, air, and sea. Calcium is one of the most abundant of the elements, and it comes fifth in the list of elements arranged in the order of their relative abundance; strontium is less abundant than barium, for it comes eighteenth on the list, while barium comes sixteenth on the list, and it is widely distributed though in small quantities. The average composition of the typical rocks shows the presence of

	Igneous rocks (95 per cent.).	Shales (4 per cent.).	Sandstones (0·75 per cent.).	Limestones (0·25 per cent.).	Weighted average.
Calcium oxide	4·48	3·11	5·50	42·57	4·86
Strontium oxide	0·04	—	—	—	0·04
Barium oxide	0·10	0·05	0·05	—	0·09

N. Ljubavin has compared the relative distribution of calcium and magnesium in the earth's crust.

Calcium is an essential constituent of many rock-forming minerals—*e.g.* in the amphiboles, pyroxenes, and scapolite, as well as in epidote, garnet, and anorthite. The carbonate, CaCO_3 , is widely distributed as *calcite* or *calcspar*, *aragonite*, *chalk*, *limestone*, *marble*, *coral*, etc.; it occurs along with magnesium carbonate as *dolomite*, or, when crystallized, as *bitter-spar*; and it occurs in isomorphous mixture with other carbonates as

Chalybite or *brown-spar*, $(\text{Ca}, \text{Mg}, \text{Fe}, \text{Mn})\text{CO}_3$; *mangano-calcite*, $(\text{Mn}, \text{Ca}, \text{Fe}, \text{Mg})\text{CO}_3$; *baryto-calcite* or *alstonite*, $(\text{Ba}, \text{Ca})\text{CO}_3$; *calcio-strontianite*, $(\text{Sr}, \text{Ca})\text{CO}_3$; *plumbo-calcite* or *tarnowitzite*, $(\text{Ca}, \text{Pb})\text{CO}_3$; *gaylussite* or *natro-calcite*, $\text{Na}_2\text{CO}_3 \cdot \text{CaCO}_3 \cdot 5\text{H}_2\text{O}$; *uranothallite*, $\text{Ca}_2\text{U}(\text{CO}_3)_4 \cdot 10\text{H}_2\text{O}$; etc.

Calcium occurs in large quantities as sulphate, tungstate, and titanate :

Gypsum or *selenite*, $\text{CaSO}_4 \cdot 2\text{H}_2\text{O}$; *anhydrite*, CaSO_4 ; *glauberite*, $\text{Na}_2\text{SO}_4 \cdot \text{CaSO}_4$; *syngenite* or *kaluszite*, $\text{K}_2\text{SO}_4 \cdot \text{CaSO}_4 \cdot \text{H}_2\text{O}$; *scheelite*, CaWO_4 ; *cuproscheelite*, $(\text{Ca}, \text{Cu})\text{WO}_4$; *uranopilite*, $\text{CaU}_6\text{S}_2\text{O}_{13}$; *polyhalite*, $\text{K}_2\text{SO}_4 \cdot \text{MgSO}_4 \cdot 2\text{CaSO}_4 \cdot 2\text{H}_2\text{O}$; *krugite*, $\text{K}_2\text{SO}_4 \cdot \text{MgSO}_4 \cdot 4\text{CaSO}_4 \cdot 2\text{H}_2\text{O}$; *wattevilleite*, $(\text{Na}, \text{K})_2(\text{Ca}, \text{Mg})(\text{SO}_4)_2 \cdot 2\text{H}_2\text{O}$; *ettringite*, $\text{Al}_2\text{Ca}_6(\text{OH})_{12}(\text{SO}_4)_3 \cdot 24\text{H}_2\text{O}$; *perowskite*, CaTiO_3 ; etc.

There is a hydrated nitrate, *nitrocalcite*, $\text{Ca}(\text{NO}_3)_2 \cdot n\text{H}_2\text{O}$; and several halides :

Chlorocalcite, CaCl_2 ; *fluorspar*, CaF_2 ; *gearksutite*, $\text{Al}(\text{F}, \text{OH})_2 \cdot \text{CaF}_2 \cdot \text{H}_2\text{O}$; *pachnolite* and *thomsenolite*, $\text{AlF}_3 \cdot \text{NaF} \cdot \text{CaF}_2 \cdot \text{H}_2\text{O}$; *prospopite*, $2\text{Al}(\text{F}, \text{OH})_3 \cdot \text{Ca}(\text{F}, \text{OH})_2$; *nocerite*, $(\text{Mg}, \text{Ca})_2\text{OF}_4$; *tachydrate*, $\text{CaCl}_2 \cdot \text{MgCl}_2 \cdot 12\text{H}_2\text{O}$; *ytrocerite*, $(\text{Y}, \text{Er}, \text{Ce})\text{F}_3 \cdot 5\text{CaF}_2 \cdot \text{H}_2\text{O}$; etc.

Calcium phosphate occurs combined with calcium chloride or fluoride as the well-known minerals *apatite*, $\text{Ca}_5(\text{PO}_4)_3(\text{Cl}, \text{F})$, and *osteolite*, *phosphorite*, *staffelite*, *coprolite*, etc. In addition to the phosphates there are arsenates, antimoniates, niobates, tantalates, and vanadates :

Arseniopleite, $(\text{Mn}, \text{Fe})_2(\text{Mn}, \text{Ca}, \text{Pb}, \text{Mg})_3(\text{MnOH})_6(\text{AsO}_4)_6$; *arsenosidcritic*, $\text{Fe}_4\text{Ca}_3(\text{OH})_6(\text{AsO}_4)_3$; *atopite*, $(\text{Ca}, \text{Na}_2, \text{Fe}, \text{Mn})_2\text{Sb}_2\text{O}_7$; *berzeliite*, $(\text{Ca}, \text{Mg}, \text{Mn}, \text{Na}_2)_3(\text{AsO}_4)_2$; *boryckite*, $\text{Fe}_4(\text{OH})_4 \cdot \text{Ca}(\text{PO}_4)_2 \cdot 3\text{H}_2\text{O}$; *brandite*, $\text{MnCa}_2(\text{AsO}_4)_2 \cdot 2\text{H}_2\text{O}$; *brushite*, $\text{CaHPO}_4 \cdot 2\text{H}_2\text{O}$; *calcio-ferrite*, $(\text{Fe}, \text{Al})_3(\text{OH})_3(\text{Ca}, \text{Mg})_3(\text{PO}_4)_4 \cdot 8\text{H}_2\text{O}$; *caryinite*, $(\text{Mn}, \text{Ca}, \text{Pb}, \text{Mg})_3(\text{AsO}_4)_2$; *cirrolite*, $\text{Al}_2\text{Ca}_3(\text{OH})_3(\text{PO}_4)_3$; *collophane*, $\text{Ca}_3(\text{PO}_4)_2 \cdot \text{H}_2\text{O}$; *coppite*, $\text{Ca}_3(\text{CaF})(\text{Na}, \text{K}) \cdot \text{CeO} \cdot (\text{Cb}_2\text{O}_7)_3$; *dahlite*, $\text{Ca}_7(\text{PO}_4)_4\text{CO}_3 \cdot \frac{1}{2}\text{H}_2\text{O}$; *fairfieldite*, $(\text{Ca}, \text{Mn}, \text{Fe})_3(\text{PO}_4)_2 \cdot 8\text{H}_2\text{O}$; *fillowite*, $(\text{Mn}, \text{Fe}, \text{Na}_2, \text{Ca})_3(\text{PO}_4)_2 \cdot \frac{1}{2}\text{H}_2\text{O}$; *goyazite*, $\text{Al}_{10}\text{Ca}_3\text{P}_{23} \cdot 9\text{H}_2\text{O}$; *haidingerite*, $\text{CaHAsO}_4 \cdot \frac{1}{2}\text{H}_2\text{O}$; *herderite*, $\text{Ca}\{\text{Be}(\text{OH}, \text{Fe})\}\text{PO}_4$; *isoclase*, $\text{Ca}(\text{CaOH})\text{PO}_4 \cdot 2\text{H}_2\text{O}$; *calc-uranite* or *autunite*, $\text{Ca}(\text{UO}_2)_2(\text{PO}_4)_2 \cdot 8\text{H}_2\text{O}$; *konichalcite*, $(\text{Cu}, \text{Ca})(\text{CuOH})(\text{As}, \text{P}, \text{V})\text{O}_4 \cdot \frac{1}{2}\text{H}_2\text{O}$; *martinite*, $\text{Ca}_5\text{H}_2(\text{PO}_4)_4 \cdot \frac{1}{2}\text{H}_2\text{O}$; *mazapilite*, $\text{Fe}_4(\text{OH})_4\text{Ca}_2(\text{AsO}_4)_4 \cdot 3\text{H}_2\text{O}$; *microlite*, $\text{Ca}_2\text{Ta}_2\text{O}_9$; *ornithite*, $\text{Ca}_3(\text{PO}_4)_2 \cdot 2\text{H}_2\text{O}$; *pharmacolite*, $\text{CaHAsO}_4 \cdot 2\text{H}_2\text{O}$; *piropharmacolite*, $(\text{Ca}, \text{Mg})_3(\text{AsO}_4)_2 \cdot 6\text{H}_2\text{O}$; *polyspharite*, $(\text{Ca}, \text{Pb})_5(\text{PO}_4)_3\text{Cl}$; *roméite*, CaSb_2O_4 ; *roselite*, $(\text{Ca}, \text{Co}, \text{Mg})_3(\text{AsO}_4)_2 \cdot 2\text{H}_2\text{O}$; *svanbergite*, $\text{Na}_2(\text{CaOH})(\text{AlO})_6(\text{PO}_4)_2(\text{SO}_4)_2 \cdot 3\text{H}_2\text{O}$; *tavistockite*, $\text{Al}_2\text{Ca}_3(\text{OH})_6(\text{PO}_4)_2$; *uranospinite*, $\text{Ca}(\text{UO}_2)_2(\text{AsO}_4)_2 \cdot 8\text{H}_2\text{O}$; *volborthite*, $(\text{Cu}, \text{Ca})(\text{CuOH})\text{VO}_4$.

Calcium borate also occurs in nature associated with many other metallic borates :

Boracite or *bechilite*, $\text{CaBr}_2 \cdot 0.74\text{H}_2\text{O}$; *boronatrocalcite* or *ulexite*, $\text{NaCaB}_5\text{O}_{10} \cdot 6\text{H}_2\text{O}$; *colemanite*, $\text{Ca}_2\text{B}_6\text{O}_{11} \cdot 5\text{H}_2\text{O}$; *franklandite*, $\text{Na}_2\text{CaB}_6\text{O}_{11} \cdot 7\text{H}_2\text{O}$; *hydroboracite*, $\text{MgCaB}_6\text{O}_{11} \cdot 6\text{H}_2\text{O}$; *pandermite*, $\text{Ca}_2\text{B}_6\text{O}_{11} \cdot 3\text{H}_2\text{O}$.

Calcium silicate is an almost invariable constituent of all the silicates, as well as of calcium silicates like wollastonite, CaSiO_3 ; apophyllite, $(\text{Ca}, \text{K}_2)\text{H}_2\text{Si}_2\text{O}_6$; etc. In addition, calcium occurs as an accessory constituent in numerous minerals.

According to A. Cornu,² spectroscopic observations indicate the presence of calcium in the sun, and W. H. Julius, R. K. Young, and M. N. Saha likewise found calcium in some of the fixed stars. The same element was found by J. L. Smith in meteorites—e.g. as calcium sulphide.

Calcium salts occur in spring waters³—usually as calcium sulphate, or as calcium hydrocarbonate—and these salts as well as calcium phosphate and fluoride occur in sea-water. According to L. Dieulaufait, the waters of the Mediterranean Sea contain 1.4 grms. of calcium sulphate per litre. The behaviour of the calcium salts during the evaporation of sea-water has been studied by J. H. van't Hoff.

The experiments of E. V. McCollum, N. Simmonds, and H. T. Parsons show that calcium is one of the limiting factors in a large proportion of our staple foods, and the amount of calcium required for normal human nutrition is estimated by H. C. Sherman to average about 0.45 gm. per 70 kgrms. of body weight per day. Calcium is invariably found amongst the mineral constituents of animals and plants. The calcium salts accumulate more in the leaves than in the roots of plants, and crystals of the oxalate, *whewellite*, $\text{CaC}_2\text{O}_4 \cdot \text{H}_2\text{O}$, are often present in the tissue. The ash of the rosaceæ are stated by F. J. Malaguti and J. Durocher to be particularly calcareous. Calcium occurs as phosphate along with a little fluoride in bones, teeth, etc. Eggshells and mollusc shells contain a large proportion of calcium carbonate. According to W. Reisinger, each of the following materials contains the indicated number of grams of calcium oxide per kgrm.: Beef, 0.31; white bread,

0.28; potatoes, 0.39; white of egg, 0.18; yolk of egg, 1.87; peas, 0.65; fruit, 0.34; beer, 0.08; cow's milk, 2.80; leaf vegetables, 2.50; and root vegetables, 2.04.

The most important strontium minerals are the sulphate, *celestine*, SrSO_4 , and the carbonate, *strontianite*, SrCO_3 . More or less strontium also occurs associated with other minerals of the alkaline earths. For example, *bromite* or *baryto-calcite* was stated by F. J. W. Johnston⁴ to contain up to 6.6 per cent. of strontium carbonate in addition to the calcium and barium carbonates; and A. Delesse found 1.10 per cent. The so-called *calcio-strontianite* or *emmonite* is an isomorphous mixture of calcium and strontium carbonates. G. R. Credner and L. Grandeau found almost all the varieties of aragonite which they analyzed to be strontianiferous, and E. Riegel found a specimen from Thurnberg to contain 2.2 per cent. of strontium carbonate, and S. de Luca found 7 per cent. in mossottite. G. Kirchhoff and R. Bunsen found strontium spectroscopically in numerous varieties of limestone and chalk, gypsum, heulandite, stilbite, etc. T. Engelbach reported its presence in calcites, marbles, dolomites, and limestones; J. S. Stas found strontium in marble. W. N. Hartley and H. Ramage also found traces of strontium in many iron ores and minerals. The mineral *baryto-celestine* is an isomorphous mixture of strontium and barium sulphates. Heavy spar was also found by L. Grandeau to contain strontium and calcium. Strontium aluminium pyrophosphate, $2\text{SrO} \cdot 3\text{Al}_2\text{O}_3 \cdot 2\text{P}_2\text{O}_5 \cdot 7\text{H}_2\text{O}$, is represented by the mineral *hamlinite* or *boumanite* with between 18 and 20 per cent. of strontia. *Brewsterite* has been reported with up to 9 per cent. of strontium silicate. Indeed, strontium is very common as a minor constituent of minerals and rocks; and W. F. Hillebrand has emphasized the very wide distribution of strontium in natural silicates. J. N. Lockyer observed what he believed to be strontium lines in the solar spectrum; M. N. Saha has also discussed the subject. L. Collot studied the distribution of strontium in sedimentary rocks. The occurrence of celestine in limestones has been examined by W. H. Sherzer, E. H. Kraus and W. F. Hunt, A. Koch, H. Bauerman and C. le Neve Foster, M. Lachat, W. H. Phalen, etc.

Strontium was found by J. J. Berzelius in many mineral waters—*e.g.* Carlsbad, Eger, etc.; T. J. and W. Herapath found it in a spring water near Bristol; A. and F. Dupré, in certain chalky waters like that of the Thames basin; F. A. Reuss, in the waters at Bilin; L. Gmelin, in the waters at Enis; K. W. G. Kastner, at Marienfels; R. H. Davis, at Harrogate; J. Steinmann, at Marienbad; B. Brandes, at Pymont; O. Henry, at Selters, Vie-sur-Serre, and Galmier; L. Dieulafait, at Schinznach, and Contrexeville; F. M. Tripiet, in Algiers; L. F. Bley, at Ernabrunn; J. N. Planiva, at Luhatschowitz; S. Baup, at Lavey; J. Girardin, St. Allyre; H. Braconnot, at Bulgneville; etc. According to G. Kirchhoff and R. Bunsen, a litre of water from Dürkheim contains 19.5 mgrms. of strontium sulphate, and 8.1 mgrms. of strontium chloride; that from Theodorshall, 2.86 mgrms. of strontium chloride; and that from Ungemach (Baden-Baden), 2.3 mgrms. of strontium chloride. Deposits from mine waters containing barium and strontium sulphates have been studied by G. Lattermann, and J. T. Dunn. A. Naupert and W. Wense found a small amount of strontium in carnallite and kainite; L. Grandeau, in the salts from Meurthe, the salt of St. Nicolas-Varaugéville, glauberite, etc. The presence of strontium in sea-water has been reported by G. Forchhammer, G. Kirchhoff and R. Bunsen, L. Dieulafait, etc.; in mollusc shells by L. Dieulafait; in the boiler scale of transatlantic liners, and in the ash of seaweeds—*fucus vesiculosus*—by G. Forchhammer.

The chief mineral form of barium is *heavy spar*, *barite*, *barytes*, or barium sulphate, BaSO_4 , in which the barium may be more or less replaced by strontium or calcium, forming respectively *celestobarite*, or *baryto-celestine*, $(\text{Ba}, \text{Sr})\text{SO}_4$, and *calceobarite*, $(\text{Ba}, \text{Ca})\text{SO}_4$; and with all three bases *calstronbarite*, $(\text{Ca}, \text{Sr}, \text{Ba})\text{SO}_4$. The mineral *witherite*, or barium carbonate, BaCO_3 , is also an important source of barium. When the barium is partly replaced by calcium, the mineral is called

alstonite, *bromlite*, *neotype*, or *barytocalcite*, $(\text{Ba}, \text{Ca})\text{CO}_3$. The so-called *baryta salt-petre* or barium nitrate, $\text{Ba}(\text{NO}_3)_2$, occurs as a mineral; there is also a phosphate in *barytapatite*, $3\text{Ba}_3(\text{PO}_4)_2 \cdot \text{BaCl}_2$; *uranocircite* or *bariumuranite*, $\text{Ba}(\text{UO}_2)_2(\text{PO}_4)_2 \cdot 8\text{H}_2\text{O}$; and a vanadate, *volborthite*, $\{(\text{Cu}, \text{Ca}, \text{Ba})\text{OH}\}_3\text{VO}_4 \cdot 6\text{H}_2\text{O}$. Small quantities occur in *psilomelane*, $(\text{Mn}, \text{Ba})\text{O} \cdot \text{MnO}_2$, as barium manganite, and in many other manganese ores. The same element occurs as an essential constituent in many silicates, for example, *brewsterite*, $(\text{Sr}, \text{Ba})\text{H}_4\text{Al}_2\text{Si}_6\text{O}_{18} \cdot 3\text{H}_2\text{O}$; *harmotome*, $(\text{K}_2, \text{Ba})\text{H}_2\text{Al}_2\text{Si}_5\text{O}_{15} \cdot 4\text{H}_2\text{O}$; *hyalophane*, or *baryta-felspar*, $(\text{K}_2, \text{Ba})_2\text{Al}_2\text{Si}_8\text{O}_{24}$; *edingtonite*, $\text{H}_6\text{BaAl}_2\text{Si}_3\text{O}_{13}$; etc. Small quantities were shown by R. Delkeskamp,⁵ and W. F. Hillebrand to occur in an extraordinary number of rocks and minerals—e.g. felspar, phillipsite, chabasite, mica, granite, gneiss, clays, marls, limestones, etc. G. C. Wittstein discussed the occurrence of barium in silicate rocks. H. Lutterkorth also found barium in many sandstones. F. Clowes, W. Mackie, C. B. Wedd, J. T. Dunn, and C. C. Moore observed its action as a cement in sandstones, and A. Koch in bituminous limestones. W. Knop found barium in the Nile mud; G. H. Failyer, in soils, and H. Schwarz, in the dust from blast furnaces. L. Collot has examined the distribution of barium in sedimentary rocks. The solar spectrum lines led G. Rayet to infer the presence of barium in the sun. M. N. Saha has also discussed the occurrence of barium in the sun and stars. Traces of barium salts have been found by R. Brandes, and R. Fresenius in the water of Pyrmont; by C. Löwig, in the waters of Kreuznach; by H. Braconnot, in the waters of Luxeuil; by J. N. Planiava, in the waters of Luhatschivitz; and by T. S. Hunt, in other mineral waters. T. W. Richards found 41 parts of barium chloride per 100,000 in the spring waters of Boston Spa; J. White found nearly the same quantity in the artesian water of Ilkeston; R. H. Davis in waters at Harrogate; and T. E. Thorpe, 6.6 grains of barium chloride per gallon in the old sulphur well at Harrogate. P. Carles has studied the equilibrium between barium hydrocarbonate and the soluble sulphates in the presence of carbon dioxide under pressure, in the waters of Nérès. A small proportion of barium was found by G. Forchhammer in sea-water, and it accordingly finds its way into sea-plants, and in the shells and skeletons of sea-organisms. C. W. Scheele found this base in the ashes of trees; G. E. Eckard, and R. Homberger have verified this, but U. Suzuki did not find any in phanerogams. P. P. Bedson, T. Richardson, and F. Clowes have observed the presence of notable amounts of barium in colliery waters, and in deposits therefrom. The pipes carrying water from the mines were often choked by deposits in which barium is rarely absent, and often the predominant constituent. Barytic sinters formed by the deposition of barium sulphate from the brine spring at Doughty Springs (Colorado) have been examined by W. P. Headden; and at Lautenthal, by G. Lattermann.

REFERENCES.

- ¹ F. W. Clarke, *The Data of Geochemistry*, Washington, 32, 1916; *Chem. News*, 61, 31, 1890; N. Ljubavin, *Journ. Russ. Phys. Chem. Soc.*, 24, 389, 1892.
- ² A. Cornu, *Compt. Rend.*, 86, 101, 983, 1878; R. K. Young, *Astrophys. Obs. Victoria*, 1, 43, 1920; *Roy. Astron. Soc. Canada*, 14, 389, 1920; W. H. Julius, *Arch. Néerl.*, (2), 10, 106, 1905; J. L. Smith, *Ann. Chim. Phys.*, (5), 16, 467, 1879; M. N. Saha, *Phil. Mag.*, (6), 40, 472, 1920; *Nature*, 107, 488, 1921.
- ³ G. Forchhammer, *Om Søvandets Bestanddele*, Copenhagen, 13, 1859; R. Jacobsen, *Liebig's Ann.*, 167, 28, 1873; A. Vierthaler, *Sitzber. Akad. Wien*, 56, 479, 1867; K. Natterer, *Monatsh.*, 13, 886, 1892; 14, 675, 1893; 15, 596, 1894; 16, 569, 591, 673, 1895; A. Delebecque, *Compt. Rend.*, 120, 790, 1895; H. St. C. Deville, *Ann. Chim. Phys.*, (3), 23, 32, 1848; F. J. Malaguti and J. Durocher, *ib.*, (3), 54, 257, 1858; L. Dieulafoy, *ib.*, (5), 14, 381, 1878; J. H. van't Hoff and E. F. Armstrong, *Sitzber. Akad. Berlin*, 559, 1900; H. Vater, *ib.*, 269, 1900; E. V. McCollum, N. Simmonds, and H. T. Parsons, *Journ. Biol. Chem.*, 38, 113, 1919; H. C. Sherman, *ib.*, 44, 21, 1920; W. Reisinger, *Ker. Rund.*, 40, 264, 1916.
- ⁴ J. N. Lockyer, *Proc. Roy. Soc.*, 27, 279, 1878; T. J. and W. Herapath, *Journ. Chem. Soc.*, 5, 193, 1852; W. N. Hartley and H. Ramage, *ib.*, 71, 533, 1897; A. and F. Dupré, *Phil. Mag.*, (4), 20, 373, 1860; F. J. W. Johnston, *ib.*, (3), 6, 1, 1835; (3), 10, 373, 1837; R. Bunsen and G. Kirchhoff, *Pogg. Ann.*, 110, 179, 1860; 113, 358, 1861; J. J. Berzelius, *ib.*, 4, 250, 1825;

Gilbert's Ann., 74. 145, 290, 1823; G. Forchhammer, *Om Sövandets Beständdele*, Copenhagen, 14, 1859; L. Grandeau, *Ann. Chim. Phys.*, (3), 67. 158, 190, 1863; A. Delesse, *ib.*, (3), 13. 425, 1845; L. Dieulafoy, *ib.*, (5), 15. 540, 1878; (5), 17. 387, 1879; *Compt. Rend.*, 84. 1303, 1877; 87. 934, 1878; 95. 999, 1882; 96. 452, 1883; L. Collot, *ib.*, 141. 832, 1905; M. N. Saha, *Phil. Mag.*, (6), 40. 472, 1920; R. H. Davis, *Chem. News*, 13. 202, 1866; T. Engelbach, *Liebig's Ann.*, 123. 255, 1862; G. R. Credner, *Journ. prakt. Chem.*, (2), 2. 292, 1870; E. Riegel, *Jahrb. prakt. Pharm.*, 23. 248, 1851; S. de Luca, *Nuovo Cimento*, 7. 453, 1858; J. T. Dunn, *Chem. News*, 35. 140, 1877; W. F. Hillebrand, *Journ. Amer. Chem. Soc.*, 16. 81, 1894; J. S. Stas, *Mém. Acad. Belg.*, 35. 1, 1865; G. Lattermann, *Jahrb. preuss. geol. Landesanst.*, 259, 1889; A. Naupert and W. Wense, *Ber.*, 26. 875, 1893; E. H. Kraus and W. F. Hunt, *Amer. Journ. Science*, (4), 21. 237, 1906; W. H. Sherzer, *ib.*, (3), 50. 246, 1895; E. H. Kraus, *ib.*, (4), 18. 30, 1904; (4), 19. 286, 1905; A. Koch, *Tschermak's Mitt.*, 9. 416, 1888; H. Bauerman and C. le Neve Foster, *Journ. Geol. Soc.*, 25. 40, 1869; M. Lachat, *Ann. Mines.* (7), 20. 557, 1881; W. H. Phalen, *Bull. U.S. Geol. Sur.*, 650. 521, 1914; F. A. Rcuss, *Berlin, Ges. Nat. Freunde*, 1. 268, 1795; K. W. G. Kastner, *Kastner's Archiv.*, 16. 229, 1829; J. Steinmann, *Schweigger's Journ.*, 51. 375, 1827; R. Brandes, *ib.*, 45. 369, 1825; 46. 403, 1826; J. Girardin, *Journ. Pharm. Chim.*, 25. 580, 1839; F. M. Tripier, *ib.*, 25. 580, 1839; O. Henry, *ib.*, 2. 482, 1823; H. Braconnot, *Mém. Scient. Soc. Nancy*, 15, 1844; *Ann. Chim. Phys.*, (2), 18. 221, 1822; S. Baup, *ib.*, (2), 58. 109, 1835; L. F. Bley, *Journ. Pharm.*, 16. 3, 1828; J. N. Planiava, *Baumgartner's Zeit.*, 4. 171, 277, 1828; C. G. Gmelin, *Schweigger's Journ.*, 43. 110, 1825.

⁵ W. F. Hillebrand, *Journ. Amer. Chem. Soc.*, 16. 81, 1894; H. Lutterkorth, *Liebig's Ann.*, 100. 296, 1856; G. E. Eckard, *ib.*, 100. 294, 1856; M. N. Saha, *Phil. Mag.*, (6), 40. 472, 1920; R. H. Davis, *Chem. News*, 13. 202, 1866; G. C. Wittstein, *Russ. Pharm. Journ.*, 10. 295, 1871; W. Knop, *Arch. Pharm.*, (3), 5. 275, 1874; R. Delkeskamp, *Zeit. prakt. Geol.*, 10. 117, 1902; R. Brandes, *Schweigger's Journ.*, 45. 369, 1825; 46. 403, 1826; R. Fresenius, *Journ. prakt. Chem.*, (1), 95. 151, 1865; T. W. Richards, *Analyst*, 26. 68, 1901; J. White, *ib.*, 24. 67, 1899; H. Braconnot, *Ann. Chim. Phys.*, (1), 18. 221, 1822; G. Rayet, *ib.*, (4), 24. 56, 1871; G. Forchhammer, *Om Sövandets Beständdele*, 14, 1859; *Pogg. Ann.*, 91. 568, 1854; L. Collot, *Compt. Rend.*, 141. 832, 1905; C. Döwig, *Mag. Pharm.*, 23. 11, 1821; 33. 6, 1824; *Pogg. Ann.*, 14. 485, 1828; J. N. Planiava, *Baumgartner's Zeit.*, 4. 171, 277, 1828; C. W. Scheele, *Opuscula chemica et physica*, Lipsiæ, 1. 258, 1788; T. E. Thorpe, *Phil. Mag.*, (5), 2. 52, 1876; G. H. Failyer, *Bull. Bur. Soils, U.S. Dept. Agric.*, 72, 1910; T. S. Hunt, *Journ. Pharm. Chim.*, (3), 43. 427, 1863; P. Carles, *ib.*, (6), 13. 562, 1901; R. Homberger, *Landw. Vers. Stat.*, 51. 473, 1899; U. Suzuki, *Bull. Coll. Agric. Tokyo*, 4. 69, 1900; W. P. Headen, *Proc. Colorado Scientific Soc.*, 8. 1, 1905; G. Lattermann, *Jahrb. preuss. geol. Landesanst.*, 259, 1888; J. T. Dunn, *Chem. News*, 35. 140, 1877; F. Clowes, *Proc. Roy. Soc.*, 46. 363, 1889; 64. 374, 1899; W. Mackie, *B.A. Rep.*, 649, 1901; C. B. Wedd, *Geol. Mag.*, 508, 1899; C. C. Moore, *Proc. Liverpool Geol. Soc.*, 8. 241, 1898; A. Koch, *Tschermak's Mitt.*, 2. 416, 1888; H. Schwarz, *Dingler's Journ.*, 218. 219, 1875; P. P. Bedson, *Journ. Soc. Chem. Ind.*, 6. 712, 1887; T. Richardson, *B.A. Rep.*, 54, 1863.

§ 3. The Preparation of the Metals of the Alkaline Earths

The three general methods for the preparation of calcium are: (1) the reduction of calcium compounds by the metals of the alkalis; (2) the electrolysis of conc. aq. soln. with a mercury cathode; and (3) the electrolysis of fused calcium halides. The unsatisfactory results obtained by H. Davy's and analogous processes for preparing calcium in all but minute quantities, led R. Bunsen¹ to investigate the electrolysis of a boiling soln. of calcium chloride acidified with hydrochloric acid, by a process analogous to that which he had found successful with magnesium. He obtained the metal, but the yield was not satisfactory because the metal, liberated at the high temp.—calcium chloride fuses at 780°—readily ignited, and made the fused mass basic. Calcium alone fuses at about 800°, and ignites in air not far above this temp. There is, therefore, but a narrow range of temp. for the safe working of electrolytic processes. The molten metal also readily forms a metal fog. If the calcium chloride be contaminated with small amounts of salts of sodium, magnesium, or aluminium, these metals are deposited along with the calcium, and at some stage of the process, lower the m.p. of the calcium making it impossible to maintain the cell in operation. It is, moreover, difficult to make the anhydrous chloride from the hydrated salt because, during the expulsion of the water, hydrolysis occurs, and what is regarded as a hydroxychloride, HO.CaCl, is formed. The calcium chloride is dehydrated by evaporating the aq. soln. with an excess of hydrochloric acid, and a few per cent. of ammonium chloride. The white

porous cake is pulverized, mixed with more ammonium chloride and heated out of contact with moist air for several hours at 500°–600°. With the incompletely dehydrated electrolyte, hydrogen is evolved at the cathode, and oxygen is liberated at the anode whereby the latter is disintegrated; the liberated metal is slowly attacked by the fused salt, hydrogen is evolved, and a sparingly soluble oxychloride is formed. This thickens the bath, the conductivity decreases, and the yield of metal falls. R. Bunsen prepared mixtures of the alkaline earth chlorides with a lower m.p., and using high-current densities, succeeded in preparing impure finely divided calcium. P. H. Brace tried a mixture of calcium chloride and fluoride, of calcium and potassium chloride, and calcium chloride alone as electrolytes, and concluded that if the last named be properly dehydrated, it forms a most suitable electrolyte. There is a difficulty in completely drying the amalgam without some oxidation; it is exceedingly difficult to remove all the mercury by distillation of the amalgam; and at best the product is a finely divided metal of rather indefinite composition which presents so much surface to the surrounding medium as to offer difficulties in working up into a satisfactory mass.

A. Matthiessen obtained a coherent mass of the metal by the electrolysis of a molten mixture of calcium and strontium chlorides with a small amount of ammonium chloride, contained in a porcelain crucible and with a carbon rod as anode and a thin iron wire as cathode. A high current density was employed. B. von Lengyel used a graphite cell with a porous cathodic cell. A. Feldmann electrolyzed a haloid salt or a mixture of the haloid salt with an alkali halide, and a metal oxide. L. P. Hulin obtained an alloy of the metal by using a heavy metal or a mixture of carbon with a heavy metal oxide as cathode. The economical production of large quantities of calcium was an unsolved problem until it was recognized that the temp. of the fused salt must be kept above the m.p. of the electrolyte and below that of the metal. O. Ruff and W. Plato kept down the temp. of the bath by using a mixture of calcium fluoride and chloride, melting at about 655° or 660°. The objection to R. Bunsen and A. Matthiessen's process is that external heat is required in addition to that afforded by the current; as a result, it is very difficult to regulate the temp. so that a crust of chilled chloride will always cover the bath. W. Borchers and L. Stockem avoided this difficulty by collecting the metal at the bottom of the bath. The metal did not combine with the chloride to such an extent as to invalidate the method. The bottom of the furnace was, however, cooled by means of a water-jacket. The apparatus finally employed was rather complicated. K. Arndt used as electrolyte a mixture of calcium fluoride and chloride, and P. Wöhler used a mixture of calcium chloride and fluoride (1 : 0.17) with a m.p. of 660°; the temp. bath was 665°–680°; a carbon rod was used as an anode and an iron rod as cathode. The current density was 50 to 250 amps. per sq. dm. The current efficiency was 82 per cent. C. Bürgel discussed the electrolytic preparation of calcium, and B. von Lengyel prepared calcium of 99.2 per cent. purity by electrolysis in a cell with a porous diaphragm.

W. Rathenau obtained fairly large quantities of calcium by the electrolysis of calcium chloride very little above its m.p. The iron cathode just touched the surface of the bath, and the calcium solidified on the rod. The rod was gradually raised, and as a result, a stick of the metal with a little adherent chloride was produced. The end of the calcium rod, dipped in the fused chloride, then forms the lower end of the cathode. J. H. Goodwin recommended a similar process with a carbon crucible as anode. F. C. Frary, H. R. Bicknell, and C. A. Tronson used a graphite crucible which was water cooled at the bottom as anode; a water-cooled iron cathode; and fused calcium chloride as electrolyte. The heat due to the current sufficed to keep the salt melted in the upper part of the cell. The cathode rod was regularly and continuously raised. The current density was 9.3 amps. per sq. dm. The e.m.f. averaged 25 volts, and the current efficiency usually exceeded 80 per cent. Consequently, the energy efficiency is $80 \times 3.24 / 25 = 10$ per cent., where 3.24 volts represents the decomposition voltage of molten calcium chloride

at 800°. Consequently, the production of a kilogram of calcium required 42 kilowatt hours. W. Moldenhauer and J. Andersen made calcium practically free from potassium by the electrolysis of a fused mixture of calcium chloride with 15 per cent. of potassium chloride, by W. Rathenau's process, and a current density of 60–110 amps. per sq. dm. The current efficiency was 75–90 per cent. An electrolyte of calcium chloride with 60 per cent. of potassium chloride did not give a coherent stick of calcium—probably due to the formation of a calcium potassium alloy. A. R. Johnson, S. O. Cowper-Coles, and P. H. Brace have also described electrolytic processes for making calcium. G. O. Seward and F. von Kugelgen have patented

the cell illustrated in Fig. 1, for the production of calcium by the electrolysis of calcium chloride.

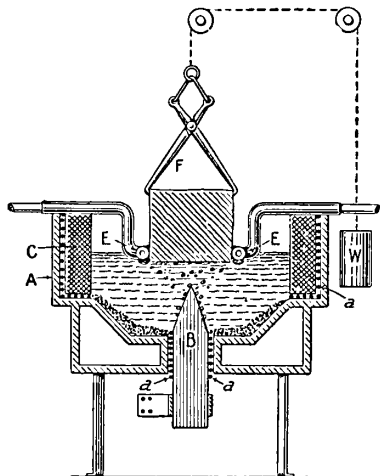

FIG. 1.—G. O. Seward and F. von Kugelgen's Electrolytic Cell for Calcium.

The cell consists of a circular iron box, *A*, through the bottom of which projects a conical iron cathode, *B*, insulated from the box at *aa*. The carbon *C*, insulated from the box, serves as anode. A water-cooled collecting ring, *E*, separates the metal which rises to the surface of the molten chloride. The metal accumulates till the ring is full. The top layer is cooled solid by the air, while the bottom is soft or melted. The solid part is fastened to a hook, *F*, which is gradually raised. The heat due to the current keeps the salt molten. The metal is protected from oxidation by the layer of fused salt.

The reduction of fused calcium iodide or phosphide at an elevated temp. was proposed by R. Hare as a means of preparing calcium; H. Caron and E. Sonstadt proposed reducing calcium chloride by sodium in the presence of zinc; C. Winkler, calcium oxide or carbonate by magnesium; and H. Moissan, calcium oxide or carbonate by carbon. The last named, however, reported that all these suggestions offered practical difficulties, *plus ou moins graves*. E. Stansfield did not succeed in getting Goldschmidt's thermite process to work with a mixture of calcium oxide and aluminium, using a mixture of calcium peroxide and aluminium for starting the reaction. Lies-Bodart and M. Jobin reduced calcium iodide with sodium, but the product obtained was really an alloy of calcium and sodium. H. Moissan modified the process, and obtained white hexagonal crystals of calcium of 98.9 to 99.2 per cent. purity.

A mixture of 600 grms. of anhydrous calcium iodide, with 240 grms. of small fragments of sodium, was placed in an iron crucible about a litre capacity. The crucible was closed and kept for an hour at a dull red heat. The contents were agitated from time to time. The calcium dissolved in the excess of heated sodium, crystallized out on cooling, and the excess of sodium was removed by treatment with absolute alcohol.

T. Curtius and J. Rissom obtained calcium by heating calcium azide, CaN_6 , for a long time to 120° or 130°. J. Malovich heated a mixture of calcium oxide or a calcium salt with sulphur and the sulphate or sulphite of another metal, between the m.p. and b.p. of the calcium. There is first formed a polysulphide of the added metal which by its decomposition reduces the calcium oxide. H. Moissan and G. Chavanne found commercial calcium with 99.3 to 99.6 per cent. of calcium, and the impurities were calcium chloride, silicon, aluminium, and traces of iron and sodium. K. Arndt found 0.2 per cent. of silicon and 0.3 per cent. of aluminium, and some calcium oxide and chloride.

Strontium, as previously indicated, was obtained by H. Davy. R. Bunsen, and A. Matthiessen also prepared pieces weighing less than half a gram by the electrolysis

of a fused mixture of strontium and ammonium chlorides with a thin iron wire as cathode; and W. Borchers and L. Stockem, R. Hare, B. von Lengyel, C. Winkler, J. Malovich, T. Curtius and J. Rissom, applied the process employed for calcium to this element. B. L. Glascock tried the method employed by J. H. Goodwin for calcium, but found it impossible to prevent the strontium either burning, or combining with the electrolyte. He obtained 76 grms. of the metal by electrolyzing fused strontium chloride in an iron mortar 15 cms. diam. at the top, 15 cms. high, and a litre capacity. A carbon anode 8 cms. \times 8 cms. was used; and the iron vessel itself served as cathode. A current of 125 amps. and 40 volts was employed for 7 hrs. The current efficiency was 5.3 per cent. If the current passed longer than 8 hrs., the current efficiency was diminished. The metal was separated from the cold mixture in the iron vessel, by crushing the contents on an iron plate, and sieving out the metal. M. Trautz electrolyzed a mixture of 2 mols of strontium chloride and 1 mol of potassium chloride contained in a tapering crucible at a bright red heat. A pointed iron cathode was cooled externally by water, and a thick carbon cylinder was used as anode. With 30 amps. and 10 volts, the current efficiency was 29-48 per cent., 90 grms. of strontium containing 97.3 per cent. strontium, 0.3 per cent. chlorine, and 0.84 per cent. potassium were prepared. Only small masses of barium could be obtained by this process. B. Neumann and E. Bergve obtained strontium in sticks by the general method employed for calcium, by the electrolysis of a fused mixture of strontium chloride with 15 per cent. of potassium chloride which melts at 628°. A current density of 20-50 amps. per sq. cm. cathode was used, and a current efficiency of 80 per cent. was obtained.

R. Böttger,² and B. Franz prepared *strontium amalgam* by heating a sat. soln. of strontium chloride to 90° with a 20 per cent. sodium amalgam, but it is more conveniently prepared by A. Guntz and G. Röderer's process, namely, by electrolyzing a soln. of strontium chloride with a mercury cathode, washing the product with water, pressing between folds of filter paper, and heating to 150°. B. Franz placed the amalgam in an iron crucible, and heated it to redness in a stream of hydrogen, but the last traces of mercury are retained by the metal with great tenacity. A. Guntz and G. Röderer first heated the amalgam with about 8 per cent. of strontium in vacuo to 700° and then to 1000° in hydrogen. The mercury is thus completely removed and a mass of *strontium hydride* is formed. This is then heated in vacuo in small quantities in an iron tube contained in a porcelain tube. The hydride decomposes, and the strontium volatilizes. The vapour is condensed on a hollow polished steel tube cooled by a stream of water. The metal thus obtained is 98.6 to 99.0 per cent. purity, and it may be obtained 99.4 per cent. purity by redistillation in vacuo. A. Guntz and M. Galliot heated a mixture of strontium oxide with the calculated quantity of aluminium for four hours at 1000° in a steel tube placed inside an evacuated porcelain tube, and they obtained silver-white crystals of 99.4 per cent. strontium as a crust on the walls of the steel tube. The yield was 75 per cent.

The isolation of barium or the preparation of barium amalgam was effected by H. Davy,³ J. J. Berzelius, R. Hare, A. Matthiessen, R. Bunsen, A. Feldmann, L. P. Hulin, T. Curtius and J. Rissom, J. Malovich, S. Kern, and C. Winkler, as indicated in connection with calcium and strontium. The electrolysis of the molten barium chloride furnished A. Matthiessen, and R. Hare with some globules of barium; C. Limb used a fused mixture of barium and sodium chlorides as electrolyte. R. Graetzel used the chloride and fluoride. A. Guntz said that some chlorine is evolved in the early stages of the electrolysis, and that barium subchloride is the main product. These results were not very satisfactory, although it is quite easy to make solid crystalline amalgams, containing over 5 per cent. of barium, by the electrolysis of a sat. soln. of barium chloride with a mercury cathode. R. Bunsen, W. Crookes, J. Donath, R. Böttger, and E. Frey prepared the amalgam by the electrolysis of a sat. soln. of the chloride, and subsequently obtained the impure metal by distilling off the mercury. B. Neumann and E. Bergve obtained barium

by the electrolysis of a fused mixture of barium and potassium chlorides as indicated in connection with strontium.

S. Kern's process in which barium iodide or chloride is reduced with sodium, and the metal extracted with mercury was found by A. Guntz to give what he regarded as a subhaloid complex, NaI.BaI , or NaCl.BaCl ; and C. Winkler's process of reduction of barium oxide with magnesium was found by A. Guntz to furnish what he regarded as a suboxide. E. D. Clarke reported the formation of barium by heating the oxide or nitrate in a cavity in a piece of charcoal or slate before the oxyhydrogen blowpipe, but this is considered to be incorrect. C. Matignon observed that barium is readily obtained by heating barium oxide with silicon, in vacuo, in a steel tube at 1200° . The metal distils and condenses in the cooler part of the tube: $3\text{BaO} + \text{Si} = \text{BaSiO}_3 + 2\text{Ba} - 37$ cals. The silicon was also replaced by ferrosilicon (95 per cent. silicon). The metal prepared by the distillation of mercury from the amalgam is invariably impure, because of the difficulty in drying the amalgam; in removing all the mercury by distillation; and in working up the powder to a compact mass. E. Stansfield obtained an impure alloy of zinc with about 12 per cent. of barium by H. Caron's process of reducing barium chloride with zinc and sodium; and he also heated barium oxide with aluminium by Goldschmidt's thermite process, using a mixture of barium peroxide and aluminium for starting the reaction, and working under reduced press. The product furnished an alloy of aluminium with up to 60 per cent. of barium. The substitution of magnesium for aluminium gave too violent a reaction. A. Guntz obtained barium by converting the amalgam into hydride, and, subsequently proceeding as indicated in the corresponding process for strontium.

REFERENCES.

- ¹ R. Bunsen, *Pogg. Ann.*, 91. 619, 1854; *Liebig's Ann.*, 92. 248, 1854; E. Frey, *ib.*, 183. 367, 1876; A. Matthiessen, *ib.*, 93. 277, 1855; *Journ. Chem. Soc.*, 8. 28, 1856; L. P. Hulín, *German Pat.*, D.R.P. 79435, 1894; J. Malovich, *ib.*, 159632, 1902; 161428, 1903; A. Feldmann, *ib.*, 50370, 1888; W. Muthmann, *ib.*, 155433, 1903; O. Ruff and W. Plato, *ib.*, 153731, 1904; P. Wöhler, *Zeit. Elektrochem.*, 11. 612, 1905; W. Moldenhauer and J. Andersen, *ib.*, 19. 444, 1913; B. Neumann and E. Bergve, *ib.*, 20. 187, 1914; K. Arndt, *ib.*, 8. 861, 1902; W. Borchers and L. Stockem, *ib.*, 8. 757, 938, 1902; F. von Kügelgen, *ib.*, 14. 143, 1908; W. von Bolton, *ib.*, 9. 209, 1903; W. Rathenau, *ib.*, 10. 508, 1904; *Proc. Amer. Phil. Soc.*, 43. 381, 1904; C. Bürgel, *Elektrochem. Zeit.*, 13. 209, 1907; B. von Lengyel, *Math. Nat. Ber. Ungarn*, 14. 180, 1878; J. H. Goodwin, *Proc. Amer. Acad.*, 43. 381, 1905; *Journ. Amer. Chem. Soc.*, 25. 873, 1903; 27. 1403, 1905; S. A. Tucker and J. B. Whitney, *ib.*, 28. 84, 1906; F. C. Frary, H. R. Bicknell, and C. A. Tronson, *Trans. Amer. Electrochem. Soc.*, 18. 117, 1910; F. C. Frary and W. L. Badger, *ib.*, 16. 185, 1909; A. R. Johnson, *ib.*, 18. 125, 1910; P. H. Brace, *ib.*, 37. 69, 1920; *Journ. Inst. Metals*, 25. 153, 1921; G. O. Seward and F. von Kügelgen, *U.S.A. Pat. No.* 880760, 1908; *Min. Ind.*, 16. 131, 1907; 17. 99, 1908; S. O. Cowper-Coles, *Brit. Pat. No.* 24396, 1909; M. Trautz, *Verh. Ges. deut. Naturforsch. Aerzte*, ii, 196, 1912; Lies-Bodart and M. Jobin, *Ann. Chim. Phys.*, (3), 54. 363, 1858; H. Moissan, *ib.*, (7), 18. 289, 1899; *Bull. Soc. Chim.*, (3), 21. 817, 1899; *Compt. Rend.*, 126. 1753, 1898; H. Moissan and G. Chavanne, *ib.*, 140. 122, 1905; B. von Lengyel, *ib.*, 127. 584, 1898; H. Caron, *ib.*, 48. 440, 1859; 50. 547, 1860; J. B. A. Drmas, *ib.*, 47. 575, 1858; E. Stansfield, *Proc. Manchester Lit. Phil. Soc.*, 46. 4, 1901; E. Sonstadt, *ib.*, 3. 243, 1864; *Chem. News*, 9. 140, 1864; R. Hare, *Journ. prakt. Chem.*, (1), 22. 383, 1841; T. Curtius and J. Rissom, *ib.*, (2), 58. 285, 1898; K. Arndt, *Ber.*, 37. 4733, 1904; W. Muthmann, L. Weiss, and J. Metzger, *Liebig's Ann.*, 355. 137, 1907; Société d'Électrochimie, *French Pat. No.* 438772, 1911; B. L. Glascock, *Journ. Amer. Chem. Soc.*, 32. 1222, 1910; C. Winkler, *Ber.*, 23. 125, 1890; H. Davy, *Phil. Trans.*, 98. 1, 333, 1808.
- ² B. Franz, *Journ. prakt. Chem.*, (1), 107. 253, 1869; R. Böttger, *ib.*, (1), 3. 283, 1834; A. Guntz and G. Röderer, *Bull. Soc. Chim.*, (3), 35. 494, 1906; *Compt. Rend.*, 142. 400, 1906; A. Guntz and M. Galliot, *ib.*, 151. 813, 1910; F. von Kügelgen, *Zeit. Elektrochem.*, 14. 143, 1908; B. L. Glascock, *Journ. Amer. Chem. Soc.*, 32. 1222, 1910.
- ³ H. Davy, *Phil. Trans.*, 98. 1, 333, 1808; J. J. Berzelius, *Gilbert's Ann.*, 35. 269, 1810; R. Hare, *B.A. Rep.*, 39. 1839; *Bibl. Univ.*, 23. 200, 1840; *Journ. prakt. Chem.*, (1), 19. 249, 1840; A. Feldmann, *German Pat.*, D.R.P. 50370, 1888; L. P. Hulín, *ib.*, 79435, 1894; J. Malovich, *ib.*, 159632, 1902; 161428, 1903; T. Curtius and J. Rissom, *Journ. prakt. Chem.*, (2), 58. 290, 1898; C. Winkler, *Ber.*, 23. 126, 1890; B. Neumann and E. Bergve, *Zeit. Elektrochem.*, 20. 187, 1914; A. Guntz, *Ann. Chim. Phys.*, (8), 4. 5, 1905; (8), 10. 437, 1907; *Bull. Soc. Chim.*, (3), 28. 483, 1903; *Compt. Rend.*, 133. 872, 1901; 136. 749, 1903; 141. 1240, 1905; 143. 339, 1906;

H. Caron, *ib.*, 48. 440, 1859; 50. 547, 1860; C. Limb, *ib.*, 112. 1434, 1891; C. Matignon, *ib.*, 156. 1378, 1913; E. Stansfield, *Mem. Manchester Lit. Phil. Soc.*, 46. 4, 1901; G. Langbein, *Beiträge zur Kenntnis der Amalgame*, Königsberg, 1900; S. Kern, *Zeit. anorg. Chem.*, 17. 284, 1898; 25. 1, 1900; R. Graetz, *Polyt. Notizbl.*, 39. 211, 1884; W. Crookes, *Chem. News*, 6. 194, 1862; J. Donath, *Ber.*, 12. 745, 1879; *Phil. Mag.*, (5), 8. 84, 1879; E. Frey, *Liebig's Ann.*, 183. 367, 1876; A. Matthiessen, *ib.*, 93. 277, 1855; R. Bunsen, *Pogg. Ann.*, 91. 619, 1854; R. Böttger, *ib.*, (1), 3. 283, 1834; E. D. Clarke, *Ann. Phil.*, 8. 357, 1816.

§ 4. The Properties of Calcium, Strontium, and Barium

The metals calcium, strontium, and barium obtained by the earlier workers—A. Matthiessen,¹ R. Bunsen, Lies-Bodart and M. Jobin, B. von Lengyel, J. Donath—were tinted yellow. E. Frey first prepared calcium of a white colour which he likened to that of aluminium. H. Moissan's calcium was described as lustrous almost silvery white. According to H. Moissan, the metals are yellow when they contain the nitride, e.g. Ca_3N_2 ; and, according to O. Ruff and W. Plato, the metal is yellow when it is contaminated with silicide. A. Guntz and G. Röderer, and W. Borchers and L. Stockem obtained silvery white strontium. H. Davy described barium as silvery white; W. Crookes as white; and A. Guntz, white like tin or silver.

L. Doermer noticed that a freshly fractured surface of electrolytic calcium showed small aggregates of the appearance of ice crystals embedded in the main bulk of metal. These aggregates are more readily acted on by moisture and less affected by hydrochloric acid in absolute alcohol than the ground mass; they are not observable in specimens of the metal which have been melted and allowed to resolidify. They are probably due to impurities. According to J. H. Goodwin, the fractured surface of calcium is more brilliant than steel, and it has a greyish-white colour. The metallic lustre of the metal is retained under petroleum. H. Moissan obtained hexagonal growths in the form of platelike crystals or distorted rhombohedra, as well as dendritic six-rayed stars resembling snow crystals, making it appear as if the crystals belong to the trigonal or hexagonal system. Analogies between the calcium and magnesium families favour the latter. A. W. Hull found that the X-radiograms of calcium show that the crystals are cubic with a face-centred cubic lattice, and that there are 4 atoms per elementary cube the side of which is 5.56 Å., and the smallest distance apart of the atoms, 3.93 Å. W. L. Bragg gave 1.70, 1.95, and 2.10 Angström units for the at. radius of the at. spheres respectively of calcium, strontium, and barium.

The specific gravity of calcium was stated by Lies-Bodart and M. Jobin not to exceed 1.55; R. Bunsen and A. Matthiessen found 1.5778; H. Caron, less than 1.6; J. H. Goodwin, 1.5446 (28.1°); B. von Lengyel, 1.5540 (18°); W. Muthmann and co-workers, 1.4153; H. Moissan and G. Chavanne, 1.548; P. W. Bridgman, 1.5563 at 21°; W. Biltz and G. Hohorst, 1.542 at 22°/4°; P. H. Brace, 1.46 at 22°; O. Ruff and W. Plato, 1.59; and K. Arndt found for the distilled metal, 1.59. The best representative value for calcium may be taken as 1.53 (20°); and the atomic volume, 25.0. For strontium, R. Bunsen and A. Matthiessen gave a sp. gr. of 2.504 to 2.58; M. Trautz, 2.50; and B. Franz gave 2.4. H. Davy said barium is heavier than sulphuric acid; E. D. Clarke gave 4 for the sp. gr., and A. Guntz 3.78 for purified silvery crystalline barium. C. T. Heycock and F. H. Neville attempted to determine the molecular weight of calcium from its effect on the f.p. of tin. M. N. Saha calculated the atomic radii of barium, strontium, and calcium from the ionization potentials.

Calcium is a soft metal which like sodium can be cut with a knife. The hardness of calcium is stated by Lies-Bodart and M. Jobin to be greater than that of tin, and less than that of lead; and it can be cut with a knife. R. Bunsen and A. Matthiessen found their sample was scratched by strontium, but was harder than lithium or lead; O. Ruff and W. Plato found the hardness of their sample to be 2.2 to 2.5 on

Mohs' scale, and was therefore softer than gold and bismuth, and harder than lead. According to J. H. Goodwin, calcium is harder than sodium, lead, or tin, almost as hard as aluminium, and softer than cadmium or magnesium. He found that calcium is not hardened by heating it red hot and plunging it into water; at 300°–400° it is as soft as lead; and when hot it can be filed and polished without losing its lustre but not when cold. R. Bunsen and A. Matthiessen stated that strontium is harder than lead or calcium, while W. Borchers and L. Stockem said it is as soft as lead; and B. L. Glascock that it is harder than sodium and softer than calcium. A. Guntz found that barium is a little harder than lead, and if a little mercury is present the barium is brittle. P. H. Brace found the Brinell hardness to be 42·5 with a load of 500 kgrms., and the Shore hardness 19–20. M. von Wogau found the velocity of diffusion of calcium in mercury to be $k=0\cdot45$ sq. cm. per day at 10·2°; for strontium, $k=0\cdot47$ sq. cm. per day at 9·4°; and for barium, 0·52 sq. cm. per day at 7·8°.

E. Frey found calcium to be brittle, and its malleability and ductility small, while Lies-Bodart and M. Jobin found it could be hammered into plates; and H. Moissan and G. Chavanne drew it out into wires 0·5 mm. diameter. B. Franz also found that strontium could be hammered to thin plates, and E. Frey that it could be rolled or drawn into wires. A. Guntz reported that barium is malleable like lead. J. H. Goodwin found the tensile strength of calcium to be 8710 lbs. per sq. in., or 612 kgrms. per sq. cm. T. W. Richards found the average compressibility of calcium at 20° to be $5\cdot7 \times 10^{-6}$ between 100 and 500 megabars per sq. cm. According to J. H. Goodwin, if some of the red-hot molten metal be collected on a wire, and struck smartly on the table, it will fly in all directions with a hissing sound, and burn violently with a blinding light. Similar energetic action takes place when the red-hot metal comes in contact with asbestos or other reducible substance. L. Doermer stated that the explosions which occur when electrolytic calcium either in the form of powder or shavings is struck on an anvil seem to be due to the presence of iron oxide. Calcium powder when heated evolves hydrogen which is reabsorbed when the temp. of the metal is lowered. O. Ohmann observed similar explosions with sodium, potassium, lithium, and phosphorus; and small ones with aluminium and magnesium; and he says it cannot be due to rust because similar results are obtained if granite or quartz be used in place of iron. The sparking which occurs when calcium is detonated is attributed to the evaporation of the metal, and subsequent chemical action. When the detonation is conducted in an atm. of oxygen, the light evolved is more intense than air.

P. W. Bridgman found the coefficient of cubical expansion of calcium from 0° to 21° to be 0·000717. According to R. Bunsen and A. Matthiessen, calcium melts at a red heat. H. Moissan found commercial calcium to soften between 790° and 795°, and to melt at 810°; O. Ruff and W. Plato give 780° for the melting point of calcium; K. Arndt gives 800°. A. Guntz and G. Röderer give 800° for the m.p. of strontium; and A. Guntz gives 850° as the m.p. of barium. W. Guertler and M. Pirani give for the best representative values; calcium, 809°; and barium, 850°, with strontium an intermediate value. H. Caron reported that the volatility of calcium is not marked at a red-heat, but when zinc is distilled from a zinc-calcium alloy, some calcium volatilizes. K. Arndt found calcium volatilizes in vacuo even below its m.p.; G. Bartha observed that calcium volatilizes in vacuo at 720°; and H. Moissan sublimed the metal. N. B. Pilling calculated the vapour pressure of calcium from the rate of evaporation in vacuo, and found:

	300°	400°	500°	600°	700°	800°	900°	1000°
<i>p</i> mm.	$9\cdot6 \times 10^{-6}$	$4\cdot2 \times 10^{-6}$	$3\cdot7 \times 10^{-4}$	$1\cdot2 \times 10^{-2}$	0·19	1·8	10·6	47·2

and at the boiling point, 1240°, 760 mm. The vap. press. at the m.p. was 2·0 mm. He represented the vap. press., *p*, at *T*° K., by $\log p = -10170T^{-1} + 9\cdot73$ mm. for the solid, and $\log p = -9670T^{-1} + 9\cdot27$ for the liquid. A. Guntz and G. Röderer found strontium evaporates considerably at 950°; and A. Guntz that barium

volatilizes at 950°, rapidly at 1150°, and it can readily be boiled in vacuo. E. Tiede and E. Birnbräuer noted that in a vacuum furnace calcium volatilizes from a carbon boat at a red heat, and the vapour is rapidly oxidized in air, but if passed into dry petroleum, by a current of carbon dioxide, spherulitic aggregates are formed.

The **specific heat** of calcium between -180° and +20° was given by P. Nordmeyer and A. L. Bernoulli as 0.1574, and for barium, 0.0681; while A. Bernini gave 0.145 for the sp. ht. of calcium between 0° and 20°; 0.1453 between 0° and 78°; 0.149 between 0° and 100°; and 0.152 between 0° and 157°. At the temp. of liquid air, J. Dewar found the sp. ht. of calcium to be 0.0714; of impure strontium, 0.0714; and of impure barium, 0.0350; the corresponding at. ht. for calcium is 2.86; for strontium, 4.80; and for barium, 4.80; R. J. Brunner gave for calcium at T° K.:

	-273°	-200°	-100°	0°	100°	200°	400°	500°
Sp. ht. . . .	0.0971	0.1209	0.0416	0.1523	0.1599	0.1672	0.2023	0.2398
At. ht. . . .	3.884	4.836	5.664	6.092	6.396	6.688	8.092	9.592

E. D. Eastman and W. H. Rodebush also determined values for C_p and C_v at temp. ranging from 676°-393.5° K. The **entropy** of calcium is given by G. N. Lewis and co-workers as 10.64 for the solid, and 36.71 for the vapour at 25° and one atm. press. W. Muthmann, L. Weiss, and J. Metzger found the **heat of combustion** of calcium to be 80.097-81.32 Cals. per gram-eq.—*vide* heats of formation of the oxides.

According to J. H. Gladstone,² the **refraction equivalent** $A(\mu-1)/D$ for calcium is 10.0, when A denotes the at. wt., and D the sp. gr. of the element. The value for strontium is 13.0; and for barium, 15.8. W. J. Pope gave 13.95 for strontium and 18.94 for barium. J. Kannonikoff found the refraction eq. of calcium in its salts for rays of infinite wave-length to be 9.11; strontium, 12.2; and barium, 15.40. R. Pohl and P. Pringsheim, and T. W. Case studied the **photoelectric effect** with calcium; the last-named also measured the effect of temp. with barium and strontium cells. W. Crookes found that calcium gives an orange-yellow **phosphorescence** in the cathode ray tube. H. R. von Traubenberg found the range of the α -particles in calcium to be 78.8×10^{-4} cm. M. N. Saha gives 8000°-10,000°, 1500°, and 4000° for the estimated temp. of complete ionization, or the temp. of luminescence of barium, strontium, and calcium vapours. R. Whiddington studied the emission of electrons by the action of X-rays on strontium.

The Bunsen flame is coloured a brick-red by calcium chloride and similar remarks apply to the alcohol flame. Strontium salts colour the flame a magnificent crimson;

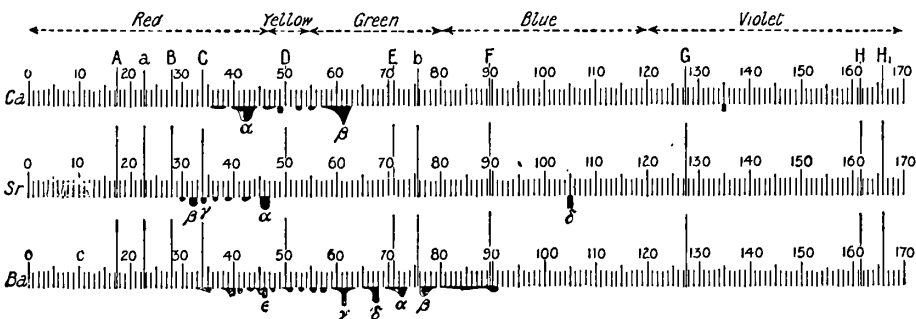

FIG. 2.—G. Kirchhoff and R. Bunsen's Spectral Chart of the Alkaline Earths.

and barium salts, a yellowish-green. The **flame spectra** of the metals of the alkaline earths³ are not so simple as those of the alkali metals. G. Kirchhoff and R. Bunsen's chart is illustrated by Fig. 2. When first introduced into the flame, certain bands appear which are different according to the particular salt introduced into the flame, and these spectra are supposed to be due to the particular compound employed. The final spectra are the same with all the different salts of a given metal, and these

are accordingly attributed either to the metal oxide or the metal itself. The spectral lines due to any particular compound are maintained and strengthened by introducing into the flame a gas which hinders the dissociation of the compound. This is the case, for instance, with a current of hydrogen chloride or chlorine in the flame coloured with the chloride; of hydrogen bromide or bromine in the flame coloured with the bromide; and similarly with the iodide—*vide* the flame spectrum of copper. Some non-volatile salts—*e.g.* the phosphate or silicate—may require a preliminary treatment with hydrochloric acid or ammonium fluoride before the spectrum can be obtained. W. N. Hartley and H. W. Moss have studied the spark and the oxygen-hydrogen flame spectra; and J. H. Pollok and A. G. G. Leonard the quantitative

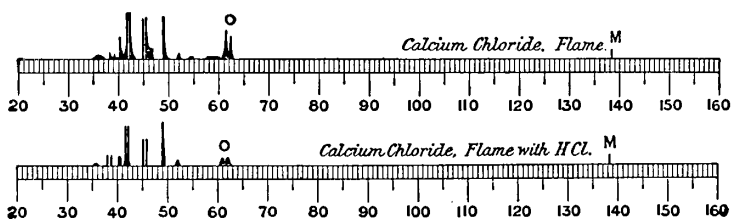

FIG. 3.—Flame Spectra of Calcium Chloride.

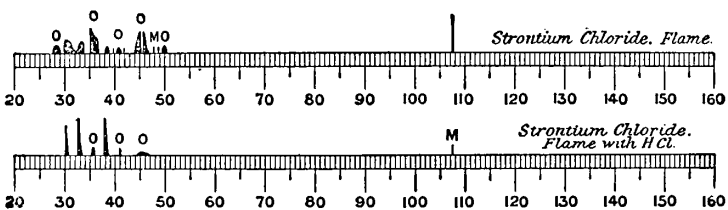

FIG. 4.—Flame Spectra of Strontium Chloride.

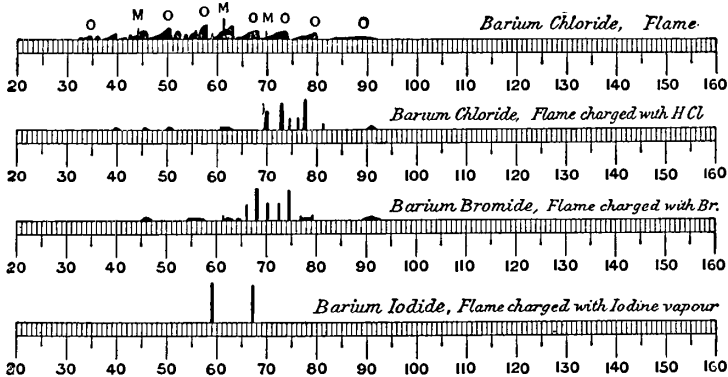

FIG. 5.—Flame Spectra of Barium Halides.

spectra of the alkaline earths. The diagrams, Figs. 3 to 5, illustrate the flame spectra of calcium, strontium, and barium chlorides, and of the same salts with the flame charged with hydrogen chloride. The letters *M* and *O* respectively denote lines attributed to metal and oxide, the others are due to the halide. In the calcium spectrum, the one line marked 138.2 is due to the metal; the lines 61.2 and 62.1 are due to the oxide; and the lines 41.75, 42.25, 45.0, 45.7, 48.8, and 52.2 are due to the chloride. In the strontium spectrum, the two lines 47.7 and 107.6 are due to the metal; the lines 30.3, 33.0, and 38.25 are due to the chloride; and the remainder are due to the oxide. In the barium spectrum, the three lines due to the metal are 44.0, 61.6, and 69.9; the lines 69.8, 72.9, 74.5, 76.0, 77.6, and 81.0

are due to the chloride; and the remainder are usually attributed to the oxide. Hence it would appear from the spectra of the chlorides, that calcium has a greater affinity for chlorine than either strontium or barium; and that barium has a greater affinity for oxygen than either strontium or calcium. According to W. N. Hartley, the oxides of the alkaline earth metals are not dissociated by heat alone because they show no spectrum in the carbon monoxide flame; they are, however, reduced by the combined action of heat and hydrogen in the oxyhydrogen flame, and by the action of cyanogen in the cyanogen flame. The flame coloration is due to the metal because not only is the flame spectrum from lime essentially the same as that of the metal calcium, but also the heats of formation of the three oxides have nearly the same value, and where calcium oxide can be reduced, the other oxides could undergo a similar reduction. As W. D. Bancroft and H. B. Weiser have emphasized, it is dangerous to base arguments on thermochemical data when dealing with reversible reactions.

The spectrum of the calcium salts, said G. Kirchhoff and R. Bunsen, shows numerous lines in the orange and green; the most prominent are the green line Ca_{β} , and the orange line Ca_{α} . The latter is nearer the red end of the spectrum than the yellow sodium and the Sr_{α} -line. The spectrum of strontium was first described by H. F. Talbot in 1825; G. Kirchhoff and R. Bunsen stated that the spectrum of strontium shows numerous lines, but the eight most prominent ones include six in the red, one in the orange, and one in the blue. Of these, the line termed Sr_{α} in the orange, Sr_{β} and Sr_{γ} in the red, and Sr_{δ} in the blue arc the most characteristic, and are considered by E. H. Reisenfeld and H. E. Wohlers to be the most valuable in detecting this element. The spectrum of the barium salts is the most complex of the alkalis and alkaline earths. G. Kirchhoff and R. Bunsen say that the green lines Ba_{α} and Ba_{β} are by far the most distinct; the line Ba_{γ} is not so prominent, but it is still well marked and characteristic. The spark spectra closely resemble the flame spectra of the metals. From R. Bunsen's experiments, quantities as small as 0.00006 mgrm. of calcium chloride; 0.000006 mgrm. of strontium chloride; and 0.001 of barium chloride can be detected spectroscopically. With over 500 parts of calcium oxide to one of barium oxide, T. Engelbach failed to recognize the presence of barium spectroscopically. According to G. Merz, the calcium flame through green glass appears yellowish green; the strontium flame vanishes; and the barium flame appears bluish-green. When viewed through a blue glass, greenish-grey; and the strontium flame appears purple or violet. According to R. Cartmell, when viewed through the indigo prism, the calcium flame appears olive-green; and the strontium flame appears intensely red. A. S. King studied the absorption spectra of calcium and barium vapours. B. E. Moore studied the excitation stages in the arc spectra of calcium, barium, and strontium.

In their study of the series spectra, H. Kayser and C. Runge found that 36 out of the 106 calcium lines can be represented by two series of triplets corresponding with the following formulæ—each equated to $10^8\lambda^{-1}$:

$$I \quad \begin{cases} 33919.51 - 123547n^{-2} - 961696n^{-4} \\ 34022.12 - 123547n^{-2} - 961696n^{-4} \\ 34073.82 - 123547n^{-2} - 961696n^{-4} \end{cases} \quad II \quad \begin{cases} 34041.17 - 120398n^{-2} - 346097n^{-4} \\ 34146.95 - 120398n^{-2} - 346097n^{-4} \\ 34199.09 - 120398n^{-2} - 346097n^{-4} \end{cases}$$

λ	6000				5000				4000				3500				3000				2500	
λ_2	17	19	21	23	25	27	29	31	33	35	37	39	41	43	45	47	49	51	53	55	57	59
$I Ca$			4			5		6	7	8	9											
$II Ca$	3				4		5	6	7	8												

FIG. 6.—Series Spectra of Calcium.

Numerous other regularities were observed by J. R. Rydberg. The arrangement of the lines in the series spectra of calcium, with n ranging from 4 to 9, is shown in Fig. 6. H. Kayser and C. Runge found only one series in the spectral lines of

strontium, but H. Lehmann found a second. These formulæ, each equated to $10^8\lambda^{-1}$, are :

$$\text{I} \begin{cases} 31030\cdot64 - 122328n^{-2} - 837473n^{-4} \\ 31424\cdot67 - 122328n^{-2} - 837473n^{-4} \\ 31610\cdot58 - 122328n^{-2} - 837473n^{-4} \end{cases} \quad \text{II} \begin{cases} 31226 - 120300n^{-2} - 301000n^{-4} \\ 31618 - 120300n^{-2} - 301000n^{-4} \\ 31806 - 120300n^{-2} - 301000n^{-4} \end{cases}$$

Their graphic representation furnishes a diagram like that for calcium. J. R. Rydberg, L. Börsch, and F. A. Saunders noticed some other regularities. H. Kayser and C. Runge did not succeed in finding any formula for the 162 barium lines, although some triplets with constant differences were found. The series spectra of the alkaline earths were also studied by W. M. Hicks, B. Götze, and A. Fowler. C. M. Olmsted studied the band spectra of the halogen salts of the alkaline earths. A. S. King and F. A. Saunders studied the arc spectra of calcium, strontium, and barium. O. Holtz studied the arc spectrum of calcium; H. Hampe, that of strontium; and K. Schmitz, and H. George, that of barium. E. Fries compared the spark spectra of the alkaline earths, and the arc spectrum of the alkalis, and showed that the results agree with the hypothesis that when an electron is removed from its outer sheath by ionization, the spectrum of the element is displaced to that of the element occupying the preceding position in the periodic system.

L. F. Miller, M. Ritter, and W. Huggins and Mrs. Huggins have studied the effect of *pressure* on the *H* and *K* violet spectral lines—respectively 3968 and 3934—obtained in the spark spectrum of metallic calcium. With dense calcium vapour, the *H* and *K* lines as well as 3706, 3737, and 4227 lines are diffuse; as the density of the vapour is diminished the lines are gradually enfeebled until the *H* and *K* lines alone appear. J. R. Rydberg has studied the effect of *magnetism* on the spectral lines of calcium, barium, and strontium; and T. Takamine and N. Kokubu, the effect of the *electric field* on those of calcium. J. Stark and G. von Wendt investigated the effect of the *canal rays* on the alkaline earth metals; and E. Hjalmar, D. Coster, and R. A. Sawyer and R. L. Becker, the effect of *X-rays*, and the X-ray spectrum.

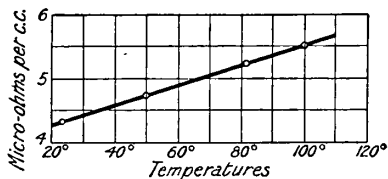

FIG. 7.—The Electrical Resistance of Calcium.

According to J. H. Goodwin,⁴ the specific electrical resistance of calcium at 0° is 3·43 micro-ohms per cm. cube, the temp. coeff. is 0·00457; and P. H. Brace found a metal with 1·08 per cent. of chlorine had an electrical resistance of 6·77 micro-ohms per cm. cube at 22°. The resistivity or electrical resistance

of calcium in micro-ohms per cm. cube, at different temp., has been also determined by E. F. Northrup. The results are indicated in the graph, Fig. 7. C. L. Swisher obtained 4·6 micro-ohms per cm. cube, and a temp. coeff. of 0·0034 per degree; J. H. Goodwin obtained a temp. coeff. of 0·00457. P. W. Bridgman found that with press., *p*, in kgrms. per sq. cm., the electrical resistance at θ° is :

	θ°	0	1000	3000	5000	7000	9000	12000
Ca	0° . . .	1·0000	1·0107	1·0330	1·0569	1·0827	1·1103	1·1550
	50° . . .	1·1552	1·1668	1·1912	1·2171	1·2451	1·2749	1·3229
	100° . . .	1·3327	1·3589	1·3865	1·4008	1·4311	1·4631	1·5146
Sr	0° . . .	1·0000	1·0516	1·1622	1·2850	1·4196	1·5670	1·8160
	50° . . .	1·1768	1·2320	1·3519	1·4842	1·6280	1·7852	2·0446
	100° . . .	1·3828	1·4341	1·5539	1·6936	1·8527	2·0272	2·3144

The press. coeff. of calcium increases with rising temp.; that of strontium decreases very slightly at 0° with rise of press., but at 50° it increases with rise of press. to 2000–3000 kgrms., then shows a flat maximum, and then decreases; at 100° the behaviour is like that at 50° except the maximum is sharper, and occurs at 700 kgrms. The temp. coeff. of both metals falls with rise of press. The electrical

conductivity of calcium at 20° is 45.1 if that of silver of the same area and length is 100; and the conductivity is exceeded only by that of silver, copper, gold, and aluminium; for the same weight and length of metal, the conductivity of silver is 32.5 when that of calcium is 100; for strontium the conductivity is 6.71. R. Bunsen and A. Matthiessen say that strontium is more electropositive than magnesium and more negative than calcium and the alkali metals. M. Born estimated the **heat of hydration** of Ca⁺⁺-ions to be 344 Cals.; K. Fajans gave 475 Cals. H. Grimm estimated the **ionic radii** of barium, strontium, and calcium ions, and W. P. Davey gave 1.25 A. for the Ca⁺⁺-ion, 1.42 A. for the Sr⁺⁺-ion, and 1.56 A. for the Ba⁺⁺-ion.

E. F. Northrup determined the **thermo-electromotive force**, or the **Seebeck effect**, of the calcium-aluminium couple, and found, in micro-volts:

E.m.f.	0°	24°	51.2°	56°	89°	90.4°	92°	96°	100°
	0	218	514	558	940	968	1000	1027	1080

The results at 335°—*viz.* 3080 micro-volts—on wire protected from oxidation, were not consistent owing to oxidation of the calcium at the joint. The direction of the current was through the hot joint from the calcium to the aluminium. C. L. Swisher found calcium is thermoelectrically positive towards lead giving 8–9 micro-volts per degree at 50° and 14.0 micro-volts at 400°. The **Thomson effect** is positive for calcium. P. Pascal studied the diamagnetism of the metals of the alkaline earths.

A **resonance potential** represents the intensity of the energy of an electron which is capable of bringing a change in the molecule of the gas—*e.g.* the dissociation of hydrogen into electrically neutral molecules: $H_2 \rightarrow 2H$. On the other hand, the **ionization potential** represents the intensity of the energy which must be imparted to an electron, in order that by its collision with an atom or molecule it may cause an electron to be eliminated—*e.g.* $H_2 \rightarrow H_2^+ + \ominus$ or $H \rightarrow H^+ + \ominus$. F. L. Mohler and co-workers⁵ found that the ionization potential of calcium vapour is 6.01 volts, and there are two resonance potentials, one at 1.90 volts and another less pronounced one at 2.85 volts. J. C. McLennan and J. F. T. Young obtained 6.12 volts for the ionization potential of calcium vapour; 5.7 volts for that of strontium vapour; and 5.21 volts for that of barium vapour. P. D. Foote and F. L. Mohler found that calcium vapour is not ionized by heating it to 700°; and they gave 1.90–2.85 volts for the resonance potential. H. Greinacher studied **flame ionization** by strontium salts. E. Rutherford and J. Chadwick obtained little if any evidence of the emission of long-range particles, detected by scintillations on a zinc sulphide screen, when α -particles pass through calcium. B. Gudden and R. Pohl measured the electrical conductivity of phosphorescent calcium under a field strength of 16,000 volts per cm. V. L. Chrisler studied the **potential gradient in the arc** with electrodes of barium, strontium, and calcium. P. Pascal determined the **magnetic susceptibility** of the alkaline earth metals and their compounds.

According to H. Davy,⁶ finely divided calcium oxidizes rapidly when exposed to the air at ordinary temp., and H. Caron found the metal is covered with a grey film after it has been exposed to dry air. H. Moissan found extremely finely divided calcium, such as is obtained by the evaporation of a soln. of calcium in liquid ammonia, inflames spontaneously on exposure to air. H. Davy, and B. Franz likewise found strontium oxidizes in air. H. Davy, A. Matthiessen, E. D. Clarke, and W. Crookes made similar observations with respect to barium. When the clean, bright metal is exposed to air, A. Guntz and G. Röderer found the surface immediately becomes dull, then yellowish-brown, and later grey, owing to the formation of oxide and nitride. A. Guntz made similar observations with respect to barium. According to H. Davy, when calcium is heated in air, it burns with a brilliant flame. J. H. Goodwin heated the metal red hot without ignition, and he found it to be quite soft at this temp. R. Bunsen and A. Matthiessen found strontium burns when heated in dry oxygen. A. Guntz found that finely divided 98.35 per cent. barium ignites

spontaneously in air. Barium also readily burns when heated in air. Lies-Bodart and M. Jobin found that when calcium is heated by the blowpipe flame, it is covered by a film of oxide which protects the metal and renders combustion difficult. H. Moissan found that when calcium is heated to 300°, it burns vigorously in oxygen gas, and the heat of combustion is so great that some calcium oxide is volatilized, but no peroxide is formed. Dry oxygen has no action at ordinary temp. W. Strecker and H. Thienemann studied the action of ozone on soln. of calcium and barium in liquid ammonia; they found that ozonates analogous with those of the alkali metals were formed, contaminated with products of the action of ozone on ammonia. Calcium is one of the most active of elements and it seems to combine with all excepting the inert gases. According to L. Maquenne, nitrogen is absorbed by the hot metals of the alkaline earths forming a nitride. O. Ruff and co-workers found that the pure calcium is passive towards nitrogen, while metals more strongly positive—*e.g.* barium, strontium, sodium, and potassium—accelerate the absorption of nitrogen; some metals—*e.g.* magnesium, lead, and tin—have no effect; others—*e.g.* arsenic and antimony—retard it; and some—*e.g.* bismuth, copper, and zinc—inhibit the action. It is hence concluded that the heteropolar nature of a metallic surface favours the combination with a homopolar gas. H. Moissan observed that when calcium is heated to dull redness in air, oxide and nitride are formed. A. Guntz and G. Röderer likewise found that when strontium is heated in air, oxide and nitride, but no peroxide, is formed. When the metals of the three alkaline earths are heated with hydrogen, the gas is absorbed and hydrides are formed (*q.v.*). F. H. Newman noted the absorption of hydrogen and nitrogen by calcium in the electrical discharge tube.

Calcium was found by Lies-Bodart and M. Jobin to be rapidly covered with calcium hydroxide and carbonate when exposed to moist air. H. Davy's preparation of calcium vigorously decomposed water, but H. Moissan showed that with cold water the action is slow, in consequence of the formation of a protective layer of calcium hydroxide; since the last-named compound is soluble in a soln. of sugar, calcium is dissolved more rapidly by a soln. of sugar than by water. Strontium was also found by R. Bunsen and A. Matthiessen to react turbulently with water; and A. Matthiessen, H. Davy, and E. D. Clarke noted that barium reacts with water at ordinary temps. The action of water on calcium is more vigorous if a little ferric chloride, auric chloride, or platinum chloride be present—a galvanic couple is possibly here formed. Lies-Bodart and M. Jobin found a soln. of sodium carbonate attacks calcium very slowly. According to J. H. Goodwin, when calcium made in an iron vessel is treated with water, it sometimes gives hydrogen with an odour of acetylene; this is probably due to the calcium extracting some carbon from the iron. Calcium can also extract sulphur and phosphorus from iron.

According to H. Moissan calcium is vigorously attacked by fluorine at ordinary temp., the mass glows with a red heat, and cubic crystals of calcium fluoride will be found in the molten product; at 400° chlorine likewise attacks calcium with incandescence, forming fused calcium chloride. A. Guntz and G. Röderer found strontium is not changed by cold chlorine, but when warmed, the metal is attacked, and at 300°, the metal burns with incandescence. The combustion of strontium in chlorine was noted by R. Bunsen and A. Matthiessen. According to H. Moissan, liquid bromine has no action on calcium, but with bromine vapour, combustion occurs at a dull red heat. Strontium was found by R. Bunsen and A. Matthiessen, and by A. Guntz and G. Röderer, to burn in bromine vapour at 400°, forming molten strontium bromide. According to R. Bunsen and A. Matthiessen, B. von Lengyel, and H. Moissan, iodine can be heated to its b.p. without acting on calcium, but at a higher temp., a vigorous reaction occurs. A. Guntz and G. Röderer found iodine unites with strontium below a red heat. According to H. Moissan, when calcium is heated to dull redness in a stream of hydrogen chloride, it glows, and forms calcium chloride. A. Guntz and G. Röderer found strontium behaves similarly at 500°. B. von Lengyel, and R. Bunsen and A. Matthiessen found dil. or

conc. **hydrochloric acid** reacts turbulently with calcium with the evolution of hydrogen. A. Guntz and G. Röderer found strontium behaves similarly. H. Moissan observed that the **alkali chlorides** are reduced by calcium at a red heat—W. Muthmann, L. Weiss, and J. Metzger say at 950° to 1200° or 1600°. F. M. Perkin and L. Pratt found that the alkali metals volatilize and burn during the reaction. H. Moissan found the **alkali iodides** under similar conditions are not attacked; and **calcium chloride or iodide** are reduced to the corresponding subhalide. W. Muthmann and L. Weiss say that **cryolite** at a red heat is reduced to aluminium; and that **strontium and barium chloride** furnish alloys which are readily oxidized in air. F. M. Perkin and L. Pratt obtained similar results. According to L. Hackspill, when calcium is heated with **silver chloride or cuprous chloride** at a red heat, the corresponding metal alloy is formed; **chromic chloride** is reduced to chromium, but **ferric chloride** is not reduced. F. M. Perkin and L. Pratt found **lead chloride** to react explosively with calcium, forming an alloy; **aluminium chloride** under similar conditions also yields an alloy. According to H. Moissan, calcium reduces **boron bromide or boron nitride**, forming boron and the corresponding calcium salts.

B. von Lengyel found that calcium burns in **sulphur** vapour with a very brilliant white flame, and, according to H. Moissan, the reaction begins about 400°. F. M. Perkin and L. Pratt say that a mixture of calcium and sulphur, fired by a taper, reacts explosively; and that **lead sulphide** (galena) does not give lead, but a grey solid which gives off hydrogen sulphide when treated with hydrochloric acid. R. Bunsen and A. Matthiessen found that strontium like calcium burns in sulphur vapour forming, according to A. Guntz and G. Röderer, strontium sulphide. H. Moissan found that **selenium and tellurium** react like sulphur with calcium at a dull red heat. Gaseous **hydrogen sulphide** reacts vigorously with red-hot calcium, forming calcium sulphide, CaS. According to A. Guntz and G. Röderer, strontium behaves similarly. H. Moissan found that calcium at a dull red heat burns in **sulphur dioxide**, forming calcium sulphide. R. Bunsen and A. Matthiessen found that calcium and strontium are attacked vigorously by dil. **sulphuric acid**, and slowly by the conc. acid, forming, according to H. Moissan, sulphur dioxide, sulphur, and hydrogen sulphide, while fuming sulphuric acid reacts similarly, but furnishes no hydrogen sulphide. According to A. Guntz and G. Röderer, with the cold acid, a layer of solid strontium sulphate is formed which hinders the attack by the acid. H. Davy noted the action of sulphuric acid on barium.

F. H. Newman studied the absorption of **nitrogen** by calcium at the cathode of a vacuum tube. H. Moissan found that calcium does not react with nitrogen at ordinary temp., but at 900° a nitride is formed; he also found that **ammonia** does not react in the cold with calcium; liquid ammonia dissolves the metal, forming at -40° the so-called calcium-ammonium. A. Guntz and G. Röderer observed that strontium, and A. Guntz, that barium, behave similarly. According to H. Erdmann and H. van der Smissen, **ethylamine** reacts with calcium at 250°, forming calcium hydride and nitride. Calcium heated to dull redness burns vigorously in **nitrous oxide**, forming molten calcium oxide, free from the nitride. According to A. Guntz and G. Röderer, when strontium is heated to dull redness with **nitrogen peroxide**, the metal is oxidized less energetically than in air and strontium nitride is formed. They also found that dil. hot conc. **nitric acid** was found by B. von Lengyel to dissolve calcium, while R. Bunsen and A. Matthiessen and H. Moissan noted that the reaction with fuming nitric acid is very slow, but if the acid be diluted the reaction is faster. A. Guntz and G. Röderer found strontium behaved similarly. Calcium reacts with **phosphorus**, forming the phosphide; with **arsenic** forming the arsenide; and with **antimony or bismuth**, alloys are formed. A. Guntz and G. Röderer observed that strontium reacts with the vapour of arsenic at 450°, forming—possibly a black arsenide—which reacts with water giving off arsine, and leaving behind a dark brown powder. H. Moissan observed that at a red heat, **phosphorus pentoxide** reacts explosively with calcium. At about 600°, **boric oxide** is reduced to a brown mass without producing calcium boride;

calcium borate is reduced to a mixture of boron and calcium boride, CaB_6 . According to F. M. Perkin, a mixture of boric oxide or of sodium borate with calcium, when ignited with a fuse of sodium peroxide and calcium, furnishes a mixture of what appears to be boron and calcium boride, which can be used in place of boron for making boron trichloride.

Calcium was found by H. Moissan to react vigorously with **carbon**; the reaction is attended by the evolution of much heat—and it begins with soot at a dull red heat, and with graphite at a rather higher temp. A. Guntz and G. Röderer found that when heated with strontium, carbon forms a grey product which develops acetylene when treated with water. According to H. Moissan, liquid **acetylene** does not react with calcium, but when calcium is warmed in the gas, a layer of carbon is formed on the metal, and the remaining gas is polymerized. When heated in a stream of acetylene, the metal burns, forming calcium carbide and hydride. A. Guntz and G. Röderer found strontium is blackened by acetylene at 600° , and the metal is covered by a protective layer of carbon, but very little carbide is formed. The reaction with **ethylene** begins at a dull red heat, and a layer of carbon is formed on the metal which hinders the reaction; acetylene is simultaneously formed; **methane** reacts similarly. R. Bunsen and A. Matthiessen observed that calcium burns brilliantly when heated in **carbon dioxide**. O. P. Watts represented the reaction as furnishing carbon and calcium oxide; and H. Moissan found that if the temp. is not so high, the metal is covered with a layer of carbon and calcium carbide and carbonate which hinders the reaction—some carbon monoxide is also formed. R. Bunsen and A. Matthiessen found strontium reacts similarly with carbon dioxide. A. Guntz and G. Röderer said that strontium burns as energetically in carbon dioxide or coal gas as in air, but not so vigorously as calcium. H. Moissan said that calcium at a dull red heat decomposes **carbon monoxide**, forming carbon and calcium carbide; and A. Guntz and M. Mantrel observed a similar reaction with barium. A. Guntz and G. Röderer found strontium behaves in carbon monoxide as it does in carbon dioxide. Dil. **acetic acid** dissolves the metal vigorously with the evolution of hydrogen, and H. Moissan made a similar observation with calcium and acetic acid. Lies-Bodart and M. Jobin say that absolute alcohol is without action on calcium. F. M. Perkin, and L. Pratt found calcium must be used with care as a drying agent for alcohol, because after half an hour's contact, a turbulent action occurs, hydrogen is evolved and calcium ethoxide is formed. Calcium was also found by H. D. Law and F. M. Perkin to react with **ketones**. According to A. Guntz and G. Röderer, absolute alcohol dissolves some strontium, but dry **ligroin**, **toluene**, **turpentine**, etc., have no action on the metal. J. A. Wanklyn found calcium attacks **zinc ethyl**. Calcium and **silicon** combine at a red heat, forming a silicide; while **silica** is reduced by calcium or strontium, forming the silicide and a little silicon. R. Bunsen and A. Matthiessen found **glass** and **poreclain** are vigorously attacked by calcium or strontium at a red heat. A. Guntz and G. Röderer said that strontium does not reduce **silicon tetrachloride**.

H. Moissan found that **sodium** dissolves calcium at a high temp. and that the calcium crystallizes out again on cooling; **potassium** possesses this quality in a smaller degree. According to W. Muthmann and L. Weiss, when a heated alloy of calcium and sodium is cooled it forms two layers, and potassium behaves similarly. H. Moissan found that calcium forms brittle alloys with **magnesium**, **zinc**, and **nickel**, and these alloys decompose water; A. Guntz and G. Röderer observed that nickel alloys with strontium. A. Guntz found that nickel is attacked by barium more than is the case with iron. H. Moissan found that calcium reacts vigorously with **tin**, but the alloy retains only a little calcium, and it too decomposes water slowly. W. Muthmann and L. Weiss say that calcium does not alloy with **lead** or tin; and L. Hackspill that it forms no alloy with **chromium**, but it does so, under press., with **iron**. A. Guntz found iron is but little attacked by barium. H. Moissan found that when calcium is rubbed up with **mercury**, an amalgam is produced;

A. Guntz and G. Röderer observed that strontium, and R. Bunsen and A. Matthiessen that barium, forms an amalgam under similar conditions. The alkali oxides—lithium, sodium, and potassium—are reduced to the metals when heated with calcium; and the alkali hydroxides are similarly reduced with detonation. This agrees with the heats of formation of the oxides, $(\text{Ca}, \text{O})=145$ Cals., $(2\text{K}, \text{O})=98.2$ Cals., and $(2\text{Na}, \text{O})=100.9$ Cals. F. M. Perkin and L. Pratt could not obtain metals from the hydroxides of the alkalies or the alkaline earths. No strontium was obtained with strontium oxide and calcium although there is a vigorous reaction; with calcium oxide and calcium, a suboxide is formed. F. E. Weston and H. R. Ellis partly reduced lime and magnesia by calcium, but in the latter case, a nitride is the chief product. H. Moissan found that uranic oxide, UO_3 ; titanic oxide, TiO_2 ; and vanadium pentoxide, V_2O_5 , are reduced to a lower state of oxidation by calcium. A. Burger obtained uranium of a high degree of purity by the calcium reduction, and likewise also titanium and zirconium—the latter from zirconium oxide. F. M. Perkin and L. Pratt found titanic oxide is reduced to a metallic powder; tungstic oxide is reduced to the metal, and the reaction is so vigorous that both the metal and the calcium oxide are fused; alumina is reduced to a metal powder. F. E. Weston and H. R. Ellis also reduced alumina by calcium. A. Burger likewise obtained molybdenum from molybdic oxide. According to F. M. Perkin, a mixture of calcium with ferric oxide gives the corresponding metal; similar remarks apply to mixtures of calcium with manganese dioxide, or with chromic oxide. The chief objections to the use of calcium for reducing the oxides to the metal are the great violence of the reaction, and the infusibility of the calcium oxide. According to A. Burger, the reduction by calcium is unsatisfactory with silica; cerium dioxide is reduced to the sesquioxide; and thorium dioxide is not reduced.

Some reactions of analytical interest.—The chlorides of the alkaline earths may be regarded as typical. Aq. ammonia free from carbonate gives no precipitate with salts of calcium, strontium, or barium, although if the ammoniacal soln. be exposed to air, carbon dioxide is absorbed, and the carbonate of the alkaline earth precipitated. An ammoniacal soln. of commercial ammonium carbonate contains ammonium carbonate and carbamate. This soln. gives a flocculent precipitate of, say, calcium carbonate which becomes crystalline on standing, and more rapidly on heating. The reaction: $\text{CaCl}_2 + (\text{NH}_4)_2\text{CO}_3 \rightleftharpoons \text{CaCO}_3 + 2\text{NH}_4\text{Cl}$, is reversible so that an excess of the precipitant is needed, and the soln. should not be boiled longer than is needed to change the flocculent precipitate into a crystalline one. If a large proportion of ammonium chloride is present, and only a small proportion of the carbonate, no precipitation may occur. A soln. of ammonium carbamate alone gives no precipitate because the carbamates are soluble, but if the soln. be warmed over 60° , ammonium carbamate forms carbonate, and the alkaline earth carbonate is precipitated. F. Jackson⁷ gives as the limits of the reaction with barium 1 : 4000, with strontium 1 : 16,000, and with calcium 1 : 8000. R. Fresenius gave 1 : 163,000 for calcium, and 1 : 201,000 for barium. Soln. of sodium carbonate precipitate the carbonates of the alkaline earths from soln. of their salts, much as is done by ammonium carbonate. According to J. L. Lassaigne, sodium carbonate gives a slight cloud, appearing only in a few minutes with calcium nitrate diluted 1 : 25,000; a very slight turbidity appearing only after standing some time when the dilution is 1 : 50,000; with 1 : 100,000 there was a scarcely perceptible turbidity after standing a long time; and with 1 : 200,000, no effect could be detected. Neutral or alkaline soln. of the salts of the alkaline earths give a precipitate of the oxalate when treated with ammonium oxalate. The crystalline precipitate formed in cold soln. is difficult to filter, but that formed in hot soln. consists of large crystals more readily filtered. The precipitated calcium oxalate is very sparingly soluble in acetic acid, the strontium salt is rather more soluble, and the barium salt readily dissolves in the hot acid. The solubility of the oxalates increases with increasing mol. wt., so that while the calcium salt is virtually insoluble in water, the barium

salt is more soluble, 100 parts of water dissolve 0.0386 part of barium oxalate. The oxalates of the alkaline earths are soluble in the mineral acids, and the addition of aq. ammonia reprecipitates the oxalates; boiling the oxalates with a soln. of sodium carbonate changes them into carbonates. According to J. L. Lassaigne, one part of strontia in 10,000 parts of water gives a scarcely appreciable turbidity, and with more water, no turbidity is visible; with calcium a precipitate is obtained with 1 : 25,000; a very slight precipitate is obtained with 1 : 50,000; and with 1 : 100,000 an opalescence appears in five minutes; and with 1 : 200,000, 1 : 400,000, and 1 : 800,000 a slight opalescence appears in five, eight, or fifteen minutes respectively. P. Harting obtained a turbidity with a soln. of calcium chloride at a dilution of 1 : 400,000. According to F. Jackson, the reaction with ammonium oxalate is sensitive to 1 : 64,000 with calcium, 1 : 32,000 with strontium, and 1 : 2000 with barium.

Conc. soln. of a calcium salt give a precipitate with sulphuric acid; but dil. soln. give no precipitate since calcium sulphate is sparingly soluble in water. Calcium sulphate is far less soluble if alcohol be added to the soln. Strontium sulphate is less soluble than calcium sulphate, and more soluble than barium sulphate. The latter is very sparingly soluble in water. Hot conc. sulphuric acid dissolves the precipitate because a soluble hydrosulphate is formed—*e.g.* with barium, $\text{BaSO}_4 + \text{H}_2\text{SO}_4 = \text{Ba}(\text{HSO}_4)_2$ —this is decomposed into sparingly soluble barium sulphate when the soln. is diluted with water. Hot dil. hydrochloric acid dissolves calcium and strontium sulphate, and barium sulphate is but sparingly soluble in the hot acid. Calcium sulphate is soluble in a soln. of ammonium sulphate owing to the formation of a soluble double salt: $\text{CaSO}_4 \cdot (\text{NH}_4)_2\text{SO}_4$. This soln. is decomposed by water and the calcium sulphate is reprecipitated. Barium sulphate is slightly soluble in a soln. of sodium thiosulphate. A soln. of calcium sulphate gives no precipitate with a soln. of a calcium salt; but in a neutral or feebly acid soln. of a strontium salt, a precipitate of strontium sulphate is formed when the soln. has stood for some time, but with a soln. of a barium salt, precipitation of barium sulphate occurs at once. According to J. L. Lassaigne, a soln. of barium nitrate containing one part of baryta in 25,000 parts of water gives a very distinct cloudiness with sulphuric acid or sodium sulphate; with 1 : 50,000 or 1 : 100,000, a slight turbidity appears; with 1 : 200,000 to 1 : 400,000, a turbidity appears in some minutes; and with 1 : 800,000 there is no reaction. According to P. Harting a soln. of barium chloride with one of baryta in 71,000 parts of water becomes turbid with sodium sulphate in half an hour, and the limits of the reaction is 1 : 79,300. J. L. Lassaigne found a soln. of strontium nitrate with one of strontia in 2500 parts of water gives a precipitate with sulphuric acid or sodium sulphate; with 1 : 5000, a slight cloudiness; with 1 : 10,000, a very slight turbidity; and with 1 : 20,000, a very slight turbidity in a few minutes; with 1 : 40,000 there was a scarcely appreciable turbidity in a few minutes. F. Jackson gives the limits 1 : 256,000 with barium; and with strontium the limits are 1 : 8000, and with calcium 1 : 2000. R. Fresenius gives 1 : 23,100, or 1 : 25,200 for the limits with strontium. The limits of the reaction with calcium sulphate as precipitant are, according to F. Jackson, 1 : 64,000 with barium, and 1 : 1000 with strontium.

When a neutral soln. of a calcium, strontium, or barium salt is treated with a soln. of sodium phosphate, a white flocculent precipitate is produced: $\text{Na}_2\text{HPO}_4 + \text{CaCl}_2 = 2\text{NaCl} + \text{CaHPO}_4$; and if aq. ammonia be added to the mixture, normal calcium phosphate, $\text{Ca}_3(\text{PO}_4)_2$, is formed. Both the calcium phosphates are soluble in mineral or acetic acid. According to J. L. Lassaigne, a precipitate is obtained with sodium phosphate in soln. of calcium nitrate diluted 1 : 25,000; a slight precipitate with a dilution of 1 : 50,000; and with 1 : 100,000 there was an opalescence in a few minutes, but no effect with a dilution 1 : 200,000. The limits of the reaction are given by F. Jackson as 1 : 16,000 with calcium, 1 : 8000 with strontium, 1 : 4000 with barium. No precipitation occurs when a soln. of a calcium salt is treated with potassium chromate, nor does precipitation occur with a dil.

soln. of a strontium salt; but a conc. soln. of a strontium salt does give a precipitate of strontium chromate. A neutral dil. or conc. soln. of a barium salt gives a yellow precipitate of barium chromate which is very sparingly soluble in water and acetic acid, but it is readily soluble in mineral acids. Consequently, potassium dichromate is not so good a precipitant since an acid is then formed: $2\text{BaCl}_2 + \text{K}_2\text{Cr}_2\text{O}_7 + \text{H}_2\text{O} = 2\text{BaCrO}_4 + 2\text{HCl} + 2\text{KCl}$. The presence of sodium acetate diminishes the solvent action of the mineral acids and the reaction is then quantitative. The limits of the reaction, according to F. Jackson, are 1 : 256,000 with barium, and 1 : 200 with strontium. Barium salt soln. give a white crystalline precipitate of barium fluosilicate, BaSiF_6 , when treated with hydrofluosilicic acid, H_2SiF_6 . The precipitation takes some time. The precipitated fluosilicate is sparingly soluble in water and dil. acids, and virtually insoluble in alcohol. According to P. Harting, one part of barium chloride in 3800 parts of water gives a precipitate with this acid, F. Jackson gives 1 : 2000. Neither calcium nor strontium salts give a precipitate with this reagent even in fairly conc. soln., and this even if the calcium soln. is mixed with half its vol. of alcohol. C. F. Rammelsberg found that sodium iodate precipitates baryta quantitatively as iodate, and the precipitate dissolves in hydrochloric acid, consequently G. Denigès recommended a 10 per cent. soln. of iodic acid as a reagent for the microdetection of calcium, strontium, or barium salts all of which give finely crystalline iodates.

The separation of barium, strontium, and calcium.⁸—Salts of the alkaline earths can be separated from the alkalis by precipitation as oxalates. Calcium can be separated from the other two elements (1) by treating the nitrates with a mixture of alcohol and ether in which the calcium salt readily dissolves, while the other two salts are very sparingly soluble (F. Stromeyer, H. Rose, R. Fresenius); (2) by extracting the calcium nitrate with amyl alcohol (P. E. Browning); (3) by treating the nitrates with nitric acid of sp. gr. 1.42–1.46, in which the calcium salt is readily soluble, and the other two salts are very sparingly soluble (S. G. Rawson); (4) by boiling the three sulphates with a soln. of an alkali or ammonium carbonate, which converts calcium and strontium sulphates into carbonates, leaving the barium sulphate virtually unchanged. The carbonates are then removed with dil. acid (H. Rose, J. L. R. Morgan, F. W. Küster); (5) by treating the sulphates with an alkali tartrate, when calcium sulphate is alone converted into tartrate which is soluble in hydrochloric acid (M. Dupasquier); (6) by precipitating the barium as chromate, the strontium as sulphate, and the calcium as oxalate (H. Robin); and (7) by the indirect method in which the mixture is converted into mixtures of different weighable salts (O. Knoblauch).

The separation of calcium and strontium.—(1) By treatment of the nitrates with the alcohol-ether mixture or amyl alcohol in which the calcium alone dissolves (*vide supra*); (2) by treatment of the soln. with a mixture of ammonium sulphate and oxalate, whereby the strontium is converted into sulphate, the calcium into oxalate (D. Sidersky); (3) by treatment of the chromates with alcohol in which the calcium alone dissolves (W. Fresenius and F. Ruppert).

The separation of calcium and barium.—(1) By precipitation of the barium as chromate or as fluosilicate (R. Fresenius); (2) by treatment of the nitrates with alcohol-ether or amyl alcohol which extracts the calcium salt alone (*vide supra*); (3) by extracting the chlorides with an ethereal soln. of hydrogen chloride which extracts the calcium salt alone (F. W. Mar); (4) by treating a dil. soln. with sulphuric acid, which precipitates the barium as sulphate; (5) by digestion with a mixture of potassium sulphate and carbonate, which converts the barium into sulphate, and the calcium into carbonate—the latter is removed by treatment with dil. hydrochloric acid (E. Fleischer); (6) by digestion with a mixture of ammonium sulphate and oxalate which converts the barium into sulphate and the calcium into oxalate—the latter is alone soluble in dil. acid; and (7) by digesting the sulphates with a soln. of sodium thiosulphate in which the calcium salt alone dissolves (W. Diehl).

The separation of strontium and barium.—(1) The barium can be precipitated as chromate, the strontium salt remains in soln. (R. Fresenius); (2) the barium can be precipitated as silicofluoride (R. Fresenius); (3) barium chloride is alone insoluble in absolute alcohol (P. E. Browning); (4) by boiling the alkali carbonate which converts strontium sulphate into the carbonate and leaves the barium salt almost unattacked. The carbonates are removed with dil. acid (H. Rose).

The accuracy of analytical processes is generally affected by the assumption that precipitates are insoluble when they are but sparingly soluble; by the precipitation of one substance in the presence of another whereby a substance assumed to be wholly in soln. is partly carried down with a precipitate; and by the assumption that one component of a mixed precipitate is insoluble in or inert towards a given menstruum, when in reality it is slightly soluble, or not quite inert. Many of these proposed methods are faulty when closely examined. The methods which have proved most satisfactory are (i) treatment of the mixed nitrates with ethereal alcohol to remove calcium nitrate, and the subsequent separation of barium and strontium by the chromate process; (ii) treatment of the soln. in acetic acid with an alkali chromate; barium chromate is precipitated, redissolved, and again precipitated; the salts in the filtrate are precipitated as carbonates; converted into nitrates; and the calcium nitrate removed from strontium nitrate by the ether alcohol mixture. The separated products are converted into sulphates and weighed.

The uses of alkaline earths.—Calcium is a powerful reducing agent, and it has been used to a very limited extent as a deoxidizer and for removing nitrogen from alloys. It has been used as an absorbent for gases—hydrogen and nitrogen—in gas-analysis. The fine-grained metal is a faster absorbent than the coarsely crystalline metal obtained by slow cooling. The use of metallic calcium is thus summarized by H. P. Brace⁹:

Calcium is used as a reducing agent in the preparation of metals and alloys from their oxygen and halogen compounds; as a reagent in the purification of the inert gases; as a scavenger for non-ferrous metals and alloys; as a scavenger, decarburizer, and desulphurizer for ferrous alloys; as a dehydrating agent in the treatment of oils and alcohols, etc.; as a means of fixing atm. nitrogen; as a source of pure calcium carbide by direct reaction with pure carbon; as a stiffening filling for hollow metal structural members; as a constituent of a light aluminium alloy having useful properties; and as a hardening component in certain lead-base antifricition alloys.

Calcium alloys have been proposed for bearing metals. Lime or limestone is used in the preparation of mortars; cements; sand-lime bricks; glass; glazes; the purification of water; the manufacture of soda; bleaching powder; calcium carbide; calcium cyanamide; calcium nitrate; etc.; the purification of coal gas; the manufacture of insecticides and sprays; the manufacture of sugar; the distillation of wood; the manufacture of paper; paints; and in tanning. Strontium salts are used in the manufacture of fireworks, signal lights, and signal shells; and to a limited extent in medicine. Strontia is used in the recovery of sugar from beet-sugar molasses. Barium carbonate is used in glass making; in rendering soluble sulphates in clays inert; in making wall-paints, etc. The chloride is used in the purification of salt; in certain medicinal and photographic preparations; for rendering soluble sulphates in clays more or less inert; as a chemical agent; the nitrate is used as a chemical agent, in certain medicinal preparations; in pyrotechnics and in making green signal lights; and for certain explosive mixtures. Barium peroxide is used as a bleaching agent. For the uses of the sulphates of the alkaline earths,¹⁰ *vide infra*.

REFERENCES.

- ¹ G. Bartha, *Ueber die Siedepunkte der Alkalimetalle und Alkalihalogenide im Vacuum des Kathodenlichts*, Heidelberg, 1912; H. Davy, *Phil. Trans.*, 98, 1, 333, 1808; A. Matthiessen, *Journ. Chem. Soc.*, 8, 28, 1856; *Liebig's Ann.*, 94, 107, 1855; W. Muthmann and L. Weiss, *ib.*, 355, 137, 1907; E. Frey, *ib.*, 183, 367, 1876; B. von Lengyel, *Math. Nat. Ber. Ungarn*, 14, 180, 1898; *Compt. Rend.*, 127, 584, 1898; M. von Wogau, *Ann. Physik*, (4), 23, 345, 1907; O. Ruff and W. Plato, *Ber.*, 35, 3617, 1902; O. Ohmann, *ib.*, 39, 866, 1906; K. Arndt, *ib.*, 37, 4733, 1904; J. Donath, *ib.*, 12, 745, 1879; *Phil. Mag.*, (5), 8, 84, 1879; R. Bunsen, *Pogg. Ann.*, 91, 619, 1854; *Liebig's Ann.*, 92, 248, 1854; Lies-Bodart and M. Jobin, *Ann. Chim. Phys.*, (3), 54, 364, 1858; H. Moissan, *ib.*, (7), 18, 302, 1899; *Bull. Soc. Chim.*, (3), 21, 817, 1899; *Compt.*

- Rend.*, 126. 1753, 1898; L. Maquenne, *ib.*, 121. 1147, 1895; H. Moissan and G. Chavanne, *ib.*, 140. 122, 1905; A. Guntz and G. Röderer, *ib.*, 142. 400, 1906; *Bull. Soc. Chim.*, (3), 35. 508, 1906; A. Guntz, *ib.*, (3), 29. 483, 1903; *Ann. Chim. Phys.*, (8), 4. 5, 1905; (8), 10. 437, 1907; *Compt. Rend.*, 133. 872, 1901; P. W. Bridgman, *Proc. Amer. Acad.*, 56. 61, 1921; M. Trautz, *Verh. Ges. deut. Naturforsch. Aerzte*, ii, 196, 1912; C. T. Heycock and F. H. Neville, *Journ. Chem. Soc.*, 61. 888. 1892; W. Guertler and M. Pirani, *Zeit. Metallkunde*, 11. 1, 1919; W. L. Bragg, *Phil. Mag.*, (6), 40. 169, 1920; E. Tiede and E. Birnbrauer, *Zeit. anorg. Chem.*, 87. 129, 1914; J. H. Goodwin, *Proc. Amer. Acad.*, 43. 381, 1905; *Journ. Amer. Chem. Soc.*, 25. 873, 1903; 27. 1403, 1905; T. W. Richards, *ib.*, 37. 1643, 1915; B. L. Glascock, *ib.*, 32. 1222, 1910; W. Borchers and L. Stockem, *Zeit. Elektrochem.*, 8. 759, 1902; P. Nordmeyer and A. L. Bernoulli, *Ber. deut. phys. Ges.*, 5. 175, 1907; W. Muthmann, L. Weiss, and J. Metzger, *Liebig's Ann.*, 355. 137, 1907; A. Bernini, *Phys. Zeit.*, 8. 150, 1907; E. D. Clarke, *Ann. Phil.*, 8. 357, 1816; L. Doermer, *Zeit. anorg. Chem.*, 49. 362, 1906; B. Franz, *Journ. prakt. Chem.*, (1), 107. 253, 1869; P. H. Brace, *Trans. Amer. Elektrochem. Soc.*, 37. 69, 1920; *Journ. Inst. Metals*, 25. 153, 1921; N. B. Pilling, *ib.*, 25. 170, 1921; W. Crookes, *Chem. News*, 6. 194, 1862; J. Dewar, *Proc. Roy. Soc.*, 76. A, 325, 1905; A. W. Hull, *Phys. Rev.*, (2), 17. 42, 1921; *Science*, 53. 227, 1820; R. J. Brunner, *Die Abhängigkeit der spezifischen Wärme des festen Calciums und Magnesiums von der Temperatur*, Zürich, 1906; E. D. Eastman and W. H. Rodebush, *Journ. Amer. Chem. Soc.*, 40. 489, 1918; W. Biltz and G. Hohorst, *Zeit. anorg. Chem.*, 121. 1, 1922; M. N. Saha, *Nature*, 107. 682, 1921; G. N. Lewis and G. E. Gibson, *Journ. Amer. Chem. Soc.*, 29. 2555, 1917; G. N. Lewis, G. E. Gibson, and W. M. Latimer, *ib.*, 44. 1008, 1922.
- ² J. H. Gladstone, *Phil. Trans.*, 159. 13, 1869; *Proc. Roy. Soc.*, 18. 49, 1694; W. J. Pope, *Journ. Chem. Soc.*, 69. 1530, 1896; M. N. Saha, *Phil. Mag.*, (6), 41. 267, 1921; R. Pohl and P. Pringsheim, *Verh. deut. phys. Ges.*, 15. 546, 1912; 15. 111, 1913; W. Crookes, *Proc. Roy. Soc.*, 32. 206, 1881; *Chem. News*, 43. 237, 1881; H. R. von Traubenberg, *Zeit. Physik*, 2. 281, 1920; J. Kannonikoff, *Journ. Russ. Phys. Chem. Soc.*, 16. 119, 1884; *Journ. prakt. Chem.*, (2), 31. 321, 1885; T. W. Case, *Phys. Rev.*, (2), 17. 398, 1921; (2), 18. 413, 1921; R. Whiddington, *Phil. Mag.*, (6), 43. 1116, 1922.
- ³ L. Börsch, *Das Bandenspektrum des Bariums*, Leipzig, 1909; V. Höller, *Untersuchungen über den langwelligen Teil des Bariumspektrums*, Bonn, 1908; R. Bunsen, *Liebig's Ann.*, 111. 266, 1859; G. Kirchhoff and R. Bunsen, *Pogg. Ann.*, 110. 177, 1860; T. Engelbach, *Liebig's Ann.*, 123. 255, 1862; S. Muspratt, *ib.*, 72. 118, 1849; G. Merz, *Journ. prakt. Chem.*, (1), 80. 497, 1860; R. Blochmann, *ib.*, (2), 4. 282, 1871; C. F. Plattner, *ib.*, (1), 17. 467, 1839; R. Cartmell, *Phil. Mag.*, (4), 16. 328, 1858; D. Smith, *ib.*, (3), 9. 87, 1836; H. Smith, *ib.*, (6), 25. 461, 1913; J. H. Pollok and A. G. Leonard, *Scient. Proc. Roy. Dublin Soc.*, (2), 11. 229, 1907; J. H. Pollok, *ib.*, (2), 11. 184, 1907; J. N. Lockyer, *Proc. Roy. Soc.*, 24. 352, 1876; J. C. McLennan, J. F. T. Young, and H. J. C. Ireton, *ib.*, 98. A, 95, 1920; G. D. Liveing and J. Dewar, *ib.*, 34. 122, 1882; W. and Mrs. Huggins, *ib.*, 61. 433, 1897; H. St. C. Deville, *Compt. Rend.*, 82. 709, 1876; L. de Boisbaudran, *ib.*, 82. 1264, 1876; J. N. Lockyer, *ib.*, 89. 714, 1879; E. Becquerel, *ib.*, 97. 71, 1883; 99. 374, 1884; C. Fabry, *ib.*, 138. 158, 1904; 140. 578, 1905; A. de Gramont, *ib.*, 144. 1101, 1907; G. A. Hemsalech and C. de Wateville, *ib.*, 147. 188, 1908; J. L. Schönönn, *Wied. Ann.*, 9. 483, 1801; 10. 143, 1880; H. Kayser and C. Runge, *ib.*, 43. 384, 1891; 50. 625, 1883; 52. 114, 1894; J. R. Rydberg, *ib.*, 50. 625, 1893; 52. 119, 1894; 62. 119, 1894; H. Ebert, *ib.*, 34. 39, 1888; C. Runge and F. Paschen, *Sitzber. Akad. Berlin*, 380, 1902; H. W. Vogel, *ib.*, 192, 1880; *Chem. News*, 41. 116, 1880; J. H. Freeman, *ib.*, 18. 1, 1868; E. Carter and A. S. King, *Astrophys. Journ.*, 49. 224, 1919; W. N. Hartley, *Phil. Trans.*, 105. 161, 1893; *Proc. Roy. Soc.*, 79. A, 242, 1907; W. N. Hartley and H. W. Moss, *ib.*, 87. A, 38, 1912; J. M. Eder and E. Valenta, *Denks. Akad. Wien*, 67, 1898; G. L. Ciamician, *Sitzber. Akad. Wied.*, 76. 499, 1878; 79. 8, 1879; H. Lehmann, *Ann. Physik*, (4), 8. 643, 1902; (4), 9. 246, 1902; A. S. King, *ib.*, (4), 16. 360, 1905; *Astrophys. Journ.*, 51. 13, 120, 179, 1920; F. A. Saunders, *ib.*, 51. 23, 1920; 52. 265, 1920; L. F. Miller, *ib.*, 53. 224, 1921; H. Ramage, *Proc. Cambridge Phil. Soc.*, 12. 350, 1904; B. E. Moore, *Ann. Physik*, (4), 25. 309, 1908; J. Stark and G. von Wendt, *ib.*, (4), 38. 669, 690, 1912; M. Ritter, *ib.*, (4), 59. 170, 1919; T. Takamine and N. Kokubu, *Mem. Coll. Science Kyoto*, 3. 173, 1918; H. G. Gale and L. F. Miller, *Phys. Rev.*, (2), 17. 428, 1921; G. V. McCauley, *ib.*, (3), 17. 430, 1921; C. Olmsted, *Zeit. wiss. Phot.*, 4. 255, 1907; C. F. O. Meisenbach, *ib.*, 6. 258, 1908; F. Beckmann, *ib.*, 4. 335, 1906; V. Hoeller, *ib.*, 6. 217, 1908; *Phys. Rösch*, 4. 384, 1907; P. Jechel, *ib.*, 5. 322, 1907; E. Walter, *Phys. Zeit.*, 9. 233, 1908; H. F. Talbot, *Brewster's Journ. Science*, 5. 77, 1825; E. H. Reisenfeld and H. E. Wohlers, *Ber.*, 39. 2628, 1906; H. M. Watts, *An Introduction to the Study of Spectrum Analysis*, London, 15, 1904 (Figs. 3 to 5 are kindly loaned from this work); L. de Boisbaudran, *Spectres lumineux*, Paris, 1874; H. Reinsch, *Jahrb. prakt. Chem.*, 17. 214, 1848; R. Fues, *Ann. Physik*, (4), 63. 1, 1920; W. D. Bancroft and H. B. Weiser, *Journ. Phys. Chem.*, 18. 213, 1914; H. Hampe, *Zeit. wiss. Photochem.*, 13. 348, 1914; H. Crew and G. V. McCauley, *Astrophys. Journ.*, 39. 29, 1914; O. Holtz, *Zeit. wiss. Photochem.*, 12. 201, 1913; W. M. Hicks, *Proc. Roy. Soc.*, 91. A, 452, 1915; *Phil. Trans.*, 214. A, 237, 1914; K. Schmitz, *Zeit. wiss. Photochem.*, 11. 209, 1912; H. George, *ib.*, 12. 257, 1913; V. L. Chrisler, *Astrophys. Journ.*, 54. 273, 1921; B. E. Moore, *ib.*, 54. 191, 1921; E. Hjalmar, *Zeit. Physik*, 7. 341, 1921; R. Sechger and D. Thaeer, *Ann. Physik*, (4), 65. 423, 1921; A. S. C. Dunstan and B. A. Wooten, *Astrophys. Journ.*, 54. 65, 1921; L. F. Miller, *ib.*, 53. 224, 1921; A. Fowler, *Report on Series in Line Spectra*, London, 121, 1922; R. A. Sawyer and R. L. Becker, *Science*, (2), 54. 305, 1921; R. Götte, *Ann. Physik*, (4), 66. 285, 1921;

D. Coster, *Phil. Mag.*, (6), 43, 1079, 1922; F. Pasehen and E. Back, *Physica*, 1, 261, 1921; R. Cartmell, *Phil. Mag.*, (4), 16, 328, 1858.

⁴ J. H. Goodwin, *Journ. Amer. Chem. Soc.*, 27, 1403, 1905; H. Moissan and G. Chavanne, *Compt. Rend.*, 140, 134, 1905; R. Bunsen and A. Matthiessen, *Liebig's Ann.*, 94, 111, 1855; P. H. Brace, *Trans. Amer. Electrochem. Soc.*, 37, 69, 1920; E. F. Northrup, *Met. Chem. Eng.*, 15, 193, 1916; K. Fajans, *Ber. deut. phys. Ges.*, 21, 549, 1919; M. Born, *Zeit. Physik*, 1, 45, 1920; C. L. Swisher, *Phys. Rev.*, (2), 10, 601, 1917; B. Gudden and R. Pohl, *Zeit. Physik*, 3, 98, 1920; P. W. Bridgman, *Proc. Amer. Acad.*, 56, 61, 1920; P. Pascal, *Compt. Rend.*, 158, 37, 1895, 1914; 173, 144, 1921; H. Grimm, *Zeit. phys. Chem.*, 98, 353, 1921; W. P. Davey, *Phys. Rev.*, (2), 19, 248, 1922.

⁵ F. L. Mohler, P. D. Foote, and H. F. Stimson, *Phil. Mag.*, (6), 40, 73, 1920; E. Rutherford and J. Chadwick, *Nature*, 107, 41, 1921; F. L. Mohler, P. D. Foote, and F. W. Meggers, *Journ. Amer. Optical Soc.*, 4, 364, 1920; J. C. McLennan and J. F. T. Young, *Proc. Roy. Soc.*, 95, A, 237, 1919; P. D. Foote and F. L. Mohler, *Phys. Rev.*, (2), 17, 394, 1921; V. L. Chrisher, *Astro-phys. Journ.*, 54, 273, 1921; P. Pascal, *Compt. Rend.*, 173, 144, 1921; R. C. Tolman, *Journ. Amer. Chem. Soc.*, 43, 1630, 1921; H. Greinaeher, *Phys. Zeit.*, 23, 65, 1922; B. Gudden and R. Pohl, *Zeit. Physik*, 3, 98, 1920.

⁶ H. Davy, *Phil. Trans.*, 98, 1, 333, 1808; F. H. Neumann, *Proc. Phys. Soc.*, 33, 73, 1921; J. H. Goodwin, *Journ. Amer. Chem. Soc.*, 25, 873, 1913; 27, 1403, 1905; Lies-Bodart and M. Jobin, *Ann. Chim. Phys.*, (3), 54, 364, 1858; A. Guntz, *ib.*, (8), 4, 5, 1905; (8), 10, 437, 1907; J. A. Wanklyn, *ib.*, (3), 55, 344, 1859; H. Moissan, *ib.*, (7), 18, 302, 1899; *Bull. Soc. Chim.*, (3), 21, 817, 1899; *Compt. Rend.*, 126, 1753, 1898; 128, 384, 1899; H. Caron, *ib.*, 48, 440, 1859; 50, 547, 1860; L. Maquenne, *ib.*, 121, 1147, 1895; A. Guntz and G. Röderer, *ib.*, 142, 400, 1906; *Bull. Soc. Chim.*, (3), 35, 508, 1906; L. Hackspill, *ib.*, (4), 1, 895, 1907; *Compt. Rend.*, 142, 89, 1906; A. Matthiessen, *Journ. Chem. Soc.*, 8, 23, 1856; *Liebig's Ann.*, 94, 107, 1855; R. Bunsen, *ib.*, 92, 248, 1854; *Pogg. Ann.*, 91, 619, 1854; B. Franz, *Journ. prakt. Chem.*, (1), 107, 253, 1869; R. Hare, *ib.*, (1), 19, 249, 1840; E. D. Clarke, *Ann. Phil.*, 8, 357, 1816; F. E. Weston and H. R. Ellis, *Trans. Faraday Soc.*, 4, 130, 166, 1909; W. Crookes, *Chem. News*, 6, 194, 1862; B. von Lengyel, *Math. Nat. Ber. Ungarn*, 14, 180, 1898; W. Muthmann, L. Weiss, and J. Metzger, *Liebig's Ann.*, 355, 137, 1907; F. M. Perkin, *Trans. Faraday Soc.*, 3, 115, 1908; F. M. Perkin and L. Pratt, *ib.*, 3, 179, 1908; *Proc. Chem. Soc.*, 23, 304, 1907; F. M. Perkin and H. D. Law, *ib.*, 23, 308, 1907; H. Erdmann and H. van der Smissen, *Liebig's Ann.*, 361, 32, 1908; A. Burger, *Reduktionen durch Calcium*, Basel, 1907; O. P. Watts, *Journ. Amer. Chem. Soc.*, 28, 1152, 1906; W. Strecker and H. Thienemann, *Ber.*, 53, B, 2096, 1920; F. H. Newman, *Proc. Phys. Soc.*, 33, 73, 1921; O. Ruff, *Zeit. phys. Chem.*, 100, 419, 1922; O. Ruff and H. Hartmann, *Zeit. anorg. Chem.*, 121, 167, 1922; A. Guntz and M. Mantrel, *Bull. Chim. Soc.*, (3), 29, 578, 1903.

⁷ P. Harting, *Journ. prakt. Chem.*, (1), 22, 52, 1841; *Bull. Sciences Néerl.*, 2, 164, 1841; J. L. Lassaigne, *Journ. Chim. Méd.*, 8, 526, 1832; F. Jackson, *Amer. Journ. Chem. Soc.*, 25, 992, 1903; R. Fresenius, *Anleitung zur qualitativen chemischen Analyse*, Braunschweig, 1843; C. F. Rammelsberg, *Pogg. Ann.*, 44, 572, 1838; G. Deniges, *Compt. Rend.*, 170, 996, 1920.

⁸ R. Fresenius, *Zeit. anal. Chem.*, 29, 30, 143, 413, 1890; 30, 18, 452, 583, 1891; 32, 194, 315, 1893; W. Fresenius and F. Ruppert, *ib.*, 30, 672, 1891; O. Knoblauch, *ib.*, 37, 733, 1898; D. Sidersky, *ib.*, 22, 10, 1883; P. E. Browning, *Amer. Journ. Science*, (3), 43, 50, 314, 1892; (3), 44, 462, 1892; F. W. Mar, *ib.*, (3), 43, 521, 1892; E. Fleischer, *Chem. News*, 19, 290, 1869; *Die Titrimethode als selbständige quantitative Analyse*, Leipzig, 178, 1884; W. Diehl, *Journ. prakt. Chem.*, (1), 79, 430, 1860; J. L. R. Morgan, *Journ. Amer. Chem. Soc.*, 21, 522, 1899; F. W. Küster, *Zeit. anorg. Chem.*, 22, 161, 1899; S. G. Rawson, *Journ. Soc. Chem. Ind.*, 16, 113, 1897; H. Robin, *Compt. Rend.*, 137, 358, 1903; M. Dupasquier, *Bull. Soc. Chim.*, (3), 13, 678, 1895; H. Rose, *Pogg. Ann.*, 110, 292, 1860; F. Stromeyer, *Gilbert's Ann.*, 54, 245, 1908.

⁹ H. P. Brace, *Journ. Inst. Metals*, 25, 153, 1921; H. S. Cooper, *U.S. Pat. No. 1224362*, 1917; L. Kroll, *Swiss Pat. No. 75891*, 1918; O. P. Watts and J. M. Breckenridge, *Electrochem. Met. Ind.*, 6, 237, 1907; O. P. Watts, *Journ. Amer. Chem. Soc.*, 28, 1152, 1906; L. Stockem, *Met.*, 3, 147, 1906; Anon., *Brass World*, 9, 317, 1913; R. Brandt, *Ueber das metallische Calcium und seine Anwendung in der Gasanalyse*, Weida i. Th., 1915.

¹⁰ R. K. Meade, *Chem. News*, 117, 126, 1918; *Amer. Chem. Age*, 28, 367, 377, 1920; *L'Ind Chim.*, 5, 124, 1918; A. Sieverts, *Zeit. Elektrochem.*, 22, 15, 1916; M. E. Holmes, *Chem. Met. Eng.*, 26, 294, 1922.

§ 5. The Atomic Weights of Calcium, Strontium, and Barium

In 1809, J. J. Berzelius¹ made a determination of the at. wt. of calcium by treating a known quantity of calcium chloride with silver nitrate, and weighing the precipitated chloride. This gave the ratio $\text{CaCl}_2 : 2\text{AgCl}$, from which it follows that the at. wt. of calcium is 40.46. J. J. Berzelius first assumed the formula of the oxide is CaO_2 , but this was later altered to CaO , with a corresponding change in the

at. wt. The last-named formula would make the at. wt. of calcium approximate to 40, the former to 20. The former value is in harmony with Dulong and Petit's sp. ht. rule; with Mitscherlich's isomorphous law; with Mendeléeff's periodic law; and with J. H. van't Hoff's extension of Avogadro's hypothesis to soln. J. J. Berzelius' value is rather too high. In 1841, S. Baup made some interesting analyses of some calcium salts of organic acids, and obtained the at. wt. 39·98 for calcium when that of oxygen is 16. This result, however, is usually regarded as being too much affected by errors to have much weight in comparison with more modern measurements. J. L. Gay Lussac and L. J. Thénard quote 40·3 for the at. wt. of calcium. T. Thomson discussed the at. wt. of strontium, barium, and calcium. A. Salvétat made a statement without details, of some results he had obtained by measuring the amount of carbon dioxide obtained from a given amount of calcium carbonate. The other determinations of this constant include:

1. *Evaluation of the ratio $\text{CaO} : \text{CaCO}_3$.*—In 1842, J. B. A. Dumas ignited Iceland spar, and determined the amount of CO_2 evolved and of the calcium oxide remaining. A correction was made for the impurities in the spar. As a result he obtained 40·171 for the at. wt. of calcium ($\text{O}=16$). The same year O. L. Erdmann and R. F. Marchand made similar determinations with native carbonate and with artificial carbonate. They obtained 40·005. J. J. Berzelius pointed out that the artificial carbonate retains moisture even at 200° , and some chloride from the mother liquid also adheres to the precipitate. These errors act in opposite directions and tend to balance one another. In 1844, the same investigators, working with Iceland spar, obtained 40·068 for the at. wt. of calcium; and in 1850, they obtained 39·996. They also observed that carbon dioxide is liable to be retained by the lime after ignition. In 1897 and 1901, A. Herzfeld, with artificial calcium carbonate, obtained 39·996; and F. W. Hinrichsen, 1901–02, obtained 40·142 with Iceland spar and 40·137 with a sample from the Crimea.

2. *Evaluation of the ratio $\text{CaCO}_3 : \text{CaSO}_4$.*—In 1842, O. L. Erdmann and R. F. Marchand treated calcium carbonate with sulphuric acid, and weighed the resulting calcium sulphate. They obtained 40·02 for the at. wt. of calcium. In 1843, J. J. Berzelius by an analogous method obtained 40·22; and in 1913, W. O. de Coninck 40·12.

3. *Evaluation of the ratio $\text{CaCl}_2 : 2\text{AgCl}$.*—J. J. Berzelius' determination of this ratio in 1809, *vide supra*, furnished 40·46; in 1843, J. C. G. de Marignac obtained 40·21; J. B. A. Dumas in 1859, 40·103; and T. W. Richards in 1902, obtained 40·126. The general mean of all the determinations is 40·13; and the International Atomic Weight Commission recommend 40·1 or 40·07 as the best representative value.

The at. wt. determinations for strontium resemble in general procedure those employed for calcium and barium, but they are fewer in number. F. Stromeyer² in 1817, and A. Salvétat in 1843, measured the volume of carbon dioxide evolved from a given amount of strontium carbonate. From the ratio $\text{SrCO}_3 : \text{CO}_2$ the former obtained 87·3, and the latter 88·0 for the at. wt. of strontium. With the exception of these results, and J. C. G. de Marignac's determination of the ratio $\text{SrCl}_2 \cdot 6\text{H}_2\text{O} : \text{H}_2\text{O}$, and of $\text{SrCl}_2 : \text{SrSO}_4$, where the former gave 87·41, and the latter 87·1 for the at. wt. of this element, and T. E. Thorpe and A. G. Francis' 87·677 from the ratio $\text{SrBr}_2 : \text{SrSO}_4$, and 87·668 from the ratio $\text{SrBr}_2 : \text{SrSO}_4$, investigations have centred about the ratio $\text{SrX}_2 : 2\text{AgX}$, or $\text{SrX}_2 : 2\text{Ag}$, where X represents an atom of chlorine or bromine. In 1816, H. Rose evaluated the ratio $\text{SrCl}_2 : 2\text{AgCl}$ and found 87·31 for the at. wt. of strontium; T. J. Pelouze (1845), 87·70; J. C. G. de Marignac (1858), 87·49; J. B. A. Dumas (1859), 87·53; T. W. Richards (1894), 87·617; T. W. Richards (1905), 87·616; and T. E. Thorpe and A. G. Francis (1910), 87·632. The general mean of the best determinations is 87·6; the International Atomic Weight Commission recommends 87·63 as the best representative value.

During the earlier part of the nineteenth century a number of determinations of the at. wt. of barium were made with widely varying results, namely, 134 to 143.

The at. wt. has been computed from the results obtained by the analysis of barium carbonate; by converting the barium chloride or nitrate into the sulphate; and by converting barium halide into the corresponding amount of silver halide, or silver. A. Levöl³ reduced auric chloride with sulphur dioxide, and determined the resulting sulphuric acid with barium chloride, and thus obtained the ratio $\text{Au} : \text{BaSO}_4$; from his data, the at. wt. of barium would now be represented by 139·3. J. C. G. de Marignac obtained some ratios including water of crystallization, but the results were poor, for they varied from 130·7 to 138·5. P. A. Guye and D. E. Tsakalotos critically examined this method and concluded the process is not suited for the determination in question. T. Andrews also gave 137·6 for the at. wt. of barium without indicating how that result was obtained. In 1883, F. W. Clark selected 137·0 from all the available data; in the same year, L. Meyer and K. Seubert selected 137·2; in 1885, W. Ostwald, 137·04; in 1886, J. D. van der Plaats, 137·1; B. Brauner in 1905, 137·43; and F. W. Clarke in 1910, 137·363. The International Atomic Weight Commission recommends 137·37 as the best representative value.

1. *The analysis of barium carbonate.*—In 1811, J. J. Berzelius analyzed barium carbonate, and obtained numbers ranging between 134·2 and 143·3 (oxygen 16). W. H. Wollaston, in 1814, obtained 139·2; and A. Salvétat converted the carbonate into sulphate, and obtained 136 for the at. wt. of barium. These results are only of historical interest.

2. *Evaluation of the ratio $\text{BaCl}_2 : \text{BaSO}_4$, or $\text{Ba}(\text{NO}_3)_2 : \text{BaSO}_4$.*—In 1818, J. J. Berzelius found that 100·00 parts of barium chloride yielded 112·175 parts of barium sulphate, which gives 135·6 for the at. wt. of barium. E. Turner, in 1829, obtained 135·4; T. Thomson, in 1831, obtained 136; H. Struve, in 1851, obtained 137·0; J. C. G. de Marignac, 138·5; and T. W. Richards, in 1893, obtained $137·43 \pm 0·2$. E. Turner, in 1833, obtained 137·0 from the ratio $\text{Ba}(\text{NO}_3)_2 : \text{BaSO}_4$.

3. *Evaluation of the ratio $\text{BaCl}_2 : 2\text{AgCl}$, or $\text{BaBr}_2 : 2\text{AgBr}$.*—In 1818, J. J. Berzelius obtained 138·07 parts of silver chloride from 100·00 parts of barium chloride; this gives 136·8 for the at. wt. of barium. T. Thomsen, in 1831, obtained in the same manner 136; E. Turner, in 1829, obtained 137·4; J. C. G. de Marignac, in 1858, obtained 137·1; T. E. Thorpe, in 1908, obtained 137·48; T. W. Richards, in 1893, obtained 137·44 from the ratio $\text{BaCl}_2 : 2\text{AgCl}$, and 137·43 from the ratio $\text{BaBr}_2 : 2\text{AgBr}$.

4. *Evaluation of the ratio $\text{BaCl}_2 : 2\text{Ag}$, or $\text{BaBr}_2 : 2\text{Ag}$.*—In 1845, T. J. Pelouze measured the amount of barium chloride required for the precipitation of a soln. of a known weight of silver in nitric acid, and obtained for the at. wt. of barium 137·28; J. C. G. de Marignac obtained 137·11 in 1848, and 137·15 in 1858; J. B. A. Dumas, in 1859, obtained 137·00; and T. W. Richards, in 1893, obtained 137·44 for the same ratio, and for the ratio $\text{BaBr}_2 : 2\text{Ag}$, he obtained 137·43.

A. Sakoschansky⁴ discussed the relationship between the at. wt. of strontium and calcium. G. P. Thomson, and A. J. Dempster found that the at. wt. of calcium and strontium are simple in that they are not compounded of sets of isotopic elements. There are no isotopes.

F. W. and A. Dupré⁵ reported the presence of a fourth member of the alkaline earth family which gave a faint blue spectral line "between the Sr_β and K_β about twice as far from the former as from the latter, in brightness and sharpness of definition quite equal to the line Sr_β ." W. Crookes showed that the blue line is not due to the new element but is a characteristic line belonging to calcium.

REFERENCES.

- ¹ W. O. de Coninck, *Bull. Acad. Belgique*, 222, 1913; J. J. Berzelius, *Pogg. Ann.*, 8, 189, 1826; *Gilbert's Ann.*, 37, 451, 1811; *Liebig's Ann.*, 46, 241, 1862; *Journ. prakt. Chem.*, (1), 31, 263, 1843; O. L. Erdmann and R. F. Marchand, *ib.*, (1), 26, 472, 1842; (1), 31, 269, 1844; (1), 50, 237, 1850; S. Baup, *Liebig's Ann.*, 52, 212, 1844; *Bibl. Univ. Genève*, 39, 347, 1842; J. C. G. de Marignac, *ib.*, 46, 368, 1843; *Œuvres complètes*, Genève, 1, 90, 1887; A. Salvétat, *Compt. Rend.*, 17, 318, 1843; J. B. A. Dumas, *ib.*, 14, 547, 1842; *Ann. Chim. Phys.*, (3), 55,

129, 159, 1859; *Liebig's Ann.*, 113. 34, 1860; T. Thomson, *Ann. Phil.*, (1), 7. 399, 1816; (1), 16. 327, 1820; (2), 1. 1, 1821; A. Herzfeld, *Zeit. Ver. Rübenzucker Ind.*, 47. 597, 1897; *Ber.*, 34. 559, 1901; F. W. Hinrichsen, *Zeit. phys. Chem.*, 39. 309, 1901; 40. 746, 1902; T. W. Richards, *Journ. Amer. Chem. Soc.*, 24. 374, 1902; J. L. Gay Lussac and L. J. Thénard, *Recherches physico-chimiques*, Paris, 1. 50, 1811.

² F. Stromeyer, *Schweigger's Journ.*, 19. 228, 1816; H. Rosc, *Pogg. Ann.*, 8. 189, 1816; A. Salvétat, *Compt. Rend.*, 17. 318, 1843; T. J. Pelouze, *ib.*, 20. 1047, 1845; J. B. A. Dumas, *Ann. Chim. Phys.*, (3), 55. 29, 1859; *Liebig's Ann.*, 113. 34, 1860; J. C. G. de Marignac, *Arch. Sciences Genève*, (2), 1. 220, 1853; *Journ. prakt. Chem.*, (1), 74. 216, 1858; *Œuvres complètes*, Genève, 1. 568, 1887; T. W. Richards, *Proc. Amer. Acad.*, 22. 369, 1894; 40. 603, 1905; *Chem. News*, 72. 18, 29, 41, 54, 72, 1895; T. E. Thorpe and A. G. Francis, *Proc. Roy. Soc.*, 83. A, 277, 1910.

³ A. Levol, *Ann. Chim. Phys.*, (3), 30. 359, 1850; T. Andrews, *B.A. Rep.*, 33, 1852; *Chem. Gaz.*, 11. 380, 1853; J. C. G. de Marignac, *Arch. Sciences Genève*, (2), 1. 209, 1853; (1), 8. 269, 1847; *Œuvres complètes*, Genève, 1. 568, 1887; *Liebig's Ann.*, 68. 212, 1848; 106. 165, 1858; L. Meyer and K. Seubert, *Die Atomgewichte der Elemente*, Leipzig, 176, 1883; F. W. Clarke, *Phil. Mag.*, (5), 12. 101, 1881; *Amer. Chem. Journ.*, 3. 263, 1881; *The Constants of Nature*, Washington, 1883; *A Recalculation of the Atomic Weights*, Washington, 1910; W. Ostwald, *Lehrbuch der allgemeinen Chemie*, Leipzig, 1. 41, 1885; P. A. Guye and D. E. Tsakalotos, *Journ. Chim. Phys.*, 7. 215, 1909; A. Salvétat, *Compt. Rend.*, 17. 318, 1843; T. J. Pelouze, *ib.*, 20. 1047, 1845; J. B. A. Dumas, *Ann. Chim. Phys.*, (3), 55. 129, 1859; J. J. Berzelius, *Gilbert's Ann.*, 1. 267, 1811; *Schweigger's Journ.*, 23. 117, 1818; *Pogg. Ann.*, 8. 177, 1826; E. Turner, *Phil. Trans.*, 119. 291, 1829; 123. 538, 1833; W. H. Wollaston, *ib.*, 104. 20, 1814; H. Struve, *Liebig's Ann.*, 80. 204, 1851; A. Bilecki, *Zeit. anorg. Chem.*, 110. 341, 1920; T. E. Thorpe, *Proc. Roy. Soc.*, 80. A, 298, 1908; T. Thomson, *System of Chemistry*, London, 1. 426, 1831; T. W. Richards, *Proc. Amer. Acad.*, 28. 1, 1893; 29. 55, 1893; 37. 399, 1901; *Chem. News*, 67. 222, 232, 246, 257, 269, 283, 1893; 69. 64, 79, 91, 101, 112, 129, 136, 150, 164, 174, 1894; B. Brauner, *Abegg's Handbuch der anorganischen Chemie*, Leipzig, 2. ii, 299, 1905; J. D. van der Plaats, *Ann. Chim. Phys.*, (6), 7. 499, 1886.

⁴ A. Sakoschansky, *Chem. News*, 124. 41, 1922; G. P. Thomson, *Phil. Mag.*, (6), 42. 857, 1921; A. J. Dempster in F. W. Aston, *Isotopes*, London, 148, 1922.

⁵ F. W. and A. Dupré, *Phil. Mag.*, (4), 21. 373, 1861; *Chem. News*, 3. 116, 1861; W. Crookes, *ib.*, 3. 130, 1861.

§ 6. The Hydrides of the Alkaline Earths

Acetylene prepared from some specimens of calcium carbide, even after being filtered through cotton wool, and passed through water, gave a deposit of calcium oxide in the conducting pipes, a fact which led C. Hoffmeister¹ to assume that a volatile calcium hydride must be present. The fumes of sulphur trioxide, however, will pass through a long train of wash-bottles, without being wholly absorbed; this favours the assumption that fine particles of a solid calcium compound can be carried along with the stream of gas. C. Hoffmeister attempted to isolate the gas by passing a large vol. of acetylene through a number of wash-bottles containing acetone, and then through an ammoniacal copper soln. to remove the acetylene. The colourless gaseous residue burned in air, forming calcium oxide and water, and formed an exceedingly explosive mixture with oxygen. The residual gas was never obtained free from air, and its composition was not determined. C. Winkler ascertained that when the oxides of the alkaline earths are reduced with magnesium, in an atm. of hydrogen, a compound is formed which he regarded as a hydride of the alkaline earth, and symbolized CaH, SrH, or BaH; and he noted that these hydrides are decomposed by contact with water, forming hydrogen gas. Neither C. Hoffmeister's gaseous hydride, nor C. Winkler's hydrides of the type MH, have been substantiated. C. Winkler, however, probably prepared a mixture of the alkaline earth metal M and a hydride of the type MH₂, because the latter have since been made. C. R. Hansen claimed to have obtained evidence of the formation of a calcium hydride, CaH, from his observations on the vap. press. of the normal hydride, CaH₂. The composition of normal calcium hydride can be represented by the formula CaH₂, and this is evidenced by the amount of hydride formed from a given weight of calcium, and from the amount of hydrogen evolved when the compound is treated with water. Similarly, the composition of strontium hydride agrees with SrH₂, and of barium hydride with BaH₂. B. von Lengyel found that

metallic calcium slowly absorbs hydrogen at ordinary temp., and rapidly at a dull red heat, forming a white pulverulent hydride.

H. Moissan prepared calcium hydride by heating crystallized calcium, contained in a nickel boat, to dull redness in an atm. of dry hydrogen. G. F. Jaubert, and the Elektrochemische Werke, Bitterfeld, patented the preparation of calcium hydride by passing hydrogen through molten calcium contained in an iron vessel for a few minutes. H. Gautier heated a cadmium-calcium alloy to dull redness in hydrogen, and volatilized the cadmium under reduced press. in hydrogen; a similar process was employed for the corresponding hydrides of strontium and barium. A. Guntz and G. Röderer made strontium hydride by heating an 8 per cent. strontium amalgam in a stream of hydrogen; amalgams with a higher content of strontium are not so suitable for the purpose, since they oxidize so readily. The mercury is distilled by heating in hydrogen to 1000°. A. Guntz prepared barium amalgam in a similar manner. K. Kaiser prepared calcium hydride by passing hydrogen over calcium chloride at 700° until no further evolution of hydrogen chloride occurs; and A. Kiewewalter made it by heating calcium oxide by the arc flame in a stream of hydrogen; if too little hydrogen is used some metallic calcium is formed along with the calcium hydride.

According to F. Ephraim and E. Michel, while the hydrides of the alkali metals are formed slowly, those of the alkaline earth metals are formed rapidly and with incandescence. This is attributed to the greater solubility of the hydride in the metal. The liquid nature of the alkali hydrides at their temp. of formation also contributes to the slowness of the reaction, since the eutectic which is formed protects the metal from the hydrogen. The hydride is a white pulverulent or fused cake with a crystalline fracture. The commercial product is grey, and it was found by G. F. Jaubert to contain 90 per cent. of calcium hydride, and 10 per cent. of oxide and nitride. According to H. Moissan, the **specific gravity** of calcium hydride is 1.7; A. Guntz gives for barium hydride 4.21. According to H. Moissan, calcium hydride does not dissociate when heated in vacuo at 600°, but, according to H. Gautier, **dissociation** is perceptible at 675°. C. R. Hansen found the vap. press. of calcium hydride to be:

	605°	675°	712°	735°	750°	780°	795°
Press. (mm.) . . .	28.1	66.3	143.6	269.7	410.0	653.5	854.0

The dissociation press. of strontium hydride was found by H. Gautier to be 190 mm. at 1000°, 300 mm. at 1100°. It is easily decomposed in vacuo at 900°. H. Gautier says barium hydride begins to dissociate at 675°; and A. Guntz found an appreciable volatilization occurs at 1200°, and the vapour is green when viewed through cobalt-blue glass; he also gives 1200° for the **melting point** of barium hydride. According to A. Guntz and H. Basset, the **heat of formation** of calcium hydride is: $\text{Ca} + \text{H}_2 = \text{CaH}_2 + 46.20$ Cals.; of strontium hydride, 34.7 Cals.; and of barium hydride, according to A. Guntz, 55.0 Cals. H. Moissan found that a 5 cm. homogeneous compact layer is a non-conductor of electricity.

H. Moissan found that calcium hydride could be heated to the softening point of Bohemian glass in an atm. of hydrogen without gain or loss in weight. According to H. Moissan, and B. von Lengyel, calcium hydride can be heated in air on a platinum foil without alteration, but when heated to redness in **air** or **oxygen**, it burns brilliantly, and sufficient heat is developed to fuse the calcium oxide produced. H. Gautier also found that strontium hydride burns slowly in air at a red heat, forming a skin of strontium oxide which protects to some extent the hydride underneath. A. Guntz made similar observations with respect to barium hydride. With oxygen, the reaction is vigorous. According to H. Moissan, calcium hydride is readily decomposed by **water** and dil. acids: $\text{CaH}_2 + 2\text{H}_2\text{O} = \text{Ca}(\text{OH})_2 + 2\text{H}_2$, as indicated in connection with hydrogen. G. F. Jaubert emphasized the use of calcium hydride in the preparation of hydrogen for aeronautical purposes. A kgrm. of the commercial hydride gives a cubic metre of hydrogen. With a little water.

B. von Lengyel found that so much heat is produced that the hydrogen inflames spontaneously. H. Gautier found strontium hydride behaves similarly. According to A. Guntz, the heat of the reaction with water is $\text{BaH}_{2\text{solid}} + n\text{H}_2\text{O}_{\text{liquid}} = \text{Ba}(\text{OH})_{2\text{soln.}} + 2\text{H}_{2\text{gas}} + 37.5 \text{ Cals.}$ No solvent for the hydrides of the alkaline earths is known.

The hydrides of the alkaline earths are powerful reducing agents. H. Moissan, and B. von Lengyel noted that calcium hydride is decomposed with incandescence when heated to dull redness with the **halogens**. In the cold, **chlorine** does not act on the hydride, but, when warmed, calcium and hydrogen chlorides are formed; **bromine** and **iodine** behave similarly. H. Gautier found strontium hydride behaved similarly, boiling bromine has no action, while the reaction is vigorous at a red heat. H. Moissan found that hydride is decomposed by **hydrogen chloride**, forming water and barium chloride. Conc. **hydrochloric acid** has but little action in the cold, but if heated a reaction ensues; and a vigorous action occurs with the dil. acid. According to H. Moissan, when a mixture of calcium hydride with **sodium fluoride** or **potassium fluoride** is heated to 500° , hydrogen and the vapour of the alkali metal are formed; **silver fluoride** reacts when triturated with calcium hydride in the cold, producing silver and calcium fluoride; **mercuric fluoride** and **lead fluoride** are reduced at 400° ; **sodium chloride** at a red heat is reduced to sodium; molten **potassium iodide** does not react with calcium hydride; but silver iodide reacts vigorously. Molten **potassium chlorate** is reduced with violence; and, generally, **chlorates**, **bromates**, or **iodates** furnish explosive mixtures; a violent explosion occurs when calcium hydride is rubbed up in a mortar with **potassium perchlorate**. H. Gautier found a vigorous reaction under similar conditions between strontium hydride and chlorates, perchlorates, and bromates; but with iodates the reaction is less vigorous.

B. von Lengyel found that when heated in **sulphur** vapour, calcium hydride is decomposed, forming a dark grey mass; some calcium sulphide is formed; H. Gautier also found strontium hydride forms strontium sulphide under similar conditions. H. Moissan also found that calcium hydride is decomposed when heated with sulphur vapour, but no action was observed with **selenium** vapour at the m.p. of glass. F. M. Perkin and L. Pratt obtained calcium selenide from a mixture of selenium and calcium hydride; they also found **lead sulphide** and **antimony sulphide** react with calcium hydride, producing but little metal, but possibly forming a calcium antimony (or lead) sulphide. H. Gautier also found dichromates and lead or copper oxide are vigorously reduced by strontium hydride. He found **hydrogen sulphide** is decomposed by calcium hydride at a red heat, forming calcium sulphide and hydrogen; and **sulphur dioxide** is reduced to a hydrosulphite by calcium or strontium hydride. Conc. **sulphuric acid** has but little action in the cold, but when heated a reaction ensues; dil. sulphuric acid has a vigorous action.

Calcium hydride was found by H. Moissan not to be affected when heated with **nitrogen** at the m.p. of glass. H. Erdmann and H. van der Smisen observed no evidence of the formation of ammonia when calcium hydride is heated with nitrogen between 500° and 800° . S. Reich and H. O. Serpek said that some ammonia is produced at 500° , but the main reaction results in the formation of calcium nitride. H. Gautier found strontium hydride is partially decomposed by nitrogen at 600° ; and A. Guntz found that, at a temp. below redness, barium hydride forms the nitride: $3\text{BaH}_2 + \text{N}_2 = \text{Ba}_3\text{N}_2 + 3\text{H}_2$; and H. Moissan obtained barium amide, $\text{Ba}(\text{NH}_2)_2$, by heating the hydride with **ammonia**. The **nitrogen oxides** are reduced to ammonia when heated to dull redness with calcium hydride. B. von Lengyel and H. Moissan reported that **nitric acid** behaves like sulphuric acid. Calcium hydride is decomposed when heated with **phosphorus** vapour. F. M. Perkin and L. Pratt said that a mixture of calcium hydride and red phosphorus cannot be ignited by a fuse, but if some calcium be also present, the reaction furnishes red calcium phosphide. H. Moissan observed no change occurred when

calcium hydride is heated to the m.p. of glass with **boron** or with **silicon**; but with silicon C. R. Hansen obtained a silicide; calcium hydride also reacted with **porcelain** and **glass**. F. M. Perkin and L. Pratt found that calcium hydride reduced **boron trioxide** and also **silica**. When heated to 700°–800° with finely divided **carbon**, H. Moissan obtained some calcium carbide, and M. Mayer and V. Altmayer observed the formation of methane and other products. M. Mayer and V. Altmayer found that **carbon monoxide** does not react with calcium hydride between 300° and 400°, but at a higher temp. some methane is formed: $3\text{CaH}_2 + 3\text{CO} = \text{CH}_4 + 2\text{C} + \text{H}_2 + 3\text{CaO}$; there is also a secondary reaction: $\text{CaH}_2 + 2\text{C} = \text{CaC}_2 + \text{H}_2$. According to S. Reich and H. O. Serpek, some formaldehyde is also produced. H. Moissan found that when heated to dull redness, **carbon dioxide** is reduced by calcium hydride, forming carbon, and calcium formate and carbide; and M. Mayer and V. Altmayer obtained some methane: $2\text{CO}_2 + 4\text{CaH}_2 = \text{CH}_4 + 4\text{CaO} + \text{C} + 2\text{H}_2$, as well as calcium formate and oxalate. H. Moissan noted that calcium hydride is not dissolved by, nor does it react with, thoroughly dried **carbon disulphide**, **carbon tetrachloride**, **benzene**, **turpentine**, **alkyl iodides**, **alkyl chlorides**, or **ethers**; but it slowly attacks **ethyl alcohol**. B. von Lengyel said the last reaction is *lebhaft*. S. Reich and H. O. Serpek found mesityl oxide and a cyclic substance, b.p. 226°–236°, is produced in the energetic reaction between calcium hydride and **acetone**. The vapour of **carbon tetrachloride** is decomposed at 400°, forming carbon, hydrogen, and hydrogen chloride; **pyridine** has no action at the m.p. of glass. Calcium hydride acts as a reducing agent only at high temp., and its use in the hydrogenation of organic substances must be very limited, since when it does react condensation products are formed. F. M. Perkin and L. Pratt found that calcium hydride reduces **cupric oxide**, **manganese dioxide**, **ferric oxide**, **stannic oxide**, **lead oxide**, and **tungstic oxide**; but not **zinc oxide**. According to S. Reich and H. O. Serpek, formic acid is produced when a mixture of calcium hydride and **sodium carbonate** or **hydrocarbonate** is gently heated. The reactions are not usually so violent as when calcium is employed as reducing agent. C. R. Hansen found that calcium hydride is decomposed by **mercury** above 200°. E. Ebler and K. Herrdegen found that calcium hydride reduces **barium sulphate** to a mixture of calcium and barium oxides and sulphides, and hydrogen gas is evolved.

REFERENCES.

- ¹ C. Hoffmeister, *Zeit. anorg. Chem.*, 48, 137, 1906; W. Moldenhauer and C. R. Hansen, *ib.*, 82, 130, 1913; C. R. Hansen, *Ueber die Zersetzung von Calcium-Wasserstoffverbindungen*, Darmstadt, 1912; S. Reich and H. O. Serpek, *Helvetica Chim. Acta*, 3, 138, 1920; C. Winkler, *Ber.*, 24, 1966, 1891; B. von Lengyel, *Math. Nat. Ber. Ungarn*, 14, 180, 1898; H. Gautier, *Compt. Rend.*, 134, 100, 1054, 1109, 1902; 133, 1005, 1901; A. Guntz, *ib.*, 132, 963, 1901; 136, 1071, 1903; G. F. Jaubert, *ib.*, 142, 788, 1906; A. Guntz and H. Basset, *ib.*, 140, 863, 1905; H. Moissan, *ib.*, 127, 29, 1898; 163, 591, 1903. *Bull. Soc. Chim.*, (3), 21, 876, 1899; *Ann. Chim. Phys.*, (7), 18, 311, 1899; (8), 6, 295, 1905; A. Guntz and G. Röderer, *Bull. Soc. Chim.*, (3), 35, 507, 1906; Elektrochem. Werke, Bitterfeld, *German Pat., D.R.P.* 188570, 1905; K. Kaiser, *ib.*, 333305, 1920; A. Kieselwaller, *ib.*, 346119, 1921; F. Ephraim and E. Michel, *Helvetica Chim. Acta*, 4, 900, 1921; H. Erdmann and H. van der Smissen, *Liebig's Ann.*, 361, 32, 1908; M. Mayer and V. Altmayer, *Ber.*, 41, 3074, 1908; F. M. Perkin and L. Pratt, *Trans. Faraday Soc.*, 3, 179, 1908; E. Ebler and K. Herrdegen, *Ber.*, 46, 2264, 1913.

§ 7. The Preparation of the Oxides of Calcium, Strontium, and Barium

The alkaline earths form oxides of the type MO and MO₂. There are also the hydroxides, M(OH)₂. Both the dioxides, MO₂, and the hydroxides, M(OH)₂, can be prepared with water of crystallization; and the dioxides, also, with hydrogen peroxide of crystallization. The so-called suboxides are not generally recognized as chemical individuals. The monoxides of barium, strontium, and calcium are respectively called *baryta*, *strontia*, and *lime*.

A. Guntz and H. Basset¹ tried to make *calcium suboxide*, Ca_2O , by melting calcium with calcium oxide in an indifferent atm., but without success. A. Guntz, however, claimed to have made *barium suboxide*, Ba_2O , by heating a mixture of eq. amounts of barium or magnesium with barium oxide in vacuo at 1100° . The reaction is violent, and the magnesium should not be too finely powdered, nor the baryta too much peroxidized. The product is said to decompose water; to absorb nitrogen at a red heat, forming the nitride, and also to absorb hydrogen under similar conditions, forming the hydride. Barium suboxide dissociates at a high temp., forming barium oxide and barium. A. Guntz said the product is not a mixture of barium and magnesium oxide, because it does not give hydrogen in accord with $2\text{Ba}[\text{+}2\text{MgO}]\text{+}4\text{H}_2\text{O}=2\text{Ba}(\text{OH})_2\text{+}2\text{MgO}\text{+}2\text{H}_2$, but rather in accord with $\text{Ba}_2\text{O}[\text{+}2\text{MgO}\text{+}2\text{Mg}]\text{+}3\text{H}_2\text{O}=2\text{Ba}(\text{OH})_2\text{+}2\text{MgO}\text{+}2\text{Mg}\text{+}3\text{H}_2$.

The three oxides, **calcium monoxide**, CaO ; **strontium monoxide**, SrO ; **barium monoxide**, BaO , are also called *lime*, *strontia*, and *baryta* respectively. Lime is also called *quicklime*—the term “quick” is applied in [several European languages to represent the living active nature of lime, especially towards water. They are produced by the oxidation of the metal; traces of the dioxide may be simultaneously produced, and this the more with barium than with calcium. The oxides are produced by the calcination of the carbonates, for instance, with calcium carbonate: $\text{CaCO}_3=\text{CaO}\text{+}\text{CO}_2$; but the last traces of the carbon dioxide are expelled with difficulty. The calcium oxide obtained by calcining calcium carbonate has been variously styled *quicklime*, *burnt lime*, *caustic lime*—from *καυστικός*, burnt—*live lime*, etc. This method of preparing calcium oxide is very old, for, under the name lime-burning, it was employed in making mortar, thousands of years ago. It is mentioned in the Pentateuch (*Deut.* 27. 2). Cato's *De re rustica*, Vitruvius' *De architectura* (2. 5), and Pliny's *Historia naturali* (36. 55), described the process of manufacturing lime and mortar.

The primitive lime-kilns were rudely constructed of stone blocks, and usually located in a cavity cut in the side of a hill, so that the top was convenient for charging the kiln with limestone. In charging the kiln, large pieces of limestone were formed into a dome-like arch with large open joints; and the kiln was filled with fragments of limestone—the larger pieces of limestone were placed above the arch, and the kiln was topped with fragments of smaller size. Kilns were also charged with alternate layers of limestone and fuel. A wood or other fire was started under the arch, and a bright heat was maintained for three or four days. The kiln was then cooled and the quicklime removed. These temporary intermittent kilns are still in use in districts where the demand is small. In the more permanent shaft-kilns, alternate layers of fuel and limestone are fed in at the top of the kiln and burnt limestone is withdrawn at the bottom, so that the process is continuous—limestone is charged in at the top and removed at the bottom. It will be observed that the air required for the combustion of the fuel is pre-heated by passing through the lime from the burning zone, and at the same time the hot lime is cooled; the products of combustion also heat the limestone on its way to the hot zone. Many kilns are provided with automatic feeding or discharging gear. The carbon dioxide can also be recovered, as in the shaft-kiln illustrated in Fig. 8. The temp. in the different zones are indicated in the diagram. In some of the more recent shaft-kilns, producer gas is led into the shaft near the base, and burnt in the shaft.² Commercial limes differ much in composition; they may contain anything from 0 to 40 per cent. of magnesium oxide, and more or less silica, alumina, and iron oxide. The lime should contain no water and less than half per cent. of carbon dioxide. The composition of the lime will be the same as that of the limestone from which it was prepared, less the carbon dioxide and plus impurities derived from the lining of the kiln, fuel ash, etc. For commercial purposes, limes carrying less than 5 per cent. of magnesium oxide can be designated *high-calcium limes*; and those with over 5 per cent., *magnesian limes*. The latter are less plastic or smooth to the trowel in working the mortar, and

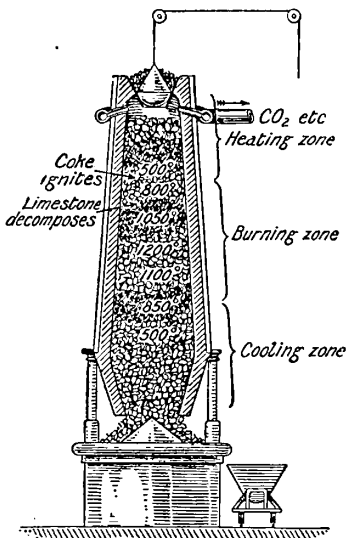

FIG. 8.—Simple Type of Shaft Lime-kiln.

they are disliked by the workmen, who call them "weak," "lean," or "poor" limes in contrast with the high calcium limes which are called "strong," "fat," or "rich" limes. The magnesian limes slake more slowly, and develop less heat than the high calcium limes. Lime with over five per cent. of impurities other than magnesium oxide will also be comparatively slow in slaking, and exhibit the lean or weak qualities. The following represent extremes of the different types :

		Lime.	Silica.	Alumina and ferric oxide.	Magnesia.	Carbon dioxide.
High Ca	Fat	98.4	0.2	0.2	1.0	0.2
		94.3	3.4	1.2	0.3	0.8
	Lean	84.4	5.5	2.0	1.8	—
		81.4	2.4	6.8	1.3	—
High Mg	Lean	90.2	0.1	1.7	6.0	0.3
		55.7	7.2	1.2	34.1	1.5

In his paper embodying *Experiments and observations on terra ponderosa* (i.e. barium carbonate), W. Withering stated :

It is very remarkable that the *terra ponderosa spar* in its native state will not burn to lime. When urged with a stronger fire it melts and unites to the crucible, but does not become caustic.

J. Priestley added his testimony to the fact that *terra ponderosa aërata* gives no fixed air by mere heat ; but when steam is passed over the mineral at a red heat in an earthen tube, "fixed air is produced with the greatest rapidity, and in the same quantity, as when it is dissolved in spirit of salt." Consequently, hypotheses respecting the relation of water to carbon dioxide were made by both W. Withering,³ and by J. Priestley ; but the hypotheses had to be discarded when T. C. Hope showed that the "fixed air can be expelled from native aërated barytes by heat alone, if sufficiently intense . . . by the assistance of the heat of a smith's forge, the barytic spar can be deprived of its acid, either entirely, or nearly so." H. Abich, and F. C. Schaffgotsch, showed that strontium carbonate does decompose at a high temp. J. T. Conroy found that the decomposition is slow when strontium carbonate is heated by a Bunsen flame, but faster when heated in the blast. According to C. Stiepel and A. Herzfeld, strontium carbonate forms no oxide when heated an hour at 1100° ; but at 1190°, 37 per cent. of oxide is formed ; and at 1250°, decomposition is nearly complete. W. Dittmar found barium carbonate decomposes completely when heated in a blast. According to P. Pott, there is a measurable dissociation of calcium carbonate at 525°, of strontium carbonate at 660°, and of barium carbonate at 1020°. K. Friedrich found that there is an incipient dissociation of calcspar and aragonite at 895°, and the dissociation is complete at 910° ; with strontianite and witherite, incipient dissociation occurs respectively at 1130° and 1100°. According to J. L. Gay Lussac :

If calcium carbonate be heated to the temp. at which it begins to decompose, the atm. of carbon dioxide which is formed hinders the subsequent development of the gas, for if any more gas is developed it must overcome the press. of the atm. of that gas. Consequently, a higher temp. must be applied, or the atm. of carbon dioxide be removed either by exhaustion or atm. air.

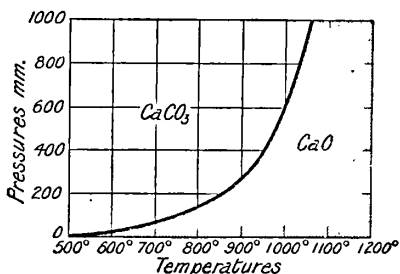

Fig. 9.—Effect of Temperature on the Dissociation Pressure of Calcium Carbonate.

where the press. in the closed vessel are plotted at different temp. H. le Chatelier's

The first measurements of the dissociation press. of calcium carbonate were made by H. Debray, who worked at the m.p. of cadmium and of zinc, and he estimated the dissociation temp., at 760 mm. press., to be 1000°. H. le Chatelier showed that if calcium carbonate be heated in a closed vessel, at different temp., when the system is in equilibrium the state of the system will be represented by a point on the curve, Fig. 9,

data are plotted in Fig. 9. J. Johnston's values are considered to be more exact; they are here interpolated by the formula: $\log p = -9340T^{-1} + 1.1 \log T - 0.0012T + 8.882$:

	500°	600°	700°	800°	850°	900°	950°	1000°
CaCO ₃ . . .	0.11	2.35	25.3	168	373	773	1490	2710 mm.

H. Riesenfeld gave a more complicated expression in terms of W. Nernst's heat theorem. According to J. Johnston, the dissociation temperature, at atm. press., is 898°; H. Riesenfeld gave 908°; D. Zavriff, 920°; and O. Brill, 825°. H. le Chatelier's value 812° is now considered too low, and 890° is the best representative value of later work. P. Pott's values for strontium carbonate are:

	492°	650°	850°	950°	1050°	1150°	1256°	1263°
SrCO ₃ . . .	9.3	18	50	99	175	320	744	785 mm.

F. Isambert found the dissociation press. of barium carbonate, at 1083°, in a stream of an indifferent gas, is 22 mm. P. Pott further found:

	997°	1017°	1057°	1097°	1137°	1157°	1177°	1197°
BaCO ₃ . . .	0	5	45	120	240	340	450	675 mm.

A. Finkelstein also measured the dissociation press. of barium carbonate and represented his results by $\log(p_1/p_2) - 14300(T_1 - T_2)/T_1T_2$. P. Pott further found that the dissociation temp. of strontium carbonate at one atm. press. is 1250°; and of barium carbonate, 1200°. The press. curve of strontium carbonate crosses that of barium carbonate at 1160°. O. Brill gives the dissociation temp. of strontium carbonate 1155°; A. Herzfeld and C. Stiepel found it to be approximately 1450°. O. Brill could not determine the temp. exactly because the platinum crucible was so violently attacked. J. A. Hedvall gave 913°-928° for the dissociation temp. of calcium carbonate; 1141° for strontium carbonate; and 1361° (the m.p.) for barium carbonate. The dissociation temp. of calcium carbonate was found to be independent of the size of grain; and the dissociation of strontium carbonate becomes rapid only at about 1255°. K. Friedrich and L. G. Smith give 895° for the temp. at which aragonite or calcite begins to decompose, and 910° for the temp. at which the maximum heat change occurs on the heating curve; and for strontianite and witherite, he obtained a temp. over 1130° when dissociation begins.

There are three phases—CaO, CaCO₃, and CO₂; and two components—CaO and CO₂. The system is therefore univariant, meaning that the conc.—that is, the press.—of the gas for each temp. has one fixed definite value called the dissociation pressure. The dissociation press. of calcium carbonate is analogous, in many ways, with the vap. press. of a liquid in a closed space. Gaseous molecules of carbon dioxide are continually leaving the dissociating carbonate, and carbon dioxide is continually recombining with calcium oxide. When the speeds of the two reactions are the same, the system is in equilibrium. The carbonate can only dissociate completely into calcium oxide and carbon dioxide if the latter be continuously removed from the reacting system. If the press. at any temp. exceeds the limit indicated by the curve, calcium carbonate will be formed until the press. of the gas attains the fixed value, constant for the given temp.; and, conversely, if the press. be less than that described by the curve, calcium carbonate will dissociate until the required press. is attained. P. Jolibois and P. Bouvier found that the reversal of the dissociation on cooling with most forms of calcium carbonate is never complete except when precipitated calcium carbonate is dissociated by heat in the presence of an excess of calcium oxide. The disturbance is due to secondary changes.

These facts are of interest in that they explain how marble or calcium carbonate can be associated with igneous rocks whose temp., at certain geological epochs, must have exceeded that of the lime-kiln. J. Hutton pointed out in 1798 that the calcium carbonate in the lime-kiln bears only the press. of the atm., which is not

sufficient to delay for long the separation of the carbon dioxide from the limestone, whereas in plutonic regions, the enormous press. which existed must have hindered the decomposition, and allowed the calcium carbonate to melt and fuse. J. Hall verified this conclusion by making over 400 experiments on the influence of press. on the melting of calcium carbonate. C. F. Buchholz, A. Pctzholdt, L. Pilla, G. Rose, J. Lemberg, A. Becker, A. Wichmann, H. le Chatelier, A. Joannis, H. E. Boeke, F. Rinne, and H. Leitmeier have also experimented on this subject, and shown that if the press. of the gas be great enough, the calcium carbonate may be fused with no appreciable dissociation. On solidification, the mass has a crystalline structure like marble. The melting of barium carbonate under press. has also been investigated by H. le Chatelier, O. Brill, A. Herzfeld and C. Stiepel, A. Finkelstein, H. E. Boeck, and O. Mügge.

It can be assumed that all solids, calcium carbonate and calcium oxide, exert a small vap. press. which is generally too small to come within the range of the instruments at present available for such measurements. This vap. press. is further assumed to be constant at any given temp., like the vap. press. of substances which are accessible to measurement; and is also unaffected by the quantity of solid present.

According to the so-called mass law, the velocity of the dissociation of calcium carbonate will be proportional to the conc. of the carbonate, and equal to the product of the conc. C of the carbonate and the affinity constant k ; the velocity of formation of the calcium carbonate will similarly be equal to the product of the conc. of the calcium oxide, C_1 , and of the carbon dioxide, C_2 , with the affinity constant k' of that reaction. Consequently, if these two velocities are the same, the system will be in equilibrium, and $kC = k'C_1C_2$. The conc., that is, the number of molecules of carbon dioxide per litre, is proportional to the partial press. p of that gas. The conc. C and C_1 are constant, and consequently, at any given temp., the press. p is constant. This means that the dissociation press. of the carbon dioxide is independent of the extent to which the calcium carbonate has dissociated, provided some of the carbonate remains. This same conclusion was obtained in applying the phase rule. The velocity constant k for the decomposition of the carbonates of the alkaline earths in the equation $dC/dt = kC$, was measured by P. Pott, and he found:

	CaCO_3			SrCO_3		BaCO_3	
k	770°	846°	890°	1080°	1200°	1195°	1220°
	0.009	0.037	0.042	0.009	0.03	0.00076	0.00076

Hence, the velocity of the reaction with calcium carbonate is greatest and with barium carbonate least—that of strontium carbonate is approximately one-twentieth of that of calcium carbonate, and that of barium carbonate is about half that of strontium carbonate. The velocity constant of calcium carbonate undergoes a five-fold increase per 100° rise of temp. The physical character of the carbonate has some influence on the speed of dissociation, for A. Herzfeld found that limestone is completely decomposed after many hours' heating at 900°, while marble, under similar conditions, suffers very little change, although at 1030° it is completely decomposed.

The burning of limestone at atm. press. should not be effected below 890°, since only at this temp. does the carbon dioxide attain atm. press. when the gas can escape at a sufficient speed. This high temp. is technically expensive, and proposals have been made to burn the lime at a lower temp. and to pass a current of inert gas like air over the heated limestone. A. Herzfeld, for instance, found that in the presence of steam at 700°, calcium carbonate forms calcium hydroxide, while with air alone, a heat of 1000° is required to decarbonate the limestone. H. Rose also found barium carbonate does not decompose at a red heat in dry air, but in moist air or in water vapour decomposition occurs. P. Duhem has showed that the important principle: *When a body is decomposed by heat, it is not the press. of any gas or vapour chosen at random, which can stop its decomposition, but rather*

the gas which arises from the decomposition which alone can act, was first enunciated by G. Aimé in an important thesis: *De l'influence de la pression sur les actions chimiques* (Paris, 1837). Consequently, in the present case, it is not the total press. but solely the partial press. of the carbon dioxide which must be taken into consideration. An inert gas acts as a vacuum because the press. of the carbon dioxide over the heated material will be the partial press. of the carbon dioxide in the whole gaseous atm. Thus, at 610°, the partial press. will be 46 mm. As the carbon dioxide corresponding to this press. is carried off, the equilibrium is disturbed, and more calcium oxide is formed. This continues until the whole of the carbon dioxide is dissociated.

As T. Bergmann⁴ pointed out, workmen reject lime which is too much burned—*dead-burned lime*—as being useless, because it does not fall into powder when slaked. Lime which has been less burned falls into powder at the instant of slaking, and is then in a form suitable for making into mortar. Limestone containing clay is particularly liable to dead-burning, presumably because a more or less inert calcium silicate or alumino-silicate is formed which is not free to take part in slaking—*vide* calcium hydroxide. A. Herzfeld found 8 per cent. of silica suffices for the dead-burning of lime at 1000°, alumina is less active than silica and required a higher temp. to produce dead-burning. A. F. Gehlen, and J. F. W. Nasse found that purified calcium carbonate is not liable to dead-burning. A. Herzfeld, and P. Lebeau observed that calcium oxide which has been fused can be slaked by water, but the action is very slow. C. F. Buchholz, and L. J. Vicat found oyster-shells and chalk are liable to be dead-burnt. H. Rose, and J. N. von Fuchs attributed the so-called dead-burning by the under calcination of limestone to the formation of a **basic carbonate**, but A. Herzfeld obtained no evidence of the existence of such a chemical individual. The subject has been discussed by A. R. Schultaschenko, F. M. Raoult, and A. Finkelstein. Neither O. Brill nor A. Herzfeld could find any evidence of the formation of a basic calcium carbonate on the heating curves; nor is there any satisfactory evidence of the formation of a basic strontium or barium carbonate. The calcium carbonate remaining in underburned lime acts as so much inert matter.

J. P. J. d'Arcet made barium oxide by the action of an alkali lye on a soln. of a barium salt, and calcining the washed product. Strontium and barium oxides can be made by calcining the respective carbonates as indicated below; and also by calcining the nitrates (A. F. de Fourcroy and L. N. Vauquelin,⁵ P. J. Robiquet, and A. C. Jaquelin); or the hydroxides (D. Smith). L. N. Vauquelin, and L. J. Thénard prepared baryta by heating barium nitrate until it is completely decomposed; a moderate heat is employed at first, and a very strong heat towards the end of the process. J. J. Berzelius recommended adding a few spoonsful of the nitrate to a crucible heated to bright redness, and heating the contents in the covered crucible until the mass had solidified. More nitrate was added, and the process continued until the crucible was half filled with baryta. If too much nitrate is added at once, the mass boils over. If a platinum crucible is employed, the baryta is difficult to detach from the metal; the platinum is oxidized and contaminates the baryta. If a fireclay crucible be employed, the baryta will be contaminated with silica, alumina, and iron and manganese oxides. As pointed out by G. Brügelmann, and C. F. Rammelsberg, if the calcination is conducted while the nitrate is exposed to air, oxygen and carbon dioxide may be absorbed, forming respectively peroxide and carbonate. F. Kuhlmann found that if the nitrate be calcined in hydrogen gas, barium hydroxide is formed. F. Mohr recommended mixing the nitrate with twice its wt. of heavy spar in order to avoid the frothing and afterwards leached out the baryta with water. W. Artus, and G. C. Wittstein similarly calcined the nitrate with one-half or two-thirds its weight of iron filings.

The technical preparation of barium oxide by the calcination of witherite is difficult, because the barium oxide fuses, and forms an impervious skin on witherite which

hinders its subsequent decomposition. A. Scheurer-Kestner⁶ mixed the carbonate with chrome iron ore in order to keep the mass more or less porous while decomposition was in progress; he then extracted the barium oxide with water. H. Schulze fused the barium carbonate in an electric furnace arranged so that the carbon dioxide could be readily recovered. J. Priestley, R. Heinz, and O. Lenoir heated the witherite in water vapour to facilitate its decomposition. A. C. Jaquelin heated a mixture of barium and calcium carbonates and carbon in a stream of water vapour; and H. Leplay a mixture of barium and alkali carbonate in steam. A. Leroy and A. Segay heated the barium carbonate to 450° in a stream of hydrogen sulphide, and recovered the latter by passing steam over the resulting barium sulphide. Here again the product is barium hydroxide.

B. Pelletier heated a mixture of witherite with one-tenth its weight of powdered charcoal, in a luted crucible lined with carbon. The baryta so prepared is often mixed with some charcoal or undecomposed carbonate; and, if the charcoal be not free from nitrogen, some barium cyanide is formed. Modifications of this process have been used by G. Lunge, A. Rivière, T. du Motay, and A. Scheurer-Kestner. It is also claimed by R. Schneider that it is an advantage to mix the witherite with some calcium or magnesium carbonate. Several modifications of these processes have been patented. W. Feld heated the witherite by the waste gases from the combustion chamber of a kiln. H. Leplay, and R. Radot heated the witherite with coal gas.

Several processes have been suggested⁷ for converting heavy spar, BaSO₄, into barium sulphide as a preliminary to its subsequent conversion into oxide, carbonate, or chloride. Many of these processes are also available for the treatment of strontium sulphate or celestine. A. Scheurer-Kestner calcined an intimate mixture of pulverized heavy spar with about 17 per cent. of coal-dust in the reducing atm. of a reverberatory furnace or in luted crucibles, and obtained 83 per cent. yield of sulphide, 17 per cent. remained undecomposed. Modifications have been recommended by T. de Brochocky, T. von Dienheim, H. Grüneberg, M. Langsdorf, O. Lenoir, J. Mactear, J. Nicklès, J. von Liebig, A. Rivière, J. Watts, A. Wurtz, etc. L. Marino found that barium sulphate is best reduced by water gas at 600°-625°. The reduction of the sulphates of the alkaline earths by gases and the technical preparations of baryta have been studied by L. Marino and D. Danesi.

A. Frank heated witherite, heavy spar, or barium chloride with the carbide, air excluded: $3\text{BaCO}_3 + \text{BaC}_2 = 4\text{BaO} + 5\text{CO}$. C. S. Bradley and C. B. Jacobs heated a mixture of barium sulphate and carbon in an electric furnace. The first reaction is represented: $4\text{BaSO}_4 + 4\text{C} = \text{BaS} + 3\text{BaSO}_4 + 4\text{CO}$, and the barium sulphide then reacts with the sulphate: $\text{BaS} + 3\text{BaSO}_4 = 4\text{BaO} + 4\text{SO}_2$; the final product contained 40 per cent. of barium sulphide, and 60 per cent. of oxide. They also heated mol. proportions of barium carbide and hydroxide, acetylene was evolved, and the resulting barium oxide was in a porous condition suitable for peroxidation. E. J. Maumené heated a mixture of barium sulphate with ferric oxide to 1000° or 1200°, whereby an insoluble compound of barium and ferric oxide is produced which is decomposed in an atm. of hydrogen, and the ferric oxide reduced to iron which then reacts: $2\text{Fe} + \text{BaO} + 2\text{BaS} + 2\text{H}_2\text{O} = 3\text{BaO} + 2\text{FeS} + 2\text{H}_2$. F. Projahn melted the heavy spar with iron; H. Schulze heated a mixture of barytes with native metal sulphides, e.g. $7\text{BaSO}_4 + 2\text{FeS} = 7\text{BaO} + \text{Fe}_2\text{O}_3 + 9\text{SO}_2$. H. Nicwerth heated celestine with an eq. of carbon and iron oxide, and extracted the strontia with water. The resulting barium sulphide can be decomposed by hydrolysis with water or steam as recommended by R. Ziomiczynsky, F. Konther, A. Rose, etc. E. Terres and K. Bruckner showed that the reaction: $2\text{BaS} + 2\text{H}_2\text{O} = \text{Ba}(\text{OH})_2 + \text{Ba}(\text{SH})_2$, is incomplete, a double salt is formed, and the baryta produced always retains some sulphide which is very difficult to remove. The results obtained vary with temp., conc., and many other factors. They finally conclude that processes based on this reaction are not industrial. A. Vogel, and J. P. J. d'Arcet recommended desulphurizing aq. soln. of barium sulphide by treatment with cupric oxide; C. Stahlschmidt, cuprous oxide. E. Asselin, J. Kuczynsky, M. Lalande, A. Müller, A. Rosenstiehl, and C. Stahlschmidt recommended zinc-dust, zinc oxide, hydroxide or zinc white. E. Riegel recommended pyrolusite, but F. Mohr said this method is useless, while H. L. Pattinson showed that when a soln. of barium sulphide is treated with manganese dioxide or Weldon's mud, at 38°, and a stream of air passed through the liquor, two-thirds of the sulphide is transformed into hydroxide, and the remainder into an insoluble thiosulphate, BaS₂O₃. C. F. Claus converted strontium sulphide resulting from the reduction of the sulphate, by treating it with barium hydroxide: E. F. Trachscl and W. Moody treated the sulphide with sodium hydroxide and obtained strontium hydroxide. Electrolytic processes have been patented by H. M. Taquet, A. Brochet and G. Ranson, and W. Pataky, etc.

V. Kohlschütter and J. L. Tüscher⁸ made calcium one electrode of an electric arc, and oxidized the vapour by a current of air. They thus obtained a highly dispersed form of the oxide.

REFERENCES.

- ¹ A. Guntz and H. Bassct, *Bull. Soc. Chim.*, (3), 35, 404, 1906; A. Guntz, *Ann Chim. Phys.*, (8), 10, 439, 1907; *Compt. Rend.*, 143, 339, 1906.

* W. E. Emley, *The Manufacture of Lime*, Washington, 1913; W. J. Faber, *Scient. Amer. Suppl.*, 88. 316, 1919; L. E. Allen, *Canadian Inst. Chem.*, 5. 99, 1921; R. K. Meade, *Chem. Met. Eng.*, 23. 841, 873, 929, 1920; B. Block, *Das Kalkbrennen im Schachtöfen mit Mischfeuerung*, Leipzig, 1917; L. Kiepenheuer, *Kalk und Mörtel*, Köln, 1907; *Wasserkalk*, Bonn, 1911; E. C. Eckel, *Cements, Limes, and Plasters*, New York, 1905; E. Orton and S. V. Peppel, *The Limestone Resources and the Lime Industry in Ohio*, Columbus, Ohio, 1906; C. Schoch, *Die moderne Aufbereitung und Wertung der Mörtel-Materialien*, Berlin, 1896; O. A. Gillmore, *Practical Treatise on Limes, Hydraulic Cements, and Mortars*, New York, 1863; R. K. Meade, *Chem. Met. Eng.*, 23. 841, 873, 929, 1920.

* W. Withering, *Phil. Trans.*, 74. 293, 1784; J. Priestley, *ib.*, 78. 152, 1788; T. C. Hope, *Trans. Roy. Soc. Edin.*, 4. 3, 1798; P. Pott, *Studien über die Dissoziation von Calcium-, Strontium-, und Baryum-Karbonat*, Freiburg i. Br., 1905; H. Debray, *Compt. Rend.*, 64. 603, 1867; F. Isambert, *ib.*, 86. 332, 1878; A. Joannis, *ib.*, 115. 939, 1892; D. Zavrieff, *ib.*, 145. 428, 1907; A. Lamy, *ib.*, 69. 347, 1869; H. le Chatelier, *ib.*, 102. 1243, 1883; 115. 817. 1009, 1892; *Bull. Soc. Chim.*, (2), 47. 300, 1887; A. Herzfeld, *Zeit. Ver. Rübenzuckerind.*, 820, 1897; C. Stiepel and A. Herzfeld, *ib.*, 833, 1898; F. H. Riesenfeld, *Journ. Chim. Phys.*, 7. 561, 1909; O. Brill, *Zeit. anorg. Chem.*, 45. 275, 1905; H. E. Boeke, *ib.*, 50. 247, 1906; J. Johnston, *Journ. Amer. Chem. Soc.*, 30. 1357, 1908; 32. 938, 1910; *Zeit. phys. Chem. Soc.*, 65. 737, 1909; O. L. Erdmann and R. F. Marchand, *Journ. prakt. Chem.*, (1), 31. 257, 1844; (2), 50. 237, 1850; A. Petzholdt, *ib.*, (1), 17. 464, 1839; J. L. Gay Lussac, *Ann. Chim. Phys.*, (2), 63. 219, 1836; H. Rose, *Pogg. Ann.*, 86. 105, 279, 1852; G. Rose, *ib.*, 118. 565, 1863; H. Abich, *ib.*, 23. 315, 1831; F. C. Schaffgotsch, *ib.*, 113. 615, 1860; J. N. von Fuchs, *ib.*, 27. 601, 1833; L. Pfaundler, *ib.*, 131. 55, 1867; A. F. Weinhold, *Program. Gewerb. Chemnitz*, 1, 1873; K. Friedrich and L. G. Smith, *Centr. Min.*, 616, 651, 684, 1912; *Met.*, 9. 409, 1912; P. Jolibois and P. Bouvier, *Compt. Rend.*, 172. 1182, 1921; P. Duhem, *Journ. Phys. Chem.*, 3. 374, 1899; J. Hutton, *Trans. Roy. Soc. Edin.*, 4. 7, 1798; J. Hall, *ib.*, 5. 43, 1805; *Nicholson's Journ.*, 4. 8, 56, 1801; C. F. Bucholz, *Gehlen's Journ.*, 3. 271, 1806; 4. 128, 1807; L. Pilla, *Neues Jahrb. Min.*, 411, 1838; O. Mügge, *Neues Jahrb. Min. B. B.*, 14. 246, 1901; J. Lemberg, *Zeit. deut. geol. Ges.*, 24. 237, 1872; A. Becker, *Tschermak's Mitt.*, 7. 122, 1886; A. Wichmann, *ib.*, 7. 256, 1886; F. Rinne and H. E. Boeke, *ib.*, 27. 293, 1908; H. Leitmeier, *Centr. Min.*, 257, 1900; K. Friedrich, *ib.*, 616, 651, 684, 1912; J. T. Conroy, *Journ. Soc. Chem. Ind.*, 10. 109, 1890; W. Dittmar, *ib.*, 7. 730, 1888; A. Finkelstein, *Ber.*, 39. 1584, 1906; A. R. Schultaschenko, *Dingler's Journ.*, 205. 335, 1872; J. A. Hedvail, *Zeit. anorg. Chem.*, 98. 47, 1916.

* T. Borgmann, *De acido aëreo*, Upsala, 1774; A. F. Gehlen, *Gehlen's Journ.*, 3. 308, 1807; C. F. Buchholz, *ib.*, 4. 128, 1807; L. J. Vicat, *Ann. Chim. Phys.*, (2), 23. 424, 1823; P. Lebeau, *Compt. Rend.*, 138. 1496, 1904; A. Herzfeld, *Zeit. Ver. Rübenzuckerind.*, 747, 893, 1897; *Tonind. Zig.*, 22. 374, 1898; J. F. W. Nasse, *Schweigger's Journ.*, 46. 91, 1826; H. Rose, *Pogg. Ann.*, 86. 280, 1852; J. N. von Fuchs, *ib.*, 27. 604, 1833; O. Brill, *Zeit. anorg. Chem.*, 45. 275, 1905; A. Finkelstein, *Ber.*, 39. 1584, 1906; F. M. Raoult, *Compt. Rend.*, 92. 189, 1110, 1487, 1881; A. R. Schultaschenko, *Dingler's Journ.*, 205. 335, 1872.

* G. C. Wittstein, *Repert. Pharm.*, 65. 359, 1839; F. Mohr, *Liebig's Ann.*, 27. 27, 1838; W. Artus, *Journ. prakt. Chem.*, (1), 6. 172, 1835; F. Kuhlmann, *Ann. Chim. Phys.*, (3), 20. 23, 1847; L. J. Thénard, *ib.*, (1), 8. 308, 1791; L. N. Vauquelin, *ib.*, (1), 6. 10, 1817; A. C. Jaquelin, *ib.*, (3), 32. 204, 1851; A. F. de Fourcroy and L. N. Vauquelin, *ib.*, (1), 21. 276, 1797; (1), 24. 276, 1797; J. J. Berzelius, *Lehrbuch der Chemie*, Dresden, 5. 243, 1841; H. Abich, *Pogg. Ann.*, 23. 314, 1831; D. Smith, *Phil. Mag.*, (3), 9. 87, 1836; C. F. Kammelsberg, *Ber.*, 2. 148, 1869; 7. 542, 1874; G. Brügelmann, *Wied. Ann.*, 2. 466, 1877; 4. 277, 1878; *Zeit. anorg. Chem.*, 10. 415, 1895; P. J. Robiquet, *Ann. Chim. Phys.*, (1), 62. 61, 1807; *Nicholson's Journ.*, 19. 23, 1808; J. P. J. d'Arcet, *ib.*, 18. 66, 1807; *Ann. Chim. Phys.*, (1), 61. 247, 1807.

* A. Scheurer-Kestner, *Bull. Soc. Chim.*, (3), 7. 708, 1892; *Bull. Soc. Mulhouse*, 36. 448, 1866; A. Rivière, *ib.*, 36. 438, 1866; W. Feld, *Brit. Pat. No.* 13519, 1897; H. Schulze, *German Pat.*, D.R.P. 108599, 1899; A. Leroy and A. Segay, *ib.*, 100969, 1898; R. Schneider, *ib.*, 42468, 44010, 1887; Höndorf, Becker & Co., *ib.*, 69908, 1891; 77002, 1894; Badische Anilin und Sodafabrik, *ib.*, 190955, 1906; W. Feld, *ib.*, 149803, 1901; A. Frank, *ib.*, 135330, 1901; R. Heinz, *Chem. News*, 85. 206, 1902; O. Lenoir, *Wagner's Jahresber.*, 13. 256, 1867; A. C. Jaquelin, *Compt. Rend.*, 32. 877, 1851; *Ann. Chim. Phys.*, (3), 32. 204, 1851; B. Pelletier, *ib.*, (1), 10. 186, 1791; H. Leplay, *Dingler's Journ.*, 254. 436, 1884; H. Niewerth, *ib.*, 251. 191, 1884; G. Lunge, *ib.*, 202. 76, 1871; E. J. Naumené, *ib.*, 244. 254, 1882; T. du Motay, *Bull. Soc. Chim.*, (2), 8. 454, 1867; H. Leplay and R. Radot, *Monit. Scient.*, (3), 15. 1194, 1885; J. Nicklès, *Amer. Journ. Science*, (2), 16. 276, 1853; C. B. Jacobs, *Journ. Soc. Chem. Ind.*, 21. 391, 1902; J. Priestley, *Phil. Trans.*, 78. 152, 1788.

* J. Watts, *Mem. Manchester Lit. Phil. Soc.*, 3. 598, 1790; A. Scheurer-Kestner, *Bull. Soc. Mulhouse*, 36. 448, 1866; A. Rivière, *ib.*, 36. 448, 1866; J. Nicklès, *ib.*, 39. 435, 1869; A. Rosenstiel, *ib.*, 40. 129, 1870; O. Lenoir, *Wagner's Jahresber.*, 13. 274, 1869; H. Grüneberg, *Journ. prakt. Chem.*, (1), 60. 168, 1853; M. Langsdorf, *Polyt. Centr.*, 1507, 1868; E. Asselin, *ib.*, 58. 1855; J. von Liebig, *Liebig's Ann.*, 35. 115, 1840; A. Wurtz, *Dingler's Journ.*, 125. 275, 1852; G. Lunge, *ib.*, 202. 76, 1871; J. Mactear, *Brit. Pat. No.* 5170, 1886; *Dingler's Journ.*, 262. 287, 1886; J. Kuczynsky, *ib.*, 135. 455, 1855; H. Niewerth, *ib.*, 251. 191, 1884; E. J. Maumené, *ib.*, 214. 254, 1882; T. de Brochocqy, *Brit. Pat. Nos.* 1300, 1890; 10476, 1891; H. L. Pattinson, *ib.*, 16989, 1884; W. Moody, *ib.*, 2259, 1883; E. F. Trachsel, *ib.*, 6022, 1884; 757, 7136, 1885;

3406, 1886; *Journ. Soc. Chem. Ind.*, 5, 630, 1886; T. von Dienheim, *German Pat.*, D.R.P. 64349, 1891; R. Ziomeczynsky, *ib.*, 20276, 1882; 27157, 1883; F. Konther, *ib.*, 31356, 1884; A. Rose, *ib.*, 9828, 1878; M. Lalande, *ib.*, 41991, 1887; F. Projahn, *ib.*, 112173, 1899; H. Schulze, *ib.*, 177613, 1904; A. Brochet and G. Ranson, *ib.*, 129324, 1901; H. and W. Pataky, *ib.*, 95754, 1897; H. W. F. Wackenroder, *ib.*, 28062, 1883; 36388, 1885; C. F. Claus, *ib.*, 26481, 27159, 1883; F. Projahn, *ib.*, 112173, 1899; F. Mohr, *Liebig's Ann.*, 27, 27, 1838; C. S. Bradley and C. B. Jacobs, *Brit. Pat. Nos.* 26059, 26060, 1898; C. Stahlschmidt, *Pogg. Ann.*, 128, 467, 1866; A. Vogel, *Journ. Pharm.*, (2), 2, 545, 1818; E. Asselin, *Polyt. Centr.*, 58, 1855; A. Müller, *Journ. prakt. Chem.*, (1), 82, 52, 1861; E. Riegel, *Jahrb. prakt. Pharm.*, 12, 105, 1846; J. P. J. d'Arcet, *Mémoire sur l'action d'un feu égal*, Paris, 1766; E. Terres and K. Bruckner, *Zeit. Elektrochem.*, 26, 1, 25, 1920; H. M. Taquet, *French Pat. No.* 225553, 1892; L. Marino, *Gazz. Chim. Ital.*, 43, i, 416, 1913; L. Marino and D. Danesi, *ib.*, 43, i, 423, 434, 1913.

* V. Kohlschütter and J. L. Tüscher, *Zeit. Elektrochem.*, 27, 225, 1921.

§ 8. The Properties of the Oxides of Calcium, Strontium, and Barium

The oxides of calcium, strontium, and barium obtained by calcination at a low temp., are usually white, earthy, porous, and probably amorphous. V. Kohlschütter and J. L. Tüscher obtained calcium oxide in a highly disperse form by vaporizing the metal in an electric arc; suddenly chilling the vapour by a current of cold air; and precipitating the fume by means of a high tension electric field. Several of the methods of preparation above described give crystalline products. If the purified nitrate of calcium, strontium, or barium be heated to the temp. of decomposition, the corresponding oxide is formed in cubic crystals. J. B. Trommsdorff¹ obtained **crystals** of calcium oxide, and G. Brügelmann, cubic crystals of calcium and strontium oxides, by melting and decomposing the dried nitrates by heat applied to the side of the tightly luted crucible. The microscopic needle-like crystals obtained from the nitrate are stated to give chromatic polarization, and these do not therefore belong to the cubic system, rather to the hexagonal system. The product obtained by similarly heating the hydroxide or carbonate was an amorphous powder. According to R. B. Sosman and co-workers, the crystalline form is obtained by heating the porous variety to a high temp., or by crystallization from soln. in molten silicates or fused calcium nitrate. It is the stable form at a high temp. There is a transition or inversion point between 400° and 430°. H. Moissan obtained crystals of calcium and barium oxides in cubes, rectangular parallelepipeds, or in fine needles by fusing the amorphous product in the electric arc furnace. P. Lebeau likewise obtained crystalline masses by heating a mixture of calcium and an alkaline carbonate under similar conditions. A. Levallois and S. Meunier found small distinct cubic crystals of calcium oxide in some parts of a continuous lime-kiln which had been in use 28 months; the crystals had no action on polarized light. Some crystals obtained by H. Moissan by sublimation in the electric furnace did polarize light, and they belonged to the hexagonal system; this makes it appear as if calcium oxide, like barium oxide, is dimorphous. A. Jouve also found some transparent acicular crystals of calcium oxide, formed in a calcium carbide furnace, were probably hexagonal. A. W. Hull, and W. P. Davey found that the **X-radiogram** of calcium oxide corresponds with a face-centred cubic lattice, with the closest approach of the atoms 2.42 Å.; and that the arrangement of the atoms is the same in calcium metal, the oxide, and the fluoride, and that the atoms are respectively 2 and 14 per cent. closer in the fluoride and oxide than in the metal. W. Gerlach found that the lattice constants of calcium, strontium, and barium oxides all belong to the sodium chloride type. According to P. Lebeau, an isomorphous mixture of calcium and lithium oxides is obtained by calcining a mixture of the two carbonates, but with strontium and lithium carbonates, or with barium and lithium carbonates, an isomorphous mixture is not obtained and the lithia volatilizes.

The **specific gravity** of amorphous calcium oxide was found by A. Royer

and J. B. A. Dumas² to be 3.08 (4°); C. J. B. Karsten, 3.16105; P. F. G. Boullay, 3.179; and E. Filhol, 3.180. G. Brügelmann gives 3.251 for the crystalline oxide, and A. Lavallois and S. Meunier, 3.32. The sp. gr. of calcium oxide is the greater the higher the temp. to which it has been calcined. H. G. F. Schröder found 3.13 for the oxide calcined at 1000°; H. Moissan, 3.30 for the oxide calcined at 1500°; and 3.40 for the oxide calcined at the high temp. of the electric arc furnace. H. Davy estimated the sp. gr. of the greyish-white porous strontium oxide to be between 3.0 and 4.0; C. J. B. Karsten gave 3.9321; and E. Filhol, 4.611. G. Brügelmann gave 4.51 for the sp. gr. of amorphous strontium oxide prepared by the calcination of the hydroxide or carbonate; and 4.51 for the crystals obtained by calcining the nitrate. A. F. de Fourcroy gave 4.0 for the sp. gr. of barium oxide; J. Tunnermann, 4.2583; C. J. B. Karsten, 4.7322; L. Playfair and J. P. Joule, 4.907; and E. Filhol, 5.456. G. Brügelmann gave 5.32 for crystallized barium oxide optically uni- or bi-axial, and 5.72 for the cubic crystals. The **hardness** of crystallized calcium oxide is between 3 and 4 on Mohs' scale.

Calcium oxide is a very powerful refractory as shown by its use in the lime-light where it resists the intense heat of the oxy-hydrogen blowpipe flame. The less pure forms of lime may fuse under these conditions as observed by E. D. Clarke.³ In 1802, R. Hare fused both baryta and lime. L. B. G. de Morveau reported the fusion of calcium oxide on charcoal ignited in a stream of oxygen, and H. Davy said that this oxide melts only with the strongest heat of a voltaic battery. H. Moissan found calcium oxide melts easily in the electric arc furnace, and the cold mass is white and crystalline; the **melting point** is near 2540°; C. W. Kanolt gave 2570°; and O. Ruff and P. Schmidt 2570° in an atm. of hydrogen. The last named say the boiling occurs only under reduced press., and they also measured the vap. press. curves. Calcium oxide crystallizes in the hottest part of the flame of the oxy-hydrogen blowpipe. A. A. Read did not detect any change when the oxides of barium, strontium, or calcium are heated to the m.p. of platinum. H. Moissan succeeded in volatilizing calcium oxide in his electric arc furnace. He also melted strontium oxide to a transparent liquid in the same furnace at about 3000°, and showed that a crystalline mass was formed on cooling. H. Abich noted that barium oxide fuses in the strongest heat of the forge; E. D. Clarke found that baryta fuses to a slag in the oxy-hydrogen blowpipe flame; and H. Moissan melted and volatilized the oxide in his electric arc furnace. He found that barium oxide is a molten liquid at 2000°, and is not decomposed at 2500°. W. R. Mott estimated that the **boiling point** of calcium oxide is about 3400°, and those of strontium and barium oxides occur respectively at 3000° and 2000°. O. Ruff and P. Schmidt found 2850° for the b.p. of calcium oxide in an atm. of an indifferent gas at 760 mm. E. Tiede and E. Birnbräuer found lime volatilizes at 1650° and upwards, and that strontia and baryta are more volatile than lime. E. W. Washburn calculated the latent heat of fusion of calcium oxide to be 28,000 (± 20 per cent.) cals. per mol, or 490 (± 20 per cent.) cals. per gram. P. N. Laschtschenko's values for the **specific heat** of fused lime point to the existence of a mol. transformation from α -CaO to β -CaO between 405° and 410°, accompanied by an absorption of 5 cal. of heat per gram. The sp. ht. of *chaux fondue* rose from 0.172 at 190° to 0.181 at 375°, and remained stationary at 0.181 at 400°, and it then rose to 0.190 at 415° and to 0.193 at 680°. H. von Wartenberg and G. Witzel found the mol. ht. of calcium oxide at 2552° to be 14.8 cal. W. Nernst and F. Schwerns found the mol. ht., C_p , at 89.3° K. to be 3.395, and at 28.2° K., 0.110. G. Gin, and B. Carlson represented the mol. ht. of calcium oxide at θ° between 0° and 3500°, by $11.4 + 0.001\theta$. Hence,

	0°	1000°	1500°	2000°	2500°	3000°	3500°
Sp. ht.	0.2036	0.2214	0.2303	0.2393	0.2482	0.2571	0.2660
Mol. ht.	11.4	12.4	12.9	13.4	13.9	14.4	14.9

According to J. Thomsen,⁴ the **heat of formation** of calcium oxide from its elements is $\text{Ca}_{\text{solid}} + \text{O}_{\text{gas}} = \text{CaO}_{\text{solid}} + 131.3$ Cals.; A. Guntz and H. Basset give

151.9 Cals. ; H. Moissan, 145 Cals. ; and R. de Forcrand, 151.9. J. Thomsen gave for strontium oxide, (Sr, O), 130.98 Cals. ; A. Guntz and G. Röderer, 141.2 Cals. ; and R. de Forcrand, 137.60 Cals. J. Thomsen likewise gave for barium oxide, (Ba, O), 130.38 Cals. ; A. Guntz, 133.4 Cals. ; and R. de Forcrand, 125.86 Cals. See the corresponding hydroxides for the heat of solution of these oxides in water. H. Gautier found that the heat of neutralization of calcium oxide in hydrochloric acid is the same for the oxide prepared by calcining the carbonate at 1000°, at 1300°, or in the electric arc furnace ; and H. Moissan observed no difference in the heat of neutralization of amorphous and crystalline calcium oxide.

R. B. Sosman and co-workers give 1.83 for the refractive index of crystalline calcium oxide. Calcium oxide luminesces at a high temp. as shown by the lime-light. According to W. Crookes,⁵ calcium oxide emits an orange-yellow phosphorescence in cathode rays of a vacuum tube ; under similar conditions, strontium oxide gives a deep blue phosphorescence, while barium oxide scarcely phosphoresces at all. On stopping the discharge, calcium oxide gives a residual glow. According to H. Jackson, if calcium oxide which gives a very bright orange glow be heated in the oxy-hydrogen flame, it subsequently gives a blue phosphorescence. Calcium oxide which has been prepared from highly purified calcium carbonate is strongly phosphorescent if in the crystalline condition, but it scarcely glows at all if amorphous. P. Bary studied the fluorescence of these oxides when stimulated by the X-rays, and by Becquerel's rays. L. de Boisbaudran, and F. Schmidt have studied the effect of impurities—particularly manganese and chromium—on the phosphorescence of the alkaline earth oxides. F. Schmidt prepared phosphorescent oxides of the three alkaline earths by mixing them with small quantities of sodium fluoride, chloride, or phosphate, calcium fluoride, magnesium fluoride, lithium phosphate, potassium borate, or potassium hydrophosphate ; and then with a soln. of nitrate of bismuth, copper, manganese, or lead. He also measured the spectra of the light. E. L. Nichols and D. T. Wilber found that calcium oxide exhibits a flame luminescence in the zone of the hydrogen flame between oxidation and reduction ; the phenomenon does not occur with the flame of alcohol, ether, sulphur, or carbon disulphide. A full supply of oxygen in the atm. surrounding the flame is essential. Rapid oxidation and reduction appear to be essential. The effect is not produced by heating in air or hydrogen outside the flame ; and the effect is not modified by strong electrostatic fields, thus excluding ionization. Barium and strontium oxides gave a dim flame luminescence.

F. Horton found that the electric resistance of a piece of lime at ordinary temp. exceeds 100 megohms, while the resistance in ohms and the electric conductivity in mhos at different temp. are :

	763°	930°	1105°	1235°	1370°	1466°
Ohms .	70×10^6	4175×10^3	600×10^3	104.1×10^3	2045	91.0
Mhos .	1.38×10^{-9}	2.33×10^{-8}	1.62×10^{-7}	9.33×10^{-7}	4.75×10^{-5}	1.035×10^{-3}

The curve resembles that showing the relation between the emission of electrons and temp. He concludes that only a small fraction of the current is carried by negative electrons. For baryta, subject to the oxidization of the compound to the dioxide at the elevated temp. :

	307°	320°	345°	369°	428°	497°
Ohms .	646×10^3	184×10^3	78400	6892	35.7	14.1
Mhos .	1.00×10^{-6}	3.53×10^{-6}	8.29×10^{-6}	9.43×10^{-5}	1.82×10^{-3}	4.61×10^{-3}

There is evidence of a slight electrolysis during the passage of the current. F. Deinger has studied the emission of ions by heated calcium oxide. According to T. W. Case, the oxides of the alkaline earths are not perceptibly photo-electric. H. B. Baker showed that heated lime ionizes gases. A. Wehnelt found the relation between absolute temp., T , the number of corpuscles, n , given out by lime (measured by the saturation current) to be $n = aT^{\frac{1}{2}}e^{-b/T}$, where a and b are constants.

The solubility of calcium, strontium, and barium oxides in water is discussed in connection with the hydroxides; calcium oxide unites with water with great avidity, forming calcium hydroxide—*slaked lime* or *hydrated lime* (*q.v.*). The moistened oxides give an alkaline reaction, and have a caustic alkaline taste; they also corrode organic matter but to a less degree than the caustic alkalies. With calcium oxide and water ranging from 17·962 to 718·67 mols of water to one mol of calcium oxide, S. Chumanoff⁶ claimed to have obtained solid phases with 1·0725 to 1·5563 mols of water per mol of calcium oxide; but W. A. Burdakoff showed that this is unlikely unless S. Chumanoff's sample was contaminated with some carbonate. According to W. Eidmann, the three oxides are insoluble in *acetone* and in *methyl acetate*. According to C. Neuberg and B. Rewald, the oxides of calcium, strontium, and barium are soluble in *methyl alcohol*, and the soln. becomes turbid when warmed and clear again on cooling. The soln. does not give the ionic reactions of the metal, but gives colloidal precipitates or soln. The soln. contains 11·2 grms. of strontium oxide or 1·125 grms. of calcium oxide per litre. A similar result was obtained with *ethyl alcohol*. S. Meunier found that one part of barium oxide dissolves in 3·3 parts of molten potassium hydroxide, and the soln. absorbs oxygen from the air. This is explained by the circumstance that when calcium, strontium, and barium oxides are heated in *air* or *oxygen*, the latter gas is absorbed, and peroxides are formed (*q.v.*). According to W. Manchot and W. Kampschulte,⁷ *ozone* is completely decomposed when passed through a 30 cm. layer of barium oxide, at ordinary temp., but if cooled with ether and carbon dioxide, the baryta is coloured yellow—*barium ozonate*; calcium oxide behaves similarly, forming *calcium ozonate*—see potassium ozonates. This is particularly the case with barium oxide; and C. F. Rammelsberg's analysis of barium oxide— Ba_3O_4 —prepared by calcining the nitrate was affected by an error due to this cause.

According to R. Bunsen and G. Kirchhoff, at the temp. of the electric spark, strontium oxide appears to be reduced by *hydrogen*. For the action of *hydrogen peroxide*, see the corresponding dioxides. J. A. Hedvall and N. von Zweigbergh studied the action of *barium dioxide*. When a piece of calcium oxide is exposed to *air*, it combines with moisture and also carbon dioxide; this is accompanied by a large increase in volume, and the lump crumbles to a powder, which is called *air-slaked lime*. The reaction occurs in two stages: (i) the absorption of water and the formation of calcium hydroxide: $\text{CaO} + \text{H}_2\text{O} = \text{Ca}(\text{OH})_2$; and (ii) the development of the water by carbon dioxide, forming calcium carbonate: $\text{Ca}(\text{OH})_2 + \text{CO}_2 = \text{H}_2\text{O} + \text{CaCO}_3$. These reactions are slow, and the product at one stage of the process is similar in composition to water-slaked lime, and it is possible to obtain air-slaked lime which has been carbonated to almost any degree. Hence, there is some confusion in literature as to the properties of air-slaked lime.

According to H. Moissan, *fluorine* acts in the cold on calcium oxide liberating oxygen and forming calcium fluoride, at the same time much heat is liberated and the mass glows. V. H. Veley found that dry *chlorine* does not act on calcium oxide below 300°, and at this temp. the oxygen is partially replaced by chlorine. J. J. Berzelius, and H. St. C. Deville and H. Debray also found chlorine transforms heated calcium and barium oxides into the chloride, and *iodine* forms the periodate. In 1814, W. Higgins observed that "dry muriatic acid has no action on dry calcareous earth, whilst these substances readily unite if moisture is present"; and V. H. Veley found that dry *hydrogen chloride* has no action on dried calcium oxide in the cold, but a reaction begins at about 80°. *Ammonium chloride* was found by F. Isambert to have no action on strontium or barium oxide at ordinary temp., but between 180° and 300° an energetic reaction occurs—*vide ammonia*.

H. St. C. Deville and H. Debray found that the oxygen of calcium oxide is displaced by *sulphur* at an elevated temp. J. J. Berzelius made a similar observation with respect to barium oxide. C. Brückner obtained calcium sulphide, polysulphide, and sulphate by heating sulphur with calcium oxide at a red heat. R. E. Hughes found that dry *hydrogen sulphide* has no action on dry calcium oxide in the cold,

but when heated, water is evolved and the mass becomes yellow owing to the separation of some sulphur. O. Schumann found **hydrogen sulphide** transforms calcium oxide into a mixture, $4\text{CaS}\cdot 3\text{CaO}$. R. E. Hughes found that the reaction with dry barium oxide and dry hydrogen sulphide is insignificant between 15° and 90° , but if moisture be present, a reaction occurs. V. H. Veley found that **sulphur dioxide** reacts slowly at 300° , and faster at 352° : $\text{CaO} + \text{SO}_2 = \text{CaSO}_3$. According to K. Birnbaum and C. Wittich, the dry gas is not absorbed by dry calcium oxide below 400° , but at 418° the gas is rapidly absorbed, and a basic sulphite, $5\text{CaSO}_3\cdot\text{CaO}$, is formed; and at 500° a mixture of sulphide and sulphate is produced by a reaction which V. H. Veley symbolizes $4\text{CaSO}_3 = 3\text{CaSO}_4 + \text{CaS}$. The absorption with strontium oxide begins at 290° ; and at 200° with barium oxide, at 230° , barium sulphate is formed. According to H. B. Baker, thoroughly dried **sulphur trioxide** does not act on dried calcium or barium oxide at ordinary temp. According to J. J. Berzelius, and H. St. C. Deville and H. Debray, when **carbon disulphide** vapour is passed over barium oxide, heated in a tube, the oxide becomes red hot, and a mixture of sulphide and carbonate is formed: $\text{CS}_2 + 3\text{BaO} = 2\text{BaS} + \text{BaCO}_3$.

H. Moissan found **boron** reacts with calcium oxide at a high temp., forming calcium borate and a little boride. H. St. C. Deville and H. Debray noted the formation of calcium carbide and carbon monoxide when **carbon** is heated with calcium oxide. E. Tiede and E. Birnbräuer also noted that calcium and strontium oxides form carbides. H. Moissan showed that if the calcium oxide is in excess, a secondary reaction occurs with the **calcium carbide** resulting in the liberation of calcium (*q.v.*): $\text{CaC}_2 + 2\text{CaO} = 3\text{Ca} + 2\text{CO}$. According to J. Kolb, H. Petzhold, H. Rose, H. Debray, A. R. Schultaschenko, and A. Vogel, dry calcium oxide absorbs no **carbon dioxide** in the cold, but a reaction occurs when the temp. is raised. According to V. H. Veley, the absorption is insignificant at 300° , it is more marked at 350° , and is complete at 420° . K. Birnbaum and M. Mahu found the lowest temp. at which absorption occurs is near 418° . F. M. Raoult found that the rate of absorption of carbon dioxide is largely determined by the thermal history of the calcium oxide; in accord with this, R. B. Sosman and co-workers found that crystalline calcium oxide combines with carbon dioxide very slowly, while the porous variety combines rapidly with the same gas. The reaction has been studied in connection with the dissociation of the carbonate—*vide supra*. J. C. Whetzel studied the effect of exposing quicklime to atm. air, and found a protective layer of carbonate is formed. Calcium oxide reacts with **ethyl alcohol** in a sealed tube between 115° and 120° , forming a mixture of hydroxide and ethoxide: $\text{Ca}(\text{OH})_2 + (\text{C}_2\text{H}_5\text{O})_2\text{Ca}$. Similar results were obtained by A. Destrem with **propyl alcohol** and **glycerol**. H. Moissan found that **silicon** is oxidized when heated with calcium oxide, and a calcium silicate is formed; H. Moissan and W. Dilthey also found that a silicide is formed: $2\text{CaO} + 5\text{Si} = 2\text{CaSi}_2 + \text{SiO}_2$; and W. P. Bradley found that carbon and silica in the electric furnace also produce the silicide: $\text{CaO} + 2\text{SiO}_2 + 5\text{C} = \text{CaSi}_2 + 5\text{CO}$. Strontium and barium oxides behave similarly. E. Mitscherlich observed that silica, alumina, chromic oxide, and ferric oxide dissolve in barium oxide at a white heat, forming crystalline compounds soluble in hydrochloric acid. L. Forquignon observed that if steel be heated in a bed of quicklime, carbon and silicon are removed from the metal. H. Moissan found that calcium oxide reacts with **titanium** at an elevated temp., forming calcium titanate.

A. Askenasy and F. Grude studied the action of **nitrogen** on a heated mixture of barium oxide and carbon—*vide nitrides*. V. H. Veley found **nitric oxide** is not absorbed by calcium oxide. H. St. C. Deville and H. Debray found that **phosphorus** vapour reacts with calcium oxide, forming the phosphide; J. J. Berzelius made a similar observation with respect to barium oxide. H. Davy observed the reduction of calcium oxide by the vapour of **potassium**, and **sodium**, but J. W. Mallet had his doubts on the matter. L. Gattermann found **magnesium** reduces calcium oxide, but the reduction of calcium oxide is slight; strontia is

reduced rather more energetically, and baryta still more so. F. E. Weston and H. R. Ellis found that magnesium partly reduces calcium oxide, and calcium partly reduces magnesium oxide; and aluminium reduces lime when heat is supplied. J. W. Mallet found that lime, strontia, and baryta are in part reduced by aluminium at a high temp. and the alkaline earth metal volatilized. E. Dufau found that chromium is oxidized by calcium oxide at the temp. of the electric arc, forming a crystalline double oxide: $\text{Cr}_2\text{O}_3 \cdot 4\text{CaO}$; manganese, iron, cobalt, and nickel are also oxidized under similar conditions. H. Moissan found calcium oxide reacts with platinum at the temp. of the electric arc, and the platinum retains 2.5 to 3 per cent. of calcium; for the action of barium oxide, *vide supra*.

REFERENCES.

- ¹ J. B. Trommsdorff, *Ann. Chim. Phys.*, (1), 29, 221, 1799; H. Moissan, *ib.*, (7), 4, 137, 1895; (7), 26, 283, 1902; *Compt. Rend.*, 134, 138, 1902; A. Levallois and S. Meunier, *ib.*, 90, 1566, 1880; R. B. Sosman, J. C. Hostetter, and H. E. Merwin, *Journ. Washington Acad. Sciences*, 5, 563, 1915; G. Brügelmann, *Wied. Ann.*, 2, 466, 1877; 4, 277, 1878; *Zeit. anorg. Chem.*, 10, 415, 1895; 59, 248, 1908; *Zeit. anal. Chem.*, 19, 283, 1880; A. Jouve, *Compt. Rend.*, 132, 1117, 1901; *Bull. Soc. Chim.*, (3), 25, 110, 1901; P. Lebeau, *ib.*, (3), 33, 407, 1905; *Compt. Rend.*, 138, 1496, 1904; A. W. Hull, *Phys. Rev.*, (2), 17, 42, 1921; W. P. Davey, *ib.*, (2), 17, 402, 1921; V. Kohlschütter and J. L. Tüscher, *Zeit. Elektrochem.*, 27, 225, 1921; W. Gerlach, *Phys. Zeit.*, 22, 557, 1921; *Zeit. Physik*, 9, 184, 1922.
- ² A. Royer and J. B. A. Dumas, *Ann. Pharm. Chim.*, 92, 48, 1821; E. Filhol, *Ann. Chim. Phys.*, (3), 21, 415, 1847; P. F. G. Boullay, *ib.*, (2), 43, 266, 1830; H. Moissan, *ib.*, (7), 4, 137, 1895; *Compt. Rend.*, 134, 158, 1902; A. Levallois and S. Meunier, *ib.*, 90, 1566, 1880; A. Jouve, *ib.*, 132, 1117, 1901; *Bull. Soc. Chim.*, (3), 25, 110, 1901; C. J. B. Karsten, *Schweigger's Journ.*, 65, 394, 1832; G. Brügelmann, *Wied. Ann.*, 4, 277, 1878; *Zeit. anorg. Chem.*, 10, 415, 1895; *Zeit. anal. Chem.*, 19, 283, 1880; *Ber.*, 13, 1741, 1880; L. Playfair and J. P. Joule, *Mem. Chem. Soc.*, 3, 84, 1848; A. F. de Fourcroy, *Ann. Chim. Phys.*, (1), 1, 34, 1789; J. Tunnermann, *Journ. Pharm.*, 18, 118, 1829; R. Böttger, *Tabellarische Uebersicht der spezifischen Gewichte der Körper*, Frankfurt, 1837; H. G. F. Schröder, *Pogg. Ann. Jubelb.*, 452, 1874; H. Davy, *Phil. Trans.*, 98, 1, 333, 1808.
- ³ H. Davy, *Phil. Trans.*, 98, 1, 333, 1808; L. B. G. de Morveau, *Journ. Phys.*, 19, 310, 382, 1782; *Ann. Chim. Phys.*, (1), 25, 205, 1798; E. D. Clarke, *Ann. Phil.*, 8, 257, 1816; H. Moissan, *Compt. Rend.*, 115, 1034, 1892; 134, 136, 1902; *Ann. Chim. Phys.*, (7), 4, 136, 1895; H. Abich, *Pogg. Ann.*, 23, 315, 1831; P. N. Laschtschenko, *Compt. Rend.*, 147, 58, 1908; *Journ. Russ. Phys. Chem. Soc.*, 42, 1604, 1910; R. Hare, *Memoir on the Supply and Application of the Blow-pipe*, Philadelphia, 1802; H. von Wartenberg and G. Witzel, *Zeit. Elektrochem.*, 25, 209, 1919; C. W. Kanolt, *Journ. Washington Acad. Sciences*, 3, 315, 1913; E. Tiede and E. Bimbräuer, *Zeit. anorg. Chem.*, 87, 129, 1914; E. W. Washburn, *Trans. Amer. Cer. Soc.*, 19, 1, 1917; W. R. Mott, *Trans. Amer. Electrochem. Soc.*, 34, 255, 1918; A. A. Read, *Journ. Chem. Soc.*, 65, 313, 1894; W. Nernst and F. Schwers, *Sitzber. Akad. Berlin*, 355, 1914; O. Ruff and P. Schmidt, *Zeit. anorg. Chem.*, 117, 172, 1921; G. Gin, *Acetylen Wiss. Ind.*, 2, 160, 1899; B. Carlson, *Zeit. Elektrochem.*, 6, 429, 1900.
- ⁴ J. Thomsen, *Journ. prakt. Chem.*, (2), 16, 97, 1877; *Ber.*, 16, 2613, 1883; M. Berthelot, *Ann. Chim. Phys.*, (5), 9, 43, 1876; *Ann. Bur. Longitudes*, 395, 1877; A. Guntz and H. Basset, *Compt. Rend.*, 140, 863, 1905; H. Gautier, *ib.*, 128, 939, 1899; H. Moissan, *ib.*, 128, 384, 1899; 134, 136, 1902; *Bull. Soc. Chim.*, (3), 21, 928, 1899; *Ann. Chim. Phys.*, (7), 18, 336, 1899; R. de Forcrand, *ib.*, (8), 9, 234, 1907; *Compt. Rend.*, 146, 217, 1908; A. Guntz, *ib.*, 136, 1071, 1903; W. Lenz, *Zeit. öffentl. Chem.*, 3, 82, 1897; A. Guntz and G. Röderer, *Bull. Soc. Chim.*, (3), 35, 512, 1906.
- ⁵ W. Crookes, *Proc. Roy. Soc.*, 32, 206, 1881; *Chem. News*, 43, 237, 1881; *Ann. Chim. Phys.*, (5), 23, 561, 1881; E. L. Nichols and D. T. Wilber, *Phys. Rev.*, (2), 17, 269, 707, 1921; E. L. Nichols and H. L. Howes, *ib.*, (2), 19, 300, 1922; T. W. Case, *ib.*, (2), 17, 398, 1921; F. Schmidt, *Ann. Physik*, (4), 63, 264, 1920; A. Wehnelt, *ib.*, (4), 14, 425, 1904; E. Clerici, *Atti Accad. Lincei*, (5), 29, i, 309, 1920; R. B. Sosman, J. C. Hostetter, and H. E. Merwin, *Journ. Washington Acad. Sciences*, 5, 563, 1915; H. Jackson, *Journ. Chem. Soc.*, 65, 734, 1894; L. de Boisbaudran, *Compt. Rend.*, 106, 452, 1781, 1888; 107, 311, 468, 490, 1888; P. Bary, *ib.*, 130, 776, 1900; F. Horton, *Phil. Mag.*, (6), 11, 505, 1906; F. Deininger, *Ber. deut. phys. Ges.*, 5, 674, 1905; F. Schmidt, *Ann. Physik*, (4), 63, 264, 1920; H. B. Baker, *Chem. News*, 99, 126, 1909.
- ⁶ W. Eidmann, *Ein Beitrag zur Erkenntnis der Verhaltens chemische Verbindungen in nicht wässrigen Lösungen*, Giessen, 1899; S. Meunier, *Compt. Rend.*, 60, 557, 1865; C. Neuberg and B. Rewald, *Biochem. Zeit.*, 9, 537, 1908; *Zeit. Koll.*, 2, 354, 1908; S. Chumanoff, *Journ. Russ. Phys. Chem. Soc.*, 44, 201, 1912; W. A. Burdakoff, *ib.*, 44, 1325, 1912.
- ⁷ C. F. Rammelsberg, *Pogg. Ann.*, 137, 315, 1869; R. Bunsen and G. Kirchhoff, *ib.*, 110, 166, 1860; H. Rose, *ib.*, 86, 280, 1852; L. Gattermann, *Ber.*, 22, 186, 1889; K. Birnbaum and

C. Wittich, *ib.*, 13. 651, 1880; K. Birnbaum and M. Mahu, *ib.*, 12. 1547, 1879; W. Manchot and W. Kampschulte, *ib.*, 40. 4984, 1907; H. St. C. Deville and H. Debray, *Ann. Chim. Phys.*, (3), 56. 385, 1859; C. Brückner, *Monatsh.*, 27. 49, 1906; R. E. Hughes, *Phil. Mag.*, (5), 33. 471, 1892; O. Schumann, *Liebig's Ann.*, 187. 286, 1877; H. Moissan, *Ann. Chim. Phys.*, (7), 26. 280, 1902; *Compt. Rend.*, 134. 138, 1902; H. Moissan and W. Dilthey, *ib.*, 134. 503, 1902; F. Isambert, *ib.*, 100. 857, 1885; J. Kolb, *ib.*, 64. 861, 1867; F. M. Raoult, *ib.*, 92. 189, 1457, 1881; E. Dufau, *ib.*, 121. 689, 1895; H. Debray, *ib.*, 62. 603, 1868; V. H. Veley, *Ber.*, 29. 577, 1896; *Chem. News*. 71. 34, 1895; W. P. Bradley, *ib.*, 82. 149, 1899; H. B. Baker, *ib.*, 67. 263, 1893; E. Mitscherlich, *Journ. prakt. Chem.*, (1) 83. 485, 1861; H. Petzhold, *ib.*, (1), 17. 464, 1839; A. R. Schultaschenko, *Dingler's Journ.*, 205. 335, 1872; A. Vogel, *Neues Jahrb. Pharm.*, 9. 289, 1838; A. Destrem, *Des alcoolates et de leur décomposition par la chaleur*, Paris, 1882; *Ann. Chim. Phys.*, (5), 27. 7, 1882; L. Forquignon, *ib.*, (5), 23. 495, 1881; J. A. Hedvall and N. von Zweigbergh, *Zeit. anorg. Chem.*, 108. 119, 1919; R. B. Sosman, J. C. Hostetter, and H. E. Merwin, *Journ. Washington Acad. Sciences*, 5. 563, 1915; F. E. Weston and H. R. Ellis, *Trans. Faraday Soc.*, 4. 130, 166, 1899; E. Tiede and E. Birnbräuer, *Zeit. anorg. Chem.*, 87. 129, 1914; H. Davy, *Phil. Trans.*, 98. 1, 333, 1808; W. Higgins, *Experiments and Observations on the Atomic Theory and Electrical Phenomena*, Dublin, 1814; J. C. Whetzel, *Journ. Ind. Eng. Chem.*, 9. 287, 1917; J. W. Mallet, *Journ. Chem. Soc.*, 30. 354, 1876; A. Askenasy and F. Grude, *Zeit. Elektrochem.*, 28. 130, 1922; J. J. Berzelius, *Lehrbuch der Chemie*, Dresden, 4. 243, 1841.

§ 9. The Higher Oxides of Calcium, Strontium, and Barium

In a paper, *Sur l'absorption de l'oxygène par les terres*, A. von Humboldt¹ reported in 1798 that moist earths—baryta, lime, and alumina—are able to decompose atm. air by removing the oxygen and leaving the nitrogen. It was supposed either that the earths unite with the oxygen, or favour the oxidation of the associated water. It had previously been shown by N. T. de Saussure, and J. Ingenhous that soil in contact with atm. air forms carbon dioxide at the expense of the contained oxygen; hence, the former argued that the result obtained by A. von Humboldt was due to the presence of oxidizable organic matter, and was not produced by the purified earths. Meanwhile, J. B. van Mons verified A. von Humboldt's observation, and compiled a number of older records of related phenomena. In 1800, C. L. Berthollet contested the hypothesis that the earths absorb oxygen under the conditions indicated by A. von Humboldt.

In 1810, J. L. Gay Lussac and L. J. Thénard found that potash and soda can form hyperoxides; and, they observed, the rapid absorption of oxygen from air passed over barium oxide heated in a tube to a dull red heat. L. J. Thénard (1811) assumed that a mol of barium oxide absorbs a gram-atom of oxygen, and this assumption was vindicated by the analyses of C. F. Rammelsberg, and J. B. J. D. Boussingault, which corresponded with the formulæ Ba_3O_7 and BaO_2 . So that the product of the action is more or less impure barium dioxide, BaO_2 . C. F. Rammelsberg, and M. Quesneville obtained this same compound by heating barium nitrate, and J. B. J. D. Boussingault by heating barium hydroxide or barium carbonate to dull redness in a stream of air. The latter also showed that the presence of a little moisture plays an important part in the reaction, for thoroughly dried oxygen or air is not absorbed or, at any rate, the absorption is very slow. It has been suggested that if B. C. Brodie worked with dried oxygen, this explains how he could fix only six parts of oxygen per 100 parts of barium oxide. H. le Chatelier confirmed the observation that dried oxygen is not absorbed by barium oxide; on the other hand, E. Beckmann stated that the presence or absence of moisture is immaterial. F. Kuhlmann also emphasized the fact that the barium oxide should not be sintered or fused, since in that state it absorbs very little oxygen. J. von Liebig and F. Wöhler calcined a mixture of barium oxide with potassium chlorate in a closed crucible and obtained a 50 per cent conversion of the oxide to dioxide; B. C. Brodie found potassium perchlorate gave no better result. J. A. Wanklyn calcined a mixture of barium oxide with cupric oxide when metallic copper and barium dioxide were formed. The use of barium peroxide for the continuous extraction of oxygen from the air by L. Q. and A. Brin's process (*g.v.*)²

attracted some attention before that process was ousted by cheaper methods of extraction. The preparation of a porous form of barium oxide suitable for rapid absorption was the subject of several patents which have been tabulated by R. Heinz. N. Sasaki studied the velocity of formation of the dioxide at 400°–625°, and his results agreed with the assumption that the oxide and dioxide are mutually soluble in one another, and that such a soln. is proved when oxygen reacts with barium oxide. The reaction occurs first at the surface of the solid and afterwards penetrates into the interior so that the mathematical soln. is analogous to that of a problem in the conduction of heat.

When barium dioxide is treated with water, it diffuses itself through the liquid without a rise of temp. and produces a white powder of the hydrated dioxide. L. J. Thénard³ added hydrogen peroxide to baryta water, and obtained a white crystalline precipitate. An excess of alkali is needed in order to avoid the formation of compounds with hydrogen peroxide of crystallization. B. C. Brodie, and J. Thomsen used an analogous process. H. Geisow added sodium peroxide to a soln. of barium chloride or hydroxide, cooled with ice-water, and washed the precipitate with warm water to remove the sodium chloride and barium oxide until the filtrate begins to decolorize potassium permanganate. G. F. Jaubert employed an analogous process—*vide infra*. The hydrate is also formed by the action of water on barium peroxide. E. Merck treated the anhydrous dioxide with baryta water in order to get hydrated barium dioxide in a form suitable for the preparation of hydrogen peroxide. N. T. de Saussure observed the formation of hydrated barium dioxide by exposing baryta water, at about 5°, for some weeks to air free from carbon dioxide. B. C. Brodie also found that acetyl peroxide in contact with baryta water forms barium acetate and hydrated barium dioxide. H. le Chatelier dehydrated these products by heating them to 700° in a stream of dry oxygen. The analyses of E. Schöne agree with the assumption that the above processes furnish more or less impure **octohydrated barium dioxide**, $\text{BaO}_2 \cdot 8\text{H}_2\text{O}$; but, said M. Berthelot, it is difficult to decide between $7\text{H}_2\text{O}$ and $8\text{H}_2\text{O}$ because of the smallness of the crystals and their proneness to efflorescence. J. von Liebig and F. Wöhler supposed the hydrate to contain 6 mols of water. He also prepared **decahydrated barium dioxide**, $\text{BaO}_2 \cdot 10\text{H}_2\text{O}$, by the action of a large proportion of water on barium hydroxy-dioxide, $\text{BaO}_2 \cdot \text{H}_2\text{O}_2$. E. Schöne believes that M. Berthelot's decahydrate is the result of working with imperfectly dried products, and that no such hydrate exists. E. Schöne prepared **monohydrated barium dioxide**, $\text{BaO}_2 \cdot \text{H}_2\text{O}$, by the spontaneous decomposition of barium hydroxy-dioxide. E. H. Riesenfeld and W. Nottebohm found that if the soln. contains more than a mol of barium hydroxide per mol of hydrogen peroxide, the octohydrate is formed; the octohydrate is always formed over 60°; and the anhydrous dioxide cannot be prepared in aq. soln. Soln. containing much hydrogen peroxide give **barium dioxide diperoxyhydrate**, $\text{BaO}_2 \cdot 2\text{H}_2\text{O}_2$, below 40°; and between 30° and 60°, **barium dioxide peroxyhydrate**, $\text{BaO}_2 \cdot \text{H}_2\text{O}_2$.

L. J. Thénard⁴ precipitated hydrated strontium dioxide by adding *eau oxygénée* to a soln. of the hydroxide. E. Schöne employed a similar process. R. de Forcrand showed the precipitate is **octohydrated strontium dioxide**, $\text{SrO}_2 \cdot 8\text{H}_2\text{O}$; and J. Conroy obtained a precipitate with variable proportions of water—8, 10, or $12\text{H}_2\text{O}$ —by adding sodium dioxide to soln. of strontium salts. G. F. Jaubert employed an analogous process to that used for hydrated calcium dioxide—*vide infra*. The hydrate can be dehydrated by heating it to 100° in a stream of air freed from carbon dioxide. B. C. Brodie and J. Conroy did not obtain strontium dioxide by passing a stream of oxygen over heated strontium oxide, or by melting strontium oxide with potassium chlorate. H. Struve, however, did obtain traces of strontium dioxide by heating the monoxide to redness in a stream of air. The presence of ferric oxide hinders the formation of the dioxide. F. Fischer and H. Plötze obtained a maximum yield of 16 per cent. of strontium peroxide by heating strontium oxide at 410° in oxygen at 100 atm. press. G. Röderer

made anhydrous **strontium dioxide**, SrO_2 , by passing oxygen into a soln. of strontium in dried liquefied ammonia. J. B. Pierce made 85 per cent. SrO_2 by the action of oxygen on strontia under a press. of 105–126 kilogrms. per sq. cm. at 400° – 500° . E. H. Riesenfeld and W. Nottebohm obtained the anhydrous dioxide from conc. soln. above 50° , otherwise the octohydrate is formed. They obtained **strontium dioxide diperoxyhydrate**, $\text{SrO}_2 \cdot 2\text{H}_2\text{O}_2$, by direct preparation from conc. hydrogen peroxides at low temp.

L. J. Thénard precipitated **octohydrated calcium dioxide**, $\text{CaO}_2 \cdot 8\text{H}_2\text{O}$, by adding a soln. of hydrogen peroxide to an aq. soln. of calcium hydroxide; and L. Mond prepared it by adding hydrogen peroxide to milk of lime. According to R. de Forcrand, if less than two mols of hydrogen dioxide be added to a mol of calcium hydroxide, the precipitate contains some calcium hydroxide; and if three to four mols of hydrogen dioxide be used, the octohydrated dioxide is precipitated. The products are to some extent dependent on the temp., the higher hydrate is not produced above 20° . E. H. Riesenfeld and W. Nottebohm obtained anhydrous calcium dioxide from very conc. soln. near 0° ; and above 40° , even from dil. soln. The octohydrate is obtained from dil. soln. at ordinary temp. They also prepared **dihydrated calcium dioxide**, $\text{CaO}_2 \cdot 2\text{H}_2\text{O}$, from the anhydrous compound. J. Conroy obtained the hydrated dioxide by mixing a soln. of a calcium salt with sodium dioxide. G. F. Jaubert treated equimolecular parts of enneahydrated sodium dioxide and the hydroxide of an alkaline earth with a little water, and the heat of the reaction was neutralized by the heat of soln. of the hydrated sodium dioxide. The resulting sodium hydroxide can be washed from the hydrated dioxide. He also substituted a sulphide of the alkaline earth in place of the hydroxide. The water of hydration can be expelled, as in the case of the hydrated strontium dioxide. By rapidly dehydrating the octohydrate, R. de Forcrand prepared what he regarded as a compound of calcium hydroxide and hydrogen peroxide, $\text{Ca}(\text{OH})_2 \cdot \text{H}_2\text{O}_2$, but which may really be dihydrated calcium dioxide, $\text{CaO}_2 \cdot 2\text{H}_2\text{O}$. In opposition to F. Bergius' statement, B. C. Brodie, F. Fischer and H. Plötze, E. H. Riesenfeld and W. Nottebohm, and J. Conroy did not succeed in making calcium dioxide by passing oxygen over the red-hot oxide, nor by heating the oxide with potassium chlorate. H. Struve, however, obtained a small amount of calcium dioxide by using calcium carbonate free from iron oxide. E. H. Riesenfeld and W. Nottebohm prepared **calcium dioxide diperoxyhydrate**, $\text{CaO}_2 \cdot 2\text{H}_2\text{O}_2$, by the method used for the compound of strontium. F. Bergius found that a soln. of lime in sodium hydroxide forms calcium peroxide if exposed to oxygen at over 100 atm. press. The low speed of the reaction, $2\text{CaO} + \text{O}_2 = 2\text{CaO}_2$, prevents equilibrium being attained in a suitable time for experimental work, but if an inert solvent be present, in which both oxide and dioxide are soluble, the experiment can be made.

The anhydrous dioxides are white powders resembling magnesia; the hydrates form pearly scales or else acicular crystals, and lose their water when heated to 100° in a current of air free from carbon dioxide. J. Conroy says the **crystals** of the octohydrates of barium, strontium, and calcium dioxides are isomorphous. J. L. Gay Lussac and L. J. Thénard, and E. Schöne studied the **action of heat** on barium dioxide; they found that it decreases in vol. when strongly heated, that it melts more easily than the monoxide at a red heat, and, giving off bubbles of oxygen, passes into barium oxide. J. B. J. D. Boussingault found that in vacuo, barium dioxide decomposes: $2\text{BaO}_2 = 2\text{BaO} + \text{O}_2$, at a dull red heat; and under a press. of 7 to 8 cms. it decomposes at 800° . According to J. A. Hedvall and N. von Zweigbergh, there is an arrest in the heating curve of decomposing barium peroxide at 795° , where the vap. press. of the evolved oxygen is one atm. In the presence of catalysts like cupric oxide, the decomposition starts at a lower temp., and extends over a longer range of temp. In the presence of silica, particularly amorphous silica, the reaction, normally endothermic, becomes exothermic, presumably owing to the formation of barium silicate by the great reactivity of barium oxide at the moment of its formation. J. Kendall and F. J. Fuchs found

the addition of silica, ceric oxide, chromic trioxide, and ferric oxide accelerate the decomposition; with cupric oxide, the decomposition temp. is lowered from 825° to about 320°. H. le Chatelier has measured the dissociation pressure of barium dioxide at different temp. and found:

	525°	555°	650°	670°	720°	735°	750°	775°	785°	790°	
Press.	20	25	65	80	210	260	340	510	620	670	mm.

The hydrate of barium dioxide loses only water when heated below 130°, but when heated still more, it loses oxygen, and the hydroxide remains. E. H. Riesenfeld and W. Nottebohm found that hydrated calcium dioxide is dehydrated at 100°, and there is no appreciable decomposition below 220°; the decomposition is slow up to 275°, and it then becomes rapid. Finely divided calcium dioxide decomposes explosively when rapidly heated to 275°. The dissociation press. exceeds 100 atm. at 255°. F. Bergius gave for the dissociation press.:

	200°	250°	300°	350°	400°
Dissociation press.	93.35	101.1	107.2	124.0	151.9 atm.

E. H. Riesenfeld and W. Nottebohm believe that F. Bergius' sample was contaminated with potash.

R. de Forcrand⁵ gives for the heat of formation of calcium dioxide, $(\text{CaO}, \text{O}) = 5.43$ Cals., and $(\text{Ca}, \text{O}_2) = 150.43$ Cals.; for strontium dioxide, $(\text{SrO}, \text{O}) = 10.875$ Cals., and $(\text{Sr}, \text{O}_2) = 152.10$ Cals.; and for barium dioxide, $(\text{Ba}, \text{O}_2) = 145.71$ Cals. F. Bergius gave $(\text{CaO}, \text{O}) = 1.65$ Cals., E. Riesenfeld and W. Nottebohm gave 3.3 Cals. M. Berthelot gave for barium dioxide, $(\text{BaO}, \text{O}) = 12.10$ Cals. R. de Forcrand gives for the heat of hydration of calcium dioxide, $(\text{CaO}_2, 8\text{H}_2\text{O}_{\text{liquid}}) = 15.636$ or $(\text{CaO}_2, 8\text{H}_2\text{O}_{\text{solid}}) = 4.196$ Cals.; and $\text{CaO}_2 \cdot 2\text{H}_2\text{O} + 6\text{H}_2\text{O} = 17.851$ Cals.; and for strontium dioxide, $(\text{SrO}_2, 9\text{H}_2\text{O}_{\text{liquid}}) = 20.481$ Cals. M. Berthelot gave for barium dioxide, $\text{Ba}(\text{OH})_2 + \text{O} = \text{BaO}_2 + \text{H}_2\text{O} - 5.52$ Cals. with liquid water, and with solid water, 4.00 Cals. He also gave $\text{BaO} \cdot 10\text{H}_2\text{O} + \text{O} = \text{BaO}_2 \cdot 7\text{H}_2\text{O} + 10.6$ Cals. with liquid water, and 6.4 Cals. with solid water: $\text{BaO}_2 + \text{H}_2\text{O} = \text{BaO}_2 \cdot \text{H}_2\text{O} + 2.8$ Cals. with liquid water, and 1.4 Cals. with solid water: $\text{BaO}_2 + 10\text{H}_2\text{O} = \text{BaO}_2 \cdot 10\text{H}_2\text{O} + 18.2$ Cals. with liquid water, and 3.8 Cals. with solid water: $\text{BaO}_2 \cdot \text{H}_2\text{O} = \text{Ba}(\text{OH})_2 + \text{O} + 2.8$ Cals.; $\text{BaO}_2 \cdot 10\text{H}_2\text{O} = \text{Ba}(\text{OH})_2 \cdot 9\text{H}_2\text{O} + \text{O} + 11.8$ Cals. R. de Forcrand gave for $\text{SrO}_{\text{solution}} + \text{H}_2\text{O}_{\text{solution}} = 26.576$ Cals. M. Berthelot gave $\text{BaO}_2 + \text{H}_2\text{O}_{2\text{aq.}} = \text{BaO}_2 \cdot \text{H}_2\text{O}_2 + 10.2$ Cals.; $\text{H}_2\text{O}_2 + \text{Ba}(\text{OH})_{2\text{aq.}} = \text{BaO}_{2\text{anhydrous}} + \text{Aq.} + 5.6$ Cals.; $2\text{H}_2\text{O}_2 + \text{Ba}(\text{OH})_{2\text{aq.}} = \text{BaO}_2 \cdot \text{H}_2\text{O}_2 + \text{Aq.} + 15.8$ Cals.; $\text{BaO}_2 \cdot \text{H}_2\text{O}_2 = \text{BaO}_2 \cdot \text{H}_2\text{O} + \text{O} = 14.2$ Cals.

M. Berthelot found that barium dioxide is stable at ordinary temp., and it can be kept many years without suffering any loss of oxygen. Octohydrated calcium dioxide was found by R. de Forcrand to be stable when dry. In vacuo, it loses a little oxygen, but it does not lose all its water in vacuo at ordinary temp. J. L. Gay Lussac and L. J. Thénard,⁶ and J. B. J. D. Boussingault found barium dioxide is reduced by heating it in a current of hydrogen, and oxygen is evolved: $2\text{BaO}_2 + 2\text{H}_2 = 2\text{Ba}(\text{OH})_2 + \text{O}_2$. E. Schöne said that anhydrous strontium dioxide has a greater affinity for water than has barium dioxide, and strontium has less affinity for oxygen than has barium; he observed a gradual decomposition when it is allowed to stand in contact with water, and J. L. Gay Lussac and L. J. Thénard said that the decomposition is comparatively fast with warm water. R. von Foregger and H. Philipp found that dihydrated calcium dioxide dissociates slowly in soln.: $\text{CaO}_2 \cdot 2\text{H}_2\text{O} \rightleftharpoons \text{Ca}(\text{OH})_2 \cdot \text{H}_2\text{O}_2$, possibly the reaction if it really occurs should be symbolized: $\text{CaO}_2 \cdot 8\text{H}_2\text{O} \rightleftharpoons 6\text{H}_2\text{O} + \text{Ca}(\text{OH})_2 \cdot \text{H}_2\text{O}_2$, and the latter compound then breaks down into calcium hydroxide and free hydrogen peroxide—possibly $\text{Ca}(\text{OH})_2 \cdot \text{H}_2\text{O}_2 \rightleftharpoons \text{Ca}(\text{OH})_2 + \text{H}_2\text{O}_2$. The decomposition attended by the precipitation of calcium hydroxide is complete after boiling the soln. for 5 hrs. According to L. J. Thénard, hydrated barium dioxide is but slightly soluble in cold water, and the soln. has an alkaline reaction. According to E. Schöne, 100 c.c. of water dissolve

0.168 grm. of the octohydrate, $\text{Ba}(\text{OH})_2 \cdot 8\text{H}_2\text{O}$; but 100 c.c. of soln. containing 0.3 and 0.6 grm. of octohydrated barium hydroxide dissolve respectively 0.102 and 0.019 grm. of the hydrated dioxide. A sat. aq. soln. of barium dioxide thus gives a precipitate with baryta water. E. H. Riesenfeld and W. Nottebohm found water converts the dioxides of the alkaline earths into the octohydrates. E. Schöne found hydrated barium dioxide to be insoluble in *alcohol* and *ether*; and W. Eidmann found hydrated barium and strontium dioxides to be insoluble in *acetone*. For the action of **hydrogen peroxide**, *vide infra*.

When barium dioxide is treated with dil. acids, it forms hydrogen peroxide. S. Tanatar ascertained that acids which react with calcium and barium dioxide with an evolution of less than 3.5 Cals. of heat—*e.g.* phenol—give off oxygen instead of forming hydrogen peroxide; a similar rule was found to apply with salt soln.—*e.g.* aluminium chloride.

A. Baudrimont found **chlorine** reacts with barium dioxide suspended in water, producing ozone-free oxygen; B. C. Brodie found that when barium dioxide is triturated with **iodine** and water, barium iodide and oxygen are formed. When a dry mixture of barium dioxide and iodine is heated, barium periodate is formed. C. Weltzien obtained chlorine, oxygen, and ozone during the action of dry **hydrogen chloride** on heated barium peroxide. Dil. **hydrochloric acid** furnishes a soln. of hydrogen peroxide; while B. C. Brodie found that the conc. acid gives chlorine or a mixture of chlorine and hydrogen peroxide. **Hypochlorites, chlorates, and nitrates** do not oxidize either barium or calcium dioxide to the tetroxide.

J. L. Gay Lussac and L. J. Thénard showed that when barium dioxide is heated with **sulphur**, barium sulphide and oxygen are produced. According to B. C. Brodie, when barium dioxide is rubbed up with water and **carbon disulphide**, a yellow liquid is produced which on standing in the cold slowly precipitates barium carbonate, while barium disulphide or, if an excess of barium dioxide is present, barium thiosulphate passes into soln. This reaction is rapid when the mixture is heated. A similar yellow liquid is produced by passing **hydrogen sulphide** into water in which barium dioxide is suspended. F. Wöhler found that a rapid stream of **sulphur dioxide** makes heated barium dioxide white-hot, and a flame is produced. With dil. **sulphuric acid**, hydrogen peroxide is produced, and with a more conc. acid, ozonized oxygen may be found.

A mixture of barium dioxide and **carbon** was found by J. L. Gay Lussac and L. J. Thénard to be decomposed by heat with the evolution of oxygen. D. Korda found that if a piece of barium dioxide and a carbon rod be dipped in molten potassium carbonate, while the free ends are in electrical connection, a current of about one volt is produced and the reaction: $2\text{BaO}_2 + \text{C} = 2\text{BaO} + \text{CO}_2$ occurs. When triturated with organic substances, A. Dupré found an explosion may be produced. F. Wöhler observed that a rapid stream of **carbon monoxide** makes heated barium dioxide white-hot, and a flame appears. B. C. Brodie found a stream of **carbon dioxide** results in the evolution of oxygen and the formation of barium carbonate; H. Struve found the hydrate also forms barium carbonate, and gives off oxygen.

O. Michel and E. Grandmougin found that **ammonia** reacts with heated barium dioxide, with the evolution of nitrogen: $3\text{BaO}_2 + 2\text{NH}_3 = 3\text{Ba}(\text{OH})_2 + \text{N}_2$. L. Santi symbolized the reaction with **ammonium chloride** soln.: $2\text{BaO}_2 + 4\text{NH}_4\text{Cl} = 2\text{BaCl}_2 + 4\text{NH}_3 + 2\text{H}_2\text{O} + \text{O}_2$. According to J. Conroy, hydrated strontium dioxide is readily soluble in soln. of ammonium chloride, and insoluble in aqua ammonia. C. A. L. de Bruyn found that an aq. soln. of **hydroxylamine** reacts with barium dioxide with inflammation. P. Sabatier and J. B. Sendrens found **nitrous oxide** reacts with barium dioxide between 500° and 600° , forming nitrogen and barium nitrate. J. L. Gay Lussac and L. J. Thénard observed that when warmed with **phosphorus**, barium dioxide is decomposed and oxygen is evolved; similarly also with **boron** and the **metals**. When an aq. soln. of **sodium carbonate** is digested with barium dioxide, B. C. Brodie observed the formation of a soln. of sodium dioxide and a precipitate of barium carbonate. C. Weltzien treated barium dioxide with

aq. soln. of the alkali sulphates—lithium, potassium, and sodium—and obtained barium sulphate and a soln. which he believed to contain alkali hydroxide and hydrogen peroxide. H. Kwasnik reported that barium dioxide does not react with soln. of salts of the alkali and alkaline earths, but it reacts slowly with magnesium salts, giving off oxygen. With ferric chloride it reacts: $6\text{BaO}_2 + 4\text{FeCl}_3 + 6\text{H}_2\text{O} = 3\text{O}_2 + 4\text{Fe}(\text{OH})_3 + 6\text{BaCl}_2$, and likewise also with manganic, chromic, and aluminium salts. There is also a rapid evolution of oxygen with nickel and cobalt salts soln.; and a feeble evolution with soln. of zinc and cadmium salts, but more quickly than with magnesium salts. The salts of the noble metals are reduced to the metal, but hydrochloroplatinic acid furnishes barium chloroplatinate. Cupric salts are not reduced and ozonized oxygen is evolved. G. Kassner found potassium ferricyanide reacts: $\text{BaO}_2 + 2\text{K}_3\text{FeCy}_6 = \text{O}_2 + \text{K}_6\text{BaFe}_2\text{Cy}_{12}$, and J. Quincke has shown that the reaction is quantitative.

J. A. Hedvall and N. von Zweigbergh found the rate of decomposition of barium oxide is accelerated by admixture with other metal oxides, and the decomposition is exothermic. Compounds were thought to be formed with barium oxide and the oxides of zinc, titanium, aluminium, lead, arsenic, antimony, vanadium, tantalum, chromium, molybdenum, tungsten, uranium, manganese, iron, nickel, and copper. Cuprous oxide and bismuth sesquioxide were oxidized without forming compounds. A catalytic action was observed with cuprous and cupric oxides, and the oxides of magnesium, calcium, cadmium, lanthanum, and cerium, while stannous and stannic oxides, and zirconia were without effect. J. H. Hildebrand, and N. Sasaki found that barium oxide and dioxide are mutually soluble in one another, and that the limits of their mutual solubilities at a given temp. vary with the states of the samples employed.

E. Schöne reported that in the decomposition of barium dioxide by water, the supernatant liquid contains proportionally more barium hydroxide than hydrogen peroxide. This is explained by assuming that a portion of the hydrogen peroxide combines with an eq. quantity of barium dioxide to produce barium dioxide hydroxyhydrate, $\text{BaO}_2 \cdot \text{H}_2\text{O}_2$. He isolated this compound by two different methods of preparation: first, by direct action on each other of the peroxides of barium and of hydrogen; secondly, by adding a determined quantity of ammonia to a soln. of hydrogen peroxide containing a barium salt. In the first process the reaction is represented by $\text{BaO}_2 + \text{H}_2\text{O}_2 = \text{BaH}_2\text{O}_4$. In the second several phases may be distinguished, thus: $\text{BaCl}_2 + 2\text{NH}_4\text{OH} = 2\text{NH}_4\text{Cl} + \text{Ba}(\text{OH})_2$; $\text{Ba}(\text{OH})_2 + \text{H}_2\text{O}_2 = 2\text{H}_2\text{O} + \text{BaO}_2$; $\text{BaO}_2 + \text{H}_2\text{O}_2 = \text{BaH}_2\text{O}_4$. The compound, BaH_2O_4 , formed microscopic crystals belonging to the monoclinic system. The crystals were usually of a yellow colour, but they could be prepared quite clear and colourless. The latter soon decomposed at room temp., but they are more stable at 0° ; they finally break down into barium dioxide, water, and oxygen. The compound is insoluble in the ordinary solvents; acids decompose the colourless compound without giving off any gas, but the yellow product gives off oxygen, and this the more the yellower the product. R. de Forcrand measured the amount of heat evolved when a mol of barium dioxide is treated with n mols of hydrogen peroxide:

Mols H_2O_2	.	.	0.5	1	2	3	10	12
Heat developed	.	.	3.121	4.350	7.801	8.552	12.261	13.586 Cals.

The breaks in the curve led him to assume that barium hydroxyhydrated-dioxide, $\text{BaO}_2 \cdot \text{H}_2\text{O}_2$, or $\text{Ba}(\text{O} \cdot \text{OH})_2$, is formed as well as another compound richer in hydrogen peroxide. E. Schöne believed that a strontium dioxide hydroxyhydrate, $\text{SrO}_2 \cdot \text{H}_2\text{O}_2$, exists analogous with the barium compound, but it is so unstable that he was unable to isolate it in a pure state. E. Schöne likewise failed to obtain pure calcium dioxide hydroxyhydrate, $\text{CaO}_2 \cdot \text{H}_2\text{O}_2$, but he obtained a yellow unstable compound by similar methods to those employed for the barium compound. R. de Forcrand inferred the existence of calcium hydroxy-dioxide, $\text{CaO} \cdot 2\text{H}_2\text{O}_2$, or $\text{CaO}_2 \cdot \text{H}_2\text{O}_2$, or $\text{Ca}(\text{O} \cdot \text{OH})_2$, by thermal methods similar to those which he employed

with the barium compound. W. Traube and W. Schulze found that calcium dioxide octohydrate is converted by warm hydrogen peroxide into a yellow substance, which, under the most favourable circumstances, may contain 8·7 per cent. of **calcium tetroxide**, CaO_4 . The products may be heated to 130°C . without undergoing change. They dissolve in dil. acid with immediate evolution of inactive oxygen which does not liberate bromine or iodine from acidified soln. of potassium bromide or potassium iodide. The corresponding **barium tetroxide** is much less stable. Ultra-violet light hastens the conversion of the hydroperoxide $\text{BaO}_2 \cdot \text{H}_2\text{O}_2$ into the tetroxide BaO_4 . The tetroxides are not *ozonates*, which, contrary to the opinion of W. Strecker and H. Thienemann, do not contain hydrogen, but an addition compound of oxygen and the dioxide.

It is not clear which of these formulæ

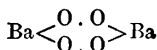

should be used to represent the composition of barium dioxide; the second is perhaps preferable because (1) just as the alkaline earth oxides, BaO , readily unite with water, forming soluble hydroxides, $\text{Ba}(\text{OH})_2$, so might the corresponding peroxides be expected to form readily soluble hydroperoxides, $\text{HO} \cdot \text{O} \cdot \text{Ba} \cdot \text{O} \cdot \text{OH}$. Barium peroxide unites with hydrogen peroxide to form a compound, $\text{BaO}_2 \cdot \text{H}_2\text{O}_2$, but since this compound dissolves in water with difficulty, it is inferred that it is not $\text{HO} \cdot \text{O} \cdot \text{Ba} \cdot \text{O} \cdot \text{OH}$, but rather $\text{BaO}_2 \cdot \text{H}_2\text{O}_2$, with "hydrogen peroxide of crystallization." (2) An organic derivative—barium ethyl peroxide—is known to have a complex molecule, $\text{C}_2\text{H}_5 \cdot \text{O} \cdot \text{O} \cdot \text{Ba} \cdot \text{O} \cdot \text{OC}_2\text{H}_5$, from actual measurements.

REFERENCES.

¹ H. Kopp, *Geschichte der Chemie*, Braunschweig, 1847; A. von Humboldt, *Ann. Chim. Phys.*, (1), 39, 125, 1898; N. T. de Saussure, *Phil. Mag.*, 10, 28, 152, 1801; J. Ingenhous, *Uitslag der proefnemingen op de planten*, Amsterdam, 1780; *Voigt's Mag.*, 1, 97, 1798; C. L. Berthollet, *École Polyt. Journ.*, 4, 315, 1802; J. L. Gay Lussac and L. J. Thénard, *Recherches physico-chimiques*, Paris, 1811; L. J. Thénard, *Ann. Chim. Phys.*, (2), 8, 308, 1818; F. Kuhlmann, *ib.*, (3), 20, 23, 1847; M. Quesneville, *ib.*, (2), 36, 108, 1827; J. B. J. D. Boussingault, *ib.*, (3), 35, 5, 1851; (5), 19, 464, 1880; *Compt. Rend.*, 84, 521, 1877; H. le Chatelier, *ib.*, 115, 654, 1892; B. C. Brodie, *Phil. Trans.*, 153, 409, 1863; *Proc. Roy. Soc.*, 12, 209, 1862; L. Mond, *Ber.*, 16, 980, 1883; J. A. Wanklyn, *ib.*, 7, 1029, 1874; C. F. Rammelsberg, *ib.*, 7, 542, 1874; J. von Liebig and F. Wöhler, *Pogg Ann.*, 26, 172, 1832; E. Beckmann, *Journ. Prakt. Chem.*, (2), 27, 141, 1883; H. Struve, *Zeit. anal. Chem.*, 11, 22, 1872; J. B. van Mons, *Crell's Ann.*, 1, 76, 129, 185, 1801.

² Brin's Oxygen Co., and K. S. Murray, *Brit. Pat. No.* 17298, 1891; C. S. Bradley and C. B. Jacobs, *ib.*, 26059, 1898; A. Brin, *ib.*, 7867, 1885; L. Q. and A. Brin, *ib.*, 151, 1885; 157, 1885; La Société Bonnet, *ib.*, 19470, 1898; P. L. Martin, *ib.*, 601, 1901; Siemens & Co., *ib.*, 4217, 1904; H. Schulze, *French Pat. No.* 335677, 1903; H. Fleck, *U.S. Pat. No.* 1349417, 1920; R. Heinz, *Chem. Ztg.*, 25, 199, 1901; *Chem. News*, 85, 206, 1902; N. Sasaki, *Mem. Coll. Science Kyoto*, 5, 9, 1921.

³ L. J. Thénard, *Ann. Chim. Phys.*, (2), 8, 308, 1818; N. T. de Saussure, *ib.*, (2), 44, 22, 1830; M. Berthelot, *ib.*, (5), 6, 209, 1875; (5), 14, 433, 1878; (5), 21, 157, 1880; E. Schöne, *Bull. Soc. Chim.*, (2), 35, 107, 1881; E. H. Riesenfeld and W. Nottebohm, *Zeit. anorg. Chem.*, 89, 405, 1914; F. Fischer and H. Plötze, *ib.*, 75, 1, 10, 1912; J. A. Hedvall, *ib.*, 104, 163, 1918; F. Wöhler, *Pogg Ann.*, 26, 172, 1832; H. le Chatelier, *Compt. Rend.*, 115, 654, 1892; J. Thomsen, *Ber.*, 7, 73, 1874; B. C. Brodie, *Journ. Chem. Soc.*, 4, 201, 1852; E. Schöne, *Ber.*, 13, 803, 1880; H. Geisow, *ib.*, 37, 515, 1904; G. F. Jaubert, *Brit. Pat. Nos.* 10630, 1900; 2504, 1901; E. Merck, *German Pat.*, D.R.P. 170351, 1905; W. Nottebohm, *Ueber Zinkperoxyd und die Peroxyde der Erkalikalien*, Freiburg i. Br., 1915; J. von Liebig and F. Wöhler, *Pogg Ann.*, 26, 172, 1832.

⁴ L. J. Thénard, *Ann. Chim. Phys.*, (2), 8, 308, 1818; B. C. Brodie, *Proc. Roy. Soc.*, 12, 209, 1862; *Phil. Trans.*, 153, 409, 1863; J. Conroy, *Journ. Chem. Soc.*, 26, 808, 1873; E. Schöne, *Ber.*, 6, 1172, 1873; G. Röderer, *Bull. Soc. Chim.*, (3), 35, 724, 1906; *Compt. Rend.*, 140, 1252, 1905; R. de Forcrand, *ib.*, 130, 1017, 1250, 1389, 1900; H. le Chatelier, *ib.*, 115, 654, 1892; E. H. Riesenfeld and W. Nottebohm, *Zeit. anorg. Chem.*, 89, 405, 1914; 90, 371, 1914; F. Bergius, *Nernst's Festschrift*, 68, 1912; F. Fischer and H. Plötze, *Zeit. anorg. Chem.*, 75, 1, 10, 1912; H. Struve, *Zeit. anal. Chem.*, 11, 22, 1872; L. Mond, *Brit. Pat. No.* 1683, 1883; G. F. Jaubert, *ib.*, 10630, 1900; 2504, 1901; R. von Foregger and H. Philipp, *Journ. Soc. Chem. Ind.*, 25,

298, 461, 1906; J. Mülder, *Pharm. Ztg.*, 34, 665, 1889; J. B. Pierce, *Brit. Pat. No.* 130840, 1919; J. Kendall and F. J. Fuchs, *Journ. Amer. Chem. Soc.*, 43, 2017, 1921; J. B. J. D. Boussingault, *Ann. Phys. Chim.*, (3), 35, 5, 1851; (5), 19, 464, 1880; J. L. Gay Lussac and L. J. Thénard, *Recherches physico-chimiques*, Paris, 1811; J. A. Hedvall and N. von Zweigbergh, *Zeit. anorg. Chem.*, 108, 119, 1919.

⁵ M. Berthelot, *Compt. Rend.*, 85, 880, 1877; 90, 334, 1880; *Bull. Soc. Chim.*, (2), 33, 289, 1877; *Ann. Chim. Phys.*, (5), 21, 153, 1880; R. de Forcrand, *Compt. Rend.*, 130, 1017, 1308, 1388, 1900; F. Bergius, *Ncrnst's Feestschrift*, 68, 1912; E. Riesenfeld and W. Nottebohm, *Zeit. anorg. Chem.*, 89, 405, 1914.

⁶ J. L. Gay Lussac and L. J. Thénard, *Recherches physico-chimiques*, Paris, 1811; R. von Foregger and H. Philipp, *Journ. Soc. Chem. Ind.*, 25, 298, 461, 1906; A. Dupré, *ib.*, 16, 492, 1897; J. Conroy, *Journ. Chem. Soc.*, 26, 808, 1873; B. C. Brodie, *Proc. Roy. Soc.*, 12, 209, 1862; *Phil. Trans.*, 153, 409, 1863; S. Tanatar, *Ber.*, 36, 1893, 1903; O. Michel and E. Grandmougin, *ib.*, 26, 2567, 1893; J. Thomsen, *ib.*, 7, 73, 1874; P. Sabatier and J. B. Senderens, *Bull. Soc. Chim.*, (3), 13, 870, 1895; *Compt. Rend.*, 120, 618, 1895; A. Baudrimont, *ib.*, 62, 829, 1866; D. Korda, *ib.*, 120, 615, 1895; R. de Forcrand, *ib.*, 130, 1250, 1900; C. Weltzien, *Liebig's Ann.*, 138, 162, 1866; F. Wöhler, *ib.*, 78, 125, 1851; J. B. J. D. Boussingault, *Ann. Chim. Phys.*, (3), 35, 5, 1851; L. J. Thénard, *ib.*, (2), 8, 308, 1818; M. Berthelot, *ib.*, (5), 14, 433, 1878; C. A. L. de Bruyn, *Rec. Trav. Pays-Bas*, 11, 18, 1892; L. Santi, *Boll. Chim. Farm.*, 43, 673, 1904; H. Kwasnik, *Arch. Pharm.*, 229, 573, 1891; G. Kassner, *ib.*, 228, 432, 1890; J. Quincke, *Zeit. anal. Chem.*, 31, 1, 1892; E. Schöne, *Bull. Soc. Moscow*, 2, 1014, 1899; *Liebig's Ann.*, 192, 266, 1878; *Ber.*, 6, 1172, 1873; W. Eidmann, *Ein Beitrag zur Erkenntnis des Verhaltens chemischer Verbindungen in nichtwässrigen Lösungen*, Giessen, 1899; J. A. Hedvall and N. von Zweigbergh, *Zeit. anorg. Chem.*, 108, 119, 1919; E. H. Riesenfeld and W. Nottebohm, *ib.*, 89, 405, 1914; W. Traube and W. Schulze, *Ber.*, 54, B, 1626, 1921; W. Strecker and H. Thienemann, *ib.*, 53, B, 2096, 1920; J. H. Hildebrand, *Journ. Amer. Chem. Soc.*, 34, 246, 1912; N. Sasaki, *Mem. Coll. Science Kyoto Univ.*, 5, 9, 1921.

§ 10. The Hydroxides of Calcium, Strontium, and Barium

According to B. Pelletier,¹ if calcium oxide is mixed with about half its weight of water, the liquid is at first absorbed by capillary action in the pores of the lime, which remain after the escape of carbon dioxide in the burning. The air contained in the pores is expelled with a hissing noise as the lime combines with the water to form a pulverulent mass of **calcium hydroxide**, $\text{Ca}(\text{OH})_2$. The operation is called *slaking lime*; and the product *slaked lime*, or *hydrated lime*. The combination is attended by the evolution of much heat, and the lime is such a bad conductor of heat that there is a considerable rise of temp. This is sometimes sufficient to inflame sulphur, gunpowder, wood, and, according to W. Lenz, straw. The rise of temp. is greater the greater the purity and the quantity of lime employed. The low-grade limes give a temp. of 270° – 300° , while with richer limes A. Herzfeld measured a rise of 468° . R. Wagner found that quicklime which has been dropped in oil, and re-calcined, hisses like a red-hot coke when dropped into water. The great amount of heat developed in the slaking of lime is not due to the passage of water from the liquid to the solid state, since the lime is heated to 100° during the slaking with ice, and the escaping steam carries away some fine particles of the solid. A lump of crystallized calcium oxide from a fused cake in water slakes so very slowly that no rise of temp. is perceptible; but A. L. Day, E. S. Shepherd, and F. E. Wright found that the powdered crystals appear to be inert when first placed in water, but in a few minutes hydration occurs with explosive violence. The decrease in the activity of calcium oxide with increasing temp. of ignition is due to shrinkage and a consequent reduction of surface. The denser the calcium oxide, the smaller the surface in proportion to its mass, and the less the reactivity with water. Calcium oxide prepared at a low temp. is loose and porous, and then offers a large surface, and in consequence hydrates rapidly; B. Pelletier, K. Kortum, P. Heinrich, and F. Göbel have noted the emission of light, visible in the dark, when lime is slaked with a little water.

C. J. D. von Grotthuss stated that some ammonia is formed during the slaking of lime, but A. Pleischl found no evidence of this. The reaction involves the change

from an anhydrous oxide to a hydroxide. J. J. Berzelius' analyses agree closely with that theoretically required for $\text{Ca}(\text{OH})_2$; A. L. Lavoisier's and J. L. Gay Lussac's analyses have the water rather low, and in J. Dalton's analysis the water is rather high. L. Reuter showed that the water in ordinary slaked lime is usually 0.5 to 1.5 per cent. higher than corresponds with the formula $\text{Ca}(\text{OH})_2$.

Hydrated lime can be obtained in commerce, and it is used for making mortar in place of quicklime. The hydrated lime has other commercial names—*new-process lime*, *limoid*, etc. If the quicklime is purchased, it is slaked by the consumer before use, and this entails a certain amount of trouble and waste. This question has been discussed by S. T. Brigham, C. Warner, S. V. Peppel, etc. In the preparation of commercial hydrated lime, the quicklime is ground to a fairly uniform small size, it is then mixed with water, and finally sieved or otherwise brought to a uniform fine powder.

The velocity of hydration of the lime (and baryta) was found by H. Rose to vary with its thermal history, and its porosity. (i) The more porous the lime, the more quickly can it be penetrated by water, and the more quickly does slaking occur. Again, (ii) P. Lebeau, A. Herzfeld, H. Moissan and G. Oddo ascertained that lime prepared at 1000° slakes violently when immersed in water, while that calcined at 1300° slakes quietly under the same conditions, and that which has been fused in the electric arc furnace is attacked *très lentement*. V. A. Jacquelin also found the crystals of calcium oxide formed by heating the nitrate at a high temp. slake very slowly. (iii) The presence of magnesium oxide in limestone retards the slaking. As E. de M. Campbell has shown, the hydration of magnesium oxide is very slow compared with that of calcium oxide, so that in the ordinary process of slaking lime, the magnesium oxide acts as so much inert matter.

According to E. Candlot, the presence of calcium chloride accelerates the hydration of calcium oxide; and, according to P. Rohland, the speed of hydration is accelerated by hydrochloric, nitric, acetic, or lactic acid, aluminium, barium, or calcium chloride, sodium acetate, asparagine, and ethyl alcohol; the speed of hydration is retarded by boric acid, potassium or sodium hydroxide, calcium chromate, potassium dichromate, acetaldehyde, glycerol, and cane or grape sugar; and no appreciable effect is produced by aqua ammonia, calcium hydroxide, sodium or potassium chloride, and potassium nitrate or hydrocarbonate. In general, therefore, acids, excepting boric acid, accelerate the hydration of lime; and alkalis retard the action.

T. J. Pelouze obtained calcium hydroxide by precipitation from soln. of calcium salts by potassium or sodium hydroxide; and F. Mohr used a similar process for barium hydroxide. Strontium or barium hydroxide is obtained by the action of moisture on strontia or baryta as shown by J. W. Döbereiner. According to C. F. Bucholz, the hydroxides are obtained by fusing the hydrates, and, according to D. Smith, by heating the hydrates to 100° . M. H. van Laar electrolyzed a soln. of barium carbonate in barium nitrate in a cell with barium carbonate in the anode vessel, and found crystalline barium hydroxide was readily formed in the cathode compartment. Several of the technical processes indicated in connection with the preparation of barium or strontium oxide really furnish the hydroxide. This applies to all those processes in which the furnace products are leached with water. These methods have been discussed by R. Heinz.

The hydroxides of calcium, strontium, and barium, obtained by slaking the oxides, are fine white powders; those of barium and strontium, obtained by dehydrating the melted hydrates, are white crystalline masses. F. F. Selivanoff showed that calcium hydroxides prepared in different ways all have the composition: $\text{Ca}(\text{OH})_2$, and all adsorb water vapour, which is largely lost by drying in a desiccator over sulphuric acid, or at 60° ; but the last traces are retained very tenaciously. The amorphous hydroxide and water behave like two mutually soluble liquids, for when shaken together, soln. of water in the hydroxide and of hydroxide in water are formed. The amorphous hydroxide cannot be transformed into the crystalline form by heating it with water, or by prolonged storage with water; but by heating

a supersat. soln. of lime, or by evaporating an aq. soln. of lime under diminished press. at 28°–30°, hexagonal plates or prisms of $\text{Ca}(\text{OH})_2$ can be obtained. A. Lamy² and R. Phillips prepared small hexagonal prisms of calcium hydroxide by gradually heating a soln. of the hydroxide, the crystals are deposited at about 80°, since the solubility of the hydroxide decreases with rise of temp. J. L. Gay Lussac obtained crystals by allowing a soln. of limewater to evaporate spontaneously in the cold over conc. sulphuric acid or in the presence of quicklime under a bell-jar. According to E. Weinschenk, these crystals had a positive double refraction. A. Riffault and N. M. Chompré passed a current through a cell containing a soln. of calcium nitrate separated by a porous partition from water. The crystals were deposited on the negative electrode which was placed in the compartment containing water. O. Luedecke found hexagonal crystals as a boiler incrustation and as a deposit in a Carré's ice machine. S. Glinka found small six-sided plates of calcium hydroxide in some hydraulic cement; these crystals were probably rhombic with a positive double refraction.

F. F. Selivanoff prepared supersat. soln. by freezing soln. of calcium hydroxide, and they contained 0.260–0.264 grm. CaO per 100 c.c.; he could not prepare a soln. with 0.29 grm. of CaO per 100 c.c., as reported by F. Guthrie. The supersat. soln. are very sensitive to heat, and readily deposit crystals of the hydroxide at ordinary temp. The cryohydrate of lime solidifies, forming transparent ice; when this ice melts, it deposits elongated hexagonal plates, or small rhombic plates of **hemihydrated calcium hydroxide**, $\text{Ca}(\text{OH})_2 \cdot \frac{1}{2}\text{H}_2\text{O}$. The hydrate is very unstable, and readily decomposes when slightly heated, forming the amorphous hydroxide. The hemihydrate, and the crystalline hydroxide, are less soluble in water, and dil. sugar soln. than the amorphous hydroxide. The crystalline or amorphous hydroxide, or crystals of the hemihydrate, are without effect on supersat. soln.

Unlike calcium hydroxide, the hydroxides of strontium and barium readily form hydrates. One hydrate of calcium hydroxide, $\text{Ca}(\text{OH})_2 \cdot \frac{1}{2}\text{H}_2\text{O}$, has been reported, but this hydroxide is sometimes stated to form no hydrate. There are two hydrated strontium hydroxides with $\text{Sr}(\text{OH})_2 : \text{H}_2\text{O} = 1 : 8$, and 1 : 1, and four hydrated barium hydroxides with $\text{Ba}(\text{OH})_2 : \text{H}_2\text{O} = 1 : 16$; 1 : 8; 1 : 3; and 1 : 1, although it is not clear if all these are chemical individuals. An increasing at. wt. of the basic metal corresponds with an increasing tendency of the hydroxide to form hydrates. **Octohydrated strontium hydroxide**, $\text{Sr}(\text{OH})_2 \cdot 8\text{H}_2\text{O}$, or **octohydrated barium hydroxide**, $\text{Ba}(\text{OH})_2 \cdot 8\text{H}_2\text{O}$, is readily obtained by crystallization from an aq. soln. of the oxide or hydroxide in hot water. According to C. L. Bloxam, the octohydrated strontium hydroxide was obtained by precipitation on adding sodium hydroxide to a soln. of strontium nitrate, just as M. Anfrue and J. P. J. d'Arcet, M. Kirchhoff, and G. Pessina obtained the corresponding barium compound. The precipitate was washed free from alkali by means of ice-cold water, or with alcohol. F. Mohr added the theoretical quantity of powdered barium nitrate to a boiling aq. soln. of sodium hydroxide of sp. gr. 1.1 to 1.5, adding water if necessary, for the complete soln. of the nitrate. The crystals which separate on cooling the filtered soln. can be purified by re-crystallization. E. Beckmann prepared octohydrated barium hydroxide by crystallization from a sat. soln. between 10° and 109°.

The analyses of A. Souchay and E. Lenssen, E. Filhol, C. L. Bloxam, H. M. Noad, J. Thomsen, and D. Smith agreed with the formula $\text{Sr}(\text{OH})_2 \cdot 8\text{H}_2\text{O}$ for this hydrate; but R. Phillips and M. Berthelot gave analyses in agreement with $\text{Sr}(\text{OH})_2 \cdot 9\text{H}_2\text{O}$. C. L. Bucholz first analyzed the crystals of hydrated barium hydroxide, and his numbers agree with the formula $\text{Ba}(\text{OH})_2 \cdot 9\text{H}_2\text{O}$; and this was confirmed by the observations of H. Rose, H. M. Noad, M. Berthelot, R. Phillips, A. Rosenstiehl, and E. Filhol's analyses with $\text{Ba}(\text{OH})_2 \cdot 7\text{H}_2\text{O}$; but C. L. Bloxam, E. Beckmann, and D. Smith showed that the composition is more in agreement with $\text{Ba}(\text{OH})_2 \cdot 8\text{H}_2\text{O}$, the value accepted at the present day. The older analyses, said W. Reuling, were made on impure hydroxide, and the water was determined by difference; the presence of aluminium, magnesium, alkalis, and may be barium cyanide, made the amount of barium oxide formed by calcination appear too low. The general formula $\text{M}(\text{OH})_2 \cdot 8\text{H}_2\text{O}$ is now considered to represent correctly the composition of these two hydrates.

According to C. Neuberg and E. Neimann, when ethyl alcohol and water are added to a methyl alcohol soln. of barium oxide, the octohydrate separates in well-formed needles, which differ from the crystals of the ordinary octohydrate in losing a mol. of water over phosphorus pentoxide.

In vacuo, or in dry air, C. L. Bloxam, and E. Beckmann found the crystals lose seven-eighths of their water, forming what they regarded as **monohydrated barium hydroxide**, $\text{Ba}(\text{OH})_2 \cdot \text{H}_2\text{O}$, which, when moistened, again forms the octohydrate with the development of heat. R. de Forcrand prepared the monohydrate by dissolving barium oxide in aq. methyl alcohol, and drying the resulting product, $\text{Ba}(\text{OH})_2 \cdot 2\text{CH}_3\text{OH}$, in vacuo. J. C. H. Meyer, and H. Lescœur obtained **monohydrated strontium hydroxide** by drying the octohydrate in vacuo; and R. Finkener by heating it to 50° . R. de Forcrand found that by heating octohydrated strontium hydroxide to 45° – 50° in a stream of hydrogen, the monohydrate is formed; if the temp. is 95° , the hydroxide $\text{Sr}(\text{OH})_2$ appears. Again, 15 hours' exposure of octohydrated barium hydroxide in a stream of hydrogen at 45° gives the monohydrate; while an hour at 95° gives $\text{Ba}(\text{OH})_2$. W. Müller-Erzbach's vap. press. measurements at 15° , correspond with the passage of octohydrated strontium hydroxide to *dihydrated strontium hydroxide*, $\text{Sr}(\text{OH})_2 \cdot 2\text{H}_2\text{O}$, and thence to the monohydrate; but the dihydrate has not yet been isolated. M. Karcz, and A. Herzfeld prepared **monohydrated calcium hydroxide** by dissolving calcium oxide in air-free distilled water, and allowing the soln. to stand some days at 60° ; the crystals which separated were dried over potassium hydroxide. The crystals lost part of their water at ordinary temp., and all between 60° and 70° . O. Bauer prepared **trihydrated barium hydroxide**, $\text{Ba}(\text{OH})_2 \cdot 3\text{H}_2\text{O}$, by gradually raising the temp. of the octohydrate, the molten salt begins to boil at 103° , and at 108.5° , crystals of the trihydrate separate out. In dry air the trihydrate forms the monohydrate. W. Artus claimed to have made crystals of the **hexadecahydrated barium hydroxide**, $\text{Ba}(\text{OH})_2 \cdot 16\text{H}_2\text{O}$. E. J. Maumené was not right in saying that the water content of the hydrates of barium hydroxide does not follow the law of constant proportion.

The hydroxides of the alkaline earths are all soluble in water, and the soln. form the so-called *lime-water* (*eau de chaux*, *Kalkwasser*), *strontia-water*, and *baryta-water* respectively. These liquids are clear and colourless; they have an acrid taste; and react alkaline towards vegetable colouring agents, and, according to M. Pettenkofer,³ this the more strongly the greater the mol. wt. of the base. The aq. soln. rapidly becomes covered with a film of the carbonate on exposure to air. The so-called *milk of lime* and *cream of lime* (*lait de chaux*, *Kalkmilch*) are not soln. but mixtures of lime-water with different proportions of undissolved calcium hydroxide.

Lime-water is made by stirring an excess of slaked lime with water, and decanting the clear liquid out of contact with the air. Lime made from native carbonate may contain sodium and potassium salts, and in order to eliminate the latter, A. Vogel, and F. Kuhlmann recommend rejecting the first liquid after the residue, and treating the solid with a fresh portion of water.

V. Kohlschütter and G. Walther⁴ have studied the rate of hydration of calcium oxide, and the rate of settling of the hydroxide in aq. soln. of various salts—sodium hydroxide, chloride, acetate, and carbonate; potassium chloride, nitrate, and thiocyanate; calcium chloride, and nitrate; ammonia; and ammonium oxalate. Dil. soln. of some salts increase while conc. soln. decrease the velocity of sedimentation; and other salts act in the converse way. The velocity of sedimentation is greater when water is added to quicklime than conversely; there is a difference with lime slaked by water and by lime-water.

When quicklime is slaked: $\text{CaO} + \text{H}_2\text{O} = \text{Ca}(\text{OH})_2$, and a very slight excess of water is employed, the product of the reaction, according to P. P. von Weimarn, assumes a colloidal form. V. Kohlschütter and G. Walther showed that it is probable that an intermediate colloidal state is assumed in the production of a

soln. of calcium hydroxide in water. B. Kosmann holds that the slaking of lime is an operation involving the step-by-step production of the following (imaginary) compounds: $\text{Ca}(\text{OH})_2 \rightarrow \text{H}\text{Ca}(\text{OH})_3 \rightarrow \text{H}_2\text{Ca}(\text{OH})_4 \rightarrow \text{H}_3\text{Ca}(\text{OH})_5 \rightarrow \text{H}_4\text{Ca}(\text{OH})_6 \rightarrow \text{H}_5\text{Ca}(\text{OH})_7 \rightarrow \text{H}_6\text{Ca}(\text{OH})_8 \rightarrow \text{H}_7\text{Ca}(\text{OH})_9$. The setting of mortar probably consists in the loss of water by the colloid, just as the hardening of gelatinous silica or the drying of plastic clay is due to desiccation of colloidal matter. The drying of colloidal calcium hydroxide is accompanied by a considerable contraction in vol., and it cracks and loses its form. The shrinkage is lessened by the addition of sand, or other inert substance. The particles of sand become coated with a film of lime which adheres very tenaciously. The cohesion of the dried colloid, and its adhesion to the sand, impart mechanical strength to the mortar, and enable it to resist the tensile stresses during its shrinkage.

The slow hardening of mortar is not due to a reaction between lime and the silica of the sand, because no such reaction occurs; although, with the less pure forms of sand—containing felspathic matters, puzzolana, etc.—a reaction may occur. Some of the ancient mortars were made by mixing the slaked lime with puzzolana, and this accounts for the presence of combined silica in many of those which have been analyzed. In general, the essential process involved in the setting of mortar is the dissociation of the colloid. The so-called *sand-lime bricks* are really mortar bricks—made by mixing slaked lime with sand and water, moulding the mixture by press., and hardening the product, either by solar heat, or more usually by superheated steam. There is no satisfactory evidence that the lime and sand react chemically under the conditions of manufacture.

There are at least two secondary changes which may supervene on the primary setting by the desiccation of the colloid. (1) When mortar is exposed to moist air, it gradually forms crystalline calcium carbonate. The crystals are closely interlaced and form a coherent mass. The mortar is thus hardened. The induration of mortar by the formation of carbonate is a secondary process, and is confined to the outer layers of a mass of mortar, because the impervious coating hinders the access of carbon dioxide to the interior. The mortar from old Roman buildings, for instance, after 2000 years' exposure, consists mainly of calcium hydroxide with a superficial layer of carbonate. (2) The crystals of calcium hydroxide which are sometimes found in hardened mortar, are not due to the primary hardening, but owe their formation to the subsequent soln. of the calcium hydroxide in water and its re-deposition in the crystalline form.

Determinations of the solubility of calcium hydroxide in water have been made by J. Dalton,⁵ R. Phillips, L. Wittstein, and many others. As J. Dalton pointed out, the remarkable feature is the decrease in solubility which occurs with rise of temp.—usually the reverse obtains. As a result, R. Phillips showed that a precipitate appears when a sat. soln. is heated, and, added T. Graham, the crystalline deposit "is not diminished sensibly by being allowed to remain in soln. till it becomes cool, or was not re-dissolved on cooling." The composite results of the different observations which have been made with $\text{Ca}(\text{OH})_2$ as the solid phase, and expressed in grams of solute per 100 grms. of water, are:

	0°	10°	20°	40°	60°	80°	100°	120°	150°	190°
$\text{Ca}(\text{OH})_2$	0.185	0.176	0.165	0.141	0.116	0.094	0.077	0.041	0.022	0.011
CaO	0.140	0.133	0.125	0.107	0.088	0.071	0.058	0.031	0.017	0.008

A. Lamy claimed that the solubility of calcium hydroxide depends on the temp. of preparation of the anhydrous oxide. Thus, expressing the results in grams per litre, he reported:

	0°	15°	30°	60°	100°
Lime from nitrate	0.1362	0.1277	0.1142	0.0844	0.0562
Lime from marble	0.1381	0.1299	0.1162	0.0868	0.0576
Precipitated hydrate	0.1430	0.1348	0.1195	0.0885	0.0584

The time required to attain equilibrium between the liquid and solid phases may be different in these cases, and, consequently, A. Lamy may not in all cases have been

dealing with sat. soln. This may also explain how the measurements by different workers are not so concordant as might have been anticipated.

The determinations of the solubility of strontium hydroxide in water are not so numerous as is the case with calcium hydroxide. A. Bineau,⁶ and C. F. Bucholz made isolated determinations, and C. Scheibler and D. Sidersky measured the results over the range of temp. between 0° and 100·2°. The solubility curve is normal in that the solubility increases with rise of temp. Expressing the results in grams of solute per 100 grms. of soln., when the solid phase is $\text{Sr}(\text{OH})_2 \cdot 8\text{H}_2\text{O}$:

	0°	10°	20°	30°	40°	50°	60°	80°	100°
$\text{Sr}(\text{OH})_2 \cdot 8\text{H}_2\text{O}$	0·90	1·23	1·74	2·57	3·80	5·46	7·77	16·83	47·71
SrO	0·35	0·48	0·68	1·00	1·48	2·13	3·03	6·56	18·60

Isolated measurements of the solubility of barium hydroxide in water have been made by H. Davy, R. Osann, and A. Bineau. Determinations from 0° to the m.p. of the octohydrate, $\text{Ba}(\text{OH})_2 \cdot 8\text{H}_2\text{O}$, 78·65°, have been made by A. Rosenstiehl, where the octohydrate is the solid phase. Expressing the results in grams of the solute per 100 grms. of soln. :

	0°	10°	20°	30°	40°	50°	60°	75°	80°
$\text{Ba}(\text{OH})_2 \cdot 8\text{H}_2\text{O}$	1·65	2·42	3·74	5·29	7·60	11·61	17·32	38·85	50·35
BaO	1·48	2·17	3·36	4·75	6·85	10·5	15·8	36·2	47·6

The solubility in water thus increases with increasing mol. wt. of the hydroxide, for 100 parts of water dissolve respectively 0·128, 2·0, and 3·44 parts of calcium, strontium, and barium hydroxides. In this respect, the hydroxides are unlike the sulphates, chlorides, and nitrates, whose solubility increases with decreasing mol. wt. The m.p. of the octohydrate is indicated above. W. A. Tilden suggested that the great difference in the solubility of hydrated barium and strontium hydroxides on the one hand and of calcium hydroxide on the other hand, makes it probable that the former retain their hydrate-water when they pass into soln. H. F. Sill found the solubility of octohydrated barium hydroxide at 25° to be augmented by *pressure* : with a press. of one megabar (*i.e.* 1·02 kgrm. per sq. cm.) the solubility is 8·299 per cent. ; with 245 megabars press., 8·840 per cent. ; and with 490 megabars press., 9·366 per cent. ; he also found the temp. coeff. of the solubility to be 0·288 per cent.

The solubility of calcium hydroxide is greatly reduced in the presence of alkali hydroxides, so much so that L. Wittstein,⁷ and T. J. Pelouze stated that calcium hydroxide is not soluble in alkaline lye, and is precipitated from its aq. soln. by the alkali hydroxides. The effect of *potassium hydroxide* or *sodium hydroxide* on the solubility of calcium hydroxide has been measured by A. d'Anselme, at different temp. ; when the conc. is expressed in grams of solute per litre, he found :

NaOH.	0	0·4	1·6	2·66	5·0	8·0	20·0
CaO	20°	1·17	0·94	0·57	0·39	0·18	0·02
	110°	0·54	0·35	0·14	0·05	0·01	0·00

Aqua ammonia acts in a similar manner, but the effect is less pronounced than with the fixed alkalis. E. Maigret measured the simultaneous effect of both sodium hydroxide and chloride on the solubility of calcium hydroxide. F. A. H. Schreinemakers investigated the decrease in the solubility of barium hydroxide produced by increasing proportions of sodium hydroxide ; G. Bodländer, the effect of *alkali carbonates* and hydroxides on the solubility of calcium hydroxide.

A. A. Noyes and E. S. Chapin observed that the solubility of calcium hydroxide is augmented in the presence of *ammonium chloride*. Thus, at 25°, the solubility was raised from 0·150 grm. of $\text{Ca}(\text{OH})_2$ per 100 c.c. of soln. to 0·442 grm., when 0·447 grm. of ammonium chloride was present. M. Berthelot explained the increased solubility by assuming that a complex salt, $2\text{NH}_4\text{Cl} \cdot \text{Ca}(\text{OH})_2$, that is, $\text{Ca}(\text{NH}_3)_2\text{Cl}_2 \cdot 2\text{H}_2\text{O}$, is formed. C. J. B. Karsten found that calcium hydroxide dissolves more copiously in the presence of *sodium chloride* than in water alone ; and G. L. Cabot found that (i) the effect is still more marked with *potassium chloride* than with sodium chloride ; that (ii) at any assigned temp., the solubility increases

with the conc. of the alkali salt up to a certain limiting value corresponding approximately with one-fifth of the conc. of a sat. soln. of the alkali chloride and subsequently decreasing with increasing conc. of the alkali chloride, becoming, according to G. Kernot and co-workers, less than in water alone; and that (iii) for a given conc. of the alkali salt, the solubility decreases with rise of temp. The raising of the solubility is here conditioned partly by double decomposition, and partly by the formation of a complex calcium salt. W. Herz found the solubility of barium hydroxide to be increased by the *lithium, sodium, potassium, and rubidium chlorides*. The effect is greatest with lithium and least with rubidium chloride. C. J. B. Karsten also ascertained that the presence of *sodium nitrate* or *potassium nitrate* also increases the solubility of calcium hydroxide; and that an aq. soln. of calcium hydroxide gives a precipitate with *sodium sulphate* only when the soln. is quite sat. with that salt, while precipitated calcium hydroxide slowly dissolves in an aq. soln. of sodium sulphate at 15° to 19°, and is slowly transformed into dihydrated calcium sulphate, $\text{CaSO}_4 \cdot 2\text{H}_2\text{O}$ —glauberite, $\text{Na}_2\text{SO}_4 \cdot \text{CaSO}_4$, is also formed (*q.v.*). I. Herold has investigated the caustification of *potassium sulphate* by calcium hydroxide.

According to C. J. B. Karsten, *calcium chloride* raises the solubility of calcium hydroxide in water; and, according to B. Zahorsky, soln. with less than 10 per cent. of calcium chloride dissolve rather less calcium hydroxide than does water, but when the conc. of the calcium chloride soln. is greater than this, the solubility of calcium hydroxide is augmented because of the formation of what B. Zahorsky regards as *calcium trihydroxychloride*, $3\text{CaO} \cdot \text{CaCl}_2 \cdot 15\text{H}_2\text{O}$, or $3\text{Ca}(\text{OH})_2 \cdot \text{CaCl}_2 \cdot 12\text{H}_2\text{O}$, or $\text{Ca}_2(\text{OH})_3\text{Cl} \cdot 6\text{H}_2\text{O}$; he gives for the number of grams of calcium oxide dissolved in 100 c.c. of soln.:

	0	5	10	15	20	25	30 per cent. CaCl.
20° . . .	0.1374	0.1370	0.1661	0.1993	0.1857*	0.1661*	0.1630*
40° . . .	0.1162	0.1160	0.1419	0.1781	0.2249	0.3020*	0.3684*
60° . . .	0.1026	0.1020	0.1313	0.1706	0.2204	0.2989	0.3664
80° . . .	0.0845	0.0936	0.1328	0.1736	0.2295	0.3261	0.4122
100° . . .	0.0664	0.0906	0.1389	0.1842	0.2325	0.3710	0.4922

The results with water alone are higher than the standard values; and those marked with an asterisk were affected by the separation of any oxychloride from the soln. which lowered the amount of the dissolved calcium chloride. G. Lunge has discussed the part played by calcium chloride in W. Weldon's process for chlorine. F. A. H. Schreinemakers and T. Figeé have studied the ternary system $\text{H}_2\text{O} - \text{CaCl}_2 - \text{Ca}(\text{OH})_2$, and obtained two oxychlorides, $\text{Ca}(\text{OH})_2 \cdot \text{CaCl}_2 \cdot \text{H}_2\text{O}$, and $4\text{Ca}(\text{OH})_2 \cdot \text{CaCl}_2 \cdot 10\text{H}_2\text{O}$; F. A. H. Schreinemakers and J. Milikan, the systems $\text{CaCl}_2 - \text{CaO} - \text{H}_2\text{O}$, and $\text{CaBr}_2 - \text{CaO} - \text{H}_2\text{O}$; J. Milikan the system with *calcium iodide*, $\text{CaI}_2 - \text{CaO} - \text{H}_2\text{O}$; and of strontium hydroxide with *strontium chloride*, $\text{SrCl}_2 - \text{SrO} - \text{H}_2\text{O}$; *strontium bromide*, $\text{SrBr}_2 - \text{SrO} - \text{H}_2\text{O}$; and *strontium iodide*, $\text{SrI}_2 - \text{SrO} - \text{H}_2\text{O}$; and F. A. H. Schreinemakers and J. Milikan, the systems with barium oxide and *barium chloride*, $\text{BaCl}_2 - \text{BaO} - \text{H}_2\text{O}$; *barium bromide*, $\text{BaBr}_2 - \text{BaO} - \text{H}_2\text{O}$; and *barium iodide*, $\text{BaI}_2 - \text{BaO} - \text{H}_2\text{O}$ —vide the corresponding oxy-halides. F. K. Cameron and W. O. Robinson, and H. Bassett and H. S. Taylor have studied the ternary system with *calcium nitrate*, namely, $\text{CaO} - \text{Ca}(\text{NO}_3)_2 - \text{H}_2\text{O}$; C. L. Parsons and C. L. Perkins, the ternary system involving *strontium hydroxide* and *strontium nitrate*, namely, $\text{SrO} - \text{Sr}(\text{NO}_3)_2 - \text{H}_2\text{O}$; C. L. Parsons and H. P. Corson the system with *barium hydroxide* and *barium nitrate*, namely, $\text{BaO} - \text{Ba}(\text{NO}_3)_2 - \text{H}_2\text{O}$; and F. K. Cameron and J. M. Bell, the ternary system with *calcium sulphate*, namely, $\text{CaO} - \text{CaSO}_4 - \text{H}_2\text{O}$.

The addition of alcohol precipitates barium hydroxide from baryta water. E. Beckmann⁸ found that barium hydroxide is sparingly soluble in mixtures of alcohol and water. At room temp., 50 per cent. alcohol dissolves 0.43 per cent. of barium hydroxide. W. Rothmund measured the solubility of strontium hydroxide in aq. soln. containing $\frac{1}{2}N$ -proportions of the following substances—the given data are expressed in grams per 100 c.c. at 25°—water alone, 1.016; *methyl alcohol*,

0.997; *ethyl alcohol*, 0.905; *propyl alcohol*, 0.861; *tertiary amyl alcohol*, 0.766; *acetone*, 0.842; *ether*, 0.785; *glycol*, 1.121; *mannitol*, 2.429; *urea*, 0.997; *ammonia*, 0.955; *dimethylamine*, 0.713; and *pyridine*, 0.844.

According to W. Eidmann, calcium, strontium, and barium hydroxides are insoluble in *acetone* and in *methyl acetate*. W. Herz and M. Knock found the solubility of barium hydroxide in aq. acetone decreases as the proportion of water becomes less from 4.506 grms. of the solute in water at 25° to 0.018 grm. in water containing 70 per cent. of acetone by vol. They also determined the sp. gr. of the soln. The solubility of calcium hydroxide in *glycerol* has been measured by M. Berthelot, P. Carles, F. K. Cameron and H. E. Patten, W. Herz and M. Knock. The latter found at 25°:

Glycerol	. 0	7.15	20.44	31.55	40.95	48.7	69.2	per cent.
Ca(OH) ₂	. 0.1593	0.3013	0.5522	0.8339	1.486	1.631	3.550	grms. per 100 c.c.
CaO	. 0.1206	0.2281	0.4180	0.6313	1.125	1.234	2.687	grms. per 100 c.c.

They also measured the sp. gr. of the soln. F. K. Cameron and H. E. Patten found that at 25° the solid phase is always calcium hydroxide, although a complex is probably formed in the soln.; and that the increase in the solubility of calcium hydroxide in aq. soln. of glycerol over that in water, is directly proportional to the conc. of the glycerol. W. Rothmund found a $\frac{1}{2}N$ -soln. of glycerol dissolves 1.331 grms. of strontium hydroxide per 100 c.c.

The solubility of calcium hydroxide in aq. soln. of *sugar* has attracted much attention on account of the use of lime in the defecation of sugar. The solubility in a soln. of sugar is much greater than in water. The solubility has been measured by E. M. Péligot, T. J. Pelouze, P. H. Déon, J. Weisberg, etc. The ratio of lime to sugar in the soln. varies almost continuously with the composition of the soln., but M. Berthelot showed that this ratio does not vary proportionally, in consequence of the formation of different compounds in the soln., e.g. calcium trisucrate, etc. Whatever compound is formed in the soln. is broken down by water, and F. K. Cameron and H. E. Patten showed that the solid phase in the ternary system, CaO-sugar-H₂O, is one of a series of solid soln. with calcium hydroxide as a limiting or end-member. They also measured the sp. gr. of the soln. F. K. Cameron and H. E. Patten's results at 25°, in grams per 100 grms. of soln., are:

Sugar	. 0	0.62	4.82	7.50	11.90	17.42	19.86
Ca(OH) ₂	. 0.117	0.188	0.730	1.355	3.21	5.38	6.07

H. Claasen has studied the various factors which influence the solubility of calcium hydroxide in soln. of sugar. J. Weisberg showed that the apparent solubility is affected by the condition of the calcium compound employed—e.g. whether the oxide, hydroxide, or milk of lime is added to the sugar soln.—the anhydride seems to be the most soluble. The solubility is less as the temp. rises, thus, P. J. H. van Ginneken found at 80°:

Sugar	. 0.90	9.90	14.75	19.50	24.60	29.70
Ca(OH) ₂	. 0.154	0.249	0.303	0.341	0.723	1.341

grams per 100 grms. of soln. The alleged calcium trisucrate present in the soln. is supposed by E. Boivin and D. Loiseau to be less soluble hot than cold. The lime is precipitated on boiling the soln. With strontium hydroxide, 100 grms. of a soln. containing 10 grms. of sugar were found by C. Scheibler to dissolve 1.21 grms. of strontium oxide at 3°; 1.41 grms. at 15°; 1.87 grms. at 24°; and 3.58 grms. at 40°. The lime is precipitated on boiling the soln. G. J. van Meurs has measured the solubility of calcium, strontium, and barium hydroxides in aq. soln. of *phenol*.

Slaked lime is a white amorphous or colloidal powder. According to H. le Chatelier,⁹ crystallized slowly, as in the hydrations of cements, it forms large well-developed crystals which may be recognized by the microscope. As previously indicated, the crystals of calcium hydroxide are probably dimorphous—rhombohedral and trigonal. According to G. Rose, the latter are possibly isomorphous with brucite,

Mg(OH)₂. The crystal forms of barium and strontium hydroxides have not been established. According to H. J. Brooke, the crystals of octohydrated strontium hydroxide belong to the tetragonal system with the axial ratio $a : c = 1 : 0.6407$, and this is in agreement with the observations of A. Eppler, and of G. B. von Foulon. The latter also found the crystals of octohydrated barium hydroxide to be monoclinic prisms, with axial ratios $a : b : c = 0.9990 : 1 : 1.2779$, and $\beta = 98^\circ 56'$. These crystals have pseudo-tetragonal symmetry, and were once thought to be isomorphous with the corresponding strontium compound. O. Bauer found the needle-like crystals of trihydrated barium hydroxide are six-sided prisms belonging to the rhombic system, with axial ratios $a : b : c = 0.58905 : 1 : 0.78038$.

A. Lamy¹⁰ found that the **specific gravity** of crystals of calcium hydroxide was 2.239, and when prepared at 60°, 2.236; E. Filhol found 2.078 for calcium hydroxide, 3.625 for strontium hydroxide, and 4.495 for barium hydroxide. The sp. gr. of octohydrated strontium hydroxide was also found by E. Filhol to be 1.911 at 16°; and of the corresponding barium compound, 2.188 at 16°; while A. Eppler gave 1.885 for the former, and 2.080 for the latter. According to J. A. Wanklyn, the sp. gr. of a soln. of 1.344 grms. of calcium oxide in a litre of water is 1.002 at 13°, so that the resulting contraction is eq. to three times the volume of the solute. The sp. gr. of milk of lime has been determined by E. Mategcek, and G. Lunge, and the following is a selection of the results for 15° :

Grms. CaO per litre	11.7	62.5	126.0	190.0	255.0	321.0
Sp. gr.	1.01	1.05	1.099	1.15	1.20	1.25

F. Kohlrausch found the sp. gr. of an aq. soln. containing 2.3 grms. of Ba(OH)₂.8H₂O in 100 grms. of soln. at 18°, to be 1.0120; and with 4.60 grms. per litre, 1.0252. M. M. Haff has measured the sp. gr. of soln. of barium hydroxide at 8°. C. L. Parsons and H. P. Corson found 1.0512 for the sp. gr. of a sat. aq. soln. with 4.29 grms. of barium hydroxide per 100 grms. of water at 25°, and they measured the sp. gr. of soln. with varying proportions of barium hydroxide and nitrate; and C. L. Parsons and C. L. Perkins measured the sp. gr. of soln. of strontium hydroxide and nitrate. G. A. Carse's data are given in Table I. H. F. Sill found the change in the sp. vol. during the soln. of octohydrated barium hydroxide is 0.0508 c.c. per gram. G. A. Carse measured the **contraction on solution**, that is, the difference in the vol. of soln. of barium and strontium hydroxides, and of the water used in its preparation; and also the **thermal expansion** of the soln. The results are indicated in Table I. The vol., v , of a gram of soln. at θ° is indicated and the difference between v and the volume v' of the water in a gram of soln. at θ° , namely, $v - v'$, is indicated in the last column of the Table.

TABLE I.—THERMAL EXPANSION OF AQUEOUS SOLUTIONS AND THE CONTRACTION ON SOLUTION OF BARIUM AND STRONTIUM HYDROXIDES.

Strontium hydroxide.					Barium hydroxide.				
Conc.	θ° .	Sp. gr.	v .	$v - v'$.	Conc.	θ° .	Sp. gr.	v .	$v - v'$.
0.32744	15	1.00363	0.99639	-0.00120	0.89387	15	1.01079	0.98933	-0.00259
"	20	1.00263	0.99738	-0.00110	"	20	1.00998	0.99010	-0.00271
"	26	1.00114	0.00886	-0.00106	"	26	1.00847	0.99160	-0.00263
"	30	0.99996	1.00004	-0.00101	"	30	1.00721	0.99285	-0.00252
0.12162	15	1.00072	0.99923	-0.00042	0.08212	15	1.00000	1.00000	-0.00005
"	20	0.99971	1.00029	-0.00026	"	20	0.99913	1.00087	-0.00008
"	26	0.99831	1.00169	-0.00028	"	26	0.99766	1.00234	-0.00004
"	30	0.99708	1.00293	-0.00020	"	30	0.99656	1.00345	-0.00007
0.02354	15	0.99946	1.00054	-0.00009	0.04303	15	0.99957	1.00043	-0.00001
"	20	0.99849	1.00151	-0.00002	"	20	0.99870	1.00130	-0.00004
"	26	0.99700	1.00306	+0.00010	"	26	0.99728	1.00273	-0.00003
"	30	0.99600	1.00432	+0.00021	"	30	0.99611	1.00390	-0.00002

The conc. of the soln. are expressed as grams of hydroxide per 100 grms. of soln. The sp. vol. v of the soln. at θ° , is represented by the formula $v=v_0\{1+a(\theta-15)+b(\theta-15)^2+c(\theta-15)^3\}$, where v_0 denotes the sp. vol. at 15° . The a , b , and c for the two hydroxides are :

Conc. . . .	Sr(OH) ₂			Ba(OH) ₂		
	0.3274	0.1216	0.0235	0.8939	0.0821	0.0430
$a \times 10^6$. . .	+180	+220	+165	+97	+130	+143
$b \times 10^8$. . .	+340	+410	+600	+1200	+980	+630
$c \times 10^9$. . .	+50	+380	-12	-180	-210	-28

The coeff. of thermal expansion, α , can be readily calculated for 15° , 20° , 26° , and 30° , since $\alpha=(dv/d\theta)/v$. S. F. Glinka found the **hardness** of crystals of calcium hydroxide to be between 2 and 3. O. Bauer gives 2.5 for the hardness of the crystals of trihydrated strontium hydroxide.

H. Rose found that when calcium hydroxide is heated, no water is lost at 100° , but at 400° , about 30 per cent. of the combined water is given off. All the water can be expelled without the hydroxide melting. H. le Chatelier found the **vapour pressure** of calcium hydroxide at 300° to be 100 mm., and at 450° , 760 mm. Both C. F. Buchholz and D. Smith observed that strontium hydroxide loses its combined water and passes into strontia when it is heated. A. Herzfeld and C. Stiepel found that strontium hydroxide dried in vacuo at 110° , loses 3 per cent. of water after one hour's heating at 590° ; 14 per cent. at 650° ; and all the combined water is lost at 710° . E. Filhol observed that barium hydroxide melts to an oily-liquid when heated, and C. F. Buchholz and A. F. Gehlen found that if no carbon dioxide be present, barium hydroxide loses no water when calcined to a high temp., but H. Abich found that water could be expelled by heat. W. Dittmar, indeed, observed that in a stream of air, at a bright red-heat, all the water is expelled, and barium monoxide or dioxide is formed. H. Lescœur found the vap. press. of the hydroxide in vacuo at 100° to be extremely small. In further illustration of the increasing affinity of the hydroxide for water with increasing mol. wt., octohydrated strontium hydroxide forms the monohydrate with a slight elevation of temp., octohydrated barium hydroxide forms the trihydrate at 109° , and this in dry air forms the monohydrate. Monohydrated barium hydroxide forms the hydroxide at a dull red heat, while the conversion with monohydrated strontium hydroxide occurs at 100° . J. Johnston found the dissociation press. of the three hydroxides to be :

Diss. press. . . .	0.0229	0.0724	0.196	0.467	1.00 atm.
Temp. { Ca(OH) ₂ . . .	389°	428°	468°	507°	547°
{ Sr(OH) ₂ . . .	488°	561°	634°	706°	778°
{ Ba(OH) ₂ . . .	670°	749°	829°	910°	998°

The free energy F of the reactions when F is defined by $F=-W+\Sigma pv$, where W stands for the maximum work produced by the change, and Σpv , for the change in the sum of the pv terms for each part of the system, then for the reaction involving $\text{Ca(OH)}_2 \rightarrow \text{CaO}$, F is 16,430 cal.; for $\text{Sr(OH)}_2 \rightarrow \text{SrO}$, 19,700 cal.; and for $\text{Ba(OH)}_2 \rightarrow \text{BaO}$, 23,360 cal. For the vap. press. of the transition $0.1\text{-H}_2\text{O}$, with calcium oxide, H. W. Foote and S. R. Scholes gave 0.8 mm.

According to C. L. Bloxam, C. Heyer, R. Finkencr, and W. Müller-Erbach, the crystals of octohydrated strontium hydroxide lose seven-eighths of their water of crystallization in vacuo, or in dry air, and form the monohydrated hydroxide; and octohydrated barium hydroxide under similar conditions also furnishes the monohydrate. R. de Forcrand found that a week's exposure of octohydrated strontium hydroxide in vacuo furnishes the monohydrate, while a month's exposure furnishes Sr(OH)_2 ; while ten days' exposure of octohydrated barium hydroxide under similar conditions produces the monohydrate, and no more change occurs during many weeks' exposure. C. F. Buchholz found that the crystals of octohydrated strontium hydroxide lose all their water of crystallization when heated, without their melting; D. Smith found the water of crystallization can be expelled at

100°. According to O. Bauer, when octohydrated strontium hydroxide is warmed slightly, it passes without fusion into the monohydrate, and the latter passes into the anhydrous hydroxide below 100°. W. Müller-Erbach found the vap. press. $\text{Sr}(\text{OH})_2 \cdot 8\text{H}_2\text{O} \rightarrow \text{Sr}(\text{OH})_2 \cdot 2\text{H}_2\text{O}$ to be 9.4 mm.; $\text{Sr}(\text{OH})_2 \cdot 2\text{H}_2\text{O} \rightarrow \text{Sr}(\text{OH})_2 \cdot \text{H}_2\text{O}$ to be 3.2 mm.; and $\text{Sr}(\text{OH})_2 \cdot \text{H}_2\text{O} \rightarrow \text{Sr}(\text{OH})_2$ to be 0 mm. He concluded that hydrates with 8, 7, 2, and 1 H_2O are formed—but there is no evidence of the existence of the di- or hepta-hydrated hydroxide. H. Lescœur found the vap. press. of the octohydrate to be 5.6 mm. at 20°.

Octohydrated barium hydroxide was found by D. Smith to melt in its water of crystallization at 100°, but this temp. is too high. A. Rosenstiehl gave 78.5° for the melting point; O. Bauer, 78°; V. H. Veley, 83° to 85°; and T. W. Richards and J. B. Churchill, 79.9°–80°. D. Smith and C. L. Bloxam found seven mols of water are lost at the m.p., but E. Beckmann found that all is expelled at this temp. W. Müller-Erbach found the vapour pressure of $\text{Ba}(\text{OH})_2 \cdot 8\text{H}_2\text{O}$ to be 11.4 mm.; $\text{Ba}(\text{OH})_2 \cdot 3$ to 7 H_2O , 2.46 mm.; $\text{Ba}(\text{OH})_2 \cdot 2\text{H}_2\text{O}$, 1.3 mm.; and $\text{Ba}(\text{OH})_2 \cdot \text{H}_2\text{O}$, 0 mm.—all at 15°. He therefore inferred the formation of hydrates with 1, 2, 7, and 8 H_2O . The existence of the di- and hepta-hydrates has not been confirmed, although O. Bauer isolated the tri-hydrate. According to O. Bauer, the octohydrate furnishes crystals of the trihydrate when heated to 108.5° and slowly cooled; the trihydrate passes into the monohydrate at about 100°; and at about 550°, the anhydrous hydroxide is formed. On comparing these results with the behaviour of hydrated strontium hydroxide, and remembering that calcium hydroxide does not form a well-defined stable hydrate, it follows that with increasing at. wt., the three metals of the alkaline earths show an increasing tendency to form hydrated hydroxides. H. Lescœur found the vap. press. of the octo- and mono-hydrates of barium hydroxide, at different temp., to be :

	13.5°	20°	35.5°	58°	70°	74.5°	100°
$\text{Ba}(\text{OH})_2 \cdot 8\text{H}_2\text{O}$.	4.5	5.5	20.5	84	124	213	530 mm.
$\text{Ba}(\text{OH})_2 \cdot \text{H}_2\text{O}$.	<1	1	1	1	1	14	15 mm.

He also found at 100°, the results indicated in Fig. 10. The molecular heat was found by W. Nernst and F. Schwerns to be 5.09 at -187° , and 0.493 at -251.6° .

O. Bauer found that the boiling point of molten octohydrated barium hydroxide is 108.5° when it contains 49.05 per cent. of baryta; at 105°, 52.43 per cent. of baryta; at 107°, 55.35 per cent. of baryta; and at 109°, 61.44 per cent. of baryta, the crystals of the trihydrate then separate. F. Guthrie found the freezing point of the cryohydrate of calcium hydroxide to be -0.15° with 1116 mols of water; of strontium hydroxide, -0.1° with 1463 mols of water; and of barium hydroxide, -0.5° with 565 mols of water. W. Nernst and F. Schwerns found the molecular heat, C_p , of calcium hydroxide to be 5.09 at 86° K., and 0.493 at 21.4° K.

H. Moissan¹¹ gave for the heat of formation of calcium hydroxide (Ca , O_2 , H_2), 229.1 Cals., and for sat. soln. of the same, 232 Cals. J. Thomsen gave for the heat of formation (Ca , O_2 , H_2), 146.46 Cals.; for (Ca , O , aq.), 149.46 Cals.; for (Sr , O , H_2O), 148.18 Cals.; for (Sr , O , aq.), 157.78 Cals.; for (Ba , O , H_2O), 148.00 Cals.; and for (Ba , O , aq.), 158.26 Cals. A. Guntz gave for the reaction, $\text{Ba} + n\text{H}_2\text{O}_{\text{liquid}} = \text{Ba}(\text{OH})_{2aq} + \text{H}_2 + 92.5$ Cals. at 16°. M. Berthelot gave (CaO , H_2O), 15.1 Cals.; J. Thomsen gave (SrO , H_2O), 17.70 Cals.; (BaO , H_2O), 22.26 Cals.; and M. Berthelot, (BaO , H_2O), 17.6 Cals. J. Johnston found the free energy of the reaction;

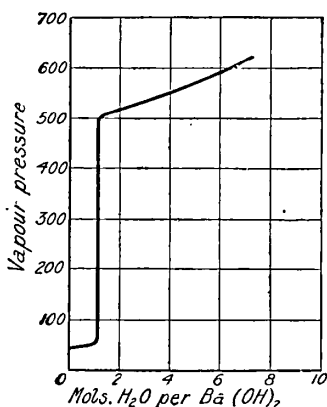

FIG. 10.—Vapour Pressure in the System $\text{Ba}(\text{OH})_2\text{—H}_2\text{O}$.

calcium hydroxide to oxide at 25° is 16.43 Cals.; for strontium hydroxide, 19.7 Cals.; and for barium hydroxide, 23.36 Cals.; J. Thomsen, (CaO, H₂O), 15.54 Cals.; (CaO, aq.), 18.33 Cals.; for (SrO, aq.), 29.34 Cals. R. de Forcrand found for the heat of soln. of Sr(OH)₂.8H₂O, -14.27 Cals.; for Sr(OH)₂.H₂O, 5.26 Cals.; for Sr(OH)₂, 10.33 Cals.; for SrO.0.14H₂O, 26.10 Cals.; and for SrO, 29.76 Cals. J. Thomsen gave for (BaO, aq.), 34.52 Cals. R. de Forcrand found for the heat of soln. of Ba(OH)₂.8H₂O, -14.5 Cals.; for Ba(OH)₂.H₂O, 7.06 Cals.; for Ba(OH)₂, 11.40 Cals.; and for BaO, 35.64 Cals. J. Thomsen suggested M. Berthelot's oxide still retained some carbon dioxide; and he gave for the heat of solution of calcium hydroxide, (Ca(OH)₂, aq.), 2.79 Cals. M. Berthelot gave 3.0 Cals. at 15°. J. Thomsen gave (Sr(OH)₂, aq.), 11.4 Cals.; (Ba(OH)₂, aq.), 18.33 Cals.; (Sr(OH)₂.8H₂O), 26.28 Cals.; (Sr(OH)₂.8H₂O, aq.), 14.64 Cals.; and (Ba(OH)₂.8H₂O), 27.47 Cals. For the heat of soln. of the octohydrate J. Thomsen gave (Ba(OH)₂.8H₂O, aq.), -15.21 Cals., or 46.0 cal. per gram of solute; and R. de Forcrand, -14.5 Cals., or 48.2 cal. per gram of solute. H. F. Sill found 51.2 cal. for the heat of soln. of octohydrated barium hydroxide at the saturation point.

According to W. Crookes,¹² while barium oxide gives scarcely any phosphorescence in the cathode rays, barium hydroxide phosphoresces with a bright orange-yellow glow. The bright glow of lime when heated in the blowpipe flame was mentioned by D. Brewster—*vide* incandescent mantle, Vol. 5. T. Drummond noted that when lime, zirconia, and magnesia cylinders are heated in the oxy-hydrogen blowpipes, the relative intensities were 37, 31, and 16 times the intensity of the light from an argand burner. The index of refraction of crystallized calcium oxide is 1.8. E. Duter found that during the electrolysis of baryta water less oxygen is given off than corresponds with the hydrogen—this is attributed to the formation of barium or hydrogen dioxide.

The electrical conductivities of aq. soln. of calcium, strontium, and barium hydroxides have been measured by S. Arrhenius, F. Kohlrausch, etc. For a soln. containing a mol of hydroxide in *v* litres of water, W. Ostwald's values for the mol. conductivity, μ , at 25°, are:

<i>v</i>	8	16	32	64	128	256	512	1024
μ -Ca(OH) ₂	—	—	—	406	426	447	455	—
μ -Sr(OH) ₂	—	—	405	419	432	446	451	452
μ -Ba(OH) ₂	372	392	410	429	448	461	465	469

These hydroxides are therefore strongly ionized in dil. soln., and this corresponds with their strong basic characteristics. A. A. Noyes has measured the eq. conductivities of soln. of different conc. at different temp. Data for the transport numbers of soln. of calcium hydroxide were given by W. Bein, and for strontium and barium hydroxides, by J. F. Daniell.

S. Marsh has studied the electrolysis of soln. of barium hydroxide with an alternating current of varying frequency by means of electrodes of gold, platinum, and nickel. The vol. of gas evolved is greater than in soln. of sulphuric acid. The rate of evolution of gas increases with time, and increasing frequency. With gold and platinum electrodes, the rate of evolution of gas falls off rapidly with time, but for frequencies less than 48, gas is still given off; with nickel electrodes very small quantities of hydrogen are given off with 60 cycles, and with 40 cycles the vol. of gas given off is too small to measure. It is assumed that the electrode is oxidized and subsequently reduced by the hydrogen of the next half-period; and that hydrogen is absorbed and adsorbed by the electrode and oxidized by the oxygen of the next half-period. F. Tiemann argued that because the electrolysis of soln. of barium hydroxide gives no hydrogen dioxide, and because of the formation of the calcium saccharates, it is likely that the hydroxides of the alkaline earths are better formulated RO.H₂O, than R(OH)₂. P. Pascal found the mol. coefficient of magnetization of Ba(OH)₂.8H₂O to be -1569×10^{-7} units.

The hydroxides of the alkaline earths react with acids like strong bases, forming

characteristic salts. When calcium hydroxide is exposed to air, it absorbs carbon dioxide, and the crystals of the former compound become opaque. According to V. H. Veley,¹³ J. Kolb, and H. Debray, carbon dioxide is not absorbed to any appreciable extent at ordinary temp. by calcium, strontium, or barium hydroxide if moisture be rigorously excluded. J. C. Whetzel studied the effect of exposure to air on hydrated and quicklime; in both cases a thin layer of protective carbonate is formed. According to N. Tarugi, when a mixture of calcium oxide and water (3:1 by weight) is allowed to stand exposed to the air, some calcium peroxide is formed. The action of carbon dioxide has been previously discussed; the action of carbon dioxide on soln. of the hydroxides of the alkaline earths is discussed in connection with that gas. Baryta water is a very sensitive reagent for carbon dioxide, since the resulting barium carbonate has a very low solubility. E. Beckmann found that carbon dioxide does not react with barium oxide below 120°, but near 500° the reaction is quantitative. J. J. Berzelius said that when barium hydroxide is heated on charcoal, it fuses with violent effervescence, sinks into the charcoal, and forms a hard mass. D. Walker found that when carbon disulphide is agitated with milk of lime, orange crystals of $\text{CaCS}_2 \cdot 2\text{Ca}(\text{OH})_2 \cdot 6\text{H}_2\text{O}$ are formed; while G. Chancel and F. Parmentier found baryta water at 100° reacts: $\text{CS}_2 + 2\text{Ba}(\text{OH})_2 = \text{BaCO}_3 + \text{Ba}(\text{SH})_2 + \text{CO}_2$. C. Bunge studied the action of barium hydroxide on glass, and found that glass made from sulphates furnished an insoluble crust containing barium sulphate. By heating calcium hydroxide with carbon (anthracite coal dust), H. Vogel obtained results pointing to a reaction: $2\text{Ca}(\text{OH})_2 + \text{C} = 2\text{CaO} + \text{CO}_2 + 2\text{H}_2$; F. Stolba also found hydrogen is evolved when calcium hydroxide is heated with iron filings, and if the hydroxide is mixed with carbonate, carbon monoxide, as well as hydrogen, is given off. According to M. Müller, lead tubes are attacked by soln. of calcium hydroxide only in the presence of oxygen; carbon dioxide played no part in the reaction. J. K. Weisberg found dry barium hydroxide does not absorb chlorine, but in contact with water it takes up a quantity of chlorine, increasing with the proportion of water, until a mol of barium hydroxide has taken up a mol of chlorine. Very little hypochlorite is formed, nearly all the chlorine being in the form of chloride or chlorate: $6\text{BaO} + 6\text{Cl}_2 = 5\text{BaCl}_2 + \text{Ba}(\text{ClO}_3)_2$. The action of chlorine on strontium hydroxide is similar—*vide* bleaching powder (2. 19, 4). For the action of sulphur, see the corresponding sulphides. A. Geuther found that at ordinary temp. barium hydroxide is partially decomposed by phosphoryl chloride, and when heat is applied, hydrogen chloride is evolved. The reaction is not completed by a prolonged heating on a water-bath. Some barium phosphate is formed. Calcium hydroxide was found by A. Terreil to attack antimony trisulphide in the wet way, while barium and strontium hydroxides have no action—*vide supra* for the oxides.

The so-called soda-lime is a mixture of calcium and sodium hydroxides made by stirring lime into the molten caustic alkali; and breaking up the cold cake. It is used as an absorbent for moisture, carbon dioxide, etc. It was also employed in admixture with sodium permanganate, and in conjunction with charcoal, in gas masks to absorb the poison gases introduced by the Germans in the Great War. The composition and properties of soda-lime were investigated by A. B. Lamb, R. E. Wilson, and N. K. Chaney.¹⁴ For general toxic gas absorption, 5 per cent. of alkali and 10–13 per cent. of water are recommended; for carbon dioxide absorption, 4–5 per cent. of alkali and 16–19 per cent. of water is best; and for chlorine absorption, 8–9 per cent. alkali is recommended. A mixture of 4 per cent. sodium hydroxide, 4 per cent. kieselguhr, and the remainder lime, with a final water content of 12 per cent., is recommended as an all-round absorbent for industrial gases.

REFERENCES

- ¹ B. Pelletier, *Ann. Chim. Phys.*, (2), 23. 217, 1823; V. A. Jacquelin, *ib.*, (3), 32. 204, 1851; J. L. Gay Lussac, *ib.*, (2), 63. 220, 1836; W. Lenz, *Zeit. öffentl. Chem.*, 3. 82, 1897; K. Kortum, *Voigt's Neues Mag.*, 2. 69, 1812; F. Göbel, *Schweigger's Journ.*, 58. 488, 1830; J. W. Döbereiner, *ib.*, 6. 367, 1912; P. Heinrich, *Die Phosphoreszenz der Körper*, Nürnberg, 573, 1811; *Journ. Phys.*, 71. 307, 1810; C. J. D. von Grothuis, *Journ. Phys.*, 45. 398, 1794; A. Pleischl, *Zeit.*

Phys. Math., 2. 315, 1827; R. Wagner, *Chem. Centr.*, 239, 1871; L. Reuter, *Pharm. Rev.*, 23. 125, 1905; J. Dalton, *A New System of Chemical Philosophy*, Manchester, 2. 331, 1810; J. J. Berzelius, *Stockholm Akad. Handl.*, 93, 1842; A. L. Lavoisier, *Opuscules physiques et chimiques*, Paris, 1774; A. Herzfeld, *Zeit. Ver. Rübenzuckerind.*, 820, 1897; *Tonind. Ztg.*, 22. 374, 1898; H. Rose, *Pogg. Ann.*, 86. 2, 80, 1852; H. Moissan, *Compt. Rend.*, 128. 384, 1899; P. Lebeau, *ib.*, 138. 1496, 1904; T. J. Pelouze, *ib.*, 33. 53, 1851; E. Candlot, *Bull. Soc. d'Enc.*, (4), 5. 685, 1890; P. Rohland, *Zeit. anorg. Chem.*, 21. 28, 1899; *Ber.*, 33. 2831, 1900; G. Oddo, *Atti Accad. Lincei*, (5), 1. 361, 1896; E. de M. Campbell, *Journ. Ind. Eng. Chem.*, 1. 665, 1909; S. T. Briggman, *Eng. News*, 50. 177, 1903; 51. 543, 1904; C. Warner, *ib.*, 50. 320, 544, 1903; 52. 220, 1904; S. V. Poppel, *Rock Products*, 3. 1, 17, 1903; F. Mohr, *Arch. Pharm.*, (2), 88. 38, 1856; R. Heinz, *Chem. Ztg.*, 25. 199, 1901; D. Smith, *Phil. Mag.*, (3), 9. 87, 1836; C. F. Bucholz, *Gehlen's Journ.*, 4. 128, 1807; A. L. Day, E. S. Shepherd, and F. E. Wright, *Amer. Journ. Sci.*, (4), 22. 265, 1906; M. H. van Laar, *Rec. Chim. Trav. Pays-Bas*, 39. 301, 1920.

² A. Lamy, *Ann. Chim. Phys.*, (5), 14. 145, 1878; J. L. Gay Lussac, *ib.*, (2), 1. 334, 1816; H. Lesœur, *ib.*, (6), 19. 65, 1890; R. Phillips, *ib.*, (2), 17. 213, 1821; *Ann. Phil.*, (2), 1. 107, 1821; *Journ. Pharm. Chem.*, (2), 21. 150, 1835; E. Filhol, *ib.*, (3), 7. 271, 1845; *Journ. prakt. Chem.*, (1), 36. 37, 1845; *Ann. Chim. Phys.*, (3), 21. 155, 1847; O. Luedecke, *Zeit. Ges. Nat. Halle*, 58. 282, 1885; *Zeit. Kryst.*, 11. 255, 1886; E. Weinschenk, *Chem. Min.*, 587, 1905; S. Glinka, *Journ. Russ. Phys. Chem. Soc.*, 17. 541, 1885; *Bull. Soc. Min.*, 10. 63, 1887; G. Rose, *Sitzber. Akad. Berlin*, 582, 1860; H. Rose, *Pogg. Ann.*, 86. 283, 1852; C. L. Bloxam, *Journ. Chem. Soc.*, 13. 48, 1859; D. Smith, *Phil. Mag.*, (3), 9. 87, 1836; H. M. Noad, *ib.*, (3), 11. 301, 1837; (3), 12. 52, 1838; F. Guthrie, *ib.*, (5), 6. 35, 105, 1879; M. Anfrye and J. P. J. d'Arceet, *Gehlen's Journ.*, 3. 325, 1804; M. Kirchhoff, *ib.*, 4. 658, 1804; G. Pessina, *Brugnatelli's Ann.*, 17. 265, 1798; A. Rosenstiehl, *Bull. Soc. Mulhouse*, 40. 152, 1870; F. Mohr, *Arch. Pharm.*, (2), 88. 38, 1856; *Liebig's Ann.*, 100. 294, 1856; A. Souchay and E. Lenssen, *ib.*, 99. 45, 1856; O. Bauer, *Zeit. angew. Chem.*, 16. 341, 1903; *Zeit. anorg. Chem.*, 47. 401, 1905; C. Neuberg and E. Neimann, *Biochem. Zeit.*, 1. 166, 1906; A. Herzfeld, *Zeit. Ver. Rübenzuckerind.*, 817, 1897; M. Karcz, *Chem. Ztg.*, 22. 38, 1898; E. Beckmann, *Untersuchungen über die Aluminate und basischen Haloidsalze des Bariums, sowie Notizen über Baryhydrat und die Haloidsalze des Bariums*, Leipzig, 1882; *Journ. prakt. Chem.*, (2), 27. 138, 1883; W. Artus, *ib.*, (1), 6. 172, 1835; C. F. Bucholz, *Gehlen's Journ.*, 4. 128, 1807; A. Riffault and N. M. Chompré, *Gilbert's Ann.*, 28. 117, 1808; W. Reuling, *Zeit. anal. Chem.*, 5. 72, 1866; J. C. H. Heyer, *Ber.*, 19. 2684, 1866; R. Finkener, *ib.*, 19. 2958, 1866; W. Müller-Erzbach, *ib.*, 20. 1628, 1887; 22. 3180, 1889; R. de Forcrand, *Compt. Rend.*, 103. 59, 1888; 147. 1651, 1908; H. Lesœur, *ib.*, 96. 1578, 1883; M. Berthelot, *ib.*, 76. 1109, 1873; E. J. Maumené, *ib.*, 96. 1730, 1883; H. J. Brooke, *Ann. Phil.*, 23. 287, 1824; G. B. von Foullon, *Jahrb. geol. Reichsanst. Wien*, 35. 727, 1885; A. Eppler, *Zeit. Kryst.*, 30. 127, 1899; F. F. Selivanoff, *Journ. Russ. Phys. Chem. Soc.*, 44. 1797, 1912; 45. 252, 257, 1913.

³ M. Pettenkofer, *Liebig's Ann. Suppl.*, 2. 28, 1863; A. Vogel, *Journ. prakt. Chem.*, (1), 25. 230, 1842; F. Kuhlmann, *Liebig's Ann.*, 38. 48, 1841.

⁴ V. Kohlschütter and G. Walther, *Zeit. Elektrochem.*, 25. 159, 1919; 26. 181, 1920; B. Kosmann, *ib.*, 26. 173, 1920; P. P. von Weimarn, *Zeit. Koll.*, 3. 282, 1908; L. Kiepenheuer, *Kalk und Mörtel*, Köln, 1907.

⁵ J. Dalton, *A New System of Chemical Philosophy*, Manchester, 2. 331, 1810; R. Phillips, *Ann. Phil.*, (2), 17. 107, 1821; L. Wittstein, *Repert. Pharm.*, 1. 182, 1815; A. Bineau, *Ann. Chim. Phys.*, (3), 51. 290, 1857; A. Lamy, *ib.*, (5), 14. 145, 1878; *Compt. Rend.*, 86. 333, 1878; A. Pavesi and E. Rotondi, *Ber.*, 7. 817, 1874; R. C. Tichborne, *Bull. Soc. Chim.*, (2), 17. 24, 1871; A. d'Anselme, *ib.*, (3), 29. 936, 1904; F. F. Selivanoff, *ib.*, (3), 28. 824, 1902; *Journ. Russ. Phys. Chem. Soc.*, 34. 14, 1902; I. Herold, *Zeit. Elektrochem.*, 11. 417, 1905; A. Herzfeld, *Zeit. Ver. Rübenzuckerind.*, 818, 1897; T. Maben, *Pharm. Journ.*, (3), 14. 505, 1883; B. Zahorsky, *Zeit. anorg. Chem.*, 3. 41, 1893; W. A. Shenstone and J. T. Cundall, *Journ. Chem. Soc.*, 53. 544, 1888; T. Graham, *Phil. Mag.*, (2), 2. 20, 1827; F. de la Croix, *Arch. Pharm.*, (3), 14. 145, 1879; A. Goldammer, *Pharm. Centrbl.*, 26. 442, 455, 1886.

⁶ A. Bineau, *Compt. Rend.*, 41. 509, 1855; W. A. Tilden, *Proc. Roy. Soc.*, 38. 401, 1886; C. F. Bucholz, *Gehlen's Journ.*, 4. 128, 1807; C. Scheibler and D. Sidorsky, *Zeit. Ver. Rübenzuckerind.*, 7. 257, 1882; H. Davy, *Phil. Trans.*, 98. 1, 333, 1808; R. Osann, *Kastner's Archiv.*, 3. 369, 1824; 4. 347, 1825; 5. 88, 1825; A. Rosenstiehl, *Bull. Soc. Mulhouse*, 40. 153, 1870; H. F. Sill, *Journ. Amer. Chem. Soc.*, 38. 2632, 1916; O. Bauer, *Zeit. angew. Chem.*, 16. 341, 1903; *Zeit. anorg. Chem.*, 47. 401, 1905.

⁷ A. A. Noyes and E. S. Chapin, *Zeit. phys. Chem.*, 28. 518, 1899; M. Berthelot, *Bull. Soc. Chim.*, (2), 24. 102, 1875; E. Maigret, *ib.*, (3), 33. 631, 1905; A. d'Anselme, *ib.*, (3), 29. 936, 1903; T. J. Pelouze, *Compt. Rend.*, 33. 53, 1851; L. Wittstein, *Repert. Pharm.*, 1. 182, 1815; G. Bodländer, *Zeit. angew. Chem.*, 18. 1138, 1905; C. J. B. Karsten, *Philosophie der Chemie*, Berlin, 175, 1843; G. L. Cabot, *Journ. Soc. Chem. Ind.*, 16. 417, 1897; G. Kernot, E. d'Agostino, and M. Pellegriano, *Gazz. Chim. Ital.*, 38. 532, 1908; I. Herold, *Ueber die Kaustifikation des Kaliumsulfates*, Halle a. S., 1905; B. Zahorsky, *Zeit. anorg. Chem.*, 3. 40, 1893; W. Herz, *ib.*, 67. 365, 1910; G. Lunge, *Journ. Soc. Chem. Ind.*, 11. 882, 1892; F. A. H. Schreinmakers and T. Feege, *Chem. Wcckb.*, 8. 683, 1911; F. A. H. Schreinmakers and J. Milikan, *Proc. Acad. Amsterdam*, 15. 52, 1912; J. Milikan, *Zeit. phys. Chem.*, 92. 59, 496, 1917; F. A. H. Schreinmakers, *ib.*, 68. 83, 1909; H. Bassett and H. S. Taylor, *Journ. Chem. Soc.*, 105. 1926, 1914;

F. K. Cameron and W. O. Robinson, *Journ. Phys. Chem.*, 11, 273, 1907; F. K. Cameron and J. M. Bell, *Journ. Amer. Chem. Soc.*, 28, 1220, 1906; C. L. Parsons and C. L. Perkins, *ib.*, 32, 1387, 1910; C. L. Parsons and H. P. Corson, *ib.*, 32, 1382, 1910.

⁸ W. Eidmann, *Ein Beitrag zur Erkenntnis des Verhaltens chemischer Verbindungen in nicht-wässrigen Lösungen*, Giessen, 1899; P. Carles, *Arch. Pharm.*, (3), 4, 558, 1874; M. Berthelot, *Ann. Chim. Phys.*, (3), 46, 173, 1856; E. M. Péligot, *ib.*, (3), 54, 383, 1858; T. J. Pelouze, *ib.*, (4), 6, 203, 1865; E. Boivin and D. Loiseau, *ib.*, (4), 6, 216, 1865; W. Herz and M. Knock, *Zeit. anorg. Chem.*, 41, 321, 1904; 46, 193, 1905; F. K. Cameron and H. E. Patten, *Journ. Phys. Chem.*, 15, 67, 1911; J. Weisberg, *Bull. Soc. Chim.*, (3), 21, 775, 1899; (3), 23, 740, 1900; P. H. Déon, *ib.*, (2), 17, 155, 1872; G. J. van Meurs, *Zeit. phys. Chem.*, 91, 313, 1916; W. Rothmund, *ib.*, 69, 523, 1909; H. Claasen, *Zeit. Vcr. Zuckerind.*, 489, 1911; P. J. H. van Ginneken, *Proc. Acad. Amsterdam*, 14, 442, 1911; *Zeit. Ver. Zuckerind.*, 1293, 1912; J. Weisberg, *ib.*, 808, 1912; C. Scheibler, *Zeit. Ver. Rübenzuckerind.*, 8, 19, 1882; E. Beckmann, *Untersuchungen über die Aluminate und basischen Haloidsalze des Bariums sowie Notizen über Barythydrat und die Haloidsalze des Bariums*, Leipzig, 1882.

⁹ O. Bauer, *Zeit. angew. Chem.*, 16, 341, 1903; *Zeit. anorg. Chem.*, 47, 401, 1905; G. B. von Foulton, *Jahrb. geol. Reichsanst. Wien*, 35, 727, 1885; A. Eppler, *Zeit. Kryst.*, 30, 127, 1899; S. F. Glinka, *ib.*, 46, 303, 1909; H. J. Brooke, *Ann. Phil.*, 23, 287, 1824; G. Rose, *Sitzber. Akad. Berlin*, 582, 1860; E. Filhol, *Ann. Chim. Phys.*, (3), 7, 271, 1845; A. Lamy, *ib.*, (5), 14, 145, 1878; H. le Chatelier, *Recherches expérimentales sur la constitution des mortiers hydrauliques*, Paris, 1887.

¹⁰ A. Lamy, *Ann. Chim. Phys.*, (5), 14, 145, 1878; E. Filhol, *ib.*, (3), 7, 271, 1845; A. Eppler, *Zeit. Kryst.*, 30, 127, 1899; S. F. Glinka, *ib.*, 46, 303, 1909; E. Mategecek, *Dingler's Journ.*, 215, 12, 1876; G. Lunge, *ib.*, 250, 464, 1883; F. Kohlrausch, *Wied. Ann.*, 6, 1, 1879; M. M. Haff, *Chem. News*, 86, 283, 1902; J. A. Wanklyn, *ib.*, 55, 217, 1887; H. F. Sill, *Journ. Amer. Chem. Soc.*, 38, 2632, 1916; H. Rose, *Pogg. Ann.*, 86, 105, 1852; H. Abich, *ib.*, 23, 315, 1831; H. le Chatelier, *Compt. Rend.*, 102, 1243, 1886; R. de Forcrand, *ib.*, 147, 165, 1908; H. Lesceur, *ib.*, 96, 1578, 1883; 103, 1260, 1886; J. B. J. D. Boussingault, *Ann. Chim. Phys.*, (3), 35, 5, 1851; A. Herzfeld and C. Stiepel, *Zeit. Ver. Rübenzuckerind.*, 833, 1898; C. F. Buchholz, *Gehlen's Journ.*, 4, 128, 1807; A. F. Gehlen and C. F. Buchholz, *ib.*, 4, 258, 1807; D. Smith, *Phil. Mag.*, (3), 9, 87, 1836; F. Guthrie, *ib.*, (5), 6, 35, 1878; G. A. Carse, *Proc. Roy. Soc. Edin.*, 25, 281, 1904; C. Heyer, *Ber.*, 19, 2684, 1886; R. Finkener, *ib.*, 19, 2958, 1886; W. Müller-Erbach, *ib.*, 19, 2876, 1886; 20, 1628, 1887; W. Dittmar, *Journ. Soc. Chem. Ind.*, 7, 730, 1888; C. L. Bloxam, *Journ. Chem. Soc.*, 13, 48, 1859; V. H. Veley, *ib.*, 49, 371, 1886; T. W. Richards and J. B. Churchill, *Zeit. phys. Chem.*, 28, 313, 1899; O. Bauer, *Zeit. anorg. Chem.*, 47, 401, 1905; *Zeit. angew. Chem.*, 16, 345, 1903; A. Rosenstiehl, *Bull. Soc. Mulhouse*, 40, 152, 1870; E. Beckmann, *Journ. prakt. Chem.*, (2), 27, 138, 1883; W. Nernst and F. Schwerns, *Sitzber. Akad. Berlin*, 355, 1914; C. L. Parsons and H. P. Corson, *Journ. Amer. Chem. Soc.*, 32, 1382, 1910; C. L. Parsons and C. L. Perkins, *ib.*, 32, 1387, 1910; J. Johnston, *ib.*, 30, 1357, 1908; *Zeit. phys. Chem.*, 62, 330, 1908; E. Filhol, *Ann. Chim. Phys.*, (3), 21, 155, 1847; *Journ. Pharm. Chim.*, (3), 7, 271, 1845; H. W. Foote and S. R. Scholes, *Journ. Amer. Chem. Soc.*, 33, 1309, 1911.

¹¹ A. Guntz, *Compt. Rend.*, 136, 1071, 1903; R. de Forcrand, *ib.*, 146, 217, 1908; 147, 165, 1908; H. Moissan, *ib.*, 128, 384, 1899; *Bull. Soc. Chim.*, (3), 21, 928, 1899; *Ann. Chim. Phys.*, (7), 18, 336, 1899; M. Berthelot, *ib.*, (5), 9, 43, 1876; *Ann. Bur. Longitudes*, 395, 1877; J. Thomsen, *Journ. prakt. Chem.*, (2), 16, 97, 1877; *Ber.*, 16, 2613, 1883; H. F. Sill, *Journ. Amer. Chem. Soc.*, 38, 2632, 1916; J. Johnston, *ib.*, 30, 1357, 1908; D. Tommasi, *Compt. Rend.*, 98, 812, 1884.

¹² J. F. Daniell, *Phil. Trans.*, 130, 209, 1840; W. Bein, *Zeit. phys. Chem.*, 27, 1, 1898; W. Crookes, *Proc. Roy. Soc.*, 32, 206, 1881; S. Arrhenius, *Recherches sur la conductibilité galvanique des électrolytes*, Stockholm, 1883; B. A. Rep., 357, 1886; W. Ostwald, *Journ. prakt. Chem.*, (2), 33, 352, 1886; F. Kohlrausch, *Wied. Ann.*, 6, 1, 1879; A. A. Noyes, *Journ. Chim. Phys.*, 5, 505, 1908; E. Duter, *Compt. Rend.*, 104, 354, 1887; S. Marsh, *Proc. Roy. Soc.*, 97, A, 124, 1920; T. Drummond, *Edin. Journ. Science*, 5, 319, 1826; D. Brewster, *ib.*, 3, 343, 1820; F. Tiemann, *Chem. Ztg.*, 45, 1125, 1921; P. Pascal, *Compt. Rend.*, 173, 144, 1921.

¹³ V. H. Veley, *Journ. Chem. Soc.*, 63, 821, 1893; H. Vogel, *Ber.*, 3, 904, 1870; F. Stolba, *Listy's Chemiké*, 12, 204, 1888; N. Tarugi, *Gazz. Chim. Ital.*, 34, ii, 254, 1904; J. C. Whetzel, *Journ. Ind. Eng. Chem.*, 9, 287, 1917; A. Terreil, *Compt. Rend.*, 77, 1500, 1893; C. Bunge, *Zeit. anal. Chem.*, 52, 15, 1913; M. Müller, *Journ. prakt. Chem.*, (2), 36, 317, 1887; H. Debray, *ib.*, 102, 56, 1867; E. Beckmann, *ib.*, (2), 27, 138, 1883; J. K. Weisberg, *Ber.*, 12, 346, 511, 1879; A. Geuther, *Liebig's Ann.*, 123, 119, 1862; D. Walker, *Chem. News*, 30, 28, 1874; G. Chancel and F. Parmentier, *Compt. Rend.*, 99, 892, 1884; J. Kolb, *ib.*, 64, 861, 1867; J. J. Berzelius, *Lehrbuch der Chemie*, Dresden, 4, 243, 1841.

¹⁴ A. B. Lamb, R. E. Wilson, and N. K. Chaney, *Journ. Ind. Eng. Chem.*, 11, 420, 1919; R. E. Wilson, *ib.*, 12, 1000, 1920; *U. S. Pat. No.* 133524, 1920.

§ 11. Calcium, Strontium, and Barium Fluorides

Calcium fluoride, CaF_2 , is the source of most of the fluorine compounds; it occurs¹ in nature as the mineral *fluorspar* or *fluorite* in eubic crystals either colourless or exhibiting a wonderful range of colours—red, yellow, green, blue, purple, or violet.—*vide* history of fluorine. B. Blount and J. H. Sequeira's analyses of a sample of blue john and of the white portions of the same sample, obtained direct from the mine, are very little different.

	CaF_2	$\text{Al}_2\text{O}_3 + \text{Fe}_2\text{O}_3$	MgO	S	P
Blue	99·69	0·048	0·006	tr	0·09
White	99·71	0·026	0·005	tr	0·08

No manganese, chlorine, or sulphates were present. They also found 0·046 per cent. of carbon, and 0·17 per cent. of hydrogen in blue john. Part of the hydrogen may have been due to occluded water. The blue john prepared as ornaments is often "filled" with resinous matter. The organic matter occurring naturally in fluorspar is not affected at 150°, but it disappears at 350°. Fluorite is most abundant in mineral veins or cavities, and it often accompanies quartz, heavy spar, galena, zinc blende, etc. It is disseminated as a minor constituent in various igneous rocks and sedimentary formations—*e.g.* small amounts occur in granites, gneisses, syenites, crystalline schists, dolomites, and limestones. It is found in limestone geodes, where it appears to have been deposited from soln. The blue, purple, or violet fluorspar of the caves of Castleton Valley (Derbyshire) is called *blue john*; the green fluorspar—*green john*. Veins of blue john occur in many other places. Fluorspar is also found in volcanic lavas as a sublimation product, or as a result of the action of fluoriferous gases on other minerals. It is supposed to be formed as a secondary mineral by the decomposition of fluosilicates or of fluotitano- or fluozirconosilicates. Calcium fluoride was found by J. J. Berzelius in bones and urine; and E. Frémy in animal bones, the enamel of teeth, and in the corals and shells of sea organisms. It has also been reported by G. Wilson in certain mineral waters—*e.g.* those of Carlsbad.

The preparation of the alkaline earth fluorides.—According to H. St. C. Deville and H. Caron,² the silica and phosphoric oxide, which contaminate colourless and transparent native fluorspar, can be removed by treating the powder with cold conc. sulphuric acid for some days, and after washing out the acid, drying and calcining the mass. H. Moissan observed the formation of alkaline earth fluoride by the action of fluorine on the metal; and C. Poulenc, by the action of gaseous hydrogen fluoride on the alkaline earth carbonate or chloride. When aq. soln. of the metal fluorides are treated with calcium salts, calcium fluoride is precipitated as an opalescent gelatinous mass which chokes the pores of the filter paper and cannot be washed in the ordinary manner. According to J. J. Berzelius, the gelatinous precipitation of calcium fluoride is more granular if the mother liquor be ammoniacal, but, says H. Rose, the calcium fluoride is slightly soluble in ammonium salts. J. L. Gay Lussac and L. J. Thénard made barium fluoride by adding hydrofluoric acid to an aq. soln. of barium hydroxide, or of sodium fluoride to barium nitrate. E. Frémy says that barium fluoride cannot be obtained by double decomposition, for, as H. W. Foote and G. A. Menge showed, by shaking barium fluoride in an aq. soln. of calcium chloride, calcium fluoride is almost quantitatively precipitated. E. Paternó and E. Mazzucchelli obtained it in colloidal soln. by treating very dil. soln. of the alkali fluoride with the calculated quantity of calcium chloride or nitrate, and afterwards removing the alkali salt by dialysis. By evaporation in vacuo over sulphuric acid, a 2 per cent. soln. can be obtained. The dil. soln. can be kept for months, but the more conc. colloidal soln. deposit crystals.

J. J. Berzelius obtained calcium, strontium, and barium fluoride as a granular powder by treating freshly precipitated alkaline earth carbonate with hydrofluoric

acid; and as a flocculent mass by treating a conc. soln. of the alkaline earth salt with hydrofluoric acid. A. C. Becquerel separated soln. of calcium chloride and ammonium fluoride by a porous membrane, and found crystals of calcium fluoride grew on the calcium chloride side of the membrane. H. Moissan obtained a crystalline precipitate by adding a soln. of the alkaline earth chloride to a boiling soln. of potassium fluoride, and boiling the mixture for half an hour. H. de Sénarmont obtained crystalline calcium fluoride by heating for 60 hrs. under press., at 250°, the gelatinous precipitate with an aq. soln. of sodium bicarbonate almost neutralized with hydrochloric acid; T. Scheerer and E. Drechsel heated the gelatinous mass for 10 hrs. at 250° with hydrochloric acid; they also heated calcium fluosilicate for 10 hrs. with an aq. soln. of calcium chloride: $\text{CaSiF}_6 + 2\text{CaCl}_2 + 2\text{H}_2\text{O} = 3\text{CaF}_2 + \text{SiO}_2 + 4\text{HCl}$; and also by melting non-crystalline calcium fluoride with sodium or potassium chloride, or a mixture of the two salts. F. Röder obtained crystals by melting sodium fluoride with calcium or strontium and sodium chlorides; A. Feldmann melted barium or strontium chloride with calcium fluoride at a red heat: $\text{CaF}_2 + \text{BaCl}_2 = \text{CaCl}_2 + \text{BaF}_2$ and the fluoride of barium or strontium remained when the cold mass was lixiviated with water. C. Poulenc fused calcium or strontium chloride with potassium hydrofluoride, and washed the soluble matters from the small cubic crystals of the fluoride of the alkaline earth; he obtained the calcium fluoride in octahedral crystals; but, by heating the amorphous fluoride with a mixture of potassium chloride and hydrofluoride, "beautiful transparent regular octahedra" were obtained. E. Defacqz heated a mixture of manganese fluoride with an excess of alkaline earth halide to at least 800° in a stream of carbon dioxide; the product was washed first with hot water and then with a 2-5 per cent. soln. of hydrochloric or acetic acid to remove soluble salts. If the temp. be below 1000° the crystals are octahedra; if above 1200°, cubes. Barium fluoride has not been obtained in well-defined crystals, but strontium fluoride furnishes octahedral crystals by fusing a mixture of manganese fluoride and strontium iodide. W. Wetzel obtained octahedral crystals of fluorite by allowing calcareous sandstone, or siliceous limestone, to stand for some days in 3 per cent. hydrofluoric acid contained in a vulcanite vessel.

The properties of the alkaline earth fluorides.—These salts furnish crystals in octahedra and cubes belonging to the cubic system. A. W. Hull,³ and W. P. Davey found that the **X-radiograms** of crystals of calcium, strontium, and barium fluoride belong to the face-centred cubic lattice, or the tetrahedral cubic lattice, and that the atoms are 2 per cent. closer than the atoms in the face-centred cubic lattice of the element calcium. W. L. Bragg gave 2·38 Å. for the closest approach of the atoms in calcium fluoride; and W. P. Davey, 2·50 Å., in strontium fluoride; and 2·69 Å. in barium fluoride. W. Gerlach studied the lattice constants of calcium fluoride. The electrostatic potential of the fluorite lattice was studied by A. Landé, and E. Bormann. A. Kennigott obtained 3·183 as a mean for the **specific gravity** of 60 samples of fluorspar—the maximum and minimum values were 3·1988 and 3·1547; and, according to A. Breithaupt, the maximum and minimum values for the ordinary mineral, more or less impure, are 3·01-3·25. E. Madelung and R. Fuchs gave 3·1808 (0°). For strontium fluoride, H. G. F. Schröder gave 4·22, whence W. Biltz gave 29·8 for the mol. vol. H. Bauhans and V. Goldschmidt studied the corrosion figures, the so-called end-figure, and the velocity of dissolution of fluorite in nitric acid.

H. E. Merwin obtained the value 3·180 at 20° for a number of samples of colourless transparent fluorspar; H. G. F. Schröder, 3·150 for the precipitated and calcined calcium fluoride, 4·20-4·24 for strontium fluoride, and 4·828 for barium fluoride; and O. Ruff and W. Plato, 3·16 (20°) for calcium fluoride. C. H. D. Bödeker gives 4·58 for the sp. gr. of barium fluoride. The **hardness** of calcium fluoride on Mohs' scale is 4. W. Voigt⁴ gave for the coeff. of **compressibility** of calcium fluoride $1·93 \times 10^{-6}$ per atm.; the modulus of **extension** or **compression** along the crystal axis when the distortion is around the axis, is 1473×10^6 grms. per sq. cm.; the same

constants for directions equally inclined to this and normal to the third, and equally inclined to all three axes are 1008×10^6 and 910×10^6 respectively. E. Madelung and R. Fuchs found for the compressibility, $1.22-1.26 \times 10^{-6}$ megabars per sq. cm. P. Drude and W. Voigt gave 10,450 kgrms. per sq. mm. for the **elastic modulus**; 0.221 for the elastic number—ratio of transverse contraction to longitudinal extension; and the **torsion modulus** around the crystal axis is 345×10^6 grms. per sq. cm. A. Mallock made some measurements of the elastic constants of fluorspar. K. Försterling studied the relation between the elastic constants and the sp. ht.

The coeff. of **thermal expansion**, according to G. Weidemann,⁵ is 0.00001934 at 52°; and, according to F. Pfaff, 0.0000195. According to H. Fizeau, at 40°, the coeff. of linear expansion, normal to the face of the octohedral cleavage of a crystal of fluorspar, is $\alpha = 0.00001910$; the same value was obtained for the face of the cube of another crystal; and $\alpha = 0.00001915$ for the face cut at an angle of 5° to a face of a cube of another crystal. According to H. Kopp, the coeff. of cubical expansion is 0.000062. F. E. Neumann gives the **specific heat** as 0.2080-0.2084; H. V. Regnault, 0.21492, and after calcination, 0.21686; H. Kopp, 0.209; and J. Joly, 0.21180 for green transparent cubic crystals, and 0.21264 for grey translucent crystalline mass.

The **melting point** of fluorspar, 902°, according to H. Moissan, is too low; O. Ruff and W. Plato give 1330°; and E. Beck, 1264°. O. Ruff and W. Plato's value for barium fluoride is 1280°. G. Magnus found there was no change in the sp. gr. of the crystalline mass after it has been melted in a porcelain oven. W. R. Mott gives 1400° for the **boiling point** of barium fluoride. The **heat of formation**, according to A. Guntz: $\text{Ca} + \text{F}_2 = 108.5$ Cals.; $\text{Sr}_{\text{solid}} + \text{F}_{2\text{gas}} = 74.3$ Cals.; and $\text{Ba}_{\text{solid}} + \text{F}_{2\text{gas}} = 222.6$ Cals.; $\frac{1}{2}\text{CaO}$ (1 eq. in 25 litres) HF (eq. in 2 litres) $= \frac{1}{2}\text{CaF}_2$ (solid at 11°) + 11.6 Cals.; similarly, 17.9 Cals. for strontium fluoride; and 17.40 Cals. for barium fluoride. Again, $\frac{1}{2}\text{Ca}(\text{OH})_2 + \text{HF}_{\text{gas}} = \frac{1}{2}\text{CaF}_{2\text{solid}} + \text{H}_2\text{O}_{\text{solid}} + 33.3$ Cals.; similarly, 35.90 Cals. for the strontium salt; and 35.70 Cals. for the barium salt. According to E. Petersen, $\text{Ca}(\text{OH})_{2\text{aq.}} + 2\text{HF}_{\text{aq.}} = 36.31$ Cals., 35.47 Cals. for the strontium salt, and 32.30 Cals. for the barium salt.

The transparency of fluorite for the infra-red and ultra-violet rays, the low refractive power, and weak colour dispersion makes fluorite useful in correcting the chromatic and spherical aberration errors in lenses for microscopes, small telescopes, and the like. The fluorite for optical purposes should be as clear as glass, and free from cloudiness, inclusions, cleavage cracks, etc. On the other hand, H. Rubens and B. W. Snow⁶ found the dispersion in the ultra-red to be very great, so that fluorite lenses are advantageously used in the production of the spectra of the heat rays. H. E. Merwin recommended the **refractive index** of different specimens of the purer varieties of fluorspar as a standard for comparison; for Na-light, $\mu = 1.43385$ at 20° when quartz has $\omega = 1.54425$. A great many determinations of the refractive indices of fluorite for rays of different wave-length have been made. F. Paschen obtained values for wave-lengths λ from 0.48607μ to 9.4291μ between 17° and 20°.

λ	• 9429.1	7071.8	5893.2(D)	3830.6	2946.6	1620.6	486.07
μ	• 1.31612	1.36806	1.38721	1.41122	1.41823	1.42592	1.43713

V. Schumann calculated for rays $242.883\mu\mu$, 1.47067; for $180\mu\mu$, 1.5176; $160\mu\mu$, 1.5529; $140\mu\mu$, 1.6195; $120\mu\mu$, 1.7862; $115\mu\mu$, 1.8748; $65\mu\mu$, 0.8772. F. J. Micheli, J. Stefan, H. Fizeau, H. Dufet, J. O. Reed, and C. Pulfrich found that the effect of an increase of temp. lowers the value for, say, $\lambda = 589.3(\text{Na})$ by 0.00001215 per 1° at 58.8° to 0.00001652 per 1° at 385°. The refractive index of differently coloured varieties of fluorspar has been determined by C. Hlawatsch, H. Dudenhausen, and F. J. M. Wülfing. H. Dudenhausen's value for Na-light with water-clear fluorspar is 1.43380; rose-coloured, 1.43394; yellow, 1.43361; pale violet, 1.43367; green, 1.43381; blue, 1.43361; greenish-violet, 1.43433; intense violet, 1.43389. The dispersion $(\mu_G - \mu_F)/(\mu_D - 1)$ is 0.0105.

The so-called *normal dispersion* occurs when the refractive index increases as the wave-length decreases at a rate dependent on the nature of the substance; but

substances which exhibit selective absorption do not usually exhibit normal dispersion because the refractive index on the blue side of the absorption band is generally less than the index for the red light on the opposite side of the absorption band.

This phenomenon is termed *anomalous dispersion*, although normal dispersion can be regarded as a special case of anomalous dispersion. To evade the implication conveyed by the term "anomalous," A. Schuster proposed to substitute the term *selective dispersion*. In the case of fluorite, the dispersion curve in the visible spectrum is convex towards the wave-length axis, Fig. 11, and eventually becomes concave in the ultra-red region, indicating that an absorption band is being approached. U. Meyer found Verdet's constant, ω , at 20°, for rays of wave-length, λ , to be :

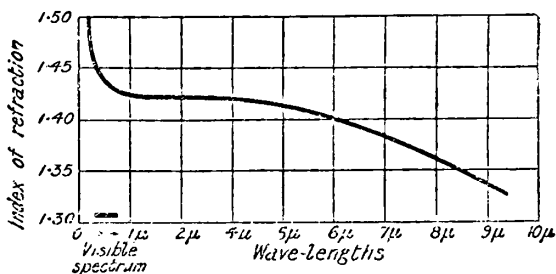

FIG. 11.—Dispersion Curve of Fluorite.

Further, U. Meyer found Verdet's constant, ω , at 20°, for rays of wave-length, λ , to be :

λ	•	•	•	0.2534	0.4358	0.4916	0.6708	0.90	3.00 μ
ω	•	•	•	0.05989	0.01717	0.01329	0.00672	0.00367	0.00030

M. Melloni⁷ noted that fluorite is more transparent than glass for the infra-red heat rays, and advantage was taken of the fact by P. Desains. G. Magnus showed that a plate 10 mm. thick transmitted 9.1 per cent. of the heat rays with the plate at 150°, and 19.1 per cent. were transmitted by a plate 3.8 mm. thick. Further.

Transmission	•	•	•	NaCl	KCl	CaF ₂	AgCl	AgBr
	•	•	•	8.3	54.5	9.1	43.6	48.3 per cent.

H. Rubens also found fluorite to be diathermous for the red heat rays down to a wave-length of 3.3 μ , and F. Paschen noticed that with a plate 4 mm. thick, absorption begins at about 7.6 μ , and with rays of wave-length 8.2 μ the plate has a 9 per cent. absorption, while with a plate 1 cm. thick, H. Rubens and A. Trowbridge obtained a 84.4 per cent. absorption for a wave-length of 8 μ ; 16.4 per cent. for 11 μ ; and none with 12 μ . Fluorite is transparent for the visible spectrum, and, according to W. A. Miller, and E. Mascart, it is also transparent for the ultra-violet. P. Ites⁸ observed a maximum in the yellowish-red—about 0.600—in the visible part of the absorption spectrum of fluorite. For a 1.487 mm. thick plate of green fluorite, for light of wave-length λ , the transparency ratio, *i.e.* the ratio of the intensities of the incident and transmitted light d , and the extinction coeff. α ,

λ	•	•	B	C	0.618 μ	D	0.556 μ	E	F
μ	•	•	1.4317	1.4324	1.4329	1.4335	1.4344	1.4355	1.4374
d	•	•	0.641	0.592	0.458	0.623	0.623	0.630	0.604
α	•	•	0.0204	0.0246	0.0384	0.0374	0.0219	0.0212	0.0235

In 1677, J. S. Elsholtz showed that fluorite luminesces when warmed; and G. W. von Leibniz accordingly named the mineral *thermophosphorus*—*vide* the sulphides of the alkaline earths. The violet light emitted during the thermo-luminescence of fluorspar is sometimes sufficiently intense to enable print, at a distance of six inches, to be read. Some colourless specimens exhibit no thermo-luminescence. Most samples decrepitate when heated—the yellow and dark violet varieties usually decrepitate most, and some colourless ones do not decrepitate at all. E. Newbery and H. Lupton found all varieties lose their colour when heated, but the green colour is most difficult to discharge, and those colours induced by exposure to radium are easiest discharged. The coloured varieties of fluorspar, when strongly heated, lose their power of emitting light, but this power is restored after exposure

to radium emanation, and a new capacity of emitting a bright green thermo-luminescence at a low temp. is acquired. In 1820, D. Brewster showed that native fluorite phosphoresces when it has been exposed to light; but after it has been heated above 300° , it loses its power of phosphorescing by insolation; and A. E. Becquerel showed this power is restored by exposure to cathode or to Röntgen rays.

According to P. Bary, fluorite phosphoresces when exposed to **X-rays** and to **Becquerel rays**; and, according to A. Wiedemann and G. C. Schmidt, the violet luminescence in **cathode rays** is largely due to the contained manganese. The green glow obtained by exposure to **radium rays** persists for a short time after removing the exciting source. The colour changes produced by radium on colourless fluorspars, or fluorspars which have been decolorized by heat, are very varied. They have been studied by E. Newbery and H. Lupton; different colours may be produced by the α -, β -, and γ -radiations. All fluorspars give a green glow by exposure to the rays from radium; and a violet glow in the cathode rays. The glow continues in each case after the removal of the exciting source. The colour changes are striking—*e.g.* colourless crystals of a fluorspar from Matlock become deep blue after exposure to radium; green crystals deepen in tone; and yellow crystals become blue or purple. They suggest that the colours and thermo-luminescent properties of many minerals have been determined by the presence of radioactive matter either in the water from which they have been deposited, or by radioactive minerals in their immediate neighbourhood. T. J. Pearsall gave a long list of the various colours emitted by different fluorspars at various temp. and times of heating. When the "store" of light is exhausted, he found that the luminescence is restored under the excitation of the electric spark, although the light emitted is never the same as that produced during the first heating. G. C. Kindt noted the broad bands in the spectrum of the thermo-luminescence, and E. Hagenbach, and G. D. Liveing made approximate measurements of the wave-lengths. H. W. Morse photographed the spectra of the thermo-luminescence. P. Schuhknecht found that the fluorescent spectrum with Röntgen or cathode rays extends further into the ultra-violet than that of any other substance. C. Doelter found that colourless fluorspar became rose colour in ultra-violet light.

The theories which have been made as to the cause of the coloration of natural crystals of rock salt apply *mutatis mutandis* to fluorspar. The coloured varieties are decolorized at 300° . Certain fluorites, *e.g.* the *stinking fluorite* from Wölsendorf, emit an alliaceous odour when powdered; the effluvium has oxidizing properties, for, if the pulverization is conducted under water, the liquid blues starch and potassium iodide. C. F. Schafhäütl¹ attributed the coloration of fluorspar to the presence of hypochlorous acid; C. F. Schönbein, and A. Schrötter, to ozone; O. Löw, to a perfluoride; G. Wyruboff, to two hydrocarbons—one producing a red and the other a blue colour; H. W. Morse, organic matter; and H. Moissan and A. H. Becquerel, to free fluorine. Many of these assumptions are untenable in the light of M. Berthelot's and A. Debiere's observations that decolorized fluorspars had their original colour restored by exposure to radium radiations. B. Blount and J. H. Sequeira do not favour the assumption that the colour is an effect of radioactivity, but believe that the colour is due to organic matter which they extracted in part by chloroform, toluene, or aniline; and determined by combustion analysis. C. S. Garnett found the colour of blue john is due to films of organic matter lying parallel to and in the plane of the faces of the otherwise colourless crystal, and also at the crystal junctions; it was probably deposited on the surfaces of the crystals at intervals during their growth. A very intensely coloured specimen contained 0.27 per cent. of carbon, on distillation gave off inflammable vapours, and a yellowish oil collected in the condenser. The residual fluorite was colourless. The colour of red fluorite is not destroyed by heat, but is readily extracted from the powdered mineral by boiling hydrochloric or nitric acid. The soln. contains rare earths and insignificant quantities of other elements. J. Barnes and W. F. Holroyd claim to have synthesized crystals of fluorspar exhibiting all natural colours; and they conclude that the colour is an optical phenomenon dependent on the crystallization and physical state of the substance. C. Doelter assumed that the colour is due to the presence of colloidal metals or other substances, and that the metals oxidize when heated. A. Debiere found that some dark violet varieties of fluorspar smell of ozone when heated, and also yield a little helium. B. Blount and J. H. Sequeira found argon but no helium in blue john. J. Jakob considered the colour of some minerals is due to the presence of chromogens or groups of colouring atoms; and that of others, by the presence of a finely divided foreign substance.

F. Mohs¹⁰ (1824), F. von Kobell (1830), and D. Brewster (1833) drew attention to the fact that some fluorspars show different colours in transmitted and in reflected light—e.g. green is transmitted, and different tints of blue by reflected light. J. F. W. Herschel named the phenomenon epipolar dispersion. The subject was studied by G. G. Stokes, and he recommended the phenomenon be called fluorescence after fluorspar in the same way that opalescence is called after opal. The phosphorescence of fluorspar when heated—thermo-luminescence—has been known for a long time. It was mentioned by J. G. Wallerius¹¹ in 1747; by M. Sage in 1777; by J. B. L. Romé d'Isle in 1783; and certain varieties were called *chlorophane* by T. von Grotthus in 1794, and *pyrosmaryd* by J. F. L. Hausmann in allusion to this phenomenon. A sample of fluorite from Dorgali (Sardinia) was found by E. Clerici to exhibit thermo-luminescence even under carbon tetrachloride or acetone; it emitted radiations capable of influencing a photographic plate, and of penetrating glass, mica, or gelatine, but not aluminium or black paper. It contained traces of rare earth impurities. J. R. Formhals attributed the thermo-phosphorescence of fluorspar to the oxidation of finely divided arsenic sulphide present in traces in these varieties of fluorspar. A specimen of felspar, which showed no sign of phosphorescence when ignited, exhibited the phenomenon after the addition of a trace of arsenic sulphide. A. Mitscherlich,¹² C. Fabry, J. Rosch, P. Leopold, H. George, C. M. Olmsted, and S. Datta studied the relations between the band spectra of the fluorides of the alkaline earths; and H. Pascal, the X-ray spectrum.

According to W. Hankel,¹³ the crystals are electrified by changes of temp., or by exposure to light. The middle of the faces of the cube are negatively and near the edges, more particularly near the corners, are positively electrified. The longer and the more intense the illumination the stronger the effect. The arc light is stronger than sunlight, and the latter is stronger than diffuse daylight. The discharged sparks from two Leyden jars produce the effect, while the light from a vacuum tube is not sufficiently intense to produce the effect. G. C. Schmidt used the limelight for his experiments in this subject. E. Meyer noted the photoelectric effect of different samples of fluorspar. According to J. Curie, the **electrical conductivity** of fluorite is very small, being less than 0.0001 at 20°. J. Curie also found the **dielectric constant** to be 6.80 in agreement with the measurements of M. Romich and J. Nowak, who found 6.70; H. Starke found 6.92; M. von Pirani, 7.36; and W. Schmidt, 6.70. F. Paschen calculated for $\lambda = \infty$, 6.09. W. Voigt and S. Kinoshita found the **diamagnetism** to be -6.27×10^{-7} mass units and -20.0×10^{-7} volume units. J. Königsberger gives -1.130×10^{-6} for the magnetization constant. P. Pascal gave for the mol. coeff. of magnetization of calcium fluoride -281×10^{-7} ; strontium fluoride, -272×10^{-7} ; and for barium fluoride, 511×10^{-7} .

Calcium fluoride is but very sparingly soluble in water. According to G. Wilson,¹⁴ at 15.6°, 1000 parts of water dissolve 0.37 part of fluorite, but even this number is probably too great, because F. Kohlrausch calculated from the electrical conductivity that at 18° a litre of water dissolves only 0.016 gm. of calcium fluoride. F. Kohlrausch also found the solubility of strontium fluoride to be rather greater, 0.117 gm. at 18°, and of barium fluoride, greater still, 1.630 grms. The eq. conductivity of a c.c. cube of calcium fluoride is $\lambda = 0.000037$ reciprocal ohms; strontium fluoride, $\lambda = 0.000172$, and barium fluoride, $\lambda = 0.001530$ reciprocal ohms. The low solubility of calcium fluoride is utilized in the gravimetric determination of fluorides and fluorine. J. Nicklès found that the solubility of fluorite in water is greater when carbon dioxide is present; H. Rose also showed that the presence of ammonium salts augments the **solubility** of calcium fluoride; and H. Reinsch states that aq. **ammonium carbonate** decomposes calcium fluoride a little, and that the etching of the glass-containing vessel is due to the formation of ammonium fluoride. J. J. Berzelius stated that boiling soln. of **potassium or sodium hydroxide** are without action on calcium fluoride; and that calcium fluoride is easily decomposed by the vapour of **sulphuric acid**, but not by that of **sulphur trioxide**. Cold conc. sulphuric acid with silica-free fluorite, continued J. J. Berzelius, forms a transparent

viscid liquid which deposits calcium fluoride when diluted with water; this liquid begins to decompose at 40° : $\text{CaF}_2 + \text{H}_2\text{SO}_4 = \text{CaSO}_4 + 2\text{HF}$. F. Röder said that artificial crystals of fluorite are decomposed by sulphuric acid with difficulty. According to J. J. Berzelius, conc. **hydrochloric and nitric acids** behave like sulphuric acids, but the resulting soln. are less viscid; boiling nitric acid partially decomposes fluorite; boiling hydrochloric acid dissolves it a little, but a precipitate is formed when the acid is neutralized with alkali, or a residue remains when the soln. is evaporated—if the fluorspar contains silica, hydrofluosilicic acid is formed. Aq. **hydrofluoric acid** dissolves a little silica-free fluorite. It is probable that calcium fluoride forms a complex with hydrofluoric acid, because E. Frémy evaporated at a low temp. a soln. of calcium hydroxide in a great excess of hydrofluoric acid, and obtained small crystals of **hexahydrated calcium hydrofluoride**, $\text{CaF}_2 \cdot 2\text{HF} \cdot 6\text{H}_2\text{O}$, which are decomposed by boiling water into calcium and hydrogen fluorides. C. Poulenc found that strontium fluoride is completely decomposed by boiling hydrochloric or sulphuric acid, and partially decomposed by nitric acid. According to J. L. Gay Lussac and L. J. Thénard, barium fluoride is readily soluble in hydrochloric, nitric, and hydrofluoric acids. T. Scheerer and E. Drechsel say that if barium fluoride is heated under press. with a few drops of hydrochloric acid to 230° , small crystals of **barium fluorochloride**, BaClF ; and if nitric acid be used, hexagonal crystals of a double compound, **barium fluoronitrate**, are formed. T. Scheerer and E. Drechsel found that if gypsum remains for a week under water in contact with barium fluoride, crystals of barium sulphate and of calcium fluoride are formed. According to E. Paternò and U. Alvisi, a conc. soln. of **oxalic acid** in contact with finely powdered fluorite converts the latter into calcium oxalate; an analogous reaction, but feebler, occurs if **tartaric acid** be employed. According to H. C. Sorby, a soln. of **sodium carbonate** between 100° and 150° transforms fluorite into calcite and sodium fluoride. A. Guntz and H. Basset observed no signs of the formation of calcium subfluoride when calcium fluoride is heated with calcium.

Fluorspar melts when heated before the blowpipe, and, according to J. Smithson, with further heating it develops hydrogen fluoride and calcium oxide; E. Frémy found that at a red heat, water vapour acts in a similar manner. C. Poulenc found strontium fluoride to be stable when heated in air to 1000° , but above that temp. it is decomposed into strontia and hydrogen fluoride; at a red heat strontium fluoride is not decomposed by water vapour or **hydrogen sulphide**; but it is decomposed by hydrogen chloride: $2\text{HCl} + \text{SrF}_2 = \text{SrCl}_2 + 2\text{HF}$. E. Frémy states that hydrogen has no action on red-hot fluorspar. H. Schulze states that **oxygen** does not attack fluorspar at a red heat, but E. Frémy observed that glass is etched by the issuing gas, and he assumed that an oxyfluoride is formed. H. Schulze showed that in E. Frémy's experiment the fluorspar was heated in a platinum vessel, and that combustible gases which attack the fluoride diffuse through the walls of the vessel. When heated with **carbon disulphide** it forms calcium sulphide and probably carbon tetrafluoride. Dry **chlorine** at a red heat forms calcium fluochloride. E. Defacqz states that when fluorite is fused with **calcium chloride, bromide, or iodide**, double compounds are formed. J. J. Berzelius says that fluospar is not decomposed when fused with **alkali hydroxides or carbonates**, but P. Berthier showed that this is wrong, fluorspar is decomposed when melted with these agents. H. Rose found fluorspar to be completely decomposed when fused with a mixture of silica and sodium carbonate. P. Berthier also examined qualitatively the result of fusing fluorspar with **calcium sulphate, calcium sulphide, strontium sulphate, barium chloride, sodium sulphate, sodium chloride, and borax**. C. Friedel found fluorspar is rapidly decomposed when fused with aluminium sulphate, forming calcium sulphate and aluminium fluoride; and W. Briegleb noticed that small crystals of apatite are formed when fluorspar is fused with **sodium phosphate** at a red heat. A. Guntz obtained what he regarded as **sodium barium difluoride**, $\text{NaF} \cdot \text{BaF}$, by the electrolysis of a molten mixture of sodium and barium fluorides.

E. Paternò, A. Mazzucchelli, and D. Vita have studied the formation of mixed colloids of calcium fluorides with calcium phosphate; silver chloride, bromide, iodide, phosphate, or sulphide; cupric sulphide; ferric hydroxide; or silicic acid, and found that these mixtures are stable; on the other hand, mixtures with calcium carbonate or oxalate; silver thiocyanate, chromate, or manganate; zinc, cadmium, or manganese sulphide; lead chromate or sulphate; or barium sulphate form less stable colloids; and calcium fluoride precipitates at once in the presence of arsenious sulphide.

REFERENCES.

- ¹ W. M. Egglestone, *Trans. Inst. Min. Eng.*, 35, 236, 1908; C. B. Wedd and G. C. Drabble, *ib.*, 35, 501, 1908; S. F. Emmons, *Trans. Amer. Inst. Min. Eng.*, 21, 31, 1893; F. J. Fohr, *Econ. Geol.*, 5, 377, 1910; G. Wilson, *Chem. Gaz.*, 7, 366, 1850; *Edin. New Phil. Journ.*, 49, 230, 1850; K. Andrée, *Tschermak's Mitt.*, 28, 585, 1909; A. Scacchi, *Zeit. Kryst.*, 16, 56, 1890; E. Frémy, *Ann. Chim. Phys.*, (3), 43, 64, 1855; J. J. Berzelius, *ib.*, (1), 61, 256, 1807; B. Blount and J. H. Sequeira, *Journ. Chem. Soc.*, 115, 705, 1919.
- ² E. Paternò and E. Mazzucchelli, *Atti Accad. Lincei*, (5), 12, 420, 520, 1903; J. J. Berzelius, *Pogg. Ann.*, 1, 20, 1824; H. Rose, *ib.*, 79, 112, 1849; H. St. C. Deville and H. Caron, *Ann. Chim. Phys.*, (3), 67, 340, 1863; E. Defacqz, *Compt. Rend.*, 137, 1251, 1903; 138, 197, 1904; *Ann. Chim. Phys.*, (8), 1, 333, 1904; H. de Sénarmont, *ib.*, (3), 32, 129, 1851; C. Poulenq, *ib.*, (7), 2, 25, 1894; *Compt. Rend.*, 116, 987, 1893; A. C. Becquerel, *ib.*, 79, 82, 1874; H. Moissan, *Bull. Soc. Chim.*, (3), 5, 152, 1891; T. Scheerer and E. Drechsel, *Journ. prakt. Chem.*, (2), 7, 63, 1873; F. Röder, *Ueber krystallisierte wasserfreie Fluor-verbindungen*, Göttingen, 1862; J. L. Gay Lussac and L. J. Thénard, *Ann. Chim. Phys.*, (1), 69, 204, 1809; E. Frémy, *ib.*, (3), 47, 12, 1856; H. W. Foote and G. A. Menge, *Amer. Chem. Journ.*, 35, 432, 1906; A. Feldmann, *Brit. Pat. No.* 15295, 1889; W. Wetzel, *Centr. Min.*, 444, 1921.
- ³ A. Kennigott, *Sitzber. Akad. Wien*, 10, 296, 1853; A. Breithaupt, *Berg. Hütt. Ztg.*, 24, 310, 1865; E. Madelung and R. Fuchs, *Ann. Physik*, (4), 65, 289, 1921; H. E. Merwin, *Journ. Washington Acad.*, 1, 59, 1911; A. Landé, *Ber. deut. phys. Ges.*, 20, 217, 1918; E. Bormann, *Zeit. Physik*, 1, 55, 1920; H. G. F. Schröder, *Dichtigkeitsmessungen*, Heidelberg, 1873; O. Ruff and W. Plato, *Ber.*, 35, 3616, 1902; C. H. D. Bödeker, *Die Beziehung zwischen Dichte und Zusammensetzung bei festen und liquiden Stoffen*, Leipzig, 1860; A. W. Hull, *Phys. Rev.*, (2), 17, 42, 1921; W. Biltz, *Zeit. anorg. Chem.*, 115, 241, 1921; W. L. Bragg, *Proc. Roy. Soc.*, 89, A, 468, 1914; W. P. Davey, *Phys. Rev.*, (2), 18, 102, 1921; H. Bauhans and V. Goldschmidt, *Beitr. Kryst. Min.*, 1, 219, 1918; W. Gerlach, *Phys. Zeit.*, 23, 114, 1922.
- ⁴ W. Voigt, *Wied. Ann.*, 31, 474, 701, 1887; 34, 981, 1888; 35, 642, 1888; P. Drude and W. Voigt, *ib.*, 42, 537, 1891; A. Mallock, *Proc. Roy. Soc.*, 49, 380, 1891; K. Försterling, *Zeit. Physik*, 8, 251, 1922.
- ⁵ H. Fizeau, *Compt. Rend.*, 68, 1125, 1869; *Phil. Mag.*, (4), 36, 31, 1868; G. Weidemann, *Wied. Ann.*, 38, 453, 1889; F. Pfaff, *Pogg. Ann.*, 104, 171, 1858; F. E. Neumann, *ib.*, 23, 32, 1831; H. V. Regnault, *Ann. Chim. Phys.*, (3), 1, 129, 1841; W. R. Mott, *Trans. Amer. Electrochem. Soc.*, 34, 255, 1918; H. Kopp, *Liebig's Ann. Suppl.*, 3, 289, 1865; J. Joly, *Proc. Roy. Soc.*, 41, 250, 1887; H. Moissan, *Bull. Soc. Chim.*, (3), 5, 880, 1881; O. Ruff and W. Plato, *Ber.*, 36, 2357, 1903; E. Beck, *Metallurgie*, 5, 504, 1908; G. Magnus, *Pogg. Ann.*, 20, 482, 1820; A. Guntz, *Compt. Rend.*, 97, 1483, 1883; *Ann. Chim. Phys.*, (6), 3, 38, 1884; E. Petersen, *Zeit. phys. Chem.*, 4, 384, 1889; E. Gruneisen, *Ann. Physik*, (4), 55, 371, 1918.
- ⁶ S. P. Thompson, *Phil. Mag.*, (5), 31, 120, 1891; E. Abbe, *Zeit. Inst.*, 10, 1, 1890; H. Rubens and B. W. Snow, *Wied. Ann.*, 46, 541, 1892; J. Stefan, *Sitzber. Akad. Wien*, 63, 243, 1871; E. Sarasin, *Arch. Sciences*, Genève, 10, 303, 1883; F. J. Micheli, *ib.*, 13, 217, 1902; A. Mülheims, *Zeit. Kryst.*, 14, 223, 1888; D. Brewster, *Trans. Roy. Soc. Edin.*, 8, 157, 1818; H. Rubens and E. Aschkinass, *Weid. Ann.*, 65, 241, 1898; B. W. Snow, *ib.*, 46, 540, 1892; F. Paschen, *ib.*, 53, 325, 821, 1894; 56, 765, 1895; H. Rubens and E. F. Nichols, *ib.*, 60, 418, 1897; C. Pulfrich, *ib.*, 45, 635, 1892; J. O. Reed, *ib.*, 65, 707, 1898; C. Hlawatsch, *ib.*, 57, 606, 1896; H. T. Simon, *ib.*, 53, 553, 1894; H. Rubens, *Wied. Ann.*, 45, 254, 1892; 51, 390, 1894; 53, 273, 1894; 54, 476, 1895; 69, 576, 1899; F. F. Martens, *Ann. Physik*, (4), 6, 616, 1901; (4), 8, 460, 1902; U. Meyer, *ib.*, (4), 30, 626, 1909; F. Paschen, *ib.*, (4), 4, 303, 1901; V. Schumann, *ib.*, (4), 5, 349, 1901; W. Carvallo, *Compt. Rend.*, 116, 1189, 1893; *Ann. Chim. Phys.*, (7), 4, 5, 1895; H. Fizeau, *ib.*, (3), 46, 455, 1862; H. Dufet, *Bull. Soc. Min.*, 8, 259, 1885; H. Dudenhausen, *Neues Jahrb. Min.*, i, 34, 1904; F. J. M. Wülfing, *ib.*, ii, 167, 1907; E. Marbach, *Beitrag zur Kenntniss der optischen Verhältnisse von Flussspat, Steinsalz, Sylvin, Kalkspat, Aragonit, und Borazit*, Weida i. Th., 1913; H. E. Merwin, *Amer. Journ. Science*, (4), 32, 430, 1911; *Journ. Washington Acad.*, 1, 59, 1911.
- ⁷ W. W. Coblenz, *Journ. Amer. Optical Soc.*, 4, 432, 1920; *Bur. Standards Scient. Papers*, 401, 1920; M. Melloni, *Ann. Chim. Phys.*, (2), 55, 337, 1833; *Compt. Rend.*, 36, 709, 1853; P. Desains, *ib.*, 65, 406, 1867; E. Mascart, *ib.*, 68, 402, 1869; G. Magnus, *Sitzber. Akad. Berlin*, 482, 1869; H. Rubens, *Wied. Ann.*, 45, 238, 1892; H. Rubens and B. W. Snow, *ib.*, 46, 529, 1892; H. Rubens and A. Trowbridge, *ib.*, 60, 724, 1897; F. Paschen, *ib.*, 53, 301, 1894;

W. H. Julius, *Verh. Akad. Amsterdam*, 1. 1, 1892; W. A. Miller, *Phil. Trans.*, 152. 861, 1863; G. G. Stokes, *ib.*, 142. 463, 1852; W. N. Hartley and A. K. Huntington, *ib.*, 170. 257, 1879; *Proc. Roy. Soc.*, 23. 233, 1879; E. Nichols, *Phys. Rev.*, 2. 302, 1895; A. Schuster, *Pogg. Ann.*, 147. 106, 1872.

⁸ P. Ites, *Zeit. Kryst.*, 41. 303, 1903; V. Agafonoff, *Neues Jahrb. Min.*, ii, 431, 1904; A. Pflüger, *Phys. Zeit.*, 5. 215, 1904; H. Rubens and A. Trowbridge, *Wied. Ann.*, 60. 724, 1897; A. Wiedemann and G. C. Schmidt, *ib.*, 54. 604, 1895; *Zeit. phys. Chem.*, 18. 529, 1895; A. Winkelmann and R. Straubel, *Wied. Ann.*, 59. 324, 1896; A. E. Becquerel, *Compt. Rend.*, 101. 205, 1885; 144. 671, 1907; P. Bary, *ib.*, 130. 776, 1900; G. Urbain and C. Seal, *ib.*, 144. 30, 1907; E. Hagenbach, *Arch. Sciences Genève*, (2), 60. 297, 1877; *Ber.*, 10. 2232, 1877; P. Schuhknecht, *Ann. Physik*, (4), 17. 717, 1905; E. Meyer, *Verh. phys. deut. Ges.*, 10. 643, 1908; G. Wyruboff, *Bull. Soc. Chim.*, (2), 49. 738, 1888; J. S. Elsholtz, *Miscellanea curiosa medico-physica academice naturae curiosarum, sive emphemeredum medico-physicarum germanicarum curiosarum*, Berlin, 32, 37. 1720; C. Doelter, *Centr. Min.*, 479, 1921; *Koll. Zeit.*, 26. 23, 1920; *Sitzber. Akad. Wien*, 129. 399, 1920; D. Brewster, *Trans. Roy. Soc. Edin.*, 12. 538, 1833; *De phosphoris observationes*, Berlin, 1681; A. Odenerantz, *Luminescence spectra of fluorites*, Upsala, 1910; E. Newbery and H. Lupton, *Mem. Manchester Lit. Phil. Soc.*, 62. 10, 1918; G. W. von Leibniz, *Schriften Acad. Berlin*, 1. 1, 91, 123, 1710; E. C. Lewis and A. C. Hardy, *Phys. Rev.*, (2), 14. 272, 1919; G. C. Kindt, *Pogg. Ann.*, 131. 160, 1867; G. D. Liveing, *Proc. Cambridge Phil. Soc.*, 3. 96, 1877; T. J. Pear-sall, *Journ. Roy. Inst.*, 1. 267, 1830; H. W. Morse, *Astrophys. Journ.*, 21. 83, 1905; *Pro. Amer. Acad.*, 41. 587, 1906.

⁹ C. F. Schaffhäutl, *Liebig's Ann.*, 46. 344, 1843; C. F. Schönbein, *Sitzber. Akad. München*, 1861; *Journ. prakt. Chem.*, (1), 84. 194, 1861; A. Schrötter, *Sitzber. Akad. Wien*, 41. 727, 1860; O. Löw, *Ber.*, 14. 1144, 1881; G. Wyruboff, *Bull. Soc. Chim.*, (1), 5. 334, 1866; E. Newbery and H. Lupton, *Mem. Manchester Lit. Phil. Soc.*, 62. 10, 1918; H. W. Morse, *Proc. Amer. Acad.*, 43. 1, 1907; C. Doelter, *Die Farben der Mineralien insbesondere der Edelsteine*, Braunschweig, 68, 1915; *Centr. Min.*, 479, 1921; *Koll. Zeit.*, 26. 23, 1920; *Sitzber. Akad. Wien*, 129. 399, 1920; J. Jakob, *Zeit. Kryst.*, 56. 194, 1921; *Helvetica Chim. Acta*, 3. 669, 1920; J. Barnes and W. F. Holroyd, *Trans. Manchester Geol. Soc.*, 24. 215, 1895; A. H. Becquerel and H. Moissan, *Compt. Rend.*, 111. 669, 1890; D. Berthelot, *ib.*, 145. 818, 1907; M. Berthelot, *ib.*, 143. 477, 1906; 145. 710, 1907; A. Debierne, *Ann. Chim. Phys.*, (9), 2. 478, 1914; C. S. Garnett, *Journ. Chem. Soc.*, 117. 620, 1920; B. Blount and J. H. Sequeira, *ib.*, 115. 705, 1919.

¹⁰ F. Mohs, *Grundriss der Mineralogie*, Dresden, 2. 84, 1824; F. von Kobell, *Charakteristik der Mineralien*, Nürnberg, 1. 48, 1830; D. Brewster, *Trans. Roy. Soc. Edin.*, 12. 538, 1833; 16. 111, 1849; *Phil. Mag.*, (3), 38. 489, 1848; *B. A. Rep.*, 10, 1838; J. F. W. Herschel, *Phil. Trans.*, 135. 143, 1845; G. G. Stokes, *ib.*, 142. 463, 1852; 143. 385, 1853; *Proc. Roy. Soc.*, 13. 144, 1854; J. W. Retgers, *Zeit. phys. Chem.*, 12. 603, 1893.

¹¹ J. G. Wallerius, *Mineralogie*, Berlin, 1750; M. Sago, *Elémens de minéralogie docimastique*, Paris, 1. 155, 1777; J. B. L. Romé d'Isle, *Cristallographie*, Paris, 2. 1, 1783; T. von Grotthus, *Journ. Phys.*, 45. 398, 1794; J. F. L. Hausmann, *Handbuch der Mineralogie*, Göttingen, 2. 1438, 1847; E. Clerici, *Atti Accad. Lincei*, (5), 29. i, 309, 1920; E. Newbery and H. Lupton, *Mem. Manchester Lit. Phil. Soc.*, 62. 10, 1918; J. R. Formhals, *Chem. Ztg.*, 38. 1111, 1914; J. Königsberger, *Zeit. Kryst.*, 36. 622, 1902.

¹² A. Mitscherlich, *Pogg. Ann.*, 121. 459, 1864; C. Fabry, *Astrophys. Journ.*, 21. 356, 1905; J. Rosch, *Zeit. wiss. Phot.*, 4. 384, 1906; P. Leopold, *ib.*, 11. 105, 137, 1913; H. George, *ib.*, 12. 237, 1913; C. M. Olmsted, *ib.*, 4. 354, 1906; S. Datta, *Proc. Roy. Soc.*, 99. A, 362, 1921; H. Pealing, *Proc. Phys. Soc.*, 33. 297, 1921.

¹³ W. Hankel, *Abhand. Ges. Wiss. Leipzig*, 12. 201, 1879; *Wied. Ann.*, 2. 66, 1877; 11. 269, 1880; G. C. Schmidt, *ib.*, 62. 407, 1897; H. Starke, *ib.*, 60. 641, 1897; J. Königsberger, *ib.*, 66. 698, 1898; W. Schmidt, *Ann. Physik*, (4), 9. 919, 1902; W. Voigt and S. Kinoshita, *ib.*, (4), 24. 505, 1907; E. Meyer, *Verh. deut. phys. Ges.*, 10. 643, 1908; J. Curie, *Ann. Chim. Phys.*, (7), 17. 385, 1899; (7), 18. 203, 1899; M. Romich and J. Nowak, *Sitzber. Akad. Wien*, 70. 380, 1874; M. von Pirani, *Zeit. Kryst.*, 41. 315, 1903; *Ueber Dielectricitätsconstanten fester Körper*, Berlin, 1903; F. Paschen, *Wied. Ann.*, 54. 668, 1896; P. Pascal, *Compt. Rend.*, 173. 144, 1921.

¹⁴ G. Wilson, *Edin. New. Phil. Journ.*, 49. 230, 1850; *Trans. Roy. Soc. Edin.*, 16. 145, 1849; *B. A. Rep.*, ii, 38, 1846; ii, 68, 1850; *Chem. Gaz.*, 4. 183, 1846; 8. 366, 1850; *B. A. Rep.*, 67. 1850; F. Kohlrausch and F. Rose, *Zeit. phys. Chem.*, 13. 241, 1893; F. Kohlrausch, *ib.*, 44. 197, 1903; 50. 355, 1905; 64. 121, 1908; J. Nicklès, *Ann. Chim. Phys.*, (3), 53. 433, 1858; J. L. Gay Lussac and L. J. Thénard, *ib.*, (1), 69. 204, 1809; P. Berthier, *ib.*, (2), 38. 253, 1828; (2), 43. 296, 1830; E. Frémy, *ib.*, (3), 47. 17, 1856; E. Defcaqz, *ib.*, (8), 1. 348, 1904; C. Poulenc, *ib.*, (7), 2. 5, 1894; *Compt. Rend.*, 116. 987, 1893; T. Scherer and E. Drechsel, *Journ. prakt. Chem.*, (2), 7. 67, 1873; A. Guntz, *Compt. Rend.*, 136. 749, 1903; *Bull. Soc. Chim.*, (3), 29. 490, 1903; *Ann. Chim. Phys.*, (8), 4. 5, 1905; J. Smithson, *Ann. Phil.*, (2), 4. 363, 1822; E. Paternò and A. Mazzucchelli, *Gazz. Chim. Ital.*, 34. i, 389, 1904; A. Mazzucchelli and D. Vita, *ib.*, 50. i, 232, 1920; F. Röder, *Ueber krystallisierte wasserfreie Fluorverbindungen*, Göttingen, 1862; A. Guntz and H. Basset, *Bull. Soc. Chim.*, (3), 35. 404, 1906; C. Friedel, *ib.*, (1), 21. 241, 1874; H. Schulze, *Journ. prakt. Chem.*, (2), 21. 407, 1880; E. Paternò and U. Alvisi, *Rend. Accad. Lincei*, 7. 327, 1898; H. Briegleb, *Liebig's Ann.*, 97. 95, 1856; H. C. Sorby, *Chem. News*, 2. 270, 1860; H. Reinsch, *Neues Jahrb. Pharm.*, 34. 11, 1870; H. Rose, *Pogg. Ann.*, 79. 112, 1849; J. J. Berzelius, *ib.*, 1. 20, 1824.

§ 12. Calcium, Strontium, and Barium Chlorides

The Dutch alchemists—Isaac of Holland and either his brother or his son—are supposed to have lived in the fifteenth century,¹ because in their writings they cite a number of authorities prior to that period, but none more recent. They quote Arnold of Villanova with reverence, but they do not mention Paracelsus. Isaac of Holland said that he obtained a salt which he called *sal ammoniacum fixum* by heating together sal ammoniac and lime; this salt could have been no other than calcium chloride. W. Homberg, in his *Observations sur un nouveau phosphore* (1693), noticed by chance that the salt prepared by calcining a mixture of sal ammoniac with twice its weight of lime is phosphorescent when fused, and hence, for a time, calcium chloride was known as *phosphore de Homberg*, or Homberg's phosphorus. Strontium chloride was first described by A. Crawford² in 1790; and barium chloride by C. W. Scheele, in his memoir *De magnesia nigra*, in 1774.

Calcium chloride is found in soln. in sea-water, and in many mineral springs, J. F. L. Hausmann³ found calcium chloride crystals in the anhydrite of Lüneburg, and called it *hydrophyllite*—*ἕδωρ*, water; *φίλος*, lover—in reference to its hygroscopicity; A. Scacchi also found it mixed with potassium, sodium, and manganese chlorides among the products of the Vesuvian eruption of 1872, and named it *chlorocalcite*. F. Zambonini regarded chlorocalcite as a compound, $\text{KCl} \cdot \text{CaCl}_2$, but there is no evidence of the homogeneity of the product he analyzed. Calcium chloride also occurs as a constituent of some minerals—*e.g.* *tachhydrite*, $2\text{MgCl}_2 \cdot \text{CaCl}_2 \cdot 12\text{H}_2\text{O}$; *apatite*, $3\text{Ca}_3(\text{PO}_4)_2 \cdot \text{Ca}(\text{Cl}_2, \text{F}_2)$.

Calcium chloride is used as a substitute for salt brine in refrigerating and ice-making plants; in the absorption of moisture from air in cold storage rooms; in the drying of gases in the manufacture of liquid carbon dioxide, ammonia, etc.; for drying air in compressed air power plants; in the manufacture of dry colours or lakes; in the composition of sizing for cotton mill use; as a hot bath in the preparation of canned vegetables and food stuffs; as a liquid in traps for plumbing systems; in the laying of dust in streets; in the seasoning of Portland cement; in the preparation of wall plaster; etc.

The preparation of chlorides of the alkaline earths.—The chlorides of the alkaline earths are formed by the action of chlorine on the metal. According to H. Moissan, in the reaction with calcium the mass becomes incandescent. J. L. Gay Lussac and L. J. Thénard⁴ prepared calcium chloride by the action of chlorine on quicklime, which becomes incandescent during the reaction, and oxygen is given off. H. Davy found that oxygen eq. to the chlorine was evolved when the latter gas reacts with barium oxide; and R. Weber, with strontium oxide. M. E. Chevreuil found that calcium oxide also vigorously absorbs gaseous hydrogen chloride, forming calcium chloride and water, without becoming incandescent. With barium and strontium oxides M. E. Chevreuil found the analogous reaction occurs with incandescence. The reaction between hydrogen chloride and calcium oxide is completed at a high temp. W. Heap and E. Newbery passed carbonyl chloride, or a mixture of carbon monoxide and chlorine over a catalyst like animal charcoal, and then over the oxide or salt of a weak acid—carbonate or oxalate—at a suitable temp.

J. B. J. D. Boussingault, and C. Hensgen found that the sulphates of the alkaline earths are very gradually converted into chlorides when heated in a stream of hydrogen chloride. C. Matignon and F. Bourion found barium sulphate or carbonate is converted into chloride when heated in a stream of sulphur chloride vapour, S_2Cl_2 , mixed with an excess of chlorine. According to G. P. A. Petzholdt, a mixture of hydrogen chloride and carbon dioxide gives a mixture of calcium chloride and carbonate. Neither calcium oxide nor carbonate, according to G. Gore, is attacked by liquid hydrogen chloride, but precipitated barium or strontium carbonate is converted into the chloride without the evolution of any gas. P. Heinrich found

that when hydrochloric acid is dropped on quicklime in the dark, a luminescence appears. Calcium chloride is usually obtained by dissolving calcium carbonate in hydrochloric acid, and evaporating the soln. to crystallization. Crystals of the hexahydrated salt, $\text{CaCl}_2 \cdot 6\text{H}_2\text{O}$, are formed.

Iceland spar or marble is dissolved in hydrochloric acid, chlorine water is added to oxidize iron and manganese compounds which are then precipitated along with silicic acid by the addition of milk of lime. The filtered soln. is acidified with hydrochloric acid, and evaporated to crystallization. The marble may also be dissolved in nitric acid and heated with an excess of lime. The filtered soln. is acidified and evaporated to crystallization, and recrystallized. Ammonium carbonate is then added to the soln., and the precipitated carbonate washed by decantation, and then dissolved in purified hydrochloric acid. This soln. is evaporated to crystallization.

G. Kirchoff and R. Bunsen dissolved marble in hydrochloric acid, and precipitated about half the lime with ammonium carbonate, and from the mother liquid the rest of the lime was precipitated by more ammonium carbonate. The first precipitate included most of the impurities in the marble as well as calcium carbonate; the second precipitate was dissolved in nitric acid and evaporated for calcium nitrate, which was dissolved in alcohol. The alcoholic soln. was evaporated, dissolved in water, and treated with ammonium carbonate. The precipitated calcium carbonate was washed and dissolved in hydrochloric acid for calcium chloride. The same process was used for strontium and barium chlorides. J. C. G. de Marignac, and J. B. A. Dumas purified strontium chloride by boiling a conc. soln. of commercial strontium chloride with a little sulphuric acid, and afterwards precipitated the chloride by a stream of hydrogen chloride. L. Barthe and E. Falières, and T. W. Richards and V. Yngve purified strontium chloride; and T. W. Richards, barium chloride by repeated precipitation by adding alcohol to the aq. soln. T. W. Richards purified barium chloride by the following method:

An aq. soln. of the commercial salt was evaporated to dryness with an excess of purified hydrochloric acid so as to decompose the thiosulphates. The hot dil. soln. was treated with an excess of hydrogen sulphide and allowed to stand in a tightly corked stout flask for some time in darkness. The clear liquid was made alkaline with purified barium hydroxide, and after standing some time decanted from the insoluble sulphides; the sulphur was expelled from the filtrate by boiling with hydrochloric acid. The soln. contained traces of calcium, strontium, potassium, sodium, and possibly magnesium. After two crystallizations from water, followed by two precipitations from alcohol, the spectroscope showed no impurity other than a trace of "the ever present sodium." This salt was ignited in a platinum dish at a dull red heat; the aq. soln. in water was acidified with hydrochloric acid and evaporated to crystallization.

If the water be expelled from the crystalline salt by heating the crystals above 200° , a white porous hygroscopic anhydrous mass is obtained. The fused product solidifies to a crystalline mass on cooling. F. P. Dunnington and F. W. Smither obtained $\text{CaCl}_2 \cdot \text{H}_2\text{O}$ after heating the hexahydrated salt 12 days at $97^\circ\text{--}98^\circ$. E. Mitscherlich supposed the dihydrated salt remains when the hexahydrated salt is dehydrated at 200° ; but J. Legrand showed that even the ground salt in a boiling sat. soln. has less than $\text{H}_2\text{O} : \text{CaCl}_2 = 2 : 1$. A. Weber says the salt dehydrated at 200° is anhydrous, although R. Bunsen showed that even after the salt has been melted at a white heat, it retains enough water to develop hydrogen when melted with iron. The anhydrous salt so prepared contains oxide or an oxychloride. According to H. C. Dibbitts, if calcium hexahydrated chloride be dehydrated below 130° , no trace of hydrogen chloride is evolved, but at a higher temp. some oxychloride is formed. H. Rose showed that if the chloride be heated with ammonium chloride, the partial decomposition is hindered. In order to obtain the anhydrous salt free from oxygen, T. W. Richards found it necessary to expel the water by heating the hydrated salt in a stream of hydrogen chloride, and during cooling to replace gradually the hydrogen chloride by nitrogen. Similar remarks apply to the preparation of the anhydrous chlorides of barium and strontium.

Barium chloride is made by dissolving witherite, native barium carbonate,

in hydrochloric acid. Powdered barium sulphate is converted into carbonate by heating it under press. with a soln. of potassium carbonate : $K_2CO_3 + BaSO_4 = BaCO_3 + K_2SO_4$. An early process was to heat a mixture of barium sulphate and calcium chloride : $BaSO_4 + CaCl_2 = BaCl_2 + CaSO_4$, but the reaction is incomplete and the process wasteful. In 1858, F. Kuhlmann proposed to heat a mixture of barytes with carbon, and manganese chloride, obtained as a by-product in the manufacture of chlorine ; but the process was not satisfactory, since the manganese sulphide readily oxidizes reforming barium sulphate. In 1889, J. Kolb modified a process recommended by A. Duflos in 1831, and this process is utilized in the manufacture of barium chloride at the present day. A mixture of barytes, $BaSO_4$, and powdered coke is heated to $1000^\circ - 1100^\circ$ when the barium sulphate is reduced to soluble sulphide : $BaSO_4 + 4C = 4CO + BaS$. The soluble barium sulphide is extracted with water, and calcium chloride added : $BaS + CaCl_2 = CaS + BaCl_2$. The decanted soln. is evaporated for barium chloride. The two reactions can be effected in one operation by heating the barytes with the coke and calcium chloride : $BaSO_4 + CaCl_2 + 4C = BaCl_2 + CaS + 4CO$. Here the barium sulphate is reduced to the sulphide, BaS , which then reacts with the calcium chloride, forming calcium sulphide and barium chloride. The mass is lixiviated with water ; the calcium sulphide remains behind, and barium chloride passes into soln. According to L. Godin, lime precipitates any calcium sulphide from the soln. as calcium oxysulphide. When the soln. is conc. and cooled, barium chloride, $BaCl_2 \cdot 2H_2O$, separates in colourless rhombic plates.

The barium sulphide can be converted into chloride by treatment with hydrochloric acid : $BaS + 2HCl = H_2S + BaCl_2$. The Consortium für elektrochemische Industrie used chlorine for the conversion ; R. Heinz used magnesium chloride ; and J. Waldenberg used ferric chloride. A. Duflos and A. d'Heureuse calcined a mixture of barium sulphate with calcium chloride and charcoal ; E. Asselin used iron in place of charcoal and heated the mixture until the flame of carbon monoxide no longer appeared. The mixture was extracted with water, as before. J. B. Trommsdorff used a similar process. The production of sulphides is avoided in B. Laeh's process, where hydrogen chloride is passed over a calcined mixture of barytes and carbon : $BaSO_4 + 4C + 2HCl = BaCl_2 + 4CO + H_2S$. H. Kunheim decomposed barium carbonate with ammonium chloride ; L. Godin used calcium chloride. F. Muck found that if a soln. of alkaline earth chlorides be mixed with sodium chloride, barium and strontium chlorides crystallize out first. C. S. Bradley and C. B. Jacobs heated the barytes in an electric furnace with insufficient carbon for the reduction ; the unconverted sulphate reacts with the sulphide : $BaS + 3BaSO_4 = 4SO_2 + 4BaO$. In practice about 40 per cent. of the product remains as sulphide, and about one per cent. as unconverted sulphate. The product can be converted to chloride with hydrochloric acid.

Much of what has been said about barium chloride applies *mutatis mutandis* to the strontium salt. H. W. F. Wackenroder obtained strontium chloride by heating the carbonate with magnesium or calcium chloride, and lixiviating the mass ; and also by the action of calcium chloride on strontium sulphide in an atm. of carbon dioxide—strontium chloride, calcium carbonate, and sulphide are formed. J. Mactear made strontium chloride by reducing celestine with carbon in the presence of calcium chloride.

Calcium chloride is a by-product in several manufacturing processes—*e.g.* the preparation of ammonia or ammonium carbonate ; the production of carbon dioxide from marble ; the preparation of potassium chlorate ; the preparation of sodium carbonate by the Solway process ; the preparation of chlorine by Weldon's process ; etc. Technically, calcium chloride is made from the residue left after the preparation of ammonia—a mixture of calcium chloride and hydroxide—which is treated with hydrochloric acid and evaporated. M. M. T. K. Kaisha made anhydrous alkaline earth chlorides suitable for electrolysis by adding ammonium chloride and the oxide, hydroxide, carbonate or oxychloride of the alkaline earth

to a halide salt of a more electropositive metal. I. Namari and Y. Hiraoka used a somewhat similar process. J. H. MacMahon treated the feeder liquor of the ammonia-soda process with barium sulphide, and obtained barium chloride

The properties of the chlorides of the alkaline earths.—The crystals of hexahydrated calcium and strontium chlorides belong to the trigonal system. A. Eppler⁵ found for the axial ratio of the former : $a : c = 1 : 0.505$, and $\alpha = 112^\circ 29'$; and of the latter, $a : c = 1 : 0.5150$, and $\alpha = 112^\circ 14'$. G. Wyruboff gave for the monoclinic prisms of dihydrated barium chloride : $a : b : c = 0.6177 : 1 : 0.6549$, and $\beta = 91^\circ 5'$. For mixed crystals of barium chloride and bromide, *vide infra*. The reported numbers⁶ of the **specific gravity** of anhydrous calcium chloride range from C. J. B. Karsten's 2.0401 to L. Playfair and J. P. Joule's 2.480. O. Ruff and W. Plato give 2.26 at 20° . G. Quincke gives 2.219 at 0° ; and 2.120 for the molten salt at the melting point. For anhydrous strontium chloride, the numbers range from C. J. B. Karsten's 2.8033 to H. G. F. Schröder's 2.054. G. Quincke's and F. Braun's value for the fused salt at the m.p. are both 2.770; and P. A. Favre and C. A. Valson's, 3.035 at 17.2° . For anhydrous barium chloride, the numbers range from P. Kremer's 3.7 at 17.5° , to P. F. G. Boullay's 4.156. P. A. Favre and C. A. Valson give 3.844 at 16.8° ; T. W. Richards, 3.856; and G. Quincke, 3.700, for the molten salt at its m.p. The best representative values at 15° may be taken as : CaCl_2 , 2.152; SrCl_2 , 3.052; BaCl_2 , 3.856; whence W. Biltz gives the respective mol. vol. 51.57, 51.97, and 54.02.

According to J. B. A. Dumas, calcium chloride loses its water and melts at a red heat, in an atm. of hydrogen chloride, and freezes to a crystalline mass. The **melting point** numbers for anhydrous calcium chloride range from W. Ramsay and N. Eumorfopoulos'⁷ 710° , to V. Meyer, and W. Riddle's 806.4° ; for anhydrous strontium chloride, from T. Carnelley's 829° to W. Plato's 872.3° ; and for anhydrous barium chloride, from T. Carnelley's 772° to F. Haber and S. Tolloczko's 965° . There is a **transformation temperature** with barium chloride at 923° – 924° when the so-called monoclinic α - BaCl_2 , melting at 960° , passes into cubic β - BaCl_2 ; H. Gemsky placed the transition temp. at 930° . This change was noted by H. le Chatelier in 1897.

According to E. Kraus, when the chlorides of the alkaline earths are heated to redness in air, a part is transformed into the oxide, so that the aq. soln. of calcined chloride has an alkaline reaction. J. B. Dumas made a similar observation with respect to barium chloride, and T. W. Richards found that a little chlorine is lost. E. Mitscherlich noticed that at a white heat a small quantity of calcium chloride volatilizes without decomposition, and R. Bunsen said that a bead on platinum wire volatilizes 2.717 times as fast as sodium chloride, while T. H. Norton and D. M. Roth found that barium chloride under similar conditions volatilizes 120 times as fast as sodium chloride. G. Bartha found some barium chloride volatilizes at 1000° . When a soln. of strontium or barium chloride is sprayed into a Bunsen's flame, spectroscopic observations by A. Gouy showed that the salt is only partially dissociated, while with calcium chloride, dissociation is complete. L. Rügheimer's determinations show that the mol. wt. of strontium and barium chlorides are normal in boiling bismuth chloride.

H. Kopp's value for the **coefficient of expansion** of calcium chloride is 0.00062. The **specific heat** of anhydrous calcium chloride, according to H. Kopp, is 0.209, and, according to H. V. Regnault, 0.215; for strontium chloride from 13° to 98° , 0.1199; and for barium chloride, from 14° to 98° , 0.08957; or from 16° to 47° , 0.0902.

According to J. Thomsen,⁸ the **heat of formation** of the chlorides of the alkaline earths from their elements is (CaCl_2 , $6\text{H}_2\text{O}$), 170.23 Cals.; (Sr , Cl_2), 184.55 Cals.; and (Ba , Cl_2), 194.24 Cals. D. Tommasi gives (Ca , Cl_2 , $6\text{H}_2\text{O}$), 191.98 Cals.; (Sr , Cl_2 , $6\text{H}_2\text{O}$), 203.19 Cals.; and (Ba , Cl_2 , $2\text{H}_2\text{O}$), 7.0 Cals.; (CaCl_2 , aq.), 17.41 Cals.; (SrCl_2 , aq.), 12.14 Cals.; and (BaCl_2 , aq.), 2.07 Cals.; (Ca , Cl_2 , aq.), 187.64 Cals.; (Sr , Cl_2 , aq.), 195.69 Cals.; and (Ba , Cl_2 , aq.), 196.32 Cals.; (CaCl_2 ,

6H₂O), 21.75 Cals.; (SrCl₂, 6H₂O), 18.64 Cals.; and (BaCl₂, 2H₂O), 7.00 Cals. M. Berthelot gives (Ca(OH)₂aq., 2HCl_{aq.}), 27.9 Cals.; (Sr(OH)₂aq., 2HCl_{aq.}), 28.0 Cals.; and (Ba(OH)₂aq., 2HCl_{aq.}), 27.78 Cals. A. Guntz and G. Röderer give $Sr_{\text{solid}} + nHCl_{\text{aq.}} = SrCl_{2\text{aq.}} + 128 \text{ Cals.}$

According to P. Sabatier, the **heat of solution** of monohydrated calcium chloride, CaCl₂.H₂O, is 11.75 Cals., at 21.5°. According to J. Thomsen, the heat of soln. of a mol of CaCl₂.6H₂O in 400 mols of water is -4.34 Cals.; for SrCl₂.6H₂O, the corresponding value is -7.51 Cals.; and of BaCl₂.2H₂O, -4.93 Cals.; a mol of BaCl₂.H₂O in 400 mols of water, -1.10 Cals. S. U. Pickering gives for the heat of soln. of anhydrous calcium chloride in water, 18.723 Cals.; and in alcohol, 17.555 Cals.; for hexahydrated calcium chloride in water, -4.251 Cals.; and in alcohol, -2.563 Cals. S. U. Pickering gives for the heat of admixture in cals. of 100 grms. of a conc. soln. of calcium chloride in an infinitely large amount of water at 17.91°:

Per cent. CaCl ₂	. 1	2	5	10	20	30	40	50	52
Heat in cals.	. 4.65	10.95	35.1	80.5	215.5	517.5	1277	2915	3328

The heat of soln. of calcium chloride associated with different proportions of water in 400 mols of water, at 18°, is, according to J. Thomsen:

Mols H ₂ O	. 0	1.67	2.75	3.49	3.76	6
Heat of soln.	. 17.80	10.80	6.93	3.75	2.97	-4.34 Cals.

Similarly for strontium chloride:

Mols. H ₂ O	. 0	1	2	3	4	5	6
Heat of soln.	. 11.14	5.88	2.08	-0.39	-2.84	-5.16	-7.5 Cals.

According to C. M. van Deventer and H. J. van de Stadt, the so-called integral heat of soln. of CaCl₂.6H₂O is -7.55 Cals. S. Arrhenius' value for the heat of ionization in $\frac{1}{10}N$ -CaCl₂ soln. at 35° is -307 Cals. F. R. Pratt, and G. McP. Smith and co-workers have studied the **heats of dilution** of soln. of barium and strontium chlorides alone and mixed with different proportions of the alkali chlorides. The heats of dilution of the mixed soln. bear no simple additive relation, and the results agree with the assumption that compounds of a higher order are formed.

When the anhydrous chlorides are dissolved in water, heat is evolved, and the soln. becomes warmer: e.g. CaCl₂+Aq.=CaCl_{2aq.}+17.4 Cals.; and with anhydrous barium chloride, 2.1 Cals. On the contrary, when the crystalline hydrates are dissolved in water, heat is absorbed, and the soln. becomes cooler: e.g. CaCl₂.6H₂O+Aq.=CaCl_{2aq.}, -4.3 Cals.; and with crystalline barium chloride, BaCl₂.2H₂O, -4.9 Cals. Thus, the temp. can be reduced from 0° to -42° by a mixture of 2 parts of crystallized calcium chloride, with half its weight of snow or powdered ice; 3 parts of potassium chloride with 2 parts of snow will lower the temp. from 0° to -33°; with 10 parts of snow, from 0° to -11°; 1 part of sodium chloride with 3 parts of snow will lower the temp. from 0° to -17.7°. Hence, the use of such salts as **freezing mixtures**.

The dissolution of a solid is attended by (i) the separation of the mols. from one another against mol. attraction; (ii) the liquefaction of the solid; and (iii) combination of the solute with the solvent. The two former involve an expenditure of energy and exercise a cooling effect, the last alone usually exercises a heating effect; whether the dissolution of a solid will be an endo- or an exo-thermal process is thus determined by the relative magnitudes of these three effects. When liquids are dissolved, (ii) will be zero; and with gases liquefaction will be attended by an evolution of heat. The great evolution of heat which attends the dissolution of anhydrous calcium chloride in water is evidence that the solute is uniting chemically with the solvent.

The **solubility** of calcium chloride in water from -55° to 260° has been determined by P. Kremers,⁹ G. J. Mulder, A. B. Poggiale, H. Hammerl, A. Étard, R. Engel,

and A. Ditte, H. W. B. Roozeboom's results expressed in grams CaCl_2 per 100 grms. of soln. are :

	0°	10°	20°	40°	60°	80°	100°	160°
CaCl_2	37.3	39.4	42.7	53.4	57.8	59.5	61.4	69.0
SrCl_2	30.3	32.3	34.6	39.5	45.0	47.5	50.2	58.5
BaCl_2	24.0	25.0	26.3	28.9	31.3	34.3	37.0	38.9

The solubility of calcium chloride at -55° is 29.8 grms. of CaCl_2 per 100 grms. of soln.; and at 260° , 77.6 grms. of CaCl_2 . The solubility of strontium chloride from -20° to 180° has been determined by G. J. Mulder, A. B. Poggiale, P. Kremers, R. Engel, A. Étard, and W. A. Tilden; at -20° , the solubility is 26.0 per cent. SrCl_2 ; and at 180° , 62.0 per cent. The solubility of barium chloride from 0° to 215° has been determined by G. J. Mulder, J. L. Gay Lussac, P. Kremers, A. Gerardin, R. Engel, and H. Precht and B. Wittzen. A. Étard found that at 215° , the solubility is 43.1 per cent. BaCl_2 . The solubility curves of these salts would be misleading if plotted from the numbers indicated above, for many of these chlorides give solubility curves with a number of breaks which would thus be smoothed out and accordingly obscured. Care must always be exercised in smoothing data obtained at widely differing temp., because some important phenomena may thus be masked. The breaks correspond with the change in the solubility which attends the transformation of one hydrate into another as the temp. rises. The same remarks apply to formulæ representing the relation between the solubility S and the temp. θ by a continuous function—*e.g.* A. Étard represented the solubility curves of calcium chloride at θ° between -18° and 6° by $S=32+0.2148\theta$; and between 50° and 170° by $S=54.5+0.0755\theta$. J. L. Gay Lussac represented the solubility curve of barium chloride by $S=30.62+0.2711\theta$; and A. E. Nordenskjöld by $\log S=1.4916+0.003413\theta-0.00000658\theta^2$.

W. D. Harkins and H. M. Paine measured the solubility of strontium chloride in water, and noted the effect of various additions, and also the sp. gr. of the soln. They found strontium chloride dissolves in water to the extent of 557.6 grms. in 1000 grms. of water, and the soln. has a sp. gr. 1.4015 at $25^\circ/4^\circ$. Strontium nitrate increases the solubility to 558.5 grms. with 0.1372 eq., and then decreases it to 551.4 grms. with 3.318 eq. per 1000 grms. of water. Sodium nitrate increases the solubility 584.8 grms. with 3.553 eq., and then decreases it to 542.6 grms. with 3.856 eq. per litre. Nitric acid has very little influence on the solubility, whereas hydrochloric acid strongly depresses the solubility to 42.09 grms. with 9.205 eq. per 1000 grms. The other substances examined all depress the solubility of strontium chloride appreciably, but not to anything like the extent that hydrochloric acid does. The solubility curve for hydrobromic acid lies above that for hydriodic acid, and hydrochloric acid, on account of its common ion effect, gives a curve which lies much below either. Just as hydrochloric acid depresses the solubility more than hydrobromic acid, so potassium chloride is more effective in lowering the solubility than potassium iodide. The curves for sodium nitrate and nitric acid have the same relative positions as potassium iodide and hydriodic acid and potassium chloride and hydrochloric acid. In all these cases, the solubility of strontium chloride is less in the acid than in the corresponding salt soln. W. D. Treadwell found the solubility of dihydrated barium chloride in alcohol and water at 15° to be:

Per cent. alcohol (wt.)	10	20	30	40	60	80	97
$\text{BaCl}_2 \cdot 2\text{H}_2\text{O}$	31.1	21.9	14.7	10.2	3.5	0.5	0.014

The hydrates of the chlorides of the alkaline earths.—The solubility curves of calcium chloride shows the existence of five hydrates: $\text{CaCl}_2 \cdot \text{H}_2\text{O}$, $\text{CaCl}_2 \cdot 2\text{H}_2\text{O}$, $\text{CaCl}_2 \cdot 6\text{H}_2\text{O}$, and two forms, α - and β - $\text{CaCl}_2 \cdot 4\text{H}_2\text{O}$. H. W. B. Roozeboom's solubility curve is shown in Fig. 12. The eutectic or cryohydric temp. is -55° with a soln. containing one part of CaCl_2 in 14.5 parts of water. At this quadruple point, the two solid phases are ice and hexahydrated

calcium chloride, the other two phases are the soln. just indicated, and vapour with a scarcely appreciable vapour press. The solubility curve of the hexahydrated salt rises steadily from -55° to 29.2° , when there is a break, corresponding with the passage of the hexahydrated to the β -tetrahydrated salt or to 29.8° , corresponding with the passage to the α -tetrahydrated salt. At the transition point, 29.2° , the two solid phases are $\text{CaCl}_2 \cdot 6\text{H}_2\text{O}$ and $\beta\text{-CaCl}_2 \cdot 4\text{H}_2\text{O}$; liquid phase with one part of CaCl_2 per 5.41 parts of water; and vapour at 5.67 mm. press. At the transition point, 29.8° , the two solid phases are $\text{CaCl}_2 \cdot 6\text{H}_2\text{O}$ and $\alpha\text{-CaCl}_2 \cdot 4\text{H}_2\text{O}$; soln. with one part of CaCl_2 per 6.10 parts of water; and vapour at 6.80 mm. press. The range of stability of $\beta\text{-CaCl}_2 \cdot 4\text{H}_2\text{O}$ is from 29.2° to 38.4° , at the latter temp., the two solid phases are $\beta\text{-CaCl}_2 \cdot 4\text{H}_2\text{O}$ and $\text{CaCl}_2 \cdot 2\text{H}_2\text{O}$; the liquid phase has one part of CaCl_2 in 4.83 parts of water; and the vapour a press. of 7.88 mm. The range of stability of $\alpha\text{-CaCl}_2 \cdot 4\text{H}_2\text{O}$ is from 29.8° to 45.3° , at the latter temp., the two solid phases are $\alpha\text{-CaCl}_2 \cdot 4\text{H}_2\text{O}$ and $\text{CaCl}_2 \cdot 2\text{H}_2\text{O}$; the liquid phase has one part of CaCl_2 to 4.73 parts of water; and the vapour has a press. of 11.77 mm. The range of stability of $\text{CaCl}_2 \cdot 2\text{H}_2\text{O}$ is either from 38.4° or 45.3° to 175.5° ; at the latter temp., the two solid phases are $\text{CaCl}_2 \cdot 2\text{H}_2\text{O}$ and $\text{CaCl}_2 \cdot \text{H}_2\text{O}$; the soln. has one part of CaCl_2 per 2.07 parts of water; and the vapour a press. of 842 mm. The range of stability of $\text{CaCl}_2 \cdot \text{H}_2\text{O}$ is between 175.5° and about 260° , when the two solid phases are $\text{CaCl}_2 \cdot \text{H}_2\text{O}$ and CaCl_2 ; the liquid has a gram of CaCl_2 for about 0.18 gm. of water; and the vapour a press. of many atm.

There has been some discussion about the point *H*, Fig. 12, the m.p. of the hexahydrated salt. H. W. B. Roozeboom regards it not as a transition point, but as a maximum on the solubility curve, where the tangent, dT/dS , is parallel to the *S*-axis. On the other hand, H. le Chatelier takes the view that *H* is a definite break or transition point. F. A. Lidbury showed that the m.p. determinations in the system with CaCl_2 with between 5.54 and 6.44 H_2O gives a curve with no definite break, but one which has a maximum between 29.918° and 29.920° , corresponding respectively with $\text{CaCl}_2 + 5.99\text{H}_2\text{O}$ and $\text{CaCl}_2 + 6.02\text{H}_2\text{O}$. F. W. Küster, and R. Kremann also regard the point *H* as a turning point or maximum and not a break.

The existence of hydrated calcium chloride, $\text{CaCl}_2 \cdot \text{H}_2\text{O}$, was suspected after the work of H. Lescœur on the vapour pressure of soln. of calcium chloride; and

its separation in crystalline needles from soln. of calcium chloride above 175.5° was demonstrated by H. W. B. Roozeboom in 1889. W. Müller-Erzbach obtained it by confining the dihydrated salt over sulphuric acid of the relative vap. press., $p/p_0 = 0.04$, where p is the vap. press. of the acid, and p_0 that of water at the same temp. The speed of conversion is slow, and the salt, $\text{CaCl}_2 \cdot \text{H}_2\text{O}$, is formed more quickly by confining the salt in a vessel with a rather higher vap. press. than is required, and subsequently removing the excess in an atm. with the water vapour at a relative press. of about 0.02. The crystals melt at about 260° under press.

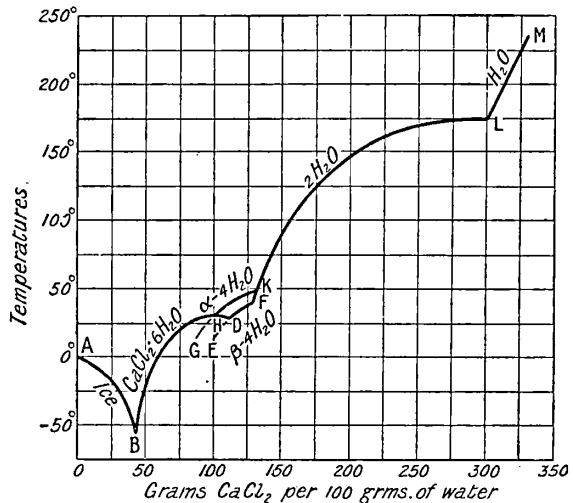

FIG 12.—Solubility Curve of Calcium Chloride

This temp. is a transition point, $\text{CaCl}_2 \cdot \text{H}_2\text{O} \rightleftharpoons \text{CaCl}_2 + \text{H}_2\text{O}$. The range of stability of this salt and its solubility are indicated in Fig. 12. Dihydrated calcium

chloride, $\text{CaCl}_2 \cdot 2\text{H}_2\text{O}$, was made by T. Graham by exposing crystals of the hexahydrated salt "in vacuo for 10 days during the heat of summer." He adds that the crystals become opaque and of a talcy lustre, without being disintegrated, and their proportion of water was reduced to $\text{CaCl}_2 \cdot 2\text{H}_2\text{O}$. A. Ditte obtained crystals of the dihydrated salt by passing a stream of hydrogen chloride over the hexahydrated salt; by passing the same gas into a conc. aq. soln. of calcium chloride, taking precautions to avoid a rise of temp.; and by gradually adding small pieces of fused calcium chloride to a conc. aq. soln. of hydrochloric acid so as to avoid the evolution of gas. The dihydrated salt gradually crystallizes from the soln. in fine transparent very hygroscopic crystals. H. W. B. Roozeboom obtained the salt by evaporating aq. soln. of calcium chloride at about 165° . The range of stability and solubility is indicated in Fig. 12. W. Müller-Erbach made this salt by confining calcium chloride in an atm. where the relative press. of the water is 0.10 mm., or over hydrating the salt and removing the excess in an atm. with the water vapour at the relative press. 0.05.

H. Hammerl formed tetrahydrated calcium chloride by partially melting the hexahydrated salt in its water of crystallization, pouring off the mother liquid, and repeating the process several times. W. Müller-Erbach made this salt by keeping calcium chloride in an atm. when the relative press. of the water vapour is between 0.13 and 0.18. The salt crystallizes in what appear to be rhombic crystals melting at 45.3° , when it passes into the dihydrated salt. E. Lefebvre also obtained transparent plates of the tetrahydrated salt by cooling below 15° a soln. containing 120 parts of CaCl_2 per 100 parts of water. H. W. B. Roozeboom showed that two different modifications of the tetrahydrated salt are here in question, and he calls Hammerl's salt $\alpha\text{-CaCl}_2 \cdot 4\text{H}_2\text{O}$, and E. Lefebvre's salt, $\beta\text{-CaCl}_2 \cdot 4\text{H}_2\text{O}$. The solubility curves and ranges of stability of the two tetrahydrated salts are indicated in Fig. 12. Soln. represented by the dotted line *DE* are sat. with respect to $\beta\text{-CaCl}_2 \cdot 4\text{H}_2\text{O}$, and supersaturated with respect to $\text{CaCl}_2 \cdot 6\text{H}_2\text{O}$. If the β -salt be heated in the presence of its sat. soln. above 38.4° , *E*, Fig. 12, it forms the stable $\alpha\text{-CaCl}_2 \cdot 4\text{H}_2\text{O}$. This transformation does not occur spontaneously over 20° except by rubbing or by seeding with the α -salt. According to D. Gernez, if a supersaturated soln. be cooled to 15° , and rubbed cautiously with a glass rod, the tetrahydrated salt crystallizes out, while, with energetic rubbing, the hexahydrated salt crystallizes out. The α -salt of H. Hammerl is the more stable form, and, as is generally the case, the more stable form possesses the smaller solubility. Soln. ranging from *H* to *G*, Fig. 12, are sat. with the α -salt, and supersaturated with the hexahydrated salt. At 45.3° , *K*, Fig. 12, $\alpha\text{-CaCl}_2 \cdot 4\text{H}_2\text{O}$ passes into the dihydrated salt.

Hexagonal crystals of hexahydrated calcium chloride, $\text{CaCl}_2 \cdot 6\text{H}_2\text{O}$, are obtained from aq. soln. of calcium chloride below 29.2° ; and W. Müller-Erbach obtained it by confining calcium chloride in an atm. where the relative vap. press. is between 0.34 and 0.192. The published values for the specific gravity range from the 1.612 (10°) of H. Kopp,¹⁰ to the 1.701 (17.1°) of P. A. Favre and C. A. Valson. J. Dewar gives 1.7187 at -188° , and 1.6775 at 17° ; the coeff. of thermal expansion between these temp. is therefore 0.0001191. H. Kopp says the crystals expand from 1 to 1.007 when heated from 0° to 20° ; and from 0° to 29° , 1.020; and in melting at 29° , the volume increases to 1.118, corresponding with a 9.6 per cent. expansion. The latent heat of fusion, according to G. G. Person, is 40.70; and, according to S. U. Pickering, 11.417 Cals.; the sp. ht., according to S. Pagliani, 0.345, and the heat of soln. -4.3 Cals., but after soln., further dilution was shown by A. Ditte to raise the temp. by the evolution of heat. J. Milikan studied the ternary system, $\text{CaCl}_2\text{—HCl—H}_2\text{O}$, at 30° , and found a soln. with 44.50 per cent. of calcium chloride and 3.3 per cent. of HCl is in equilibrium with the hexa- and tetra-hydrates; and soln. with 28.48 per cent. of calcium chloride and 21.40 per cent. of HCl is in equilibrium with the tetra- and di-hydrates.

The hydrates of strontium and barium chlorides have not been so closely

examined as those of calcium. Strontium forms the hydrates, $\text{SrCl}_2 \cdot 2\text{H}_2\text{O}$ and $\text{SrCl}_2 \cdot 6\text{H}_2\text{O}$. P. Kremers¹¹ showed that although the latter crystallizes from soln. at ordinary temp., **dihydrated strontium chloride**, $\text{SrCl}_2 \cdot 2\text{H}_2\text{O}$, separates out when the temp. is high—between 90° and 100° , according to A. Etard; and above 61.5° , according to T. W. Richards and J. B. Churchill. A. Ditte, and H. Lescœur made the same compound by leading hydrogen chloride into a sat. soln. of the hexahydrated salt; by treating the solid hexahydrated salt with conc. hydrochloric acid; or by adding the anhydrous chloride to conc. hydrochloric acid—the soln. becomes warm and the dihydrated salt crystallizes out on cooling in water clear plates which becomes anhydrous when heated. According to O. Lehmann, the crystals of dihydrated strontium chloride which separate from hot soln. of barium and strontium chlorides are amorphous, but the (cold) crystals of the strontium salt form ordinary crystals when they are squeezed or scratched.

The long six-sided crystals of **hexahydrated strontium chloride**, $\text{SrCl}_2 \cdot 6\text{H}_2\text{O}$, belonging to the trigonal system are isomorphous with those of $\text{CaCl}_2 \cdot 6\text{H}_2\text{O}$, and, according to A. Eppler, have the axial ratio $a:c=1:0.5150$, and $\alpha=112^\circ 14'$. The crystals of hexahydrated strontium chloride have a sp. gr. 1.933 (17°), according to P. A. Favre and C. A. Valson; 1.964 (16.7°), according to F. W. Clarke; and 1.921, according to H. J. Buignct. They melt, according to W. A. Tilden, at 112° , and pass into the dihydrated salt above 61.5° , as indicated previously. J. Milikan studied the system, $\text{SrCl}_2\text{—HCl—H}_2\text{O}$, at 25° , and found the solid phases, $\text{SrCl}_2 \cdot 6\text{H}_2\text{O}$ and $\text{SrCl}_2 \cdot 2\text{H}_2\text{O}$, coexist in equilibrium with soln. containing 2.11 per cent. of strontium chloride and 27.14 per cent. of HCl.

H. Lescœur deduced the existence of **hydrated barium chloride**, $\text{BaCl}_2 \cdot \text{H}_2\text{O}$, from the constancy of the vap. press. curves of the system containing BaCl_2 , and up to one eq. of water; and J. Thomsen inferred the existence of the same compound from the fact that the thermal value of the reaction, $\text{BaCl}_2 + \text{H}_2\text{O}$, is not half so great as for the reaction, $\text{BaCl}_2 + 2\text{H}_2\text{O}$. H. Lescœur claims to have made the monohydrate by saturating the aq. soln. with hydrogen chloride, and by heating the dihydrated salt between 60° and 65° . Colourless plates of the monohydrate are also said to be formed when the dihydrate is agitated with methyl alcohol, and the filtered soln. allowed to crystallize. Monoclinic prismatic crystals of **dihydrated barium chloride**, $\text{BaCl}_2 \cdot 2\text{H}_2\text{O}$, are formed when barium chloride crystallizes from aq. soln. The transition point for the passage: $\text{BaCl}_2 \cdot 2\text{H}_2\text{O} \rightleftharpoons \text{BaCl}_2 \cdot \text{H}_2\text{O} + \text{H}_2\text{O}$, has not yet been observed, although probably one does exist at an elevated temp. F. A. H. Schreinemakers and J. Milikan studied the ternary system, $\text{BaCl}_2\text{—HCl—H}_2\text{O}$, at 30° . According to G. Wyruboff, the axial ratio for the crystals of dihydrated barium chloride is $a:b:c=0.6177:1:0.6549$, $\beta=91^\circ 5'$. O. Mügge measured these ratios. The crystals of dihydrated barium chloride are not isomorphous with those of dihydrated barium bromide, or dihydrated barium iodide, although the two latter salts crystallize isomorphously from aq. soln. of the chloride, and, consequently, these forms are unstable under ordinary conditions. The crystals of dihydrated barium chloride have a sp. gr. 3.054 (3.9°), according to J. P. Joule and L. Playfair; 3.054 (15.5°), P. A. Favre and C. A. Valson; 3.097, according to T. W. Richards; and 3.090 (18°), according to O. Brill and C. de B. Evans. The crystals lose their water when heated to 121° , without melting. F. A. Gooch and F. M. McClenahan find that it makes no difference to the product whether dihydrated barium chloride be heated in air or in hydrogen chloride below 100° , and at this temp. dehydration is complete. E. Jänecke also found similar remarks apply when the dehydration is conducted under press. T. W. Richards plotted the total loss of water which occurred when dihydrated barium chloride was heated at 30° for different periods of time and found the curve

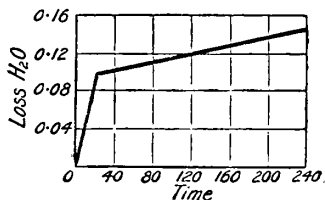
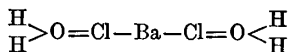

FIG. 13.—Velocity Curve of the Dehydration of $\text{BaCl}_2 \cdot 2\text{H}_2\text{O}$.

presented a sharp angle "exactly at the point corresponding with $\text{BaCl}_2 \cdot \text{H}_2\text{O}$," as illustrated in Fig. 13. F. A. Gooch and F. M. McClenahan explain the fact that the water can be expelled without the loss of chlorine by assuming the constitutional formula :



Contrast this with the phenomena attending the dehydration of the hydrated magnesium and aluminium chlorides. E. H. Davis claimed to have made monohydrated barium chloride, $\text{BaCl}_2 \cdot \text{H}_2\text{O}$, but this has not been confirmed.

The specific gravities of aq. soln. of calcium chloride have been determined by J. B. Richter,¹² P. Kremers, G. T. Gerlach, J. G. McGregor, and S. U. Pickering. The relation between the percentage composition of the soln. at 17.925° and the sp. gr. is (water alone 0.99869) :

Per cent. of salt .	0.1	1.0	5.0	10.0	20.0	30.0
Sp. gr. CaCl_2 .	0.99954	1.00703	1.04089	1.08467	1.17910	1.28271
„ SrCl_2 .	—	1.0092	1.0458	1.0951	1.2061	—
„ BaCl_2 .	—	—	1.0453	1.0929	1.1989	1.3220

Soln. with 40 to 50 per cent. calcium chloride have the respective sp. gr. 1.39489 and 1.50676. The values for barium and strontium chlorides at 16° are by G. T. Gerlach. P. Kremers and F. Kohlrausch, G. T. Gerlach, H. Schiff, D. I. Mendeléeff have also measured the sp. gr. of soln. of strontium and barium chlorides. According to R. Engel, a soln. sat. with calcium chloride at 0° has a sp. gr. of 1.367; strontium chloride, 1.334; and barium chloride, 1.25. T. Poleck has also measured the contraction which occurs on dissolving calcium chloride in water. According to G. T. Gerlach, the sp. gr. of a soln. of strontium chloride at 15° rises from 1.0453 for a 5 per cent. soln. to 1.3633 for a 33 per cent. soln.; and the sp. gr. of a soln. of barium chloride rises from 1.0092 for a one per cent. soln. to 1.2702 for a 25 per cent. soln. N. A. Tschernay gives for the volume, v , of a soln. at θ° , barium chloride, $\text{BaCl}_2 + 50\text{H}_2\text{O}$, $v = 1 + 0.032393\theta + 0.052456\theta^2$; $\text{BaCl}_2 + 100\text{H}_2\text{O}$, $v = 1 + 0.031345\theta + 0.053537\theta^2$; strontium chloride, $\text{SrCl}_2 + 50\text{H}_2\text{O}$, $v = 1 + 0.032204\theta + 0.052542\theta^2$; calcium chloride, $\text{CaCl}_2 + 50\text{H}_2\text{O}$, $v = 1 + 0.031925\theta + 0.052647\theta^2$; $\text{CaCl}_2 + 100\text{H}_2\text{O}$, $v = 1 + 0.031085\theta + 0.053613\theta^2$.

The lowering of the temp. of maximum density of water by calcium chloride was found by L. C. de Coppel to be proportional to the conc. : soln. with $M = 0.0431$, 0.0744 , and 0.1500 mol of CaCl_2 per litre lowered the temp. of maximum density of water respectively to 3.208° , 2.645° , and 1.234° , where $dT = 0.776^\circ$, 1.337° , and 2.748° respectively, so that the mol. lowering of the temp. of maximum density, dT/M , is respectively 17.97° , 18.00° , and 18.31° . Similar results were obtained with barium chloride; with soln. containing 0.0002 and 0.1995 gram-mol. of BaCl_2 per litre, the temp. of maximum density is respectively $+3.982^\circ$ and -0.843° , and the mol. lowering of the temp. of maximum density is 24.1° .

According to J. Dreyer,¹³ the coeff. of compressibility of 5.8 per cent. soln. of calcium chloride is 39.7×10^{-6} ; for 17.8 per cent. soln. 31.3×10^{-6} ; and for 40.9 per cent. soln. 21.7×10^{-6} . V. Schumann, and L. Grassi also made observations with soln. of calcium chloride. V. Schumann gave for 1.24, 17.7, and 27.26 per cent. soln. of strontium chloride between 16° and 19° , 45.4×10^{-6} , 37.2×10^{-6} , and 32.3×10^{-6} respectively. V. Schumann gave for the compressibility coeff. of 2.11, 10.84, and 20.16 per cent. soln. of barium chloride, respectively 44.7×10^{-6} , 41.1×10^{-6} , and 36.0×10^{-6} , between 19° and 20° . P. G. Tait, and O. Schmidt also calculated values for soln. of barium chloride. According to E. Jänecke, by compression, dihydrated barium chloride can be melted at 100° , and it is then converted into the anhydrous chloride. G. Wertheim measured the velocity of sound in soln. of calcium chloride. According to G. Timberg, the surface tension of soln. of calcium chloride of sp. gr. 1.4007 is 9.581 mgrms. at 6.73° ; and for soln. of sp. gr. 1.4007 it is 9.581 mgrms. at 6.73° . For soln. of strontium chloride of sp. gr. 1.3357, 8.800 mgrms. at 6.2° ,

and for soln. of sp. gr. 1.2994, 7.049 mgrms. at 70°. J. Wagner's valuc¹⁴ for the viscosities of N -, $\frac{1}{2}N$ -, $\frac{1}{4}N$ -, and $\frac{1}{8}N$ -soln. of calcium chloride at 25°, are respectively 1.1342, 1.0631, 1.0310, and 1.0202, when the value for water is unity; for strontium chloride, 1.1411, 1.0674, 1.0338, and 1.0141; and for barium chloride, 1.1228, 1.0572, 1.0253, and 1.0128 respectively. G. Quincke's values for σ for molten calcium, strontium, and barium chlorides are respectively 98.7, 111.1, and 150.5 dynes per cm.; and for a^2 respectively 9.49, 8.18, and 8.29 sq. mm. According to J. D. R. Scheffer,¹⁵ the diffusion coefficient of calcium chloride changes very little with conc. and for soln. containing 0.047 and 1.22 mols per litre at 9°, k is respectively 0.68 and 0.72; similarly, for soln. with 0.028 and 0.201 mol of barium chloride per litre at 8°, k is respectively 0.65 and 0.66. F. E. Bartell and O. E. Madison studied the osmosis of soln. of barium chloride through animal membranes.

The thermal expansion of soln. of calcium chloride has been measured by G. J. W. Bremer, N. A. Tschernay, and J. Dreckcr.¹⁶ According to N. A. Tschernay, the vol. v of soln. in 50 mols of water at θ° between 0° and 60° is $v=1+0.0001925\theta+0.000002647\theta^2$; for strontium chloride, $v=1+0.0002204\theta+0.000002542\theta^2$; and for barium chloride, $v=1+0.0002393\theta+0.00000245\theta^2$. With soln. containing between 4 and 31 parts of CaCl_2 per 100 parts of water, the coeff. of expansion ranges from 0.0001126 to 0.0003425. G. Bender's value for the coeff. of cubical expansion of a soln. with 9.5 per cent. of barium chloride is 0.00025818; for a 24.7 per cent. soln., 0.0003613. The comparatively large coeff. of thermal expansion for soln. of calcium chloride has led to the selection of these soln. for use in thermostats.

According to G. Jäger,¹⁷ the heat conductivity of soln. of calcium, strontium, and barium chlorides decreases regularly—respectively 309×10^{-5} , 216×10^{-5} , 176×10^{-5} —for each per cent. increase in conc. The relative conductivities (water 100) of 15 and 30 per cent. soln. of calcium chloride are respectively 95.4 and 90.7; of a 25 per cent. soln. of strontium chloride, 94.6; and of 21 per cent. soln. of barium chloride, 96.3. C. H. Lees found a decrease of about 20 per cent. on the thermal conductivity of solid and molten hexahydrated calcium chloride.

The specific heat, C , of soln. of calcium chloride, according to J. Dreckcr,¹⁸ with soln. containing p per cent. of the salt, is $S=1.022-0.01603p+0.00016p^2$. According to J. C. G. de Marignac, soln. with a mol of the salt in n eq. of water have the sp. ht.:

Eq. H_2O	10	25	50	100	200
Sp. ht. CaCl_2	0.6178	0.7538	0.8510	0.9714	0.9550
Mol. ht. CaCl_2	179.6	422.8	860	1753	3544
Sp. ht. SrCl_2	—	—	0.8165	0.8950	0.9424
Mol. ht. SrCl_2	—	—	864	1753	3542
Sp. ht. BaCl_2	—	—	0.7799	0.8751	0.9318
Mol. ht. BaCl_2	—	—	864	1757	3549

Anhydrous calcium chloride has long been used for drying gases; thus P. L. Dulong and J. J. Berzelius¹⁹ about 1820, and O. L. Erdmann and R. F. Marchand about 1842, employed it for drying the gases in their work on the at. wt. of oxygen. They seem to have assumed that it removes a relatively large proportion of water in the gas, although J. B. A. Dumas in 1842, and M. Pettenkofer in 1862, mentioned as well known that calcium chloride will not dry a gas so completely as sulphuric acid. The relative efficiency of many desiccating agents has been indicated in connection with the drying of hydrogen gas ($q.v.$). According to W. Müller-Erzbach, calcium chloride has almost the same attractive force as sodium hydroxide for water, but smaller than potassium hydroxide, sulphuric acid, or phosphorus pentoxide. Calcium chloride deliquesces rapidly in air. G. J. Mulder found that 100 parts of calcium chloride in air sat. with moisture at 16° to 20°, absorbed 712 parts of water, and strontium chloride, 354 parts of water in 56 days. R. Brandes made observations on this subject. According to H. W. Hake, the

hygroscopicity of calcium chloride at a definite temp. has a definite maximum. W. Busnikoff has compared the speeds of absorption of moisture from air by sulphuric acid and calcium chloride.

H. Lescœur²⁰ has measured the vapour pressures of the different hydrates of calcium chloride. According to H. Lescœur, the vap. press. of

	35·5°	65°	78°	100°	129°
CaCl ₂ ·2H ₂ O	4	13	24	60	175 mm.
CaCl ₂ ·4H ₂ O	8·5	32	57	132	decomposed

By gradually removing water from the system calcium chloride and water at a constant temp., say 100°, the vapour gradually falls until the system contains a single hydrate, CaCl₂·4H₂O, the vap. press. then remains constant at 132 mm., until the system contains the hydrate, CaCl₂·2H₂O, with a lower vap. press., when the vap. press. of the system abruptly falls to 66 mm. and then remains constant until the system contains the hydrate with a still lower vap. press., CaCl₂·H₂O, whose vap. press. is very small. A system with two hydrates has three phases and two components, and has therefore one degree of freedom, so that the vap. press. at a constant temp. is independent of the amount of hydrate present. W. Müller-Erzbach, and H. W. B. Roozeboom have measured the vap. press. of the different hydrates in the presence of their sat. soln. If p denotes the vap. press. of the hydrate, p_0 that of pure water at the same temp., p/p_0 represents the relative vap. press. of the sat. soln., which, according to H. W. B. Roozeboom, have the values:

CaCl ₂ ·6H ₂ O	α -CaCl ₂ ·4H ₂ O	β -CaCl ₂ ·4H ₂ O	CaCl ₂ ·2H ₂ O	CaCl ₂ ·H ₂ O
0·380 (10°)	0·273 (20°)	0·205 (20°)	0·155 (46°)	0·160 (160°)
0·323 (20°)	0·218 (29·8°)	0·188 (29·2°)	0·178 (10°)	0·121 (180°)
0·210 (30·2°)	0·207 (35°)	0·173 (35°)	0·187 (125°)	0·115 (205°)

At 25°, the vap. press. at the transition α -4H₂O→6H₂O is 6·3 mm., according to W. Müller-Erzbach; and 5·1 mm., according to H. W. B. Roozeboom. A. Wüllner, G. Tammann, R. Emden, C. Dieterici, and W. Biltz have measured the vap. press. of more dil. soln. of calcium chloride. According to R. Emden, the relative vap. press., in agreement with L. von Babo's rule, is independent of temp.—*e.g.* at 19·64°, $p_0 = 17·09$ mm., $p = 16·0$ mm., or $p/p_0 = 0·936$; at 50·04°, $p_0 = 92·19$ mm., $p = 85·9$ mm., or $p/p_0 = 0·931$; and at 96·94°, $p_0 = 679·15$ mm., $p = 633·35$ mm., or $p/p_0 = 0·932$. G. Tammann did not find his results in agreement with L. von Babo's rule. R. Emden did not find the lowering of the vap. press., in agreement with A. Wüllner's rule, to be proportional with the conc. If C denotes the number of grams of CaCl₂ and C' , the number of grams of CaCl₂·6H₂O in 100 grms. of water:

C	$\frac{1}{C} \cdot \frac{p_0 - p}{p_0}$	C'	$\frac{1}{C'} \cdot \frac{p_0 - p}{p_0}$
12·55	5·44	28·22	2·42
19·99	5·86	48·96	2·39
20·22	6·06	49·64	2·47

Analogous results were obtained by C. Dieterici, and W. Biltz. G. R. Paranjpe, and E. M. Baker and V. H. Waite measured the vap. press. and b.p. of aq. soln. of calcium chloride; and W. Pieper of aq. and alcoholic soln. of calcium and barium chlorides.

The vap. press. of soln. of strontium chloride have been measured by G. Tammann, and W. Biltz; and of the hydrates by H. Lescœur, P. C. F. Frowein, and J. L. Andreadæ. The vap. press. of SrCl₂·6H₂O given by J. L. Andreadæ are:

	19·7°	25·6°	29·9°	34·1°	37·5°
SrCl ₂ ·6H ₂ O	5·61	8·72	11·84	15·83	19·86 mm.

The vap. press. of the hexahydrated strontium chloride is therefore greater than for the corresponding calcium salt, and if the barium salt be ever prepared, it is probable that its vap. press. will be still greater. From the fact that the vap. press. of systems SrCl₂+0 to 2H₂O, and SrCl₂+2 to 6H₂O, have a constant vap. press.,

it is inferred that only the hydrated salts, $\text{SrCl}_2 \cdot 2\text{H}_2\text{O}$ and $\text{SrCl}_2 \cdot 6\text{H}_2\text{O}$, exist. J. B. Hannay found the curve representing the velocity at which hexahydrated strontium chloride lost water at 100° showed a break only with the formation of $\text{SrCl}_2 \cdot 2\text{H}_2\text{O}$; but when dehydrated over sulphuric acid at 10° , there was a break with $\text{SrCl}_2 \cdot 3\text{H}_2\text{O}$. G. P. Baxter and J. E. Lansing measured the vap. press. of hydrated strontium chloride, and represented their results at $T^\circ \text{K.}$ by $\log p = 15.081 - 6731/(T+152)$. At 25° , for the transition $2-6\text{H}_2\text{O}$, P. C. F. Frowein gave 7.5 mm.; J. L. Andr  , 8.5 mm.; and G. P. Baxter, 8.37 mm. A. W. C. Menzies also measured the dissociation press. of hexahydrated strontium chloride.

H. Lesc  ur's measurements of the vap. press. of solid barium chloride at 100° :

$\text{BaCl}_2 +$	$2\text{H}_2\text{O}$	$1.90\text{H}_2\text{O}$	$1.20\text{H}_2\text{O}$	$0.94\text{H}_2\text{O}$	$0.18\text{H}_2\text{O}$
	620	626	615	272	270 mm.

correspond with the possible existence of $\text{BaCl}_2 \cdot 2\text{H}_2\text{O}$ and $\text{BaCl}_2 \cdot \text{H}_2\text{O}$; and his values at 10° , $\text{BaCl}_2 + 2\text{H}_2\text{O}$, 2.7 mm.; $+2.25\text{H}_2\text{O}$, 7.5 mm.; $+2.40\text{H}_2\text{O}$, 7.5 mm.; $+2.51\text{H}_2\text{O}$, 7.4 mm., indicate the possible existence of a still higher hydrated salt; and because barium chloride acts as a nucleus for seeding supersat. soln. of $\text{CaCl}_2 \cdot 6\text{H}_2\text{O}$, he believes that *hexahydrated barium chloride*, $\text{BaCl}_2 \cdot 6\text{H}_2\text{O}$, isomorphous with the calcium salt, really exists. The first argument is not sound, because at a constant temp. the vap. press. of the mixture, $\text{BaCl}_2 \cdot 2\text{H}_2\text{O} + n\text{H}_2\text{O}$, will be a constant. There are present 3 phases and 2 components, and the system has accordingly only one degree of freedom—the temp. The vap. press., p , of dihydrated barium chloride at different temp., determined by P. C. F. Frowein, are 2.97 mm. at 18.25° ; 7.125 mm. at 28.83° ; 13.478 mm. at 37.30° ; and 21.117 mm. at 43.45° . According to W. M  ller-Erbach, the relative vap. press. of $\text{BaCl}_2 \cdot 2\text{H}_2\text{O}$ at 17.5° is 0.21; and of $\text{BaCl}_2 \cdot \text{H}_2\text{O}$ at 16.7° , 0.10. For the transition, $0-1\text{H}_2\text{O}$, at 25° , H. W. Foote and S. R. Scholes gave 2.5 mm.; W. M  ller-Erbach, 2.4 mm.; A. H. Pareau, 2.9 mm.; and H. Schottky, 1.1 mm.; while for the transition, $1-2\text{H}_2\text{O}$, H. W. Foote and S. R. Scholes gave 4.8 mm.; P. C. F. Frowein, 5.2 mm.; H. Lesc  ur, 6.9 mm.; W. M  ller-Erbach, 4.9 mm.; J. R. Partington, 5.6 mm.; and R. E. Wilson, 5.8 mm. G. Tammann found the transition temp., $0-6\text{H}_2\text{O}$, is 29.7° at atm. press., and 60.22° at 3030 kgrms. per sq. cm.; or, at a press. p kgrms. per sq. cm., the transition temp. θ is $\theta = 29.7 + 0.01163p - 0.066p^2$. He also found for $\text{SrCl}_2 \cdot 6\text{H}_2\text{O} \rightarrow \text{SrCl}_2 \cdot 4\text{H}_2\text{O}$ the transition temp. 62.6° at one atm. press., and 75.08° at a press. of 2820 kgrms. per sq. cm. A. W. C. Menzies measured the dissociation press. of dihydrated barium chloride. According to G. Tammann, the lowerings of the vap. press. of $\frac{1}{2}N$ -, N -, and $2N$ -soln. of barium chloride are respectively 16.4 mm., 36.7 mm., and 77.6 mm. He further found that the effects of variations of temp. and conc. are not in accord respectively with L. von Babo's and A. W  llner's rules.

According to F. R  dorff,²¹ the boiling point of a sat. soln. of calcium chloride is 180° ; for a sat. soln. of strontium chloride, P. Kremers gives 114° ; G. J. Mulder, 118.8° ; and J. Legrand, 117.45° ; and for a sat. soln. of barium chloride, P. Kremers gives 106° ; J. L. Gay Lussac, 105.48° ; J. Legrand, 104.2° ; and G. J. Mulder, 104.1° . H. Hammerl found that the rise in the b.p. over that of water for soln. containing p per cent. of anhydrous calcium chloride is $0.0519p + 0.011163p^2$. A. Schlamp has measured the b.p. of dil. soln. G. T. Gerlach gave for conc. soln. with over 6 grms. of CaCl_2 per 100 grms. of water:

Grms. CaCl_2 .	0.585	2.405	6.0	11.5	25.0	101	222	305
B.p. .	100.091°	100.302°	101°	102°	105°	130°	160°	178°

The rise in the b.p. of the first-named soln. corresponds with the factor $i=3.32$, for the second soln. $i=2.58$, and the value of i steadily increases to $i=2.93$ for a soln. with 10.87 grms. CaCl_2 per 100 grms. of water which boils at 101.49° . S. Skinner has measured the b.p. of alcoholic soln. of calcium chloride. G. T. Gerlach gives the b.p. of strontium chloride containing 20 grms. of $\text{SrCl}_2 \cdot 6\text{H}_2\text{O}$ per 100 grms. of water as 101° ; 40 grms., 102° ; 60 grms., 103° ; rising to 117° with 819

grms. of $\text{SrCl}_2 \cdot 6\text{H}_2\text{O}$ per 100 grms. of water. G. T. Gerlach, and L. Kahlenberg also measured the b.p. of soln. of barium chloride. According to G. T. Gerlach, soln. with 15 and 17.6 grms. $\text{BaCl}_2 \cdot 2\text{H}_2\text{O}$ per 100 grms. of water boil respectively at 101° and 104.5° . J. Sakurai, and G. Harker studied the temp. of the steam arising from boiling soln. of calcium chloride.

The freezing points of soln. of calcium chloride have been measured from many points of view by L. C. de Coppet,²² H. W. B. Roozeboom, S. U. Pickering, S. Arrhenius, H. C. Jones and V. J. Chambers, A. Ponsot, E. H. Loomis, etc. S. U. Pickering found that the mol. depression of the f.p. of soln. of calcium chloride rises steadily with soln. containing less than 0.4 per cent. of calcium; there is then a break in the curve, and also a second break when the soln. has 2.4 per cent. of the salt. The lowering of the f.p. of soln. with 0.0100 mol per litre is 0.0513° ; 0.1004 mol, 0.4823° ; 0.5021 mol, 2.605° ; 2.0 mols, 17.867° . The f.p. of soln. of strontium and barium chlorides have likewise been measured by S. Arrhenius, E. H. Loomis, H. C. Jones and F. H. Getman, H. C. Jones and V. J. Chambers, F. Rüdorff, and by L. C. de Coppet. With all three chlorides of the alkaline earths, the mol. lowering of the f.p. increases with increasing conc.

The cryohydric or eutectic temperature with water and calcium chloride, $\text{CaCl}_2 \cdot 6\text{H}_2\text{O}$, is -55° , according to H. W. B. Roozeboom,²³ with soln. containing one part of calcium chloride in 14.5 of water. According to F. Guthrie, the cryohydric temp. of strontium chloride is -17° to -18° . L. C. de Coppet gives -18.7° . According to F. Guthrie, also, the cryohydric temp. of barium chloride is -8° with soln. containing 23.2 per cent. of $\text{BaCl}_2 \cdot 2\text{H}_2\text{O}$; L. C. de Coppet gives -7.85° with soln. containing 25.1 parts of BaCl_2 per 100 parts of water; F. Rüdorff gives -8.7° . The cryohydric point is the lowest temp. which can be obtained by mixing ice and the salt in question, consequently hexahydrated calcium chloride is far more suited than dihydrated barium chloride for making a freezing mixture. H. Hammerl obtained the data indicated in Table II, for hexahydrated calcium chloride used as a freezing mixture.

TABLE II.—CALCIUM CHLORIDE AND SNOW AS A FREEZING MIXTURE.

Kilograms of snow at 10° mixed with a kilogram of $\text{CaCl}_2 \cdot 6\text{H}_2\text{O}$.	Heat absorbed in Cals. per kilogram.	Temp. when all snow is melted.
0.35	522	0°
0.45	592	-14.1°
0.53	667	-28.7°
0.64	736	-45.5°
0.66	748	-49.5°
0.70	779	-54.9°
0.74	811	-48.2°
0.81	871	-40.3°
0.91	909	-36.5°
1.19	1160	-22.7°
1.39	1319	-18.3°
1.64	1518	-14.7°
2.46	2169	-9.0°
4.92	4136	-4.0°

Although H. Lescœur²⁴ supposed that the introduction of hydrogen chloride into an aq. soln. of calcium chloride will not precipitate the salt, both R. Engel and A. Ditte have shown that the solubility of calcium chloride is depressed in the presence of *hydrochloric acid*, as in the analogous case of sodium chloride; thus, expressing quantities in grams per 100 c.c. of soln., at 0° :

HCl.	0	3.32	5.83	10.66	15.84	23.15	34.62
CaCl_2	51.45	46.45	42.80	36.77	29.84	20.12	11.29
Sp. gr.	1.367	1.344	1.326	1.310	1.283	1.250	1.238

Similarly with strontium chloride and hydrochloric acid at 0° :

HCl	• 0	2.22	4.65	8.49	10.35	13.58	19.23
SrCl ₂	• 49.9	35.5	30.0	21.56	17.44	11.09	3.37
Sp. gr.	• 1.334	1.304	1.269	1.220	1.201	1.167	1.133

In 1843, C. J. B. Karsten, and also S. Schlesinger, found that the solubility of barium chloride in hydrochloric acid is less than in water ; that barium chloride is scarcely soluble at all in conc. hydrochloric acid ; and the salt is precipitated from sat. aq. soln. by hydrochloric acid. R. Engel showed that with barium chloride and hydrochloric acid at 0°, as in the two preceding tables :

HCl	• 0	1.51	4.58	6.13	7.55	10.81	16.92
BaCl ₂	• 24.07	20.14	12.76	9.37	6.33	2.64	0.28
Sp. gr.	• 1.250	1.210	1.143	1.118	1.099	1.079	1.088

According to F. W. Mar, less than one part of barium chloride is soluble in 20,000 parts of conc. hydrochloric acid, and in 120,000 parts of hydrochloric acid containing one-sixth of its vol. of *ether*. The solubility of these salts is also lowered by the presence of alkali chloride ; thus G. J. Mulder found 100 grms. of water dissolve 63.5 grms. CaCl₂ in the presence of 4.9 grms. of KCl at 7° ; 59.5 grms. CaCl₂ with 4.6 grms. NaCl at 7° ; 57.6 grms. of CaCl₂ with 2.4 grms. NaCl at 4° ; and, according to F. Rüdorff, 72.6 grms. of CaCl₂ with 16 grms. NaCl at 15°. H. W. Foote found 100 grms. of a sat. soln. contains 13.83 grms. of barium chloride and 18.97 grms. of potassium chloride at 25° ; and there is no sign of the formation of a double salt. H. Precht and B. Wittjen, and F. Rüdorff have measured the effect of sodium chloride, and found that at 20°, a soln. containing 25 per cent. of NaCl dissolves 2.9 per cent. of BaCl₂ ; and at 100°, 22.2 per cent. of NaCl and 11.8 per cent. of BaCl₂. H. W. Foote and H. S. Bristol found that barium chloride unites with mercuric chloride, forming a series of double salts. C. J. B. Karsten, and S. Schlesinger found that *nitric acid* precipitates barium nitrate from a sat. aq. soln. of barium chloride, and hydrochloric acid precipitates barium chloride from a sat. aq. soln. of the nitrate. A. Étard found the effect of barium nitrate on the solubility of barium chloride, C. J. B. Karsten showed that the addition of either salt to a sat. soln. of the other does not precipitate either salt, and, accordingly, P. N. Evans assumed that a double salt is formed. C. J. B. Karsten also showed that no salt is precipitated when soln. of barium chloride and *potassium nitrate*, sat. at 7.5°, are mixed ; and that *sodium nitrate* dissolves readily in sat. soln. of barium chloride with the precipitation of barium nitrate ; while barium chloride dissolves but slowly in a conc. soln. of sodium nitrate and becomes covered with crystals of barium nitrate. R. W. Pearson found that *acetic acid*, *ammonium acetate*, and *ammonium chloride* dissolve barium chloride with greater difficulty than dil. hydrochloric acid ; 5 to 5.5 vols. of dil. *aqueous ammonia* dissolve as much barium chloride as 4 vols. of water. According to C. J. B. Karsten, pieces of *ammonium chloride* dissolve in aq. soln. of barium chloride, while barium chloride separates out ; barium chloride dissolves in a sat. soln. of ammonium chloride, and later the salt separates out again. F. Rüdorff found that a sat. soln. of both salts, formed by warming and cooling at 20°, contains 33.8 parts of NH₄Cl and 11.6 of BaCl₂ per 100 parts of water—the composition is not altered by adding either salt. Calcium chloride is readily soluble in ethyl, propyl, isobutyl, and amyl alcohols. From E. Bödtker's measurements²⁵ the solubility of calcium chloride in *ethyl alcohol* increases as the conc. of the alcohol increases, but, as A. Gerardin has shown, the converse obtains with strontium chloride—for, at 18°, 100 grms. of 6 per cent. ethyl alcohol dissolve 49.81 grms. of strontium chloride, while 100 grms. of 91 per cent. alcohol dissolve 3.2 grms. ; the same conclusion follows from H. Schiff's and P. Rohland's measurements with barium chloride—for, at 15°, 100 grms. of 10 per cent. ethyl alcohol dissolve 31.1 grms. of BaCl₂.2H₂O ; and 100 grms. of 97 per cent. alcohol dissolve 31.1 grms. of BaCl₂.2H₂O ; and 100 grms. of 97 per cent.

alcohol dissolve 0.014 grm. of $\text{BaCl}_2 \cdot 2\text{H}_2\text{O}$. According to C. A. L. de Bruyn, 100 grms. of absolute ethyl alcohol at 6° dissolve 3.8 grms. of $\text{SrCl}_2 \cdot 6\text{H}_2\text{O}$; and 100 grms. of absolute *methyl alcohol* at 6° , 63.3 grms. of $\text{SrCl}_2 \cdot 6\text{H}_2\text{O}$; or 7.3 grms. of $\text{BaCl}_2 \cdot 2\text{H}_2\text{O}$; and at 15.5° , 2.18 grms. of BaCl_2 . According to A. Schlamp, 100 grms. of *propyl alcohol* dissolve 10.75 grms. of CaCl_2 . According to P. Rohland, one part of $\text{BaCl}_2 \cdot 2\text{H}_2\text{O}$ dissolves in 78 parts of methyl alcohol of sp. gr. 0.790 (15°) at room temp.; in 7000 parts of ethyl alcohol of sp. gr. 0.8035 (15°); and in 100,000 parts of propyl alcohol of sp. gr. 0.8085 (15°). According to R. Fresenius, one part of barium chloride dissolves 7500 parts of absolute alcohol (99.3 volumes per cent.) at 14° , and in 4800 parts of the boiling alcohol; and one part of strontium chloride dissolves in 111.6 and 262 parts of the same alcohol at 14° and at the b.p. respectively.

According to T. Graham, anhydrous calcium chloride unites with ethyl alcohol, forming a compound $\text{CaCl}_2 \cdot 3\text{C}_2\text{H}_5\text{OH}$ with *alcohol of crystallization*. P. Einbrodt objected to the evidence of chemical union, but R. Kane obtained a complex with methyl alcohol, $\text{CaCl}_2 \cdot 4\text{CH}_3\text{OH}$, which is analogous to A. Chodnew's view of the composition of T. Graham's compound, viz. $\text{CaCl}_2 \cdot 4\text{C}_2\text{H}_5\text{OH}$. J. B. Heindl prepared a series of compounds with ethyl, isobutyl, and amyl alcohols with the general formula $\text{CaCl}_2 \cdot 3\text{ROH}$ —where R represents the radicles C_2H_5 , C_4H_9 , or C_5H_{11} . E. Linnemann also made a compound with isopropyl alcohol. B. Völlmer measured the electrical conductivity of soln. of calcium chloride in ethyl alcohol, A. Schlamp in propyl alcohol. J. Wölfer determined the effect of calcium chloride on the b.p. of alcohol. The results show that calcium chloride in ethyl alcohol is partly ionized. According to L. Cailletet, calcium chloride is insoluble in *liquid carbon dioxide*. W. Eidmann found calcium and strontium chlorides to be soluble in *acetone*; and barium chloride insoluble. A. Lieben found a series of double compounds are formed with the *fatty acids*—e.g. with butyric acid, $\text{CaCl}_2 \cdot 2\text{C}_4\text{H}_8\text{O}_2 \cdot 2\text{H}_2\text{O}$; $\text{CaCl}_2 \cdot \text{Ca}(\text{C}_4\text{H}_7\text{O}_2)_2 \cdot 4\text{C}_4\text{H}_8\text{O}_2$; and $\text{CaCl}_2 \cdot \text{C}_4\text{H}_8\text{O}_2$. P. B. Davis and co-workers measured the conductivity of soln. of barium chloride in *formamide*. According to A. Köhler, 100 grms. of a sat. soln. contain 42.84 grms. of *sugar* and 25.25 grms. of calcium chloride; and, according to C. A. L. de Bruyn, 100 parts by weight of *glycerol* dissolve 10 parts of barium chloride at 15.5° . L. Kahlenberg and F. C. Krauskopf say that calcium and strontium chlorides are very slightly soluble, and that barium chloride is insoluble in dehydrated *pyridine*, while calcium and strontium chlorides are soluble in pyridine with over 3 volumes per cent. of water, and barium chloride is insoluble in pyridine with 5 per cent. of water and slightly soluble in pyridine with 7 per cent. of water.

The crystals of dihydrated barium chloride have a positive double refraction. A. des Cloiseaux²⁶ gives the **indices of refraction** for the red rays, $\alpha=1.628$; $\beta=1.64$; $\gamma=1.657$; and for the yellow rays, $\alpha=1.635$; $\beta=1.646$; $\gamma=1.660$. The index of refraction of soln. of calcium chloride has been measured by V. S. M. van der Willigen, H. C. Jones and F. H. Getman, J. H. Gladstone, and G. J. W. Bremer. The following is a selection from G. J. W. Bremer's results for the *D*-line:

TABLE III.—REFRACTION CONSTANTS OF SOLUTIONS OF CALCIUM CHLORIDE.

Per cent. CaCl_2 .	Temp.	μ	Sp. gr., <i>D</i> .	$\frac{\mu - \mu_0}{p}$	$\frac{\mu^2 - 1}{(\mu^2 + 2)D}$
7.0110	20°	1.35089	1.05389	0.002525	0.20464
10.9749	17°	1.35897	1.09053	0.002357	0.20344
13.0884	16°	1.36631	1.11139	0.002529	0.20176
19.6565	13°	1.38230	1.17210	0.002544	0.19912

This is in agreement with the view that the difference $\mu - \mu_0$ is proportional to the conc.; and the Lorenz and Lorentz's formula summarizes the effects very well. P. Barbier and L. Roux have measured the dispersion of soln. of calcium chloride.

A. G. Hankel and H. Lindenberg²⁷ found the crystals of dihydrated barium chloride to be electrified on warming. H. Jahn gives the mol. **electromagnetic rotation** of the plane of polarization of soln. of calcium chloride, 9·39 (water unity); strontium chloride, 9·71; and barium chloride, 10·094. P. Bary found the salts to fluoresce in the **Röntgen rays** and **Becquerel rays**. Molten calcium chloride is a fairly good conductor of electricity.

During the electrolysis of fused calcium chloride, there appears at the cathode a red pleochroic crystalline product which has a composition approximating calcium subchloride, CaCl. A. Guntz and H. Basset²⁸ did not make calcium subchloride by melting calcium with calcium chloride in a neutral atm., contrary statements are said to be based on a product containing a mixture of calcium hydride, CaH₂, and chloride. F. Haber and S. Tolloczko claim to have obtained an almost theoretical yield of barium subchloride, BaCl, by the electrolysis of solid barium chloride in an atm. of nitrogen at 600°, and the failure to obtain metallic barium by the electrolysis of fused barium chloride is attributed to the formation of this product. A. Guntz also claims to have made this compound by heating in an iron boat a mixture of barium and barium chloride to 850° in vacuo. Barium subchloride is said to be a brown crystalline substance which develops hydrogen when treated with water. It is difficult to obtain this compound in a pure state, because, says A. Guntz, if the attempt be made to volatilize the excess of barium, the barium subchloride decomposes at 1000° into BaCl₂ and barium. F. Haber and S. Tolloczko calculated the heat of formation of BaCl to be 115·8 Cals.

W. Hampe²⁹ found a similar remark applies to fused chlorides of strontium and barium, and K. Arndt has investigated the electrical conductivity of the fused salts. According to K. Arndt and A. Gessler, the eq. conductivity at 900° of calcium chloride with 36·2 gram-eq. per litre is $\lambda=64\cdot1$; 34·0 gram-eq. of strontium chloride per litre, $\lambda=58\cdot2$; and 30·5 gram-eq. of barium chloride per litre, $\lambda=56\cdot1$. According to K. Arndt and K. Willner, the decomposition potential of fused calcium chloride at 800° is 3·24 volts; strontium chloride, 3·40 volts; and over 3·3 volts barium chloride. The electrolysis of soln. of calcium chloride gives hydrogen and calcium hydroxide at the cathode, and chlorine, oxygen, hypochlorite, and chlorate at the anode. The mechanism of the chemical reactions³⁰ involved is analogous with that which occurs during the electrolysis of the alkali chloride (*q.v.*).

The **electrical conductivities** of soln. of calcium chloride have been measured by J. G. MacGregor,³¹ H. C. Jones and F. H. Getman, S. Arrhenius, and C. Heim. F. Kohlrausch has measured the eq. conductivity, λ , at 18°. H. C. Jones and co-workers gave for the mol. conductivity, μ , and the percentage degree of ionization, α , of soln. with a mol of the salt in v litres of water:

v	2	8	32	128	512	2048	
CaCl ₂	μ_0°	80·5	95·3	106·4	117·8	124·0	131·4
	μ_{85°	—	318·7	378·5	418·9	452·5	474·8
	α_0°	61·2	72·5	80·9	89·6	94·3	100·0
	α_{85°	—	67·1	79·7	88·2	95·3	100·0
SrCl ₂	μ_0°	81·36	92·97	106·3	118·5	125·0	133·9
	μ_{85°	—	324·4	377·5	424·6	453·9	476·5
	α_0°	60·8	69·5	79·4	88·5	93·4	100·0
	α_{85°	—	66·6	77·5	87·2	93·2	97·8
BaCl ₂	μ_0°	86·62	99·06	—	—	126·5	132·7
	μ_{85°	259·8	322·3	375·3	421·5	453·8	478·0
	α_0°	65·3	74·6	—	—	95·3	100·0

The same subject has been considered by G. Kümmell, and J. Drucker. The temp. coeff. of the conductivities of the chlorides of the alkaline earths have been studied by H. C. Jones and A. P. West, H. C. Jones, and A. C. MacGregory and F. Kohlrausch. C. Heim detected no abrupt change in the electrical conductivity of conc. soln. of calcium chloride in their passage to the supersaturated state. According to J. Trötsch, a 25 per cent. soln. of calcium chloride is the best conductor, and has the smallest temp. coeff.; he considers this phenomenon is not explained satisfactorily by assuming the formation of hydrates. O. Gropp studied the effect of

temp. on the conductivity of liquid and frozen soln. of calcium chloride; G. Dickhaus, the effect of temp. on the conductivity of aq. soln. of barium and calcium chlorides. S. Lussana has studied the effect of press. on the conductivity of soln. of barium chloride; and E. MacKay measured the conductivity of mixed soln. of barium and sodium chlorides. G. N. Lewis and G. A. Linhart measured the **degree of ionization** of soln. of barium chloride; and G. N. Lewis and M. Randall, the activity coeff. of the ions. According to S. Arrhenius, the **heat of ionization** of barium chloride at 35° in $\frac{1}{10}N$ -soln. is -307 cal. S. von Lasczynsky and S. von Gorsky found a soln. of calcium chloride in pyridine is a non-conductor. J. C. Ghosh measured the conductivity of soln. of barium chloride in mixtures of pyridine and water; and A. Schlamp, of calcium chloride in a number of non-aqueous solvents. A. B. Bryan measured the conductivity of planes charged with calcium and barium chlorides.

The **transport numbers** of the anion Cl' with soln. of the alkaline earth chlorides have been determined by W. Hittorf, A. Weiske, W. Bein, B. D. Steele, etc.³² The transport number with calcium chloride rises from 0.553 for 0.01*N*-soln. to 0.715 for 2*N*-soln.; from 0.625 for 0.5*N*-soln. to 0.715 for 2*N*-soln. of strontium chloride; and from 0.576 for 0.5*N*-soln. to 0.633 for 2*N*-soln. of barium chloride. The increase in the transport number with increasing conc. has led to the assumption that complex ions BaCl₃' and BaCl₄'' are formed. A. Heydweiller found the **dielectric constant** of anhydrous barium chloride to be 3.11, and of the dihydrate 4.14, for $\lambda=478$ cms. The value for the contained water in the hydrated salt is 6.36, showing that the water is profoundly modified.

The chemical properties of the chlorides of the alkaline earths.—K. Kaiser³³ found that **hydrogen** converts calcium chloride at 700° into calcium hydride. According to H. Schulze, when chlorides of the alkaline earths are calcined in **oxygen** gas they are transformed into the oxides and chlorine, and, even in air, there is evidence of the same reaction as shown by E. Kraus, J. C. G. de Marignac, J. B. A. Dumas, and T. W. Richards. With barium chloride, the oxidation proceeds less readily than with the calcium salt. H. Schulze also showed that if the chloride be heated with chlorate, it is oxidized and chlorine gas is liberated. According to H. Kunheim, when calcined in a stream of **water vapour**, calcium chloride is less easily decomposed than magnesium chloride, and more easily than barium chloride, and, according to T. J. Pelouze, the reaction is incomplete, presumably $\text{CaCl}_2 + 2\text{H}_2\text{O} \rightleftharpoons \text{Ca}(\text{OH})_2 + 2\text{HCl}$. E. Solvay says the reaction is accelerated when china clay or silica is present. C. Göpner says that **hydrogen chloride** transforms calcium oxide into a stone-like mass containing 40 per cent. CaCl₂ and 60 per cent. Ca(OH)₂. G. P. A. Petzholdt found that when strongly heated with **carbon dioxide**, the chloride of the alkaline earth is partly decomposed, and, according to F. Haber and S. Tolloczko, the thermal value of the reaction: $2\text{CaCl}_2 + 2\text{CO}_2 + \text{O}_2 = 2\text{CaCO}_3 + 2\text{Cl}_2 + 3.1$ Cals.; and with barium chloride, 23.7 Cals. Calcium chloride which contains some oxide, absorbs carbon dioxide, a fact which O. L. Erdmann and H. Hess found requires attention when carbon dioxide is being dried by calcium chloride.

Calcium chloride, said H. Moissan, is attacked in the cold by **fluorine**, and chlorine is disengaged. J. Post, and A. Gorgeu say that an oxychloride is formed by the action of moist **chlorine** on red-hot calcium chloride, and that the oxychloride is impure because it is partly decomposed by the water. W. L. Goodwin showed that chlorine dissolves more copiously in soln. of calcium or strontium chloride than in water, and although no chlorohydrate separates out on cooling, it is supposed that the soln. contains *calcium or strontium polychloride*. A. Potilitzin and M. Berthelot found that **bromine** partially converts calcium, strontium, or barium chloride into the bromide, in a sealed tube at 400°. A 40 per cent. soln. of strontium chloride dissolves three times as much bromine or nine times as much iodine as water, and the bromine is expelled by passing a current of air through the diluted soln. The reactions are exothermal. There is only

a very slight substitution of the chlorine by the bromine or iodine, and hence, adds M. Berthelot, strontium chlorobromide or chloriodide must be formed. Similar remarks apply to the barium salt : $\text{BaCl}_2 + 4\text{Br}_2 = \text{BaBr}_6 + 2\text{BrCl} + 16.4 \text{ Cals.}$; but A. Potilitzin objects to this hypothesis. According to W. T. O. Casselmann, **phosphorus oxychloride**, POCl_3 , at 100° , transforms barium chloride into a jelly. V. Merz and W. Weith found that if potassium iodide be melted with barium chloride, in air, iodine is evolved.

According to L. Smith, molten calcium chloride dissolves **calcium oxide**, but, says K. Arndt, no oxychloride is formed. At 800° , 5.4 per cent. CaO is dissolved; at 850° , 5.6 per cent.; and at 900° , 7.3 per cent. The solubility is not appreciably affected by the addition of calcium fluoride. The cooling curve shows that a solid soln. not a compound is formed. K. Arndt found similar results with strontium chloride and oxide; a soln. sat. at 910° contains 34.4 mols of SrO to 1000 of SrCl_2 ; with barium chloride and oxide, a eutectic is formed melting at about 870° , and containing 111 mols of BaCl_2 to 473 mols of BaO . B. Zahorsky studied the solubilities of lime in soln. of calcium chloride—*vide* calcium hydroxide. P. Berthier studied qualitatively the product obtained by fusing calcium sulphide and chloride, or barium sulphide and chloride; J. W. Döbereiner, mixtures of strontium chloride and sulphate; and P. Berthier, barium chloride and sulphate. According to H. Caron, when an alloy of sodium with lead, bismuth, antimony, or zinc is heated with strontium chloride, an alloy of sodium and strontium is formed. A. Rosenshtiel says that calcium chloride, at a high temp., undergoes double decomposition with **barium hydroxide or sulphide**; C. J. B. Karsten, with **barium carbonate**; G. Lunge, with **calcium sulphide**; and G. Borsche and F. Brünjes, with **magnesium carbonate** in an atm. of carbon dioxide : $\text{MgCO}_3 + \text{CaCl}_2 = \text{MgCl}_2 + \text{CaCO}_3$. A soln. of **potassium dichromate** was found by M. Prud'homme and E. Binder to precipitate normal barium chromate from a soln. of barium chloride : $\text{K}_2\text{Cr}_2\text{O}_7 + \text{BaCl}_2 = \text{BaCrO}_4 + 2\text{KCl} + \text{CrO}_3$. F. Ullik also noted that on evaporating a soln. of a little strontium sulphate in calcium chloride, a little strontium chloride is formed which can be extracted from the residue by alcohol. According to H. A. von Vogel, acetic, phosphoric, and boric acids displace a part of the chlorine from calcium chloride; the same observation was made by E. L. Salkowsky with respect to the action of nitrous anhydride. H. Schulz says that **nitric acid** partially converts a soln. of the alkaline earth into nitrate. M. Prud'homme and E. Binder found that **carbonic acid** at a low temp. and under press. decomposes soln. of the chloride of the alkaline earth, forming hydrochloric acid and calcium carbonate. The vapour of *sulphuric anhydride*, says H. Rose, does not act on anhydrous barium chloride; but, according to S. U. Pickering, **sulphuric acid** or a soluble sulphate gives a turbidity in a soln. containing 0.000012 grm. of barium chloride per c.c. A soln. of **potassium carbonate** also converts a soln. of barium chloride into carbonate, a reaction studied by J. Bevad, who found that the speed of precipitation is greater the more conc. the soln. of the chloride, and is greatest with the barium salt and slowest with the calcium salt. M. M. P. Muir has studied the conditions of equilibrium between soln. of calcium chloride and the alkali carbonates. J. Piccard studied the action of aq. **phosphoric acid** on soln. of calcium chloride, and found that the product behaves like a mixture of normal calcium phosphate and hydrochloric acid, and that hydrogen chloride is given off when evaporated. The repeated soln. and evaporation at 100° of equi-molar parts of phosphoric acid and calcium chloride gives a residue of calcium hydrophosphate, CaHPO_4 , with the evolution of hydrogen chloride; if more calcium chloride be employed, the excess remains unchanged; and with double the proportion of phosphoric acid, calcium dihydrophosphate, $\text{Ca}(\text{H}_2\text{PO}_4)_2$, is produced. C. J. B. Karsten noted that **sodium hydroxide** dissolves in soln. of calcium chloride without the separation of calcium hydroxide; and that soln. of sodium chloride dissolve more calcium hydroxide than water does. S. Chumanoff, and W. A. Burdakoff studied the effect of mixing soln. of **potassium hydroxide** of different conc. with aq. soln. of calcium chloride, and when the soln.

are mixed in the converse way. A. Tixier proposed to heat various silicates with calcium chloride to form chlorine, or if water vapour be present hydrogen chloride. The alkali chlorides and undecomposed chloride can be dissolved out by water; and the residual lime and the aluminium silicate decomposed by hydrochloric acid. The aluminium and calcium chlorides are evaporated to dryness, heated to 300°, and the residual alumina washed with water. The chlorides of the alkaline earths are but incompletely reduced when heated with **magnesium**.

J. J. Berzelius³⁴ noted in 1824 that anhydrous calcium chloride absorbs **ammonia** gas and at the same time swells up, cracks, splits in all directions, and at last falls to a white powder; according to H. Rose, with the vitreous salt, the initial absorption is rapid, and slows down towards the end; he also found the product of the action occupies 20 times the original volume of the solid. M. Faraday noted that the absorbed ammonia is expelled on heating, and the chloride remains chemically unchanged; and he added that vitreous barium and strontium chlorides slowly change in ammonia gas after many days' exposure—about 2 grms. of strontium chloride absorbed about 16.4 c.c. of the gas in a fortnight, and “a slight efflorescent appearance was seen on the broken edge.” T. Weyl showed that the absorption by barium chloride is greater under press., and that the absorbed ammonia is rapidly lost on exposure to air. A. Joannis condensed liquid ammonia at -30° on still warm freshly prepared vitreous barium chloride in a tube provided with a stop-cock. When the action was complete, the stop-cock was opened and the tube warmed to 0°. The excess of ammonia escaped. The composition of the residue corresponded with **barium tetrammino-chloride**, $\text{BaCl}_2 \cdot 4\text{NH}_3$. The vap. press. at 0° is 541 mm.; and at 28.4°, 1850 mm. The press. remained constant until all the ammonia had escaped, showing that a lower ammino-compound was not formed at this temp. H. Rose regarded the product formed by strontium chloride and ammonia to be **strontium octammino-chloride**, $\text{SrCl}_2 \cdot 8\text{NH}_3$; and with the calcium salt, **calcium octammino-chloride**, $\text{CaCl}_2 \cdot 8\text{NH}_3$. According to F. Isambert, the dissociation press. of calcium octammino-chloride at 0° is 120 mm., and at 46.2°, 1551 mm. C. Antoine represented the vap. press., p mm., of calcium ammino-chloride by $\log p = 2.1361 + 0.023\theta$. The compound inflames spontaneously in chlorine gas, forming nitrogen chloride; it dissolves in water with the evolution of ammonia. F. Isambert inferred the existence of **calcium tetrammino-chloride**, $\text{CaCl}_2 \cdot 4\text{NH}_3$, and of **calcium diammino-chloride**, $\text{CaCl}_2 \cdot 2\text{NH}_3$, from the arrests in the press. curves of the dissociating octammino-salt, and from the heat developed per mol of ammonia when the product is dissolved in water—for $\text{CaCl}_2 \cdot 2\text{NH}_3$, 14.03 Cals.; for $\text{CaCl}_2 \cdot 4\text{NH}_3$, 12.16 Cals.; and for $\text{CaCl}_2 \cdot 8\text{NH}_3$, 12.16 Cals. per mol of ammonia. R. O. E. Davis and co-workers measured the vap. press. of ammoniacal soln. of calcium chloride. L. Crismer³⁵ obtained impure compounds of calcium chloride with *hydroxylamine*, and G. N. Antonoff a series of compounds with $\text{CaCl}_2 : \text{NH}_2\text{OH} : \text{H}_2\text{O}$ as 2 : 1 : 5; 2 : 3 : 6; 1 : 2 : 0; 1 : 2 : 1; 1 : 2 : 2; 2 : 5 : 4; and $\text{CaCl}_2 \cdot 3\text{NH}_2\text{OH} \cdot \text{HCl}$. G. N. Antonoff also made $2\text{SrCl}_2 \cdot 5\text{NH}_2\text{OH} \cdot 2\text{H}_2\text{O}$; and $2\text{SrCl}_2 \cdot 9\text{NH}_2\text{OH} \cdot 3\text{HCl} \cdot \text{H}_2\text{O}$. L. Crismer and G. N. Antonoff also made $\text{BaCl}_2 \cdot \text{NH}_2\text{OH} \cdot 2\text{H}_2\text{O}$.

F. A. H. Schreinemaker and W. C. de Baat³⁶ have studied the quaternary system, $\text{NH}_4\text{Cl} - \text{CuCl}_2 - \text{BaCl}_2 - \text{H}_2\text{O}$; $\text{NaCl} - \text{CuCl}_2 - \text{BaCl}_2 - \text{H}_2\text{O}$; and $\text{KCl} - \text{CuCl}_2 - \text{BaCl}_2 - \text{H}_2\text{O}$, in addition to the corresponding ternary system, with the alkali or ammonium chloride, cupric chloride, and water; and the ternary systems, $\text{CuCl}_2 - \text{BaCl}_2 - \text{H}_2\text{O}$ and $\text{BaCl}_2 - \text{KCl} - \text{H}_2\text{O}$. In neither of the two latter is there any sign of a double salt.

The basic chlorides of the alkaline earths.—Calcium oxychlorides have been reported by J. B. Trommsdorff, C. F. Buchholz, and C. L. Berthollet³⁷ (*vide supra*). H. Rose made calcium oxychloride by boiling calcium hydroxide (0.4 part) with calcium chloride (15 parts) and water (5 parts), and filtering the hot soln. Needle-like crystals of **calcium oxychloride**, $3\text{CaO} \cdot \text{CaCl}_2 \cdot 15$ or $15\text{H}_2\text{O}$, separated in a few hours; they were dried between filter paper in an atm. free from carbon dioxide. G. André used 100 grms. each of hexahydrated calcium chloride and water,

and 10–15 grms. of powdered calcium chloride. B. Zahorsky made this salt by treating hydrochloric acid with an excess of lime. The formula for the calcium salt has given rise to some discussion—A. Ditte, and G. André gave $16\text{H}_2\text{O}$; T. Beesley, $14\text{H}_2\text{O}$; H. Rose (1854) later gave $2\text{CaO}\cdot\text{CaCl}_2\cdot\text{H}_2\text{O}$. B. Zahorsky gave $15\text{H}_2\text{O}$; and H. Grimshaw, $3\text{CaO}\cdot\text{CaCl}_2\cdot 15\text{H}_2\text{O}$, or $\text{CaCl}_2\cdot\text{O}\cdot\text{Ca}(\text{OH})_2 + 7\text{H}_2\text{O}$. F. A. H. Schreinemakers and co-workers have studied the ternary system, $\text{CaO}-\text{CaCl}_2-\text{H}_2\text{O}$, at different temp., and found at 10° the results indicated in Fig. 14. The solubility curve is *abade*, where *ab* refers to $\text{Ca}(\text{OH})_2$ soln. in equilibrium with $\text{Ca}(\text{OH})_2$ as solid phase; *bc*, to $\text{CaCl}_2\cdot 3\text{CaO}\cdot 16\text{H}_2\text{O}$ as solid phase; *cd*, to $\text{CaCl}_2\cdot\text{CaO}\cdot 2\text{H}_2\text{O}$ as solid phase; and *de*, to $\text{CaCl}_2\cdot 6\text{H}_2\text{O}$ as solid phase. Similar solid phases were obtained at 25° , but at 50° the solid phases in equilibrium with the soln. are $\text{CaCl}_2\cdot\text{CaO}\cdot 5(\text{or } 4)\text{H}_2\text{O}$, $\text{CaCl}_2\cdot\text{CaO}\cdot 2\text{H}_2\text{O}$, $\text{CaCl}_2\cdot 2\text{H}_2\text{O}$, and $\text{Ca}(\text{OH})_2$. G. André made crystalline plates of **strontium oxychloride**, $\text{SrO}\cdot\text{SrCl}_2\cdot 9\text{H}_2\text{O}$, in a similar manner to the process employed for the calcium oxychlorides. G. André also reported $\text{SrO}\cdot\text{SrCl}_2$ with 12, 14, and $15\text{H}_2\text{O}$. J. Milikan's study of the ternary system $\text{SrO}-\text{SrCl}_2-\text{H}_2\text{O}$ at 40° gave as solid phases $\text{Sr}(\text{OH})_2\cdot 8\text{H}_2\text{O}$; $\text{SrCl}_2\cdot\text{SrO}\cdot 9\text{H}_2\text{O}$;

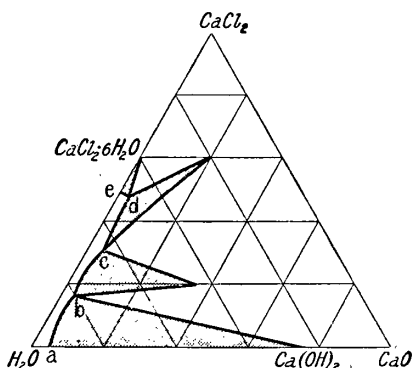

FIG. 14.—Ternary System,
 $\text{CaO}-\text{CaCl}_2-\text{H}_2\text{O}$, at 10° .

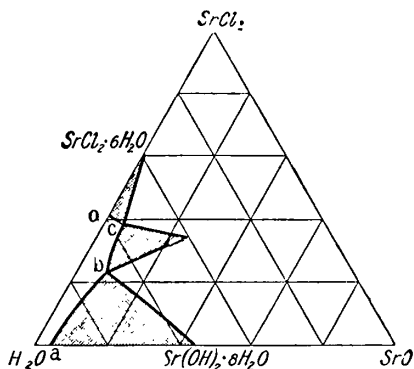

FIG. 15.—Ternary System,
 $\text{SrO}-\text{SrCl}_2-\text{H}_2\text{O}$, at 25° .

and $\text{SrCl}_2\cdot 6\text{H}_2\text{O}$. In Fig. 15, the curve *ab* refers to soln. in equilibrium with $\text{Sr}(\text{OH})_2\cdot 8\text{H}_2\text{O}$; *bc*, with $\text{SrCl}_2\cdot\text{SrO}\cdot 9\text{H}_2\text{O}$; and *cd*, with $\text{SrCl}_2\cdot 4\text{H}_2\text{O}$ at 25° , the zone of stability of the oxychloride becomes very small, and at 0° disappears. E. Tassily, and G. André also made crystalline plates of **barium oxychloride**, $\text{BaO}\cdot\text{BaCl}_2\cdot 5\text{H}_2\text{O}$, in a similar way by dissolving barium oxide in a conc. soln. of barium chloride. E. Beckmann reported the formation of an oxychloride, $\text{Ba}(\text{OH})\text{Cl}\cdot 2\text{H}_2\text{O}$ or $\text{BaCl}_2\cdot\text{Ba}(\text{OH})_2\cdot 4\text{H}_2\text{O}$, by the action of baryta on a soln. of barium chloride in conc. hydrochloric acid. This was confirmed by F. A. H. Schreinemakers whose study of the ternary system, $\text{BaO}-\text{BaCl}_2-\text{H}_2\text{O}$, at 40° , gave a result obtained later by J. Milikan for the strontium oxychloride, but the solid phases were $\text{Ba}(\text{OH})_2\cdot 8\text{H}_2\text{O}$; $\text{BaCl}_2\cdot\text{BaO}\cdot 5\text{H}_2\text{O}$; and $\text{BaCl}_2\cdot 2\text{H}_2\text{O}$.

The heat of formation of G. André's ($\text{CaCl}_2\cdot 3\text{CaO}$, $16\text{H}_2\text{O}_{\text{liquid}}$) was 92.006 Cals.; with the $16\text{H}_2\text{O}_{\text{solid}}$, 69.126 Cals.; (SrO , $\text{SrCl}_2\cdot 9\text{H}_2\text{O}_{\text{liquid}}$), 24.44 Cals.; or with the $9\text{H}_2\text{O}_{\text{solid}}$, 18.01 Cals. E. Tassily gives (BaCl_2 , BaO , $5\text{H}_2\text{O}_{\text{solid}}$), 39.2 Cals., or with $5\text{H}_2\text{O}_{\text{liquid}}$, 32.2 Cals. The heat of soln. of a mol of $\text{SrO}\cdot\text{SrCl}_2\cdot 9\text{H}_2\text{O}$ in a dil. soln. of two mols of HCl at 22° is 8.36 Cals.; with a mol of $\text{BaO}\cdot\text{BaCl}_2\cdot 5\text{H}_2\text{O}$ under similar conditions, 18.5 Cals. The crystals of the calcium salt lose the eq. of $14\text{H}_2\text{O}$ in vacuo; the barium salt loses $4\text{H}_2\text{O}$ at 120° . Water or alcohol decomposes the oxychlorides, so also do aq. soln. of ammonium and the alkali chlorides. Glycerol readily dissolves the calcium salt. Carbon dioxide forms the carbonate, but, according to E. Beckmann, at ordinary temp. carbon dioxide scarcely attacks the barium salt, which has been partially dehydrated at 120° , but at a red heat it is rapidly decomposed. According to P. A. Bolley, dry chlorine forms hypochlorite.

Complex salts.—E. Defacqz³⁸ prepared barium fluorochloride, $\text{BaF}_2 \cdot \text{BaCl}_2$, by heating 10 parts of manganese fluoride and 40 parts of barium chloride for 2 hrs. at 1000° ; and purifying the product by repeated extraction with cold water, and finally with alcohol at 95° . The colourless crystalline plates have a sp. gr. 4.51 at 18° . The salt is insoluble in, and undecomposed by, boiling alcohol, very slowly decomposed by cold water, but much more readily attacked by the boiling solvent, being thereby converted into the chloride and fluoride of barium; dil. acetic, hydrochloric, or nitric acid effects a similar decomposition; it is soluble in conc. hydrochloric or nitric acids, whilst hot sulphuric acid decomposes it into barium sulphate, hydrofluoric, and hydrochloric acids. It is not changed by fusion with manganese chloride, but converted into barium fluoride on fusion with barium chloride. **Strontium fluorochloride**, $\text{SrF}_2 \cdot \text{SrCl}_2$, sp.gr. 4.18, and **calcium fluorochloride**, $\text{CaF}_2 \cdot \text{CaCl}_2$, sp.gr. 3.07, were prepared in a similar way. They resemble the barium salt, but are more readily dissociated by water. O. Ruff and W. Plato found mixtures of barium fluoride and chloride have a eutectic at about 860° and 86 molar per cent. of barium chloride; and mixtures of calcium fluoride and chloride, a eutectic at about 660° , and 78 molar per cent. of calcium chloride; there is also a break in the curve at about 750° and 50 molar per cent. of calcium chloride— $\text{CaCl}_2 \cdot \text{CaF}_2$.

W. Plato found that the f.p. curve of calcium fluoride with calcium chloride gave a minimum at 644° , and 80 mols per cent. of calcium chloride; and a break in the curve at 737° , corresponded with the formation of calcium fluorochloride, $\text{CaF}_2 \cdot \text{CaCl}_2$; with strontium chloride and fluoride there are two eutectics at 751° and 945° with respectively 36 and 89 mols per cent. of strontium fluoride, the intermediate maximum at 955° corresponds with the formation of strontium fluorochloride, $\text{SrF}_2 \cdot \text{SrCl}_2$; and with barium chloride and fluoride the two eutectics are at 942° and 845° corresponding respectively with 30 and 80 mols per cent. of barium chloride, the intermediate maximum at 1005° represents the m.p. of barium fluorochloride, $\text{BaF}_2 \cdot \text{BaCl}_2$.

C. Sandonini³⁹ showed that lithium and calcium chlorides furnish a continuous series of mixed crystals with a sharp minimum temp., Fig. 16, at 492° and 36.4

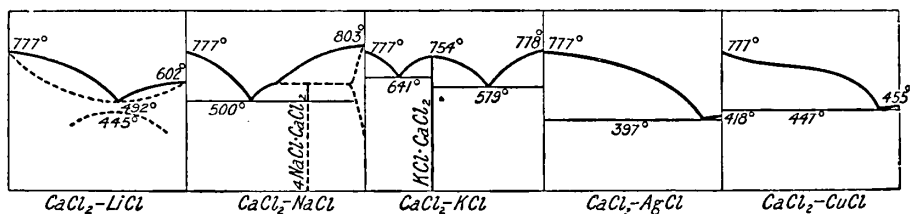

FIGS. 16 to 20.—Freezing-point Curves of Binary Mixtures of Calcium Chloride with Lithium, Sodium, Potassium, Cuprous, and Silver Chloride.

molar per cent. of calcium chloride. Mixtures with 10–60 molar per cent. of calcium chloride show an evolution of heat after solidification. This corresponds with a breaking up of the solid soln. very near the temp. of crystallization. Simple eutectics are obtained with lithium chloride and strontium or barium chloride—in the former case at 492° and 48 molar per cent. of SrCl_2 ; and in the latter case at 510° and 33 molar per cent. of BaCl_2 . O. Menge found that mixtures of molten calcium chloride with sodium, potassium, cuprous, or silver chloride are miscible in all proportions. E. Vortisch, and H. Gemsky found that the f.p. curve of binary mixtures of sodium and barium chlorides has one typical V-eutectic at 506° for 39 molar per cent. of barium chloride. H. le Chatelier noted the break in the curve corresponding with the transformation of α - to β - BaCl_2 . With mixtures of sodium and strontium chloride; and with sodium and calcium chlorides, F. E. E. Lamplough, and K. Scholich obtained a V-eutectic at 506° with 53 molar

per cent. of calcium chloride. For the last case, O. Menge obtained a break corresponding with *sodium hexachlorocalciate*, $4\text{NaCl}\cdot\text{CaCl}_2$, Fig. 17, but this has not been confirmed by other observers. C. Sandonnini measured the sp. gr. and electrical conductivities of the fused mixtures, and obtained no evidence of the formation of a compound.

O. Menge obtained a maximum with mixtures of potassium and calcium chlorides corresponding with **potassium calcium trichloride**, $\text{KCl}\cdot\text{CaCl}_2$, or KCaCl_3 , m.p. 754° , with two eutectics at 641° and 597° corresponding respectively with 19 and 65 molar per cent. of potassium chloride, Fig. 18. W. Moldenhauer and J. Andersen determined the m.p. of mixtures of the two chlorides. The existence of the double salt was confirmed by K. Scholich. C. Sandonnini measured the sp. gr. and electrical conductivities of the fused mixtures, and obtained evidence of the formation of a compound. Evidence of the formation of complexes of the chlorides of the alkalis and alkaline earths was obtained from a study of the heats of dilution of mixed soln. by G. McP. Smith and co-workers. With strontium and potassium chlorides, K. Scholich obtained long rhombic prisms of **potassium strontium tetrachloride**, $2\text{KCl}\cdot\text{SrCl}_2$, m.p. 597° ; and what are probably monoclinic prisms of **potassium strontium pentachloride**, $\text{KCl}\cdot 2\text{SrCl}_2$, m.p. 638° . H. Gemsky obtained the m.p. diagram, Fig. 21, for mixtures of barium and potassium chloride; there

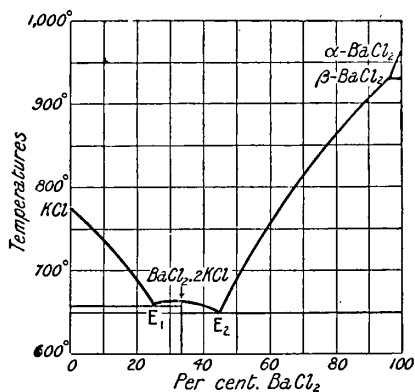

FIG. 21.—Melting-point Curve of Binary Mixtures, BaCl_2 — KCl .

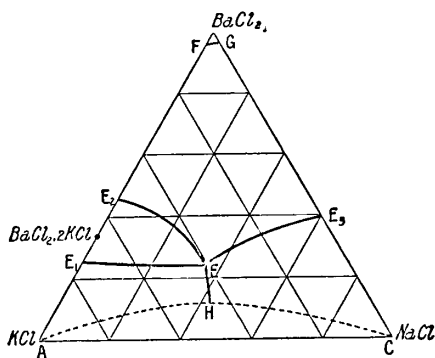

FIG. 22.—Ternary System, BaCl_2 — KCl — NaCl .

are two eutectic temp., E_1 and E_2 respectively, at 672° – 680° and 652° – 660° . The maximum between the eutectics corresponds with the formation of **potassium barium tetrachloride**, $\text{BaCl}_2\cdot 2\text{KCl}$, or **potassium tetrachlorobarate**, K_2BaCl_4 . O. Ruff and W. Plato obtained a similar result. The corresponding curve with barium and sodium chlorides is of the simple V-type with a eutectic at 654° and 39 mol per cent. of barium chloride. The area FGE_3EE_2 , Fig. 22, represents the range of existence of the double salt K_2BaCl_4 ; the area AHC , the region of mixed crystals. The eutectic lines are represented E_2E , E_1E , and E_3E . The dotted curve AHC represents the breaking down of the mixed crystals into their components.

G. S. Jamieson obtained slender prisms of dihydrated **cæsium calcium chloride**, $2\text{CsCl}\cdot\text{CaCl}_2$, from soln. containing 1–4 mols of each component per litre. E. H. Ducloux used the formation of the salt as a microchemical test for calcium. Similarly, with soln. containing 2 mols of cæsium chloride to one of strontium chloride, hydrated **cæsium strontium chloride**, $5\text{CsCl}\cdot 2\text{SrCl}_2\cdot 8\text{H}_2\text{O}$, was obtained; but with soln. containing $\text{CsCl}:\text{SrCl}_2=3:1$, only cæsium chloride appeared, and with 1:1 only strontium chloride.

E. Chauvenet, P. Job, and G. Urbain's analysis of the thermal effect on mixing soln. indicated the formation in soln. of **cupric calcium decachloride**, $2\text{CuCl}_2\cdot 3\text{CaCl}_2$, and **cupric calcium tetrachloride**, $\text{CuCl}_2\cdot\text{CaCl}_2$. O. Menge found that with mixtures

of calcium and silver chlorides there is a eutectic at 452° with 95 per cent. of silver chloride, Fig. 19; and with mixtures of calcium and cuprous chloride, a eutectic at 386° with 91 per cent. of cuprous chloride, Fig. 20. A. C. Becquerel prepared what he regarded as **barium cupric chloride**, by allowing soln. of barium chloride and cupric nitrate to diffuse slowly one into the other. F. A. H. Schreinemakers and W. C. de Baat obtained no complex salts in their study of the quaternary systems, $\text{H}_2\text{O}-\text{NH}_4\text{Cl}-\text{BaCl}_2-\text{CuCl}_2$; $\text{H}_2\text{O}-\text{NaCl}-\text{BaCl}_2-\text{CuCl}_2$; and $\text{H}_2\text{O}-\text{KCl}-\text{BaCl}_2-\text{CuCl}_2$. There is some evidence of the formation of complex salts **calcium, strontium, and barium silver chlorides** in soln. G. S. Forbes measured the solubility of silver chloride in soln. of calcium, strontium, and barium chlorides, at 25° , and found that when conc. are expressed in gram-eq. per 1000 grms. of water, the following values of $K_m = [\text{Ag}]/[\text{MCl}]^m$, where M is a gram-eq. of the metal, and m is a small whole number:

$[\text{Ag}] \times 10^3$.	.	.	0.289	0.900	2.802	5.823
$[\frac{1}{3}\text{CaCl}_2]$.	.	.	1.748	2.741	4.033	5.005
$K_2 \times 10^4$.	.	.	0.95	1.20	1.72	2.32
$K_3 \times 10^4$.	.	.	0.54	0.44	0.427	0.464
$[\text{Ag}] \times 10^3$.	.	.	0.033	0.236	1.252	12.04
$[\frac{1}{2}\text{SrCl}_2]$.	.	.	0.550	1.572	2.992	5.775
$K_2 \times 10^4$.	.	.	1.10	0.95	1.40	3.61
$K_3 \times 10^4$.	.	.	2.00	0.61	0.47	0.62
$[\text{Ag}] \times 10^3$.	.	.	0.186	0.339	1.274	2.366
$[\frac{1}{3}\text{BaCl}_2]$.	.	.	1.248	1.610	2.676	3.260
$K_2 \times 10^4$.	.	.	1.20	1.31	1.78	2.20
$K_3 \times 10^4$.	.	.	0.96	0.81	0.67	0.67

Data were also obtained for hydrogen, sodium, potassium, and ammonium chlorides. The increase in solubility was explained by assuming that complex anions, AgCl_3'' , AgCl_4''' , and possibly AgCl_5'''' , are formed which are stable throughout considerable ranges of conc. No evidence of the complex anion AgCl_2' was obtained.

A. Guntz prepared what he regarded as **barium sodium dichloride**, BaCl.NaCl , by the electrolysis of a molten mixture of sodium and barium chlorides; and by heating in a covered iron crucible, two gram-atoms of sodium with a mol of barium chloride. The product is a greyish-white mass which develops hydrogen when treated with water, and when heated to 700° , loses its sodium and leaves a residue of barium chloride.

According to T. Liebisch and E. Korreng, the fusion curve of the binary system with barium and calcium chlorides has a eutectic at 600° and 40 molar per cent. of barium chloride; there is a break in the curve at 631° corresponding with the formation of **calcium barium tetrachloride**, or *calcium tetrachlorobarate*, $\text{CaCl}_2.\text{BaCl}_2$, crystallizing at 631° . O. Ruff and W. Plato obtained a simple V-eutectic with mixtures of barium and calcium chloride at about 590° and 64 molar per cent. of calcium chloride. The binary system with calcium and strontium chlorides has a U-shaped minimum at 658° and 33 molar per cent. of strontium chloride; similarly also with strontium and barium chlorides at 847° and 30 molar per cent. of barium chloride. C. Sandonnini, W. Schäfer, and O. Ruff and W. Plato obtained confirmatory results.

T. Liebisch and E. Vortisch studied the ternary system, $\text{BaCl}_2-\text{SrCl}_2-\text{NaCl}$; H. Gemsky, E. Vortisch, and E. Jänecke, $\text{BaCl}_2-\text{KCl}-\text{NaCl}$ —*vide* Fig. 22; K. Scholich, $\text{SrCl}_2-\text{KCl}-\text{NaCl}$, and $\text{CaCl}_2-\text{KCl}-\text{NaCl}$; and W. Schäfer, $\text{BaCl}_2-\text{SrCl}_2-\text{CaCl}_2$. In the last case there is evidence of the ternary compound **calcium strontium barium hexachloride**, $\text{CaCl}_2.\text{SrCl}_2.\text{BaCl}_2$, crystallizing at about 500° .

REFERENCES.

- ¹ W. P. Jorissen, *Chem. Weekbl.*, 14. 304, 897, 1917; H. Schelenz, *Zeit. angew. Chem.*, 30. 195, 1917; H. J. Holgen, *Chem. Ztg.*, 41. 643, 1917; E. O. von Lippmann, *ib.*, 40. 605, 1916; W. Homberg, *Mém. Acad.*, 609, 1693-1730; *Hist. Acad. Paris*, 2. 208, 1723.
- ² C. W. Scheele, *Acta Acad. Stockholm*, 1, 1774; A. Crawford, *London Med. Comm.*, 2. 301, 1790.
- ³ J. F. L. Hausmann, *Handbuch der Mineralogie*, Göttingen, 3. 857, 1813; A. Scacchi, *Atti Acad. Napoli*, 6. 37, 1875; F. Zambonini, *Mineralogia Vesuviana*, Leipzig, 50, 1910.
- ⁴ J. L. Gay Lussac and L. J. Thénard, *Recherches physico-chimiques*, Paris, 2. 145, 1811; R. Weber, *Pogg. Ann.*, 112. 619, 1861; G. Kirchhoff and R. Bunsen, *ib.*, 110. 162, 1860; A. d'Heureuse, *ib.*, 75. 276, 1848; M. E. Chevreuil, *Ann. Chim. Phys.*, (1), 84. 285, 1812; C. Matignon and F. Bourion, *Compt. Rend.*, 138. 760, 1904; J. F. A. Götting, *Nicholson's Journ.*, 11. 133, 165, 1805; T. W. Richards and V. Yngve, *Journ. Amer. Chem. Soc.*, 40. 89, 1918; H. Toussaint, *L'Ind. Chim.*, 5. 250, 1918; *German Pat.*, D.R.P. 111667, 1898; Société pour l'utilisation de l'air et de ses dérivés, *French Pat. No.* 408357, 1910; C. S. Bradley and C. B. Jacobs, *Brit. Pat. Nos.* 260592, 26060, 1898; W. Heap and E. Newbery, *ib.*, 130626, 1918; J. Waldenberg, *ib.*, 8184, 1902; R. Heinz, *German Pat.*, D.R.P. 186738, 1907; Consortium für elektrochemische Industrie, Nürnberg, *ib.*, 162913, 1905; R. Phillips, *Chemist*, 2. 205, 1841; A. Duflos, *Arch. Pharm.*, (1), 36. 275, 1831; J. Kolb, *Ann. Chim. Phys.*, (4), 17. 126, 1866; (4), 8. 150, 1866; F. Kuhlmann, *Ann. Chim. Phys.*, (3), 54. 389, 1858; *Compt. Rend.*, 47. 403, 464, 674, 1858; H. Moissan, *ib.*, 126. 1753, 1893; J. B. J. D. Bousingault, *ib.*, 78. 593, 1874; C. Hensgen, *Ber.*, 9. 1674, 1876; G. P. A. Petzholdt, *Journ. prakt. Chem.*, (1), 17. 464, 1839; G. Gore, *Phil. Mag.*, (4), 29. 541, 1865; H. Davy, *Phil. Trans.*, 101. 1, 155, 1811; H. C. Dibbitts, *Arch. Neerl.*, 13. 478, 1879; F. P. Dunnington and F. W. Smither, *Amer. Chem. Journ.*, 19. 227, 1897; T. W. Richards, *Journ. Amer. Chem. Soc.*, 24. 374, 1902; J. C. G. de Marignac, *Bibl. Univ. Arch.*, 1. 209, 1853; J. B. A. Dumas, *Ann. Chim. Phys.*, (3), 55. 191, 1859; A. Duflos, *Schweigger's Journ.*, 26. 263, 1819; L. Godin, *Dingler's Journ.*, 171. 316, 1864; 262. 153, 1856; J. Mactear, *ib.*, 262. 288, 1886; H. W. F. Wackenroder, *ib.*, 262. 143, 1886; 253. 440, 1884; E. Asselin, *Polyt. Centr.*, 53, 1855; H. Kunheim, *ib.*, 620, 1866; B. Lach, *German Pat.*, D.R.P. 19188, 1881; F. Muck, *ib.*, 23372, 1882; L. Barthe and E. Falières, *Bull. Soc. Chim.*, (2), 7. 106, 1867; R. Weber, *Ber.*, 15. 2316, 1882; R. Bunsen, *Pogg. Ann.*, 91. 619, 1854; H. Rose, *ib.*, 74. 569, 1848; E. Mitscherlich, *Journ. prakt. Chem.*, (1), 83. 485, 1861; J. Legrand, *Ann. Chim. Phys.*, (2), 59. 423, 1855; P. Heinrich, *Gehlen's Journ.*, 5. 413, 1808; M. M. T. K. Kaisha, *Brit. Pat. No.* 163304, 1921; I. Namari and Y. Hiraoka, *Japan Pat. No.* 37118, 1920; J. H. MacMahon, *U.S. Pat. No.* 1378594, 1921; J. B. Trommsdorff, *Trommsdorff's Journ.*, 10. 3, 1802.
- ⁵ A. Fppler, *Zeit. Kryst.*, 30. 129, 1899; G. Wyruboff, *Bull. Soc. Min.*, 9. 262, 1886.
- ⁶ P. F. G. Boullay, *Ann. Chim. Phys.*, (2), 43. 266, 1830; E. Filhol, *ib.*, (3), 21. 415, 1847; L. Playfair and J. P. Joule, *Mém. Chem. Soc.*, 2. 401, 1845; C. J. B. Karsten, *Schweigger's Journ.*, 65. 394, 1832; H. Schiff, *Liebig's Ann.*, 108. 21, 1858; H. G. F. Schröder, *ib.*, 174. 249, 1874; *Ber.*, 11. 2131, 1878; *Pogg. Ann.*, 107. 113, 1861; *Dichtigkeitsmessungen*, Heidelberg, 1873; P. A. Favre and C. A. Valson, *Compt. Rend.*, 77. 579, 1873; G. Quincke, *Pogg. Ann.*, 135. 642, 1868; 138. 141, 1869; P. Kremers, *ib.*, 85. 42, 1852; W. Biltz, *Zeit. anorg. Chem.*, 115. 241, 1921; T. E. Thorpe and A. G. Francis, *Proc. Roy. Soc.*, 83. A, 277, 1910; F. Braun, *Journ. Chem. Soc.*, 28. 31, 1875; G. Brügelmann, *Ber.*, 17. 2359, 1884; O. Ruff and W. Plato, *ib.*, 35. 3616, 1902; T. W. Richards, *Zeit. anorg. Chem.*, 6. 89, 1894.
- ⁷ W. Ramsay and N. Eumorfopoulos, *Phil. Mag.*, (5), 41. 360, 1896; H. Moissan, *Bull. Soc. Chim.*, (3), 5. 880, 1891; H. le Chatelier, *ib.*, (2), 47. 300, 1887; T. Carnelley, *Journ. Chem. Soc.*, 29. 489, 1876; 31. 365, 1877; 33. 273, 1878; E. Mitscherlich, *Journ. prakt. Chem.*, (1), 83. 485, 1861; H. le Chatelier, *Compt. Rend.*, 118. 712, 1897; *Ann. Mines*, (9), 11. 131, 1897; A. Woloskoff, *Ann. Inst. St. Petersburg*, 16. 438, 1911; C. Sandonini, *Rend. Accad. Lincei*, (5), 20. ii, 496, 1911; H. Gernsky, *Krystallographische und thermische Untersuchung des ternären Systems Bariumchlorid—Kaliumchlorid—Natriumchlorid*, Berlin, 1913; K. Arndt, *Zeit. Elektrochem.*, 12. 337, 1906; O. Ruff and W. Plato, *Ber.*, 35. 3616, 1902; 36. 2527, 1903; V. Meyer and W. Riddle, *ib.*, 27. 3129, 1894; L. Rügheimer, *ib.*, 36. 3033, 1903; J. McCrae, *Wied. Ann.*, 55. 95, 1895; F. Braun, *Pogg. Ann.*, 454. 190, 1875; E. Kraus, *ib.*, 43. 138, 1838; W. Plato, *Zeit. phys. Chem.*, 55. 721, 1906; 58. 350, 1907; F. Haber and S. Tolloczko, *Zeit. anorg. Chem.*, 41. 407, 1904; J. B. A. Dumas, *Ann. Chim. Phys.*, (3), 55. 137, 190, 1859; T. H. Norton and D. M. Roth, *Journ. Amer. Chem. Soc.*, 19. 155, 1897; T. W. Richards, *ib.*, 24. 374, 1902; A. Gouy, *Compt. Rend.*, 84. 231, 1877; *Phil. Mag.*, (5), 3. 238, 1877; G. Bartha, *Ueber die Siedepunkte der Alkalimetalle und Alkalihalogenide im Vacuum des Kathodenlichts*, Heidelberg, 1912; H. V. Regnault, *Ann. Chim. Phys.*, (3), 1. 129, 1841; H. Kopp, *Liebig's Ann. Suppl.*, 3. 289, 1865; R. Bunsen, *Liebig's Ann.*, 138. 257, 1866.
- ⁸ A. E. Stearn and G. McP. Smith, *Journ. Amer. Chem. Soc.*, 42. 18, 1920; G. McP. Smith, A. E. Stearn, and R. F. Schneider, *ib.*, 42. 32, 1920; J. Thomsen, *Journ. prakt. Chem.*, (2), 16. 97, 1877; (2), 18. 1, 1878; S. U. Pickering, *Journ. Chem. Soc.*, 53. 865, 1888; *Ber.*, 27. 67, 1385, 1894; P. Sabatier, *Bull. Soc. Chim.*, (3), 1. 88, 1889; A. Guntz and G. Röderer, *ib.*, (3), 35. 512, 1906; D. Tommasi, *ib.*, (3), 29. 858, 1903; C. M. van Deventer and H. J. van de Stadt,

Zeit. phys. Chem., 9. 43, 1892; S. Arrhenius, *ib.*, 9. 339, 1892; A. Ditte, *Compt. Rend.*, 85. 1103, 1877; H. Berthelot, *Ann. Bur. Longitudes*, 395, 1877; F. R. Pratt, *Journ. Franklin Inst.*, 185. 663, 1918.

⁹ P. Kremers, *Pogg. Ann.*, 92. 499, 1854; 99. 435, 1856; 103. 65, 1858; A. E. Nordenskjöld, *ib.*, 136. 316, 1869; G. J. Mulder, *Bijdragen tot de geschiedenis van het Scheikundig gebonden Water*, Rotterdam, 105, 1864; H. Hammerl, *Sitzber. Akad. Wien*, 72. 287, 1875; A. Ditte, *Compt. Rend.*, 92. 242, 1881; H. le Chatelier, *ib.*, 108. 565, 801, 1889; H. W. B. Roozeboom, *ib.*, 108. 744, 1889; H. Lescœur, *ib.*, 98. 1158, 1881; *Bull. Soc. Chim.*, (2), 26. 2, 1881; E. Lefebvre, *Compt. Rend.*, 70. 684, 1870; D. Gernez, *ib.*, 94. 1389, 1877; A. Étard, *ib.*, 98. 1433, 1884; *Ann. Chim. Phys.*, (7), 2. 532, 1894; A. B. Poggiale, *ib.*, (3), 8. 468, 1843; J. L. Gay Lussac, *ib.*, (2), 11. 309, 1819; A. Gerardin, *ib.*, (4), 5. 142, 1865; R. Engel, *ib.*, (6), 13. 372, 1888; *Bull. Soc. Chim.*, (2), 47. 318, 1887; H. W. B. Roozeboom, *Rec. Trav. Chim. Pays-Bas*, 8. 1, 1889; *Zeit. phys. Chem.*, 4. 31, 1889; W. Müller-Erbach, *ib.*, 21. 545, 1896; F. A. Lidbury, *ib.*, 39. 453, 1902; W. A. Tilden, *Journ. Chem. Soc.*, 45. 409, 1884; H. Precht and B. Wittzen, *Ber.*, 14. 1674, 1881; W. D. Harkins and H. M. Paine, *Journ. Amer. Chem. Soc.*, 38. 2709, 1916; F. W. Küster, *Verh. Vers. Naturf. Hamburg*, 121, 1901; R. Kremann, *Sitzber. Akad. Wien*, 113. 809, 865, 1904; T. Graham, *Phil. Trans.*, 137. 47, 1837; W. D. Treadwell, *Helvetica Chim. Acta*, 4. 982, 1921.

¹⁰ L. Playfair and J. P. Joule, *Mem. Chem. Soc.*, 2. 401, 1845; J. Milikan, *Zeit. phys. Chem.*, 92. 496, 1917; E. Filhol, *Ann. Chim. Phys.*, (3), 21. 415, 1847; G. G. Person, *ib.*, (3), 27. 251, 1849; H. Kopp, *Liebig's Ann.*, 93. 129, 1885; P. A. Favre and C. A. Valson, *Compt. Rend.*, 77. 579, 1873; A. Ditte, *ib.*, 85. 1103, 1877; H. G. F. Schröder, *Dichtigkeitsmessungen*, Heidelberg, 1873; J. Dewar, *Chem. News*, 91. 216, 1905; A. Eppler, *Zeit. Kryst.*, 30. 129, 1899; S. U. Pickering, *Ber.*, 27. 67, 1894; S. Pagliani, *Atti Accad. Torino*, 20. 54, 1885.

¹¹ P. Kremers, *Pogg. Ann.*, 92. 499, 1854; 103. 66, 1858; A. Étard, *Compt. Rend.*, 113. 864, 1891; P. A. Favre and C. A. Valson, *ib.*, 77. 579, 1873; T. W. Richards and J. B. Churchill, *Zeit. phys. Chem.*, 28. 314, 1899; F. A. H. Schreinemakers and J. Milikan, *Proc. Acad. Amsterdam*, 15. 52, 1912; E. H. Davis, *Trans. N.Z. Inst.*, 3. 220, 1870; A. Ditte, *Ann. Chim. Phys.*, (5), 22. 559, 1881; H. Lescœur, *ib.*, (7), 2. 78, 1894; E. Filhol, *ib.*, (3), 21. 415, 1847; O. Lehmann, *Zeit. Kryst.*, 8. 437, 1883; A. Eppler, *ib.*, 30. 129, 1899; W. A. Tilden, *Journ. Chem. Soc.*, 45. 266, 1884; F. W. Clarke, *Amer. Chem. Journ.*, 5. 240, 1883; *Chem. News*, 49. 3, 1884; F. A. Gooch and F. M. McClenahan, *Amer. Journ. Science*, (4), 17. 365, 1904; E. Jänecke, *Zeit. phys. Chem.*, 90. 265, 1915; H. J. Buignet, *Journ. Pharm. Chim.*, (2), 40. 161, 337, 1860; T. W. Richards and Y. Yngve, *Journ. Amer. Chem. Soc.*, 40. 89, 1918; G. P. Baxter and L. J. Lansing, *ib.*, 42. 419, 1920; J. Thomsen, *Journ. prakt. Chem.*, (2), 16. 97, 1877; O. Mügge, *Neues Jahrb. Min.*, i, 130, 1889; i, 111, 1898; H. G. F. Schröder, *Dichtigkeitsmessungen*, Heidelberg, 1873; H. Schiff, *Liebig's Ann.*, 108. 21, 1858; O. Brill and C. de B. Evans, *Journ. Chem. Soc.*, 93. 1442, 1908; J. P. Joule and L. Playfair, *Mem. Chem. Soc.*, 1. 137, 1843; 2. 401, 1845; J. Milikan, *Zeit. phys. Chem.*, 92. 496, 1917.

¹² G. T. Gerlach, *Zeit. anal. Chem.*, 8. 283, 1869; J. G. McGregor, *Chem. News*, 55. 3, 1887; *Wied. Ann.*, 51. 128, 1894; F. Kohlrausch, *ib.*, 6. 38, 1879; D. I. Mendelëff, *Journ. Russ. Phys. Chem. Soc.*, 16. 184, 1884; S. U. Pickering, *Ber.*, 27. 1385, 1894; R. Engel, *Bull. Soc. Chim.*, (2), 47. 318, 1887; L. C. de Coppet, *Compt. Rend.*, 92. 1158, 1881; 125. 533, 1897; T. W. Richards, *Proc. Amer. Acad.*, 33. 23, 1897; J. B. Richter, *Anfangsgründe der Stöchiometrie*, Breslau, 3. 171, 1794; P. Kremers, *Pogg. Ann.*, 99. 444, 1857; 103. 65, 1858; 105. 360, 1858; R. Broom, *Proc. Roy. Soc. Edin.*, 13. 172, 1886; J. H. Pollock, *ib.*, 13. 626, 1886; N. A. Tschernay, *Journ. Russ. Phys. Chem. Soc.*, 20. 486, 1888; 21. 176, 1889.

¹³ P. G. Tait, *Proc. Roy. Soc. Edin.*, 20. 63, 141, 1895; O. Schmidt, *Sitzber. Akad. Wien*, 114. 945, 1905; L. Grassi, *Ann. Chim. Phys.*, (3), 31. 438, 1851; E. Jänecke, *Zeit. phys. Chem.*, 90. 265, 1915; V. Schumann, *Wied. Ann.*, 31. 14, 1887; W. C. Röntgen and J. Schneider, *ib.*, 31. 1000, 1887; J. Drecker, *ib.*, 34. 961, 1888; G. Wertheim, *Ann. Chim. Phys.*, (3), 23. 434, 1848; G. Timberg, *Wied. Ann.*, 30. 545, 1887.

¹⁴ J. Wagner, *Zeit. phys. Chem.*, 5. 30, 1890; S. Arrhenius, *ib.*, 1. 285, 1887; G. Quincke, *Pogg. Ann.*, 138. 141, 1869.

¹⁵ J. D. R. Scheffer, *Zeit. phys. Chem.*, 2. 390, 1888; J. Schumeister, *Sitzber. Akad. Wien*, 79. 603, 1879; F. E. Bartell and O. E. Madison, *Journ. Phys. Chem.*, 24. 593, 1920.

¹⁶ G. J. W. Bremer, *Rec. Trav. Chim. Pays-Bas*, 7. 268, 1888; N. A. Tschernay, *Journ. Russ. Phys. Chem. Soc.*, 20. 430, 486, 1888; 21. 176, 1889; J. Drecker, *Wied. Ann.*, 34. 952, 1888; G. Bender, *ib.*, 31. 872, 1887.

¹⁷ G. Jäger, *Sitzber. Akad. Wien*, 99. 245, 1890; W. Bctetz, *Wied. Ann.*, 7. 442, 1879; C. H. Lees, *Phil. Trans.*, 191. A, 399, 1898.

¹⁸ A. Blumcke, *Wied. Ann.*, 23. 161, 1884; J. Drecker, *ib.*, 34. 952, 1888; J. C. G. de Marignac, *Arch. Sciences Genève*, 55. 113, 1876; *Ann. Chim. Phys.*, (5), 8. 410, 1876; G. G. Person, *ib.*, (3), 33. 437, 1851; J. Thomsen, *Pogg. Ann.*, 142. 337, 1871; H. Teudt, *Ueber die Aenderung der spezifischen Wärmen wässriger Salzlösungen mit der Temperatur*, Erlangen, 1900.

¹⁹ P. L. Dulong and J. J. Berzelius, *Ann. Chim. Phys.*, (2), 15. 388, 1820; J. B. A. Dumas, *ib.*, (3), 26. 193, 1842; O. L. Erdmann and R. F. Marchand, *Journ. prakt. Chem.*, (1), 26. 464, 1842; M. Pettenkofer, *Liebig's Ann. Suppl.*, 2. 29, 1863; W. Müller-Erbach, *Verh. Nat. Bremen*, 215, 1881; G. J. Mulder, *Bijdragen tot de geschiedenis van het Scheikundig gebonden Water*,

Rotterdam, 1864; R. Brandes, *Schwigger's Journ.*, 51. 433, 1827; H. W. Hake, *Proc. Chem. Soc.*, 13. 147, 1897; W. Busnikoff, *Journ. Russ. Phys. Chem. Soc.*, 29. 482, 1898.

²⁰ R. Emden, *Wied. Ann.*, 31. 145, 1887; C. Dieterici, *ib.*, 62. 616, 1897; A. H. Pareau, *ib.*, 1. 39, 1877; 2. 144, 1877; W. Müller-Erzbach, *ib.*, 26. 409, 1885; 27. 624, 1886; *Zeit. phys. Chem.*, 19. 135, 1896; 21. 545, 1896; H. W. B. Roozeboom, *ib.*, 4. 31, 1889; W. Biltz, *ib.*, 40. 185, 1902; P. C. F. Frowein, *ib.*, 1. 5, 1887; J. L. Andreae, *ib.*, 7. 248, 1891; G. Tammann, *ib.*, 2. 42, 1888; *Wied. Ann.*, 24. 523, 1885; G. P. Baxter and J. E. Lansing, *Journ. Amer. Chem. Soc.*, 42. 419, 1920; A. W. C. Menzies, *ib.*, 42. 1951, 1920; G. R. Paranjpe, *Journ. Ind. Inst. Science*, 2. 59, 1918; H. Lescœur, *Compt. Rend.*, 92. 1158, 1881; 103. 1260, 1886; 104. 1511, 1887; 134. 1206, 1902; *Bull. Soc. Chim.*, (2), 26. 2, 1881; A. Wüllner, *Pogg. Ann.*, 103. 529, 1858; 110. 564, 1860; J. B. Hannay, *Journ. Chem. Soc.*, 32. 392, 1877; W. Pieper, *Dampfspannungen wässriger und alkoholischer Salzlösungen*, Bonn, 1917; H. W. Foote and S. R. Scholes, *Journ. Amer. Chem. Soc.*, 33. 1309, 1911; R. E. Wilson, *ib.*, 43. 704, 1921; J. R. Partington, *Journ. Chem. Soc.*, 99. 466, 1911; H. Schottky, *Zeit. phys. Chem.*, 64. 433, 1908; G. Tammann, *ib.*, 75. 75, 733, 1911; E. M. Baker and V. H. Waite, *Chem. Met. Eng.*, 25. 1137, 1174, 1921; L. von Babo, *Ueber die Spannkraft des Wasserdampfes in Salzlösungen*, Freiburg, 1847.

²¹ F. Rüdorff, *Pogg. Ann.*, 114. 63, 1861; P. Kremers, *ib.*, 99. 444, 1856; H. Hammerl, *Sitzber. Akad. Wiss.*, 72. 8, 1875; L. Kahlenberg, *Journ. Phys. Chem.*, 5. 366, 1901; A. Schlamp, *Zeit. phys. Chem.*, 14. 272, 1893; G. T. Gerlach, *ib.*, 2. 496, 1888; *Zeit. anal. Chem.*, 26. 413, 1887; S. Skinner, *Journ. Chem. Soc.*, 61. 339, 1892; J. L. Gay Lussac, *Ann. Chim. Phys.*, (2), 11. 309, 1819; J. Legrand, *ib.*, (2), 59. 423, 1835; G. Harker, *Journ. Roy. Soc. New South Wales*, 54. 218, 1920; J. Sakurai, *Journ. Chem. Soc.*, 61. 495, 1892; G. J. Mulder, *Scheikund. Verh. Rotterdam*, 116, 1864.

²² L. C. de Coppet, *Ann. Chim. Phys.*, (4), 24. 519, 1871; A. Ponsot, *ib.*, (7), 10. 71, 1897; E. H. Loomis, *Wied. Ann.*, 60. 523, 1897; F. Rüdorff, *Pogg. Ann.*, 114. 63, 1861; C. Despretz, *Compt. Rend.*, 5. 19, 1837; S. U. Pickering, *Ber.*, 25. 1590, 1892; 26. 2766, 1893; 27. 1385, 1894; H. C. Jones and F. H. Getman, *Zeit. phys. Chem.*, 46. 244, 1903; 49. 385, 1904; S. Arrhenius, *ib.*, 2. 490, 1888; H. W. B. Roozeboom, *ib.*, 4. 31, 1889; H. Hammerl, *Sitzber. Akad. Wien*, 78. 59, 1879; H. C. Jones and J. N. Pearce, *Amer. Chem. Journ.*, 38. 695, 1907; H. C. Jones and V. J. Chambers, *ib.*, 23. 89, 1900.

²³ H. W. B. Roozeboom, *Zeit. phys. Chem.*, 4. 31, 1889; L. C. de Coppet, *ib.*, 22. 239, 1897; F. Guthrie, *Phil. Mag.*, (4), 49. 1, 206, 266, 1875; (5), 1. 49, 1876; F. Rüdorff, *Pogg. Ann.*, 122. 337, 1864; H. Hammerl, *Sitzber. Akad. Wien*, 78. 59, 1879.

²⁴ H. Lescœur, *Ann. Chim. Phys.*, (7), 2. 78, 1894; A. Ditte, *ib.*, (5), 22. 559, 1881; A. Étard, *ib.*, (7), 2. 535, 1894; R. Engel, *ib.*, (6), 13. 371, 1888; *Compt. Rend.*, 104. 434, 1887; *Bull. Soc. Chim.*, (2), 47. 316, 1887; G. J. Mulder, *Bijdragen tot de geschiedenis van het Scheikundig gebonden Water*, Rotterdam, 1864; F. Rüdorff, *Ber.*, 18. 1611, 1885; H. Precht and B. Wittjen, *ib.*, 14. 1667, 1881; H. W. Foote, *Amer. Chem. Journ.*, 32. 253, 1904; H. W. Foote and H. S. Bristol, *ib.*, 32. 248, 1904; C. J. B. Karsten, *Philosophie der Chemie*, Berlin, 1843; P. N. Evans, *Chem. News*, 86. 4, 1902; S. Schlesinger, *Repert. Pharm.*, 85. 74, 1844; H. Kopp, *Liebig's Ann.*, 34. 267, 1840; R. W. Pearson, *Zeit. Chem.*, (2), 5. 662, 1869; F. W. Mar, *Amer. Journ. Science*, (3), 43. 521, 1892.

²⁵ E. Bödtker, *Zeit. phys. Chem.*, 22. 505, 1897; C. A. L. de Bruyn, *ib.*, 10. 783, 1892; A. Schlamp, *ib.*, 14. 272, 1894; A. Gerardin, *Ann. Chim. Phys.*, (4), 5. 156, 1865; H. Schiff, *Liebig's Ann.*, 118. 365, 1861; P. Einbrodt, *ib.*, 65. 115, 1848; E. Linnemann, 136. 38, 1865; P. Rohland, *Zeit. anorg. Chem.*, 15. 412, 1897; T. Graham, *Phil. Mag.*, (3), 4. 265, 331, 1828; R. Kane, *ib.*, (3), 7. 397, 1847; A. Chodnew, *Bull. Acad. St. Petersburg*, 8. 150, 1841; J. B. Heindl, *Monatsh.*, 2. 200, 1881; S. W. Johnson, *Journ. prakt. Chem.*, (1), 62. 264, 1854; B. Völlmer, *Die molekulare elektrische Leitfähigkeit von einigen alkoholischen Lösungen*, Halle a. S., 1892; J. Wölfer, *Ueber die Erhöhung des Siedepunktes von absolutem Alkohol durch Lösung einiger Salze*, Halle a. S., 1894; W. Eidmann, *Ein Beitrag zur Erkenntnis des Verhaltens chemischer Verbindungen in nichtwässrigen Lösungen*, Giessen, 1899; L. Cailletet, *Compt. Rend.*, 75. 1271, 1872; A. Lieben, *Anz. Akad. Wien*, 251, 1880; R. Fresenius, *Liebig's Ann.*, 59. 117, 1846; A. Köhler, *Z. i. Ver. Zuckerind.*, 47. 447, 1897; L. Kahlenberg and F. C. Krauskopf, *Journ. Amer. Chem. Soc.*, 30. 1104, 1908; P. B. Davis, W. S. Putman, and H. C. Jones, *Journ. Franklin Inst.*, 180. 567, 1915.

²⁶ A. des Cloizeaux, *Ann. Mines*, (5), 14. 363, 1858; V. S. M. van der Willigen, *Arch. Musée Teyler*, 2. 153, 1889; H. C. Jones and F. H. Getman, *Zeit. phys. Chem.*, 49. 385, 1904; J. H. Gladstone, *Journ. Chem. Soc.*, 59. 590, 1891; G. J. W. Bremer, *Arch. Neerl.*, (2), 5. 202, 1900; P. Barbier and L. Roux, *Bull. Soc. Chim.*, (3), 3. 255, 419, 424, 1890; (3), 4. 9, 614, 620, 1890.

²⁷ A. G. Hankel and H. Lindenberg, *Abh. Ges. Wiss. Leipzig*, 21. 17, 1894; H. Jahn, *Wied. Ann.*, 43. 280, 1891; P. Bary, *Compt. Rend.*, 130. 776, 1900.

²⁸ J. A. W. Borchers and L. Stockem, *Zeit. Elektrochem.*, 8. 759, 1902; A. Guntz and H. Basset, *Bull. Soc. Chim.*, (3), 35. 404, 1906; A. Guntz, *ib.*, (3), 29. 490, 1903; *Compt. Rend.*, 136. 749, 1903; *Ann. Chim. Phys.*, (8), 4. 5, 1905; F. Haber and S. Tolloczko, *Zeit. anorg. Chem.*, 41. 407, 1904.

²⁹ K. Arndt, *Zeit. Elektrochem.*, 12. 377, 1906; K. Arndt and A. Gessler, *ib.*, 14. 665, 1908; K. Arndt and K. Willner, *ib.*, 14. 216, 1908; *Ber.*, 40. 3025, 1907; W. Hampe, *Chem. Ztg.*, 11. 816, 846, 904, 934, 1109, 1158, 1549, 1887; A. Bogorodsky, *Journ. Russ. Phys. Chem. Soc.*, 37. 760, 1905.

³⁰ F. Förster and E. Müller, *Zeit. Elektrochem.*, 9, 271, 1903; F. Förster, *ib.*, 4, 464, 1898; F. Oettel, *ib.*, 1, 480, 1894; 5, 1, 1899; S. A. Tucker and H. R. Moody, *Journ. Soc. Chem. Ind.*, 19, 977, 1900.

³¹ J. G. MacGregor, *Wied. Ann.*, 51, 132, 1894; A. C. MacGregory and F. Kohlrausch, *ib.*, 26, 178, 1885; F. Kohlrausch and O. Grotrian, *Pogg. Ann.*, 154, 1, 215, 1875; J. Trötsch, *Wied. Ann.*, 41, 259, 1890; H. C. Jones, *The Electrical Conductivity Dissociation, and Temperature Coefficients of Conductivity of Aqueous Solutions of a Number of Salts and Organic Acids*, Washington, 1912; H. C. Jones and V. J. Chambers, *Amer. Chem. Journ.*, 23, 89, 1900; H. C. Jones and F. H. Getman, *Zeit. phys. Chem.*, 49, 385, 1904; S. Arrhenius, *ib.*, 9, 430, 1892; W. C. D. Whetham, *Phil. Trans.*, 184, 337, 1893; 186, 507, 1895; L. Kahlenberg, *Proc. Roy. Soc.*, 71, 332, 1903; H. C. Jones and A. P. West, *Amer. Chem. Journ.*, 34, 357, 1906; H. C. Jones, *ib.*, 35, 445, 1906; P. B. Davis, W. S. Putman, and H. C. Jones, *Journ. Franklin Inst.*, 180, 567, 1915; C. Heim, *Wied. Ann.*, 27, 643, 1886; F. Kohlrausch, *Sitzber. Akad. Berlin*, 1026, 1901; S. Lussana, *Nuovo Cimento*, (4), 5, 357, 1897; S. Arrhenius, *Recherches sur la conductibilité galvanique des électrolytes*, Stockholm, 1883; *B.A. Rep.*, 357, 1886; G. Kümmel, *Zeit. Elektrochem.*, 11, 94, 1905; J. Drucker, *ib.*, 11, 94, 1905; E. MacKay, *Trans. Nova Scotia Inst.*, 9, 321, 1898; O. Gropp, *Der Einfluss der Temperatur auf die elektrische Leitfähigkeit einiger flüssigen und festen Salzlösungen in Wasser*, Rostock, 1915; S. von Laszcynsky and S. von Gorsky, *Zeit. Elektrochem.*, 4, 290, 1897; J. C. Ghosh, *Journ. Chem. Soc.*, 117, 1390, 1920; G. N. Lewis and G. A. Linhart, *Journ. Amer. Chem. Soc.*, 41, 1951, 1919; G. N. Lewis and M. Randall, *ib.*, 43, 1112, 1921; G. Dickhaus, *Einfluss der Temperatur auf die Leitfähigkeit von Elektrolyten in wässriger Lösung*, Bonn, 1912; A. Schlamp, *Zeit. phys. Chem.*, 14, 272, 1894; A. B. Bryan, *Phys. Rev.*, (2), 18, 275, 1921.

³² W. Hittorf, *Pogg. Ann.*, 108, 1, 1856; *Ann. Physik*, (4), 9, 243, 1902; A. Weiske, *ib.*, 113, 474, 1859; W. Bein, *Wied. Ann.*, 46, 29, 1892; *Zeit. phys. Chem.*, 27, 1, 1898; 28, 439, 1898; B. D. Steele, *ib.*, 40, 589, 1902; R. Abegg and W. Gaus, *ib.*, 40, 742, 1902; R. B. Denison, *ib.*, 44, 575, 1903; K. Hopfgartner, *ib.*, 25, 115, 1898; A. A. Noyes, *ib.*, 36, 74, 1901; B. D. Steele and R. B. Denison, *Journ. Chem. Soc.*, 81, 456, 1902; O. J. Lodge, *B.A. Rep.*, 389, 1886; T. Descoudres, *Wied. Ann.*, 57, 232, 1896; A. Chassy, *Ann. Chim. Phys.*, (6), 21, 241, 1890; W. C. D. Whetham, *Proc. Roy. Soc.*, 52, 284, 1892; *Phil. Trans.*, 184, A, 337, 1892; 186, A, 507, 1895; *Phil. Mag.*, (5), 38, 392, 1894; B. D. Steele, *Phil. Trans.*, 198, A, 105, 1902; H. Jahn, *Zeit. phys. Chem.*, 37, 673, 1901; 38, 127, 1901; A. Heydweiller, *Zeit. Physik*, 3, 310, 1920.

³³ H. Schulze, *Journ. prakt. Chem.*, (2), 21, 407, 1880; O. L. Erdmann, *ib.*, (1), 13, 424, 1838; H. Hess, *ib.*, (1), 13, 406, 1838; G. P. A. Petzholdt, *ib.*, (1), 17, 464, 1839; E. Beckmann, *ib.*, (2), 27, 142, 1883; H. Kunheim, *Ueber Einwirkung des Wasserdampfes auf Chlormetalle bei hoher Temperatur*, Göttingen, 1861; F. Ullik, *Anz. Akad. Wien*, 5, 111, 1868; E. Kraus, *Pogg. Ann.*, 43, 140, 1838; J. W. Döbereiner, *ib.*, 15, 240, 1829; M. Prud'homme and E. Binder, *Bull. Soc. Chim.*, (2), 37, 194, 1882; S. U. Pickering, *Chem. News*, 46, 223, 1882; M. M. P. Muir, *ib.*, 35, 229, 1877; J. C. G. de Marignac, *Liebig's Ann.*, 106, 165, 1858; W. T. O. Casselmann, *ib.*, 98, 213, 1856; L. Smith, *ib.*, 159, 84, 1871; E. L. Salkowsky, *ib.*, 173, 62, 1874; H. Rose, *ib.*, 19, 187, 1836; J. B. A. Dumas, *Ann. Chim. Phys.*, (3), 55, 137, 1859; M. Berthelot, *ib.*, (5), 29, 343, 1883; P. Berthier, *ib.*, (2), 43, 303, 1830; J. Piccard, *Schweiz. Polyt. Zeit.*, 11, 83, 1866; A. Rosensthiel, *Bull. Soc. Mulhouse*, 40, 134, 1870; T. W. Richards, *Journ. Amer. Chem. Soc.*, 24, 374, 1902; H. A. von Vogel, *Journ. Pharm. Chim.*, (2), 5, 61, 1819; J. Bevad, *Journ. Russ. Phys. Chem. Soc.*, 17, 89, 1885; C. J. B. Karsten, *Lehrbuch der Salinenkunde*, Berlin, 2, 274, 1847; T. J. Pelouze, *Compt. Rend.*, 52, 1267, 1861; A. Gorgeu, *ib.*, 90, 256, 1884; H. Caron, *ib.*, 48, 440, 1859; 50, 547, 1859; M. Berthelot, *ib.*, 100, 761, 1885; F. Haber and S. Tolloczko, *Zeit. anorg. Chem.*, 41, 407, 1904; B. Zahorsky, *ib.*, 3, 34, 1893; H. Schulz, *Pflüger's Archiv*, 27, 454, 1882; A. Potilitzin, *Ber.*, 7, 733, 1874; 8, 766, 1875; 9, 1025, 1876; 12, 2368, 1879; 15, 918, 1882; 17, 1308, 1884; V. Merz and W. Weith, *ib.*, 13, 718, 1880; K. Arndt, *ib.*, 40, 427, 1907; J. Post, *ib.*, 13, 53, 1880; W. L. Goodwin, *ib.*, 15, 3039, 1882; *Trans. Roy. Soc. Edin.*, 30, 587, 1882; S. Chumanoff, *Zeit. Koll.*, 10, 248, 1912; W. A. Burdakoff, *Journ. Russ. Phys. Chem. Soc.*, 44, 1325, 1912; K. Kaiser, *German Pat., R.D.P.* 333305, 1920; C. Göpner, *Dingler's Journ.*, 209, 204, 1873; E. Solvay, *ib.*, 255, 307, 1885; G. Lunge, *ib.*, 243, 157, 1882; A. Tixier, *Monit. Scient.*, (4), 14, 218, 1900; G. Borsche and F. Brünjes, *Brit. Pat.* 7046, 1888; H. Moissan, *Le fluor et ses composés*, Paris, 1900.

³⁴ J. J. Berzelius, *Pogg. Ann.*, 1, 20, 1824; H. Rose, *ib.*, 20, 154, 1830; T. Weyl, *ib.*, 123, 362, 1864; A. Lamy, *Compt. Rend.*, 10, 393, 1870; C. Antoine, *Compt. Rend.*, 107, 681, 1778, 836, 1888; F. Isambert, *ib.*, 66, 1259, 1868; 86, 968, 1878; A. Joannis, *ib.*, 112, 339, 1891; C. Matignon, *ib.*, 128, 103, 1899; A. F. Weinhold, *Program. Gewerbeschule Chemnitz*, 34, 1873; M. Faraday, *Quart. Journ. Science*, 5, 74, 1818; R. O. E. Davis, L. B. Olmstead, and F. O. Lundstrum, *Journ. Amer. Chem. Soc.*, 43, 1580, 1921.

³⁵ L. Crismer, *Bull. Soc. Chim.*, (3), 3, 119, 1890; G. N. Antonoff, *Journ. Russian Phys. Chem. Soc.*, 37, 479, 1905.

³⁶ F. A. H. Schreinemakers and W. C. de Baat, *Chem. Weekbl.*, 5, 801, 847, 1908; *Proc. Acad. Amsterdam*, 15, 467, 1913.

³⁷ C. L. Berthollet, *Essai de statique chimique*, Paris, 1803; H. Rose, *Pogg. Ann.*, 93, 612, 1854; *Schweigger's Journ.*, 29, 155, 1820; B. Zahorsky, *Zeit. anorg. Chem.*, 3, 34, 1893; G. André, *Compt. Rend.*, 92, 1453, 1881; 93, 58, 1881; 98, 572, 1884; *Ann. Chim. Phys.*, (6), 3, 68, 1884;

E. Tassily, *ib.*, (7), 17. 53, 1899; *Compt. Rend.*, 122. 812, 1897; A. Ditte, *ib.*, 91. 576, 1880; H. Grimshaw, *Chem. News*, 30. 280, 1875; T. Beesley, *Pharm. Journ.*, 9. 568, 1850; E. Beckmann, *Journ. prakt. Chem.*, (2), 27. 126, 1883; P. A. Bolley, *Chem. Centrbl.*, 601, 1859; F. A. H. Schreinemakers and T. Figeé, *Chem. Weekbl.*, 8. 683, 1911; F. A. H. Schreinemakers and J. Milikan, *Proc. Acad. Amsterdam*, 15. 52, 1912; *Zeit. phys. Chem.*, 68. 88, 1909; J. Milikan, *ib.*, 92. 59, 496, 1918; C. F. Buchholz, *Gehlen's Journ.*, 4. 128, 1897; J. B. Trommsdorff, *Trommsdorff's Journ.*, 3. 106, 1796; *Ann. Chim. Phys.*, (1), 22. 218, 1797.

⁸⁸ E. Defacqz, *Compt. Rend.*, 138. 197, 1904; *Ann. Chim. Phys.*, (8), 1. 333, 1904; W. Plato, *Zeit. phys. Chem.*, 58. 350, 1907; O. Ruff and W. Plato, *Ber.*, 36. 2357, 1903.

⁸⁹ O. Menge, *Zeit. anorg. Chem.*, 72. 162, 1911; O. Ruff and W. Plato, *Ber.*, 36. 2357, 1903; H. Gemsky, *Kristallographische und thermische Untersuchung des ternären Systems Bariumchlorid—Kaliumchlorid—Natriumchlorid*, Berlin, 1913; *Neues Jahrb. Min. B.B.*, 36. 513, 1913; E. Vortisch, *Centr. Min.*, 293, 1919; *Neues Jahrb. Min. B.B.*, 38. 513, 1914; K. Scholich, *ib.*, 43. 251, 1920; E. Jänecke, *ib.*, 38. 501, 1914; *Centr. Min.*, 271, 1919; F. A. H. Schreinemakers and W. C. de Baat, *Chem. Weekbl.*, 5. 801, 847, 1908; *Proc. Acad. Amsterdam*, 15. 467, 1913; W. Moldenhauer and J. Andersen, *Zeit. Elektrochem.*, 19. 444, 1913; E. Chauvnet, P. Job, and G. Urbain, *Compt. Rend.*, 171. 855, 1920; A. E. Stearn and G. McP. Smith, *Journ. Amer. Chem. Soc.*, 42. 18, 1920; G. McP. Smith, A. E. Stearn, and R. F. Schneider, *ib.*, 42. 32, 1920; L. S. Wells and G. McP. Smith, *ib.*, 42. 185, 1920; G. McP. Smith and E. A. Rees, *ib.*, 40. 1802, 1918; T. Liebisch and E. Korreng, *Sitzber. Akad. Berlin*, 192, 1914; T. Liebisch and E. Vortisch, *ib.*, 426, 1920; F. E. E. Lamplough, *Proc. Cambridge Phil. Soc.*, 16. 193, 1911; G. S. Jamieson, *Amer. Journ. Science*, (4), 43. 67, 1917; C. Sandonini, *Gazz. Chim. Ital.*, 50. i, 289, 1920; *Atti Accad. Lincei*, (5), 20. ii, 496, 646, 1911; (5), 22. i, 629, 1913; H. le Chatelier, *Ann. Mines*, (9), 11. 131, 1897; *Compt. Rend.*, 118. 712, 1897; A. Guntz, *ib.*, 136. 749, 1903; *Bull. Soc. Chim.*, (3), 29. 490, 1903; *Ann. Chim. Phys.*, (8), 4. 5, 1905; A. C. Becquerel, *ib.*, (2), 41. 33, 1829; G. S. Forbes, *Journ. Amer. Chem. Soc.*, 33. 1937, 1911; E. H. Ducloux, *Anal. Assoc. Quim. Argentina*, 9. 215, 1921; H. Gemsky, *Neues Jahrb. Min. B.B.*, 36. 513, 1913; W. Schäfer, *ib.*, 43. 132, 1919; *Neues Jahrb. Min.*, i, 15, 1914.

§ 13. Calcium, Strontium, and Barium Bromides

According to A. J. Balard (1826),¹ calcium bromide is formed when bromine acts on red-hot calcium oxide or carbonate, and a little is formed when the bromine acts on heated calcium chloride. C. Löwig made it by the action of hydrobromic acid on calcium oxide; C. Wendler, by the action of bromine on calcium sulphite; C. Klein, by the action of 200 parts of bromine, 16 parts of phosphorus, and 75 parts of calcium oxide; O. Henry, by the action of bromine on lime in the presence of metallic iron, or of ferrous bromide on the hydroxide or carbonate; J. S. Stas and G. Macdonald made it by mixing bromine with ammoniacal milk of lime, or ammonium bromide with calcium carbonate; and A. Faust, by the action of sulphur bromide on milk of lime: $5\text{Br}_2 + 4\text{CaO} = 3\text{CaBr}_2 + \text{CaSO}_4$. According to M. Henner and J. Hohenhauser, if bromine is allowed to act on an aq. soln. with an excess of the hydroxide of the alkaline earth, a mixture of the bromide and bromate is formed. The latter can be separated by crystallization, or by adding 90 per cent. alcohol. The alcohol can be distilled from the filtrate, and the bromide obtained; the bromate can be converted into bromide by calcination with charcoal, and leaching the product with water. The corresponding salts of barium and strontium are prepared in a similar manner. The hexahydrated bromides separate from aq. soln.—the barium dihydrated salt is formed as in the case of the corresponding chloride. The anhydrous salts are obtained by heating the hydrated salt, or by the calcination of the bromate. A. J. Balard prepared barium bromide by the action of hydrobromic acid on barium hydroxide or carbonate; C. Löwig, on barium sulphide. T. W. Richards in his work on the at. wt. of barium prepared barium bromide by the action of purified hydrobromic acid on the carbonate; by the decomposition of barium bromate; by the action of bromine on the hydroxide prepared by the action of potassium oxide on the nitrate, and by the ignition of the nitrate. The chief difficulty was to obtain the barium salt free from strontium and calcium.

Barium hydroxide was prepared by treating purified barium nitrate with purified potassium hydroxide, and recrystallizing several times from hot water. In order to remove potassium salts, the hydroxide was precipitated from its aq. soln. by purified alcohol, and the precipitate washed with alcohol by suction. The barium hydroxide was boiled in a platinum vessel for some time to remove the alcohol, and sat. with bromine in a Bohemian glass flask. The large amount of bromide filtered off from the bromate was half crystallized out by boiling down the mother liquor in a platinum dish, treating with alcohol, and cooling. The mother liquor from these crystals contained most of the strontium. The solid was dissolved, boiled down, treated with alcohol, and cooled: and the new crystals were washed four times with alcohol. After repeating this round of operations once again, the mother liquor showed no trace of strontium. The pure crystals yielded a faintly brownish mass upon fusion, and this in turn left a brownish precipitate upon soln. The clear filtered liquid was boiled down and treated with alcohol just as described above. The crystals were again fused, and again subjected to the same succession of operations. For the last time the crystals were raised to a dull heat by means of a spirit lamp, and the residue was dissolved in the purest water in a platinum dish, allowed to stand exposed to the air until neutral, filtered, recrystallized twice more, and washed with the purest alcohol.

Similar remarks apply to the preparation of strontium bromide free from barium and calcium in T. W. Richards' work on the at. wt. of strontium.

A soln. of 500 grms. of strontium nitrate in 2 litres of water was treated four times in succession with a cubic centimetre of dil. sulphuric acid, and in each case, after standing 4 days, the clear liquid was decanted. The liquid was evaporated to a small bulk, filtered from the precipitated sulphate, and twice recrystallized. Each lot of crystals was washed three times with alcohol by suction. The nitrate was treated with ammonium carbonate, and the washed precipitate of strontium carbonate was treated with purified hydrobromic acid. The strontium bromide was evaporated in a platinum dish. This was slightly attacked, bromine having been set free by a little occluded strontium nitrate in the carbonate. After evaporation to dryness the bromide was fused at a bright red heat in platinum. The alkaline soln. of the fused cake was treated with hydrogen sulphide, filtered, acidified with hydrobromic acid, warmed, filtered from the platinum sulphide, boiled to free it from sulphuretted hydrogen, again filtered, and crystallized twice from water.

The properties of the bromides of the alkaline earths.—Hexahydrated calcium bromide forms silky needle-like crystals, likewise also the corresponding strontium salt which, according to O. Mügge,² belong to the hexagonal system. The latter also stated that the crystals of dihydrated barium bromide are monoclinic prismatic crystals with axial ratios $a : b : c = 1.4494 : 1 : 1.1656$, and $\beta = 113^\circ 29\frac{1}{2}'$, and isomorphous with the corresponding chloride, $\text{BaCl}_2 \cdot 2\text{H}_2\text{O}$. J. Herbetie studied mixed crystals of barium chloride and bromide. There are the monoclinic crystals resembling the chloride, studied by G. Wyrouboff, and O. Mügge: $a : b : c = 0.1676 : 1 : 0.6548$, and $\beta = 88^\circ 55'$; the monoclinic crystals resembling the bromide studied by O. Mügge, and H. Dufet: $a : b : c = 1.44943 : 1 : 1.6559$, and $\beta = 66^\circ 30'$; and another form studied by J. Herbetie: $a : b : c = 1.17104 : 1 : 1.6240$, and $\beta = 89^\circ 50'$. T. W. Richards and V. Yngve found evidence of the existence of dihydrated strontium bromide, and they gave 88.62° for the transition temp., $\text{SrBr}_2 \cdot 6\text{H}_2\text{O} \rightarrow \text{SrBr}_2 \cdot 2\text{H}_2\text{O} + 4\text{H}_2\text{O}$. O. Mügge said that crystals of pentahydrated strontium bromide, $\text{SrBr}_2 \cdot 5\text{H}_2\text{O}$, resemble those of hexahydrated barium iodide, and have the axial ratio $a : c = 1 : 0.515$. The **specific gravity** of anhydrous calcium bromide is 3.32 (11°), according to C. H. D. Bödeker³; and 3.4 (20°), according to O. Ruff and W. Plato, for anhydrous strontium bromide. C. H. D. Bödeker gives 3.962 (12°); T. W. Richards, 4.216 (24°); and P. A. Favre and C. A. Valson, 3.985 (20.5°); and for anhydrous barium bromide, H. Schiff gave 4.23 and T. W. Richards 4.781 (24°). The best representative values for the sp. gr. of calcium, strontium, and barium bromides are given by W. Biltz as 3.956, 4.549, and 5.150 respectively, and the mol. vol. 74.29, 75.07, and 75.96 respectively. For hexahydrated strontium bromide, P. A. Favre and C. A. Valson give 2.358 (18°); and for dihydrated barium bromide, H. Schiff gives 3.690; H. G. F. Schröder, 3.710; F. W. Clark, 3.679 (24.3°); and J. W. Retgers, 3.827 (20°).

The reported numbers for the **melting point** of calcium bromide vary from W. Ramsay and N. Eumorfopoulos' 485° ,⁴ which is very much too low, to O. Ruff

and W. Plato's 760°. G. Kellner gave 730°, and T. Carnelley, 676°–680°. For the m.p. of strontium bromide there is W. Ramsay and N. Eumorfopoulos' very low value 498°; G. Kellner's 643°; and T. Carnelley's 630°. For barium bromide, W. Ramsay and N. Eumorfopoulos gave the very low value 728°; O. Ruff and W. Plato, 880°; T. Carnelley, $812 \pm 3^\circ$; and G. Kellner, 847°. E. Lubarsky's value for the m.p. of hexahydrated calcium bromide is 38.2° ; and C. O. Curtmann's for trihydrated calcium bromide, 80° – 81° .

According to J. Thomsen,⁵ the heat of formation (Ca, Br₂) is 141.25 Cals.; (Sr, Br₂), 157.7 Cals.; and (Ba, Br₂), 169.46 Cals. M. Berthelot's values are: (Ca, Br₂(liquid)), 151.6 Cals.; (Sr, Br₂), 168 Cals.; and (Ba, Br₂), 172.4 Cals. J. Thomsen also gives (Ca, Br₂, 6H₂O), 166.85 Cals.; (Sr, Br₂, 6H₂O), 181.01 Cals.; and (Ba, Br₂, 2H₂O), 178.57 Cals.; (CaBr₂, aq.), 24.51 Cals.; (SrBr₂, aq.), 16.11 Cals.; and (BaBr₂, aq.), 4.98 Cals.; (Ca, Br₂, aq.), 165.76 Cals.; (Sr, Br₂, aq.), 173.81 Cals.; and (Ba, Br₂, aq.), 174.44 Cals.; (CaBr₂, 6H₂O), 26.60 Cals.; (SrBr₂, 6H₂O), 23.31 Cals.; and (BaBr₂, 2H₂O), 9.11 Cals.

The heat of solution of CaBr₂.6H₂O, 400 mols of water is, –1.09 Cals.; for SrBr₂.6H₂O, –7.2 Cals.; and for BaBr₂.2H₂O, –4.13 Cals. S. U. Pickering gives the heat of soln. of CaBr₂ in water, 23.293 Cals., and in alcohol, 2.1471 Cals. J. Thomsen also gives for the heat of soln. of strontium bromide associated with different amounts of water, SrBr₂ + nH₂O, in 400 mols of water at 18°, n=0, 16.11 Cals.; n=1, 9.96 Cals.; n=2, 6.16 Cals.; n=3, 3.06 Cals.; n=4, –0.04 Cals.; n=5, –3.20 Cals.; and n=6, –7.20 Cals.

P. Kremers' values for the solubility of the bromides of the alkaline earths⁶ in grams of MCl₂ per 100 grms. of soln. are:

	0°	10°	20°	25°	40°	60°	80°	100°
CaBr ₂	55.5	57.0	58.8	60.5	68.1	73.5	74.7	75.7 (105°)
SrBr ₂	46.0	48.3	50.6	51.7	55.2	60.0	64.5	69.0
BaBr ₂	49.5	50.2	51.0	52.1	53.2	55.1	57.4	60.0

A. Étard gives for calcium bromide at 22°, the solubility 50.5; at –7°, 52.6; and for barium bromide at –20°, A. Étard gives 45.6; and at 145°, 60.5; at 160°, 59.4; and at 175°, 60.3. A. Étard's values for calcium bromide are considered to be less accurate than those of P. Kremers; the solubility curve travels in a straight line to 50°; there are two breaks in the curve between 50° and 70°, which A. Étard attributes to the formation of two hydrates; and from 70° to 170°, the curve again travels in a straight line. The values for strontium bromide are averaged from those of P. Kremers and A. Étard. W. D. Harkins measured the solubility of strontium bromide in water and in soln. of strontium nitrate at 25°. They found that strontium bromide dissolves in water to the extent of 1066.2 grms. per 1000 grms. of water at 25°, and the soln. has a sp. gr. 1.7002 at 25°/4°. The following values have been obtained for the solubility of strontium bromide in grams per 1000 grms. of water in soln. of the following mol. conc. of strontium nitrate, and the soln. have the appended sp. gr.:

Solubility SrBr ₂	1066.2	1066.95	1067.42	1068.54	1068.9	1069.17	1073.97
Conc. Sr(NO ₃) ₂	0.0000	0.0360	0.07216	0.14568	0.3066	0.61124	1.8610
Sp. gr. 25°/4°	1.7002	—	1.70325	1.72844	1.73766	1.74866	1.77368

A. Étard's values for barium bromide are rather lower than those of P. Kremers. A. Étard found a maximum between 104° and 160°, and since the heat of soln. does not here change its sign, it is assumed that the maximum—if not a mal-observation—has the same character as that with hexahydrated calcium chloride at 29.9°. A. Étard found the solubility of barium bromide is reduced by salts of barium or soluble bromides. Aq. soln. of calcium and strontium bromides, at ordinary temp., furnish crystals of the hexahydrated salts; barium bromide forms dihydrated barium bromide. J. L. Kreider⁷ heated dihydrated barium bromide at different temp. for half an hour in a stream of dry air, and also in a current of hydrogen bromide, and the loss of hydrogen bromide and of water was determined

in each case. There was no appreciable difference in the results by the two sets of experiments, and he infers that the two mols of water are similarly associated in the mol., and he gives the graphic formula :

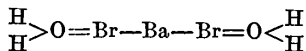

which may be compared with those for magnesium and hexahydrated aluminium bromides.

According to C. O. Curtmann, when hexahydrated calcium bromide is dehydrated, **trihydrated calcium bromide**, $\text{CaBr}_2 \cdot 3\text{H}_2\text{O}$, is formed which melts between 80° and 81° ; and at 180° is said to form $\text{CaBr}_2 \cdot 2.5\text{H}_2\text{O}$, which is probably not a true compound. If freshly dehydrated calcium bromide be dissolved in absolute alcohol, the soln. becomes hot, and, after filtering off the calcium oxide, X. Roques found the syrupy liquid furnished rhombic plates of $\text{CaBr}_2 \cdot 3\text{H}_2\text{O}$, which are very deliquescent; and which, if hot soln. are used, may contain a little ethyl bromide, $\text{C}_2\text{H}_5\text{Br}$. The **specific gravities** of soln. of calcium bromide have been determined by D. I. Mendeléeff, and G. T. Gerlach. P. Kremer's observations at 19.5° furnish :

Per cent. salt	5	10	20	30	40	50	55
Sp. gr. CaBr_2	1.044	1.089	1.194	1.315	1.461	1.641	—
Sp. gr. SrBr_2	1.046	1.094	1.204	1.332	1.492	1.694	—
Sp. gr. BaBr_2	1.045	1.092	1.201	1.329	1.485	1.685	1.800

H. C. Jones and F. H. Getman also determined the sp. gr. of soln. of calcium bromide at 25° (water at 4° unity). The sp. gr. of the sat. soln. of calcium bromide at 20° is 1.82; of strontium bromide, 1.70 (20°); and of barium bromide, 1.71 (20°). P. Kremers also measured the changes in volume of soln. of these salts; and L. C. de Coppet, the effect of calcium and barium bromides on the temp. of maximum density—the lowering of the temp. is proportional to the conc. for the temp. with 0.0403 and 0.1631 mols of the salt per litre are respectively 2.969° and -0.304° ; and $d\theta/dM=25.14$ and 26.28 respectively.

The **lowering of the vapour pressures** of soln. of calcium, strontium, and barium bromide were determined by G. Tammann,⁸ and W. Biltz. The quotient $(p_0-p)/C$ rises with increasing conc. and falls with rise of temp. H. Lesœur's value for the vap. press. of hexahydrated strontium bromide at 20° is 9.1 mm. W. Pieper measured the vap. press. of aq. and alcoholic soln. of calcium bromide. H. C. Jones and V. J. Chambers⁹ measured the **lowering of the freezing point** of soln. of calcium chloride, and they found for calcium bromide :

Gram-mols/litre, C	0.04355	0.08710	0.13065	0.17422	0.2613	0.5226
Lowering f.p., dt	0.228°	0.445°	0.664°	0.904°	1.368°	2.049°
dt/C	5.24	5.11	5.07	5.18	5.23	5.64

Hence the mol. lowering first decreases continuously with increasing conc. to 0.13065 mol per litre, and in more conc. soln., as with the lowering of the vap. press., increases more rapidly than would occur if ionization alone were in question. The halides of the alkaline earths all show a similar behaviour, and W. Biltz has shown that the phenomenon is more pronounced in passing from barium to strontium and to calcium, and from chlorides to bromides to iodides.

The **refraction equivalents** of 42.36 to 43.50 per cent. soln. of calcium bromide for the A -line were found by J. H. Gladstone¹⁰ to be in accord with the $(n-1)/D$ formula. H. C. Jones and F. H. Getman also determined the index of refraction of soln. of calcium bromide. The **index of refraction** rises from 1.34106 to 1.42339 for soln. with 0.542 to 3.011 mols per litre when the sp. gr. rises from 1.07535 to 1.48093. P. Barbier and L. Roux have measured the dispersion of these soln. According to H. Jahn, the mol. **electromagnetic rotation** of the plane of polarization of soln. of calcium bromide is 17.605 (water unity); strontium bromide, 18.163 ; barium bromide, 18.54 . C. Sheard and C. S. Morris found the **emission spectrum** of calcium bromide had a band between 5500 and 4850.

According to W. Hampe,¹¹ molten strontium bromide is a good conductor of electricity. H. C. Jones and V. J. Chambers found the deductions from the mol. **electrical conductivity** of soln. of the bromides of the alkaline earths agreed with the conclusions obtained with the lowering of the f.p. of soln. of the bromides of the alkaline earths. H. C. Jones and co-workers' values for the mol. conductivity, μ , and the percentage **degree of ionization**, α , of soln. with a mol of the salt in v litres, are :

v	2	8	32	128	512	2048	
CaBr_2	μ_0°	85.95	97.74	108.2	117.3	122.9	126.8
	μ_{65°	262.05	339.40	391.68	431.83	458.67	487.30
	α_0°	67.7	77.1	85.3	92.5	96.9	100.0
	α_{65°	53.8	69.6	70.4	88.6	94.1	100.0
SrBr_2	μ_0°	88.03	100.0	110.0	171.8	128.8	—
	μ_{65°	—	343.7	338.7	437.6	470.1	501.0
	α_0°	68.2	77.5	85.2	91.2	99.8	—
	α_{65°	—	68.6	77.6	87.3	93.8	100.0
BaBr_2	μ_0°	91.81	103.4	114.4	123.6	131.8	134.2
	μ_{65°	—	340.1	392.8	439.2	467.6	484.6
	α_0°	68.4	77.1	85.3	92.1	98.2	100.0
	α_{65°	—	68.4	79.0	83.3	94.0	97.4

H. C. Jones and A. P. West have measured the temp. coeff. of the conductivities of soln. of these salts ; H. C. Jones and H. P. Bassett also investigated the formation of hydrates in conc. soln. from the conductivities, the lowering of the f.p., and the sp. gr. of those soln. G. Dickhaus measured the effect of temp. on the conductivity of soln. of calcium bromide. A. Heydweiller found the **dielectric constant** of dihydrated barium bromide to be 4.25 for $\lambda=478$ cms.

Anhydrous calcium bromide is soluble in **alcohol**, and X. Roques¹² found the soln. furnishes rhombic hygroscopic crystals of the compound, $\text{CaBr}_2 \cdot 3\text{C}_2\text{H}_5\text{OH}$. H. Fonzes-Diacon found that 64.5 grms. of anhydrous strontium chloride dissolve in 100 grms. of absolute alcohol, and the soln., at 0° , has the sp. gr. 1.210. Rhombic prismatic crystals of a compound, $\text{SrBr}_2 \cdot 2\frac{1}{2}\text{C}_2\text{H}_5\text{OH}$, are formed by slow evaporation. According to O. Henry, and R. Piria, barium bromide is soluble in absolute alcohol, and P. Rohland found at room temp. one part of dihydrated barium bromide is dissolved by 36 parts of methyl alcohol, 207 parts of ethyl alcohol, and 652 parts of propyl alcohol, while 100 parts of 50, 93.5, and 100 per cent. methyl alcohol at 15° dissolve respectively 4, 27.3 and 45.9 parts of barium chloride, and at 22.5° , 100 parts of absolute methyl alcohol dissolve 56.1 parts of BaCl_2 . At 15° , 100 parts of 97 per cent. ethyl alcohol dissolve 0.48 part of $\text{BaBr}_2 \cdot 2\text{H}_2\text{O}$, while at 22.5° , 100 parts of 100 and 87 per cent. ethyl alcohol dissolve respectively 3 and 6 parts of BaBr_2 . According to W. Eidmann, barium bromide is soluble in **acetone**.

Calcium bromide rapidly deliquesces on exposure to air ; and C. Löwig¹³ showed that when melted, calcium bromide loses some bromine ; and that with conc. **sulphuric acid** it develops first hydrogen bromide, and then bromine and sulphur dioxide. According to C. Löwig, hexahydrated strontium bromide effloresces in air, and, according to T. W. Richards, it loses five-sixths of its water of crystallization over sulphuric acid, and the water is restored on exposure to air. Strontium bromide loses its water of crystallization when heated to a low temp., and, when melted, C. F. Rammelsberg found that the salt loses all its water of crystallization. If carbon dioxide and air is passed through an aq. soln. of barium bromide what is considered to be a complete reaction occurs : $\text{BaBr}_2 + \text{CO}_2 + \text{O} = \text{BaCO}_3 + \text{Br}_2$. H. Schulze found that when barium bromide is heated red hot in **oxygen** gas, some barium oxide is formed, but E. Beckmann says it is indifferent to oxygen and carbon dioxide at a red heat. A. Potilitzin found that bromine is partially displaced by **chlorine** at 100° .

If anhydrous calcium bromide be warmed with **bromine**, in equi-mol proportions, J. Meyer obtained a red liquid which on cooling gave a crystalline mush, which at

ordinary temp. loses bromine until calcium bromide remains. Similar remarks apply to strontium and barium bromides. It is supposed an unstable **calcium polybromide**—possibly CaBr_4 —is formed, a conclusion confirmed by the lowering of the f.p. of soln. of calcium bromide and bromine. Evidence has likewise been obtained of the existence of **strontium polybromide**, but the solid has not been isolated. M. Berthelot also found a soln. of 400 grms. of hexahydrated strontium chloride in a litre of water dissolves 92 grms. of bromine developing 0.5 cal. per 80 grms. of bromine. The soln. is not altered by dilution, but it loses bromine in a stream of air. M. Berthelot also found evidence of the formation of **barium polybromide**: $\text{BaBr}_2 + 2\text{Br}_{2\text{gas}} = \text{BaBr}_6 + 20.8 \text{ Cals.}$, but J. Meyer found no signs of the depression of the f.p. of soln. of barium or strontium bromide by the addition of bromine.

C. F. Rammelsberg found that anhydrous calcium bromide absorbs ammonia gas, forming a voluminous unstable white powder, heat is developed at the same time. The composition approximates to **calcium hexammino-bromide**, $\text{CaBr}_2 \cdot 6\text{NH}_3$. This salt forms a clear soln. with water which deposits calcium carbonate on exposure to air. C. F. Rammelsberg said that anhydrous strontium bromide under similar conditions forms **strontium hemiammino-bromide**, $\text{SrBr}_2 \cdot \frac{1}{2}\text{NH}_3$. A. Joannis made **barium octammino-bromide**, $\text{BaBr}_2 \cdot 8\text{NH}_3$, by condensing ammonia in a tube with recently fused barium bromide, at -30° , and then allowing the excess of ammonia to escape at 0° . The vap. press. of the product remains constant for many hours. Barium bromide reacts with liquid ammonia and potassium: $\text{BaBr}_2 + 2\text{KNH}_3 = 2\text{KBr} + \text{Ba}(\text{NH}_2)_2 + \text{H}_2$.

C. Löwig¹⁴ reported the formation of fine needle-like crystals of **calcium oxybromide** by boiling a soln. of calcium bromide with milk of lime. E. Tassily obtained a basic calcium bromide, or calcium oxybromide, $3\text{CaO} \cdot \text{CaBr}_2 \cdot 16\text{H}_2\text{O}$, by digesting on hot plates 100 grms. of calcium bromide in 75 c.c. of water, with 3 grms. of calcium oxide. The hot soln. is filtered, and needle-like crystals of the salt in question separate out; they can be washed by a soln. of calcium bromide. F. A. H. Schreinemakers and J. Milikan obtained besides E. Tassily's oxybromide, a second one, $3\text{CaBr}_2 \cdot 4\text{CaO} \cdot 16\text{H}_2\text{O}$. In the isothermal lines of Fig. 23 for the ternary system, CaBr_2 — CaO — H_2O , at 25° , the sat. soln. is in equilibrium with the solid phase, $\text{Ca}(\text{OH})_2$ along ab ; with $\text{CaBr}_2 \cdot 3\text{CaO} \cdot 16\text{H}_2\text{O}$ along bc ; with $3\text{CaBr}_2 \cdot 4\text{CaO} \cdot 16\text{H}_2\text{O}$ along cd ; and with $\text{CaBr}_2 \cdot 6\text{H}_2\text{O}$ along de . The salt is decom-

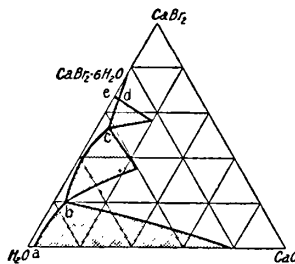

FIG. 23.—Ternary System, CaBr_2 — CaO — H_2O , at 25° .

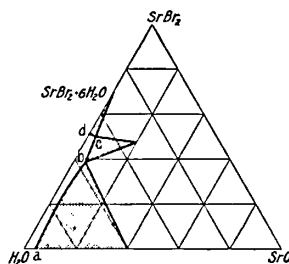

FIG. 24.—Ternary System, SrBr_2 — SrO — H_2O , at 25° .

posed by water with the separation of calcium hydroxide; it is also decomposed by carbon dioxide, alcohol, and acids. The heat of formation is given as $\text{CaBr}_2 + 3\text{CaO} + 16\text{H}_2\text{O}_{\text{solid}} = 76.45 \text{ Cals.}$, and the heat of soln. in 6 mols hydrogen bromide in a dil. soln. at 20° is 63.55 Cals. If this salt be dehydrated at 120° in a stream of dry air freed from carbon dioxide, $3\text{CaO} \cdot \text{CaBr}_2 \cdot 3\text{H}_2\text{O}$ is formed. The heat of formation is given as $\text{CaBr}_2 + 3\text{CaO} + 3\text{H}_2\text{O}_{\text{solid}} = 62.3 \text{ Cals.}$, and the heat of soln. in 6 mols of a dil. soln. of hydrogen bromide is 95.7 Cals. E. Tassily also obtained non-hygroscopic crystals of **strontium oxybromide**, $\text{SrO} \cdot \text{SrBr}_2 \cdot 9\text{H}_2\text{O}$, with the heat of formation $\text{SrO} + \text{SrBr}_2 + 9\text{H}_2\text{O}_{\text{solid}} = 41.95 \text{ Cals.}$, and a heat of soln. of 38.3 Cals. in two mols of hydrogen bromide in dil. soln. at 20° . J. Milikan obtained E. Tassily's strontium oxybromide, and its range of stability is indicated in Fig. 24, where the composition of the sat. soln. in equilibrium with the solid phase $\text{SrO} \cdot 9\text{H}_2\text{O}$ is indicated by the isothermal line ab ; with $\text{SrBr}_2 \cdot \text{SrO} \cdot 9\text{H}_2\text{O}$ by

bc; and with $\text{SrBr}_2 \cdot 6\text{H}_2\text{O}$ by *cd*. If the oxybromide, $\text{SrBr}_2 \cdot \text{SrO} \cdot 9\text{H}_2\text{O}$, be dehydrated at 120° in a stream of dry air free from carbon dioxide, $\text{SrO} \cdot \text{SrBr}_2 \cdot 3\text{H}_2\text{O}$ is formed. The heat of formation is $\text{SrBr}_2 + \text{SrO} + 3\text{H}_2\text{O} = 32.7$ Cals., and the heat of soln. at 13° is 38.3 Cals. in a dil. soln. with 2 mols of hydrogen bromide. E. Beckmann made an impure barium oxybromide, $\text{BaO} \cdot \text{BaBr}_2 \cdot 7.54\text{H}_2\text{O}$, by dissolving 3 grms. of $\text{BaO} \cdot 9\text{H}_2\text{O}$ and 10 grms. of $\text{BaBr}_2 \cdot 2\text{H}_2\text{O}$ in 30 grms. of water, and adding 120 grms. of alcohol. He also made $\text{BaO} \cdot \text{BaBr}_2 \cdot 5\text{H}_2\text{O}$, or $\text{Ba}(\text{OH})\text{Br}_{\text{aq}}$, by a method analogous to that employed for the corresponding chloride. E. Tassily made the same compound and found the heat of formation, $\text{BaBr}_2 + \text{BaO} + 5\text{H}_2\text{O}_{\text{solid}} = 34.2$ Cals.; and the heat of soln. at 20° in a dil. soln. of 2 mols of hydrogen bromide, 19.5 Cals. E. Tassily's oxybromide was obtained by J. Milikan and F. A. H. Schreinemakers in their study of the ternary system, $\text{BaBr}_2 - \text{BaO} - \text{H}_2\text{O}$, at 25° . The composition of the sat. soln. in equilibrium with the solid phase $\text{BaO} \cdot 9\text{H}_2\text{O}$ is represented by the line *ab*, Fig. 25; with $\text{BaBr}_2 \cdot \text{BaO} \cdot 9\text{H}_2\text{O}$ by *bc*; and with $\text{BaBr}_2 \cdot 2\text{H}_2\text{O}$ by *cd*. By dehydrating the oxybromide product at 120° in a stream of air free from carbon dioxide, E. Tassily made $\text{BaO} \cdot \text{BaBr}_2 \cdot 2\text{H}_2\text{O}$; E. Beckmann considers the compound contains $3\text{H}_2\text{O}$. E. Tassily calculated the heat of formation $\text{BaO} + \text{BaBr}_2 + 2\text{H}_2\text{O}_{\text{solid}} = 24.1$ Cals.; and the heat of soln. at 13° in a dil. soln. of 2 mols of hydrogen bromide, 33.8 Cals.

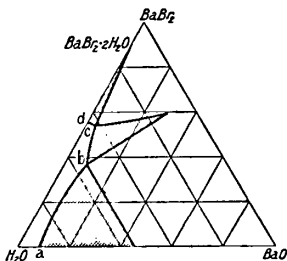
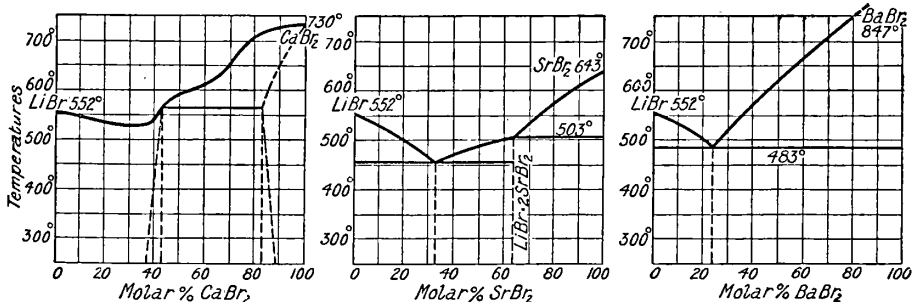

FIG. 25.—Ternary System, $\text{BaBr}_2 - \text{BaO} - \text{H}_2\text{O}$, at 25° .

E. Defacqz¹⁵ prepared barium fluorobromide, $\text{BaF}_2 \cdot \text{BaBr}_2$, of sp. gr. 4.96, at 18° like the fluorochloride, *q.v.*, but the former salt is more readily decomposed by water. He also prepared crystalline strontium fluorobromide, $\text{SrF}_2 \cdot \text{SrBr}_2$, sp. gr. 4.06; and calcium fluorobromide, $\text{CaF}_2 \cdot \text{CaBr}_2$, sp. gr. 3.15; the two latter are more readily decomposed by water than the barium salt. According to O. Ruff and W. Plato, mixtures of barium fluoride and bromide give a eutectic at about 800° with 90 molar per cent. of barium bromide; calcium fluoride and bromide, at 660° , and 82 molar per cent. of calcium bromide; calcium chloride and bromide, a depression in the curve reaching a minimum at about 740° and about 60 molar per cent. of calcium bromide; and barium chloride and bromide at about 870° with 90 molar per cent. of barium bromide. According to J. Herbette, barium chloride and bromide form mixed crystals containing large proportions of the chloride, the crystals resemble those of the chloride, and M. Berthelot supposed that barium chlorobromide was formed: $\text{BaBr}_2 + \text{BaCl}_2 = \text{BaCl}_2 \cdot \text{BaBr}_2 + 3$ Cals., in the cold.



FIGS. 26 TO 28.—Freezing-point Curves of Binary Mixtures of Lithium Bromide with Calcium, Strontium, and Barium Bromides.

Lithium bromide forms solid soln. of limited conc. with calcium bromide; G. Kellner's results are shown in Fig. 26; with strontium bromide, the double salt lithium strontium pentabromide, $\text{LiBr} \cdot 2\text{SrBr}_2$, is formed, decomposing at 503° ,

Fig. 27; and with barium bromide, the f.p. curve is a simple eutectic, Fig. 28. No solid soln. are formed in the two last cases. Sodium and calcium bromide solidify to form two series of solid soln. with a eutectic at 513° , and on further cooling a reaction occurs at 469° , and **sodium calcium pentabromide**, $\text{NaBr} \cdot 2\text{CaBr}_2$, is formed, Fig. 29. Sodium bromide forms simple eutectiferous systems with both strontium

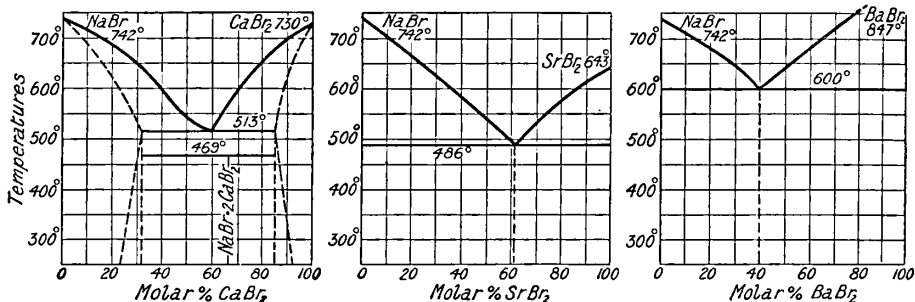

FIGS. 29 TO 31.—Freezing-point Curves of Binary Mixtures of Sodium Bromide with Calcium, Strontium, and Barium Bromides.

bromide, Fig. 30, and barium bromide, Fig. 31, the eutectic temp. being 486° and 600° respectively. Potassium bromide forms double salts with all the alkaline earths without forming solid soln. With calcium bromide, the compound **potassium calcium tribromide**, $\text{KBr} \cdot \text{CaBr}_2$, is represented by a maximum at 637° ; the adjacent eutectic temp. are 544° and 563° , Fig. 32. With strontium bromide, there are two

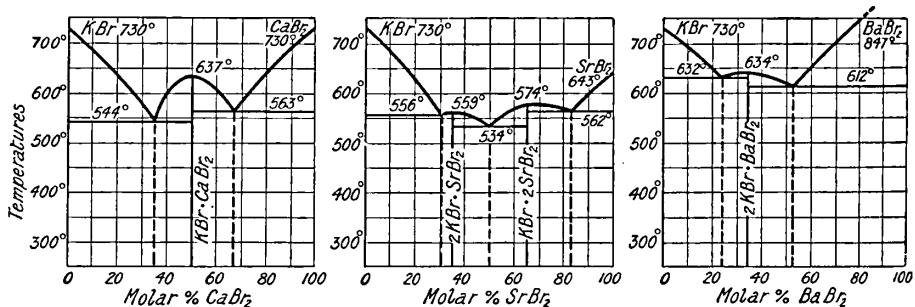

FIGS. 32 TO 34.—Freezing-point Curves of Binary Mixtures of Potassium Bromide with Calcium, Strontium, and Barium Bromides.

flat maxima, Fig. 33; the one at 559° , corresponds with **potassium strontium tetrabromide**, $2\text{KBr} \cdot \text{SrBr}_2$, and the other at 574° , corresponds with **potassium strontium pentabromide**, $\text{KBr} \cdot 2\text{SrBr}_2$; the three eutectics are respectively 556° , 534° , and 562° . With barium bromide, one flat maximum, Fig. 34, at 634° , corresponds with **potassium barium tetrabromide**, $2\text{KBr} \cdot \text{BaBr}_2$. The adjacent eutectic temp. are 632° and 612° .

REFERENCES.

- ¹ A. J. Balard, *Ann. Chim. Phys.*, (2), 32, 337, 1826; C. Löwig, *Pogg. Ann.*, 14, 485, 1828; C. Wendler, *Wagner's Jahresber.*, 291, 1863; C. Klein, *Liebig's Ann.*, 128, 237, 1863; T. W. Richards, *Proc. Amer. Acad.*, 28, 1, 1893; 30, 369, 1894; *Chem. News*, 67, 269, 1873; 72, 29, 1895; J. S. Stas, *Mém. Acad. Roy. Belgique*, 35, 3, 1865; G. Macdonald, *Neues Jahrb. Pharm.*, 38, 322, 1870; A. Faust, *Archiv. Pharm.*, (2), 131, 216, 1867; M. Henner and J. Hohenhauser, *Dingler's Journ.*, 173, 360, 1864; O. Henry, *Journ. Pharm. Chim.*, (2), 15, 52, 1829; J. B. Berthelot, *ib.*, (2), 16, 660, 1830.

² O. Mügge, *Neues Jahrb. Min.*, i, 130, 1889; *Centr. Min.*, 105, 1918; H. Dufet, *Bull. Soc. Min.*, 26, 65, 1903; G. Werther, *Journ. prakt. Chem.*, (1), 91, 167, 1864; T. W. Richards and V. Yngve, *Journ. Amer. Chem. Soc.*, 40, 89, 1918; J. Herbette, *Contribution à l'étude de l'isomorphisme*, Paris, 1906; G. Wyruboff, *Bull. Soc. Min.*, 9, 262, 1886.

³ O. Ruff and W. Plato, *Ber.*, 35, 3616, 1902; C. H. D. Bödeker, *Die Beziehungen zwischen Dichte und Zusammensetzung bei festen und liquiden Stoffen*, Leipzig, 1860; P. A. Favre and C. A. Valson, *Compt. Rend.*, 77, 579, 1873; H. Schiff, *Liebig's Ann.*, 108, 21, 1858; H. G. F. Schröder, *Dichtigkeitsmessungen*, Heidelberg, 1873; F. W. Clarke, *A Table of Specific Gravity for Solids and Liquids*, London, 1888; *Ber.*, 12, 1398, 1879; J. W. Retgers, *Zeit. phys. Chem.*, 3, 497, 1889; T. W. Richards, *Proc. Amer. Acad.*, 28, 1, 1893; 30, 369, 1894; W. Biltz, *Zeit. anorg. Chem.*, 115, 241, 1921; T. E. Thorpe and A. G. Francis, *Proc. Roy. Soc.*, 83, A, 277, 1910.

⁴ W. Ramsay and N. Eumorfopoulos, *Phil. Mag.*, (5), 41, 360, 1896; T. Carnelley, *Journ. Chem. Soc.*, 29, 489, 1876; 31, 365, 1877; 33, 273, 1878; O. Ruff and W. Plato, *Ber.*, 36, 2367, 1903; E. Lubarsky, *Journ. Russ. Phys. Soc.*, 28, 460, 1896; C. O. Curtmann, *Journ. Amer. Chem. Soc.*, 16, 621, 1894; G. Kellner, *Zeit. anorg. Chem.*, 99, 137, 1917; *Die binären Systeme aus den Bromiden der Alkali- und Erdalkalimetalle*, Berlin, 1917.

⁵ J. Thomsen, *Journ. prakt. Chem.*, (2), 16, 97, 1877; (2), 18, 1, 1878; M. Berthelot, *Ann. Chim. Phys.*, (5), 15, 185, 1878; (5), 16, 442, 1878; S. U. Pickering, *Journ. Chem. Soc.*, 53, 865, 1888.

⁶ P. Kremers, *Pogg. Ann.*, 103, 65, 1858; 99, 43, 1856; A. Étard, *Ann. Chim. Phys.*, (7), 2, 532, 1894; (7), 3, 275, 1894; W. D. Harkins and W. T. Pearce, *Journ. Amer. Chem. Soc.*, 38, 2714, 1916.

⁷ D. I. Mendelcéff, *Journ. Russ. Phys. Chem. Soc.*, 16, 184, 1884; P. Kremers, *Pogg. Ann.*, 99, 444, 1857; 105, 360, 1858; 108, 115, 1859; H. C. Jones and F. H. Getman, *Zeit. phys. Chem.*, 49, 385, 1904; G. T. Gerlach, *Zeit. anal. Chem.*, 8, 285, 1869; L. C. de Coppet, *Compt. Rend.*, 134, 1208, 1902; C. O. Curtmann, *Journ. Amer. Chem. Soc.*, 16, 621, 1894; X. Roques, *Journ. Pharm. Chim.*, (6), 1, 301, 1895; J. L. Kreider, *Amer. Journ. Scienc.*, (4), 20, 97, 1905.

⁸ G. Tammann, *Wied. Ann.*, 24, 523, 1883; *Zeit. phys. Chem.*, 2, 45, 1888; W. Biltz, *Zeit. anal. Chem.*, 26, 413, 1887; H. Lesœur, *Compt. Rend.*, 103, 1260, 1886; W. Pieper, *Dampfspannungen wässriger und alkoholischer Salzlösungen*, Bonn, 1917.

⁹ H. C. Jones and V. J. Chambers, *Amer. Chem. Journ.*, 23, 89, 1900; H. C. Jones and F. H. Getman, *Zeit. phys. Chem.*, 49, 385, 1904; W. Biltz, *ib.*, 40, 185, 1902.

¹⁰ J. H. Gladstone, *Journ. Chem. Soc.*, 59, 589, 1891; H. C. Jones and F. H. Getman, *Zeit. phys. Chem.*, 49, 385, 1904; H. Jahn, *Wied. Ann.*, 43, 280, 1891; P. Barbier and L. Roux, *Bull. Soc. Chim.*, (3), 3, 255, 419, 424, 1890; (3), 4, 9, 614, 620, 1890; C. Sheard and C. S. Morris, *Ohio Journ. Science*, 16, 113, 1916.

¹¹ H. C. Jones and V. J. Chambers, *Amer. Chem. Journ.*, 23, 89, 1900; H. C. Jones and A. P. West, *ib.*, 34, 357, 1905; H. C. Jones, *ib.*, 35, 445, 1906; H. C. Jones and H. P. Bassett, *ib.*, 33, 534, 1905; H. C. Jones and F. H. Getman, *Zeit. phys. Chem.*, 49, 385, 1904; W. Hampe, *Chem. Ztg.*, 11, 816, 846, 904, 934, 1109, 1158, 1549, 1897; A. Heydweiller, *Zeit. Physik*, 3, 310, 1920; G. Dickhaus, *Einfluss der Temperatur auf die Leitfähigkeit von Elektrolyten in wässriger Lösung*, Bonn, 1912; H. C. Jones, *The Electrical Conductivity, Dissociation, and Temperature Coefficients of Conductivity of Aqueous Solutions of a Number of Salts and Organic Acids*, Washington, 1912.

¹² X. Roques, *Journ. Pharm. Chim.*, (6), 1, 301, 1895; O. Henry, *ib.*, (2), 28, 214, 1827; H. Fonzes-Diacon, *ib.*, (6), 1, 59, 1895; R. Piria, *Journ. Chim. Méd.*, 14, 65, 1838; W. Eidmann, *Ein Beitrag zur Erkenntnis der Verhaltens chemischer Verbindungen in nichtwässrigen Lösungen*, Giessen, 1899; A. C. L. de Bruyn, *Zeit. phys. Chem.*, 10, 783, 1892; T. W. Richards, *Zeit. anorg. Chem.*, 3, 455, 1893; P. Rohland, *ib.*, 15, 412, 1897.

¹³ C. Löwig, *Das Brom und seine chemischen Verhältnisse*, Heidelberg, 1829; J. B. Berthelot, *Journ. Pharm. Chim.*, (2), 16, 660, 1830; C. F. Rammelsberg, *Pogg. Ann.*, 55, 239, 1842; R. G. van Name and W. G. Brown, *Amer. Journ. Science*, (4), 44, 105, 1917; T. W. Richards, *Proc. Amer. Acad.*, 28, 1, 1893; 30, 369, 1894; H. Schulze, *Journ. prakt. Chem.*, (2), 21, 407, 1880; E. Beckmann, *ib.*, (2), 27, 142, 1883; A. Potilitzin, *Ber.*, 12, 697, 1879; A. Joannis, *Compt. Rend.*, 140, 1244, 1905; M. Berthelot, *ib.*, 100, 761, 1885; *Ann. Chim. Phys.*, (5), 29, 343, 1883; *Bull. Soc. Chim.*, (2), 39, 58, 1883; J. Meyer, *Zeit. anorg. Chem.*, 30, 113, 1902.

¹⁴ C. Löwig, *Das Brom und seine chemischen Verhältnisse*, Heidelberg, 1829; E. Tassily, *Ann. Chim. Phys.*, (7), 17, 45, 1899; *Bull. Soc. Chim.*, (3), 11, 931, 1889; (3), 13, 725, 1895; *Compt. Rend.*, 119, 371, 1894; J. Milikan, *Zeit. phys. Chem.*, 92, 59, 1918; F. A. H. Schreinemakers and J. Milikan, *Proc. Acad. Amsterdam*, 15, 52, 1912; E. Beckmann, *Journ. prakt. Chem.*, (2), 27, 132, 1883.

¹⁵ E. Defaeqz, *Compt. Rend.*, 138, 197, 1904; *Ann. Chim. Phys.*, (8), 1, 333, 1904; G. Kellner, *Zeit. anorg. Chem.*, 99, 137, 1917; *Die binären Systeme aus dem Bromiden der Alkali- und Erdalkalimetalle*, Berlin, 1917; J. Herbette, *Bull. Soc. Min.*, 29, 97, 1906; *Compt. Rend.*, 143, 243, 1906; M. Berthelot, *Ann. Chim. Phys.*, (5), 29, 343, 1883; *Bull. Soc. Chim.*, (2), 39, 58, 1883; O. Ruff and W. Plato, *Ber.*, 36, 2357, 1903.

§ 14. Calcium, Strontium, and Barium Iodides

When hydrogen iodide acts on barium oxide the mass becomes incandescent, and barium iodide is formed. In 1814, J. L. Gay Lussac¹ prepared calcium iodide by evaporating a soln. of calcium oxide in hydriodic acid with the exclusion of air. H. Moissan led a stream of hydrogen iodide into a vessel containing fragments of the purer forms of marble, and after standing 24 hrs. to ensure the neutralization of the acid and the precipitation of the iron, he filtered and evaporated the soln. G. P. Baxter and F. N. Brink prepared calcium iodide of a high degree of purity.

A soln. of marble in nitric acid was heated with an excess of lime to precipitate iron and manganese compounds. The filtered soln. was acidified, and evaporated to crystallization, and the product recrystallizes three times. Calcium carbonate was precipitated by the addition of ammonium carbonate, and the precipitate thoroughly washed by decantation. The carbonate was dissolved in purified hydriodic acid, and the iodide crystallized from the soln. In order to remove any mother liquid included in the crystals, the salts were fused; if the fusion be conducted in a stream of nitrogen the soln. of the product in water is strongly basic; this is but partially prevented by mixing the calcium iodide before fusion with ammonium iodide, and keeping the temp. below the sublimation point of the ammonium iodide until practically all the water is expelled; the salt is then heated to fusion long enough to drive off all the ammonium salt. The product is still slightly alkaline.

Strontium and barium iodides were prepared in a similar manner. O. Henry, O. Hesse, and R. Rother made it by the joint action of iodine, iron, calcium carbonate, and water as in the process for alkali iodides; Lies-Bodart and M. Jobin, by the action of iodine and water on calcium sulphide; J. von Liebig, by the action of iodine and phosphorus on milk of lime; C. Wendler, and R. Wagner, by the action of iodine on calcium sulphite: $\text{BaSO}_3 + \text{Ba}(\text{OH})_2 + \text{I}_2 = \text{BaI}_2 + \text{BaSO}_4 + \text{H}_2\text{O}$; J. B. Berthelot, by the double decomposition of lead iodide and calcium carbonate; and H. Croft made the barium salt by treating baryta water with iodine and filtering off the very soluble iodate formed at the same time. S. Kern reduced the iodate with hydrogen sulphide, and evaporated the soln. to dryness. The evaporation of the aq. soln. furnish hydrated salts, which are dehydrated to form the anhydrous salts by heating them in a current of hydrogen iodide, as recommended by E. Tassily for ignition in nitrogen or air, it is attended by some decomposition of the iodide.

According to O. Mügge,² dihydrated barium iodide, $\text{BaI}_2 \cdot 2\text{H}_2\text{O}$, crystallizes in monoclinic prisms isomorphous with dihydrated barium bromide, and with axial ratios $a : b : c = 1.4580 : 1 : 1.1528$, and $\beta = 112^\circ 58'$. E. Beckmann says heptahydrated barium iodide crystallizes in prisms. O. Mügge found hexahydrated barium iodide, $\text{BaI}_2 \cdot 6\text{H}_2\text{O}$, crystallizes in hexagonal prisms isomorphous with hexahydrated strontium chloride, and with axial ratio $a : c = 1 : 0.538$. The crystals are doubly refracting. The specific gravity of anhydrous calcium iodide by O. Ruff and W. Plato³ is 4.9 at 20° ; G. P. Baxter and F. N. Brink give 3.956 at 25° (water at 4° unity); for anhydrous strontium iodide, C. H. D. Bödeker gives 4.415 at 10° ; G. P. Baxter and F. N. Brink, 4.549 at 25° (water at 4° unity); and for anhydrous barium iodide, E. Filhol gives 4.917, G. P. Baxter and F. N. Brink 5.150 at 25° (water at 4° unity). F. W. Clarke gives the sp. gr. of heptahydrated barium iodide, 3.67 (20°).

The reported numbers for the melting point of anhydrous calcium iodide vary from W. Ramsay and N. Eumorfopoulos' 575° ,⁴ to O. Ruff and W. Plato's 740° ; for the hexahydrated salt, $\text{CaI}_2 \cdot 6\text{H}_2\text{O}$, E. Lubarsky gives 42° . J. L. Gay Lussac noted in 1814 that strontium iodide melts at a red heat; W. Ramsay and N. Eumorfopoulos' value for the m.p. of anhydrous strontium iodide is 402° ; and T. Carnelley's, 507° . For barium iodide, W. Ramsay and N. Eumorfopoulos give 539° , and O. Ruff and W. Plato, 740° . The b.p. of calcium iodide is between 718° and 719° . It is possible that the discordant data here given arise from the use of impure or imperfectly dehydrated salts. J. L. Gay Lussac noted that in melting calcium iodide in air, there is a partial decomposition, iodine is liberated and calcium

oxide is formed; and that in the absence of air strontium iodide can be melted without decomposition, but in the presence of air the iodide is partially decomposed. The hydrated forms of barium iodide readily melt in their water of crystallization. O. Mügge said that hexahydrated barium iodide melts in its water of crystallization at 25.7°. When anhydrous barium iodide is melted, much of the salt is decomposed: $2\text{BaI}_2 + \text{O}_2 \rightleftharpoons 2\text{BaO} + 2\text{I}_2$.

J. Thomsen's values for the heats of formation are: (Ca, I₂), 107.65 Cals.; M. Berthelot's values (Ca, I₂), 118.6 Cals.; (Sr, I₂), *circa* 134 Cals.; and E. Tassily⁵ gives (Sr, I_{2(gas)}), 123.1 Cals.; (Sr, I_{2(solid)}), 112.3 Cals., and (Ba, I_{2(gas)}), 13.7 Cals., or (Ba, I_{2(solid)}), 2.9 Cals. E. Tassily gives $\text{Ca} + \text{I}_2 + 8\text{H}_2\text{O}_{\text{liquid}} = \text{CaI}_2 \cdot 8\text{H}_2\text{O} + 133.7$ Cals. and for the formation (Sr, I_{2(solid)}, 7H₂O_{liquid}), 147.3 Cals. J. Thomsen's value for (CaI₂, aq.) is 27.69 Cals.; and for (Ca, I₂, aq.), 135.34 Cals.; (Sr, I₂, aq.), 143.39 Cals.; (Ba, I₂, aq.), 144.02 Cals.; and for (Ba, I₂, 7H₂O), 151.37 Cals. S. U. Pickering's value for the heat of solution of anhydrous calcium iodide in water is 15.973 Cals., and in alcohol, 19.833 Cals. J. Thomsen's value for the heat of soln. of BaI₂ + 7.17H₂O in 500 mols of water is -6.85 Cals. E. Tassily's value for the heat of soln. of CaI₂ · 8H₂O is 1.735 Cals., of anhydrous strontium iodide at 12°, 20.5 Cals., and of SrI₂ · 7H₂O at 15°, -4.47 Cals.; and for anhydrous barium iodide, at 16°, 10.3 Cals. The heat of soln. of the three anhydrous barium halides increase in passing from the chloride to the iodide: BaCl₂, 2.07 Cals.; BaBr₂, 4.98 Cals.; and BaI₂, 10.3 Cals.

Anhydrous calcium, strontium, and barium iodides deliquesce in moist air. Calcium iodide forms hexahydrated calcium iodide, CaI₂ · 6H₂O. According to H. Croft, hexahydrated strontium iodide, SrI₂ · 6H₂O, crystallizes in six-sided plates; E. Tassily says the sat. soln. at 70° gives SrI₂ · 7H₂O. According to A. Étard, the transition temp.: SrI₂ · 6H₂O \rightleftharpoons SrI₂ · 2H₂O + 4H₂O, is near 90°; and for BaI₂ · 6H₂O \rightleftharpoons BaI₂ · 2H₂O + 4H₂O it is nearly 35°. According to P. Kremers' solubility data, there is also a transition point with calcium iodide between 40° and 43°. Hexahydrated barium iodide, BaI₂ · 6H₂O, as well as salts with 1, 2, and 7H₂O, have been reported. The stability of the higher hydrates thus appear to be greater with the iodides than with the bromides, and with the bromides than with the chlorides. The equilibrium conditions and transformation points of the different hydrates on the iodides of the alkaline earths have not been investigated closely. There are some differences in the views of different workers on the composition of the hydrates of the iodides of the alkaline earths and more particularly of barium iodide, owing to its great solubility and deliquescence. Thus H. Croft, J. Thomsen, and E. Beckmann give for ordinary crystalline iodide, BaI₂ · 7H₂O, while H. Lesceur gives BaI₂ · 6H₂O. E. Beckmann says hydrated barium iodide, BaI₂ · H₂O, is stable over 125°, and begins to dehydrate at 150°; and G. Werther obtained barium di- or tri-hydrated iodide by evaporating soln. of the salt nearly to dryness.

The solubilities of calcium, strontium, and barium iodides have been measured by P. Kremers,⁶ and A. Étard; the results represented in grams of MI₂ per 100 grms. of soln. are:

	0°	10°	20°	40°	60°	80°	100°
CaI ₂	64.6	66.0	67.6	70.8	74.0	78.0	81.0
SrI ₂	62.3	—	64.0	65.7	68.5	73.0	79.3
BaI ₂	63.0	65.0	67.0	69.8	71.2	72.3	73.1

According to A. Étard, the solubility of strontium iodide at 120° is 80.7; at 140°, 82.5; and at 175°, 75.6; and the solid phase below 90° is SrI₂ · 6H₂O, and above 90°, SrI₂ · 2H₂O. The solubilities of a mol of strontium chloride, bromide, and iodide are as 2.79 : 3.54 : 4.81 at 0°. Similarly for barium iodide, the solubility at -20° is 59.0; at 120°, 73.8; and at 140°, 74.6; the solid phase below 35° is BaI₂ · 6H₂O, and above that temp. BaI₂ · 2H₂O. A. Étard also found that the solubilities of barium and strontium iodides were depressed in the presence of one another.

The **specific gravities** of soln. with different amounts of the iodides of the alkaline earths in 100 grms. of water at 19.5°, are, according to G. T. Gerlach: ⁷

Grms. of salt	.	.	5	10	20	40	60	65
Sp. gr. CaI ₂	.	.	1.044	1.090	1.198	1.477	1.910	—
„ SrI ₂	.	.	1.045	1.091	1.200	1.491	1.955	2.150
„ BaI ₂	.	.	1.045	1.091	1.201	1.495	1.970	—

H. C. Jones and F. H. Getman have also measured the sp. gr. of soln. of these salts. P. Kremers has studied the change in the vol. of soln. of the iodides of the alkaline earths with temp. L. C. de Coppet finds the **temperature of maximum density** of water is lowered to 2.980° and 0.872° respectively by the addition of 0.0384 and 0.1166 mol of CaI₂ per litre; and to 2.827° and 1.152° respectively by the addition of 0.0395 and 0.0962 mol of BaI₂ per litre. The mol. lowering dT/M is a constant in both cases.

C. Dieterici ⁸ has measured the **vapour pressures** of soln. of calcium iodide at 0°, H. C. Jones and F. H. Getman found the mol. **lowering of the freezing point** of soln. of calcium iodide dT/M showed a minimum with a 0.32*N*-soln., and rose to 19.23 with a 6.24*N*-soln. Similar results were observed with soln. of calcium chloride and bromide. Strontium and barium iodide soln. behave similarly. H. C. Jones and F. H. Getman also measured the **index of refraction** of soln. at 25°, and found it to rise from $\mu=1.01468$ to 1.693 respectively with soln. containing 0.078 and 3.120 mols of calcium iodide per litre. C. Sheard and C. S. Morris ⁹ measured the emission spectrum of calcium iodide and found that there are continuous spectral regions or bands between 6075 and 5845; 5615 and 5528; 5180 and 5100; 4830 and 4787; 4507 and 4465; and 4438 and 4360, and these corresponded closely with bands from mercuric and zinc iodides.

The **electrical conductivities** of soln. of calcium iodide have also been measured by H. C. Jones and F. H. Getman, ¹⁰ and they find the results agree with a rise in the percentage ionizations from 26.0 to 80.0 respectively for soln. with a mol per 0.32 and 12.82 litres of solvent at 0°, when the mol. conductivity $\mu_{\infty}=135.7$. H. C. Jones and B. P. Caldwell measured the conductivities of strontium iodide soln. at 25°, and also of mixtures of strontium and cadmium iodide. The conductivity of the mixture in aq. soln. is less than in the corresponding soln. of strontium iodide; and they assume that both salts form complex ions corresponding with strontium polyiodide, SrI₄“. R. G. van Name and W. G. Brown have studied this subject. W. Hittorf gave data for the **transport numbers** of the ions of calcium iodide. H. C. Jones and C. F. Lindsay have also measured the electrical conductivities of soln. of strontium iodide in water, methyl, ethyl, and propyl alcohols, and noted a continuous decrease in the conductivity and in the temp. coeff. of the conductivity in passing through the series from water to propyl alcohol; and they therefore conclude that the association of the salt with the solvent decreases in the same series. With methyl alcohol and water mixtures containing a mol of strontium iodide in 32 litres of the soln., the conductivity falls to a minimum value with about 50 per cent. alcohol at 0°, or 75 per cent. alcohol at 25°. For example:

Per cent. alcohol	.	0	25	50	75	100
μ at 0°	.	113.1	63.06	50.19	55.53	75.82
μ at 25°	.	205.3	131.3	103.8	98.09	101.4

The iodides of the alkaline earths are easily soluble in *ethyl alcohol*. As with water, the solubilities of the halides of the alkaline earths in alcohol decrease in passing from the chlorides to the iodides. According to A. Étard, ¹¹ 100 grms. of a sat. soln. of strontium iodide contains 2.6 grms. SrI₂ at -20°; 3.1 grms. at 4°; 4.3 grms. at 39°; and 4.7 grms. at 82°. P. Rohland found that 100 grms. of 97 per cent. alcohol dissolve 1.07 gm. of BaI₂.2H₂O at 15°, and that one part of BaI₂.2H₂O dissolves at room temp. in 22 parts of methyl, 93 parts of ethyl, and 307 parts of propyl alcohol. W. Eïdmann says that calcium and barium iodides are soluble in *acetone*.

The iodides of the alkaline earths can be preserved unchanged in air free from carbon dioxide. J. L. Gay Lussac¹² mentions that barium iodide becomes brown when exposed to the air, and that barium carbonate is formed. E. Beckmann observed that soln. of this salt behaved in a similar manner, and that the brown colour which soln. of barium iodide acquire when exposed to sunlight, disappears in darkness, while in an atm. of hydrogen the brown colour persists. M. Berthelot found that when barium iodide is heated in an atm. of oxygen, it is completely converted to barium oxide; and E. Beckmann that in a stream of air at 170° all the iodine is driven off, while in a stream of carbon dioxide or hydrogen no change occurs. S. Kern found that molten barium iodide is reduced to barium by sodium, and if mercury is present, barium amalgam is formed. Fuming hydrochloric acid, said F. Gramp, converts barium iodide into barium chloride and hydriodic acid, not free iodine. F. Isambert gave evidence of the formation of **calcium hexammino-iodide**, $\text{CaI}_2 \cdot 6\text{NH}_3$, by the action of *ammonia* on calcium iodide; and W. Biltz has shown that the temp. of decomposition of this salt and those of the corresponding **strontium hexammino-iodide**, $[\text{Sr}(\text{NH}_3)_6]\text{I}_2$, and **barium hexammino-iodide**, $[\text{Ba}(\text{NH}_3)_6]\text{I}_2$, at a press. $p=50$ mm., are respectively 369°, 335°, and 298°. The corresponding heats of formation, Q , calculated from $\log p = -Q/4.57T + 1.75 \log T - aT + 3.3$, are respectively 13.63, 13.40, and 10.80 Cals. C. F. Rammelsberg states that soln. of barium iodide readily absorb sulphur dioxide; F. Ephraim and I. Kornblum prepared an orange-red **barium tetrasulphonioidide**, $\text{BaI}_2 \cdot 4\text{SO}_2$, and a yellowish-red **barium disulphonioidide**, $\text{BaI}_2 \cdot 2\text{SO}_2$; they also made red **strontium tetrasulphonioidide**, $\text{SrI}_2 \cdot 4\text{SO}_2$; **strontium disulphonioidide**, $\text{SrI}_2 \cdot 2\text{SO}_2$; and **calcium tetrasulphonioidide**, $\text{CaI}_2 \cdot 4\text{SO}_2$.

J. J. Berzelius¹³ noted that iodine dissolves more copiously in soln. of calcium iodide than in water, and that when evaporated over potassium hydroxide dark grey crystals with a metallic lustre are obtained. The solubility of iodine in water is 0.0142 per cent., and J. Meyer found that 100 c.c. of 10 per cent. soln. of the halides of the alkaline earths dissolve the following amounts of iodine:

	Chloride.	Bromide.	Iodide.
Barium	0.067	0.231	6.541 grms.
Strontium	0.066	0.270	6.616 "
Calcium	0.078	0.274	8.062 "

The f.p. of the soln. of iodine in these halide soln. is not appreciably depressed, possibly because of the formation of periodides, e.g. CaI_4 . Indeed, while an aq. soln. of 8.062 grms. iodine in 10 per cent. calcium iodide exhibits a slightly greater lowering of the f.p. than calcium iodide alone, less conc. soln. exhibit a rather smaller depression of the f.p. than calcium iodide alone, due, it is suggested, to the smaller degree of ionization exhibited by the polyiodide than by the normal iodide. A. Mosnier claimed to have obtained crystals of $\text{CaI}_2 \cdot 15\text{H}_2\text{O}$ by the spontaneous decomposition of the double iodide of lead and calcium in contact with its sat. soln. Similar remarks apply to $\text{SrI}_2 \cdot 15\text{H}_2\text{O}$. J. Meyer supposes **calcium polyiodide**, CaI_4 , to be formed as a hygroscopic mass when the necessary proportions of iodine and calcium iodide are mixed, and heated to 70°–80°; when melted and cooled, needle-like crystals can be separated from the mass—these reflect light with a green metallic lustre; no iodine vapours are given off at 100°; a reddish-brown soln. is produced with water, and carbon disulphide or chloroform extracts from the aq. soln. two gram-atoms of iodine per mol of calcium iodide. The f.p. curve for mixtures of calcium iodide and iodine was found by F. Olivari to give no distinct maximum, but it has an almost horizontal branch with a eutectic on the iodine side. The polyiodide, if formed at all, must therefore be greatly dissociated under these conditions. If calcium iodide be melted with a large proportion of iodine, the product dissolves in a little water, but iodine separates when this soln. is diluted; the product is assumed to contain higher periodides than CaI_4 —possibly CaI_{10} —because with heating there is a low iodine tension. There is also evidence of the formation of

poly-chloroiodides and poly-bromoiodides. Similar remarks apply to **barium and strontium polyiodides**, but the polyiodides of calcium are more stable than those of strontium, or barium. R. G. van Name and W. G. Brown have studied the formation of strontium polyiodide. A. A. Jakowkin assumed that the soln. of iodine in barium iodide soln. corresponded with the formation of barium polyiodide, BaI_9 . C. K. Tinkler obtained some evidence of the existence of barium polyiodide from the identity of the absorption spectra of soln. of barium iodide and iodine with the spectra of analogous soln. of cadmium, sodium, potassium, magnesium, zinc, and aluminium. Barium iodide forms crystalline double salts with the iodides of zinc, cadmium, mercury, antimony, tin, and lead; *e.g.* A. Mosnier¹⁴ prepared **lead calcium iodide**, $2\text{PbI}_2 \cdot \text{CaI}_2 \cdot 7\text{H}_2\text{O}$; **lead strontium iodide**, $2\text{PbI}_2 \cdot \text{SrI}_2 \cdot 7\text{H}_2\text{O}$; and **lead barium iodide**, $2\text{PbI}_2 \cdot \text{BaI}_2 \cdot 7\text{H}_2\text{O}$. C. F. Rammelsberg also reported the formation of complex compounds by heating barium peroxide with iodine—*e.g.* $\text{BaI}_2 \cdot 2\text{BaO}_2$ and $\text{BaI}_2 \cdot \text{Ba}_3\text{O}_4$. R. F. Weinland and F. Schlegelmilch prepared compounds of calcium chloride with *iodine trichloride*, $\text{CaCl}_2 \cdot 2\text{ICl}_3 \cdot 8\text{H}_2\text{O}$, in golden-yellow deliquescent needle-like crystals by the action of iodine on a soln. of anhydrous calcium chloride in hydrochloric acid. Likewise also $\text{SrCl}_2 \cdot 2\text{ICl}_3 \cdot 8\text{H}_2\text{O}$ was prepared.

E. Tassily¹⁵ claims to have made **calcium oxyiodide**, $3\text{CaO} \cdot \text{CaI}_2 \cdot 16\text{H}_2\text{O}$, needle-like crystals, similar to the corresponding oxybromide; and he calculates the heat of formation to be $\text{CaI}_2 + 3\text{CaO} + 16\text{H}_2\text{O}_{\text{solid}} = 79.9$ Cals.; and the heat of soln. in dil. hydriodic acid with six mols of HI, at 20° , to be 53.4 Cals. J. Milikan's study of the ternary system, CaI_2 — CaO — H_2O , at 25° , gave the isothermal line *ab*, Fig. 35, for soln. in equilibrium with the solid phase, $\text{Ca}(\text{OH})_2$; *bc*, with $\text{CaI}_2 \cdot 3\text{CaO} \cdot 16\text{H}_2\text{O}$; and *cd*, with $\text{CaI}_2 \cdot 6\text{H}_2\text{O}$. The crystals of the oxyiodide are less hygroscopic than the iodide, CaI_2 . When kept in vacuo over sulphuric acid, crystals of $3\text{CaO} \cdot \text{CaI}_2 \cdot 3\text{H}_2\text{O}$ are formed: $(\text{CaI}_2 \cdot 3\text{CaO} \cdot 3\text{H}_2\text{O}_{\text{solid}})$, 64.7 Cals.; and the heat of soln. under the same conditions as the preceding compound, 96.7 Cals. E. Tassily made **strontium oxyiodide**, $5\text{SrO} \cdot 2\text{SrI}_2 \cdot 30\text{H}_2\text{O}$, in a similar manner. J. Milikan's study of the ternary system, SrI_2 — SrO — H_2O , at 25° , gave the isothermal

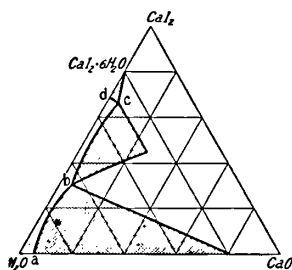

FIG. 35.—Ternary System, CaI_2 — CaO — H_2O , at 25° .

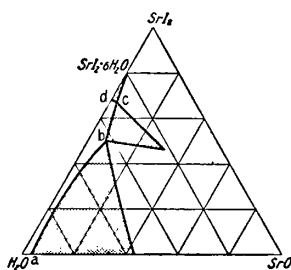

FIG. 36.—Ternary System, SrI_2 — SrO — H_2O , at 25° .

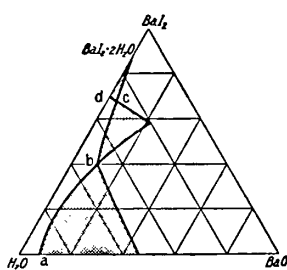

FIG. 37.—Ternary System, BaI_2 — BaO — H_2O , at 25° .

line *ab*, Fig. 36, for soln. in equilibrium with $\text{SrO} \cdot 9\text{H}_2\text{O}$; *bc*, with $\text{SrI}_2 \cdot 2\text{SrO} \cdot 9\text{H}_2\text{O}$; and *cd* with $\text{SrI}_2 \cdot 6\text{H}_2\text{O}$. Needle-like prismatic crystals of **barium oxyiodide**, $\text{BaI}_2 \cdot \text{BaO} \cdot 9\text{H}_2\text{O}$, were likewise formed: $(\text{BaI}_2 \cdot \text{BaO} \cdot 9\text{H}_2\text{O}_{\text{solid}})$, 41.64 ; and the heat of soln. in dil. hydriodic acid with 2 mols of HI at 20° is 11.76 Cals. E. Beckmann prepared barium oxyiodide, $\text{Ba}(\text{OH})\text{I} \cdot 2\text{H}_2\text{O}$, analogous with the oxychloride. J. Milikan's study of the ternary system, BaI_2 — BaO — H_2O , at 25° , gave the isothermal line *ab*, Fig. 37, for soln. in equilibrium with $\text{BaO} \cdot 9\text{H}_2\text{O}$; *bc* with $\text{BaI}_2 \cdot \text{BaO} \cdot 9\text{H}_2\text{O}$; and *cd* with $\text{BaI}_2 \cdot 2\text{H}_2\text{O}$. According to E. Beckmann, at 120° , the crystals lose a mol. of water. E. Tassily dried the preceding salt in vacuo over sulphuric acid, and obtained crystals of $\text{BaO} \cdot \text{BaI}_2 \cdot 2\text{H}_2\text{O}$, with a heat of soln. of 33 Cals. in dil. hydriodic acid with two mols of HI at 20° ; and a heat of formation, $(\text{BaO} \cdot \text{BaI}_2 \cdot 2\text{H}_2\text{O}_{\text{solid}})$, 29.9 Cals. The individuality of all these oxy-salts is by no means established.

E. Defacqz¹⁶ prepared barium fluoriodide, $\text{BaF}_2 \cdot \text{BaI}_2$, of sp. gr. 5.21, 118°, by a similar process to that employed for the fluorochloride, *q.v.*, but the former salt is more readily decomposed by water. He also made strontium fluoriodide, $\text{SrF}_2 \cdot \text{SrI}_2$, sp. gr. 4.5; and calcium fluoriodide, $\text{CaF}_2 \cdot \text{CaI}_2$. The latter is very deliquescent. O. Ruff and W. Plato found the f.p. curve of mixtures of barium fluoride and iodide has a eutectic at about 660° with about 92 molar per cent. of barium iodide; and with calcium fluoride and iodide, a eutectic at about 625° with about 82 molar per cent. of calcium iodide. Mixtures of barium chloride and iodide give a eutectic at about 700° with about 91 molar per cent. of barium iodide; and mixtures of calcium chloride and iodide, a eutectic at 550° with 49 molar per cent. of calcium iodide.

REFERENCES.

- ¹ J. L. Gay Lussac, *Ann. Chim. Phys.*, (1), 91. 5, 1814; H. Moissan, *ib.*, (7), 18. 289, 1899; Lies-Bodart and M. Jobin, *ib.*, (3), 54. 363, 1858; G. P. Baxter and F. N. Brink, *Journ. Amer. Chem. Soc.*, 30. 46, 1908; O. Henry, *Journ. Pharm. Chim.*, (2), 13. 408, 1827; J. B. Berthelot, *ib.*, (2), 13. 415, 1827; C. Wendler, *Zeit. Chem.*, 6. 291, 1863; H. Croft, *Journ. prakt. Chem.*, (2), 68. 402, 1856; J. von Liebig, *Liebig's Ann.*, 121. 122, 1862; R. Rother, *Amer. Journ. Pharm.* (4), 13. 230, 1883; E. Tassily, *ib.*, (7), 17. 113, 1899; *Bull. Soc. Chim.*, (3), 13. 449, 1895; *Compt. Rend.*, 120. 733, 1895; O. Hesse, *Chem. Centrbl.*, (2), 33. 174, 1862; R. Phillips, *Chemist*, 2. 205, 1841; R. Wagner, *Kunst-Gewerbeblatt Bayerischer*, 48. 235, 1862; S. Kern, *Chem. News*, 31. 244, 1875.
- ² O. Mügge, *Neues Jahrb. Min.*, i, 130, 1898; *Centr. Min.*, 105. 1918; G. Werther, *Journ. prakt. Chem.*, (1), 91. 331, 1864; E. Beckmann, *ib.*, (2), 26. 385, 1882.
- ³ O. Ruff and W. Plato, *Ber.*, 35. 3512, 1902; C. H. D. Bödeker, *Die Beziehung zwischen Dichte und Zusammensetzung bei festen und liquiden Stoffen*, Leipzig, 1860; E. Filhol, *Ann. Chim. Phys.*, (3), 21. 415, 1847; G. P. Baxter and F. N. Brink, *Journ. Amer. Chem. Soc.*, 30. 46, 1908; F. W. Clarke, *Ber.*, 12. 1398, 1879; O. Mügge, *Centr. Min.*, 105. 1918.
- ⁴ W. Ramsay and N. Eumorfopoulos, *Phil. Mag.*, (5), 41. 360, 1896; T. Carnelley, *Journ. Chem. Soc.*, 33. 273, 1878; 37. 125, 1880; O. Ruff and W. Plato, *Ber.*, 36. 2357, 1903; E. Lubarsky, *Journ. Russ. Phys. Chem. Soc.*, 28. 460, 1896; J. L. Gay Lussac, *Ann. Chim. Phys.*, (1), 91. 60, 1814; O. Mügge, *Neues Jahrb. Min.*, i, 130, 1898; *Centr. Min.*, 105. 1918.
- ⁵ H. Croft, *Chem. Gaz.*, 14. 125, 1856; *Journ. prakt. Chem.*, (1), 68. 402, 1856; E. Beckmann, *ib.*, (2), 26. 385, 1882; (2), 27. 126, 1883; G. Werther, *ib.*, (1), 91. 331, 1864; J. Thomsen, *Ber.*, 10. 1343, 1877; H. Lesœur, *Ann. Chim. Phys.*, (7), 2. 110, 1894; E. Tassily, *ib.*, (7), 17. 48, 1899; *Bull. Soc. Chim.*, (3), 9. 629, 1898; E. Lubarsky, *Journ. Russ. Phys. Chem. Soc.*, 28. 460, 1899; A. Étard, *Ann. Chim. Phys.*, (7), 2. 528, 1894.
- ⁶ P. Kremers, *Pogg. Ann.*, 103. 65, 1858; A. Étard, *Ann. Chim. Phys.*, (7), 2. 528, 1894; (7), 3. 275, 1894.
- ⁷ G. T. Gerlach, *Zeit. anal. Chem.*, 8. 285, 1869; L. C. de Coppet, *Compt. Rend.*, 134. 1208, 1903; P. Kremers, *Pogg. Ann.*, 11. 60, 1860; H. C. Jones and F. H. Getman, *Zeit. phys. Chem.*, 49. 385, 1904.
- ⁸ C. Dieterici, *Wied. Ann.*, 50. 47, 1894; H. C. Jones and F. H. Getman, *Zeit. phys. Chem.*, 49. 385, 1904; P. Bary, *Compt. Rend.*, 130. 776, 1900.
- ⁹ C. Sheard and C. S. Morris, *Ohio Journ. Science*, 16. 113, 1916.
- ¹⁰ R. G. van Name and W. G. Brown, *Amer. Journ. Science*, (4), 44. 105, 1917; H. C. Jones and F. H. Getman, *Zeit. phys. Chem.*, 49. 385, 1904; H. C. Jones and B. P. Caldwell, *Amer. Chem. Journ.*, 25. 349, 1901; H. C. Jones and C. F. Lindsay, *ib.*, 28. 329, 1902; W. Hittorf, *Pogg. Ann.*, 106. 337, 513, 1859.
- ¹¹ A. Étard, *Ann. Chim. Phys.*, (7), 2. 528, 1874; P. Rohland, *Zeit. anorg. Chem.*, 15. 417, 1897; W. Eidmann, *Ein Beitrag zur Kenntnis des Verhaltens chemischer Verbindungen in nicht-wässrigen Lösungen*, Giessen, 1899.
- ¹² J. L. Gay Lussac, *Ann. Chim. Phys.*, (1), 91. 60, 1814; M. Berthelot, *ib.*, (5), 15. 185, 1878; (5), 16. 442, 1878; S. Kern, *Chem. News*, 31. 243, 1875; F. Ephraim and I. Kornblum, *Ber.*, 49. 2007, 1916; W. Biltz, *Zeit. Elektrochem.*, 26. 375, 1920; F. Gramp, *ib.*, 7. 6723, 1874; C. F. Rammelsberg, *Liebig's Ann.*, 28. 223, 1838; E. Beckmann, *Journ. prakt. Chem.*, (2), 26. 385, 1882; (2), 27. 126, 1883; F. Isambert, *Compt. Rend.*, 66. 1259, 1868.
- ¹³ J. J. Berzelius, *Pogg. Ann.*, 19. 296, 1830; J. Meyer, *Zeit. anorg. Chem.*, 30. 113, 1902; H. M. Dawson and E. E. Goodson, *Journ. Chem. Soc.*, 85. 796, 1904; A. A. Jakowkin, *Zeit. phys. Chem.*, 20. 19, 1896; A. Mosnier, *Ann. Chim. Phys.*, (7), 12. 396, 1897; C. K. Tinkler, *Journ. Chem. Soc.*, 91. 996, 1907; F. Olivari, *Atti Accad. Lincei*, (5), 17. ii, 717, 1908; R. G. van Name and W. G. Brown, *Amer. Journ. Science*, (4), 44. 105, 1917.
- ¹⁴ A. Mosnier, *Ann. Chim. Phys.*, (7), 12. 396, 1897; C. F. Rammelsberg, *Liebig's Ann.*, 28. 223, 1838; *Pogg. Ann.*, 137. 313, 1869; J. Schäfer, *ib.*, 109. 611, 1860; C. Rohrbach, *Wied. Ann.*, 20. 169, 1883; R. F. Weinland and F. Schlegelmilch, *Zeit. anorg. Chem.*, 30. 142, 1902.

¹⁵ E. Tassily, *Ann. Chim. Phys.*, (7), 17, 48, 1899; *Bull. Soc. Chim.*, (3), 9, 629, 1893; E. Beckmann, *Journ. prakt. Chem.*, (2), 27, 134, 1883; F. A. H. Schreinemakers and J. Milikan, *Proc. Acad. Amsterdam*, 15, 52, 1912; J. Milikan, *Zeit. phys. Chem.*, 92, 59, 1918.

¹⁶ E. Defacqz, *Compt. Rend.*, 138, 197, 1904; *Ann. Chim. Phys.*, (8), 1, 333, 1904; O. Ruff and W. Plato, *Ber.*, 36, 2357, 1903.

§ 15. Calcium, Strontium, and Barium Sulphides

According to W. P. Jorissen and J. H. Wieten,¹ an impure form of calcium sulphide is supposed to have played a part in the old Bacchanalia—*vide* hydrogen sulphide. V. Casciorolo's *lapis solaris* or Bologna stone was an impure barium sulphide, and in 1700, F. Hoffmann obtained a product with similar properties by the calcination of a German mineral, presumably gypsum. A. S. Marggraf likewise obtained a luminescent product by calcining gypsum. In 1675, C. A. Baldwin (Latin, Balduinus) found that a like phenomenon was presented by the residue obtained when calcium nitrate is calcined, and the product came to be known as *Baldwin's phosphorus*. In 1730, W. Homberg heated a mixture of *sel armoniak* with twice its weight of *chaux vive*, and obtained a phosphorescent substance which he regarded as a *nouvcau phosphore*, and which came to be called *Homberg's phosphorus*. In 1768, J. Canton made a similar substance by calcining a mixture of oyster shells and sulphur, and the impure calcium sulphide so prepared came to be called *Canton's phosphorus*.

The mixture of calcium sulphide and calcium sulphate, investigated by L. N. Vauquelin, was obtained by calcining a mixture of sulphur and lime: $4\text{CaO} + 4\text{S} = 3\text{CaS} + \text{CaSO}_4$, came to be called *hepar sulphuris calcarem*. T. von Grotthus, G. F. Wach, G. Osann, J. P. Dessaignes described modifications of J. Canton's process; and they prepared phosphori with other bases—tin, cadmium, zinc, arsenic, antimony, barium, strontium, etc. F. Förster, T. P. de Sagan, W. F. McCorty, and F. Pfeiffer, A. Verneuil, etc., have also discussed the preparation of these phosphori. Quite a number of compounds of calcium and sulphur, with and without oxygen, have been reported. Similar remarks apply to compounds of sulphur with barium and strontium. The calcium sulphides, hydrosulphides, and oxysulphides have an important economical bearing because the soln. prepared by boiling together lime, sulphur, water, etc., is extensively employed as an insecticide for scab on animals, and for soft-bodied scale insects on fruit trees. Calcium sulphide is a by-product in the Leblanc's soda process, and is treated for the recovery of sulphur—*vide* alkali sulphides. W. Flight and N. S. Maskelyne reported the occurrence of calcium sulphide in an aerolite found at Busti (India).

R. Bunsen and A. Matthiessen,² and B. von Lengyel obtained calcium sulphide by the direct union of the elements. J. J. Berzelius prepared **calcium monosulphide**, CaS, by passing hydrogen sulphide over red-hot calcium oxide or hydroxide free from carbon dioxide and water. The reactions are symbolized: $\text{CaO} + \text{H}_2\text{S} = \text{H}_2\text{O} + \text{CaS}$; or $\text{Ca}(\text{OH})_2 + \text{H}_2\text{S} = \text{CaS} + 2\text{H}_2\text{O}$. V. H. Veley prepared the sulphide by these processes, and in the case of calcium hydroxide, the temp. of the solid was maintained at 60° during the action of the gas. He noted that the excess of hydrogen sulphide was retained by the calcium sulphide with considerable pertinacity, possibly owing to the soln. of calcium oxide in the water, and the formation of calcium hydrosulphide, or by the union of hydrogen and calcium sulphides: $\text{CaS} + \text{H}_2\text{S} = \text{Ca}(\text{HS})_2$. V. H. Veley also observed that thoroughly dried calcium oxide is unaltered by dried hydrogen sulphide, as is also the case with dried calcium oxide and carbon dioxide. The former case, however, is the more remarkable, in that it would appear more *a priori* probable that the elimination of an infinitesimally small proportion of water would cause the reaction to proceed to its final completion. Neither J. J. Berzelius nor L. N. Vauquelin succeeded in preparing a polysulphide in the dry way. P. Sabatier passed hydrogen sulphide

for an hour over red-hot calcium carbonate, and cooled the resulting calcium sulphide in a stream of hydrogen. A. Forster heated a mixture of sulphur and calcium oxide to redness in a stream of hydrogen: $4\text{CaO} + 4\text{S} = 3\text{CaS} + \text{CaSO}_4$; and $3\text{CaS} + \text{CaSO}_4 + 4\text{H}_2 = 4\text{CaS} + 4\text{H}_2\text{O}$. E. H. Riesenfeld and H. Feld purified calcium monosulphide by first dissolving the sulphide in an aq. soln. of hydrogen sulphide, and removing the hydrogen sulphide from the soln. of calcium hydrosulphide by suction. If air be not excluded, the soln. of hydrosulphide will be yellow owing to the formation of polysulphides, etc. Hence, all operations should be conducted in an atm. of hydrogen sulphide. E. Becquerel emphasized the fact that if air be not excluded the sulphide will be partially oxidized to sulphate.

P. Berthier prepared an impure form of calcium sulphide by heating calcium sulphate, or a mixture of calcium sulphate with one-third its weight of charcoal, in a graphite crucible to a white heat; and A. Mourlot heated the mixture of calcium sulphate and carbon in an electric arc furnace for a few minutes. The molten calcium sulphide so formed crystallized on cooling. F. Sestini, and A. Violi reduced calcium sulphate to sulphide by heating it with sulphur. C. Stammer reduced calcium sulphate by heating it in a stream of carbon monoxide; and B. Unger, L. Marino, and E. H. Riesenfeld, in a stream of hydrogen or water gas. O. Schumann so obtained an 85–86 per cent. yield. H. A. Pagenstecher (1819) first employed hydrogen for reducing barium sulphate. E. Divers and T. Shimidzu converted calcium hydrosulphide, $\text{Ca}(\text{SH})_2 \cdot 2\text{H}_2\text{O}$, into the sulphide, by heating it in a stream of hydrogen sulphide first at 65° and finally at 100° ; the product was contaminated with a little hydrosulphide. A. P. Dubrunfaut, and A. Scheurer-Kestner heated to redness equi-mol. parts of calcium carbonate and sodium sulphide: $\text{Na}_2\text{S} + \text{CaCO}_3 = \text{Na}_2\text{CO}_3 + \text{CaS}$. According to T. J. Pelouze, sodium or potassium monosulphide precipitates calcium hydroxide from soln. of calcium salts, and the alkali hydrosulphide is formed. E. Schöne prepared calcium sulphide by heating calcium carbonate in a stream of carbon dioxide sat. with the vapour of carbon disulphide; the yield of calcium sulphide is almost quantitative. J. J. Berzelius first used this process for making barium sulphide.

P. Berthier, A. Mourlot, A. Violi, E. Schöne, and O. Schumann prepared **strontium monosulphide**, SrS , by the process they employed for calcium sulphide. O. Schumann obtained a 66–67 per cent. yield by passing hydrogen sulphide over heated strontium oxide. J. R. Mourelle recommended cooling the product in a stream of hydrogen. G. Kessler, and S. Kern heated strontium thiosulphate: $2\text{SrS}_2\text{O}_3 = \text{SrS} + \text{SrSO}_4 + \text{S} + \text{SO}_2$, the mass was extracted with water, and the soln. evaporated on a water-bath. J. J. Berzelius, V. H. Veley, O. Schumann, J. Violi, E. Schöne, P. Berthier, and A. Mourlot prepared **barium monosulphide**, BaS , by processes similar to those which they employed for preparing calcium monosulphide. The reaction is utilized in preparing barium salts from heavy spar. The product of the reduction by P. Berthier's process, is extracted with water, and the resulting soln. of barium sulphide is treated with the required acid.

J. von Liebig, for example, mixed heavy spar with about 20 per cent. of charcoal or soot from bituminous coal, and by means of a paste made from starch, moulded the whole into rods. The rods were dried and heated red hot in a furnace, while suitably protected from oxidation. Crucibles or saggars can be used, and E. F. Anthon has described a special furnace for the purpose. C. F. Buchholz recommended the addition of about 16 per cent. of sodium chloride to the mixture of heavy spar and charcoal so as to facilitate the decomposition of the heavy spar. A. Duflos recommended sodium sulphate. In any case the furnace product is dissolved when digested with boiling water, and filtered from the undecomposed heavy spar, charcoal, iron sulphide, etc.

The reduction of the barium sulphate to sulphide by means of carbon has been studied by H. Grüneberg, C. F. Buchholz, H. Langsdorf, J. Kuczynsky, F. J. Otto, M. Rivière, A. Scheurer-Kestner, H. Rose, O. Lenoir, A. Rosenstiehl, etc.

The crude barytes is crushed and mixed with the proper proportions of pulverized coal—say one part of coal and four parts of barytes. The mixture is roasted for about 4 hrs.

in a rotating reduction furnace, and barium sulphate is thereby converted to sulphide. The black ash containing 70 per cent. of sulphide is extracted with water. The resulting soln. of barium sulphide is the starting-point for the preparation of many other commercial salts. For example, with salt cake it forms the so-called *blanc fixe* or precipitated barium sulphate; with soda-ash it forms barium carbonate; with calcium chloride it forms barium chloride; with Chile saltpetre it forms barium nitrate; etc. Strontium sulphide is made in a similar manner. L. Marino claims that water gas is a better reducing agent than coal. E. H. Riesenfeld has studied the reduction of the sulphates of the alkaline earths by carbon and by methane with the idea of extracting the sulphur industrially.

The purified sulphides of the alkaline earths are white amorphous powders or masses. The impurities found in native limestone or gypsum are present, and these impart a yellowish or a reddish tinge to the sulphide. The sulphides are then phosphorescent, for they are luminescent in darkness; the pure sulphides are not luminescent—*vide infra*. A. Mourlot's products were masses containing crystals of cubes and octohedra belonging to the cubic system. According to W. P. Davey,³ X-radiograms of the crystals of calcium and barium sulphides show a simple cubic lattice. The side of the elementary cube is 5·64 Å. with calcium sulphide, and 6·40 Å. with barium sulphide; the closest approach of the atoms on calcium sulphide is 2·82 Å. and 3·20 Å., with barium sulphide. According to A. Mourlot, at 15°, the specific gravity of amorphous calcium sulphide is 2·25, and when crystalline, 2·80; amorphous strontium sulphide, 3·35, and crystalline, 3·70; and amorphous barium sulphide, 4·18, and crystalline, 4·30.

The heat of formation of calcium sulphide, according to P. Sabatier, is (Ca, S) = 92·0 Cals.; of strontium sulphide, (Sr, S) = 99·2 Cals.; and of barium sulphide, (Ba, S) = 102·5 Cals. J. Thomsen gave (Ca, S, aq.) = 110·23 Cals. (Sr, S, aq.) = 104·68 Cals.; and (Ba, S, aq.) = 107·67 or $x - 40·84$ Cals., where x represents the heat of formation of the sulphide. M. Berthelot gave $\text{Ca}(\text{OH})_2 + \text{H}_2\text{S}_{\text{aq.}} = 78$ Cals. P. Sabatier gave for $\text{CaO} + \text{H}_2\text{S}_{\text{gas}} = \text{CaS} + \text{H}_2\text{O}_{\text{gas}} + 13·6$ Cals.; and for the corresponding reaction with strontia, 21·6 Cals.; and with baryta, 22·1 Cals. P. Sabatier gave for the heat of solution for calcium monosulphide, 6·3 Cals.; for strontium monosulphide, 6·8 Cals.; and for barium monosulphide, 7·3 Cals. He gave for the reaction $\text{CaS} + 2\text{HCl}_{\text{aq.}} = 26·3$ Cals.; $\text{SrS} + 2\text{HCl}_{\text{aq.}} = 21·6$ Cals.; for $\text{BaS} + 2\text{HCl}_{\text{aq.}} = 27·2$ Cals.; he also gave for the oxidation, $\text{CaS} + \text{O} = \text{CaO} + \text{S}_{\text{solid}}$, 40·0 Cals., and with gaseous sulphur, 37·4 Cals.; for the corresponding reaction with strontium sulphide the numbers are respectively 33·6 and 31·0 Cals.; and with barium sulphide, respectively 31·5 and 28·9 Cals. Again, for the heat of oxidation of calcium sulphide to sulphate: $\text{CaS} + 2\text{O}_2 = \text{CaSO}_4 + 227·0$ Cals.; strontium sulphide, 230·60 Cals.; and barium sulphide, 236·50 Cals. B. Vaillant found the electrical conductivity of calcium sulphide rapidly increases with temp.

The action of water on the sulphides of the alkaline earths.—According to E. H. Riesenfeld and H. Feld,⁴ a litre of water at 20° dissolves 0·2120 gm. of calcium monosulphide, and the solubility is greatly augmented if hydrogen sulphide be present when the monosulphide passes into hydrosulphide—*q.v.* According to A. Mourlot, when crystalline calcium monosulphide is heated with air-free water, it is rapidly converted into a mixture of calcium hydroxide and hydrosulphide, and hydrogen sulphide is evolved. E. Terres and K. Brückner found that the same remarks apply to strontium sulphide, but when barium sulphide is extracted with water at all temp. up to 100°, barium hydroxyhydrosulphide, $\text{Ba}(\text{SH})(\text{OH}) \cdot 5\text{H}_2\text{O}$, is formed. This is fairly stable, and under no circumstances can barium hydroxide be separated from the soln. by crystallization. When strontium sulphide is treated with boiling water, the soln. deposits crystals of strontium hydroxide on cooling. These facts explain many failures to manufacture barium hydroxide from barium sulphide. Crystalline calcium sulphide is peculiar in that it is more readily attacked by water than the amorphous sulphide. As a rule, the amorphous form of a compound is the more susceptible to attack by chemical agents. C. Lauth found that when calcium or barium sulphide is heated to redness in a current of steam, hydrogen sulphide and the corresponding oxide are formed. According to O. Schumann,

calcium sulphide also furnished a little calcium sulphate, and he found strontium sulphide is oxidized to the sulphate by water vapour. H. V. Regnault said that steam reacts with red-hot barium sulphide forming barium sulphate and hydrogen. The reaction was also studied by O. Lenoir. E. H. Riesenfeld showed that an excess of steam favours the desulphurization of calcium sulphide by the reaction $\text{CaS} + \text{H}_2\text{O} = \text{CaO} + \text{H}_2\text{S}$; but, partly in consequence of the dissociation of the hydrogen sulphide, and partly in consequence of its reaction with water vapour, as shown by M. Randall and F. R. von Bichowsky, the sulphur was obtained in the form of sulphur dioxide, or elementary sulphur. The latter predominated when an excess of steam was used. When amorphous calcium sulphide is boiled with an excess of water, frequently renewed, H. Rose found that calcium or barium sulphide is slowly converted into a soln. of hydrosulphide, and a residue of the hydroxide mixed with a little undecomposed sulphide, e.g. $2\text{BaS} + 2\text{H}_2\text{O} \rightleftharpoons \text{Ba}(\text{OH})_2 + \text{Ba}(\text{SH})_2$, and, added T. J. Pelouze, some hydrogen sulphide is simultaneously evolved. According to A. Béchamp, calcium monosulphide is but slightly soluble in water, the solubility is augmented by raising the temp., and J. Kolb found that :

Grm. CaS	10°	18°	40°	60°	90°
	0·15	0·23	0·30	0·48	0·33 per litre

F. Stolle's numbers are not consistent with J. Kolb's, and they are indicated below. A prolonged contact results in what appears to be increased solubility. H. Rose believed it to be very doubtful if calcium sulphide can exist in aq. soln. According to P. de Clermont and J. Frommel, the reaction is more vigorous the higher the temp.; and, according to R. Rickmann, the presence of calcium chloride facilitates the decomposition of calcium sulphide by water. The sulphide is really hydrolyzed by water: $2\text{CaS} + 2\text{H}_2\text{O} \rightleftharpoons \text{Ca}(\text{OH})_2 + \text{Ca}(\text{SH})_2$; or, expressed ionically: $\text{S}'' + \text{H}_2\text{O} \rightleftharpoons \text{SH}' + \text{OH}'$. It might, therefore, be anticipated that the solubility of calcium sulphide in water will be diminished by soluble hydroxides, as was found to be the case with sodium and calcium hydroxides. Thus, a soln. of *calcium hydroxide*, limewater at 14°, dissolves the same quantity of calcium sulphide as water alone, and at 60° it dissolves 0·18 gm. of calcium sulphide. Milk of lime at 60° was found to dissolve 0·55 gm. of calcium sulphide. Again, water at 10°, containing the eq. of 4 to 102 grms. of *sodium hydroxide* per litre dissolves only traces of calcium sulphide; at 40° to 60°, or at the b.p., considerable amounts of sodium sulphide are formed, and this the more the greater the conc. of the soln. J. Kolb also found that the solubility of calcium sulphide in water between 10° and 60° appears to be slightly diminished by *sodium chloride*, and increased by *sodium sulphate*. W. Gossage stated that calcium sulphide is not decomposed by an aq. soln. of *sodium carbonate*, but, added J. Kolb, the carbonate is decomposed if it be in conc. soln., if the action be long continued and if the soln. be warmed; if sodium or calcium hydroxide are also present, the action between calcium sulphide and sodium carbonate is retarded. F. Stolle has measured the solubility of calcium sulphide in soln. of *sugar*, at different conc.—selecting the extreme limits employed by him, the amounts in grams of calcium sulphide dissolved by a litre of water, and of a soln. containing 55 per cent. of sugar are :

	30°	40°	50°	60°	70°	80°	90°
Water alone	1·982	2·123	1·235	1·390	1·696	2·032	2·496
55 per cent. sugar soln.	2·509	2·226	2·340	2·882	2·766	2·972	3·616

C. L. Berthollet found a soln. of strontium sulphide in boiling water gives crystals of octohydrated strontium hydroxide on cooling, and, according to H. Rose, the mother liquid contains the hydrosulphide; while if strontium sulphide is treated with a small proportion of water, strontium hydrosulphide passes into soln., and if the residue is again extracted with water, strontium hydroxide is mainly dissolved. Anhydrous barium sulphide prepared at a temp. below red heat has not been described. H. Rose, and E. Schöne found an aq. soln. of barium mono- or polysulphide

when evaporated in vacuo furnishes thin, white, colourless plates of **hexahydrated barium sulphide**, $\text{BaS}\cdot 6\text{H}_2\text{O}$, or possibly **pentahydrated barium hydroxyhydro-sulphide**, $\text{Ba}(\text{OH})(\text{SH})\cdot 5\text{H}_2\text{O}$; if the crystals are contaminated with the mother liquid, they have a yellow tinge; and, according to H. Rose, they are coloured yellow by exposure to air. E. Schöne found that at 100° the water of crystallization and some hydrogen sulphide is given off, and above 350° , hydrogen sulphide and sulphur are evolved, and the residue is a mixture of barium sulphide and sulphate with a little sulphite. When the crystals are extracted with a little water, H. Rose found that barium hydrosulphide passes into soln. and the hydroxide remains; and when boiled with a large proportion of water, E. Schöne found that the crystals gradually pass into soln., giving a clear liquid which when treated with acids gives off hydrogen sulphide without the decomposition of sulphur. When the crystals are boiled with alcohol, some hydrogen sulphide is given off, but the sulphide does not dissolve. According to W. Eidmann, calcium sulphide is soluble in *methylal*. For the **monohydrated barium sulphide**, $\text{BaS}\cdot \text{H}_2\text{O}$, see barium hydroxyhydrosulphide.

The chemical properties of the sulphides of the alkaline earths.—When a sulphide of the alkaline earths is exposed to air, it is decomposed by the action of water and carbon dioxide, and the compound smells of hydrogen sulphide, for this gas is continuously evolved. At the same time, the mass acquires a pale yellow colour owing to the formation of what H. Rose regarded as oxysulphides. According to B. Unger, moist calcium sulphide is readily oxidized by the oxygen of the air, forming calcium thiosulphate. According to A. Mourlot, crystalline calcium monosulphide is not reduced by **hydrogen**, but when heated in **oxygen**, it is quantitatively oxidized to the sulphate, but no sulphur dioxide is formed. Similar results were obtained with strontium and barium sulphides. The sulphides of the alkaline earths were found by A. Maillert to form sulphates when exposed to **ozone**. A. Mourlot found that **fluorine** reacted with the cold sulphides of the alkaline earths, heating the mass red hot and forming the corresponding fluoride as well as sulphur fluoride; **chlorine** reacts with barium sulphide in a similar manner at a suitable temp.; and **bromine** and **iodine** react with greater difficulty. The **hydrogen halides** decompose the cold sulphide with a slight rise of temp. The sulphides give off hydrogen sulphide when treated with **dilute acids**. When heated with **sulphur**, polysulphides are formed—*vide infra*. H. Feigel studied the action of a benzene soln. of **sulphur chloride** on the dry sulphides of the alkaline earths, and obtained a yellow product; and in the action of sulphur chloride in benzene soln. on calcium sulphide, he obtained a yellow precipitate of a phenyl sulphide. Dil. **sulphuric acid** furnishes hydrogen sulphide; but A. Mourlot found that fuming sulphuric acid decomposes the sulphide with the separation of sulphur.

According to P. Berthier, dil. **nitric acid**, or **aqua regia**, gives off hydrogen sulphide, but V. H. Veley found that the sulphide becomes red hot, owing to the vigour of the reaction, if conc. nitric acid is dropped on the compound, and A. Mourlot found that with the conc. acid, an evolution of nitrous fumes and separation of sulphur occurs; with **phosphorus pentoxide**, sulphur dioxide is formed and the mass becomes red hot; with **phosphorus trichloride**, PCl_3 , or **phosphoryl chloride**, POCl_3 , a sulphide of the alkaline earth is completely decomposed, and phosphorus sulphide is formed; A. Baudrimont obtained similar results with phosphorus pentachloride, PCl_5 ; and A. Mourlot found that with **arsenic trichloride**, AsCl_3 , arsenic sulphide is formed. According to A. Mourlot, when the sulphide is heated in the electric arc furnace with **carbon**, the corresponding carbide is formed. According to E. Schöne, **carbon dioxide** decomposes heated barium sulphide, forming the carbonate, and if the carbon dioxide is dry, free sulphur is sublimed, but if moisture be present, O. Lenoir found that hydrogen sulphide is formed, and this same gas is evolved when moist air is passed over the heated sulphide. If carbon dioxide be passed through an aq. soln. of the sulphide, barium hydrosulphide is formed as an intermediate product. According to B. Unger, if carbon dioxide be passed slowly over red-hot calcium sulphide, some carbon monoxide is produced. E. H. Riesenfeld has shown that the

equilibrium, $\text{CaS} + \text{H}_2\text{O} + \text{CO}_2 \rightleftharpoons \text{CaCO}_3 + \text{H}_2\text{S}$, cannot be utilized for the desulphurization of calcium sulphide, because the temp. at which the action is sufficiently rapid, favours the re-formation of calcium sulphide. According to J. Kolb, dried calcium monosulphide is not altered by dry carbon dioxide.

According to P. Berthier, when equi-molar parts of barium sulphide and **sodium carbonate** are fused together, a pale brown opaque mass is obtained which, when treated with water, furnishes a soln. of sodium sulphide and an insoluble residue of barium carbonate. J. W. Kynaston found that when calcium sulphide is heated with **sodium hydroxide**, sodium sulphide and calcium oxide are formed. Aq. soln. of barium sulphide with the **metal hydroxides** give barium hydroxide and the metal sulphide which is often united with the barium sulphide. A. Rosenstiehl found this is the case with calcium, manganous, ferric, and ferrous hydroxides, while with zinc hydroxide, the metal sulphide does not unite with the barium sulphide. Oxidizing agents like **lead dioxide**, **potassium chlorate**, and **potassium nitrate** react vigorously when heated with the sulphides of the alkaline earths—according to P. Berthier, there is an “imperfect” detonation with the mixture of barium sulphide and potassium chlorate, and a “perfect” one with potassium nitrate. A. Mourlot found that **chromyl chloride**, CrO_2Cl_2 , reacts vigorously with the sulphides of the alkaline earths. F. Mohr found **ferric oxide** and **manganese dioxide** do not act on boiling soln. of barium sulphide, but when evaporated with the latter, some barium sulphide is formed.

According to A. Brochet and G. Ranson, when a conc. soln. of barium sulphide is electrolyzed at $60^\circ\text{--}65^\circ$, sulphur, barium hydroxide, and hydrogen are formed. The sulphur forms polysulphides with the barium sulphide, and these are reduced by the hydrogen to sulphide and hydrogen sulphide. In dil. soln. sulphur, sulphite, thiosulphate, and sulphate are formed, and as these oxidized products are insoluble they are deposited on the anode. Platinum, iron, nickel, carbon, or lead may be used as anode. Copper behaves as a soluble anode. The addition of sodium chloride has no effect on the general course of the electrolysis, but if iron or nickel be used as electrodes, they behave like soluble anodes. Increase of cathodic current density has little effect. The primary action when barium sulphide soln. is electrolyzed with the electrodes separated by a diaphragm is the same as when no diaphragm is used; sulphur and polysulphides are formed at the anode, and the cathode chamber contains barium hydroxide, hydrogen being evolved at the cathode. The barium hydroxide diffuses into the anode compartment, but as it has no action on the soluble polysulphides it may be recovered, since it separates on cooling the soln. The electrolysis of barium sulphide soln. offers a convenient method for the manufacture of barium hydroxide.

The photo-luminescence of the sulphides of the alkaline earths.—The photo-luminescence or phosphorescent action which occurs when the so-called Bolognian and Canton's phosphori have been exposed to sunlight or the electric light, has attracted much attention. The duration and intensity of the phosphorescence is determined by a number of factors—nature and amount of impurity; the temp.; the intensity and duration of the light stimulus; etc., so that apparently discrepant statements of the duration of the phosphorescence have been reported. Thus, J. P. Dessaignes⁵ found Canton's phosphorus will shine for 10 hrs. after being exposed to sunlight for 10 secs., and T. von Grotthus found it to shine for five days; while F. M. Zanottus found that 1–2 secs.' illumination suffices to make Bolognian phosphorus luminesce for about 30 mins. L. J. M. Daguerre found that Bolognian phosphorus will shine for 48 hrs. after it has been insolated; P. Heinrich said 1 hr.; G. Osann, 4 mins.; and J. P. Dessaignes, 80 secs. J. P. Dessaignes and P. Heinrich found that a momentary illumination lasting 10 secs. produces as bright and lasting a phosphorescence as a long-continued insolation.

Instruments called *phosphorescopes* have been designed by E. Becquerel, W. Crookes, E. Wiedemann, C. de Watteville, and P. Lenard for measuring the duration of short-lived phosphorescences. J. R. Mourello showed that with calcium, strontium,

barium, and zinc sulphides the effect is more intense and of longer duration when stimulated by diffused light; bright sunlight shortens the duration and lessens the intensity of the phosphorescence. Diffused light also increased the sensibility of the substance to light stimuli, and this sensibility may be augmented by repeated exposure, and J. R. Mourelle developed the sensibility of a specimen of strontium sulphide to such a degree that the light of a candle sufficed to excite the phosphorescence. Again, if the phosphorescence of the strontium sulphide be of sufficient intensity, it can excite the phosphorescence of another sample of the sulphide, but to a less degree. This phenomenon has been termed *auto-excitation*. In illustration, when a flask of phosphorescent sulphide is exposed to light, only the outside layers are directly stimulated by light, but yet the mass is phosphorescent in zones of decreasing intensity towards the centre of the flask. The phosphori retain their peculiar properties so long as they are not chemically changed, and therefore those which are liable to oxidize and change when exposed to air must be preserved in sealed tubes. According to D. Gernez, alkaline earth sulphides lose their property of phosphorescing when exposed for a long time, but heating the substance in a current of dry hydrogen acts as a restorative—probably by reducing the sulphates. F. M. Zanottus stated that Bolognian stone phosphoresces in vacuo.

F. M. Zanottus experimented on the effect of coloured light on the phosphorescent substance. He inquired whether the phosphorescent light is the same as the exciting light; he stated that the luminosity is whiter or redder than the exciting light, and that the colour of the phosphorescence is the same whether it is excited by exposure to red or blue light. He thought the phenomenon was due to a kind of internal combustion of the stone. J. Herbert experimented on the same subject in 1763; and in 1771, J. B. Beccaria proved that *light which is absorbed is alone capable of exciting phosphorescence*. In 1775, B. Wilson ascertained that the most refrangible rays, near the violet end of the spectrum, are the most active, while the least refrangible rays, near the red end of the spectrum, may even quench the phosphorescence excited by the other rays. In 1777, L. Euler expressed the opinion that the smallest particles of the phosphorescent body have a definite period of oscillation, and that light of the same vibration frequency can set these particles vibrating so as to enable them to emit light. The action of light of various colours was also studied by W. L. Krafft (1777), M. de Magellan (1777), A. A. Scherer (1795), G. Osann (1825), T. von Grotthus (1815), C. L. Morozzo (1786), J. W. Ritter (1803), and P. Heinrich (1820), etc. E. Becquerel ascertained that the property possessed by light of rendering certain bodies luminous in the dark appears to reside, if not entirely, at least to a great extent, in the violet rays, whilst the red rays are completely devoid of this property. T. J. Seebeck, J. B. Biot, and F. J. Arago showed that the invisible ultra-red rays render a phosphorescent body luminous, or visible, whilst when plunged in the visible red, yellow, or green rays, the same body is not rendered luminous, and the luminescence previously excited by the invisible rays is quenched. E. Becquerel and E. Wiedemann concluded, as J. B. Beccaria had done previously, that those rays which are absorbed by a body can alone produce phosphorescence; rays which are not absorbed do not induce the phenomenon.

E. Becquerel, E. Lommel, W. de W. Abney, and P. Lenard have studied the *spectrum* of the phosphorescent light. In general, the spectrum consists of one or more continuous bands having maxima at different wave-lengths determined by the nature of the phosphorescent substance. Thus, there are three maxima with calcium sulphide which phosphoresces with a blue light—the first in the yellow with $\lambda=0\cdot584$; the second in the green with $\lambda=0\cdot517$; and the third in the blue with $\lambda=0\cdot462$. The position of the maxima are determined by the impurities in the sulphide; and P. Lenard stated that the wave-length in vacuo of such a maximum determined by a given impurity is proportional to the dielectric k of the containing medium. If $k=\mu^2$ be true, then the wave-length in the substance corresponding to such a maximum is always the same.

The *colour* of the phosphorescent light is less refrangible than the incident light, thus Bolognian phosphorus excited by blue or violet light, shines with a yellowish-red light, and Canton's phosphorus under similar conditions shines with a yellow or rose-coloured light. The light which is capable of exciting a green phosphorescent band consists of one or more bands in the spectrum. All wave-lengths corresponding with a maximum exciting power are shorter than those of the maximum of the phosphorescent bands which they excite, but the band of the exciting light may overlap that containing the phosphorescent light. In general, therefore, *the incident light is of shorter wave-length and greater frequency than that of the excited light*. This is in accord with G. G. Stokes' law, cited in connection with the fluorescence of the halogens. The intensity of the phosphorescence increases up to a maximum with a rise of *temperature*, but it is of shorter duration. E. Dreher found that the phosphorescence endures longer at -15° than at 20° , and it vanishes at 40° . F. P. le Roux, and R. Pictet and M. Altschul found that illuminated calcium sulphide does not phosphoresce if cooled down to -100° , but as the temp. rises, the phosphorescence appears. J. Canton, T. von Grotthus, and G. Osann stated that Canton's phosphorus, which has ceased to shine at a certain temp., will phosphoresce again, even months afterwards, when its temp. is raised—*e.g.* by boiling water—but it afterwards requires renewed exposure to make it shine again.

L. Vanino and E. Zumbusch found that the luminosity is augmented by covering the phosphori with hot water, benzene, amyl alcohol, glycerol, acids, anhydrides, bases, and salt soln. Uninsolated calcium and strontium phosphori become luminous by this treatment—*thermo-luminescence*. Hot sulphuric acid causes calcium phosphori to emit a blue light; strontium phosphori, a green light; and barium phosphori, an orange-yellow light—there is simultaneously an evolution of hydrogen sulphide. The phosphorescence is also augmented by treating the stones with water along with a reagent which develops heat by contact with water. Bolognian phosphorus insolated at -31° , was found by T. von Grotthus to shine at 10° longer, and with greater intensity, than when exposed to light at 31° ; G. Osann found that freshly prepared and warm phosphori acquire little or no luminosity by exposure to light, it is only when cool that they are susceptible; and E. Becquerel found that Canton's phosphorus insolated at 100° – 200° exhibits but little phosphorescence, and the effect of temp. on the colour of phosphorescent strontium sulphide is:

-20°	20°	40°	70°	100°	200°
Pale violet	Violet-blue	Pale blue	Green	Yellow	Pale orange

The change is not always so marked as this. It will be observed that with a rise of temp. the colour moves towards the less refrangible red end of the spectrum. J. Dewar found that the phosphorescence of the alkaline earth sulphides ceases at a temp. of -0° , but they are yet capable of absorbing light energy, so that when the sulphide is insolated at -80° , it phosphoresces when warmed up to ordinary temp. If the light stimulation be at a still lower temp., the intensity of the resulting phosphorescence is increased. M. Curie studied the action of the red and infra-red rays on phosphorescent substances. P. Lenard and V. Klatt showed that the phosphorescent glow is decreased by *pressure*, and the colour is at the same time altered. C. Gutton found that the luminescence is perceptibly increased in a *magnetic field*.

The method of preparation, and the nature of the raw materials has an important influence on the phenomenon. The sulphides of a high degree of purity do not exhibit the phenomenon, while E. Becquerel showed that the sulphides produced from different specimens of native calcium carbonate, furnished an orange, yellow, green, or violet phosphorescence. The phenomenon seems to be dependent on the presence of some foreign substance. In 1791, J. Marchetti attributed the phosphorescence of Bolognian stone to the presence of a little *hepar sulphures*, and in 1909, L. Vanino and E. Zumbusch stated that the phosphorescence of Bolognian stone is

mainly dependent on the presence of a small proportion—say, 0·5 to 2·5 per cent.—of a polysulphide. They prepared a good phosphorescing sample of Canton's phosphorus by heating calcium oxide with sulphur at 1200°. The quality of the sulphur was found to be immaterial, but the quality of the lime is of vital importance. It was found that preparations from calcium hydroxide or carbonate are of good quality. Barium and strontium oxides are rather fusible to be used alone, and they are mixed with the carbonates; the thiosulphates were found by L. Vanino and J. Gans to give good results. The total amount of sulphur in Canton's phosphorus may vary from 12 to 30 per cent., but if the sulphur content is slightly greater than this, the luminosity is impaired. Whenever polysulphides could not be detected, the phosphori were but feebly luminescent, and the addition of a small proportion of sulphur to feebly luminescent phosphori, free from polysulphides, enhanced the phosphorescence to a marked degree. The phosphorescence also depends on the texture of the product. The hard, stony varieties of the monosulphide phosphoresce feebly or not at all. The addition of metal oxides improves the photo-luminescence. According to E. Tiede and A. Schleede, pure fused alkaline earth sulphides are phosphorescent.

P. Breteau prepared phosphorescent calcium sulphide by heating a mixture of calcium carbonate with 15 times its weight of sulphur in a crucible at a dull red heat for an hour. The cold mass was ground to a paste with alcohol, and sufficient alcoholic soln. of basic bismuth nitrate was added to introduce one part of bismuth to 10,000 parts of the sulphide. The mixture was dried in air, and slowly cooled. The product has a violet phosphorescence. The *phosphorogen*— γ ερνάω, I produce—bismuth can be replaced by molybdenum, vanadium, or tungsten.

The presence of traces of foreign metal sulphides—copper, lead, bismuth, thorium, and thallium—modifies the colour and intensity of the luminescence. According to L. Vanino and E. Zumbusch, it is astonishing what a small proportion of these metals is required—often one millionth part of copper, manganese, bismuth, etc., is effective. H. Jackson found that in some cases the amount of impurity is too small to be detected by ordinary chemical tests. Different phosphorescent colours are produced by using different metals. For example :

Rb	Al	Mn	Na	Li	Zn	Bi
Crimson	Red	Yellow	Yellowish-green	Green	Bluish-green	Blue

P. Lenard and V. Klatt found that a certain proportion of the impurity corresponds with a maximum effect of phosphorescence, the effect being diminished if the amount of impurity is increased or diminished.

The effect of additions of traces of the *exciters*, bismuth, manganese, lead, antimony, cadmium, mercury, tin, copper, platinum, uranium, zinc, and molybdenum, was studied by A. Verneuil, E. Becquerel, L. Bruninghaus, J. R. Mourello, J. de Kowalsky and C. Garnier, L. E. O. de Visser, O. Prager, P. Wöntig, L. Vanino and J. Gans, etc. The presence of cobalt, nickel, iron, or silver seems to diminish appreciably the phosphorescence. According to E. Becquerel, the presence of some alkali appears to be necessary—lithium and sodium salts produce a greenish light; and rubidium salts give a fiery-red luminescence; while potassium salts produce but little effect. L. Vanino and E. Zumbusch observed that sodium sulphate (m.p. 880°) and lithium carbonate (m.p. 660°) have a greater effect than potassium sulphate (m.p. 1074°) in increasing the phosphorescence, and that generally salts of a low m.p. have more influence than those of a high m.p. Too much of any of these salts does not favour the phosphorescence. The presence of 2 per cent. of lithium carbonate gives a bright luminescence, while 12 per cent. is less luminous. It was also found that a salt of silver, gold, or platinum, ultramarine, arsenic sulphide, or Thénard's blue has very little influence on the phosphorescence. Reducing agents like starch prevent the phosphorescence if present in large quantities, but smaller amounts favour the luminosity; e.g. 4 per cent. of starch or cane sugar has a

good influence, but this is not the case with lamp-black. P. Lenard showed that phosphorescent sulphides contain three components: (i) a compound of, say, zinc, calcium, strontium, or barium with sulphur; (ii) a heavy metal—bismuth, manganese, nickel, copper, uranium, thallium, platinum, etc.—which is present in minute proportions as a readily soluble salt; and (iii) a flux—an alkali salt, fluor-spar, etc. The heavy metal exists in the form of a solid soln. in the sulphide of the alkaline earth or zinc. P. Wöntig produced phosphorescent sulphides with constantly increasing proportions of the heavy metal, and found 800° to be the most advantageous temp. of calcination; it is assumed that a sat. solid soln. of the heavy metal is formed. At higher temp. some of the heavy metal is volatilized.

Robert Boyle, J. Canton, and the early observers assumed that material light is actually absorbed by the phosphorescent body. The general idea is that light or some associated form of energy is held by the substance in the form of a strain, and during the recovery from the strain, light is emitted. One set of hypotheses—A. Debiere, E. Wiedemann and G. C. Schmidt, E. L. Nichols and E. Merritt, etc.—assumes that under the influence of light a substance A is converted into a new substance B, which is reconverted to A when the stimulus is removed, and luminescence is the energy evolved as a result of the transformation of B to A. Another group of hypotheses—L. E. O. de Visser, G. T. Beilby, etc.—explained the necessary presence of minute traces of impurities by assuming a solid soln. is formed, and that the solute is ionized in the act of soln.; the ions are still further split into electron-like particles by exposure to light. When the stimulus is removed, the latter reunite to form ions, and the phosphorescence is produced in the act of combination. In the electron theories of J. Stark, P. Lenard, H. S. Allen, etc., it is assumed that under the influence of light electrons are emitted from certain centres, and not uniformly from the whole area of the alkaline-earth sulphide exposed to light. The areas from which the electrons have been liberated acquire a positive charge of electricity, while the electrons themselves become attached to the sulphur atoms. Phosphorescence occurs when the electrons return from the sulphur atoms to their original centres, and in the consequent neutralization of the charges.

It is assumed by P. Lenard that the *centres of emission* with the calcium-copper sulphide is a complex $\text{Ca}_x\text{Cu}_y\text{S}_z$; and the calcium sulphide forms a closed-chain molecule, with the added metal forming a kind of side chain:



A complex ray of light splits off an electron, which after the lapse of a certain interval of time returns to its former position. The oscillations of the *liberated electron* induce sympathetic vibrations in another electron—the *emission electron*. The two kinds of electrons have been compared with “two electric vibration circuits such as are employed in wireless telegraphy, one of which excites the other to a sympathetic vibration by means of resonance.” The emission electron sends off light rays when its period of vibration coincides with that of the liberated electron. The period of vibration of the latter becomes less and less until it is finally smaller than that of the first; otherwise expressed, the wave-length of the exciting light is shorter than that of the excited light—Stokes’ law. When the insulated sulphide is cooled to the temp. of liquid air, no phosphorescence occurs, because it is assumed that the electrons split off do not return, and the energy is in a measure stored up. If the temp. is allowed to rise, the sulphide becomes feebly phosphorescent, because the electrons slowly return to their original centres corresponding with a quiet uniform emission of light. If the insulated sulphide be heated by a Bunsen flame, the phosphorescent light is brilliant, because the electrons return with great rapidity; when the original state is restored, the sulphide loses its capacity to phosphoresce until it is re-illuminated.

W. P. Jorissen and W. E. Ringer compared the phosphorescence of calcium and barium sulphides with that of Sidot’s blende. T. J. Seebeck, T. von Grotthus,

and P. Heinrich noted that Canton's phosphorus becomes luminous when placed in a glass tube over which an electric discharge is passed. J. P. Dessaignes found that the phosphorescence produced by exposure to the light of an electric discharge has the same colour and duration as when produced by ordinary light, and, according to T. von Grotthus, the phosphorescence excited by the electric light is brighter than that excited by ordinary light. T. J. Pearsall, A. C. Becquerel, J. B. Biot and E. Becquerel, J. W. Draper, C. Matteucci, K. Kortum, J. Trowbridge and J. E. Burbank, and H. Dufour, studied the effects of electricity on phosphorescent minerals; H. E. Armstrong and T. M. Lowry, the relation between the phosphorescence of calcium-bismuth sulphide mixture and its radio-activity. H. Becquerel studied the effect of **radium radiations**; J. Lepinay, and E. A. Bichat, the effect of **N-rays**; A. W. Hofmann, J. Precht, and P. Bary, the effect of **X-rays** and **Becquerel's rays**; E. Becquerel, H. Jackson, E. Goldstein, and P. Lenard, E. Wiedemann and G. C. Schmidt, the effect of **cathode rays**, on the phosphorescent sulphides of the alkaline earths. E. L. Nichols and D. T. Wilber found that purified calcium sulphide, like calcium oxide, exhibits **flame luminescence**. P. Vaillant found the **photoelectrical conductivity** of a thin plate of calcium sulphide exposed to light increases up to a maximum and then rapidly diminishes. In darkness the decrease is continuous, and is immeasurably small after five days. The results are not due to changes of temp. B. Gudden and R. Pohl studied the photoelectric conductivity and phosphorescence of calcium sulphide.

The hydrosulphides of the alkaline earths.—J. J. Berzelius⁶ prepared aq. soln. of hydrated calcium hydrosulphide, $\text{Ca}(\text{SH})_2 \cdot 6\text{H}_2\text{O}$, by passing hydrogen sulphide into water in which calcium hydroxide or sulphide is suspended so long as the gas is absorbed. A relatively large proportion of water must be used in order that all the calcium hydroxide or sulphide can be converted into the soluble hydrosulphide; if the proportion of water is too small, some calcium sulphide remains undissolved. E. H. Riesenfeld and H. Feld found for the solubility, *S*, of calcium hydrosulphide—grams per 100 c.c.—in water in the presence of hydrogen sulphide at the partial press., *p*,

<i>p</i>	100	200	300	400	500	600	700	760 mm.
<i>S</i> { 0°	26·61	29·45	30·09	30·67	31·17	31·66	32·08	32·41
20°	24·87	26·15	27·35	28·10	28·76	29·43	30·09	30·42
40°	21·97	24·24	25·20	25·94	26·61	27·35	28·04	28·44

Calcium sulphide of a high degree of purity can be made by extracting the crude material with aq. hydrogen sulphide under press. and in the absence of air, and precipitating the calcium sulphide by removing the hydrogen sulphide from the soln. at a low press.

Water is needed for the production of hydrosulphide; however long the gas may be passed over calcium hydroxide, the monosulphide is formed with but a trace of hydrosulphide in consequence of the small amount of water set free from the hydroxide—the reaction is incomplete. Conc. soln. of calcium chloride and potassium hydrosulphide give a slimy precipitate with the evolution of hydrogen sulphide, whereas dil. soln. give no precipitate because of the formation of the soluble calcium hydrosulphide. For an analogous reason, T. Graham showed that moistened calcium hydroxide absorbs the gas very much more slowly than if it is mixed with sodium sulphide, because, in the latter case, calcium sulphate and sodium hydrosulphide are formed, and the latter, unlike calcium hydrosulphide, can exist when only a little water is present. The soln. prepared by T. J. Pelouze contained only 7 per cent. of hydrosulphide—any calcium hydroxide in excess of this remains undissolved without passing into the monosulphide; but he obtained more conc. soln. of the hydrosulphide by using calcium sulphide, or a soln. of the so-called sugar-lime in place of the hydroxide. According to A. Béchamp, if hydrogen sulphide be passed into water in which calcium carbonate is suspended, an alkaline liquid is obtained containing calcium hydrosulphide and hydrocarbonate, and free hydrogen sulphide. The reaction is

reversible, for E. Divers and T. Shimidzu showed that carbon dioxide decomposes the hydrosulphide; and a mixture of carbon dioxide and hydrogen sulphide may be sent through lime-water without causing a precipitate, because soluble calcium hydrosulphide is formed. This is a case where lime-water would fail to detect carbon dioxide by the generally recognized test for that gas. R. Böttger's and L. T. Wright's directions for making calcium hydrosulphide in which hydrogen sulphide is passed into milk of lime until the mass acquires a bluish-grey colour, is founded on a misapprehension, because the production of this colour is due to the formation of ferrous sulphide, and this occurs as soon as any soluble sulphide is present. E. Divers and T. Shimidzu's directions for preparing crystals of calcium hydrosulphide are:

Hydrogen sulphide is passed into a paste-like mass made by mixing calcium oxide gradually with four parts of water. When the lime has all dissolved, fresh lime is gradually added about four times until the point of sat. is reached. The current of gas is then stopped, and the liquid left in the tube to clarify, very carefully sealed up, at the ordinary, or a slightly warm, temp., in order that most of the crystals which may have formed in the cold shall redissolve. After decantation, the clear soln. is again kept in ice, when it crystallizes, and the more abundantly the better it has been sat. at a low temp. The calcium hydrosulphide thus obtained is separated from its mother-liquor by draining, and blowing a current of hydrogen sulphide through the mass of crystals, the tube being all the while immersed in snow. The crystals cannot be removed from an atm. of hydrogen sulphide without undergoing change, and admit therefore of no further drying, except by a momentary swinging of the tube to expel adhering liquid centrifugally.

The operations required several days. V. H. Veley obtained good results with this process. H. Rose obtained a soln. of calcium hydrosulphide by boiling calcium monosulphide repeatedly with water, and filtering off the calcium hydroxide. Calcium hydrosulphide is found in the drainings from soda-waste heaps. C. Kraushaar leached with cold water the interior of a heap of soda-waste, and obtained a soln. containing 3 per cent. of the sulphur in the alkali-waste, and of this, 90 per cent. was in the form of hydrosulphide of calcium and sodium. It has also been proposed to make a soln. of calcium hydrosulphide on an industrial scale by treating a mixture of alkali-waste and water with hydrogen sulphide. C. Kraushaar also recommended acting on the calcium sulphide with water under press. According to H. von Miller and C. Opl, if the soln. be evaporated, hydrogen sulphide is expelled, and crystals of calcium hydroxide are formed, since during the evaporation the salt hydrolyzes: $\text{Ca}(\text{SH})_2 + 2\text{H}_2\text{O} \rightleftharpoons \text{Ca}(\text{OH})_2 + 2\text{H}_2\text{S}$. On account of this reversal of the reaction, E. Divers and T. Shimidzu recommend drying in a stream of hydrogen sulphide the crystals of calcium hydrosulphide obtained by cooling the sat. soln. to 0° .

J. J. Berzelius, and H. Rose prepared a soln. of **strontium hydrosulphide**, $\text{Sr}(\text{SH})_2$, by the same process as they employed for the calcium salt. J. J. Berzelius described the preparation of crystals of hydrated **barium hydrosulphide**, $\text{Ba}(\text{SH})_2 \cdot 4\text{H}_2\text{O}$, by saturating an aq. soln. of the oxide with hydrogen sulphide, adding alcohol to the soln., filtering off the sulphur and oxidized products, and cooling the soln. to -10° , when colourless four-sided prisms are produced; the soln. may also be crystallized by evaporating it in vacuo, when white opaque prisms are produced; H. Rose concentrated a soln. of barium sulphide by evaporation in a retort, and obtained on cooling the liquid a crystalline mass of the hydrosulphide. V. H. Veley employed a modification of the process used by E. Divers and T. Shimidzu for calcium hydrosulphide and found the crystals had the composition $\text{Ba}(\text{SH})_2 \cdot 4\text{H}_2\text{O}$. The barium salt is far more stable than the corresponding calcium compound. E. Schöne's crystals of tetrabarium heptasulphide, $\text{Ba}_4\text{S}_7 \cdot 25\text{H}_2\text{O}$ —*vide infra*—are possibly impure barium hydrosulphide.

The hydrosulphides of the alkaline earths form colourless prismatic crystals; those of the hydrated calcium salt melt with a slight rise of temp. in their water of crystallization, and, according to E. Divers and T. Shimidzu, a little decomposition occurs even in an atm. of hydrogen sulphide. V. H. Veley found the crystals of the

hydrated barium salt when heated in an atm. of hydrogen in a sealed capillary tube, showed no signs of liquefaction in their water of crystallization, but were simply dehydrated, as previously recorded by J. J. Berzelius. E. Schöne found the crystals of barium hydrosulphide did not give off hydrogen sulphide below 230° , but V. H. Veley found no decomposition at 18° ; there is a very slight decomposition at 50° , with the evolution of hydrogen sulphide and water; and as the temp. rises, the decomposition proceeds more quickly. When barium hydrosulphide is dehydrated, its stability is much increased, the hydrogen sulphide is retained with great persistence. The hydrogen sulphide is completely eliminated only at a red heat, forming barium monosulphide. According to J. Thomsen, the heats of formation are: $(\text{Ca}, \text{S}_2, \text{H}_2, \text{aq.}) = 115.36$ Cals.; $(\text{Sr}, \text{S}_2, \text{H}_2, \text{aq.}) = 123.68$ Cals.; and $(\text{Ba}, \text{S}_2, \text{H}_2, \text{aq.}) = 124.16$ Cals. According to E. Divers and T. Shimidzu, calcium hydrosulphide is readily soluble in water. The aq. colourless soln. is corrosive and has a bitter taste; it reacts alkaline. With calcium hydrosulphide at ordinary temp., one-fourth of its weight of water appears more than sufficient to hold it in soln.; and 4 or 5 drops of water in 10 c.c. of a sat. soln. prevents its crystallization when cooled in ice. This phenomenon is characteristic of salts with a large amount of water of crystallization, at a temp. near their m.p. A soln. nearly sat., even when warm, loses scarcely any water in a stream of dry hydrogen sulphide. The sp. gr. of an aq. soln. containing 32 per cent. of $\text{Ca}(\text{SH})_2$ was 1.225 at 23° , and a soln. with 37 per cent. of $\text{Ca}(\text{SH})_2$ was 1.210 at 23.5° . J. J. Berzelius showed that when the aq. soln. of calcium hydrosulphide is evaporated in an atm. of hydrogen, hydrogen sulphide is evolved, and acicular crystals are deposited; and when the evaporation is nearly completed, the mass swells up, hydrogen sulphide is rapidly evolved, and calcium monosulphide remains. When the soln. is evaporated in a retort, H. Rose found that hydrogen sulphide is evolved, and calcium sulphate, and later calcium oxysulphide, $4\text{CaO} \cdot \text{CaS}_4 \cdot 18\text{H}_2\text{O}$, is deposited. When the aq. soln. of the calcium salt is boiled, it gives off hydrogen sulphide and forms a soln. of the pentasulphide. P. V. Robiquet and M. E. Chevreul found that when a soln. of barium sulphide is oxidized, the sulphite is formed before the sulphate. J. J. Berzelius noted that the crystals of hydrated barium hydrosulphide effloresce in air and form barium sulphite and thiosulphate. E. Divers and T. Shimidzu say that the crystals of hydrated calcium hydrosulphide are readily soluble in alcohol, H. Rose that hydrated barium hydrosulphide is insoluble in alcohol. T. J. Pelouze ascertained that calcium hydroxide does not convert the hydrosulphide into the monosulphide. The aq. soln. of barium hydrosulphide dissolves sulphur with the evolution of hydrogen sulphide and the formation of polysulphides—*vide infra*; a soln. of manganous sulphate or chloride gives a precipitate of manganese sulphide when added to a soln. of barium hydrosulphide, hydrogen sulphide is at the same time evolved; and iodine forms barium iodide, hydriodic acid, and sulphur. A soln. of the calcium salt gives a precipitate with carbon dioxide, and with salts of zinc. Soln. containing calcium hydrosulphide have been used as a delapidary.

The polysulphides of the alkaline earths.—According to G. Calcagni, 100 c.c. of a cold sat. soln. of calcium hydroxide dissolves 0.1116 gm. of sulphur, or 32.3 parts of sulphur for 40 parts of calcium. This proportion corresponds with the formation of calcium monosulphide. Similarly, a cold sat. soln. of barium hydroxide dissolves 2.6 grms. of sulphur; and the conc. of the soln. furnishes acicular crystals of the tetrasulphide, BaS_4 . All the soln. respond to reactions for sulphides, polysulphides, thiosulphates, and sulphites. No disulphide has been obtained. Barium tri-, tetra-, and penta-sulphides, and $\text{Ba}_4\text{S}_7 \cdot 25\text{H}_2\text{O}$, have been reported; and strontium and calcium tetra-, and penta-sulphides, but not the trisulphides. L. N. Vauquelin⁷ calcined a mixture of eight parts of barium oxide with six parts of sulphur, and extracted the product with water; barium sulphate remained behind, and a soln. of barium trisulphide, BaS_3 , was supposed to remain in soln.: $4\text{BaO} + 10\text{S} = 3\text{BaS}_3 + \text{BaSO}_4$. E. Schöne prepared barium trisulphide by melting together an intimate mixture of barium monosulphide with half its weight of sulphur, and distilling off

the excess of the latter at a temp. not exceeding 360° . According to the latter, the yellowish-green mass when crushed forms a yellow powder, which melts at 400° to a black liquid and at the same time loses sulphur; sulphur is expelled at a red heat until barium monosulphide remains; in moist air the powder smells of hydrogen sulphide, and, according to J. L. Gay Lussac, the gas is formed when steam is passed over the red-hot sulphide. According to E. Schöne, barium trisulphide dissolves when repeatedly boiled with much water and forms an alkaline liquid which is dark red when hot, and yellowish-red when cold. The soln. gives off no hydrogen sulphide when treated with manganese sulphate; but it changes rapidly on exposure to air, and barium carbonate and thiosulphate separate out. When the soln. is evaporated in vacuo, it furnishes first a crop of white or pale yellow plates of hexahydrated barium sulphide, $\text{BaS}\cdot 6\text{H}_2\text{O}$; second a crop of pale orange-red monoclinic prisms of tetrabarium heptasulphide, $\text{Ba}_4\text{S}_7\cdot 25\text{H}_2\text{O}$ —possibly $3(\text{BaS}\cdot 6\text{H}_2\text{O})\text{-(Ba}_4\text{S}_7\cdot 25\text{H}_2\text{O})\cdot 6\text{H}_2\text{O}$, or impure hydrosulphide.

The crystals of tetrabarium heptasulphide are yellow by transmitted light, and pale red by reflected light. When exposed to air, a yellowish-white crust of barium thiosulphate appears on the crystals; barium thiosulphate is also formed if air be excluded, possibly by interaction with the water of crystallization. Part of the water of crystallization is expelled at ordinary temp., part at 100° ; and at 230° , barium thiosulphate or a decomposition product and hydrogen sulphide are formed. Decomposition into the monosulphide and hydrosulphide is not complete at 280° to 300° . The aq. soln. form barium thiosulphate on exposure to air; it develops hydrogen sulphide when treated with acids, but not with manganous sulphate, and sulphur is at the same time deposited.

According to E. Schöne, if an aq. soln. of a mol of calcium sulphide be boiled with three gram-atoms of sulphur, a soln. of **calcium tetrasulphide**, CaS_4 , is formed. If less than this amount of sulphur be employed, the excess of calcium monosulphide is hydrolyzed, forming calcium hydroxide and hydrosulphide, and crystals of an oxysulphide, $4\text{CaO}\cdot\text{CaS}_4\cdot 18\text{H}_2\text{O}$, are formed by the union of the hydroxide with the tetrasulphide. E. Divers and T. Shimidzu doubt the existence of calcium tetrasulphide (*vide infra*). E. Schöne prepared crystals of **hexahydrated strontium tetrasulphide**, $\text{SrS}_4\cdot 6\text{H}_2\text{O}$, by evaporating at 16° in vacuo a soln. prepared like that containing calcium tetrasulphide, and cooling the red syrupy liquid below 8° . The syrup crystallizes to radiating masses of red crystals which melt at 25° . The crystals are very deliquescent, and at 100° form **dihydrated strontium tetrasulphide**, $\text{SrS}_4\cdot 2\text{H}_2\text{O}$. The latter compound is formed by evaporating the aq. soln. of strontium tetrasulphide at 20° – 25° in vacuo. The resulting crystal aggregates are pale yellow, and readily deliquesce, forming a dark yellow syrupy liquid which on exposure to air forms an oxysulphide, $\text{SrO}\cdot\text{SrS}_4\cdot 12\text{H}_2\text{O}$. E. Schöne prepared **hydrated barium tetrasulphide**, $\text{BaSr}_4\cdot 1$ or $2\text{H}_2\text{O}$, by boiling a mixture of four parts of sulphur with seven of barium sulphide, and allowing the filtered soln. to crystallize out of contact with air; the same salt is obtained as indicated above as the final crop in the crystallization of a soln. of barium trisulphide. The red crystals so obtained are frequently mixed with acicular crystals of barium thiosulphate and other barium polysulphides. The product is purified by dissolving it in air-free water and evaporating the soln. in vacuo. H. Rose prepared what he regarded as a soln. of barium polysulphide by dissolving sulphur in a hot soln. of the hydrosulphide. According to V. H. Veley, sulphur dissolves with effervescence in a warm sat. soln. of barium hydrosulphide, forming a dark red liquid which furnishes red crystals with the composition $2\text{BaS}_3\cdot 7\text{H}_2\text{O}$, and which are probably $\text{BaS}_4\cdot 2\text{H}_2\text{O}$ slightly dehydrated. E. Schöne's analysis corresponds more nearly with imperfectly dried $\text{BaSO}_4\cdot \text{H}_2\text{O}$.

According to E. Schöne, the rhombic crystals of barium tetrasulphide are strongly dichroic. When freshly prepared, the colour is red, and this becomes paler on standing, finally passing to orange-red. The colour in transmitted light is yellow, in reflected light, red. The powdered crystals are yellow. The sp. gr. is 2.988 (20°). The crystals oxidize in air more slowly than the other barium sulphides. At 105° ,

in vacuo, sulphur is given off, and the colour darkens; at 200°, the crystals lose water and hydrogen sulphide; at 300°, the pseudomorphs after the tetrasulphide consist of a mixture of trisulphide and barium sulphate: $8(\text{BaS}_4 \cdot \text{H}_2\text{O}) = \text{BaSO}_4 + 7\text{BaS}_3 + 4\text{H}_2\text{O} + 4\text{H}_2\text{S} + 6\text{S}$; and at a higher temp. the trisulphide loses sulphur to form the monosulphide. A dil. aq. soln. is orange yellow. At 15°, 100 parts of water dissolve 41.3 parts of the tetrasulphide, and the red soln. has an alkaline reaction; the soln. becomes dark brown when heated. The sulphide may be crystallized unchanged from its aq. soln. The soln. when exposed to air smells of hydrogen sulphide, and it gradually becomes turbid owing to the separation of barium carbonate and thiosulphate. The sulphide is insoluble in alcohol and in carbon disulphide; alcohol precipitates orange-yellow crystals from the aq. soln. According to V. H. Veley, the aq. soln. dissolves sulphur and gives off hydrogen sulphide, with the precipitation of sulphur, when treated with hydrochloric acid, but not with manganese sulphate.

According to H. Rose, hydrogen sulphide is given off when a soln. of calcium hydrosulphide is boiled, but when sulphur is present, the evolution of gas is augmented. E. Divers and T. Shimidzu noted that the temp. falls 2°–3° when powdered sulphur dissolves in a soln. of calcium hydrosulphide at ordinary temp.; and that conc. soln. of calcium hydrosulphide react with sulphur almost as vigorously as hydrochloric acid acts on marble. If sulphur be dissolved in a soln. of calcium hydrosulphide heated on a water-bath, until a further addition of sulphur produces no effervescence, and sinks to the bottom, the hydrosulphide is almost completely decomposed, and **calcium pentasulphide**, CaS_5 , is formed—all the calcium which is not present as hydrosulphide is pentasulphide. The hot soln. takes up a little more sulphur than corresponds with the pentasulphide, but the excess is deposited as the soln. cools, and it then takes up no more sulphur if boiled with that element. The reaction is reversible, for hydrogen sulphide decomposes the yellow soln. of calcium pentasulphide with the copious precipitation of sulphur, and a colourless soln. of calcium hydrosulphide is formed. It is assumed that hydrogen pentasulphide is formed as an unstable intermediate product in both cases: $\cdot\text{CaS}_5 + 2\text{H}_2\text{S} = \text{Ca}(\text{SH})_2 + \text{H}_2\text{S}_5$; and $\text{Ca}(\text{SH})_2 + 8\text{S} = \text{CaS}_5 + \text{H}_2\text{S}_5$. The preparation of impure calcium pentasulphide by boiling milk of lime with sulphur is described below.

J. J. Berzelius was unable to prepare a polysulphide by fusing calcium monosulphide with sulphur; but when calcium monosulphide or hydroxide and water is boiled for a long time with sulphur, a soln. of calcium pentasulphide is formed. If the hydroxide be employed, some thiosulphate is formed, and if the hydroxide be in excess, an oxysulphide is formed. When the conc. reddish-brown or dil. yellowish-brown liquid is evaporated in vacuo, an amorphous yellow mass is obtained, which is soluble in water and alcohol, and when heated in vacuo loses sulphur, forming the monosulphide. E. Schöne was unable to crystallize the pentasulphide by the conc. of its aq. soln. since it readily decomposes into calcium monosulphide and hydroxide, and free sulphur. J. J. Berzelius and E. Schöne obtained similar results in their attempt to obtain crystals of **strontium pentasulphide**, SrS_5 , from the aq. soln. prepared as in the case of the calcium pentasulphide. As indicated above, H. Rose prepared a soln. of barium pentasulphide by boiling a soln. of barium sulphide or hydrosulphide with sulphur; and J. J. Berzelius and E. Schöne, in their attempt to isolate **barium pentasulphide**, BaS_5 , obtained similar results to those which attended the attempt to crystallize calcium and strontium pentasulphides from the aq. soln. Barium pentasulphide has not been isolated. L. Guitteau boiled two parts of barium hydroxide with one of sulphur and 25 parts of water, and obtained a black liquid which became orange-red when cold. The soln. decomposed slowly depositing needles of the thiosulphate, and evolving hydrogen sulphide. On evaporation a crystalline crust of barium tetrasulphide mixed with the thiosulphate and sulphur was obtained and the mother-liquor contained $\text{Ba} : \text{S}$ in the at. proportions 1 : 5. This shows that barium pentasulphide is unstable and probably decomposes in aq. soln.: $2\text{BaS}_5 + 3\text{H}_2\text{O} = \text{BaS}_4 + \text{BaS}_2\text{O}_3 + 3\text{H}_2\text{S} + \text{S}$.

The ready decomposition of the pentasulphides of the alkaline earths led E. Divers and T. Shimidzu to suggest that the soln. really contains an unstable hydroxy-derivative of hydrogen pentasulphide, H_2S_5 , namely HO.Ca.HS_5 ; and in support of this they show that the only known solid polysulphides of the alkaline earths—namely, the tetrasulphides—all contain water. The action of water is then symbolized: $\text{CaOH}(\text{HS}_5) + \text{H}_2\text{O} = \text{Ca}(\text{OH})_2 + \text{H}_2\text{S}_5 (=4\text{S} + \text{H}_2\text{S})$; and of hydrogen sulphide: $\text{CaOH}(\text{HS}_5) + 2\text{H}_2\text{S} = \text{Ca}(\text{SH})_2 + \text{H}_2\text{O} + \text{H}_2\text{S}_5 (=4\text{S} + \text{H}_2\text{S})$. When soln. of calcium pentasulphide are boiled out of contact with air, E. Schöne found that only small quantities of thiosulphate are formed; but if the soln. be boiled down until solid matter—sulphur and lime—is deposited and the hydrogen sulphide has escaped, much thiosulphate is produced. According to E. Divers and T. Shimidzu, the result is rather due to the interaction of lime and sulphur than to hydrolysis: $\text{CaS}_5 + 3\text{H}_2\text{O} = \text{CaS}_2\text{O}_3 + 3\text{H}_2\text{S}$, suggested by E. Schöne; the action of air on calcium pentasulphide gives thiosulphate and sulphur, and the former believe that the reaction should not be symbolized; $2\text{CaS}_5 + 3\text{O}_2 = 2\text{CaS}_2\text{O}_3 + 6\text{S}$. They argue that hydrogen sulphide is first liberated by the pentasulphide, and if this gas be removed as rapidly as it is formed, the soln. undergoes no marked oxidation; but if this gas remains in contact with the liquid, it is oxidized, and the products of the oxidation react with the pentasulphide to form thiosulphate and sulphur. The reaction is analogous to the oxidation of calcium hydrosulphide into thiosulphate, except that additional lime is needed in order that no sulphur may be deposited. Air does not directly oxidize either calcium hydrosulphide or pentasulphide.

The oxysulphides of the alkaline earths.—J. J. Berzelius showed that the decomposition of an aq. soln. of calcium hydrosulphide furnishes, presumably hydrated, calcium sulphide; T. J. Pelouze obtained calcium hydroxide. E. Divers and T. Shimidzu reported that calcium hydrosulphide is converted into the hydroxy-hydrosulphide in conc. soln., hydroxide in weak ones, and mixtures, or possibly compounds of the two, when the soln. are of medium strength, while the hydroxy-hydrosulphide itself becomes hydroxide by the action of water. These decompositions proceed only when the hydrogen sulphide produced can escape or become dil., and are much more rapid and complete in hot soln. than in cold soln. Crystals of hydrated calcium hydroxyhydrosulphide, $\text{Ca}(\text{SH})(\text{OH}).3\text{H}_2\text{O}$, have been isolated by E. Divers and T. Shimidzu; and since the composition of the hydrated hydrosulphide is $\text{Ca}(\text{SH})_2.6\text{H}_2\text{O}$, they give the graphic formulæ:

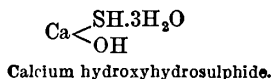
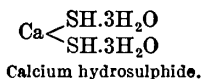

This mixed salt is formed from the hydrosulphide by reaction with water: $\text{Ca}(\text{SH})_2 + \text{H}_2\text{O} = \text{Ca}(\text{SH})(\text{OH}) + \text{H}_2\text{S}$, or with calcium hydroxide: $\text{Ca}(\text{SH})_2 + \text{Ca}(\text{OH})_2 = 2\text{Ca}(\text{SH})(\text{OH})$. It is also formed by the union of calcium sulphide with water, as occurs in the interior of heaps of alkali-waste; and by the action of hydrogen sulphide on calcium hydroxide in the purification of coal-gas. Calcium hydroxyhydrosulphide is conveniently made by passing a stream of hydrogen through a conc. aq. soln. of the hydrosulphide, when colourless four-sided prisms, or minute acicular crystals of the desired salt separate from the liquid. When the crystals of calcium hydrosulphide deliquesce at ordinary temp., hydrogen sulphide is simultaneously evolved; consequently, deliquescence is accompanied by a loss of weight—the deliquescence of normal ammonium carbonate is also accompanied by a loss of weight owing to the loss of water and ammonia: $(\text{NH}_4)_2\text{CO}_3.H_2\text{O} = \text{NH}_3 + \text{H}_2\text{O} + (\text{NH}_4)\text{HCO}_3$. The crystals of calcium hydroxy-hydrosulphide gradually decompose and become opaque, when exposed to air, hydrogen sulphide is slowly evolved, oxygen is absorbed and the crystals become yellow; the salt also takes up carbon dioxide from the air, but not very freely at first.

C. Neuberg and E. Neimann treated a soln. of barium oxide in methyl alcohol

with an alcohol soln. of potassium hydrosulphide and obtained a gelatinous precipitate of hydrated barium monosulphide, $\text{BaS}\cdot\text{H}_2\text{O}$, possibly barium hydroxyhydrosulphide, $\text{Ba}(\text{SH})\text{OH}$, which dissolves slowly in methyl alcohol. Hexahydrated barium sulphide, $\text{BaS}\cdot 6\text{H}_2\text{O}$, is very probably pentahydrated **barium hydroxyhydrosulphide**, $\text{Ba}(\text{SH})(\text{OH})\cdot 5\text{H}_2\text{O}$. Its preparation and properties have been previously described. Both the calcium and barium hydroxyhydrosulphides are crystalline, and have a relatively large proportion of water of crystallization; they dissolve readily in water, but the soln. is soon decomposed into hydroxide which is precipitated, and hydrosulphide which remains in soln. This shows how improbable it is that the hydrosulphides can without decomposition lose their water of crystallization by heat; anhydrous barium sulphide has not been prepared in the wet-way at a temp. below redness. Calcium hydroxyhydrosulphide is insoluble in, and is not affected by, a moderately conc. soln. of the hydrosulphide; it is insoluble in alcohol, but is slowly decomposed by that liquid, as by water, and hydrosulphide passes into soln. From the readiness with which calcium hydroxyhydrosulphide is converted into the hydroxide, the preparations of the former are apt to be more or less mixed with the latter. Hydrogen sulphide converts the hydroxyhydrosulphide into hydrosulphide; and, according to V. H. Veley, calcium hydroxyhydrosulphide absorbs carbon disulphide, forming unstable basic calcium thiocarbonates which are slowly decomposed by hydrogen sulphide, and rapidly by carbon dioxide.

T. J. Pelouze,⁸ and A. W. Hofmann were unable to obtain any evidence of combination when a mixture of calcium oxide and sulphide is heated to redness; nor was the former able to find any satisfactory evidence of the presence of an oxysulphide in the alkali-waste of Leblanc's soda process. E. Kopp is of the opinion that calcium hydroxide and sulphide do combine to form an oxysulphide. J. K. Hayward, and R. W. Thatcher found that the lime-sulphur soln. prepared by boiling milk of lime and sulphur contains two main constituents, calcium pentasulphide and thiosulphate, with small amounts of sulphite or sulphate produced by the oxidation of the soln. When freshly slaked lime and sulphur—with or without sodium chloride—are boiled with an excess of water in open vessels, they dissolve in the proportion $\text{CaO}:\text{S}=1:1.94$ if lime is in excess, and $1:2.24$ if sulphur is in excess. The solubility of lime as calcium hydroxide in water in the proportions used accounts for most of the difference in these ratios, so that the proportion of lime united with sulphur is probably the same whichever component be in excess. Allowing for the excess of lime in soln., therefore, the ratio may be regarded as $1:2.24$. After a time, however, the excess of lime may unite with some of the calcium pentasulphide, for the soln. frequently deposits yellow or red crystals of calcium oxysulphide—*vide infra*—which O. B. Winter represents as $2\text{CaO}\cdot\text{CaS}_5\cdot 11\text{H}_2\text{O}$. The ratio $\text{CaO}:\text{S}=1:2.286$ corresponds with the reaction $3\text{Ca}(\text{OH})_2+12\text{S}=\text{CaS}_2\text{O}_3+2\text{CaS}_5+3\text{H}_2\text{O}$. Although the ratio $\text{CaO}:\text{S}$ approximates to $1:2.24$, the ratio of the sulphur present as CaS_5 to that present as CaS_2O_3 was found to vary from $1:4.19$ to $1:27.78$. Hence, some secondary reaction must take place—*e.g.* $\text{CaS}_2\text{O}_3+\text{Ca}(\text{OH})_2+4\text{S}=\text{CaS}_5+\text{CaSO}_4+\text{H}_2\text{O}$; $2\text{CaS}_2\text{O}_3+3\text{Ca}(\text{SH})_2=2\text{CaS}_5+3\text{Ca}(\text{OH})_2$; etc., and R. W. Thatcher believes the first of these equations represents the most probable reaction.

C. W. Folkard exposed calcium hydroxide to hydrogen sulphide so long as there was any gain in weight, and obtained a grey powder which he regarded as a compound: $4\text{Ca}(\text{OH})_2\cdot 3\text{H}_2\text{S}$. When this product was treated with coal-gas, hydrogen sulphide was given off, and at 100° water was eliminated leaving behind a greyish-green substance which he regarded as a compound: $2\text{Ca}(\text{OH})_2\cdot 2\text{Ca}(\text{SH})\text{OH}$. When gently heated, this product loses a mol of water and forms a yellowish-white substance, $2\text{Ca}(\text{OH})_2\cdot \text{CaS}\cdot \text{Ca}(\text{SH})\text{OH}$; and at a red heat, out of contact with air, it loses two mols of water, producing $2\text{CaO}\cdot \text{CaS}\cdot \text{Ca}(\text{SH})\text{OH}$, which, when ignited in air, burns like tinder, producing calcium sulphate. W. Foster also prepared some oxygenated sulphides of calcium.

V. H. Veley studied the action of hydrogen sulphide on calcium hydroxide, and found that both by the dry and the wet method the calcium oxide is converted

respectively into calcium sulphide and hydrosulphide; and he concludes that "the mol. combinations described by C. W. Folkard are in all probability mixtures of calcium sulphide with unaltered oxide." In addition to E. Divers and T. Shimidzu's hydroxyhydrosulphide two other oxysulphides, or more probably hydroxyhydrosulphides, have been reported, and in the absence of definite or precise information as to their composition, they are conveniently called Herschel's crystals and Buchner's crystals after their respective discoverers. Their limits of existence in the ternary system, $\text{CaO}-\text{S}-\text{H}_2\text{O}$, or even their individuality, have not been established.

J. F. W. Herschel boiled two parts of calcium hydroxide with one of sulphur and 20 of water for an hour, and allowed the filtrate to cool in a closed vessel out of contact with air. A piece of calcium hydroxide was placed in the liquid, and the crystals of oxysulphide which were deposited on the lime, were washed with cold water, and dried in vacuo over sulphuric acid. According to E. Schöne, if the mother liquid is boiled with calcium hydroxide, another crop of crystals of the oxysulphide are deposited on a piece of calcium hydroxide provided the soln. contained calcium thiosulphate. A. Geuther has also described the preparation of this substance, and he objected to the washing of the crystals with water, which has a decomposing action; he preferred to dry them by press. between filter paper. According to J. F. W. Herschel, and A. Geuther, the crystals are orange-yellow, dichroic, transparent, four- or six-sided prisms with di- or tri-hedral summits. According to A. Geuther, the so-called *Herschel's crystals* have the composition of a hydrated calcium tetrahydroxytrisulphide, $\text{Ca}_3(\text{OH})_4\text{S}_3 \cdot 8$ (or 9) H_2O ; or $\text{CaS}_3 \cdot 2\text{CaO} \cdot 10$ or 11 H_2O , or $\text{CaS}_3 \cdot 2\text{Ca}(\text{OH})_2 \cdot 8$ or 9 H_2O ; E. Schöne's analysis $\text{CaS}_4 \cdot 3\text{CaO} \cdot 12\text{H}_2\text{O}$, or $\text{CaS}_4 \cdot 3\text{Ca}(\text{OH})_2 \cdot 9\text{H}_2\text{O}$, is vitiated by the fact that he decomposed the crystals before analysis, by washing them with water. The crystals were partially analyzed by H. Rose, and J. F. W. Herschel. The crystals gradually effloresce at a summer's temp. over sulphuric acid; but they are stable when kept in a sealed tube. They give off water and hydrogen sulphide when heated to 100° , and sulphur sublimes at a higher temp., the residue is white, and is very slightly soluble in water with an alkaline reaction. Both J. F. W. Herschel and E. Schöne reported that water extracts calcium polysulphides— CaS_n —and leaves a residue of calcium hydroxide. According to A. Geuther, the aq. extract contains insignificant quantities of sulphuric acid, and no thiosulphate; and, according to E. Schöne, it gives off no hydrogen sulphide when treated with manganese sulphate; and no sulphur dioxide when treated with a hydrochloric acid soln. of arsenic trioxide. J. F. W. Herschel and E. Schöne observed that the crystals are not changed by alcohol; and they dissolve in hydrochloric acid with the evolution of hydrogen sulphide. A. Geuther said that with dil. hydrochloric acid, the crystals become brownish-yellow, and sulphur is separated; while with conc. acid, hydrogen trisulphide, H_2S_3 , is formed with but a slight evolution of hydrogen sulphide.

J. A. Buchner, and C. F. Buchholz and R. Brandes obtained orange-yellow monoclinic prismatic crystals, the so-called *Buchner's crystals*, by treating *hepar sulphuris calcarem* with insufficient hydrochloric or acetic acid for complete soln., and allowing the liquid to stand while protected from air. E. Schöne prepared them by digesting calcium tetrasulphide with calcium hydroxide and hydrosulphide; and also by boiling two parts of calcium tetrasulphide with one of sulphur and 20 of water for half an hour, and allowing the unfiltered liquid to stand while protected from the air. H. Rose also obtained what appeared to be similar crystals among the products obtained by allowing a soln. of calcium hydrosulphide to stand slightly exposed to air. The composition of Buchner's crystals has not been definitely established; H. Rose deduced the formula $\text{CaS}_5 \cdot 5\text{CaO} \cdot 20\text{H}_2\text{O}$ from his analysis; E. Schöne, $\text{CaS}_4 \cdot 4\text{CaO} \cdot 18\text{H}_2\text{O}$; and A. Geuther, $\text{CaS}_3 \cdot 3\text{CaO} \cdot 14$ or 15 H_2O . The latter agrees with the formula $\text{CaS}_3 \cdot 3\text{Ca}(\text{OH})_2 \cdot 11$ or 12 H_2O , or hydrated calcium hexahydroxytrisulphide, $\text{Ca}_4(\text{OH})_6 \cdot \text{S}_3 \cdot 11$ or 12 H_2O . The crystals when protected from air become paler and finally white. At 100° , they lose about three-fourths of the water,

and half the hydrogen sulphide. The action of water, manganese sulphate, acids, and alcohol on Buchner's crystals is the same as with Herschel's crystals. J. L. Gay Lussac, on the contrary, stated that they are soluble in alcohol.

E. Schöne reported the formation of hydrated **strontium dihydroxytetrasulphide**, $\text{Sr}(\text{OH})_2\text{S}_4 \cdot 11\text{H}_2\text{O}$, or $\text{SrO} \cdot \text{SrS}_4 \cdot 12\text{H}_2\text{O}$, by slightly exposing to the air an aq. or alcoholic soln. of strontium tetrasulphide. The ruby-red, transparent crystals decompose when heated in a glass tube giving off water, hydrogen sulphide, and sulphur, and leaving a residual mixture of strontium monosulphide, sulphate, and a little sulphite. Water gives a yellow soln. with an alkaline reaction, from which strontium hydroxide soon separates; the aq. soln. gives hydrogen sulphide and sulphur when treated with hydrochloric acid. Barium chloride gives no signs of a sulphate, nor arsenious chloride any signs of a thiosulphate. It is insoluble in alcohol, ether, and carbon disulphide. A. Geuther expressed the opinion that Schöne's oxysulphate is a mixture of a polysulphide and a thiosulphate. H. Rose extracted barium sulphide with water five times and analyzed the residue; the analyses have been represented by formulæ showing $x\text{BaS} + y\text{BaO} + z\text{H}_2\text{O}$, but there is nothing to justify the assumption that any of the products are chemical individuals.

P. Berthier⁹ heated a mixture of gypsum with twice its weight of cupric sulphate in a carbon crucible, and obtained a leaden grey sulphide sprinkled with granules of copper. Acetic acid dissolved out of the lime, with the evolution of hydrogen sulphide. Similar results were obtained with barium sulphate. There is no evidence here of the formation of *calcium copper sulphide* or of *barium copper sulphide*. P. Berthier treated a mixture of barium and potassium sulphates in a similar way, but there is little to show that the reddish mass so obtained is really *potassium barium sulphide*.

REFERENCES.

- ¹ W. P. Jorissen and J. H. Wieten, *Chem. Weekbl.*, 12. 768, 1915; F. Hoffmann, *Demonstrationes physicae curiosæ*, Halle, Magdeburgicæ, 1700; A. S. Marggraf, *Hist. l'Acad. Berlin*, 5. 56, 1749; 6. 114, 1750; *Chymische Schriften*, Berlin, 2. 113, 135, 1767; J. Canton, *Phil. Trans.*, 58. 337, 1768; *Crell's Chem. Journ.*, 6. 179, 1781; L. N. Vauquelin, *Ann. Chim. Phys.*, (1), 6. 36, 1790; G. Osann, *Kastner's Archiv.*, 4. 347, 1825; 5. 88, 1825; *Pogg. Ann.*, 33. 405, 1834; F. Förster, *ib.*, 133. 97, 1868; T. P. de Sagan, W. F. McCorty, and F. Pfeiffer, *Dingler's Journ.*, 234. 303, 1879; A. Verneuil, *Compt. Rend.*, 103. 600, 1886; C. A. Balduinus, *Aurum superius et inferioris auræ superioris et inferioris hermeticum*, Amstelodami, 1675; G. F. Wach, *Schweigger's Journ.*, 67. 283, 1833; T. von Grothaus, *ib.*, 14. 133, 1815; 15. 171, 1815; 49. 259, 1827; J. P. Dessaignes, *ib.*, 8. 70, 115, 1813; *Journ. Phys.*, 68. 444, 1809; 69. 5, 1809; 73. 41, 1811; 74. 101, 173, 1812; W. Flight and N. S. Maskelyne, *Ber.*, 3. 39, 1870.
- ² J. J. Berzelius, *Schweigger's Journ.*, 34. 12, 1822; V. H. Veley, *Journ. Chem. Soc.*, 47. 478, 1885; E. Divers and T. Shimidzu, *ib.*, 45. 278, 1884; H. Grüneberg, *Journ. prakt. Chem.*, (1), 60. 168, 1853; C. F. Buchholz, *Gehlen's Journ.*, 1. 310, 1806; H. Langsdorf, *Polyt. Centrbl.*, 1507, 1868; J. Kuczynsky, *Dingler's Journ.*, 135. 455, 1855; P. Berthier, *Ann. Chim. Phys.*, (2), 22. 233, 1823; (3), 24. 275, 1823; A. Scheurer-Kestner, *ib.*, (4), 1. 412, 1864; L. N. Vauquelin, *ib.*, (2), 6. 36, 1817; T. J. Pelouze, *ib.*, (4), 7. 172, 1866; A. Mourlot, *ib.*, (7), 17. 525, 1899; *Compt. Rend.*, 127. 408, 1898; J. R. Mourelle, *ib.*, 125. 775, 1897; P. Sabatier, *ib.*, 88. 651, 1879; *Ann. Chim. Phys.*, (5), 22. 9, 1881; E. Becquerel, *ib.*, (3), 22. 244, 1848; F. Sestini, *Ber.*, 7. 1295, 1874; A. Violi, *ib.*, 10. 293, 1877; *Annali Chimi.*, (3), 13. 311, 366, 1896; L. Marino, *Gazz. Chim. Ital.*, 43. i, 416, 1913; W. P. Davey, *Phys. Rev.*, (2), 17. 402, 1921; E. H. Riesenfeld, *Journ. prakt. Chem.*, (2), 100. 115, 1920; E. H. Riesenfeld and H. Feld, *Zcit. anorg. Chem.*, 116. 213, 1921; L. T. Wright, *Journ. Soc. Chem. Ind.*, 2. 122, 1883; E. Schöne, *Pogg. Ann.*, 112. 184, 1861; C. Stammer, *ib.*, 82. 135, 1851; G. Kessler, *ib.*, 74. 281, 1847; H. Rose, *ib.*, 55. 537, 1842; A. Forster, *ib.*, 133. 94, 228, 1868; B. Unger, *Liebig's Ann.*, 67. 95, 1848; O. Schumann, *ib.*, 187. 286, 1877; R. Bunsen and A. Matthiessen, *ib.*, 94. 111, 1855; F. J. Otto, *ib.*, 26. 92, 1838; A. P. Dubrunfaut, *Bull. Soc. Chim.*, (2), 1. 346, 1864; H. A. Pagenstecher, *Neues Journ. Pharm.*, 3. 1, 291, 1819; B. von Lengyel, *Math. Nat. Ber. Ungarn.*, 14. 180, 1898; S. Kern, *Chem. News*, 32. 137, 1875; M. Rivière, *Bull. Soc. Mulhouse*, 36. 438, 1866; A. Scheurer-Kestner, *ib.*, 36. 448, 1866; A. Rosenstiehl, *ib.*, 40. 129, 1870; O. Lenoir, *Wagner's Jahresber.*, 256, 1867; E. F. Anthon, *Journ. prakt. Chem.*, (1), 8. 406, 1836; A. Duflos, *Archiv. Pharm.*, 36. 275, 1831; J. von Liebig, *Liebig's Ann.*, 35. 115, 1840.
- ³ P. Sabatier, *Compt. Rend.*, 88. 651, 1879; 89. 44, 1879; J. Thomsen, *Journ. prakt. Chem.*, (2), 19. 1, 1878; M. Berthelot, *Ann. Bur. Longitudes*, 395, 1877; P. Vaillant, *Compt. Rend.*, 171. 1380, 1920; A. Mourlot, *ib.*, 127. 408, 1898; *Ann. Chim. Phys.*, (7), 17. 525, 1899; W. P. Davey, *Phys. Rev.*, (2), 18. 102, 1921.

⁴ H. Feigel, *Verhalten von Schwermetallverbindungen gegen Polysulfide und Chlorschwefel*, Erlangen, 1905; E. Terres and K. Brückner, *Zeit. Elektrochem.*, 26. 1, 25, 1920; E. H. Riesenschfeld and H. Feld, *Zeit. anorg. Chem.*, 116. 213, 1921; A. Mourlot, *Compt. Rend.*, 127. 408, 1897; *Ann. Chim. Phys.*, (7), 17. 525, 1899; A. Baudrimont, *ib.*, (4), 2. 19, 1864; A. Béchamp, *ib.*, (4), 16. 222, 1868; P. Berthier, *ib.*, (2), 22. 233, 1823; (2), 38. 246, 1828; (2), 24. 275, 1823; T. J. Pelouze, *ib.*, (4), 7. 172, 1866; H. V. Regnault, *ib.*, (2), 62. 386, 1836; P. de Clermont and J. Frommel, *ib.*, (5), 18. 205, 1879; J. Kolb, *ib.*, (4), 7. 126, 1866; (4), 8. 150, 1866; *Bull. Soc. Chim.*, (2), 6. 11, 1866; C. Lauth, *ib.*, (1), 5. 249, 1863; A. Brochet and G. Ranson, *ib.*, (3), 29. 568, 1903; *Compt. Rend.*, 136. 1134, 1195, 1358, 1903; A. Mailfert, *ib.*, 94. 1186, 1882; W. Gossage, *Chem. News*, 6. 269, 1862; F. Stolle, *Zeit. Ver. Rübenzuckerind.*, 321, 1900; R. Rickmann, *Chem. Ztg.*, 4. 234, 1880; E. H. Riesenschfeld, *Journ. prakt. Chem.*, (2), 100. 115, 1920; M. Randall and F. R. von Bichowsky, *Journ. Amer. Chem. Soc.*, 40. 368, 1918; H. Rose, *Pogg. Ann.*, 55. 415, 533, 1842; E. Schöne, *ib.*, 112. 194, 1861; 117. 70, 1862; E. Divers and T. Shimidzu, *Journ. Chem. Soc.*, 45. 281, 1884; V. H. Veley, *ib.*, 47. 482, 1885; J. W. Kynaston, *ib.*, 2. 155, 1859; O. Schumann, *Liebigs Ann.*, 187. 286, 1877; B. Unger, *ib.*, 67. 95, 1848; C. L. Berthollet, *Journ. Polyt.*, 4. 315, 1802; O. Lenoir, *Wagner's Jahresber.*, 336, 1863; A. Rosentstiel, *Bull. Soc. Mulhouse*, 40. 129, 1879; F. Mohr, *Arch. Pharm.*, (2), 76. 21, 1853; W. Eidmann, *Ein Beitrag zur Kenntnis das Verhältnisses chemischer Verbindungen in nichtwässriger Lösung*, Giessen, 1899.

⁵ J. P. Dessaignes, *Journ. Phys.*, 70. 109, 1810; 71. 67, 353, 1810; 68. 444, 1809; 69. 5, 169, 1809; 73. 41, 1811; 74. 101, 173, 1812; *Schweigger's Journ.*, 8. 70, 115, 1813; T. von Grothaus, *ib.*, 14. 133, 1815; 17. 171, 1815; 49. 259, 1827; T. J. Seebeck, *ib.*, 2. 263, 1811; 7. 119, 1813; P. Heinrich, *ib.*, 29. 101, 450, 1820; *Die Phosphoreszenz der Körper nach allen Umständen untersucht und erläutert*, Nürnberg, 1811; G. Osann, *Kastner's Archiv.*, 4. 347, 1825; 5. 83, 1825; J. W. Ritter, *Gehlen's Journ.*, 6. 633, 1803; J. B. Beccaria, *De quam plurimis phosphoris nunc primum detectis*, Bologna, 1744; *Comment. Bonon.*, 2. 136, 498, 1747; *Phil. Trans.*, 61. 212, 1771; B. Wilson, *A Series of Experiments relating to phosphori and the prismatic colours they are found to exhibit in the dark*, London, 1775; *Journ. Phys.*, 15. 92, 1775; E. Becquerel, *Compt. Rend.*, 107. 892, 1888; 103. 1089, 1886; 137. 629, 1904; L. Bruninghaus, *ib.*, 144. 839, 1040, 1907; J. de Kowalsky and C. Garnier, *ib.*, 145. 391, 1907; F. P. le Roux, *ib.*, 140. 84, 239, 1905; J. R. Mourelo, *ib.*, 124. 1024, 1237, 1521, 1897; 125. 462, 1897; 126. 430, 904, 1508, 1898; 128. 427, 557, 1899; 127. 229, 372, 1898; 129. 1236, 1900; 160. 174, 1915; 161. 172, 1915; C. Gutton, *ib.*, 138. 268, 557, 1904; J. Lepinay, *ib.*, 138. 798, 1904; E. A. Bichat, *ib.*, 139. 254, 1904; P. Bary, *ib.*, 130. 776, 1900; L. J. M. Daguerre, *ib.*, 8. 243, 1839; F. J. Arago, *Ann. Chim. Phys.*, (2), 71. 313, 1839; D. Gernez, *ib.*, (8), 30. 66, 1910; *Compt. Rend.*, 150. 295, 1910; J. B. Biot, *ib.*, 8. 259, 313, 1839; P. Breteau, *ib.*, 161. 732, 1915; J. B. Biot and E. Becquerel, *ib.*, 8. 315, 1839; A. Verneuil, *ib.*, 103. 600, 1886; 104. 501, 1887; *Bull. Soc. Chim.*, (2), 46. 302, 1886; (2), 47. 739, 1887; E. Becquerel, *Arch. Sciences Genève*, (4), 57. 506, 1876; *La lumière, ses causes et ses effets*, Paris, 1867; *Ann. Chim. Phys.*, (3), 9. 257, 1843; (3), 22. 244, 1848; (3), 55. 5, 1859; (3), 57. 40, 1859; (4), 27. 539, 1872; (5), 10. 5, 1877; *Journ. Phys.*, (1), 6. 137, 1877; (2), 1. 139, 1882; W. de W. Abney, *Phil. Mag.*, (5), 13. 212, 1882; J. Trowbridge and J. E. Burbank, *ib.*, (5), 45. 100, 1898; J. W. Draper, *ib.*, (3), 27. 435, 1845; (4), 1. 81, 1851; (5), 11. 157, 1881; E. Wiedemann, *Wied. Ann.*, 56. 237, 1895; E. Lommel, *ib.*, 20. 847, 1883; 30. 473, 1887; A. W. Hoffmann, *ib.*, 60. 269, 1897; G. C. Schmidt, *ib.*, 58. 103, 1896; J. Precht, *ib.*, 60. 330, 1897; V. Klatt and P. Lenard, *ib.*, 38. 90, 1889; *Ann. Physik*, (4), 15. 225, 633, 1904; (4), 31. 675, 1910; A. Dahms, *ib.*, (4), 13. 425, 1904; P. Lenard, *ib.*, (4), 12. 449, 1903; L. Vanino, *Die künstlichen Leuchsteine*, Heidelberg, 1906; *Journ. prakt. Chem.*, (2), 88. 77, 1913; L. Vanino and E. Zumbusch, *ib.*, (2), 80. 69, 1909; (2), 82. 193, 1910; (2), 84. 303, 1911; L. Vanino and J. Gans, *ib.*, (2), 71. 196, 1905; P. Lenard, *Sitzber. Akad. Heidelberg*, 7, 1917; 8, 11, 1918; J. Canton, *Phil. Trans.*, 58. 337, 1768; L. E. O. de Visser, *Rec. Trav. Chim. Pays-Bas*, 20. 435, 1902; 22. 133, 1903; P. Wäntig, *Zeit. phys. Chem.*, 51. 435, 1905; R. Pictet and M. Altschul, *ib.*, 15. 386, 1894; E. Wiedemann and G. C. Schmidt, *ib.*, 18. 529, 1895; *Wied. Ann.*, 54. 604, 1895; E. Dreher, *Chem. Ztg.*, 5. 726, 1881; W. P. Jorissen and W. E. Ringer, *Ber.*, 37. 3983, 1904; H. E. Armstrong and T. M. Lowry, *Proc. Roy. Soc.*, 72. 258, 1903; L. Euler, *Acta Acad. St. Petersburg*, 1. 71, 1777; W. L. Krafft, *ib.*, 1. 77, 1777; M. de Magellan, *Rozier's Obs. Phys.*, 9. 153, 1777; A. A. Scherer, *Gren's Journ. Phys.*, 1. 319, 1795; J. Marchetti, *Comment. Bonon.*, 7. 25, 289, 1791; C. L. Morozzo, *Mem. Math. Fis. Italiana*, 3. 420, 1786; T. J. Pearsall, *Proc. Roy. Inst.*, 1. 77. 267, 1831; A. C. Becquerel, *Compt. Rend.*, 8. 183, 216, 1839; A. Debiere, *ib.*, 142. 568, 1906; C. de Watteville, *ib.*, 142. 1078, 1906; M. Curie, *ib.*, 172. 272, 1921; 174. 550, 1922; E. Becquerel, *ib.*, 14. 901, 1842; 51. 921, 1860; 63. 142, 1866; 69. 994, 1869; 75. 296, 1872; 77. 302, 1872; 83. 294, 1878; H. Becquerel, *ib.*, 96. 121, 1215, 1853, 1883; 97. 71, 1883; 99. 374, 417, 1884; 107. 892, 1888; L. Clémendot, *ib.*, 92. 1107, 1881; A. C. and E. Becquerel and J. B. Biot, *Arch. Muséum Hist. Nat.*, 1. 215, 1839; H. Jackson, *Journ. Chem. Soc.*, 65. 734, 1894; *Phil. Mag.*, (5), 46. 402, 1898; E. L. Nichols and E. Merritt, *Phys. Rev.*, (1), 27. 367, 1908; J. Stark, *Prinzipien der Atomdynamik*, Leipzig, 2. 213, 1911; H. S. Allen, *Photoelectricity*, London, 1913; G. T. Beilby, *Proc. Roy. Soc.*, 74. 506, 1905; W. Crookes, *ib.*, 42. 111, 1887; E. L. Nichols and D. T. Wilber, *Phys. Rev.*, (2), 17. 269, 1921; P. Vaillant, *Compt. Rend.*, 154. 867, 1912; 171: 712, 1380, 1920; *Journ. Phys. Radium*, 3. 87, 1922; J. F. Corrigan, *Chem. News*, 122. 25, 1921; A. A. Guntz, *Chim. Ind.*, 4. 597, 1920; B. Gudden and R. Pohl, *Zeit. Physik*, 3. 98, 1920; C. Matteucci, *Bibl. Univ. Genève*, 40. 159, 1842; E. Goldstein, *Sitzber. Akad. Berlin*, 279, 1876; *Sitzber. Akad. Wien*, 80. 151,

1879; F. Licetus, *Lithosphorus sive de lapide Bononiensi lucem in se conceptam ab ambiente claro mox in tenebris mire conservante*, Utini, 1640; A. J. C. da Galla, *De phenomenis in orbem lunæ novi telescopii*, Venetiis, 1612; O. Montalbani, *De illuminabili lapide bononiensi epistola*, Bononia, 1634; J. B. van Helmont, *Opera omnia*, Hafniensi, 1707; D. Hahn, *Die Phosphorescenz der Mineralien*, Halle, 1874; A. Kircher, *Magnes sive de arte magnetica*, Romæ, 1641; P. C. Schott, *Thaumaturgus physicus*, Herpipoli, 1659; N. Zucchi, *Optica philosophia experimentis et ratione a fundamentis constituta*, Lugduni, 1652; C. A. Balduinus, *Aurum superius et inferius auræ superioris et inferioris Hermeticum*, Amstelodami, 1675; C. Metzel, *Lapis bononiensis*, Bieldefeldiæ, 1675; G. K. Kirchmayer, *De phosphoris et natura lucis nec non de igne*, Wittelbergæ, 1680; M. A. Cellio, *Il fosforo ovvero la pietra bolognese preparata per far lucere fra l'ombra*, Roma, 1680; J. E. Elsholtz, *De phosphoris observationes*, Berolini, 1681; P. Borelli, *Historiarum et observationum medico-physicarum*, Francoforti, 1676; R. Hooke, *Philosophical Experiments and Observations*, London, 1726; E. Tiede and A. Schleede, *Ber.*, 53. 1721, 1920; O. Prager, *Chem. Trade Journ.*, 69. 158, 1921; W. Homberg, *Hist. Acad. Paris.* 2. 208, 1723; *Mém. Acad.*, 10. 445, 1730; A. F. Marsigli, *Dissertatione epistolare del fosforo mineale ò sia della pietra illuminabile bolognese*, Lipsiæ, 1698; J. H. Cohausen, *Lumen novum phosphoris accensum, sive exercitatio physico-chymica, de causa lucis in phosphoris tam naturalibus quam artificialibus*, Amstelodami, 1717; F. M. Zanottus, *Comment. Bonon.*, 1. 181, 1748; J. B. Becari, *ib.*, 1. 274, 1745; 2. 136, 498, 1747; C. du Fay, *Hist. Acad. Paris.* 58, 1726; 524, 1732; 347, 1738; J. Herbert, *Dissertatio de igne*, Viennæ, 165, 1763; N. H. Marne, *Über Feuer, Licht, und Wärme*, Berlin, 1787; M. de Grosser, *Phosphorescentia adamantum novis experimentis illustrata*, Viennæ, 1777; H. B. de Saussure, *Rozier's Obs. Phys.*, 40. 161, 1792; G. Laumont, *ib.*, 40. 97, 1792; N. Hulme, *Phil. Trans.*, 90. 16, 1800; 91. 403, 1801; L. G. Brugnatelli, *Ann. Chimica*, 13. 13, 1797; *Gilbert's Ann.*, 4. 438, 1800; J. F. John, *ib.*, 55. 453, 1817; H. C. Englefeld, *ib.*, 12. 399, 1803; *Proc. Roy. Inst.*, 1. 202, 1802; J. Dewar, *ib.*, 14. 115, 1895; C. E. Wünsch, *Gehlen's Journ.*, 6. 597, 1803; *Mag. Ges. Nat. Freunde, Berlin*, 1. 185, 1807; K. Kortum, *Voigt's Mag.*, 9. 1, 1794; B. Severign, *Acta Acad. St. Petersburg*, 14, 1805; D. Splittgerber, *Pogg. Ann.*, 47. 466, 1839; A. Förster, *ib.*, 143. 658, 1871; G. Osann, *ib.*, 94. 640, 1855; H. Kayser, *Handbuch der Spectroscopie*, Leipzig, 4. 599, 1908; J. Precht, *Ann. Physik*, (4), 21. 595, 1906; H. Dufour, *Arch. Sciences Genève*, (4), 18. 201, 1904.

⁶ J. J. Berzelius, *Pogg. Ann.*, 6. 442, 1824; H. Rose, *ib.*, 55. 430, 1842; E. Schöne, *ib.*, 112. 194, 1861; 117. 58, 224, 1862; T. Graham, *Phil. Mag.*, 18. 519, 1831; E. H. Riesenfeld and H. Feld, *Zeit. anorg. Chem.*, 116. 213, 1921; A. Béchamp, *Ann. Chim. Phys.*, (4), 16. 222, 1869; T. J. Pelouze, *Compt. Rend.*, 62. 108, 1866; V. H. Veley, *Journ. Chem. Soc.*, 47. 485, 1885; 49. 369, 1886; E. Divers and T. Shimidzu, *ib.*, 45. 270, 1884; R. Böttger, *Liebig's Ann.*, 29. 79, 1839; L. T. Wright, *Journ. Soc. Chem. Ind.*, 2. 122, 1883; C. Kraushaar, *Dingler's Journ.*, 226. 412, 1877; H. von Miller and C. Opl, *German Pat.*, D.R.P., 28067, 1884; J. Thomsen, *Journ. prakt. Chem.*, (2), 19. 1, 1878; P. J. Robiquet and M. E. Chevreul, *Ann. Chim. Phys.*, (1), 62. 180, 1807; *Nicholson's Journ.*, 19. 25, 1808.

⁷ L. N. Vauquelin, *Ann. Chim. Phys.*, (2), 6. 10, 1817; J. L. Gay Lussac, *ib.*, (2), 40. 304, 1829; E. Schöne, *Pogg. Ann.*, 112. 194, 1861; 117. 59, 224, 1862; H. Rose, *ib.*, 55. 415, 1842; J. J. Berzelius, *ib.*, 6. 442, 1826; *Schweigger's Journ.*, 34. 12, 1822; V. H. Veley, *Journ. Chem. Soc.*, 49. 378, 1886; E. Divers and T. Shimidzu, *ib.*, 45. 282, 1884; *ib.*, C. Neuberger and E. Neimann, *Biochem. Zeit.*, 1. 174, 1906; L. Guiteau, *Compt. Rend.*, 173. 390, 1916; G. Calcagni, *Gazz. Chim. Ital.*, 50. ii, 331, 1920; T. J. Pelouze, *Ann. Chim. Phys.*, (4), 7. 294, 1866.

⁸ T. J. Pelouze, *Ann. Chim. Phys.*, (4), 7. 294, 1866; J. L. Gay Lussac, *ib.*, (1), 85. 100, 1813; E. Kopp, *Compt. Rend.*, 61. 791, 1865; A. W. Hofmann, *ib.*, 62. 291, 1866; C. W. Folkard, *Chem. News*, 49. 258, 1884; W. Foster, *Journ. Gas Lighting*, 44. 586, 1884; J. F. W. Herschel, *Edin. Phil. Journ.*, 1. 8, 1819; V. H. Veley, *Journ. Chem. Soc.*, 49. 378, 1886; E. Schöne, *Pogg. Ann.*, 117. 58, 1862; H. Rose, *ib.*, 55. 433, 1842; A. Geuther, *Liebig's Ann.*, 224. 178, 1884; J. A. Buchner, *Schweigger's Journ.*, 16. 397, 1816; C. F. Buchholz and R. Brandes, *ib.*, 22. 43, 1818; J. K. Haywood, *Journ. Amer. Chem. Soc.*, 27. 244, 1905; R. W. Thatcher, *ib.*, 30. 63, 1908; O. B. Winter, *Journ. Ind. Eng. Chem.*, 10. 539, 1918; E. Divers and T. Shimidzu, *Journ. Chem. Soc.*, 45. 270, 1884.

⁹ P. Berthier, *Ann. Chim. Phys.*, (2), 22. 244, 1823; (2), 43. 300, 1830.

§ 16. The Sulphates of the Alkaline Earths

The native form of dihydrated calcium sulphate, $\text{CaSO}_4 \cdot 2\text{H}_2\text{O}$, called **gypsum**, occurs as a fine-grained or compact mass which is normally white, but may be coloured grey, brown, or red owing to admixtures of clay, carbonaceous matter, ferric oxide, etc. An earthy or sandy variety is sometimes called gypsum dirt, or *gypsîte*. The pure white massive varieties are known as **alabaster**, and have been used for making statuary, vases, and other objects for internal decoration. The same term is also applied to the white and banded stalagmite or onyx marble varieties of calcite; and this is generally considered to have been the alabaster of

the ancients. The so-called *lapis specularis*, referred to by Pliny, was possibly crystalline gypsum mixed with mica. The colourless, water-clear or transparent, crystalline variety is known as *selenite*; and in the eighteenth century it was sometimes called *glacies maris*, or *Marienglas*. Some fibrous varieties of gypsum are called *satın spar*. The anhydrous form of calcium sulphate is known as *anhydrite*, CaSO_4 , and also as *muricacite*, or *karstenite*. This variety is usually found massive, and is sometimes found associated with gypsum and rock-salt; it also occurs in coloured—brown or blue—crystals. Gypsum is soft enough to be scratched by the finger-nail; anhydrite is slightly harder.

The mineral *gypsum* is of considerable commercial importance as a source of plaster of Paris, so named because it was obtained by burning the gypsum from the quarries of Montmartre, Pantin, Belleville, Sannois, and Enghein in the Tertiary deposits of the Paris basin. The deposits in Nottinghamshire, Derbyshire, Leicestershire, Staffordshire, and Gloucestershire, are all associated with the keuper marls. The gypsum industry of Germany is developed in the southern part of the Hartz Mountain district, in Thuringia near Possench and Krolpa, and at various towns on the Rhine near the mouth of the Neckar. Deposits occur in Switzerland, Sweden, Italy, Cyprus, Sicily, India, Queensland, Canada, and in Ohio, Virginia, Iowa, Arkansas, Colorado, Nevada, Michigan, etc. Numerous reports have been made on these various deposits.¹ Crystals of gypsum have been found in the residues obtained by the evaporation of natural waters holding calcium sulphate in soln.—*e.g.* in boiler scale, etc.²

Anhydrite associated with gypsum occurs in the salt mines near Hall (Tyrol), Bex (Switzerland), Sulz (Württemberg), Himmelsberg (Ilfeld), Bleiberg (Carinthia), Lüneberg (Hanover), Lauterberg (Harz), Hapnik (Hungary), Ischl (Austria), Aussee (Styria), Berchtesgaden (Bavaria), at Rienthal (Alps), Stassfurt, Lockport (N.Y.), Windsor (Nova Scotia), Hillsboro (New Brunswick), etc. Celestine occurs in the Bristol basin, in Gloucester and Somerset, Westphalia, Thuringia, Pshov (Silesia), Dornberg (near Jena), Sicily, Bex (Switzerland), Montmartre, Beaumont, and Meudon (France), Conil (Spain). Deposits occur in numerous localities in the United States, at Strontian Island (Lake Erie). Barytes occurs at Dufton (Westmorland), Liskeard (Cornwall), Egremont (Cumberland), Breidden Hills (Shropshire), Wetherton and Newhaven (Derbyshire), Nutfield (Surrey), Felsöbanya and Kremnitz (Hungary), Freiberg, Marienberg, and Clausthal (Germany), Roya and Raure (Austria), Connecticut, North Carolina, Tennessee, Virginia, Missouri, etc., Prizibran and Mies (Bohemia).

In connection with the alkali halides, it was shown that during the evaporation of sea-water, gypsum or anhydrite is deposited before the more soluble salt; and the common and intimate association of gypsum or anhydrite with rock-salt points clearly to the marine origin of most of the gypsum beds.³ Gypsum also occurs as irregular masses in limestone. It is then supposed to have resulted directly from the action of sulphuric acid on the limestone, when the sulphuric acid is derived from the oxidation of pyrites or other sulphides by the joint action of air and water. Small quantities of gypsum found in some volcanic districts are supposed to have been formed by the action of sulphuric acid vapours on the lime of volcanic tuffa and other rocks.

About three centuries before our era, Theophrastus, in his *Περὶ Λίθων*, described very clearly the occurrence and some of the properties of the mineral gypsum and alabaster. The name of the mineral is derived from *γύψος*, a term applied to what is equivalent to burnt gypsum. Attempts have been made to derive the term alabaster from Greek words; another connects the word with the town Alabastron in Egypt, where ornaments were made from gypsum in early times. Theophrastus stated that it was employed as a cement and for casing the outsides of buildings; for making internal ornaments and statues; as a colour for painters; and for "fulling" cloth. He said:

Gypsum is prepared for use by burning certain stones. It is then reduced to powder, and well mixed with water by stirring with wooden instruments. The mixing cannot be done by hand because of the heat which is developed. This mixture is prepared immediately

before it is used, for in a very short time after moistening it dries and becomes hard, and not in a condition to be used. The gypsum which has been used can be re-burnt and made fit for use.

In the first century, Pliny, in his *Historia naturalis*, described this mineral, and stated that it has a close relationship with lime—*cognata calci res gypsum est*. The opinion was based rather on its properties as a cement, which is prepared like lime by the calcination of the native stone.

The earliest plaster casts are said to have been made by Lysistratus of Sicyon, brother of the sculptor Lysippus. He first made a cast in plaster from the object, and then made a second one in wax. According to A. Rees,⁴ the walls of the temple of Fortuna Seia were made of compact gypsum which, though without windows, was sufficiently illuminated by light transmitted through the semi-pellucid walls; the old Arabian monastery of Arsoffa Emu is also said to have been constructed of gypsum; at Florence, the gypsum of Volterra was made into vases in which lamps were placed, and thus diffused a soft light over the room; and a church at Florence was illuminated by large slabs of alabaster in place of panes of glass. The light transmitted through plates of gypsum seems to have reminded the ancients of light from the moon—hence selenite, from *σελήνη*, the moon.

G. Agricola, in his *De natura fossilium* (Basil, 1546), supposed gypsum to consist of lime because the former can be converted into the latter. J. H. Pott, in his *Lithogegnosia* (Potsdam, 1746), said that many chemists regarded true gypsum as a compound of lime and sulphuric acid, and they called it *gypsum arte factum*, but he considered the two were different. In the eighteenth century, the white substance obtained by the action of sulphuric acid on chalk was called *selenite*. B. Allen⁵ prepared this mineral by the action of sulphuric acid on chalk. The chemists of this period regarded gypsum and artificially prepared calcium sulphate as two different substances. In 1747, P. J. Macquer showed that gypsum contained sulphuric acid, but the mineral was still considered to be different from the calcium sulphate, because calcination converted the former into a substance which reacted with water, forming a kind of mortar, while the latter remained unaffected by fire. In 1750, A. S. Marggraf showed that when gypsum is heated with charcoal, a gas with the pungent smell characteristic of burning sulphur is given off, and he hence inferred that it is a compound of sulphuric acid and lime. He explained the formation of gypsum in nature by the gradual deposition of the crystals from calcareous waters; time, said he, brings about marvellous results which cannot be reproduced in our laboratories. In 1768, A. L. Lavoisier confirmed Marggraf's analysis, and showed that the hardening of gypsum is a result of its re-combining with the water of crystallization from which it had been deprived by heat. He said:

If the water of hydration removed from gypsum by fire be returned to it, the water is taken up with avidity, and a sudden and irregular crystallization occurs so that the small crystals which are formed become confused with one another, and a very hard mass results.

A. L. Lavoisier stated that in his opinion these results leave *rien à désirer sur l'explication de ce phénomène*. Analyses were also made by R. Chenevix and others.

The recognition of the mineral *celestine* or *celcstite* as the native form of strontium sulphate, and of *heavy spar* as the native form of barium sulphate, has been described at the beginning of this chapter. For a long time, the minerals barytes and celestine were confused, and the difference in the crystalline forms was regarded as a puzzling exception to R. J. Haüy's law of the constancy of the angles of the crystals of a given substance. L. N. Vauquelin, however, demonstrated that the minerals belong to two different species, since the one (barytes) imparts a green colour to the flame, while the other (celestine) gives a crimson flame. Heavy spar, also called *barytes*, and *barite*, occurs in fine crystals and granular or fibrous masses. It is a very common mineral in metalliferous veins—*e.g.* lead, silver, cobalt, etc.—both with the veinstone and on the wall. That in the Derbyshire lead mines occurs in aggregates of white, opaque crystals, where it is called *cawk*. The

aggregates of tabular crystals are known as *crested barytes*, or *cockscomb barytes*. The mineral celestine occurs in tabular crystals, and in granular or fibrous masses. The colour of both forms is usually white or creamy, and in some cases the mineral has red or brown ferruginous stains. Many forms of celestine have a blue tinge—hence the name, from *caelestinus*, blue. Analyses of barytes were made by T. Gruner and R. Brandes, etc. There has been some discussion as to the existence of true barium strontium sulphates—*barytocelestines*. Are the barytocelestines mixtures of barytes with strontium sulphate, or of celestine with some barium sulphate? The evidence is indecisive; the barytocelestines with analyses corresponding with *strontium barium sulphates*, $\text{BaSO}_4 \cdot 2\text{SrSO}_4$ and $\text{BaSO}_4 \cdot 3\text{SrSO}_4$, reported from Ontario, are probably mixtures.

The preparation of the sulphates of the alkaline earths.—According to K. W. G. Kastner, when sulphuric acid is poured upon calcium oxide, the whole becomes red hot if relatively large quantities of material are used; and P. Heinrich said that chemi-luminescence occurs if sulphuric acid is dropped on calcium oxide in a darkened room. **Dihydrated calcium sulphate** is precipitated when dil. sulphuric acid, or a soln. of an alkali sulphate, is added to a soln. of a calcium salt. The same salt is also formed by the action of dil. sulphuric acid on powdered calcium oxide, hydroxide, or carbonate. As emphasized by J. J. Berzelius, the solid is very liable to form clots in which the interior is protected from the action of the acid by an impervious skin of the sulphate. A. Lacroix⁶ obtained crystals of gypsum by the action of sulphuric acid on powdered fluorspar at 12° for some months. P. P. von Weimarn obtained a **colloidal calcium sulphate** by precipitating the salt in alcoholic soln. **Hemihydrated calcium sulphate**, $\text{CaSO}_4 \cdot \frac{1}{2}\text{H}_2\text{O}$, or $2\text{CaSO}_4 \cdot \text{H}_2\text{O}$, was obtained by N. A. E. Millon, by the dehydration of the dihydrate at 110°.

The partially dehydrated gypsum forms the hemihydrate, $\text{CaSO}_4 \cdot \frac{1}{2}\text{H}_2\text{O}$, and this is virtually the composition of the commercial *plaster of Paris*, *Stuckgips*, or *plâtre*. This product is not hygroscopic, but it generally holds up to 1.5 per cent. of adsorbed moisture and a total 6 to 8 per cent. of water. The adsorbed moisture can be removed by a stream of dry air. The term *stucco* is almost a synonym for plaster of Paris; if there is a difference, plaster of Paris is whiter and more finely ground than stucco. C. Cloez found some samples of plaster of Paris contained considerable proportions of soluble anhydrite, and they contained less than 6 per cent. of combined water. Plaster of Paris with over 7.5 per cent. of moisture probably contains unconverted gypsum. P. Berthier's analyses, confirmed by those of E. Landrin and others, showed that commercial plaster of Paris contains 4 to 8 per cent. of water.

F. Hoppe-Seyler obtained needle-like crystals of hemihydrated calcium sulphate by heating to 140°–160° the dihydrate with water in a sealed tube. H. le Chatelier prepared the hemihydrate by heating a sat. soln. of calcium sulphate in a sealed tube at 130°–150°; but special precautions are needed to remove water rapidly before it cools much below 130°, or rehydration sets in; H. le Chatelier, therefore, transferred the hot crystals into absolute alcohol and dried them at 100°. A simple method of making the hemihydrate was devised by J. H. van't Hoff and E. F. Armstrong, who heated between 40° and 50°, for 18 hrs., 20 grms. of precipitated gypsum with 50 c.c. of conc. nitric acid (sp. gr. 1.4), and obtained well-defined minute needles. J. F. W. Johnston reported the formation of transparent prismatic crystals of the hemihydrate in a marine boiler working under a press. of two atm. H. Rose thought that he had prepared crystals of *monohydrated calcium sulphate*, $\text{CaSO}_4 \cdot \text{H}_2\text{O}$, by boiling gypsum for a short time with a half-sat. soln. of sodium chloride, but he probably obtained crystals of the hemihydrate which practically re-hydrated on cooling, and which were also contaminated with some sodium chloride. According to R. Grengg, the formation of the hemihydrate by heating gypsum appears to involve the intermediate formation of soluble anhydrite, which then absorbs water.

H. Rose found that sulphuric anhydride, SO_3 , reacts with calcium oxide at a temp. approaching redness, but not at ordinary temp. The product is **anhydrous calcium sulphate**. Calcium hydroxide does react with sulphuric trioxide at ordinary

temp. C. M. Marx showed that hot or cold calcspar, limestone or chalk, does not react with the vapour of sulphur trioxide, and only a superficial film of sulphate is formed with the vapour of sulphuric acid. The anhydrous sulphate is obtained by heating one of the hydrates above the temp. of dehydration. J. H. van't Hoff, W. Hinrichsen, and F. Weigert obtained a soluble form of anhydrite by heating the hemihydrate to 100° with an excess of water, or by dehydrating precipitated calcium sulphate in vacuo between 60° and 90° . A. Lacroix obtained what appeared to be a triclinic form of anhydrite by keeping gypsum at 125° for a long time; if the temp. be kept at bright redness ordinary anhydrite is formed, and E. Mitscherlich obtained crystals of anhydrite by heating precipitated calcium sulphate in a pottery oven, where the cooling is slow. N. S. Manross obtained crystals of anhydrite by fusing potassium sulphate with four times its weight of calcium chloride, and extracting the more soluble product with water. F. Hoppe-Seyler obtained anhydrite by heating gypsum with a sat. soln. of sodium or calcium chloride in a sealed tube at 125° - 130° ; L. Bourgeois, from a sat. soln. of calcium sulphate in nitric acid sp.gr. 1.384, diluted with one-third its vol. of water; and R. T. Simmler, by melting hydrated gypsum with sodium chloride in the presence of silica.

F. Posepny found anhydrite is formed from gypsum in soln. of calcium or magnesium chloride. H. Rose and F. Hoppe-Seyler said that while gypsum loses water at a temp. as low as 100° , gypsum is always the form which separates from soln. of sodium chloride. J. Roth objected to this statement, because he obtained deposits of anhydrite from sodium chloride soln. at ordinary temp. G. Spezia obtained a separation of anhydrite from a sat. soln. of sodium chloride at 500 atm. press. in spite of the fact that gypsum occupies a less vol. than anhydrite, and water resulting from the decomposition. H. Vater evaporated soln. of gypsum sat. with respect to sodium or magnesium chloride, and obtained crystals of gypsum while natural anhydrite remained unchanged in these soln. It is unlikely that H. Vater realized equilibrium conditions in his experiments. R. Fassbender found gypsum to be the stable phase in equilibrium with cold sat. soln. of sodium chloride at ordinary temp., but at higher temp. anhydrite is the stable phase. R. Brauns obtained natural anhydrite at ordinary temp. with gypsum in contact with sat. soln. of calcium or magnesium chloride. H. Struve and K. Haushofer found natural anhydrite to be the stable phase in the presence of conc. sulphuric acid. The general conclusion from the work of J. H. van't Hoff is that gypsum and natural anhydrite are the only forms of calcium sulphate which are stable in the presence of any soln., and the conditions under which one or other form is stable depend on the temp. and nature of the soln. with which it is in contact. For an aq. soln. of calcium sulphate, this temp. is about 66° ; for a sat. soln. of sodium bromate, 50° ; for a sat. soln. of sodium chloride, 30° ; and for a sat. soln. of magnesium chloride, 11° . So long as it was assumed that the change of gypsum to anhydrite requires a temp. exceeding 150° , there appeared no satisfactory explanation of the presence of anhydrite in natural deposits. The geological evidence is in agreement with the work of J. H. van't Hoff in showing that anhydrite has been deposited from soln. containing sodium chloride and other soluble salts, all of which depressed the inversion temp.

As in the case of calcium oxide, K. W. G. Kastner found strontia can be made red hot when it is treated with conc. sulphuric acid; J. S. E. Julia-Fontenelle and G. A. Quesneville did not get so high a temp. when smaller quantities were used. Anhydrous **strontium sulphate**, SrSO_4 , is precipitated by treating a soln. of a strontium salt with sulphuric acid or a soluble sulphate. The precipitate with dil. soln. is a crystalline powder, but with conc. soln., it is flocculent and amorphous, and later assumes a crystalline form. M. M. P. Muir and C. Slater studied the effect of conc. on the reaction between sulphuric acid and strontium chloride. By working with alcoholic soln., P. P. von Weimarn obtained **colloidal strontium sulphate**. O. Schumann oxidized heated strontium sulphide to sulphate by the action of steam. A. B. de Schulten prepared crystals of artificial celestine by adding a soln. of 5 grms.

sulphuric acid in 3 litres of water in a soln. of 28 grms. of strontium chloride in 3 litres of water, and allowing the mixture to stand for a couple of weeks. L. Bourgeois prepared artificial celestine by repeatedly heating to 150° and cooling a mixture of precipitated strontium sulphate with an excess of hydrochloric acid (1 : 2); N. S. Manross, by melting potassium sulphate with an excess of strontium chloride; H. Struve, by evaporating a conc. sulphuric acid soln. of precipitated strontium sulphate; and A. Gorgeu, by fusion with alkali chlorides.

According to A. A. B. Bussy, the vapour of anhydrous sulphuric acid is absorbed by heated baryta, and the mass becomes incandescent; similarly, F. Kuhlmann found that when baryta is brought in contact with anhydrous sulphuric acid, fused at 26° , it becomes incandescent; and M. Barry found the baryta becomes red hot when mixed with conc. sulphuric acid containing a little more or a little less than one mol of acid to one of water; and F. Kuhlmann added that sulphuric acid of sp. gr. 1.848 does not combine with baryta at ordinary temp., but if the solid, moistened with the acid, be touched at any point with a hot iron, or a wet glass rod, combination commences at that point, and is propagated throughout the mass; combination also ensues on exposure to moist air. If the same acid be mixed with a little water and cooled, it unites with baryta with incandescence; but if the acid be mixed with more water, the phenomenon does not occur. When the acid is mixed with water, no reaction occurs if the baryta has been previously mixed with alcohol or ether.

Sulphuric acid and soluble sulphates precipitate **barium sulphate**, BaSO_4 , from aq. soln. of its salts. Sulphuric acid also transforms insoluble barium salts wholly or partially into the sulphate. A protective film of sulphate is formed when witherite is treated with sulphuric acid, but, according to T. J. Pelouze, dil. sulphuric acid mixed with 4 per cent. of hydrochloric acid, rapidly converts witherite into the sulphate. The purification of native barium sulphate has been discussed by C. Coffignier, J. Ramsden, etc. Barium sulphate was formerly made by treating a soln. of barium chloride with sodium sulphate or sulphuric acid, but it is now made by treating barium sulphide with salt-cakes. The latter process furnishes a denser product than the former, and gives sodium sulphide as a valuable by-product. Barium sulphate is also a by-product in the manufacture of hydrogen peroxide from barium dioxide and sulphuric acid. P. A. Mackay obtained barium and strontium sulphates in a finely divided form by grinding the native mineral, dissolving it in sulphuric acid containing free sulphur trioxide and pouring the soln. into water to precipitate the dissolved sulphates. C. H. Hall studied the electro-precipitation of colloidal barium sulphate.

The structure of precipitated barium sulphate has been studied by P. P. von Weimarn, and S. Odèn—*vide* 3, 23, 8. According to G. Buchner, **colloidal barium sulphate** is obtained by mixing equal mol. proportions of a 40 per cent. soln. of barium acetate and a 60 per cent. soln. of aluminium acetate. Y. Kato obtained it by adding a dil. alcoholic soln. of sulphuric acid to a dil. alcoholic soln. of barium acetate. E. Feilmann heated a mixed aq. soln. of casein and sodium sulphate with an aq. soln. of barium chloride. N. G. Chatterji and N. R. Dhar observed no peptization of barium sulphate with glycerol and alkali hydroxide.

According to R. Pictet, a mixture of sulphuric acid with an alcoholic soln. of barium chloride is quite clear at -85° ; but as the temp. rises to -70° , the liquid suddenly becomes turbid, showing that no reaction occurs at the lower temp. L. Joulin showed that a slight excess of sulphuric acid is needed for the complete precipitation of barium from soln. of its salts, and conversely a slight excess of barium salt soln. is needed for the complete precipitation of sulphuric acid; soln. containing an equal number of mols of sodium sulphate and barium chloride, at a dilution of 1 : 5000, are completely precipitated in four days, but in 24 hrs. $\frac{1}{3}$ th part still remained unchanged. According to E. Schöne, when barium sulphide is oxidized by fuming nitric acid to barium sulphate, the filtered soln. contains both a little barium and a little sulphuric acid. W. Spring compressed an intimate

mixture of one part of dry barium carbonate with three parts of dry sodium sulphate, at 6000 atm., and found 59.16 per cent. of the carbonate was converted to sulphate; by re-grinding the mass, another compression gave a 73.3 per cent. conversion. Equilibrium was obtained when 80 per cent. was converted.

In 1829, E. Turner⁷ pointed out that barium sulphate has a tendency to carry down other salts during its precipitation :

The adhesion of potassium sulphate to the precipitate ensues even in a dil. soln. ; and it is not prevented by the presence of other salts, such as potassium nitrate, ammonium chloride, or ammonium nitrate. The quantity of adhering salt is variable, depending apparently as well on the relative quantity of the two salts, and the strength of the soln., as on the manner and extent of edulcoration. I have known it to increase the weight of the barium sulphate by 1 per cent.

A large number of observers have placed similar facts on record. Salts of the alkalis, alkaline earths, silica, magnesium, cobalt, copper, iron, and aluminium compounds may be carried down with the precipitate. There are difficulties also due to the solubility of barium sulphate in the presence in the soln. of certain other compounds.

Crystalline barium sulphate can be made by evaporating a conc. sulphuric acid soln. of the precipitated salt ; T. Scheerer and E. Drechsel evaporated a soln. of barium sulphate in metaphosphoric acid ; and they fused barium fluoride with calcium sulphate in the presence of potassium or sodium chloride, and extracted the cold mass with water ; H. de Sénarmont⁸ heated precipitated barium sulphate with dil. hydrochloric acid, or sodium bicarbonate to 250° for 60 hrs., and C. M. Manross fused 12 grms. of potassium sulphate with 50 grms. of barium chloride ; A. Macé obtained crystals of barium sulphate by double decomposition between barium nitrate and ferrous sulphate ; and C. E. Guignet, by double decomposition between sodium sulphate and barium chloride.

REFERENCES.

¹ R. L. Sherlock and B. Smith, *Mem. Geol. Sur. Special Rep. Gypsum and Anhydrite, Celestine and Strontianite*, London, 1915 ; R. G. Carruthers, *Mem. Geol. Sur. Special Rep. Barytes and Witherite*, London, 1915 ; L. H. Cole, *Gypsum in Canada*, Ottawa, 1913 ; G. P. Grimsley, *The Gypsum of Michigan and the Plaster Industry*, Lansing, 1904 ; M. Pedrotti, *Der Gips und seine Verwendung*, Wien, 1901. The geological reports of many States and Countries describe the deposits of the alkaline earth sulphates.

² L. Fletcher, *Min. Mag.*, 16, 137, 1911.

³ T. S. Hunt, *Chemical and Geological Essays*, Boston, 80, 1878 ; *Journ. Geol. Soc.*, 16, 154, 1859 ; L. D. Dawson, *ib.*, 5, 339, 1849 ; J. D. Dana, *Manual of Geology*, New York, 554, 1895 ; C. Lyell, *The Principles of Geology*, London, 245, 1830 ; A. de Lapparent, *Traité de géologie*, Paris, 135, 1926, 1893 ; G. P. Grimsley, *The Gypsum of Michigan and the Plaster Industry*, Lansing, 182, 1904 ; F. A. Wilder, *Iowa Geol. Sur.*, 12, 116, 1902.

⁴ A. Rees, *The Cyclopædia of Arts, Sciences, and Literature*, London, 1814.

⁵ B. Allen, *Natural History of Mineral Waters*, London, 1711 ; P. J. Macquer, *Mém. Acad.*, 678, 1747 ; T. Gruner and R. Brandes, *Schweigger's Journ.*, 46, 245, 1826 ; A. S. Marggraf, *Mém. Acad. Berlin*, 144, 1750 ; A. L. Lavoisier, *Mém. Acad.*, 341, 1768 ; *Œuvres*, Paris, 3, 122, 1865 ; R. Chenevix, *Nicholson's Journ.*, 2, 196, 1802 ; L. N. Vauquelin, *Journ. Mines*, 11, 425, 1801.

⁶ A. Lacroix, *Journ. Pharm. Chim.*, (5), 9, 111, 1884 ; *Compt. Rend.*, 126, 360, 553, 1898 ; L. Bourgeois, *ib.*, 105, 1072, 1887 ; T. J. Pelouze, *ib.*, 48, 771, 1858 ; R. Pictet, *ib.*, 115, 814, 1892 ; 116, 816, 1893 ; F. Hoppe-Seyler, *Zeit. deut. geol. Ges.*, 27, 495, 1875 ; *Pogg. Ann.*, 127, 161, 1866 ; H. Rose, *ib.*, 76, 305, 1849 ; 38, 117, 1836 ; 93, 606, 1854 ; 145, 177, 1872 ; E. Schöne, *ib.*, 112, 214, 1861 ; E. Mitscherlich, *ib.*, 11, 331, 1827 ; *Journ. prakt. Chem.*, (1), 83, 485, 1861 ; R. T. Simmler, *ib.*, (1), 76, 430, 1859 ; A. Völcker, *ib.*, (1), 101, 497, 1867 ; G. Buchner, *Chem. Ztg.*, 17, 878, 1893 ; J. F. W. Johnston, *Amer. Journ. Science*, (2), 5, 112, 1842 ; *Phil. Mag.*, (2), 13, 325, 1838 ; E. F. Armstrong, *Ueber das Halbhydrat von Calciumsulfat*, Berlin, 1901 ; J. H. van't Hoff and E. F. Armstrong, *Sitzber. Akad. Berlin*, 559, 1900 ; J. H. van't Hoff, W. Hinrichsen, and F. Weigert, *ib.*, 570, 1901 ; Y. Kato, *Mem. Coll. Science Eng. Kyoto*, 2, 187, 1910 ; N. A. E. Millon, *Ann. Chim. Phys.*, (3), 19, 222, 1847 ; J. S. E. Julia-Fontenelle and G. A. Quesneville, *ib.*, (2), 37, 223, 1828 ; L. Joulin, *ib.*, (4), 30, 274, 1873 ; A. Gorgeu, *Bull. Soc. Min.*, 10, 284, 1887 ; K. Haushofer, *Sitzber. Akad. München*, 19, 12, 1889 ; H. Struve, *Zeit. anal. Chem.*, 9, 34, 1870 ; *Zeit. Chem.*, (2), 5, 324, 1869 ; N. S. Manross, *Liebig's Ann.*, 82, 353, 1852 ; O. Schumann, *ib.*, 187, 286, 1877 ; F. Kuhlmann, *ib.*, 27, 22, 1838 ; J. J. Berzelius, *ib.*, 43, 246, 1843 ; K. W. G. Kastner,

Kastner's Archiv, 16, 229, 1829; E. Feilmann, *Trans. Faraday Soc.*, 4, 175, 1909; C. M. Marx, *Arch. Pharm.*, (2), 15, 103, 1838; C. Marquart, *Jahrb. Min.*, 819, 1859; R. Brandes and T. Gruner, *Schweigger's Journ.*, 46, 245, 1826; S. Odén, *Svensk. Kem. Tids.*, 32, 90, 1920; *Om Fällningar*, Stockholm, 1920; N. G. Chatterji and N. R. Dhar, *Chem. News*, 121, 253, 1920; S. J. Cook, *Canadian Chem. Journ.*, 3, 147, 1919; J. Ramsden, *Chem. Trade Journ.*, 68, 203, 1921; C. Coffignier, *Rev. Chim. Ind.*, 29, 263, 1920; P. P. von Weimarn, *Zeit. Koll.*, 2, 76, 1907; P. Heinrich, *Die Phosphoreszenz der Körper nach allen Umständen untersucht und erläutert*, Nürnberg, 1811; A. B. de Schulten, *Bull. Soc. Min.*, 26, 103, 1903; A. A. B. Bussy, *Journ. Pharm.*, 10, 370, 1824; M. Barry, *Ann. Phil.*, 18, 77, 1821; W. Spring, *Bull. Soc. Chim.*, (2), 44, 166, 1885; C. Cloez, *ib.*, (3), 29, 169, 171, 1903; P. Berthier, *Ann. Mines*, (3), 19, 655, 1841; E. Landrin, *Ann. Chim. Phys.*, (5), 3, 441, 1874; M. M. P. Muir and C. Slater, *Journ. Chem. Soc.*, 37, 60, 1880; F. Posepny, *Verh. geol. Reichsanst.*, 140, 1869; J. Roth, *Sitzber. Akad. Berlin*, 89, 1879; H. Vater, *ib.*, 269, 1900; G. Spezia, *Zeit. Kryst.*, 13, 302, 1888; J. H. van't Hoff, *Zeit. Phys. Chem.*, 45, 257, 1903; R. Fassbender, *Ber.*, 11, 1968, 1878; R. Brauns, *Neues Jahrb. Min.*, ii, 257, 1894; R. Grengg, *Zeit. anorg. Chem.*, 90, 327, 1914; P. A. Mackay, *Brit. Pat. No.* 161655, 1920; L. Bourgeois, *Bull. Soc. Chim.*, (4), 31, 160, 1922; C. H. Hall, *Journ. Amer. Chem. Soc.*, 44, 1246, 1922; H. le Chatelier, *Compt. Rend.*, 96, 1668, 1883.

⁷ E. Turner, *Phil. Trans.*, 119, 295, 1829; H. Rose, *Pogg. Ann.*, 113, 627, 1861; R. Fresenius, *Zeit. anal. Chem.*, 8, 52, 1869; 9, 52, 1870; 19, 53, 1880; 16, 339, 1877; 30, 452, 1891; R. Fresenius and E. Hintz, *ib.*, 35, 170, 1896; G. Brügelmann, *ib.*, 16, 19, 1877; E. Hintz and H. Weber, *ib.*, 45, 31, 1906; H. Weber, *ib.*, 45, 714, 1906; G. Lunge, *ib.*, 19, 419, 1880; C. Meincke, *ib.*, 38, 210, 1899; T. O. Sloane, *Journ. Amer. Chem. Soc.*, 3, 37, 1881; O. W. Foulk, *ib.*, 18, 793, 1896; J. Johnston and L. H. Adams, *ib.*, 33, 829, 1911; L. Archbutt, *Journ. Soc. Chem. Ind.*, 9, 25, 1890; W. Smith, *ib.*, 1, 85, 1882; P. Jannasch, *Journ. prakt. Chem.*, (2), 40, 233, 1889; P. Jannasch and T. W. Richards, *ib.*, (2), 39, 321, 1889; A. Mitscherlich, *ib.*, (1), 83, 456, 1861; E. Siegle, *ib.*, (1), 69, 142, 1856; C. Diehl, *ib.*, (1), 79, 430, 1860; R. Silberberger, *Monatsh.*, 25, 220, 1904; A. Ziegeler, *Chem. Centr.*, (3), 12, 553, 1881; W. Ostwald, *Zeit. phys. Chem.*, 34, 495, 1900; G. Hulett, *ib.*, 37, 385, 1901; 47, 357, 1904; F. W. Küster and A. Thiel, *Zeit. anorg. Chem.*, 19, 97, 1899; 22, 424, 1900; G. Hulett and L. H. Duschak, *ib.*, 40, 196, 1904; O. N. Heidenreich, *ib.*, 20, 233, 1899; A. Fischer, *ib.*, 42, 408, 1904; A. Thiel, *ib.*, 36, 85, 1903; T. W. Richards, *ib.*, 1, 150, 187, 1892; *Proc. Amer. Acad.*, 26, 258, 1891; T. W. Richards and H. G. Parker, *ib.*, 31, 67, 1896; *Zeit. anorg. Chem.*, 8, 413, 1895; O. Herting, *Zeit. angew. Chem.*, 12, 274, 1899; *Chem. Ztg.*, 23, 768, 1899; E. Ruppig, *ib.*, 33, 17, 398, 1909; 34, 1201, 1910; J. F. Sacher, *ib.*, 33, 28, 1909; O. Folin, *Journ. Biol. Chem.*, 1, 131, 1905; E. F. Teschemacher and J. D. Smith, *Chem. News*, 24, 61, 66, 171, 1871; N. Glendinning and A. Edgar, *ib.*, 24, 140, 220, 1871; S. Wyrouboff, *Bull. Soc. Chim.*, (3), 21, 1046, 1899; J. I. Phinney, *Amer. Journ. Science*, (3), 45, 468, 1891; W. S. Allen and H. B. Bishop, *Internat. Cong. App. Chem.*, 8, i, 33, 1912; J. W. Mellor, *A Treatise on Quantitative Inorganic Analysis*, London, 610, 1913.

⁸ H. de Sénarmont, *Ann. Chim. Phys.*, (3), 32, 156, 1851; T. Scherer and E. Drehschl, *Journ. prakt. Chem.*, (2), 7, 63, 1873; C. M. Manross, *Liebig's Ann.*, 82, 353, 1852; A. Macé, *Compt. Rend.*, 36, 825, 1853; C. E. Guignet, *ib.*, 103, 873, 1886.

§ 17. The Dehydration and Rehydration of Gypsum. Plaster of Paris

C. Pape¹ found that crystals of gypsum effloresce at 100°, and J. W. Gunning showed that the dihydrate loses water when dried in a steam-bath. According to F. Knapp, gypsum loses the whole of its water below 100°; and, according to W. A. Shenstone and J. T. Cundall, gypsum can be dehydrated by heating it to 70° in dry air; and 3 per cent. of water was lost by heating hydrated calcium sulphate at 40° for 144 hrs. The dehydration of gypsum has been also studied by N. A. E. Millon, G. and E. Plessy, H. Precht and K. Kraut, etc. A. Payen noted that gypsum begins to lose its water when heated to 115°, and it then loses water more quickly the higher the temp. W. A. Davis confirmed an observation of W. A. Shenstone and J. T. Cundall that there is a distinct initial period of inertness during the dehydration of gypsum. H. How found tabular gypsum dehydrated more readily than the fibrous variety. J. B. Hannay found a break in the dehydration curve corresponding with $\text{CaSO}_4 \cdot 1\frac{1}{2}\text{H}_2\text{O}$, but none with $\text{CaSO}_4 \cdot \frac{1}{2}\text{H}_2\text{O}$; on the other hand, H. le Chatelier determined the time rate of rise of temp., *i.e.* the heating curve, Fig. 38, of powdered gypsum. The temp. rose steadily up to 128°, when there was a long interval during which the temp. remained stationary; a second

steady rise occurred between 128° and 163° , when a second but shorter break occurred; this was followed by another continuous rise. There was a continuous loss of weight on heating gypsum to 155° , until 15.6 per cent. had been lost, when the residue retained a constant weight corresponding with $\text{CaSO}_4 \cdot \frac{1}{2}\text{H}_2\text{O}$; similarly, the loss at 194° was continuous until the anhydrous sulphate was formed, when the weight remained stationary.

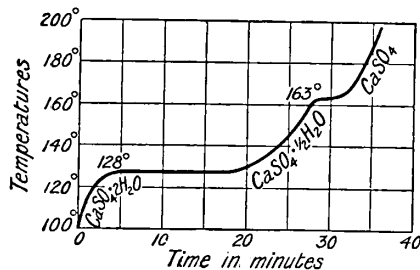

FIG. 38.—Heating Curve of Gypsum.

The following is a selection from the vapour pressure measurements of J. H. van't Hoff and E. F. Armstrong² for the system $\text{CaSO}_4 \cdot 2\text{H}_2\text{O} - \text{CaSO}_4 \cdot \frac{1}{2}\text{H}_2\text{O} - \text{H}_2\text{O}_{\text{vapour}}$ at different temp.:

	0°	10°	20°	40°	60°	80°	100°	110°
Vap. press.	1.17	2.78	6.24	26.3	91.4	272.4	710.8	1104 mm.

where the corresponding values for the vap. press. of water are :

Vap. press.	4.57	9.14	17.4	54.9	149	355	760	1075 mm.
---------------------	------	------	------	------	-----	-----	-----	----------

The observed results are in close agreement with the formula: $\log p = \log p^n + 1.493 - 567.7/(\theta + 273)$, where p denotes the vap. press. of the system at θ° , and p_w that of water at the same temp. They are plotted in Figs. 39 and 40 on different

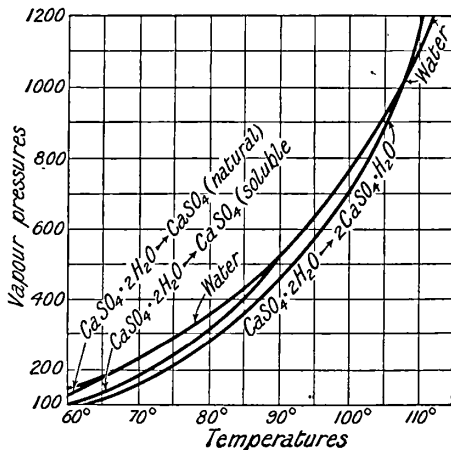
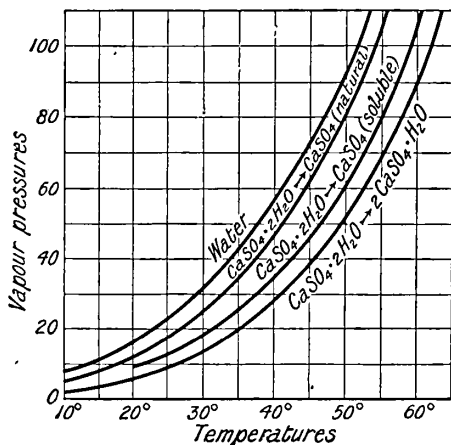

FIGS. 39 and 40.—Vapour Pressure Curves of the Hydrates of Calcium Sulphate.

scales—the latter shows diagrammatically the transition points; otherwise expressed, when gypsum is heated with water under press., above 107° , the hemihydrate will be formed, and when the latter is heated with water below 107° , gypsum will be formed. The transition temp. is lowered in the presence of aq. soln. having a lower vap. press. than water—e.g. a sat. soln. of sodium chloride converts gypsum into the hemihydrate above 77° , the temp. at which the vap. press. of the system: $\text{CaSO}_4 \cdot 2\text{H}_2\text{O} - \text{CaSO}_4 \cdot \frac{1}{2}\text{H}_2\text{O}$, becomes equal to the vap. press. of the sat. soln. In the presence of a 20 per cent. soln. the transition temp. is 93.3° ; and in the presence of a 3.5 per cent. soln. (sea-water), 105° . Again, in the presence of solid hexahydrated calcium chloride, the transformation temp. is 17° ; in a 13 per cent. soln. of calcium chloride, it is a little above 100° ; and in a sat. soln. of magnesium chloride, 11° . The effect of soln. of sodium or calcium chloride on the dehydration of gypsum was also investigated by F. Hoppe-Seyler, and G. Rose; and of soln. of sodium sulphate by

H. Rose. W. A. Davis and E. F. Armstrong have indicated that there is a possibility that these measurements really refer to the system: Hemihydrate \rightleftharpoons soluble anhydrite. Two determinations by H. Lescœur are not in close agreement with these values. The transformation temp. for gypsum \rightarrow hemihydrate is 107° at a press. of 970 mm., and at 758.8 mm. press., 101.45°.

A. Potilitzin found that if gypsum be converted into anhydrous sulphate below 200°, it sets with water, and he calls this α -anhydrite in contrast with the dead-burned form which he calls β -anhydrite. He represents the di- and hemi-hydrates and the α - and β -forms of anhydrite by the formulæ:

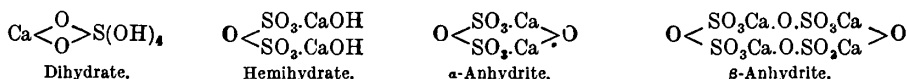

The dihydrate is thus regarded as the calcium salt of orthosulphuric acid, S(OH)_6 ; and the hemihydrate as the calcium salt of parasulphuric acid, SO(OH)_4 . Again, β -anhydrite is considered to be a polymerized form of α -anhydrite. K. Zulkowsky and P. Rohland regard the dihydrate as a calcium salt of orthosulphuric acid, H_6SO_6 or S(OH)_6 . J. H. van't Hoff, W. Hinrichsen, and F. Weigert showed that under special circumstances, gypsum in the presence of water is converted into anhydrous calcium sulphate, which, unlike natural anhydrite, is fairly soluble in water, and sets in water even more rapidly than the hemihydrate. This soluble anhydrite is produced when precipitated gypsum is heated in vacuo over conc. sulphuric acid between 60° and 90°; or when gypsum, regenerated from plaster of Paris, is heated at 100°. It was assumed that gypsum is converted directly into soluble anhydrite, and not through the hemihydrate as an intermediary, because the vap. press. of gypsum in equilibrium with soluble anhydrite is greater than gypsum in equilibrium with the hemihydrate. Vap. press. measurements show that the transformation temp. of gypsum into soluble anhydrite, in contact with water, is lower than the transformation temp. of gypsum into hemihydrate, being 93° in the former case and 107° in the latter. The production of the hemihydrate in E. F. Armstrong's experiments in preference to soluble anhydrite is explained by assuming that it is due to the suspension of the transformation: gypsum \rightarrow soluble anhydrite. In the absence of a lag—*Verzögerung*—J. H. van't Hoff believed that the change of gypsum into soluble or natural anhydrite should precede the change into the hemihydrate. W. A. Davis takes the opposite view—*vide infra*. The vap. press. of the system $\text{CaSO}_4 \cdot 2\text{H}_2\text{O} - \text{CaSO}_4 \text{soluble anhydrite} - \text{H}_2\text{O vapour}$ was found to be:

	15°	20°	40°	50°	60°	70°	80°	85°
Vap. press.	7	10.7	34	61.5	108	185	314	407 mm.

and the results represented by $\log p = \log p_w + 3341.5T^{-1} + 25.905 \log T - 75.198$. The transformation temp. is given as 90°–93°. The data are plotted on different scales in Figs. 39 and 40.

J. H. van't Hoff further assumes that a second variety of gypsum which gives rise to natural anhydrite should occur at an even lower temp., but is normally prevented from appearing; and it is estimated that the transformation temp. of gypsum into natural non-setting anhydrite is as low as 63.5° when in contact with water. He also gives for the system $\text{CaSO}_4 \cdot 2\text{H}_2\text{O} - \text{CaSO}_4 \text{natural anhydrite} - \text{H}_2\text{O vapour}$

	0°	5°	10°	20°	30°	40°	50°	60°
Vap. press.	2.62	3.93	5.79	12.2	24	45.4	82.5	143 mm.

and the transformation temp. is given as 63.5°–66°. They are plotted on different scales in Figs. 39 and 40.

TABLE IV.—TRANSFORMATION TEMPERATURES OF GYPSUM.

The conversion temp. of gypsum into	In the presence of		Press. of water.
	Water.	Sat. soln. NaCl.	
Natural anhydrite . . .	63.5°	36°	17.5 mm.
Soluble anhydrite . . .	93°	62°	588.0 mm.
Hemihydrate . . .	107°	76°	791.0 mm.

These results are summarized in Table IV. This classical work of J. H. van't Hoff wants revision in the light of W. A. Davis' work: *The nature of the changes involved in the production and setting of plaster of Paris.*

W. A. Davis has shown that when monoclinic gypsum is heated, it is very probably converted into a second rhombic form of gypsum; and that before monoclinic gypsum is dehydrated, it first changes into the rhombic form. This is evidenced (i) by the inflection in the dehydration curve of gypsum, which shows that the loss of water does not begin immediately the material is heated, but there is a distinct period of induction. W. A. Shenstone and J. T. Cundall first showed the initial reluctance of gypsum to give up water, and attributed the phenomenon to the presence of "molecular aggregates of great stability, and it is only after the gradual breaking up of these that the dissociation can take place." (ii) The change which occurs in the optical properties when gypsum is heated. At ordinary temp., the optic axes of gypsum lie in the plane of symmetry of the crystal, but on heating to a temp. slightly above 100°, and before dehydration begins, the optic axes revolve so as to take up a position at right angles to this plane. A. Lacroix has shown that when a plate of gypsum is heated, long needles appear within the crystal, and they are elongated in the direction of the vertical axes of the gypsum, and give a rigidly longitudinal extinction. (iii) All the products of the dehydration of gypsum—hemihydrate, soluble anhydrite, and ordinary anhydrite—have rhombic symmetry. (iv) No period of induction has been observed in the transformation of the rhombic hemihydrate to rhombic soluble anhydrite.

W. A. Davis has also shown that just as the dehydration of monoclinic gypsum is preceded by a change into a rhombic form, so when the hemihydrate is rehydrated, it is first converted into the rhombic form and subsequently into ordinary monoclinic gypsum. The changes are strictly reversible:

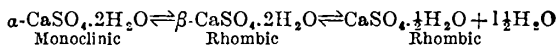

W. A. Davis inferred that the setting of plaster of Paris is not simply a regeneration of gypsum by the rehydration of the hemihydrate, for if the setting is observed under the polarizing microscope, "not a single gypsum crystal can at first be detected in the set mass; the cake of set material, during the first quarter of an hour after it has hardened to a coherent mass, which is only slightly indented by the finger-nail, is made up of crystals showing a straight extinction only, and therefore probably orthorhombic. The first product of the setting of the half-hydrate (or soluble anhydrite) is, indeed, the same orthorhombic dihydrate as is produced in the first stage of the dehydration of gypsum. Gypsum crystals subsequently make their appearance within the set mass owing to the fact that the orthorhombic form of the dihydrate is labile at the ordinary temp., and undergoes change, more or less rapidly—during the course of several hours or several days, the time varying greatly—into the more stable form gypsum."

When gypsum plaster is ground, the heat developed is sufficient to liberate all the water, forming soluble anhydrite; if ground under such circumstances that the water is not permitted to escape, W. E. Emley showed that the product is as plastic as lime putty—*plastic gypsum plaster.*

The continuity of the dehydration curves obtained by heating gypsum in a stream of dry air between 98° and 130°, whereby soluble anhydrite is formed, appears at first sight to favour J. H. van't Hoff's assumption that soluble anhydrite is formed directly from gypsum, but W. A. Davis also showed that (i) the hemihydrate is likewise converted into soluble anhydrite after 4 hrs.' heating at 98°; (ii) gypsum heated in an open crucible at 98° is converted into the hemihydrate, and that the latter remained unchanged after 18 hrs.' heating under the same conditions. This agrees with W. A. Shenstone and J. T. Cundall's experiment where gypsum was completely dehydrated at 70° in a stream of dry air, but formed only the hemihydrate at 100° in ordinary undried air. Hence it was inferred that in the formation of soluble anhydrite by heating gypsum, the hemihydrate is formed as an intermediate product.

W. A. Davis also found that although the hemihydrate does not lose water in an open vessel at 98°, it gives soluble anhydrite when heated for 9 hrs. in a toluene bath at 107°–108°, and gypsum, under similar conditions, gives the same product in about the same time. At 129°, the loss of water is completed in half the time, and soluble anhydrite is formed. C. Cloez also showed that gypsum can be entirely converted into soluble anhydrite at 145° in 4 hrs. Hence, at a temp. below 100°, the vap. press. of the system gypsum-hemihydrate is sufficiently great to allow gypsum to pass to the hemihydrate, but only above 100° does the press. become sufficient for the hemihydrate to form soluble anhydrite. E. F. Armstrong stated that the vap. press. of the system gypsum-hemihydrate is equal to one atm. at 101.45°, but he has also stated that, owing to lack of knowledge concerning the crystallographic characters of the hemihydrate and soluble anhydrite, what was regarded as the hemihydrate was probably soluble anhydrite; and the transition point really refers to the change from the hemihydrate to soluble anhydrite.

The change of the hemihydrate to soluble anhydrite and water vapour is reversible. Soluble anhydrite was shown by C. Cloez to be very hygroscopic and to take up 8 per cent. of its weight of moisture from the air. W. A. Davis showed that the excess above the 6.62 per cent. required for the formation of the hemihydrate is mechanically retained, as is evident by (i) the variability in the amount which depends on the humidity of the air, (ii) no gypsum can be detected among the products of the action, and (iii) if dry air be passed over the product at ordinary temp., the excess of water is removed, and the actual absorption compounds with that theoretically required for the formation of the hemihydrate; while the gypsum shows no sign of a loss of weight under similar conditions. The original hemihydrate can be quantitatively regenerated from a known weight of hemihydrate which has been converted into soluble anhydrite at 100°, by exposing it to humid air, followed by treatment with a current of dry air so as to remove the excess or adsorbed moisture. The raising of the amount of adsorbed moisture above the limit required for the hemihydrate owing to adsorption plus chemical combination misled C. Cloez into stating that *cette limite ne correspond à aucun hydrate défini*, and hence believing that no definite hydrate is formed.

W. A. Davis has shown that gypsum loses water to form the hemihydrate when heated to 98° in an open crucible. J. C. G. de Marignac observed no change when gypsum is heated with boiling water; nor could E. F. Armstrong transform gypsum into the hemihydrate by heating it with water at 100° for a couple of hours. W. A. Davis treated 4 grms. of the hemihydrate with 500 c.c. of water at 100°, and found nearly all dissolved; on heating this soln. minute crystals separated out—these crystals gave an oblique extinction of 52.5°, and the twin forms characteristic of gypsum; when these crystals were heated under boiling water for 3 hrs., they had the characteristics of rhombic crystals—not a single crystal of gypsum remained. The crystals had the composition $\text{CaSO}_4 \cdot \frac{1}{2}\text{H}_2\text{O}$. Unlike the ordinary hemihydrate, that prepared by the prolonged action of boiling water on gypsum sets very slowly, and is not very coherent after standing a couple of hours; it thus resembles that prepared by H. le Chatelier by heating gypsum with water at 130°–

150°, and which he said sets *moins rapide et moins complète qu'avec la plâtre*. W. A. Davis regarded the slow-setting hemihydrate as a dimorphous variety, which is distinct from the quick-setting hemihydrates obtained (i) by the partial dehydration of gypsum at 100°; (ii) by the adsorption of water vapour by soluble anhydrite; and (iii) by the action of nitric acid on gypsum. These varieties of the hemihydrate bear the same relation to one another as do the natural and soluble forms of anhydrite. W. A. Davis infers that calcium sulphate is dimorphous not only when anhydrous, but also when hydrated, for both the di- and hemihydrates exist in two different forms. His summary of the relationship with isodimorphous calcium chromate is indicated in Table V. The dimorphism of calcium chromate has been observed only in the case of the dihydrate; and it is remarkable that the monohydrate is the most stable hydrate of calcium chromate, while a monohydrated calcium sulphate does not exist.

TABLE V.—COMPARISON OF CALCIUM SULPHATE AND CHROMATE (W. A. DAVIS).

	CaSO ₄	CaCrO ₄
Dihydrate	α-form : monoclinic gypsum β-form : rhombic (labile)	α-form : monoclinic (labile). β-form : rhombic.
Monohydrate	Not known	Rhombic.
Hemihydrate	α-form : rhombic (slow setting) β-form : rhombic (quick setting)	One form only is known.
Anhydrous	α-form : rhombic (native anhydrite) β-form : rhombic (soluble anhydrite)	α-form only is known.

Anhydrous, hemihydrated, and dihydrated calcium sulphate are therefore all dimorphous. As a rule, the hydrated sulphates of the bivalent metals are also dimorphous—*e.g.* MnSO₄.4H₂O; MnSO₄.7H₂O; FeSO₄.4H₂O; FeSO₄.7H₂O; MgSO₄.7H₂O; ZnSO₄.6H₂O; ZnSO₄.7H₂O; NiSO₄.6H₂O; NiSO₄.7H₂O; CuSO₄.7H₂O; and CuSO₄.5H₂O—and the dimorphism generally extends to the different hydrates of the same sulphates as in the case of the manganese, nickel, zinc, and ferrous sulphates; and in nearly all cases two forms crystallize in different systems, generally rhombic and monoclinic.

The cause of the setting of plaster of Paris is mainly that indicated by A. L. Lavoisier in 1768; and, nearly 120 years later, further details were established and described by H. le Chatelier in his *Recherches expérimentales sur la constitution des mortiers hydrauliques* (Paris, 1887). Minor details have since been elucidated by J. H. van't Hoff and co-workers, W. A. Davis, etc.

The predominant constituent in normal plaster of Paris is hemihydrated calcium sulphate, 2CaSO₄.H₂O, or CaSO₄.½H₂O. J. C. G. de Marignac showed that when plaster of Paris is stirred with water, it gives a more conc. soln. of calcium sulphate than can be prepared from powdered gypsum. F. Knapp, E. Landrin and H. le Chatelier assumed that such a soln. is formed when plaster of Paris is mixed with a small proportion of water. If a large proportion be employed, the hemihydrate is readily hydrated and a loose coherent mass of isolated prismatic crystals is formed, but, continued H. le Chatelier, with a small proportion of water, the particles of the plaster are in close contact, and minute crystals of gypsum separate from the super-saturated soln. More plaster is dissolved and more crystals of gypsum are formed, the final result—the set plaster—is a confused mass of interlocking lath-shaped prismatic crystals. In favour of this explanation, H. le Chatelier showed that anhydrous sodium sulphate readily forms a soln. supersaturated with respect to the decahydrate, Na₂SO₄.10H₂O, and it too sets when moistened with water; the hardening of zinc oxide in contact with a soln. of zinc chloride is likewise preceded by the formation of a supersaturated soln. from which crystals of zinc oxychloride separate. F. Knapp also showed that the setting of plaster of Paris is an alternating process of dissolution and crystallization. If the hemihydrated calcium sulphate

be hydrated without a solvent being present no setting occurs. For example, gypsum dehydrated at 150° , takes up water from 80 per cent. alcohol, and forms a non-setting mush, since the resulting dihydrated calcium sulphate does not dissolve. The mass hardens if one-third to one-fourth part of water is present. E. Landrin stated that the strongly heated anhydrous sulphate will set if it be mixed with a little calcium sulphate and moistened with water.

C. Cloez believes that the same soluble anhydrite is always present in plaster of Paris, and that this constituent, not the hemihydrate, is the important constituent. He said that the hemihydrate *ne se formait pas pendant la cuisson du plâtre*, and it plays no part in the setting of plaster. The formation of the supersaturated soln. of the soluble anhydrite and its subsequent crystallization in a mass of interlocking bundles of radiating prisms of gypsum, produces set plaster. C. Cloez is probably wrong, and H. le Chatelier right, in assuming that the hemihydrate is the essential constituent of plaster of Paris; although it may be conceded that if the boiling or baking of plaster is a little overdone, some soluble anhydrite may be present; and if a little underdone, some unconverted gypsum remains with the hemihydrate. According to P. Rohland, the setting of plaster of Paris is not solely due to the anastomosing of the crystals of the dihydrate, but a colloidal soln. with water is formed, and the setting in part proceeds as with mortar. A. Cavazzi, indeed, did obtain a gelatinous mass by grinding fresh plaster of Paris with water, and crystals were subsequently formed; he therefore assumed that a highly hydrated intermediate product (colloid) is formed which subsequently loses water and becomes crystalline. I. Traube also favours A. Cavazzi's hypothesis; he found that the influence of cations on the setting is all-important, that of the anions is very small; the order in which cations influence the setting is the reverse order in which they precipitate colloids from soln. This points to a preliminary gel formation in the setting.

There is an apparent expansion during the setting of plaster, and the utility of plaster of Paris in the preparation of moulds, etc., depends on this quality which enables it to fill the mould and take a sharp impression on the surface.

Mouldmakers habitually make an allowance for the expansion of plaster. R. J. Friswell reported that up to about 1880, the expansion of plaster in setting was utilized in Persia as a means of executing criminals. The criminals were placed in hollow stone columns and surrounded with wet plaster of Paris. At first a little inconvenience was suffered, they would then show signs of distress and scream loudly; finally paralysis and death supervened. This would no doubt occur as the expansion of the plaster compressed the thorax and abdomen.

The expansion of the setting plaster, however, is only apparent; for the actual volume of the set plaster is less than the combined volume of water and hemihydrate before setting. The sp. gr. of the hemihydrate is 2.75, and of the dihydrate 2.32; and, assuming the change during setting to be: $2\text{CaSO}_4 \cdot \text{H}_2\text{O} + 3\text{H}_2\text{O} = 2(\text{CaSO}_4 \cdot 2\text{H}_2\text{O})$, the volume before setting is $3 \times 18 + 290/2.75 = 159.5$ units, and after setting $2 \times 172/2.32 = 148.1$ units. This corresponds with a contraction of about 7 per cent. J. H. van't Hoff's measurements with a dilatometer showed that during the hydration of plaster, a large contraction occurs during the first half-hour, and this is succeeded by a smaller expansion, which continues during several hours. W. A. Davis interprets this by showing that the first contraction corresponds with the formation of the rhombic modification of gypsum, and the subsequent expansion, with the conversion of rhombic into monoclinic gypsum. As G. P. Grimsley has shown, the outward thrust of the crystals in the direction of their growth also accounts for the sudden apparent expansion which accompanies the setting.

E. Leduc and M. Pellet observed no change of temp. in the setting of alabaster dehydrated at 400° ; but if dehydrated at 250° , there is a considerable rise of temp. According to C. Cloez, if anhydrous calcium sulphate be mixed with an equal amount of water, the temp. rises 14° to 22° owing to the formation of the hydrate; in about ten minutes the temp. falls 4° to 6° owing to the dissolution of the hydrate;

and it then rises again, higher than at the beginning, owing to the crystallization from the supersaturated soln. If the hemihydrate is employed, the phenomena are correspondingly modified.

J. F. McCaleb measured the hydration of powdered samples of anhydrite and of selenite (previously heated to bright redness). A gram of the powder was moistened with water, and confined over water in a bell-jar between 25° and 30°; the sample was then dried over sulphuric acid to remove mechanically mixed water.

	1	2	3 weeks.
Anhydrite, Sulzberg . . .	0.0209	0.0357	0.0493 grm.
Anhydrite, Nova Scotia . . .	0.0072	0.0155	0.0234 ..
Calc. selenite, Montmartre . . .	0.0022	0.0048	0.0073 ..

The first-named sample also absorbed per gram :

	4	8	12	16	20	28	36 weeks.
Water	0.0308	0.0488	0.0629	0.0700	0.0803	0.0873	0.0949 grm.

According to C. Cloez, calcium sulphate dehydrated at 145° at 14°–16°, absorbs 3.7 per cent. of moisture from the atm. in 1 hr.; 4.27 per cent. in 2 hrs.; 5.7 per cent. in 3½ hrs.; 7.57 per cent. in 19 hrs.; 7.77 per cent. in 27 hrs.; and 7.93 per cent. in 74 hrs. There is no sign of the formation of a definite hydrate on the resulting composition-time curve. According to V. Zunino, when artificial gypsum, dehydrated at 200° or 230°, is heated in a current of steam, it re-absorbs all its water of crystallization; if dehydrated at 240°, it absorbs 75 per cent.; if at 250°, 32 per cent.; if at 260°, 11 per cent.; and over 260°, it absorbs no water, while natural selenite loses this property when calcined to 300°. E. Leduc and M. Pellet found that alabaster dehydrated at 120° begins to set 8 mins. after mixing with water, and has finished in 16 mins.; if dehydrated at 250°, the beginning and ending of the setting are respectively 4 and 6 mins.; if dehydrated at 450°, the setting begins in 4 mins. and is not completed in 5 hrs.; if dehydrated at 600°, it gives a solid mass after some days; and no signs of setting occur with alabaster dehydrated at 650°–800°; while gypsum heated to 1185° forms a friable mass.

The manufacture of plaster of Paris is comparatively simple. The selected raw material is partially dehydrated, and finely ground. If the boiling, as it is called, is conducted in iron vessels called kettles, the grinding is usually done first. The escape of the water in kettle boiling gives the powder the appearance of a boiling liquid. The powder is agitated in order that the material may be as uniformly heated as possible. If the burning is performed in ovens or rotary cylinders, the raw material is preferably fed into the furnace in lumps, and the fine grinding follows the burning. The dehydration may be conducted between 100° and 200°, but in practice the temp. is kept at about 130°. The product contains about one-fourth the original amount of water, and is completely converted into the hemihydrate.

F. Schott, F. Knapp, M. Zeidler, and V. Zunino have shown that if gypsum be heated to a temp. exceeding 200°, all the water of crystallization is expelled, and anhydrous calcium sulphate is formed. P. Rohland and R. K. Hursh agree that above 200° an anhydrous sulphate is formed which hydrates slowly without setting. The former assumes that the non-setting form is of high mol. wt., and, at about 525°, dissociates into simpler mols., forming a second modification of the anhydrous sulphate which sets very hard without expansion, and he considers this to be flooring gypsum. The setting qualities, however, are not really lost when gypsum is calcined above 200°, but instead of, say, about a quarter of an hour being required as in the case of ordinary plaster of Paris, the anhydrous plaster requires some days or even weeks for hardening. This product is called *flooring plaster*—*Estrichgips*. R. Grengg said that flooring plaster consists of anhydrite and calcium oxide in solid soln., partly crystalline and partly glassy. According to J. H. van't Hoff and G. Just, the total dehydration of gypsum occurs at about 190°, the capacity to bind water is at first retained, and is only gradually lost, either by more intense or by longer

heating. The higher the temp. of calcination of the flooring plaster the slower the setting. Thus, with gypsum calcined for 10 hrs. at 200°, 93 per cent. was set in 23½ hrs., and in a sample calcined at 300°, only 56 per cent. was set in 21 hrs. Again, 69 per cent. of a sample of commercial flooring gypsum was set in 13 days, and with a sample of the same material calcined 10 hrs. at 400°, only 39 per cent. had set in the same time. A further calcination at a higher temp. produced dead-burning, and the sample showed no signs of hardening even after weeks. According to P. Rohland, when heated above 600°, a third variety of the anhydrous sulphate is formed which is *vollständig totgebrannt*, and neither sets nor hardens, so that it is of little industrial interest. J. H. van't Hoff and G. Just continue: There is no evidence to show that after dead-burning a new binding capacity appears at a high temp., in which case even natural anhydrite would be suitable for making flooring gypsum. P. Rohland's figures for the supposed transition temp. have not therefore been confirmed. *Dead-burnt plaster* and natural anhydrite dissolve in water with extreme slowness, and they show no tendency to form supersaturated soln., a condition which, according to H. le Chatelier's theory, is necessary for the setting.

M. Glasenapp has shown that if plaster be heated below the critical temp. the product retains the crystalline form of gypsum; and above that temp. it acquires the granular structure characteristic of flooring plaster. At a red heat some basic sulphate is formed which may play some part in the hardening, for a product with 83 per cent. calcium oxide still sets quite hard without appreciable change of vol.—*vide infra*, Scott's selenitic cement. F. A. Wilder has described the manufacture of flooring plaster.

The work of D. C. Winterbottom and A. L. Keane on the supposed modifications of anhydrite may be solely due to differences in the fineness of the particles. Even natural anhydrite will set if ground sufficiently fine; and A. C. Gill found finely ground anhydrite and rough lumps of dead-burnt plaster were both largely converted into crystals of gypsum after standing covered with water in glass bottles for seven years. A. L. Keane also found gypsum calcined at 600°, and ground to particles 0.05 mm. diameter behaved like dead-burnt plaster, but when reduced to particles 0.005 mm. diameter, it set quite rapidly, forming a hard mass.

It is probable that Grecian and mediæval plasters, made by burning gypsum, were types of flooring plaster. The hardening of these plasters has not been closely investigated; M. Gary has done a little work on the subject; and Wo. Ostwald and P. Wolsky have studied the colloidal processes occurring in the setting, by measuring the viscosity of suspensions of burnt gypsum at various periods of time and with various additions—alkali chloride, acetic acid, gelatine, etc. O. Frey recommended regulating the time of setting of plaster of Paris by mixing definite proportions of ordinary plaster of Paris and flooring plaster.

According to J. L. Gay Lussac, the hardness of plaster of Paris when set is greater the harder the raw gypsum. This statement has not been confirmed. If the raw gypsum carries a large proportion of impurities, or if certain materials be added to the plaster after burning, the product sets more slowly. The slow-setting plasters are used in structural work and sometimes marketed as *cement plasters*. Normal plaster of Paris, made from a fairly pure gypsum, sets in from five to fifteen minutes after mixing with water, while the cement plaster may set in from one to two hours, or even more. P. Rohland found that the speed of re-hydration or setting is dependent on the grain-size of the plaster; and A. Ditte showed that the speed of setting may also be modified by the nature of the soluble salts in the water employed in mixing the plaster, for anhydrous calcium sulphate is more rapidly hydrated in the presence of alkali chlorides than in water, and this the more with potassium than with sodium chloride. P. Rohland found that the presence of salts like potassium sulphate, sodium chloride, aluminium chloride, calcium chromate, and potassium dichromate accelerate, while borax and boric acid retard the setting; and calcium chloride has no appreciable influence, hence salts which accelerate the action are called *accelerators*, and those which retard the setting are called *retarders*. P. Rohland

found that in general, substances which increase the solubility of the gypsum accelerate the setting, and those which decrease the solubility of gypsum retard the rate of setting. I. Traube found that the order of setting from the most rapid is with $\frac{1}{2}N$ -soln. hydrochloric acid, oxalic acid, sulphuric acid, trichloroacetic acid, tartaric acid, boric acid, phosphoric acid, dichloroacetic acid, chloroacetic acid, acetic acid, propionic acid, and citric acid. The effect of potassium hydroxide is nearly the same as that of hydrochloric acid. No effect was observed with chloral hydrate, amyl alcohol, propionitrile, mannitol, paraldehyde, methyl alcohol, and methyl ethyl ketone. With 10 grms. of plaster of Paris and 4 c.c. of $\frac{1}{2}N$ -KCl, setting occurred almost instantly; with 5 c.c., in 2.5 mins.; with 7 c.c., in 4 mins.; with 15 c.c. setting had not occurred in 10 mins. Further, with 7 c.c. of a sat. soln. of potassium chloride setting occurred in 12 mins.; with a $\frac{1}{2}N$ -soln., in 4.5 mins.; with a $\frac{1}{4}N$ -soln., in 5.5 mins.; and with $\frac{1}{16}N$ -soln., in 19 mins. Hence there is a maximum velocity of setting with soln. of medium conc. W. Rohland, and I. Traube found that substances of a colloidal nature—*i.e.* glue, gelatine, etc.—interfere with the formation of crystals, and retard the setting. For instance, a small proportion of gelatine or glue retards the setting of plaster of Paris, while a larger proportion completely inhibits the formation of crystals and prevents the setting. It is said that the ancient Romans used blood to retard the setting of plaster of Paris, numerous patents have been taken for the use of organic matter in this connection—*e.g.* glue, tankage from packing houses, prepared hair, sawdust, etc. The glues and gelatines increase the viscosity of the soln., and retard circulation so that the growing crystal exhausts its immediate neighbourhood, and new material is more slowly supplied.

The salts which accelerate the setting of plaster of Paris do not necessarily act in the same way on flooring plaster. Thus, ammonium chloride, calcium chloride, magnesium chloride, aluminium chloride, and potassium dichromate retard the setting of flooring plaster and accelerate that of plaster of Paris; sodium chloride, potassium sulphate, aluminium sulphate, and potassium nitrate accelerate that of both plaster of Paris and flooring plaster; while borax retards the setting of both plasters. Quick-setting plaster of Paris probably contains a little crystalline gypsum which provides nuclei for the crystallization of the supersaturated soln. in setting. Hence, gypsum is an accelerator; and natural anhydrite a retarder.

The so-called *hard-finish plasters* are used for producing a smooth white surface in internal building work, etc. *Keene's cement* is one such, and it is made by calcining a fairly pure gypsum at a red heat; the resulting anhydrous calcium sulphate is immersed in a bath of potash alum soln., dried, and again burned at a high temp. The product is then ground to a fine-grained powder, which, when mixed with water, hardens comparatively slowly. Another peculiarity is that the partially set cement may be reworked with water, and it sets apparently as well as if the setting had not been interrupted. This type of plaster is therefore sharply distinguished from the ordinary plaster cements derived from gypsum. In *Martin's cement*, sodium or potassium carbonate is used as well as alum, and the burning is conducted at a higher temp. The so-called *parian cement* is made by incorporating borax with gypsum in a similar manner; and in *Mack's cement*, flooring plaster is mixed with about 0.4 per cent. of anhydrous sodium or potassium sulphate. The mechanism of the setting of hard-finish plaster has not been established. *Scott's selenitic cement* is a compound cement made by mixing hydraulic lime with 2 to 5 per cent. of gypsum, either by grinding the two components in the dry state, or by slaking lime with an aq. soln. of gypsum. The different plasters derived from gypsum have therefore been classed in the following manner:

I. The temp. of calcination does not exceed 200° C., and the product consists mainly of hemihydrated calcium sulphate.

1. Produced by the calcination of the purer forms of gypsum without the addition of foreign materials before or after calcination—*e.g.* PLASTER OF PARIS.

2. Produced by the calcination of less pure gypsums, or by the addition of retarders to plaster of Paris—*e.g.* CEMENT PLASTERS.
- II. The temp. of calcination exceeds 200° C., and the product is anhydrous calcium sulphate.
1. Produced by the calcination of gypsum—*e.g.* FLOORING PLASTER.
 2. Produced by the recalcination of flooring plaster or dead-burned plaster with alum, borax, etc.—*e.g.* HARD-FINISH PLASTERS.

REFERENCES.

- ¹ C. Pape, *Pogg. Ann.*, **135**, 1, 1868; J. W. Gunning, *Chem. News*, **22**, 307, 1871; W. A. Shensstone and J. T. Cundall, *Journ. Chem. Soc.*, **53**, 544, 1888; J. B. Hannay, *ib.*, **32**, 381, 1877; W. A. Davis, *Journ. Soc. Chem. Ind.*, **26**, 727, 1907; N. A. E. Millon, *Ann. Chim. Phys.*, (3), **19**, 222, 1847; *Compt. Rend.*, **24**, 695, 1847; E. Plessy, *ib.*, **24**, 658, 1847; G. Plessy, **24**, 812, 1847; H. How, *Phil. Mag.*, (4), **39**, 279, 1870; H. Precht and K. Kraut, *Liebigs Ann.*, **178**, 129, 1875; H. le Chatelier, *Recherches expérimentales sur la constitution des mortiers hydrauliques*, Paris, 1887; A. Payen, *Précis de chimie industrielle*, Paris, 304, 1850; F. Knapp, *Dingler's Journ.*, **202**, 513, 1872.
- ² A. L. Lavoisier, *Mém. Acad.*, 341, 1768; *Œuvres*, Paris, 3, 106, 1865; H. le Chatelier, *Recherches expérimentales sur la constitution des mortiers hydrauliques*, Paris, 1887; J. C. G. de Marignac, *Arch. Sciences Genève*, **48**, 120, 1873; *Œuvres complètes*, Genève, 2, 571, 1903; *Ann. Chim. Phys.*, (5), 1, 274, 1874; J. L. Gay Lussac, *ib.*, (2), **40**, 436, 1829; W. A. Davis, *Journ. Soc. Chem. Ind.*, **26**, 727, 1907; E. F. Armstrong, *ib.*, **26**, 737, 1907; R. J. Friswell, *ib.*, **26**, 737, 1907; C. L. Haddon, *ib.*, **39**, T. 165, 1920; C. Cloez, *Bull. Soc. Chim.*, (3), **29**, 169, 171, 1903; P. Rohland, *Zeit. anorg. Chem.*, **35**, 194, 1903; **36**, 332, 1903; **40**, 182, 1904; *Zeit. Elektrochem.*, **14**, 421, 1908; *Koll. Zeit.*, **13**, 61, 1913; *Zeit. angew. Chem.*, **18**, 327, 1905; *Ber.*, **33**, 2831, 1900; *Chem. Ztg.*, **26**, 804, 1902; R. K. Hursh, *Trans. Amer. Cer. Soc.*, **17**, 549, 1915; A. C. Gill, *Journ. Amer. Cer. Soc.*, **1**, 65, 1918; A. L. Keane, *Journ. Phys. Chem.*, **20**, 701, 1916; M. Gary, *Mitt. Materialprüf. Amt.*, **22**, 50, 1904; A. Cavazzi, *Gazz. Chim. Ital.*, **42**, ii, 626, 1912; V. Zunino, *ib.*, **30**, 333, 1900; M. Glasenapp, *Tonind. Ztg.*, **32**, 1148, 1197, 1230, 1908; O. Frey, *ib.*, **34**, 242, 1910; D. C. Winterbottom, *Bull. South Australian Dept. Chem.*, **7**, 1917; W. A. Shensstone and J. T. Cundall, *Journ. Chem. Soc.*, **53**, 544, 1888; J. H. van't Hoff, E. F. Armstrong, W. Hinrichsen, F. Weigert, and G. Just, *Zeit. phys. Chem.*, **45**, 257, 1903; G. P. Grimsley, *The Gypsum of Michigan and the Plaster Industry*, Lansing, 1904; L. Mack, *Monit. Céramique*, **27**, 171, 1896; *Baugewerksztg.*, **25**, 230, 1896; E. F. Armstrong, *Ueber das Halbhydrat von Calcium-sulfat*, Berlin, 1901; H. Lescoeur, *Sur la dissociation des hydrates salins et des composés analogues*, Lille, 1888; J. H. van't Hoff, W. Hinrichsen, and F. Weigert, *Sitzber. Akad. Berlin*, **570**, 1901; J. H. van't Hoff and F. Weigert, *ib.*, **1140**, 1901; J. H. van't Hoff and E. F. Armstrong, *ib.*, **563**, 1900; G. Rose, *ib.*, **363**, 1871; J. H. van't Hoff and G. Just, *ib.*, **249**, 1903; J. H. van't Hoff, J. C. Donnan, E. F. Armstrong, W. Hinrichsen, and F. Weigert, *Arch. Néerl.*, (2), **6**, 471, 1901; F. Hoppe-Seyler, *Pogg. Ann.*, **127**, 161, 1866; H. Rose, *ib.*, **93**, 606, 1854; C. H. Desch, *The Chemistry and Testing of Cement*, London, 1911; *Trans. Cer. Soc.*, **18**, 15, 1919; A. Lacroix, *Compt. Rend.*, **126**, 360, 553, 1898; H. le Chatelier, *ib.*, **96**, 1668, 1883; E. Leduc and M. Pellet, *ib.*, **143**, 317, 1906; A. Ditte, *ib.*, **126**, 694, 1898; J. H. Droeze, *Ber.*, **10**, 330, 1837; J. Mylius and J. von Wrochem, *ib.*, **53**, 3689, 1900; E. Landrin, *Ann. Chim. Phys.*, (5), **3**, 441, 1874; *Compt. Rend.*, **79**, 658, 1874; R. Grengg, *Zeit. anorg. Chem.*, **90**, 327, 1914; Wo. Ostwald and P. Wolsky, *Koll. Zeit.*, **27**, 78, 1920; P. Berthier, *Ann. Mines*, (3), **19**, 655, 1841; G. A. Hulett and L. E. Allen, *Journ. Amer. Chem. Soc.*, **24**, 667, 1902; F. Schott, *Dingler's Journ.*, **202**, 513, 1872; M. Zeidler, *ib.*, **180**, 471, 1866; F. Knapp, *ib.*, **202**, 513, 1872; A. Potilitzin, *Journ. Russ. Phys. Chem. Soc.*, **26**, 170, 221, 1894; **27**, 265, 1895; J. F. McCaleb, *Amer. Chem. Journ.*, **11**, **31**, 35, 1889; K. Zulkowsky, *Chem. Ind.*, **22**, 349, 1899; I. Traube, *Zeit. Koll.*, **25**, 62, 1919; W. E. Emley, *U.S. Pat. No.* 1392574, 1921; F. A. Wilder, *Rep. Iowa Geol. Sur.*, **12**, 192, 1902.

§ 18. The Solubility of the Sulphates of the Alkaline Earths

Gypsum is the stable form of calcium sulphate under ordinary conditions of temp. and in contact with air, but the hemihydrate and anhydrite often exist as metastable forms, because of the slowness of the transformation to gypsum. In water, gypsum is stable up to about 66°, when it passes into natural anhydrite; while in the presence of other salts, the transformation temp. is lowered, as previously indicated. In spite of this, the solubility of gypsum can be determined in these different menstrua far above the transformation temp. because of the slowness of

these transformations. Many misconceptions regarding the properties of gypsum have arisen, and many of these were not cleared until the researches of J. H. van't Hoff and allied workers had yielded extensive and precise knowledge of various transformations of calcium sulphate. This work is outlined in J. H. van't Hoff's *Untersuchungen über die Bildungsverhältnisse der ozeanischen Salzablagerungen insbesondere des Stassfurter Salzlagers* (Leipzig, 1912).

The accurate determination of the solubility of calcium sulphate in water has presented many unforeseen difficulties which have not all, even yet, been satisfactorily explained. J. C. G. de Marignac¹ showed that the early observations of the solubility of calcium sulphate by C. F. Bucholz, F. von Giese, A. B. Poggiale, M. Tipp, L. de Boisbaudran, A. H. Church, E. Erlenmeyer, A. Cossa, and K. Möller are inaccurate because insufficient precautions have been taken to provide against the great tendency of this salt to form supersaturated soln. He said that "it is exceedingly easy to obtain such soln., and they are very slow to come to equilibrium, even in the presence of an excess of solid gypsum." A. Cavazzi obtained supersaturated soln. with 0.947 gm. CaSO_4 or 1.1976 grms. $\text{CaSO}_4 \cdot 2\text{H}_2\text{O}$ per 100 c.c. J. C. G. de Marignac found that when a quantity of plaster of Paris is shaken with water for five minutes, and rapidly filtered, the filtrate is five times more conc. than a sat. soln. of gypsum. The supersaturated soln. soon becomes turbid, deposits crystals, and attains normal conc. J. C. G. de Marignac's data, grams of salt per 100 grms. of water, are :

	0°	18°	24°	32°	38°	41°	53°	72°	86°	99°
$\text{CaSO}_4 \cdot 2\text{H}_2\text{O}$	0.241	0.259	0.264	0.270	0.272	0.270	0.267	0.256	0.240	0.222
CaSO_4	0.190	0.205	0.209	0.213	0.215	0.214	0.211	0.202	0.189	0.175

G. A. Hulett showed that the conc. of a soln. in equilibrium with a plane surface is different from that of a soln. in equilibrium with a curved surface, and this the more the greater the curvature; further, the solubility of the finely divided gypsum is appreciably greater than that of the coarse-grained solid—*e.g.* he found the solubility was increased 20 per cent. by decreasing the size of the particles to 0.3μ . He found that the solubility of particles over 0.002 mm. in diameter is 15.33 millimols per litre at 25°, and of particles 0.0003 mm. diameter 18.2 millimols per litre. In the latter case, the excess separates from the soln. if it be brought in contact with particles not less than 0.002 mm. diameter—*vide* 1. 10, 1. The soln. sat. with the fine grains is in an unstable condition, and the coarser grains slowly grow at the expense of the finer grains until the conc. of the soln. is in the state of equilibrium characteristic of one in contact with a plane surface of the solid; he calls this a *normally saturated solution*. J. C. G. de Marignac, and J. H. Droeze took care to have an excess of finely divided gypsum distributed throughout the liquid, but even then the results are rather high, because, although the soln. were in equilibrium with the solid, gypsum is a very soft mineral, easily ground to fine powder, and the soln. were not therefore in a state of normal saturation. G. A. Hulett found it necessary to remove all the fine particles before he could obtain normal saturation. If the powder be not removed, equilibrium is not attained after five days' stirring; while if the stirring be too rapid, the abrasion from the soft gypsum continually yields a fine powder, and a normally sat. soln. is never attained. G. A. Hulett and L. E. Allen's determinations of the solubility of calcium sulphate in a state of normal saturation (here partly interpolated), and expressed in grams of calcium sulphate, CaSO_4 , per 100 grms. of soln., are :

	0°	10°	30°	40°	50°	60°	80°	100°
Grm. of CaSO_4	0.1759	0.1928	0.2090	0.2097	0.2038	0.1996	0.1802	0.1619
Solid phase	$\text{CaSO}_4 \cdot 2\text{H}_2\text{O}$					CaSO_4		

The early workers found a change in the direction of the solubility curve, and the results of J. C. G. de Marignac and J. H. Droeze give 38° as the temp. of maximum

solubility; while those of G. A. Hulett and L. E. Allen give 40° as the temp. of greatest conc. The conc. of the normally sat. soln. thus increases as the temp. rises up to 40°, and subsequently decreases, being nearly the same at 90° as it is at 0°; and at 107° it has decreased 12 per cent. more. There is no abrupt break in the curve at 40°. The uniformity of the vap. press. curves of gypsum excludes the idea of explaining the change at 40° by assuming the appearance of a new phase; thermodynamics connects the change at 40° with the change in the sign of the heat of soln., and this is supported by M. Berthelot's observations on the heat of precipitation of the dihydrate above and below 40°. The downward course of the curve above 40° is explained by W. A. Davis as follows: The crystallographic character of the solid phase in the solubility determinations has not been investigated, and, therefore, it is not certain if the two branches of the curve really correspond with the same form of the dihydrate. By analogy with F. Mylius and J. von Wrochem's work on the calcium chromates, the two branches of the gypsum curve may belong to α - and β -forms of the dihydrate, a transition of one form into the other occurring at 38°; for the solubility of α -CaCrO₄·2H₂O decreases with temp. while that of the β -form increases. Moreover, the formation of a mono- or hemi-hydrate is not excluded; it is certain that a form of the hemi-hydrate can be produced from gypsum at 100°. G. A. Raupenstrauch represented the solubility of gypsum, S , at θ° between 0° and 38° by the expression: $S=0.1771+0.00187162(\theta-0.8)-0.0000247095(\theta-0.8)^2$; and between 38° and 100° by $S=0.2117-0.000192371(\theta-38.8)-0.00001000029(\theta-38.8)^2$.

B. Guillon, and W. A. Tilden and W. A. Shenstone found a solubility of 0.049 at 151.2°; 0.031 at 169.6°; 0.027 at 180°; 0.016 at 220.4°; and 0.018 at 245°—the last result is probably a little too large. There are also A. C. Melcher's determinations of the so-called soluble anhydrite as an unstable phase. Expressing the results in millimols per litre:

	18°	50°	100°	156°	218°
Gypsum	15.69	14.47	9.13	—	—
Soluble anhydrite	—	—	9.00	2.29	—
Anhydrite	—	—	4.62	1.22	0.20

The combined results of G. A. Hulett and L. E. Allen on gypsum, and of B. Guillon on the solubility of soluble anhydrite, are shown graphically in Fig. 41. Anhydrite is the stable solid phase above 60°, and its solubility decreases rapidly with rising temp., and at 218° its value is one-fortieth that of gypsum at 18°; the solubility curve of soluble anhydrite cuts that of gypsum at about 97°, whereas J. H. van't Hoff's vap. press. measurements place the transition temp. of these two forms at 93°. The plotting of J. C. G. de Marignac's solubilities furnishes two curves which intersect at the maximum, at 38°. W. A. Davis has shown that when J. C. G. de Marignac's and G. A. Hulett and L. E. Allen's solubility data are plotted on the same chart, and the two limbs of the latter's curve be extended, they intersect on J. C. G. de Marignac's curve at 38°. W. A. Davis believes that the differences in the two sets of results are due to differences in the nature of the gypsum used, and to the presence in the gypsum of impurities modifying the changes in dimorphous gypsum.

According to G. A. Hulett and L. E. Allen, the ratio of the solubility of soluble anhydrite to that of ordinary anhydrite is almost the same at 100° as at 156°, namely, 2.48 at 100° and 2.37 at 156°. This, said A. C. Melcher, agrees with the assumption that soluble anhydrite is really another form of the anhydrite, and not

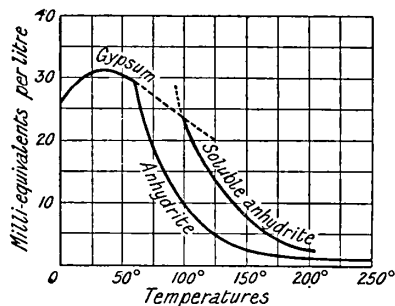

FIG. 41.—Solubility of Calcium Sulphate in Water.

a hydrate. From the relation $d \log (S_1/S_2) = (Q/RT^2)dT$, it follows that when the ratio of the solubilities $S_1 : S_2$ is constant, the heat of transition Q is zero, and this is not so likely to be the case for the transition of an anhydride into a hydrate, as for the transition of one form of a given substance into another.

According to A. Goldammer, the solubilities of different varieties of dihydrated calcium sulphate in water—grams of salt in 100 grms. of water—are :

	0°	15°	30°	37.5°	45°	60°	90°	100°
Precipitated	0.178	0.201	0.210	0.216	0.211	0.207	0.186	0.180
Native	0.179	0.201	0.210	0.213	0.211	0.206	0.187	0.180
Powdered selenite	0.174	0.203	0.213	0.215	0.213	0.207	0.187	0.180

These numbers are in close agreement, as should be the case if the soln. were in equilibrium. Other determinations of the solubility have been made by F. Kohlrausch and F. Rose, and A. F. Hollemann, but here again the results are too high, possibly owing to G. A. Hulett's effect. J. F. McCaleb measured the ratio of dissolution of anhydrite and gypsum in water by exposing 6–9 sq. cms. of surface to 4 litres of distilled water contained in tall jars at 20°, and found pink micaceous gypsum lost 0.2219 gm. under similar conditions; honey-yellow selenite, 0.1177 gm.; and grey massive anhydrite, 0.0666 gm. Similarly :

	First	Second	Third	Fourth	Fifth week.
Gypsum, white massive	0.2219	0.4638	0.6788	0.8168	0.8768 gm.
Selenite, honey-yellow	0.1177	0.2021	0.3250	0.4179	0.4893 „
Anhydrite, grey massive	0.0666	0.0999	0.1514	0.1881	0.2398 „

According to F. Rinne, the rate of soln. of the faces of a crystal of gypsum is not the same in different directions, although G. A. Hulett found that no change in form occurs when a crystal of gypsum stands a long time in contact with a sat. soln. of calcium sulphate.

Strontium sulphate is sparingly soluble in cold or hot water. According to T. C. Hope,² a litre of boiling water dissolves 0.266 gm. R. Brandes reported that a litre of water dissolves 0.0665 gm. of strontium sulphate at 11°, and 0.282 gm. at 100°; R. Fresenius, 0.145 gm. at 14°, and 0.104 gm. at 100°; J. C. G. de Marignac, 0.154 to 1.167 gm. at ordinary temp.; P. Kremers, 0.187 gm.; T. Andrews, 0.278 gm.; and P. Schweitzer, 0.0970 to 0.133 gm. F. Kohlrausch found 0.1133 gm. per litre at 2.85°; 0.1135 gm. per litre at 10.18°; 0.1143 gm. per litre at 18°, and also at 32.26° for natural and artificial strontium sulphate; and he reported that a litre of water at 2.85° dissolves 0.1133 gm. of strontium sulphate; at 17.4°, 0.1143 gm.; and at 32.3°, 0.1143 gm. J. Wolfmann found for 100 grms. of water the solubility :

	0°–5°	10°–12°	20°	30°	50°	80°	90°	95°–98°
SrSO ₄	0.0983	0.0994	0.1479	0.1600	0.1629	0.1688	0.1727	0.1789

F. C. Calvert reported that barium sulphate has a solubility of 0.00125 gm. per litre; R. Fresenius gave 0.0025 gm. per litre of cold or hot water; and, expressing the results in grams per 100 c.c. of water, F. Kohlrausch obtained :

	0.77°	3.35°	18°	26.75°	34°
BaSO ₄	0.000171	0.000207	0.000230	0.000266	0.000291

A. C. Melcher found in milli-eq. per litre :

	18°	25°	50°	100°
BaSO ₄	0.0190	0.0212	0.0288	0.3354

R. Fresenius and E. Hintz, W. Böttger, Z. Karaoglanoff, A. F. Hollemann, and F. W. Küster have also made observations on this subject. G. A. Hulett obtained similar results with respect to the solubility of barium sulphate of different size of grain as those he obtained with solubility of calcium sulphate. For particles of

a grain size not under 0.0019 mm. diam., the solubility is 2.29 millimols per litre ; and for particles below 0.0001 mm. diameter, 4.15 millimols per litre—*vide* l. 10, 1.

H. Rose³ reported that cold *hydrochloric acid* dissolves a little calcium sulphate, but boiling dil. acid dissolves much more. The solubility at 25° and at 102° has been determined by G. Lunge. Expressing the results in grams of HCl and of CaSO₄ per 100 c.c. of soln. :

Grms. HCl		0	1	2	3	4	6	8
Grms. CaSO ₄	} 25°	0.208	0.72	1.02	1.25	1.42	1.65	1.74
		} 102°	0.160	1.38	2.38	3.20	3.64	4.65

This shows the solubility increases with the increasing conc. of acid and with temp. C. R. Fresenius found a litre of cold 8.5 per cent. hydrochloric acid dissolved 2.11 grms. of strontium sulphate, and a litre of cold 4.8 per cent. nitric acid dissolved 2.31 grms. According to H. Rose, cold hydrochloric or nitric acid does not dissolve appreciable quantities of heavy spar, or artificial barium sulphate after many days' contact ; the boiling acids, however, do attack barium sulphate, so that the filtered liquid gives a precipitate with both barium chloride and sulphuric acid ; and R. Piria and E. Siegle also found that by washing precipitated barium sulphate with dil. hydrochloric or nitric acid, a similar result is obtained. F. C. Calvert, G. S. Fraps, E. C. Nicholson and D. S. Price, H. M. Noad, and C. Gutkowsky have made observations on this subject. Expressing the results in grams per 100 c.c., it follows that :

BaSO ₄	Hydrochloric Acid			Nitric Acid			
	1.82	3.65	7.29	3.15	6.31	12.61	31.52
	0.0067	0.0089	0.0101	0.0070	0.0107	0.0170	0.0241

The solubility of barium sulphate in hydrochloric acid has been measured by W. Ostwald, by E. T. Allen and J. Johnston, and by J. M. Kolthoff and E. H. Vogelzang. Expressing the results in milligrams per litre of acid, at 20° :

N-HCl	0.003	0.016	0.08	0.16	0.3	0.5	1.0	1.5	2.0	5.0
BaSO ₄	2.6	4.3	9.4	11.1	34.3	67*	84*	103	101	86*

Those marked with an asterisk are by W. Ostwald, the others are by E. T. Allen and J. Johnston. For strontium and barium sulphates, W. Ostwald found :

N-HCl	SrSO ₄				CaSO ₄				
	0.1	0.5	1.0	2.0	5.0	0.1	0.5	1.0	2.0
Mgram.	3.25	2.20	1.72	0.96	0.29	22.96	15.75	11.51	7.61

A. Gawalowsky found barium sulphate to be soluble in *chlorine water*. A. R. Haslam found that 100 c.c. of 40 per cent *hydrobromic acid* dissolve 0.04 gm. of barium sulphate ; and the same amount of 40 per cent. *hydriodic acid* dissolve 0.0016 gm.

The solubility of gypsum in *nitric acid* at 25° is also raised much as it is with hydrochloric acid ; but the increase in solubility is not so great with *chloroacetic acid* and with *formic acid*. W. Ostwald's values for nitric, monochloroacetic, and formic acids are shown in Table VI. O. Aschan found that 100 c.c. of a sat. soln.

TABLE VI.—SOLUBILITIES OF THE ALKALINE EARTH SULPHATES IN NITRIC, MONOCHLOROACETIC, AND FORMIC ACIDS.

N-acid.	Nitric acid.			Monochloroacetic.		Formic acid.	
	BaSO ₄ .	SrSO ₄ .	CaSO ₄ .	SrSO ₄ .	CaSO ₄ .	SrSO ₄ .	CaSO ₄ .
5	0.048	0.73	—	—	—	—	—
2	0.084	1.46	9.27	—	—	—	—
1	0.106	2.01	13.09	0.104	0.41	0.080	0.31
0.5	0.137	2.44	20.37	0.133	0.17	—	—
0.1	—	3.22	23.36	—	—	—	—

of barium sulphate in 95 per cent. formic acid at 18.5° contain 0.01 grm. of that salt. Table VII embodies W. Ostwald's data for these acids expressed in mgrms. of salt dissolved per mgrm. of acid diluted to the extent indicated. With the more conc. soln. of acids nitric acid dissolves barium sulphate more readily than hydrochloric acid, but with the acids of lower conc., the solvent action is nearly the same. R. Fresenius found a litre of 15.6 per cent. *acetic acid* dissolves 0.1275 per cent. of strontium sulphate; and E. Siegle noted that barium sulphate is less soluble in this acid than in nitric or hydrochloric acid.

According to H. Endemann, calcium sulphate is more readily soluble in dil. *sulphuric acid* than in water. H. Struve found 100 parts of sulphuric acid of sp. gr. 1.82 dissolved 2 parts of calcium sulphate, and 100 parts of fuming sulphuric acid, 10.17 parts of the same salt. Liès Bodart and E. Jacquemin observed that

TABLE VII.—SOLUBILITIES OF CALCIUM, STRONTIUM, AND BARIUM SULPHATES IN DILUTE ACIDS.

Conc. of acid.	Hydrochloric acid.			Nitric acid.			Monochloroacetic.		Formic acid.	
	BaSO ₄ .	SrSO ₄ .	CaSO ₄ .	BaSO ₄ .	SrSO ₄ .	CaSO ₄ .	SrSO ₄ .	CaSO ₄ .	SrSO ₄ .	CaSO ₄ .
5N.	0.017	0.29	—	0.048	0.73	—	—	—	—	—
2N.	0.055	0.96	7.61	0.084	1.46	9.27	—	—	—	—
N.	0.088	1.72	11.51	0.106	2.01	13.09	0.104	0.41	0.080	0.31
0.5N.	0.130	2.20	15.75	0.137	2.44	20.37	0.133	0.17	—	—
0.1N.	—	3.25	22.96	—	3.22	23.36	—	—	—	—

100 parts of conc. sulphuric acid dissolved 2.5 parts of calcium sulphate, and the soln. on standing became turbid. F. K. Cameron and J. F. Breazeale give the following data, where the numbers represent the number of grams of H₂SO₄ or CaSO₄ per litre of soln.:

Grms. H ₂ SO ₄	0.00	0.48	4.87	48.67	75.00	97.35	146.01	292.02
Grms. CaSO ₄	25° . 2.126	2.128	2.144	2.727	2.841	2.779	2.571	1.541
	35° . —	2.209	2.451	3.397	—	3.606	3.150	—
	43° . 2.145	2.236	2.456	3.843	4.146	—	4.139	2.481

There is thus a maximum in the solubility curve at 25° somewhere near soln. with 75 grms. H₂SO₄ per litre, and 2.84 grms. CaSO₄ per litre; at 35°, with 85 grms. H₂SO₄ and 3.70 grms. CaSO₄; and at 43°, with 105 grms. H₂SO₄ and 4.26 grms. CaSO₄. The sp. gr. of the soln. were measured, and F. K. Cameron and J. F. Breazeale inferred that there is a condensation not alone of the soln., but of the solvent itself. For example, at 25°, a litre of the soln. containing 0.49 grm. of sulphuric acid, and 2.128 grms. of calcium sulphate, weighs 1002.493 grms., while the weight of an equal vol. of water is 997.12 grms. It is stated that the results are not satisfactorily explained by the ionization theory, although it is possible that complex ions of the type Ca(SO₄)₂'' or HCa(SO₄)₂' are formed; but an examination of the solid phases, and the determination of the acidity of the soln. before and after adding calcium sulphate, gave no information on this point. H. Endemann, however, found that by keeping the time and temp. constant the amount of glucose produced by heating dextrine with dil. sulphuric acid is dependent on the conc. of the acid. He found that with a given conc. of sulphuric acid, sufficient glucose was produced to reduce 0.220 grm. of copper; and by adding potassium sulphate to the acid soln. the glucose reduced 0.168 grm. of copper; and with an eq. amount of calcium sulphate 0.180 grm. of copper. It was therefore inferred that some of the sulphuric acid united chemically with the salt, which prevented it reacting with the dextrine. It was also assumed that just as potassium sulphate and sulphuric acid furnish potassium hydrosulphate, KHSO₄, so do calcium sulphate and sulphuric acid give a calcium hydrosulphate.

According to J. J. Berzelius, if anhydrous calcium sulphate be digested with hot sulphuric acid, calcium hydrodisulphate, $\text{Ca}(\text{HSO}_4)_2$, crystallizes out on cooling; and the colourless, transparent, prismatic crystals can be dried on porous tiles. They are decomposed into calcium sulphate and free sulphuric acid when exposed to moist air, or when treated with water. According to C. Schultz, anhydrous calcium sulphate separates from a boiling soln. of calcium sulphate in conc. sulphuric acid; calcium hydrosulphate, $\text{Ca}(\text{HSO}_4)_2$, separates from the soln. at 100° ; and calcium hydrotetrasulphate, $\text{CaSO}_4 \cdot 3\text{H}_2\text{SO}_4$, at ordinary temp. If a soln. of one part of calcium sulphate in 10 parts of sulphuric acid be evaporated, a crop of crystals of anhydrite is produced; and if the soln. be cooled, prismatic crystals of $\text{CaSO}_4 \cdot 3\text{H}_2\text{SO}_4$ are formed. They melt to a mush at 100° . T. Garside also obtained crystals of the acid sulphate from a sulphuric acid soln. of calcium sulphate. In addition to these two acid sulphates, H. A. G. Willoughby obtained calcium hydrotrisulphate, $2\text{CaSO}_4 \cdot \text{H}_2\text{SO}_4$, in coarse irregular rhombic plates. F. Bergius made some inaccurate measurements of the solubility of calcium sulphate in sulphuric acid owing to his soln. not being in equilibrium with the solid phases. J. Kendall and A. W. Davidson found the f.p. of soln. of calcium sulphate in sulphuric acid to be :

Per cent. CaSO_4 . . .	0.0	1.99	4.00	4.84	6.63	7.59
F.p. (stable form) . . .	10.4	7.2	2.2	19.1	45.4	55.1
F.p. (unstable form) . . .	—	—	—	13.5	39.7	49.4
Solid phases	H_2SO_4			$\text{CaSO}_4 \cdot 3\text{H}_2\text{O}$		

Soln. with over 8 molar per cent. CaSO_4 deposited crystals when warmed. The curves, Fig. 42, illustrate the results obtained.

T. C. Hope reported that strontium sulphate is soluble in conc. sulphuric acid, and is re-precipitated by water. Similar observations were made by M. H. Klaproth, G. Moretti, etc. T. Andrews reported that water acidulated with sulphuric acid dissolves less strontium sulphate than does water alone; and, according to R. Fresenius, a litre of such a liquid dissolves 83 to 91 mgrms. of strontium sulphate. Working at ordinary temp., Liès Bodart and E. Jacquemin reported that strontium sulphate dissolves in sulphuric acid less readily than barium sulphate, and that 100 grms. of conc. sulphuric acid dissolve 2.2 grms. of strontium sulphate; H. Struve, that 100 grms. of the conc. acid dissolve 5.58 grms. of strontium sulphate, and 100 grms. of the fuming acid, 9.77 grms.; E. Varenne and M. Pauleau, that 100 grms. of 91 per cent. sulphuric acid dissolve 0.08 gm. of strontium sulphate. F. Bergius found that absolute sulphuric acid dissolves 21.7 grms.

of strontium sulphate per 100 c.c. of sat. soln., and the solid phase is $\text{SrSO}_4 \cdot 14\text{H}_2\text{SO}_4$. T. Garside found that 100 grms. of sulphuric acid, sp. gr. 1.843, at 70° , dissolve 14 grms. of strontium sulphate, and that on raising the temp. the soln. deposits cubic and octahedral crystals, while if the soln. at 70° be cooled tabular crystals appear. C. Schultz found boiling sulphuric acid dissolves 15 per cent. of strontium sulphate; no salt separates on cooling, and on dilution crystalline strontium sulphate is obtained. If the warm soln. be digested with an excess of strontium sulphate, or if potassium sulphate be dissolved in it, granular crystals of strontium hydro-sulphate, $\text{Sr}(\text{HSO}_4)_2$, were produced which formed plates of the hydrated salt, $\text{Sr}(\text{HSO}_4)_2 \cdot \text{H}_2\text{O}$, by exposure to moist air.

According to E. Varenne, and M. Pauleau, 100 grms. of 91 per cent. sulphuric acid dissolve 0.0317 gm. of barium sulphate precipitated from the chloride, or 0.0658 gm. precipitated from the nitrate—the difference is attributed to the presence of adsorbed nitrate forming nitric acid. Working at ordinary temp.,

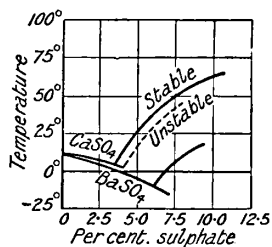

FIG. 42.—Freezing-point Curves of Binary Mixtures of Sulphuric Acid with Barium or Calcium Sulphate.

Liès Bodart and E. Jacquemin found 100 parts of conc. sulphuric acid dissolve 2.22 parts of barium sulphate. H. Struve, and C. C. Selleck measured the solubility of barium sulphate in sulphuric acid, and found 100 parts of an acid, sp. gr. 1.32, dissolve 5.6 parts of barium sulphate, and an acid, sp. gr. 1.90, dissolve 15.89 parts of the same salt. Z. Karaoglanoff also made observations on this subject. T. Garside found that when 14 parts of barium sulphate are added to 100 parts of sulphuric acid, sp. gr. 1.843, and the mixture stirred, a nearly clear soln. is obtained; when this is heated to 100°, needle-shaped crystals separate which do not redissolve in the cold acid; when the temp. is raised to 170°, the needle-shaped crystals are replaced by others of a prismatic shape which increase in quantity as the temp. is raised. At the b.p., the acid still retains in soln. 8.5 to 9.0 parts of the salt.

According to J. J. Berzelius, barium sulphate, or, according to Liès Bodart and E. Jacquemin, barium oxide, borate, phosphate, chloride, etc., dissolve in conc. sulphuric acid, forming a soln. which furnishes acicular crystals of the acid sulphate, **barium hydrosulphate**, $\text{Ba}(\text{HSO}_4)_2$. J. J. Berzelius prepared barium hydrosulphate, $\text{Ba}(\text{HSO}_4)_2$, by allowing barium sulphate to stand for some days in contact with warm conc. sulphuric acid when small crystals of the hydrosulphate separated out, and prismatic crystals were formed as the soln. cooled. C. Schultz digested a soln., sat. at 100°, with a not too large excess of barium sulphate, until the separation of crystals of the hydrosulphate began. The soln. then contained less barium sulphate than the original soln. sat. at 100°. The crystals melt over 100° with partial decomposition. According to Liès Bodart and E. Jacquemin, they are decomposed by water, alcohol, or ether; and, according to J. J. Berzelius, and C. Schultz, they form a soln. in moist air from which acicular crystals of the dihydrated hydrosulphate, $\text{Ba}(\text{HSO}_4)_2 \cdot 2\text{H}_2\text{O}$, separate. In J. D. Barter's study he obtained evidence of the existence of $3\text{BaO} \cdot 8\text{SO}_3 \cdot 7\text{H}_2\text{O}$, and $4\text{BaO} \cdot 5\text{SO}_3 \cdot 6\text{H}_2\text{O}$. J. Kendall and A. W. Davidson obtained crystals of **barium hydrotetrasulphate**, $\text{BaSO}_4 \cdot 3\text{H}_2\text{SO}_4$, and found the f.p. of soln. of barium sulphate in sulphuric acid to be:

Per cent. BaSO_4 .	0.0	2.12	5.46	6.70	6.70	7.30	8.59
F.p.	10.4	6.6	-3.2	-7.3	5.7	12.4	23.0
Solid phase	H_2SO_4				$\text{BaSO}_4 \cdot 3\text{H}_2\text{SO}_4$		

Soln. containing more than 7 molar per cent. of barium sulphate deposited crystals on heating, which redissolved on cooling. The results are plotted in Fig. 42.

According to P. P. von Weimarn, the solubility of barium sulphate in sulphuric acid, when the amounts of H_2SO_4 are expressed in grams per 100 grms. of solvent, and the BaSO_4 in grams per 100 c.c. of solvent, at 20°, is:

H_2SO_4 .	73.83	78.04	83.10	85.78	88.08	96.17	96.46
BaSO_4 .	0.0030	0.0135	0.0800	0.3215	1.2200	4.9665	18.6900
Solid phases	$\text{BaSO}_4 \cdot \text{H}_2\text{SO}_4$			$\text{BaSO}_4 \cdot 2\text{H}_2\text{SO}_4 \cdot \text{H}_2\text{O}$		BaSO_4	

E. Volchonsky reported that, at ordinary temp., the solid phase of soln. containing 87.36 per cent. and 92.48 per cent. sulphuric acid respectively has the composition in each case, $\text{BaSO}_4 \cdot (\text{H}_2\text{SO}_4)_2 \cdot \text{H}_2\text{O}$, but at 93° the solid phase at the lower conc. consists of 94.94 per cent. BaSO_4 , that of the higher conc. consists of 68.16 per cent. BaSO_4 and 31.26 per cent. H_2SO_4 , the salt being anhydrous and crystallizing in needles. As the temp. rises so the solubility of the compound, $\text{BaSO}_4 \cdot (\text{H}_2\text{SO}_4)_2 \cdot \text{H}_2\text{O}$, increases, whilst that of the salt, $\text{BaSO}_4 \cdot \text{H}_2\text{SO}_4$, decreases. The curve for the three solid phases, BaSO_4 ; $\text{BaSO}_4 \cdot \text{H}_2\text{SO}_4$; $\text{BaSO}_4 \cdot (\text{H}_2\text{SO}_4)_2 \cdot \text{H}_2\text{O}$, is given. The temp. of decomposition of the last salt is about 53°, and its transformation into $\text{BaSO}_4 \cdot \text{H}_2\text{SO}_4$ and into BaSO_4 are both endothermic reactions. The compound $\text{BaSO}_4 \cdot \text{H}_2\text{SO}_4$, decomposes at about 158°-160°, and its transformation into BaSO_4 is also an endothermic reaction. According to F. Bergius, 100 c.c. of a sat. soln. of barium sulphate in absolute sulphuric acid contain 28.51 grams of barium sulphate with the solid phase $\text{BaSO}_4 \cdot 3\text{H}_2\text{SO}_4$, but the results are inaccurate, since the soln. were not

in equilibrium with the solid phase. E. H. Riesenfeld and H. Feld electrolyzed a soln. of barium sulphate in 90 per cent. sulphuric acid, and showed that the so-called acid sulphate is really a complex acid, $\text{H}_2[\text{Ba}(\text{SO}_4)_2]$; and, added J. Meyer and W. Friedrich, 100 c.c. of 97·86 per cent. sulphuric acid at 25° dissolves 14·91 grms. of barium sulphate as barium hydrodisulphate, or *hydrobariosulphuric acid*, or *hydrosulphatobaric acid*, $\text{H}_2\text{Ba}(\text{SO}_4)_2$. By electrolysis, the complex accumulates in the anode compartment and can be crystallized from the anode liquor.

W. C. Taber found that the solubility of calcium sulphate is increased by *phosphoric acid*, but the curve has a maximum; at 25°, this is attained when the conc. of the phosphoric acid is 230 grms. per litre, and this soln. dissolves 8 grms. of calcium sulphate per litre. The sp. gr. of the soln. were also measured. T. Scheerer found barium sulphate is soluble in soln. of the alkali phosphates owing to the formation of some soluble barium phosphate. A. Beyer also measured the effect of *carbonic acid* on the solubility of calcium sulphate, and found 100 parts of water sat. with carbon dioxide dissolve 0·465 gm. of this salt. According to P. Carles natural waters may contain both barium hydrocarbonate, $\text{Ba}(\text{HCO}_3)_2$, and alkali sulphates in soln., and he therefore infers that *alkali carbonates* can dissolve barium sulphate in the presence of carbonic acid. J. Davy found very little difference between the solubility of dihydrated calcium sulphate in water sat. with carbon dioxide under press., and in water alone.

In general, the solubility of calcium sulphate in water is augmented if a salt with no common ion is present, and decreased by the addition of a salt with a common ion. According to F. Margueritte,⁴ if a soln. of gypsum be mixed with ammonium, potassium, or sodium nitrate or chloride, the calcium sulphate is alone precipitated when alcohol is added. The presence of *sodium chloride* augments the solubility of calcium sulphate, so that, according to J. B. Trommsdorff, calcium sulphate is not precipitated by sulphuric acid from a soln. containing sodium chloride. N. A. Orloff found a 20 per cent. soln. of sodium chloride dissolved twice as much calcium sulphate as a 1 per cent. soln. M. M. P. Muir investigated the equilibrium of aq. soln. of alkali chlorides and calcium sulphate. Measurements of the solubility of calcium sulphate in aq. soln. of sodium chloride have been made by H. W. F. Wackenroder, J. H. Droeze, G. Lunge, F. K. Cameron and B. E. Brown, C. Cloez, J. B. Trommsdorff, and A. d'Anselme. According to W. A. Tilden and W. A. Shenstone, 100 c.c. of a *p* per cent. soln. of sodium chloride dissolves the following amounts of calcium sulphate at the temp. stated:

	20°	44°	67°	85°	101°	130°	169°	225°
Per cent. NaCl	19·90	19·93	19·95	19·90	20·08	19·92	20·05	21·00
Grms. CaSO ₄	0·823	0·830	0·832	0·823	0·682	0·392	0·244	0·178

F. K. Cameron gives for the solubility, at 23°, in grams per litre:

Grms. NaCl	0·99	10·40	49·17	75·58	129·50	197·20	229·70	315·55
Grms. CaSO ₄	2·37	3·54	5·94	6·74	7·50	7·25	7·03	5·37

The last-named soln. was in contact with both gypsum and sodium chloride in the solid phase. The solubility of calcium sulphate in soln. of sodium chloride follows the same general law in showing a maximum point as in aq. soln. for temp. up to 37·5°, above that temp. the existence of a maximum has not been established. Sp. gr. measurements show that there is a condensation of water as a solvent when gypsum and sodium chloride are together brought into soln. G. Arth and M. Crétien stated that when calcium sulphate is dissolved in soln. of sodium chloride at temp. below 62·5° to 65·0°, the soln. apparently contain more lime than is eq. to the sulphuric acid present, and at higher temp. the reverse is the case. If this be correct, it follows that below 62° there is a marked hydrolysis of calcium sulphate in the presence of soln. of sodium chloride; more lime than sulphuric acid passes into soln., and at a higher temp., a new solid phase separates, containing relatively more sulphuric acid than is required by the formula CaSO_4 . F. K. Cameron has

shown that G. Arth and M. Crétien's method of analysis was probably defective, for he could find no appreciable hydrolysis of calcium sulphate; nor, within a temp. range of 25° to upwards of 80°, could he detect a double salt in soln. of any conc. of sodium chloride. F. K. Cameron and A. Seidell found that the solubility of gypsum in soln. containing up to 9 per cent. of sodium chloride, is but little affected by the presence of solid calcium carbonate, but beyond this conc., the solubility is considerably diminished, so that with soln. with 140 grms. of sodium chloride per litre, the maximum solubility attains 7.5 grms. of gypsum per litre, and in the presence of calcium carbonate this solubility becomes 5.0 grms. per litre, and attains a maximum of 6.35 grms. per litre in soln. containing 80-90 grms. of sodium chloride per litre—with water alone, the maximum solubility is 2.1 grms per litre. A. Manuelli measured the solubility of gypsum in *sea-water* from the Adriatic and in various mixtures of it with distilled water. The results show that an approximately fixed proportion of calcium sulphate is dissolved by sea-water and its aq. soln. containing 12-37 parts of saline residue per 1000. The constancy of the relations is attributed to the enormous extent to which river waters are diluted in the whole mass of sea-water, and not to the attainment of a state of saturation with respect to certain salts. H. Ehlert found 5 and 10 per cent. and sat. soln. of sodium chloride dissolved respectively 0.07005, 0.0934, and 0.22183 gm. of barium sulphate per litre of solvent.

A. Ditté found the solubility of calcium sulphate in aq. soln. of *potassium chloride*, *potassium bromide*, and *potassium iodide* to be respectively 7.5, 7.3, and 6.00 grms. of CaSO₄ in soln. with respectively 125, 200, and 250 grms. of the potassium salt per litre. He added that double salts were formed with respectively 125, 250, and 300 grms. of the potassium salt per litre. According to H. W. F. Wackenroder, strontium sulphate dissolves slowly and completely in a soln. of sodium chloride, while barium sulphate under similar conditions is not appreciably attacked. The last statement is also confirmed by R. H. Brett, and G. C. Wittstein. The strontium salt is precipitated from its soln. in sodium chloride by the addition of sulphuric acid. A. Virck found the solubility of strontium sulphate in aq. soln. of potassium and sodium chlorides to be:

Grms. salt in 100 grms. soln. .	Sodium chloride.			Potassium chloride.		
	8.44	15.54	22.17	8.22	12.54	18.08
Grms. SrSO ₄ in 100 grms. solvent .	0.165	0.219	0.181	0.193	0.193	0.251

J. Wolfmann has studied the solubility of strontium sulphate in aq. soln. of the alkali chlorides. R. Fresenius also found that the solubility of barium sulphate is not appreciably affected by the alkali chlorides or *potassium chlorite* soln.

The solubility of calcium sulphate is decreased in the presence of *calcium chloride*. Expressing the results in grams per litre, F. K. Cameron and A. Seidell found at 25°:

CaCl ₂ . . . 0	7.489	11.959	25.770	97.023	192.705	280.303	367.850
CaSO ₄ . . . 2.056	1.244	1.181	1.096	0.841	0.465	0.203	0.032

The solubility of gypsum thus decreases very rapidly as the conc. of the calcium chloride increases; when the conc. of the latter salt has attained 20 grms. per litre the solubility of the calcium sulphate decreases slowly until, by extrapolation, when the conc. has attained 375 grms. CaCl₂ per litre, practically no sulphate would be dissolved. The solubility of calcium sulphate in soln. of the chloride has also been measured by N. A. Orloff, F. K. Cameron and B. E. Brown, and by W. A. Tilden and W. A. Shenstone. The latter worked at temp. ranging from 15° to 195°. A. Virck found that aq. soln. of 8.67, 61.51, and 33.70 grms. of calcium chloride per 100 c.c. dissolved respectively 0.176, 0.185, and 0.171 gm. of strontium sulphate per 100 grms. of solvent. J. Wolfmann measured the solubility of the salt in soln. of the nitrates of the alkaline earths.

F. K. Cameron and A. Seidell measured the solubility of calcium sulphate in

soln. of *magnesium chloride*, at 26°, and, expressing the results in grams per litre, found:

MgCl ₂ . . .	0	8.501	19.175	46.640	121.381	206.985	336.985	441.128
CaSO ₄ . . .	2.082	4.258	5.692	7.588	8.622	6.567	2.774	1.385

There is thus a well-defined maximum in the solubility curve attaining 8.8 grms. of calcium sulphate per litre in soln. with about 105 grms. of magnesium chloride per litre. This soln. therefore contains four times as much calcium sulphate as a sat. soln. of this salt alone. Beyond the maximum, the solubility of calcium sulphate decreases quite rapidly as the conc. of the magnesium chloride increases, until, in a soln. containing 370 grms. per litre, the solubility of gypsum is the same as in water alone. Other determinations of the solubility of calcium sulphate in soln. of magnesium chloride have been made by F. K. Cameron and B. E. Brown, and by W. A. Tilden and W. A. Shenstone. A. Virck measured the solubility of strontium sulphate in aq. soln. containing 1.59, 4.05, and 13.63 grms. of magnesium chloride per 100 grms. of soln., and found 100 grms. of the solvent dissolved respectively 0.199, 0.206, 0.242 grms. of strontium sulphate. The solubility of barium sulphate in aq. soln. of *ferric chloride*, *aluminium chloride*, or magnesium chloride was found by G. S. Fraps to decrease in the order named. The last-named salt exercises but a small influence on the solubility. His results expressed in grams of salt per 100 c.c. of soln :

Salt per 100 c.c.	0.1	0.25	0.5	1.0	2.5	5.0	10.0
Grms. BaSO ₄ {	FeCl ₃	0.0058	0.0072	0.0115	0.0123	0.0150	0.0160
	AlCl ₃	0.0033	0.0043	0.0060	0.0094	0.0116	0.0170
	MgCl ₂	0.0030	0.0030	0.0033	0.0033	0.0050	0.0050

The subject was also investigated by R. Fresenius, P. Rohland, Z. Karaoglanoff, and by P. Jannasch and T. W. Richards. The latter attribute the effect with ferric chloride to the formation of a soluble double ferric barium sulphate, and add that in a soln. containing ferric chloride, "an accurate determination of sulphuric acid by direct precipitation with barium chloride is not practicable." F. W. Küster found the presence of *chromic chloride*, CrCl₃, also augmented the solubility of barium sulphate, and E. White observed similar results with *thorium chloride* soln. Z. Karaoglanoff measured the effect of *lead nitrate* on the solubility of barium sulphate. There is an interaction of the two salts, and the barium sulphate increases in weight.

The solubility of calcium sulphate in soln. of *ammonium chloride* of different conc. has been measured by R. Fassbender, S. Cohn, A. Ditte, etc. W. A. Tilden and W. A. Shenstone measured the solubility in a soln. of ammonium chloride of fixed conc. at temp. between 8° and 120°. Expressing the results in grams of the respective salts per litre, F. K. Cameron and B. E. Brown found at 25°:

NH ₄ Cl	10.8	46.7	94.5	149.7	198.6	210.0	275.0	375.3
CaSO ₄	3.9	7.07	8.8	10.30	10.85	10.88	10.60	7.38

The last-named soln. is sat. with respect to the two salts in the solid phase. The solubility of calcium sulphate thus increases with increasing conc. of ammonium chloride until 210 grms. per litre are present, when 10.9 grms. of calcium sulphate are dissolved; while a further increase in the conc. of the ammonium chloride decreases the solubility of the calcium sulphate until both salts are present as solid phases. R. H. Brett reported strontium and barium sulphate to be insoluble in soln. of ammonium chloride, G. C. Wittstein and H. W. F. Wackenroder made a similar observation with respect to barium sulphate; but, according to O. L. Erdmann, 100 parts of a boiling soln. of ammonium chloride can dissolve 0.000435 part of barium sulphate, and, according to H. Ehlert, a litre of a 10 per cent. and of a sat. soln. of ammonium chloride can dissolve 0.15178 and 0.46117 gm. of barium sulphate.

A. Vogel, R. Fassbender, and J. H. Droeze have made some observations on

the solubility of calcium sulphate in soln. of potassium or sodium nitrate. The solubility of calcium sulphate in aq. soln. of *sodium nitrate* was found by A. Seidell and J. G. Smith to increase steadily with increasing conc. until the soln. contained 300 grms. of the sodium salt per litre; and beyond this, the amount of sulphate dissolved decreased as the conc. of the nitrate increased. Expressing the results in grams per litre, at 25°:

NaNO ₃ . . .	0	25	50	100	200	300	600	655
CaSO ₄ . . .	2·084	4·252	5·500	7·100	8·790	9·282	7·886	7·238

The sp. gr. of the soln. were also determined. With *potassium nitrate* likewise, the solubility of the calcium sulphate increased as the conc. of the nitrate increased until 200 grms. of the latter salt per litre were present:

KNO ₃ . . .	0	12·5	25	50	100	150	200	260
CaSO ₄ . . .	2·084	3·284	4·080	5·255	6·855	7·907	8·688	—

So far the determination of lime or sulphate in soln. are in agreement, but this is no longer the case with more conc. soln. of the nitrate—*e.g.* with 260 grms. of KNO₃ per litre, the sulphate determination furnishes by calculation 6·278 grms. of CaSO₄ per litre, and the lime determination, 12·112 grms. of CaSO₄. The discrepancy is due to double decomposition and the formation of a new solid phase of syngenite, Ca(KSO₄)₂·H₂O. W. D. Harkins and H. M. Paine measured the effect of potassium nitrate on the solubility of calcium sulphate. J. Wolfmann measured the solubility of strontium sulphate in the presence of nitrates of the alkalis and alkaline earths. J. J. Berzelius, R. Fresenius, and M. Mittentzwey found that the solubility of barium sulphate is raised by the alkali nitrates, but is not perceptibly influenced by *barium nitrate*. M. Raffo and G. Rossi found that at room temp. 100 c.c. of sat. soln. of strontium sulphate with various proportions of *calcium nitrate* contained, in grms.:

Ca(NO ₃) ₂ . . .	0·5	1	2	3	4	5	6
SrSO ₄ . . .	0·0483	0·0619	0·1081	0·1275	0·1489	0·1698	0·1955

H. Ehlert found a litre of a 10 per cent. and a sat. soln. of sodium nitrate dissolved 0·35609 and 1·2959 grms. of barium sulphate at 18°. H. J. Phillips found *copper nitrate* raises the solubility of barium sulphate, but *copper chloride* does not. The solubility of calcium sulphate is steadily depressed when increasing proportions of calcium nitrate are added to the solvent. Thus, expressing the results in grams per litre, at 25°, A. Seidell and J. G. Smith found:

Added salt	0	25	50	100	300	400	514	544
CaSO ₄ with {Ca(NO ₃) ₂	2·084	1·238	1·196	1·134	0·759	0·569	—	0·346
{Mg(NO ₃) ₂	2·084	5·772	7·884	9·920	14·000	14·683	15·040	—

Z. Karaoglanoff measures the effects of *calcium chloride* and *strontium chloride* on the solubility of barium sulphate. A. Seidell and J. G. Smith found no sign of a maximum value in the solubility of calcium sulphate in soln. of *magnesium nitrate*, but the solubility of the sulphate increases with increasing proportions of the nitrate, and in a nearly sat. soln. of the nitrate, the solubility is nearly seven times as great as it is in pure water. The solubility of calcium sulphate in soln. of *ammonium nitrate* has been determined by R. Fassbender, J. H. Droeze, S. Cohn, and F. K. Cameron and B. E. Brown. Expressing the results in grams of salt per litre, at 25°, the latter find:

NH ₄ NO ₃ . . .	10	55	150	300	550	750	1000	1400	Sat.
CaSO ₄ . . .	3·18	5·80	8·88	10·80	12·02	12·20	11·81	10·02	7·55

showing that the solubility increases rapidly as the conc. of the ammonium salt increases, then gradually approaches a maximum as the conc. attains 750 grms. of the ammonium salt per litre, when 12·02 grms. of calcium sulphate is dissolved. From this point, the solubility of calcium sulphate decreases with increasing conc.

of ammonium nitrate, until both salts exist as solid phases. P. Rohland measured the solubility of barium sulphate in soln. of ammonium nitrate.

Z. Karaoglanoff found that the solubility of barium sulphate in different electrolytes is determined by the anion and cation. The anion SO_4^{--} diminishes the solubility; the NO_3^- ion increases it; and the Cl^- ion is indifferent. Of the cations, Ba^{++} decreases the solubility of barium sulphate, while K^+ , Na^+ , Sr^{++} , Pb^{++} , Fe^{+++} , and H^+ ions increase it; and Ca^{++} ions are indifferent. The solubility of calcium sulphate in aq. soln. of *ammonium sulphate*, *sodium sulphate*, *potassium sulphate*, *rubidium sulphate*, and *cæsium sulphate* is discussed in connection with the double salts of these components. T. Andrews found strontium sulphate dissolves less readily in aq. soln. of sodium sulphate than in water. W. D. Harkins and H. M. Paine, and J. M. Bell and W. C. Taber have measured the effect of *cupric sulphate* on the solubility of calcium sulphate, and, expressing the results in grams per litre, at 25° , the latter found :

CuSO_4	. 1.144	6.048	14.814	29.543	49.382	97.950	196.021	224.916
CaSO_4	. 2.068	1.944	1.760	1.688	1.744	1.931	2.076	2.088

There is a decrease in the solubility of calcium sulphate with increasing proportions of cupric sulphate until a minimum of 1.688 grms. of calcium sulphate is obtained with 30 grms. of cupric sulphate. This is in agreement with the general depression of the solubility of a salt produced by the addition of a common ion. With a further addition of cupric sulphate, there is a sharp rise in the solubility of calcium sulphate, and this is followed by a slower rise as the proportion of copper sulphate increases until both salts are present as solid phases which occurs when the soln. has 2.08 grms. of calcium sulphate and 224.916 grms. of copper sulphate per litre. The remainder of the curve would represent the solubility of cupric sulphate in soln. of calcium sulphate, and since the solubility of the latter is small, it will probably have but little effect on the solubility of cupric sulphate. This is in agreement with the value 22.29 grms. per 100 grms. of water found for the solubility of cupric sulphate in water alone. The sp. gr. of the soln. were also determined. H. von Euler found that at 17° a sat. soln. contained 2.31 grms. of calcium sulphate and 7.235 grms. of *silver sulphate*, and had a sp. gr. of 1.0083; at 25° , a sat. soln. contained 2.61 grms. of calcium sulphate, 8.11 grms. of silver sulphate, and had a sp. gr. of 1.010. The solubility of calcium sulphate in soln. of *magnesium sulphate* has been investigated by R. Fassbender, W. D. Harkins and H. M. Paine, J. H. Droeze, E. E. Basch, and F. K. Cameron and J. M. Bell. Expressing the results in grams per litre, the latter found at 25° :

MgSO_4	. . 0	6.38	10.64	21.36	64.14	128.28	149.67	355.0
CaSO_4	. . 2.046	1.507	1.471	1.478	1.608	1.627	1.597	0.501

There is a minimum in the curve with soln. having approximately 13 grms. of magnesium sulphate and 1.46 grms. of calcium sulphate per litre; from this point, the solubility gradually increases with increasing amounts of magnesium sulphate to a maximum with about 105 grms. of magnesium sulphate, and 1.64 grms. of calcium sulphate per litre; from this point, the solubility decreases again until the soln. is sat. with both salts, which occurs with a conc. of 355 grms. of magnesium sulphate, and 0.50 gm. of calcium sulphate per litre. The sp. gr. of the soln. were also measured. C. Diehl, and F. Field found calcium sulphate to be readily soluble in a cold sat. soln. of *sodium thiosulphate*, and more rapidly when heated. The former assumes that the two salts in soln. react producing a double salt. He reported strontium sulphate to be insoluble in a soln. of sodium thiosulphate. R. Fresenius, and T. Salzer reported barium sulphate to be distinctly soluble in a soln. of sodium thiosulphate. L. Dobbin has also emphasized the fact that the presence of thiosulphate greatly retards or entirely prevents the precipitation of barium sulphate. Dil. hydrochloric or nitric acid also dissolves appreciable amounts of barium sulphate in the presence of sodium thiosulphate. Several analytical

processes have been devised which are stultified owing to the solubility of barium sulphate in this menstruum. H. de Sénarmont found the solubility of barium sulphate is not appreciable in soln. of *sodium sulphide* at 250°.

J. W. Marden measured the solubilities of barium, strontium, and calcium sulphate in soln. of *ammonium acetate*, and expressing the conc. of the ammonium acetate soln. in grams of salt per 100 grms. of soln., and that of the sulphate in grams per 100 grms. of soln., at 25°, found :

Amm. acetate	.	0	2.13	5.34	10.68	21.37
CaSO ₄	.	0.2085	0.454	0.754	1.146	1.755
SrSO ₄	.	0.0151	0.0451	0.0732	0.0942	0.015
BaSO ₄	.	0.00023	—	—	—	0.016

The sp. gr. of some of these soln. were also measured. G. C. Wittstein found the solubility of calcium sulphate is raised in the presence of *ammonium succinate*; O. Popp made a similar observation with respect to *ammonium borate*, and found that when a boiling soln. is cooled, calcium borate crystallizes out. R. Spiller found that the solubility of barium sulphate is much influenced by *citrate*s, and J. Wolfmann measured the solubility of strontium sulphate in salts of the organic acids. G. Magnanini found that at 20°, while water dissolved 0.2238 gm. of calcium sulphate per 100 grms. of soln., a 0.005*N*-soln. of *potassium hydrotartrate*, KHC₄H₄O₆, dissolved 0.2323 gm., and the same soln. with 5 per cent. of tartaric acid dissolved 0.2566 gm. of calcium sulphate. Again, a 10 per cent. soln. of alcohol dissolved 0.0970 gm. of calcium sulphate per 100 grms. of soln., a 0.005*N*-soln. of potassium hydrotartrate in 10 per cent. alcohol dissolved 0.0866 gm. of calcium sulphate, and a 0.0025*N*-soln. of potassium hydrotartrate in 10 per cent. alcohol with 5 per cent. of tartaric acid, dissolved 0.1086 gm. of calcium sulphate per 100 grms. of soln. V. Teodossiu found that a 0.2 molar soln. of *ammonium citrate* at 20° dissolved in 3 hrs. 2.59 grms. of CaSO₄; 0.68 gm. of SrSO₄; and 0.21 gm. of BaSO₄.

A. M. Ossendowsky found that 100 grms. of *glycerol* of sp. gr. 1.256 dissolve 5.17 grms. of calcium sulphate between 15° and 16°; and E. Asselin, 100 grms. of glycerol of sp. gr. 1.114, dissolve 0.95 gm. of calcium sulphate at ordinary temp. F. Stolle measured the solubility of calcium sulphate in soln. of *sugar* of different conc. between 30° and 80°. The solubility is depressed by increasing the conc. of the sugar, and it is also depressed by raising the temp. although some anomalies appear about 70°. E. Sostmann has also made observations on this subject. According to J. M. Kolthoff and E. H. Vogelenzang, at 19°, 25 and 50 per cent. *ethyl alcohol* dissolve respectively 19 and 0 mgrms. of strontium sulphate per litre; and 50 per cent. alcohol with respectively $\frac{1}{10}$ *N*-HCl and $\frac{1}{10}$ *N*-NH₄Cl dissolve 120 and 40 mgrms. of strontium sulphate per litre. Strontium sulphate is said to be insoluble in absolute alcohol, and scarcely soluble in aq. alcohol. A. Gawalowsky found barium sulphate to be appreciably soluble in soln. of *hydrogen peroxide*.

REFERENCES.

- ¹ C. F. Bucholz, *Gehlen's Journ.*, 1. 310, 1803; A. B. Poggiale, *Ann. Chim. Phys.*, (3), 8. 469, 1843; L. de Boisboudran, *ib.*, (4), 9. 173, 1866; (5), 3. 477, 1874; J. C. G. de Marignac, *ib.*, (5), 1. 274, 1874; M. Tipp, *Pharm. Vierteljahr.*, 3. 506, 1854; A. H. Church, *Laboratory*, 1. 418, 1867; A. Goldammer, *Pharm. Centrbl.*, 29. 193, 375, 1888; C. A. Raupenstranch, *ib.*, 29. 229, 1888; *Monatsh.*, 6. 563, 1885; A. Cossa, *Bull. Soc. Chim.*, (2), 20. 440, 1873; E. Erlenmeyer, *Sitzber. Akad. Bayern*, 269, 1872; K. Möller, *Pogg. Ann.*, 117. 386, 1862; J. H. Droeze, *Ber.*, 10. 330, 1877; F. von Giese, *Mém. Soc. Nat. Moscovie*, 1. 199, 1811; G. A. Hulett and L. E. Allen, *Journ. Amer. Chem. Soc.*, 24. 667, 1902; A. C. Melcher, *ib.*, 32. 50, 1908; B. Guillon, *Ann. Conservatoire Arts Mét.*, (3), 2. 207, 1900; W. A. Tilden and W. A. Shenstone, *Phil. Trans.*, 175. A, 31, 1884; G. A. Hulett, *Zeit. phys. Chem.*, 37. 388, 1901; J. H. van't Hoff, *ib.*, 45. 279, 1903; F. Kohlrausch, *ib.*, 50. 355, 1905; A. F. Hollemann, *ib.*, 12. 125, 1893; F. Kohlrausch and F. Rose, *Wied. Ann.*, 50. 127, 1893; A. Cavazzi, *L'Ind. Chimica*, 6. 366, 1905; *Gazz. Chim. Ital.*, 42. ii, 626, 1912; W. A. Davis, *Journ. Soc. Chem. Ind.*, 26. 727, 1907; F. Mylius and J. von Wrochem, *Ber.*, 33. 3689, 1900; J. F. McCaleb, *Amer. Chem. Journ.*, 11. 31, 1889;

F. Rinne, *Centr. Min.*, 116, 1904; F. K. Cameron and J. M. Bell, *Calcium Sulphate in Aqueous Solutions*, Washington, 1906.

² T. C. Hope, *Trans. Roy. Soc. Edin.*, 4, 3, 1792; R. Brandes, *Archiv. Apothekerker.*, 33, 61, 1830; R. Fresenius, *Liebig's Ann.*, 59, 120, 1846; R. Fresenius and E. Hintz, *Zeit. anal. Chem.*, 35, 170, 1896; P. Schweitzer, *Proc. Amer. Assoc.*, 26, 201, 1877; P. Kremers, *Pogg. Ann.*, 86, 375, 1852; 92, 520, 1854; T. Andrews, *Phil. Mag.*, (2), 7, 406, 1830; J. C. G. de Marignac, *Arch. Sciences Genève*, 1, 209, 1858; *Liebig's Ann.*, 106, 169, 1858; L. L. de Koninck, *Bull. Soc. Chim. Belgique*, 19, 86, 1905; F. Kohlrausch, *Zeit. phys. Chem.*, 50, 355, 1905; 64, 129, 1908; F. Kohlrausch and F. Rose, *ib.*, 12, 243, 1893; G. A. Hulett, *ib.*, 37, 385, 1901; A. F. Hollemann, *ib.*, 12, 131, 1893; W. Böttger, *ib.*, 46, 521, 1903; 56, 83, 1906; J. Wolfmann, *Oester. Zeit. Zuckerind.*, 25, 986, 1897; F. C. Calvert, *Chem. Gaz.*, 13, 55, 1856; F. W. Küster, *Zeit. anorg. Chem.*, 12, 261, 1896; Z. Karaoglanoff, *Zeit. anal. Chem.*, 56, 225, 1917; A. C. Melcher, *Journ. Amer. Chem. Soc.*, 32, 50, 1910.

³ H. Rose, *Pogg. Ann.*, 95, 108, 1855; C. Schultz, *ib.*, 133, 137, 1868; C. C. Selleck, *ib.*, 133, 137, 1868; W. Ostwald, *Journ. prakt. Chem.*, (2), 29, 49, 1884; E. Sigle, *ib.*, (1), 69, 142, 1856; T. Scheerer, *ib.*, (1), 75, 113, 1858; O. L. Erdmann, *ib.*, (1), 75, 214, 1858; G. Lunge, *Journ. Soc. Chem. Ind.*, 4, 32, 1885; R. Piria, *Il Cimento*, 5, 257, 1847; G. A. Hulett, *Journ. Amer. Chem. Soc.*, 27, 49, 1905; E. T. Allen and J. Johnston, *ib.*, 32, 588, 1910; J. Kendall and A. W. Davidson, *ib.*, 43, 979, 1921; F. K. Cameron and J. F. Breazeale, *Journ. Phys. Chem.*, 7, 571, 1903; W. C. Taber, *ib.*, 10, 626, 1906; H. Endemann, *Journ. Anal. App. Chem.*, 7, 181, 1893; H. Struve, *Zeit. anal. Chem.*, 9, 34, 1870; R. Fresenius, *ib.*, 9, 62, 1870; J. M. Kolthoff and E. H. Vogelenzang, *ib.*, 58, 49, 1919; Z. Karaoglanoff, *Zeit. anal. Chem.*, 56, 225, 1917; E. H. Riesenfeld and H. Feld, *Zeit. Elektrochem.*, 26, 286, 1920; A. Gawalowsky, *Zeit. Oester. Apoth. Ver.*, 44, 258, 1900; Liès Bodart and E. Jacquemin, *Compt. Rend.*, 46, 1206, 1858; E. Varenne and M. Pauleau, *ib.*, 93, 1016, 1881; T. Garside, *Chem. News*, 31, 245, 1875; A. R. Haslam, *ib.*, 53, 87, 1886; J. J. Berzelius, *Liebig's Ann.*, 46, 241, 1843; A. Beyer, *Arch. Pharm.*, (2), 150, 193, 1872; F. C. Calvert, *Chem. Gaz.*, 13, 55, 1856; T. C. Hope, *Trans. Roy. Soc. Edin.*, 4, 3, 1792; O. Aschan, *Chem. Ztg.*, 37, 1117, 1913; P. Carles, *Journ. Chim. Pharm.*, (6), 13, 562, 1901; *Ann. Chim. Anal. App.*, 7, 91, 1902; M. H. Klaproth, *Crell's Ann.*, i, 99, 1794; H. M. Noad, *Journ. Chem. Soc.*, 9, 15, 1856; G. Moretti, *Schweigger's Journ.*, 9, 169, 1813; F. Bergius, *Zeit. phys. Chem.*, 72, 338, 1910; H. A. G. Willoughby, *Trans. Roy. Soc. Canada*, 7, 211, 1913; J. D. Barter, *ib.*, 7, 208, 1913; G. S. Fraps, *Amer. Chem. Journ.*, 27, 288, 1902; T. Andrews, *Phil. Mag.*, (2), 7, 406, 1831; E. C. Nicholson and D. S. Price, *ib.*, (4), 11, 169, 1856; E. Volchonsky, *Journ. Russ. Phys. Chem. Soc.*, 42, 1180, 1910; P. P. von Weimarn, *Zeit. Koll.*, 8, 24, 1911; C. Gutkowsky, *Ber.*, 5, 330, 1872; J. Meyer and W. Friedrich, *Zeit. phys. Chem.*, 101, 498, 1922; J. Davy, *Edin. Phil. Journ.*, 45, 61, 1847.

⁴ J. B. Trommsdorff, *Neues Journ. Pharm.*, 18, 1, 234, 1829; A. M. Ossendowsky, *Pharm. Journ.*, 79, 575, 1907; H. W. F. Wackenroder, *Liebig's Ann.*, 41, 316, 1842; F. Field, *Journ. Chem. Soc.*, 16, 28, 1863; J. H. Droeze, *Ber.*, 10, 338, 1877; R. Fassbender, *ib.*, 9, 1361, 1876; M. M. P. Muir, *Chem. News*, 36, 229, 1877; H. J. Phillips, *ib.*, 62, 239, 1890; I. Spiller, *ib.*, 8, 280, 1863; 19, 166, 1869; *Journ. Chem. Soc.*, 10, 110, 1858; J. J. Berzelius, *Ann. Chim. Phys.*, (2), 14, 374, 1820; M. Mittentzwey, *Journ. prakt. Chem.*, (1), 75, 214, 1858; N. A. Orloff, *Journ. Russ. Phys. Chem. Soc.*, 34, 949, 1903; G. Lunge, *Journ. Soc. Chem. Ind.*, 4, 31, 1885; L. Dobbin, *ib.*, 20, 218, 1901; *Pharm. Journ.*, 64, 182, 1900; W. A. Tilden and W. A. Shenstone, *Proc. Roy. Soc.*, 38, 331, 1885; F. K. Cameron and B. E. Brown, *Journ. Phys. Chem.*, 9, 210, 1905; F. K. Cameron, *ib.*, 5, 556, 1901; 11, 495, 1907; F. K. Cameron and A. Seidell, *ib.*, 5, 643, 1902; A. Seidell and J. G. Smith, *ib.*, 8, 493, 1904; J. M. Bell and W. C. Taber, *ib.*, 11, 637, 1907; F. K. Cameron and J. M. Bell, *ib.*, 10, 210, 1906; *Calcium Sulphate in Aqueous Solutions*, Washington, 1906; G. Arth and M. Crétien, *Bull. Soc. Chim.*, (3), 35, 778, 1906; C. Cloez, *ib.*, (3), 29, 167, 1903; A. d'Anselme, *ib.*, (3), 29, 372, 1903; A. Vogel, *Journ. prakt. Chem.*, (1), 1, 196, 1834; S. Cohn, *ib.*, (2), 35, 43, 1887; C. Dichl, *ib.*, (1), 79, 430, 1860; P. Jannasch and T. W. Richards, *ib.*, (2), 39, 321, 1889; (2), 40, 233, 1889; O. L. Erdmann, *ib.*, (1), 75, 214, 1858; T. Scheerer, *ib.*, (1), 75, 113, 1858; A. Ditte, *Compt. Rend.*, 126, 694, 1898; *Ann. Chim. Phys.*, (7), 14, 294, 1898; A. Gawalowsky, *Zeit. Oester. Apoth. Ver.*, 44, 258, 1900; A. Manuelli, *Ann. Chim. Applicata*, 5, 13, 1916; E. E. Basch, *Die künstliche Darstellung und die Bildungsverhältnisse des Polyhalit*, Berlin, 1901; E. White, *Thorium and its Compounds*, London, 26, 1912; H. von Euler, *Ark. Kem. Min.*, 143, 1904; G. S. Fraps, *Amer. Chem. Journ.*, 27, 288, 1902; J. M. Kolthoff and E. H. Vogelenzang, *Zeit. anal. Chem.*, 58, 20, 1919; Z. Karaoglanoff, *Zeit. anorg. Chem.*, 56, 225, 1917; T. Andrews, *Trans. Roy. Irish Acad.*, 19, 228, 1841; *Phil. Trans.*, 134, 21, 1844; W. D. Harkins and H. M. Paine, *Journ. Amer. Chem. Soc.*, 41, 1155, 1919; J. W. Marden, *ib.*, 38, 310, 1916; O. Popp, *Liebig's Ann. Suppl.*, 8, 11, 1872; G. Magnanini, *Gazz. Chim. Ital.*, 31, ii, 542, 1901; M. Raffo and G. Rossi, *ib.*, 45, i, 45, 1915; G. C. Wittstein, *Repert. Pharm.*, 57, 18, 1837; J. Wolfmann, *Oester. Zeit. Zuckerind.*, 25, 986, 1897; F. Margueritte, *Compt. Rend.*, 38, 308, 1854; E. Asselin, *ib.*, 76, 884, 1873; F. Stolle, *Zeit. Ver. Rübenzuckerind.*, 321, 1900; E. Sostmann, *ib.*, 517, 1866; F. W. Küster, *Zeit. anorg. Chem.*, 43, 348, 1905; P. Rohland, *ib.*, 35, 194, 1903; R. Fresenius, *Zeit. anal. Chem.*, 9, 62, 1870; 30, 459, 1891; T. Salzer, *ib.*, 31, 388, 1892; A. Virck, *ib.*, 1, 473, 1862; R. H. Brett, *Phil. Mag.*, (3), 10, 95, 1837; H. Ehlerst, *Studien über Salzlösungen*, Leipzig, 1909; V. Teodossiu, *Bull. Soc. Chim. Roumania*, 3, 9, 1921.

§ 19. The Properties of the Sulphates of the Alkaline Earths

According to J. H. van't Hoff and F. Weigert,¹ the crystals of anhydrous calcium sulphate occurs in two modifications: (i) the stable rhombic bipyramids of anhydrite, with axial ratios $a : b : c = 0.8932 : 1 : 1.008$; and (ii) the metastable soluble calcium sulphate which, in contact with water, very easily passes to gypsum, and by longer contact with boiling water, passes into anhydrite. The metastable form is readily produced by the dehydration of gypsum below 100° , and, according to A. Lacroix, it probably forms triclinic crystals which show plagioclase twinning, but W. A. Davis says that its close relationship with the hemihydrate, and its straight extinction, show that it is more probably rhombic. No change in crystalline form is observed when the hemihydrate is converted into soluble anhydrite, or when the latter is converted into the former. R. Grengg found that the hexagonal prisms of the hemihydrate obtained by digesting gypsum with warm nitric acid, or by heating gypsum with a conc. soln. of sodium chloride, are repeated by twinned rhombic crystals. Gently heating the prisms in paraffin increases the double refraction, without altering the external form, and soluble anhydrite is produced. Insoluble anhydrite is formed at 360° , and the crystals, still rhombic, are arranged in parallel fibres, giving the appearance of optically uniaxial crystals.

Strontium sulphate forms rhombic bipyramids of celestine, with axial ratios $a : b : c = 0.7790 : 1 : 1.2800$; and barium sulphate forms isomorphous bipyramids with axial ratios $a : b : c = 0.8152 : 1 : 1.3136$. A. Lacroix reported a sample of barytes from Templeton near Quebec (Canada), in monoclinic crystals. He claimed this to be an example of dimorphism, and named the mineral *michelleveite* after A. Michel-Lévy. The mixed crystals of barium and strontium sulphates occur in nature as indicated in connection with the occurrence of these earths. J. F. W. Johnston obtained acicular crystals of hemihydrated calcium sulphate belonging to the rhombic system; and J. H. van't Hoff also obtained needle-like crystals of this hydrate from gypsum. According to A. Lacroix, these crystals belong to the hexagonal system, although F. Mylius and J. von Wrochem obtained rhombic crystals of the related hemihydrated calcium chromate. According to W. A. Davis, both forms of the hemihydrate as well as soluble and natural anhydrite all form needles with rectangular ends, and have a straight extinction. The prismatic crystals of dihydrated calcium sulphate, gypsum, belong to the monoclinic system; they have axial ratios $a : b : c = 0.6898 : 1 : 0.4132$, and $\beta = 98^\circ 58'$; they are isomorphous with the corresponding dihydrated calcium chromate, $\text{CaCrO}_4 \cdot 2\text{H}_2\text{O}$. The optical and electrical axes of gypsum have been determined by H. Rubens. W. A. Davis showed that under the microscope, gypsum crystals consist of small plates with oblique ends (often twinned), or long needles; they show an extinction between crossed nicols at an angle of $52\frac{1}{2}^\circ$ to the long direction. H. Gaudefroy said that the passage from the hemihydrate to the soluble form of anhydrite at 120° – 130° , is not accompanied by a change in the form or size of the crystals. The anhydrous salt, however, is less refractive and has a double refraction almost twice that of the hemihydrate. **X-radiograms** of anhydrite have been studied by F. Rinne, and of gypsum by E. Hjalmar, and H. Haga and F. M. Jaeger. The **corrosion figures** of celestine have been studied by F. Rinne and M. Kemter.

W. Grahmann studied the isomorphism of the three anhydrous sulphates of the alkaline earths. The heating curves show a transition at 1193° with calcium sulphate, at 1152° with strontium sulphate, and at 1149° with barium sulphate. Strontium and barium sulphates are miscible in all proportions in both α - and β -forms, and baryto-celestite is therefore a true isomorphous mixture. Calcium and strontium sulphates are completely miscible in the α -form above the transition temp., but in the β -form they are isodimorphous. Addition of strontium sulphate to calcium sulphate first raises the transition temp. up to about 20 mols per cent. strontium sulphate; then up to 80 mols per cent. the transition temp. gradually

falls to a minimum at 1010°. The sat. β -mixed crystals co-existing at the eutectic temp. contain 55 to 82 mols per cent. strontium sulphate. The sp. gr. curves indicate that the form of strontium sulphate isomorphous with anhydrite should have a density of 3.55, while the second form of calcium sulphate should have a sp. gr. of 3.29. Barium sulphate and calcium sulphate are likewise isodimorphous and their miscibility is slight, at most 5 mols per cent. of calcium sulphate in the barium sulphate crystals. It is suggested that the term *baryto-celestine* should be confined to minerals containing between 10 and 90 mols per cent. of barium and strontium sulphate.

Numbers have been given² for the **specific gravity** of anhydrous calcium sulphate, ranging from 2.736 by H. G. F. Schröder to 3.102 by E. Filhol. N. S. Manross gave 2.969, A. Gorgeu 2.980, and H. Struve 3.028 (12°) for artificial crystals of anhydrite; E. Madelung and R. Fuchs gave 2.9369–2.9468 (0°) for anhydrite; and A. Schrauf, 2.983. J. F. McCaleb found that after heating calcium sulphate to

Sp. gr. .	200°.	Dull redness.	Bright redness.	M.p.	Fusion.	Anhydrite.
.	2.577	2.912	2.890	2.796	2.654	2.907

J. F. W. Johnston gave 2.757 for the sp. gr. of crystals of hemihydrated calcium sulphate, $2\text{CaSO}_4 \cdot \text{H}_2\text{O}$; A. Moyer gave 2.75; and E. Madelung and R. Fuchs, 2.3081–2.3123 (0°) for gypsum. A. Kenngott gave 2.317 as the mean of fifteen measurements of gypsum, and values ranging from F. Stolba's 2.3057 to A. le Royer and J. B. A. Dumas' 2.322 have been given for the sp. gr. of dihydrated calcium sulphate, $\text{CaSO}_4 \cdot 2\text{H}_2\text{O}$. O. Pettersson gave 2.3228 (18°) and 2.2745 (19.4°) for the sp. gr. of the powdered dihydrate. The sp. gr. of selenite is between 2.30 and 2.33 and of natural anhydrite 2.92 to 2.98. A. Moyer found the sp. gr. of the completely dehydrated salt to be 2.86.

The published values of the sp. gr. of celestine range from F. Mohs' 2.86 to A. Breithaupt's 3.973; E. Madelung and R. Fuchs gave 3.9631–3.9684 (0°) for celestine; and N. S. Manross gave 3.927; and A. Gorgeu, 3.9 for artificial crystals of strontium sulphate; and the numbers for the precipitated strontium sulphate range from C. J. B. Karsten's 3.5883 to J. Schweitzer's 3.9702 (18°); and the last named also gave 3.6679 to 3.6949 (18°) for the ignited precipitate. The reported values for the sp. gr. of barytes range from F. E. Neumann's 4.429 to G. Rose's 4.872. E. Madelung and R. Fuchs gave 4.4657–4.4741 (0°) for barytes; and N. S. Manross gave 4.179 and A. Gorgeu 4.44 to 4.50 for artificial crystals of barium sulphate. The values for precipitated barium sulphate range from H. G. F. Schröder's 4.022 to J. Schweitzer's 4.4881 (18°); the last named gave 4.2688 (18°) for the precipitate dried at 95°, and 4.2942 for the ignited precipitate. E. Wiedemann gave 4.3964 at 14.5° and 4.3963 at 14.9°. Earl of Berkeley found a mean value of 4.4701 between 15.05° and 17.35°, with a deviation of 0.0011 between the maximum and minimum. The best representative values for the sp. gr. of the sulphates at about 15°, are:

Sp. gr.	BaSO_4	SrSO_4	CaSO_4 (natural anhydrite)	CaSO_4 (soluble anhydrite)	$\text{CaSO}_4 \cdot \frac{1}{2}\text{H}_2\text{O}$	$\text{CaSO}_4 \cdot 2\text{H}_2\text{O}$
.	4.45	3.84	2.96	2.86	2.75	2.32

A. Lacroix found the monoclinic variety he obtained from Templeton to have a sp. gr. of 4.39 (15°). F. Stolba found the sp. gr. of a sat. soln. of calcium sulphate at 15° to be 1.0022; F. K. Cameron, at 26°, 1.0026; and at 31°, 1.0031. G. A. Hulett and L. E. Allen gave for sat. soln.:

Sp. gr.	0°	10°	30°	35°	40°	55°	75°
.	1.00197	1.00173	0.99789	0.99612	0.99439	0.98796	0.97772

Anhydrite, celestine, and of barytes are each stated to have a **hardness** between 3 and 3.5; while that of gypsum is given between 1.5 and 2.

According to A. Johnsen,³ cooling by liquid air diminished the **plasticity** of gypsum. P. von Bjerken gave 360 kgrms. per sq. mm. for the **elastic modulus** of

gypsum; P. Drude and W. Voigt, 5910 kgrms. per sq. mm. for that of barytes. W. Voigt also measured the elastic modulus of rhombic crystals of barytes along the different axes, and obtained maximum and minimum values of 9582–3715 kgrms. per sq. mm. L. A. Coromilas likewise obtained maximum and minimum values for monoclinic crystals of gypsum—8870–3130 kgrms. per sq. mm. For the **elastic number**—ratio of transverse contraction to longitudinal extension—of samples of grey and red barytes, P. Drude and W. Voigt gave respectively 0.273 and 0.288. W. Voigt gave for the **compressibility** of barytes 1.93×10^{-6} kgrm. per sq. mm. E. Madelung and R. Fuchs gave for gypsum $2.45 - 1.53 \times 10^{-6}$ megabars per sq. cm.; for anhydrite, $1.76 - 1.90 \times 10^{-6}$ megabars per sq. cm.; celestine, $1.57 - 1.63 \times 10^{-6}$ megabars per sq. cm.; and for barytes, $1.74 - 1.78 \times 10^{-6}$ megabars per sq. cm.

J. L. Gay Lussac⁴ did not decompose the neutral sulphates of the alkaline earths by fire. According to E. Mitscherlich, calcium sulphate melts when heated in a platinum crucible over a blast gas-blowpipe, some sulphur trioxide is given off, and the residue has an alkaline reaction; J. B. J. D. Boussingault found 0.5 to 2.0 grms. of calcium sulphate, when heated over a blast gas-blowpipe, lost all its sulphur trioxide in 20 min. R. Bunsen also found some sulphur trioxide was lost when calcium sulphate was heated over Bunsen's flame. Confirmatory observations on the loss of sulphur trioxide have been made by F. Schott, K. Zulkowsky, etc. By extrapolation from H. Müller's or G. Galcagni and G. Mancini's f.p. curves of mixtures of calcium sulphate and the alkali sulphates, the **melting point** of calcium sulphate is between 1350° and 1375° , but the salt decomposes so readily at 1000° , that an accurate determination cannot be made. As indicated above, W. Grahmann found that calcium sulphate can be melted in an electric furnace without decomposition, and the molten sulphate freezes at 1450° ; the cooling curve shows a transition point at 1193° ; strontium sulphate has a transition point at 1152° ; and barium sulphate at 1149° . J. B. J. D. Boussingault made similar observations with respect to the action of heat on strontium and barium sulphates as those he made on the calcium salt; and M. Darmstadt likewise observed a loss of sulphur trioxide when strontium sulphate is heated in a crucible over Bunsen's flame. F. Jeremin found that when heated in the electric arc, calcium sulphate is reduced to calcium sulphide; and with the barium salt he found some barium sulphate appeared to be volatilized, possibly owing to alternate reduction and oxidation. N. T. de Saussure melted barium sulphate to a white enamel; R. Hare melted barytes in the oxy-hydrogen blowpipe; and F. O. Doeltz and W. Mostowitsch found that barium sulphate, prepared from barium chloride and sulphuric acid, loses weight at 1300° , and that the m.p. on platinum foil is 1453° ; when heated for half an hour between 1550° and 1582° , it volatilized completely. The behaviour of barium sulphate when heated depends to some extent on the way it has been prepared; that obtained from ammonium sulphate and barium hydroxide, fused after heating in air for 10–20 mins. on platinum at 1580° , and lost 9 per cent. in weight. W. Vernadsky found that calcium and strontium sulphates over 1200° each pass into a second rhombic modification, and W. Grahmann found that anhydrite, celestine, and heavy spar pass from the β - to α -, probably monoclinic, modifications as the temp. rises above the transition points indicated in Table VIII. E. Jänecke saw that gypsum has an incongruent m.p. at

TABLE VIII.—SOME THERMAL CONSTANTS OF THE ALKALINE EARTH SULPHATES.

	CaSO ₄ .	SrSO ₄ .	BaSO ₄ .
Molecular weight . . .	136.16	183.66	233.46
Melting point . . .	1450°	1605°	1580°
Transition temperature . . .	1193°	1152°	1149°
Time of transformation . . .	60	110	100 secs.

107°, and the liquid which is obtained by compressing gypsum in very dil. soln., the residue has the composition $\text{CaSO}_4 \cdot \frac{1}{2} \text{H}_2\text{O}$. O. Ruff and W. Plato obtained a flattened eutectic at 900° with mixtures of barium sulphate with 65 to 82 molar per cent. of barium chloride.

K. E. Guthe gave 0·000025 for the **coefficient of linear expansion** of gypsum between 12° and 25°. G. Linder⁵ found the **specific heat** of crystallized anhydrite to be 0·1753 between 0° and 100°, and 0·1908 between 0° and 300°; R. Weber gave 0·1802 at 0°; and for gypsum, 0·254 at 0°; while H. Kopp gave 0·259 between 16° and 46°. For celestine, the latter gave 0·135 between 18° and 51°; and for ignited artificial strontium sulphate, H. V. Regnault gave 0·1428 between 21° and 99°; and 0·1128 for barytes between 10° and 98°. According to P. N. Laschtschenko, the sp. ht. of barytes increases regularly up to about 500°, being 0·114 at 150°; 0·115 at 170°; 0·125 at 300°; and 0·129 at 500° and 1050°. R. Weber found the **heat conductivity** at 0° for $K_0 = 0·0123$ cal. per cm. per sec. per degree for anhydrite, $K_0 = 0·0009$ at 0° for artificial gypsum, and $K_0 = 0·0031$ at 0° for natural gypsum. He also gave for the conductivity of anhydrite at θ , $K = K_0(1 + 0·0024\theta)$. H. Hecht found that if D denotes the sp. gr. and C the sp. ht., what he calls the temp. conductivity $K = a^2DC$, where $a^2 = 0·0030$.

J. Thomsen⁶ found the **heat of formation** of anhydrous calcium sulphate to be (Ca, S, 40) = 317·4 Cals.; (Sr, S, 40) = 330·9 Cals.; (Ba, S, 40) = 340·2 Cals.; (Ca, O₂, SO₂) = 248·97 Cals.; (Sr, O₂, SO₂) = 259·82 Cals.; (Ba, O₂, SO₂) = 266·49 Cals.; $\text{Ca}(\text{OH})_{2\text{aq.}} + \text{SO}_{3\text{aq.}} = 31·14$ Cals., similarly, for strontium hydroxide 30·71 Cals., and for barium hydroxide 36·90 Cals.—including the heat of precipitation. M. Berthelot gave (CaO, SO₃) = 84 Cals.; (SrO, SO₃), both solid, 95·6 Cals.; and (BaO, SO₃) = 102 Cals.; $\text{Ca}(\text{OH})_{2\text{solid}} + \text{H}_2\text{SO}_{4\text{solid}} = \text{CaSO}_{4\text{solid}} + \text{H}_2\text{O}_{\text{solid}} + 98·8$ Cals., similarly, for strontium sulphate, 118 Cals., and for barium sulphate, 132·0 Cals. R. de Forcrand gave for the **heat of hydration**, $\text{CaSO}_{4\text{anhydrite}} + 2\text{H}_2\text{O}_{\text{liquid}} = -3·61$ Cals.; he also gave $\text{CaSO}_4 \cdot 2\text{H}_2\text{O} = \alpha\text{-CaSO}_4 \cdot \frac{1}{2}\text{H}_2\text{O} + 1\frac{1}{2}\text{H}_2\text{O} - 3·8$ Cals., with $\beta\text{-CaSO}_4 \cdot \frac{1}{2}\text{H}_2\text{O}$, -4·025 Cals., and with $\gamma\text{-CaSO}_4 \cdot \frac{1}{2}\text{H}_2\text{O}$, -4·25 Cals.; and for the conversion of α -, β -, and γ -forms to anhydrite and liquid water, 0·19, 0·415, and 0·64 Cal. respectively. A. Potilitzin gave (CaSO₄, 2H₂O) = 9·30 Cals.; and $\frac{1}{2}(2\text{CaSO}_4 \cdot \text{H}_2\text{O}, 3\text{H}_2\text{O})$, 6·10 Cals. J. Thomsen gave -0·60 Cal for the **heat of solution** of CaSO₄·2H₂O; and M. Berthelot found the heat of soln. of CaSO₄·2H₂O to be almost zero at ordinary temp.; negative, a little below 15°; and positive, above 25°. According to R. de Forcrand, the heat of soln. of CaSO₄·2H₂O at 10° is -0·65 Cal.; of 2CaSO₄·H₂O, 3·56 Cals.; of anhydrous calcium sulphate which had been previously heated to 155°, 5·655 Cals. at 10°, and previously heated to redness, 2·92 Cals. at 10°. M. Berthelot found the heat of soln. of strontium sulphate to be almost zero at ordinary temp., positive below 15°, and negative above 25°. J. Thomsen gave 5·58 for the heat of soln. of barium sulphate; and A. C. Melcher represented the value at $T^\circ \text{K.}$ by $Q = 30800 - 85 \cdot 2T$, which gives for 18°, 6 Cals.

The **index of refraction** of anhydrite is moderate, and the double refraction is high. The mean values of the indices of refraction from A. Mühlheims,⁷ J. Danker's, and K. Zimanyi's observations for the D -line are, $\alpha = 1·5696$, $\beta = 1·5755$, and $\gamma = 1·6135$; and $\gamma - \alpha = 0·0439$. The index of refraction of anhydrite has been determined by J. Danker, A. Mühlheims, and K. Zimanyi; of celestine by A. Arzruni, M. Grunenberg, G. H. Williams, and E. Artini; and of barytes by A. Arzruni, J. Danker, K. Feussner, J. C. Heussner, A. Mühlheims, A. Offret, and C. Pulfrich. The indices of refraction for the C -, D -, F -lines for anhydrite (A. Mühlheims), celestine (A. Arzruni), and barytes (A. Arzruni) are:

Line	Anhydrite.			Celestine.			Barytes.		
	α	β	γ	α	β	γ	α	β	γ
C	1·56722	1·57295	1·61056	1·61954	1·62120	1·62843	1·63351	1·63457	1·64531
D	1·56933	1·57518	1·61300	1·62198	1·62367	1·63092	1·63609	1·63712	1·64795
F	1·57472	1·58079	1·61874	1·62790	1·62960	1·63697	1·64254	1·64357	1·65469

The mean refractive index of anhydrite is given as 1·59; of celestine, 1·62; and of

barytes, 1·64. The mean double refraction of anhydrite is given as 0·045; of celestine, 0·007; of barytes, 0·012. Gypsum or selenite is optically positive with the plane of the optic axes parallel to the (010)-face at ordinary temp. The mean values of the indices of refraction for the *D*-line, from the observations of V. von Lang, C. Klein, C. Viola, and H. Dufet, are $\alpha : \beta : \gamma = 1·5205 : 1·5227 : 1·5298$, with $\gamma - \alpha = 0·0093$ as the mean value of the double refraction. Other observations have been made by A. J. Angstrom, F. Kohlrausch, A. Matthiessen, G. Quincke, C. Pulfrich, and A. E. H. Tutton. A. Hutchinson and A. E. H. Tutton's values for the refractive index of gypsum at different temp. and with light of different wave-lengths, λ , are shown in Table IX.

TABLE IX.—INDICES OF REFRACTION OF GYPSUM.

λ	α			β			γ		
	12°	98°	105°	12°	98°	105°	12°	98°	105°
Li .	1·5178	1·5162	1·5154	1·5201	1·5166	1·5158	1·5270	1·5247	1·5243
C .	1·5184	1·5168	1·5160	1·5207	1·5172	1·5164	1·5276	1·5253	1·5249
Na .	1·5207	1·5193	1·5184	1·5230	1·5196	1·5188	1·5299	1·5277	1·5274
573	1·5213	1·5198	1·5190	1·5237	1·5201	1·5194	1·5307	1·5284	1·5280
Tl .	1·5231	1·5219	1·5209	1·5255	1·5222	1·5213	1·5325	1·5304	1·5300
F .	1·5262	1·5248	1·5239	1·5285	1·5252	1·5243	1·5355	1·5334	1·5330
G .	1·5303	1·5294	1·5285	1·5328	1·5299	1·5259	1·5400	1·5379	1·5377

The mean refractive index of gypsum is taken as 1·52; and the mean double refraction as 0·010.

In 1826, E. Mitscherlich⁸ showed that gypsum suffers a larger change in the position of its optic axes with a change of temp. than any other substance then known. At ordinary temp. it is biaxial, with an optic axial angle of 60°, but on raising the temp., the angle diminishes until in the neighbourhood of 100°, the axes come together, producing, in convergent polarized light, the rectangular cross, and circular rings of a uniaxial crystal. Beyond that temp., the axes again separate, but in the direction at right angles to their former one. On allowing the crystal to cool, the phenomena are repeated in the reverse order. This has been called *Mitscherlich's experiment*. He found the inversion temp. to be 91·9°. The crossed-axial-plane dispersion is exhibited by brookite; the triple tartrate of potassium sodium, and ammonium; rubidium sulphate; caesium selenate; ammonium selenate; caesium magnesium sulphate; caesium magnesium selenate; and monoclinic ethyltriphenyl pyrrolone. A. E. H. Tutton has shown that the phenomenon is due to very low double refraction combined with a close approximation of the intermediate index of refraction to one of the extreme indices, and to the fact that change of wave-length of the light or change of temp., or both, cause the intermediate index to approach still nearer to the extreme one in question until it becomes identical with it, and eventually to pass it, the relative positions of the two indices thus becoming reversed. The uniaxial rectangular cross and circular rings are produced at the critical point of identity. This critical point is a function of both wave-length and temp.; it is a fixed one only for a particular wave-length and an assigned temp. A. E. H. Tutton and A. Hutchinson found that the temp. at which selenite becomes uniaxial, given by the former, were a little too high, and that the corrected temp. of optical uniaxiality of gypsum, for different wave-lengths, are:

671 (Li)	656 ($H_a=C$)	589 ($Na=D$)	573	535 (Tl)	486 ($H_\beta-F$)
90·2°	90·4°	90·9°	91·0°	90·8°	90·1°

E. H. Kraus and L. J. Youngs obtained 89·67°–91·6°. E. Goens showed that the

directions of maximum and minimum transparency and reflective power indicate the positions of the optic axes of gypsum.

W. W. Coblentz's⁹ measurements of the **absorption spectrum** of selenite and anhydrite are shown in Fig. 43, the former by the continuous line, the latter by the dotted line. With anhydrite there are small absorption bands at 1.9 , 3.2 , 5.7 , 6.15 , and 6.55μ , and a large band at 4.55μ due to the SO_4 group. All the absorption bands of selenite coincide with those of water excepting the 4.75μ band of water is shifted to 4.6μ . W. H. Julius showed that the absorption spectrum of a chemical compound is not the composite of the bands of the constituent elements, for the molecules are changed. In selenite, the absorption spectrum is a composite of the bands characteristic of calcium sulphate, CaSO_4 , and water. The water of crystallization of selenite, $\text{CaSO}_4 \cdot 2\text{H}_2\text{O}$, is therefore assumed by W. W. Coblentz to be in the mol. state, and the water and anhydrous calcium sulphate to crystallize together, building up a complex crystal much as it is possible to grow a crystal of a mixture of alums. This is assumed because the absorption spectrum of the hydrated salt, $\text{CaSO}_4 \cdot 2\text{H}_2\text{O}$, is a composite of the spectra of anhydrite, CaSO_4 , and water, H_2O . If the water were chemically combined in selenite, the absorption bands of water would not appear. The large absorption band with selenite at 4.6μ is characteristic of sulphates. It is generally assumed that if the water passes off from crystals in stages at one, two, or more fixed temp., the water is present as an integral part of the compound, whereas if the water is expelled continuously on a gradually rising temp., it is inferred that absorbed water is involved. Against these assumptions, W. W. Coblentz shows that the absorption spectrum indicates that, in selenite, the water is not chemically combined, although when heated, the water comes off in stages, whereas in tremolite, E. T. Allen and J. K. Clement found that the water comes off continuously, but the absorption bands show no signs of the contained water. The water is given off gradually from the zeolites between 100° and 400° , but it is inferred that the water is not chemically combined to form one sp. mol. because as with opal and selenite, the absorption spectrum is a composite of the spectra of the anhydrous mineral and water.

W. W. Coblentz's values for the absorption spectra of barytes and celestine are indicated by the continuous curves in Fig. 44. The reflection curves of anhydrite, celestine, and barytes are represented by the dotted lines. All show the harmonic bands at 4.55μ and 9.1μ , as in the case of anhydrite. The region 6μ to 7μ is characteristic of the sulphate. T. Liebisch and H. Rubens studied the optical behaviour of strontianite in the ultra-red rays.

According to P. Bary,¹⁰ calcium sulphate shows no **phosphorescence** when exposed to **X-rays** or **Becquerel rays**, while barium sulphate does phosphoresce under these conditions. E. Wiedemann, and H. Jackson studied the luminescence of calcium sulphate, particularly when mixed with manganese sulphate, on exposure to **cathode rays**. Colourless selenite crystals decompose at a low temp. without showing thermo-luminescence. According to E. Newbery and H. Lupton, when selenite is exposed to **radium rays**, certain parts are coloured brown. The blue colour of some varieties of anhydrite, celestine, and barytes can be discharged by heat; and some colourless specimens are coloured blue by exposure to radium rays. The crystals exhibit a green phosphorescence during exposure to radium. P. Schuknecht found the spectrum of the phosphorescence produced by Röntgen and cathodic rays extends far into the ultra-violet.

K. Prizbram and E. Kara-Michailova¹¹ studied the effect of the high-potential

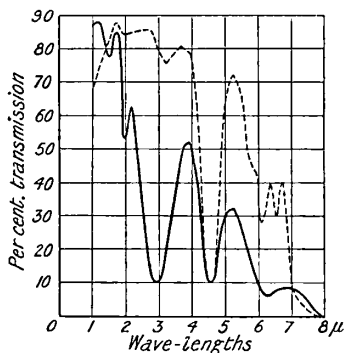

FIG. 43.—Absorption Spectra of Selenite and Anhydrite.

discharge on the surface of a plate of gypsum. J. Königsberger and K. Schilling found rhombic barium sulphate conducted an electric current electrolytically, by ions. A. C. MacGregory, W. Böttger, and others have measured the **electrical conductivity** of aq. soln. of calcium sulphate. G. A. Hulett and L. E. Allen measured the eq. conductivity of sat. soln. between 0° and 65° . F. Kohlrausch found a cm. cube of sat. soln. at 18° had a conductivity $\lambda=18.85 \times 10^{-4}$ rec. ohms. A. C. MacGregory found the temp. coeff. between 18° and 26° to be 0.023 per degree. F. Kohlrausch and F. Rose, A. F. Hollemann, A. C. Melcher, and A. C. MacGregory have measured the electrical conductivity of soln. of strontium and barium sulphates, and from the results calculated the solubility of the salt in water. For sat. aq. soln. at 18° , F. Kohlrausch found for precipitated barium and strontium sulphates $\lambda=2.4 \times 10^{-6}$ and 127×10^{-6} rec. ohms respectively; and for heavy spar and celestine, respectively $\lambda=2.7 \times 10^{-6}$ and 127×10^{-6} rec. ohms; and for a sat. soln. of gypsum $\lambda=1885 \times 10^{-6}$ rec. ohms. For the conductivity of a sat. soln. of heavy spar at θ° between 10° and 26° , he found $\lambda=2.7 \times 10^{-6} \{1+0.0232(\theta-18)+0.00010(\theta-18)^2\}$;

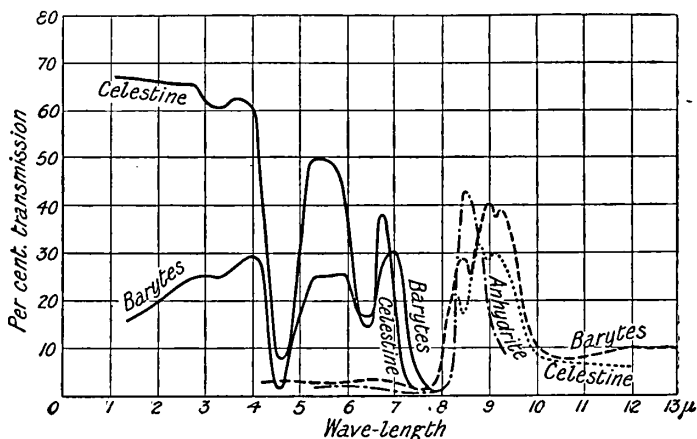

FIG. 44.—Absorption Spectra of Barytes and Celestine.

and for celestine, $\lambda=127 \times 10^{-6} \{1+0.0230(\theta-18)+0.00009(\theta-18)^2\}$. G. A. Hulett suggested a sat. soln. of gypsum as a standard for conductivity determinations; he represented the conductivity between 10° and 30° by $0.002208+0.0445(\theta-25)+0.061626(\theta-25)^2$; and the sp. conductivity λ is related with the conc. C , in mgrm. mols per litre, by $C=-0.354+5211\lambda+841400\lambda^2$. P. Walden measured the conductivity of soln. of strontium sulphate in conc. sulphuric acid. B. D. Steele and R. B. Denison found the **transport number** for the cation in 0.005*N*-soln. of calcium sulphate to be 0.441; J. F. Daniell and W. A. Miller also experimented on the subject in 1844. J. A. Muller represented the **heat of ionization**, q , of barium sulphate at the absolute temp. T by $-q=105502.32-696.357T+1.2118T^2$. G. N. Lewis and M. Randall calculated the activity coeff. of the ions.

According to R. Fellingner,¹² the **dielectric constants** of barytes for the α -, β -, and γ -axes, for definite wave-length, are respectively 6.17, 10.09, and 7.00; and, according to W. Schmidt, for wave-lengths of 75 cms., these constants are respectively 6.65, 12.20, and 7.70, and for celestine respectively 7.70, 18.5, and 8.20. For gypsum, C. B. Thwing gave 5.61; J. Curie, 6.33; H. Starke, 5.04; and M. von Pirani, 5.66. According to S. Meyer, the **magnetic susceptibility** of anhydrite is -0.38×10^{-6} at 17° ; and of gypsum, -0.36×10^{-6} . P. Pascal gave for the mol. coeff. of magnetization of BaSO_4 , 713×10^{-7} ; SrSO_4 , 597×10^{-7} ; CaSO_4 , 496×10^{-7} ; and $\text{CaSO}_4 \cdot \frac{1}{2}\text{H}_2\text{O}$, 557×10^{-7} .

B. Ungcr¹³ found that when heated in a stream of **hydrogen**, calcium sulphate is reduced to the sulphide which, according to O. Schumann, is mixed with about

one-seventh of calcium oxide. Strontium under similar conditions furnishes the sulphide mixed with one-thirteenth of oxide. Hydrogen likewise reduces barium sulphate. Anhydrous calcium sulphate obtained by heating scelenite to redness, or by evaporation with conc. sulphuric acid, is not hygroscopic and does not change in weight on exposure to air; the anhydrous salt made by heating selenite sufficiently to expel the water without loss of sulphuric anhydride is hygroscopic. The latter also gives off sulphuric acid more readily than the former. E. Jacquemin found **water vapour** reduces red-hot barium sulphate forming carbon monoxide, hydrogen sulphide, and barium oxide. R. A. Tilghmann passed water vapour over a red-hot mixture of calcium sulphate and sodium chloride, and obtained sodium sulphate and hydrogen chloride. According to F. Knapp, the silica of the containing vessel plays a part in this reaction. According to O. Siemens, if water vapour is passed over a molten mixture of sodium chloride with twice its weight of calcium sulphate, hydrogen chloride, sulphur dioxide, and hydrogen sulphide are evolved; and a mixture of carbon dioxide and water vapour produces only sulphur dioxide and hydrogen chloride. The residue contains undecomposed sodium chloride, sodium hydroxide, calcium sulphide, and oxide, and small quantities of sodium thiosulphate and sodium sulphite; according to H. L. Buff, the iron of the containing vessels plays an essential part in the reaction. According to E. Ebler and K. Herrdegen, a mixture of **calcium hydride** with barium sulphate when ignited by the thermite process forms a mixture of calcium oxide and barium sulphide: $\text{BaSO}_4 + 4\text{CaH}_2 = \text{BaS} + 4\text{CaO} + 4\text{H}_2$; a little barium oxide and calcium sulphide may be formed. The hydrogen does not appear to take part in the reaction. This furnishes a means of getting insoluble sulphates into soln. Some of the sulphates of the heavy metals give the metal itself.

According to M. Cari-Mantrand, **chlorine** transforms red-hot calcium sulphate into the chloride; and **hydrogen chloride** acts in a similar way, liberating sulphur dioxide and oxygen; according to C. Hensgen, the decomposition is complete at a dull red heat; as found by J. B. J. D. Boussingault, the reaction is facilitated by mixing the sulphate with carbon, when calcium chloride, sulphur, carbon monoxide, and hydrogen sulphide are formed. Strontium and barium sulphates, according to J. B. J. D. Boussingault and C. Hensgen, are also completely transformed at a bright red heat by hydrogen chloride into the corresponding chloride. A. B. Prescott found that when 1.00 grm. of calcium, strontium, or barium sulphate is evaporated with 4.035 grms. of **hydrochloric acid** containing 1.251 grms. of HCl, no appreciable quantity of sulphate is decomposed. P. Chroustchoff, and W. Ostwald studied the distribution of sulphuric acid between barium and strontium salts. The contamination of barium sulphate with chlorides when precipitated in the presence of chlorides led G. Hulett and L. H. Duschak and others to suggest that *barium chlorosulphate* is formed, $(\text{BaCl})_2\text{SO}_4$, or Cl.Ba.HSO_4 . The chloride, however, may be simply adsorbed by the sulphate.

C. Matignon and F. Bourion found that when calcium sulphate is heated in a stream of **sulphur chloride**, S_2Cl_2 , it is also converted into calcium chloride, and barium sulphate is similarly converted into barium chloride. When barium sulphate is heated with **carbon** to $600^\circ\text{--}800^\circ$, $\text{BaSO}_4 + 2\text{C} = \text{BaS} + 2\text{CO}_2$; and to $1000^\circ\text{--}1100^\circ$, $\text{BaSO}_4 + 4\text{C} = 4\text{CO} + \text{BaS}$. If in an electric furnace with insufficient carbon for complete reduction, $3\text{BaSO}_4 + \text{BaS} = 4\text{SO}_2 + 4\text{BaO}$, as in C. S. Bradley and C. B. Jacobs' process for barium chloride—*q.v.* The action of carbon on the sulphates of the alkaline earths in the electric arc furnace was studied by E. Kuhnheim. E. H. Riesenfeld has also studied the reduction of the sulphates of the alkaline earths by carbon and by methane. According to H. Quantin, the vapour of **carbon tetrachloride** converts red-hot barium sulphate into barium chloride and carbon dioxide, carbonyl chloride, and pyrosulphuryl chloride, $\text{S}_2\text{O}_5\text{Cl}_2$. B. Neumann and G. Kotyga studied the action of **ammonium hydroxide** on calcium sulphate; and B. Neumann and W. Gellendien, the action of **ammonium carbonate** on the same salt. H. Rose converted barium sulphate into the chloride by

igniting it with **ammonium chloride**, although R. Fresenius found the reaction is incomplete. According to F. Sestini, and A. Violi, when calcium sulphate is heated with **sulphur**, it forms sulphur dioxide and calcium sulphide; and analogous results were obtained with strontium and barium sulphates. F. le Play and A. Laurent, and C. Stammer reduced calcium sulphate to the sulphide by heating it with **carbon** or **carbon monoxide**, and B. Unger, by heating it with **water-gas**. L. Marino found that the reduction of barium sulphate to barium sulphide is effected by reducing gases better than by coal, which is generally employed at present. The reduction with hydrogen, methane, water-gas, illuminating gas, etc., occurs at about the same temp., as these gases inflame with oxygen, and the temp. of reduction can be lowered by the aid of suitable catalyts, just as combination with oxygen can be favoured by the same means. For commercial purposes the best results are obtained with water-gas, the reduction occurring at 525°-540°. In practice a temp. of 600°-625° is employed. L. Marino and D. Danesi also noted that strontium sulphate requires a higher temp. for the reduction, and calcium sulphate a temp. still higher. The product with barium sulphate is always the sulphide; with strontium sulphate, the sulphide and a trace of oxide and thiosulphate; and with calcium sulphate, sulphide, and small quantities of the oxide and thiosulphate. E. Jacquemin reduced strontium and barium sulphates with moist carbon monoxide. According to E. H. Jenkins, hydrated calcium sulphate does not absorb gaseous **ammonia**, but if some of the water is expelled from the hydrate ammonia is absorbed; for example, a sulphate with 0.7 per cent. of water, absorbed 2.27 per cent. of ammonia at ordinary temp. E. Berger used a mixture of sodium or potassium nitrate with 40 per cent. of calcium silicide as a priming mixture for the reduction of calcium or barium sulphate with red **phosphorus**. According to G. Moretti, **arsenic oxide** drives out sulphur dioxide from heated strontium sulphate. A mixture of **iron** filings with barium, strontium, or calcium sulphate was found by A. d'Heurèuse to form ferric oxide and the corresponding sulphide; e.g. $3\text{BaSO}_4 + 8\text{Fe} = 3\text{BaS} + 4\text{Fe}_2\text{O}_3$, but with a less proportion of the sulphide some ferrous sulphite may be produced; he also found **zinc** reduces strontium sulphate at a dull red heat forming zinc oxide, and strontium oxide and sulphide; the action with barium or calcium sulphate is similar, but the mixture detonates at dull redness.

Sintered mixtures of calcium oxide and sulphate furnish *Scott's selenitic cement*, as previously indicated. There is no evidence that an oxysulphate is here formed. F. K. Cameron and S. M. Bell studied the ternary system, $\text{CaO}-\text{CaSO}_4-\text{H}_2\text{O}$, but found no signs of the formation of a *calcium oxysulphate*. Expressing the results in grams per litre, they found at 25°:

CaO	0	0.062	0.349	0.939	1.222	1.242	1.150	1.166
CaSO ₄	2.126	2.030	1.853	1.634	1.588	1.214	0.666	0.00
Solid phases	CaSO ₄ ·2H ₂ O			CaSO ₄ ·2H ₂ O + Ca(OH) ₂		Ca(OH) ₂		

The results are plotted in Fig. 45. The curve *AB* shows that the solubility of calcium hydroxide in an aq. soln. of calcium sulphate is nearly constant, but is slightly more in the more conc. soln. of the sulphate. The curve *BC* shows that the solubility of calcium sulphate decreases regularly as the conc. of the latter increases.

It does not follow that the equilibrium constant in reactions which take place in soln. will be independent of the nature of the solvent. Thus, L. Pissarjewsky and A. Levites found that the equilibrium constant in the reaction, $\text{CaSO}_4 + 2\text{KOH} \rightleftharpoons \text{K}_2\text{SO}_4 + \text{Ca(OH)}_2$, in a 10 per cent. mannitol soln. is eleven times, and in a 24 per cent. glycerol soln. nine times less than it is in water. This means that the respective solvents do not act as simple catalytic agents. According to J. F. John,¹⁴ barium sulphate is completely decomposed when boiled down to dryness with a soln. of **potassium hydroxide** and the product is a mixture of barium hydroxide and potassium sulphate; but H. Rose found that barium sulphate is

not attacked by a boiling soln. of the alkali hydroxide freed from carbon dioxide, while if carbon dioxide is present barium carbonate is formed. C. J. B. Karsten, on the other hand, reported that barium hydroxide dissolves in a conc. aq. soln. of sodium sulphate between 15° and 19°, and as the soln. is diluted, barium sulphate and sodium hydroxide remain in soln. H. Rose, and H. Reinsch found that no perceptible action occurred when a cold or boiling soln. of **ammonium carbonate** acts on barium sulphate for 20 hrs. A large number of observations have been made on the reaction between aq. soln. of fused **alkali carbonates** and the sulphates of the alkaline earths. There is a difficulty in determining the composition of the product obtained by fusing the two constituents, because, when subsequently treated with water, the reaction may be reversed. Boiling the sulphate with a soln. of sodium or potassium carbonate results in a partial decomposition of the sulphate, but the effect is reversed on cooling. W. Meyerhoffer found that a fused mixture of barium carbonate and potassium sulphate deposits very little, if any, barium sulphate on cooling, but when this mixture is treated with water, a reaction sets up, so that no matter whether barium carbonate is fused with potassium sulphate, or potassium carbonate with barium sulphate, the amount of barium carbonate in the residue is 90–95 per cent. The reaction in aq. soln. in the heterogeneous system: $K_2CO_3 + BaSO_4 \rightleftharpoons K_2SO_4 + BaCO_3$, is reversible with $BaSO_4$ and $BaCO_3$ as solid phases. From C. M. Guldberg and P. Waage's law, $C_1C_2 = K'C_3C_4$, where C_1 , C_2 , C_3 , and C_4 respectively denote the conc. of the salts in the order stated in the chemical equation, the constant $K = C_1/C_3$, when the conc. of the solid phases are regarded as constant. W. Meyerhoffer, however, showed that the ratio $C_1 : C_3$, that is $K_2CO_3 : K_2SO_4$, varies not only with the temp. but also with the conc. of the soln. The system has also been studied by E. Ramann and H. Sallinger. Similar remarks apply to the system: $Na_2CO_3 + BaSO_4 = Na_2SO_4 + BaCO_3$. W. Spring has investigated the influence of press. of 600 atm. on mixtures of solid sodium carbonate and barium sulphate, and reported the conversion of as much as 80·31 per cent. of barium sulphate to the carbonate—*vide* 1. 13, 18. The corresponding reactions with strontium sulphate were investigated by P. Berthier, H. Grüneberg, H. Rose, and F. J. Malaguti; and with calcium sulphate by P. Berthier. W. Herz studied the equilibria in the systems containing a sulphate of calcium or strontium and an aq. soln. of sodium carbonate.

According to J. B. Trommsdorff, C. J. B. Karsten, H. L. Buff, and A. Levöl, no reaction occurs when calcium sulphate is fused with **sodium chloride**. C. J. B. Karsten, and P. Berthier similarly melted barium sulphate with sodium chloride. W. O. de Coninck and L. Arzalier found that barium sulphate is partially decomposed when heated with an aq. soln. of **potassium chloride** for 5 months. According to J. Treumann, a boiling soln. of **ammonium chloride** decomposes a little strontium sulphate. W. O. de Coninck and L. Arzalier found that barium sulphate is partially decomposed when heated with an aq. soln. of **methylamine hydrochloride** for 620 hrs. at 100°. H. Rose melted barium sulphate with **calcium chloride**, and stated that barium chloride and calcium sulphate are formed. P. Chrustschoff and A. Martinoff found that when strontium sulphate is treated with a soln. of **barium chloride**, about 50 per cent. is converted into barium sulphate and strontium chloride in about a couple of hours, and the reaction is complete in a few more hours. P. Berthier, J. J. Berzelius, and T. Scheerer and E. Drechsel fused mixtures of barium sulphate and **calcium fluoride**, and obtained crystalline masses corresponding

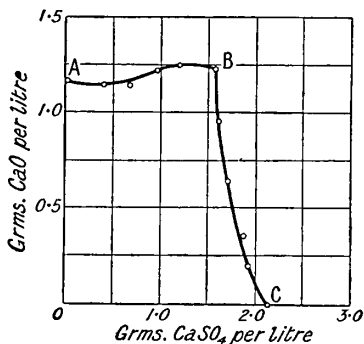

FIG. 45.—Mutual Solubility of Calcium Oxide and Sulphate in Water at 25°.

to $\text{BaSO}_4 \cdot \text{CaF}_2$, but there is nothing to show that a compound is formed. J. Smithson analyzed a Derbyshire mineral of sp. gr. 3.75 containing 51.5 per cent. BaSO_4 , and 48.5 per cent. calcium fluoride; it was therefore called *fluoro-heavy spar*. P. A. Dufrenoy analyzed the rhombohedral crystals of a mineral called *dreelite*, sp. gr. 3.3, and hardness exceeding that of calcspar. It contained 61.73 per cent. of BaSO_4 and 14.27 per cent. of CaSO_4 ; or $\text{BaSO}_4 : \text{CaSO}_4 = 5.2$, as well as some silica, alumina, calcium carbonate, and water.

Uses of gypsum, celestine, and barytes.—Alabaster and mammillated gypsum are used as ornamental stones. Gypsum is used in the preparation of plaster of Paris—which is often sold under various special trade names, for wall plaster, etc.—and of various cements—Keene's cement, Martin's cement, parian cement, etc. Finely-ground gypsum is sold as *mineral white*, or *terra alba*, and is used as filling for paper; in finishing cotton goods; in adulterating paints and various other substances in manufacturing crayons; etc. Gypsum is used by some breweries for hardening the water—*brewer's gypsum*—on the assumption that hard water gives better results—due, it is said, to the greater solvent action of such water on the albuminous matters in the malt. Gypsum is used in making some polishing powders; as a fertilizer for restoring sulphates to certain soils—*e.g.* the hop districts of Kent and Sussex. It is also used as a retarder for the setting of Portland cement. Strontianite and celestine are the main sources of strontium compounds which are mainly used in pyrotechny, and in the beet-sugar industry. The uses of barytes are mainly dependent on the fact that it is a heavy white mineral, cheap, and chemically inert. Precipitated barium sulphate is the *blanc fixe*, and *permanent white* of commerce. The finest qualities are finely ground and used in the preparation of white paints; it is also used as an adulterant for white-lead in paint. Ground barytes—it may be water-floated, or air-elutriated—is admixed with white-lead and zinc oxide, and used in place of white-lead for making paint. The powdered barytes is also tinted with dyes and likewise used as a pigment—*e.g.* the para-red paints have 90 per cent. of barium sulphate.¹⁵ Barytes is used in filling wall papers, glazed paper, rubber goods, linoleum, oil-cloth, flannel, shoddy cloth, etc. It has several minor uses—*e.g.* it is employed as a fluxing agent in certain operations. Barytes, and witherite are the main sources of the barium compounds.

REFERENCES.

¹ J. H. van't Hoff and F. Weigert, *Sitzber. Akad. Berlin*, 1140, 1901; H. Vater, *ib.*, 269, 1900; H. Rubens, *Zeit. Physik*, 1, 11, 1920; W. Grahmann, *Neues Jahrb. Min.*, i, 1, 1920; A. Lacroix, *Compt. Rend.*, 108, 1126, 1889; 126, 360, 1898; *Bull. Soc. Min.*, 12, 515, 1889; F. Mylius and J. von Wrochem, *Ber.*, 33, 3692, 1900; O. Maschke, *Zeit. Kryst.*, 33, 57, 1900; J. F. W. Johnston, *Phil. Mag.*, (3), 13, 325, 1838; W. A. Davis, *Journ. Soc. Chem. Ind.*, 26, 727, 1907; R. Grengg, *Zeit. anorg. Chem.*, 90, 327, 1914; F. Rinne, *Ber. Sächs. Ges. Wiss.*, 67, 303, 1915; E. Hjalmar, *Zeit. Phys.*, 1, 439, 1920; H. Gaudefroy, *Compt. Rend.*, 159, 263, 1914; F. Rinne and M. Kemter, *Sitzber. Akad. Leipzig*, 92, 56, 1920; H. Haga and F. M. Jaeger, *Versl. Akad. Amsterdam*, 24, 443, 460, 1135, 1403, 1410, 1412, 1916.

² C. J. B. Karsten, *Schweigger's Journ.*, 65, 394, 1832; A. Breithaupt, *ib.*, 68, 291, 1833; F. E. Neumann, *Pogg. Ann.*, 23, 1, 1831; G. Rose, *ib.*, 23, 1, 1831; A. Schrauf, *ib.*, 117, 650, 1872; H. G. F. Schröder, *ib.*, 106, 226, 1859; *Pogg. Ann. Ergbd.*, 6, 622, 1874; *Dichtigkeitsmessungen*, Heidelberg, 1873; N. S. Manross, *Liebig's Ann.*, 82, 353, 1852; O. Ruff and W. Plato, *Ber.*, 36, 2357, 1903; E. Madelung and R. Fuchs, *Ann. Physik*, (4), 289, 1921; J. F. W. Johnston, *Phil. Mag.*, (2), 13, 325, 1838; E. Wiedemann, *ib.*, (5), 15, 371, 1883; A. le Royer and J. B. A. Dumas, *Journ. Pharm. Chim.*, 92, 408, 1821; G. A. Hulct and L. E. Allen, *Journ. Amer. Chem. Soc.*, 24, 667, 1902; A. Gorgeu, *Ann. Chim. Phys.*, (6), 515, 1885; E. Filhol, *ib.*, (3), 21, 415, 1847; A. Kennigott, *Sitzber. Akad. Wien*, 9, 557, 1852; P. Schweitzer, *Proc. Amer. Assoc.*, 26, 201, 1877; F. K. Cameron, *Journ. Phys. Chem.*, 5, 556, 1902; F. Stolba, *Journ. prakt. Chem.*, (1), 97, 503, 1866; A. Moye, *Chem. Ztg.*, 30, 544, 1906; O. Pettersson, *Nova Acta Upsala*, (3), 9, 1, 1873; (3), 10, 1, 1876; C. W. C. Fuchs, *Berg. Hütt. Ztg.*, 21, 198, 1862; F. S. Beudant, *Travail élémentaire de mineralogie*, Paris, 441, 1824; W. Grüner, *Gilbert's Ann.*, 60, 72, 1819; H. Struve, *Zeit. Chem.*, (2), 5, 324, 1869; J. F. McCalcb, *Amer. Chem. Journ.*, 11, 35, 1889; A. Lacroix, *Compt. Rend.*, 108, 1126, 1889; A. de Schulten, *ib.*, 136, 1444, 1903; Earl of Berkeley, *Journ. Chem. Soc.*, 91, 56, 1889; F. W. Clarke, *Amer. Journ. Science*, (3), 14, 281, 1877; T. E. Thorpe and A. G. Francis, *Proc. Roy. Soc.*, 83, A, 277, 1910.

³ P. von Bjerken, *Wied. Ann.*, 43, 817, 1891; P. Drude and W. Voigt, *ib.*, 42, 537, 1891; W. Voigt, *ib.*, 34, 981, 1888; L. A. Coromilas, *Ueber die Elastizitäts-Verhältnisse im Gyps und Glimmer*, Tübingen, 1877; A. Johnsen, *Centr. Min.*, 233, 1918; E. Madelung and R. Fuchs, *Ann. Physik*, (4), 65, 289, 1921.

⁴ E. Mitscherlich, *Journ. prakt. Chem.*, (1), 83, 485, 1861; J. B. J. D. Boussingault, *Ann. Chim. Phys.*, (4), 12, 419, 1867; R. Bunsen, *Liebig's Ann.*, 111, 456, 1859; F. Schott, *Dingler's Journ.*, 202, 355, 1872; K. Zulkowsky, *Tonind. Ztg.*, 23, 1250, 1899; F. Jeremin, *Journ. Russ. Phys. Chem. Soc.*, 13, 244, 1881; *Ber.*, 14, 1704, 1881; G. Calcagni and G. Mancini, *Atti Accad. Lincei*, (5), 19, 422, 1910; M. Darmstadt, *Zeit. anal. Chem.*, 6, 376, 1867; F. O. Doeltz and W. Mostowitsch, *Zeit. anorg. Chem.*, 54, 146, 1907; W. Grahmann, *ib.*, 81, 257, 1913; H. Müller, *Neues Jahrb. Min. B.B.*, 30, 1, 1910; W. Vernadsky, *On polymorphism as a general property of matter*, Moscow, 1891; O. Ruff and W. Plato, *Ber.*, 36, 2357, 1903; R. Hare, *Tilloch's Phil. Mag.*, 14, 238, 298, 1802; *Trans. Amer. Phil. Soc.*, 6, 99, 1804; E. Jänecke, *Kali*, 10, 371, 1916; 11, 10, 21, 1917; *Zeit. phys. Chem.*, 96, 265, 1915; J. L. Gay Lussac, *Journ. Mines*, 22, 325, 1807; *Nicholson's Journ.*, 33, 44, 1812; N. T. de Saussure, *Bull. Soc. Philom.*, 1, 102, 1807; *Ann. Chim. Phys.*, (1), 65, 189, 1808; *Brugnatelli's Giorn.*, 1, 198, 1808.

⁵ P. N. Laschtschenko, *Compt. Rend.*, 147, 58, 1909; *Journ. Russ. Phys. Chem. Soc.*, 42, 1602, 1910; R. Weber, *Arch. Sciences Genève*, (3), 35, 590, 1895; H. Hecht, *Ann. Physik*, (4), 14, 1008, 1904; K. E. Guthe, *ib.*, (4), 21, 913, 1906; G. Linder, *Die Abhängigkeit der spezifischen Wärme fester Körper von der Temperatur*, Erlangen, 1903; H. V. Regnaud, *Ann. Chim. Phys.*, (3), 1, 129, 1841; H. Kopp, *Liebig's Ann. Suppl.*, 3, 289, 1865; *Phil. Trans.*, 155, 71, 1865.

⁶ M. Berthelot, *Ann. Bur. Longitudes*, 395, 1877; *Ann. Chim. Phys.*, (5), 9, 43, 1876; J. Thomsen, *Journ. prakt. Chem.*, (2), 16, 97, 1877; A. Potilitzin, *Journ. Russ. Phys. Chem. Soc.*, 25, 201, 1893; R. de Forcrand, *Bull. Soc. Chim.*, (3), 35, 781, 1150, 1806; A. C. Melcher, *Journ. Amer. Chem. Soc.*, 32, 50, 1910.

⁷ A. Mühlheims, *Zeit. Kryst.*, 14, 202, 1888; C. Viola, *ib.*, 32, 120, 1899; K. Feussner, *Ueber eine neue Methode der Brechungsexponentbestimmung mittelst Totalreflexion*, Marburg, 1882; *Zeit. Kryst.*, 7, 506, 1883; A. Arzruni, *ib.*, 1, 165, 1877; G. H. Williams, *ib.*, 13, 1, 1891; K. Zimanyi, *ib.*, 22, 321, 1894; J. Danker, *Neues Jahrb. Min. B.B.*, 4, 290, 1886; E. H. Kraus and L. J. Young, *Neues Jahrb. Min.*, i, 123, 1912; V. von Lang, *Sitzber. Akad. Wien*, 76, 793, 1877; C. Klein, *Sitzber. Akad. Berlin*, 361, 1899; J. C. Heussner, *Pogg. Ann.*, 87, 462, 1852; 91, 517, 1854; H. Dufet, *Bull. Soc. Min.*, 11, 125, 1888; A. E. H. Tutton, *Proc. Roy. Soc.*, 81, A, 40, 1908; C. Pulfrich, *Wied. Ann.*, 30, 496, 1887; F. Kohlrausch, *ib.*, 4, 28, 1878; A. J. Angstrom, *Pogg. Ann.*, 86, 211, 1852; A. des Cloizeaux, *Manuel de minéralogie*, Paris, 1862; E. Artini, *Rend. Ist. Lombardo*, (2), 26, 329, 1893; A. Matthiessen, *Zeit. Math. Phys.*, 23, 190, 1878; G. Quincke, *Festsch. Nat. Ges. Halle*, 321, 1879; M. Grunenberg, *Uebersicht über die Geschichte des Coelestins und Beiträge zur Kenntniss seiner physikalischen Eigenschaften*, Breslau, 1892; A. E. H. Tutton and A. Hutchinson, *Min. Mag.*, 16, 257, 1912; A. Offret, *Bull. Soc. Min.*, 13, 405, 1890.

⁸ E. Mitscherlich, *Pogg. Ann.*, 8, 519, 1826; F. E. Neumann, *ib.*, 35, 81, 1835; A. des Cloizeaux, *Ann. Mines*, (5), 11, 261, 1857; (5), 14, 339, 1858; *Pogg. Ann.*, 129, 349, 1866; E. H. Kraus and L. J. Youngs, *Neues Jahrb. Min.*, i, 123, 1912; H. Dufet, *Bull. Soc. Min.*, 4, 113, 191, 1881; A. E. H. Tutton, *Proc. Roy. Soc.*, 81, A, 40, 1908; *Zeit. Kryst.*, 46, 135, 1909; *Crystal Structure and Chemical Constitution*, London, 170, 1910; A. E. H. Tutton and A. Hutchinson, *Min. Mag.*, 16, 257, 1912; R. Brauns, *Centr. Min.*, 401, 1911; E. Goens, *Zeit. Physik*, 6, 12, 1921.

⁹ W. W. Coblentz, *Bull. Bur. Standards*, 2, 457, 1907; 4, 392, 1907; *Investigations of Infra-red Spectra*, Washington, 1905-8; *Scient. Papers Bur. Standards*, 418, 1921; T. Liebisch and H. Rubens, *Sitzber. Akad. Wien*, 128, 876, 1919; E. T. Allen and J. K. Clement, *Amer. Journ. Science*, (4), 26, 101, 1908; W. H. Julius, *Verh. Akad. Amsterdam*, (1), 1, 1, 1892; J. Königsberger, *Wied. Ann.*, 61, 703, 1897.

¹⁰ P. Bary, *Compt. Rend.*, 130, 776, 1900; E. Wiedemann, *Zeit. Electrochem.*, 2, 155, 159, 1896; H. Jackson, *Journ. Chem. Soc.*, 65, 734, 1894; P. Schuknecht, *Ann. Physik*, (4), 17, 1717, 1905; E. Newbery and H. Lupton, *Mem. Manchester Lit. Phil. Soc.*, 62, 10, 1918.

¹¹ A. C. MacGregory, *Wied. Ann.*, 51, 132, 1894; F. Kohlrausch and F. Rose, *ib.*, 50, 127, 1893; F. Kohlrausch, *Zeit. phys. Chem.*, 44, 197, 1903; G. A. Hullett, *ib.*, 42, 577, 1903; W. Böttger, *ib.*, 46, 521, 1903; A. F. Hollemann, *ib.*, 12, 125, 1893; J. Kendall, *Phil. Mag.*, (6), 23, 958, 1912; B. D. Steele and R. B. Denison, *Journ. Chem. Soc.*, 81, 456, 1902; G. A. Hullett and L. E. Allen, *Journ. Amer. Chem. Soc.*, 24, 667, 1902; A. C. Melcher, *ib.*, 32, 50, 1908; J. F. Daniell and W. A. Miller, *Phil. Trans.*, 134, 1, 1844; P. Walden, *Zeit. anorg. Chem.*, 29, 371, 1907; K. Prizbram and E. Kara-Michailova, *Zeit. Physik*, 2, 297, 1920; J. A. Muller, *Bull. Soc. Chim.*, 23, 13, 1918; G. N. Lewis and M. Randall, *Journ. Amer. Chem. Soc.*, 43, 1112, 1921; J. Königsberger and K. Schilling, *Ann. Physik*, (4), 32, 179, 1910.

¹² R. Fellinger, *Ann. Physik*, (4), 7, 333, 1902; W. Schmidt, *ib.*, (4), 9, 919, 1902; (4), 11, 114, 1903; S. Meyer, *ib.*, (4), 1, 664, 668, 1900; *Wied. Ann.*, 68, 324, 1899; 69, 236, 1899; M. von Pirani, *Ueber Dielectricitätsconstanten fester Körper*, Berlin, 1903; H. Starke, *Wied. Ann.*, 60, 629, 1897; J. Curie, *Ann. Chim. Phys.*, (6), 17, 385, 1889; C. B. Thwing, *Zeit. phys. Chem.*, 14, 286, 1894; P. Pascal, *Compt. Rend.*, 173, 144, 1921.

¹³ H. Feigel, *Verhalten von Schwermetallverbindungen gegen Polysulfide und Chlorschwefel*, Erlangen, 36, 1905; A. B. Prescott, *Chem. News*, 36, 179, 1877; P. Chroustchoff, *Compt. Rend.*, 104, 1711, 1887; P. Chroustchoff and A. Martinoff, *ib.*, 104, 571, 1887; W. Ostwald, *Zeit. phys.*

Chem., 1. 419, 1887; E. H. Riesenfeld, *Journ. prakt. Chem.*, (2), 100. 115, 1920; M. Carl-Mantrand, *Compt. Rend.*, 38. 864, 1854; E. Berger, *ib.*, 170. 1492, 1920; H. Quantin, *ib.*, 106. 1074, 1888; C. Matignon and F. Bourion, *ib.*, 138. 760, 1904; E. Jacquemin, *ib.*, 46. 1164, 1858; J. B. J. D. Bousingault, *ib.*, 78. 593, 1874; C. Hensgen, *Ber.*, 9. 1671, 1876; A. Violi, *ib.*, 10. 293, 1877; F. Sestini, *ib.*, 7. 1295, 1874; F. le Play and A. Laurent, *Ann. Chim. Phys.*, (2), 65. 403, 1837; C. S. Bradley and C. B. Jacobs, *Brit. Pat. Nos.* 26059, 26060, 1898; B. Unger, *Liebig's Ann.*, 67. 65, 1848; O. Schumann, *ib.*, 187. 286, 1877; A. d'Heurèuse, *Pogg. Ann.*, 75. 277, 1847; H. Rose, *ib.*, 74. 569, 1847; G. Moretti, *Schweigger's Journ.*, 9. 169, 1813; E. H. Jenkins, *Journ. prakt. Chem.*, (2), 13. 239, 1876; R. Fresenius, *Zeit. anal. Chem.*, 6. 92, 1867; L. Marino, *Garz. Chim. Ital.*, 43. i, 416, 1913; L. Marino and D. Danesi, *ib.*, 43. i, 423, 434, 1913; R. A. Tilghmann, *Dingler's Journ.*, 106. 196, 1847; F. Knapp, *ib.*, 202. 513, 1872; O. Siemens, *ib.*, 169. 207, 1863; H. L. Buff, *ib.*, 172. 282, 1864; C. Stammer, *Pogg. Ann.*, 82. 135, 1823; L. Pissarjewsky and A. Levites, *Journ. Russ. Phys. Chem. Soc.*, 40. 611, 1908; G. Hulett and L. H. Duschak, *Zeit. anorg. Chem.*, 40. 196, 1904; E. Ebler and K. Herdragen, *Ber.*, 46. 2264, 1913; B. Neumann and W. Gellendien, *Zeit. angew. Chem.*, 34. 441, 445, 1921; B. Neumann and G. Kotyga, *ib.*, 34. 457, 1921; E. Kunheim, *Ueber die Einwirkung des Lichtbogens auf Gemische von Sulfaten mit Kohle*, Berlin, 1900; F. K. Cameron and S. M. Bell, *Journ. Phys. Chem.*, 10. 210, 1906; *Calcium Sulphate in Aqueous Solutions*, Washington, 1906.

¹⁴ A. S. Marggraf, *Mém. Acad. Berlin*, 56, 1749; 144, 1750; M. H. Klaproth, *Beiträge zur chemischen Kenntnis der Mineralkörper*, Berlin, 2. 70, 73, 1797; P. L. Dulong, *Ann. Chim. Phys.*, (1), 82. 273, 1812; J. J. Ebelman, *ib.*, (3), 30. 324, 1850; F. J. Malaguti, *ib.*, (3), 37. 198, 1853; (3), 51. 328, 1857; P. Berthier, *ib.*, (2), 38. 246, 1828; P. A. Dufrénoy, *ib.*, (2), 60. 102, 1835; M. Berthelot and L. Ilosvay de N. Ilosva, *ib.*, (5), 29. 295, 1883; *Compt. Rend.*, 94. 482, 1487, 1551, 1882; P. Chrustschoff and A. Martinoff, *ib.*, 104. 571, 1887; *Ann. Chim. Phys.*, (6), 11. 234, 1887; H. Rose, *Pogg. Ann.*, 94. 481, 1855; 95. 96, 284, 426, 1855; W. Ostwald, *Journ. prakt. Chem.*, (2), 25. 1, 1882; J. W. Gunning, *ib.*, (1), 67. 10, 1856; A. Levoll, *ib.*, (1), 36. 28, 1845; T. Scheerer and E. Drechsel, *ib.*, (2), 7. 69, 1873; W. Meyerhoffer, *Zeit. phys. Chem.*, 38. 307, 1901; 53. 603, 1905; H. Grüneberg, *Ber.*, 11. 1701, 1878; A. Vogel and C. Reischauer, *Neues Jahrb. Pharm.*, 9. 72, 1858; F. Meyer, *ib.*, 10. 315, 1858; H. Reinsch, *ib.*, 34. 11, 1870; W. O. de Coninck and L. Arzalier, *Bull. Acad. Belg.*, 713, 800, 1907; 577, 1908; E. Ramann and H. Sallinger, *Zeit. phys. Chem.*, 98. 103, 1921; O. L. Erdmann, *Journ. techn. Chem.*, 14. 461, 1832; R. Phillips, *Journ. Science Arts*, 1. 80, 1816; *Schweigger's Journ.*, 25. 290, 1819; J. F. John, *ib.*, 14. 412, 1815; J. Smithson, *ib.*, 31. 362, 1821; L. W. Köhlreuter, *Mag. Pharm.*, 8. 181, 1824; A. Gossmann, *Repert. Pharm.*, 61. 49, 1837; R. von Wagner, *Regesten der Sodafabrikation*, Leipzig, 46, 1866; G. Lunge, *Dingler's Journ.*, 207. 137, 1873; H. L. Buff, *ib.*, 172. 282, 1864; W. Herz, *Zeit. anorg. Chem.*, 68. 69, 1910; 71. 206, 1911; C. J. B. Karsten, *Lehrbuch der Salinenkunde*, Berlin, 1847; *Philosophie der Chemie*, Berlin, 1843; J. B. Trommsdorff, *Neues Journ. Pharm.*, 18. 1, 234, 1829; F. B. Guthrie, *Journ. Chem. Soc.*, 47. 94, 1885; W. Spring, *Bull. Acad. Belgique*, (3), 10. 204, 1885; *Bull. Soc. Chim.*, (2), 44. 166, 1885; (2), 46. 299, 1886; A. Mikolajczak, *Ueber die Einwirkung der schwefelsauren Alkalien auf kohlen-sauren Baryt und kohlen-saure Strontian*, Breslau, 1874; J. Treumann, *De alkalinarum terrarum quibusdam salium decompositionibus adumbratis Bergmannis et Bertholletii de affinitate doctrines*, Breslau, 1864; C. M. Goldberg and P. Waage, *Ostwald's Klassiker*, 104, 1899; F. Kuhlmann, *Liebig's Ann.*, 27. 22, 1838; J. J. Berzelius, *Pogg. Ann.*, 1. 18, 1824.

¹⁵ S. J. Cook, *Canadian Chem. Journ.*, 3. 147, 1919.

§ 20. The Complex Sulphates of the Alkalies and Alkaline Earths

According to H. Müller,¹ mixtures of calcium sulphate and lithium sulphate form neither double salts nor mixed crystals; the f.p. curve is of simple V-type descending from the m.p. of α -lithium sulphate at 874° to the eutectic at 700° with about 18 mol per cent. of calcium sulphate, and rising to near 1350° the extrapolated m.p. of calcium sulphate. The cooling solid undergoes a transformation corresponding with the change to β -lithium sulphate at 572° .

P. Berthier melted together equi-molar proportions of sodium and calcium sulphates and obtained a mass with a fracture like chalcodony. H. Müller obtained evidence of the double salt **sodium calcium pentasulphate**, $\text{CaSO}_4 \cdot 4\text{Na}_2\text{SO}_4$, on the f.p. curve of mixtures of the component salts, but he could not obtain glauberite, $\text{CaSO}_4 \cdot \text{Na}_2\text{SO}_4$, by fusing equi-molar proportions of the two salts, because, on cooling, the product dissociates into anhydrite and a eutectic of anhydrite and $\text{CaSO}_4 \cdot 4\text{Na}_2\text{SO}_4$. The last-named salt is completely miscible with sodium sulphate, and exists in one doubly refracting variety only—sodium sulphate alone has a transition temp. at 233° , and G. Calcagni and G. Mancini found that no polymorphic change is observed

with mixtures containing over 7 per cent. of calcium sulphate. The last named also measured the f.p. curve of binary mixtures of sodium and calcium sulphates, and found that the curve rises from 887° , the f.p. of sodium sulphate to the maximum 949° , Fig. 46, corresponding with **sodium calcium tetrasulphate**, $\text{CaSO}_4 \cdot 3\text{Na}_2\text{SO}_4$, or $\text{Na}_6\text{Ca}(\text{SO}_4)_4$, the calcium analogue of vanthoffite, $\text{MgSO}_4 \cdot 3\text{Na}_2\text{SO}_4$. The eutectic point is at 917° and 51 per cent. of sodium sulphate corresponding with the composition of glauberite. Other double salts may exist at lower temp. Two liquid layers occur with mixtures containing 73.0–82.6 per cent. of sodium sulphate. G. Calcagni also studied the f.p. curves of the binary systems, $\text{SrSO}_4\text{—Na}_2\text{SO}_4$, and $\text{BaSO}_4\text{—Na}_2\text{SO}_4$. He found a maximum on the m.p. curve of strontium and sodium sulphates corresponding with the formation of **sodium strontium tetrasulphate**, $3\text{Na}_2\text{SO}_4 \cdot \text{SrSO}_4$, the strontium analogue of vanthoffite. The addition of barium sulphate to sodium sulphate raises the m.p. of the latter from 887° to 921° for an addition of 21.6 molar per cent. Further proportions of barium sulphate cause very gradual lowering of the f.p. to 913° for a mixture containing 29 molar per cent. BaSO_4 . From this point the curve rises continuously to the m.p. of barium sulphate, which extrapolation gives as 1345° . The very flat and scarcely appreciable maximum shown by the curve would correspond with **sodium barium heptasulphate**, $\text{BaSO}_4 \cdot 6\text{Na}_2\text{SO}_4$, but double sulphates of this type are apparently unknown. Between 71 and 100 per cent. Na_2SO_4 , the curve shows a point corresponding with the initial crystallization, a second with the temp. of decomposition of the solid soln., and a third with the temp. of transformation of sodium sulphate. The following regions are distinguished: (1) existence of the homogeneous liquid phase; (2) equilibrium between BaSO_4 and liquid phase; (3) existence of solid soln.; (4) equilibrium between solid soln., (3) and $\alpha\text{-Na}_2\text{SO}_4\text{—BaSO}_4$; (5) existence of $\beta\text{-Na}_2\text{SO}_4\text{—BaSO}_4$; (6) equilibrium between solid soln. (3) and $\beta\text{-Na}_2\text{SO}_4\text{—BaSO}_4$.

The solubility of calcium sulphate is augmented in the presence of sodium sulphate, as was observed by J. H. Droeze, O. Henry, F. K. Cameron and A. Siedell, etc. Expressing the amounts of salt in grams per litre, F. K. Cameron and J. F. Breazeale found, at 15° :

Na_2SO_4	• 2.390	9.535	14.132	24.369	46.150	94.220	146.612	257.100
CaSO_4	• 1.650	1.457	1.388	1.471	1.650	1.980	2.234	2.650

They also measured the sp. gr. of the soln. The results show that with increasing conc. of the more soluble salt, therefore, there is at first a decrease in the solubility of the calcium salt in accord with the rule for salts with a common ion, and there is then an increase which can be explained by the assumption that there are formed complexes between the solvent and one or more of the solutes, between the two solutes, or a change in the density of the solvent. P. N. Evans inferred that a double salt is formed in soln. because the calcium sulphate cannot be separated from the sat. soln. by salting with sodium sulphate. A. Ditte was unable to isolate a double compound by allowing the mixed soln. to stand for some months.

The salt **sodium calcium disulphate**, $\text{Na}_2\text{SO}_4 \cdot \text{CaSO}_4$, or $\text{Ca}(\text{NaSO}_4)_2$, occurs in nature as *glauberite*. J. Fritzsche described a dihydrated form, $\text{Ca}(\text{NaSO}_4)_2 \cdot 2\text{H}_2\text{O}$, which he prepared by heating gypsum with a small amount of water, and a large excess of Glauber's salts; it was also obtained in fine needle-like crystals at ordinary temp. by adding gypsum to a soln. of one part of sulphuric acid with two of a sat. soln. of sodium sulphate. At 80° , fine prismatic needles of dihydrated **sodium calcium trisulphate**, $2\text{Na}_2\text{SO}_4 \cdot \text{CaSO}_4 \cdot 2\text{H}_2\text{O}$, are formed, which are readily decomposed

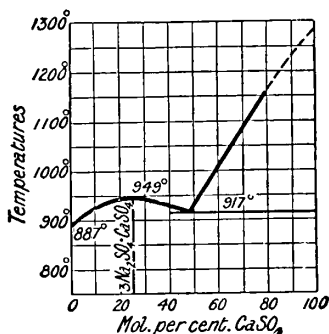

FIG. 46.—Fusion Curve of Calcium and Sodium Sulphates.

by water; but if the mixture be warmed still further fine needles of glauberite appear. The double salt is not obtained by evaporating spontaneously at room temp. a soln. of sodium sulphate sat. with calcium sulphate. The dihydrate loses water when heated and forms the anhydrous double salt. J. B. Hannay, and C. W. Folkard studied the anhydrous double salt. J. H. van't Hoff and D. Chiaraviglio have shown that gypsum and decahydrated sodium sulphate will form glauberite at 25° if the soln. be sat. with both these salts and with sodium chloride as well. Glauberite and gypsum exist together as solid phases only when decahydrated sodium sulphate is not also present. The double salt is not stable in the presence of water alone, and it breaks down into the simple salts, gypsum and Glauber's salt. J. H. van't Hoff showed that the temp. of formation of glauberite is 29° when other salts are absent, but is 14·8° in the presence of sodium chloride; 13° in the presence of sodium chloride and glaserite, or sodium syngenite; 12° in the presence of sodium chloride and astracanite; and 10·4° in the presence of sodium chloride, astracanite, and glaserite, or sodium syngenite. The prismatic crystals of glauberite belong to the monoclinic system, and, according to P. Groth, they have axial ratios $a : b : c = 1.2209 : 1 : 1.0270$, and $\beta = 112^\circ 10\frac{1}{2}'$; they have a sp. gr. 2·64–2·85, and a hardness of 2·5 to 3. According to J. Fritzsche, the crystals dissolve gradually in water, with the separation of gypsum; while J. H. van't Hoff and D. Chiaraviglio found that with a small proportion of water, crystals of Glauber's salts and of gypsum can be detected microscopically in the residue. A soln. of 54 mols of Na_2Cl_2 and 3 mols of Na_2SO_4 in 1000 mols of water does not decompose glauberite. C. W. Folkard said the crystals are insoluble in alcohol, and in a conc. soln. of sodium acetate. J. Fritzsche observed that when heated the crystals lose their transparency, and give up sodium sulphate to water, leaving behind calcium sulphate. J. d'Ans reported the preparation of small doubly refracting needle-like crystals of an acid salt, $n\text{Na}_6\text{Ca}_3(\text{SO}_4)_6 \cdot 5\text{H}_2\text{O} \cdot \text{Na}_3\text{H}(\text{SO}_4)_2 \cdot \text{H}_2\text{O}$, where n ranges from 1·6 to 3. F. K. Cameron, J. M. Bell, and W. O. Robinson have studied the four component system, Na_2SO_4 — CaSO_4 — NaCl — H_2O . M. Enderli found that when soln. of sodium and calcium sulphates and a base, or soln. of sodium sulphate and calcium hydroxide, are heated, preferably under press., at a temp. over 100°, the precipitated **sodium tricalcium dihydroxytetrasulphate**, $\text{Na}_4\text{Ca}_3(\text{SO}_4)_4(\text{OH})_2$, is useful as a substitute for caustic alkali in treating straw and wood cellulose; in the preparation of bleaching liquors, formates, lacquers and varnishes; for liming hides, etc. There is nothing to show that the product is a chemical individual.

In 1826, H. Braconnot found a mixture of potassium and calcium sulphate melted more easily than either alone. H. Müller has studied the f.p. curves of mixtures of potassium and calcium sulphates, and his results are illustrated by Fig. 47, a double salt, **potassium dicalcium trisulphate**, $\text{K}_2\text{SO}_4 \cdot 2\text{CaSO}_4$, or $\text{Ca}_2\text{K}_2(\text{SO}_4)_3$, melting at 1004°, is formed, and like potassium sulphate itself, the complex salt shows enantiotropic dimorphism with a transition temp. at 936°. W. Grahmann's curve is rather different from H. Müller's, since he finds that α -potassium sulphate retains up to 18 molar per cent. of calcium sulphate in solid soln. at high temp., but the solubility diminishes with falling temp., and disappears at the transition temp. The compound $\text{K}_2\text{SO}_4 \cdot 2\text{CaSO}_4$ decomposes it into β -calcium sulphate and liquid at 1004°; and undergoes a polymorphic change at 938°. There are thus three breaks in the descending branch of the f.p. curve. W. Grahmann found that potassium and strontium sulphates give a similar diagram. The limits of the solid soln. at the eutectic temp. are 0–22 molar per cent. of SrSO_4 , and **potassium strontium trisulphate**, $\text{K}_2\text{SO}_4 \cdot 2\text{SrSO}_4$, is resolved into liquid and β - SrSO_4 at 980°, and undergoes a transformation at 775°. G. Calcagni found a maximum in the f.p. curve of mixtures of potassium and strontium sulphates corresponding with 90 molar per cent. of K_2SO_4 , and a marked thermal change in the solid state corresponds with the formation of **potassium strontium disulphate**, $\text{K}_2\text{SO}_4 \cdot \text{SrSO}_4$. W. Grahmann found no evidence of a compound with the system BaSO_4 — K_2SO_4 . The first branch

of the f.p. curve, representing the solidification of solid soln., passes through a maximum at 1087° . The limit of saturation is 24 molar per cent. of BaSO_4 , and the β -modification does not form solid soln. According to G. Calcagni, the addition of barium sulphate to potassium sulphate raises the m.p. to a maximum of 1080°

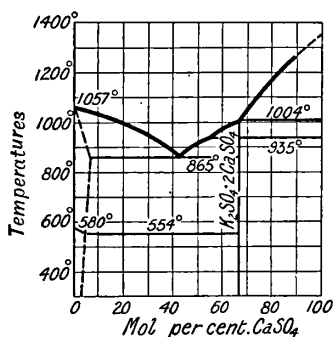

FIG. 47.—Fusion Curve of Calcium and Potassium Sulphates.

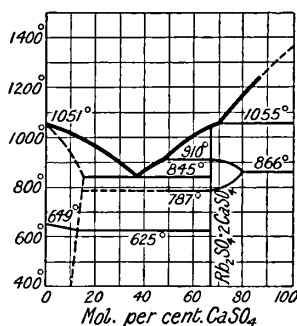

FIG. 48.—Fusion Curve of Calcium and Rubidium Sulphates.

for a concentration of 90 per cent. K_2SO_4 . As this composition would correspond with 14 mols of K_2SO_4 per mol of BaSO_4 , this maximum cannot represent a compound of the two salts. Beyond this concentration of BaSO_4 , the m.p. falls to 1015° for 60 per cent. K_2SO_4 , this being the eutectic temp. Further increase in the concentration of BaSO_4 is accompanied by rise of the temp. to the m.p. of the barium salt. The cooling curves of this system show, in general, three changes of direction; exceptions are that corresponding with 95 per cent. K_2SO_4 , which represents the eutectic of the decomposition curve of the solid soln., and that corresponding with 60 per cent. K_2SO_4 , which is the eutectic mixture of the melting curve. Curves up to 70 per cent. K_2SO_4 exhibit a point corresponding with the crystallization of mixed crystals, another with the decomposition of the solid soln., and a third with transformation of the potassium sulphate. The curves from 60 per cent. K_2SO_4 to BaSO_4 show a temp. of primary separation of barium sulphate, a eutectic temp., and a temp. of transformation of the potassium salt.

J. H. Droeze, and F. K. Cameron and J. F. Breazeale have measured the solubility of calcium sulphate in soln. of potassium sulphate, and, expressing the results in grams per litre, the latter found at 25° :

K_2SO_4	. . . 5.09	9.85	19.57	28.35	30.66	35.19	40.53	96.00
CaSO_4	. . . 1.563	1.446	1.485	1.553	1.587	1.257	0.970	0.257
			K ₂ SO ₄				Syngenite	

There are here two intersecting curves, Fig. 49; the upper one represents the solubility of calcium sulphate in a soln. of potassium sulphate, and the lower curve the solubility of syngenite, $\text{K}_2\text{SO}_4 \cdot \text{CaSO}_4 \cdot \text{H}_2\text{O}$, in soln. of potassium sulphate, for this salt appears in soln. with over 32 grms. of potassium sulphate per litre. The triple point at the intersection of these two curves represents a soln. in equilibrium with both potassium sulphate and syngenite as solid phases.

Four double sulphates of potassium and calcium have been reported: (i) Anhydrous potassium calcium trisulphate, $\text{K}_2\text{SO}_4 \cdot 2\text{CaSO}_4$, prepared by H. Müller, was stated to take up water, forming the hydrate $\text{K}_2\text{SO}_4 \cdot 2\text{CaSO}_4 \cdot \frac{1}{2}\text{H}_2\text{O}$; A. Ditte also described the hydrate $\text{K}_2\text{SO}_4 \cdot 2\text{CaSO}_4 \cdot 3\text{H}_2\text{O}$. The soln. in equilibrium with the double salt and with solid potassium sulphate has nearly the same conc. of the latter salt as the soln. sat. with the double salt and gypsum. Later investigators have not succeeded in preparing this salt from soln. of potassium sulphate. (ii) Hydrated potassium calcium disulphate, $\text{CaSO}_4 \cdot \text{K}_2\text{SO}_4 \cdot \text{H}_2\text{O}$, was identified as

a by-product in the manufacture of tartaric acid by J. A. Phillips about 1850; and soon afterwards it was found to be identical with the double salt associated with sylvine, found by V. von Zepharovich, in the Stassfurt salt deposits of Kalusz, and called by J. Rumpf *kaluszite*; but, on account of its relation with polyhalite, V. von Zepharovich called the salt *syngenite*—

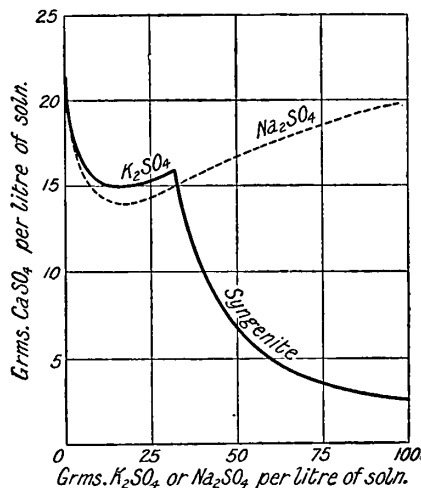

FIG. 49.—Solubility of Calcium Sulphate in Soln. of Potassium and Sodium Sulphates.

of potassium nitrate, chloride, bromide, or iodide on gypsum, although R. Fassbender expressed his doubts whether syngenite can be obtained in this way from soln. of potassium chloride because his product corresponded with $\text{CaSO}_4 \cdot \text{K}_2\text{SO}_4 \cdot 2\text{KCl} \cdot \text{H}_2\text{O}$, which is probably a mixture of syngenite and potassium chloride. H. Precht obtained syngenite by treating finely divided krugite with cold water—magnesium sulphate passes into soln., and a mixture of gypsum and syngenite remains. J. d'Ans and others have prepared syngenite by the interaction of anhydrite or gypsum and a soln. of potassium chloride. A. C. Becquerel prepared syngenite by the action of potassium aluminate on gypsum. According to J. H. van't Hoff and H. A. Wilson, syngenite is best prepared by dissolving 120 grms. of potassium sulphate in 1000 grms. of water, and adding to this 100 c.c. of a 20 per cent. soln. of calcium chloride. At first, gypsum separates out, and this is then converted into syngenite, which appears under the microscope in square-ended, needle-like crystals.

W. H. Miller, and V. von Lang regarded the artificial crystals as rhombic; V. von Zepharovich found the crystals from Kalusz to be monoclinic. J. Rumpf supposed this salt in consequence to be dimorphous, but this is wrong, since both natural and artificial crystals are really monoclinic prisms. V. von Zepharovich gave $a : b : c = 1.3699 : 1 : 0.8738$, and $\beta = 76^\circ$; J. Rumpf, $1.3801 : 1 : 0.8667$, and $\beta = 76^\circ 9'$; and H. Schreiber, $1.352 : 1 : 0.871$, and $\beta = 75^\circ 55'$, and when heated to 200° , the last-named found the axial ratios changed to $a : b : c = 1.359 : 1 : 0.894$, and $\beta = 76^\circ 3'$. J. Rumpf, O. Mügge, and H. Schreiber studied the cleavage and twinning of the crystals; V. von Zepharovich, and H. Schreiber, the corrosion figures with water, sulphuric and hydrochloric acids, and sodium hydroxide; and H. Schreiber, the percussion figures, pressure figures, and the scratch-figures. J. Rumpf gave the sp. gr. as 2.252 at 17.5° ; V. von Zepharovich, 2.603 at 17.5° ; and H. Schreiber, 2.579 at the same temp. The three last named also agree that the hardness is between 2 and 3 on Mohs' scale.

The optical properties of syngenite have been studied by J. Rumpf, V. von Lang, V. von Zepharovich, H. Schreiber, and G. Bartalini. P. Gaubert, O. Mügge, and

from *συγγενής*, having a common origin. A. Ditte reported a tetrahydrated form of this salt, $\text{CaSO}_4 \cdot \text{K}_2\text{SO}_4 \cdot 4\text{H}_2\text{O}$; and (iii) J. H. van't Hoff and A. Geiger first obtained hydrated potassium pentacalcium hexasulphate, $\text{K}_2\text{SO}_4 \cdot 5\text{CaSO}_4 \cdot \text{H}_2\text{O}$, by boiling a precipitated calcium sulphate with a 5 per cent. soln. of potassium sulphate. Well-formed crystals of this salt, resembling gypsum, then appear.

H. Rose, J. B. Hannay, J. Grosjean, prepared the hydrated potassium calcium disulphate, syngenite, by mixing soln. of the component salts. J. B. Emmet noticed the hardening of calcium sulphate in contact with soln. of potassium carbonate or hydrocarbonate, while potassium nitrate and chloride were without action; F. Schott, A. Ditte, and H. Struve obtained similar results with potassium sulphate, and noted that crystals of syngenite were formed. They also obtained syngenite by the action

H. Schreiber measured the indices of refraction and the dispersion of the crystals. Using for red light $\lambda=0\cdot70652\mu$; for yellow, $\lambda=0\cdot58757\mu$; for green, $\lambda=0\cdot50157\mu$; and for blue, $\lambda=0\cdot47131$, H. Schreiber found the results shown in Table X, for the influence of temp. on the refractive indices and dispersion of syngenite.

TABLE X.—EFFECT OF TEMPERATURE ON THE REFRACTIVE INDICES AND DISPERSION OF SYNGENITE.

Crystal axis.	Light.	21°	61°	111°	156°	168°	203°
α	Red . . .	—	1·4971	1·4959	1·4946	1·4942	1·4931
	Yellow . . .	—	1·5004	1·4989	1·4975	1·4972	1·4961
	Green . . .	—	1·5041	1·5028	1·5014	1·5011	1·5000
	Blue . . .	—	1·5060	1·5047	1·5034	1·5031	1·5020
	Dispersion . . .	—	0·0089	0·0088	0·0088	0·0089	0·0089
β	Red . . .	1·5132	1·5125	1·5113	1·5098	1·5095	1·5084
	Yellow . . .	1·5166	1·5159	1·5144	1·5132	1·5127	1·5116
	Green . . .	1·5207	1·5197	1·5184	1·5171	1·5167	1·5156
	Blue . . .	1·5228	1·5218	1·5204	1·5192	1·5188	1·5177
	Dispersion . . .	0·0096	0·0093	0·0091	0·0094	0·0093	0·0093
γ	Red . . .	1·5139	1·5128	1·5113	1·5096	1·5092	1·5079
	Yellow . . .	1·5176	1·5166	1·5148	1·5132	1·5126	1·5112
	Green . . .	1·5217	1·5206	1·5188	1·5171	1·5167	1·5155
	Blue . . .	1·5240	1·5228	1·5210	1·5194	1·5189	1·5176
	Dispersion . . .	0·0101	0·0100	0·0097	0·0098	0·0097	0·0097

H. Struve found that a part of the combined water is expelled at 100°, and all is lost at a higher temp., while at a dull red heat the crystals melt to a liquid which forms a crystalline mass on cooling. H. Rose found the crystals of syngenite are decomposed by water leaving a residue of gypsum and a soln. of the alkali sulphate; and when the crystals, dehydrated at 300°, are treated with water, they swell up to a voluminous mass. V. von Zepharovich said: "When finely powdered syngenite is shaken with distilled water, and quickly filtered, a clear liquid is obtained, which, when warmed, becomes turbid owing to the separation of gypsum. 400 parts of water are needed to dissolve one part of syngenite so that its solubility approaches that of gypsum." The solubility of syngenite in aq. soln. is greater than in water. F. K. Cameron and J. F. Breazeale's solubility curve is shown in Fig. 49. A. Ditte found that a soln. prepared in the cold, becomes turbid when heated to the b.p., and calcium sulphate separates out.

J. A. Philips found the crystals are soluble in dil. hydrochloric acid. Analyses of syngenite were made by H. Rose, F. Schott, F. Ullik, H. Vater, A. Ditte, V. von Zepharovich, and H. Schreiber, and the results agree with the formula, $\text{CaSO}_4\cdot\text{K}_2\text{SO}_4\cdot\text{H}_2\text{O}$.

The equilibrium conditions for aq. soln. of syngenite and potassium pentasulphate have been studied by J. H. van't Hoff and co-workers, and by J. d'Ans. Syngenite is stable in soln. of the proper conc. at all temp. between 0° and 170°, while potassium pentacalcium sulphate was not stable below 31·8°. From 0° to 31·8°, syngenite is the only stable double salt, above 31·8°; either syngenite or potassium pentacalcium sulphate can exist—the latter with soln. of the lower conc. and the former with soln. of higher conc. According to J. H. van't Hoff, G. L. Voerman, and W. C. Blasdale, the vap. press. p of the sat. soln. at 31·8° in presence of syngenite and gypsum is $\log p = \log p_w + 315\cdot7 - 1\cdot0325T^{-1}$, where p_w denotes the vap. press. of water. Hence the compounds can be formed in salt deposits at 25°, since the vap. press. is less than corresponds with the formula. Table XI indicates the conc. of potassium sulphate required to establish equilibrium with syngenite and the pentacalcium salt, at the temp. indicated.

TABLE XI.—EQUILIBRIUM CONCENTRATIONS OF SOLUTIONS OF POTASSIUM SULPHATE FOR THE DIFFERENT SOLID PHASES.

Temp.	Mols K_2SO_4 per 1000 mols of H_2O .	Mols of K_2SO_4 per 1000 grms. of soln.	Solid phases	Mols K_2SO_4 per 1000 mols of H_2O .	Mols of K_2SO_4 per 1000 grms. of soln.	Solid phases.
0°	2.1	0.119	Syngenite, gypsum.	—	—	—
25°	3.22	0.173	Syngenite, gypsum.	—	—	—
31.8°	3.70	0.20	Syngenite, gypsum, pentacalcium salt.	3.70	0.20	Syngenite, gypsum, pentacalcium salt.
40°	4.4	0.23	Syngenite, pentacalcium salt.	3.8	0.203	Syngenite, pentacalcium salt.
60°	6.8	0.35	Syngenite, pentacalcium salt.	2.4	0.130	Syngenite, pentacalcium salt.
83°	6.9	9.50	Syngenite, pentacalcium salt.	1.3	0.070	Syngenite, pentacalcium salt.

The results indicated in Table XI are plotted in Fig. 50, which gives a clear idea of the conditions necessary for the formation and existence of these double salts. The equilibrium conc. of calcium sulphate for solid syngenite and gypsum, at 0° and 25°, are respectively 0.113 and 0.223 gm. $CaSO_4$ per 1000 mols of water or 0.0064 and 0.012 mols of $CaSO_4$ per 1000 grms. of soln. In Table VIII and Fig. 35, it is of course assumed that sufficient time has been allowed for the soln. to attain a state of equilibrium. The presence of the alkali chlorides also modifies the equilibrium diagram. J. H. van't Hoff and H. A. Wilson studied the equilibrium conditions of soln. sat. with sodium chloride as well as with soln. containing potassium chloride and sodium sulphate. They found at 25° :

SOLN. SAT. WITH	MOLS Na_2Cl_2	K_2Cl_2	Na_2SO_4 PER 1000 MOLS H_2O
NaCl	55.5	—	—
NaCl, KCl	44.5	19.5	—
NaCl, KCl, glaserite	44	20	4.5
NaCl, Na_2SO_4 , glaserite	44.5	10.5	14.5
NaCl, Na_2SO_4	51	—	12.5
NaCl, KCl, syngenite, gypsum	46	19.5	—
NaCl, Na_2SO_4 , syngenite, glauiberite.	47	5.5	14
NaCl, syngenite, gypsum, glauiberite.	50	6	4

According to E. Anderson, virtually all the sulphur in the fuel leads to the formation of sulphates, and in leaching ordinary cement-mill flue dust with water, soln. containing calcium and potassium sulphates are formed, and in amounts required for the formation of either or both syngenite and the pentacalcium salt. There may be also formed carbonates and hydroxides as well as smaller quantities of magnesium salts. When potassium in the collected dust is largely present as chloride, and where sodium chloride is formed, reactions like $2(CaSO_4 \cdot 2H_2O) + 2KCl \rightleftharpoons CaCl_2 + K_2SO_4 \cdot CaSO_4 \cdot H_2O + H_2O$ may occur. E. Anderson and R. J. Nestell studied the equilibrium conditions at 100°.

A. Ditte has reported the formation of radiating masses of needle-like crystals of hydrated rubidium calcium disulphate, $Rb_2SO_4 \cdot CaSO_4 \cdot 1\frac{1}{2}H_2O$, or *rubidium-syngenite*, when a mixed soln. of the component salts is allowed to stand in the cold. The salt melts at a red heat and is decomposed by water. The curve, Fig. 36, is considered by J. d'Ans to represent the equilibrium conditions with rubidium and calcium sulphates, and it is to be compared with the corresponding diagram, Fig. 50, for potassium sulphate. Tri-hydrated rubidium dicalcium trisulphate, $Rb_2SO_4 \cdot 2CaSO_4 \cdot 3H_2O$, takes the place of potassium pentacalcium sulphate. With caesium and calcium sulphate, between 0° and 100°, J. d'Ans was able to prepare only one double salt, caesium dicalcium trisulphate, $Cs_2SO_4 \cdot 2CaSO_4$, which is very stable,

the stability increasing with the temp. Attempts to prepare *cæsium-syngenite* and a pentacalcium salt were abortive. The temp. limit of the stability of the alkali dicalcium trisulphates falls as the mol. wt. of the alkali metal decreases. This is illustrated in Table XII.

TABLE XII.—TEMPERATURE OF FORMATION OF THE ALKALI CALCIUM SULPHATES.

	Syngenite.		Dicalcium salt.		Pentacalcium salt.		Mol vol. alkali sulphate.
	Upper.	Lower.	Upper.	Lower.	Upper.	Lower.	
K_2SO_4 . . .	c. 150°	—	—	—	>150°	30°	64·91
$(NH_4)_2SO_4$. . .	c. 85°	—	—	76°	c. 105°	17°	74·04
Rb_2SO_4 . . .	42°	—	—	20°	—	—	73·34
Cs_2SO_4 . . .	—	—	—	—	—	—	84·58

J. d'Ans has investigated the influence of various foreign salts on the equilibrium diagrams of the alkali calcium sulphates. The f.p. curve of mixtures of rubidium and calcium sulphates, Fig. 48, has been determined by H. Müller, and there is evidence of the formation of an enantiotropic trimorphic rubidium dicalcium trisulphate, $Rb_2SO_4 \cdot 2CaSO_4$, melting at 1043°.

The first transition point is 910°–915°, the second at 787°. The double salt, *cæsium dicalcium trisulphate*, $Cs_2SO_4 \cdot 2CaSO_4$, was likewise obtained by H. Müller from the

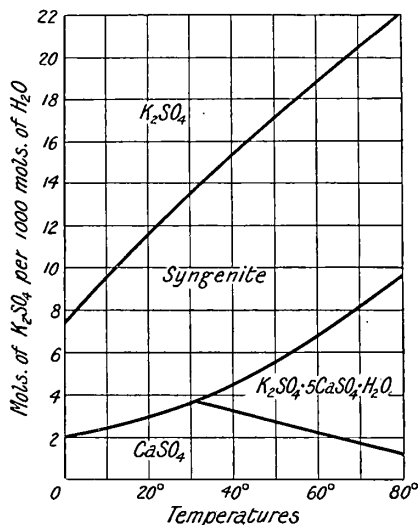

FIG. 50.—Equilibrium Concentration of Potassium Sulphate for the different Solid Phases with Calcium Sulphate.

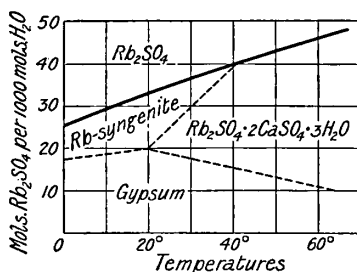

FIG. 51.—Equilibrium Concentration of Rubidium Sulphate for the different Solid Phases with Calcium Sulphate.

fused salt. J. d'Ans prepared a number of triple salts by boiling gypsum or a mixture of gypsum and syngenite with a conc. soln. of the sulphates of copper, cadmium, zinc, or nickel. He thus prepared *copper ammonium calcium tetrasulphate*, $Ca_2Cu(NH_4)_2 \cdot (SO_4)_4 \cdot 2H_2O$; and *copper potassium calcium tetrasulphate*, $Ca_2CuK_2(SO_4)_4 \cdot 2H_2O$.

H. Rose² noticed that a boiling conc. aq. soln. of ammonium sulphate readily dissolves powdered calcium sulphate, and that if an excess of the former salt be employed, a soluble double salt is formed. The solubility of calcium sulphate in soln. of ammonium sulphate has been measured by J. H. Droeze, and by S. Cohn. It was shown that there is a minimum in the solubility curve. E. C. Sullivan found at 25°, calcium sulphate is two-thirds as soluble in a soln. containing 0·1 mol per litre, and twice as soluble in a soln. containing 3 mols per litre as it is in water alone. The sp. conductivity of a conc. soln. of ammonium sulphate is lessened by

saturating it with calcium sulphate. Expressing the results in grams per litre, at 25° :

$(\text{NH}_4)_2\text{SO}_4$. . .	0	0.129	1.033	4.123	8.266	33.065	132.259	264.578
CaSO_4 . . .	2.083	2.043	1.807	1.540	1.440	1.617	3.330	4.500

The sp. gr. of the soln. were also determined. J. M. Bell and W. C. Taber measured the solubility and sp. gr. of the soln. at 50°. There were breaks in the curve at 416 and 564 grms. of $(\text{NH}_4)_2\text{SO}_4$ per litre, and between these conc. the solid phase was dihydrated **ammonium calcium disulphate**, $(\text{NH}_4)_2\text{SO}_4 \cdot \text{CaSO}_4 \cdot 2\text{H}_2\text{O}$. This formula is similar to that obtained by J. Fritzsche for the double sulphate of sodium and calcium. The monohydrated salt, $(\text{NH}_4)_2\text{SO}_4 \cdot \text{CaSO}_4 \cdot \text{H}_2\text{O}$, was reported by O. Popp as a constituent of the salt which separated from the waters of the Tuscany boric acid lagoons. R. Fassbender prepared it by dissolving 285 grms. of ammonium sulphate in 800 c.c. of water, and saturating the soln. with gypsum. After evaporation to 500–600 c.c., the mother liquid was filtered at 40°–50° from the crystals of the salt which is isomorphous with the corresponding potassium salt. A. Ditte obtained the double salt from a conc. soln. after allowing it to stand for some days. J. d'Ans called the salt *ammonium-syngenite*, and showed that it exists at 25° and even at lower temp. J. M. Bell and W. C. Taber showed that if the salt be washed with water, there is a partial decomposition; they believed that J. d'Ans' preparation was partially decomposed and that the formula of the salt is really $(\text{NH}_4)_2\text{SO}_4 \cdot \text{CaSO}_4 \cdot 2\text{H}_2\text{O}$. J. d'Ans also prepared crystals of **ammonium dicalcium trisulphate**, $(\text{NH}_4)_2\text{SO}_4 \cdot 2\text{CaSO}_4$, by boiling a 40 per cent. soln. of ammonium sulphate with gypsum. The mother liquid was filtered, washed rapidly with water, then with 50 per cent. alcohol, and finally with a mixture of alcohol and ether.

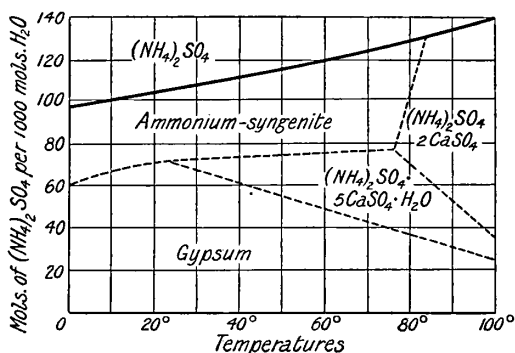

FIG. 52.—Equilibrium Concentration of Ammonium Sulphate for the different Solid Phases with Calcium Sulphate.

vol. of water, saturating the soln. with calcium sulphate and then adding a slight excess of potassium sulphate. The salt is decomposed by conc. soln. of various sodium salts or ammonium chloride.

The mineral *urvölygite* or *herrengrundite* occurs in rhombic crystals of sp. gr. 3.132, and with a composition which, according to A. Schenck's and C. A. Winkler's analyses,³ can be represented by the formula, $\text{CaSO}_4 \cdot 3\text{Cu}(\text{OH})_2 \cdot \text{CuSO}_4 \cdot 3\text{H}_2\text{O}$, and it has accordingly been regarded as a *basic calcium cupric disulphate*, although there is nothing to show that it is a chemical individual. S. U. Pickering,⁴ in his study of Bordeaux mixture, treated soln. of cupric sulphate with lime-water, and obtained precipitates containing various proportions of calcium hydroxide and sulphate, and cupric hydroxide and sulphate; and precipitates also containing sodium sulphate by precipitating cupric sulphate with lime-water in the presence of an excess of sodium sulphate. Here again there is no evidence which would justify S. U. Pickering's products being regarded as chemical individuals. J. d'Ans obtained small

The salt is not very stable, and is decomposed by water into ammonium syngenite and gypsum. The range of stability of this salt and of hydrated **ammonium pentacalcium hexasulphate**, $(\text{NH}_4)_2\text{SO}_4 \cdot 5\text{CaSO}_4 \cdot \text{H}_2\text{O}$, are shown in J. d'Ans' diagram, Fig. 52. The latter salt was obtained in strongly refracting prisms readily decomposed by water. R. Fassbender prepared crystals of the triple salt, **ammonium potassium calcium disulphate**, $(\text{NH}_4)\text{KSO}_4 \cdot \text{CaSO}_4 \cdot n\text{H}_2\text{O}$, by diluting a sat. soln. of ammonium sulphate with an equal

pale blue crystals of what he regarded as dihydrated ammonium dicalcium cupric tetrasulphate, $(\text{NH}_4)_2\text{Ca}_2\text{Cu}(\text{SO}_4)_4 \cdot 2\text{H}_2\text{O}$, by boiling a sufficiently conc. soln. of cupric, calcium, and ammonium sulphates. The mother liquid was drained off, and the crystals washed rapidly first with water, then with dil. alcohol, and finally with a mixture of alcohol and ether. The crystals are fairly stable.

R. Silberberger⁵ obtained a white product which he regarded as potassium barium sulphato-nitrate, $\text{KNO}_3 \cdot 2\text{BaSO}_4$, or $\text{NO}_3 \cdot \text{Ba} \cdot \text{SO}_4 \cdot \text{Ba} \cdot \text{SO}_4 \cdot \text{K}$, by mixing 3–6 grms. of potassium sulphate and 2 grms. of potassium nitrate in conc. soln. with 4·5 grms. of barium chloride. The product is dried on a porous tile over sulphuric acid. It is readily soluble in conc. sulphuric acid. He also made potassium barium sulphato-chloride, $\text{KCl} \cdot 3\text{BaSO}_4$, or $\text{Cl} \cdot \text{Ba} \cdot \text{SO}_4 \cdot \text{Ba} \cdot \text{SO}_4 \cdot \text{Ba} \cdot \text{SO}_4 \cdot \text{K}$, by mixing under similar conditions 3 grms. of potassium sulphate, 3 grms. of potassium chloride, and 4·2 grms. of barium chloride; or respectively 6, 9, and 4 grms. of the components. As previously indicated, J. Smithson described a native *barium calcium sulphato-fluoride*.

REFERENCES.

- ¹ J. A. Phillips, *Journ. Chem. Soc.*, 3, 348, 1850; H. Precht, *Wochenschr. Ver. Ing.*, 370, 1880; *Ber.*, 14, 2139, 1881; W. H. Miller, *Journ. Chem. Soc.*, 3, 348, 1850; J. Rumpf, *Tschermak's Mitt.*, 117, 1872; G. Tschermak, *ib.*, 197, 1872; H. Müller, *Neues Jahrb. Min. B.B.*, 30, 1, 1910; P. Berthier, *Ann. Chim. Phys.*, (2), 22, 245, 1823; H. Braconnot, *ib.*, (2), 31, 38, 1826; J. H. Droeze, *Ber.*, 10, 330, 1877; R. Fassbender, *ib.*, 9, 1358, 1876; O. Henry, *Journ. Pharm.*, 12, 31, 1826; F. K. Cameron and B. E. Brown, *Journ. Phys. Chem.*, 9, 210, 1905; F. K. Cameron and A. Siedell, *ib.*, 5, 643, 1901; F. K. Cameron and J. F. Breazeale, *ib.*, 7, 335, 1903; F. K. Cameron, J. M. Bell, and W. O. Robinson, *ib.*, 11, 396, 1907; P. N. Evans, *Chem. News*, 86, 4, 1902; C. W. Folkard, *ib.*, 43, 6, 1881; J. B. Hannay, *ib.*, 34, 256, 1876; *Journ. Chem. Soc.*, 32, 399, 1877; J. H. van't Hoff and D. Chiaraviglio, *Sitzber. Akad. Berlin*, 810, 1899; J. H. van't Hoff, *ib.*, 478, 1905; J. H. van't Hoff and H. A. Wilson, *ib.*, 1142, 1900; J. H. van't Hoff and A. Geiger, *ib.*, 935, 1904; J. H. van't Hoff, G. L. Vocerman, and W. C. Blasdale, *ib.*, 305, 1905; J. Fritzsche, *Journ. prakt. Chem.*, (1), 72, 291, 1857; M. Naumann, *Neues Jahrb. Min. B.B.*, 32, 624, 1911; H. Schreiber, *ib.*, 37, 247, 1914; J. H. van't Hoff, *Zeit. anorg. Chem.*, 47, 244, 1905; W. Grahmann, *ib.*, 81, 257, 1913; J. d'Ans, *ib.*, 53, 419, 1907; 62, 128, 1909; *Ber.*, 39, 3326, 1906; 40, 192, 1907; 41, 1776, 1777, 1908; J. d'Ans and W. Zeh, *ib.*, 40, 4912, 1907; G. Calcagni and G. Mancini, *Atti Accad. Lincei*, (5), 19, ii, 422, 1910; G. Calcagni, *ib.*, (4), 21, i, 483, 1912; (4), 21, ii, 77, 1912; A. Ditte, *Compt. Rend.*, 79, 215, 956, 1254, 1874; 84, 86, 1876; 126, 694, 1898; A. C. Becquerel, *ib.*, 75, 52, 1872; H. le Chatelier, *ib.*, 96, 1057, 1883; P. Groth, *Chemische Kristallographie*, Leipzig, 491, 1908; E. Anderson, *Journ. Ind. Eng. Chem.*, 11, 327, 1919; E. Anderson and R. J. Nestell, *ib.*, 12, 243, 1920; H. Struve, *Zeit. Chem.*, 5, 323, 1869; J. B. Emmet, *New Edin. Phil. Journ.*, 15, 69, 1833; F. Schott, *Dingler's Journ.*, 196, 357, 1870; J. Grosjean, *ib.*, 250, 371, 1883; V. von Zepharovich, *Lotos*, 137, 211, 1872; *Sitzber. Akad. Wien*, 67, 128, 1873; F. Ullik, *ib.*, 67, 137, 1873; H. Vater, *Zeit. Kryst.*, 30, 373, 1898; H. Rose, *Pogg. Ann.*, 93, 594, 1854; F. K. Cameron and J. M. Bell, *Calcium Sulphate in Aqueous Solutions*, Washington, 1907; O. Mügge, *Neues Jahrb. Min.*, i, 266, 1895; P. Gaubett, *Bull. Soc. Min.*, 30, 104, 1907; E. Zimmermann, *Kali*, 3, 525, 1909; H. E. Boeke, *Zeit. Kryst.*, 47, 282, 1910; G. Bartolini, *ib.*, 14, 525, 1888; V. von Lang, *Sitzber. Akad. Wien*, 61, 194, 1870; M. Enderli, *German Pat.*, D.R.P. 345049, 1919.
- ² H. Rose, *Pogg. Ann.*, 110, 297, 1860; E. C. Sullivan, *Journ. Amer. Chem. Soc.*, 27, 529, 1905; J. M. Bell and W. C. Taber, *Journ. Phys. Chem.*, 10, 119, 1906; 11, 492, 1907; O. Popp, *Liebig's Ann. Suppl.*, 8, 1, 1872; J. d'Ans, *Ber.*, 39, 3326, 1906; 40, 192, 1907; *Zeit. anorg. Chem.*, 62, 128, 1909; R. Fassbender, *Ber.*, 9, 1359, 1876; 11, 1968, 1878; J. H. Droeze, *ib.*, 10, 330, 1877; A. Ditte, *Compt. Rend.*, 84, 86, 1877; S. Cohn, *Journ. prakt. Chem.*, (2), 35, 43, 1887; J. Fritzsche, *ib.*, (1), 72, 291, 1857; F. K. Cameron and J. M. Bell, *Calcium Sulphate in Aqueous Solutions*, Washington, 1907.
- ³ A. Schenck, *Tschermak's Mitt.*, (2), 2, 311, 1879; C. A. Winkler, *Jahrb. Berg. Hütt. Sachsen*, 70, 1878; C. F. Rammelsberg, *Handbuch der Mineralchemie*, Leipzig, 2, ii, 102, 1895; F. Berwerth, *Zeit. Kryst.*, 3, 373, 1879.
- ⁴ S. U. Pickering, *Journ. Chem. Soc.*, 91, 1981, 1988, 1907; J. d'Ans, *Ber.*, 41, 1778, 1908.
- ⁵ R. Silberberger, *Monatsh.*, 25, 231, 1904; J. Smithson, *Ann. Phil.*, (1), 16, 48, 1820.

§ 21. The Occurrence and Preparation of Carbonates of the Alkaline Earths

The occurrence of witherite, barium carbonate, and of strontianite, strontium carbonate, has been already outlined. They occur in one crystalline form belonging to the rhombic system. Calcium carbonate occurs in nature as rhombohedral *calcspar*, *Iceland spar*, or *calcite* and rhombic *aragonite*. The former is stable at ordinary temp., the latter is metastable. With the exception of quartz, the former variety is the most common of all the minerals. It is the *lapis calcarius* of Pliny. The class includes a series of minerals ranging from Iceland spar, through the *limestones*, *marbles*, and *chalk*. There are enormous quantities of limestone which occur both as original deposit and as a metamorphic mineral. Crystals of calcite are commonly found wherever calcareous soln. have penetrated—*e.g.* in veins, cavities, and amygdules. The attention of physicists was early directed to the fine crystals of calcite largely because of E. Bartholinus, in his *Experimenta crystalli Islandici* (Hafniæ, 1669) studied the cleavage and birefringence; C. Huyghens,¹ in 1690, the laws of double refraction; and E. L. Malus, in 1808, the polarization of light.

Special names have been given to the more peculiar habits of calcite—for instance, there are the so-called *dog-tooth spar*, *nail-head spar*, *slate spar*, and *satın spar*. The latter is a fibrous variety with a silky lustre resembling the satin spar variety of gypsum—the latter is harder than the former. There are several varieties of minor importance which have been named after some admixture, or the colour, use, or locality, and do not generally indicate important structural or chemical differences. For instance, *dolomitic calcite* contains magnesium carbonate; *mangano-calcite* contains up to about 20 per cent. or more manganese carbonate in the form of mixed crystals. In fact, there appears to be a complete series of mixed crystals of calcspar and manganese spar. A. Breithaupt² called a specimen he analyzed *spartaite*. A sample from Sterling with some franklinite and zincite was called *calcimangite* by C. U. Shepard. *Ferro-calcite* has ferrous carbonate and turns brown on exposure to air. F. Millosevich obtained a sample of calcite from Cape Calamita, Elba, with about 2 per cent. of cobalt carbonate, and it has been called *cobalto-calcite*; C. F. Rammeisberg and W. Lindgren have reported samples with up to about 5 per cent. of zinc carbonate—*zinc-calcite*; J. Johnston, R. Schöffel and H. Hofer, J. S. Thomson, A. Lacroix, and J. N. Collie found samples containing up to about 20 per cent. of lead carbonate—*plumbo-calcite*; T. Thomson, and H. Vater have studied *baryto-calcite*—a variety from Cumberland was called *neotype* by A. Breithaupt and F. A. Genth. These workers, and B. Doss have analyzed samples with strontium carbonate, which are accordingly called *strontio-calcite*. According to J. M. F. de Lassone, the so-called *Fontainebleau limestones* have 50–63 per cent. of quartz crystals; the *hislopit* of S. Haughton, from India, is coloured by glauconite

The limestones are more or less impure forms of calcium carbonate; and they occur in many diverse forms—calcareous sinter or tufa or *travertine*; the *tophus* of Pliny, and the *lapis tiburtinus* of Pliny and Vitruvius. At the Mammoth Hot Springs (Yellowstone National Park),³ the snow-white deposits from the geysers and hot springs form massive terraces of travertine, as the calcium carbonate, held in soln. by carbonated water, is deposited through the escape of the carbon dioxide from its soln. in water—*vide infra*. The formation of *stalactites* and *stalagmites* in caves, and the work of the so-called *petrifying springs*, is due to the same cause. The carbon dioxide may also be abstracted from the water by vegetable organisms—bacteria, algæ, mosses, and aquatic plants like the chara, etc., which, according to J. Walther, and E. J. Garwood, are active agents in the formation of limestones. A. Payen discussed the occurrence of calcium carbonate in plants. G. Steinmann has shown that the albumen present in the organic parts of aquatic animals, may, by fermentation, form ammonium carbonate which would precipitate calcium carbonate from calcareous waters. Calcium carbonate may also be precipitated from river waters charged with calcium carbonate as they enter the sea; and C. Lyell noted that this is taking place in the delta of the Rhône, and S. Sanford, and T. W. Vaughan, along the coast of Florida. Limestone is made up of shells and corals, and the organic remains may be conspicuous or they may be quite obliterated. Chalk is derived from marine ooze. *Pearls* are largely composed of calcium carbonate deposited by the oyster about an invading parasite.

The *sandy, argillaceous, glauconitic, ferruginous, phosphatic, and bituminous limestones* owe their names to the corresponding impurities. The so-called *fætid limestone* or *stinkstone* owes its name to the presence of hydrogen sulphide, which escapes when the stone is struck or bruised. B. J. Harrington found a bed of calcite in Chatham (Canada) with 0.016 per cent. of hydrogen sulphide eq. to 500 c. ins. per c. foot. W. Skey made a similar observation.

Limestones are formed in various ways, but in all cases the primary action involves the separation of calcium carbonate from its soln. in fresh or salt water. Oceanic ooze may form a soft substance like chalk or a mixture of the same with sand or clay; fragments of coral may be broken into fine granules by the waves, and subsequently cemented by the soln. and redeposition of calcium carbonate to form massive *coralline limestone* containing, in the samples examined by S. P. Sharples,⁴ 95.37–98.07 per cent. of calcium carbonate, and 0.28–0.84 per cent. of calcium phosphate, with a little organic and earthy matter. Many fossil corals are found in the limestones of Devon. Masses of shell fragments may likewise be cemented, as in the case of the coralline limestone, by the soln. and redeposition of calcium carbonate, so as to form a massive rock suitable for building purposes—*e.g. shell limestone, coquina, oolitic limestone, etc.* Fragments of limestone cemented together by the soln. and deposition of calcium carbonate, or other infiltrations form *breccia*. Some have the fragments of different colour, and are used as ornamental stones; *pudding-stone marble* has rounded pebbles likewise cemented together.

Calcium carbonate may be transported as silt, and solidify to a smooth fine-grained rock—*e.g. lithographic limestone* is a fine-grained compact rock of uniform texture and composition. The lithographic stone from the neighbourhood of Solenhofen, near Munich (Germany), is specially prized—it readily receives delicate markings from engraver's tools, and by etching acids, and it is porous enough to receive and retain the greasy preparation used by the lithographer in transferring and printing. Limestones may have been buried under other sediments, whereby they become more or less modified; the fossils are more or less obliterated, and in the extreme case, a crystalline limestone may be produced. Crystalline limestone or *marble* may be produced from apparently amorphous calcium carbonate, by press. alone, by heat alone, or by the two agents acting together. The fine-grained white statuary *Carrara marble* from quarries at Monte Crestola and Monte Sagro in Italy, and the *parian marble* from the Isle of Paros, are of great historical interest. There are numerous other varieties of white, coloured, and mottled marbles. The ornamental nature of the stone is dependent on variations in colour and texture produced by impurities or inclusions—*e.g. ferric oxide, mud, clay, etc.* Some marbles have the remains of various fossil shells—*e.g. the panno-di-morti* is a black marble with white fossil shells; the *verd-antique marble* is clouded with green serpentine inclusions; the so-called *onyx-marbles*; the *fire marble, etc.*

Aragonite is a variety of calcium carbonate which was named after the locality, Aragon (Spain), where it was first found. It crystallizes in a system different from calcite, and it was the earliest known case of dimorphism in the mineral kingdom. In 1788, M. H. Klaproth⁵ showed that the two minerals had the same chemical composition, but this was contested by R. J. Haiiy and others, who were confused by a too rigid interpretation of the hypothesis that every crystalline substance of definite chemical composition has a characteristic and specific form. H. Stromeyer suggested that the dimorphism is due to the presence of a little strontium in aragonite, but J. W. Döbereiner, C. F. Bucholz and K. F. W. Meissner, and others showed that strontium is not always a constituent of aragonite. The examples of polymorphism established by E. Mitscherlich rendered it necessary to recognize that polymorphism is a specific property. Aragonite is less common than calcite, and it is not always possible to distinguish with certainty the massive forms of these two minerals if the cleavage or sp. gr. cannot be determined. Many concretionary and stalactitic forms of calcium carbonate are regarded as aragonite—*e.g. the pisolites* deposited from the hot springs of Carlsbad (Bohemia); and the white stalactites known as *flor ferri* from the iron mines of Eisenerz (Styria). The pisolitic carbonate formed at the hot springs of Hammam-Meskoutine (Algeria) was regarded by A. Lacroix as a specific variety to which he gave the name *ktypéite*, but H. Vater identified it with aragonite. J. Dreger found aragonite separates from the mineral waters of Rohitsch.

According to W. Meigen,⁶ aragonite is coloured lilac when immersed in a soln. of cobalt nitrate, and the colour persists on boiling; calcite under similar conditions remains white in the cold, and is coloured blue on long boiling. Aragonite gives a dark greenish precipitate of ferrous hydroxide when immersed in a soln. of ferrous sulphate, while calcite under similar conditions gives a yellow precipitate of ferric hydroxide. G. Panebianco says that in the ferrous sulphate test, the precipitates are carbonates not hydroxides; and W. Diesel has further discussed this test. S. J. Thugutt has studied the colour discriminations based on organic dyes. J. Kendall found the sp. gr. of vaterite to be identical with that of aragonite; and he attributed the higher values for the solubility to the retention of the last trace of carbon dioxide by the soln.

R. Lang⁷ reported a monoclinic variety of calcium carbonate occurring as *rock-milk*, of a texture resembling mould or cotton-wool, as a coating on the crevices of the calcareous tufa near Horb (Württemberg). He called it *lublinite*. O. Mügge, however, showed that lublinite is merely a pseudomorph of calcite after organic remains, and is not a species. H. Vater prepared spherical aggregates of feebly birefringent crystals of calcium carbonate. We know very little about this form except that it belongs to a system with two optical axes; it generally appears in sphaerolites, rarely in needles; it has a feeble double refraction; and like aragonite, it is stained blue by cobalt soln. in a few minutes; and its sp. gr. is about 2.6. G. Linck called it *vaterite*. J. Johnstone and co-workers say that vaterite is not really a definite form of calcium carbonate; since its peculiar properties are due to differences in the size of grain and state of aggregation. O. Bütschli has also prepared an isotropic, gelatinous form—*colloidal calcium carbonate*—by adding potassium carbonate to a soln. of calcium acetate mixed with the white of an egg. The precipitate was washed with alcohol. It is quite stable when dry, but between 200° and 230° it rapidly changes into calcite. J. Johnstone and co-workers say that like vaterite it is not really a definite form of calcium carbonate, and for similar reasons. L. Bondonneau also obtained gelatinous calcium carbonate by passing carbon dioxide into a soln. of lime in sugar mixed with sodium chloride or nitrate.

J. Johnstone and co-workers say that another crystalline form, μ -CaCO₃, is produced by precipitation at 60°; it is always accompanied by calcite or aragonite from which it can be separated by flotation in a liquid of sp. gr. 2.6, since its sp. gr. is 2.54 while the other forms have sp. gr. respectively 2.71 and 2.88. The microscopic plates belong to the hexagonal system. The refractive indices are 1.550 and 1.650. It persists indefinitely when dry, but when heated passes into calcite.

As indicated by M. J. Schleiden, A. Payen, and J. Bacon, calcite occurs in the cellular tissue of many phanerogamia—*e.g.* cycadaceæ and cactaceæ. The lithothamnia seaweeds have a framework or skeleton of calcite; and the halimeda contain aragonite. Calcium carbonate is found along with calcium phosphate in the bones of the vertebrata; in egg-shells; and in corals, and the skeletons of the invertebrata—*e.g.* crustacea, mollusca, gastropoda, etc. A. Kelly supposed that a distinct crystalline variety of calcium carbonate is found in the shells of many mollusca, and called it *conchite*; but R. Brauns and H. Vater identified Kelly's conchite with aragonite as was previously supposed.

H. C. Sorby showed that shells composed of aragonite are comparatively rare as fossils, and V. Cornish and P. F. Kendall found that carbonated waters decompose and disintegrate shells of aragonite much more readily than those of calcite, but the difference is attributed rather to structure than to constitution. P. F. Kendall found the shells of the pteropoda are mainly aragonite, and they disappear below 1500 fathoms depth, while the calcite shells of the globigerina are found in the ooze at 2925 fathoms. The upper chalk of England contains only calcite organisms, and P. F. Kendall infers that it was deposited at a depth of at least 1500 fathoms—this is based on the assumption that no aragonite has been converted to calcite subsequent to its deposition. G. Linck has shown that while recent deposits of the oolites are composed of aragonite, the older occurrences are calcitic; and he assumes that the oolites were originally deposited as aragonite and subsequently converted to the more stable calcite. Some shells have a principal mass of calcite with a pearly layer

of aragonite; and other associations of these two forms of calcium carbonate are found. During the fossilization of these shells, the aragonite is generally destroyed while the calcite is preserved. The direct separation of calcium carbonate as calcite or aragonite by precipitation is largely conditioned by the temp., and maybe other conditions.

Dry calcium oxide does not absorb carbon dioxide provided moisture be excluded. In 1773, J. B. M. Bucquet⁸ said:

Je conclus qu'il ne suffit pas de rendre à la chaux de l'air fixé pour la convertir en craie, qu'il faut un intermède pour que cette union se fasse, et que cet intermède est l'eau.

When calcium oxide absorbs carbon dioxide from the air, moisture is simultaneously absorbed. J. Kolb and H. Debray showed that the dried oxides or hydroxides of calcium, barium, magnesium, sodium, and potassium do not increase in weight in an atm. of dry carbon dioxide. The action was studied by H. Rose, A. R. Schulatschenko, F. M. Raoult, K. Birnbaum and M. Mahu, etc., as previously indicated in connection with the action of this gas on calcium oxide; and the reversible reaction; $\text{CaO} + \text{CO}_2 = \text{CaCO}_3$, has been discussed in connection with the preparation of calcium oxide. According to F. M. Raoult, the absorption of carbon dioxide by calcium, strontium, and barium oxides proceeds rapidly at 550°, and the temp. rises to 1100°, 1050°, and 1200° with the respective oxides. According to P. Rohland,⁹ the immeasurably slow reaction between dried carbon dioxide and dried calcium hydroxide is augmented if one per cent. of water be present. A. R. Schulatschenko found that moist carbon dioxide is more slowly absorbed by calcium hydroxide at 360° than it is at 16°. Moist calcium hydroxide and lime-water rapidly absorb carbon dioxide; and W. Wolters has studied the action of carbon dioxide on milk of lime. According to H. Rose, and C. Scheibler, dry carbon dioxide is not absorbed by dried barium oxide, hydroxide, or monohydrated hydroxide. The gas, however, is rapidly absorbed if moisture be present—*e.g.* carbon dioxide is rapidly absorbed from the air. According to C. Scheibler, if carbon dioxide is passed over the hydroxides of calcium, strontium, and barium, any excess of water will be removed, and the gas thus moistened will act on the hydroxides with the formation of carbonate, but the reaction is not complete even with the octohydrates; he added that the use of carbon dioxide to remove water from the hydroxides or oxides of the alkaline earths does not work as an analytical method. C. Heyer took the contrary view; he found that dry monohydrated strontium hydroxide is completely converted into carbonate by dry carbon dioxide, but only traces of carbon dioxide are absorbed by the dry hydroxide. R. Finkener held that a basic carbonate is formed when dry carbon dioxide is passed over monohydrated strontium hydroxide, but C. Heyer holds that R. Finkener's product is merely a mixture of partially carbonated hydroxide.

According to H. A. von Vogel,¹⁰ carbon dioxide precipitates amorphous calcium carbonate from lime-water, but on standing the precipitate becomes crystalline; and M. Pettenkofer showed that the crystallization is retarded if an excess of calcium hydroxide be present. He also showed that when air containing carbon dioxide, or an aq. soln. of that gas, is added to lime-water, an appreciable time elapses before the soln. becomes turbid, and he believes that this is due to the formation of a soluble carbonate. G. Rose found that if a little carbon dioxide is passed into a cold soln. of calcium hydroxide, calcite is formed, and aragonite if the soln. is hot. Similar products were respectively obtained by exposing cold and hot soln. to the carbon dioxide of the atm. He reported that calcite is obtained by the action of carbon dioxide on lime-water below 30°; aragonite at temp. above 90°; while a mixture of the two is obtained at intermediate temp. He further found that a conc. and warm soln. of calcium hydroxide furnishes calcite when treated with carbon dioxide; while a very dil. soln. at ordinary temp. furnishes aragonite. H. Watson found that if the liquid from which the calcium carbonate is precipitated is above 30°, aragonite is formed, if below that temp., calcite, and this whether the soln. be

seeded with these minerals or not. L. Roon made calcium carbonate by spraying milk of lime in an atm. containing carbon dioxide; J. Faldner dissolved quicklime in a soln. of an ammonium salt, removed the impurities by precipitation and filtration, and saturated the liquid with carbon dioxide under press. so as to precipitate the carbonate, and regenerate the ammonium salt.

The addition of an ammonium carbonate soln. to a cold soln. of calcium chloride furnishes a voluminous flocculent precipitate of calcium carbonate which, according to G. Rose,¹¹ if immediately filtered and dried, appears under the microscope to consist of opaque granules like grains of chalk; but if this same precipitate be left for some time in contact with the liquid from which it has been precipitated, it collects into microscopic crystals of calcite. Again, if the boiling soln. of ammonium carbonate be added to one of calcium chloride, the precipitate consists of aragonite mixed with a little calcite, while if the admixture be made in the reverse order, small crystals of aragonite are alone obtained. If the crystals be not immediately collected on a filter, washed, and dried, but allowed to remain in the cold mother liquid for about a week, they are completely converted into calcite. The transformation goes more slowly under water. O. Knöfler stated that if precipitated above 17°, the grains of calcium carbonate are crystalline and not amorphous, and J. L. Smith added that in order to get as dense a precipitate as possible the soln. should be warmed at least to 70°. R. Fresenius showed that ammonium carbonate is retained very tenaciously by the precipitated carbonate. According to E. Drechsel, if commercial ammonium carbonate be used as precipitant, some soluble calcium carbonate will be formed. O. Knöfler also found that if strontium or barium carbonate be precipitated below 0° it is crystalline. According to M. Adler, the precipitation of calcium carbonate as aragonite is determined by the temp. of the soln., the conc., the nature of the atm. in which the precipitation is made, and by the press. In the preparation of calcium carbonate from soln. of calcium chloride and ammonium carbonate, the temp. at which the aragonite-form is converted into the calcite-form is increased to a much greater extent by an increase in the conc. of the calcium chloride. Using the ammonium carbonate of such a conc. that on adding the calcium chloride a thick, gelatinous mass is obtained, the limit of temp. for the ammonium carbonate soln. is 32°, whilst the calcium chloride may be used boiling. With dil. soln. at the same temp., the aragonite crystals are at once converted into calcite; the limit of temp. for weak soln. is 22°, and the lower the temp. the smaller and more stable are the crystals of aragonite. The presence of carbonic anhydride in the soln. determines the formation of calcite, and this explains the formation of calcite when the ammonium carbonate is at a high temp., as it is then decomposed, with the formation of carbonic anhydride. Precipitated aragonite—when subjected to a press. of 5–6 atm., is converted into calcite. The aragonite, form is more stable when the soln. is alkaline with an excess of ammonium carbonate, and also when the precipitate is washed with water containing calcium sulphate instead of with pure water. When the aragonite prepared from calcium chloride and ammonium carbonate is separated from the mother liquor and heated to 60°, it is converted into calcite; on the other hand, the aragonite precipitated by sodium carbonate can be heated to 100° without change. H. A. von Vogel obtained similar results with ammonium carbonate and soln. of barium chloride as he obtained with potassium hydrocarbonate.

Calcium carbonate is likewise precipitated when an alkali carbonate is added to a soln. of a calcium salt. J. J. Berzelius emphasized the fact that when calcium carbonate is precipitated by an alkali carbonate, the latter is retained very tenaciously; and in order to remove the adsorbed alkali, C. Heyer recommended calcining the precipitate until it begins to sinter, and then extracting the adsorbed alkali with water—*vide* the double alkali and calcium carbonates. According to H. Rose, if a soln. of potassium hydrocarbonate in 20 parts of water be added to an eq. soln. of barium chloride, one-fourth of the precipitate formed redissolves. The barium carbonate separates when the soln. is allowed to stand, and when

an excess of the precipitant is used. Similar results were obtained with a calcium salt and potassium hydrocarbonate. J. B. J. D. Boussingault studied the reaction, and C. J. B. Karsten found that if barium hydroxide be added to a conc. soln. of potassium carbonate no precipitation occurs; but if the soln. be diluted, barium carbonate separates out. J. Bevad¹² attempted to measure the rate of formation of the carbonates of the alkaline earths under different conditions by the action of lithium, sodium, and potassium carbonates on soln. of the corresponding chlorides. He concluded that the speed of formation of the carbonates is greatest during the first five minutes, and it increases at the same rate as the quantity of insoluble salt formed and as the conc. of the salt used for the precipitation increases in the direction from lithium to potassium, and from calcium to barium. The average speeds of the reactions after the first five minutes decrease rapidly with increasing conc. of the alkali carbonate, and in the direction from lithium to potassium, and from calcium to barium. The equilibrium conditions between soln. of calcium chloride and sodium carbonate have been studied by M. M. P. Muir; and between barium chloride and sodium carbonate by J. Morris. The reaction: $\text{Na}_2\text{CO}_3 + \text{Ca}(\text{OH})_2 \rightleftharpoons \text{CaCO}_3 + 2\text{NaOH}$, has been discussed in connection with the caustification of sodium carbonate.

According to G. Rose, if dil. soln. of calcium chloride and sodium carbonate are allowed to diffuse slowly into one another, crystals of aragonite are formed; while if conc. soln. be employed, crystals of calcite are produced. If boiling soln. of the two salts are mixed, aragonite is precipitated; P. Harting obtained similar results. G. Rose further found that if the turbid liquid obtained by mixing calcium chloride and sodium hydrocarbonate be boiled, calcite is formed. F. Senft evaporated soln. of calcium carbonate in ammonium crenate, and obtained crystals of calcite; while calcite was deposited from soln. of the carbonate in aq. carbonic acid. L. M. Michel obtained aragonite by the slow evaporation of a soln. of calcium hydrocarbonate in water sat. with carbon dioxide. Crystals of strontianite and witherite can be prepared in a similar way. In opposition to G. Rose, H. Credner, etc., H. Vater found that while aq. soln. below 30° always gave trigonal calcite, hot soln., particularly when cooled rapidly, gave rhombic aragonite; he observed that when the soln. contained calcium, sodium, and potassium sulphates, chlorides, nitrates, hydrocarbonates, etc., calcite, never aragonite, crystals were always obtained. F. Vetter studied the effect of seeding the crystallizing soln. with aragonite, and found that aragonite does not crystallize from the soln. if the temp. is below 30°; while the seeding of a soln. above 30° with calcite, hinders the formation of aragonite and furnishes calcite crystals. L. Bourgeois heated precipitated calcium carbonate with ammonium chloride or nitrate, urea, and water in a sealed tube at 150°–180°, and obtained crystals of calcite and aragonite; and when the urea was omitted, crystals of calcite alone appeared. He also made crystals of strontianite and witherite by a similar method. C. Friedel and E. Sarasin heated precipitated calcium carbonate with an aq. soln. of calcium chloride in a sealed steel tube for 10 hrs. at 500°, and obtained large crystals of calcite; the formation of aragonite was not observed. M. Kleinstück obtained crystals of calcite by heating precipitated and well-washed calcium carbonate with a neutral soln. of calcium chloride. A. C. Becquerel found that crystals of calcite were formed on a crystal of gypsum which has been for 20 years in contact with a soln. of potassium carbonate, and aragonite crystals with a soln. of potassium hydrocarbonate; A. C. Becquerel also obtained crystals of calcite by leaving gypsum in contact with a soln. of sodium hydrocarbonate of sp. gr. 1.014, and aragonite with a soln. of the same salt of sp. gr. 1.036–1.043. M. Miron and M. Bruneau observed that when a river-water was used to work an aspirator sucking air charged with ammonia gas, the ammonia neutralized the free carbonic acid in the water, and the calcium carbonate, previously held in soln., was deposited in the exit tube in the form of crystals of calcite. Crystals of witherite are obtained in a similar way by using a soln. of barium carbonate in water charged with carbon

dioxide. J. Zöega, H. Drevermann, H. Vohl, and H. Vater prepared crystals of calcite or witherite by the slow admixture of the required soln. J. Zöega suspended a bag containing crystallized baryta in a mixed soln. of baryta-water and potassium hydroxide, and allowed the air to act thereon. Calcite crystals were obtained in an analogous manner. According to H. Credner, the presence of a little lead or strontium carbonate, or calcium sulphate, favours the formation of aragonite. M. Bauer used soln. containing a little barium carbonate. F. Cornu obtained aragonite by crystallization from aq. soln. of calcium carbonate in carbonic acid containing a little manganese sulphate; H. Leitmeier found other readily dissociated salts—*e.g.* magnesium chloride—act similarly. Crystals of calcite, aragonite, and dolomite are formed when a soln. of calcium carbonate in water sat. with carbon dioxide is mixed with some magnesium chloride or sulphate and kept at 2°, 20°, and 90°. A larger proportion of aragonite is formed at the higher temp. H. Leitmeier said that only the rhombic form crystallizes from a soln. of calcium hydrocarbonate containing magnesium sulphate; at 20°, the ratio is $\text{H}_2\text{O} : \text{CaCO}_3 : \text{MgSO}_4 \cdot 7\text{H}_2\text{O} = 1000 : 1 : 10$. W. Meigen and E. Hatschek have studied the crystallization of calcite and aragonite from soln. of calcium chloride and various carbonates. According to G. Rose, if a little chalk, calcite, aragonite, or calcium chloride be dissolved in a molten mixture of sodium and potassium carbonates, and the cold mass extracted with water, a granular mass is obtained which forms calcite crystals on standing 24 hrs. in the cold, whereas if the soln. be boiled, aragonite crystals appear. L. Bourgeois obtained crystals of calcite from a soln. of calcium carbonate in a fused mixture of sodium and potassium chlorides. Crystals of strontianite and witherite were prepared in a similar manner.

G. Linck¹³ represents the transformations of the different forms of calcium carbonate by the scheme :

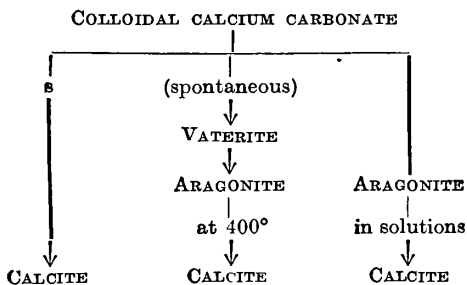

which makes it appear as if calcite is the stable form at ordinary temp. The phases aragonite and calcite are monotropic for they present a case where the two allotropic forms can remain in contact with one another without undergoing transformation, so that it is not clear which of the two forms is the more stable. If the denser form aragonite be heated to about 400°, E. Mitscherlich, and G. Rose found that it passes into the less dense calcite, but on cooling, the reverse transformation does not occur. Both calcite and aragonite crystallize at ordinary press. from solvents. G. Rose, and O. Mügge have shown that the transformation of aragonite into calcite proceeds very slowly at 410°, and even as low as 400°; and at 470° H. E. Boeke converted aragonite from Bilin into calcite. The velocity of transformation of calcite to aragonite was found by H. L. J. Bäckström to be zero for a considerable range of temp., and also decreases with time, so that the law for heterogeneous reactions does not apply. P. N. Laschtschenko found the heats of cooling of aragonite and calcite are the same up to 455°; between 445° and 465° the value for aragonite is greater than for calcite; and the difference increases with the temp. Above 465° the difference becomes less, and at 470° the two values are identical, thus showing that the transformation of aragonite into calcite begins at 445° and is completed at 470°. The beginning of the transformation is characterized by the

crystals becoming turbid, and the turbidity disappears at 470° . The sp. gr. determinations at different temp. are in harmony with this conclusion. It is therefore inferred that at temp. exceeding 470° , calcite is alone stable at atm. press. H. E. Boeke showed that pseudomorphs of calcite after aragonite are formed above 470° . H. W. Foote showed that at a temp. of about 100° , calcite is probably more stable than aragonite. G. Tammann suggested that the transformations with aragonite and calcite resemble those with phenol and illustrated them diagrammatically by curves resembling Fig. 53. If the temp. exceeds the limits *AC*, aragonite is converted into calcite; and calcite is converted into aragonite if the temp. exceeds *BC*, and *CD* represents the effect of press. on the transition temp.:—Aragonite \rightleftharpoons Calcite. H. W. Foote believes that calcite is the stable form; his argument is based on the general observation that of two modifications of the same substance the more soluble variety is usually the less stable; aragonite is more soluble than calcite; and is therefore the less stable form. Usually also that modification which is stable at the higher temp. has the lower density—e.g. sulphur, mercuric iodide, silica, etc.—here, aragonite, the denser form, is that which is stable at the higher temp. Several other examples are known—e.g. arsenious oxide, antimonious oxide, potassium calcium chromate, phosphorus, arsenic, etc. W. Vaubel assumed that aragonite contains a little basic carbonate, $\text{CO}_2(\text{O.Ca.OH})_2$, in order to explain the difference in the behaviour of aragonite and calcite; but H. Leitmeier showed that this hypothesis is not valid. J. Johnstone and co-workers say that while aragonite does not change at an appreciable rate into calcite below 400° , yet calcite is the stable form at ordinary press. below 970° , at which temp. it changes irreversibly into $\alpha\text{-CaCO}_3$. There are indications that aragonite has a stable field of existence below -100° .

According to M. Rivière,¹⁴ if carbon dioxide be passed into an aq. soln. of barium sulphide, barium carbonate and hydrosulphide are first formed: $2\text{BaS} + \text{H}_2\text{O} + \text{CO}_2 = \text{BaCO}_3 + \text{Ba}(\text{SH})_2$; and the hydrosulphide is then decomposed: $\text{Ba}(\text{SH})_2 + \text{H}_2\text{O} + \text{CO}_2 = \text{BaCO}_3 + 2\text{H}_2\text{S}$. The second reaction was found by A. Scheurer-Kestner to be very slow; and the product always contained sulphur. According to H. W. F. Wackenroder, the precipitated barium carbonate will be free from sulphur if the barium sulphide be mixed with an eq. amount of calcium chloride and the carbon dioxide be passed into the boiling soln. C. F. Claus also converted barium or strontium sulphide into carbonate by boiling it with magnesium chloride to get rid of the hydrogen sulphide, and afterwards treating the liquor with carbon dioxide to precipitate strontium carbonate. H. W. F. Wackenroder digested the sulphide with a soln. of calcium chloride and then passed carbon dioxide into the boiling soln.

The first stage in the conversion of native barium sulphate to carbonate usually involves the reduction of the sulphate to sulphide by heating it with carbonaceous matters as indicated in connection with barium oxide. C. F. Bucholz calcined a mixture of heavy spar, carbon, and sodium chloride; A. Duflos used a mixture of heavy spar, carbon, and sodium sulphate; E. F. Anthon used a mixture of heavy spar, carbon, and potassium carbonate; H. W. F. Wackenroder calcined the heavy spar with carbon, and extracted the soluble matter with a soln. of sugar. Barium saccharate was precipitated by boiling the soln., and by treatment with carbon dioxide was transformed into a soln. of sugar and a precipitate of barium carbonate. The mother liquid from the barium saccharate was evaporated to dryness and calcined for barium carbonate. W. H. Bresler claimed a quantitative yield by treating strontium sulphate in the presence of water and alkali carbonate, at 175° , with carbon dioxide under press. F. Gärtner treated strontium sulphate and a soln. of sodium phenolate with carbon dioxide under press. E. A. Mebus and J. W. Decastro digested the finely ground sulphate with a soln. of ammonium carbonate; F. G. Bolton treated the moist finely ground sulphate with a mixture of carbon dioxide and ammonia.

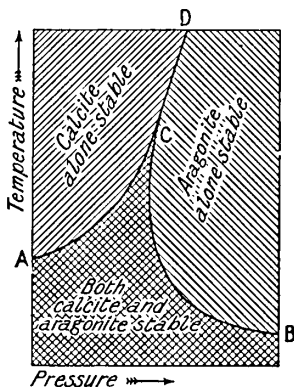

FIG. 53.—Zones of Stability of Calcite and Aragonite.

D. Urquhart and W. A. Rowell treated barium or strontium sulphate with sodium sulphate and sulphite, and heated the mixture with sodium carbonate. H. Grouven ignited a mixture of the sulphate with coal-dust and potassium magnesium sulphate, and extracted the mass with water. The strontium in soln. was precipitated with carbon dioxide.

C. Brunner¹⁵ made barium carbonate by calcining a mixture of barium and sodium chlorides with sodium carbonate; and L. G. G. Daudenart and E. Verbert treated a soln. of barium chloride with magnesium carbonate, and passed in carbon dioxide. W. Spring obtained crystals of barium carbonate by fusing barium sulphate with sodium carbonate; and also by compressing a mixture of the dry salts at 6000 atm. J. H. MacMahon obtained barium carbonate by adding barium sulphide to the ammonium hydrocarbonate obtained from the liquor in the ammonia-soda process.

The following might appear to be a logical corollary from Bertholet's law (1. 7, 5). *Chemical reactions proceed wholly in one direction when one of the products of the reaction is more volatile or less soluble than the others and separates from the sphere of the reaction.* It is, however, necessary to apply caution, for while potash will completely precipitate *insoluble* copper hydroxide from soln. of copper sulphate, potash does not precipitate *insoluble* mercuric oxide from soln. of mercuric cyanide—probably because of the formation of a soluble double salt. Similarly, potassium oxalate will completely precipitate *insoluble* calcium oxalate from soln. of calcium chloride, but potassium oxalate will not precipitate *insoluble* mercuric oxalate from soln. of mercuric chloride. Again, *insoluble* barium sulphate is attacked by sodium carbonate, $\text{BaSO}_{4\text{solid}} + \text{Na}_2\text{CO}_{3\text{soln.}} \rightleftharpoons \text{BaCO}_{3\text{solid}} + \text{Na}_2\text{SO}_{4\text{soln.}}$, so that the reaction appears slightly reversible, even at comparatively low temp. When sodium carbonate is fused with barium sulphate, the latter is converted into the carbonate.

In 1819, J. F. Daniell¹⁶ obtained from a sugar refinery, rhombohedral crystals of a hydrated calcium carbonate. T. Scheerer found in a running stream some small rhombohedral crystals which, when dried between filter-paper, had a composition corresponding with *pentahydrated calcium carbonate*, $\text{CaCO}_3 \cdot 5\text{H}_2\text{O}$. E. Pfeiffer, W. F. Salm-Horstmar, and C. F. Rammelsberg found similar crystals. A. C. Becquerel obtained similar crystals on the platinum anode by the electrolysis of a soln. of lime in sugar; and T. J. Pelouze obtained these crystals by boiling one part of lime with three parts of sugar—lactose, gum, or starch—and six of water, and then exposing the soln. in a cold place for some six months. T. S. Hunt dissolved freshly precipitated calcium and magnesium carbonates in an aq. soln. of calcium chloride, or magnesium sulphate, and found crystals of the hydrated calcium carbonate gradually deposited while the magnesium carbonate remained in soln. J. Roth used a soln. of sodium hydrocarbonate as solvent.

O. Bütschli obtained crystals corresponding with **hexahydrated calcium carbonate**, $\text{CaCO}_3 \cdot 6\text{H}_2\text{O}$, from soln. containing the blood of the cray-fish at 0°, and W. Biedermann similarly obtained monoclinic crystals which rapidly passed into the monohydrate on exposure to air. H. Vetter obtained the hexahydrate from sea-water containing calcium hydrocarbonate and magnesium salts. J. Johnstone and co-workers made it by precipitation from an alkaline soln. at 0°. The monoclinic crystals have the axial ratios $a:b:c=1.02:1:?$. The refractive indices are $\alpha=1.460$; $\beta=1.535$; and $\gamma=1.545$.

K. Kosmann described a Silesian mineral as *hydrocalcite*; for when dried over sulphuric acid, it corresponded with *dihydrated calcium carbonate*, $\text{CaCO}_3 \cdot 2\text{H}_2\text{O}$. In 1905, L. Iwanoff described a monoclinic or triclinic mineral from New Alexandria (Russia) with the composition $\text{CaCO}_3 \cdot n\text{H}_2\text{O}$, where n is not less than 3. According to N. Krischtowitsch, this mineral was described in 1872 by K. Jurkiewicz as *Kalkschaum*. P. Tschirwinsky found that L. Iwanoff's mineral is *trihydrated calcium carbonate*, $\text{CaCO}_3 \cdot 3\text{H}_2\text{O}$, or *trihydrocalcite*. J. Morozewicz has also made observations on the same mineral. With indecisive evidence of this nature, it appears as if there is a di- or tri-hydrocalcite, and a penta- or hexa-hydrocalcite, or possibly mixtures of colloidal calcium carbonate with the anhydrous salt.

REFERENCES.

- ¹ C. Huyghens, *Traité de la lumière*, Paris, 1690; E. L. Malus, *Bull. Soc. Philomath.*, 1. 16, 1809.
- ² A. Breithaupt, *Berg. Hütt. Ztg.*, 17. 53, 1858; *Vollständiges Handbuch der Mineralogie*, Dresden, 2. 313, 1841; C. U. Shepard, *Treatise on Mineralogy*, New Haven, 1852; C. F. Rammelsberg, *Handbuch der Mineralchemie*, Leipzig, 1875; G. Jentsch, *Pogg. Ann.*, 96. 145, 1855; D. Clark and R. H. Wahott, *Proc. Roy. Soc. Victoria*, 11. 253, 1901; H. B. Foullon, *Verh. geol. Reichsanst.*, 177. 1893; T. Thomson, *Phil. Mag.*, (3), 11. 45, 1837; *Ann. Phil.*, (1), 7. 399, 1816; J. Kovar, *Abhand. böhm. Akad.*, 28, 1899; W. T. Roepper, *Amer. Journ. Science*, (2), 50. 35, 1870; H. Sjögren, *Verh. geol. Ver. Stockholm*, 4. 1061, 1878; F. Millosevich, *Atti Accad. Lincei*, (5), 19. i, 91, 1909; C. F. Rammelsberg, *Handbuch der Mineralchemie*, Leipzig, 224, 1875; W. Lindgren, *Geol. Förh. Stockholm*, 5. 552, 1881; J. Johnston, *Edin. Phil. Journ.*, (2), 6. 79, 1829; R. Schöffel and H. Hoefel, *Neues Jahr. Min.*, 80, 1871; B. Doss, *ib.*, i, 105, 1897; A. Lacroix, *Bull. Soc. Min.*, 8. 35, 1885; J. S. Thomson, *Phil. Mag.*, (5), 7. 143, 1887; S. Houghton, *ib.*, (4), 17. 16, 1859; J. N. Collie, *Journ. Chem. Soc.*, 55. 91, 1889; H. Vater, *Zeit. Kryst.*, 21. 460, 1893; F. A. Genth, *Proc. Acad. Science Philadelphia*, 6. 114, 1852; J. M. F. de Lassone, *Mém. Acad.*, 68, 1775; E. J. Garwood, *Geol. Mag.*, (5), 10. 440, 490, 552, 1913.
- ³ J. S. Diller, *The Educational Series of Rock Specimens collected and distributed by the United States Geological Survey*, Washington, 1898; B. J. Harrington, *Amer. Journ. Science*, (4), 19. 345, 1905; W. Skey, *Trans. N.Z. Inst.*, 25. 379, 1892; J. Walther, *Zeit. deut. phys. Ges.*, 37. 329, 1885; G. Steinmann, *Ber. Naturfors. Ges. Freiburg*, 4. 288, 1889; C. Lyell, *Principles of Geology*, London, 1. 426, 1875; S. Sanford, *Rep. Florida Geol. Sur.*, 2. 224, 228, 1909; T. W. Vaughan, *Pub. Carnegie Inst.*, 133. 144, 168, 1910; A. D. Little, *Chem. Met. Engg.*, 25. 149, 1921; A. Payen, *Compt. Rend.*, 38. 241, 1854; *Ann. Chim. Phys.*, (3), 41. 164, 1854; E. J. Garwood, *Geol. Mag.*, (5), 10. 440, 490, 552, 1913.
- ⁴ S. P. Sharples, *Amer. Journ. Science*, (3), 1. 168, 1871; G. Forchhammer, *Neues Jahrb. Min.*, 854, 1852; A. Liversidge, *Proc. Roy. Soc. New South Wales*, 14. 159, 1880; A. J. Jukes-Brown and J. B. Harrison, *Journ. Geol. Soc.*, 47. 224, 1891; F. W. Clarke, *The Data of Geochemistry*, Washington, 1916.
- ⁵ M. H. Klaproth, *Berg. Journ.*, 1. 299, 1788; H. Stromeyer, *Soc. Reg. Scient. Göttingen*, 2. 12, 1813; J. W. Döbereiner, *Schweigger's Journ.*, 10. 217, 1814; C. F. Bucholz and K. F. W. Meissner, *ib.*, 13. 1, 1815; E. Mitscherlich, *Ann. Chim. Phys.*, (2), 19. 407, 1821; (2), 24. 264, 1823; R. J. Haijy, *Journ. Mines*, 23. 241, 1808; A. Lacroix, *Compt. Rend.*, 126. 602, 1898; L. Duparc, *Arch. Sciences Genève*, (3), 30. 537, 1888; H. Vater, *Zeit. Kryst.*, 35. 149, 1902; J. Dreger, *Tschermak's Mitt.*, 28. 184, 1910; H. Leitmeier, *Neues Jahrb. Min. B.B.*, 40. 655, 1916.
- ⁶ W. Meigen, *Ber. Oberrhein. geol. Ver.*, 31, 1902; *Ber. Naturfors. Ges. Freiburg*, 15. 55, 1905; *Centr. Min.*, 577, 1901; S. J. Thugutt, *ib.*, 786, 1910; A. Hutchinson, *Min. Mag.*, 13. 28, 1903; G. Wyrouboff, *Bull. Soc. Min.*, 24. 371, 1901; S. Kreutz, *Tschermak's Mitt.*, 28. 487, 1909; K. Niederstadt, *Zeit. angew. Chem.*, 25. 1219, 1912; G. Panebianco, *Zeit. Kryst.*, 40. 288, 1904; W. Diesel, *ib.*, 49. 250, 1911; H. Vater, *ib.*, 21. 433, 1893; 22. 209, 1894; 24. 366, 378, 1895; 27. 477, 1897; 30. 295, 485, 1899; 31. 538, 1899; 35. 149, 1901; W. Vaubel, *Journ. prakt. Chem.*, (2), 86. 366, 1912; O. Mügge, *Neues Jahrb. Min. B.B.*, 14. 246, 1901; H. Leitmeier, *ib.*, 40. 655, 1915; *Neues Jahrb. Min.*, i, 49, 1910; J. Kendall, *Phil. Mag.*, (6), 23. 969, 1912.
- ⁷ R. Lang, *Neues Jahrb. Min. B.B.*, 38. 121, 1894; O. Mügge, *Centr. Min.*, 673, 1914; H. Vater, *Zeit. Kryst.*, 21. 433, 1893; 22. 209, 1894; 24. 366, 1895; 27. 477, 1896; 30. 295, 495, 1899; 31. 538, 1899; L. Bondonneau, *Bull. Soc. Chim.*, (2), 23. 100, 1875; W. Meigen, *Ber. Naturfors. Ges. Freiburg*, 13. 40, 1903; 15. 38, 55, 1907; O. Bütschli, *Abhand. Akad. Gött.*, 4. 3, 1908; M. J. Schleiden, *Grundzüge der wissenschaftlichen Botanik*, Leipzig, 1. 169, 1850; A. Payen, *Ann. Chim. Phys.*, (3), 41. 164, 1854; J. Bacon, *Rép. Chim. App.*, 2. 324, 1860; A. Kelly, *Sitzber. Bayr. Akad.*, 30. 187, 1900; *Min. Mag.*, 12. 363, 1900; B. Silliman, *Amer. Journ. Science*, (2), 12. 174, 1851; H. Rose, *Sitzber. Akad. Berlin*, 63, 1858; R. Brauns, *Centr. Min.*, 134, 1901; H. C. Sorby, *Journ. Geol. Soc.*, 35. 56, 1879; V. Cornish and P. F. Kendall, *Geol. Mag.*, (3), 5. 66, 1888; A. R. Horwood, *ib.*, (5), 7. 173, 1910; G. A. J. Cole and O. H. Little, *ib.*, (5), 8. 49, 1911; P. Tesch, *Proc. Acad. Amsterdam*, 11. 236, 1908; P. F. Kendall, *B.A. Rep.*, 789, 791, 1896; G. Linck, *Neues Jahrb. Min. B.B.*, 16. 495, 1903; H. Fischer, *Monats. deut. geol. Ges.*, 247, 1910; R. C. Wells, *Journ. Washington Acad.*, 10. 249, 1920; A. R. Schulatschenko, *Dingler's Journ.*, 205. 335, 1872; H. Debray, *Compt. Rend.*, 62. 603, 1868; J. Kolb, *ib.*, 64. 861, 1869; K. Birnbaum and M. Mahu, *Pogg. Ann.*, 12. 1547, 1879; J. Dreger, *Tschermak's Mitt.*, 28. 184, 1910; J. Johnstone, H. E. Merwin, and E. D. Williamson, *Amer. Journ. Science*, (4), 41. 473, 1916; K. Spangenberg, *Zeit. Kryst.*, 56. 433, 1921.
- ⁸ H. Rose, *Pogg. Ann.*, 86. 293, 1852; C. Scheibler, *Ber.*, 19. 1973, 2865, 1886; C. Heyer, *ib.*, 192. 684, 3222, 1886; R. Finkener, *ib.*, 19. 2958, 1886; F. M. Raoult, *Compt. Rend.*, 92. 189, 1110, 1881; J. B. M. Bucquet, *Mém. Acad.*, 7. 1, 1773; 9. 563, 1780.
- ⁹ P. Rohland, *Chem. Ztg.*, 30. 808, 1906; A. R. Schulatschenko, *Dingler's Journ.*, 205. 335, 1872; W. Wolters, *ib.*, 196. 343, 1870; C. Heyer, *Ber.*, 192. 684, 3222, 1886; R. Finkener, *ib.*, 19. 2958, 1886; H. Rose, *Pogg. Ann.*, 86. 293, 1852; C. Scheibler, *Ber.*, 19. 1973, 2865, 1886.
- ¹⁰ G. Rose, *Pogg. Ann.*, 42. 354, 1837; 111, 156, 1860; 112. 43, 1860; O. Knöfler, *Wied. Ann.*, 38. 136, 1889; M. Pettenkofer, *Liebig's Ann. Suppl.*, 2. 23, 1862; *Journ. prakt. Chem.*, (1).

82. 32, 1860; E. Drechsel, *ib.*, (2), 16. 169, 1877; H. A. von Vogel, *Schweigger's Journ.*, 33. 207, 1821; *Ann. Chim. Phys.*, (2), 89. 131, 1814; M. Adler, *Zeit. angew. Chem.*, 14. 431, 1897; J. L. Smith, *Liebig's Ann.*, 159. 84, 1871; N. Gräger, *Zeit. anal. Chem.*, 7. 467, 1868; R. Fresenius, *ib.*, 2. 49, 1863; H. Watson, *Chem. News*, 68. 109, 1891; L. Roon, *U.S. Pat. No.* 1372193, 1919; J. Faldner, *German Pat.*, *D.R.P.* 334014, 1919.

¹¹ G. Rose, *Pogg. Ann.*, 42. 354, 1837; 111. 156, 1860; 112. 43, 1860; O. Knöfler, *Wied. Ann.*, 38. 136, 1889; M. Pettenkofer, *Liebig's Ann. Suppl.*, 2. 23, 1862; *Journ. prakt. Chem.*, (1), 82. 32, 1860; E. Drechsel, *ib.*, (2), 16. 169, 1877; H. A. von Vogel, *Schweigger's Journ.*, 33. 207, 1821; *Ann. Chim. Phys.*, (2), 89. 131, 1814; M. Adler, *Zeit. angew. Chem.*, 14. 431, 1897; J. L. Smith, *Liebig's Ann.*, 159. 84, 1871; N. Gräger, *Zeit. anal. Chem.*, 7. 467, 1868; R. Fresenius, *ib.*, 2. 49, 1863; H. Watson, *Chem. News*, 68. 109, 1891.

¹² E. Hatschek, *Chem. Ztg.*, 33. 49, 1909; J. Bevad, *Journ. Russ. Phys. Chem. Soc.*, 10. 89, 1885; M. M. P. Muir, *Journ. Chem. Soc.*, 37. 60, 1880; C. Heyer, *German. Pat.*, *D.R.P.* 37597, 1886; J. J. Berzelius, *Jahresber.*, 23. 106, 1844; H. Rose, *Pogg. Ann.*, 86. 293, 1852; G. Rose, *ib.*, 42. 354, 1837; 111. 156, 1860; 112. 43, 1860; *Abhand. Akad. Berlin*, 1, 1856; 63, 1858; *Monatsb. Akad. Berlin*, 365, 575, 1860; L. Bourgeois, *Bull. Soc. Min.*, 6. 111, 1882; *Compt. Rend.*, 94. 228, 991, 1882; 103. 1088, 1886; A. C. Becquerel, *ib.*, 34. 32, 573, 1852; 75. 52, 1872; M. Miron and M. Bruneau, *ib.*, 95. 182, 1882; H. Credner, *Journ. prakt. Chem.*, (2), 2. 292, 1870; L. M. Michel, *Bull. Soc. Min.*, 27. 220, 1905; C. Friedel and E. Sarasin, *ib.*, 8. 304, 1885; H. Drevermann, *Liebig's Ann.*, 87. 120, 1853; 89. 11, 1854; H. Vohl, *ib.*, 88. 114, 1853; J. Morris, *ib.*, 213. 253, 1882; H. Vater, *Zeit. Kryst.*, 21. 433, 1893; 22. 209, 1894; 24. 366, 378, 1895; 27. 477, 1896; 30. 295, 485, 1899; 31. 538, 1899; 35. 149, 1901; P. Harting, *Bull. Sciences Néerlande*, 287, 1840; M. Kleinstück, *Pharm. Centr.*, 51. 63, 1910; J. Zöega, *Karsten's Archiv*, 2. 17, 1824; W. Meigen, *Neues Jahrb. Min.*, ii, 19, 1903; M. Bauer, *ib.*, i, 12, 1890; H. Leitmeier, *ib.*, i, 49, 1910; *Neues Jahrb. Min. B.B.*, 40. 655, 1915; F. Cornu, *Oester. Zeit. Berg. Hütt.*, 55. 596, 1907; F. Vetter, *Zeit. Kryst.*, 48. 45, 1910; J. B. J. D. Bousingault, *Ann. Chim. Phys.*, (2), 29. 288, 1825; C. J. B. Karsten, *Philosophie der Chemie*, Berlin, 173, 1843; F. Sandmeyer, *Pogg. Ann.*, 129. 472, 1866; H. W. Foote, *Zeit. phys. Chem.*, 33. 740, 1900; F. Senft, *Ber.*, 9. 1799, 1876.

¹³ W. Vaubel, *Journ. prakt. Chem.*, (2), 86. 366, 1912; H. Leitmeier, *Neues Jahrb. Min. B.B.*, 40. 655, 1916; E. Mitscherlich, *Pogg. Ann.*, 21. 157, 1831; G. Rose, *ib.*, 42. 360, 1837; G. Tammann, *Kristallisieren und Schmelzen*, Leipzig, 113, 1903; G. Linck, *Naturwiss. Wochenschr.*, 8. 691, 1909; H. W. Foote, *Zeit. phys. Chem.*, 33. 741, 1900; O. Mügge, *Neues Jahrb. Min. B.B.*, 14. 246, 1901; H. E. Boeke, *Zeit. anorg. Chem.*, 50. 244, 1906; P. N. Laschtschenko, *Journ. Russ. Phys. Chem. Soc.*, 43. 793, 1911; H. L. J. Bäckström, *Zeit. phys. Chem.*, 97. 179, 1921; *Medd. Vet. Nobelinst.*, 4. 11, 1921; K. Spangenberg, *Zeit. Kryst.*, 56. 432, 1921; J. Johnstone, H. E. Merwin, and E. D. Williamson, *Amer. Journ. Science*, (4), 41. 473, 1916.

¹⁴ C. F. Bucholz, *Gehlen's Journ.*, 1. 310, 1803; A. Duflos, *Arch. Pharm.*, (1), 36. 275, 1831; E. F. Anthon, *Repert. Pharm.*, 59. 326, 1837; H. W. F. Wackenroder, *Monit. Scient.*, (4), 1. 1215, 1887; *German Pat.*, *D.R.P.P.* 28062, 1883; 36388, 1885; 41154, 1886; 49013. 1888; W. H. Bresler, *ib.*, 120317, 121973, 1899; F. Gärtner, *ib.*, 131566, 1901; D. Urquhart and W. A. Rowell, *ib.*, 26241, 1883; C. F. Claus, *ib.*, 26481, 27159, 1883; E. A. Mebus and J. W. Decastro, *ib.*, 31668, 1884; F. G. Bolton, *ib.*, 21588, 1882; *Dingler's Journ.*, 248. 249, 1883; H. Grouven, *Zeit. Rübenzuckerind.*, 11. 113, 1883; M. Rivière, *Bull. Soc. Mulhouse*, 36. 438, 1866; A. Scheurer-Kestner, *ib.*, 36. 448, 1866.

¹⁵ C. Brunner, *Dingler's Journ.*, 150. 375, 1858; L. G. G. Daudenart and E. Verbert, *Ber.*, 8. 169, 1875; W. Spring, *Bull. Soc. Chim.*, (2), 44. 166, 1885; *Bull. Acad. Belgique*, (3), 10. 204, 1885; J. H. MacMahon, *U.S. Pat. No.* 1378595, 1921.

¹⁶ T. Scheerer, *Pogg. Ann.*, 68. 382, 1846; W. F. Salm-Horstmar, *ib.*, 35. 515, 1835; J. Roth, *ib.*, 95. 172, 1855; C. F. Rammelsberg, *Ber.*, 4. 569, 1871; E. Pfeiffer, *Arch. Pharm.*, (3), 15. 212, 1879; A. C. Becquerel, *Ann. Chim. Phys.*, (2), 47. 9, 1831; T. J. Pelouze, *ib.*, (2), 48. 301, 1831; *Compt. Rend.*, 60. 429, 1865; T. S. Hunt, *Amer. Journ. Science*, (2), 42. 49, 1866; J. F. Daniell, *Journ. Science and Arts*, 6. 32, 1819; O. Bütschli, *Abhand. Ges. Wiss. Göttingen*, 6, 1908; W. Biedermann, *Biol. Centr.*, 21. 343, 1901; *Zeit. allg. Physiol.*, 2. 395, 1905; K. Kosmann, *Zeit. deut. geol. Ges.*, 44. 155, 1892; L. Iwanoff, *Ann. Géol. Min. Russ.*, (8), 1. 23, 1905; N. Krischtofowitsch, *ib.*, (8), 3. 124, 1906; P. Tschirwinsky, *ib.*, (8), 8. 238, 1910; *Proc. Nat. Soc. Kieff*, 21. 285, 1910; J. Morozewicz, *Kosmos*, 32. 487, 1907; T. C. N. Bröksmit, *Pharm. Weekbl.*, 58. 210, 1921; J. Johnstone, H. E. Merwin, and E. D. Williamson, *Amer. Journ. Science*, (4), 41. 473, 1916.

§ 22. The Solubility of the Carbonates of the Alkaline Earths

Calcium carbonate is but sparingly soluble in water and its solubility in different solvents has attracted much attention on account of the bearing of the results on geological processes, and on the nature of soil soln. Determinations were made by C. Weltzien,¹ A. Cossa, T. Schlösing, L. F. Caro, A. W. von Hofmann, R. Irvine

and G. Young, W. S. Anderson, N. Ljubawin, E. Pollacci, etc. The reported numbers for the solubility of calcium carbonate in water in contact with air are somewhat discrepant. For example, R. Fresenius found a litre of water dissolves 0.0602 part of calcium carbonate at ordinary temp., while A. Bineau found 0.02 part; G. Bischof, 0.028 part; L. F. Caro, 0.03 part; J. L. Lassaigne, 0.007 to 0.088 part. A. F. Hollemann, 0.01004 part at 8.7° and 0.0125 part at 23.8°; R. Warington, 0.009852 part at 21°; and F. Gothe gave 0.037 grm. per litre of gas-free water. A. Bineau wrongly inferred that calcium carbonate is less soluble at 100° than at 16°. R. Fresenius found that a litre of water at 100° dissolves 0.0111 part, and E. Pollacci, 0.0143 part of calcium carbonate.

J. Kendall obtained the results indicated in Fig. 54, for the solubility of calcite and aragonite in a litre of water freed from carbon dioxide and in an atm. freed from the same gas; while the dotted curve represents the solubility of calcite in water exposed to atm. air. The results, in grams per litre, are:

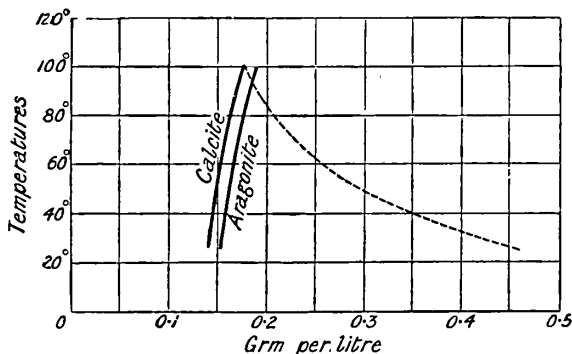

FIG. 54.—Solubility of Calcite and Aragonite in Water.

		25°	50°	100°
Calcite		0.0143	0.0150	0.0178
Aragonite		0.0154	0.0162	0.0190

The ratio of the two solubilities at a given temp. is nearly constant as illustrated by the nearly parallel solubility curves. The data for precipitated calcium carbonate and soft chalk are virtually the same as for calcite, so that amorphous calcium carbonate is assumed to be so extremely unstable that solubility data cannot be obtained. J. Kendall also stated that vaterite has the same sp. gr. as aragonite, and that the higher solubility is due to the obstinate retention of a trace of carbon dioxide by the soln. H. L. J. Bäckström found the solubilities in the presence of carbon dioxide at a press. of 742–777 mm. to be for calcite 1.30, 0.943, and 0.765 grms. per litre respectively at 9°, 25°, and 35°, and likewise for aragonite 1.46, 1.066, and 0.876 grms. per litre. F. Kohlrausch and F. Rose showed that a litre of water dissolved:

		2°	10°	18°	26°	34°	
CaCO ₃ {	precipitated	16	21	27	30	—	mgrams.
	calcite	4.6	20	26	32	39	„
	aragonite	17.6	23.5	30.5	39	48	„
SrCO ₃		7.7	11	15	—	26	„
BaCO ₃		—	17	24	—	—	„

In harmony with the generalization: *Of two different forms of a compound, the less stable modification is usually the more soluble*, the solubility of aragonite in water is a little greater than that of calcite. Corresponding with this, the equilibrium constant in the reaction between aragonite and potassium oxalate, $\text{CaCO}_3 + \text{K}_2\text{C}_2\text{O}_4 \rightleftharpoons \text{CaC}_2\text{O}_4 + \text{K}_2\text{CO}_3$, is nearly 1.3 times greater than that in the reaction between calcite and potassium carbonate; similar results were obtained in the precipitation of the heavy metals by calcite and by aragonite. The partial pressure of the carbon dioxide over aragonite is nearly 1.4 times greater than it is with calcite at 8°. and 1.13, at 25°.

The temp. coeff. at 18° for the solubility of calcium carbonate is 0.0008; for

strontium carbonate, 0.015; and for barium carbonate, 0.013. Solubilities calculated from the electrical conductivities are erroneous when the salts are appreciably hydrolyzed. D. Gardner and D. Gerassimoff found the conductivity of a sat. soln. of barium carbonate diminishes in the presence of an increasing proportion of sodium hydroxide until it reaches a limiting value 6×10^{-6} in place of 28.6×10^{-6} obtained with water as solvent. The conductivity of a soln. of barium sulphate is not affected by the presence of sodium hydroxide.

The solubility of strontium carbonate in water was found by A. Bineau to be 0.010 grm. per litre; by R. Fresenius, 0.0554 grm. per litre; and 0.080 grm. per litre by P. Kremers. A. F. Hollemann found a litre of water at 8.8° dissolves 0.00082 grm. of strontium carbonate; and at 24.3°, 0.0109 grm.; and for barium carbonate he found 0.016 grm. per litre at 8.8° and 0.024 grm. at 24.2°. A litre of water sat. with CO₂ dissolves 1.19 grms. of strontium hydrocarbonate, and, according to A. M. Pleischl, when the soln. is evaporated it redeposits the strontium carbonate in needle-like crystals. H. N. McCoy and H. J. Smith measured the solubility of strontium carbonate in water containing carbon dioxide at press. ranging from 0.05 to 1.1 atm. A. Bineau also found the solubility of barium carbonate to be 0.0025 grm. per litre of water; R. Fresenius gave 0.0707 grm. per litre at 16°–20°; and 0.068 grm. per litre in boiling water; and P. Kremers gave 0.083 grm. per litre. G. Wagner gives a solubility of 7.25 grms. of barium carbonate per litre with water sat. with carbon dioxide at 4–6 atm. press. According to H. W. Foote and G. A. Menge, the relative solubilities of calcium and barium carbonates at room temp. are $\sqrt[3]{(\text{Ca}/\text{Ba})} = 1.20$; F. Kohlrausch and F. Rose's data give for this ratio 1.08.

The aq. soln. of calcium carbonate was found by M. Pettenkofer to be neutral towards turmeric, but if the soln. has lost some carbon dioxide the indicator is browned. As shown by A. Laugier, A. M. Pleischl, and G. Rose, if water is boiled with powdered marble or chalk, it colours red-litmus blue. Powdered marble, chalk, Iceland spar, calcite, or aragonite were found by C. A. Kenngott, A. Laugier, A. M. Pleischl, G. Rose, C. R. C. Tichborne, and W. Skey to be alkaline towards litmus or extract of violets; and F. Cornu, that a soln. of phenolphthalein is reddened when the powdered mineral is shaken with water. F. Mohr found that cochineal tincture is coloured violet; but R. Fresenius reported an aq. soln. has a scarcely appreciable alkaline reaction. H. Rose believed that boiling water exerted no chemical action on calcium and barium carbonates. The solubility of calcium carbonate in water at 100° is given by A. W. von Hofmann as 0.034; C. Weltzien, 0.036; R. Fresenius, 0.111; and E. Pollacci, 0.143 grm. per litre. The increased solubility at 100° is not likely to be due to the formation of a hydrate stable at 100°. H. le Chatelier showed that calcium carbonate dissociates in boiling water and loses carbon dioxide, and A. Cavazzi found that in consequence it is not possible to get a soln. of calcium carbonate alone in boiling water, for calcium hydroxide also passes into soln. This quantity depends on the duration of boiling, and on the conc. and vol. of the soln. The limit of the dissociation is attained when 15 c.c. of a soln. of calcium hydroxide, sat. at ordinary temp., is present per litre. The dissociation of calcium carbonate in boiling soln. is prevented if 0.05 grm. of sodium carbonate per litre is present.

F. W. Küster showed that in aq. soln. calcium carbonate is not only ionized, but is also hydrolyzed; and G. Bodländer calculated that between 80 and 83.4 per cent. of calcium carbonate is hydrolysed in aq. soln.; and between 78 and 82 per cent. of barium carbonate is similarly hydrolyzed. Consequently, assuming that the reaction is typified by $\text{CaCO}_3 + 2\text{H}_2\text{O} \rightleftharpoons \text{Ca}(\text{OH})_2 + \text{H}_2\text{CO}_3$, the dissociation of the carbonic acid is determined by the partial press. of the carbon dioxide of the atm. in contact with the soln. It follows from the balanced reaction that the greater the conc. of the carbon dioxide in the soln., the less the solubility of the calcium carbonate. The direct converse actually obtains, for calcium carbonate readily dissolves in aq. soln. of carbonic acid. Sat. lime-water is rendered turbid by carbon

dioxide, but as the passage of the gas is continued, the opacity nearly disappears, and if a little more water is added, a clear soln. is obtained. When the aq. soln. is exposed to air, or boiled, normal calcium carbonate is precipitated. It is therefore inferred, by analogy with other cases, that soluble calcium hydrocarbonate, $\text{Ca}(\text{HCO}_3)_2$, is formed: $\text{CaCO}_3 + \text{H}_2\text{CO}_3 \rightleftharpoons \text{Ca}(\text{HCO}_3)_2$. R. Irvine found heat was evolved during the precipitation of the carbonate when carbon dioxide is passed into a soln. of lime-water, and a second rise of temp. occurs when the precipitate begins to dissolve. The second rise of temp. was attributed to the formation of the hydrocarbonate. E. P. Treadwell and M. Reuter found that under press. of one atm., the solubility of calcium carbonate varied continuously with the press. in the gas phase; and at 15°, with a zero partial press. in the gas phase, the molar proportions $\text{CaO} : \text{CO}_2$ in the soln. exactly correspond with calcium hydrocarbonate. P. N. Raikow found lime-water absorbed enough carbon dioxide to form a hydrocarbonate, and, making a correction for the solubility of carbon dioxide in water, it is claimed that the remaining gas must be bound chemically, since it cannot be removed by mechanical means, and was always present in the requisite amount. A. Cavazzi analyzed soln. of the alleged calcium hydrocarbonate prepared in various ways, and found the results in agreement with the formula $\text{CaO} \cdot 2\text{CO}_2 \cdot n\text{H}_2\text{O}$.

The partial press. of the carbon dioxide in the atm. determines the conc. of the unstable carbonic acid: $\text{H}_2\text{CO}_3 \rightleftharpoons \text{H}_2\text{O} + \text{CO}_2$, in the soln., and the conc. of the carbonic acid, in turn, determines the conc. of the carbonate in soln. While air normally contains about 3 parts of carbon dioxide per 10,000, comparatively small changes in the conc. of this gas in the atm. may bring about the soln. or deposition of large quantities of calcium carbonate. The amount of calcium carbonate which will dissolve in water in contact with air, and the variability of this solubility with the carbon dioxide content of the atm., are of great importance in connection with a number of geological processes. R. C. Wells obtained rather higher solubilities than J. Kendall for calcite and aragonite, possibly because of the greater conc. of the atm. carbon dioxide; and, when the atm. contained between 3.02 and 3.27 parts of carbon dioxide in 10,000, R. C. Wells found the solubility of calcium carbonate in grams per litre to be:

	0°	10°	20°	25°	30°	40°	50°
CaCO_3 . . .	0.081	0.070	0.065	0.050	0.052	0.044	0.038

T. Schlösing measured the solubility of calcium and barium carbonates in water with carbon dioxide in soln. J. Johnstone calculated the solubility of calcium carbonate in water, at 16°, from measurements by T. Schlösing, and R. Engel, and expressing the results in gram-atoms of Ca and in mols of $\text{Ca}(\text{HCO}_3)_2$ per litre, when the partial press. of the carbon dioxide is p atm., found:

p . . .	0.000504	0.000808	0.00333	0.0282	0.0501	0.1422	0.5533	0.9841
Ca . . .	0.000746	0.000850	0.001372	0.002965	0.003600	0.005330	0.008855	0.01086
$\text{Ca}(\text{HCO}_3)_2$	0.000731	0.000837	0.001364	0.002961	0.003597	0.005328	0.008854	0.01086

H. N. McCoy and H. J. Smith obtained the following solubilities for calcium carbonate at 25°, in contact with air containing carbon dioxide at partial press. p atm., when the results are expressed in grams per litre of sat. soln.:

p . . .	0.1	1.1	9.9	13.2	16.3	25.4
H_2CO_3 . . .	0.22	2.3	20.6	27.5	34.1	53.2
$\text{Ca}(\text{HCO}_3)_2$	0.67	1.58	3.62	4.04	4.21	4.22
Solid phase		CaCO ₃			Ca(HCO ₃) ₂	

These results show that the soln. is sat. with calcium hydrocarbonate when the carbon dioxide exerts about 15 atm. press., and that it should be theoretically possible to convert all the normal carbonate into hydrocarbonate by introducing sufficient carbon dioxide at 15 atm. The reaction is so slow that it would require

three months for the complete conversion. A. Cavazzi found the solubility of calcium carbonate in water sat. at one atm. press. to be 1.50 grms. per litre at 0°, and 1.1752 grms. at 15°. A supersat. soln. prepared by passing a very rapid stream of carbon dioxide through a sat. soln. of lime-water at 15° contained 2.29 grms. of calcium carbonate. J. W. Leather and J. Sen measured the solubility of calcium carbonate in contact with air containing 0.8 to 31.6 partial press. of carbon dioxide at 15°, 20°, 25°, 30°, 35°, and 40°, but their results for carbon dioxide are probably too low. They found the solid phase to be always the normal carbonate, and concluded that

the solid hydrocarbonate is not stable above 15°. H. Ehlert, and C. A. Seyler and P. V. Lloyd also measured the solubility of calcium carbonate in the presence of an excess of carbon dioxide.

J. Johnstone and E. D. Williamson have shown that the conc. of the calcium carbonate in soln. at equilibrium in the system $\text{CaO}-\text{H}_2\text{O}-\text{CO}_2$ can be represented by three curves along which the stable solid phase is hydroxide, carbonate, and hydrocarbonate respectively. In Fig. 55, the stable solid phase along AP_1 is hydroxide; between P_1 and P_2 it is carbonate; and along P_2B it is hydro-

carbonate. The curves, Fig. 55, were plotted from Table XIII. J. Johnstone and E. D. Williamson have shown that the equilibrium between the hydroxide

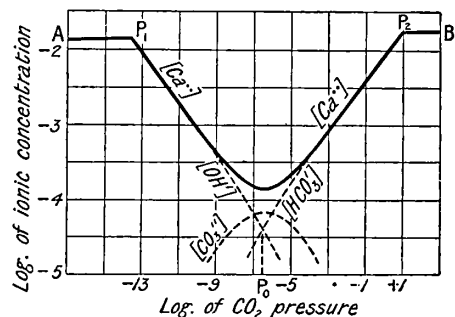

FIG. 55.—Relation between the Partial Pressure of Carbon Dioxide and the Concentrations of the several Ions in the System, $\text{CaO}-\text{H}_2\text{O}-\text{CO}_2$, at 16°.

TABLE XIII.—IONIC CONCENTRATIONS OF SOLUTIONS OF CALCITE IN CONTACT WITH AIR HOLDING CARBON DIOXIDE AT A PARTIAL PRESSURE P , at 16°.

P	$[\text{HCO}_3'] \times 10^4$	$[\text{OH}'] \times 10^4$	$[\text{CO}_3''] \times 10^4$	$[\text{Ca}'''] \times 10^4$	Parts CaC_2 per million.
2.15×10^{-4}	10.0	0.0174	1.188	5.197	56
7.63×10^{-5}	7.0	0.034	0.260	3.777	40
7.62×10^{-6}	3.0	0.147	0.478	2.051	22
6.07×10^{-7}	1.0	0.614	0.666	1.473	16.0
3.85×10^{-7}	0.80	0.774	0.672	1.459	15.9
3.73×10^{-7}	0.787	0.787	0.672	1.459	15.9
2.19×10^{-7}	0.60	1.02	0.665	1.476	16.0
6.14×10^{-8}	0.30	1.82	0.593	1.654	18
9.78×10^{-9}	0.10	3.82	0.414	2.377	26
2.80×10^{-10}	0.01	13.3	0.144	6.81	74
3.16×10^{-14}	0.0000235	277.0	0.0071	138.5	2000

$\text{Ca}(\text{OH})_2$ and the sat. aq. soln. is affected by a progressive increase from zero to a partial press. P of carbon dioxide in the atm. in contact with the soln., in the following manner: The addition of carbon dioxide is followed by a distribution between the vapour and liquid phases until there is equilibrium between the residual partial press. of the carbon dioxide and the carbonic acid, H_2CO_3 , in soln., and, in turn, between the latter and the several ions. The net effect is a definite decrease in the conc. of the hydroxide ions $[\text{OH}']$, which requires that more hydroxide be dissolved in order to maintain the constancy of the solubility product $[\text{Ca}'''][\text{OH}']^2$. Consequently, the total conc., $[\text{Ca}''']$, increases, part of it being now present as carbonate and hydrocarbonate. Otherwise expressed, the apparent solubility of the base increases if the method of analysis is a determination of Ca, and it would decrease if the conc. $[\text{OH}']^2$ were determined. This

process continues until the product $[Ca^{..}][CO_3^{..}]$ reaches the value needed for the precipitation of calcium carbonate—assuming that no supersaturation occurs, and no basic carbonate is formed. This precipitation occurs at a definite value of P , which depends only on the temp. and is about $P_1=10^{-14}$ atm. at 16° . At a given temp., this transition press. is the highest under which solid hydroxide is stable. At P_1 the solubility as measured by the total $[Ca^{..}]$ begins to diminish, because an increase of the partial press. of carbon dioxide increases the conc. $[CO_3^{..}]$, while the product $[Ca^{..}][CO_3^{..}]$ remains constant so long as $CaCO_3$ is the stable solid phase. This increase of $[CO_3^{..}]$ continues until a definite press. P_0 is reached, and the formation of hydrocarbonate in soln. then becomes the predominant reaction, and the conc. $[CO_3^{..}]$ begins to decrease again. P_0 thus corresponds with a minimum in the solubility curve. At 16° , P_0 is nearly 3.73×10^{-7} atm. or about 0.016 gm. of calcium carbonate per litre. As the partial press. of carbon dioxide increases beyond P_0 , the conc. of both $Ca^{..}$ and HCO_3' increase steadily until the precipitation value of the product $[Ca^{..}][HCO_3']_2$ is reached, when the partial press. is approximately $P_2=15$ atm., and both carbonate and hydrocarbonate are present as solid phases. Beyond P_2 , the hydrocarbonate is alone stable, and its total solubility falls off very slowly with a further increase in the partial press. of carbon dioxide.

Again, there can be no real equilibrium in aq. soln. of calcium carbonate except in the presence of a definite press. of carbon dioxide in the atm. in contact with the soln. If a stream of an indifferent gas—free from carbon dioxide—be passed through a soln. of calcium carbonate, the soln. would gradually lose its carbonate and ultimately contain only the hydroxide. For equilibrium in the system: $CaCO_3 + H_2CO_3 \rightleftharpoons Ca(HCO_3)_2$, $[H_2CO_3]=k[Ca(HCO_3)_2]$; and assuming that the carbonic acid is non-ionized, $i=1$, and that for the hydrocarbonate, $Ca(HCO_3)_2$, $i=2.56$, in agreement with f.p. measurements, J. H. van't Hoff writes $\log [H_2CO_3]-2.56 \log [Ca(HCO_3)_2]=k$, or, if y denotes the conc. of the dissolved lime, corresponding with the conc. of the hydrocarbonate, and if P denotes the partial press. corresponding to the conc. of the carbonic acid, and c be a constant, $y=cP^{0.39}$, so that the quantity of lime dissolved is proportional to the press. of the carbon dioxide raised to the 0.39 power. The limiting case for complete ionization of the hydrocarbonate gives $y=cP^{0.333}$. T. Schlösing found empirically $0.92128y=P^{0.37866}$, when P is between zero and unity. If a curve of this type correctly interprets the observed results it is not probable that calcium hydrocarbonate is formed, because the initial solid phase is calcium carbonate, and the curve would be continuous without a break for a change of the solid phase to hydrocarbonate. L. F. Caro showed that the relation is not applicable at higher press. H. Vater investigated the relation between the conc. of the hydrocarbonate and that of the carbon dioxide in soln.

G. Bodländer has studied the equilibrium conditions between the dissolved carbon dioxide and calcium or barium carbonate. So long as calcium carbonate is the solute, the equilibrium condition is $[Ca^{..}][CO_3^{..}]=k_1$; when carbon dioxide is introduced, the conc. of the Ca-ions increases, and that of the CO_3 -ions decreases. The carbonic acid, H_2CO_3 , in soln. ionizes: $H_2CO_3 \rightleftharpoons H^+ + HCO_3'$ and $HCO_3' \rightleftharpoons H^+ + CO_3^{..}$. The equilibrium condition for the former is $[H^+][HCO_3']/[H_2CO_3]=k_2$, and for the latter, $[H^+][CO_3^{..}]/[HCO_3']=k_3$; or $k_2[H_2CO_3][CO_3^{..}]=k_3[HCO_3']^2$; and $k_1k_2[H_2CO_3]=k_3[HCO_3']^2[Ca^{..}]$; but each Ca-ion corresponds with two HCO_3 -ions, or $[Ca^{..}]=\frac{1}{2}[HCO_3']$, and therefore $2k_1k_2[H_2CO_3]=k_3[HCO_3']^3$. By Henry's law, $[H_2CO_3]=k_4[CO_2]$. Consequently, $2k_1k_2k_4[CO_2]=k_3[HCO_3']^3$. All four constants have been determined. J. Walker and W. Cormack found k_2 to be 3.04×10^{-7} ; J. Shields found $k_3=1.295 \times 10^{-11}$; and k_4 , calculated from T. Schlösing's data, is 0.04354. Hence, $[HCO_3']=12.69 \sqrt[3]{k_1[CO_2]}$; and again from T. Schlösing's data, $k_1=28.42 \times 10^{-16}$. Similar results were obtained with barium carbonate. G. Bodländer's value for the solubility product of calcium carbonate is considered to be erroneous owing to the use of an incorrect value for k_3 , the secondary ionization constant of carbonic acid. J. Stieglitz calculated $k_3=6.20 \times 10^{-11}$. This secondary

constant increases with increasing conc. of the alkali carbonate soln. used in its determination. The **solubility product** of calcium carbonate, calculated by J. Stieglitz, is $k_1=12.6 \times 10^{-9}$; H. N. McCoy and H. J. Smith found $k_1=9.3 \times 10^{-9}$. The latter also give for the solubility product of strontium carbonate, $[\text{Sr}^{++}][\text{CO}_3^{--}]=k_1$, or $k_1=1.567 \times 10^{-9}$; and for barium carbonate, $[\text{Ba}^{++}][\text{CO}_3^{--}]=k_1$, or $k_1=8.1 \times 10^{-9}$. J. Johnstone gives for barium carbonate 7.0×10^{-9} at 16° , and he found the solubility product of calcium carbonate (calcite) to be 0.98×10^{-8} , at 16° , and C. A. Seyler and P. V. Lloyd found 0.86×10^{-8} at the laboratory temp. The data have been re-calculated by Y. Osaka.

F. K. Cameron and A. Seidell measured the solubility of calcium carbonate in aq. soln. of *sodium chloride*. Expressing the solubilities in grams per 100 c.c. of soln., at 25° , they found with soln. in equilibrium with ordinary air:

NaCl	:	:	1	4	8	10	15	20	25
CaCO ₃	:	:	0.0112	0.0140	0.0137	0.0134	0.0119	0.0106	0.0085

F. K. Cameron, J. M. Bell, and W. O. Robinson found for soln. in contact with air freed from carbon dioxide, at 25° :

NaCl	.	.	1.60	5.18	9.25	11.48	16.66	22.04	30.50
CaCO ₃	.	.	0.0079	0.0086	0.0094	0.0104	0.0106	0.0115	0.0119

and for carbon dioxide at atm. press.:

NaCl	.	.	1.49	5.69	11.06	15.83	19.62	29.89	35.85
CaCO ₃	.	.	0.150	0.160	0.174	0.172	0.159	0.123	0.103

The solubility curve shows a well-defined maximum corresponding with a soln. containing 0.1402 grm. of normal carbonate per litre. This is about 80 times the amount dissolved by water freed from carbon dioxide. The maximum point with the soln. in equilibrium with air represents a solubility about 2.36 times the result with water containing no sodium chloride. The sp. gr. of the soln. were also measured. F. K. Cameron, J. M. Bell, and W. O. Robinson also obtained data for the solubility of calcium carbonate in aq. soln. containing both sodium chloride and calcium sulphate, and in aq. soln. containing both sodium chloride and calcium sulphate. E. P. Treadwell and M. Reuter, E. A. Rowe, F. Gothe, H. Cantoni and G. Goguélia, and C. A. Seyler and P. V. Lloyd measured the effect of sodium chloride on the solubility of calcium carbonate. H. Ehlert and W. Hempel likewise measured the solubility in sodium chloride soln. at 5° in contact with an atm. freed from carbon dioxide, and in contact with that gas at 2 atm. press. T. Warynsky and S. Kouropatwinka found a litre of an aq. soln. containing 175.5 grms. of sodium chloride dissolved 0.062 grm. of calcite, or 0.071 grm. of aragonite at 60° .

F. K. Cameron and W. O. Robinson measured the solubility of calcium carbonate in aq. soln. of *potassium chloride*, at 25° , (a) in contact with air, and (b) in contact with carbon dioxide at one atm. press. Expressing the results in grams of salt per 100 grms. of sat. soln., they found:

KCl	.	.	0	3.90	7.23	11.10	13.82	18.21	26.00
CaCO ₃ (a)	:	:	0.0013	0.0078	0.0078	0.0076	0.0072	0.0070	0.0060
CaCO ₃ (b)	:	:	0.062	0.145	0.150	0.166	0.165	0.154	0.126

The sp. gr. of the soln. were also measured. E. A. Rowe, and H. Cantoni and G. Goguélia also measured the effect of potassium chloride on the solubility of calcium carbonate. H. Cantoni and G. Goguélia investigated the action of the alkali chlorides on barium carbonate; E. Taponier, the action of *alkali bromides* on barium carbonate. T. Warynsky and S. Kouropatwinka found a litre of an aq. soln. of potassium chloride at 60° dissolves 0.075 grm. of calcite, or 0.093 grm. of aragonite.

The latter also found for the solubility of calcite and of aragonite in aq. soln. of *ammonium chloride*, when the results are expressed in grams per litre, at 60°:

NH ₄ Cl . . .	0	1.07	5.035	10.70	26.76	53.52	160.56
Calcite . . .	0.028	0.164	0.333	0.453	0.664	0.934	1.21
Aragonite . .	0.041	0.184	0.371	0.505	0.728	1.015	1.36

H. Cantoni and G. Goguélia measured the solubility at 12°–18°, and A. Rindell at 25°. M. Bertrand, and E. A. Rowe also studied the solubility of calcium carbonate in soln. of the ammonium salts. A. Vogel found freshly precipitated calcium carbonate dissolves readily in a cold conc. soln. of an ammonium chloride, but with difficulty after the precipitate has stood for 24 hrs., and calcite or marble dissolves with still greater difficulty. E. A. Rowe, and C. A. Seyler and P. V. Lloyd measured the solubility of calcium carbonate in aq. soln. of *calcium chloride*. The solubilities of barium and strontium carbonates in aq. soln. of *ammonium nitrate*, ammonium chloride, and *ammonium succinate* have been studied by A. Vogel, R. H. Brett, G. C. Wittstein, H. W. F. Wackenroder, D. Smith, H. Demarçay, and H. Cantoni and G. Goguélia. The latter found that strontium carbonate is less soluble in a soln. of ammonium chloride than is calcium or barium carbonate; and they also measured the solubility of barium carbonate in soln. of sodium and potassium chlorides. G. Kernot, E. d'Agostino, and M. Pellegrino found the solubility of barium carbonate steadily increases with increasing proportions of ammonium chloride, and, at 25°, when the soln. contains 5 mols of the chloride per litre, the solubility curve assumes an upward inflexion, probably due to the formation of a double salt. C. J. B. Karsten observed the solubility of barium carbonate in an aq. soln. of calcium chloride; and H. Ehlert and W. Hempel, in aq. soln. of *magnesium chloride*, at 5°, in contact with an atm. freed from carbon dioxide, and also in contact with that gas at a press. of 2 atm.; E. A. Rowe also measured the solubility of calcium carbonate in the same menstruum. C. J. B. Karsten measured the solubility of barium carbonate in a soln. of *zinc chloride*.

R. Irvine and G. Young, W. Howchin, and E. Cohen and H. Raken studied the solubility of calcium carbonate in *sea-water*. R. C. Wells found that sea-water at 1° tends to retain more calcium carbonate in soln. than it does at 25°. Ordinary sea-water at 1° seems to contain so much carbonate that, in contact with the atm. at 1°, it has no appreciable solvent action on calcite; at a higher temp., sea-water undergoes a slow diminution in its carbonate content when agitated in contact with air. The equilibrium in the exchange of carbon dioxide between sea-water and the atm. is so slow, and the bulk of the ocean is so great, that the expected variations in the equilibria with temp. do not occur in the water of the open sea.

F. K. Cameron and A. Seidell measured the solubility of calcium carbonate in soln. of *sodium sulphate* in contact with air at 24°. Expressing the results in grams per litre:

Na ₂ SO ₄ . . .	5	10	20	40	80	150	250
CaCO ₃ . . .	0.175	0.232	0.277	0.332	0.400	0.510	0.725

Similarly, F. K. Cameron, J. M. Bell, and W. O. Robinson found at 25°, for soln. in contact with air freed from carbon dioxide:

Na ₂ SO ₄ . . .	0.97	1.65	4.90	12.69	14.55	19.38	23.90
CaCO ₃ . . .	0.151	0.180	0.262	0.313	0.322	0.346	0.360

H. Vater, E. A. Rowe, H. Ehlert and W. Hempel, and C. A. Seyler and P. V. Lloyd also measured the solubility of calcium carbonate in aq. soln. of sodium sulphate. the former at 14° in the absence of carbon dioxide, and with that gas at 2 atm. press. C. J. B. Karsten measured the solubility of barium carbonate in a soln. of sodium sulphate. F. K. Cameron and W. O. Robinson, E. A. Rowe, and H. Vater measured the solubility of calcium carbonate in aq. soln. of *potassium sulphate* at 25°; C. A. Seyler and P. V. Lloyd, in an aq. soln. of *calcium sulphate*; and they, as

well as H. Ehlert and W. Hempel, and E. A. Rowe, in an aq. soln. of *magnesium sulphate*. C. J. B. Karsten observed that calcium carbonate does not dissolve in a conc. aq. soln. of magnesium chloride; and F. Hoppe-Seyler observed the formation of no dolomite when the soln. of magnesium chloride is allowed to stand in contact with calcium carbonate for a month; some magnesium carbonate, however, is precipitated, and calcium carbonate dissolved. A. Gössmann said that when boiled, a little calcium chloride and basic magnesium chloride is formed. C. J. B. Karsten observed the solubility of barium carbonate in a soln. of *zinc sulphate*. L. Vecchiotti investigated the action of *alkali nitrates* on barium carbonate: $\text{BaCO}_3 + 2\text{MNO}_3 \rightleftharpoons \text{M}_2\text{CO}_3 + \text{Ba}(\text{NO}_3)_2$, where M stands for K, Na, or NH_4 . G. Berju and W. Kosinenko, and A. Rindell measured the solubility of calcium carbonate in aq. soln. of *ammonium nitrate* respectively at $1\cdot8^\circ$ and at 25° . Expressing results in grams per litre, the former found:

NH_4NO_3	.	0	5	10	20	40	80
CaCO_3	.	0·131	0·211	0·258	0·340	0·462	0·584

C. J. B. Karsten studied the solubility of barium carbonate in a soln. of *calcium nitrate*. J. Spiller noted that the presence of *sodium citrate* raises the solubility of calcium carbonate in water; and A. Rindell found the solubility of calcium carbonate in aq. soln. containing 0·0625 and 0·500 mol of *triammonium citrate* per litre, at 25° , to be respectively 1·492 and 6·687 grms. per litre. M. le Blanc and K. Novotny measured the solubility of calcium carbonate in aq. soln. of *sodium hydroxide* in contact with air freed from carbon dioxide, and found at 18° and between 95° and 100° :

NaOH	.	0	0·0001N-	0·0010N-	0·0100N-
CaCO_3 at 18°	.	0·0128	0·0087	0·0042	0·0042 gm. per litre
CaCO_3 at 95° to 100°	.	0·0207	0·0096	0·0069	0·0057 „ „

C. A. Seyler and P. V. Lloyd, and E. A. Rowe measured the solubility of calcium carbonate in aq. soln. of *sodium* and *potassium hydrocarbonate*. H. W. F. Wackenroder measured the solubility of barium carbonate in an aq. soln. of *potassium carbonate*. R. Wegscheider and H. Walter measured the conditions of equilibrium in aq. soln. containing calcium and sodium carbonates, and sodium hydroxide. H. Noll found that the solubility of calcium carbonate in water, free from carbon dioxide, is lessened in the presence of *magnesium carbonate*.

F. Gothe thus summarizes his results: The solubility of calcium carbonate is increased by the presence of *alkali chlorides, nitrates, and sulphates* in the water, but decreased by *alkali carbonates*, and by the *alkaline earth chlorides, nitrates, and sulphates*; *ammonium salts* decompose the carbonate and the effect on the solubility cannot be determined. The solubility is increased when the water contains *organic (humus) substances*, especially when alkali salts are also present, but is decreased in the presence of alkaline-earth salts. E. A. Rowe studied the solubility of calcium carbonate in soln. of *sodium hydrophosphate*.

REFERENCES.

- ¹ C. Weltzien, *Liebig's Ann.*, 136. 165, 1865; G. C. Wittetein, *Repert. Pharm.*, 57. 18, 1837; R. Wegscheider and H. Walter, *Liebig's Ann.*, 351. 87, 1907; *Monatsh.*, 28. 633, 1907; A. W. von Hofmann, *Journ. Chem. Soc.*, 4. 375, 1851; J. Walker and W. Cormack, *ib.*, 77. 8, 1900; C. A. Seyler and P. V. Lloyd, *ib.*, 95. 1347, 1909; R. Warrington, *ib.*, 6. 296, 1852; H. Ehlert, *Studien über Salzlösungen*, Leipzig, 1909; G. Bischof, *Lehrbuch der chemischen und physikalischen Geologie*, Bonn, 2. 64, 1855; P. Kremers, *Pogg. Ann.*, 85. 247, 1852; H. Rose, *ib.*, 86. 279, 1852; R. Irvine and G. Young, *Proc. Roy. Soc. Edin.*, 15. 316, 1889; W. S. Anderson, *ib.*, 16. 319, 1890; E. Pollacci, *L'Orosi*, 19. 217, 1896; L. F. Caro, *Arch. Pharm.*, (3), 4. 145, 1873; F. Mohr, *ib.*, 2) 148. 184, 1871; N. Ljubawin, *Journ. Russ. Phys. Chem. Soc.*, 24. 389, 1892; J. Stieglitz, *Carnegie Inst. Pub.*, 107. 233, 1908; F. Kohlrausch, *Ber. Nat. Ges. Freiburg*, 15. 38, 1905; *Zeit. phys. Chem.*, 44. 197, 1903; A. F. Hollemann, *ib.*, 12. 125, 1893; G. Bodländer, *ib.*, 35. 23, 1900; J. Shields, *ib.*, 12. 167, 1893; A. Rindell, *ib.*, 70. 452, 1910; D. Gardner and D. Geras-

simoff, *ib.*, 48. 359, 1904; F. Kohlrausch and F. Rose, *ib.*, 12. 234, 1893; *Wied. Ann.*, 50. 127, 1893; H. W. Foote and G. A. Menge, *Amer. Chem. Journ.*, 35. 432, 1906; T. Warynsky and S. Kouropatwinska, *Journ. Chim. Phys.*, 14. 328, 1916; T. Schlössing, *Compt. Rend.*, 74. 1552, 1872; 75. 50, 73, 1872; H. le Chatelier, *ib.*, 102. 1243, 1886; E. Cohen and H. Raken, *Versl. Akad. Amsterdam*, 9. 28, 1910; J. H. van't Hoff, *Vorlesungen über theoretische und physikalische Chemie*, Braunschweig, 1. 149, 1898; *Zeit. phys. Chem.*, 1. 505, 1887; A. Vogel, *Journ. prakt. Chem.*, (1), 7. 453, 1836; J. L. Lassaingne, *ib.*, (1), 44. 248, 1837; M. Pettenkofer, *ib.*, (1), 82. 32, 1860; C. A. Kenngott, *ib.*, (1), 101. 5, 1867; H. Ehlert and W. Hempel, *Zeit. Elektrochem.*, 18. 727, 1912; C. J. B. Karsten, *Philosophie der Chemie*, Berlin, 190, 1843; *Lehrbuch der Salinenkunde*, Berlin, 2. 274, 1847; R. Fresenius, *Liebig's Ann.*, 59. 119, 1846; H. W. F. Wackenroder, *ib.*, 24. 30, 1837; 41. 315, 1842; H. Demarçay, *ib.*, 11. 251, 1834; A. Bincau, *Ann. Chim. Phys.*, (3), 51. 290, 1857; R. Engel, *ib.*, (6), 13. 346, 1888; *Compt. Rend.*, 101. 949, 1885; J. Johnstone, *Journ. Amer. Chem. Soc.*, 37. 2001, 1915; J. Johnstone and E. D. Williamson, *ib.*, 38. 975, 1916; H. N. McCoy and H. J. Smith, *ib.*, 33. 468, 1911; E. H. Keiser and L. McMaster, *ib.*, 30. 1714, 1908; A. F. Charlard-Boutron and F. Boudet, *Journ. Pharm. Chim.*, (3), 26. 16, 1854; A. Mayer, *Landw. Ver. Stat.*, 16. 274, 1873; G. Berju and W. Kosinenko, *ib.*, 60. 419, 1904; H. Cavendish, *Phil. Trans.*, 57. 92, 1766; E. P. Treadwell and M. Reuter, *Zeit. anorg. Chem.*, 17. 170, 1898; K. Kippenberger, *ib.*, 18. 413, 1899; M. le Blanc and K. Novotny, *ib.*, 51. 181, 1906; F. W. Kiister, *ib.*, 22. 161, 1900; J. W. Leather and J. Sen, *Mem. Dept. Agric. India*, 1. 117, 1909; T. S. Hunt, *Amer. Journ. Science*, (2), 28. 170, 355, 1859; J. Kendall, *Phil. Mag.*, (6), 23. 958, 1912; R. H. Brett, *ib.*, (3), 10. 96, 1831; D. Smith, *ib.*, (3), 9. 540, 1831; H. Vater, *Zeit. Kryst.*, 30. 373, 1898; M. Bertrand, *Monit. Scient.*, (3), 10. 477, 1880; F. K. Cameron and L. J. Briggs, *Journ. Phys. Chem.*, 5. 537, 1901; F. K. Cameron and A. Seidell, *ib.*, 5. 643, 1901; 6. 50, 1902; F. K. Cameron, J. M. Bell, and W. O. Robinson, *ib.*, 11. 396, 1907; F. K. Cameron and W. O. Robinson, *ib.*, 11. 577, 1907; G. Rose, *Pogg. Ann.*, 112. 57, 1861; H. L. J. Bäckström, *Zeit. phys. Chem.*, 97. 179, 1921; *Medd. Vet. Nobelinst.*, 4, 11, 1921; Y. Osaka, *Journ. Tokyo Chem. Soc.*, 41. 453, 1920; E. A. Rowe, *Trans. New Zealand Inst.*, 52. 192, 1920; H. Noll, *Zeit. angew. Chem.*, 23. 2025, 1910; P. N. Raikow, *Chem. Ztg.*, 28. 1247, 1905; F. Gothe, *ib.*, 39. 305, 326, 1915; F. Hoppe-Seyler, *Zeit. deut. geol. Ges.*, 27. 509, 1875; A. Gössmann, *Repert. Pharm.*, 61. 49, 1837; R. Irvine, *Chem. News*, 63. 192, 1891; W. Skey, *ib.*, 22. 85, 1870; C. R. C. Tichborne, *ib.*, 22. 150, 1870; V. Rose, *Gehlen's Journ.*, 3. 548, 1807; A. M. Pleischl, *Zeit. phys. Math.*, 5. 54, 1829; A. Laugier, *Journ. Chim. Méd.*, 6. 225, 1830; L. B. G. de Morveau, *Journ. Phys.*, 19. 310, 382, 1782; J. Dalton, *New System of Chemical Philosophy*, Manchester, 1808; A. Cossa, *Bull. Soc. Chim.*, (2), 20. 440, 1873; H. Cantoni and G. Goguéla, *ib.*, (3), 31. 282, 1904; (3), 33. 13, 1905; F. P. Treadwell, *Zeit. anorg. Chem.*, 18. 418, 1899; F. Senft, *Ber.*, 9. 1799, 1876; G. Wagner, *Zeit. anal. Chem.*, 6. 167, 1867; R. C. Wells, *Journ. Washington Acad. Science*, 5. 617, 1915; F. Cornu, *Centr. Min.*, 550, 1906; A. Cavazzi, *Gazz. Chim. Ital.*, 46. ii, 122, 1916; 47. ii, 47, 1917; G. Kernot, E. d'Agostino, and M. Pellegrino, *ib.*, 38. i, 532, 1908; E. Taponier, *Étude de l'action des bromures alcalins sur le carbonate de baryum*, Genève, 1905; A. Corcelle, *Étude sur l'action des sulfates alcalins sur le phosphate tribarytique*, Genève, 1904; R. C. Wells, *Carnegie Inst. Pub.*, 213, 1918; W. Howchin, *Trans. Roy. Soc. South Australia*, 44. 381, 1920; J. Spiller, *Chem. News*, 8. 280, 1863; 15. 166, 1869; *Journ. Chem. Soc.*, 10. 110, 1858; L. Vecchiotti, *Étude de l'action des nitrates alcalins sur le carbonate de baryum*, Genève, 1907.

§ 23. The Properties of the Carbonates of the Alkaline Earths

The crystals of the calcite modification of calcium carbonate belong to the rhombohedral class of the hexagonal system or the trigonal system. P. Groth¹ gives for the axial ratio $a:c=1:0.8543$, and $\alpha=101^{\circ}55'$. There are more varieties of the crystalline form of calcite than with any other mineral. Count de Bournon, in his *Traité complet de la chaux carbonatée et de l'aragonite* (Londres, 1808), described over fifty, and since then hundreds have been reported. The crystals show four distinct habits—rhombohedral, prismatic, scalenohedral, and tabular. Twinning is also common. R. C. Wells reported the formation of aragonite crystals as a deposit in sea-water kept some years sealed up in glass jars. Calcite is isomorphous with magnesite, $MgCO_3$; mesitite, $Mg_2Fe(CO_3)_3$; ankerite, $Ca(Mg, Fe)CO_3$; dolomite, $MgCO_3 \cdot CaCO_3$; chalybite, $FeCO_3$; rhodochrosite or diallogite, $MnCO_3$; sphærocobaltite, $CoCO_3$; calamine, $ZnCO_3$ —*vide* Fig. 88, 1. 11, 10. Calcite is isomorphous with trigonal sodium nitrate; the two compounds have the rhombohedral angles respectively $74^{\circ}55'$ and $73^{\circ}27'$. T. V. Barker found that sodium nitrate forms parallel growths on clean fresh cleavage surfaces of calcite, independent of the habit or variety of the latter; but it does not form parallel growths on the other minerals

of the calcite family—the necessary condition for parallel and regular growths being closeness of mol. vol. rather than similarity of angle or axial ratios. According to H. le Chatelier, when rhombic strontianite is heated to 820° , it undergoes a reversible transformation into a trigonal modification corresponding with calcite, and W. Vernadsky places the transition temp. at 700° . O. Mügge, L. Bourgeois, and H. Vater showed that trigonal forms of strontium and barium carbonates occur in isomorphous mixtures with calcite. The *ncotype* of A. Breithaupt, and the *baryto-calcite*, from Långban (Sweden), and elsewhere, were shown by A. des Cloizeaux to belong to the trigonal system. G. Aminoff described crystals of calcite from Clausthal, with curved faces.

The crystals of aragonite form bipyramids belonging to the rhombic system and these crystals are isomorphous with strontianite, SrCO_3 ; witherite, BaCO_3 ; and cerussite, PbCO_3 . These carbonates form a eutropic series. The axial ratios of calcite, according to J. Beckenkamp, are $a : b : c = 0.6228 : 1 : 0.7204$; for strontianite, according to J. Beykirch, the axial ratios are $a : b : c = 0.60904 : 1 : 0.72661$; and for witherite, according to W. H. Miller, $a : b : c = 0.5949 : 1 : 0.7413$. Aragonite and potassium nitrate are homomorphous, the axial ratios of the latter are $a : b : c = 0.591 : 1 : 0.701$. T. V. Barker obtained no signs of the formation of parallel growths of potassium nitrate on fresh clean cleavage surfaces of aragonite. The rhombic mixed crystals of calcium and strontium carbonates form the minerals *emmonite* of T. Thomson and *calcio-strontianite* of A. Cathrein; and the rhombic mixed crystals of calcium and barium carbonates form the minerals *bromlite* of J. F. W. Johnston and T. Thomson, or the *alstonite* of A. Breithaupt, found at Fallowfield (Northumberland), and at Alstone (Cumberland). According to T. J. Pelouze, pentahydrated calcium carbonate forms very acute rhombohedral crystals; A. C. Becquerel said the crystals were rhombic prisms with dihedral summits like aragonite; and W. F. Salm-Horstmar, irregular six-sided prisms. W. Biedermann found the crystals of hexahydrated calcium carbonate to be monoclinic; and P. Tschirwinsky, the crystals of trihydrated calcium carbonate to be also monoclinic. The corrosion or etching figures of calcite have been studied by O. Meyer,² L. Lavizzari, V. von Ebner, A. Elterlin, V. Goldschmidt, A. Hamberg, E. Sommerfeldt, etc.

The X-radiogram of calcite has been studied by W. H. and W. L. Bragg,³ M. L. Huggins, F. M. Jäger and H. Haga, B. Davis and W. M. Stempel, F. Rinne, and E. Schiebold—*vide* Fig. 80, 1. 11, 8—and that of aragonite by W. H. and W. L. Bragg, F. M. Jäger and H. Haga, and F. Rinne. In the calcite rhombohedron lattice, R. W. G. Wyckoff calculated the distance between the carbon atom and three of its nearest oxygen atoms as 1.21×10^{-8} cm.; the distance of the calcium atom from the nearest oxygen atom as 2.30×10^{-8} cm.; and the shortest distance between the calcium and carbon atoms as 3.04×10^{-8} cm. H. Haga and F. M. Jäger also studied the X-radiograms of strontianite and witherite. M. L. Huggins gave for the volume of unit cell 112.7 cub. A. for aragonite, 131.7 cub. A. for strontianite, and 150.6 cub. A. for witherite; for the shortest distance between the carbon and the alkaline earth metal 3.004 A. for aragonite, 3.162 A. for strontianite, and 3.322 A. for witherite; the shortest distance between atoms of calcium and oxygen in aragonite is 1.28 A.

Various members of this carbonate group have been shown to have both the same general arrangement of atoms within the unit of structure and units of about the same size and shape. They are commonly said to be isomorphous with one another. According to W. L. Bragg, and R. W. G. Wyckoff, calcite and sodium nitrate have not only the same sort of grouping of atoms in the unit, but the size and shape of the unit and the absolute distances apart of corresponding atoms are practically identical in the two cases; yet they are not truly isomorphous, even though the crystal structures of calcite and sodium nitrate are more nearly alike than are those of calcite and rhodochrosite, for instance. It is in strict accordance with their crystal structures that, as shown by T. V. Barker, sodium nitrate will

grow in parallel orientation upon a crystal of calcite, but not upon a crystal of any of the other members of the group. The difference in the crystal structure of calcite on the one hand and rhodrochisite and siderite on the other, may account for the fact that, according to W. E. Ford, while a complete series of mixed crystals of the last two is known, calcite and either of the other two are not known to show complete miscibility.

G. Rose⁴ gave 2·949 for the **specific gravity** of chalk, and C. J. B. Karsten gave 2·6946. The sp. gr. of aragonite is greater than that of calcite. L. Bourgeois gave for artificial calcite 2·71. The reported values for calcite range from C. J. B. Karsten's 1·7064 to F. E. Neumann's 2·750. V. Goldschmidt obtained values for calcite ranging between 2·713 and 2·735. E. Madelung and R. Fuchs gave 2·7067–2·7121 (0°) for the sp. gr. of calcite. J. Johnstone and co-workers gave 2·71. The reported values of aragonite range from E. Riegel's 2·920 to A. Breithaupt's 2·995. V. Goldschmidt obtained for aragonite values ranging between 2·919 and 2·937: E. Madelung and R. Fuchs gave 2·9325 at 0°; and J. Johnstone and co-workers gave 2·88. P. N. Laschtschenko found an abrupt change in the sp. gr., at 16·5°, of aragonite which had been heated to 465°–470°:

Sp. gr.	16·5°	400°	410°	450°	460°	465°	475°	525°	650°
	2·9219	2·9278	2·9209	2·9218	2·9231	2·9231	2·7691	2·7711	2·7800

Accordingly, the turbidity and brittleness which H. E. Boeke observed in aragonite crystals at 445° is not connected with its transformation into calcite. B. O. Peirce and R. W. Wilson found the sp. gr. of various samples of marble ranged between 2·69 and 2·75; and M. Websky gave for Carrara marble 2·699–2·732. Y. Tadokoro gave 2·699. The reported values for strontium carbonate range from F. Mohs' 3·605 to C. J. B. Karsten's 3·6245. E. Madelung and R. Fuchs gave 3·7222 (0°); and J. Beykirch gave 3·706 for a variety of strontianite free from calcium. The reported values for barium carbonate or witherite range from A. Breithaupt's 4·24 to E. Filhol's 4·565. E. Madelung and R. Fuchs gave 4·2891. The differences in the values for the sp. gr. are mainly due to the presence of foreign matter in the native carbonates. In illustration it is very rare to find a strontianite free from calcium carbonate, and the formula for by far the larger number of samples of this mineral is better (Sr, Ca)CO₃ than SrCO₃. H. G. F. Schröder gave 3·584 for precipitated strontium carbonate, and 4·274 for precipitated barium carbonate. J. Schweitzer obtained 4·2210 for barium carbonate precipitated in the cold, and 4·1848 for barium carbonate precipitated from hot soln. The best representative values are:

Sp. gr. (18°)	CaCO ₃ (trigonal)	CaCO ₃ (rhombic)	SrCO ₃	BaCO ₃
	2·72	2·94	3·70	4·30

H. Vater's estimate for the unknown barium carbonate is 4·05; and his value for vaterite is about 2·6. For the sp. gr. of pentahydrated calcium carbonate, T. J. Pelouze gave 1·783, and W. F. Salm-Horstmar, 1·75. The sp. gr. of hexahydrated calcium carbonate is given by W. Biedermann as 1·752 at 18°; and that of trihydrated calcium carbonate is given by P. Tschirwinsky as 2·626 at 16°. According to F. K. Cameron, the sp. gr. of an aq. soln., sat. at 26°, is 1·0026, and of a soln., sat. at 31°, is 1·0031; and for a soln., sat. at 15°, F. Stolba gave 1·0022.

The **hardness** of aragonite, strontianite, and witherite is given respectively as 55, 14·6, and 9, when that of steatite is unity. G. de Götzen⁵ said that calcite free from impurities is as hard as fluorspar. The hardness of calcite on Mohs' scale is usually given as 3; aragonite, 3½–4; strontianite, 3½; witherite, 3½. A. Rosiwal studied this subject. F. D. Adams and J. T. Nicolsen investigated the **deformation by pressure** of marble. According to A. Johnsen, cooling by liquid air diminished the **plasticity** of calcite. F. Rinne, O. Mohr, and F. Loewinson-Lessing have studied the effect of press. on the crystals of calcite. P. Drude and W. Voigt gave 2600 kgrms. per sq. mm. for the **elastic modulus** of marble, C. Bach gave 1900

kgms. per sq. mm. for that of limestone. W. Voigt, and G. Baumgarten measured the elastic constants of trigonal calcspar and found maximum and minimum values 14298–5128 kgms. per sq. mm. H. Nagaoka also measured the elastic and torsion moduli of limestone and marble, for the **torsion modulus** he found respectively 1900–3000 and 2200–3000 kgms. per sq. mm. L. H. Adams, E. D. Williamson, and J. Johnston represented the effect of a change of press. from p_0 to p on the vol. δv per c.c. by $\delta v = 1.75 \times 10^4 + 1.39 \times 10^6(p - p_0)$. The **compressibility** of calcite is 1.39×10^{-6} per megabar—W. Voigt gave 1.54×10^{-6} , E. Madelung and R. Fuchs gave 1.33 – 1.35×10^{-6} mcgabars per sq. cm. for calcite; 1.53×10^{-6} for aragonite; 1.74×10^{-6} for strontianite; and 2.02×10^{-6} for witherite.

The action of heat on the carbonates of the alkaline earths has already been discussed both with respect to their decomposition, and with respect to allotropic changes of calcite to aragonite, and *vice versa*. J. L. Gay Lussac and L. J. Thénard⁶ stated that strontium carbonate volatilizes with a red light when heated on a piece of charcoal by a stream of oxygen. According to C. H. Pfaff, barium carbonate melts in the oxy-hydrogen blowpipe flame, and H. Abich said that it volatilizes when heated on a piece of charcoal in a stream of oxygen, and glows with a yellow light. H. le Chatelier placed the m.p. of barium carbonate at 795° , while H. E. Boeke said that it partially fuses at 1380° in a current of carbon dioxide, and at a lower temp. when exposed in an open vessel; the lower fusion temp. is attributed to the basic carbonate formed under those conditions. H. E. Boeke found the **melting point** of calcium carbonate to be 1289° under a press. of 110 atm.; that of strontium carbonate, 1497° under a press. of 60 atm.; and that of barium carbonate, 1740° under a press. of 90 atm. According to K. Friedrich, strontium carbonate has an **inversion point** between 920° and 930° ; and barium carbonate undergoes two reversible transformations, passing from the γ -form or rhombic and pseudohexagonal form at 811° to the β -form which is hexagonal, and at 982° to the α -form which is cubic. K. Friedrich said that strontium and barium carbonates undergo a mol. transformation below 300° . For the transition of calcite and aragonite *vide supra*. H. Fizeau⁷ found $\alpha = 0.042581$ to 0.042621 for the **coefficient linear expansion** of a rhombohedral crystal of Iceland spar along the principal crystallographic axis: $\alpha' = -0.05540$ to -0.05562 along the normal to the crystallographic axis: for the mean of α and α' , 0.05514 ; and 0.05507 for a plane in the direction of the angle $54^\circ 41'$. Hence, when heated, calcite contracts in a direction perpendicular to the principal crystallographic axis. This phenomenon was employed by G. Tschermak as an argument against the isomorphism of calcite with the other rhombohedral carbonates. For aragonite, H. Fizeau found for a temp. of about 40° , $\alpha = 0.041016$ when parallel to the a -axis, 0.041719 when parallel to the b -axis, and 0.043460 when parallel to the c -axis.

The **specific heat** of calcite was found by H. V. Regnault⁸ to be 0.20857 between 20° and 100° ; F. E. Neumann, 0.2046 between 20° and 100° ; by H. Kopp, 0.203 between 16° and 45° ; F. A. Lindemann and W. Nernst, 0.2027 ; and P. E. V. Oeberg, 0.2042 . The latter also found the sp. ht. of calcite to be in good agreement with the additive rule for mixtures. J. Joly found the sp. ht. of water-clear calcite to be 0.2036 ; for transparent rhombohedra, 0.2044 ; for hexagonal prisms, 0.2034 ; and for transparent aragonite, 0.2036 . The rhombohedral and rhombic forms of calcium carbonate thus have the same sp. ht. G. Linder measured the effect of temp. on the sp. ht. of calcite, and found

Sp. ht.	0° – 50°	0° – 100°	0° – 150°	0° – 200°	0° – 250°	0° – 300°
	0.1877	0.2005	0.2054	0.2093	0.2136	0.2204

and for the following intervals of temp.:

	50° – 100°	100° – 150°	150° – 200°	200° – 250°	250° – 300°
Mean sp. ht.	0.1233	0.2153	0.2209	0.2313	0.2546
Increase per 50°	—	0.94	2.5	4.5	9.1 per cent.

showing that the increase in the sp. ht. increases with rise of temp. For the true sp. ht. at θ° , he found $0.1802 + 0.0002015\theta - 0.062320\theta^2$. For marble, J. Thoulet and H. Legarde found 0.2164 ; B. O. Peirce and R. W. Wilson, 0.212 ($25^\circ-100^\circ$); R. Weber, 0.2028 (0°); and H. Hecht, 0.206 ($0^\circ-100^\circ$). H. V. Regnault gave for white marble 0.2158 ($16^\circ-98^\circ$) and for grey marble 0.2099 ($23^\circ-98^\circ$). Y. Tadokoro gave 0.202 for marble. In addition to J. Joly's value for aragonite, *vide supra*, F. E. Neumann gave 0.2018 ; H. Kopp, 0.203 ($10^\circ-45^\circ$); H. V. Regnault, 0.20850 ($18^\circ-99^\circ$); and G. Linder,

Sp. ht.	50°	100°	150°	200°	250°
Percentage increase	0.2065	0.2121	0.2177	0.2232	0.2286
		2.6	2.6	2.5	2.4

P. N. Laschtschenko found the curve showing the relation between the temp. and the amount of heat evolved on cooling aragonite cannot be distinguished from that of calcite up to 400° ; but at 445° , the heat of cooling aragonite increases rapidly to $465^\circ-470^\circ$; after that the curve again coincides with that for calcite although there are indications of a divergence above 600° . H. V. Regnault gave 0.1475 ($8^\circ-98^\circ$) for the sp. ht. of strontianite, and 0.1104 ($11^\circ-99^\circ$) for witherite. For the latter, J. Joly gave 0.1086 , and P. N. Laschtschenko found

Sp. ht.	250°	520°	720°	800°	810°	850°	905°	975°	1030°
	0.116	0.126	0.130	0.130	0.145	0.151	0.158	0.161	0.162

It is inferred that a mol. change occurs at about 800° , in order to explain the abrupt change. W. Nernst and F. Schwers found that the mol. ht. C_p , of calcium carbonate at 88.2° K. to be 8.683 , and at 22.3° K., 0.996 .

The heat conductivity of marble was found by J. D. Forbes⁹ to be 0.001 cal. per cm. per sec. per degrec difference of temp.; E. Pécel found 0.007 ; and numbers varying from 0.0054 to 0.00817 have been variously reported by C. Christiansen, C. H. Lees, C. Grassi, K. Yamagawa, G. Stadler, H. Hecht, R. Weber, B. Despretz, G. von Helmersen, O. J. Lodge, etc. B. O. Peirce and R. W. Wilson found that the thermal conductivity of a gram of marble between θ° and 25° is $0.01848(\theta-25) + 0.001895(\theta-25)^2$. Y. Tadokoro gave 0.00555 for marble. For chalk, A. S. Herschel found 0.0022 , and R. Weber, 0.0017 . For limestone, G. Stadler gave 0.00877 . For calcite, A. Tuschmid found the conductivities parallel and perpendicular to the axis are respectively 0.006 and 0.008 ; C. H. Lees found 0.010 and 0.0084 respectively. E. Jannetaz found for the ratio of the two conductivities 0.913 , and F. Stenger, 0.915 . R. A. Nelson gave 0.00614 for the conductivity of white marble between 50° and 100° ; 0.00524 between 100° and 150° ; and 0.00415 between 150° and 200° .

According to J. Thomsen,¹⁰ the heat of formation of the carbonates of the alkaline earths: (Ca, O_2 , CO) = 240.66 Cals.; (Sr, O_2 , CO) = 251.02 Cals.; and (Ba, O_2 , CO) = 252.77 Cals. He also found (CaO, CO_2) = 55.58 Cals. in a dry way, and 18.51 in the wet way; the respective values for strontium carbonate are 53.23 Cals. and 20.55 Cals.; and for barium carbonate, 42.49 Cals. and 21.82 Cals. M. Berthelot gave (BaO, CO_{2solid}) = 50.0 Cals.; and (BaO, CO_{2gas}) = 56.0 Cals. According to A. Finkelstein, the heat of formation of (CaO, CO_2) is 63.2 Cals. between 915° and 1300° , and J. Thomsen found 62.2 Cals. at ordinary temp., hence the former inferred that the sp. ht. of calcium carbonate must change in the same way as that of the carbon dioxide. According to J. Johnston, the free energy of the reaction calcium carbonate \rightarrow oxide is 41.45 Cals. at 25° ; for strontium carbonate, 44.9 Cals.; and for barium carbonate, 51.4 Cals. M. Berthelot gave $Ca(OH)_{2aq.} + H_2CO_{3aq.} = CaCO_{3precipitate} + H_2O + 19.6$ Cals.; for the corresponding reaction with strontium carbonate (crystalline) he gave 21.0 Cals. and for barium carbonate 22.2 Cals. R. de Forcrand gives $CaO_{aq.} + CO_2 = CaCO_3 + Aq. + 4.3$ Cals. J. Thomsen gives for the heat of decomposition of $CaCl_2 + Na_2CO_3$ (in 400 mols of water) = -2.08 Cals.; for the corresponding reaction with strontium chloride, he found 0.23 Cal. R. de Forcrand

gives -1.3 Cals. for the heat of transformation of amorphous precipitated calcium carbonate to calcite. P. A. Favre and J. T. Silbermann found the **heat of transformation** of aragonite to calcite to be $+2.36$ Cals., while H. le Chatelier gave -0.3 Cal., H. Bäckström gave -0.335 Cal. ± 0.100 Cal., and P. N. Laschtschenko, 2.72 Cals. H. W. Foote believes that the heat of formation of calcite is greater than that of aragonite, and therefore the transformation of aragonite to calcite is an exothermal process. H. L. J. Bäckström found the **transition temperature** to be $-43^\circ \pm 5^\circ$, and to be raised 1° per 40 atm. increase of press. Hence, aragonite can never constitute a stable phase under ordinary circumstances.

The **indices of refraction** of calcite,¹¹ μ_ω for the ordinary ray, and μ_ϵ for the extraordinary rays have been measured from $\lambda=198\mu\mu$ in the ultra-violet to $\lambda=759\mu\mu$ in the visible spectrum, and to $\lambda=2324.3\mu\mu$ in the ultra-red.

λ	198	257	361	394	589	795	800.7	1497.2	2324.3
μ_ω	—	1.76038	1.69317	1.68374	1.65835	1.64886	1.64869	1.63457	—
μ_ϵ	1.57796	1.53005	1.50228	1.49810	1.48640	1.48216	1.48216	1.47744	1.47392
	Ultra-violet.			Visible spectrum.			Ultra-red.		
			Li	671 $\mu\mu$	Na	589 $\mu\mu$	H β	486 $\mu\mu$	
μ_ω				1.65368		1.65836		1.66785	
μ_ϵ				1.48430		1.48643		1.69080	

The mean values for the indices of refraction are 1.63 for aragonite, 1.60 for calcite, and for the mean double refractions, 0.156 and 0.172 respectively. According to F. F. Martens, calcite is opaque for smaller wave-lengths than $\lambda=199\mu\mu$. E. Ashkinass and T. Liebisch, and H. Rubens have measured the **metallic reflection** of calcite. According to H. Rubens, and E. Merritt, calcite is dichroic in the ultra-red. The ordinary ray has sharp absorption bands at 2.44μ , 2.74μ , and for greater wave-lengths than 3.1μ , it is no longer transparent. The extraordinary ray has absorption bands at 3.28μ , 3.75μ , 4.66μ , and for longer wave-lengths than 5.5μ it is no longer transparent. E. P. Lewis and A. C. Hardy have measured the reflecting power of calcite for the ultra-violet rays; T. Liebisch and H. Rubens, the long-wave infra-red spectrum of strontianite; and B. Davis and W. M. Stempel, the reflection of X-rays. S. Procopiu studied the effect of suspended calcite on birefringence of carbon disulphide, etc.

J. E. Burbank¹² found that minerals which contain calcium are in general strongly influenced by **X-rays**, and calcite gave a pale reddish-yellow phosphorescence which becomes paler when the mineral is heated, and finally vanishes. C. Doelter found calcite is opaque to weak X-rays. W. C. Röntgen found the electrical conductivity of calcite is raised 100 to 200-fold by exposure to X-rays. P. Bary found neither strontianite nor witherite fluoresces when exposed to X-rays, or to **Becquerel's rays**. According to C. Doelter, a specimen of colourless calcite was not affected by exposure to **radium radiations**, but a violet specimen was darkened to a purple-red colour after 10 hrs.' exposure. E. Newbery and H. Lupton found that samples of colourless calcite with minute cleavage planes showed a considerable multiplication and enlargement of the latter, but colourless crystals were otherwise unchanged. A sample of Iceland spar which luminesced under the action of radium, was thermo-luminescent after the removal of the radium. A. Pochettino found calcite to be luminescent when exposed to the action of the cathode rays—**cathodo-luminescence**—and the colour is the same as the phosphorescence produced by exposure to ordinary light; but with aragonite the colour is different. The afterglow persists a long time with calcite. J. Schincaglia found that the fluorescent light of calcite is blood-red in all directions. W. Crookes found that calcite has a straw-yellow luminescence when exposed to the cathode rays, and the glow persists after the current has ceased. The spectrum showed no bands. H. Jackson found that calcite, strontianite, and witherite exhibit a marked cathodo-luminescence; E. Newbery and H. Lupton, that a clear flawless crystal gave a fine red cathodo-luminescence, while a sample of Iceland spar gave a whiter light; the

variation in the colour of the glow appears to indicate that it is due to the presence of an impurity and is not an essential property of the pure substance. A piece of native strontianite also gave a fine orange-red glow on one part of the mass under the action of the cathode rays, while the other part remained unaltered. On warming the specimen so treated, a bluish-white glow was observed on the previously inactive part of the mass, while the remainder was quite dark. W. P. Headden and L. Clém- andot described the phosphorescence of calcite after exposure to sunlight. Some samples phosphoresced 13 hrs. G. F. Kunz and C. Baskerville found a sample phosphoresced after exposure to ultra-violet light. L. de Boisbaudran has studied the effect of impurities—copper and iron—on the phosphorescence of calcite.

W. C. Röntgen¹³ studied the electrical conductivity of calcite. C. Maragoni examined the directions traversed by electric sparks passing through calcite. F. Kohlrausch measured the specific electrical conductivity of sat. aq. soln. of calcium carbonate at different temp. and found,

Conduc. $\times 10^6$	Precipitated.			Calcite.			Aragonite.		
	7.90°	17.38°	25.96°	2.03°	17.44°	34.8°	3.18°	17.60°	31.1°
	20.29	28.28	36.83	15.28	26.67	41.1	19.46	31.75	47.0

The conductivity of the soln. of calcite is the least and that of aragonite the greatest. This is in agreement with the general observation that the electrical conductivity of the stable modification of a substance is less than that of the labile form. The dielectric constant of calcite has been determined by M. Romich and J. Nowak, J. Curie, H. Starke, etc. For directions parallel to the *c*-axis, the reported numbers range from 7.5 to 8.5, and for directions normal to the *c*-axis, 7.7 to 9.9. W. Schmidt gave for calcite with $\lambda=75$, 8.50 and 8.00 respectively for directions perpendicular and parallel to the *c*-axis; and for λ_∞ , the mean values of R. Fellingner's and M. von Pirani's determinations are respectively 8.59 and 7.87. W. Schmidt gave for the dielectric constant of aragonite for $\lambda=75$, 9.8 in the direction of the *a*-axis, 7.69 in the direction of the *b*-axis, and 6.84 in the direction of the *c*-axis; for $\lambda=\infty$, R. Fellingner found 9.14 (*a*-axis), and 7.00 (*c*-axis). W. Schmidt found for witherite for $\lambda=75$, the dielectric constants 7.80, 7.50, and 6.35 respectively in the directions of the *a*-, *b*-, and *c*-axes. C. Thwing found 7.37 for the powdered mineral; and 6.13 for marble.

According to Thomson's law, if *F* be the intensity of the magnetic field, *v* the vol. of a crystal sphere, then $M=DvF^2$, where *D* is a constant calculated from the chief axes K_1, K_2, K_3 of the crystal sphere, and the direction cosines λ, μ, ν such that $D=\{\mu^2\nu^2(K_2-K_3)^2+\nu^2\lambda^2(K_3-K_1)^2+\mu^2\lambda^2(K_1-K_2)^2\}^{\frac{1}{2}}$. E. Stenger's and J. Beckenkamp's measurements with calcite did not agree with Thomson's formula; W. König's measurements did. A. P. Wills found the magnetic susceptibility of calcite and of marble to range from -0.6×10^{-6} to -0.9×10^{-6} . P. Pascal gave for the mol. coeff. of magnetization of BaCO_3 , 589×10^{-7} ; SrCO_3 , 467×10^{-7} ; and CaCO_3 , 382×10^{-7} .

Chemical properties of the carbonates of the alkaline earths—G. Spezia¹⁴ observed no change in calcite and aragonite when kept 6 months under a press. of 7000 atm. When calcium carbonate was heated to redness in a stream of hydrogen, A. P. Dubrunfaut stated that it decomposed, forming carbon dioxide, water, and carbon. H. Rose also found some carbon dioxide is given off when dry air or hydrogen is passed over heated strontium carbonate. J. L. Gay Lussac and L. J. Thénard found that when water vapour is passed over strontium carbonate below its dissociation temp., carbon dioxide is evolved and strontium hydroxide is formed. E. Donath and A. Lang state that the hardening of a mixture of lime, calcium carbonate, and water is probably due to the formation of calcium hydroxy-carbonate.

When calcium carbonate is treated with cold chlorine water, A. W. Williamson,¹⁵ and A. Richardson observed that hypochlorous acid (*q.v.*) is formed; and this

decomposes when heated or when the soln. is evaporated, forming calcium chlorate. C. Matignon and F. Bourion found that when heated in a stream of **sulphur chloride** and chlorine, calcium chloride is formed. P. A. Bolley obtained similar results with barium carbonate. The carbonates are readily soluble in **hydrochloric acid**. J. G. Bogusky found that the quantity of marble decomposed at any instant of time is directly proportional to the conc. of the acid at that instant. J. G. Bogusky and N. Kajander compared the effect of hydrochloric acid with that of **nitric acid** and **hydrobromic acid**, and found the speed of the reaction is inversely as the mol. wt. of the acid. Soln. which have an eq. conc. of acid react with the same velocity, or the mol. reaction velocity of the acid is independent of the chemical nature of the acid. W. Spring found that at a constant temp., nitric, hydrochloric, and hydrobromic acids, as well as **hydriodic acid** and **hypochlorous acid** of eq. conc., react with the same velocity. The action of **acetic acid** is not uniform,

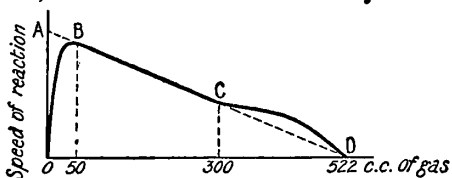

FIG. 56.—W. Spring's Diagram showing the Speed of the Reaction between Calcium Carbonate and Hydrochloric Acid.

but the velocity of attack is less than that of the other acids. W. Spring observed that there is a marked period of induction, *OB*, Fig. 56, and this is followed by a period, *BC*, during which the speed of the reaction is proportional to the conc. of the acid. There is then a period, *CD*, during which the speed of the reaction is greater

than what would occur if the rate of the reaction were proportional to the conc. of the acid. W. Spring represents the effect of temp. θ on the velocity V by the exponential equation: $V = k^{20.05\theta}$, where k is a constant. He also found all cleavage surfaces of calcspar are dissolved at the same rate; at 15° a surface cut parallel to the chief axis is dissolved by 10 per cent. hydrochloric acid at the same rate as cleavage surfaces, but at 35° , the former surface is attacked 1.23 times as fast, and at 55° , 1.28 times as fast as the cleavage surface. The speed of dissolution of a surface cut normal to the chief axis is 1.14 times as great as one cut parallel to that axis. W. Spring compared the speeds of dissolution of surfaces perpendicular and parallel to the chief axis with the indices of refraction of the ordinary and extraordinary rays; and G. Cèsaro, with the elasticity of the crystals. W. Spring also found that acids attack aragonite rather more slowly than calcite, for, at 15° , the speed of dissolution of aragonite in 10 per cent. hydrochloric acid is 0.476. L. Lavizzari found that the rates of attack of aragonite on the basal and prismatic surfaces are as 3 : 1. C. Vallée, and M. Geiger studied the action on marble of soln. of acids in ethyl or methyl alcohol. W. Spring showed that if a crystal of calcite be partially immersed in hydrochloric acid, the action is most rapid at the surface, so that the crystal is cut in two pieces. Similar results were observed with sugar and water. If dry calcium, strontium, or barium carbonate be suspended in absolute alcohol, it is attacked by sulphuric, nitric, or acetic acid with extreme slowness—between three and four months being required for complete neutralization. The velocity of the action is slowest with barium carbonate, and fastest with the calcium salt. By introducing water, the speed of neutralization is increased proportionally with the amount of water added. L. Kahlenberg and H. Schlundt found that calcium carbonate is not attacked by a soln. of **hydrogen chloride** in water-free **hydrogen cyanide**. The speeds of dissolution of barium carbonate in hydrochloric and nitric acids has been measured by B. Pawlowsky. H. Cantoni and G. Goguélia¹⁶ found that boiling soln. of **ammonium chloride** react with calcium or barium carbonate as typified by $\text{BaCO}_3 + 2\text{NH}_4\text{Cl} = \text{BaCl}_2 + 2\text{NH}_3 + \text{H}_2\text{O} + \text{CO}_2$. They also studied the action of **potassium chloride** or **sodium chloride**, and E. Taponier, **potassium and sodium bromides** as well as **ammonium bromide** on barium carbonate; H. Schreib found the speed of decomposition with calcium carbonate depends on the grain size of the carbonate, and that the

decomposition is complete. The solubilities of the alkaline earth carbonates in soln. of the alkali and ammonium chlorides has been previously considered.

F. Sestini¹⁷ found that carbon dioxide is evolved when calcium carbonate is heated with boiling sulphur, and calcium sulphide is formed. According to E. Pollacci, when a mixture of calcium carbonate and sulphur is moistened with water and allowed to dry, and the moistening and drying repeated several times, gypsum is formed. A. Cossa denied that the reaction occurs, even if the mixture be boiled 8–10 hrs. It is supposed that the apparent discrepancy is due to the oxidation of the sulphur to sulphuric acid during the drying of the mixture. G. Bellucci found that moist mixtures of calcium carbonate and sulphur form calcium sulphate in 75–80 days; and in the presence of organic matter in 30–35 days. The amount of sulphate formed is small. T. Brugnatelli and P. Pellogio found that in E. Pollacci's experiment some calcium thiosulphate as well as sulphate is formed, and they believe that the sulphur is oxidized at the expense of the water, and not by atm. oxygen. They found tetrathionic and pentathionic acids appear before the sulphuric acid. C. Geitner found that if calcium carbonate be heated with water and sulphur at 120°–130°, calcium sulphite and traces of sulphate are formed; at 150° the liquid is coloured blue, green, and brown, and on cooling it becomes yellow owing to the formation of calcium polysulphide; similar results were obtained with strontium and barium carbonates. According to L. Naudin and F. de Montholon, when calcium, strontium, or barium carbonate, suspended in water at 10°, is treated with a slow current of hydrogen sulphide, it is gradually converted into sulphide, the conversion being partial or complete according to the proportion of water present. The soln. is colourless at first, but turns yellow in the air. E. Divers and T. Shimidzu observed that while calcium hydrosulphide is decomposed by carbon dioxide, precipitated calcium carbonate, suspended in water, is decomposed by a stream of hydrogen sulphide. Similar remarks apply to barium carbonate. H. Feigl found that sulphur chloride converted calcium sulphide into a yellow product—possibly calcium sulphochloride, CaS_2Cl_2 . L. Kahlenberg and H. Schlundt found that a soln. of sulphur trioxide in water-free hydrogen cyanide does not attack calcium carbonate. A. Gossmann studied the action of **alkali sulphates** on barium carbonate.

A. Scheurer-Kestner¹⁸ observed that when calcium carbonate is calcined with 24 per cent. of carbon, a mixture of 87.8 per cent. of carbon monoxide and 12.2 per cent. of carbon dioxide is evolved. At a red heat, however, A. P. Dubrunfaut found that calcium carbonate is not decomposed by carbon, but if steam be passed over the mixture, carbon monoxide is evolved. A. Finkelstein studied the equilibrium press. of the system containing carbon, barium carbonate, carbon monoxide and dioxide. When heated in the electric arc-furnace, a mixture of calcium carbonate and carbon furnishes calcium carbide (*q.v.*). L. P. Cailletet found that calcium carbonate is not affected by liquid **carbon dioxide**; for the action of gaseous carbon dioxide, *vide infra* hydrocarbonates. H. Debus studied the distribution of carbon dioxide between barium and calcium salts. H. Cantoni and G. Goguélia studied the action of **alkali chlorides**; E. Taponier, the action of the **alkali bromides**; and L. Vecchiotti, the action of the **alkali nitrates**. The observations of R. Bunsen and L. Playfair on the action of **nitrogen** on heated barium carbonate may be regarded as the starting-point of the attempts to bring about the direct synthesis of cyanogen from carbon and atm. nitrogen. According to G. Dragendorff, at a red heat, calcium carbonate is imperfectly decomposed by **phosphorus**, forming carbon and calcium phosphate, and, according to S. Tennant, calcium phosphide. Barium carbonate was found by G. Dragendorff to be decomposed in a limited measure when heated with red phosphorus. A. Frébault and A. Destrem found that when calcium carbonate is treated with **sodium hydrophosphate**, Na_2HPO_4 , a basic calcium phosphate and sodium hydrocarbonate are formed. When calcium carbonate is treated with a soln. of **ammonium phosphate**, R. Irvine and W. S. Anderson found an exchange of the acid radieles.

J. L. Gay Lussac and L. J. Thénard found that when a mixture of calcium

carbonate and **sodium** is warmed, vivid inflammation occurs, and a black mass is formed which leaves a residue of carbon when treated with hydrochloric acid. J. W. Döbereiner also studied the reaction. The clear melt obtained by fusing barium carbonate with four times its weight of barium chloride, was found, by F. Haber and S. Tolloczko, to deposit dendritic carbon on the cathode when electrolyzed at 550°–600°. J. Parkinson and C. Winkler found that **magnesium** completely reduces the carbonates to the corresponding metal. J. A. Hedvall and J. Heuberger found the temp. at which the reaction begins and the heat of the reaction to be respectively 280° and 6.14 Cals. for $\text{BaO} + \text{SrCO}_3 = \text{SrO} + \text{BaCO}_3$; 240° and 20.14 Cals. for $\text{BaO} + \text{CaCO}_3 = \text{CaO} + \text{BaCO}_3$; and 400° and 8 Cals. for $\text{SrO} + \text{CaCO}_3 = \text{CaO} + \text{SrCO}_3$.

J. von Liebig found a conc. soln. of **potassium hydroxide** decomposes calcium carbonate. C. J. B. Karsten observed no change when an aq. soln. of **barium hydroxide** at 15° to 19° is allowed to act ten months on precipitated calcium carbonate—the precipitate remains free from barium, the soln. free from calcium. A. Rosenstichl found no change occurred when the soln. were boiled. F. Knapp added a little baryta-water to spring-water containing a little calcium hydrocarbonate, and obtained either no precipitate or a slight turbidity. The addition of an excess of baryta-water, or boiling the soln., results in the precipitation of barium and calcium carbonates. According to C. J. B. Karsten, calcium hydroxide is not changed by a conc. soln. of **potassium carbonate**; and a clear soln. of lime-water remains clear when mixed with a conc. soln. of potassium carbonate, and if the soln. be diluted with water, calcium carbonate is precipitated. According to P. Lebeau, mixtures of calcium carbonate with the alkali carbonates decompose completely at about 1000° in vacuo. The dissolution of the mixed carbonates proceeds much less readily than that of calcium carbonate alone, and the dissolution press. of the mixture is always lower than that with calcium carbonate, and higher than that with alkali carbonate for the same temp.; thus, the decomposition of the mixture with cæsium carbonate began at 540°, and the dissolution press. at 1020° was 490° mm.—that of calcium carbonate alone is greater than one atm. It is said that these facts point to the existence of double carbonates of calcium and the alkali metals, possessing different dissociation press. Mixtures with lithium carbonates lose lithium oxide by volatilization.

According to C. J. B. Karsten, a mixture of **sodium chloride** with twice its weight of calcium carbonate melts at a bright red heat—a higher proportion of sodium chloride gives a more fusible mixture, and a smaller proportion of that salt gives a less fusible mixture. The clear melt solidified to a mass with a scaly fracture. P. Berthier made observations on this subject. Similar observations were made by P. Berthier, C. J. B. Karsten, and J. W. Döbereiner with respect to strontium and barium carbonates. W. O. de Coninck and L. Arzalier found that when strontium carbonate is shaken for 4 months with a conc. soln. of **potassium chloride**, some strontium chloride is formed by double decomposition. P. Berthier also observed that equi-molar parts of **calcium chloride** and calcium carbonate form a clear melt; and J. Fritzsche prepared microscopic plates of what he regarded as hexahydrated **calcium chloro-carbonate**, $\text{CaCl}_2 \cdot 2\text{CaCO}_3 \cdot 6\text{H}_2\text{O}$, by leaving a highly conc. ammoniacal soln. of calcium chloride exposed to air containing carbon dioxide. The crystals are said to belong to the rhombic or monoclinic system; and they are decomposed by water. According to F. B. Guthrie, fused **sodium nitrate** dissolves 0.294 per cent. of calcium carbonate; 0.69 per cent. of strontium carbonate; and 0.916 per cent. of barium carbonate. E. Ramann and H. Sallinger studied the equilibrium conditions in the reaction: $\text{K}_2\text{SO}_4 + \text{BaCO}_3 \rightleftharpoons \text{K}_2\text{CO}_3 + \text{BaSO}_4$.

R. Irvine and W. S. Anderson treated corals with soln. of **manganese**, zinc, chromium, mercury, and tin chlorides, iron sulphate, nickel, cobalt, copper, lead, and silver nitrates, and ammonium phosphate. The action of salts of nickel and cobalt was very slow, whilst that with salts of copper and manganese was rapid. In most cases there is a direct interchange, the oxide of the metal taking the place of the

lime. Silver and mercury salts are deposited as oxides. Freshly prepared and moist barium carbonate precipitates hydroxides or carbonates from hot or cold soln. of many **metal salts**. Thus, H. Rose¹⁹ decomposed cold soln. of the oxy-salts of copper, cadmium, mercury, tin, and palladium. G. Bauck likewise decomposed cupric chloride, but not mercuric or palladous chloride. H. Rose further noted that salts of aluminium and zirconium are incompletely decomposed, while the salts of the sesquioxides of manganese, cobalt (acetate), iron, bismuth, uranium, and rhodium (chloride), and iridic chloride are completely decomposed. Antimonious and arsenious salts are precipitated by barium salts. Cold soln. of calcium, strontium, magnesium, yttrium, and silver are not precipitated. Ferrous and manganous salts, according to H. Rose, are not precipitated, while, according to G. Bauck, they are in great part precipitated—an excess of carbon dioxide hinders the precipitation. C. J. B. Karsten found barium carbonate decomposes soln. of magnesium and calcium chlorides very slowly. W. Mcigen compared the action of aragonite and calcite on soln. of salts of the heavy metals.

The **hydrocarbonates of the alkaline earths**.—J. H. Gladstone²⁰ obtained a white earthy mineral which he called *hovite*, and which contained alumina and silica besides lime and carbon dioxide in the ratio 1 : 1·67 to 1·99, thus corresponding closely with the proportion required for **calcium hydrocarbonate**, $\text{Ca}(\text{HCO}_3)_2$. The solvent action of aq. soln. of carbon dioxide on the carbonates of the alkaline earths noted by H. Cavendish in 1766, has been previously discussed, and the various phenomena are explained on the assumption that an unstable hydrocarbonate is formed :

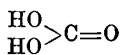

Carbonic acid.

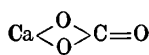

Calcium carbonate.

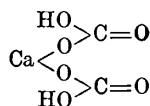
Calcium hydrocarbonate, $\text{Ca}(\text{HCO}_3)_2$.

F. K. Cameron and W. O. Robinson measured the vap. press., p cm. of mercury, produced when successive amounts of carbon dioxide, w grms., are added to wet calcium carbonate at 0° , and found :

w	.	.	0·00	0·014	0·056	0·098	0·140	0·182	0·224	0·252
p	.	.	76	84	127	174	220	268	314	346

The curve is approximately a straight line making a large angle with the p -axis. There is therefore no sign of the formation of a new solid carbonate by adding carbon dioxide to wet calcium carbonate below 4·5 atm. press. at 0° .

When the hydrocarbonates of ammonium, potassium, or sodium are added to a soln. of a calcium salt, calcium carbonate is precipitated—less completely, added V. Rose, the greater the proportion of water present. According to C. L. Berthollet, and G. Longchamp, by mixing a soln. of an alkali hydrocarbonate with a soluble barium salt, a soln. of barium hydrocarbonate is obtained if a large proportion of water be used. Soln. of barium hydrocarbonate were also made by J. Setschenoff, P. Carles, etc., and when evaporated furnished a mixture of amorphous and crystalline barium carbonate ; and a crystalline precipitate when the soln. was boiled. According to G. Rose, when the sat. soln. of calcium hydrocarbonate is warmed with the exclusion of air, calcium carbonate is precipitated because the salt is less soluble hot than cold. A. Bineau found that when the soln. is allowed to stand in vacuo, or over solid potassium hydroxide, some calcium hydrocarbonate remains in soln. The passage of an inert gas through a soln. of the hydrocarbonates of the alkaline earths was found by D. Gernez to precipitate the normal carbonate. R. Ludwig and G. Theobald found that soln. of calcium hydrocarbonate deposit calcareous tufa or sinter when in contact with mosses, coniferæ, or algæ. When nascent hydrogen is passed through a soln. of a hydrocarbonate of the alkaline earths, A. Lieben found that formates are produced. F. Ullik found a soln. of calcium hydrocarbonate converts strontium sulphate into carbonate.

Attempts were made by E. H. Keiser and S. Leavitt to isolate the hydrocarbonates of the alkaline earths by adding an excess of alcohol and ether to the aq. soln. of the acid carbonate, made by conducting an excess of carbon dioxide through a soln. of the hydroxide; a white flocculent precipitate was formed which rapidly gave off carbon dioxide and left behind the normal carbonate. By treating a soln. of the chloride of the alkaline earth with a soln. of potassium or ammonium hydrocarbonate both cooled by a freezing mixture, a heavy flocculent precipitate of the hydrocarbonate is formed which can be dried by press. between filter paper in a trough surrounded by a freezing mixture. Analyses by E. H. Keiser and L. McMaster agree with the formula $\text{CaCO}_3 \cdot 1.75\text{H}_2\text{CO}_3$, and with $\text{BaCO}_3 \cdot 1.5\text{H}_2\text{CO}_3$. The products may be $\text{Ca}(\text{HCO}_3)_2$ or $\text{Ba}(\text{HCO}_3)_2$, with some admixed or absorbed carbonic acid.

Complex or double salts of the carbonates of the alkalis and alkaline earths.—P. Lebeau²¹ obtained small acicular crystals of lithium calcium carbonate by fusing a mixture of one mol of calcium carbonate with two mols of lithium carbonate in an atm. of carbon dioxide, and treating the product with a small quantity of water; the salt is decomposed by excess of water, and when heated in a vacuum is dissociated, the dissociation press. for any particular temp. being intermediate between those of the constituent salts. The product of complete dissociation is an isomorphous mixture of lime and lithia in the form of regular octahedral crystals. The formation of these mixed crystals of lime and lithia indicates that the crystals of the latter belong to the cubic system. P. Berthier, and H. le Chatelier melted calcium carbonate with sodium carbonate; the latter employed equi-molar proportions, and obtained a mass with a crystalline fracture which is possibly sodium calcium carbonate, $\text{Na}_2\text{Ca}(\text{CO}_3)_2$. A. Lamy obtained turbid soln. by the action of potassium or sodium carbonate on lime-water. J. H. Pratt found pyramidal rhombic crystals of the dihydrated form of this salt, $\text{Na}_2\text{Ca}(\text{CO}_3)_2 \cdot 2\text{H}_2\text{O}$, in the borax deposits of California. The mineral was called *pirssonite*. Artificial crystals were made by O. Bütschli, by digesting a mixed soln. of sodium hydroxide and carbonate with calcium carbonate for a few days at 40° – 50° . The salt is also made by mixing an excess of a conc. soln. of sodium carbonate with one of calcium chloride, and digesting the amorphous precipitate with the mother liquid for 12 hrs. in a closed vessel on a water-bath. The crystals are rapidly washed with water; then with

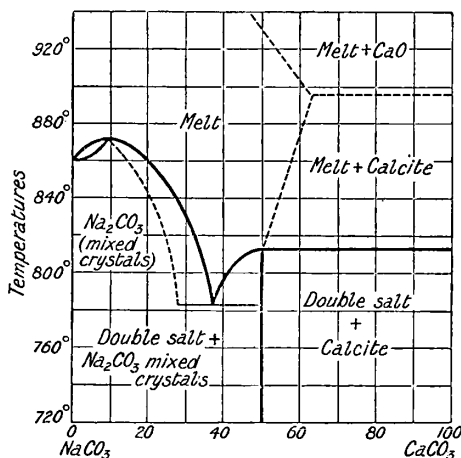

FIG. 57.—Fusion Curve of Binary Mixtures of Sodium and Calcium Carbonates.

he found it to be stable at 60° in soln. containing 1.8 to 3.7N- Na_2CO_3 and 2.6 to 1.3N- NaOH ; and at 80° , in soln. with 1.9 to 3.3N- Na_2CO_3 , and 2.9 to 3.0N- NaOH .

alcohol and ether; and dried over sulphuric acid. The rhombic pyramidal crystals were found by J. H. Pratt to have the axial ratios $a:b:c = 0.5662:1:0.9019$. According to A. de Schulten, the sp. gr. of the natural crystals is 2.352 (15°), and of the artificial 2.349 (15°). The crystals scratch calcspar but not fluorspar. The salt is stable in the air, and when heated to 100° , but at 130° it loses 14.28 per cent. of water; the residue melts at a red heat; 790° , according to H. le Chatelier; or 813° , according to P. Niggli. The f.p. curve of P. Niggli for binary mixtures of sodium and calcium carbonates is shown in Fig. 57. The salt is slowly decomposed into its components by water. R. Wegscheider has studied the equilibrium conditions of *pirssonite*, and

The pentahydrated salt, $\text{Na}_2\text{Ca}(\text{CO}_3)_2 \cdot 5\text{H}_2\text{O}$, occurs naturally as gaylussacite. G. H. Bauer obtained it as a white powder by adding sodium carbonate to a soln. of a calcium salt above 0° . The gelatinous precipitate was found by J. Fritzsche to form on standing, finely divided calcium carbonate and crystals of gaylussacite. J. Fritzsche obtained this salt by the prolonged action of a conc. soln. of sodium carbonate on amorphous precipitated calcium carbonate; O. Bütschli obtained it by treating the corresponding potassium salt with a conc. soln. of sodium carbonate. M. Barre stated that when precipitated calcium carbonate is boiled with a conc. soln. of sodium carbonate, the dihydrate, not the pentahydrate, is formed. The compound is not formed at 98° unless at least 21.06 per cent. of sodium carbonate is present. According to R. Wegscheider, at temp. exceeding 40° , gaylussacite is not stable, since, in systems containing water and sodium and calcium carbonates, it passes into pirssonite. The minute prismatic crystals of gaylussacite belong to the monoclinic system with axial ratios $a:b:c=1.4897:1:1.442$ and $\beta=101^\circ 33'$. In 1829, G. Barruel analyzed a sample of what was probably impure gaylussacite; its sp. gr. was 2.291. G. H. Bauer found artificial gaylussacite weathers in dry air. According to J. B. J. D. Boussingault, the powdered uncalcined mineral dissolves in water, and is only slightly decomposed thereby. H. Rose also found that the mineral previously heated to 100° , is decomposed by water into its component salts. A. de Schulten has drawn attention to the peculiar fact that gaylussacite loses all its water of crystallization at 100° , while pirssonite loses its water at 130° . According to O. Bütschli, the mineral dehydrated at 105° , re-forms gaylussacite when treated with a conc. soln. of sodium carbonate; but with a conc. soln. of potassium carbonate, hexahydrated **potassium dicalcium pentacarbonate**, $3\text{K}_2\text{CO}_3 \cdot 2\text{CaCO}_3 \cdot 6\text{H}_2\text{O}$, is formed in double refracting hexagonal plates. It is also formed by the action of a very conc. soln. of potassium carbonate on calcium hydroxide, or on precipitated calcium carbonate. H. Molisch also prepared this salt. H. le Chatelier prepared a crystalline mass of **potassium calcium carbonate**, $\text{K}_2\text{Ca}(\text{CO}_3)_2$, melting at 790° , by fusing a mixture of potassium and calcium carbonates. M. Barre obtained prismatic crystals of potassium calcium carbonate, $\text{K}_2\text{CO}_3 \cdot \text{CaCO}_3$, which are readily hydrolyzed by water, and at 18° , are stable only with over 59.25 per cent. K_2CO_3 . P. Niggli gave 813° for the m.p., and his f.p. diagram for binary mixtures of potassium and calcium carbonates, is shown in Fig. 58. O. Bütschli obtained double refracting rhombohedral crystals of the same salt by rubbing up a little calcium hydroxide with a very conc. soln. of potassium carbonate; or by digesting the same soln. with calcium carbonate at 40° – 60° . When either of these salts is treated with sodium carbonate it forms gaylussacite. H. le Chatelier obtained a crystalline mass, m.p. 760° , thought to be the triple salt: **sodium potassium calcium carbonate**, $\text{K}_2\text{CO}_3 \cdot \text{Na}_2\text{CO}_3 \cdot 2\text{CaCO}_3$, by melting and cooling an eq. mixture of the component salts. P. Niggli studied the systems, $\text{Na}_2\text{O}—\text{K}_2\text{O}—\text{CaO}—\text{CO}_2$, and $\text{NaCl}—\text{Na}_2\text{CO}_3—\text{CaCO}_3—\text{CaCl}_2$, between 600° and 1000° , and with the carbon dioxide at one atm. press. Similarly, with systems $\text{Na}_2\text{O}—\text{TiO}_2—\text{CO}_2$; $\text{K}_2\text{O}—\text{TiO}_2—\text{CO}_2$; $\text{K}_2\text{O}—\text{CaO}—\text{TiO}_2—\text{CO}_2$. The so-called *cupro-calcite* found at Jca, in Peru, and examined by A. Damour and A. Raimondi, has 50.45 per cent. Cu_2O , 10.26 per cent. CaO , 24.00 per cent. CO_2 , and 3.20 per cent. H_2O , and it is probably a mixture of calcite and cuprous oxide. H. le Chatelier prepared a crystalline mass, **sodium barium carbonate**, $\text{Na}_2\text{Ba}(\text{CO}_3)_2$, m.p. 740° , by fusing and cooling an eq. mixture of the component salts. Similar results were obtained with **potassium barium**

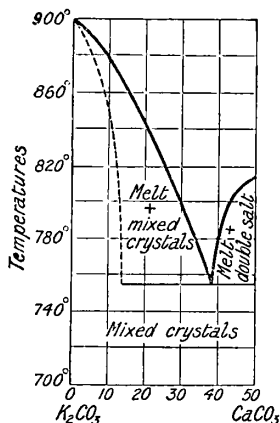

FIG. 58.—Fusion Curve of Binary Mixtures, $\text{K}_2\text{CO}_3—\text{CaCO}_3$.

carbonate, $K_2CO_3 \cdot BaCO_3$, m.p. 800° . The crystals are uniaxial and negative; they are stable in air; and decompose above their m.p. with the loss of carbon dioxide. Sodium strontium carbonate, $Na_2Sr(CO_3)_2$, m.p. 750° , was made in the same way. M. Barre said that barium and strontium carbonates do not form double salts with the alkali carbonates in aq. soln. The monoclinic mineral *barytocalcite*, described by T. Thomson, has axial ratios $a:b:c = 0.7717:1:0.6255$, and $\beta = 106^\circ 8'$. This and other analogous mixed crystals, *bromlite* and *neotype*, represent a series of so-called barium calcium carbonates. Similarly, also, the minerals *emmonite* and *strontioalcite* represent strontium calcium carbonate. There is no sign of the formation of alkali compounds of strontium or barium carbonate when the latter are digested with soln. of the alkali carbonates. H. le Chatelier prepared the triple salts, potassium barium calcium carbonate, $K_2CO_3 \cdot 0.5BaCO_3 \cdot 0.5CaCO_3$, m.p. 758° ; and sodium barium calcium carbonate, $Na_2CO_3 \cdot 0.5BaCO_3 \cdot 0.5CaCO_3$, m.p. 660° ; and sodium strontium calcium carbonate, $Na_2CO_3 \cdot 0.5SrCO_3 \cdot 0.5CaCO_3$, m.p. 720° , by melting together eq. proportions of the constituent salts. Similarly, with the quadruple salt, potassium sodium barium calcium carbonate, $K_2CO_3 \cdot Na_2CO_3 \cdot CaCO_3 \cdot BaCO_3$, melting at 690° . There is little evidence that these salts are chemical individuals. According to H. E. Boeke, mixtures of barium and calcium carbonates, under a high press. of carbon dioxide to prevent dissociation, show a eutectic at 1139° , corresponding with $0.47BaCO_3 \cdot 0.53CaCO_3$. There is no sign of the formation of *barytocalcite*, $BaCO_3 \cdot CaCO_3$.

REFERENCES.

- ¹ P. Groth, *Chemische Krystallographie*, Leipzig, 2. 204, 1908; T. V. Barker, *Journ. Chem. Soc.*, 89. 1128, 1906; W. Vernadsky, *Proc. Univ. Moscow*, 1. 9, 1891; R. C. Wells, *Journ. Washington Acad.*, 10. 249, 1920; H. le Chatelier, *Bull. Soc. Chim.*, (2), 47. 302, 1887; A. Breithaupt, *Berg. Hütt. Ztg.*, 17. 53, 1858; *Handbuch der Mineralogie*, Dresden, 2. 255, 1841; A. des Cloizeaux, *Bull. Soc. Min.*, 2. 95, 1881; L. Bourgeois, *ib.*, 12. 464, 1889; H. Vater, *Zeit. Kryst.*, 21. 462, 1893; J. Beckenkamp, *ib.*, 19. 242, 1891; 20. 161, 1892; 32. 21, 1900; O. Mügge, *Neues Jahrb. Min. B.B.*, 14. 246, 1901; J. Beykirch, *ib.*, 13. 426, 1901; F. Stromeyer, *De arragonite ejusque differentia a spatho calcareo rhomboidali chemica*, Göttingen, 1813; *Gilbert's Ann.*, 43. 229, 1813; 49. 297, 1815; *Schwigger's Journ.*, 13. 490, 1815; D. Brewster, *Quart. Journ. Science*, 4. 112, 1818; *Trans. Roy. Soc. Edin.*, 7. 285, 1815; T. Thomson, *Records General Science*, 17. 373, 1835; 18. 415, 1836; *Phil. Mag.*, (3), 11. 45, 48, 1837; J. F. W. Johnston, *ib.*, (3), 6. 1, 1835; (3), 10. 373, 1837; A. Cathrein, *Zeit. Kryst.*, 14. 369, 1888; T. J. Pelouze, *Ann. Chim. Phys.*, (2), 48. 301, 1831; A. C. Becquerel, *ib.*, (2), 47. 9, 1831; W. F. Salm-Horstmar, *Pogg. Ann.*, 35. 515, 1835; W. Biedermann, *Zeit. allgem. Physiol.*, 2. 395, 1903; P. Tschirwinsky, *Ann. Geol. Min. Russ.*, 8. 238, 1910; W. H. Miller, *Introduction to Mineralogy*, London, 1852; L. Weber, *Centr. Min.*, 353, 1919; K. Mieleitner, *Zeit. Kryst.*, 56. 193, 1921; G. Aminoff, *Geol. För. Förh. Stockholm*, 39. 664, 1917.
- ² O. Meyer, *Neues Jahrb. Min.*, i, 74, 1885; E. Sommerfeldt, *ib.*, i, 10, 1905; V. von Ebner, *Sitzber. Akad. Wien*, 89. 368, 1884; 91. 760, 1885; A. Elterlin, *Zeit. Kryst.*, 17. 281, 1890; V. Goldschmidt, *ib.*, 38. 656, 1904; A. Hamberg, *Geol. Fören. Förh. Stockholm*, 12. 567, 1890; V. Goldschmidt and F. E. Wright, *Neues Jahrb. Min. B.B.*, 17. 355, 1905; L. Lavizzari, *Nouveaux phénomènes des corps cristallisés*, Lugano, 1865.
- ³ R. Ledoux-Lenard and A. Dauvallier, *Compt. Rend.*, 169. 965, 1919; E. Schiebold, *Leipzig's Abhandl.*, 36. 65, 1919; *Die Verwendung der Lauediagramme zur Bestimmung der Struktur des Kalkspates*, Leipzig, 1920; F. M. Jäger and H. Haga, *Proc. Acad. Amsterdam*, 17. 430, 1915; *Versl. Acad. Amsterdam*, 24. 443, 460, 1135, 1403, 1410, 1412, 1916; F. Rinne, *Ber. Sächs. Ges. Wiss.*, 67. 303, 1915; W. H. and W. L. Bragg, *X-rays and Crystal Structure*, London, 1915; W. L. Bragg, *Proc. Roy. Soc.*, 89. A, 468, 1914; W. H. Bragg, *Phil. Trans.*, 215. A, 253, 1915; E. W. G. Wyckoff, *Amer. Journ. Science*, (4), 50. 317, 1920; *Phys. Rev.*, (2), 16. 149, 1920; T. V. Barker, *Zeit. Kryst.*, 45. 1, 1908; W. E. Ford, *Trans. Connecticut Acad.*, 22. 211, 1917; B. Davis and W. M. Stempel, *Phys. Rev.*, (2), 17. 608, 1921; J. Beckenkamp, *Centr. Min.*, 353, 393, 1917; H. S. Uhler and C. D. Cooksey, *Phys. Rev.*, (2), 10. 645, 1917; M. L. Huggins, *ib.*, (2), 19. 354, 1922.
- ⁴ G. Rose, *Pogg. Ann.*, 42. 360, 1837; H. G. F. Schröder, *Pogg. Ann.*, 106. 226, 1859; F. E. Neumann, *ib.*, 23. 1, 1831; W. F. Salm-Horstmar, *ib.*, 35. 515, 1835; W. Haidinger, *ib.*, 45. 179, 1838; 53. 139, 1841; V. Goldschmidt, *Verh. Geol. Reichsanst.*, 439, 1886; M. Wewsky, *Die Mineral-species nach den für das spezifische Gewicht derselben angenommenen, und gefundenen Werten*, Breslau, 1868; H. Vater, *Zeit. Kryst.*, 21. 462, 1893; J. Schwitzcr, *Proc. Amer. Assoc.*, 201, 1877;

U. J. B. Karsten, *Schweigger's Journ.*, 65. 394, 1832; A. Breithaupt, *ib.*, 68. 291, 1833; F. Stolba, *Journ. prakt. Chem.*, (1), 97. 503, 1866; J. B. Biot, *Ann. Chim. Phys.*, (2), 94. 281, 1815; F. S. Beudant, *Traité élémentaire de minéralogie*, Paris, 441, 1824; F. Mohs, *Grundriss der Mineralogie*, Dresden, 1824; B. O. Peirce and R. W. Wilson, *Proc. Amer. Acad.*, 36. 13, 1900; H. Kopp, *Liebig's Ann.*, 40. 173, 1841; C. M. Nendtwich, *Ber. deut. Natwif. Vers.*, 185, 1843; E. Riegel, *Rheinl. Westphal. Verh.*, 1. 52, 1844; W. von der Marck, *ib.*, 6. 269, 1849; 8. 56, 1851; 12. 263, 1855; E. Stieren, *Amer. Journ. Science*, (3), 34. 46, 1862; F. von Hochstetter, *Sitzber. Akad. Wien*, 9. 829, 1852; F. K. Cameron, *Journ. Phys. Chem.*, 5. 556, 1902; L. Bourgeois, *Ann. Chim. Phys.*, (5), 29. 493, 1883; E. Filhol, *ib.*, (3), 21. 415, 1847; T. J. Pelouze, *ib.*, (2), 48. 301, 1831; *Compt. Rend.*, 60. 429, 1865; S. de Luca, *ib.*, 47. 481, 1858; P. N. Laschtschenko, *Journ. Russ. Phys. Chem. Soc.*, 43. 793, 1911; E. Madelung and R. Fuchs, *Ann. Physik*, (4), 65. 289, 1921; R. Kirwan, *Elements of Mineralogy*, London, 1784; A. le Royer and J. B. A. Dumas, *Journ. Pharm. Chim.*, 92. 408, 1821; W. Biedermann, *Zeit. allgem. Physiol.*, 2. 395, 1903; P. Tschirwinsky, *Ann. Geol. Min. Russ.*, 8. 238, 1910; J. Beykirch, *Neues Jahrb. Min. B.B.*, 13. 426, 1901; H. E. Boeke, *Neues Jahrb. Min.*, i, 91, 1912; *Mitt. Nat. Ges. Halle*, 3, 1913; J. Johnstone, H. E. Merwin, and E. D. Williamson, *Amer. Journ. Science*, (4), 41. 473, 1916; Y. Tadokoro, *Science Rep. Tohoku Univ.*, (1), 10. 339, 1921.

⁵ G. de Götzen, *Riv. di Min.*, 26. 35, 1901; F. D. Adams and J. T. Nicolsen, *Proc. Roy. Soc.*, 67. 228, 1900; *Phil. Trans.*, 195. 363, 1901; F. Rinne, *Neues Jahrb. Min.*, i, 160, 1903; O. Mohr, *Zeit. Ver. deut. Ing.*, 44. 1524, 1900; F. Loewinson-Lessing, *Proc. Russ. Min. Soc.*, 43. 1905; L. H. Adams, E. D. Williamson, and J. Johnston, *Journ. Amer. Chem. Soc.*, 41. 12, 1919; W. Voigt, *Wied. Ann.*, 31. 720, 1887; 35. 655, 1888; 39. 413, 1890; A. Johnsen, *Centr. Min.*, 233, 1918; P. Drude and W. Voigt, *Wied. Ann.*, 42. 537, 1891; C. Bach, *Elastizität und Festigkeit*, Berlin, 64, 1902; H. Nagaoka, *Phil. Mag.*, (5), 50. 53, 1900; G. Baumgarten, *Pogg. Ann.*, 152. 369, 1874; A. Rosiwal, *Mitt. Wien. Min. Ges.*, 69, 1917; E. Madelung and R. Fuchs, *Ann. Physik*, (4), 65. 289, 1921.

⁶ H. E. Boeke, *Neues Jahrb. Min.*, i, 91, 1912; *Mitt. Natur. Ges., Halle*, 3, 1913; C. H. Pfaff, *Schweigger's Ann.*, 22. 385, 1818; H. Abich, *Pogg. Ann.*, 23. 314, 1831; K. Friedrich, *Centr. Min.*, 616, 651, 654, 1912; H. le Chatelier, *Bull. Soc. Chim.*, (2), 47. 300, 1887; J. L. Gay Lussac and L. J. Thénard, *Recherches physico-chimiques*, Paris, 1811.

⁷ H. Fizeau, *Phil. Mag.*, (4), 36. 31, 1868; G. Tschermak, *Tschermak's Mitt.*, 4. 121, 1882.

⁸ H. V. Regnault, *Ann. Chim. Phys.*, (3), 1. 129, 1841; J. Thoulet and H. Legarde, *Compt. Rend.*, 94. 1512, 1882; P. N. Laschtschenko, *ib.*, 147. 58, 1908; *Journ. Russ. Phys. Chem. Soc.*, 42. 1604, 1910; B. O. Peirce and R. W. Wilson, *Proc. Amer. Acad.*, 36. 13, 1900; R. Weber, *Arch. Sciences Genève*, (3), 33. 590, 1895; R. J. Brunner, *Die Abhängigkeit der spezifischen Wärme des festen Calciums und Magnesiums von der Temperatur*, Zürich, 1906; K. Friedrich and L. G. Smith, *Centr. Min.*, 616, 651, 684, 1912; *Met.*, 9. 409, 1912; H. Kopp, *Liebig's Ann.*, 140. 173, 1841; W. Nernst and F. Schweser, *Sitzber. Akad. Berlin*, 355, 1914; H. Hecht, *Ann. Physik*, (4), 14. 1008, 1904; J. Joly, *Proc. Roy. Soc.*, 41. 250, 1887; P. E. V. Oeberg, *Oefvcrs. Vet. Akad. Förh.*, 43, 1885; G. Linder, *Sitzber. phys. mediz. Soc. Erlangen*, 34. 217, 1902; F. A. Lindemann and W. Nernst, *Sitzber. Akad. Berlin*, 247, 1910; F. E. Neumann, *Pogg. Ann.*, 126. 123, 1865; Y. Tadokoro, *Science Rep. Tohoku Univ.*, (1), 10. 339, 1921.

⁹ J. D. Forbes, *Trans. Roy. Soc. Edin.*, 23. 133, 1862; 24. 73. 1865; A. Tuschmid, *Das innere Wärmeleitungsvermögen von Quarz, Kalkspat, und Steinsalz*, Zurich, 1883; F. Stenger, *Wied. Ann.*, 22. 535, 1874; B. Despretz, *Compt. Rend.*, 35. 540, 1852; E. Jannetaz, *ib.*, 114. 1352, 1892; G. von Helmersen, *Pogg. Ann.*, 88. 461, 1853; E. Pécelet, *ib.*, 55. 167, 1842; F. Neumann, *Ann. Chim. Phys.*, (3), 66. 183, 1862; G. Stadler, *Bestimmung des absoluten Wärmeleitungsvermögens*, Bern, 1889; K. Yamagawa, *Journ. Science Univ. Japan*, 2. 263, 1888; R. Weber, *Bull. Soc. Scient. Nat. Neuchâtel*, 23, 1900; A. S. Herschel, *B.A. Rep.*, 40, 1873; 323, 1874; 19, 1876; 133, 1878; 158, 1879; C. Christiansen, *Wied. Ann.*, 14. 23, 1881; H. Hecht, *Ann. Physik*, (4), 14. 1008, 1904; C. H. Lees, *Proc. Roy. Soc.*, 50. 422, 1892; *Phil. Trans.*, 183. A, 481, 1892; 191. A, 399, 1898; G. Grassi, *Atti Ist. Napoli*, (4) 5. ii, 35, 1892; B. O. Peirce and R. W. Wilson, *Proc. Amer. Acad.*, 34. 3, 1898; 36. 13, 1900; O. J. Lodge, *Phil. Mag.*, (5), 5. 110, 1875; R. A. Nelson, *Phys. Rev.*, (2), 18. 113, 1921; Y. Tadokoro, *Science Rep. Tohoku Univ.*, (1), 10. 339, 1921.

¹⁰ A. Finkelstein, *Ber.*, 39. 1584, 1906; J. Thomsen, *ib.*, 12. 2031, 1879; *Journ. prakt. Chem.*, (2), 21. 38, 1880; M. Berthelot, *Ann. Bur. Longitudes*, 395, 1877; R. de Forcrand, *Compt. Rend.*, 146. 511, 1907; J. Johnston, *Journ. Amer. Chem. Soc.*, 30. 1357, 1908; P. A. Favre and J. T. Silbermann, *Ann. Chim. Phys.*, (3), 37. 434, 1853; H. le Chatelier, *Compt. Rend.*, 116. 390, 1893; H. W. Foote, *Zeit. phys. Chem.*, 33. 740, 1900; H. Bäckström, *ib.*, 97. 179, 1921; *Medd. Vet. Nobelinst.*, 4. 11, 1921; P. N. Laschtschenko, *Journ. Russ. Phys. Chem. Soc.*, 43. 793, 1911.

¹¹ F. Carvallo, *Journ. Phys.*, (2), 9. 257, 1890; (3), 9. 257, 1900; *Compt. Rend.*, 126. 950, 1898; *Ann. Écol. Norm.*, (3), 7. 112, 1890; A. Cornu, *ib.*, (2), 3. 1, 1874; (2), 9. 21, 1880; E. Mascart, *ib.*, (1), 1. 238, 1864; (1), 4. 7, 1867; F. F. Martens, *Ann. Physik*, (4), 6. 603, 1901; (4), 8. 459, 1902; W. Orloff, *Zeit. phys. Chem.*, 19. 217, 1896; H. Dufet, *Bull. Soc. Min.*, 16. 165, 1893; A. Offret, *ib.*, 13. 405, 1890; F. Paschen, *Wied. Ann.*, 56. 762, 1895; H. Stark, *ib.*, 60. 629, 1897; H. Rubens and E. Ashkinass, *ib.*, 67. 459, 1899; E. Merritt, *ib.*, 55. 49, 1895; E. Sarasin, *Compt. Rend.*, 95. 680, 1882; *Arch. Science Genève*, (3), 8. 394, 1882; *Journ. Phys.*, (2), 2. 370, 1883; V. S. M. van der Willigen, *Arch. Mus. Teyler*, 3. 48, 1874; J. Beckenkamp, *Zeit. Kryst.*, 20. 167, 1892; A. Mühlheims, *ib.*, 14. 202, 1888; J. Danker, *Neues Jahrb. Min.*

B.B., 4. 241, 1886; S. W. Clifford, *Proc. Roy. Soc.*, 70. 336, 1902; R. Glazebrook, *ib.*, 29. 204, 1879; C. S. Hastings, *Amer. Journ. Science*, (3), 35. 60, 1888; J. Müller, *Publ. Astrophysik. Obs. Potsdam*, 4. 151, 1885; F. Rudberg, *Pogg. Ann.*, 14. 45, 1728; E. P. Lewis and A. C. Hardy, *Phys. Rev.*, (2), 14. 272, 1919; T. Liebisch and H. Rubens, *Sitzber. Akad. Berlin*, 211, 1921; B. Davis and W. M. Stempel, *Phys. Rev.*, (2), 17. 608, 1921; E. Marbach, *Beitrag zur Kenntnis der optischen Verhältnisse von Flussspat, Steinsalz, Sylvin, Kalkspat, Aragonit, und Borazit*, Weida i. Th., 1913; S. Procopiu, *Compt. Rend.*, 172. 1172, 1921.

¹² J. E. Burbank, *Amer. Journ. Science* (4), 5. 53, 1898; W. P. Headden, *ib.*, (1), 21. 301, 1906; C. Doelter, *Neues Jahrb. Min.*, i, 93, 1896; *Das Radium und die Farben*, Dresden, 29, 1910; *Ion*, 1. 301, 1909; *Le Radium*, 7. 58, 1910; *Sitzber. Akad. Wien*, 120. 88, 1911; E. Newbery and H. Lupton, *Mém. Proc. Manchester Lit. Phil. Soc.*, 62. 10, 1918; G. F. Kunz and C. Baskerville, *Science*, (2), 18. 769, 1903; A. Pochettino, *Atti Accad. Lincei*, (5), 13. ii, 301, 1904; J. Schinacaglia, *Nuovo Cimento*, 4. 10, 212, 1899; L. de Boisbaudran, *Compt. Rend.*, 106. 1386, 1708, 1888; P. Bary, *ib.*, 130. 776, 1900; H. Jackson, *Journ. Chem. Soc.*, 65. 734, 1894; W. Crookes, *Proc. Roy. Soc.*, 32. 206, 1881; *Chem. News*, 43. 237, 1881; W. C. Röntgen, *Sitzber. Bayr. Akad.*, 113, 1907; W. Banco, *Abhand. Akad. Wien*, 55, 1906; L. Clémantot, *Compt. Rend.*, 92. 1107, 1881.

¹³ W. C. Röntgen, *Sitzber. Bayr. Akad.*, 113, 1907; *Ann. Physik*, (4), 64. 1, 1921; F. Kohlrausch, *Zeit. phys. Chem.*, 44. 237, 1903; F. P. Treadwell and M. Reuter, *Zeit. anorg. Chem.*, 17. 171, 1898; M. Romich and J. Nowak, *Sitzber. Akad. Wien*, 70. 380, 1874; J. Curie, *Journ. Phys.*, 17. 385, 1889; H. Starke, *Wied. Ann.*, 60. 629, 1897; E. Stenger, *ib.*, 20. 228, 1883; W. König, *ib.*, 31. 273, 1887; 32. 222, 1887; R. Fellinger, *Ann. Physik*, (4), 7. 333, 1901; W. Schmidt, *ib.*, (4), 9. 919, 1902; M. von Pirani, *Zeit. Kryst.*, 41. 314, 1906; J. Beckenkamp, *ib.*, 10. 279, 1885; C. Thwing, *Zeit. phys. Chem.*, 14. 287, 1894; C. Maragoni, *Rivista Min. Italiana*, 2. 49, 1888; A. P. Wills, *Phil. Mag.*, (5), 45. 432, 1898; *Phys. Rev.*, (1), 20. 188, 1905; P. Pascal, *Compt. Rend.*, 173. 144, 1921.

¹⁴ A. P. Dubrunfaut, *Compt. Rend.*, 74. 125, 1872; H. Rose, *Pogg. Ann.*, 86. 114, 1852; J. L. Gay Lussac and L. J. Thénard, *Recherches physico-chimiques*, Paris, 1811; E. Donath and A. Lang, *Oesterr. Chem. Ztg.*, 20. 175, 1917; N. Busvold, *Zeit. anorg. Chem.*, 98. 202, 1916; G. Spezia, *Riv. Min. Crist. Ital.*, 35. 62, 1908.

¹⁵ A. W. Williamson, *Mém. Chem. Soc.*, 2. 234, 1850; A. Richardson, *Proc. Chem. Soc.*, 23. 118, 1907; P. A. Bolley, *Schweiz. polyt. Zeit.*, 4. 82, 1859; J. G. Bogusky, *Ber.*, 9. 118, 1876; J. G. Bogusky and N. Kajander, *ib.*, 10. 34, 1877; W. Spring, *Zeit. phys. Chem.*, 1. 209, 1887; *Bull. Acad. Belgique*, (3), 13. 173, 1887; *Bull. Soc. Chim.*, (2), 49. 3, 1888; G. Césaro, *Ann. Soc. Géol. Belgique*, 15. 219, 1888; 17. 241, 1890; *Ann. Chim. Phys.*, (6), 17. 1, 1889; M. Geiger, *Gazz. Chim. Ital.*, 30. i, 225, 1900; L. Lavizzari, *Nouveaux phénomènes des corps cristallisés*, Lugano, 1865; C. Vallée, *Compt. Rend.*, 132. 667, 1901; L. Kahlenberg and H. Schlundt, *Journ. Phys. Chem.*, 6. 447, 1902; B. Pawlowsky, *Ber.*, 13. 334, 1880; N. Kajander, *Bull. Soc. Chim.*, (2), 35. 169, 1881; C. Matignon and F. Bourion, *Compt. Rend.*, 138. 760, 1904.

¹⁶ H. Cantoni and G. Goguëlia, *Bull. Soc. Chim.*, (3), 31. 282, 1904; (3), 33. 13, 1905; E. Taponier, *ib.*, (3), 35. 280, 1906; H. Schreib, *Zeit. angew. Chem.*, 4. 211, 1889.

¹⁷ F. Sestini, *Bull. Soc. Chim.*, (2), 24. 492, 1875; L. Naudin and F. de Montholon, *ib.*, (2), 26. 71, 1876; *Compt. Rend.*, 83. 58, 1876; E. Pollacci, *Gazz. Chim. Ital.*, 4. 177, 469, 1874; A. Cossa, *ib.*, 4. 26, 1874; G. Bellucci, *ib.*, 4. 179, 1874; T. Brugnatelli and P. Pellogio, *ib.*, 4. 536, 1874; C. Geitner, *Liebig's Ann.*, 129. 250, 1864; H. Feigl, *Verhalten von Schwermetallverbindungen gegen Polysulfide und Chlorschwefel*, Erlangen, 1905; L. Kahlenberg and H. Schlundt, *Journ. Phys. Chem.*, 6. 447, 1902; E. Divers and T. Shimidzu, *Journ. Chem. Soc.*, 45. 282, 1884; A. Gossmann, *Repert. Pharm.*, 61. 49, 1837.

¹⁸ A. Scheurer-Kestner, *Ann. Chim. Phys.*, (4), 1. 412, 1864; A. P. Dubrunfaut, *Compt. Rend.*, 74. 125, 1872; L. P. Cailletet, *ib.*, 74. 1271, 1872; A. Finkelstein, *Ber.*, 39. 1585, 1906; G. Dragen-dorff, *Chem. Centr.*, 865, 1865; A. Frébault and A. Destrem, *Bull. Soc. Chim.*, (2), 27. 499, 1877; S. Tennant, *Journ. Phys.*, 51. 157, 1800; J. W. Döbereiner, *Arch. Pharm.*, (2), 18. 155, 1839; *Pogg. Ann.*, 15. 240, 1829; J. Parkinson, *Journ. Chem. Soc.*, 20. 127, 1867; F. B. Guthrie, *ib.*, 47. 94, 1885; C. Winkler, *Ber.*, 23. 120, 1890; J. von Liebig, *Pogg. Ann.*, 24. 366, 1832; J. L. Gay Lussac and L. J. Thénard, *Recherches physico-chimiques*, Paris, 1. 364, 1811; C. J. B. Karsten, *Philosophie der Chemie*, Berlin, 173, 1843; *Lehrbuch der Salinenkunde*, Berlin, 2. 49, 1847; P. Berthier, *Ann. Chim. Phys.*, (2), 22. 245, 1823; (2), 38. 253, 1828; P. Lebeau, *Compt. Rend.* 138. 1496, 1904; *Bull. Soc. Chim.*, (3), 33. 407, 1905; A. Rosenstiehl, *Bull. Soc. Mulhouse*, 40. 34, 1870; F. Knapp, *Liebig's Ann.*, 158. 114, 1871; J. Fritzsche, *Journ. prakt. Chem.*, (1), 83. 213, 1861; (1), 93. 347, 1866; H. Debus, *Liebig's Ann.*, 85. 103, 1853; 86. 156, 1853; 87. 238, 1853; H. Cantoni and G. Goguëlia, *Bull. Soc. Chim.*, (3), 33. 13, 1905; E. Taponier, *Étude de l'action des bromures alcalins sur le carbonate de baryum*, Genève, 1905; L. Vecchiotti, *Étude de l'action des nitrates alcalins sur le carbonate de baryum*, Genève, 1907; F. Haber and S. Toloczko, *Zeit. anorg. Chem.*, 41. 407, 1904; W. O. de Coninck and L. Arzalier, *Bull. Acad. Belg.*, 577, 1908; R. Irvine and W. S. Anderson, *Proc. Roy. Soc. Edin.*, 18. 52, 1891; E. Ramann and H. Sallinger, *Zeit. phys. Chem.*, 98. 103, 1921; R. Bunsen and L. Playfair, *B.A. Rep.*, 142, 1845; *Journ. prakt. Chem.*, (1), 47. 145, 1847.

¹⁹ H. Rose, *Pogg. Ann.*, 83. 133, 1851; G. Bauck, *Analyse der Salzsäuren von Colberg nebst Beiträgen zur analytischen Chemie*, Göttingen, 52, 1860; C. J. B. Karsten, *Lehrbuch der Salinenkunde*, Berlin, 2. 274, 286, 1847; W. Meigen, *Neues Jahrb. Min.*, ii, 19, 1903; R. Irvine and W. S. Anderson, *Proc. Roy. Soc. Edin.*, 18. 52, 1891.

¹⁰ J. H. Gladstone, *Phil. Mag.*, (4), 23. 462, 1862; H. Cavendish, *Phil. Trans.*, 57. 92, 1766; V. Rose, *Gehlen's Journ.*, 3. 548, 1807; C. L. Berthollet, *ib.*, 3. 261, 1807; G. Longchamp, *Ann. Chim. Phys.*, (2), 23. 191, 1823; F. K. Cameron and W. O. Robinson, *Journ. Phys. Chem.*, 12. 561, 1908; J. Setschenoff, *Med. Centrbl.*, 35, 1875; P. Carles, *Journ. Chim. Pharm.*, (6), 13. 562, 1901; R. Wagner, *Zeit. anal. Chem.*, 6. 167, 1867; E. H. Keiser and S. Leavitt, *Journ. Amer. Chem. Soc.*, 30. 1711, 1908; E. H. Keiser and L. McMaster, *ib.*, 30. 1714, 1908; A. Bineau, *Ann. Chim. Phys.*, (3), 51. 290, 1857; D. Gernez, *Compt. Rend.*, 64. 606, 1867; R. Ludwig and G. Theobald, *Pogg. Ann.*, 87. 91, 1852; R. Ludwig, *ib.*, 87. 143, 1852; G. Rose, *ib.*, 112. 57, 1861; A. Lieben, *Monatsh.*, 16. 211, 1895; F. Ullik, *Anz. Akad. Wien*, 13, 1868.

²¹ P. Lebeau, *Bull. Soc. Chim.*, (3), 33. 1550, 1905; *Compt. Rend.*, 138. 1602, 1904; H. le Chatelier, *ib.*, 118. 416, 1894; A. de Schulten, *ib.*, 123. 1023, 1896; *Bull. Soc. Chim.*, (3), 29. 724, 1903; T. Thomson, *Phil. Mag.*, (3), 11. 45, 1837; M. Barre, *Compt. Rend.*, 154. 279, 1912; A. Damour, *Bull. Soc. Min.*, 1. 130, 1878; A. Raimondi, *Zeit. Kryst.*, 6. 630, 1882; P. Berthier, *Ann. Chim. Phys.*, (2), 38. 248, 1828; J. B. J. D. Boussingault, *ib.*, (2), 31. 270, 1826; G. Baruel, *ib.*, (2), 42. 313, 1829; A. Lamy, *ib.*, (5), 14. 155, 1878; J. H. Pratt, *Zeit. Kryst.*, 27. 416, 1897; O. Bütschli, *Verh. Nat. Ver. Heidelberg*, (2), 8. 277, 1907; *Journ. prakt. Chem.*, (2), 75. 557, 1907; J. Fritzsche, *ib.*, (2), 93. 339, 1864; R. Wegscheider, *Monatsh.*, 28. 633, 1907; *Liebig's Ann.*, 350. 89, 1906; H. Molisch, *Ber. deut. bot. Ges.*, 34. 288, 357, 1916; H. Rose, *Pogg. Ann.*, 93. 606, 1854; G. H. Bauer, *ib.*, 24. 367, 1832; F. Soret and S. Moricand, *Mém. Sciences Genève*, 1. 309, 1821; P. Groth, *Chemische Kristallographie*, Leipzig, 2. 220, 1908; P. Niggli, *Zeit. anorg. Chem.*, 98. 241, 1916; 106. 126, 1919; H. E. Boeke, *Neues Jahrb. Min.* i, 91, 1912.

§ 24. Nitrates of the Alkaline Earths

Calcium nitrate occurs as *wall saltpetre*, or *nitrocalcite*, as an efflorescence on walls; in spring waters; and, according to T. Schlösing,¹ in soils. P. Groth has described a specimen of barium nitrate, *barytasaltpetre*, which he found in Chilean saltpetre. The nitrates of the alkaline earths are produced by crystallization from a soln. of the oxides, hydroxides, carbonates, or sulphides in dil. nitric acid. A. Duflos,² and F. Kuhlmann precipitated barium nitrate as a crystalline powder by adding a hot sat. soln. of sodium nitrate to a soln. of barium chloride, about one-third of the barium remains in the mother liquid, and it can be recovered by evaporation; F. Muck used a somewhat similar process for barium and strontium nitrates. F. Mohr also obtained barium nitrate from a mixture of barium sulphide and sodium nitrate, but G. C. Wittstein does not recommend the process because of the incompleteness of the exchange.

Anhydrous **barium nitrate**, $\text{Ba}(\text{NO}_3)_2$, crystallizes during the evaporation of aq. soln. of the nitrate. It is prepared commercially by the action of sodium nitrate on a soln. of barium chloride or barium sulphide. C. H. Hirzel claims to have obtained cubic crystals of *dihydrated barium nitrate*, $\text{Ba}(\text{NO}_3)_2 \cdot 2\text{H}_2\text{O}$, by the evaporation of aq. soln. between 0° and 12° , but this is thought to be a mistake; R. A. Berry obtained **tetrahydrated barium nitrate**, $\text{Ba}(\text{NO}_3)_2 \cdot 4\text{H}_2\text{O}$, isomorphously mixed with 83 per cent. of tetrahydrated strontium nitrate, by saturating the same water with both nitrates, introducing a crystal of the tetrahydrated strontium salt, and evaporating in vacuo over sulphuric acid; if the temp. is much higher than 0° , a mixture of crystals of anhydrous barium nitrate and tetrahydrated strontium nitrate is obtained. Anhydrous **strontium nitrate**, $\text{Sr}(\text{NO}_3)_2$, crystallizes from hot soln., according to A. Scacchi, at temp. exceeding 25° , although, according to A. L. Baker, by the slow evaporation of a sat. soln. at 32° , he obtained a mixture of anhydrous salt and **tetrahydrated strontium nitrate**, $\text{Sr}(\text{NO}_3)_2 \cdot 4\text{H}_2\text{O}$. J. T. Cooper, and R. Kirwan assumed that the hydrated salt was a pentahydrate, but A. Souchay and E. Lenssen, and A. Laurent showed that the tetrahydrate is produced. A. L. Baker failed to prepare a higher hydrate than this by the slow evaporation of soln. at temp. ranging from 2° to 32° . H. Lescœur could make only the anhydrous salt. According to G. J. Mulder, the transition temp. for the tetrahydrate and the anhydrous salt is 31.3° ; Earl of Berkeley and M. P. Appleby gave 29.3° .

At ordinary temp. G. H. Hess, N. A. E. Millon, and J. C. G. de Marignac found

that **tetrahydrated calcium nitrate**, $\text{Ca}(\text{NO}_3)_2 \cdot 4\text{H}_2\text{O}$, separates from aq. soln. in monoclinic prisms. H. Lescœur's vap. press. measurements also agree with the formation of this hydrate. J. G. Gilbert prepared calcium nitrate by mixing conc. soln. of calcium chloride and sodium nitrate so that the soln. is sat. with calcium nitrate and sodium chloride at 80° . The precipitated sodium chloride is removed, and the tetrahydrated calcium nitrate precipitates below 30° . The conditions of stability of the different hydrates of calcium nitrate in aq. soln. by H. Bassett and H. S. Taylor are illustrated in Fig. 59; in acid soln., in Fig. 60; and in alkaline soln., in Fig. 61. M. Hasselblatt showed that melted tetrahydrated cadmium nitrate cannot be inoculated with tetrahydrated calcium nitrate, but the former readily inoculated the molten calcium salt. It was therefore inferred that there are two forms of tetrahydrated calcium nitrate, an unstable or β -form isomorphous with tetrahydrated cadmium nitrate, and melting at 39.7° , and the ordinary stable or α -form, melting at 42.6° . H. S. Taylor and W. N. Henderson prepared the unstable β -form by the inoculation of a supersaturated soln. of calcium nitrate, over 30° , with a small crystal of tetrahydrated cadmium nitrate. The solubility relations and the equilibrium conditions are illustrated in Fig. 59. Anhydrous **calcium nitrate**, $\text{Ca}(\text{NO}_3)_2$, is obtained by dehydrating the tetrahydrate at about 170° . N. A. E. Millon reported the hydrate, $\text{Ca}(\text{NO}_3)_2 \cdot 3\frac{1}{2}\text{H}_2\text{O}$, but D. Gernez showed that the latter is impure tetrahydrate, and that it crystallizes from soln. containing less water than corresponds with the tetrahydrate. H. Lescœur prepared **trihydrated calcium nitrate**, $\text{Ca}(\text{NO}_3)_2 \cdot 3\text{H}_2\text{O}$, by adding an equal volume of fuming nitric acid to a sat. aq. soln. of the nitrate, and seeding the soln. with a crystal of the anhydrous salt. H. Bassett and H. S. Taylor prepared the trihydrate by allowing a supersaturated soln. to crystallize at about 45° —*vide* Figs. 59 and 60. H. Lescœur deduced the existence of a tri- or di-hydrate of calcium nitrate, but his method of preparing the latter furnishes a mixture of hydrates and the anhydrous salt. H. Bassett and H. S. Taylor prepared crystals of **dihydrated calcium nitrate**, $\text{Ca}(\text{NO}_3)_2 \cdot 2\text{H}_2\text{O}$, by crystallization from soln. between 48.4° and 51.3° ; the dihydrate is stable over a considerable range of nitric acid conc., as illustrated in Fig. 60. No hydrate between $\text{Ca}(\text{NO}_3)_2 \cdot \text{H}_2\text{O}$ and the anhydrous salt was observed. W. A. Tilden reported hexahydrated calcium nitrate, $\text{Ca}(\text{NO}_3)_2 \cdot 6\text{H}_2\text{O}$, melting at 26.4° ; but no one has confirmed this observation. There are thus three hydrates of calcium nitrate whose individuality has been established.

Isolated measurements of the **solubility** of calcium nitrate in *water* have been made by A. B. Poggiale,³ and G. J. Mulder; the former gave for 100 parts of water at 0° , 84.2; and the latter, 93.1 parts of $\text{Ca}(\text{NO}_3)_2$. Determinations were also made by J. Legrand, F. Guthrie, F. Mylius, and R. Funk, and F. K. Cameron and W. O. Robinson. Table XIV contains a selection from the results of H. Bassett

TABLE XIV.—THE SOLUBILITY OF CALCIUM NITRATE IN WATER.

t	$\text{Ca}(\text{NO}_3)_2$	Solid phase.	θ	$\text{Ca}(\text{NO}_3)_2$	Solid phase.	θ	$\text{Ca}(\text{NO}_3)_2$	Solid phase.
-0.4°	1.4	Ice	10°	51.97	Tetrahydrate	40°	70.37	Trihydrate
-1.4°	4.78	"	15°	54.94	"	45°	71.45	"
-3.05°	10	"	20°	56.39	"	51°	74.73	"
-15.7°	33.13	"	25°	57.98	"	49°	77.49	Dihydrate
-21.7°	38.7	"	30°	60.41	"	51°	78.05	"
26.7°	43.7	Tetrahydrate	40°	66.21	"	55°	78.16	Anhydride
-10°	47.31	"	42.4°	68.75	"	100°	78.43	"
0°	50.50	"	42.45°	71.60	"	151°	79.00	"

and H. S. Taylor above -15.7° ; and of F. Rüdorff below that temp.; the results are expressed in grams of $\text{Ca}(\text{NO}_3)_2$ per 100 grms. of sat. soln., when 28.7° is the eutectic temp.; 42.7° , the m.p. of the tetrahydrate; and 51.1° , the m.p. of the

trihydrate. The results of H. S. Taylor and W. N. Henderson for the α - and β -forms of tetrahydrated calcium nitrate are shown in Table XV, where 39.7° with

TABLE XV.—SOLUBILITY OF TETRAHYDRATED CALCIUM NITRATE IN WATER.

θ	Ca(NO ₃) ₂ .	Solld phase.	θ	Ca(NO ₃) ₂ .	Solld phase.	θ	Ca(NO ₃) ₂ .	Solld phase.
0°	50.17	α	34°	63.66	β	39.6°	69.50	β
22.2°	56.88	α	35°	62.88	α	40°	66.22	α
30°	60.16	α	38°	64.34	α	42.7°	69.50	α
30°	61.57	β	38°	66.65	β	[25°	77.30	Ca(NO ₃) ₂]

69.50 per cent. β -Ca(NO₃)₂.4H₂O, and 42.7° with 71.70 per cent. α -Ca(NO₃)₂.4H₂O are reflex points. The corresponding curves for binary systems, Ca(NO₃)₂-H₂O, are shown in Fig. 59. The curve *OA* is the ice-line, and *A* is the eutectic point—at -28.7° with 42.9 per cent. of Ca(NO₃)₂. The curve *ABC* represents the solubility of the α -tetrahydrate, and *CDE*, that of the trihydrate. The maxima of these curves at *B*, 42.7° , and *D* 51.1° , represent true m.p. The curve *A'B'C'* represents the solubility curve of the β -tetrahydrate, and illustrates the solubility curve of a metastable hydrate with a metastable m.p. The solubility curve *EF* of the dihydrate does not have a true m.p., but exhibits a transition temp., 51.3° , where partial fusion occurs, with the formation of the anhydrous salt and a sat. soln. The curve *FG* above 51.3° represents the solubility of the anhydrous salt. The extensions of the different curves beyond the regions indicated represent super-saturated soln. or metastable states.

Isolated measurements of the solubility of strontium nitrate in water were made by A. B. Poggiale, G. J. Mulder, and P. Kremers, who gave at 0° respectively 40.16, 39.5, and 43.1 grms. of Sr(NO₃)₂ in 100 grms. of water; and at 100° , they gave respectively 119.25, 101.1, and 106.5 grms. Earl of Berkeley and M. P. Appleby's data for the solubility of strontium nitrate, expressed in grams of Sr(NO₃)₂ per 100 grms. of water, are :

Sr(NO ₃) ₂ . . .	0.58°	14.71°	29.06°	30.28°	39.74°	61.34°	78.98°	88.94°
	40.124	60.867	87.648	88.577	90.086	93.856	97.865	100.136
Solid phase	Sr(NO ₃) ₂ .4H ₂ O			Sr(NO ₃) ₂				

The transition temp. from the tetrahydrate to the anhydrous salt is 29.3° . G. J. Mulder gave 101.1 for the solubility at 100° , 102.3 at 105° , and 102.9 at 107.9° . According to F. Guthrie, the eutectic or cryohydric temp. is -6° with 25.99 per cent. of Sr(NO₃)₂. L. C. de Coppet gave -5.75° with 32.4 parts of Sr(NO₃)₂ in 100 parts of water.

Isolated measurements with soln. of barium nitrate have also been made by G. J. Mulder, J. L. Gay Lussac, C. J. B. Karsten, and H. Kopp. The following

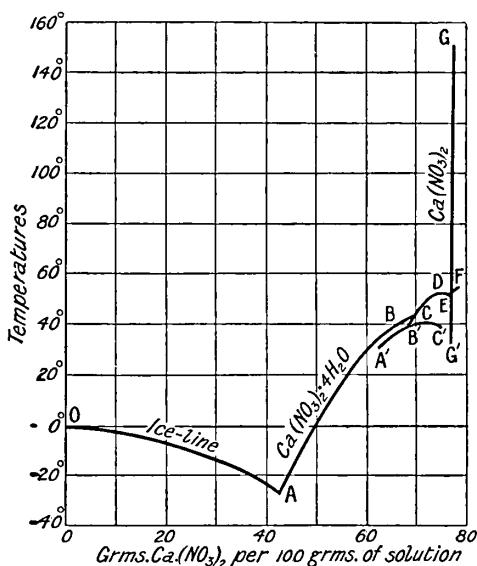

FIG. 59.—Solubility Curve of Calcium Nitrate.

is a selection of the best representative values, expressed in grams of $\text{Ba}(\text{NO}_3)_2$ per 100 grms. of soln. :

	0°	10°	20°	40°	60°	80°	100°	140°	180°	215°
$\text{Ba}(\text{NO}_3)_2$.	4.8	6.5	8.4	12.4	16.9	21.3	25.5	33.3	40.1	45.8

The solid phase is $\text{Ba}(\text{NO}_3)_2$. According to F. Guthrie, the cryohydrate contains 5.30 per cent. $\text{Ba}(\text{NO}_3)_2$, and freezes at -0.9° , and it is not changed by admixture with a little strontium nitrate ; and, according to L. C. de Coppet, the cryohydrate has 4.5 parts of $\text{Ba}(\text{NO}_3)_2$ in 100 parts of water, and it freezes at -0.7° . A. Étard found the solubility curve has but a slight curvature, and between 0° and 210° can be represented by the linear equation $S=4.5+0.2000\theta$; and between 0.4° and about 400° , by $4.5+0.2025\theta$.

According to E. Mitscherlich,⁴ conc. nitric acid precipitates calcium, strontium, and barium nitrates as crystalline powders from their aq. soln., and the barium nitrate is less soluble in dil. nitric acid than it is in water. He said barium nitrate is precipitated by adding conc. nitric acid to a soln. of barium chloride, and, conversely, barium chloride is precipitated by hydrochloric acid from an aq. soln. of barium nitrate. C. Schultz said that strontium nitrate is insoluble in conc. nitric acid, while H. Wurtz stated that it is sparingly soluble. S. G. Rawson, however, stated that, unlike strontium and barium nitrates, the calcium salt is soluble in conc. nitric acid, and he based a method for the separation of barium and strontium from calcium, upon the insolubility of the nitrates of the two former elements and the solubility of the latter, in conc. nitric acid. H. Bassett and H. S. Taylor have studied the ternary system, $\text{Ca}(\text{NO}_3)_2-\text{HNO}_3-\text{H}_2\text{O}$, at 25° . The following is a selection from their results, with the conc. expressed in grams per 100 grms. of sat. soln. :

$\text{Ca}(\text{NO}_3)_2$.	57.98	54.82	40.70	32.50	33.44	27.79	31.09	8.52	5.06	0
HNO_3 .	0	3.33	19.65	33.52	35.63	45.70	40.56	67.20	71.12	96.86
	$\text{Ca}(\text{NO}_3)_2 \cdot 4\text{H}_2\text{O}$				$\text{Ca}(\text{NO}_3)_2 \cdot 3\text{H}_2\text{O}$		$\text{Ca}(\text{NO}_3)_2 \cdot 2\text{H}_2\text{O}$		$\text{Ca}(\text{NO}_3)_2$	

The results are plotted in Fig. 60, where *A* represents the aq. soln. in equilibrium with the tetrahydrate ; the curve *AB* represents soln. of nitric acid in equilibrium

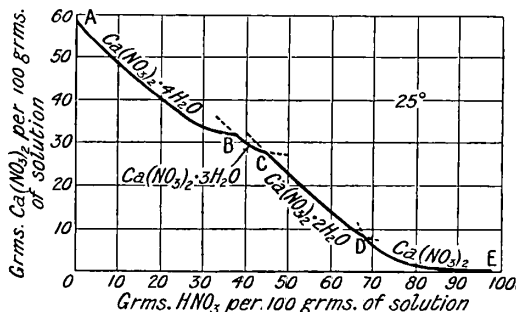

FIG. 60.—Equilibrium Conditions of the Ternary System, $\text{Ca}(\text{NO}_3)_2-\text{HNO}_3-\text{H}_2\text{O}$, at 25° .

with this same hydrate ; *B*, a soln.—37 per cent. nitric acid—in equilibrium with the tetra- and tri-hydrates ; *BC*, a soln.—37–43 per cent. nitric acid—in equilibrium with the trihydrate ; *C*, a soln.—43 per cent. nitric acid—in equilibrium with the tri- and di-hydrates ; *CD*, a soln. in equilibrium with the dihydrate ; *D*, a soln. in equilibrium with the dihydrate and anhydrous salt ; and *DE*, a soln. in equilibrium with the anhydrous salt. The dotted lines represent unstable

supersaturated soln. According to A. H. Pearson,⁵ dil. acetic acid dissolves barium nitrate less readily than dil. hydrochloric acid ; and aqua ammonia dissolves barium nitrate less readily than water.

According to F. M. Raoult, the aq. soln. of calcium nitrate absorbs a larger proportion of ammonia than water alone, and this the more, the greater the conc. of the calcium nitrate in soln.—presumably complex ions, $\text{Ca}(\text{NH}_3)_n^{++}$, are formed. Changes of press. influence the solubility of ammonia in calcium nitrate soln., the same as in aq. soln. The spontaneous evap. of the aq. ammoniacal soln. leaves

unchanged calcium nitrate. According to E. C. Franklin and C. A. Kraus, *liquid ammonia* dissolves calcium, strontium, and barium nitrates, and they have measured the electrical conductivities of the soln.; the liquid ammonia soln. of calcium nitrate gives a precipitate when treated with ammonium chloride or bromide, but not with ammonium iodide—with strontium or barium nitrate soln. ammonium iodide gives a crystalline precipitate; ammonium sulphide slowly gives a white precipitate; ammonium chromate or borate also gives a precipitate. C. A. L. de Bruyn found that 100 parts of dried *hydroxylamine* dissolve 11.4 parts of barium nitrate, and if a soln. of potassium sulphate in hydroxylamine be added, no barium sulphate is precipitated. According to T. W. B. Welsh and H. J. Brodersen, 100 grms. of anhydrous *hydrazine* dissolve 5 grms. of strontium nitrate, or 3 grms. of barium nitrate at room temp.

According to C. J. B. Karsten, *potassium hydroxide*, or *sodium hydroxide*, dissolves in a sat. soln. of calcium or barium nitrate without the precipitation of calcium hydroxide; and conversely calcium hydroxide dissolves in conc. soln. of potassium or sodium nitrate.

G. G. Rousseau and G. Tite prepared the dihydrate, $\text{CaO} \cdot \text{Ca}(\text{NO}_3)_2 \cdot 2\text{H}_2\text{O}$, by heating a soln. of the nitrate in presence of the oxide at 180° – 200° . He said that the needle-like crystals have a longitudinal extinction, and that they are insoluble in alcohol, and decomposed by water. N. A. E. Millon previously prepared a basic nitrate by boiling a soln. of the nitrate with the hydroxide, and extracted the residue with water. A. Werner added milk of lime to a cold sat. soln. of calcium nitrate until it ceased to be dissolved; the soln. was then shaken, and after some minutes set to a semi-solid mass of long needles. This was protected from carbon dioxide, and left for two or three days, after which it was collected on an asbestos filter by means of a filter pump. The basic nitrate thus obtained was dried on glazed porcelain in an atm. free from carbon dioxide. It had the composition $\text{Ca}(\text{NO}_3)_2 \cdot \text{Ca}(\text{OH})_2 \cdot 2\frac{1}{2}\text{H}_2\text{O}$, and lost its water of crystallization at 160° . It was decomposed by water into calcium nitrate and hydroxide. The heat of formation of the anhydrous salt was $+2.0$ Cals., and a further amount of 8.4 Cals. was developed in the formation of the hydrated salt.

F. K. Cameron and W. O. Robinson studied the ternary system, CaO — $\text{Ca}(\text{NO}_3)_2$ — H_2O , at 25° , and inferred that the solid phases, $\text{Ca}(\text{OH})_2$; a solid soln., $\text{CaO} \cdot x\text{N}_2\text{O}_5 \cdot y\text{H}_2\text{O}$; a basic nitrate, $2\text{CaO} \cdot \text{N}_2\text{O}_5 \cdot 3\frac{1}{2}\text{H}_2\text{O}$, *i.e.* $\text{Ca}_2\text{N}_2\text{O}_7 \cdot 3\frac{1}{2}\text{H}_2\text{O}$; and $\text{Ca}(\text{NO}_3)_2 \cdot 4\text{H}_2\text{O}$, can be in stable equilibrium with alkaline soln. of calcium nitrate. H. Bassett and H. S. Taylor have shown that, owing mainly to complications introduced by the use of impure calcium nitrate, the solid soln. assumed to exist is in reality a part of the curve with calcium hydroxide as equilibrium solid, and that, at 25° , the only basic nitrate is trihydrated calcium oxynitrate, $\text{CaO} \cdot \text{Ca}(\text{NO}_3)_2 \cdot 3\text{H}_2\text{O}$, not $\text{CaO} \cdot \text{Ca}(\text{NO}_3)_2 \cdot 3\frac{1}{2}\text{H}_2\text{O}$. At 100° the trihydrate is no longer stable, and there can exist dihydrated calcium oxynitrate, $\text{CaO} \cdot \text{Ca}(\text{NO}_3)_2 \cdot 2\text{H}_2\text{O}$; and hemihydrated calcium oxynitrate, $\text{CaO} \cdot \text{Ca}(\text{NO}_3)_2 \cdot \frac{1}{2}\text{H}_2\text{O}$, can exist in equilibrium with the soln. There is no indication of any other basic salt intermediate between $\text{Ca}(\text{OH})_2$ and $\text{Ca}_2\text{N}_2\text{O}_7$. By plotting the number of grams of "free" calcium oxide with the number of grams of calcium nitrate per 100 grms. of soln., the curves shown in Fig. 61 are obtained—the dotted curve applies for 25° , the other at 100° . The dotted curve *AB* shows that calcium hydroxide can exist at 25° in stable equilibrium with soln. containing less than 44.5 grms. of calcium nitrate per 100 grms. of soln.; small quantities of calcium nitrate lower the solubility of calcium hydroxide, while in the more conc. soln. of calcium nitrate the solubility of the hydroxide is three times its value in aq. soln. The dotted curve *BC* shows that basic salt, $\text{Ca}_2\text{N}_2\text{O}_7 \cdot 3\text{H}_2\text{O}$, can exist in stable equilibrium with soln. containing from 44.5 to 57.5 grms. of calcium nitrate per 100 grms. of soln. The salt forms large acicular crystals. The dotted curve *CD* corresponds with tetrahydrated calcium nitrate as solid phase. The curve *FG*, at 100° , corresponds with $\text{Ca}(\text{OH})_2$ as solid phase, and the maximum amount

of "free" lime in soln. is about five times as great as at 25°; the curve *GHI* ranges from 57 to 70.6 per cent. of calcium nitrate, and corresponds with the crystals of $\text{Ca}_2\text{N}_2\text{O}_7 \cdot 2\text{H}_2\text{O}$ as solid phase; the curve *IK* corresponds with the crystals of $\text{Ca}_2\text{N}_2\text{O}_7 \cdot \frac{1}{2}\text{H}_2\text{O}$ as solid phase; and the curve *KL* with anhydrous calcium nitrate as solid phase.

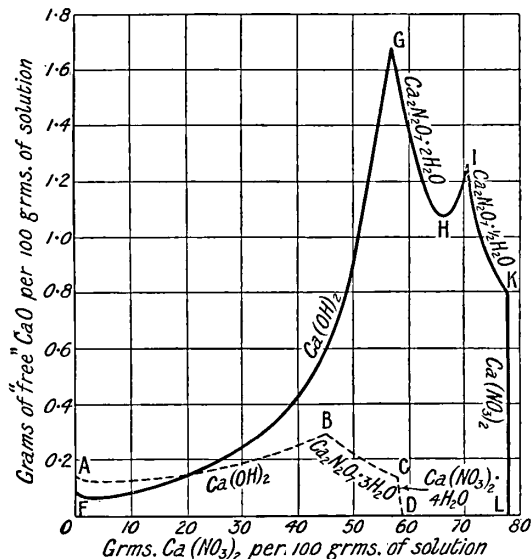

FIG. 61.—Equilibrium Curves in the Ternary System, $\text{CaO}-\text{Ca}(\text{NO}_3)_2-\text{H}_2\text{O}$, at 25° and at 100°.

soln. of the other; similar results were obtained with *sodium chloride*, and with *sodium nitrate*. G. J. Mulder and H. Kopp also made observations on the effect of sodium nitrate on the solubility of barium, and strontium nitrates. According to A. Müntz, a soln. of calcium nitrate and sodium chloride may form sodium nitrate by double exchange. According to R. Kremann and H. Rodemund, at 25°, the solubilities, expressing conc. in grams per 100 grms. of sat. soln., are :

$\text{Ca}(\text{NO}_3)_2$.	.	54.58	53.22	52.73	52.40	37.31	26.91	14.61
NaNO_3	.	.	7.25	10.70	12.08	11.88	19.48	24.98	36.12
Solid phase			$\text{Ca}(\text{NO}_3)_2 \cdot 4\text{H}_2\text{O}$		$\text{Ca}(\text{NO}_3)_2 + \text{NaNO}_3$	NaNO_3			

Analogous results were obtained at 9°. A. Coppadoro studied the ternary system, $\text{Ba}(\text{NO}_3)_2-\text{NaNO}_3-\text{H}_2\text{O}$, at 30°; the ternary system, $\text{Ba}(\text{NO}_3)_2-\text{NaCl}-\text{H}_2\text{O}$; and the corresponding quaternary system. G. J. Mulder, C. J. B. Karsten, and H. Kopp studied the solubility of barium nitrate in soln. of *potassium nitrate* and obtained indications of the formation of a double salt. A. Findlay, I. Morgan, and I. P. Morris, and H. W. Foote studied the ternary system, $\text{Ba}(\text{NO}_3)_2-\text{KNO}_3-\text{H}_2\text{O}$, at 9.1°, 21.1°, 25°, and 35°. No double salt was observed with sodium nitrate; potassium barium tetranitrate, $\text{K}_2\text{Ba}(\text{NO}_3)_4$, or $2\text{KNO}_3 \cdot \text{Ba}(\text{NO}_3)_2$, was formed with potassium nitrate. Thus, at 35°, expressing conc. in grams of salt per 100 grms. of soln. :

$\text{Ba}(\text{NO}_3)_2$.	11.39	9.18	8.08	8.42	5.85	5.02	3.02	1.77	0
KNO_3	.	0	12.99	17.48	19.75	24	26.05	34.87	34.93	35.01
Solid phase		$\text{Ba}(\text{NO}_3)_2$			+	$2\text{KNO}_3 \cdot \text{Ba}(\text{NO}_3)_2$		+	KNO_3	

W. K. Wallbridge prepared the double salt by evaporating conc. soln. of the component salts. The tetrahedral crystals resembled those of barium nitrate. It is

remarkable that crystals of double salts of rubidium or cæsium nitrate, or of potassium nitrate with strontium nitrate, could not be prepared. Nor have double salts with calcium nitrate and the alkali nitrates been obtained. A. Fock, and H. Euler measured the solubility of mixtures of *lead nitrate* and barium nitrate at 15°, 25°, 30°, and 47°. F. Margueritte found that when *potassium chlorate* is dissolved in a soln. of barium nitrate, the latter is not so readily precipitated by many reagents. R. Kremann and H. Rodemund have studied the effect of *sodium thio-sulphate* on aq. soln. of calcium nitrate, and the reciprocal salt pairs; $\text{Na}_2\text{S}_2\text{O}_3 + \text{Ca}(\text{NO}_3)_2 \rightleftharpoons \text{CaS}_2\text{O}_3 + 2\text{NaNO}_3$. No double salt is observed, but there is a small region of stability for the triple salt, *sodium calcium nitrate-thiosulphate*, $\text{NaNO}_3 \cdot \text{CaS}_2\text{O}_3 \cdot \text{Na}_2\text{S}_2\text{O}_3 \cdot 11\text{H}_2\text{O}$; this region diminishes with rises of temp. and the invariant transformation temp. is 29°–29.2°, beyond which single salts are formed. According to K. von Hauer, 100 parts of water at 19°–20°, dissolves singly 8.73 parts of barium nitrate or 45.94 parts of strontium nitrate; and if strontium nitrate be added to a sat. soln. of barium nitrate, almost the whole of the barium nitrate is precipitated, and the soln. contains 45.96 parts of salt per 100 parts of water.

Calcium nitrate is readily soluble in *ethyl alcohol*, and in *methyl alcohol*, and the electrical conductivities and the raising of the b.p. of these soln. have been determined, *vide infra*, from which J. Wölfer,⁶ and B. Völlmer infer that there is a partial association of the solvent with the salt, or complex ions are formed. According to C. A. Gerardin, barium nitrate is insoluble in absolute alcohol; and in aq. alcohol, the solubility increases linearly with rise of temp. According to H. Rose, 100 parts of absolute alcohol dissolve 0.01176 part and, according to J. R. Hill, 0.02387 part of strontium nitrate; according to the latter, 100 parts of commercial rectified spirit dissolve 0.5 part of strontium nitrate; and, according to H. Rose, 100 parts of a mixture of equal vol. of alcohol and ether dissolve 0.00167 part of strontium nitrate.

J. d'Ans and R. Siegler obtained three types of solubility isothermal curves with mixtures of ethyl alcohol and water and the three nitrates of the alkaline earths: (1) The curve with barium nitrate, which does not form compounds with either water or alcohol, is a straight line, showing a decreasing solubility with increasing alcohol conc. (2) The curve with strontium nitrate, which forms the compound $\text{Sr}(\text{NO}_3)_2 \cdot 4\text{H}_2\text{O}$, with water, but does not form a compound with alcohol, is divided into two branches corresponding with the fact that the hydrated salt is stable in the dil. alcoholic soln., whilst the anhydrous salt is stable in the conc. alcoholic soln.

(3) The curve with calcium nitrate, which forms $\text{Ca}(\text{NO}_3)_2 \cdot 4\text{H}_2\text{O}$ with water and $\text{Ca}(\text{NO}_3)_2 \cdot 2\text{C}_2\text{H}_5\text{OH}$ with alcohol, consists of three branches. It is found that between the areas in which the hydrate and the alcoholate are stable there is a small metastable region, in which anhydrous calcium nitrate constitutes the solid phase. The observed data are plotted in Fig. 62. It will be observed that barium nitrate forms no hydrate and no alcoholate; and it is almost insoluble in alcohol; strontium nitrate forms a tetrahydrate but no alcoholate; calcium nitrate forms three hydrates and one alcoholate, $\text{Ca}(\text{NO}_3)_2 \cdot 2\text{C}_2\text{H}_5\text{OH}$, which was discovered by T. Graham and regarded by him as having the composition $\text{Ca}(\text{NO}_3)_2 \cdot 2.2\text{C}_2\text{H}_5\text{OH}$. The solubilities of the

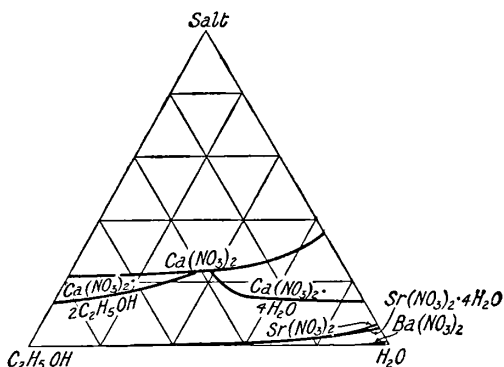

FIG. 62.—Equilibrium Diagram for the Ternary Systems, $\text{M}(\text{NO}_3)_2$ — $\text{C}_2\text{H}_5\text{OH}$ — H_2O .

alkaline earth nitrates, $\text{Ca}(\text{NO}_3)_2$, $\text{Sr}(\text{NO}_3)_2$, and $\text{Ba}(\text{NO}_3)_2$, are shown in the diagram. The diagram shows the stability of different phases as a function of the composition of the mixture.

three nitrates were also determined in some other solvents, at 25°, expressing the results in grams of nitrate in 100 grms. of soln.

	Ba(NO ₃) ₂	Sr(NO ₃) ₂	Ca(NO ₃) ₂
Water	9.55	46.61	82.5
Methyl alcohol	0.50	1.26	65.5
Ethyl alcohol	0.005	0.02	52
Propyl alcohol	—	0.02	36.5
Isobutyl alcohol	—	0.01	25
Amyl alcohol	—	0.003	13.3
Acetone	0.005	0.02	58.5

P. E. Browning gave 0.004 per cent. for the solubility of strontium nitrate in amyl alcohol. Barium nitrate thus dissolves to a slight extent only in all the solvents except water. Strontium nitrate is very slightly more soluble, whilst calcium nitrate is very soluble, except in the cases of *ether*, and *paracetaldehyde*, in which it is not more soluble than the other nitrates. W. Eidmann found calcium nitrate to be insoluble in *methylal*, and barium and strontium nitrates to be soluble in *acetone*, and J. F. Snell observed no layer formation by the soln. of barium nitrate in mixtures of acetone and water. According to A. Naumann, *methyl acetate* dissolves 41 grms. of calcium nitrate per 100 grms. of soln. at 18°, and the soln. has a sp. gr. 1.313. V. Rothmund and N. T. M. Wilsmore measured the solubility of barium nitrate in aq. soln. of *phenol* at 25°; and J. Timmermans has also studied the system.

J. W. Retgers⁷ found the **crystals** of anhydrous calcium nitrate to form microscopic octahedra which are singly-refracting and belong to the cubic system; they are isomorphous with strontium and barium nitrates. These crystals have been studied by A. Scacchi, and by L. Wulff, W. J. Lewis, and R. Henriques. According to J. C. G. de Marignac, the crystals of tetrahydrated calcium nitrate form monoclinic prisms with axial ratios $a : b : c = 1.5839 : 1 : 0.6876$, and $\beta = 98^\circ 6'$, and, according to H. de Sénarmont, the monoclinic prisms of the tetrahydrated salt, have the axial ratios $a : b : c = 0.6547 : 1 : 0.8976$, and $\beta = 91^\circ 10'$. The artificial coloration of crystals of tetrahydrated strontium nitrate has been studied by H. de Sénarmont, H. Becquerel, and C. Camichel. S. Nishikawa and K. Hudinuki, and L. Vegard studied the **X-radiograms** of calcium, barium, and strontium nitrates. The **corrosion figures** of crystals of barium and strontium nitrates have been studied by L. Wulff, and by H. Baumhauer. G. Brügelmann studied the isomorphism of mixed crystals of barium nitrate with sodium or potassium nitrate.

The **specific gravity** of crystals of anhydrous calcium nitrate is, according to A. Filhol,⁸ 2.240; P. Kremers, 2.472; P. A. Favre and C. A. Valson, 2.504 at 17.9°. The reported values for anhydrous strontium nitrate range from 2.704 at 3.9° of L. Playfair and J. P. Joule, to 3.0061 of J. H. Hassenfratz—M. le Blanc and P. Rohland gave 2.497—and for anhydrous barium nitrate from the 3.16052 at 3.9° of the last named to the 3.404 of H. J. Buignet—M. le Blanc and P. Rohland gave 3.245. The best representative values are 2.444 for calcium nitrate, 2.986 for strontium nitrate, and 3.243 for barium nitrate. For tetrahydrated calcium nitrate E. Filhol gave 1.78; P. A. Favre and C. A. Valson, 1.878 at 18°; and J. M. Ordway, 1.90 at 15.5° for the solid and 1.79 at 15.5° for the liquid; and for tetrahydrated strontium nitrate, E. Filhol gave 2.113; and P. A. Favre and C. A. Valson, 2.249 at 15.5°.

The sp. gr. of aq. soln. of calcium nitrate have been determined by F. Mylius and R. Funk,⁹ A. C. MacGregory, G. T. Gerlach, etc. B. Franz gave for soln. of the following percentage composition at 17.5°:

Per cent.	1	5	10	15	20	25	30	40	50	60
Sp. gr., Ca(NO ₃) ₂	1.009	1.045	1.086	1.129	1.174	1.222	1.272	1.385	1.515	1.666
Sp. gr., Sr(NO ₃) ₂	—	1.041	1.085	1.131	1.181	1.235	1.292	1.422	—	—
Sp. gr., Ba(NO ₃) ₂	1.009	1.042	1.087	—	—	—	—	—	—	—

G. T. Gerlach, A. C. MacGregory, etc., have given values for the sp. gr. of soln. of

strontium nitrate; and C. J. B. Karsten, A. Michel and L. Krafft, etc., for barium nitrate. P. Kremers' values for strontium and barium nitrates are indicated above. Earl of Berkeley and M. P. Appleby give for soln. of strontium nitrate sat. at the different temp:

Sp. gr.	0°58'	14°71'	29°06'	30°28'	39°74'	61°34'	78°89'	88°94'
	1.28561	1.39380	1.51098	1.51441	1.51282	1.51048	1.51091	1.51174

J. Wagner gave for the viscosity of aq. soln. 0.125*N*-, 0.25*N*-, 0.5*N*-, and *N*- of calcium nitrate at 25° the respective values 1.0076, 1.0218, 1.0533, and 1.1172 when the value for water is unity; for 0.125*N*-, 0.25*N*-, 0.5*N*-, and *N*-soln. of strontium nitrate, under similar conditions, he gave the respective values 1.0114, 1.0240, 1.0491, and 1.150; and for 0.125*N*-, 0.25*N*-, and 0.5*N*-soln. of barium nitrate the respective values 1.0084, 1.0214, and 1.0437. He also measured the effect of temp. on the viscosity of these soln. S. de Lannoy represented the vol. *v* of soln. of strontium nitrate at θ° by the formula $v=v_0(1+a\theta+b\theta^2)$, where v_0 is the volume at the initial temp., and *a* and *b* are constants for the ranges of conc. and temp.:

Per cent. Sr(NO ₃) ₂	4	4	8	8	15	15	25
Temperature.	0°-40°	40°-82°	0°-40°	40°-75°	0°-40°	40°-75°	0°-75°
<i>a</i>	0.0498	0.0455	0.031525	0.03126	0.032766	0.032038	0.03371
<i>b</i>	0.00337	0.004775	0.00344	0.00341	0.002413	0.002685	0.003176

N. A. Tschernay represented the thermal expansion between 0° and 60° of a soln. of a mol of calcium nitrate in 50 mols of water by $v=1+0.0001719\theta+0.000003531\theta^2$; and of a mol of strontium nitrate in 100 mols of water by $v=1+0.0001787\theta+0.000003557\theta^2$. G. Jäger found the thermal conductivity of 20, 36, and 40 per cent. soln. of strontium nitrate to be respectively 96.4, 92.3, and 92.8 when that of water is 100. H. V. Regnault¹⁰ found that specific heat of solid barium nitrate to be 0.1523 between 13° and 98°; and H. Kopp found for crystalline strontium nitrate, 0.181 between 17° and 47°. J. C. G. de Marignac measured the sp. ht. of soln. of nitrates of the alkaline earths and found for soln. with *n* mols of water per mol of Ca(NO₃)₂, at 21.51°,

<i>n</i>	10	15	25	50	100	200
Sp. ht., Ca(NO ₃) ₂	0.6255	0.6856	0.7597	0.8463	0.9116	0.9510
Sp. ht., Sr(NO ₃) ₂	—	—	—	0.8169	0.8905	0.9348
Sp. ht., Ba(NO ₃) ₂	—	—	—	—	—	0.9299

T. Carnelly¹¹ gave 561°±6° for the melting point of anhydrous calcium nitrate; 645°±3° for strontium nitrate; and 593°±1° for barium nitrate. W. Ramsay and N. Eumorfopoulos gave 499° for calcium nitrate; 570° for strontium nitrate; and 575° for barium nitrate; H. le Chatelier gave 592° for barium nitrate; and W. D. Harkins and G. L. Clark found 595.53°. For the m.p. of tetrahydrated calcium nitrate, J. L. R. Morgan and P. T. Owen gave 42.31°; J. d'Ans and R. Siegler, 42.89°±0.03°; S. U. Pickering, 42.4°; and T. W. Richards, and H. Bassett and H. S. Taylor, 42.7° for stable α -Ca(NO₃)₂·4H₂O; the latter gave 39.7° for unstable β -Ca(NO₃)₂·4H₂O; H. Bassett and H. S. Taylor also gave 51.1° for the m.p. of trihydrated calcium nitrate, and they found that the dihydrate does not possess a true m.p. as indicated in Fig. 61. S. U. Pickering gave 33.49 Cals. for the heat of fusion of tetrahydrated calcium nitrate.

The fusion curves of barium, strontium, or calcium nitrate with lithium, sodium, or potassium nitrate, have been partially studied but no evidence of the formation of double salts has been obtained. According to A. W. C. Menzies and N. N. Dutt,¹² the V-eutectic with calcium and sodium nitrates is near 240° with 50 per cent. of each component; with calcium and potassium nitrates, it is nearer 210° with 42 per cent. of calcium nitrate—F. Guthrie found the eutectic at 251° with 25.86 per cent. of calcium nitrate, A. W. C. Menzies and N. N. Dutt also studied the ternary system, Ca(NO₃)₂—KNO₃—NaNO₃, and found the ternary eutectic approximated to 175° with 30:50:20 eq. per cent. of the respective salts. E. J. Maumené gave the m.p. of the mixture NaNO₃+Ca(NO₃)₂ as 235°, A. W. C. Menzies and N. N. Dutt found 261°. W. D. Harkins and G. L. Clark found for barium and sodium nitrates the eutectic near 300° with about 8 or 9 eq. per cent. of the

sodium salt; for the barium and potassium nitrates a eutectic near 310° with nearly 80 eq. per cent. of the potassium salt; and for the ternary system, $\text{Ba}(\text{NO}_3)_2\text{—KNO}_3\text{—NaNO}_3$, the ternary eutectic is 214.1° with 5:50:45 eq. per cent. of the respective salts. E. J. Maumené measured the m.p. of the mixtures $\text{Ba}(\text{NO}_3)_2 + \text{KNO}_3$ and $\text{Ba}(\text{NO}_3)_2 + \text{NaNO}_3$; and of $\text{Sr}(\text{NO}_3)_2 + \text{KNO}_3$ and $\text{Sr}(\text{NO}_3)_2 + \text{NaNO}_3$. F. Guthrie found the eutectic point with barium and potassium nitrate corresponded with 29.53 per cent. of the barium salt and a temp. of 278.5° ; he also found that a eutectic at 285° with potassium and strontium nitrates corresponding with 25.81 per cent. of the latter salt. W. D. Harkins and G. L. Clark determined the m.p. of a few points in the ternary system, $\text{Sr}(\text{NO}_3)_2\text{—KNO}_3\text{—NaNO}_3$, and the ternary eutectic is not far from 208.4° with the respective eq. percentages 9:50:49. Attempts to deal with the ternary system, $\text{Ba}(\text{NO}_3)_2\text{—KNO}_3\text{—LiNO}_3$, were abandoned because when over 10 eq. per cent. of the first-named salt was present oxygen was rapidly evolved—even so low as 266° .

The cryohydric temp. of the three salts are indicated in connection with the solubilities of the salts in water. H. C. Jones and F. H. Getman's values for the lowering of the freezing point $d\theta$ of soln. of calcium nitrate with the conc. C expressed in mols per litre:

C	. . . 0.042	0.104	0.208	0.415	1.038	1.660	2.075	2.905	3.320
$d\theta$. . . 0.200°	0.470°	0.910°	1.820°	5.070°	8.680°	11.600°	19.320°	24.320°
$d\theta/C$. . . 4.76	4.52	4.37	4.39	4.89	5.23	5.59	6.65	7.33

The increase in the value of $d\theta/C$ with conc. soln. owing to the formation of hydrates is not so marked as with soln. of the halides. S. Arrhenius, and S. U. Pickering also studied the f.p. of soln. of this salt. H. C. Jones and F. H. Getman also found soln. of strontium nitrate gave a minimum value of $d\theta/C=4.00$ in $0.15N$ -soln. For soln. of barium nitrate, mols per litre, H. Hausrath found for $C=0.000383$, 0.002681 , and 0.008552 ; $d\theta=0.002140^\circ$, 0.01401° , and 0.04311° ; and $d\theta/C=5.58$, 5.22 , and 5.05 respectively. F. M. Raoult also measured the lowering of the f.p. of soln. of barium nitrate.

The boiling point of a sat. soln. containing 351.2 grms. of calcium nitrate in 100 grms. of water was found by J. Legrand¹³ to be 150° ; P. Kremers gave 152° ; and G. T. Gerlach gave for soln. with w grms. of $\text{Ca}(\text{NO}_3)_2 \cdot 2\text{H}_2\text{O}$ in 100 grms. of water;

w	. . . 12	25.5	68.5	152.5	607	1376	2614	10880
B.p.	. . . 101°	102°	105°	110°	130°	140°	145°	150°

T. Griffiths found the b.p. of a sat. soln. of strontium nitrate is 106.8° with 113 grms. of the salt in 100 grms. of water; P. Kremers gave 107.5° to 108° ; G. J. Mulder, 107.9° , and for a soln. with w grms. of $\text{Sr}(\text{NO}_3)_2$ in 100 grms. of water, G. T. Gerlach gave

w	. . . 12	24	63.6	89.6	97.6	105	112.2	116.5
B.p.	. . . 100.5°	101°	103°	104.5°	105°	105°	106°	106.3°

T. Griffiths found the b.p. of a sat. soln. of barium nitrate is 101.1° with 36.18 grms. of the salt in 100 grms. of water; P. Kremers, 102.5° ; G. J. Mulder, 101.9° ; and J. L. Gay Lussac, 101.65° ; G. T. Gerlach found the b.p. of a soln. of barium nitrate, when w is 12.5, 26, and 27.5 , is respectively 100.5° , 101° , and 101.1° . J. M. Ordway gave 132° for the b.p. of melted tetrahydrated calcium nitrate. S. Arrhenius calculated for the mol. raising of the boiling point of $0.0643N$ -, $0.1073N$ -, and $0.179N$ -soln. of calcium nitrate, the respective values 4.72, 4.62, 4.58; A. Smits, for $0.0429N$ -, $0.0848N$ -, $0.4142N$ -, and $0.9005N$ -soln. of strontium nitrate, the respective values 1.166, 1.156, 1.190, and 1.215; or the values of i are respectively 2.24, 2.22, 2.19, and 2.34. A. Smits also found, for $0.0461N$ -, $0.0868N$ -, $0.4233N$ -, and $0.8890N$ -soln. of barium nitrate, the respective values of $d\theta/C$, 1.140, 1.210, 1.101, and 1.025, or the values of i are respectively 2.71, 2.33, 2.12, and 1.92.

G. Tammann¹⁴ has measured the lowering of the vapour pressure of water at 100° by soln. of the nitrates of the alkaline earths:

	$\text{Ca}(\text{NO}_3)_2$			$\text{Sr}(\text{NO}_3)_2$			$\text{Ba}(\text{NO}_3)_2$		
Grms. of salt	. . . 6.69	44.40	168.13	7.30	45.32	78.58	5.83	18.28	32.32
Lowering v.p.	. . . 13.1	104.2	403.4	11.0	69.1	123.1	6.0	18.8	32.4 mm.

H. Lescoeur gives 9.3 mm. for the vap. press. of a sat. soln. of tetrahydrated calcium nitrate at 20°, and he has measured the changes of vap. press. during the dehydration of a soln. of the salt, and the hydration of the anhydrous salt. According to W. Müller-Erbach, the vap. press. of the tetrahydrate is 0.6 to 0.7 of that of water, and the salt loses its water of crystallization under the same press.; the accidental formation of the trihydrate showed 0.11 for the relative press. for the first mol and 0.04 for the two last mols. F. M. Raoult measured the lowering of the vap. press. of soln. of barium nitrate. J. Waddell compared what T. Graham called the in-vaporation or the absorption of water by lithium nitrate and the nitrates of the alkaline earths. He found lithium nitrate to be the least absorbent, the calcium salt was more absorbent, the strontium salt still more, and the barium salt was the most absorbent. R. O. E. Davis and co-workers measured the vap. press. of ammonical soln. of calcium nitrate; and considered that soln. of calcium nitrate are most promising for practical use as an absorbent for ammonia.

According to J. Thomsen,¹⁵ the heat of formation is (Ca, N₂, 3O₂), 203.23 Cals.; (Ca, O₂, N₂O₄), 207.21 Cals.; (Sr, O₂, N₂O₄), 223.83 Cals.; (Sr, N₂, 3O₂), 219.85 Cals.; (Ba, O₂, N₂O₄), 229.72 Cals.; and (Ba, N₂, 3O₂), 225.74 Cals. M. Berthelot gave with solid components (CaO, N₂O₅), 59.2 Cals.; (SrO, N₂O₅), 76.2 Cals.; (BaO, N₂O₅), 81.4 Cals.; Ca(OH)₂+2HNO₃, all in dil. soln., 27.8 Cals.; similarly for Sr(OH)₂+2HNO₃, 27.8 Cals.; and Ba(OH)₂+2HNO₃, 27.8 Cals. J. Thomsen gave for the heat of solution of a mol of Ca(NO₃)₂ in 400 mols of water 3.95 Cals.; for Sr(NO₃)₂, 4.62 Cals.; Ba(NO₃)₂, 9.40 Cals.; and for Ca(NO₃)₂.4H₂O, -7.25 Cals. S. U. Pickering found 3.943 Cals. for the heat of soln. of Ca(NO₃)₂ in water, and 8.710 Cals. in alcohol; and for Ca(NO₃)₂.4H₂O, -8.354 Cals. in water, and -1.835 Cals. in alcohol. E. von Stackelberg measured the heat of soln. *Q* of *n* mols of barium nitrate in 100 mols of water and found $Q=10638-8108n+608n^2$ cal. F. R. Pratt measured the heats of dilution of soln. of barium and strontium nitrates.

The index of refraction of crystals of strontium nitrate for Na-light is 1.57, according to A. Fock;¹⁶ and 1.5665, according to M. le Blanc and P. Rohland—while J. Behr's value 1.5878 is considered to be incorrect. H. Topsøe and C. Christiansen found for crystals of barium nitrate 1.5665 for the *C*-line; 1.5711 for the *D*-line; and 1.5825 for the *F*-line; A. Fock found 1.5716 and M. le Blanc and P. Rohland, 1.5711 for the *D*-line; J. Behr, 1.5655 for the *Li*-line; 1.5699 for the *Na*-line; and 1.5735 for the *Tl*-line.

According to H. de Sénarmont, the crystals of tetrahydrated strontium nitrate gave a strong negative double refraction. The anomalous double refraction of the crystals of anhydrous strontium and barium nitrates has been studied by H. Marbach, L. Wulff, W. J. Lewis, F. Klocke, and J. Morel. The indices of refraction of aq. soln. of calcium nitrate have been studied by H. C. Jones and F. H. Getman, and B. C. Damien; the latter found for a soln. sp. gr. 1.7621, at 12.3°; 1.46436 and 1.48341 respectively for *H_α* and *H_γ*; 1.46308 and 1.48142 respectively for a soln. of sp. gr. 1.7580 at 17.0°; 1.45782 and 1.47534 respectively for a soln. of sp. gr. 1.7425 at 34.1°; and 1.45201 and 1.46813 respectively for a soln. of sp. gr. 1.7252 at 53.2°. M. le Blanc and P. Rohland found for 10.5 and 25.51 per cent. soln. of strontium nitrate, of sp. gr. 1.095 and 1.2440 respectively, the refractive indices for the *D*-line 1.3387 and 1.3459 respectively; and for 6.08 and 6.97 per cent. soln. of barium nitrate of sp. gr. 1.0517 and 1.0597 respectively, the refractive indices 1.3398 and 1.3408 respectively. S. Koskinen and V. J. Saarialho also studied the optical properties of soln. of barium nitrate. The respective refraction equivalents of solid and soln. of strontium nitrate by the $(\mu-1)M/D$ formula are 20.33 and 20.40; and of barium nitrate, 22.98 and 22.27; similarly, by the $(\mu^2-1)M/(\mu^2+1)D$ formula, 11.72 and 11.83 for strontium nitrate, and 13.22 and 12.94 for barium nitrate. W. N. Hartley¹⁷ has studied the absorption spectra of soln. of calcium and barium nitrates. C. Schaefer and M. Schubert measured the infra-red spectrum of strontium and barium nitrates. W. Crookes observed that calcium nitrate gives an orange-yellow phosphorescence with a continuous spectrum when exposed

to cathode rays. P. Bary found strontium and barium nitrate fluoresces when exposed to X-rays or to Becquerel's rays. P. Heinrich noted the luminescence which occurs when barium oxide is treated with nitric acid in the dark.

P. Wenger and A. Lubomirsky¹⁸ studied the electro-reduction of barium nitrate in aq. soln. The equivalent **electrical conductivity**, λ , of soln. of the nitrates of the alkaline earths was measured by F. Kohlrausch and E. Grüneisen, at 18°. H. C. Jones and co-workers measured the mol. conductivity, μ , and the percentage **degree of ionization**, α , of soln. of the nitrates of the alkaline earths containing a mol of salt in v litres of water.

	v	2	8	32	128	512	2048
Ca(NO ₃) ₂	μ_{0°	65.84	85.50	102.3	114.5	122.6	130.0
	μ_{65°	—	287.8	350.6	397.7	432.5	458.3
	α_{0°	50.7	65.3	78.7	88.1	94.3	100.0
	α_{65°	—	62.8	76.5	86.8	94.4	100.0
Sr(NO ₃) ₂	μ_{0°	63.24	84.33	100.7	114.8	122.5	131.3
	μ_{65°	—	288.0	354.4	400.7	441.0	460.9
	α_{0°	48.2	64.2	77.7	87.4	93.3	100.0
	α_{65°	—	62.5	76.9	86.9	95.7	100.0
Ba(NO ₃) ₂	μ_{0°	—	76.37	97.62	114.4	124.3	131.4
	μ_{65°	—	276.2	334.2	398.3	440.7	467.0
	α_{0°	—	58.1	74.3	87.1	94.6	100.0
	α_{65°	—	58.1	72.4	83.8	92.7	98.2

L. Wöhler found 10.8 rec. ohms for the difference in the conductivities of soln. of strontium nitrate at dilutions between $v=32$ and $v=1024$; the corresponding difference with soln. of barium nitrate was 12.7 rec. ohms. H. C. Jones and co-workers also measured the temp. coeff. of the conductivities.

G. Kümmell, and K. Drucker also discussed the degree of ionization of soln. of these salts. Measurements have also been made of the conductivity of aq. soln. of calcium nitrate soln. by A. C. MacGregory, S. Arrhenius, H. C. Jones, etc. A. C. MacGregory gives 0.0219 for the temp. coeff. of the conductivity of soln. of calcium nitrate between 18° and 26°; and 0.0224 for soln. of strontium nitrate between 10° and 26°; H. C. Jones also gave values for this constant. H. C. Jones and C. G. Carroll have measured the electrical conductivities of soln. of nitrates of the alkaline earths in methyl and ethyl alcohols; R. J. Holland, in methyl alcohol soln. containing benzene, toluene, xylene, and turpentine; H. C. Jones and E. C. Bingham, in water containing ethyl or methyl alcohol, or acetone; C. A. Kraus and J. E. Bishop, in propyl alcohol; and E. C. Franklin and C. A. Kraus, in soln. in liquid ammonia. The **transport numbers** of the ions have been determined by W. Hittorf, and many others.¹⁹ G. N. Lewis and M. Randall calculated the activity coeff. of the ions of barium nitrate. The **pyroelectricity** and **piezoelectricity** of crystals of barium nitrate have been studied by W. Hankel. A. Heydweiller found the **dielectric constant** of barium nitrate to be 3.42 for $\lambda=478$ cm. P. Pascal gave for the mol. **coefficient of magnetization** of barium nitrate, 665×10^{-7} units.

Calcium nitrate decomposes when heated above its m.p., and gives off oxygen, nitrogen, and nitrogen peroxide. The residue obtained with partially decomposed calcium nitrate is phosphorescent in the dark, and it is the so-called *Baldwin's phosphorus*. Barium oxide, mixed maybe with some barium peroxide, remains as a solid when the nitrate has all decomposed; barium nitrite is an intermediate stage in the decomposition. The nitrates of the alkaline earths detonate feebly when strewn over red-hot coke, and when mixed with organic matter they detonate slightly when heated. Strontium and barium nitrates decompose if heated near their m.p. According to M. Rivière,²⁰ only a trace of nitrogen peroxide is produced. According to B. N. Gottlieb, and E. E. Basch, in heating barium nitrate, for the purpose of recovering the nitric acid, it is best to heat the salt as rapidly as possible without fusion. The former analyzed the gases evolved by heating barium nitrate

to different temp. E. J. Maumené found that when calcium, strontium, or barium nitrate is mixed with an equi-molar proportion of sodium or potassium nitrate, it can be fused without decomposition, but W. D. Harkins and G. L. Clark found that while mixtures of barium and potassium nitrates could be readily fused without decomposition, mixtures of barium and lithium nitrates, with over 40 eq. per cent. of the latter decomposed, and ternary mixtures of these three nitrates decomposed when over 10 eq. per cent. of the barium salt was present. Molten tetrahydrated calcium nitrate decomposes, and when a third of the water has been lost, the anhydrous salt begins to separate; similar remarks apply to tetrahydrated strontium nitrate. The latter salt, according to H. J. Brooke, and A. Souchay and E. Lenssen, effloresces rapidly in air, and loses all its water at 100°; on the contrary, according to N. A. E. Millon, tetrahydrated calcium nitrate deliquesces rapidly in air and loses the water in vacuo over conc. sulphuric acid. F. W. Smither found tetrahydrated calcium nitrate retains one-fourth of its water very tenaciously at 97°–98°, although it is given off very slowly at this temp.

According to F. Kuhlmann,²¹ when **hydrogen** is passed over red-hot barium nitrate, the hydroxide is formed; according to J. W. Thomas, gaseous **hydrogen chloride** does not change anhydrous or hydrated barium, strontium or calcium nitrates; according to K. Stammer, **carbon monoxide** reduces red-hot barium nitrate forming the carbonate and oxide; according to J. Lang, **lead** vigorously reduces hot barium nitrate, forming a trace of nitrite; according to J. W. Slater, **arsenic** forms arsenic trioxide when boiled with an aq. soln. of barium nitrate, but **phosphorus** is not attacked; and, according to C. J. B. Karsten, trituration of a dry mixture of **potassium sulphate** and barium nitrate is attended by the same double decomposition. E. M. Walton found a powdered mixture of barium nitrate and **sodium carbonate** liquefies with the absorption of heat, so that the temp. initially at 21·3° fell to –13·7°.

According to E. Lucius, barium nitrate unites with **barium acetate** to form a double salt. W. C. de Baat,²² in his study of the ternary system, $\text{NH}_4\text{NO}_3\text{—Ba}(\text{NO}_3)_2\text{—H}_2\text{O}$, at 30°, found no evidence of the formation of a double salt of barium nitrate, and **ammonium nitrate**; nor in his study of the quaternary system, $\text{Ba}(\text{NO}_3)_2\text{—NH}_4\text{NO}_3\text{—AgNO}_3\text{—H}_2\text{O}$, at 30°, did he find any evidence of the formation of a double salt with barium nitrate and **silver nitrate**. N. Busvold claims to have made white needle-like crystals of **calcium hydroxynitrate**, $2\text{Ca}(\text{OH})_2\cdot\text{Ca}(\text{NO}_3)_2\cdot 2\text{H}_2\text{O}$, by crystallization from a soln. of calcium oxide in one of calcium nitrate. C. L. Parsons and H. P. Corson found the mutual solubility of barium hydroxide and nitrate in aq. soln. at 25°. A soln. containing 5·02 parts of barium oxide, and 11·48 parts of barium nitrate in 100 parts of water, is sat. with respect to $\text{Ba}(\text{OH})_2\cdot 8\text{H}_2\text{O}$ and $\text{Ba}(\text{NO}_3)_2$. The solubility of each is thus increased by the presence of the other. Similarly, also, C. L. Parsons and C. L. Perkins found a soln. of strontium oxide and nitrate is sat. with the hydrated hydroxide and nitrate when it contains 1·76 parts of strontia, and 81·06 parts of strontium nitrate in 100 parts of water at 25°. In neither case was any evidence of basic nitrates—*strontium hydroxynitrate* or *barium hydroxynitrate*—obtained.

REFERENCES.

- ¹ T. Schlösing, *Compt. Rend.*, **73**, 1326, 1871; P. Groth, *Neues Jahrb. Min.*, **14**, 1883.
² A. Duflos, *Schwigger's Journ.*, **65**, 236, 1832; F. Kuhlmann, *Ann. Chim. Phys.*, (3), **54**, 396, 1858; A. Laurent, *ib.*, (3), **36**, 352, 1852; H. Lescœur, *ib.*, (6), **21**, 521, 1880; (7), **7**, 416, 1896; F. Mohr, *Liebig's Ann.*, **25**, 290, 1832; A. Souchay and E. Lenssen, *ib.*, **99**, 45, 1856; G. C. Wittstein, *Repert. Pharm.*, **66**, 69, 1839; F. Muck, *German Pat.*, *D.R.P.* 23372, 1882; C. H. Hirzel, *Zeit. Pharm.*, **49**, 1854; R. A. Berry, *Chem. News*, **44**, 190, 1881; A. L. Baker, *ib.*, **42**, 196, 1880; A. Scacchi, *Nuovo Cimento*, **1**, 170, 1855; *Pogg. Ann.*, **109**, 366, 1860; R. Kirwan, *Trans. Irish Acad.*, **5**, 243, 1794; *Crell's Ann.*, **ii**, 119, 205, 1795; G. J. Mulder, *Bijdragen tot de geschiedenis van het Scheikundig gebonden water*, Rotterdam, 114, 1864; Earl of Berkeley and M. P. Appleby, *Proc. Roy. Soc.*, **85**, A, 489, 1911; J. C. G. de Marignac, *Ann. Mines*, (5), **9**, 28, 1856; N. A. E. Millon, *Compt. Rend.*, **14**, 905, 1842; *Ann. Chim. Phys.*, (3),

6. 90, 1842; G. H. Hess, *Pogg. Ann.*, 12. 260, 1828; W. A. Tilden, *Journ. Chem. Soc.*, 45. 266, 1884; H. Bassett and H. S. Taylor, *ib.*, 101. 576, 1912; 105. 1926, 1914; D. Gernez, *Ann. École Norm.*, (2), 8. 46, 1879; *Compt. Rend.*, 84. 773, 1877; W. Müller-Erbach, *Ber.*, 19. 2875, 1886; M. Hasselblatt, *Zeit. phys. Chem.*, 83. 1, 1913; H. S. Taylor and W. N. Henderson, *Journ. Amer. Chem. Soc.*, 37. 1688, 1915; J. T. Cooper, *Ann. Phil.*, 23. 289, 1824; J. G. Gilbert, *Brit. Pat. No.* 124780, 1916.

³ A. B. Poggiale, *Ann. Chim. Phys.*, (3), 8. 469, 1843; J. L. Gay Lussac, *ib.*, (2), 11. 313, 1819; A. Étard, *ib.*, (7), 2. 503, 1894; *Compt. Rend.*, 108. 176, 1889; H. Kopp, *Liebigs Ann.*, 34. 203, 1840; C. J. B. Karsten, *Philosophie der Chemie*, Berlin, 1843; G. J. Mulder, *Scheikund. Verh. Rotterdam*, 3. 109, 1864; *Bijdragen tot de geschiedenis van het scheikundig gebonden water*, Rotterdam, 1864; F. Rüdorff, *Pogg. Ann.*, 114. 63, 1861; P. Kremers, *ib.*, 92. 499, 1854; F. K. Cameron and W. O. Robinson, *Journ. Phys. Chem.*, 11. 273, 1907; H. Bassett and H. S. Taylor, *Journ. Chem. Soc.*, 101. 576, 1912; 105. 1926, 1914; H. S. Taylor and W. N. Henderson, *Journ. Amer. Chem. Soc.*, 37. 1688, 1915; J. Legrand, *Ann. Chim. Phys.*, (2), 59. 423, 1825; F. Guthrie, *Phil. Mag.*, (4), 49. 1, 206, 266, 1875; (5), 1. 49, 1876; (5), 2. 211, 1876; F. Mylius and J. G. Gilbert, *Brit. Pat. No.* 124780, 1916; L. C. de Coppet, *Zeit. phys. Chem.*, 22. 239, 1897; R. Funk, *Ber.*, 30. 1718, 1897; Earl of Berkeley and M. P. Appleby, *Proc. Roy. Soc.*, 85. A, 489, 1911.

⁴ E. Mitscherlich, *Pogg. Ann.*, 18. 159, 1830; S. G. Rawson, *Journ. Soc. Chem. Ind.*, 16. 113, 1897; H. Bassett and H. S. Taylor, *Journ. Chem. Soc.*, 101. 576, 1912; C. Schultz, *Zeit. Chem.*, (2), 5. 531, 1869; C. J. B. Karsten, *Philosophie der Chemie*, Berlin, 1843; H. Wurtz, *Amer. Journ. Science*, (2), 25. 377, 1858.

⁵ A. H. Pearson, *Zeit. Chem.*, (2), 5. 662, 1869; E. C. Franklin and C. A. Kraus, *Amer. Chem. Journ.*, 21. 1, 1899; 27. 191, 1905; C. A. L. de Bruyn, *Rec. Trav. Chim. Pays-Bas*, 11. 18, 1893; T. W. B. Welsh and H. J. Brodersen, *Journ. Amer. Chem. Soc.*, 37. 816, 1915; F. M. Raoult, *Ann. Chim. Phys.*, (5), 1. 270, 1874; H. Euler, *Arkhiv. Min.*, 1. 143, 1904; A. Fock, *Zeit. Kryst.*, 28. 337, 1897; C. J. B. Karsten, *Philosophie der Chemie*, Berlin, 1843; W. Eidmann, *Ein Beitrag zur Kenntnis des Verhaltens chemischer Verbindungen in nichtwässrigen Lösungen*, Giessen, 1899; A. Coppadoro, *Gazz. Chim. Ital.*, 42. i, 433, 1912; *Atti Accad. Lincei*, (5), 21. ii, 842, 1913; F. Margueritte, *Compt. Rend.*, 38. 304, 1854; H. Kopp, *Liebigs Ann.*, 34. 203, 1840; A. Müntz, *Ann. Chim. Phys.*, (6), 11. 131, 1887; G. J. Mulder, *Scheikund. Verh. Rotterdam*, 3. 164, 171, 1864; K. von Hauer, *Sitzber. Akad. Wien*, 53. 221, 1866; R. Kremann and H. Rodemund, *Zeit. anorg. Chem.*, 86. 373, 1914; A. Findlay, I. Morgan, and I. P. Morris, *Journ. Chem. Soc.*, 105. 779, 1914; H. W. Foote, *Amer. Chem. Journ.*, 32. 251, 1904; W. K. Wallbridge, *ib.*, 30. 154, 1903; F. K. Cameron and W. O. Robinson, *Journ. Phys. Chem.*, 11. 273, 1907; H. Bassett and H. S. Taylor, *Journ. Chem. Soc.*, 105. 1926, 1914; A. Werner, *Ann. Chim. Phys.*, (6), 27. 570, 1892; *Compt. Rend.*, 115. 169, 1892; G. G. Rousseau and G. Tite, *ib.*, 114. 1186, 1892; N. A. E. Millon, *Journ. Pharm.*, 29. 184, 1873.

⁶ B. Völlmer, *Die molekulare elektrische Leitfähigkeit von einigen alkoholischen Lösungen*, Halle, 1892; J. Wölfer, *Ueber die Erhöhung des Siedepunktes von absolutem Alkohol durch Lösung einiger Salze*, Halle, 1894; W. Eidmann, *Ein Beitrag zur Erkenntnis des Verhaltens chemischer Verbindungen in nichtwässrigen Lösungen*, Giessen, 1899; J. d'Ans and R. Siegler, *Zeit. phys. Chem.*, 82. 35, 1913; J. F. Snell, *Journ. Phys. Chem.*, 2. 457, 1899; C. A. Gerardin, *Ann. Chim. Phys.*, (4), 5. 145, 1866; *Recherches sur la solubilité des sels dans les mélanges d'alcool et d'eau*, Paris, 1865; P. E. Browning, *Amer. Journ. Science*, (3), 43. 50, 1892; (3), 44. 462, 1892; R. Fresenius, *Zeit. anal. Chem.*, 29. 30, 143, 1890; 30. 18, 452, 583, 1891; 32. 189, 1893; F. Stromeyer, *Gilbert's Ann.*, 54. 245, 1816; *Untersuchungen über die Mischungen der Mineralkörper*, Göttingen, 1. 196, 1821; H. Rose, *Pogg. Ann.*, 110. 296, 1860; J. R. Hill, *Pharm. Journ.*, (3), 19. 420, 1888; A. Naumann, *Ber.*, 42. 3789, 1909; V. Rothmund and N. T. M. Wilmore, *Zeit. phys. Chem.*, 40. 620, 1902; J. Timmermans, *ib.*, 58. 129, 1907; T. Graham, *Trans. Roy. Soc. Edin.*, 11. 175, 1831; *Phil. Mag.*, (2), 4. 265, 331, 1828.

⁷ J. W. Retgers, *Zeit. Kryst.*, 21. 257, 1893; L. Wulff, *ib.*, 4. 139, 1880; R. Henriques, *ib.*, 5. 365, 1881; H. Baumhauer, *ib.*, 1. 52, 1877; W. J. Lewis, *Phil. Mag.*, (5), 3. 453, 1877; H. J. Brooke, *Ann. Phil.*, 23. 288, 1824; S. Nishikawa and K. Hudinuki, *Proc. Tokyo Math. Phys. Soc.*, (2), 9. 197, 1917; H. de Sénarmont, *Ann. Chim. Phys.*, (3), 41. 326, 1854; H. Becquerel, *ib.*, (6), 14. 170, 1888; C. Camichel, *ib.*, (7), 5. 433, 1895; J. C. G. de Marnage, *Ann. Mines*, (5), 9. 31, 1856; *Œuvres complètes*, Genève, 1. 459, 1902; G. Brügelmann, *Ber.*, 17. 2359, 1884; A. Scacchi, *Nuovo Cimento*, 1. 170, 1855; L. Vegard, *Zeit. Physik*, 9. 395, 1922.

⁸ E. Filhol, *Ann. Chim. Phys.*, (3), 21. 415, 1847; H. J. Buignet, *Journ. Pharm. Chim.*, (3), 40. 161, 337, 1860; P. A. Favre and C. A. Valson, *Compt. Rend.*, 77. 579, 1873; P. Kremers, *Pogg. Ann.*, 99. 435, 1856; 85. 37, 246, 1852; J. H. Hassenfratz, *Liebigs Ann.*, 28. 3, 1838; C. J. B. Karsten, *Schweigger's Journ.*, 65. 394, 1832; L. Playfair and J. P. Joule, *Mem. Chem. Soc.*, 2. 401, 1845; *Journ. Chem. Soc.*, 1. 137, 1849; H. G. F. Schröder, *Pogg. Ann.*, 106. 226, 1859; G. Brügelmann, *Ber.*, 17. 2359, 1884; J. Behr, *Neues Jahrb. Min.*, i, 138, 1903; M. le Blanc and P. Rohland, *Zeit. phys. Chem.*, 19. 277, 1896; H. Töpsoc and C. Christiansen, *Pogg. Ann. Ergbd.*, 6. 499, 1874; A. Eppler, *Zeit. Kryst.*, 30. 153, 1899; J. M. Ordway, *Amer. Journ. Science*, (2), 27. 14, 1859.

⁹ F. Mylius and R. Funk, *Ber.*, 30. 1718, 1897; B. Franz, *Journ. prakt. Chem.*, (2), 5. 274, 1872; G. T. Gerlach, *Zeit. anal. Chem.*, 27. 282, 1888; 8. 286, 1869; A. C. MacGregory, *Wied. Ann.*, 51. 128, 1894; P. Kremers, *Pogg. Ann.*, 95. 110, 1855; 96. 62, 1855; S. de Lannoy, *Zeit.*

phys. Chem., 18. 443, 1895; M. le Blanc and P. Rohland, *ib.*, 19. 277, 1896; J. Wagner, *ib.*, 5. 31, 1890; *Wied. Ann.*, 18. 259, 1883; C. J. B. Karsten, *Philosophie der Chemie*, Berlin, 1843; A. Michel and L. Kraft, *Ann. Chim. Phys.*, (3), 41. 482, 1854; Earl of Berkeley and M. P. Appleby, *Proc. Roy. Soc.*, 85. A, 489, 1911; N. A. Tschernay, *Journ. Russ. Phys. Chem. Soc.*, 20. 430, 1888; 21. 73, 1889; G. Jäger, *Sitzber. Akad. Wien*, 99. 245, 1890.

¹⁰ J. C. G. de Marignac, *Arch. Sciences Genève*, 55. 113, 1876; *Ann. Chim. Phys.*, (5), 8. 410, 1876; H. V. Regnault, *ib.*, (3), 1. 129, 1841; H. Kopp, *Liebig's Ann. Suppl.*, 3. 289, 1865; *Phil. Trans.*, 155. 71, 1865.

¹¹ T. Carnelly, *Journ. Chem. Soc.*, 33. 273, 1878; H. Bassett and H. S. Taylor, *ib.*, 101. 576, 1912; W. Ramsay and N. Eumorfopoulos, *Phil. Mag.*, (5), 41. 360, 1896; H. le Chatelier, *Bull. Soc. Chim.*, (2), 47. 300, 1877; J. L. R. Morgan and P. T. Owen, *Zeit. anorg. Chem.*, 56. 168, 1908; H. C. Jones and F. H. Getman, *Zeit. phys. Chem.*, 49. 385, 1904; S. Arrhenius, *ib.*, 2. 489, 1888; T. W. Richards, *ib.*, 26. 689, 1898; J. d'Ans and R. Siegler, *ib.*, 82. 35, 1913; S. U. Pickering, *Ber.*, 25. 1594, 1892; F. M. Raoult, *Compt. Rend.*, 87. 167, 1878; H. Hausrath, *Ann. Physik*, (4), 9. 522, 1902; W. D. Harkins and G. L. Clark, *Journ. Amer. Chem. Soc.*, 37. 1816, 1915; J. M. Ordway, *Amer. Journ. Science*, (2), 27. 14, 1859.

¹² E. J. Maumené, *Compt. Rend.*, 97. 45, 1215, 1883; F. M. Raoult, *ib.*, 87. 167, 1878; S. U. Pickering, *Ber.*, 25. 1594, 1892; A. W. C. Menzies and N. N. Dutt, *Journ. Amer. Chem. Soc.*, 33. 1366, 1911; W. D. Harkins and G. L. Clark, *ib.*, 37. 1916, 1915; F. Guthrie, *Phil. Mag.*, (5), 17. 462, 1884; H. C. Jones and F. H. Getman, *Zeit. phys. Chem.*, 49. 385, 1904; S. Arrhenius, *ib.*, 2. 489, 1888; H. Hausrath, *Ann. Physik*, (4), 9. 522, 1902.

¹³ J. Legrand, *Ann. Chim. Phys.*, (2), 59. 423, 1835; J. L. Gay Lussac, *ib.*, (2), 11. 313, 1819; P. Kremers, *Pogg. Ann.*, 95. 110, 1855; 96. 62, 1855; G. T. Gerlach, *Zeit. anal. Chem.*, 26. 413, 1887; T. Griffiths, *Quart. Journ. Science*, 18. 90, 1824; *Pogg. Ann.*, 2. 227, 1824; G. J. Mulder, *Bijdragen tot geschiedenis van het Scheikundig gebonden water*, Rotterdam, 1864; A. Smits, *Zeit. phys. Chem.*, 39. 385, 1902; S. Arrhenius, *ib.*, 2. 496, 1888; J. M. Ordway, *Amer. Journ. Science*, (2), 27. 14, 1859.

¹⁴ G. Tammann, *Mém. Acad. St. Petersburg*, (7), 35. 1, 1887; H. Lescœur, *Compt. Rend.*, 103. 1269, 1886; *Recherches sur la dissociation des hydrates salines et des composés analogues*, Lille, 1888; A. Willner, *Pogg. Ann.*, 110. 387, 1860; J. Waddell, *Chem. News*, 72. 201, 1895; W. Müller-Erbach, *Ber.*, 19. 2875, 1886; F. M. Raoult, *Compt. Rend.*, 87. 167, 1878; T. Graham, *Edin. Journ. Science*, 16. 326, 1828; R. O. E. Davis, L. B. Olmstead, and F. O. Lundstrum, *Journ. Amer. Chem. Soc.*, 43. 1580, 1921.

¹⁵ J. Thomsen, *Journ. prakt. Chem.*, (2), 16. 97, 1877; (2), 17. 165, 1878; *Ber.*, 12. 2062, 1879; 11. 1021, 1878; M. Berthelot, *Ann. Bur. Longitudes*, 395, 1877; S. U. Pickering, *Journ. Chem. Soc.*, 53. 865, 1888; E. von Stackelberg, *Zeit. phys. Chem.*, 20. 159, 1896; 26. 433, 1898; F. R. Pratt, *Journ. Franklin Inst.*, 185. 663, 1918.

¹⁶ A. Fock, *Zeit. Kryst.*, 4. 585, 1880; A. Eppler, *ib.*, 30. 153, 1899; L. Wulff, *ib.*, 4. 139, 1880; H. de Sénarmont, *Ann. Chim. Phys.*, (3), 41. 326, 1854; M. le Blanc and P. Rohland, *Zeit. phys. Chem.*, 19. 277, 1896; H. Töpsoe and C. Christiansen, *Pogg. Ann. Ergbd.*, 6. 499, 1874; J. Behr, *Neues Jahrb. Min.*, i, 138, 1903; F. Klocke, *ib.*, i, 159, 1880; H. Marbach, *Pogg. Ann.*, 94. 417, 1855; W. J. Lewis, *Phil. Mag.*, (5), 3. 453, 1877; J. Morel, *Bull. Soc. Min.*, 10. 318, 1887; B. C. Damien, *Recherches sur la pouvoir réfringente des liquides*, Paris, 1887; *Ann. École Norm.*, (2), 10. 233, 1881; H. C. Jones and F. H. Getman, *Zeit. phys. Chem.*, 49. 385, 1904; S. Koskinen and V. J. Saarialho, *Bestimmung optischen Brechungsquotienten von Bariumnitratlösungen bei verschiedenen Konzentrationen und Temperaturen*, Helsingfors, 1912.

¹⁷ W. N. Hartley, *Journ. Chem. Soc.*, 81. 556, 1902; C. Schaefer and M. Schubert, *Ann. Physik*, (4), 55. 577, 1918; W. Crookes, *Chem. News*, 43. 237, 1881; P. Bary, *Compt. Rend.*, 130. 776, 1900; P. Heinrich, *Schweigger's Journ.*, 29. 101, 450, 1820; *Die Phosphoreszenz der Körper nach allen Umständen untersucht und erläutert*, Nürnberg, 1811.

¹⁸ H. C. Jones, *The Electrical Conductivities, Dissociation and Temperature Coefficients of Conductivity of Aqueous Solutions of a Number of Salts and Organic Acids*, Washington, 1912; P. Wenger and A. Lubomirsky, *Ann. Chim. Anal.*, 1. 339, 1919; F. Kohrausch and E. Grüneisen, *Sitzber. Akad. Berlin*, 1215, 1904; H. C. Jones and F. H. Getman, *Zeit. phys. Chem.*, 49. 385, 1904; A. A. Noyes, *ib.*, 36. 36, 75, 1901; L. Kahlenberg, *Journ. Phys. Chem.*, 5. 339, 1901; A. C. MacGregory, *Wied. Ann.*, 51. 123, 1894; R. J. Holland, *ib.*, 50. 261, 1893; J. H. Long, *ib.*, 11. 37, 1880; G. Kümmell, *Zeit. Elektrochem.*, 11. 94, 1905; K. Drucker, *ib.*, 11. 211, 1905; S. Arrhenius, *Recherches sur la conductibilité galvanique des électrolytes*, Stockholm, 1884; *B.A. Rep.*, 357, 1888; H. C. Jones, *Amer. Chem. Journ.*, 35. 445, 1906; E. C. Franklin and C. A. Kraus, *ib.*, 21. 1, 1899; 23. 277, 1900; H. C. Jones and C. G. Carroll, *ib.*, 32. 521, 1904; H. C. Jones and E. C. Bingham, *ib.*, 34. 481, 1906; L. Wöhler, *Ber.*, 38. 1351, 1905; C. A. Kraus and J. E. Bishop, *Journ. Amer. Chem. Soc.*, 43. 1586, 1921.

¹⁹ W. Hankel, *Abhand. Ges. Wiss. Leipzig*, 24. 482, 1899; J. F. Daniell and W. A. Miller, *Phil. Trans.*, 134. 1, 1844; W. C. D. Whetham, *ib.*, 184. A, 337, 1892; *Proc. Roy. Soc.*, 52. 284, 1892; A. Chassy, *Ann. Chim. Phys.*, (6), 21. 241, 1890; G. N. Lewis and M. Randall, *Journ. Amer. Chem. Soc.*, 43. 1112, 1921; A. Heydweiller, *Zeit. Physik*, 3. 310, 1920; A. A. Noyes, *Journ. Amer. Chem. Soc.*, 23. 36, 1901; *Phys. Rev.*, (1), 12. 15, 1901; W. Hittorf, *Pogg. Ann.*, 106. 337, 513, 1859; B. D. Steele and R. B. Denison, *Journ. Chem. Soc.*, 81. 456, 1902; P. Pascal, *Compt. Rend.*, 173. 144, 1921.

²⁰ M. Rivière, *Bull. Soc. Mulhouse*, 36. 438, 1866; E. J. Maumené, *Compt. Rend.*, 97. 45, 1215,

1883; N. A. F. Millon, *ib.*, 14. 905, 1842; B. N. Gottlieb, *Chem. Ztg.*, 23. 356, 1904; E. F. Basch, *ib.*, 29. 31, 1905; W. D. Harkins and G. L. Clark, *Journ. Amer. Chem. Soc.*, 37. 1816, 1915; J. M. Ordway, *Amer. Journ. Science*, (2), 27. 14, 1859; H. J. Brooke, *Ann. Phil.*, 23. 289, 1824; A. Souchay and E. Lenssen, *Liebig's Ann.*, 99. 45, 1856; F. W. Smither, *Amer. Chem. Journ.*, 19. 227, 1897.

²¹ F. Kuhlmann, *Ann. Chim. Phys.*, (3), 20. 234, 1847; J. W. Slater, *Chem. Gaz.*, 11. 329, 1853; J. W. Thomas, *Journ. Chem. Soc.*, 33. 367, 1878; *Chem. News*, 37. 246, 1878; K. Stammer, *Pogg. Ann.*, 82. 136, 1851; J. Lang, *ib.*, 118. 285, 1863; C. J. B. Karsten, *Philosophie der Chemie*, Berlin, 60, 1843; E. Lucius, *Liebig's Ann.*, 103. 113, 1857; E. M. Walton, *Phil. Mag.*, (5), 12. 290, 1818.

²² W. C. de Baat, *Chem. Weekbl.*, 15. 463, 1918; N. Busvold, *Zeit. anorg. Chem.*, 98. 202, 1916; W. D. Harkins and G. L. Clark, *Journ. Amer. Chem. Soc.*, 37. 1816, 1915; A. W. C. Menzies and N. N. Dutt, *ib.*, 33. 1366, 1911; C. L. Parsons and C. L. Perkins, *ib.*, 32. 1387, 1910; C. L. Parsons and H. P. Corson, *ib.*, 32. 1383, 1910.

§ 25. The Normal Phosphates of the Alkaline Earths

If the notation were consistent, orthophosphoric acid should be $P(OH)_5$, and the orthophosphates derivatives of this acid; but through some aberration, the acid $O : P(OH)_3$ is called orthophosphoric acid, and the derivative salts, orthophosphates. The calcium salts of this acid, H_3PO_4 , whose individuality has been established, are indicated in Table XVI. Their relationship with orthophosphoric acid is

TABLE XVI.—THE CALCIUM ORTHOPHOSPHATES.

Empirical formula.	Ratios $CaO : P_2O_5 : H_2O$.	Orthophosphate.	Calcium.
$Ca(H_2PO_4)_2$. . .	$CaO.P_2O_5.2H_2O$	Monocalcium	Dihydrophosphate
$Ca(H_2PO_4)_2.H_2O$. . .	$CaO.P_2O_5.3H_2O$	Dicalcium	Hydrophosphate
$CaHPO_4$. . .	$2CaO.P_2O_5.H_2O$	Tricalcium	Phosphate
$CaHPO_4.2H_2O$. . .	$2CaO.P_2O_5.5H_2O$	Tetracalcium	Oxyphosphate
$Ca_3(PO_4)_2$. . .	$3CaO.P_2O_5$	Decacalcium	Oxyhexaphosphate
$Ca_2(PO_4)_2.H_2O$. . .	$3CaO.P_2O_5.H_2O$		
$Ca_4P_2O_9$. . .	$4CaO.P_2O_5$		
$Ca_4P_2O_9.4H_2O$. . .	$4CaO.P_2O_5.4H_2O$		
$Ca_{10}P_6O_{25}$. . .	$10CaO.3P_2O_5.H_2O$		

illustrated by the graphic formulæ

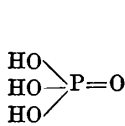

H_3PO_4

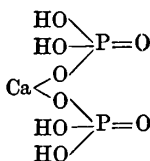

$Ca(H_2PO_4)_2$

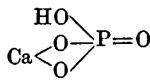

$CaHPO_4$

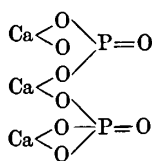

$Ca_3(PO_4)_2$

The oxyphosphate or hydroxyphosphate has been variously represented :

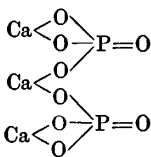

$Ca_3(PO_4)_2.CaO$

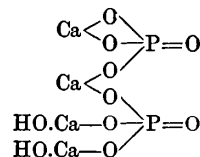

$Ca_3(PO_4)_2Ca(OH)_2 + 3H_2O$

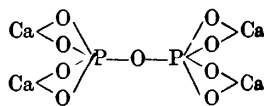

$Ca_4P_2O_9$

H. Bassett prefers the last formula. According to A. Werner's scheme,¹ it is

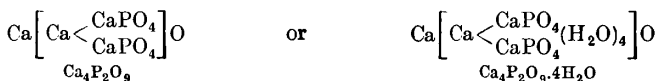

Normal calcium phosphate, and calcium hydro- and dihydro-phosphates are all unstable in the presence of water, for they break down into solids containing more lime than the original solid, and in the soln., the ratio of acid to lime is greater than in the original solid. This was clearly shown by H. E. Causse's investigation² on the solubility of the calcium phosphates in soln. of phosphoric acid. The composition of aq. soln. containing calcium hydroxide and phosphoric acid has been investigated by F. K. Cameron, A. Seidell, and J. M. Bell, and by H. Bassett. A selection from the results of the last-named is indicated in Table XVII, and the results for the three-component system, $\text{CaO}-\text{P}_2\text{O}_5-\text{H}_2\text{O}$, in the region of the orthophosphates, are illustrated by Fig. 63.

TABLE XVII.—CONDITIONS OF EQUILIBRIUM OF THE CALCIUM ORTHOPHOSPHATES IN AQUEOUS SOLUTIONS OF PHOSPHORIC ACID.

25°		40°		50.7°	
Grms. per 100 grms. sat. soln.		Grms. per 100 grms. sat. soln.		Grms. per 100 grms. sat. soln.	
Solid phases.		Solid phases.		Solid phases.	
CaO.	P ₂ O ₅ .	CaO.	P ₂ O ₅ .	CaO.	P ₂ O ₅ .
3.088	36.11	1.768	42.42	0.336	62.01
4.908	28.34	3.584	36.79	—	—
5.809	24.20	5.755	27.25	0.635	58.08
5.523	22.90	4.813	21.67	1.428	50.25
4.499	17.55	3.810	16.35	2.974	41.92
2.638	9.100	2.536	9.905	4.880	33.18
1.878	6.049	1.847	6.979	5.725	29.61
0.826	2.387	1.267	4.397	3.507	15.48
0.165	0.417	0.576	1.819	2.328	9.465
0.07	0.166	0.156	0.426	1.563	6.157
0.06	0.140	0.0592	0.158	0.692	2.281
0.05	0.118	0.0508	0.128	0.0596	0.1527
0.04	0.093	0.0098	0.0262	0.0514	0.1331
0.03	0.070	0.0709	trace	0.0351	0.0942
0.02	0.047	0.0814	"	0.0106	0.0309
0.01	0.023	0.0840	"	0.0007	0.0007

The regions for the phosphoric acids and for calcium hydroxides as solid phases are probably very small, and they are shown diagrammatically in Fig. 63. At each of the three quintriple points—21°, 36°, and 152°—in addition to soln. and vapour phases, there are three solid phases in equilibrium as indicated in Table XVIII.

TABLE XVIII.—QUINTRIPLE POINTS WITH SOLUTIONS OF CALCIUM PHOSPHATES.

Temp.	Solid phases.	100 grms. of soln. contain	
		P ₂ O ₅ grms.	CaO grms.
21°	Ca(H ₂ PO ₄) ₂ ·H ₂ O; CaHPO ₄ ; CaHPO ₄ ·2H ₂ O	23.50	5.81
36°	CaHPO ₄ ; CaHPO ₄ ·2H ₂ O; Ca ₃ (PO ₄) ₂ ·H ₂ O	0.140	0.0514
153°	Ca(H ₂ PO ₄) ₂ ; Ca(H ₂ PO ₄) ₂ ·H ₂ O; CaHPO ₄	54.00	5.60

There are other quintuple points which have not been so well explored. F. K. Cameron, A. Seidell, and J. M. Bell, from their examination of the system at 25°, concluded that no definite compound exists between $\text{CaHPO}_4 \cdot 2\text{H}_2\text{O}$ and $\text{Ca}(\text{OH})_2$, but only a series of solid soln. Against this, H. Bassett showed that two phosphates more basic than calcium hydrophosphate can exist in stable equilibrium with an aq. soln. at 25°, and probably at higher temp. These are normal calcium phosphate, $\text{Ca}_3(\text{PO}_4)_2$, and calcium hydroxyhexaphosphate, $3\text{Ca}_3(\text{PO}_4)_2 \cdot \text{Ca}(\text{OH})_2$. He found that $\text{Ca}_4\text{P}_2\text{O}_9 \cdot \text{H}_2\text{O}$ or $\text{Ca}_4\text{P}_2\text{O}_9 \cdot 5\text{H}_2\text{O}$ did not appear under these conditions.

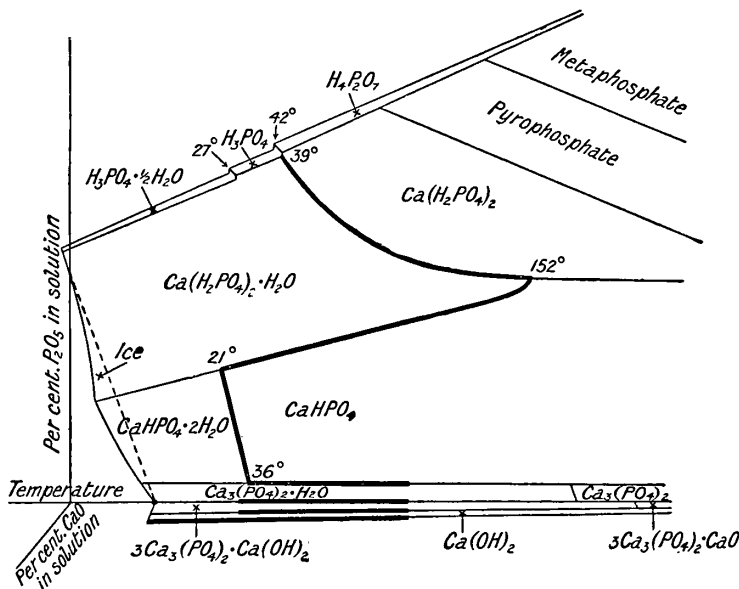

FIG. 63.—Equilibrium Conditions in the Ternary System, $\text{CaO}-\text{P}_2\text{O}_5-\text{H}_2\text{O}$, in the Region of the Orthophosphates—partly diagrammatic.

Tricalcium phosphate, tertiary calcium phosphate, tribasic calcium phosphate, normal calcium phosphate, or calcium orthophosphate, $\text{Ca}_3(\text{PO}_4)_2$, is represented in nature by crystals of the hydrated mineral *ornithite*, which is found in Sombréro (West Indies), and which, according to A. A. Julien,³ has the composition $\text{Ca}_3(\text{PO}_4)_2 \cdot 2\text{H}_2\text{O}$. The mineral, however, is far from being a satisfactory representative owing to its admixture with other substances. It is also supposed to occur in bones. Yellowish-white *collophanite*, $\text{Ca}_3(\text{PO}_4)_2 \cdot \text{H}_2\text{O}$, was reported by F. Sandberger in the guano beds of Sombréro (West Indies), and an analogous snow-white mineral, named *monite*, was reported by C. U. Shepard in the guano beds of Mona (West Indies). The sp. gr. of the former was given as 2.70, and the hardness 5, while the sp. gr. of the latter was given as 2.1, and the hardness 2. The two are now supposed to be the same mineral species. C. U. Shepard's *pyroclasite* from Moneta (West Indies) is probably a mixture of collophanite and monite: $6\text{CaHPO}_4 \cdot \text{Ca}_3(\text{PO}_4)_2 \cdot \text{H}_2\text{O}$. When coral is treated with a soln. of ammonium phosphate, R. Irvine and W. S. Anderson found an interchange between the acid radicles, and they add that the reaction accounts for the formation of calcium phosphate deposits in rainy climates, through the excreta of birds deposited on coral or calcium carbonate. The reaction does not occur in the absence of a solvent—water.

F. K. Cameron and A. Seidell have stated that the normal phosphate prepared by precipitation is non-crystalline, and a reasonably pure and crystalline product with well-defined characteristics of a definite mol. species has not been prepared. According to R. Warrington, it is obtained by precipitation on adding trisodium

phosphate or disodium hydrophosphate to an ammoniacal soln. of calcium chloride; or, according to J. J. Berzelius, by dropping diammonium hydrophosphate into a similar soln. W. Windisch and W. Dietrich found the precipitates obtained by boiling primary potassium phosphate with increasing proportions of calcium hydrocarbonate show an increasing proportion of calcium, and range from the secondary to the primary calcium phosphate, and some entrained alkali phosphate. J. N. von Fuchs, and R. Warington treated a soln. of phosphoric acid with calcium oxide and obtained the impure normal phosphate. M. Berthelot found that the precipitate obtained by treating a soln. of a calcium salt with normal alkali phosphate is not wholly normal calcium salt, but a mixture of that salt with a little calcium hydrophosphate, CaHPO_4 . W. A. Withers and A. L. Field studied the reaction between calcium nitrate and dipotassium hydrophosphate in aq. soln. Soon after mixing the reaction is considered to be $4\text{K}_2\text{HPO}_4 + 4\text{Ca}(\text{NO}_3)_2 = \text{Ca}_3(\text{PO}_4)_2 + \text{Ca}(\text{H}_2\text{PO}_4)_2 + 8\text{KNO}_3$, and after a few minutes the stable condition is represented by $4\text{K}_2\text{HPO}_4 + 3\text{Ca}(\text{NO}_3)_2 = \text{Ca}_3(\text{PO}_4)_2 + 2\text{KH}_2\text{PO}_4 + 6\text{KNO}_3$. If an excess of calcium nitrate is used, the unstable state is either not produced, or it persists an exceedingly short time. The normal calcium phosphate undergoes partial hydrolysis and is converted into calcium hydrophosphate; the extent of the hydrolysis is roughly proportional to the conc. of the dihydrophosphate present, and is slightly diminished by an excess of calcium nitrate. G. M. de Toni prepared **colloidal calcium orthophosphate** by mixing with continued agitation hot normal soln. of sodium phosphate and calcium chloride containing sufficient protective colloid—gelatin, gum arabic, blood serum, and starch—not sucrose or caramel. The sol may also be obtained by mixing a soln. of orthophosphoric acid with one of calcium hydroxide containing gelatin.

R. Warington found that the precipitated normal phosphate dried in vacuo retained two mols of water, and 6.35 per cent. when dried at 100° . G. C. Wittstein found that the air-dried precipitate retains five mols of water; R. Ludwig, 5.5 mols; the latter also found that after standing three years, the precipitate retained 3.5 mols of water, and when dried at 100° , one mol. The technical preparation of calcium phosphate by extracting basic slag or phosphorite with hydrochloric acid and treating the soln. with calcium hydroxide was discussed by A. Gawalowsky. The salt is also obtained by digesting bone-ash with hydrochloric or nitric acid, boiling the soln. to eliminate carbon dioxide, and precipitating calcium phosphate by the addition of aqua ammonia—the product may be here contaminated with some magnesium ammonium phosphate, calcium fluoride, ferric and aluminium phosphates, etc.

Analogous methods furnish **strontium orthophosphate**, $\text{Sr}_3(\text{PO}_4)_2$; L. Barthe claims to have prepared it free from other phosphates, by evaporating a mixture of a cold ammoniacal soln. of 90 grms. of crystalline sodium hydrophosphate and one of 100 grms. of crystalline strontium chloride; both soln. should be free from carbon dioxide. The colloidal precipitate was washed by decantation, and dried at 100° . T. Graham prepared **barium orthophosphate**, $\text{Ba}_3(\text{PO}_4)_2$, as a flocculent precipitate by adding a soln. of barium chloride to one of normal sodium phosphate; according to M. Traube, this product contains foreign salts which cannot be washed out, and he preferred to make it by saturating phosphoric acid with barium carbonate. L. V. R. Ouvrard obtained crystals of normal barium phosphate by saturating fused sodium, ortho-, pyro-, or meta-phosphate, at a red heat, with barium oxide; and extracting the slowly cooled product with water. The addition of a little sodium chloride favours the crystallization, but if a large proportion is used, a chlorophosphate is formed. M. Berthelot has studied the conditions of equilibrium between barium chloride and ammonium phosphate.

Precipitated normal calcium phosphate is an amorphous powder, which after calcination has a white earthy appearance. Similar remarks apply to precipitated strontium and barium orthophosphates; L. V. R. Ouvrard's crystals of the latter salt were tabular and belonged to the cubic system. P. Gaubert claimed to have made

the so-called liquid crystals of calcium phosphate. According to A. de Schulten, crystals of artificial monetite had a sp. gr. 1.05. L. V. R. Ouvrard's crystals of normal barium phosphate had a sp. gr. 4.1 at 16°.

H. Bassett⁴ found that water is retained very tenaciously by calcium phosphate, and is not expelled by several hours' calcination in a muffle; S. Gabriel mentioned that over one per cent. of water in bone phosphate is not driven off by ignition, but it is expelled by strong ignition with silica. J. M. van Bemmelen also found water to be retained very tenaciously by fossil bones. Calcined calcium phosphates are often a pink colour, particularly with the basic phosphates, bone-ash, etc. A. Cossa stated that ceria earths are present in bone-ash, but H. Bassett and S. Gabriel could not confirm this, and the latter could not obtain the pink colour with cerium or manganese salts and pure calcium phosphate. G. Bergeron and L. l'Hôte, and F. Raoult and H. Breton noted the constant presence of traces of copper in animal tissues, and H. Bassett believes that the pink coloration of calcined basic calcium phosphates is due to the presence of traces of copper. It might be added, however, that the humidity of the atm. in the earlier stages of the calcination for bone-ash, as well as whether the carbon is burnt out early or late in the calcination, may give respectively white and pink ashes. Similar remarks apply to china clays.

N. T. de Saussure,⁵ and J. P. J. d'Arcet found that normal calcium phosphate can be melted to a porcelain-like mass. O. Nielsen gives 1550° for the **melting point** of calcium orthophosphate. H. V. Regnault found 0.1992 for the **specific heat** of normal calcium phosphate between 15° and 98°. The **heat of formation**, according to M. Berthelot, is $3\text{Ca}(\text{OH})_2 + 2\text{H}_3\text{PO}_4 = \text{Ca}_3(\text{PO}_4)_2 + 6\text{H}_2\text{O} + 64$ Cals.; and $3\text{CaO}_{\text{aq.}} + 2\text{H}_3\text{PO}_{4\text{aq.}} = 3\text{H}_2\text{O} + \text{Ca}_3(\text{PO}_4)_2 + 58.4$ to 60.8 Cals. when an eq. of each component is dissolved in six litres of water at 16°; and similarly with strontium phosphate, 30.30 Cals. The heat of the reaction between normal sodium phosphate and strontium chloride is -1.76 Cals. for the amorphous salt and 14.18 Cals. for the crystalline; the corresponding reaction with barium chloride is thermally neutral for amorphous barium orthophosphate; and for the crystalline salt, 32.32 Cals. are developed. The heat of neutralization, $3\text{Sr}(\text{OH})_2 + 2\text{H}_3\text{PO}_4 = \text{Sr}_3(\text{PO}_4)_2 + 6\text{H}_2\text{O}$, is 65.40 Cals. for the amorphous salt, and 97.4 Cals. for the crystalline salt; and with a soln. of barium hydroxide and orthophosphoric acid, 68.40 Cals. for amorphous barium orthophosphate, and 100.80 Cals. for the crystalline salt.

According to P. Bary,⁶ normal strontium phosphate does not luminesce when exposed to X-rays, or to Becquerel's rays. E. Newbery and H. Lupton found that many coloured phosphorites are decolorized when heated. A sample of French phosphorite gave no visible **thermo-luminescence**, but when a sample of Spanish phosphorite was gently warmed, it appeared to take fire, and emitted a beautiful and brilliant yellow glow which lasted from 30 to 60 secs., and then disappeared, after which further heating had no effect. By exposing the heated inert sample to radium for about six days, no external change was perceptible, but the power of emitting the yellow light was restored, and the glow was brighter and more lasting than that of the original specimen. No change of colour was observed by exposing the original samples to **radium rays**, but the thermo-luminescence was always increased by this treatment. A bright yellow light was emitted when the original sample of Spanish phosphorite was exposed to **cathode rays**, and there was no diminution of the effect with time. A specimen deprived of thermo-luminescence by strongly heating regained this property with increased brilliancy by exposure to the cathode rays. W. Crookes noted an orange-yellow phosphorescence with a continuous spectrum when calcium phosphate was exposed to the cathode rays.

A. Lassieur said that calcium phosphate at 1300° is reduced by **hydrogen** to a mixture of calcium oxide and phosphorus; only traces of phosphine and calcium phosphide are formed. Possibly a basic phosphate is produced as an intermediate compound. When normal calcium phosphate is heated in a stream of **chlorine** there is very little action, but M. Cari-Mantrand⁷ found that when mixed with carbon, it produces carbon monoxide and free phosphorus, or if the amount of carbon suffices only for the reduction of the lime, phosphorus pentoxide is formed; and J. Riban found that a mixture of carbon and normal calcium phosphate readily

reacts with chlorine mixed with carbon monoxide : he said that the carbon suffers no perceptible change, and that the reaction takes place in two stages : $\text{Ca}_3(\text{PO}_4)_2 + 2\text{CO} + 2\text{Cl}_2 = \text{Ca}(\text{PO}_3)_2 + 2\text{CO}_2 + 2\text{CaCl}_2$, followed by $\text{Ca}(\text{PO}_3)_2 + 4\text{CO} + 4\text{Cl}_2 = 2\text{POCl}_3 + 4\text{CO}_2 + \text{CaCl}_2$; the reaction begins at 180° , and is rapidly completed between 330° and 340° . M. Cari-Mantrand also found that a mixture of carbon and calcium phosphate, at a bright red heat, reacts with **hydrogen chloride**, as with chlorine, forming carbon monoxide and free phosphorus. According to H. E. Quantin, when calcium phosphate is heated to redness in a stream of the vapour of **carbon tetrachloride**, phosphoryl chloride is first formed, and this is converted into phosphorus pentachloride. According to W. Crum, calcium phosphate is readily dissolved by **hydrochloric acid** and converted into dihydrophosphate, $\text{Ca}(\text{H}_2\text{PO}_4)_2$; 100 parts of the dil. acid dissolve 198 to 225 parts of normal calcium phosphate—the calculated amount is 218.3 parts. According to G. Bischof, 100 grms. of the acid of sp. gr. 1.153 (31 per cent. HCl), at 17° , dissolves, when diluted with *w* grms. of water :

<i>w</i>	0	1	4	7	10	13	16	19 grms.
$\text{Ca}_3(\text{PO}_4)_2$	25.3	45.0	62.3	64.7	68.0	71.9	69.5	69.7 „

According to J. Piccard, a mol of normal phosphate is completely dissolved by a soln. containing four mols of HCl, and if shaken with a soln. containing two mols of HCl, and filtered rapidly, half the phosphoric oxide is extracted, but if the mixture be allowed to stand, it slowly deposits crystals of calcium hydrophosphate, CaHPO_4 , the reaction is fast if the mixture be heated : $\text{CaH}_4(\text{PO}_4)_2 + \text{Ca}_3(\text{PO}_4)_2 = 4\text{CaHPO}_4$. E. Erlenmeyer also obtained crystals of what he regarded as a *chlorophosphate*—compounds of calcium phosphate and chloride—from the soln. According to K. Birnbaum and A. S. Packard, the soln. of calcium phosphate, in not a large excess of hydrochloric acid, becomes turbid when heated, owing to the separation of calcium hydrophosphate, CaHPO_4 , and, according to J. Piccard, the same salt is obtained by adding alcohol or sodium acetate to the soln. A hydrochloric acid soln. of normal barium phosphate was found by E. Erlenmeyer to give crystals of barium chloride, and of barium dihydrophosphate, $\text{Ba}(\text{H}_2\text{PO}_4)_2$, or, when an excess of acid is used, phosphoric acid is formed. When the boiling soln. is evaporated, crystals of the chlorophosphate, $\text{BaCl}_2 \cdot 4\text{Ba}(\text{H}_2\text{PO}_4)_2$, separate. Unlike barium and calcium orthophosphates, the hydrochloric acid soln. of strontium phosphate does not yield a chlorophosphate.

According to J. B. Senderens,⁸ when calcium phosphate is boiled with water and **sulphur**, calcium thiosulphate is formed very slowly; with barium phosphate, the decomposition is very slow and does not proceed further than barium hydrophosphate, BaHPO_4 . According to A. Béchamp, if finely divided calcium phosphate, suspended in water, be treated with **hydrogen sulphide**, a liquid is obtained which reddens blue litmus, colours sodium nitroprusside bluish-violet, and contains 190 to 240 mgrms. of normal calcium phosphate per litre. The action of soln. of **sulphurous acid** on the calcium phosphates resembles that of other acids; with conc. acid soln., calcium dihydrophosphate is the stable solid; with less conc. soln., calcium hydrophosphate is the stable solid; while in dil. soln. a more basic phosphate separates, which B. W. Gerland believes to be an addition product of normal calcium phosphate and sulphurous acid. B. W. Gerland found that artificial and natural calcium phosphate, as well as bone-ash, dissolves in sulphurous acid so that one mol P_2O_5 passes into soln. for 4 to 6 mols of SO_2 . These soln. smell and taste a little less strongly of sulphur dioxide than do eq. aq. soln. of that gas. If the soln. be allowed to stand in air, or in vacuo, warmed over 18° , or mixed with alcohol, a precipitate of variable composition is produced; a precipitate is formed if hydrogen or some other gas is passed into the soln. If the mixed soln. still contains a moderate proportion of sulphur dioxide, the precipitate is either calcium hydrophosphate or a mixture of that salt with calcium sulphate; if very little sulphur

dioxide be present, the precipitate approximates to *calcium sulphito-hydrophosphate*, $2\text{CaHPO}_4 \cdot \text{CaSO}_3 \cdot \text{H}_2\text{O}$, or $\text{Ca}_3(\text{PO}_4)_2 \cdot \text{SO}_2 \cdot 2\text{H}_2\text{O}$. It is claimed that this substance is a chemical individual, and not a mixture of calcium hydrophosphate and sulphite, since it does not behave like a sulphite—*e.g.* it is stable in oxidizing agents like chlorine—but E. Rotondi believed it to be a mixture of the two salts in question. The soln. of calcium phosphate in sulphurous acid precipitates a mixture of normal calcium phosphate, calcium hydrophosphate, and calcium sulphate when treated with ammonia; the soln. also gives precipitates with barium chloride, magnesium chloride, ferric chloride, lead acetate, and cupric acetate. According to E. Rotondi, when normal barium phosphate is suspended in water, and treated with sulphur dioxide, barium sulphide is precipitated, and barium dihydrophosphate, $\text{Ba}(\text{H}_2\text{PO}_4)_2$, passes into soln.

Moderately conc. **sulphuric acid** was found by J. J. Berzelius to convert calcium phosphate into a mixture of phosphoric acid and calcium sulphate. The reaction between calcium phosphate and sulphuric acid has been studied by J. Kolb, A. Millot, R. Weber, J. Piccard, H. Joulie, W. Crum, H. P. Armsby, and E. Erlenmeyer. If one to two mols of sulphuric acid be used for a mol of normal calcium phosphate, and enough water to make the whole into "slip," A. Millot found that calcium dihydrophosphate and calcium sulphate are formed; and if less than one mol of sulphuric acid be used, half the calcium phosphate remains unchanged. H. P. Armsby found that the amount of soluble phosphate, $\text{CaH}_4(\text{PO}_4)_2$, which is formed by the sulphuric acid depends on the temp. and on the duration of the action; and he assumed that calcium dihydrophosphate is initially formed by the action of the acid, and that this then reacts with the unchanged calcium phosphate to form the monohydrophosphate, $\text{Ca}_3(\text{PO}_4)_2 + \text{CaH}_4(\text{PO}_4)_2 = 4\text{CaHPO}_4$. A. Millot further showed that with two mols of sulphuric acid per mol of normal phosphate, 96.63 per cent. of soluble phosphate is formed, and with the equi-molar proportions of acid and normal phosphate, 48.72 per cent. of soluble phosphate is formed. A. Millot, and J. Piccard showed that on standing the proportion of soluble phosphate in the product decreases owing to the formation of the monohydrophosphate; while J. Kolb supposes that free phosphoric acid is formed by the action of two mols of sulphuric acid on one mol of calcium phosphate, which on standing forms the soluble dihydrophosphate, $\text{Ca}(\text{H}_2\text{PO}_4)_2$. A. Gossmann studied the action of **alkali sulphates** on barium phosphate.

Calcium dihydrophosphate is much more soluble than the other calcium phosphates; and a mixture of this salt with calcium sulphate is used as a fertilizer under various names: *superphosphate*, *acid phosphate*, and *soluble lime phosphate*.⁹ It is prepared by treating rock or bone phosphate with sulphuric acid—generally chamber acid—approximately 60 per cent. H_2SO_4 , and of sp. gr. 1.55. Rather less acid is employed than is needed to convert all the lime in excess of that required to form the dihydrophosphate, into calcium sulphate, because, if the theoretical amount of acid is used, the resulting product is of a pasty consistency, difficult to handle, and it is so acid as to be considered harmful to vegetation. The water and the acid forms hydrated calcium dihydrophosphate, $\text{Ca}(\text{H}_2\text{PO}_4)_2 \cdot \text{H}_2\text{O}$, and gypsum, $\text{CaSO}_4 \cdot 2\text{H}_2\text{O}$. On standing exposed to the air some water is absorbed, and the undecomposed phosphate reacts with the dihydrophosphate to form the less soluble hydrophosphate. This process is known as *the reversion of the superphosphate*; and the process of reversion is accelerated by the presence of iron oxide and alumina, which form slightly soluble phosphates. When mixed with soil, the superphosphate rapidly and completely reverts; this is shown by the fact that the aq. extract of such a soil is no richer in phosphoric acid than that of an untreated soil.

The four component system, $\text{CaO} - \text{H}_3\text{PO}_4 - \text{H}_2\text{SO}_4 - \text{H}_2\text{O}$, has been partially studied by F. K. Cameron and J. M. Bell, and they represent their results by a series of diagrams resembling Fig. 64. *O* represents a sat. soln. of lime in water. On the *Ox*-axis, *A* represents a soln. in equilibrium with calcium hydrophosphate and the limiting solid soln.; and *B*, a soln. sat. with both calcium hydro-, and

dihydro-phosphate. On the *Oy*-axis, *C* represents a soln. sat. with both calcium hydroxide and gypsum, and *D* a soln. in equilibrium with both gypsum and anhydrite. The fields over which the calcium phosphates can exist are very narrow. The data for 25° are shown in Table XIX.

TABLE XIX.—PHASES IN THE QUATERNARY SYSTEM, $\text{CaO}-\text{P}_2\text{O}_5-\text{SO}_3-\text{H}_2\text{O}$, at 25°.

Fig. letter.	Grms. P_2O_5 per litre.	Grms. SO_3 per litre.	Grms. CaO per litre.	Solid phases.
<i>O</i>	0	0	1.17	$\text{Ca}(\text{OH})_2$
<i>A</i>	3	0	1.5	Solid soln.; $\text{CaHPO}_4 \cdot 2\text{H}_2\text{O}$
<i>B</i>	317	0	77	$\text{Ca}(\text{H}_2\text{PO}_4)_2 \cdot \text{H}_2\text{O}$; $\text{CaHPO}_4 \cdot 2\text{H}_2\text{O}$
<i>C</i>	0	0.9	1.9	$\text{Ca}(\text{OH})_2$; $\text{CaSO}_4 \cdot 2\text{H}_2\text{O}$
<i>D</i>	0	317.5	1	$\text{CaSO}_4 \cdot 2\text{H}_2\text{O}$; CaSO_4
<i>E</i>	3	0.9	1.5	Solid soln.; $\text{CaSO}_4 \cdot 2\text{H}_2\text{O}$; $\text{CaHPO}_4 \cdot 2\text{H}_2\text{O}$
<i>F</i>	317	0.6	77	$\text{CaSO}_4 \cdot 2\text{H}_2\text{O}$; $\text{CaHPO}_4 \cdot 2\text{H}_2\text{O}$; $\text{Ca}(\text{H}_2\text{PO}_4)_2 \cdot \text{H}_2\text{O}$
<i>G</i>	545	0.2	38	$\text{CaSO}_4 \cdot 2\text{H}_2\text{O}$; CaSO_4 ; $\text{Ca}(\text{H}_2\text{PO}_4)_2 \cdot \text{H}_2\text{O}$

The changes which occur by raising the temp. have been partially investigated. The point *F* moves to the right, *G* to the left. At 66° the two points meet, and there is a sextuple point where the six phases—soln., vapour, CaSO_4 , $\text{CaSO}_4 \cdot 2\text{H}_2\text{O}$, $\text{CaHPO}_4 \cdot 2\text{H}_2\text{O}$, and $\text{Ca}(\text{H}_2\text{PO}_4)_2 \cdot \text{H}_2\text{O}$ —are in equilibrium. At higher temp. the gypsum field disappears, and anhydrite is the stable solid.

F. K. Cameron and J. M. Bell thus described the leaching of a superphosphate, containing calcium dihydrophosphate and gypsum, by water at 25°. Stage I. The addition of water to monocalcium phosphate crystals causes a partial change to dicalcium phosphate and a soln. saturated with respect to both phosphates. A small amount of gypsum will also pass into the soln. Stage II. If water be added to this soln., or if the soln. be drained away and fresh water added, more of the monocalcium phosphate will disappear and dicalcium phosphate will be formed. The net effect of this leaching is to wash out some free phosphoric acid, together with considerable quantities of calcium and a very small quantity of gypsum. If the addition of water is rapid, the time for this change may be very short indeed. During this change the composition of the soln. is represented by the point *F* of Fig. 64, and if equilibrium conditions are obtained the composition of the soln. will remain constant until all the monocalcium phosphate disappears. It will be observed that the greater part of the original calcium phosphate has been removed. This may be partially represented by the equation: $\text{CaH}_4(\text{PO})_2 = \text{CaHPO}_4 + \text{H}_3\text{PO}_4$, all the phosphoric acid in excess of the compound CaHPO_4 being leached away, together with a considerable amount of the diphosphate, which is dissolved. Upon the removal of some of the soln. and the dilution of the residue by fresh water, the composition of the leachings will change rapidly until the point *E* is reached. Stage III. Here another change takes place, the crystalline dicalcium phosphate giving up phosphoric acid, which carries some of the phosphate into soln. The solid changes to a solid soln. of lime and phosphoric acid, and upon continued leaching this solid soln. changes gradually to that solid soln. which in sat. gypsum

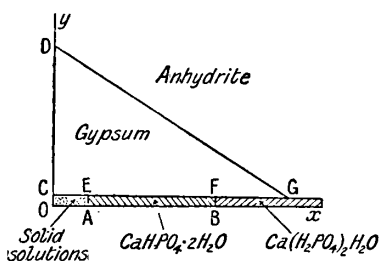
FIG. 64.—Phases of the Four Component System: $\text{CaO}-\text{H}_3\text{PO}_4-\text{H}_2\text{SO}_4-\text{H}_2\text{O}$.

soln. dissolves unchanged, *i.e.* the ratio of lime and phosphoric acid which have gone into soln. is the same as in the solid soln. Over this range of conc. gypsum has a much higher solubility, and it will probably disappear before the solid soln. have all disappeared. Stage IV consists in the slow soln. in water of a relatively insoluble solid soln. of lime in phosphoric acid, which contains relatively more lime than would be required by the formula $\text{Ca}_3(\text{PO}_4)_2$.

According to O. Nielsen,¹⁰ the reduction of normal calcium phosphate by **carbon** begins at 1400°. According to P. Berthier, a mixture of calcium phosphate, silica, and carbon at a white heat forms calcium silicate, carbon monoxide, and phosphorus; and a mixture of ten parts of calcium phosphate with five of quartz and five of clay gives, when heated in a carbon crucible, three parts of phosphorus, and the quantity of the latter increases when the proportion of silica is increased. T. Schlösing found that when normal calcium phosphate is heated white-hot in a stream of **carbon monoxide**, the phosphorus is quantitatively liberated. According to O. Nielsen, normal calcium phosphate is not reducible by carbon monoxide, and A. Lassieur also said no reduction occurs at 1300°. When a mixture of water vapour and **carbon dioxide** is passed over heated calcium phosphate, C. Seybold and F. Heeder found that calcium hydrophosphate is first produced: $\text{Ca}_3(\text{PO}_4)_2 + \text{CO}_2 + \text{H}_2\text{O} = \text{CaCO}_3 + 2\text{CaHPO}_4$, and this in turn decomposes producing calcium tetrahydrophosphate: $2\text{CaHPO}_4 + \text{CO}_2 + \text{H}_2\text{O} = \text{CaCO}_3 + \text{CaH}_4(\text{PO}_4)_2$. G. von Georgievics passed carbon dioxide into water holding normal calcium phosphate in suspension, and obtained calcium hydrophosphate and carbonate; the latter dissolves as calcium hydrocarbonate, and the soln. can then dissolve normal phosphate so that the ratio $\text{Ca} : \text{PO}_4$ in soln. lies between that required for CaHPO_4 and $\text{Ca}_3(\text{PO}_4)_2$. J. B. A. Dumas observed that Seltz-water, which contained considerable quantities of carbon dioxide in soln., etches ivory in a similar way to a dil. soln. of hydrochloric acid; J. L. Lassaigne also observed that at 10°, water sat. with carbon dioxide dissolves a small quantity of calcareous material from human bones; and J. von Liebig found that a litre of water, sat. with carbon dioxide, dissolved 0.6626 gm. of bone-phosphate, of which 0.500 gm. separated out on boiling. R. Maly and J. Donath, and J. Joffre made similar observations. R. Warington noted that the presence of carbon dioxide raised the solubility of calcium phosphate in water; and in view of the converse effect of calcium salts on the solubility, it might have been anticipated that carbonic acid would act in the same way. J. Davy observed that water sat. with carbon dioxide under press. dissolved more calcium phosphate than did water alone. According to J. Joffre, a litre of water dissolves 0.009 gm. of normal calcium phosphate under conditions where water sat. with carbon dioxide dissolves 0.153 gm.; and T. Schlösing found the solubility increases as the proportion of carbon dioxide increases. According to A. Rindell, an aq. soln. of carbon dioxide in contact with normal calcium phosphate contains:

CO_2	.	.	.	1.95	3.91	7.81	15.63 millimol per litre
CaO	.	.	.	0.11	0.10	0.17	0.44 grm. per litre
P_2O_5	.	.	.	3.32	2.90	1.77	3.30 grms. per litre

R. Warington has also discussed the increased solubility of bone-ash in aq. soln. of carbon dioxide; C. P. Williams made a similar observation on phosphorites; and L. Dusart and J. Pelouze found gelatinous calcium phosphate is more soluble in water carrying carbon dioxide than it is in water free from that gas. A precipitate was formed by boiling the soln. in carbonic acid. F. K. Cameron and A. Seidell found that carbonic acid soln. like aq. soln. dissolve less calcium phosphate when sat. with calcium carbonate than when free from the latter salt. Sat. soln. of calcium sulphate and carbon dioxide dissolve rather less calcium phosphate than if gypsum is absent. A. Barillé studied the effect of increased press. of carbon dioxide on the solubility of calcium phosphate, and found that calcium hydrophosphate and hydrocarbonate are formed, and that the latter decreased the solubility of the hydrophosphate. H. Ehlert and W. Hempel drew no general

conclusions from their study of the solubility of calcium phosphate in aq. soln. of a number of salts in the absence and in the presence of carbon dioxide at 2 atm. press. With conc. soln. of the salt, and carbon dioxide at 2 atm. and 14°, the following numbers of grams per litre of normal calcium phosphate were dissolved :

NH ₄ Cl	(NH ₄) ₂ SO ₄	MgCl ₂ .6H ₂ O	MgSO ₄ .7H ₂ O	K ₂ SO ₄	NaCl	NaNO ₃	Na ₂ SO ₄ .10H ₂ O
1.293	5.885	2.892	3.6001	4.765	0.641	0.864	3.227

with MgCl₂.KCl.6H₂O, 1.154; with MgSO₄.K₂SO₄.MgCl₂.6H₂O, 2.491; and with water, 0.228. B. Foster and H. A. D. Neville studied the solubility of the phosphate in sat. soln. of carbon dioxide containing ammonia, and found with increasing proportion of ammonia, the quantity of phosphate passing into soln. increased at first rapidly, and then more slowly; the solubility of the phosphate being then almost directly proportional to the amount of ammonia present. According to W. Windisch and W. Dietrich, if soln. of primary potassium phosphate are boiled with increasing proportions of calcium hydrocarbonate, the resulting precipitates show increasing percentages of calcium corresponding to a transition from secondary to tertiary calcium phosphate, and the increase in alkalinity of the filtrate (due to formation of secondary potassium phosphate) becomes less rapid as the proportion of hydrocarbonate is increased. The alkalinities of the filtrates are lower than the calculated values, the differences being ascribed to entrainment of soluble alkaline compounds with the precipitates. An aq. soln. of carbon dioxide was found by R. Warrington, and L. Dusart and J. Pelouze, to dissolve normal calcium phosphate, and the soln., on standing, slowly deposits calcium hydrophosphate and carbonate. According to O. Nielsen, when a mixture of normal calcium phosphate and silica is heated in a neutral atm., no phosphorus pentoxide is liberated; silica begins to react chemically with normal calcium phosphate at about 1150°. There is a well-defined maximum at 1630°, in the m.p. curve of SiO₂—Ca₃(PO₄)₂ mixtures for Ca₃(PO₄)₂.3SiO₂, or calcium trisilico-phosphate, Ca₃Si₃P₂O₁₄. The fusion curve is shown in Fig. 65. This compound is readily reduced by carbon and, according to R. Müller, the evolution of phosphorus begins at about 1150°. O. Nielsen suggests these possible formulæ for the silicophosphate :

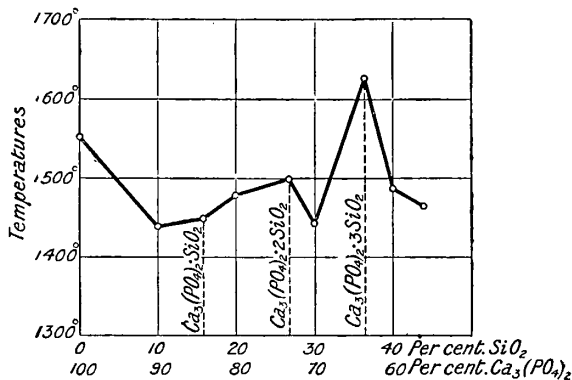
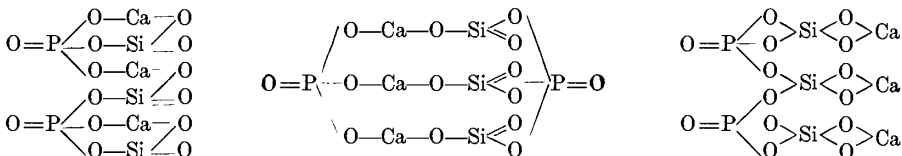

FIG. 65.—Fusion Temperatures of Mixtures of Silica and Normal Calcium Phosphate.

phosphate, Ca₃Si₃P₂O₁₄. The fusion curve is shown in Fig. 65. This compound is readily reduced by carbon and, according to R. Müller, the evolution of phosphorus begins at about 1150°. O. Nielsen suggests these possible formulæ for the silicophosphate :



and he prefers the third since it harmonizes with the easy reducibility of the compound, and its decomposition into CaSiO₃, etc.

The fusion curve of mixtures of calcium oxyorthophosphate, Ca₃(PO₄)₂.CaO, and calcium orthosilicate, Ca₂SiO₄, has been explored by H. Blome. There are two maxima corresponding with the two calcium silicophosphates, 4CaO.P₂O₅+2CaO.SiO₂ and 4CaO.P₂O₅+4(CaO.SiO₂). The solubility curve of the mixtures in a soln. of

citric acid also shows two corresponding maxima. The cake obtained by slowly cooling the former product; the cooling mass appears to decompose into free lime, and the solubility in citric acid is augmented. The slower the cooling between 1800° and 1400°, the more marked these changes, while slow cooling below 1400° seems to have no influence on the result. Slow cooling is thus said to favour the formation of a form of calcium silicophosphate soluble in a soln. of citric acid. If the mixture $4\text{CaO} \cdot \text{P}_2\text{O}_5 + \text{CaO} \cdot \text{SiO}_2$ be slowly cooled, the product is completely soluble in citric acid, but contains no free lime. The silicophosphate soluble in citric acid may be the same in both cases. According to T. Dieckmann and E. Houdremont, the silicophosphate $5\text{CaO} \cdot \text{P}_2\text{O}_5 \cdot \text{SiO}_2$, has a sp. gr. 3.01; it melts at 1760°; and it has a percentage solubility of 96.2 in citric acid—*vide infra*, calcium oxyphosphates.

According to P. Berthier, bone-ash readily dissolves in fused **sodium carbonate**, forming when cold a marble-like mass; at a white-heat, some carbon dioxide is given off; F. Wöhler found that calcium phosphate is decomposed by fusion with sodium carbonate, but the double decomposition is not complete if four times the amount of alkali carbonate be present. Calcium phosphate was found by H. Rose to be partially decomposed by repeatedly boiling it with an aq. soln. of sodium carbonate, and he suggested that a compound of calcium carbonate, and normal phosphate is formed. F. J. Maguti showed that the reaction, $\text{Ca}_3(\text{PO}_4)_2 + 3\text{Na}_2\text{CO}_3 \rightleftharpoons 3\text{CaCO}_3 + 2\text{Na}_3\text{PO}_4$, is reversible. R. Fresenius, C. Neubauer, and E. Luck found that calcium phosphate is incompletely decomposed by a boiling soln. of **sodium hydrocarbonate**. J. Pinnow found that the reaction between calcium hydrophosphate or between calcium carbonate and sodium hydrophosphate furnishes normal sodium phosphate if a sufficient excess of base is present, and the carbon dioxide is removed by water vapour, $6\text{CaHPO}_4 + 3\text{Na}_2\text{CO}_3 = 2\text{Ca}_3(\text{PO}_4)_2 + 2\text{Na}_3\text{PO}_4 + 3\text{CO}_2 + 3\text{H}_2\text{O}$. The action has also been studied by F. Bolm, L. Grünhut, and L. Wolfrum. The reaction $3\text{CaHPO}_4 + 2\text{NaHCO}_3 = \text{Ca}_3(\text{PO}_4)_2 + \text{Na}_2\text{HPO}_4 + 2\text{CO}_2 + 2\text{H}_2\text{O}$ is accompanied by a number of side reactions. J. von Liebig, and R. Fresenius, C. Neubauer, and E. Luck found that calcium phosphate is transformed into oxalate by boiling it with a soln. of **ammonium oxalate**.

W. Crum has measured the solubility of calcium phosphate in various **organic acids**—acetic acid, malic acid, lactic acid, and tartaric acid—and A. Rindell, the solubility in acetic and citric acids. G. Paturel found that acetic acid has a relatively greater solvent action than citric acid. J. Langel, and E. Erlenmeyer investigated the solvent action of ammonium citrate on the calcium phosphates; the latter worked with (a) a soln. of **diammonium citrate** of sp. gr. 1.09; (b) a soln. of **triammonium citrate** of sp. gr. 1.09; and (c) a one-fourth per cent. soln. of **citric acid**. One to two per cent. of the phosphate was added to soln. (a) and (b), and 0.25 per cent. to soln. (c). The temp. kept between 35° and 38°. His results are indicated in Table XX. A. Terreil found that every 100 grms. of citric acid neutralized with ammonia dissolved 7.01 grms. of the phosphate, and when neutralized with potash, 1.90 grms., and he concluded that a soln. of ammonium citrate has a greater solvent action on basic calcium phosphate than have soln. of **potassium citrate** or **sodium citrate**. R. Fresenius, C. Neubauer, and E. Luck also noted the marked solvent action of ammonium citrate. E. Kröber studied the effect of bacteria on the solubility of “insoluble” phosphates.

TABLE XX.—SOLVENT ACTION OF VARIOUS CITRATE SOLUTIONS ON NORMAL CALCIUM PHOSPHATE.

	Per cent. of the original P_2O_5 dissolved.		
	(a)-soln.	(b)-soln.	(c)-soln.
Air-dried $\text{Ca}_3(\text{PO}_4)_2 + 11\text{H}_2\text{O}$	100	55.46	83.84
Dried at 50°, $8\text{Ca}_3(\text{PO}_4)_2 + 15\text{H}_2\text{O}$	100	52.30	—
Ignited $\text{Ca}_3(\text{PO}_4)_2$	93.23	31.92	53.36

G. Bischof¹¹ said that nitric and hydrochloric acid behave similarly. He found 100 grms. of nitric acid of sp. gr. 1.230, at about 17°, dissolves, when diluted with *w* grms. of water :

<i>w</i>	0	0.827	3.309	8.273	10	13	15.718	40 grms.
Ca ₃ (PO ₄) ₂	36.785	43.226	43.050	45.589	52.831	52.857	46.368	43.078 grms.

W. Crum found that **nitric acid** readily dissolves calcium phosphate transforming it into calcium tetrahydrophosphate. According to E. Duvillier, normal barium phosphate is converted by nitric acid completely into orthophosphoric acid and barium nitrate, only when the acid is sufficiently conc. to make the barium nitrate insoluble, and J. F. Persoz found that glacial acetic acid precipitates this salt from the soln. of calcium phosphate in nitric acid. H. E. Causse has studied the solubility of calcium phosphate in **phosphoric acid** of different conc.; the soln. when evaporated spontaneously deposits crystals of calcium dihydrophosphate—*vide infra*. H. Bassett found :

Temp.	Grms. per 100 grms. sat. soln.		Solid phase.
	CaO.	P ₂ O ₅ .	
100°	2.503	53.71	Ca(H ₂ PO ₄) ₂ ; Ca(H ₂ PO ₄) ₂ .H ₂ O
115°	5.623	43.60	Ca(H ₂ PO ₄) ₂ .H ₂ O ; CaHPO ₄
132°	4.327	53.43	Ca(H ₂ PO ₄) ₂ ; Ca(H ₂ PO ₄) ₂ .H ₂ O
169°	4.489	63.95	Ca(H ₂ PO ₄) ₂

J. A. Völcker¹² found that a litre of cold water dissolves 31 mgrm. of calcined, and 79 mgrm. of precipitated calcium phosphate in seven days ; and the aq. soln. does not give a precipitate when treated with ammonia, but it is rendered turbid by ammonium oxalate, or by silver, uranium, and ferric salts, or, according to R. Phillips, by lead salts. According to R. L. Maly and J. Donath, 100 parts of water dissolve 0.00236 part of gelatinous normal calcium phosphate, or 0.00256 part of the ignited phosphates, or 0.003 part of bone powder. The reports by different authorities of the so-called solubility of calcium phosphate in water are conflicting. The soln. has an acid reaction, and the solid residue contains more base than before contact with water. Indeed, F. K. Cameron and L. A. Hurst¹³ have shown that if normal calcium phosphate, or calcium hydro- or dihydro-phosphate be placed in water, some phosphoric acid passes into soln. and calcium hydroxide separates to form, maybe, a more basic and less soluble phosphate, or a mixture whose solubility is decreased by its presence. While the phosphoric acid in soln. tends to increase the solubility of the phosphate, the base, even though in soln. in correspondingly smaller amounts, exerts a greater effect in decreasing the solubility. Therefore, the addition of increasing amounts of water produces a relatively smaller, though in actual amount a larger soln. and decomposition of the salt. It is not therefore strictly correct to speak of the soln. of calcium phosphate in water ; rather is it a soln. of the products of the hydrolysis of the phosphate which itself is present, if at all, only in small quantities. The relative masses of the solid phosphate and solvent have a marked effect on the amount of hydrolysis ; the temp. also has a marked influence ; the size of the particles of the solid phosphate affects the result in that the smaller the particles the more rapid or complete the dissolution ; adsorption phenomena occur ; and the reactions between water and the solid phosphate are rather slow, so that in much of the recorded work, there is nothing to show that the final equilibrium conditions had been attained. Strictly normal calcium phosphate has not been prepared in the wet way. F. K. Cameron and A. Seidell found that with two samples of calcium phosphate one, A, containing a 0.14 per cent. excess of lime, and the other, B, 2.83 per cent. excess of acid, and using 5, 10, 20, and

40 grms. of the phosphate per litre, the amounts of PO_4 dissolved (grams per litre) were, at 25° :

Grms. phosphate per litre	.	.	5	10	20	40
A grms. PO_4 per litre	.	.	0.068	0.113	0.185	0.310
B grms. PO_4 per litre	.	.	0.109	0.189	0.324	0.558

thus showing that the source and mode of preparation of the calcium phosphate have an important influence, and that the absolute values of the results have very little value as physical constants. The system in equilibrium is somewhat complex, because, under certain conditions of conc. and temp., many definite mol. species—mono-, di-, or tri-calcium phosphates or hydrates—may be formed as solid phases in contact with the soln. as illustrated in Figs. 63 and 64. R. Warington showed that normal calcium phosphate containing slightly more calcium oxide than is required by the formula is decomposed by boiling in water for two hours to such an extent that the soln. contained about three times as much phosphoric acid as calcium oxide. Cold water also decomposes the phosphate to a lesser degree. The amount of phosphoric acid which water would extract was found to depend on the relative masses of the phosphate and water which are brought into contact. The solid residue remaining after many extractions was found by R. Warington, and J. H. Aeby to approximate $3\text{Ca}_3(\text{PO}_4)_2 \cdot \text{Ca}(\text{OH})_2$, although F. Wibel held that the composition of the residue is not constant.

According to J. L. Lassaigne,¹⁴ the solubility of calcium phosphate in water is much favoured by the presence of the salts of the alkali metals. T. Thomson, for example, found this to be the case with *sodium chloride*. J. von Liebig, J. L. Lassaigne, R. Maly and J. Donath, A. Rindell, H. Ehlert and W. Hempel, and L. Mandl made similar observations with sodium chloride soln. F. K. Cameron and L. A. Hurst found that *potassium chloride* exerts a decomposing as well as a solvent action on calcium phosphate, and with an increasing conc. of the soln. with respect to potassium chloride, the calcium phosphate yields a decreasing amount of phosphoric acid and an increasing amount of base. A. Corcelle studied the action of *alkali sulphates* on normal barium phosphate. H. Ehlert and W. Hempel also studied the effect of soln. of *potassium sulphate*, *sodium sulphate*, *magnesium chloride*, *magnesium sulphate*, and the double salts $\text{MgCl}_2 \cdot \text{KCl} \cdot 6\text{H}_2\text{O}$, and $\text{MgSO}_4 \cdot \text{K}_2\text{SO}_4 \cdot \text{MgCl}_2 \cdot 6\text{H}_2\text{O}$. J. von Liebig, H. Ehlert and W. Hempel, and F. K. Cameron and L. A. Hurst obtained similar results with *sodium nitrate*. The latter noted that the soln. of sodium nitrate also exerts a decomposing action on the phosphate. F. Wöhler, H. Ehlert and W. Hempel, and R. Warington found *ammonium chloride* has a marked influence in raising the solubility; similar results were observed by G. C. Wittstein and A. Rindell with *ammonium nitrate*, by J. von Liebig and H. Ehlert and W. Hempel, with *ammonium sulphate*, by B. Foster and H. A. D. Neville in *ammonium carbonate*; and by G. C. Wittstein with *ammonium succinate*. G. de Morveau, L. Hünefeld, and G. C. Wittstein have also studied the solubility of calcium phosphate in ammonium salts. G. Magnanini found a litre of 0.005*N*-*potassium bitartrate*, when sat. with calcium phosphate, contained 0.08 gm. Ca, and 0.181 gm. H_3PO_4 at 25° . According to H. Grandeau, when normal strontium phosphate is melted with an *alkali sulphate* it forms a double phosphate which is never free from strontia. Similarly also with normal barium phosphate. When barium phosphate is shaken with a cold aq. soln. of an equal wt. of potassium sulphate, W. L. Kölreuter found it is converted into barium sulphate, and the same result is obtained if twice the weight of Glauber's salt be used. C. Scheibler also found that freshly precipitated normal barium phosphate is converted into barium sulphate by a soln. of *calcium sulphate* in phosphoric acid.

The marked solvent action of ammonium salts on calcium phosphates has been also noted by J. B. A. Dumas, R. Warington, R. Maly and J. Donath, etc. A. Terriil found that when 100 grms. of the acid were neutralized with ammonia, the following amounts in grams of normal calcium phosphate were dissolved :

Ammonium.	Chloride.	Nitrate.	Sulphate.	Acetate.	Tartrate.	Citrate.	Malate.
Grms. $\text{Ca}_3(\text{PO}_4)_2$	0.655	0.309	1.050	0.255	4.56	6.01	1.12

L. N. Vauquelin, F. Wöhler, and A. A. Hayes observed the effect with *starch*, *glue*, and other *organic substances*; H. Minssen and B. Tacke with *humic acid*; and M. Mercadante with a soln. of *albumen*; L. Mandl with soln. of *gelatine*, *sugar*, or *albumen*; and A. Bobierre showed that calcium phosphate found in the residues of sugar refineries, is held in soln. by *calcium succrate*. J. J. Berzelius obtained what was probably an adsorption product with *barium nitrate* by the precipitation of barium phosphate from soln. of barium nitrate. F. K. Cameron and A. Seidell found that the presence of *calcium sulphate* slightly increases the amount of phosphoric acid dissolved from normal calcium phosphate—H. P. Armsby found a decrease. R. Warrington, A. Terreil, and F. K. Cameron and A. Seidell found that the presence of *calcium carbonate* decreases the amount of phosphoric acid dissolved. F. K. Cameron and L. A. Hurst have measured the effects of soln. of *calcium chloride*, of calcium chloride and hydrochloric acid, and of *calcium nitrate*, from which it appears that an increased conc. with respect to the lime salt decreases the amount of phosphoric acid entering into the soln. They ascribe this effect to “the formation of a common ion from both substances, and a forcing back of the solubility of calcium phosphate in consequence of a lessening of the amount of phosphoric acid entering the soln.”

H. Grandeau¹⁵ heated barium pyrophosphate with a large excess of potassium sulphate to 800°–1000°, and obtained a mixture of barium sulphate and potassium phosphate; but between 1400° and 1500°, a double salt, mixed with barium sulphate, is produced. H. Rose prepared **barium potassium phosphate**, BaKPO_4 , by heating a mixture of potassium carbonate and barium pyrophosphate; the product decomposed when leached with hot water. L. V. R. Ouvrard obtained transparent crystals of this salt by melting together mol. proportions of barium oxide and potassium phosphate, and extracting the slowly cooled mass with water. A. de Schulten obtained **decahydrated barium potassium phosphate**, $\text{BaKPO}_4 \cdot 10\text{H}_2\text{O}$, by mixing boiling dil. soln. of potassium phosphate and barium hydroxide in an excess of a soln. of potassium silicate; and obtained on cooling cubic crystals without action on polarized light, and which effloresced in air. H. Grandeau, H. Rose, and L. V. R. Ouvrard prepared **potassium strontium phosphate**, K_2SrPO_4 , and **potassium calcium phosphate**, KCaPO_4 , in a similar manner.

L. B. G. de Morveau obtained a clear glass by melting barium oxide with twice its weight of sodium hydrophosphate; and J. J. Berzelius noted the solubility of barium oxide in fused sodium ammonium hydrophosphate. M. Berthelot studied the reactions between barium and sodium hydroxides and phosphoric acid, and between barium chloride, alkali phosphate, and phosphoric acid. A. Quartaroli found that on saturating a mol of phosphoric acid with an eq. of calcium or barium oxide, and two eq. of sodium (or potassium) hydroxide, contrary to the statement of M. Berthelot, precipitation of two-thirds of the phosphoric acid with the formation of $\text{Ca}_3\text{Na}_6(\text{PO}_4)_4$, or of $\text{Ba}_3\text{Na}_6(\text{PO}_4)_4$, does not occur, for scarcely one-third of the phosphoric acid is precipitated in the form of tri- and tetra-basic phosphates. Two-thirds of the phosphoric acid remains in soln. as tri- and di-basic phosphates. Hence, bases added in eq. quantities to phosphoric acid distribute themselves unequally between the soln. and the precipitate, and, as the latter is partly composed of tetra-basic phosphates, the soln. must contain a certain amount of dibasic phosphates. An exception to this is met with when a soln. of phosphoric acid containing one eq. of baryta and two eq. of sodium hydroxide is left for a long time; one atom of sodium and one of barium (less than was calculated by M. Berthelot) then pass into the insoluble condition and precipitate a little less than half of the phosphoric acid. Nor when one mol. of phosphoric acid is sat. with one eq. each of lime (or baryta) and sodium (or potassium) hydroxide is it found that two-thirds of the phosphoric acid is precipitated with formation of insoluble double phosphates containing eq. quantities of calcium and sodium. In this case, too, the bases are unequally distributed between the precipitate and the soln., the latter containing mono- and di-basic phosphates and the former di- and tri-basic, and in some cases tetra-basic phosphates.

H. Rose obtained a **barium sodium phosphate**, BaNaPO_4 , by a process analogous to that which he employed for the corresponding potassium compound, and found it behaved similarly towards water. According to A. Villiers, a mixture of soln. of barium chloride and sodium hydrophosphate is acid towards phenolphthalein; if the soln. be made alkaline by the addition of baryta-water, it again becomes acid in about an hour. Baryta-water is added until the soln. remains alkaline after standing some time. The precipitate is well washed and dried at 120° – 130° . The composition of the granular mass corresponds with NaBaPO_4 . Cold water has no action, hot water extracts soda. A. de Schulten made **decahydrated barium sodium phosphate**, $\text{BaNaPO}_4 \cdot (9 \text{ or } 10)\text{H}_2\text{O}$, by a process analogous to that used for the corresponding potassium compound; the crystals are tetrahedral; they effloresce in air; and, according to A. Joly, they have a heat of formation of $50 \cdot 8$ Cals. L. V. R. Ouvrard made **sodium strontium phosphate**, NaSrPO_4 , by dissolving strontium oxide, phosphate, or sulphate in molten sodium ortho-, pyro-, or meta-phosphate. It was also made by H. Rose by the method employed for the potassium salt. **Octodecahydrated sodium strontium phosphate**, $\text{NaSrPO}_4 \cdot 18\text{H}_2\text{O}$, was made by A. Joly by mixing dil. soln. of one eq. of sodium hydrophosphate with two of strontium chloride; the gelatinous precipitate soon becomes crystalline. Sodium hydroxide is then added to the mother liquid until it remains permanently neutral towards phenolphthalein. A gelatinous precipitate is formed which likewise soon becomes crystalline. H. Rose made **sodium calcium phosphate**, NaCaPO_4 , by the method employed for the potassium salt. A. Ditte made it by fusing a gram of normal calcium phosphate with 50 grms. of sodium or potassium chloride, and adding more than 11 per cent. of sodium phosphate to the fused mass. The cold product was extracted with water. L. V. R. Ouvrard slowly cooled a sat. soln. of calcium oxide, chloride, fluoride, or sulphate in fused sodium pyro- or ortho-phosphate, and extracted the mass with water. The presence of sodium chloride favours the crystallization. If an excess of halide be employed apatite or wagnerite is formed. The crystals have a sp. gr. $2 \cdot 9$ at 20° ; and they are soluble in dil. acid. When the fused phosphate was not sat. with calcium oxide, L. V. R. Ouvrard obtained monoclinic needles of the composition $3\text{Na}_2\text{O} \cdot 3\text{CaO} \cdot 2\text{P}_2\text{O}_5$, of sp. gr. $2 \cdot 1$ at 20° , and soluble in dil. acid. H. Rose prepared **lithium calcium phosphate**, LiCaPO_4 , by heating equi-mol. parts of calcium pyrophosphate and lithium carbonate and washing the cold mass with hot water.

H. Lasne dissolved 10 grms. of calcium carbonate in dil. hydrochloric acid, and then added a gram of calcium oxide, and 15 grms. of citric acid in order to keep the calcium phosphate in soln., which was then made feebly ammoniacal. In about 24 hrs., a conc. soln. of ammonium phosphate was added, and the soln. allowed to crystallize at not too high a temp. The crystals of **ammonium calcium phosphate**, $(\text{NH}_4)\text{CaPO}_4 \cdot 7\text{H}_2\text{O}$, were washed with aq. ammonia. According to A. de Schulten, the monoclinic crystals have the axial ratios $a:b:c=0 \cdot 5256:1:0 \cdot 5932$, and $\beta=91^\circ 26'$. The sp. gr. is $1 \cdot 561$ at 15° . The salt loses ammonia and water when exposed to the air, and, according to H. Lasne, it loses 6·28 per cent. in weight when kept for six weeks in a closed vessel. At 100° , all the water is evolved. The salt is incompletely decomposed by cold water, in 45 mins., and completely by hot water, forming normal calcium and ammonium phosphates. J. W. Davis also studied this salt. A. H. Church's analysis of the mineral *tirolicite* corresponds with the formula, $2\text{Ca}_3(\text{PO}_4)_2 \cdot 2\text{Cu}(\text{OH})_2 \cdot \text{CaCO}_3 \cdot 2\text{H}_2\text{O}$, and it is probably a mixture.

REFERENCES.

- ¹ A. Werner, *Ber.*, 40. 4441, 1907; H. Bassett, *Zeit. anorg. Chem.*, 59. 1, 1908.
- ² H. E. Causse, *Compt. Rend.*, 114. 414, 1892; F. K. Cameron, A. Seidell, and J. M. Bell, *Journ. Amer. Chem. Soc.*, 27. 1503, 1512, 1905; F. K. Cameron and A. Seidell, *ib.*, 27. 1503, 1905; F. K. Cameron and J. M. Bell, *ib.*, 27. 1512, 1905; 28. 1222, 1906; 32. 869, 1910; *The Action of Water and Aqueous Solutions upon Soil Phosphates*, Washington, 1907; H. Bassett, *Zeit. anorg. Chem.*, 53. 34, 49, 1907; 59. 1, 1908; *Journ. Chem. Soc.*, 111. 620, 1917.
- ³ A. A. Julien, *Amer. Journ. Science*, (2), 40. 370, 1865; R. Warington, *Journ. Chem. Soc.*,

19. 296, 1866; 24. 80, 1871; 25. 269, 1871; 26. 983, 1873; J. J. Berzelius, *Liebig's Ann.*, 53. 286, 1845; T. Graham, *Phil. Trans.*, 123. 253, 1833; *Pogg. Ann.*, 32. 68, 1834; J. N. von Fuchs, *Schweigger's Journ.*, 24. 124, 1818; M. Berthelot, *Compt. Rend.*, 132. 1277, 1901; L. Barthe, *ib.*, 114. 1267, 1892; L. V. R. Ouvrard, *ib.*, 106. 1499, 1888; *Ann. Chim. Phys.*, (6), 16. 298, 1889; M. Berthelot, *ib.*, (7), 25. 197, 1902; A. Gawalowsky, *Oester. Chem. Ztg.*, 2. 412, 1899; G. C. Wittstein, *Pharm. Viertel.*, 15. 189, 1866; M. Traube, *Ber.*, 24. 1765, 1891; R. Ludwig, *Arch. Pharm.*, (2), 69. 286, 1852; G. M. de Toni, *Koll. Zeit.*, 28. 145, 1921; W. A. Withers and A. L. Field, *Journ. Amer. Chem. Soc.*, 37. 1091, 1915; C. U. Shepard, *Amer. Journ. Science*, (3), 23. 400, 1882; F. Sandberger, *Journ. prakt. Chem.*, (1), 110. 128, 1870; W. Windisch and W. Dietrich, *Woch. Brau.*, 37. 177, 187, 1920; F. K. Cameron and A. Seidell, *Journ. Amer. Chem. Soc.*, 26. 1454, 1904; P. Groth, *Tabellarische Uebersicht der Mineralien*, Braunschweig, 71, 1898; A. Brives, *Compt. Rend. Géol. France*, 95, 1917; L. Gentil, *ib.*, 25, 1920; P. Gaubert, *Compt. Rend.*, 174. 1115, 1922; R. Irvine and W. S. Anderson, *Proc. Roy. Soc. Edin.*, 18. 52, 1892.
- ⁴ S. Gabriel, *Zeit. physiol. Chem.*, 18. 257, 1894; J. M. von Bemmelen, *Zeit. anorg. Chem.*, 15. 90, 1897; H. Bassett, *Journ. Chem. Soc.*, 111. 620, 1917; A. Cossa, *Atti Accad. Lincei*, 3, 17, 1878; *Gazz. Chim. Ital.*, 9. 118, 1879; G. Bergeron and L. P'Hôte, *Compt. Rend.*, 80. 268, 1875; F. Raoult and H. Breton, *ib.*, 85. 40, 1877.
- ⁵ N. T. de Saussure, *Journ. Phys.*, 45. 24, 1794; J. P. J. d'Arcet, *Second mémoire sur l'action d'un feu égal violent*, Paris, 31, 1771; M. Berthelot, *Compt. Rend.*, 87. 575, 1878; 103. 911, 1886; O. Nielsen, *Ferrum*, 10. 97, 1913; H. V. Regnault, *Ann. Chim. Phys.*, (3), 1. 129, 1841.
- ⁶ P. Bary, *Compt. Rend.*, 130. 776, 1900; E. Newbery and H. Lupton, *Mem. Manchester Lit. Phil. Soc.*, 62. 10, 1918; W. Crookes, *Chem. News*, 43. 237, 1881.
- ⁷ M. Cari-Mantrand, *Compt. Rend.*, 38. 864, 1865; H. E. Quantin, *ib.*, 106. 1074, 1888; J. Riban, *ib.*, 95. 1160, 1882; *Bull. Soc. Chim.*, (2), 39. 14, 1883; W. Crum, *Liebig's Ann.*, 63. 394, 1847; J. Piccard, *Schweiz. Polyt. Zeit.*, 11. 83, 1866; K. Birnbaum and A. S. Packard, *Zeit. Chem.*, (2), 7. 137, 1871; E. Erlenmeyer, *ib.*, (1), 3. 351, 1860; G. Bischof, *Schweigger's Journ.*, 67. 39, 1833; A. Lassieur, *Internat. Cong. App. Chem.*, 8. ii, 171, 1912.
- ⁸ J. B. Senderens, *Bull. Soc. Chim.*, (3), 7. 511, 1892; A. Béchamp, *Ann. Chim. Phys.*, (4), 16. 241, 1869; A. Gossmann, *Repert. Pharm.*, 61. 49, 1837; J. Kolb, *Compt. Rend.*, 78. 825, 1874; A. Millot, *ib.*, 78. 1134, 1874; H. Joulie, *ib.*, 76. 1288, 1873; J. Piccard, *Schweiz. polyt. Zeit.*, 11. 156, 1867; H. P. Armsby, *Amer. Journ. Science*, (3), 12. 46, 1876; W. Crum, *Liebig's Ann.*, 63. 394, 1847; E. Erlenmeyer, *Ueber Bildung und Zusammensetzung des sogenannten sauren phosphorsäuren Kalks*, Heidelberg, 1857; *Ber.*, 14. 1253, 1881; *Zeit. Chem.*, (1), 3. 351, 1860; B. W. Gerland, *Chem. News*, 20. 268, 1870; R. Weber, *Pogg. Ann.*, 109. 505, 1860; J. J. Berzelius, *Liebig's Ann.*, 53. 286, 1845; E. Rotondi, *Annali Chimica*, 74. 129, 1882; *Ber.*, 15. 1441, 1882.
- ⁹ F. K. Cameron and J. M. Bell, *The Action of Water and Aqueous Solutions upon Soil Phosphates*, Washington, 1907; *Journ. Amer. Chem. Soc.*, 28. 1220, 1906; F. K. Cameron and J. F. Breazeale, *Journ. Phys. Chem.*, 7. 571, 1903.
- ¹⁰ P. Berthier, *Ann. Chim. Phys.*, (2), 33. 179, 1826; F. J. Malaguti, *ib.*, (3), 51. 346, 1857; T. Schlösing, *Compt. Rend.*, 59. 384, 1864; L. Dusart and J. Pelouze, *ib.*, 66. 1327, 1868; W. Windisch and W. Dietrich, *Woch. Brau.*, 37. 177, 187, 1920; J. Anderson, *Brit. Pat. No.* 513, 1872; C. Seybold and F. Heeder, *ib.*, 11804, 1893; *German Pat.*, D.R.P. 72171, 1892; H. Rose, *Pogg. Ann.*, 95. 437, 1855; R. Fresenius, C. Neubauer, and E. Luck, *Zeit. anal. Chem.*, 10. 133, 1871; W. Crum, *Liebig's Ann.*, 63. 394, 1847; J. von Liebig, *ib.*, 61. 128, 1847; A. Rindell, *Untersuchungen über Löslichkeit einiger Kalkphosphate*, Helsingfors, 1899; B. Foster and H. A. D. Neville, *Proc. Chem. Soc.*, 26. 236, 1910; J. B. A. Dumas, *Compt. Rend.*, 23. 1018, 1846; T. Schlösing, *ib.*, 131. 149, 1900; J. L. Lassaigne, *ib.*, 23. 1019, 1846; *Journ. Chim. Méd.*, (3), 3. 11, 1847; (3), 4. 536, 1848; (3), 5. 258, 1849; A. Barillé, *Rép. Pharm.*, 145, 1901; R. Maly and J. Donath, *Journ. prakt. Chem.*, (2), 7. 413, 1873; F. K. Cameron and A. Seidell, *Journ. Amer. Chem. Soc.*, 26. 1454, 1904; J. Joffre, *Bull. Soc. Chim.*, (3), 19. 372, 1898; A. Terrell, *ib.*, (2), 35. 548, 1881; J. von Liebig, *Liebig's Ann.*, 106. 196, 1858; G. Patureau, *Ann. Agron.*, 20. 332, 1894; O. Nielsen, *Ferrum*, 10. 97, 1913; C. P. Williams, *Chem. News*, 24. 306, 1871; R. Müller, *Beiträge zur Kenntnis der Phosphorfabrikation*, Dresden, 1911; H. Ehlert, *Studien über Salzlösungen*, Leipzig, 1909; F. Bolm, *Zeit. Unters. Nahr. Genuss.*, 35. 418, 1918; L. Grünhut, *ib.*, 35. 39, 1918; L. Wolfrum and J. Pinnow, *ib.*, 36. 138, 1918; J. Pinnow, *ib.*, 40. 243, 1920; *Zeit. Elektrochem.*, 27. 309, 1921; E. Kröber, *Ueber das Löslichwerden den Phosphorsäure, aus wasserunlöslichen Verbindungen unter der Einwirkung von Bakterien und Hefen*, Merseburg, 1909; G. von Georgievics, *Monatsh.*, 12. 565, 1892; R. Warington, *Journ. Chem. Soc.*, 19. 296, 1866; 24. 80, 1871; F. Wöhler, *Liebig's Ann.*, 51. 437, 1844; H. Ehlert and W. Hempel, *Zeit. Elektrochem.*, 18. 727, 1913; J. Langel, *Action du citrate d'ammonium sur les phosphates mono-, bi-, et tri-calcique*, Genève, 1909; A. Lassieur, *Internat. Cong. App. Chem.*, 8. ii, 171, 1912; H. Blohme, *Stahl Eisen*, 30. 2161, 1910; *Beiträge zur Konstitution der Thomasschlacke*, Berlin, 1910; T. Dieckmann and E. Houdremont, *Zeit. anorg. Chem.*, 120. 129, 1920; J. Davy, *Edin. Phil. Journ.*, 45. 61, 1847; E. Erlenmeyer, *Ueber Bildung und Zusammensetzung des sogenannten sauren phosphorsäuren Kalks*, Heidelberg, 1857.
- ¹¹ W. Crum, *Liebig's Ann.*, 63. 394, 1847; G. Bischof, *Schweigger's Journ.*, 67. 37, 1833; J. F. Persoz, *Introduction à l'étude de la chimie moléculaire*, Paris, 346, 1839; H. E. Causse, *Compt. Rend.*, 114. 414, 1892; E. Du villier, *ib.*, 81. 1251, 1875; H. Bassett, *Zeit. anorg. Chem.*, 59. 1, 1908.
- ¹² J. A. Völcker, *B.A. Rep.*, 169, 1862; R. Warington, *Journ. Chem. Soc.*, 19. 296, 1866; 24.

80, 1871; 25. 269, 1871; 26. 983, 1873; G. Pollacci, *L'Orosi*, 19. 217, 1896; E. Reichardt, *Zeit anal. Chem.*, 11. 275, 1872; R. Phillips, *Ann. Phil.*, 22. 188, 1831; M. Berthelot, *Ann. Chim. Phys.*, (6), 11. 350, 1887; W. F. Louguinine, *ib.*, (5), 9. 33, 1876; R. L. Maly and J. Donath, *Journ. prakt. Chem.*, (2), 7. 413, 1873; J. Joffre, *Bull. Soc. Chim.*, (3), 19. 372, 1898; C. P. Williams, *Chem. News*, 24. 306, 1871; F. K. Cameron and L. A. Hurst, *Journ. Amer. Chem. Soc.*, 26. 885, 1904; J. Joly, *Compt. Rend.*, 94. 529, 1882; 97. 1480, 1883; G. Viard, *ib.*, 127. 178, 1898; A. Joly and E. Sorel, *ib.*, 118. 738, 1894; A. Rindell, *ib.*, 134. 112, 1902; A. Barille, *Rép. Pharm.*, 529, 1897; C. Delattre, *Bull. Soc. Chim.*, (2), 35. 358, 1881; A. Millot, *ib.*, (2), 33. 194, 1880; F. Wibel, *Journ. prakt. Chem.*, (2), 9. 113, 1897; J. H. Aeby, *ib.*, (2), 9. 469, 1874; J. Stoklasa, *Landw. Versuch. Stat.*, 38. 401, 1891; 44. 437, 1894.

¹³ F. K. Cameron and L. A. Hurst, *Journ. Amer. Chem. Soc.*, 26. 885, 1904; F. K. Cameron and A. Seidell, *ib.*, 26. 1454, 1904; F. K. Cameron and J. M. Bell, *ib.*, 27. 1512, 1905; 28. 1222, 1906; R. Warington, *Journ. Chem. Soc.*, 19. 296, 1866; 24. 80, 1871; 25. 269, 1871; 26. 983, 1873; J. A. Völcker, *B.A. Rep.*, 169, 1862; R. Phillips, *Ann. Phil.*, 22. 188, 1831; R. Maly and J. Donath, *Journ. prakt. Chem.*, (2), 7. 413, 1873; J. H. Aeby, *ib.*, (2), 9. 469, 1874.

¹⁴ J. L. Lassaigne, *Journ. Chim. Méd.*, (3), 3. 11, 1847; (3), 4. 536, 1848; J. von Liebig, *Liebig's Ann.*, 106. 185, 1858; 61. 128, 1847; F. Wöhler, *ib.*, 98. 143, 1856; *Pogg. Ann.*, 4. 166, 1825; T. Thomson, *Ann. Phil.*, 17. 12, 1821; R. Warington, *Journ. Chem. Soc.*, 26. 983, 1873; H. Minssen and B. Tacke, *Biedermann's Centr.*, 29. 447, 1900; L. Hünefeld, *Arch. Med. Erfind.*, 520, 1826; G. C. Wittstein, *Pharm. Vierteljahr.*, 15. 189, 1866; H. Grandeau, *Compt. Rend.*, 100. 1134, 1885; L. Mandl, *ib.*, 44. 1108, 1857; A. Bobierre, *ib.*, 32. 859, 1851; A. Rindell, *ib.*, 134. 112, 1902; *Untersuchungen über Löslichkeit einiger Kalkphosphate*, Helsingfors, 1899; G. Maganini, *Gazz. Chim. Ital.*, 31. ii, 542, 1901; H. Ehlert and W. Hempel, *Zeit. Elektrochem.*, 18. 727, 1912; B. Foster and H. A. D. Neville, *Proc. Chem. Soc.*, 26. 236, 1910; J. J. Berzelius, *Ann. Chim. Phys.*, (2), 2. 162, 1816; G. de Morveau, *Journ. polyt. Cah.*, 3. 434, 1795; J. W. Davis, *Chem. News*, 25. 249, 258, 1872; W. L. Köreuter, *Mag. Pharm.*, 8. 181, 1823; R. Fresenius, C. Neubauer, and E. Luck, *Zeit. anal. Chem.*, 10. 133, 1871; A. Terrell, *Chem. News*, 44. 66, 1881; *Bull. Soc. Chim.*, (2), 35. 548, 1881; L. N. Vauquelin, *Journ. Phys.*, 85. 126, 1817; A. A. Hayes, *Edin. Phil. Journ.*, 5. 378, 1857; C. Scheibler, *Dingler's Journ.*, 211. 275, 1874; M. Mercadante, *Ber.*, 8. 1357, 1875; F. K. Cameron and A. Seidell, *Journ. Amer. Chem. Soc.*, 26. 1454, 1904; F. K. Cameron and L. A. Hurst, *ib.*, 26. 885, 1904; H. P. Armsby, *Amer. Journ. Science*, (3), 12. 46, 1876; R. Maly and J. Donath, *Journ. Phys. Chem.*, (2), 7. 413, 1873; A. Corcelle, *Étude sur l'action des sulfates alcalins sur le phosphate tribarytique*, Genève, 1904; J. B. A. Dumas, *Compt. Rend.*, 23. 1018, 1846.

¹⁵ H. Grandeau, *Ann. Chim. Phys.*, (6), 8. 205, 1886; L. V. R. Ouvrard, *ib.*, (6), 16. 297, 1889; *Compt. Rend.*, 106. 1599, 1888; A. Villiers, *ib.*, 104. 1103, 1887; A. Joly, *ib.*, 104. 1702, 1887; A. Ditte, *ib.*, 94. 1592, 1882; A. de Schulten, *ib.*, 96. 706, 1883; *Bull. Soc. Min.*, 27. 97, 1904; *Bull. Soc. Chim.*, (2), 39. 500, 1883; H. Lasne, *ib.*, (3), 27. 131, 1902; H. Rose, *Pogg. Ann.*, 77. 292, 1849; A. Quartaroli, *Gazz. Chim. Ital.*, 35. ii, 290, 1905; 37. i, 198, 1907; M. Berthelot, *Compt. Rend.*, 132. 1517, 1901; 133. 5, 1901; *Ann. Chim. Phys.*, (7), 25. 157, 176, 1902; L. B. G. de Morveau, *Journ. Polyt.*, 3. 434, 1795; A. H. Church, *Ber.*, 5. 1062, 1872; J. J. Berzelius, *Ann. Chim. Phys.*, (2), 2. 162, 1816; J. W. Davis, *Chem. News*, 25. 249, 258, 1872.

§ 26. Hydrophosphates of the Alkaline Earths

The more important calcium phosphates reported in beds of guano are *monetite*, HCaPO_4 ; *brushite*, $\text{HCaPO}_4 \cdot 2\text{H}_2\text{O}$; *metabrushite*, $\text{HCaPO}_4 \cdot 1\frac{1}{2}\text{H}_2\text{O}$; *stoffertite*, $\text{CaHPO}_4 \cdot 4\frac{1}{2}\text{H}_2\text{O}$, of C. Klein¹; *martinite*, $2\text{H}_2\text{Ca}_5(\text{PO}_4)_4 \cdot \text{H}_2\text{O}$; *collophanite*, $\text{Ca}_5(\text{PO}_4)_2 \cdot \text{H}_2\text{O}$. There are thus several hydrated and one anhydrous calcium hydrophosphate. The mineral monetite studied by C. U. Shepard, and A. de Schulten has the composition CaHPO_4 . It was found at Moneta, West Indies. J. von Liebig reported the occurrence of concretions of calcium hydrophosphate in the guano of Jarvis Island; A. H. Hassall found it as pathological concretions in animal bodies; D. Ples, F. A. Abel, and F. Wöhler reported crystals in the wood of the teak (*tectonia grandis*); and F. Wöhler and A. E. Mermet and B. Delachanal in the urinary canal of the sturgeon.

J. J. Berzelius² obtained calcium hydrophosphate, CaHPO_4 , also called *dicalcium phosphate*, contaminated with normal calcium phosphate by dropping a soln. of disodium hydrophosphate into an excess of a soln. of calcium chloride; on the other hand, if a soln. of calcium chloride be dropped into one of disodium hydrophosphate, calcium hydrophosphate is first formed, which in the presence of an excess of disodium hydrophosphate, decomposes into $\text{Ca}_4\text{H}(\text{PO}_4)_3$ and phosphoric acid, which latter, according to J. J. Berzelius and C. L. Berthollet, reforms some disodium hydrophosphate. Hence, said R. Warington, the liquid is first alkaline, then neutral,

and finally acid, and only in the last case is calcium hydrophosphate obtained. G. E. Davis found that ammonium sodium hydrophosphate behaves like disodium hydrophosphate.

In W. Palmaer and J. Wiborgh's process, a soln. of sodium perchlorate is electrolyzed, $\text{NaClO}_4 + \text{H}_2\text{O} = \text{NaOH} + \text{HClO}_4$, and the resulting perchloric acid is allowed to act on rock phosphate: $6\text{HClO}_4 + \text{Ca}_3(\text{PO}_4)_2 = 2\text{H}_3\text{PO}_4 + 3\text{Ca}(\text{ClO}_4)_2$, and the filtered soln. is treated with the sodium hydroxide obtained at the cathode: $2\text{H}_3\text{PO}_4 + 4\text{NaOH} + 3\text{Ca}(\text{ClO}_4)_2 = 2\text{CaHPO}_4 + 4\text{NaClO}_4 + \text{Ca}(\text{ClO}_4)_2 + 4\text{H}_2\text{O}$. The resulting sodium perchlorate soln. is regenerated: $4\text{NaClO}_4 + \text{Ca}(\text{ClO}_4)_2 + \text{Na}_2\text{CO}_3 = 6\text{NaClO}_4 + \text{CaCO}_3$. It is claimed that low-grade natural phosphates can be utilized by this process.

W. Skey made **strontium hydrophosphate**, SrHPO_4 , by precipitation from a soln. of strontium chloride by sodium hydrophosphate, and, according to L. Barthe, the precipitate is free from other phosphates if a soln. of 70 grms. of crystalline strontium chloride be poured into a soln. of 100 grms. of crystalline sodium hydrophosphate—both soln. should be feebly acid, and the temp. not over 50° . A. de Schulten employed a modification of this process. J. J. Berzelius prepared **barium hydrophosphate**, BaHPO_4 , by precipitation from a soln. of barium chloride by sodium or ammonium hydrophosphate. W. Skey, and A. de Schulten employed modifications of this process. R. Ludwig noted that if an excess of ammonium hydrophosphate is employed, the precipitate contains rather more barium oxide than corresponds with the formula BaHPO_4 . E. Erlenmeyer obtained crystals of the barium salts by boiling a soln. of the normal phosphate in aq. phosphoric acid. According to J. H. Debray, and E. Erlenmeyer, the anhydrous salt is generally obtained by boiling calcium tetrahydro-diphosphate with water or alcohol. J. Piccard obtained calcium hydrophosphate by adding alcohol to a soln. of bone-ash in hydrochloric acid; H. E. Causse by adding ammonia to a soln. of calcium phosphate mixed with alkali acetate; R. E. Ghislain, by neutralizing with milk of lime a soln. of a natural phosphate in hydrochloric acid; B. W. Gerland, by adding alcohol to a soln. of calcium phosphate in sulphurous acid; and W. Baer, by adding calcium chloride to a soln. of disodium hydrophosphate in conc. acetic acid. According to A. Millot, boiling soln. of calcium chloride, disodium hydrophosphate and acetic acid furnish a mixture of calcium hydrophosphate with normal phosphate.

According to A. Barillé, if a soln. of calcium dihydrophosphate be treated with ammonia, half the phosphoric acid is precipitated as calcium hydrophosphate, and half remain in soln. as ammonium phosphate. If this soln. be treated with calcium chloride, the remainder of the phosphoric acid can be precipitated as calcium hydrophosphate, and ammonium chloride remains in soln. The latter reaction probably occurs in a number of stages—ammonium chloride and calcium hydrophosphate and dihydrophosphate are first formed; the latter then splits into normal calcium phosphate and phosphoric acid; and the two then react, forming calcium hydrophosphate. A. Barillé gradually added 1.454 kgrms. of hydrochloric acid, sp. gr. 1.17, to a kgrm. of bone-ash suspended in hot water. The soln. was mixed with three litres of hot water, and dil. to 10 litres. The filtrate was then slowly mixed with 442 grms. of ammonia, sp. gr. 0.925, diluted 1 : 20. The feebly acid liquid was filtered off, and the washed precipitate dried at 60° . A. Barillé thought that this product was $\text{CaHPO}_4 \cdot 4\text{H}_2\text{O}$, but it was probably colloidal.

H. Vohl obtained crystals of calcium hydrophosphate by the slow diffusion of calcium chloride and disodium hydrophosphate through a diaphragm; or, according to A. Drevermann, through a layer of water. A. C. Becquerel obtained the crystals by the action of a soln. of disodium hydrophosphate on calspar. A. de Schulten prepared crystals of the anhydrous salt—*monetite*—by heating the hydrated salt or brushite with water in a tube at 150° . The crystals are also obtained by dissolving the amorphous precipitate in a weak acid, and allowing the soln. to stand, or to be heated—e.g. C. Boedeker dissolved half the precipitate in the calculated quantity of cold hydrochloric or nitric acid, and added thereto the other half of the precipitate. Crystals were deposited when the mixture was allowed to stand 48 hrs. G. Vorbringer saturated a hydrochloric acid soln. of bone-ash with ammonia, dis-

solved the precipitate in acetic acid, and warmed the soln. to precipitate ferrio phosphate. When the filtrate was conc. by slow evaporation, crystals of the desired salt were obtained. J. Percy dissolved freshly precipitated calcium hydrophosphate suspended in water sat. with carbon dioxide, and obtained crystals of the acid phosphate by spontaneous evaporation. R. Warington, E. Reichardt, and L. Dusart and J. Pelouze employed an analogous process.

A. de Schulten prepared crystals of **dihydrated calcium hydrophosphate**, $\text{CaHPO}_4 \cdot 2\text{H}_2\text{O}$, or *brushite*, by the action of calcium carbonate on phosphoric acid of sp. gr. 1.05. T. Chandelon prepared dihydrated calcium hydrophosphate, entirely soluble in ammonium citrate, by treating raw calcium phosphate with 15 to 25 per cent. sulphuric acid; the resulting soln., containing 7 to 12 per cent. P_2O_5 , was cooled, and neutralized with cooled lime-water. The salt separated on cooling the soln. to 0° . The precipitates of calcium hydrophosphate obtained by treating hydrochloric acid soln. of calcium phosphate with ammonia have a variable proportion of water, and, according to H. Bassett, the precipitates are variable mixtures of the dihydrate with the anhydrous salt. The degree of hydration of the precipitate depends on the temp. and on the acidity of the soln. According to H. Bassett's vap. press. measurements *sesquihydrated calcium hydrophosphate*, $\text{CaHPO}_4 \cdot 1\frac{1}{2}\text{H}_2\text{O}$, does not exist as a chemical individual, and *metabrushite* is a mixture of the dihydrated and anhydrous salts. The colloidal precipitate contains variable proportions of water, and in the older literature many hydrates have been reported which probably represent different stages in the dehydration of the colloidal hydrophosphate:

G. Vorbringer precipitated what he regarded as $\text{CaHPO}_4 \cdot \frac{1}{2}\text{H}_2\text{O}$ from boiling soln. of calcium phosphate in phosphoric acid; when dried over conc. sulphuric acid. K. Birnbaum found the product was free from water. B. W. Gerland obtained a product with the composition $\text{CaHPO}_4 \cdot \frac{1}{2}\text{H}_2\text{O}$, by adding alcohol to a sulphurous acid soln. of calcium phosphate, and drying the washed precipitate in a water-oven; and A. Millot obtained a product of the same composition by heating an acetic acid soln. of calcium phosphate to 50° – 60° . L. Dusart and J. Pelouze obtained a precipitate corresponding with $\text{CaHPO}_4 \cdot 2\frac{1}{2}\text{H}_2\text{O}$, by neutralizing a soln. of calcium tetrahydro-diphosphate with calcium carbonate; but J. H. Debray, and R. Warington obtained the dihydrate under these conditions. The sesquihydrate, $\text{CaHPO}_4 \cdot 1\frac{1}{2}\text{H}_2\text{O}$, was reported by M. Raewsky to be precipitated by adding calcium chloride to a soln. of disodium hydrophosphate; by W. Skey, by allowing an acid soln. to stand for some time; and by C. Delattre, by the dehydration of the dihydrate at 150° . A. Barilló thought that the product obtained by his process had the composition $\text{CaHPO}_4 \cdot 4\text{H}_2\text{O}$.

C. Neuberg and C. W. Neimann³ prepared **colloidal barium hydrophosphate** by neutralizing a methyl alcohol soln. of barium hydroxide with aq. phosphoric acid, using phenolphthalein as indicator. A slight excess of acid does no harm. The gelatinous precipitate becomes pulverulent when dried. C. Neuberg and B. Rewald prepared **colloidal strontium hydrophosphate** and also **colloidal calcium hydrophosphate** in a similar manner.

According to A. de Schulten,⁴ the crystals of anhydrous calcium hydrophosphate are triclinic prisms with axial ratios $a : b : c = 0.6467 : 1 : 0.8744$, and axial angles $\alpha = 64^\circ 57'$, $\beta = 90^\circ 17'$, and $\gamma = 94^\circ 22'$; while the crystals of the dihydrated salt are monoclinic prisms; according to J. D. Dana, they have the axial ratios and axial angle $a : b : c = 0.6221 : 1 : 0.3415$, and $\beta = 95^\circ 18'$; triclinic crystals of monetite, CaHPO_4 , $a : b : c = 0.6467 : 1 : 0.8244$, and $\alpha = 84^\circ 57'$, $\beta = 90^\circ 17'$, and $\gamma = 94^\circ 22'$; A. de Schulten gave for the rhombic crystals of strontium hydrophosphate, SrHPO_4 , the axial ratios $a : b : c = 0.6477 : 1 : 0.8581$; and for the rhombic prisms of barium hydrophosphate, $a : b : c = 0.7133 : 1 : 0.8117$.

The **specific gravity** of anhydrous calcium hydrophosphate, CaHPO_4 , according to H. Bassett, is 2.892 at $16^\circ/4^\circ$, 2.886 at $100^\circ/4^\circ$, and, by extrapolation, 2.881 at $152^\circ/4^\circ$; and of the dihydrate $\text{CaHPO}_4 \cdot 2\text{H}_2\text{O}$, 2.306 at $16.5^\circ/4^\circ$. G. E. Moore's value for the sp. gr. of brushite, $\text{CaHPO}_4 \cdot 2\text{H}_2\text{O}$, is 2.208. A. A. Julien obtained numbers between 2.288 and 2.362 at 15.5° for the sp. gr. of metabrushite,

$\text{CaHPO}_4 \cdot 1\frac{1}{2}\text{H}_2\text{O}$. A. de Schulten gave 2.317 for the sp. gr. of brushite, 2.929 for the sp. gr. of monetite, CaHPO_4 , 3.544 for the sp. gr. of strontium hydrophosphate, SrHPO_4 , at 15° ; and 4.165 for that of barium hydrophosphate, BaHPO_4 . The hardness of brushite and of stoffertite is $2-2\frac{1}{2}$ on Mohs' scale.

The work of F. K. Cameron and J. M. Bell, and of H. Bassett shows that above 25° , solid calcium hydrophosphate changes into the anhydrous salt: $\text{CaHPO}_4 \cdot 2\text{H}_2\text{O} \rightleftharpoons \text{CaHPO}_4 + 2\text{H}_2\text{O}$. This transition temp. is an invariant point with five phases— anhydrous and dihydrated calcium hydrophosphate, monohydrated calcium dihydrophosphate, soln., and vapour—in equilibrium. The two former found that in the presence of potassium chloride, the lime content of soln. containing calcium oxide and phosphoric oxide in equilibrium with calcium hydro- and dihydrophosphates, is slightly increased. According to W. Baer,⁵ anhydrous calcium hydrophosphate loses water at a red heat, and forms calcium pyrophosphate; and before the blowpipe, J. J. Berzelius stated that it fuses to a colourless glass. According to M. Berthelot, the heat of formation⁶ of calcium hydrophosphate from a soln. containing an eq. of calcium oxide and phosphoric acid, per six litres, is 24.50 Cals. at 16° ; and with strontium oxide, 25.30 Cals. A. Joly found the heat of precipitation of amorphous calcium hydrophosphate from a mixture of disodium hydrophosphate and calcium chloride is -2.92 Cals. and the heat of crystallization is

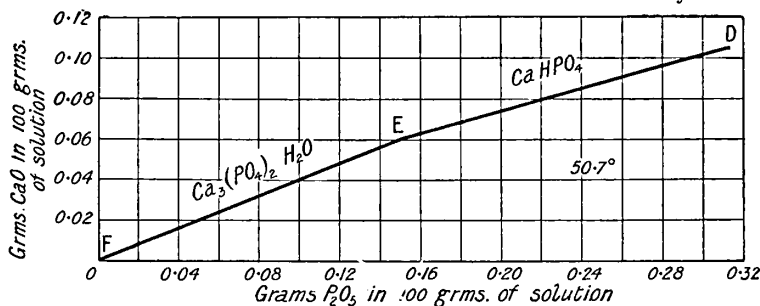

FIG. 66.—The Composition of Solutions in Equilibrium with Crystalline Calcium Hydrophosphate, and with Monohydrated Normal Calcium Phosphate.

$+2.87$ Cals., so that the total heat is nearly zero. A. Joly found the reaction between strontium chloride and sodium hydrophosphate takes place in three stages with thermal values respectively -1.86 , $+5.95$, and -5.92 Cals. The heat of precipitation of dihydrated calcium hydrophosphate from a soln. of its components was found by A. Joly to be 26.90 Cals., and for the heat of formation of crystallized dihydrated strontium hydrophosphate from phosphoric acid and strontium hydroxide, he gives 25.20 Cals. According to A. Joly, amorphous barium hydrophosphate is precipitated from a mixed soln. of barium chloride and sodium hydrophosphate without any perceptible thermal change, and crystallization occurs with the evolution of 1.21 Cals. The heat of neutralization of equi-mol. parts of phosphoric acid and barium hydroxide, both in soln., is 27.80 Cals. The indices of refraction of stoffertite are $\mu_a=1.5392$; $\mu_\beta=1.5455$; and $\mu_\gamma=1.5509$. According to C. Delattre,⁷ A. Millot, A. Joly and E. Sorel, and G. Viard, when calcium hydrophosphate is boiled with water, calcium dihydrophosphate goes into soln. and the normal phosphate is precipitated, and, according to E. Reichardt, calcium hydrophosphate is slowly decomposed by cold water and rapidly by hot water, and the liquid acquires an acid reaction. C. Delattre found that a state of equilibrium is attained, but, according to A. Rindell, this state is attained very slowly, for 252 hrs. are needed with 10 grms. of the salt in a litre of water, and the ratio $\text{CaO} : \text{H}_3\text{PO}_4$, in soln. is 1.56. In Fig. 66, by H. Bassett, DE represents a part of the CaHPO_4 -curve; and EF represents the composition of soln. at 50.7° in equilibrium with monohydrated normal calcium phosphate, $\text{Ca}_3(\text{PO}_4)_2 \cdot \text{H}_2\text{O}$. According to A. Rindell,

the solubility of anhydrous calcium hydrophosphate in water free from carbon dioxide is represented, in grams per litre, by :

	30°	40°	50°	60°	68°	72·9°	100·1°
CaO . . .	0·0414	0·0590	0·0667	0·0723	0·0985	0·1031	0·1046
P ₂ O ₅ . . .	0·0866	0·1364	0·1630	0·1747	0·2234	0·2478	0·2461

and the solubility of dihydrated salt, also in grams per litre :

	24°	30°	40°	50°	60°	68°	72·9°	100·1°
CaO . . .	0·0806	0·0954	0·1557	0·2617	0·4347	0·3409	0·3154	0·3109
P ₂ O ₅ . . .	0·1678	0·2066	0·3434	0·6182	1·0530	0·8245	0·7624	0·7591

There appears a maximum in the solubility curve of the dihydrate. The results show that the degree of hydration of the salt has an important influence on the solubility, or else on the speed at which equilibrium is attained, on the assumption that this condition has not been attained in the case of the anhydrous salt. A. Joly and E. Sorel successively extracted one part of calcium hydrophosphate with 100 parts of water and found that the water acquired an acid reaction, and the solid became gelatinous, and approximated $\text{Ca}_3(\text{PO}_4)_2 \cdot \frac{1}{2}\text{H}_2\text{O}$; they also determined the composition of the solid residue after various quantities of calcium hydrophosphate had been extracted with equal quantities of water; they ascribed the formula $\text{Ca}_3(\text{PO}_4)_2 \cdot 8\text{CaHPO}_4 \cdot 2\text{H}_2\text{O}$ to one of these solid residues, but it is more probable that this is a mixture of two solid phases, or one of a series of solid soln. J. Joffre extracted the calcium dihydrophosphate with a very large proportion of water, and stated that the solid residue was composed of calcium hydrophosphate and normal calcium phosphate. K. Buch subjected calcium hydrophosphate to a continuous leaching by removing the soln. and adding more water. After 53 successive extractions, the hydrophosphate was converted to normal phosphate, but he added that "it is difficult to decide at the present time whether this stage is the limit of the decomposition, or whether the transformation may be carried further to a basic compound so that normal calcium phosphate is to be considered as a stable intermediate step. Several facts, especially the numerous basic phosphates occurring in nature, are evidence for the latter alternative." F. K. Cameron and A. Seidell found that, unlike normal calcium phosphate, and calcium dihydrophosphate, this salt is but slightly decomposed by water, and appears to dissolve mainly as such; and it is the only calcium phosphate which is stable under water under ordinary conditions. L. N. Vauquelin reported strontium hydrophosphate to be insoluble in water, but it is only sparingly soluble in that menstruum. F. J. Malaguti reported that 100 parts of water dissolve 0·01 part of barium hydrophosphate; and G. Bischof, that 100 parts of water dissolve 0·0486 part of the barium salt at 20°. The old observers—*e.g.* K. Birnbaum, L. Dusart and J. Pelouze, A. Barillé, etc.—did not notice that the proportion $\text{CaO} : \text{P}_2\text{O}_5$ is different in the soln. from what it is in the original salt.

According to A. Rindell, the solubility of the salt is different in water with *carbon dioxide* in soln., and the solubility increases with increasing proportions of carbonic acid; for example, expressing conc. in milli-mols per litre, at 30° :

	CaHPO ₄				CaHPO ₄ ·2H ₂ O			
CO ₂ . . .	1·95	3·91	7·81	15·63	1·95	3·91	7·81	15·63
CaO . . .	0·93	1·04	1·54	2·32	1·67	1·71	1·92	2·80
P ₂ O ₅ . . .	1·24	1·31	1·85	2·40	2·65	2·50	2·20	2·98

L. Dusart and J. Pelouze, and A. Barillé noted the increased solubility of calcium hydrophosphate in water containing carbon dioxide in soln. J. Setschenoff found barium hydrophosphate is not completely soluble in water sat. with carbon dioxide. A soln. of barium chloride and sodium hydrophosphate sat. with carbon dioxide gives no precipitate if less than 7·16 grms. per litre of the last-named salt are present. F. K. Cameron and A. Seidell found that rather more calcium hydrophosphate is

dissolved by water and by water carrying carbon dioxide than by the same solvent sat. with gypsum.

J. J. Berzelius, and W. Baer found that calcium hydrophosphate is readily soluble in *hydrochloric acid* and *nitric acid*, and less readily soluble in *acetic acid*. K. Birnbaum found that it dissolves more readily in dil. than in conc. acetic acid. L. N. Vauquelin found strontium hydrophosphate is soluble in *phosphoric acid*, as well as in nitric and hydrochloric acids. Barium hydrophosphate is soluble in phosphoric acid with the formation of barium dihydrophosphate. Similar remarks apply to hydrochloric acid; G. Bischof found it to be very soluble in acetic acid; he also found that nitric acid of sp. gr. 1.275 has but little action on barium hydrophosphate, but the action increases with increasing dilution of the acid, and reaches a maximum when ten times the amount of water has been added to the acid. E. Duvillier has studied the effect of nitric acid of various conc. on barium hydrophosphate. A. Rindell, and A. A. Ramsay measured the solubility of calcium hydrophosphate in acetic acid and in *citric acid*; and H. E. Causse, the solubility in *lactic acid*, and in *phosphoric acid*. According to B. W. Gerland, the salt is readily soluble in *sulphurous acid*—the soln. contains CaO : P₂O₅ : SO₂ in the ratios 2 : 1 : 2. The soln. of calcium hydrophosphate loses its sulphur dioxide more readily than a soln. of normal calcium phosphate. A current of sulphur dioxide passed through water in which barium hydrophosphate is suspended forms sparingly soluble barium sulphite, and free phosphoric acid.

J. von Liebig found that the presence of *sodium chloride*, *sodium nitrate*, or *ammonium sulphate* raises the solubility of calcium hydrophosphate. A. Rindell studied the effect of sodium chloride, *ammonium nitrate*, etc., on the solubility of calcium hydrophosphate; he found sodium chloride and sodium nitrate have nearly the same influence. With *sodium acetate*, larger quantities of lime are dissolved; and, according to K. Birnbaum, the aq. soln. with sodium acetate becomes turbid when boiled. R. Ludwig found barium hydrophosphate is soluble in water containing *barium chloride* or sodium chloride in soln., and therefore an excess of barium chloride does not precipitate the phosphoric acid completely from a soln. of sodium hydrophosphate. K. Kraut found that calcium hydrophosphate dissolves slowly in soln. of *ammonium chloride*, and when boiling, phosphoric acid is extracted faster than the calcium oxide. R. H. Brett, and G. C. Wittstein stated that strontium hydrophosphate is readily soluble in cold soln. of ammonium chloride, *ammonium nitrate*, or *ammonium succinate*, and is partly precipitated by a small proportion of aq. ammonia and completely precipitated by a large proportion. They also obtained similar results with barium hydrophosphate. A. Herzfeld and G. Feuerlein, and A. Grupe and B. Tollens found it dissolves copiously in *ammonium citrate*. The solubility is so much augmented by the presence of this salt that A. Rindell assumes complex salts are formed. J. Langel also investigated the subject. According to A. Millot, dihydrated calcium hydrophosphate dissolves rapidly in an ammoniacal soln. of ammonium citrate while the anhydrous salt dissolves slowly. According to F. J. Malaguti, by boiling it with an eq. soln. of *sodium carbonate* or *potassium carbonate* for four hours, 25 to 33 per cent. of the calcium hydrophosphate was decomposed, and conversely, by boiling eq. soln. of sodium or potassium hydrophosphate 39 to 41 per cent. of calcium carbonate was converted into hydrophosphate; analogous results were obtained with the strontium and barium salts. When a mixture of eq. quantities of barium hydrophosphate and *potassium sulphate* in aq. soln. is boiled, for four hours, F. J. Malaguti found that 35 per cent. of the former is decomposed. According to H. Bassett, dry *ammonia* gas has no action on either calcium hydrophosphate or on dihydrated calcium hydrophosphate at ordinary temp., but above 80°, the dihydrate gives off water which decomposes the salt partially. This soln. rapidly absorbs ammonia gas, forming normal calcium phosphate and diammonium phosphate: $3(\text{CaHPO}_4 \cdot 2\text{H}_2\text{O}) + 2\text{NH}_3 = \text{Ca}_3(\text{PO}_4)_2 + (\text{NH}_4)_2\text{HPO}_4 + 6\text{H}_2\text{O}$; neither NH_4CaPO_4 nor $\text{Ca}(\text{NH}_4\text{HPO}_4)_2$ is formed.

REFERENCES.

- ¹ J. Samojloff, *Les gisements de phosphate de chaux de l'Algérie et de la Tunisie*, Paris, 1912; F. W. Clarke, *The Data of Geochemistry*, Washington, 519, 1916; C. U. Shepard, *Amer. Journ. Science*, (2), 22, 97, 1856; (3), 23, 400, 1882; J. D. Dana, *ib.*, (2), 39, 45, 1865; A. A. Julien, *ib.*, (2), 40, 369, 1865; G. E. Moore, *ib.*, (2), 39, 43, 1865; A. de Schulten, *Bull. Soc. Min.*, 24, 323, 1901; 26, 11, 1903; 27, 109, 1904; A. Laeroix, *ib.*, 20, 112, 1897; *Compt. Rend.*, 124, 419, 1897; L. Barthe, *ib.*, 114, 1268, 1892; C. Klein, *Sitzber. Akad. Berlin*, 720, 1901; A. Gautier, *Ann. Mines*, (9), 5, 1, 1894; *Compt. Rend.*, 116, 928, 1023, 1893; 158, 912, 1914; *Bull. Soc. Chim.*, (4), 15, 533, 1914; F. Sandberger, *Journ. prakt. Chem.*, (1), 110, 128, 1870; *Neues Jahrb. Min.*, 631, 1869; 308, 1870; J. H. Kloos, *ib.*, i, 41, 1888; F. Wöhler, *Liebig's Ann.*, 51, 437, 1849; A. E. Mermet and B. Delachanal, *Ber.*, 7, 1039, 1874; D. Ples, *Rep. Chim. Appl.*, 2, 141, 1860; A. H. Hassall, *Proc. Roy. Soc.*, 10, 281, 1860; J. von Liebig, *Chem. Centrbl.*, (2), 6, 264, 1861; F. A. Abel, *Journ. Chem. Soc.*, 15, 91, 1862; A. de Schulten, *Bull. Soc. Min.*, 24, 323, 1901; 26, 15, 1903; 27, 109, 1904.
- ² J. J. Berzelius, *Ann. Chim. Phys.*, (1), 11, 114, 1819; *Liebig's Ann.*, 53, 286, 1845; H. Vahl, *ib.*, 88, 114, 1853; A. Drevermann, *ib.*, 87, 120, 1853; C. Boedeker, *ib.*, 69, 206, 1849; C. L. Berthollet, *Essai de statique chimique*, Paris, 1, 117, 1803; R. Warington, *Journ. Chem. Soc.*, 19, 296, 1866; G. E. Davis, *Chem. News*, 25, 258, 1872; W. Skey, *ib.*, 22, 61, 1870; R. E. Ghislain, *German Pat. D.R.P.* 119327, 1900; H. E. Causse, *Journ. Pharm. Chim.*, (5), 21, 244, 1890; *Bull. Soc. Chim.*, (3), 5, 154, 1891; A. Millot, *ib.*, (2), 33, 195, 1880; C. Delattre, *ib.*, (2), 35, 358, 1881; A. Barillé, *Pharm. Centrbl.*, 39, 24, 1898; J. Piccard, *Schweiz. Polyt. Zeit.*, 11, 83, 1866; A. C. Becquerel, *Compt. Rend.*, 34, 573, 1852; L. Dusart and J. Pelouze, *ib.*, 66, 1327, 1868; J. Joly, *ib.*, 103, 1197, 1886; M. Raewsky, *ib.*, 26, 205, 1848; L. Barthe, *ib.*, 114, 268, 1892; J. H. Debray, *Ann. Chim. Phys.*, (3), 61, 424, 1860; W. Baer, *Pogg. Ann.*, 75, 152, 1847; G. Vorbringer, *Zeit. anal. Chem.*, 9, 457, 1870; J. Percy, *Phil. Mag.*, (3), 27, 194, 1845; *Chem. Gaz.*, 49, 162, 1849; E. Reichardt, *Arch. Pharm.*, (3), 2, 236, 1872; B. W. Gerland, *Chem. News*, 20, 268, 1870; *Journ. prakt. Chem.*, (2), 4, 104, 1871; A. de Schulten, *Bull. Soc. Min.*, 26, 11, 1903; 27, 109, 1905; E. Erlemeyer, *Ueber Bildung und Zusammensetzung des so genannten sauren phosphorsäuren Kalks*, Heidelberg, 1857; *Zeit. Chem.*, (1), 3, 570, 1860; *Neues Jahrb. Pharm.*, 7, 225, 1857; H. Bassett, *Zeit. anorg. Chem.*, 53, 34, 1907; A. Rindell, *Untersuchungen über Löslichkeit einiger Kalkphosphate*, Helsingfors, 1899; K. Birnbaum, *Zeit. Chem.*, (2), 7, 131, 1871; *Ber.*, 6, 898, 1873; R. Ludwig, *Arch. Pharm.*, (2), 56, 265, 1847; T. Chandelon, *Brit. Pat. No.* 13842, 1893; W. Palmaer and J. Wiborgh, *Chem. Trade Journ.*, 67, 541, 1920; *Swedish Pat. No.* 12010, 1900; G. Vorbringer, *Zeit. anal. Chem.*, 9, 457, 1870.
- ³ C. Neuberg and C. W. Neimann, *Biochem. Zeit.*, 1, 168, 1906; C. Neuberg and B. Rewald, *ib.*, 9, 541, 1908; *Zeit. Koll.*, 2, 354, 1908.
- ⁴ A. de Schulten, *Bull. Soc. Min.*, 24, 323, 1901; 26, 15, 1904; 27, 109, 120, 1904; H. Bassett, *Zeit. anorg. Chem.*, 59, 1, 1907; G. E. Moore, *Proc. Acad. Cal.*, 3, 167, 1864; *Amer. Journ. Science*, (2), 39, 43, 1865; J. D. Dana, *ib.*, (2), 39, 45, 1865; A. A. Julien, *ib.*, (2), 40, 371, 1865; F. K. Cameron and J. M. Bell, *Journ. Amer. Chem. Soc.*, 32, 869, 1910; H. Bassett, *Zeit. anorg. Chem.*, 53, 34, 1907; 59, 1, 1908.
- ⁵ W. Baer, *Pogg. Ann.*, 75, 152, 1847; J. J. Berzelius, *Ann. Chim. Phys.*, (2), 11, 114, 1819.
- ⁶ M. Berthollet, *Compt. Rend.*, 37, 575, 1878; A. Joly, *ib.*, 103, 1197, 1886.
- ⁷ E. Reichardt, *Arch. Pharm.*, (3), 2, 236, 1872; K. Kraut, *ib.*, (2), 111, 102, 1862; C. Delattre, *Bull. Soc. Chim.*, (2), 35, 358, 1881; A. Millot, *ib.*, (2), 33, 194, 1880; A. Rindell, *Compt. Rend.*, 134, 112, 1902; *Untersuchungen über Löslichkeit einiger Kalkphosphate*, Helsingfors, 1899; K. Buch, *Zeit. anorg. Chem.*, 52, 325, 1907; H. Bassett, *ib.*, 53, 34, 1907; E. Duvallier, *Ann. Chim. Phys.*, (5), 8, 250, 1876; F. K. Cameron and A. Seidell, *Journ. Amer. Chem. Soc.*, 26, 1454, 1904; R. H. Brett, *Phil. Mag.*, (3), 10, 95, 1837; G. C. Wittstein, *Pharm. Vierteljahr.*, 15, 189, 1866; L. N. Vauquelin, *Journ. Pharm.*, 85, 126, 1817; R. Ludwig, *Arch. Pharm.*, (2), 56, 265, 1847; A. Joly and E. Sorel, *Compt. Rend.*, 118, 738, 1894; G. Viard, *ib.*, 127, 178, 1898; L. Dusart and J. Pelouze, *ib.*, 66, 1327, 1868; H. E. Causse, *ib.*, 114, 414, 1892; *Bull. Soc. Chim.*, (3), 7, 165, 1892; J. Joffre, *ib.*, (3), 19, 372, 1898; J. Setschenow, *Chem. Centrbl.*, 97, 1875; J. J. Berzelius, *Liebig's Ann.*, 53, 286, 1845; J. von Liebig, *ib.*, 61, 128, 1847; K. Birnbaum, *Zeit. Chem.*, (2), 7, 131, 1871; *Ber.*, 6, 898, 1873; A. Grupe and B. Tollens, *ib.*, 13, 1267, 1880; 14, 754, 1881; A. Herzfeld and G. Feuerlein, *ib.*, 14, 191, 1881; *Zeit. anal. Chem.*, 20, 191, 1881; A. Barillé, *Pharm. Centrbl.*, 39, 24, 1898; W. Baer, *Pogg. Ann.*, 75, 152, 1847; B. W. Gerland, *Chem. News*, 20, 268, 1870; *Journ. prakt. Chem.*, (2), 4, 104, 1871; F. J. Malaguti, *Ann. Chim. Phys.*, (3), 51, 346, 1857; J. Stoklasa, *Listy's Chem.*, 13, 203, 240, 273, 1890; G. Bischof, *Schweigger's Journ.*, 68, 39, 1833; J. Langel, *Action du citrate d'ammonium sur les phosphates mono-, bi-, et tri-calcique*, Genève, 1909; A. A. Ramsay, *Journ. Agric. Science*, 8, 277, 1917.

§ 27. Dihydrophosphates of the Alkaline Earths

H. Bassett¹ prepared *monocalcium phosphate*, or calcium dihydrophosphate, $\text{Ca}(\text{H}_2\text{PO}_4)_2$, by digesting in a porcelain dish at 160° , a mixture of 8.65 grms. of precipitated calcium carbonate, 25 grms. of yellow phosphorus, and a conc. soln. of

phosphoric acid. In about $6\frac{1}{2}$ hrs., the solid was drained by suction and rapidly washed with acetone, and then with ether. According to H. Bassett, anhydrous calcium dihydrophosphate can be obtained by evaporating at 160° a soln. containing phosphoric acid and lime when the ratio of $P_2O_5 : CaO$ is greater than 3 ; if this ratio be less than 3, the **monohydrated calcium dihydrophosphate**, $Ca(H_2PO_4)_2 \cdot H_2O$, is formed. When the anhydrous salt is exposed to air it gradually passes into monohydrate. J. J. Berzelius prepared hydrated calcium dihydrophosphate by evaporating a soln. of the hydrophosphate in nitric or phosphoric acid—if hydrochloric acid be employed, E. Erlenmeyer found a double salt of calcium chloride and dihydrophosphate is formed, although W. Whittread mixed a conc. hydrochloric acid soln. of calcium phosphate with calcium carbonate until the evolution of carbon dioxide had ceased, and found that when the clear decanted liquid was cooled, crystals of the hydrated salt were formed. It is necessary that the soln. be conc. K. Birnbaum prepared crystals of the salt by the evaporation of a phosphoric acid soln. of the salt over sulphuric acid. Hydrated calcium dihydrophosphate was obtained by L. Prunier and A. Jouve, J. Stoklasa, and G. Pointet, by slowly evaporating a soln. of calcium hydrophosphate in the calculated quantity of phosphoric acid. L. Barthe made **monohydrated strontium dihydrophosphate**, $Sr(H_2PO_4)_2 \cdot H_2O$, by adding 100 grms of phosphoric acid in a 5 per cent. soln. to an excess of strontium hydrophosphate, and evaporating the filtered soln. in vacuo. The gelatinous mass slowly crystallizes, and it is contaminated with a little hydrophosphate. J. J. Berzelius likewise prepared **barium dihydrophosphate**, $Ba(H_2PO_4)_2$, by the slow evaporation of a soln. of barium hydrophosphate in phosphoric acid : and E. Mitscherlich, by adding ammonia to a mixed soln. of sodium dihydrophosphate and barium chloride.

Anhydrous calcium dihydrophosphate forms long prismatic crystals which, according to K. Haushofer,² belong to the triclinic system and have the axial ratios $a : b : c = 1.9250 : 1 : 0.7332$, with the axial angles $\alpha = 86^\circ 34'$, $\beta = 91^\circ 8'$, and $\gamma = 96^\circ 17'$, and the crystals of the monohydrated calcium salt form thin triclinic plates which, according to K. Haushofer, have the axial ratios $a : b : c = 0.4753 : 1 : 0.5448$, and axial angles $\alpha = 98^\circ 40'$, $\beta = 118^\circ 21'$, and $\gamma = 83^\circ 16'$. E. Erlenmeyer said the crystals of the calcium salt are thin rhombic plates, and the crystals of the barium salts are triclinic, but H. Dufet found the barium salt forms rhombic crystals with axial ratios $a : b : c = 0.7602 : 1 : 0.8238$. The sp. gr. of the monohydrated calcium salt was given by H. Schröder as 2.020 ; H. Bassett found 2.220 at $16^\circ/4'$, 2.147 at $100^\circ/4'$, and by extrapolation, 2.120 at $152^\circ/4'$ for the monohydrated salt ; and for the anhydrous salt, $Ca(H_2PO_4)_2$, 2.546 at $15.5^\circ/4'$, 2.461 at $100^\circ/4'$, and, by extrapolation, 2.420 at $152^\circ/4'$.

J. J. Berzelius,³ and K. Birnbaum stated that the crystals of hydrated calcium dihydrophosphate are hygroscopic, but J. Stoklasa said that if free from phosphoric acid, this salt is not hygroscopic, but free phosphoric acid splits from the salt when heated in a sealed tube. According to E. Erlenmeyer, the crystals of the barium salt are stable in air. According to H. Bassett, when rapidly heated, monohydrated calcium dihydrophosphate melts in its water of crystallization. K. Birnbaum detected no change when the crystals of the hydrated calcium salt are kept over sulphuric acid ; at 100° the water of monohydrate is given off ; at 150° a change occurs ; and at 200° a mixture of metaphosphoric acid and calcium pyrophosphate is formed : $2Ca(H_2PO_4)_2 = Ca_2P_2O_7 + 2HPO_3 + 3H_2O$; at a higher temp. the mixture of the two phosphates is said to melt and $Ca_2P_4O_{12}$ results. H. Bassett found the range of existence of the monohydrate to be very great, ranging from 0° up to about 160° . According to E. Erlenmeyer, and J. J. Berzelius, when the crystals of barium dihydrophosphate are heated, they swell up and lose water like alum, and readily melt to a colourless glass. According to W. Spring, the hydrated calcium salt under press. decomposes at ordinary temp. : $Ca(H_2PO_4)_2 \cdot H_2O = CaHPO_4 + H_3PO_4 + H_2O$.

According to M. Berthelot,⁴ the heat of formation from half a mol. of CaO , and a mol. of phosphoric acid, in six litres of water, at 16° , is 14.8 Cals. ; similarly for the monohydrated strontium salt, 15.05 Cals. ; and for the barium salt, 24.5 Cals.

E. Erlenmeyer⁵ found that when calcium dihydrophosphate is mixed with a greater proportion of water than 1 : 700, solid calcium hydrophosphate is formed, and the soln. contains more acid than corresponds with $\text{Ca}(\text{H}_2\text{PO}_4)_2$. H. Wattenberg said one part of salt dissolves in 144 parts of water without other change, and H. Otto stated that one part of phosphate in 25 parts of water suffered no decomposition. Between 10° and 20°, J. Stoklasa found that with a gram of monohydrated calcium dihydrophosphate, and

	Water	. 1	25	50	75	150	200 grms.
In soln.	{CaO	. 0.1624	0.1900	0.2063	0.2148	0.2180	0.2236 grm.
	{P ₂ O ₅	. 0.4902	0.5259	0.5486	0.5598	0.5642	0.5668 grm.

as the proportion of water is increased, the absolute quantity of lime and phosphoric acid dissolved increases, but the conc. of the soln. falls rapidly. J. Stoklasa represented the action of cold water by the equation: $n\text{Ca}(\text{H}_2\text{PO}_4)_2 \cdot \text{H}_2\text{O} + \text{H}_2\text{O} = (n-1)\text{Ca}(\text{H}_2\text{PO}_4)_2 \cdot \text{H}_2\text{O} + \text{CaHPO}_4 + 2\text{H}_2\text{O} + \text{H}_3\text{PO}_4$, for equal parts of water and salt, $n=4$. With increasing proportions of water the proportion of salt dissolved increases, so that with 200 parts of water very little decomposition—0.1 per cent.—occurs, and virtually all passes into soln.— $n=1024$. Phosphoric acid and calcium hydrophosphate form calcium dihydrophosphate quantitatively if in soln. with over 200 parts of water. A. Joly found that by mixing varying proportions of water and calcium dihydrophosphate, the resulting solid phase was calcium hydrophosphate, while the soln. contained both lime and phosphoric acid. G. Viard also studied the composition of the soln. and solids resulting from the mixing of calcium dihydrophosphate with varying proportions of water at 100°; in every case, anhydrous calcium hydrophosphate was formed which differs from the hydrated salt in being insoluble in acetic acid.

According to H. Bassett, the curve AB, Fig. 67, represents the composition of soln. in equilibrium with $\text{Ca}(\text{H}_2\text{PO}_4)_2 \cdot \text{H}_2\text{O}$ at 50.7°; the point A, soln. in equilibrium

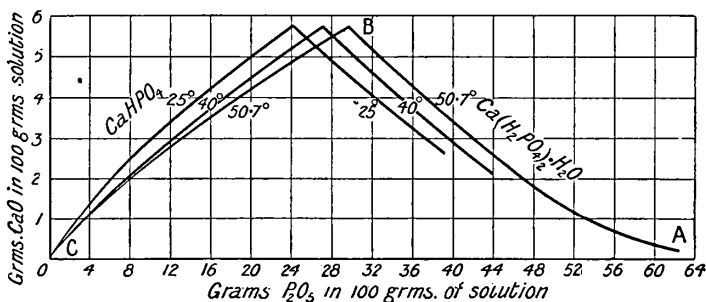

FIG. 67.—The Composition of Solutions in Equilibrium with Crystalline Calcium Hydro- and Dihydrophosphates.

with both $\text{Ca}(\text{H}_2\text{PO}_4)_2$ and $\text{Ca}(\text{H}_2\text{PO}_4)_2 \cdot \text{H}_2\text{O}$; the curve BC, soln. in equilibrium with CaHPO_4 . Corresponding curves for soln. at 40° and 25° are shown in the same diagram. The relation of the different solid phases is shown in Fig. 67. According to J. Stoklasa, some of the older observations of the action of water on this salt were made on samples, contaminated with phosphoric acid; F. K. Cameron and A. Seidell found that a soln. of calcium dihydrophosphate is a soln. of the decomposition products rather than of the salt itself. The presence of calcium sulphate does not materially affect the proportion of phosphoric acid passing into soln., but the conc. and acidity of the soln. are reduced in amounts practically eq. to the added calcium carbonate. A. Joly has studied the action of water on the calcium salt; J. Langel, the action of ammonium citrate.

According to E. Erlenmeyer, the crystals of the barium salt have an acid reaction. According to J. J. Berzelius, the barium salt is soluble in phosphoric and some other

acids; and it is decomposed by large quantities of water into barium hydrophosphate and an aq. soln. of phosphoric acid.

TABLE XXI.—ACTION OF WATER ON BARIUM DIHYDROPHOSPHATE.

Grms. $\text{Ba}(\text{H}_2\text{PO}_4)_2$ per 100 c.c. water at 15°.	BaO.	P_2O_5 .			Undecomposed $\text{Ba}(\text{H}_2\text{PO}_4)_2$ in soln.
		Total.	as $\text{Ba}(\text{H}_2\text{PO}_4)_2$.	Free.	
0.96	0.395	0.39	0.37	0.02	0.89
5.23	1.46	1.80	1.36	0.44	0.61
10.28	2.33	3.28	2.16	1.12	0.49
30.30	5.12	8.88	4.75	4.13	0.365
72.40	11.20	20.73	10.37	10.36	0.333

The behaviour of different proportions of barium dihydrophosphate in 100 c.c. of water at 15° is indicated in Table XXI, which embodies a selection from A. Joly's data. Further studies have been made by A. Joly and E. Sorel, and by G. Viard. E. Erlenmeyer found that if the soln. of calcium dihydrophosphate be heated to boiling, calcium hydrophosphate separates out, and $2\text{CaO} : 3\text{P}_2\text{O}_5$ remains in soln., but, according to K. Birnbaum, the proportion of calcium oxide in soln. increases with dilution, so that a one per cent. soln. is not decomposed by boiling. The presence of calcium sulphate, or of ammonium chloride or sulphate, retards the decomposition. No precipitation occurs if four parts of acetic acid to one of phosphoric acid be present. A. Reynoso found that when heated to 280° with water, the salt splits into phosphoric acid and normal calcium phosphate. A precipitate of calcium hydrophosphate is produced, according to J. H. Debray, by boiling the soln. with calcium chloride; according to L. Dusart and J. Pelouze, by neutralization with sodium carbonate; according to E. Erlenmeyer, by mixing the solid with normal calcium phosphate, or by standing a long time, or by boiling the soln. with absolute alcohol; or, according to K. Birnbaum, by adding sodium or calcium acetate. The latter also found that free acetic acid hinders the precipitation with sodium acetate, one mol of acetic acid to two mols of phosphoric acid is required in the cold, and nine mols of acetic acid to two mols of phosphoric acid are required for a boiling soln. A. Frébault and J. A. Destrém found that calcium carbonate is not precipitated from the aq. soln. by sodium carbonate, for the reaction is $\text{Ca}(\text{H}_2\text{PO}_4)_2 + \text{Na}_2\text{CO}_3 = \text{Na}_2\text{HPO}_4 + \text{CaHPO}_4 + \text{CO}_2 + \text{H}_2\text{O}$. E. Erlenmeyer found the calcium salt is not altered by dry ether, but when boiled with absolute alcohol, calcium hydrophosphate is formed. According to H. Bassett, a little dry ammonia gas is absorbed by the anhydrous salt at ordinary temp., but at 100°, the gas is rapidly absorbed, and an unstable compound, $(\text{NH}_4)_2\text{Ca}(\text{HPO}_4)_2$, is formed, showing that the salt does not first break down into calcium hydrophosphate and phosphoric acid. The compound $\text{Ca}(\text{NH}_4)_2(\text{HPO}_4)_2$ is not stable in the presence of the water formed in the reaction. The decomposition products are diammonium phosphate and dihydrated calcium hydrophosphate, and the reaction comes to an end when sufficient calcium hydrophosphate has been formed to absorb all the water. With the monohydrated salt and dried ammonia, $(\text{NH}_4)_2\text{Ca}(\text{HPO}_4)_2$ and water are formed in aq. soln., the compound $(\text{NH}_4)_2\text{Ca}(\text{HPO}_4)_2$ first formed is not stable but decomposes so that the end-reaction appears to be $\text{Ca}(\text{H}_2\text{PO}_4)_2 \cdot \text{H}_2\text{O} + 2\text{NH}_3 = \text{CaHPO}_4 + (\text{NH}_4)_2\text{HPO}_4 + \text{H}_2\text{O}$; or $3\text{Ca}(\text{H}_2\text{PO}_4)_2 \cdot \text{H}_2\text{O} + 8\text{NH}_3 = \text{Ca}_3(\text{PO}_4)_2 + 4(\text{NH}_4)_2\text{HPO}_4 + 3\text{H}_2\text{O}$. According to A. Joannis, a mol of calcium dihydrophosphate fixes two atoms of potassium when digested with a soln. of potassium in liquid ammonia, and if an excess of the latter is used, potassium amide and hydrogen are formed.

A. A. Julien ⁶ reported the occurrence of a mineral *zeugite* in Sombréro (West Indies), which has a composition corresponding with $8\text{CaO} \cdot \text{P}_2\text{O}_5 \cdot n\text{H}_2\text{O}$, and a sp. gr. 2.988–3.030.

It does not form crystals, but appears rather as a crust on the surface of phosphorites. It is rather more acidic than the normal phosphate, and is possibly a mixture of normal phosphate with an acid phosphate—possibly $\text{Ca}_3(\text{PO}_4)_2 \cdot \text{CaHPO}_4 \cdot n\text{H}_2\text{O}$. J. J. Berzelius, and R. Warington obtained a product of analogous composition by adding calcium chloride to an ammoniacal soln. of phosphoric acid—the latter in excess—if the calcium salt be in excess, the normal phosphate is produced. R. Warington, and J. N. von Fuchs obtained the normal phosphate by adding calcium chloride to an excess of an ammoniacal soln. of disodium hydrophosphate. C. Tissier precipitated the product $8\text{CaO} \cdot 3\text{P}_2\text{O}_5$ by adding sodium borate to a soln. of calcium phosphate in hydrochloric acid, or an acidified mixture of a calcium salt with disodium hydrophosphate. When the gelatinous precipitate is dried in vacuo, R. Warington found that it lost 9.65 per cent. of water; when dried at 100° , 5.37 per cent. of water. The product has a neutral reaction, but gives an acid soln. when treated with water; it is reprecipitated by adding ammonia to its soln. in an acid.

Various other acid phosphates have been reported, but these are probably mixtures. J. J. Berzelius⁷ obtained $4\text{CaO} \cdot 3\text{P}_2\text{O}_5$ by adding alcohol to a sat. aq. soln. of phosphoric acid and calcium phosphate. J. J. Berzelius also obtained what has been regarded as $\text{Ba}_3\text{H}_6(\text{PO}_4)_4$ in an analogous manner. M. Raewsky stated that calcium dihydrophosphate is decomposed by alcohol into phosphoric acid and $3\text{CaO} \cdot 2\text{P}_2\text{O}_5 \cdot 4\text{H}_2\text{O}$, and after drying at 100° , A. Millot found the product had the composition $\text{Ca}_3\text{H}_6(\text{PO}_4)_4 \cdot 2\text{H}_2\text{O}$; J. Piccard obtained a product $17\text{CaO} \cdot 9\text{P}_2\text{O}_5 \cdot 10\text{H}_2\text{O}$ from a soln. of calcium oxide in phosphoric acid. J. Piccard found that a soln. of calcium chloride in phosphoric acid, or bone-ash in hydrochloric acid, gives a precipitate of CaHPO_4 when treated with alcohol; and E. Erlenmeyer obtained a similar product by boiling calcium dihydrophosphate, $\text{Ca}(\text{H}_2\text{PO}_4)_2 \cdot \text{H}_2\text{O}$, with absolute alcohol.

REFERENCES.

- ¹ J. J. Berzelius, *Ann. Chim. Phys.*, (2), 2, 167, 1816; (2), 11, 114, 1819; *Liebig's Ann.*, 53, 286, 1845; E. Erlenmeyer, *Ueber Bildung und Zusammensetzung des so-genannten sauren phosphorsaureren Kalks*, Heidelberg, 1857; *Neues Jahrb. Pharm.*, 7, 225, 1857; *Zeit. Chem.*, (1), 3, 570, 1860; K. Birnbaum, *ib.*, (2), 7, 131, 1871; *Ber.*, 6, 898, 1873; J. Stoklasa, *Listy's Chem.*, 13, 203, 240, 273, 1890; *Landw. Vers. Stat.*, 28, 197, 1890; *Zeit. anorg. Chem.*, 3, 71, 1893; L. Prunier and A. Jouve, *Journ. Pharm. Chim.*, (6), 10, 529, 1900; G. Pointet, *Bull. Soc. Chim.*, (3), 5, 254, 1891; W. Whitbread, *Brit. Pat. No.* 2398, 1875; H. Bassett, *Zeit. anorg. Chem.*, 53, 34, 55, 1907; *Chem. News*, 95, 21, 1907; E. Mitscherlich, *Ann. Chim. Phys.*, (2), 19, 350, 1821; L. Barthe, *Compt. Rend.*, 114, 1268, 1892.
- ² E. Erlenmeyer, *Neues Jahrb. Pharm.*, 7, 225, 1857; H. Dufet, *Zeit. Kryst.*, 18, 443, 1894; K. Haushofer, *ib.*, 7, 265, 1883; H. Schröder, *Ber.*, 12, 126, 1879; H. Bassett, *Zeit. anorg. Chem.*, 59, 1, 38, 1908.
- ³ J. J. Berzelius, *Ann. Chim. Phys.*, (2), 2, 167, 1816; *Liebig's Ann.*, 53, 286, 1845; E. Erlenmeyer, *Ueber Bildung und Zusammensetzung des so-genannten sauren phosphorsaureren Kalks*, Heidelberg, 1857; *Neues Jahrb. Pharm.*, 7, 225, 1857; *Zeit. Chem.*, (1), 3, 570, 1860; K. Birnbaum, *ib.*, (2), 7, 131, 1871; *Ber.*, 6, 898, 1873; J. Stoklasa, *Listy's Chem.*, 13, 203, 240, 273, 1890; *Zeit. anorg. Chem.*, 1, 309, 1892; 3, 71, 1893; H. Bassett, *ib.*, 53, 58, 1907; 59, 1, 1908; W. Spring, *Bull. Soc. Chim. Belgique*, 21, 91, 1907; *Arch. Sciences Genève*, (4), 23, 229, 1907; P. Jolibois, *Compt. Rend.*, 169, 1161, 1919.
- ⁴ M. Berthelot, *Compt. Rend.*, 87, 575, 1878.
- ⁵ K. Birnbaum, *Ber.*, 6, 898, 1873; *Zeit. Chem.*, (2), 7, 131, 1871; E. Erlenmeyer, *Ueber Bildung und Zusammensetzung des so-genannten sauren phosphorsaureren Kalks*, Heidelberg, 1857; *ib.*, (1), 3, 570, 1860; *Neues Jahrb. Pharm.*, 7, 225, 1857; J. Stoklasa, *Listy's Chem.*, 13, 203, 240, 273, 1890; *Zeit. anorg. Chem.*, 1, 309, 1892; 3, 71, 1893; *Landw. Vers. Stat.*, 38, 197, 1891; H. Bassett, *ib.*, 53, 58, 1907; 59, 1, 1908; J. Langel, *Action du citrate d'ammonium sur les phosphates mono-, bi-, et tri-calcique*, Genève, 1909; F. K. Cameron and A. Seidell, *Journ. Amer. Chem. Soc.*, 26, 1454, 1904; A. Reynoso, *Compt. Rend.*, 34, 795, 1852; L. Dusart and J. Pelouze, *ib.*, 66, 1327, 1868; A. Joannis, *ib.*, 168, 1202, 1919; A. Joly, *ib.*, 97, 1480, 1883; A. Joly and E. Sorel, *ib.*, 118, 738, 1894; G. Viard, *ib.*, 127, 178, 1898; J. H. Debray, *Ann. Chim. Phys.*, (3), 61, 424, 1860; A. Frébault and J. A. Destréum, *Bull. Soc. Chim.*, (2), 27, 499, 1877; J. J. Berzelius, *Liebig's Ann.*, 53, 286, 1845; H. Wattenberg, *Zur Bestimmung der löslichen Phosphorsäure in den Superphosphaten*, Hanover, 1870; A. S. Packard, *Zeit. Chem.*, (2), 1, 137, 1871; H. Otto, *Chem. Ztg.*, 16, 1128, 1892.
- ⁶ A. A. Julien, *Amer. Journ. Science*, (2), 40, 370, 1865; J. J. Berzelius, *Liebig's Ann.*, 53, 286, 1845; R. Warington, *Journ. Chem. Soc.*, 19, 302, 1866; J. N. von Fuchs, *Schweigger's Journ.*, 24, 124, 1818; C. Tissier, *Compt. Rend.*, 38, 192, 1854.
- ⁷ J. J. Berzelius, *Ann. Chim. Phys.*, (2), 2, 167, 1816; M. Raewsky, *Compt. Rend.*, 26, 205, 1847; A. Millot, *ib.*, 78, 1138, 1874; J. Piccard, *Schweiz. Polyt. Zeit.*, 11, 83, 1866; E. Erlenmeyer, *Zeit. Chem.*, (1), 3, 570, 1860; *Neues Jahrb. Pharm.*, 7, 225, 1857

§ 28. Pyrophosphates of the Alkaline Earths

A. Schwarzenberg¹ prepared anhydrous calcium pyrophosphate, $\text{Ca}_2\text{P}_2\text{O}_7$, by heating calcium hydrophosphate, CaHPO_4 , strontium pyrophosphate, $\text{Sr}_2\text{P}_2\text{O}_7$, and barium pyrophosphate, $\text{Ba}_2\text{P}_2\text{O}_7$, were prepared in a similar manner. L. V. R. Ouvrard obtained the strontium salt by very slowly cooling a soln. of strontium sulphate in molten potassium pyrophosphate or of strontium oxide in molten sodium meta- or pyro-phosphate; he also made the barium salt in an analogous way. Barium pyrophosphate was stated by L. V. R. Ouvrard to form rhombic prisms, of sp. gr. 3.9 at 20°. C. N. Pahl did not melt barium pyrophosphate by strongly heating it. According to F. Wibel, when the calcium salt is heated with calcium carbonate, carbon dioxide is given off, and normal calcium phosphate is formed. H. Rose found that when calcium pyrophosphate is melted with an excess of sodium carbonate, a portion remains unconverted into orthophosphate—*vide* the double alkali calcium pyrophosphate—he also found that although barium pyrophosphate is more readily attacked by fused alkali carbonate, than calcium or strontium pyrophosphate, the reaction is in no case quantitative. H. Struve found that when barium pyrophosphate is heated in a stream of hydrogen, phosphine is evolved and the orthophosphate is formed. T. Dieckmann and E. Houdremont gave 3.09 for the sp. gr. of calcium pyrophosphate; 1230° for the m.p.; and 1.6 for the percentage solubility in citric acid.

O. Nielsen gave 1250° for the m.p. of calcium pyrophosphate. According to H. Rose, aq. soln. of barium chloride and pyrophosphoric acid give a precipitate of hydrated barium pyrophosphate when ammonia is added. C. N. Pahl precipitated the hydrated salt by treating an aq. soln. of sodium pyrophosphate with an ammoniacal soln. of barium chloride; A. Schwarzenberg, by treating an aq. soln. of sodium pyrophosphate, $\text{Na}_4\text{P}_2\text{O}_7$, with a soln. of barium chloride; C. H. Hess, by treating a soln. of pyrophosphoric acid with barium hydroxide; C. N. Pahl's preparation dried at 100° was reported to have the composition dihydrated barium pyrophosphate, $\text{Ba}_2\text{P}_2\text{O}_7 \cdot 2\text{H}_2\text{O}$; and in the case of strontium, dihydrated strontium pyrophosphate, $\text{Sr}_2\text{P}_2\text{O}_7 \cdot 2\frac{1}{2}\text{H}_2\text{O}$. A. Schwarzenberg's preparation has the composition monohydrated barium pyrophosphate, $\text{Ba}_2\text{P}_2\text{O}_7 \cdot \text{H}_2\text{O}$, and in the case of strontium, monohydrated strontium pyrophosphate, $\text{Sr}_2\text{P}_2\text{O}_7 \cdot \text{H}_2\text{O}$. G. von Knorre and E. Oppelt likewise prepared $\text{Sr}_2\text{P}_2\text{O}_7 \cdot 2\frac{1}{2}\text{H}_2\text{O}$ by dissolving strontium pyrophosphate in pyrophosphoric acid, or by the action of sodium pyrophosphate in the presence of free pyrophosphoric acid on strontium chloride. The hydrated calcium salt was prepared by W. Baer, G. von Knorre and E. Oppelt, H. Rose, and A. Schwarzenberg by similar methods, but the analyses of W. Baer, and of G. von Knorre and E. Oppelt corresponded with tetrahydrated calcium pyrophosphate, $\text{Ca}_2\text{P}_2\text{O}_7 \cdot 4\text{H}_2\text{O}$. These salts when first precipitated are often gelatinous, and difficult to filter and wash, but they often crystallize on standing or during the washing. According to A. Schwarzenberg, they are all somewhat soluble in water, readily soluble in mineral acids, sparingly soluble in acetic acid, and insoluble in sodium pyrophosphate. W. Baer observed the dissolution of the calcium salt in acetic acid, and, according to A. Schwarzenberg, the soln. in sulphurous acid, precipitates crystals of the salt on standing or boiling; the soln. of the barium salt in sulphurous acid gives a precipitate of barium sulphate on standing. H. Rose found that the salts are partially attacked by a boiling soln. of sodium carbonate. According to H. W. F. Wackenroder, hydrated barium pyrophosphate is insoluble in a soln. of ammonium chloride; while K. Birnbaum showed that the soln. in hydrochloric acid gives no precipitate when sodium acetate is added.

Several hydroxyphosphates of the alkaline earths have been reported. C. N. Pahl prepared rhombic plates of dihydrated calcium dihydroxyphosphate, $\text{CaH}_2\text{P}_2\text{O}_7 \cdot 2\text{H}_2\text{O}$, by partially decomposing calcium pyrophosphate with soln. of oxalic acid. By boiling tetrahydrated calcium pyrophosphate for a long time with

water, and washing the product with boiling water until the filtrate was free from acid, G. von Knorre and E. Oppelt obtained $\text{Ca}_2\text{P}_2\text{O}_7 \cdot \text{CaH}_2\text{P}_2\text{O}_7 \cdot 3\text{H}_2\text{O}$; they also prepared crystals of $\text{Ca}_2\text{P}_2\text{O}_7 \cdot 2\text{CaH}_2\text{P}_2\text{O}_7 \cdot 6\text{H}_2\text{O}$, by allowing mixed soln. of sodium dihydropyrophosphate and calcium chloride to stand for a long time; with very conc. soln. a flocculent precipitate is obtained at once. The product is very sparingly soluble in hot water, and the soln. on cooling deposits crystals of the salt; the salt is also precipitated if the aq. soln. is acidified with acetic acid. C. N. Pahl reported the following hydrated **strontium dihydropyrophosphates**: $\text{Sr}_2\text{P}_2\text{O}_7 : \text{SrH}_2\text{P}_2\text{O}_7 : \text{H}_2\text{O} = 9 : 1 : 5, 9 : 1 : 18, 9 : 1 : 20, 4 : 1 : 3, \text{ and } 4 : 1 : 8 \text{ or } 12$; while G. von Knorre and E. Oppelt reported $3 : 1 : 1$ or 2 , and $2 : 1 : 6$. Similarly with hydrated **barium dihydropyrophosphates**, C. N. Pahl reported $4 : 1 : 9, 3 : 1 : 5, 2 : 1 : 5, \text{ and } 5 : 4 : 12$; while G. von Knorre and E. Oppelt reported $1 : 1 : 3$. There is little to show whether these products are mixtures or chemical individuals.

G. Tammann obtained a product which he regarded as **sodium barium pyrophosphate**, $\text{Na}_4\text{Ba}_4(\text{P}_2\text{O}_7)_3$, by melting a mol of ammonium sodium hydrophosphate with a mol of a barium salt, and vigorously stirring the mass while it is cooling. The prismatic crystals are readily soluble in hot nitric or hydrochloric acid. W. Baer obtained a hydrated sodium barium pyrophosphate by gradually adding barium chloride to a boiling soln. of sodium pyrophosphate. L. V. R. Ouvrard prepared **potassium strontium pyrophosphate**, $\text{K}_2\text{SrP}_2\text{O}_7$, by slowly cooling a soln. of strontium oxide or orthophosphate in molten potassium meta- or pyro-phosphate. After extracting with water, hexagonal plates, derived from octahedra, are obtained. The sp. gr. is 2.9 at 20° ; the salt is soluble in dil. acids. W. Baer obtained a hydrated form of **sodium strontium pyrophosphate** by a process analogous to that he used for the corresponding barium compound. L. V. R. Ouvrard prepared **potassium calcium pyrophosphate**, $\text{K}_2\text{CaP}_2\text{O}_7$, by a process like that he employed for the strontium salt; the crystals were similar and their sp. gr. was 2.7 at 20° . K. A. Wallroth, and L. V. R. Ouvrard prepared a crystalline powder of **sodium calcium pyrophosphate**, $4\text{Na}_2\text{O} \cdot 5\text{CaO} \cdot \text{P}_2\text{O}_5$, by melting ammonium sodium hydrophosphate with calcium oxide. The monoclinic plates have a sp. gr. 2.7 at 20° ; they are soluble in acids. W. Baer obtained a hydrate, $\text{Na}_2\text{Ca} \cdot \text{P}_2\text{O}_7 \cdot 4\text{H}_2\text{O}$.

C. U. Shepard's² mineral *pyrophosphorite*, from the West Indies, has a composition corresponding with $\text{Mg}_2\text{P}_2\text{O}_7 \cdot 4\{\text{Ca}_2\text{P}_2\text{O}_7 \cdot \text{Ca}_3(\text{PO}_4)_2\}$; its sp. gr. was 2.50-2.53; its hardness, 2-3½. P. Jolibois studied the phosphates formed by mixing calcium hydroxide and phosphoric acid, and obtained crystals of a mixed **calcium ortho-pyrophosphate**, $\text{Ca}_2\text{P}_2\text{O}_7 \cdot \text{Ca}_3(\text{PO}_4)_2 \cdot 10\text{H}_2\text{O}$, which is slowly converted into dicalcium phosphate in the presence of an excess of phosphoric acid.

F. Schwarz³ reported the formation of plates of **calcium triphosphate**, $5\text{CaO} \cdot 3\text{P}_2\text{O}_5$, or $\text{Ca}_5(\text{P}_3\text{O}_{10})_2$, by mixing dil. soln. of sodium triphosphate and of a calcium salt. The precipitate was dried on a porous tile; it is soluble in an excess of the calcium salt. He prepared **barium triphosphate**, $\text{Ba}_5(\text{P}_3\text{O}_{10})_2$, in a similar manner. T. Fleitmann and W. Henneberg prepared **calcium tetraphosphate**, $3\text{CaO} \cdot 2\text{P}_2\text{O}_5$, or $\text{Ca}_3\text{P}_4\text{O}_{13}$, by treating a soln. of the sodium salt with one of a calcium salt; or by melting the sodium salt with calcium chloride. They also prepared **barium tetraphosphate**, $\text{Ba}_3\text{P}_4\text{O}_{13}$, in a similar way, and stated that the barium salt is infusible, while H. Lüderer said that it fuses in a platinum crucible to a colourless glass.

REFERENCES.

- ¹ A. Schwarzenberg, *Liebig's Ann.*, 65, 144, 1847; L. V. R. Ouvrard, *Compt. Rend.*, 106, 1599, 1888; *Ann. Chim. Phys.*, (6), 16, 301, 1889; F. Wibel, *Ber.*, 7, 220, 1874; G. von Knorre and E. Oppelt, *ib.*, 21, 772, 1888; H. Rose, *Pogg. Ann.*, 76, 16, 230, 1849; W. Baer, *ib.*, 75, 152, 1848; C. H. Hess, *ib.*, 18, 71, 1830; C. N. Pahl, *Köngl. Akad. Handl.*, 7, 1873; *Ark. Kem. Min.*, 2, 1, 1905; H. Struve, *Journ. prakt. Chem.*, (1), 79, 348, 1860; G. Tammann, *ib.*, (2), 45, 469, 1892; A. Reynoso, *Compt. Rend.*, 34, 795, 1852; H. W. F. Wackenroder, *Liebig's Ann.*, 41, 315, 1842; 51, 163, 1844; K. Birnbaum, *Zeit. Chem.*, (2), 7, 139, 1871; K. A. Wallroth, *Bull. Soc. Chim.*, (2), 39, 318, 1883; O. Nielsen, *Ferrum*, 10, 97, 1913; T. Dieckmann and E. Houdremont, *Zeit. anorg. Chem.*, 120, 129, 1922.

² C. U. Shepard, *Amer. Journ. Science*, (3), 15, 49, 1878; P. Jolibois, *Compt. Rend.*, 169, 1161, 1919.

³ F. Schwarz, *Zeit. anorg. Chem.*, 9, 264, 1895; H. Lüder, *ib.*, 5, 33, 1893; T. Fleitmann and W. Henneberg, *Liebig's Ann.*, 65, 331, 1847.

§ 29. Metaphosphates of the Alkaline Earths

Various precipitates of undetermined composition have been reported¹ to be formed when a soln. of an alkali metaphosphate or metaphosphoric acid is treated with a soln. of a salt of the alkaline earths under various conditions. H. Rose stated that an aq. soln. of phosphoric acid gives with a soln. of barium hydroxide or chloride a precipitate which is soluble in a great excess of metaphosphoric acid, and the soln. is not precipitated by aq. ammonia. What has been regarded as **barium monometaphosphate**, $\text{Ba}(\text{PO}_3)_2$, was obtained by R. Maddrell² by heating barium carbonate with an excess of orthophosphoric acid for a long time at 316° . The white residue is insoluble in water and dil. acids, but it is decomposed by conc. sulphuric acid. R. Maddrell's salt is not decomposed by digestion with alkali carbonates, and therefore, said T. Fleitmann, the nature of the combined acid cannot be determined. R. Maddrell prepared what have been regarded as **strontium monometaphosphate**, $\text{Sr}(\text{PO}_3)_2$, and **calcium monometaphosphate**, $\text{Ca}(\text{PO}_3)_2$, in a similar manner to the barium salt. O. Nielsen gave 1020° for the m.p. of calcium metaphosphate, $(\text{CaP}_2\text{O}_6)_n$. T. Dieckmann and E. Houdremont gave $2'65\text{--}2'85$ for the sp. gr.; and $970^\circ\text{--}980^\circ$ for the m.p.

A. Glatzel³ evaporated a soln. of barium carbonate with about one per cent. excess of orthophosphoric acid, first on a water-bath, then on a sand-bath, and finally at 400° . The resulting cake was coarsely powdered, and washed with cold water acidified with a few drops of nitric acid. The white crystalline powder was regarded as **barium dimetaphosphate**, BaP_2O_6 . The salt melts at a red heat, and passes into tetrametaphosphate. Barium dimetaphosphate is not altered by hydrochloric or nitric acid, but it is completely decomposed by hot conc. sulphuric acid. When melted with sodium carbonate, it forms sodium orthophosphate, Na_3PO_4 ; and when digested with aq. soln. of the alkali carbonates, it gives double salts whose composition led A. Glatzel to regard it as a dimetaphosphate. A. Glatzel similarly prepared **strontium dimetaphosphate**, SrP_2O_6 , and **calcium dimetaphosphate**, CaP_2O_6 . T. Fleitmann obtained a crystalline precipitate of **dihydrated barium dimetaphosphate**, $\text{BaP}_2\text{O}_6 \cdot 2\text{H}_2\text{O}$, by mixing ammonium dimetaphosphate with barium chloride; good crystals are obtained when a mixture of the conc. soln. has stood some time. Part of the water is lost at 150° , and all at a red heat. A. Glatzel said that the salt which has lost its water of crystallization, still remains a dimetaphosphate. T. Fleitmann showed that the salt does not melt at a red heat, and A. Glatzel said it does melt, but passes into the tetrametaphosphate. According to T. Fleitmann, the salt which has been heated to redness does not form sodium dimetaphosphate when digested with an aq. soln. of sodium carbonate, while the uncalcined salt does so. Barium dimetaphosphate is less soluble in water than is the case with the tetrametaphosphate. A. Glatzel showed that 100 parts of water dissolve two parts of water. According to T. Fleitmann, boiling conc. hydrochloric or nitric acid has but little action, while conc. sulphuric acid readily decomposes the salt. It unites neither with sodium nor ammonium dimetaphosphate. A. Glatzel similarly prepared **dihydrated strontium dimetaphosphate**, $\text{SrP}_2\text{O}_6 \cdot 2\text{H}_2\text{O}$, and T. Fleitmann, **dihydrated calcium dimetaphosphate**, which are analogous to the barium salt.

A. Glatzel prepared **ammonium barium dimetaphosphate**, $(\text{NH}_4)_2\text{Ba}(\text{PO}_3)_4 \cdot 2\text{H}_2\text{O}$, by mixing a dil. soln. of ammonium dimetaphosphate with barium chloride. If the soln. be not very dil., the barium salt is alone obtained. It is sparingly soluble in acids, and is completely decomposed by conc. sulphuric acid. The water of crystallization is expelled by feeble calcination, and when strongly heated it loses

ammonia and phosphoric oxide. With slow cooling, barium tetraphosphate is formed. A. Glatzel also prepared in a similar way ammonium strontium dimetaphosphate, $(\text{NH}_4)_2\text{Sr}(\text{P}_2\text{O}_6)_2 \cdot 2\text{H}_2\text{O}$, and ammonium calcium dimetaphosphate, $(\text{NH}_4)_2\text{Ca}(\text{P}_2\text{O}_6)_2 \cdot 2\text{H}_2\text{O}$. T. Fleitmann also prepared the latter salt by adding alcohol to a mixed soln. of calcium chloride and an excess of ammonium dimetaphosphate; if calcium chloride be in excess, calcium dimetaphosphate is precipitated. The crystals do not lose their water at 100° , they are sparingly soluble in water, and are not decomposed by acids. A. Glatzel prepared fine needles of potassium barium dimetaphosphate, $\text{K}_2\text{Ba}(\text{P}_2\text{O}_6)_2 \cdot 4\text{H}_2\text{O}$, from very dil. soln. of potassium dimetaphosphate and barium chloride. The corresponding sodium barium dimetaphosphate, $\text{Na}_2\text{Ba}(\text{P}_2\text{O}_6)_2 \cdot 4\text{H}_2\text{O}$, was prepared in a similar manner; he also made potassium strontium dimetaphosphate, $\text{K}_2\text{Sr}(\text{P}_2\text{O}_6)_2 \cdot 4\text{H}_2\text{O}$; sodium strontium dimetaphosphate, $\text{Na}_2\text{Sr}(\text{P}_2\text{O}_6)_2 \cdot 4\text{H}_2\text{O}$; potassium calcium dimetaphosphate, $\text{K}_2\text{Ca}(\text{P}_2\text{O}_6)_2 \cdot 4\text{H}_2\text{O}$; and sodium calcium dimetaphosphate, $\text{Na}_2\text{Ca}(\text{P}_2\text{O}_6)_2 \cdot 4\text{H}_2\text{O}$.

T. Fleitmann and W. Henneberg,⁴ and C. G. Lindbom prepared barium trimetaphosphate, $\text{Ba}_3(\text{P}_3\text{O}_9)_2 \cdot 6\text{H}_2\text{O}$, by mixing a soln. of one part of the sodium salt with a soln. of 2 or 3 parts of barium chloride; if other proportions are employed, a double salt is produced. According to H. Rose, no precipitation occurs with strontium chloride. The filtrate furnishes rhombic crystals which become acid, and lose two-thirds their water when heated on a water-bath. T. Fleitmann and W. Henneberg say that the salt does not melt at a red heat, but it thereby becomes insoluble in acids, because, according to C. G. Lindbom, it is converted into the hexametaphosphate. The crystals have a neutral reaction, and lose no water over sulphuric acid, all the water is lost at 180° . At ordinary temp., A. Wiesler found 100 c.c. of water dissolve 0.2589 grm. of salt; and the aq. soln., at a dilution $v=128$, 512, and 2048, has an eq. conductivity 64.7, 89.4, and 125.5 respectively. The salt is readily soluble in hydrochloric acid.

C. G. Lindbom prepared prismatic crystals of ammonium barium trimetaphosphate, $(\text{NH}_4)\text{Ba}(\text{P}_3\text{O}_9)_3 \cdot \text{H}_2\text{O}$, by adding to a soln. of sodium barium trimetaphosphate sufficient ammonium sulphate to precipitate half the barium. The salt does not lose its water at 100° , and at red heat it loses water and ammonia, and melts to a clear glass soluble in hydrochloric acid. C. G. Lindbom prepared crystals of potassium barium trimetaphosphate, $\text{KBa}(\text{P}_3\text{O}_9)_3 \cdot \text{H}_2\text{O}$, by adding to barium trimetaphosphate, or to sodium barium trimetaphosphate, sufficient potassium sulphate to precipitate half the barium. This salt is less soluble in water than the corresponding ammonium or sodium barium triphosphate. The crystals at a red heat melt to a white enamel, which is soluble in hydrochloric acid. T. Fleitmann and W. Henneberg obtained prisms of sodium barium trimetaphosphate, $\text{NaBaP}_3\text{O}_9 \cdot 4\text{H}_2\text{O}$, from a mixed soln. of one part of barium chloride and 2 to 3 parts of sodium triphosphate. The salt is more soluble in water than barium trimetaphosphate. The crystals effloresce in air, and lose 9.86 per cent. of water at 100° , at a higher temp. they lose the remaining water. According to C. G. Lindbom, the feebly calcined salt slowly dissolves in boiling hydrochloric acid, and the clear glass obtained at a red heat dissolves easily in that acid. T. Fleitmann and W. Henneberg prepared crystals of sodium strontium trimetaphosphate, $\text{NaSrP}_3\text{O}_9 \cdot 3\text{H}_2\text{O}$, by the spontaneous evaporation of a mixed soln. of one part of strontium chloride with three of sodium trimetaphosphate. The corresponding sodium calcium trimetaphosphate, $\text{NaCaP}_3\text{O}_9 \cdot 3\text{H}_2\text{O}$, was prepared by T. Fleitmann and W. Henneberg, and by C. G. Lindbom.

According to A. Glatzel,⁵ barium tetrametaphosphate, $\text{Ba}_2\text{P}_4\text{O}_{12}$, is formed when the dimetaphosphate is melted, and slowly cooled. The small white crystals are incompletely decomposed by sulphuric acid; completely decomposed by fusion with sodium carbonate; and when digested with an aq. soln. of an alkali carbonate, alkali tetrametaphosphate is formed. Strontium tetrametaphosphate, $\text{Sr}_2\text{P}_4\text{O}_9$, and calcium tetrametaphosphate, $\text{Ca}_2\text{P}_4\text{O}_{12}$, correspond with the barium

salt. **Octohydrated barium tetrametaphosphate**, $\text{Ba}_2\text{P}_4\text{O}_{12}\cdot 8\text{H}_2\text{O}$, was obtained by A. Glatzel as a white crystalline powder by adding an excess of barium chloride to a soln. of sodium tetrphosphate. 100 parts of water dissolve 1.54 parts of the salt. It loses its water of crystallization at a dull red heat. Before calcination, it is attacked by nitric acid, but after calcination only by conc. sulphuric acid. When melted and slowly cooled it forms anhydrous $\text{Ba}_2\text{P}_4\text{O}_{12}$. **Octohydrated strontium tetrametaphosphate**, $\text{Sr}_2\text{P}_4\text{O}_{12}\cdot 8\text{H}_2\text{O}$, and **octohydrated calcium tetrametaphosphate**, $\text{Ca}_2\text{P}_4\text{O}_{12}\cdot 8\text{H}_2\text{O}$, were prepared in a similar manner; 100 parts of water dissolve 1.818 parts of the former, and 2.0 parts of the latter. G. Tammann made what he regarded as *barium ditetrametaphosphate*, $\text{BaBa}_2(\text{PO}_3)_6\cdot 12\text{H}_2\text{O}$, by treating a soln. of barium chloride with a soln. of $\text{K}_2\text{Na}_4(\text{PO}_3)_6$, or $\text{Li}_2\text{Na}_4(\text{PO}_3)_6$. The white powder melts when heated in the blast flame.

According to H. Rose,⁶ hexametaphosphoric acid, prepared by the action of hydrogen sulphide on the silver salt, furnishes a flocculent precipitate of **barium hexametaphosphate**, $\text{Ba}_3\text{P}_6\text{O}_{18}$, when added to a soln. of barium hydroxide or chloride; a soln. of hexametaphosphate also gives a voluminous precipitate with barium chloride, and the filtrate has an acid reaction. The precipitate dissolves in an excess of the sodium hexametaphosphate soln. and no precipitation occurs when ammonia is added. According to T. Graham, an aq. soln. of the salt obtained by calcining sodium dihydrophosphate, gives a gelatinous precipitate when treated with barium chloride. The precipitate gives off water at a red heat, and sinters; it then dissolves with difficulty in nitric acid. When boiled with water, it slowly forms a soln. of barium dihydrophosphate, $\text{Ba}(\text{H}_2\text{PO}_4)_2$. According to H. Wackenroder, barium hexametaphosphate is insoluble in an aq. soln. of ammonium chloride. H. Lüdert prepared **strontium hexametaphosphate**, $\text{Sr}_3\text{P}_6\text{O}_{18}$, by adding the sodium salt to a soln. of strontium nitrate. The white flocculent precipitate is almost insoluble in water, it melts to a clear glass when heated; and it is soluble in dil. acids. T. Scheerer showed that the precipitation of strontium compounds by alkali sulphates and carbonates is influenced by sodium hexametaphosphate. According to H. Rose, an aq. soln. of hexametaphosphoric acid does not give a precipitate with calcium chloride, but a precipitate is obtained with a soln. of calcium hydroxide if the latter is in excess. H. Lüdert, and H. Rose also prepared **calcium hexametaphosphate**, $\text{Ca}_3\text{P}_6\text{O}_{18}$, and it resembles the strontium and barium salts. G. Tammann prepared what he regarded as **potassium strontium hexametaphosphate**, $\text{K}_2\text{Sr}_2\text{P}_6\text{O}_{18}$, by digesting the product obtained by melting potassium dihydrophosphate, with a soln. of strontium chloride for two months. J. J. Berzelius also made a clear glass by melting sodium hexametaphosphate with calcium oxide or carbonate, and this may contain some *sodium calcium hexametaphosphate*. T. Scheerer prepared a product which has been regarded as *barium sulphatophosphate* with variable proportions of phosphate and sulphate by adding dil. sulphuric acid to a mixture of a soln. of sodium hexametaphosphate with a large excess of dil. hydrochloric acid and barium chloride. It is probably a mixture of the sulphate and phosphate.

REFERENCES.

- ¹ H. Rose, *Pogg. Ann.*, 76. 5, 1849; J. von Liebig, *Liebig's Ann.*, 11. 262, 1834; A. Reynoso, *Compt. Rend.*, 34. 795, 1852; T. Scheerer, *Journ. prakt. Chem.*, (1), 75. 113, 1858; J. J. Berzelius, *Lehrbuch der Chemie*, Dresden, 4. 277, 1835; J. Funke, *Neues Journ. Pharm.*, 8. 2, 17, 1824; K. Birnbaum, *Zeit. Chem.*, (2), 7. 139, 1871; O. Nielsen, *Ferrum*, 10. 97, 1913.
- ² R. Maddrell, *Mem. Chem. Soc.*, 3. 273, 1847; *Phil. Mag.*, (3), 30. 322, 1847; *Liebig's Ann.*, 61. 61, 1847; T. Fleitmann, *Pogg. Ann.*, 78. 352, 1849; H. Rose, *ib.*, 76. 5, 1849; O. Nielsen, *Ferrum*, 10. 97, 1913; T. Dieckmann and E. Houdremont, *Zeit. anorg. Chem.*, 120. 129, 1922.
- ³ A. Glatzel, *Ueber dimetaphosphorsäure und tetrametaphosphorsäure Salze*, Würzburg, 1880; T. Fleitmann, *Pogg. Ann.*, 78. 254, 1849; G. Tammann, *Journ. prakt. Chem.*, (2), 45. 422, 1892.
- ⁴ T. Fleitmann and W. Henneberg, *Liebig's Ann.*, 65. 313, 1847; C. G. Lindbom, *Lunds. Univers. Arsskrift*, 10, 1873; A. Wiesler, *Zeit. anorg. Chem.*, 28. 198, 1901; G. von Knorre, *ib.*, 24. 383, 1900; H. Rose, *Pogg. Ann.*, 76. 8, 1849; T. Fleitmann, *ib.*, 78. 233, 338, 1849.
- ⁵ A. Glatzel, *Ueber dimetaphosphorsäure und tetrametaphosphorsäure Salze*, Würzburg, 1880; G. Tammann, *Journ. prakt. Chem.*, (2), 45. 444, 1892.

* H. Rose, *Pogg. Ann.*, 76. 3, 1849; T. Graham, *ib.*, 32. 68, 1834; *Phil. Trans.*, 123. 253, 1833; H. Wackenroder, *Liebig's Ann.*, 41. 315, 1842; 51. 163, 1844; T. Scheerer, *Journ. prakt. Chem.*, (1), 75. 113, 1858; G. Tammann, *ib.*, (2), 45. 435, 1892; H. Lüder, *Zeit. anorg. Chem.*, 5. 36, 1893; J. J. Berzelius, *Liebig's Ann.*, 53. 286, 1845.

§ 30. Complex Phosphates of the Alkaline Earths

Calcium fluoride or chloride unites with normal calcium phosphate, forming calcium fluo-orthophosphate, or chloro-orthophosphate. **Calcium fluotriorthophosphate**, $3\text{Ca}_3(\text{PO}_4)_2 \cdot \text{CaF}_2$, or $\text{Ca}_5(\text{PO}_4)_3\text{F}$, is represented by the mineral *apatite*, sometimes called *fluoro-apatite*, to distinguish it from the isomorphous *chloro-apatite*, or **calcium chlorotriorthophosphate**, $3\text{Ca}_3(\text{PO}_4)_2 \cdot \text{CaCl}_2$, or $\text{Ca}_5(\text{PO}_4)_3\text{Cl}$. Both minerals occur in isomorphous mixtures, and are included as varieties of the mineral species: apatite. Apatite is the most important and the most widely distributed natural phosphate; it occurs¹ in all classes of rocks—igneous, metamorphic, and sedimentary; but it is more common in rocks with the lower proportions of silica. It is found in the titaniferous magnetites of Norway, Adirondacks, etc. J. H. L. Vogt² has suggested that when apatite occurs as a vein mineral, it has been formed by pneumatolytic agencies. W. M. Hutchings, and J. H. L. Vogt have reported the presence of apatite in lead-furnace slags. S. Meunier, and C. Vélain also found crystals of apatite in the ashes of burnt vegetation. A. Damour reported a hydrated variety, *hydro-apatite*, $3\text{Ca}_3(\text{PO}_4)_2 \cdot \text{CaF}_2 \cdot 3\text{H}_2\text{O}$, of sp. gr. 3.10, and hardness $5\frac{1}{2}$, occurring as white concretions.

Apatite was at first confused with other minerals—fluorspar, aquamarine, amethyst, schorl, and chrysolite—but in 1786, A. G. Werner³ recognized it as a distinct mineral species, and gave it the name apatite, from *ἀπατάω*, to deceive. Various synonyms have been employed for more or less impure varieties—e.g. *moroxite*, *lazurapatite*, *phosphorite*, *hydroapatite*, *pseudoapatite*, *sombrérite*, *osteolite*, *staffelite*, *francolite*, *eupyrochroite*, *talcapatite*, etc. The analyses of M. H. Klaproth, and of L. N. Vauquelin showed that it contained lime and phosphoric acid. B. Pelletier and L. Donadei recognized chloro- and fluoro-apatites in Estremadura phosphorites, and G. Rose showed that the chlorine and fluorine are interchangeable. Numerous analyses have been reported.⁴ T. Scheerer, and W. C. Brögger found cerium in a Norwegian apatite; A. Cossa, and I. Bellucci and L. Grassi, cerium, lanthanum, and didymium; and F. Zambonini, praseodymium.

The analyses of fluoapatite correspond with $\text{CaF} \cdot \text{Ca}_4(\text{PO}_4)_3$, or $3\text{Ca}_3(\text{PO}_4)_2 \cdot \text{CaF}_2$:

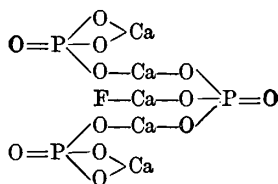

The fluorine may be partly replaced by chlorine, or hydroxyl, $\text{Ca}(\text{F}, \text{Cl}, \text{OH}) \cdot \text{Ca}_4(\text{PO}_4)_3$. In some cases J. A. Völcker, and J. L. Hoskins-Abrahall found too low a content of fluorine, chlorine, or hydroxyl, and they assumed that oxygen may also be present: $3\text{Ca}_3(\text{PO}_4)_2 \cdot \text{Ca}(\text{F}_2, \text{Cl}_2, (\text{OH})_2, \text{O})$. The mineral *dahlite*, $3\text{Ca}_3(\text{PO}_4)_2 \cdot \text{CaCO}_3$, is a *carbonato-apatite*, or **calcium carbonato-phosphate**, and, also, according to A. F. Rogers, it is isomorphous with apatite. W. Tschirwinsky's *podolite* is, according to W. T. Schaller, identical with dahlite. These minerals have also been studied by W. C. Brögger and H. Bäckström, A. Schwantke, etc. The evidence is not conclusive, but it does indicate that such apatites are possible. According to A. Barillé, when dicalcium phosphate suspended in water is heated with carbon dioxide under press. (13 kgrms. per sq. cm.), 25 to 50 per cent. dissolves according to the duration of the action. The soln., when exposed to air, deposits crystals

of dicalcium phosphate. Calcium phosphate similarly treated dissolves to a less extent (10–25 per cent.), and the soln. deposits a mixture of dicalcium phosphate and calcium carbonate (1 mol. P_2O_5 to 3 mols. CaO). It is supposed that an unstable carbonatophosphate of the formula $H_2Ca_2P_2O_8 \cdot 2CO_2$ is formed, but all attempts to isolate the substance failed. It has been suggested by A. H. Church⁵ that the mineral *tirolite* is calcium cupric oxycarbonatophosphate, $CaCO_3 \cdot 2Cu(OH)_2 \cdot 2Cu_3(PO_4)_2 \cdot 2H_2O$.

A. Ditte prepared calcium bromophosphate, $3Ca_3(PO_4)_2 \cdot CaBr_2$, or *bromo-apatite* in hexagonal plates by fusing together sodium bromide and normal calcium phosphate; and he also prepared needle-like crystals of *bromo-wagnerite*, $Ca_3(PO_4)_2 \cdot CaBr_2$, in a similar way. The corresponding calcium iodophosphates, strontium bromophosphates, and strontium iodophosphates, were obtained in an analogous manner. The iodo-apatites could not be obtained by fusing together the iodides and phosphates of the alkaline earths, because the iodides decompose when fused, but if alkali iodides are also present, and access of oxygen to the fused salt be excluded, the iodophosphates are formed.

According to R. J. Haüy,⁶ apatite was first synthesized by N. T. de Saussure by the action of gypsum on phosphoric acid, but it is questionable if apatite was here obtained. A. Daubrée, however, prepared microscopic crystals of chloro-apatite by passing the vapour of phosphorus trichloride over red-hot lime. N. S. Manross fused sodium or calcium phosphate with calcium chloride or fluoride, or a mixture of the two, and obtained prismatic crystals resembling natural apatite; and H. Briegleb, and R. Nacken used a slight modification of this process with success. G. Forchhammer prepared chloro-apatite by fusing a mixture of sodium chloride with calcium phosphate or bone-ash, or marl. A. Ditte also obtained prismatic crystals of fluoro-apatite by slowly cooling a molten mixture of calcium phosphate with three times its wt. of calcium fluoride and an excess of potassium chloride. If calcium chloride is used chloro-apatite is formed. According to A. Ditte, chloro-apatite is formed by fusing at 1000° a mixture of calcium phosphate with fifty times its weight of sodium chloride, the sodium phosphate simultaneously formed does not interfere with the result provided no more than 0.11 is present, but if more than this proportion is formed, plates of sodium calcium phosphate, $CaNaPO_4$, free from chloride are produced. H. St. C. Deville and H. Caron fused bone-ash with ammonium chloride, and either calcium fluoride or chloride. H. Debray heated calcium phosphate and calcium chloride with water under press. at 250° ; E. Weinschenksimilarly heated a mixture of ammonium and calcium chlorides and ammonium phosphate between 150° and 180° in a sealed tube. H. Debray also passed hydrogen chloride over red-hot calcium phosphate, and H. Rosenbusch explained the occurrence of apatite in some eruptive rocks by this reaction. F. K. Cameron and W. J. McCaughey prepared fluoro-apatite by dissolving calcium fluoride in fused disodium hydrophosphate and lixiviating the cooled melt; and chloro-apatite by adding an excess of calcium dihydrophosphate to molten calcium chloride. N. Sheldon, and F. Bainbridge found crystals of fluoro-apatite in fluoriferous Thomas slags.

A. Ditte stated that if the proportion $Ca_3(PO_4)_2 : CaCl_2$ be over 0.2 : 1.0, apatite alone is formed; if over 0.07 : 1.00, a mixture of apatite and *calcium-wagnerite*, $Ca_3(PO_4)_2 \cdot CaCl_2$, is formed, and if under 0.07 : 1.00, lime wagnerite is alone produced. A. Sjögren suggests that the mineral *spodiosite*, from Nordmark (Sweden), with a composition $mCa_3(PO_4)_2 \cdot nCaF_2$, where $m : n$ approximates 8 : 3, is isomorphous with wagnerite, but this is not in agreement with G. Nordenskjöld's measurements of the rhombic crystals which have the axial ratios $a : b : c = 0.8944 : 1 : 1.5836$. H. V. Tiberger's specimen had a composition corresponding with $Ca_3(PO_4)_2 \cdot CaF_2$, or $CaF \cdot CaPO_4$, but there is usually also some evidence of some hydroxyl, and this makes the composition $CaPO_4 \cdot Ca(F, OH)$. F. K. Cameron and W. J. McCaughey prepared an artificial chlorospodiosite in rhombic plates.

R. Nacken studied the conditions under which fluoro- and chloro-apatites are

obtained from a fused mixture of calcium phosphate with calcium chloride or fluoride. A mixture of calcium phosphate gives a fusion curve, Fig. 68, with a eutectic at about 1205° and about 65 per cent. of calcium fluoride. The data are :

CaF ₂	100	90	81	72.8	56.6	40	24 per cent.
Cryst. begins . . .	1392°	1356°	1316°	1270°	1255°	1395°	1524°
Eutectic cryst. . .	—	1205°	1203°	1205°	1205°	1198°	1180°

There is a maximum melting at about 1650° (extrapolated), corresponding with the formation of fluoro-apatite, $3\text{Ca}_3(\text{PO}_4)_2 \cdot \text{CaF}_2$. The corresponding curve with calcium chloride, Fig. 69, shows that two compounds may be formed. The data are :

CaCl ₂	97	95	93	92	88	82	70 per cent.
M.p.	786°	861°	900°	958°	1040°	1160°	1280°
	$\text{Ca}_3(\text{PO}_4)_2 \cdot \text{CaCl}_2$					$3\text{Ca}_3(\text{PO}_4)_2 \cdot \text{CaCl}_2$	

Calcium-wagnerite has an incongruent m.p. at 1040° , and decomposes when heated into chloro-apatite. There is a eutectic at 770° , which is very close to 772° , the m.p. of calcium chloride. Fluoro- and chloro-apatites form a continuous series of mixed crystals.

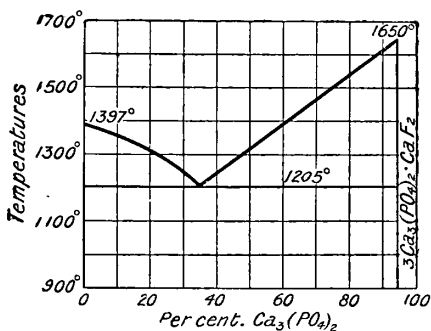

FIG. 68.—Fusion Curve of Mixtures of Calcium Phosphate and Fluoride.

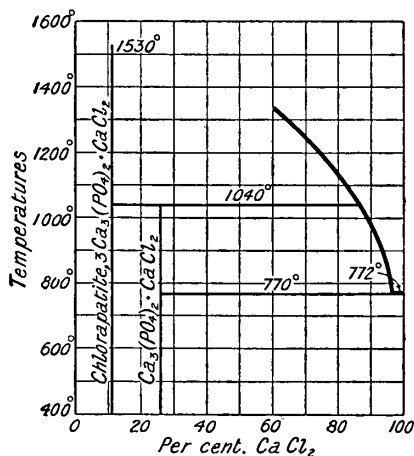

FIG. 69.—Fusion Curve of Mixtures of Calcium Phosphate and Chloride.

Apatite forms hexagonal pyramidal crystals⁷ with axial ratio $a : c = 1 : 0.7346$. The crystals are isomorphous with pyromorphite, vanadinite, and mimetite; and, according to A. F. Rogers, fluoro-apatite, $3\text{Ca}_3(\text{PO}_4)_2 \cdot \text{CaF}_2$, chloro-apatite, $3\text{Ca}_3(\text{PO}_4)_2 \cdot \text{CaCl}_2$, dahllite, $3\text{Ca}_3(\text{PO}_4)_2 \cdot \text{CaCO}_3$, and vöckerite, $3\text{Ca}_3(\text{PO}_4)_2 \cdot \text{CaO}$, are isomorphous. F. Rinne and J. Lorenz found the corrosion figures corresponded with hexagonal-bipyramidal symmetry; H. Haga and F. M. Jaeger studied the X-radiogram of apatite. The reported values for the specific gravity of apatite range from G. Forchhammer's⁸ 3.069 to S. L. Penfield's 3.39 for a sample from Branchville. H. St. C. Deville and H. Caron gave 3.14 for a sample of chloro-fluoroapatite, and C. Vrba, 3.09 for a sample from Pisek. J. A. Douglas found 3.197 for a sample from St. Gotthard, and for the glass, obtained by fusion and cooling, 2.972, this corresponding with an expansion of 7.57 per cent. K. A. Grönwall gave 3.194 for the sp. gr. of apatite from Nordmarken; and T. Dieckmann and E. Houdremont gave 3.18 for artificial apatite. A. Daubrée gave 2.95 for the sp. gr. of chloro-apatite which had been fused. P. Pusirewsky believed that the sp. gr. of apatite increases proportionally with the content of chloro-apatite. R. Nacken

found 3.18 (25°) for the sp. gr. of artificial fluoro-apatite, and 3.17 (20°) for chloro-apatite. F. K. Cameron gave 3.010 for the sp. gr. of chloro-apatite, and for chlorospodiosite, 3.041 (23°); G. Nördenskjöld gave for natural spodiosite, 2.94. The **hardness** of apatite on Mohs' scale is 5. F. Auerbach found 237 in his scale of absolute hardness; and T. A. Jaggat found with a scratching sclerometer a hardness of 1.23 when that of gypsum is 0.04; calcite, 0.26; fluorspar, 0.75; orthoclase, 25; quartz, 40; topaz, 152; and corundum, 1000. A. Rosiwal discussed the subject. G. Nördenskjöld's value for the hardness of spodiosite is 5. F. Auerbach's value for the **modulus of elasticity** is 13,800 kgrms. per sq. mm.

When heated in the blowpipe flame, apatite melts to a white enamel, without colouring the flame. R. Cusack⁹ found the **melting point** of two samples to be respectively 1221° and 1227°; T. Dieckmann and E. Houdremont gave 1630°. C. Doelter found a sample from Renfrew (Canada) began to melt at 1270°, and was quite liquid at 1300°. A. Bran obtained a m.p. 1550°, and R. Nacken gave 1530° for the m.p. of chloro-apatite and 1650° for fluoro-apatite. F.p. curves of binary mixtures with calcium phosphate are shown in Figs. 68 and 69. J. Joly found the **specific heat** of a transparent green sample to be 0.1829, and of a red opaque sample, 0.1920. P. E. W. Oeberg found 0.1903 for a greyish-green sample from Gjerrestadt. F. M. Jäger found the ratio of the **thermal conductivity** in a direction parallel to the principal axis to that in a direction at right angles to this axis is 1.35 : 1. W. Voigt also made measurements of this constant.

Numerous observations of the **index of refraction** have been made.¹⁰ K. Walter's limiting values for samples from Luxullian (Cornwall), and from Malmberget (Sweden); K. Zimanyi's values for samples from Pisek; K. Busz's values for a sample from Gletsch; and M. Seebach's value for a sample from Katzenbuckel (Odenwald), are given in Table XXII. The reported values for the Na-line range

TABLE XXII.—INDEX OF REFRACTION AND DISPERSION OF APATITE.

Origin of apatite.	μ_a			μ_γ			$\mu_a - \mu_\gamma$		
	Li	Na	Tl	Li	Na	Tl	Li	Na	Tl
Luxullian .	1.6301	1.6330	1.6352	1.6287	1.6316	1.6337	0.0014	0.0014	0.0015
Gletsch .	1.6389	1.6426	1.6450	1.6372	1.6409	1.6432	0.0017	0.0017	0.0018
Malmberget .	1.6341	1.6356	1.6389	1.6319	1.6332	1.6356	0.0022	0.0024	0.0035
Katzenbuckel .	1.6328	1.6361	1.6395	1.6294	1.6325	1.6360	0.0034	0.0036	0.0035
Pisek .	1.6349	1.6381	1.6415	1.6310	1.6343	1.6377	0.0039	0.0038	0.0038
	1.6345	1.6379	1.6410	1.3303	1.6336	1.6368	0.0042	0.0043	0.0042
	1.6445	1.6482	1.6516	1.6396	1.6431	1.6465	0.0049	0.0051	0.0050

from 1.6330 to 1.6482 for μ_a ; and from 1.6316 to 1.6431 for μ_γ . The lowest is for apatite from Luxullian, and the highest for apatite from Pisek. K. Walter found the index of refraction, double refraction, and dispersion of apatite increased with increasing proportions of chlorine, but was not able to find any definite relation between the chemical composition and refractive power of apatite. J. E. Wolff and C. Palache examined a number of natural apatites, and were unable to detect any definite relation between the double refraction and the proportion of contained chlorine. K. A. Grönwall obtained the refractive indices 1.638 and 1.635 for a sample of apatite from Woodmarken. R. Nacken found for artificial chloro-apatite, $\mu_a = 1.6667 \pm 0.002$; and for fluoro-apatite, $\mu_a = 1.6325 \pm 0.001$, and $\mu_\gamma = 1.630$, or $\mu_a - \mu_\gamma = 0.003$. F. K. Cameron and W. J. McCaughey gave 1.666 for the index of refraction of chloro-apatite with Na-light, and 1.635 for fluoro-apatite. There is a linear increase in the index of refraction with increasing proportions of chloro-apatite, thus, fluoro-apatites with 13, 45, and 74 per cent. of chloro-apatite have the respective indices of refraction 1.638, 1.649, and 1.658. K. Zimanyi

found that yellowish-green apatite from Malmberget became colourless after heating to redness, and there was a small decrease in the index of refraction after the sample had been heated—the decrease was greater with the ordinary than with the extraordinary ray.

The coloured varieties of apatite exhibit **dichroism**. H. Rosenbusch,¹¹ and K. Zimanyi found that the extraordinary ray is more strongly absorbed than the ordinary ray even with colourless crystals. The latter found the ordinary and extraordinary rays to be respectively light yellow and bluish-green with pale green crystals; reddish-yellow and bluish-green with bright green crystals; brownish-yellow and yellowish-green with yellow and brown crystals; and yellowish-brown and dark green with dark yellow crystals. A. K. Coomaraswamy found blue crystals of apatite from Ceylon to have sky-blue and pale wine-red colours respectively parallel and perpendicular to the *c*-axis; and P. Termier found the red crystals from Guillestre (Hautes-Alpes) to be orange or red when viewed along the *a*-axis, and pale yellow or white when viewed along the *c*-axis. A. Karnojitzky found crystals of apatite from Ehrenfriedersdorf to exhibit anomalous **trichroism**. C. Doelter noted that crystals of apatite are optically anomalous. H. Becquerel found the extraordinary ray **absorption spectrum** of a didymiferous apatite from Spain gave numerous lines—the most prominent corresponded with $\lambda=583$; with the ordinary ray absorption spectrum, the lines $\lambda=582$ and 575 are prominent.

The **colour** of native apatite may be white, green, blue, red, yellow, grey, or brown. The colour of the mineral changes when heated—thus, K. Zimanyi¹² found greenish-yellow crystals from Malmberget became water-clear after heating to redness; J. E. Wolff and C. Palache found the deep amethyst-coloured apatite from Minot became colourless when heated to about 320° ; P. Gaubert obtained a similar result with blue apatite from Priziac; and C. Doelter found the violet apatite from Auburn became paler when heated in chlorine at 500° , and colourless if heated to the same temp. in oxygen. F. Pupke attributed the colouring matter to the presence of manganese. E. von Kraatz-Koschlaue and L. Wöhler found up to 0.02 per cent. of carbon and 0.011 per cent. of hydrogen in coloured samples and attributed the coloration to the presence of organic matter; but it must be remembered that many minerals have liquid and gaseous inclusions, and colourless minerals, in consequence, may furnish carbon dioxide and water, hence, the organic nature of the pigment has not yet been established. C. Doelter also showed that many colourless minerals are also coloured by exposure to cathode and other rays. Thus, violet-blue apatite from Auburn becomes paler and more violet by exposure to radium; ultra-violet rays darken the colour, cathode rays were without action. Colourless apatite from Pinzgan was changed to violet after 42 days' exposure to radium; and pale yellow apatite from Sulzbachtal was not changed.

All varieties of apatite so far examined are luminescent. Eupyrochroite and many phosphorites exhibit **thermo-luminescence**, and when heated, glow with a coloured light. E. Newbery and H. Lupton found that a sample of Canadian apatite which has been decolorized by heat, and recoloured brown in two days' exposure to radium, emitted a strong violet thermo-luminescence many times stronger than the original unheated specimen. The brown colour disappeared rapidly in daylight. K. Keilhack¹³ found that many apatites glow with a yellow light when exposed to **X-rays**. He found the relative intensity of the light from green apatite from Ehrenfriedersdorf to be 34; that from a red apatite from the same locality, 43; that from yellow apatite from Tyrol, 18, and from Jumilla, 14; a water-clear apatite from Sulzbachtal, 30; from a Norwegian apatite, 21; and from a Canadian apatite, 20. A. Pochettino found no luminescence with X-rays, and with **radium rays** he found a feeble yellowish-green luminescence the light of which was feebly polarized. C. Doelter found that the violet apatite from Auburn luminesced with a greenish-yellow light when exposed to the **cathode rays**, and pale yellow apatite from Sulzbachtal give a yellowish-green luminescence. L. Sohncke, and G. C. Schmidt have studied the yellowish-green **fluorescence** of apatite. The

former inferred that the fluorescing particles oscillate vertically to the chief axis, and in this plane, the fluorescence is equally strong in all directions.

According to W. G. Hankel,¹⁴ the crystals of apatite are **thermo-electric**. With most crystals, on cooling, the basal face is positively and the prism face is negatively charged—*e.g.* specimens from Tokawaia, Ehrenfriedersdorf, St. Gotthard, etc.; but more rarely the opposite effect is obtained—*e.g.* specimens from Ehrenfriedersdorf and St. Gotthard. The **dielectric constant** of apatite was found by W. Schmidt to be 7.40 parallel to and 9.50 vertical to the crystal axis, for $\lambda=75$. J. Königsberger found the **magnetic susceptibility** of apatite from Zillertal to be -1.23×10^{-6} . W. Voigt and S. Kinoshuto found no measurable difference in the diamagnetism when measured in directions parallel or vertical to the chief axis. W. Voigt found apatite to exhibit **pyromagnetism**, and also **piezomagnetism**; and the **magnetic moment** to be 0.6×10^{-6} C.G.S. units.

According to H. Rose,¹⁵ boiling water extracts a little calcium chloride from apatite, but no phosphoric acid is removed. According to G. Bischof and J. L. Lassaingne, apatite is soluble to a small extent in water sat. with carbon dioxide. A litre of water, sat. with carbon dioxide at ordinary temp. and press., dissolves 0.00254 part of apatite; and, after strongly shaking, 0.01034 part; 0.9074 part of artificially prepared undried apatite—and 0.184 part if previously dried, and 0.0321 part if previously dried and calcined. According to F. K. Cameron and J. M. Bell, water dissolved 0.002 grm. of fluoro-apatite per litre, while water sat. with carbon dioxide dissolved 0.014 grm. per litre. R. Müller also examined the action of a soln. of carbon dioxide under a press. of $3\frac{1}{2}$ atm., and after 50 days' treatment he found 1.417P₂O₅ and 1.696CaO per litre was extracted from moroxite of Hammond, 1.822P₂O₅ and 2.168CaO from apatite of Katharinenberg; 2.12P₂O₅ and 1.946CaO from apatite from Chili. The glass was not attacked. Dil. mineral acids—*hydrochloric acid*, *nitric acid*, and *sulphuric acid*—slowly dissolve apatite in the cold, more rapidly when heated. According to A. Ditte, sulphuric acid in the cold liberates some hydrogen fluoride. T. Petersen found acetic acid dissolves apatite less readily, and A. F. Rogers found that if the mineral contains carbonate, this is dissolved first. T. Dieckmann and E. Houdremont gave 10 per cent. for the solubility of apatite in *citric acid*. H. Baumhauer has studied the *corrosion figures* of apatite.

P. W. Forchhammer¹⁶ found apatite to be readily soluble in molten sodium chloride, and on cooling the apatite separates in long needles. P. A. Wagner used molten sodium chloride to separate apatite from kimberlite. B. Vukits melted one part of apatite with 18 parts of *labradorite*, and found apatite crystallizes first, and a little lime felspar (anorthite) is formed; with 9 parts of *labradorite*, the reaction is greater and anorthite first separates. It is therefore inferred that the apatite forms a complex ion, $[3\text{Ca}_3(\text{PO}_4)_2\cdot\text{Ca}]^{\cdot}$. With 5 parts of *labradorite* a calcareous plagioclase is formed. The m.p. of mixtures of one part of apatite with 5, 9, and 18 parts of *labradorite* are respectively 1210°–1220°, 1220°–1240°, and 1225°–1235°, when apatite melts at 1300° and *labradorite* at 1210°. Apatite dissolves in fused *microcosmic salt* to a clear glass which freezes to a white enamel. Fused *borax* behaves similarly, and if lead oxide is also present, W. Florence obtained crystals of sodium phosphate. According to C. F. Platner, fused sodium carbonate dissolves and decomposes apatite.

A. Ditte prepared **barium fluorophosphate**, $3\text{Ba}_3(\text{PO}_4)_2\cdot\text{BaF}_2$, or *barium fluoro-apatite*, by a process analogous to that for the corresponding calcium compound, and C. von Woyczynsky¹⁷ mixed 5.88 grms. of orthophosphoric acid with 26.24 grms. of barium nitrate dissolved in water acidified with nitric acid, and mixed with soln., in a platinum dish, with 0.7 grm. of 57 per cent. hydrofluoric acid. When neutralized with ammonia, a granular precipitate is formed which when recrystallized furnishes crystals resembling apatite. A. Ditte, and C. von Woyczynsky prepared **strontium fluorophosphate**, $3\text{Sr}_3(\text{PO}_4)_2\cdot\text{SrF}_2$, or *strontium fluoro-apatite*, in similar ways. The properties of these compounds resemble those of calcium apatite. H. St. C. Deville and H. Caron prepared hexagonal prisms of **barium chlorophosphate**, $3\text{Ba}_3(\text{PO}_4)_2\cdot\text{BaCl}_2$,

barium chloro-apatite, by melting barium orthophosphate with an excess of barium chloride. The corresponding **strontium chlorophosphate**, $3\text{Sr}_3(\text{PO}_4)_2 \cdot \text{SrCl}_2$, *strontium chloro-apatite*, was obtained in a similar manner.

H. St. C. Deville and H. Caron.¹⁸ prepared *calcium wagnerite*, $\text{Ca}_3(\text{PO}_4)_2 \cdot \text{CaCl}_2$, by melting bone-ash with an excess of calcium chloride; A. Ditte prepared it by melting calcium phosphate and chloride. The conditions under which it is formed have been previously indicated, Fig. 69. The monoclinic crystals have a sp. gr. 3.05. According to A. Ditte, when melted with sodium chloride, it is decomposed with the formation of apatite, and mixtures of calcium and sodium chlorides containing over 30 per cent. of the latter behave similarly.

E. Erlenmeyer¹⁹ has prepared a series of hydrated **calcium chloro-dihydrophosphates**. The product, $7\text{Ca}(\text{H}_2\text{PO}_4)_2 \cdot \text{CaCl}_2 \cdot 14\text{H}_2\text{O}$, crystallizes in rhombohedral plates during the spontaneous evaporation of a cold sat. soln. of normal calcium phosphate in hydrochloric acid; if the mother liquid be treated with half as much hydrochloric acid as is already present, and evaporated until crystals separate on cooling to 0° , a crop of crystals, $4\text{Ca}(\text{H}_2\text{P}^{\text{O}}_4)_2 \cdot \text{CaCl}_2 \cdot 8\text{H}_2\text{O}$, appear—the filtrate furnishes crystals of $7\text{Ca}(\text{H}_2\text{PO}_4)_2 \cdot \text{CaCl}_2 \cdot 14\text{H}_2\text{O}$. If the mother liquors from the preceding operations be evaporated on the water-bath, crystals of calcium hydrophosphate are first obtained, and then a crop of white talc-like plates of $\text{Ca}(\text{H}_2\text{PO}_4)_2 \cdot \text{CaCl}_2 \cdot 2\text{H}_2\text{O}$ separate out. These crystals are only partially soluble in water with some decomposition. If the last-named crystallization occurs at a temp. below 6° , long needles of $\text{Ca}(\text{H}_2\text{PO}_4)_2 \cdot \text{CaCl}_2 \cdot 8\text{H}_2\text{O}$ appear. E. Erlenmeyer also crystallized **barium chloro-dihydrophosphate**, $4\text{Ba}(\text{H}_2\text{P}^{\text{O}}_4)_2 \cdot \text{BaCl}_2$, from a soln. of normal barium phosphate in hydrochloric acid. R. Ludwig added ammonia to a soln. of barium hydrophosphate in hydrochloric acid (with or without the addition of barium chloride), and obtained a precipitate of variable composition; so too H. Rose extracted the soluble matter from the product obtained by calcining a mixture of phosphorus pentoxide with barium chloride, here again the residue has a variable composition.

F. Wibel²⁰ prepared what he regarded as a basic phosphate by heating to redness a mixture of calcium carbonate and normal calcium phosphate. The precipitates formed by adding a soln. of sodium phosphate to a hot soln. of calcium chloride were found by F. Wibel to contain some calcium chloride—*e.g.* $4\text{Ca}_3(\text{PO}_4)_2 \cdot \text{CaCl}_2$. According to R. Warrington, if freshly precipitated normal calcium phosphate be allowed to stand in contact with water for ten to twelve hours, a soln. with an acid reaction is obtained, and the undissolved residue contains an excess of calcium hydroxide which corresponds approximately with $\text{Ca}_3(\text{PO}_4)_2 \cdot \text{Ca}(\text{OH})_2$. C. Blarez also found that if a conc. soln. of lime-water be shaken with dil. phosphoric acid, a precipitate is obtained which contains $\text{CaO} : \text{P}_2\text{O}_5$ in the ratio 3.67 : 1, and when washed until the runnings are neutral 3.3 : 1. The mineral *isoclase* was found by F. Sandberger to approximate in composition to $\text{Ca}_3(\text{PO}_4)_2 \cdot \text{Ca}(\text{OH})_2 \cdot 4\text{H}_2\text{O}$ or tetrahydrated **calcium hydroxyphosphate**. The formula can also be represented $4\text{CaO} \cdot \text{P}_2\text{O}_5 \cdot 5\text{H}_2\text{O}$, or, with P. Groth, $\text{CaPO}_4(\text{CaOH}) \cdot 2\text{H}_2\text{O}$. The colourless crystals were considered by F. Sandberger to belong to the monoclinic system; to have the hardness $1\frac{1}{2}$ and sp. gr. 2.92. The water is readily evolved when isoclase is heated, and the crystals melt when heated before the blowpipe. The mineral is readily soluble in nitric or hydrochloric acid.

C. von Woyczynsky prepared plates, belonging to the cubic system, of **strontium hydroxyphosphate**, $\text{Sr}_3(\text{PO}_4)_2 \cdot \text{Sr}(\text{OH})_2$, by melting in a silver crucible, protected as far as possible from air, a mixture of 15 grms. of strontium hydroxide, 7 grms. of sodium hydroxide, and 6 grms. of sodium hydrophosphate. The cold mass was extracted with water. He prepared **barium hydroxyphosphate**, $\text{Ba}_3(\text{PO}_4)_2 \cdot \text{Ba}(\text{OH})_2$, in a similar manner. C. Blarez also obtained basic phosphates by shaking a dil. soln. of phosphoric acid with a conc. soln. of strontium or barium hydroxide, and washing the precipitate until the runnings were neutral.

Four kinds of crystals have been reported in basic slag: (i) brown plates; (ii) blue rhombohedra; (iii) brown needles; and (iv) blue or green pyramids. A. Carnot and A. Richard obtained blue rhombic crystals of the composition $\text{Ca}_3(\text{P}^{\text{O}}_4)_2 \cdot \text{Ca}_2\text{SiO}_4$ from Thomas slag; V. A. Kroll called the substance *carnotite*, a name likely to lead to confusion with the vanadium ore. J. E. Stead and

C. H. Ridsdale, and H. Bücking and G. Linck isolated monoclinic, pseudo-rhombic colourless or brown plates of anhydrous **calcium oxyorthophosphate**, $\text{Ca}_4\text{P}_2\text{O}_9$, *i.e.* $\text{Ca}_3(\text{PO}_4)_2\cdot\text{CaO}$, also called *tetracalcium phosphate*; V. A. Kroll called it *hilgenstockite*, after its discoverer. According to P. Termier and A. Richard, this compound has axial ratios, $a:b:c=0\cdot5773:1:1\cdot255$ and $\beta=90^\circ$. The sp. gr. is 2·9 to 3·1—H. Bücking and G. Linck gave 3·06; and the hardness is about $3\frac{1}{2}$; the m.p. 1870° (H. Blome); and the index of refraction 1·6. The brown plates are feebly pleochroic; the short prismatic crystals are also pleochroic, with different shades of blue. G. Hilgenstock prepared hexagonal colourless needles of calcium oxyphosphate by melting together the calculated quantities of lime and normal calcium phosphate, or calcium hydrophosphate, or phosphoric oxide, with fluorspar as a flux. H. Bücking and G. Linck believe that the hexagonal and monoclinic forms are really silicophosphates or phosphatosilicates—*vide supra*, Fig. 65; and their analyses of the uniaxial hexagonal clear or brownish crystals correspond with $4\text{Ca}_3(\text{PO}_4)_2\cdot\text{Ca}_3\text{SiO}_5$ —V. A. Kroll calls the black crystals *steadite* and represents the composition by the formula $3\text{Ca}_3(\text{PO}_4)_2\cdot\text{Ca}_2\text{SiO}_4\cdot 2\text{CaO}$ —and the blue pleochroic monoclinic crystals, $4\text{Ca}_3(\text{PO}_4)_2\cdot 3\text{Ca}_3\text{SiO}_5$. J. Ortlieb found brown grains of a mineral species, $4\text{CaO}\cdot 2\text{P}_2\text{O}_5\cdot\text{SiO}_2$, in the chalk of Ciply (Belgium), and he called it *ciplyte*. J. E. Stead and C. H. Ridsdale also found 1·64 per cent. of vanadium in the blue crystals. H. B. Kosmann believes the constitution of the crystals to be $\text{O}\{\text{CaO}\cdot\text{PO}(\text{O}_2\text{Ca})\}_2$; and P. Groth regards them as representing the normal salt of an acid, $\text{H}_8\text{P}_2\text{O}_9$, *i.e.* $(\text{OH})_4\text{P}\cdot\text{O}\cdot\text{P}(\text{OH})_4$. J. E. Stead and C. H. Ridsdale also found in basic slag some feathery crystals with 95 per cent. of base; and two kinds of black needle-like crystals containing calcium oxide, alumina, and ferric oxide. V. A. Kroll described crystals of $6\text{CaO}\cdot\text{P}_2\text{O}_5\cdot\text{Fe}_2\text{SiO}_4$, which he called *thomasite*, since they were found in Thomas slag. According to D. N. McArthur and A. Scott, there are at least four well-defined silicophosphates in basic slags: (i) J. E. Stead and C. H. Ridsdale's brown crystals with the ratio $\text{SiO}_2:\text{P}_2\text{O}_5=1:4$; (ii) J. E. Stead and C. H. Ridsdale's pleochroic crystals with the ratio 1:1; (iii) V. A. Kroll's octobasic compound with the ratio 1:1; and (iv) one which they themselves describe with the ratio 3:1. V. A. Kroll, and E. Steinweg found that the slow cooling of the slags favoured the formation of silicophosphates. The nature of basic slags has been discussed by E. Jensch, A. Frank, H. von Jüptner, etc.

A. von Groddeck and K. Broockmann found crystals analogous with $\text{Ca}_4\text{P}_2\text{O}_9$. H. Blome found the crystals of $\text{Ca}_4\text{P}_2\text{O}_9$, or $\text{CaO}\cdot\text{Ca}_3(\text{PO}_4)_2$, to have a m.p. of 1870° . H. Otto stated that the compound is readily soluble in dil. acetic, hydrochloric, or nitric acid; and is decomposed by dil. sulphuric or citric acid. According to R. Hartleb, calcium oxyorthophosphate, $4\text{CaO}\cdot\text{P}_2\text{O}_5$, *i.e.* $\text{Ca}_3(\text{PO}_4)_2\cdot\text{CaO}$, rarely occurs in basic slag, and that even without this, the slag may be very soluble in a soln. of citric acid. Calcium oxyorthophosphate is almost insoluble in a soln. of citric acid, while normal calcium phosphate is completely soluble. E. Dittler has further investigated this subject. Ammonium citrate extracts all the phosphoric acid; and 100 c.c. of water sat. with carbon dioxide dissolves 0·02 grm. According to O. Förster, when calcium oxyorthophosphate is treated with water, it passes first into calcium hydrophosphate, CaHPO_4 , and calcium hydroxide; and it then forms a compound, $\text{Ca}_3(\text{PO}_4)_2\cdot\text{Ca}(\text{OH})_2$, from which calcium hydroxide extracts no calcium hydroxide, and it is hence supposed to be a true compound and not a mechanical mixture. The compound is soluble in citric acid, but the product obtained by heating calcium oxide and phosphate is not soluble in that menstruum. A soln. of the crystals in very dil. nitric acid gives a precipitate of silver phosphate, Ag_3PO_4 , when treated with silver nitrate.

H. Bassett found no evidence of the existence of tetracalcium salt, $\text{Ca}_4\text{P}_2\text{O}_9$, in his study of the ternary system, $\text{CaO}-\text{P}_2\text{O}_5-\text{H}_2\text{O}$; but he obtained what he regarded as *hydroxyapatite*, $3\text{Ca}_3(\text{PO}_4)_2\cdot\text{Ca}(\text{OH})_2$ —**calcium hydroxyhexaphosphate**. The region of stability of this compound is fairly extensive, and reaches very nearly

to the point representing the solubility of calcium hydroxide; the solubility curve extends from markedly acid, through neutral, to markedly alkaline soln. Of all the calcium phosphates this is the only one not decomposed by water; it can dissolve unchanged in water, but the sat. soln. is extremely dil. The isotherm at 25° is shown in Fig. 70. R. Warington showed that by repeatedly extracting normal calcium phosphate with boiling water, a product is finally obtained with analyses corresponding closely with hydroxyapatite, and K. Buch's experiments on the action of water on calcium hydrophosphate point in the same direction. There is also the Norwegian mineral *völckerite* with a composition approximating $3\text{Ca}_3(\text{PO}_4)_2 \cdot \text{CaO}$, or *oxyapatite*, which A. F. Rogers believes to be isomorphous with apatite. O. Förster obtained this substance as a residue when basic slag is treated with citric acid. T. Dieckmann and E. Houdremont prepared oxyapatite, or

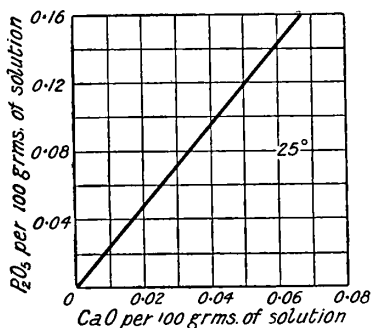

FIG. 70.—Isothermal Solubility Curve for Basic Calcium Phosphate.

calcium oxyhexaphosphate, $3\text{Ca}_3(\text{PO}_4)_2 \cdot \text{CaO}$, of sp. gr. 2.99; m.p., 1540°; and percentage solubility in citric acid, 67.

The salt $3\text{Ca}_3(\text{PO}_4)_2 \cdot \text{CaO}$ is usually regarded as a basic salt in that it contains more base than corresponds with the normal salt. H. Bassett suggests that hydroxy- or oxy-apatite, and possibly normal calcium phosphate, are related to calcium hydro- and dihydro-phosphate, much as an orthophosphate is related to a pyrophosphate, so that hydroxyapatite is the salt of an acid, $\text{H}_{11}\text{P}_3\text{O}_{13}$, in which one acidic hydrogen atom is not neutralized. The great difficulty involved in the expulsion of the water is taken to indicate that it is directly associated with the acid rather than with the base. The halogen of fluoro- or chloro-apatite is then regarded as being directly attached to the phosphorus. The compound $\text{CaO} \cdot 2\text{POCl}_3$ is regarded as a chloro-derivative of calcium dihydrophosphate, **calcium hexahydroxy phosphate**, $\text{CaO} \cdot 2(\text{OH})_3 \cdot \text{P} \cdot \text{O}$, i.e. of $\text{Ca}(\text{H}_2\text{PO}_4)_2 \cdot \text{H}_2\text{O}$. If hydroxyapatite has the formula $3\text{Ca}_3(\text{PO}_4)_2 \cdot \text{Ca}(\text{OH})_2 \cdot \text{H}_2\text{O}$, the corresponding acid is $\text{H}_{24}\text{P}_6\text{O}_{27}$, i.e. $3\text{H}_3\text{P}_2\text{O}_9$, an acid which has the greatest range of existence of all the phosphoric acids.

The liquid from which bone is deposited in animal tissues is very nearly neutral; and, although complicated by the presence of additional salts, the conditions are probably similar, so far as calcium salts are concerned, to those of the simpler ternary system, $\text{CaO} - \text{P}_2\text{O}_5 - \text{H}_2\text{O}$. Hydroxyapatite is the stable phase in soln. with the degree of acidity characteristic of animal tissues. S. Gabriel²¹ has analyzed *bone phosphate* prepared by digesting dry powdered bone with a glycerol soln. of potassium hydroxide at 180°–200°, and obtained the results indicated in Table XXIII.

TABLE XXIII.—S. GABRIEL'S ANALYSES OF BONE PHOSPHATE.

Per cent. of	Human bone.	Goose bone.	Ox bone.	Ox teeth.	Ox teeth.	
					Enamel.	Remainder.
CaO	51.31	51.01	51.28	50.70	51.98	50.36
MgO	0.77	1.27	1.05	1.52	0.53	1.83
K ₂ O	0.32	0.19	0.18	0.20	0.20	0.14
Na ₂ O	1.04	1.11	1.09	1.16	1.10	0.80
Water of crystallization	2.46	3.05	2.33	2.21	1.80	2.90
P ₂ O ₅	36.65	38.19	37.46	38.88	39.70	38.60
CO ₂	5.86	4.11	5.06	4.09	3.23	3.97
Cl	0.01	0.06	0.04	0.05	0.21	0.03
Water of constitution	1.32	1.07	1.37	1.27	1.17	1.25
Total	99.74	100.06	99.86	100.08	99.92	99.88

The alkali in the analyses was not derived from the glycerol soln. The product was a white powder showing the structure of the original bone, and almost free from organic matter. When this product is heated over a small flame in a platinum crucible, carbon dioxide begins to be evolved before the bottom of the crucible is red hot, and he therefore believes that the carbon dioxide is not present as calcium or magnesium carbonate, but rather as a phosphato-carbonate or carbonato-phosphate. H. Bassett has recalculated the data in Table XXIII, and shown that the most probable conclusion is that the mineral constituents of bone consist in the main of hydroxyapatite, $(\text{Ca}_3\text{P}_2\text{O}_8)_3\text{Ca}(\text{OH})_2$, mixed with a certain amount of calcium carbonate. In addition to these chief constituents, there are also small amounts of the bicarbonates of magnesium, sodium, and potassium, which appear to be merely adsorbed by the aggregate of phosphate and carbon. The small amount of chloride also present is probably also adsorbed in the form of sodium chloride, although it may be present as chloroapatite. Several other investigators—J. H. Aeby, W. Heintz, R. Müller, E. Erlenmeyer, etc.—have suggested that the inorganic base of bones is a basic calcium phosphate. W. Heintz also suggested that teeth contain a basic calcium phosphate. J. H. Aeby also found the composition of bone phosphate to be $6\text{Ca}_3(\text{PO}_4)_2 \cdot \text{Ca}(\text{OH})_2 \cdot \text{CaCO}_3 \cdot 4\text{H}_2\text{O}$, or $3\text{Ca}_3(\text{PO}_4)_2 \cdot \text{Ca}(\text{OH})_2 \cdot 2\text{H}_2\text{O}$, although F. Wibel held that the composition of bone phosphate is not constant. H. Bassett also added that similar remarks apply to *soil phosphates*. He said:

The range of acidity or alkalinity in most ordinary soils comes well within the range over which hydroxyapatite is the stable calcium phosphate, and it seems certain that it is the only such phosphate that can exist permanently in the soil. Any other phosphate added to it will be converted into hydroxyapatite with greater or less readiness according to circumstances. It has long been recognized that calcium hydrophosphate added to the soil in superphosphate very quickly ceases to be present as such, although it is generally stated to revert to normal calcium phosphate. By adding the phosphate in the form of superphosphate, the hydroxyapatite is obtained in a finely divided state, which is important owing to its sparing solubility. Finely ground basic slag when added to the soil will also be converted fairly quickly into hydroxyapatite, whether it contains tetracalcium phosphate, or some other compound possibly more closely related to hydroxyapatite. It is highly probable that the earthy phosphorites and coprolites are impure mixtures of hydroxyapatite and calcium carbonate, and it is known that when extremely finely ground they give satisfactory results when used directly as fertilizers. Under the conditions which have led to the accumulation of phosphatic deposits, a certain amount of replacement of the hydroxyl of hydroxyapatite by chlorine or fluorine has occurred, owing no doubt to the action of saline soln.

REFERENCES.

- ¹ H. Rosenbusch, *Mikroskopische Physiographie der Mineralien und Gesteine*, Stuttgart, 1. ii, 108, 1905; A. Osann, *Rosenbusch's Festschrift*, 288, 1906; *Rep. Geol. Sur. Canada*, 12, 11, 1899; O. Lang, *Zeit. deut. geol. Ges.*, 31, 484, 1879; W. C. Brögger and H. H. Reusch, *ib.*, 27, 646, 1875; *Nyt. Mag. Nat. Vidensk.*, 25, 1880; H. Sjogren, *Geol. För. Förh.*, 6, 447, 1883; J. H. L. Vogt, *ib.*, 6, 783, 1883; W. B. Dawkins, *Trans. Manchester Geol. Soc.*, 18, 47, 1885; G. H. and G. A. Kinahan, *ib.*, 18, 123, 1885; O. Stutzer, *Die wichtigsten Lagerstätten der Nichterze*, Berlin, 1911.
- ² J. H. L. Vogt, *Trans. Amer. Inst. Min. Eng.*, 31, 134, 1901; *Zeit. prakt. Geol.*, 458, 1894; 367, 444, 465, 1895; *Ueber die Mineralbildung in Silikat schmelzmassen*, Christiania, 263, 1903; W. M. Hutchings, *Nature*, 36, 460, 1887; J. E. Stead and C. H. Ridsdale, *Journ. Chem. Soc.*, 51, 601, 1887; S. Meunier, *Les méthodes de synthèse en minéralogie*, Paris, 74, 1891; C. Vélain, *Bull. Soc. Min.*, 1, 113, 1878; A. Damour, *Ann. Mines*, (5), 10, 65, 1856.
- ³ A. G. Werner, *Gerhard's Grundr.*, 281, 1786; *Berg. Journ.*, 576, 1788; 378, 1789; 74, 1790; M. H. Klaproth, *Berg. Journ.*, 1, 396, 1788; L. N. Vauquelin, *Journ. Min.*, 7, 26, 1798; B. Pelletier and L. Donadei, *Mém. Obs. Chim.*, 1, 309, 1798; G. Rose, *Pogg. Ann.*, 9, 205, 1827.
- ⁴ T. Scheerer, *Nyt. Mag. Nat. Vidensk.*, 5, 308, 1848; A. Cossa, *Atti Accad. Lincei*, 3, 17, 1878; *Mem. Accad. Torino*, 28, 309, 1878; A. Knop, *Ber. Oberrhein. Geol. Ver. Frankfurt*, 17, 1, 1884; W. C. Brögger, *Zeit. Kryst.*, 16, 70, 1890; W. C. Brögger and H. Bäckström, *ib.*, 17, 426, 1890; H. Fischer, *ib.*, 4, 374, 1880; F. Zambonini, *ib.*, 40, 223, 1905; F. Grünling, *ib.*, 33, 217, 1900; J. König, *ib.*, 18, 40, 1890; G. H. Williams, *Rep. Geol. Sur. Arkansas*, 2, 1890; P. Jannasch and J. Locke, *Zeit. anorg. Chem.*, 7, 154, 1894; *Ber.*, 43, 3135, 1910; J. A. Völcker, *ib.*, 16, 2460, 1883; *Die chemische Zusammensetzung des Apatits*, Giessen, 1883; N. S. Maskelyne and W. Flight, *Journ. Chem. Soc.*, 24, 3, 1871; J. E. Wolff and C. Palache, *Proc. Amer. Acad.*, 37, 517, 1902; I. Bellucci and L. Grassi, *Gazz. Chim. Ital.*, 49, ii, 232, 1919; G. Flink, *Medd. om*

Grönland, 24. 7, 1899; J. L. Hoskyns-Abrahall, *Über die Zusammensetzung des Apatits*, München, 1889; W. Mayer, *Liebig's Ann.*, 101. 281, 1857; C. Brommeis, *ib.*, 79. 1, 1851; R. Bluhme, *ib.*, 94. 354, 1855; E. Schröder, *ib.*, 101. 283, 1857; P. Pusirewsky, *Proc. Min. Soc. St. Petersburg*, 59, 1862; G. C. Hoffmann, *Rep. Geol. Sur. Canada*, 1, 1879; W. Pettersson, *Neues Jahrb. Min. B.B.*, 24. 639, 1907; J. Lehder, *ib.*, 22. 73, 1906; L. Kraft, *ib.*, 15. 13, 1902; K. Walter, *ib.*, 23. 581, 1907; *Centr. Min.*, 760, 1906; A. Sachs, *ib.*, 421, 1903; W. Tschirwinsky, *ib.*, 279, 1907; A. Damour, *Ann. Mines*, (5), 10. 65, 1856; A. Carnot, *ib.*, (9), 10. 140, 1896; *Bull. Soc. Min.*, 19. 214, 1896; H. Rowan, *Chem. News*, 50. 208, 1884; R. Sachse, *Neues Jahrb. Min.*, i, 267, 1889; A. Schertel, *ib.*, i, 267, 1889; A. Hilger, *ib.*, i, 172, 1885; W. Tschirwinsky, *ib.*, ii, 70, 1911; O. Förster, *ib.*, 716, 1866; J. C. H. Mingaye, *Rep. Geol. Sur. N.S. Wales*, 6. 116, 1898; J. Clement, *Bull. Mus. Belgique*, 5. 159, 1888; C. F. Rammelsberg, *Handbuch der Mineralchemie*, Berlin, 1. 297, 1875; *Pogg. Ann.*, 85. 297, 1852; G. Rose and R. Weber, *ib.*, 84. 310, 1851; P. Waage, *Zeit. deut. geol. Ges.*, 27. 674, 1883; A. Schwantke, *Centr. Min.*, 641, 1905; W. C. Hancock, *Journ. Geol. Soc.*, 59. 91, 1903; S. L. Penfield, *Amer. Journ. Science*, (3), 19. 367, 1880; F. P. Dewey, *ib.*, (3), 19. 367, 1880; J. E. Whitfield, *ib.*, (3), 19. 207, 1880; W. T. Schaller, *ib.*, (4), 30. 309, 1910; A. F. Rogers, *ib.*, (4), 33. 475, 1912; *Zeit. Kryst.*, 52. 213, 1913; L. J. Igelström, *Bull. Soc. Min.*, 5. 303, 1882; M. Siewert, *Zeit. deut. geol. Naturwiss.*, 10. 350, 1874; M. Weibull, *Geol. För. Förh.*, 8. 492, 1886; A. Frenzel, *Tschermak's Mitt.*, 3. 364, 1880; R. Hermann, *Journ. prakt. Chem.*, (1), 31. 101, 1844; K. Mauzelius, *Medd. om Grönland*, 24. 1, 1899; G. Grewingk, *Beiträge zur Kenntnis der gross Phosphoritzone Russlands*, Dorpat, 1871; O. Helm, *Schrift. Naturfor. Ges. Danzig*, (2), 6. 240, 1885; L. Schlucht, *Ueber Phosphate*, Leipzig, 1900; O. Stutzer, *Die wichtigsten Lagerstätten der Nichterze*, Berlin, 304, 1911; N. Sahlbom, *Bull. Geol. Inst. Upsala*, 4. 83, 1898; W. Wicke, *Journ. Landwirtschaft*, 16. 219, 1868; P. N. Garza and L. Penuelas, *Bull. Soc. Geol.*, 17. 157, 1860; D. Forbes, *Phil. Mag.*, (4), 29. 340, 1865; T. Petersen, *Ber. Offenbach. Ver. Natur.*, 8. 69, 1868; I. Bellucci and L. Grassi, *Gazz. Chim. Ital.*, 49. 232, 1920; A. Barillé, *Répert. Pharm.*, 145, 1901; *Compt. Rend.*, 137. 566, 1903.

⁵ A. Ditte, *Ann. Chim. Phys.*, (6), 8. 511, 1886; A. H. Church, *Ber.*, 5. 1062, 1872.

⁶ R. J. Häüy, *Traité de minéralogie*, Paris, 1. 504, 1822; H. St. C. Deville and H. Caron, *Ann. Chim. Phys.*, (3), 67. 447, 1863; *Compt. Rend.*, 47. 985, 1863; H. Debray, *ib.*, 52. 43, 1861; 59. 42, 1864; A. Ditte, *ib.*, 96. 575, 846, 1226, 1883; 99. 792, 967, 1884; A. Daubrée, *ib.*, 32. 625, 1851; *Ann. Mines*, (4), 19. 654, 1851; N. S. Manross, *Liebig's Ann.*, 82. 338, 1852; H. Briegleb, *ib.*, 97. 95, 1856; G. Forchhammer, *ib.*, 90. 77, 1854; E. Weinschenk, *Zeit. Kryst.*, 17. 489, 1890; R. Nacken, *Centr. Min.*, 545, 1912; H. Rosenbusch, *Mikroskopische Physiographie der Mineralien und Gesteine*, Stuttgart, 1. ii, 108, 1905; G. Nordenskjöld, *Geol. För. Förh.*, 15. 460, 1893; H. V. Thiberg, *ib.*, 1. 84, 1872; A. Sjögren, *ib.*, 7. 666, 1885; F. K. Cameron and W. J. McCaughey, *Journ. Phys. Chem.*, 15. 463, 1911; T. Dieckmann and E. Houdremont, *Zeit. anorg. Chem.*, 120. 129, 1920; F. Bainbridge, *Trans. Faraday Soc.*, 16. 302, 1921; *Carnegie Scholarship Mem.*, 10. 1, 1920; N. Sheldon, *Trans. Faraday Soc.*, 16. 310, 1921; N. T. de Saussure, *Bull. Soc. Philom.*, 1. 102, 1807; *Ann. Chem. Phys.*, (1), 65. 189, 1808.

⁷ V. Goldschmidt, *Index der Kristallformen der Mineralien*, Berlin, 1. 231, 1886; P. Pusirewsky, *Proc. Russ. Min. Soc.*, 1. 1860; 59, 1862; H. Baumhauer, *Zeit. Kryst.*, 18. 31, 1891; J. E. Wolff and C. Palache, *ib.*, 36. 446, 1902; P. Groth, *Chemische Kristallographie*, Leipzig, 2. 826, 1908; A. F. Rogers, *Zeit. Kryst.*, 52. 213, 1913.

⁸ C. Vrba, *Zeit. Kryst.*, 15. 463, 1889; T. A. Jaggar, *ib.*, 29. 274, 1898; S. L. Penfield, *Amer. Journ. Science*, (3), 19. 367, 1880; P. Pusirewsky, *Proc. Russ. Min. Soc.*, 59, 1862; R. Nacken, *Centr. Min.*, 547, 1912; J. A. Douglas, *Journ. Geol. Soc.*, 63. 145, 1907; H. St. C. Deville and H. Caron, *Ann. Chim. Phys.*, (3), 67. 443, 1863; G. Forchhammer, *Pogg. Ann.*, 91. 568, 1864; A. Daubrée, *Ann. Min.*, (4), 19. 684, 1851; F. K. Cameron and W. J. McCaughey, *Journ. Phys. Chem.*, 15. 463, 1911; G. Nordenskjöld, *Geol. För. Förh.*, 15. 460, 1893; K. A. Grönwall, *ib.*, 38. 411, 1916; F. Auerbach, *Wied. Ann.*, 43. 61, 1891; 45. 262, 1892; 53. 1000, 1894; 58. 357, 1896; A. Rosiwal, *Mitt. Wien. Min. Geol.*, 69, 1917; F. Rinne and J. Lorenz, *Ber. Sächs. Akad. Leipzig*, 73. 249, 1921; T. Dieckmann and E. Houdremont, *Zeit. anorg. Chem.*, 120. 129, 1920; H. Haga and F. M. Jaeger, *Versl. Akad. Amsterdam*, 24. 443, 460, 1135, 1403, 1410, 1412, 1910.

⁹ R. Cusack, *Proc. Roy. Irish Acad.*, (3), 4. 399, 1897; C. Doelter, *Tschermak's Mitt.*, 22. 316, 1903; A. Bran, *Arch. Sciences Genève*, 13. 217, 1902; R. Nacken, *Centr. Min.*, 549, 1912; J. Joly, *Proc. Roy. Soc.*, 41. 250, 1887; P. E. W. Oeberg, *Oefvers. Vet. Akad. Förh.*, 8. 43, 1885; F. M. Jäger, *Arch. Sciences Genève*, 22. 240, 1906; W. Voigt, *Gött. Nachr.*, 87, 1903; T. Dieckmann and E. Houdremont, *Zeit. anorg. Chem.*, 120. 129, 1920.

¹⁰ K. Walter, *Neues Jahrb. Min. B.B.*, 23. 636, 1907; J. E. Wolff, *Zeit. Kryst.*, 36. 445, 1902; L. Brugnattelli, *ib.*, 36. 100, 1902; K. Zimanyi, *ib.*, 22. 332, 1894; 39. 514, 1904; 40. 282, 1905; F. Zambonini, *ib.*, 40. 222, 1905; 37. 730, 1903; J. E. Wolff and C. Palache, *ib.*, 36. 447, 1902; K. Busz, *Centr. Min.*, 753, 1906; R. Nacken, *ib.*, 546, 1912; L. Weber, *ib.*, 594, 1909; P. Gaubert, *Bull. Soc. Min.*, 30. 104, 1907; 28. 186, 1905; M. Seebach, *Verh. nat. med. Ver. Heidelberg*, (2), 11. 460, 1912; H. Rosenbusch, *Mikroskopische Physiographie der Mineralien und Gesteine*, Stuttgart, 1. ii, 107, 1905; J. C. Heusser, *Pogg. Ann.*, 87. 468, 1852; F. K. Cameron and W. J. McCaughey, *Journ. Phys. Chem.*, 11. 463, 1911; K. A. Grönwall, *Geol. För. Förh.*, 38. 411, 1916.

¹¹ H. Rosenbusch, *Mikroskopische Physiographie der Mineralien und Gesteine*, Stuttgart, 1. ii, 107, 1905; K. Zimanyi, *Zeit. Kryst.*, 39. 518, 1904; A. K. Coomaraswamy, *Journ. Geol. Soc.*, 58. 399, 1902; P. Termier, *Bull. Soc. Min.*, 23. 49, 1900; A. Karnojitzky, *Proc. Russ. Min. Soc.*

27. 434, 1891; C. Doelter, *Neues Jahrb. Min.*, ii, 220, 1884; H. Becquerel, *Ann. Chim. Phys.*, (6), 14. 170, 1888.

¹² K. Zimanyi, *Zeit. Kryst.*, 39. 518, 1904; J. E. Wolf and C. Palache, *ib.*, 36. 444, 1902; P. Gaubert, *Bull. Soc. Min.*, 25. 359, 1902; C. Doelter, *Das Radium und die Farben*, Dresden, 1910; E. von Kraatz-Koschlau and L. Wöhler, *Tschermak's Mitt.*, 18. 319, 1899; E. Newbery and H. Lupton, *Mem. Proc. Manchester Lit. Phil. Soc.*, 62. 10, 1918; F. Pupke, *Die optischen Anomalien bei Apatit*, Bonn, 1908.

¹³ K. Keilhack, *Zeit. deut. geol. Ges.*, 131, 1898; A. Pochettino, *Rend. Accad. Lincei*, (5), i, 14. 505, 1905; (5), ii, 220, 1905; L. Sohneke, *Wied. Ann.*, 58. 417, 1896; G. C. Schmidt, *ib.*, 60. 740, 1897; C. Doelter, *Das Radium und die Farben*, Dresden, 30, 1910.

¹⁴ W. G. Hankel, *Abhand. Sächs. Ges. Wiss. Leipzig*, 12. 1, 1878; J. Königsberger, *Wied. Ann.*, 66. 698, 1898; W. Voigt, *Gött. Nachr.*, 1, 1901; W. Voigt and S. Kinoshuto, *ib.*, 123, 270, 1907; W. Schmidt, *Ann. Physik*, (4), 9. 919, 1902; (4), 11. 114, 1903.

¹⁵ H. Rose, *Pogg. Ann.*, 82. 559, 1851; J. L. Lassaigne, *Compt. Rend.*, 23. 1019, 1846; R. Müller, *Tschermak's Mitt.*, 2.5, 1877; G. Bischof, *Lehrbuch der chemischen und physikalischen Geologie*, Bonn, 2. 242, 1864; A. F. Rogers, *Zeit. Kryst.*, 52. 212, 1913; T. Petersen, *Ber. Offenbach Ver. Natur.*, 8. 69, 1868; H. Baumhauer, *Sitzber. Bayr. Akad.*, 169, 1875; *Sitzber. Akad. Berlin*, 863, 1887; 447, 1890; *Die Resulte der Aetzmethode*, Leipzig, 47, 1894; F. K. Cameron and J. M. Bell, *The Action of Water and Aqueous Solutions upon Soil Phosphates*, Washington, 1907; A. Ditte, *Compt. Rend.*, 99. 792, 1884; T. Dieckmann and E. Houdremont, *Zeit. anorg. Chem.*, 120. 129, 1920.

¹⁶ P. W. Forchhammer, *Liebig's Ann.*, 90. 77, 1854; P. A. Wagner, *Centr. Min.*, 550, 1909; B. Vukits, *ib.*, 739, 1904; W. Florence, *Neues Jahrb. Min.*, ii, 141, 1898; C. F. Plattner, *Probierkunde mit dem Löthrohr*, Leipzig, 1897.

¹⁷ C. von Woyczynsky, *Zeit. anorg. Chem.*, 6. 310, 1894; A. Ditte, *Compt. Rend.*, 99. 794, 1884; H. St. C. Deville and H. Caron, *Ann. Chim. Phys.*, (3), 67. 451, 1863.

¹⁸ H. St. C. Deville and H. Caron, *Ann. Chim. Phys.*, (3), 67. 458, 1863; A. Ditte, *Compt. Rend.*, 94. 1594, 1882; R. Naeken, *Centr. Min.*, 545, 1912.

¹⁹ E. Erlenmeyer, *Neues Jahrb. Pharm.*, 7. 225, 1857; *Ueber Bildung und Zusammensetzung des so genannten sauren phosphorsaurcn Kalk*, Heidelberg, 1857; R. Ludwig, *Arch. Pharm.*, (2), 56. 265, 1847; H. Rose, *Pogg. Ann.*, 8. 211, 1826.

²⁰ R. Hartleb, *Zeit. öffent. Chem.*, 17. 381, 1911; K. Buch, *Zeit. anorg. Chem.*, 52. 323, 1907; R. Warington, *Journ. Chem. Soc.*, 26. 933, 1873; J. E. Stead and C. H. Ridsdale, *ib.*, 51. 601, 1887; H. Bassett, *ib.*, 111. 620, 1917; C. Blarez, *Compt. Rend.*, 108. 264, 1886; J. H. Aeby, *Journ. prakt. Chem.*, (2), 5. 308, 1872; (2), 6. 169, 1872; (2), 7. 37, 1873; (2), 9. 469, 1874; R. Müller, *ib.*, (1), 80. 193, 1860; F. Sandberger, *ib.*, (2), 2. 126, 1870; *Neues Jahrb. Min.*, 307, 1870; P. Groth, *Tabellarische Uebersicht der Mineralien*, Braunschweig, 96, 1898; *Chemische Krystallographie*, Leipzig, 2. 817, 1908; W. Heintz, *Pogg. Ann.*, 77. 267, 1849; F. Wibel, *Ber.*, 7. 220, 1874; G. Hilgenstock, *Stahl Eisen*, 3. 498, 1883; 6. 525, 719, 1886; 7. 557, 1887; 9. 498, 1889; H. Bücking and G. Linck, *ib.*, 7. 245, 1887; H. B. Kosmann, *ib.*, 7. 171, 1887; A. von Groddeck and K. Broockmann, *ib.*, 2. 237, 1888; 3. 141, 1884; H. Blome, *ib.*, 30. 2161, 1910; *Beiträge zur Konstitution der Thomasschlacke*, Berlin, 1910; *Met.*, 7. 659, 698, 1910; E. Dittler, *Doelter's Handbuch der Mineralchemie*, Dresden, 3. 368, 1914; J. Ortlieb, *Ann. Soc. Géol. Nord*, 16. 270, 1889; A. F. Rogers, *Amer. Journ. Science*, (4), 33. 475, 1912; *Min. Mag.*, 17. 155, 1914; *Zeit. Kryst.*, 52. 213, 1913; C. von Woyczynsky, *Zeit. anorg. Chem.*, 6. 311, 1894; O. Nielsen, *Ferrum*, 10. 97, 1913; A. Carnot, *Ann. Mines*, (9), 8. 300, 1895; A. Carnot and A. Richard, *Compt. Rend.*, 97. 320, 1883; *Bull. Soc. Min.*, 6. 237, 1883; P. Termier and A. Richard, *ib.*, 18. 391, 1895; H. Otto, *Chem. Ztg.*, 11. 255, 1887; O. Förster, *Zeit. angew. Chem.*, 5. 13, 1892; E. Erlenmeyer, *Zeit. Chem.*, (1), 3. 570, 1860; M. Popp, *Vers. deut. Naturfors. Wien*, 1913; M. Popp, J. Coutzen, H. Hoffer, and H. Mentz, *Journ. Landw. Ver. Stat.*, 79. 229, 1913; T. Dieckmann and E. Houdremont, *Zeit. anorg. Chem.*, 120. 129, 1920; V. A. Kroll, *Journ. Iron Steel Inst.*, 80. 126, 1911; *Stahl Eisen*, 28. 675, 1908; 31. 2020, 1911; E. Steinweg, *Zeit. deut. Ges. Hütt.*, 9. 28, 1912; D. N. McArthur and A. Scott, *Journ. West Scotland Iron Steel Inst.*, 29. 79, 1922; E. Jensch, *Ber.*, 19. 3093, 1886; A. Frank, *Tagebl. Naturfor. Berlin*, 118, 1886; H. von Jüptner, *Journ. Iron Steel Inst.*, 59. 276, 1900.

²¹ S. Gabriel, *Zeit. physiol. Chem.*, 13. 257, 1894; T. Gassmann, *ib.*, 70. 161, 1910; J. H. Aeby, *Journ. prakt. Chem.*, (2), 5. 308, 1872; (2), 6. 169, 1872; (2), 7. 37, 1873; *Ber.*, 7. 555, 1874; F. Wibel, *Journ. prakt. Chem.*, (2), 9. 113, 1874; R. Müller, *ib.*, (1), 80. 193, 1860; W. Heintz, *Pogg. Ann.*, 77. 267, 1849; E. Erlenmeyer, *Ueber Bildung und Zusammensetzung des so genannten sauren phosphorsaurcn Kalk*, Heidelberg, 1857; *Zeit. Chem.*, (1), 3. 570, 1860; G. Schein, *Untersuchungen über die chemische Zusammensetzung des Knochens an verschiedenen Körperstellen und bei verschiedenen Behandlungsmethoden*, Halle, 1913; H. Bassett, *Journ. Chem. Soc.*, 111. 620, 1917; G. S. Robertson, *Basic Slags and Rock Phosphates*, Cambridge, 1922.

§ 31. Some Relations between Calcium, Strontium, and Barium

The elements of the alkaline earths—calcium, strontium, and barium—exhibit a close kinship and display a gradation in their properties from member to member as the atomic weight increases in passing from calcium to barium. The elements

become more active chemically as their atomic weight increases; the sp. gr. of the elements and compounds increase; the basic properties and solubilities of the hydroxides increase; and the solubilities of the halides, nitrates, sulphates, and chromates decrease. The physical properties of the elements are indicated in Table XXIV.

TABLE XXIV.—PHYSICAL PROPERTIES OF THE ALKALINE EARTH METALS.

—	Calcium.	Strontium.	Barium.
At. wt.	40·09	87·63	137·37
Sp. gr.	1·52	2·55	3·75
At. vol.	26·4	35·15	36·6
M.p.	780°	800°	850°
Sp. ht.	0·152	—	0·068
Flame coloration	Brick-red	Crimson	Green
Heat of formation of monoxide R''O Cals.	131·3	130·98	130·38

The metals are fairly stable in air; they quickly tarnish in ordinary air; and when heated, they burn to the monoxide; they are all bivalent; they combine with water with the evolution of hydrogen at ordinary temperatures; and form soluble oxides of the type R''O, hydroxides of the type R''(OH)₂, and peroxides of the type R''O₂. The salts are discussed under "Chlorides," "Sulphates," "Nitrates," "Sulphides," etc. The normal carbonates are but sparingly soluble in water; the unstable acid carbonates are more soluble. The low solubility of the carbonates, chromates, and sulphates is utilized in analytical work. All three carbonates are precipitated when ammonium carbonate is added to solutions of their salts. Radium, in this family of elements, will be discussed later.

INDEX

A

- Absorption index, 47
 Acquerite, 300
 Aerugo nobilis, 76, 270
 Aes, 2
 — cuprium, 2
 — cyprium, 2
 Aguilarite, 300
 Aikenite, 7
 Alabaster, 760
 Algodonite, 7
 Alloy, 358
 Alluvial gold, 491
 Alstonite, 662, 625, 834
 Amalgam, 300
 — gold, 494
 — tables, 498
 Amalgamation, 303
 — European process, 303
 — Mexican process, 303
 — process, gold, 495
 Ammonium ammino-iodocuprite, 205
 — argentofluoride, 390
 — barium dimetaphosphate, 893
 — — trimetaphosphate, 894
 — bromoaurate, 607
 — bromocuprate, 200
 — calcium copper tetrasulphate, 811
 — — cupric tetrasulphate, 813
 — — dimetaphosphate, 894
 — — disulphate, 812
 — — hexasulphate, 812
 — — phosphate, 878
 — — trisulphate, 81
 — chloride, $\text{BaCl}_2\text{—CuCl}_2\text{—H}_2\text{O}$, 716, 720
 — chloroaurates, 594
 — chlorocuprate, 185
 — cupri-tetrafluoride, 156
 — — trifluoride, 156
 — cupric calcium tetrasulphate, 813
 — — diammino-iodide, 209
 — — dimetaphosphate, 292-3
 — — sulphate, 255
 — — tetrammino-iodide, 209
 — cuprous orthophosphate, 287
 — diammino tetrachlorocuprate, 186
 — dibromocuprite, 195
 — dichlorocuprite, 163
 — dichlorodicuprite, 163
 — dicupric sulphate, 255
 — disulphatocuprate, 255
 — iodocuprite, 205
 — nitratoaurate, 616
 — pentachlorocuprite, 163
 — phosphatocuprite, 287
 — potassium calcium disulphate, 812
 — Ammonium potassium disulphatocuprite, 259
 — — silver chloroaurates, 595
 — — nitrate, 479
 — strontium dimetaphosphate, 894
 — syngenite, 812
 — tetrasulphocuprate, 227
 — triammino-bromocuprite, 195
 — triammino-cuprite, 205
 — tribromocuprite, 195
 — trichlorocuprate, 184
 — trichlorocuprite, 163
 — trifluorocuprate, 156
 — trisulphato-cuprate, 255
 Angle of principal incidence, 47
 Anhydrite, 623, 761
 — soluble, 769
 Anode mud, 27
 — slime, 27
 Antimonial silver, 300
 Antlerite, 265
 Apatite, 623, 697, 896
 Aragonite, 622, 814
 Arg, 295
 Argat, 295
 Argenterie niellée, 447
 Argentic acid, 483
 Argentite, 300, 438
 Argentum, 295
 — purum, 295
 Argillaceous limestone, 815
 Argyroditite, 300
 Argyroze, 438
 Armitite, 266
 Arsenioleite, 623
 Arseniosiderite, 623
 Asperolithite, 8
 Atopite, 623
 Augustin's process, silver, 305
 Aurates, 577, 584
 Aureus pulvis pyrius, 582
 Auric acid, 584
 — bromide, 605, 606
 — diethylbromide, 607
 — chloride, 586, 589
 — hydronitrate, 616
 — hydroxide, 586
 — imidochloride, 583
 — iodide, 609
 — nitrate, 616
 — nitrosyl chloride, 595
 — oxide, 577, 579
 — phosphorobromide, 608
 — phosphorochloride, 595
 — salts, 577
 — selenochloride, 595
 — silicochloride, 595

- Auric stannichloride, 595
 — stibnochloride, 595
 — sulphate, 615
 — sulphide, 613
 — sulphochloride, 595
 — titanochloride, 595
 Aurites, 577
 Auroauric sulphide, 612
 Aurora, 296
 Aurosoauric bromide, 605
 — chloride, 586
 — hydroxide, 579
 — oxide, 577, 579
 — sulphates, 615
 Aurous ammino-iodide, 609
 — aminochloride, 589
 — bromide, 605, 606
 — bromoaurate, 605
 — chloride, 586, 587
 — chloroaurate, 586
 — diammino-bromide, 606
 — diammino-chloride, 589
 — dodeca-amminochloride, 589
 — hexamminiodide, 609
 — hydroxide, 578
 — iodide, 608
 — nitrate, 616
 — oxide, 577, 578
 — phosphinobromide, 606
 — phosphorochloride, 589
 — phosphorochlorobromide, 606
 — phosphorotriethoxychloride, 589
 — salts, 577
 — sulphide, 610
 — — colloidal, 611
 — triamminochloride, 589
 Aurum, 296
 — fulminans, 582
 — obryzum, 301
 — sclopetans, 582
 — volatile, 582
 Auryl hydrosulphate, 615
 — nitrate, 616
 — oxide, 580
 — oxynitrate, 616
 Ausis, 296
 Ausum, 296
 Autunite, 623
 Awr, 296
 Azurite, 7, 270, 274
 — zinc, 275
- B**
- Baldwin's phosphorus, 740
 Ball mills, 497
 Barite, 762
 Barium, 620
 — ammonium dimetaphosphate, 893
 — — trimetaphosphate, 894
 — analytical reactions, 641
 — aurate, 584
 — atomic wt., 646
 — bromide, 725
 — — dihydrated, 727
 — — properties, chemical, 727
 — — physical, 726
 — bromoaurate, 607
 — calcium carbonate, 846
 Barium calcium sodium potassium car-
 bonate, 846
 — — sulphatofluoride, 813
 — — tetrachloride, 720
 — carbonate, occurrence, 814
 — — preparation, 814
 — — properties, chemical, 839
 — — — physical, 833
 — — solubility, 824
 — chloride, 697
 — — and fluoride, 718
 — — $\text{CaCl}_2\text{—NaCl—H}_2\text{O}$, 715, 720
 — — $\text{CaCl}_2\text{—SrCl}_2$, 720
 — — chloroaurate, 595
 — — $\text{CuCl}_2\text{—KCl—H}_2\text{O}$, 715, 720
 — — $\text{CuCl}_2\text{—NH}_4\text{Cl—H}_2\text{O}$, 715, 720
 — — dihydrated, 705
 — — hydrated, 702, 705
 — — KCl—NaCl , 720
 — — preparation, 697
 — — properties, chemical, 714
 — — — physical, 700, 706
 — — $\text{SrCl}_2\text{—NaCl}$, 720
 — chlorobromide, 731
 — chlorodihydrophosphate, 902
 — chlorosulphate, 799
 — cuprate, 149
 — cupric chloride, 720
 — dihydrophosphate, 886, 887
 — dihydropyrophosphate, 892
 — dimetaphosphate, 893
 — — dihydrated, 893
 — dioxide, 666
 — — diperoxyhydrate, 667
 — — hydroxyhydrate, 671
 — — monohydrated, 667
 — — octohydrated, 667
 — — peroxyhydrate, 667
 — disulphoniodide, 737
 — ditetrametaphosphate, 895
 — fluoride, 688
 — — and chloride, 718
 — — preparation, 688
 — — properties, chemical, 693
 — — — physical, 689
 — fluoroapatite, 901
 — fluorobromide, 731
 — fluorochloride, 694, 718
 — fluoroiodide, 739
 — fluoronitrate, 694
 — fluorophosphate, 901
 — hexametaphosphate, 895
 — hexamminiodide, 737
 — history, 619
 — hydride, 649
 — hydrocarbonate, 844
 — hydrodisulphate, 784
 — hydrophosphate, 881
 — — colloidal, 882
 — hydrosulphate, 784
 — hydrosulphide, 750
 — hydrotetrasulphate, 784
 — hydrotrisulphate, 784
 — hydroxide, 673
 — — hexadecahydrated, 676
 — — monohydrated, 676
 — — octohydrated, 675
 — — properties, chemical, 685
 — — — physical, 681
 — — solubility, 677

- Barium hydroxide, trihydrated, 676
 — hydroxyhydrosulphide, 742
 — pentahydrated, 744
 — hydroxyphosphate, 902
 — iodide, 734
 — dihydrated, 734
 — hexahydrated, 734, 735
 — iodoaurate, 610
 — isotopes, 648
 — lead iodide, 738
 — metaphosphate, 893
 — monometaphosphate, 893
 — monosulphide, 741
 — monoxide, 653
 — nitrate, 849
 — dihydrated, 849
 — properties, chemical, 860
 — physical, 856
 — solubility, 850
 — tetrahydrated, 849
 — occurrence, 622
 — octaminobromide, 730
 — orthophosphate, 866
 — properties, chemical, 868
 — physical, 867
 — oxide, higher, 666
 — properties, chemical, 663
 — physical, 660
 — oxides, 652
 — oxybromide, 731
 — oxychloride, 716, 717
 — oxyiodide, 738
 — pentasulphide, 755
 — phosphates, 864
 — photoluminescence, 745
 — polybromide, 730
 — polyiodide, 738
 — polysulphides, 752
 — potassium calcium carbonate, 846
 — carbonate, 845
 — dimetaphosphate, 894
 — pentabromide, 732
 — phosphate, 877
 — decahydrated, 877
 — sulphato-chloride, 813
 — nitrate, 813
 — tetrachloride, 719
 — trimetaphosphate, 894
 — preparation, 626
 — properties, chemical, 637
 — physical, 631
 — pyrophosphate, 891
 — dihydrated, 891
 — monohydrated, 891
 — silver chloride, 720
 — sodium calcium carbonate, 846
 — carbonate, 845
 — chloride, 720
 — fluoride, 695
 — heptasulphate, 805
 — phosphate, 878
 — decahydrated, 878
 — pyrophosphate, 892
 — trimetaphosphate, 894
 — strontium calcium hexachloride, 720
 — sulphate, 763
 — subchloride, 713
 — suboxide, 653
 — sulphate, 760, 765
 — colloidal, 765
- Barium sulphate preparation, 763
 — properties, chemical, 798
 — physical, 792
 — solubility, 777
 — sulphatophosphate, 895
 — sulphide hexahydrated, 744
 — monohydrated, 744
 — properties, chemical, 742, 744
 — physical, 742, 750
 — sulphides, 740
 — tetrametaphosphate, 894
 — octohydrated, 895
 — tetramminochloride, 716
 — tetraphosphate, 892
 — tetrasulphide hydrated, 753
 — tetrasulphonide, 377
 — tetroxide, 672
 — trimetaphosphate, 894
 — triphosphate, 892
 — trisulphide, 752
 — uses, 644
- Bariumuranite, 625
 Barote, 620
 Baryta, 620, 652
 — felspar, 625
 — saltpetre, 625, 849
 — water, 676
 Barytapatite, 625
 Barytes, 762
 — cockscomb, 763
 — crested, 763
 — uses, 802
- Barytocalcite, 622, 625, 834, 814, 846
 Barytocelestines, 763
 Base metal, 358, 525
 Bechilite, 623
 Beer's law, 175
 Berlin blue, 274
 Berzelianite, 7
 Berzeliite, 623
 β -copper, 115
 Bismuthaurite, 494, 531
 Bitter spar, 622
 Bituminous limestone, 815
 Black gold, 531
 Blast furnace smelting, 23
 Blister copper, 25
 — roasting, 25
 Blue, Berlin, 274
 — felspar, 274
 — john, 688
 — spar, 274
 — vitriol, 234
- Bologna spar, 619
 — stone, 619, 740
 Bolognian stone, 619
 Bone phosphate, 904
 Bononian stone, 619
 Boothite, 234
 Boracite, 623
 Bordeaux mixture, 262
 — soda, 267
- Boronatocalcite, 623
 Boryckite, 623
 Boss process, silver extraction, 304
 Botallacite, 178
 Boville bordelaise, 262
 Brandtite, 623
 Brass, 1, 2
 — distillation of zinc from, 10

Breccia, 815
 Breithauptite, 220
 Brewsterite, 625
 Brittle silver ore, 300
 Brochantite, 7, 234, 262, 264, 265
 Bromargyrite, 300, 418
 Bromite, 418
 Bromlite, 625, 846
 Bromoargyrite, 300, 418
 Bromocuprates, 200
 Bromocuprites, 195
 Bromowagnerite, 897
 Bronze, 1, 2
 — analysis ancient, 1, 2
 — caries of, 76
 Brown spar, 622
 Brushite, 623, 880, 882
 Buchner's crystals, 757
 Burnt lime, 653

C

Cadmium chloroaurate, 595
 Cæsium argentioidides, 433
 — bromoaurate, 607
 — bromocuprates, 200
 — calcium tetrachloride, 719
 — — trisulphate, 810, 811
 — chloroaurates, 594
 — disulphatocuprate, 257
 — heptachlorodicuprate, 189
 — pentachlorocuprite, 163
 — silver chloride, 404
 — — chloroaurate, 595
 — — nitrate, 481
 — strontium enneachloride, 719
 — syngenite, 811
 — tetrachlorocuprate, 467
 — tetrachlorocuprite, 163
 — tetrasulphocuprate, 228
 — trichlorocuprate, 189
 — trichlorocuprite, 163
 Calaverite, 494
 Calcareous sinter, 814
 Calcimangite, 814
 Calcio-ferrite, 623
 Calcimalachite, 274
 Calciostrontianite, 622, 834
 Calcite, 622, 814
 — dolomitic, 814
 Calcium ammonium dimetaphosphate, 894
 — disulphate, 812
 — hexasulphate, 812
 — phosphate, 878
 — trisulphate, 811
 — analytical reactions, 621
 — atomic wt., 646
 — aurate, 584
 — barium carbonate, 846
 — — sodium carbonate, 846
 — — potassium carbonate, 846
 — strontium carbonate, 846
 — — hexachloride, 720
 — sulphato-fluoride, 813
 — tetrachloride, 720
 — bromide, 725
 — properties, chemical, 727
 — —, physical, 726
 — trihydrated, 728
 Calcium bromophosphate, 897
 — cæsium tetrachloride, 719
 — — trisulphate, 810, 811
 — carbonate, basic, 657
 — — colloidal, 815
 — — dihydrated, 822
 — — hexahydrated, 822
 — — occurrence, 814
 — — pentahydrated, 822
 — — preparation, 814
 — — properties, chemical, 839
 — —, physical, 833
 — — solubility, 824
 — — trihydrated, 822
 — chloride, 697
 — — and fluoride, 718
 — — $BaCl_2$ - $SrCl_2$, 720
 — — cuprous chloride, 718
 — — dihydrated, 703
 — — hexahydrated, 704
 — — hydrated, 702, 703
 — — lithium chloride, 718
 — — preparation, 697
 — — properties, chemical, 714
 — —, physical, 700, 706
 — — silver chloride, 718
 — — sodium chloride, 718
 — — $NaCl$ - KCl , 720
 — — tetrahydrated, 704
 — chloroaurate, 595
 — chlorodihydrophosphate, 902
 — chlorophosphate, 869
 — chlorotriorthophosphate, 896
 — copper potassium tetrasulphate, 811
 — cuprate, 149
 — cupric ammonium tetrasulphate, 813
 — — decachloride, 719
 — — disulphate, 812
 — — oxycarbonate phosphate, 897
 — — tetrachloride, 719
 — diammino-chloride, 716
 — dihydrophosphate, 886
 — — monohydrated, 887
 — dimetaphosphate, 893
 — — dihydrated, 893
 — — dioxide, 666
 — — dihydrated, 668
 — — diperoxyhydrate, 668
 — — hydroxyhydrate, 671
 — — octohydrated, 668
 — fluoride, 688
 — — and chloride, 718
 — — preparation, 688
 — — properties, chemical, 693
 — —, physical, 689
 — fluorobromide, 731
 — fluorochloride, 718
 — fluoroiodide, 739
 — fluotriorthophosphate, 896
 — hexahydroxyphosphate, 904
 — hexahydroxysulphide, 757
 — hexametaphosphate, 895
 — hexamminobromide, 730
 — hexamminoiodide, 737
 — history, 619
 — hydride, 649
 — hydrocarbonate, 843
 — hydrodisulphate, 783
 — hydrofluoride, 694
 — hydrophosphate, 880, 882

- Calcium hydrophosphate, colloidal, 882
 — dihydrated, 882
 — sesquihydrated, 882
 — hydrosulphide, 750
 — hydrotetrasulphate, 783
 — hydrottrisulphate, 783
 — hydroxide, 673
 — hemihydrated, 675
 — monohydrated, 676
 — properties, chemical, 635
 — —, physical, 681
 — solubility, 677
 — hydroxycarbonate, 839
 — hydroxyhexaphosphate, 903
 — hydroxyhydrosulphide, 755
 — hydroxynitrate, 861
 — hydroxyphosphate, 902
 — iodide, 734
 — hexahydrated, 735
 — iodochloride, 738
 — iodophosphate, 897
 — isotopes, 648
 — lead iodide, 738
 — lithium carbonate, 844
 — — phosphate, 878
 — metaphosphate, 893
 — monometaphosphate, 893
 — monosulphide, 740
 — monoxide, 653
 — nitrate, 849, 850
 — and ethyl alcohol, 855
 — dihydrated, 850
 — properties, chemical, 860
 — —, physical, 856
 — solubility, 850
 — tetrahydrated, 850
 — trihydrated, 850
 — occurrence, 622
 — octamino chloride, 716
 — orthophosphate, 866
 — colloidal, 866
 — properties, chemical, 868
 — —, physical, 867
 — orthopyrophosphate, 892
 — oxide, higher, 666
 — properties, chemical, 663
 — —, physical, 660
 — oxides, 652
 — oxybromide, 730
 — oxychloride, 716
 — oxyhexaphosphate, 904
 — oxyiodide, 738
 — oxynitrate, 853
 — dihydrated, 853
 — hemihydrated, 853
 — trihydrated, 853
 — oxyorthophosphate, 903
 — oxysulphate, 800
 — pentasulphide, 755
 — phosphate, normal, 866
 — ternary, 866
 — tribasic, 866
 — phosphates, 864
 — polybromide, 730
 — polyiodide, 737
 — polysulphide, 752
 — potassium ammonium disulphate, 812
 — carbonate, 845
 — dimetaphosphate, 894
 — disulphate, 807
- Calcium potassium hexasulphate, 808
 — pentacarbonate, 845
 — phosphate, 877
 — pyrophosphate, 892
 — sodium carbonate, 845
 — tribromide, 732
 — trichloride, 719
 — trisulphate, 806
 — preparation, 626
 — properties, chemical, 637
 — —, physical, 631
 — pyrophosphate, 891
 — tetrahydrated, 891
 — relations Ba, Sr, 907
 — rubidium disulphate, 810
 — — trisulphate, 810, 811
 — silicophosphate, 873
 — silver chloride, 720
 — sodium carbonate, 864
 — dihydroxytetrasulphate, 806
 — dimetaphosphate, 894
 — disulphate, 805
 — hexametaphosphate, 895
 — pentabromide, 732
 — pentasulphate, 804
 — phosphate, 878
 — pyrophosphate, 892
 — tetrasulphate, 806
 — trimetaphosphate, 894
 — trisulphate, 805
 — strontium carbonate, 846
 — sodium carbonate, 846
 — subchloride, 713
 — suboxide, 653
 — sulphate, 760
 — anhydrous, 763
 — colloidal, 763
 — dihydrated, 763
 — hemihydrated, 763
 — preparation, 763
 — properties, chemical, 798
 — —, physical, 792
 — solubility, 777
 — sulphides, 740
 — photoluminescence, 745
 — properties, chemical, 742, 744
 — —, physical, 742, 750
 — tetrachlorobariate, 720
 — tetrahydroxytrisulphide, 757
 — tetrametaphosphate, 894
 — octohydrated, 895
 — tetramminochloride, 716
 — tetraphosphate, 892
 — tetrasulphide, 753
 — tetrasulphonionide, 737
 — tetroxide, 672
 — triphosphate, 892
 — trisilicophosphate, 873
 — uses, 644
 — wagnerite, 897, 902
- Calespar, 622, 814
 Calcuranite, 623
 Calotype process, 416
 Canton's phosphorus, 740
 Carat, 532
 Carbonate of copper, blue, 7
 — green, 7
 Carbonato-apatite, 896
 Carbonyl cuprous chloride, 162
 Carbuncle, 117

- Caries of bronze, 76
 Carmenite, 210
 Carnotite, 902
 Carrara marble, 815
 Caryinite, 623
 Cassius, purple of, 564
 Cataphoresis, 541
 Caustic lime, 619, 653
 Cawk, 762
 Cazo process, extraction silver, 303
 Celestine, 762
 — uscs, 802
 Cement copper, 30
 — Keene's, 776
 — Mack's, 776
 — plasters, 775,
 — Scott's selenitic, 776, 800
 Cementation, 30
 — process, gold parting, 508
 Cerargyrite, 300, 390
 Cerous bromoaurate, 607
 — chloroaurate, 595
 Chalcanthite, 7, 234
 Chalcitis, 3
 Chalcocite, 7, 210
 Chalcolithite, 8
 Chalcopyrite, 7
 Chalcostibnite, 7
 Chalcotrichite, 117
 Chalk, 622, 814
 Chalkomelan, 131
 Chalkosine, 210
 Chalmersite, 7
 Chalybite, 622
 Charutz, 296
 Chemico-capillary actions, 222
 Chessylite, 274
 Chlorargyrite, 390
 Chloridizing roast, 31, 307
 Chlorination process, gold, 490
 Chlorinization gold, 507
 Chloroapatite, 896
 — strontium, 902
 Chloroargyrite, 300
 Chloroaurates, 593
 Chlorocalcite, 623, 697
 Chlorocuprites, 163
 Chlorocuprous acid, 162
 Chlorophane, 693
 Chrysocolla, 8
 Ciplyte, 903
 Cirrolite, 623
 Clinoclare, 8
 Cobalt auric hexamminochloride, 595
 — — pentamminonitratochloride, 595
 — chloroaurate, 595
 Cobalto-calcite, 814
 Cockscorn barytes, 763
 Colemanite, 623
 Colloidal cupric oxide, 142
 — cuprous oxide, 127
 — silver bromide, 418
 — — carbonate, 457
 — — orthophosphate, 486
 — soln., electrical conductivity, 543
 — — preparation, 551
 Colloids, deflocculation, 536
 — flocculation, 536
 — gold numbers, 547
 — peptization, 538
 — Colloids, precipitation, 542
 — — Hardy's rule, 543
 — — Schulze's rule, 543
 — protective, 539, 547
 Collophane, 623
 Collophanite, 866, 880
 Colour of cupric chloride soln., 173
 Concentrate, 22
 Conchite, 816
 Conductivity, electrical, 52
 — thermal, 52
 Converter, 25
 — acid, 25
 — basic, 25
 Coolgardite, 494
 Coperite, 210
 Copper, allotropic forms of, 113
 — alpha, (α -), 115
 — ammonium calcium tetrasulphate, 800
 — antimonides, 98
 — arsenides, 98
 — atomic number, 112
 — — weight, 110
 — aurides, 573
 — beta, (β -), 115
 — black, 72, 131
 — blister, 25
 — blue, 7
 — burning, 71
 — calcium ammonium tetrasulphate, 811
 — — potassium tetrasulphate, 811
 — catalytic, 32
 — cement, 30
 — chemical properties, 69
 — coarse, 25
 — colloidal, 31, 554, 563
 — compounds, reduction, 10
 — dendritic, 33
 — dioxide, 116, 149
 — — monohydrated, 147
 — dry, 26
 — electrotyping, 13
 — enneiodide, 207
 — extraction, 21
 — — Hunt and Douglas, 30
 — — Longmaid and Henderson, 30
 — filiform, 34
 — finely divided, 31
 — flowers of, 70, 117
 — fluorides, 154
 — glance, 7
 — gold alloys, 573
 — green, 270
 — hair, 34
 — hexaiodide, 207
 — highly purified, 31
 — history, 1
 — hydride, 72
 — indigo, 7, 220
 — matte, 23
 — metaphosphates, 292
 — moss, 34
 — muriate white, 157
 — native, 6
 — nitrates, 280
 — occurrence, 5
 — ore, 7
 — — blistered, 7
 — — grey, 7
 — — livery, 117

- Copper ore, purple, 7
 — red, 117
 — variegated, 7
 — yellow, 7
 — oxide, black, 131
 — red, 117
 — scale, 70
 — *vide* cuprous and cupric oxides.
 — oxysulphides, 226
 — passivity, 95
 — peroxide, 116
 — phosphides, 97
 — phosphor, 97
 — physical properties, 33
 — polyiodides, 206
 — potassium alloy, 571
 — precipitation from compounds, 10
 — metallic, 14
 — purple, 7
 — pyrites, 7
 — pyrophoric, 69
 — quadrantoxide, 116
 — red, 117
 — refining, 26
 — by electrolysis, 27
 — rust, 270
 — separation from compounds, 10
 — sesquioxide, 116, 149
 — silver alloys, 572
 — gold alloys, 576
 — relations, 617
 — smelting, 3
 — sodium alloy, 571
 — subchloride, 157
 — suboxides, 116
 — sulphide, complex salts, 227
 — sulphides colloidal, 225
 — sulphur-iron, ternary system, 24
 — tetraiodide, 207
 — tetrtraoxide, 116
 — tough pitch, 27
 — tritoxide, 116, 118
 — uses, 104
 — vitreous, 7
 — wool, 32
 — world's production, 6
 Coppite, 623
 Copralite, 623
 Coquina, 815
 Coral, 622
 Coralline limestone, 815
 Cornetite, 289
 Covellite, 7, 220
 Cradles, 496
 Cream of lime, 676
 Crème de chaux, 620
 Crested barytes, 763
 Crookesite, 7
 Crushers, 497
 Crystalli Dianæ, 459
 Crystallization, 546
 Cubanite, 7
 Cupellation, 302
 — English furnace, 302
 — German furnace, 302
 — gold, 507
 Cuprane, 157
 Cupraneæ, 157
 Cuprates, 149
 Cuprein, 210
 Cupri resina, 157
 Cupric acid, 149
 — ammimo-pyrophosphate, 291
 — ammonium diammino-iodide, 209
 — dimetaphosphate, 292-3
 — sulphate, 255
 — anhydride, 149
 — barium chloride, 720
 — bromide, 192, 196
 — hydrated, 196
 — properties, 196
 — calcium decachloride, 719
 — disulphate, 812
 — oxycarbonatophosphate, 897
 — tetrachloride, 719
 — chloride, 157, 168
 — $BaCl_2-KCl-H_2O$, 716, 720
 — $BaCl_2-NaCl-H_2O$, 716, 720
 — $BaCl_2-NH_4Cl-H_2O$, 716, 720
 — colour of soln., 173
 — complex salts, 180
 — hexol, 178
 — hydrated, 168, 170
 — preparation, 168
 — properties, chemical, 177
 — physical, 169
 — trihydrated, 170
 — colloidal, 142
 — hydrated, 142
 — physical properties, 133
 — preparation, 131
 — decammino-bromide, 198
 — decammino-chloride, 189, 190
 — decammino-iodide, 208, 209
 — diammino-bromide, 198
 — diammino-carbonate, 275
 — diammino-chloride, 190
 — diammino-hydroxide, 151
 — diamminohydroxyfluoride, 150
 — diammino-iodide, 209
 — diammino-oxylbromide, 198
 — diammino-sulphate, 252
 — dihydrotetrachloride, 183
 — dihydroxylamine sulphate, 256
 — dimetaphosphate, 292
 — dioxy carbonate, 269
 — dioxy sulphate, 264
 — dioxytricarboxate, 269
 — dipotassium pyrophosphate, 292
 — tetrametaphosphate, 293
 — disodium dicarbonate, 276
 — dipyrophosphate, 291
 — tetrametaphosphate, 293
 — enneaoxysulphate, 261.
 — enneaoxytetrarsulphate, 265
 — fluoride, 154
 — dihydrated, 154
 — heptafluoride, 154
 — heptoxycarbonate, 268
 — heptoxydisulphate, 264
 — heptoxytrisulphate, 266
 — hexametaphosphate, 293
 — hexammino-bromide, 198
 — hexammino-chloride, 189
 — hexammino-iodide, 208
 — hexammino-nitrate, 284
 — hexasodium dipyrophosphate, 292
 — hexasulphide, 226
 — hydrazine chloride, 191
 — nitrate, 286

- Cupric hydrazine sulphate, 256
 — hydrobromide, 198
 — hydrophosphate, 288
 — hydrosulphide, 225
 — hydrotrichloride, 181
 — hydroxide, 142
 — properties, 144
 — hydroxybromide, 198
 — hydroxydicarbonate, 274
 — hydroxyfluoride, 156
 — hydroxylamine sulphate, 256
 — hydroxyorthophosphate, 289
 — hydroxypyrophosphate, 291
 — iodide, 206
 — nitrate, 281
 — enneahydrated, 281
 — hexahydrated, 281
 — properties, chemical, 283
 — physical, 282
 — trihydrated, 281
 — nitrogen iodide, 209
 — octoxytrisulphate, 265
 — orthocarbonate, 270
 — orthophosphate, 287
 — oxide, 116, 131
 — chemical properties, 133
 — oxybromide, 198
 — oxycarbonate, 290
 — oxychlorides, 178
 — oxydisulphide, 226
 — oxyfluoride, 156
 — oxymonosulphide, 226
 — oxypentasulphide, 226
 — oxysulphate, 266
 — pentahydroxydicarbonate, 269
 — pentahydroxylamine sulphate, 256
 — pentametaphosphate, 293
 — pentammino-bromide, 198
 — pentammino-chloride, 190
 — pentammino-hexaiodide, 209
 — pentammino-nitrate, 284
 — pentammino-sulphate, 251
 — pentasulphide, 225, 226
 — pentoxycarbonate, 268
 — pentoxydicarbonate, 269
 — pentoxydisulphate, 265
 — phosphates, basic, 288
 — polysulphide, 225
 — potassium carbonate, 278
 — pyrophosphates, 290
 — salts, 139
 — silver nitrate, 481
 — sulphide, 447
 — sodium chlorophosphates, 290
 — hexametaphosphate, 293
 — phosphate, 290
 — sulphate, 256
 — trimetaphosphate, 292
 — sulphate, 234
 — basic, 261
 — dihydrated, 237
 — enneahydrated, 237
 — heptahydrated, 237
 — hexahydrated, 237
 — monohydrated, 235
 — pentahydrated, 235
 — properties, chemical, 246
 — physical, 238
 — $\text{Na}_2\text{SO}_4 \cdot \text{H}_2\text{O}$, 257
 — $\text{Na}_2\text{SO}_4 \cdot \text{H}_2\text{SO}_4 \cdot \text{H}_2\text{O}$, 257
- Cupric sulphate, solubility, 237
 — trihydrated, 235
 — sulphide, 220
 — alcocol, 225
 — colloidal, 225
 — ethersol, 225
 — hydrosol, 225
 — preparation, 220
 — properties, chemical, 223
 — physical, 222
 — tetrametaphosphate, 293
 — tetrammino-chloride, 190
 — tetrammino-hexaiodide, 209
 — tetrammino-hydroxides, 151
 — tetrammino-iodide, 209
 — tetrammino-nitrate, 284
 — tetrammino-orthophosphate, 290
 — tetrammino-oxyfluoride, 156
 — tetrammino-pyrophosphate, 291
 — tetrammino-sulphate, 251
 — hydrated, 253
 — tetrammino-tetraiodide, 209
 — tetraoxysulphate, 262
 — tetrasulphide, 225
 — trihydropentachloride, 183
 — trihydroxy-nitrate, 284
 — trimetaphosphate, 293
 — trioxydicarbonate, 268
 — trioxysulphate, 262
 — triphosphate, 292
 — trisulphide, 226
- Cuprifluorides, 156
 Cuprite, 7, 117
 Cuprites, 145
 Cuprobismuthite, 7
 Cuprobromides, 195
 Cuprocalcite, 274
 Cupriodargyrite, 426
 Cuproscheelite, 623
 Cuprosic oxide, 126
 — tetrammino-chloride, 165
 Cuprosocupric chloride, 157
 — oxide, 116
 Cuprotungsite, 8
 Cuprous ammino-bromide, 194
 — ammino-carbonate, 267
 — ammino-chloride, 164
 — ammino-nitrate, 281
 — ammonium orthophosphate, 287
 — bromide, 192
 — properties, 192
 — carbonate, 267
 — chloride, 157
 — carbonyl, 162
 — non-aqueous soln., 176
 — phosphine, 162
 — preparation, 157
 — properties, chemical, 160
 — physical, 159
 — diammino-iodide, 205
 — dihydrodichloride, 162
 — fluoride, 154
 — hemiammino-iodide, 205
 — hexammino-chloride, 164
 — hydrobromide, 194
 — hydrocarbonate, 267
 — hydrosulphate, 232
 — hydroxide, 127
 — hydroxybromide, 194
 — hydroxydichloride, 164

Cuprous hydroxyiodide, 201
 — iodide, 201
 — — — properties, 201
 — — — metaphosphate, 287
 — — — nitrate, 281
 — — — orthophosphate, 287
 — — — oxide, 116, 117
 — — — — chemical properties, 124
 — — — — colloidal, 127
 — — — — hydrated, 127
 — — — — physical properties, 122
 — — — — preparation, 117
 — — — oxybromide, 194
 — — — oxychloride, 164
 — — — oxydichloride, 164
 — — — oxydisulphide, 226
 — — — oxyiodide, 201
 — — — oxysulphate, 232
 — — — potassium iodide, 210
 — — — salt, 127
 — — — sesquiammino-bromide, 194
 — — — sesquiammino-chloride, 164
 — — — sesquiammino-iodide, 205
 — — — sulphate, 231
 — — — sulphide, 210
 — — — — alcohol, 225
 — — — — and ferrous sulphide, 24
 — — — — preparation, 210
 — — — — properties, chemical, 216
 — — — — — physical, 214
 — — — tetrammino-sulphate, 232
 — — — — hydrated, 233
 — — — thioaurites, 614
 — — — triammino-bromide, 194
 — — — triammino-chloride, 164
 — — — triammino-iodide, 205
 Cuprum gummatosum, 157
 — — — sulphure mineralisatum, 210
 — — — vitreum, 210
 Cyanide process, gold, 305, 499, 504
 — — — silver, 305
 Cyanochroite, 257
 Cyanosite, 7
 Cyprian vitriol, 234

D

Daguerrotype process, 416
 Dahllite, 623, 896
 Darumite, 7
 Dead-burnt plaster, 775
 Deflocculation colloids, 536
 Depolarizer, 415
 Desilverization of lead, 311
 — — — — electrotype process, 312
 — — — — Parkes' process, 312
 — — — — Pattinson's process, 311
 — — — — Rozan's process, 312
 Devilline, 263
 Dicalcium phosphate, 880
 Digenite, 210
 Dihydrite, 289
 Dioptase, 8
 Dog's tooth spar, 814
 Dolerophanite, 266
 Dolomite, 622
 Dolomitic calcite, 814
 Domeykite, 7
 Dreehite, 802

Dry copper, 26
 Dyscrasite, 300

E

Earth, 619
 Eau de chaux, 676
 Edelpatina, 78
 Edingtonite, 625
 Ehlite, 289
 Electrical conductivity, 52
 Electrocapillary actions, 222
 Electrotyping, 13
 Electrolysis, refining copper by, 27
 — — — — multiple system, 27
 — — — — parallel system, 27
 — — — — series system, 27
 Electrolytic process, desilverization, lead,
 313
 Electrostatic separation ores, 22
 Electrothermic smelting, 23
 Electrum, 493
 Embolite, 300, 418
 Emmonite, 834, 846
 Emplectite, 7
 Enargite, 7
 Epigenite, 7
 Eriochalcite, 168
 Estrichgyps, 774
 Ettringite, 623
 Eucairite, 300
 Eupyrochroite, 896
 Extinction coefficient, 47, 175

F

Fahlerz, 7
 Fairfieldite, 623
 Famatinite, 7
 Faraday's gold, 554
 Fehling's soln., 120
 Felspar blue, 274
 Ferrocacite, 814
 Ferrous sulphide and cuprous sulphide, 24
 Ferruginous limestone, 815
 Fillowite, 623
 Fire blende, 300
 — — — marble, 815
 Flocculation colloids, 536
 Flooring plaster, 774
 Flores cupri, 70, 117
 Flos ferri, 815
 Flotation of ores, 22
 Flouring of mercury, 498
 Flowers of copper, 70, 117
 Flume, 498
 Fluorite, 688
 — — — stinking, 692
 Fluoroapatite, 896
 — — — barium, 901
 — — — strontium, 901
 Fluorocuprates, 156
 Fluoro-heavy spar, 802
 Fluorspar, 623, 688
 — — — coloration, 692
 — — — stinking, 692
 Fœtid limestone, 815
 Foliated tellurium, 494

Fondon process extraction, silver, 303
 Footeite, 178
 Fourth state matter, 936
 Francolite, 896
 Franklandite, 623
 Freezing mixtures, 701, 710
 Freiberg vitriolization process, silver, 305
 Fulminating gold, 582
 Furnace, reverberatory, 25
 Fusion, oxidizing, 26
 ——— reducing, 26

G

Gadolinum chloroaurate, 595
 Gangue, 5
 Gaylussacite, 622
 Gearskutite, 623
 Gerhardtite, 285
 Glaciers mariae, 761
 Glance ore, 300
 Glaserz, 300, 438
 Glass ore, 300
 ——— ruby, 564
 Glauberite, 623, 805
 Glauconitic limestone, 815
 Gold, 491
 ——— allotropic, 568
 ——— alluvial, 491
 ——— amalgam, 494
 ——— and silver parting, 508
 ——— ——— separation, 508
 ——— atomic number, 536
 ——— weight, 535
 ——— black, 531
 ——— bromides, 605
 ——— calx, 579
 ——— chlorides, 586
 ——— coinage, 532
 ——— colloidal, 554
 ——— copper alloys, 573
 ——— dibromide, 605
 ——— dioxide, 577, 579
 ——— distribution, 491
 ——— disulphide, 612
 ——— extraction, 495
 ——— ——— amalgamation process, 495
 ——— ——— chlorination, 499
 ——— ——— cyanide process, 499, 504
 ——— Faraday's, 554
 ——— fluoride, 585
 ——— fulminating, 582
 ——— hall-marked, 533
 ——— highly purified, 509
 ——— history, 295
 ——— hydride, 526
 ——— hydrosols, 557
 ——— mining, 495
 ——— monobromide, 606
 ——— monochloride, 587
 ——— moniodide, 608
 ——— monosulphide, 610
 ——— monoxide, 577, 578
 ——— native, 493
 ——— nitrates, 615
 ——— numbers, 547
 ——— occurrence, 491
 ——— oxide—ammoniacal, 582

Gold, oxides, 577
 ——— parting, cementation process, 508
 ——— pentoxide, 577, 579
 ——— placer, 491
 ——— plating, 359
 ——— precipitation from cyanide soln., 502
 ——— properties, chemical, 525
 ——— ——— physical, 509
 ——— purification, 507
 ——— purple oxide, 578
 ——— red carat, 532
 ——— reef, 491
 ——— refining, 507
 ——— ——— chlorination, 507
 ——— ——— cupellation, 507
 ——— ——— electrolysis, 507
 ——— ——— oxidation, 507
 ——— ——— sulphurization, 507
 ——— silver alloys, 575
 ——— ——— copper alloys, 576
 ——— ——— relations, 617
 ——— sodium alloy, 571
 ——— soviet, 493
 ——— standard, 532
 ——— sterling, 532
 ——— suboxide, 578
 ——— sulphates, 615
 ——— sulphides, 610
 ——— tetramminoxide, 583
 ——— tetroxide, 577, 579
 ——— tribromide, 605
 ——— trichloride, 586, 589
 ——— triiodide, 609
 ——— trioxide, 577, 579
 ——— trisulphide, 613
 ——— uses, 532
 ——— world's production, 493
 Golle, 296
 Goyazite, 623
 Graphic tellurium, 494
 Green john, 688
 ——— spar, 270
 Gulth, 296
 Gypsum, 623, 760
 ——— arte factum, 762
 ——— dehydration, 767
 ——— rehydration of dehydrated, 767
 ——— spathosum, 620
 ——— uses, 802

H

Haidingcrite, 623
 Hall-marked gold, 533
 Hard finish plasters, 776
 ——— lead, 311
 Hardy's rule, precipitation colloids, 543
 Harmotome, 625
 Heavy spar, 762
 Hepar sulphuris calcarem, 740, 757
 Herderite, 623
 Herrengrundite, 265, 266, 812
 Herschel's crystals, 757
 Hessite, 300, 494
 Hexocupric chloride, 178
 Hilgenstockite, 903
 Hiranya, 296
 Hislopit, 814
 Hofmann's vitriolization process, silver, 305

Homburg's phosphorus, 697, 740
 Horn silver, 300, 390
 Horsfordite, 7
 Hyalophane, 625
 Hydrated lime, 673
 Hydraulic mining, 496
 Hydrazine, cupric nitrate, 286
 ——— sulphate, 256
 Hydroapatite, 896
 Hydrobariosulphuric acid, 785
 Hydroboracite, 623
 Hydrobromoaauric acid, 606
 Hydrocalcite, 822
 Hydrochloroargentic acid, 397
 Hydrochloroauric acid, 593
 Hydrocupricarbonic acid, 273
 Hydrocuprite, 127
 Hydrocyanite, 234
 Hydroiodoauric acid, 610
 Hydrometallurgical processes extraction
 copper, 29
 chemical, 29
 electrolytic, 29
 Hydronitratosaauric acid, 616
 Hydrophylite, 697
 Hydrosulphatobaric acid, 785
 Hydrosulphocupric acid, 226
 Hydrotetrasulphocupric acid, 229
 Hydroxyapatite, 903
 Hydroxylamine cupric sulphates, 256

I

Iceland spar, 814
 Idrociano, 234
 Image, latent, 412
 Incidence, angle of, 47
 Index of absorption, 47
 ——— refraction, 47
 Indigo copper, 220
 Induced radioactivity, 1005
 Iodargyrite, 426
 Iodite, 426
 Iodoargyrite, 300
 Iodobromite, 426
 Iodocuprites, 205
 Iodyrite, 426
 Iron copper-sulphur, ternary system, 24
 Isoclase, 623, 902

J

Jalpaite, 300, 447
 Jig, 22
 Jigging of ores, 22
 Judgments, influence temperamert on, 526
 Jval, 296
 Jvalita, 296

K

Kalgoorlite, 494
 Kalkmilch, 676
 Kalkschaum, 822
 Kalkwasser, 676
 Kaluszite, 623, 808

Karstenite, 761
 Kataphoresis, 541
 Keene's cement, 776
 Kerargyrite, 300, 390
 Kiss' wet process, silver, 306
 Klaprothite, 274
 Klaprotholite, 7
 Konichalcite, 623
 Krennerite, 494
 Kröhnkite, 256, 257
 Krugite, 623
 Ktypeite, 815
 Kuld, 296
 Kupferglanz, 210
 Kupferglas, 210, 220
 Kupferglaserz, 210
 Kupferlasur, 274
 Kupferschwarze, 131

L

Labradorite, 901
 Lac argenti, 391
 Lait de chaux, 676
 Lambert's law, 175
 Langite, 7, 263
 Lanthanum bromoaurate, 607
 ——— chloroaurate, 595
 Lapis infernalis, 459
 ——— lazuli, pseudo-, 274
 ——— solaris, 619, 740
 ——— specularis, 761
 ——— tiburtinus, 814
 Lasurite, 274
 Latent image, 412
 Lazulite, 274
 Lazurapatite, 896
 Lead barium iodide, 738
 ——— calcium iodide, 738
 ——— desilverization, 311
 ——— electrolytic process, 313
 ——— Parkes' process, 312
 ——— Pattinson's process, 311
 ——— Rozan's process, 312
 ——— hard, 311
 ——— malachite, 274
 ——— soft, 311
 ——— strontium iodide, 738
 Libethenite, 8, 289
 ——— black, 961
 Lime, 672
 ——— burning, 653
 ——— burnt, 653
 ——— caustic, 653
 ——— cream of, 676
 ——— high calcium, 653
 ——— hydrated, 673
 ——— live, 653
 ——— malachite, 274
 ——— milk of, 676
 ——— slaked, 673
 ——— slaking, 673
 ——— water, 676
 Limestone, 622, 814
 ——— coralline, 815
 ——— Fontainebleau, 814
 ——— lithographic, 815
 ——— oolitic, 815
 ——— shell, 815

Limestones, argillaceous, 815
 — bituminous, 815
 — ferruginous, 815
 — foetid, 815
 — glauconitic, 814
 — phosphatic, 815
 — sandy, 815
 Liroconite, 8
 Lithium argentoiodides, 433
 — calcium carbonate, 844
 — — phosphate, 878
 — chloroaurate, 593
 — silver nitrate, 479
 — — sulphate, 454
 — strontium pentabromide, 731
 — sulphate cuprate, 256
 — trichlorocuprate, 183
 Lithographic limestone, 815
 Live lime, 653
 Luma cornea, 391
 Lunar caustic, 459, 461, 474
 Lunnites, 289
 Luzonite, 7

M

Mack's cement, 776
 Magisterium ceraunochryson, 582
 Magistral, 234, 304
 Magnesium aurate, 584
 — chloroaurate, 595
 Magnetic separation of ores, 22
 Malachite, 270
 — lead, 274
 — lime, 274
 — preparation, 270
 — properties, 272
 Malaconite, 7
 Maldonite, 494, 531
 Manganese bromoaurate, 607
 — chloroaurate, 595
 Mangano-calcite, 622, 814
 Marble, 622, 814, 815
 — Canara, 815
 — fire, 815
 — onyx, 815
 — panno-di-morti, 815
 — parian, 815
 — pudding-stone, 815
 — verd antique, 815
 Marienglas, 761
 Marmor metallicum, 620
 Marshite, 201
 Martinite, 623, 880
 Martin's cement, 776
 Matte, 24
 — copper, 23
 — — to blister copper, 23
 Mazapilite, 623
 Megabromite, 418
 Melaconise, 131
 Melaconite, 7, 131
 Melantheria, 3
 Menstruum sine strepitu, 526
 Mercury, flouring of, 498
 — sickening of, 498
 Meretrix metallorum, 69
 Metabrushite, 880, 882
 Metallorum rex, 500

Metallum rex, 297
 Metal, base, 358, 525
 — noble, 525
 — white, 25
 Metals, solubility in potas. cyanide, 500
 Métaux malades, 76
 Microbromite, 418
 Microlith, 623
 Miersite, 426
 Milk of lime, 676
 Mineral green, 270
 Mining gold, hydraulic, 496
 — — placer, 496
 — — reef, 497
 — — vein, 497
 Misy, 3
 Mobius' process gold refining, 508
 Moebius' electrolytic process silver, 308
 Mohawkite, 7
 Monetite, 880, 881
 Monocalcium phosphate, 886
 Moroxite, 896
 Mud, 27
 Müllerine, 494
 Muriacite, 761
 Mysorine, 267, 269

N

Nagyagite, 494
 Nail-head spar, 814
 Nantokite, 157
 Nantoquite, 157
 Natrocalcite, 622
 Natrochalcite, 257
 Naumannite, 300
 Negative, 412
 Neotype, 625, 814, 834, 846
 Nickel chloroaurate, 595
 Niello work, 447
 Nitrocalcite, 623, 849
 Nobel metal, 525
 Nobilite, 494
 Nocerite, 623

O

Obriza, 525
 Obrussa, 301, 525
 Obryza, 525
 Ochre, vanadium, 127
 Olata pina, 304
 Olivenite, 8
 Onyx marble, 815
 Oolitic limestone, 815
 Or, 296
 Ore, 5
 — fahl, 7
 — horseflesh, 7
 — livery copper, 117
 — peacock, 7
 — ruby, 7
 — tile, 117
 Ores, concentration of, 22
 — electrostatic separation, 22
 — flotation, 22
 — jigging, 22
 — magnetic separation, 22

- Ornithite, 623, 866
 Osteolite, 623, 896
 Ost's solution, 273
 Oxidation process, gold refining, 507
 Oxide of copper, black, 7
 ———— red, 7
 Oxidizing fusion, 26
 Oxyapatite, 904
- F
- Fachnolite, 623
 Pan washing, 496
 Pandermite, 623
 Panning, 496
 Panno-di-morti marble, 815
 Pantogen, 911
 Paratacamite, 179
 Parian cement, 776
 ———— marble, 815
 Parke's process, desilverization lead, 312
 Passivity of copper, 95
 Paterna's process, silver, 305
 Patina, 70, 76
 ———— noble, 78
 ———— red, 70
 Patio, 304
 ———— process, extraction silver, 303
 Pattinson's process, desilverization lead, 311
 Pearls, 814
 Pentachloro-cupric acid, 183
 Peptization colloids, 538
 Perauric acid, 577, 579
 Perowskite, 623
 Petrifying springs, 814
 Petzite, 300, 494
 Pharmacolite, 623
 Phosphate, bone, 904
 ———— soil, 905
 Phosphatic limestone, 815
 Phosphine cuprous chloride, 162
 Phosphochalcite, 8, 289
 Phosphor copper, 97
 Phosphore de Homberg, 697
 Phosphorescopes, 745
 Phosphorite, 623, 896
 Phosphorus, Baldwin's, 740
 ———— Canton's, 740
 Photographic plate, 411
 Photography, 411
 Photoluminescence, 745
 Phyllinglanz, 494
 Picropharmacolite, 623
 Pirssonite, 844
 Placer deposits, 496
 ———— gold, 491
 ———— mining, 496
 Planchéilate, 8
 Plaster, dead burnt, 775
 ———— flooring, 774
 ———— of Paris, 763, 767
 ———— setting of, 770
 Plasters, cement, 775
 ———— hard finish, 776
 Plating, gold, 359
 ———— silver, 359
 Plâtre, 763
- Plumbocalcite, 622, 814
 Plumbomalachite, 274
 Plutonium, 620
 Podolite, 896
 Polybasite, 300
 Polyhalite, 623
 Polysphürite, 623
 Positive, 412
 Potassium ammonium calcium disulphate, 812
 ———— disulphatocuprate, 259
 ———— argento iodide, 432
 ———— aurate, 584
 ———— aurochloride, 589
 ———— barium calcium carbonate, 846
 ———— carbonate, 845
 ———— dimetaphosphate, 894
 ———— pentabromide, 732
 ———— phosphate, 877
 ———— ———— decahydrated, 877
 ———— sulphato-chloride, 813
 ———— sulphato-nitrate, 813
 ———— tetrachloride, 719
 ———— trimetaphosphate, 894
 ———— bromaurate, 607
 ———— bromocuprate, 200
 ———— calcium carbonate, 845
 ———— dimetaphosphate, 894
 ———— disulphate, 807
 ———— hexasulphate, 808
 ———— pentacarbonate, 845
 ———— phosphate, 877
 ———— pyrophosphate, 892
 ———— tribromide, 732
 ———— trichloride, 719
 ———— trisulphate, 806
 ———— chloride, $\text{BaCl}_2\text{—CuCl}_2\text{—H}_2\text{O}$, 716, 720
 ———— $\text{BaCl}_2\text{—NaCl}$, 720
 ———— $\text{CaCl}_2\text{—NaCl}$, 720
 ———— NaCl—SrCl_2 , 720
 ———— chloroaurates, 593
 ———— chloroaurites, 588
 ———— copper alloy, 571
 ———— calcium tetrasulphate, 811
 ———— cupric carbonate, 278
 ———— phosphate, 290
 ———— tetrametaphosphate, 293
 ———— cuprous iodide, 210
 ———— cyanide, solubility metals in, 500
 ———— decasulphotricuprate, 229
 ———— diargentiodide, 432
 ———— dichlorocuprite, 163
 ———— dioxynneasulphodicuprate, 229
 ———— disulphate aurate, 615
 ———— disulphato-cuprate, 257
 ———— dithioaurite, 612
 ———— hydroxytetrasulphato-cuprate, 259
 ———— iodoaurate, 610
 ———— nitratourate, 616
 ———— pentasulphocuprite, 227
 ———— silver bromide, 424
 ———— carbonate, 458
 ———— nitrate, 480
 ———— sulphate, 454
 ———— sulphide, 447
 ———— sodium, barium calcium carbonate, 846
 ———— calcium carbonate, 845
 ———— strontium dimetaphosphate, 894
 ———— disulphate, 806

- Potassium strontium hexametaphosphate, 895
 ——— pentabromide, 732
 ——— pentachloride, 719
 ——— phosphate, 877
 ——— pyrophosphate, 892
 ——— tetrabromide, 732
 ——— tetrachloride, 719
 ——— trisulphate, 806
 ——— sulphocuprite, 227
 ——— tellurocuprate, 150
 ——— tetrachlorocuprate, 188
 ——— tetraphosphatocuprate, 290
 ——— tetrasulphocuprate, 228
 ——— triammino-chloroaurate, 594
 ——— tribromocuprite, 195
 ——— trichlorocuprate, 187
 ——— trichlorocuprite, 163
 ——— trifluorocuprate, 156
 Praseodymium chloroaurate, 595
 Precipitation, 546
 ——— colloids, 542
 ——— Hardy's rule, 543
 ——— Schulze's rule, 543
 Print, 412
 Propezite, 494
 Prosopite, 623
 Protective colloids, 539
 Proustite, 300
 Pseudoapatite, 896
 Pseudolibethenite, 289
 Pseudomalachite, 289
 Psilomelane, 625
 Pulp, 22, 303, 498
 Pulsator tables, 498
 Pulvis chrysocearaunius, 582
 Purification gold, 509
 Purple of Cassius, 564
 Pyrarгыrite, 300
 Pyrites, copper, 7
 Pyritic smelting, 23
 Pyroclasite, 866
 Pyrophosphorite, 892
 Pyrosmargyd, 693
 Pyrostilpnite, 300
- Q
- Quicklime, 653
- R
- Rayons continuateurs, 415
 ——— excitateurs, 415
 Reducing fusion, 26
 Reduction, copper compounds, 10
 Redruthite, 210
 Reef gold, 491
 Refining copper by electrolysis, 27
 Reflecting power, 47
 Refractive index, 47
 Regula veneris, 99
 Regulus, 23
 Resina cupri, 157
 Reverberatory furnace, 25
 ——— smelting, 23
 Rhodite, 494
 Richardite, 7
 Roast, chloridizing, 31, 306
- Roast, sulphatizing, 30, 306
 Roaster, smelting, 25
 Roasting, blister, 25
 Rochelle salt, 120
 Rogna, 76
 Romeite, 623
 Roselite, 623
 Rozan's process, desilverization lead, 312
 Ruberite, 117
 Rubidium, argentoiodides, 433
 ——— bromoaurate, 607
 ——— calcium disulphate, 810
 ——— ——— trisulphate, 810, 811
 ——— chloroaurates, 594
 ——— decasulphotricuprate, 229
 ——— disulphato-cuprate, 257
 ——— nitrate aurate, 616
 ——— silver bromide, 424
 ——— ——— chloroaurate, 594
 ——— ——— nitrate, 481
 ——— -syngenite, 810
 ——— tetrasulphocuprate, 228
 ——— trifluorocuprates, 156
 Ruby glass, 564
 ——— ore, 7
 ——— silver, 300
 Russell's wet process, silver, 306
- S
- Saffran d'or, 582
 Sal ammoniacum fixum, 697
 Saltpetre baryta, 625
 ——— wall, 849
 Samarium bromoaurate, 609
 ——— chloroaurate, 595
 Sandy limestone, 815
 Sarpu, 295
 Satin spar, 761, 814
 Scandium chloroaurate, 595
 Scheelite, 623
 Schulze's rule, precipitation colloids, 543
 Schutzkolloide, 547
 Schweizer's liquid, 152
 ——— reagent, 152
 Scott's selenitic cement, 776, 800
 Seignette's salt, 120
 Selenite, 623, 761, 762
 Selenitic cement, 776
 Self-reduction, 23
 Shattuckite, 8
 Shell limestone, 815
 Sickening of mercury, 498
 Silber, 295
 Silberglanz, 438
 Silberglas, 438
 Silfr, 295
 Silfrer, 295
 Silubr, 295
 Silver, allotropic, 568, 569
 ——— ammino-bromide, 423
 ——— ammino-fluoride, 390
 ——— ammino-iodide, 434
 ——— ammino-nitrates, 477
 ——— antimonial, 300
 ——— atomic number, 366
 ——— ——— weight, 363
 ——— barium chloride, 720
 ——— black, 359

- Silver blende, antimonial, 300
 ——— arsenical, 300
 ——— Britannia, 358
 ——— bromide, 418
 ——— colloidal, 418
 ——— potassium, 424
 ——— properties, chemical, 421, 423
 ——— physical, 419
 ——— rubidium, 424
 ——— bromonitrate, 468
 ——— bullion, 358
 ——— calcium chloride, 720
 ——— carbonate, 456
 ——— colloidal, 457
 ——— potassium, 458
 ——— sodium, 458
 ——— chloride, 390, 408
 ——— caesium, 404
 ——— colloidal, 393
 ——— preparation, 391
 ——— properties, chemical, 396, 401
 ——— physical, 393
 ——— sodium, 404
 ——— chloroaurate, 595
 ——— chloronitrate, 468
 ——— colloidal, 309, 554, 560
 ——— copper alloys, 572
 ——— gold relations, 617
 ——— cyanodinitrate, 469
 ——— decametaphosphate, 489
 ——— decaphosphate, 490
 ——— diammino-chloride, 400
 ——— diammino-hydroxide, 382
 ——— diammino-iodide, 435
 ——— diammino-nitrate, 478
 ——— diamminoxide, 382
 ——— dihydrophosphate, 487
 ——— dihydropyrophosphate, 488
 ——— dimetaphosphate, 488
 ——— dinitrate, 385, 484
 ——— dioxide, 383
 ——— diphosphate, 490
 ——— distillation, 329
 ——— distribution, 298
 ——— disulphatoaurate, 615
 ——— disulphide, 448
 ——— dithioaurite, 614
 ——— Doré, 358
 ——— electrochemical eq., 367
 ——— electroplating, 359
 ——— extraction, 301
 ——— amalgamates, Boss process, 304
 ——— Cazo process, 303
 ——— Patio process, 303
 ——— amalgamation, 303
 ——— Fondon process, 303
 ——— cupellation, 302
 ——— electrolytic process, 308
 ——— Moebius', 308
 ——— lead smelting, 301
 ——— matte smelting, 301
 ——— wet processes, 305
 ——— Augustin's process, 305
 ——— cyanide process, 305
 ——— Freiberg vitriolization process, 305
 ——— Hofmann's vitriolization process, 305
 ——— Kiss' process, 306
 ——— Patera's process, 305
- Silver extraction, wet processes, Russell's process, 306
 ——— Ziervogel's process, 305
 ——— fine, 358
 ——— fluoiodide, 430
 ——— fluoride, 387
 ——— dihydrated, 387
 ——— hydrated, 387
 ——— preparation, 387
 ——— properties, 387
 ——— tetrahydrated, 387
 ——— frosted, 359
 ——— fulminating, 381
 ——— glance, 300, 438
 ——— gold alloys, 575
 ——— copper alloys, 576
 ——— halides, action light, 408
 ——— hemiammino-iodide, 434
 ——— hemitrioxide, 368, 385
 ——— hexametaphosphate, 489
 ——— sodium, 489
 ——— history, 295
 ——— horn, 300, 390
 ——— hydride, 472
 ——— hydrocarbonate, 456
 ——— hydrofluoride, 307
 ——— hydroiodide, 432
 ——— hydrophosphate, 487
 ——— hydrosols, 561
 ——— hydrosulphate, 452
 ——— hydroxide, 380
 ——— imide, 381
 ——— iodide, 426
 ——— allotropes, 427
 ——— caesium, 433
 ——— lithium, 433
 ——— potassium, 432
 ——— preparation, 426
 ——— properties, chemical, 435
 ——— physical, 427
 ——— rubidium, 433
 ——— sodium, 433
 ——— iododinitrate, 433, 468
 ——— iodonitrate, 433, 468
 ——— iodosesquinitrate, 433
 ——— iodotetranitrate, 469
 ——— metallic precipitation, 318
 ——— monammino-hydroxide, 380
 ——— monammino-nitrate, 477
 ——— monoxide, 368, 371
 ——— native, 299
 ——— nitrate, 459
 ——— ammonium, 479
 ——— caesium, 481
 ——— complex, 477
 ——— cupric, 481
 ——— double, 477
 ——— lithium, 479
 ——— potassium, 480
 ——— properties, chemical, 465, 466
 ——— physical, 460
 ——— rubidium, 481
 ——— nitratoantimonide, 472
 ——— nitratoarsenide, 471
 ——— nitratophosphide, 470
 ——— nitride, 381
 ——— occurrence, 298
 ——— ore, black, 300
 ——— brittle, 300
 ——— dark red, 300

- Silver ore, light red, 300
 — orthophosphate, 485
 — colloidal, 486
 — oxide, 371
 — colloidal, 372
 — properties, chemical, 375
 — physical, 373
 — oxybromide, 423
 — oxyfluoride, 387
 — perbromide, 423
 — peroxide, 368, 383
 — peroxyfluoride, 387
 — peroxyhydrate, 482, 484
 — peroxysulphate, 482, 484
 — phosphates, 485
 — plating, 359
 — properties, chemical, 342
 — physical, 321
 — purification, 314
 — Richards and Wells' process, 308
 — Stas' process, 308
 — pyrometaphosphate, 490
 — pyrophosphate, 487
 — sodium, 488
 — quadrantoxide, 368
 — refined, 358
 — refining, 308
 — ruby, 300
 — saltpetre, 459
 — separation from compounds, 314
 — sesquiammino-bromide, 422
 — sesquiammino-chloride, 400
 — sesquiammino-iodide, 435
 — sesquioxide, 368, 385
 — sodium alloy, 571
 — spitting, 342
 — standard, 358
 — sterling, 358
 — strontium chloride, 720
 — subbromide, 423
 — subchloride, 391, 409
 — subfluoride, 386
 — subiodide, 435
 — subnitrate, 467
 — suboxide, 368
 — subsulphide, 440
 — sulfochlorure, 401
 — sulphate, 450
 — lithium, 454
 — potassium, 454
 — sulphide, 438
 — copper, 447
 — potassium, 447
 — properties, chemical, 442
 — physical, 441
 — sodium, 447
 — telluroargentate, 150
 — tetrammino-carbonate, 458
 — tetrammino-orthophosphate, 487
 — tetraphosphate, 489
 — tetrithoxide, 368
 — thioaurite, 612, 614
 — thiocyanatodinitrate, 469
 — triammino-bromide, 422
 — triammino-chloride, 400
 — triammino-nitrate, 479
 — tri-iodide, 435
 — trimetaphosphate, 489
 — triphosphate, 490
 — ultraphosphates, 490
 Silver valency, 363
 — world's production, 299
 Silvering of mirrors, 359
 Sinter, calcareous, 814
 Slaked lime, 673
 Slate spar, 814
 Slime, 27
 Sluice, 496
 Smalt blue, 274
 — native, 274
 Smelting copper ores, 23
 — blast-furnace, 23
 — electrothermic, 23
 — pyritic, 23
 — reverberatory, 23
 — roaster, 25
 Soda α -cupricarbonate, 277
 — argenio-iodics, 433
 — aurate, 584
 — auroauric chloride, 589
 — aurochloride, 589
 — barium calcium carbonate, 846
 — carbonate, 845
 — chloride, 720
 — fluoride, 695
 — heptasulphate, 805
 — phosphate, 878
 — decahydrated, 878
 — pyrophosphate, 892
 — trimetaphosphate, 894
 — β -cupricarbonate, 277
 — Bordeaux, 267
 — bromoaurate, 607
 — calcium carbonate, 844
 — BaCl_2 -KCl, 720
 — BaCl_2 -SrCl₂, 720
 — CuCl_2 - BaCl_2 -H₂O, 716, 720
 — dihydroxytetrasulphate, 806
 — dimetaphosphate, 894
 — disulphate, 805
 — hexametaphosphate, 895
 — KCl-CaCl₂, 720
 — pentabromide, 732
 — pentasulphate, 804
 — phosphate, 878
 — pyrophosphate, 892
 — SrCl₂-KCl, 720
 — tetrasulphate, 805
 — trimetaphosphate, 894
 — trisulphate, 805
 — chloroaurates, 593
 — chloroaurites, 589
 — chlorocuprocuprate, 184
 — copper alloy, 571
 — cupric chlorophosphates, 290
 — dicarbonate, 276
 — hexametaphosphate, 293
 — phosphate, 290
 — sulphate, 256
 — tetrametaphosphate, 293
 — trimetaphosphate, 292
 — cuprite, 145
 — diauride, 572
 — disulphato-cuprate, 256
 — dithioaurate, 612
 — gold alloy, 571
 — hexachlorocalciate, 719
 — hexametaphosphate silver, 489
 — hydroxy-sulphato-cuprate, 257
 — iodoaurate, 610

- Soda lime, 685
 — phosphatocuprate, 290
 — potassium barium, calcium carbonate, 846
 — calcium carbonate, 845
 — pyrophosphate silver, 438
 — silver alloy, 571
 — carbonate, 458
 — chloride, 404
 — sulphide, 447
 — strontium calcium carbonate, 846
 — carbonate, 846
 — dimetaphosphate, 894
 — phosphate, 878
 — octodecahydrated, 878
 — pyrophosphate, 892
 — tetrasulphate, 805
 — trimetaphosphate, 894
 — sulphate— $\text{CuSO}_4 \cdot \text{H}_2\text{O}$, 257
 — $\text{CuSO}_4 \cdot \text{H}_2\text{SO}_4 \cdot \text{H}_2\text{O}$, 257
 — sulphocuprite, 227
 — thioaurite, 611
 — trichlorocuprite, 163
 — tricupric dipyrophosphate, 291
 — trisulphocuprite, 227
 — trithioaurite, 612
- Sölv, 295
- Soft lead, 311
 — ore, 300
- Soil phosphate, 905
- Soluble anhydrite, 769
- Sombrérite, 896
- Sory, 3
- Soviet gold, 493
- Spar blue, 274
- Spartaite, 814
- Speise, 25
- Spitting of silver, 342
- Spodiosite, 897
- Staffelite, 623, 896
- Stalactites, 814
- Stalagmites, 814
- Stamper mills, 497
- Standard gold, 532
 — silver, 358
- Steadite, 903
- Stelznerite, 265
- Stephanite, 300
- Sterling gold, 532
 — silver, 358
- Stinkstone, 815
- Stoffertite, 880
- Stromeyerite, 447
- Strontia, 652
 — water, 676
- Strontioalcite, 814, 846
- Strontium ammonium dimetaphosphate, 894
 — analytical reactions, 621
 — atomic wt., 646
 — barium calcium hexachloride, 720
 — sulphate, 763
 — bromide, 725
 — properties, chemical, 727
 — physical, 726
 — bromophosphate, 897
 — caesium enneachloride, 719
 — calcium carbonate, 846
 — sodium carbonate, 846
 — carbonate occurrence, 814
- Strontium carbonate preparation, 814
 — properties, chemical, 839
 — physical, 833
 — solubility, 824
 — chloride, 697
 — and fluoride, 718
 — $\text{BaCl}_2 \cdot \text{NaCl}$, 720
 — $\text{CaCl}_2 \cdot \text{BaCl}_2$, 720
 — dihydrated, 705
 — hexahydrated, 705
 — hydrated, 702
 — $\text{KCl} \cdot \text{NaCl}$, 720
 — preparation, 697
 — properties, chemical, 714
 — physical, 700, 706
 — chloroaurate, 595
 — chloropatite, 902
 — chlorophosphate, 902
 — dihydrophosphate, 886
 — monohydrated, 887
 — dihydropyrophosphate, 892
 — hydroxyhydrate, 671
 — dihydroxytetrasulphide, 758
 — dimetaphosphate, 893
 — dihydrated, 893
 — dioxide, 666, 668
 — diperoxyhydrate, 668
 — octohydrated, 667
 — disulphonide, 737
 — fluoride, 688
 — and chloride, 718
 — preparation, 688
 — properties, chemical, 693
 — physical, 689
 — fluoroapatite, 901
 — fluorobromide, 731
 — fluorochloride, 718
 — fluoroiodide, 739
 — fluorophosphate, 901
 — hemiammino-bromide, 730
 — hexametaphosphate, 895
 — hexammino-iodide, 737
 — history, 619
 — hydride, 629-649
 — hydrophosphate, colloidal, 889
 — hydrosulphate, 783
 — hydrosulphide, 750
 — hydrophosphate, 880
 — hydroxide, 673
 — monohydrated, 676
 — octohydrated, 675
 — properties, chemical, 635
 — physical, 681
 — solubility, 677
 — hydroxyphosphate, 902
 — hydroxyhydrosulphide, 755
 — iodide, 734
 — hexahydrated, 735
 — iodochloride, 738
 — iodophosphate, 897
 — isotopes, 648
 — lead iodide, 738
 — lithium pentabromide, 731
 — metaphosphate, 893
 — monometaphosphate, 893
 — monosulphide, 741
 — monoxide, 653
 — nitrate, 849
 — properties, chemical, 860
 — physical, 856

- Strontium nitrate, solubility, 850
 ——— tetrahydrated, 849
 ——— occurrence, 622
 ——— octammino-chloride, 716
 ——— orthophosphate, 866
 ——— ——— properties, chemical, 868
 ——— ——— ——— physical, 867
 ——— oxide properties, chemical, 663
 ——— ——— physical, 660
 ——— ——— higher, 666
 ——— oxides, 652
 ——— oxybromide, 730
 ——— oxychloride, 716, 717
 ——— oxyiodide, 738
 ——— pentasulphide, 755
 ——— phosphates, 864
 ——— polybromide, 730
 ——— polyiodide, 738
 ——— polysulphide, 752
 ——— potassium dimetaphosphate, 894
 ——— ——— disulphate, 806
 ——— ——— hexametaphosphate, 895
 ——— ——— pentabromide, 732
 ——— ——— pentachloride, 719
 ——— ——— phosphate, 877
 ——— ——— pyrophosphate, 892
 ——— ——— tetrabromide, 732
 ——— ——— trisulphate, 806
 ——— preparation, 626
 ——— properties, chemical, 637
 ——— ——— physical, 631
 ——— pyrophosphate, 891
 ——— ——— dihydrated, 891
 ——— ——— monohydrated, 891
 ——— relations Ba, Ca, 907
 ——— silver chloride, 720
 ——— sodium carbonate, 846
 ——— ——— dimetaphosphate, 894
 ——— ——— octodecahydrated, 878
 ——— ——— phosphate, 878
 ——— ——— pyrophosphate, 892
 ——— ——— tetrasulphate, 805
 ——— ——— trimetaphosphate, 894
 ——— sulphate, 760, 764
 ——— ——— colloidal, 764
 ——— ——— preparation, 763
 ——— ——— properties, chemical, 798
 ——— ——— ——— physical, 792
 ——— ——— solubility, 777
 ——— sulphide photoluminescence, 745
 ——— ——— properties, chemical, 742, 744
 ——— ——— ——— physical, 742, 750
 ——— sulphides, 740
 ——— tetrametaphosphate, 894
 ——— ——— octohydrated, 895
 ——— tetrasulphide dihydrated, 753
 ——— ——— hexahydrated, 753
 ——— tetrasulphoniodide, 737
 ——— uses, 644
 Stuckgips, 763
 Stylopyrite, 7
 Sulphatizing roast, 30, 603
 Sulphide ores, roasting, 22
 ——— ——— smelting, 22
 Sulphocupric anhydride, 226
 Sulphur, copper-iron, ternary system, 24
 Sulphuric acid— Na_2SO_4 — CuSO_4 — H_2O , 257
 Sulphurization process, gold refining, 507
 Sulvanite, 7
 Swanbergite, 623
 Sylvanite, 494
 Syngenite, 623, 808
 ——— ammonium, 812
 ——— caesium, 811
 ——— rubidium, 810
- ### T
- Tachydrite, 623, 697
 Tagilite, 289
 Talbot process, 416
 Talcapatite, 896
 Tallingite, 178
 Tarnowitzite, 622
 Tavistockite, 623
 Tellurium, foliated, 494
 ——— graphic, 494
 Tellurocupric acid, 150
 Temperament, influence on judgments, 526
 Temperature, transition, 113
 Tennantite, 7
 Tenorite, 7, 131
 Terra alkalina, 619
 ——— ponderosa, 620, 654
 Tetracalcium phosphate, 903
 Tetracupric trioxydihydroxide, 142
 Thallium chloroaurate, 595
 Thermal conductivity, 52
 Thomasite, 903
 Thomsenolite, 623
 Thrombolite, 288
 Tile ore, 117
 Tirolite, 896
 Ton, gross, 6
 ——— long, 6
 ——— metric, 6
 ——— net, 6
 ——— short, 6
 Tonne, 6
 Tophus, 814
 Torta, 304
 Tough pitch copper, 27
 Towanite, 7
 Transition temperature, 113
 Travertine, 814
 Tricalcium phosphate, 866
 Trichlorocupric acid, 183
 Trihydrocalcite, 822
 Tube mills, 497
 Tufa, 814
 Turacine, 8
 Tzanab, 296
- ### U
- Ulexite, 623
 Umangite, 7
 Ungentum Aegyptiacum, 120
 Uranapillite, 623
 Uranocircite, 625
 Uranospinite, 623
 Uranothallite, 622
 Urvölgyte, 265, 812
- ### V
- Vadj, 295
 Vanadium ochre, 127

Vaterite, 816
 Venetian sublimate, 157
 Verd antique marblo, 815
 Verdigris, 76, 270
 Vitriol blue, 234
 — cyprian, 234
 — de Luna, 459
 Vitriolum argenti, 459
 — veneris, 234
 Völckerite, 904
 Volborthite, 623, 625

W

Wagnerite calcium, 902
 Wall saltpetre, 849
 Wattevillite, 623
 Wet processes extraction, copper, 29
 — — — — — chemical, 29
 — — — — — electrolytic, 29
 Whewellite, 623
 White metal, 25
 Whitneyite, 7
 Wiedemann and Franz's law, 52
 Wittichenite, 7
 Woodwardite, 7

X

Xanthoconite, 300

Y

Yttrium chloroaurate, 595
 Yttrocerite, 623

Z

Zengite, 889
 Ziegelerz, 117
 Ziervogel's process, silver, 305
 Ziguéline, 117
 Zilver, 295
 Zinc azurite, 275
 — bromoaurate, 607
 — chloroaurate, 595
 Zincocalcite, 814
 Zorgite, 7

END OF VOL. II

