

# *Waipatia maerewhenua*, New Genus and New Species (Waipatiidae, New Family), an Archaic Late Oligocene Dolphin (Cetacea: Odontoceti: Platanistoidea) from New Zealand

R. Ewan Fordyce

Department of Geology, University of Otago, P.O. Box 56, Dunedin, New Zealand

**ABSTRACT.**—*Waipatia maerewhenua*, from the Otekaieke Limestone (late Oligocene), Waitaki Valley, New Zealand, is a new genus and species in a new family Waipatiidae (Odontoceti: Platanistoidea) near the base of the radiation of platanistoids. Its features include skull about 600 mm long; rostrum long and narrow; incisors long, procumbent, and gracile; cheek teeth heterodont and polyodont; maxillae telescoped back over frontals toward supraoccipital; parietal narrowly exposed on vertex; pterygoid sinus fossa restricted to basicranium; and palatine broad and not invaded by pterygoid sinus fossa. Features of the tympano-periotic, periotic fossa, and foramen spinosum indicate platanistoid relationships. *Waipatia maerewhenua* is more closely related to the Squalodelphidae and Platanistidae than to the Squalodontidae. Of the similar small dolphins previously identified as Squalodontidae, *Microcetus ambiguus* (late Oligocene, Germany) and *Sachalinocetus cholmicus* (early or middle Miocene, Sakhalin) are possible waipatiids. *Microcetus hectori* (earliest Miocene, New Zealand) is a probable squalodelphid. *Prosqualodon marplei* (early Miocene, New Zealand) is transferred to *Notocetus* (Squalodelphidae) as *Notocetus marplei* (new combination). *Sulakocetus dagestanicus* (late Oligocene, Caucasus) is probably a waipatiid close to *W. maerewhenua*. These taxa reveal an early radiation of the Platanistoidea by the late Oligocene.

## INTRODUCTION

This article describes a new family, new genus, and new species of late Oligocene marine platanistoid dolphin from New Zealand. Heterodont dolphins from Oligocene and Miocene rocks worldwide have played a key role in interpretations of cetacean evolution because they are transitional in grade between archaic Cetacea (Archaeoceti) and extant odontocetes. *Waipatia maerewhenua* meets traditional concepts of the Squalodontidae, a family often used for heterodont odontocetes, but is more closely related to the Squalodelphidae and Platanistidae than to the Squalodontidae. It is an early member of the platanistoid radiation that led to diverse Miocene taxa and ultimately to the two extant species of "river dolphins" of the genus *Platanista*; the latter represent the last of the Platanistidae and, probably, the superfamily Platanistoidea. *Waipatia maerewhenua* thus has implications for odontocete history and for defining and delimiting the Squalodontidae, Squalodelphidae, and Platanistoidea.

The article has three main sections: (1) a description reviewing morphology and commenting on other taxa as needed to help interpret homology, (2) a comparison covering broader aspects of morphology, homology, and function, and (3) cladistic relationships. A new combination, *Notocetus marplei* (Dickson, 1964) (Platanistoidea: Squalodelphidae), is used throughout for the so-called *Prosqualodon marplei* of New Zealand.

## MATERIAL AND METHODS

Descriptions are based on the right or left side, whichever is more informative, with differences between right and left mentioned only if asymmetry is evident. Unreferenced statements about morphology are based on personal observations. The specimen was prepared with pneumatic chisels and scrapers. Fine details were prepared under a microscope with an ultrasonic dental scaler and an air-abrasive unit; some sutures could not be traced fully because the cancellous bone is friable and not permineralized. Photographs were taken with a 35-mm Asahi Pentax camera with a 50-mm macro lens. Illustrations derived from photographs are not corrected for parallax.

Acronyms used here are NMNZ Ma, marine mammal catalog in the National Museum of New Zealand, Wellington, New Zealand; OM C and OM A, catalogs in Otago Museum, Dunedin, New Zealand; OU, fossil catalog in Geology Museum, University of Otago, Dunedin, New Zealand; USNM, Department of Pale-

biology, National Museum of Natural History, Smithsonian Institution, Washington, D.C.

## SYSTEMATICS

Order Cetacea Brissou, 1762

Suborder Odontoceti Flower, 1867

Superfamily Platanistoidea Simpson, 1945

Family Waipatiidae, new

*Type genus.*—*Waipatia*, new genus.

*Included genera.*—*Waipatia*, new genus, only.

*Diagnosis of family.*—As for the only included species, *Waipatia maerewhenua*, in the only included genus, *Waipatia*, below.

*Comment.*—The family probably includes *Sulakocetus dagestanicus* Mchedlidze, 1976 (late Oligocene, Caucasus), and may include species of *Microcetus* and *Sachalinocetus*; these are discussed below.

Genus *Waipatia*, new

*Type species.*—*Waipatia maerewhenua*, new species.

*Included species.*—*Waipatia maerewhenua*, new species, only.

*Diagnosis.*—As for the only included species, *Waipatia maerewhenua*, below.

*Etymology.*—From the Maori name Waipati, a place near the type locality. Probable derivation: wai, water; pati, shallow. Regarded as indeclinable. Pronunciation: wai-pa-ti, with a pronounced as in English "far," and i as in "he."

*Waipatia maerewhenua*, new species

Figs. 2–8, 9b, 10a–k, 11, 12, 13a–g

*Material.*—Holotype only, OU 22095: a skull with 23 teeth in pair, both mandibles, 17 loose teeth, left tympanic bulla, right periotic, left periotic lacking anterior process, atlas, natural cast of anterior of axis, and anterior thoracic vertebra. Collected by R. Ewan Fordyce, A. Grebneff, and R. D. Connell, January 1991.

*Type locality.*—North-facing cliff near Waipati Creek, 5 km west-southwest of Duntroon and 1.2 km north of "The Earthquakes," North Otago (Fig. 1). Grid reference: NZMS [New

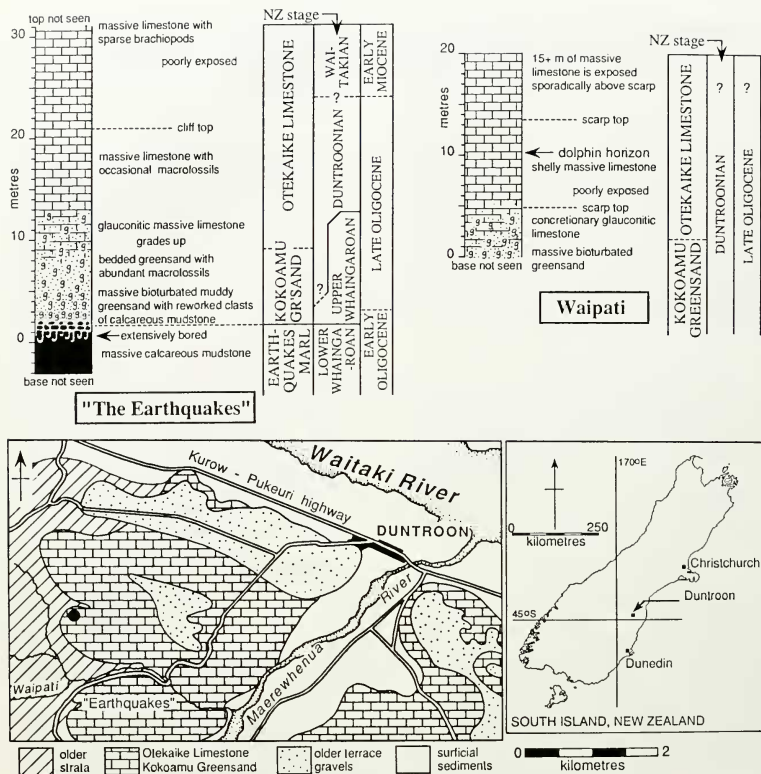

Figure 1. Locality map, geological map, and stratigraphic sections. Dot marks type locality of *Waipatia maerewhenua*. The "Earthquakes" section based on Hornibrook (1966), Fordyce et al. (1985), and Fordyce and M.A. Ayress field data. The Waipati section from Fordyce's field data; detailed microfossil dates unavailable for Waipati. Correlations between "Earthquakes" and Waipati sections are lithostratigraphic. Upper parts of both sections, exposed discontinuously on sloping hillsides, are measured less reliably than lower parts. Geological map based on Gage (1957).

Zealand Mapping Series] 260 metric sheet 140 (1987): 222912; near latitude  $44^{\circ} 51.5' S$ , longitude  $170^{\circ} 37.25' E$ . See Gage (1957: Geological Map No. 2).

**Horizon and age.**—Massive limestone with sparse macrofossils (Maerewhenua Member), 8–9 m above the base of the Otekaike Limestone Formation (Fig. 1). Fossil record number 140/f284 (New Zealand fossil record file, Geological Society of New Zealand). Matrix lacks *Globoquadrina dehiscentis*, a planktonic foraminiferal

index species for the Waitakian Stage; this species appears nearby in the upper Otekaike Limestone (Hornibrook et al. 1989). Other foraminifera in the sample indicate a Duntroonian to Waitakian age. The upper Duntroonian Stage is likely; this is equivalent to late or latest Oligocene, about 24–26 Ma (Hornibrook et al. 1989). Nearby, at "The Earthquakes," the stratigraphic sequence is established better (Fig. 1; Fordyce et al. 1985; Gage 1957; Hornibrook 1966; Hornibrook et al. 1989), reinforcing an upper Duntroonian determi-

nation. Here, the lower Otekaike Limestone represents the Duntroonian Stage (late to latest Oligocene), while Waitakian faunas (earliest Miocene) appear 13–14 m above the base of the limestone.

**Diagnosis.**—Odontocete with slightly asymmetrical skull of medium size (condylobasal length approximately 600 mm), attenuated rostrum, heterodont polyodont teeth, and basicranium of archaic grade. Placed in the Platanistoidea because the periotic has an incipient articular process, the anterior process is roughly cylindrical in cross section and deflected ventrally, and the tympanic bulla has an incipient anterior spine, anterolateral convexity, and ventral groove extending anteriorly as a series of long fissures. Allied with the Squalodelphidae and Platanistidae, rather than the Squalodontidae, because the long asymmetrical posterior apex of the premaxilla extends posterior to the nasal to wedge between the elevated edge of the maxilla and frontal on vertex, the cheek teeth are small, the incisors are relatively delicate and procumbent. The premaxillary sac fossa is relatively wide and expanded medially to form a significant prenarial constriction, the pterygoid sinus fossa is in the alisphenoid and/or basioccipital dorsolateral to the basioccipital crest and posteromedial to the foramen ovale, the lateral groove affects the external profile of the periotic, rendering it sigmoidal in dorsal view, the dorsal ridge on the anterior process and body of the periotic is associated with a depression near the groove for the tensor tympani, the profile of the anteroexternal sulcus of the periotic is recurved and concave dorsally, and the squamosal carries a smoothly excavated periotic fossa associated with an incipient subcircular fossa (enlarged foramen spinosum) dorsal to the periotic. More derived than described Squalodelphidae, Platanistidae, and Dalpiastidae in that the mandibles have a shorter unfused symphysis, the sinus fossa in the alisphenoid and/or basioccipital is larger, and the anterior process of the periotic is relatively larger and more inflated transversely, with a blunter apex reflected more abruptly ventrally.

**Etymology.**—From the Maori name Maerewhenua, name of a river near the type locality. Probable derivation: maere, perhaps from maru, shelter, or maero, the original inhabitants; wenua, country or land. Regarded as indeclinable. Pronunciation: maerewhenua, with a pronounced as in English “far,” e as “ea” in English “leather,” wh usually as “f” but sometimes as “wh” as in “when,” u as double “o” in English “moon.”

**General description.**—The skull is nearly complete; it lacks the apex of the rostrum, the pterygoids, and all but the bases of the jugals. There is a little shear (structures on the right side lie anterior to those on the left) but no major diagenetic distortion; the brain case is slightly crushed. The asymmetry of the nasals, frontals, premaxillae, and base of the rostrum appears real. The skull was found upside down; the right mandible lay bent over the rostrum with its body perforated by maxillary teeth. The earbones and 17 partial or whole teeth were loose in the matrix around the skull. About 1.5 m<sup>2</sup> was excavated without revealing the rest of the skeleton.

**Cranium.**—The cranium (that portion of skull posterior to the antorbital notches) is about as long as it is wide. In lateral view (Fig. 2e), the orbit is little elevated above the base of the rostrum. The external nares open from subvertical narial passages about level with the postorbital processes of the frontals. At the level of the nasals, the face is up to 30–35 mm deep, indicating well-developed maxillo-naso-labialis (facial) muscles (Fig. 2). Facial muscle origins, formed by the maxilla, are relatively long and narrow and not expanded or deepened posterolaterally; the posterior of the face is shallow. The maxilla and frontal only partly roof the relatively large temporal fossa (Figs. 2a, b). A prominent temporal crest with a long straight postorbital border bounds all of the dorsal edge of the fossa; within the fossa the braincase is not obviously inflated. The intertemporal constriction is reduced, with

a narrow band of parietals exposed dorsally. The supraoccipital lies well forward, not encroached upon by facial elements.

**Rostrum.**—The rostrum is relatively long, wide at its base at the antorbital notches, and attenuated anteriorly (Figs. 2a, 3a). Each antorbital notch, which transmitted the facial nerve, is open anteriorly but is shallow dorsoventrally. A prominent antorbital (preorbital) process extends forward to bound the notch laterally. Anterior to the right notch, the rostral margin of the maxilla flares out to form a marked flange missing on the left (Figs. 2a, 4a, 5a). The right notch is deeper and more U-shaped than the left. As viewed laterally (Fig. 2e), the premaxilla forms all of the dorsal profile; the ventral surface of the rostrum, formed by the maxilla, is roughly flat, and the rostrum thins only a little apically. In ventral view (Fig. 2c), the anterior half of the rostrum is grooved medially, while posteriorly it is gently convex. Palatal ridges are indistinct, and there are no rostral fossae for pterygoid sinuses. In dorsal view, the open mesorostral groove is wide posteriorly but narrow anteriorly. Other profiles of the rostrum are shown in Figs. 2 and 4.

**Premaxilla.**—Anteriorly, the premaxilla is narrowest in dorsal view at mid-rostrum, where it bounds and slightly roofs the mesorostral groove. Further forward, the premaxilla forms the apical 55+ mm of the rostrum. The dorsal rostral suture with the maxilla is prominent but not deep. The premaxilla forms an internarial constriction medially, where the premaxillary sac fossa is widest between the level of the nares and premaxillary foramina. Anteriorly, the fossa is nearly horizontal in transverse profile; it narrows and is elevated behind the prenarial constriction. Each premaxillary foramen is single; the right is longer than the left and lies more posteriorly, but both open anterior to the antorbital process. The anteromedial and, particularly, the posterolateral premaxillary sulci are prominent (Fig. 4a), but the posteromedial sulcus is shallow and indistinct. The nasal plug muscle probably originated on the narrow shelf of the premaxilla that overhangs the mesorostral groove anteromedial to the premaxillary foramen. Much of the outer margin of the premaxilla lateral to the premaxillary sulci carries a low thick rounded ridge. In dorsal view, the lateral edge of the premaxilla is gently convex around the region of the external nares. Lateral to each naris and within the premaxilla is a long median premaxillary cleft (new term; Figs. 4d, 5b), perhaps a vascular feature, which ascends posteriorly toward the junction of premaxilla, maxilla, nasal, and frontal at the vertex. The cleft lies just internal to the prominent medial facial crest formed by the maxilla and premaxilla and does not strictly mark the boundary between the posterolateral plate and posteromedial splint of the premaxilla. On the left, the premaxillary cleft grades forward into the posterolateral sulcus.

The premaxilla is split or bifurcated posteriorly into a more dorsal, posteromedial thin ascending process (splint) and a more ventral posterolateral plate (*sensu* Fordyce 1981). The posterolateral plate is developed where a thin portion of the premaxilla external to the posterolateral sulcus overlaps the maxilla; this plate is conspicuous in lateral view (Figs. 4c, 6b) but is indistinct from above (Figs. 4d, 5b). The narrow posteromedial splint extends behind each nasal to wedge between the maxilla and frontal, thus separating the nasal from the maxilla. The left and right splints are asymmetrical (Figs. 4d, 5b).

**Maxilla.**—Rostral profiles of the maxilla are shown in Figs. 2a, b, e and 4a–c. At least one maxillary foramen opens in the shallow depression between the maxillary flange and antorbital notch, and two or three foramina also open around each notch, but numbers are uncertain because the bone surface is damaged. Contacts with the frontal and lacrimal can be localized only to within a few millimeters. The right antorbital process, formed by the lacrimal, is not covered by the maxilla. Ventrally, the maxilla forms most of the surface of the rostrum; it extends back between the subhorizontally

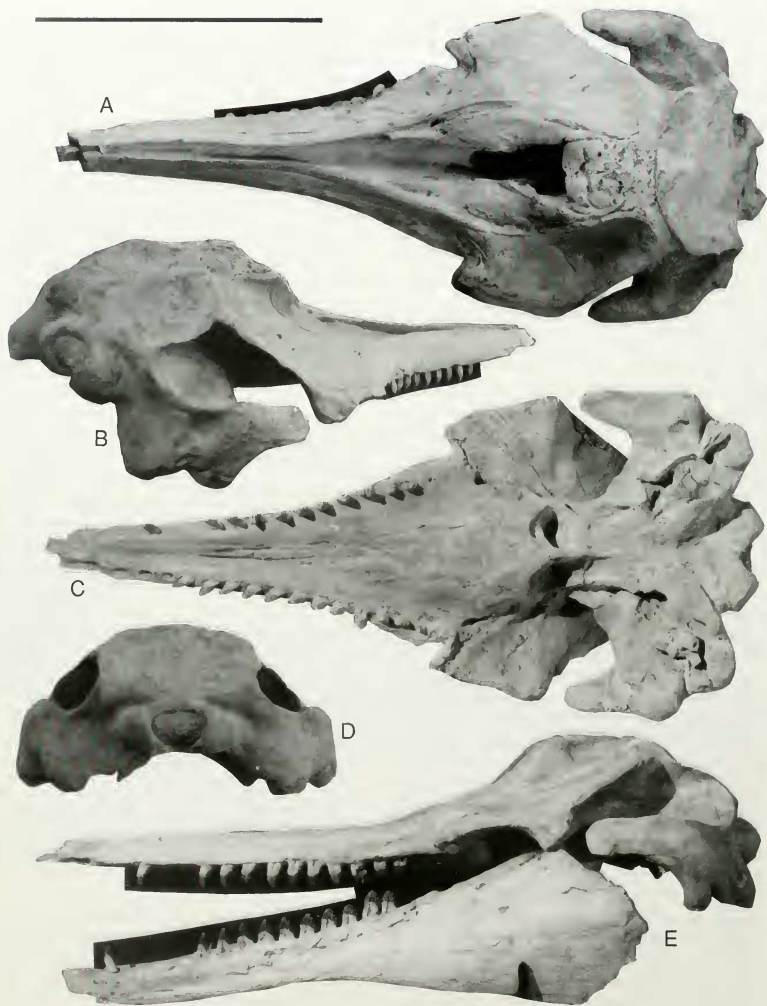

Figure 2. *Waipatia maerewhenua*, holotype, OU 22095. Skull, coated with sublimed ammonium chloride. All to same scale; scale = 200 mm. A, dorsal; B, right posterolateral; C, ventral; D, posterior; E, left lateral of skull and left mandible.

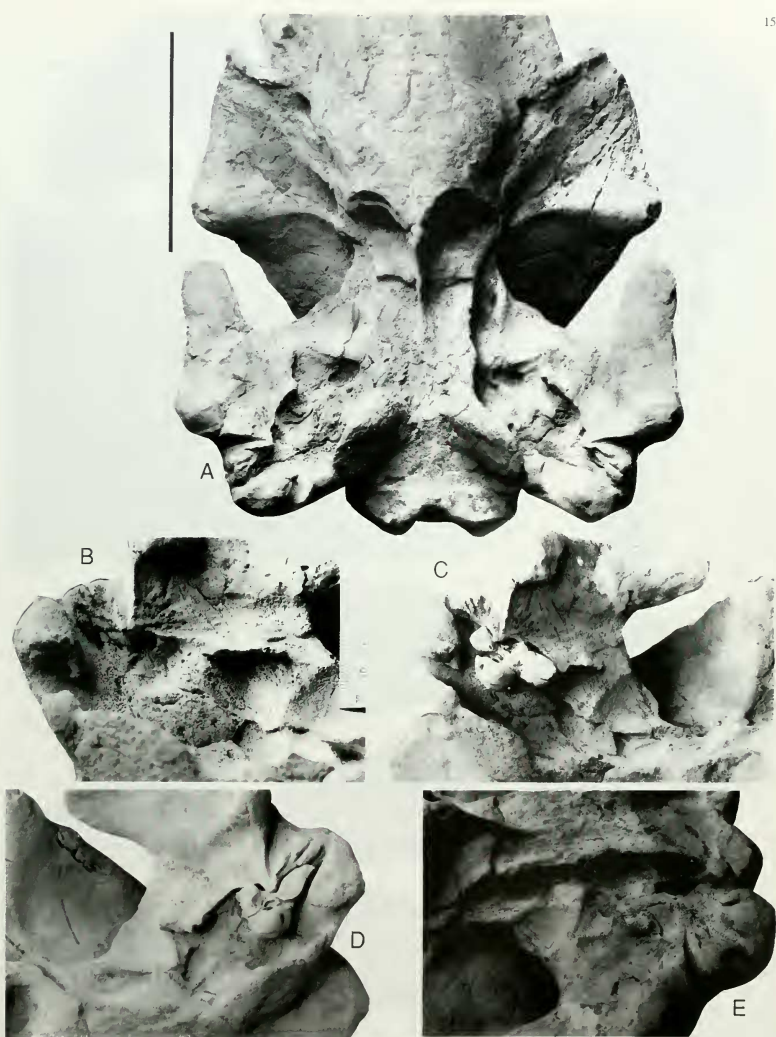

Figure 3. *Waipatia maerewhenua*, holotype, OU 22095. Skull, coated with sublimed ammonium chloride. A, ventral view, posterior of basicranium, right side. Scale = 100 mm. B-E all to same scale, ruler divisions are 1 mm. B, ventromedial view, posterior of basicranium, right side. C, ventral view, posterior of basicranium with periotic in place, right side. D, ventral view, posterior of basicranium with periotic in place, left side. E, ventrolateral view, posterior of basicranium showing pterygoid sinus fossa posteromedial to foramen ovale, right side.

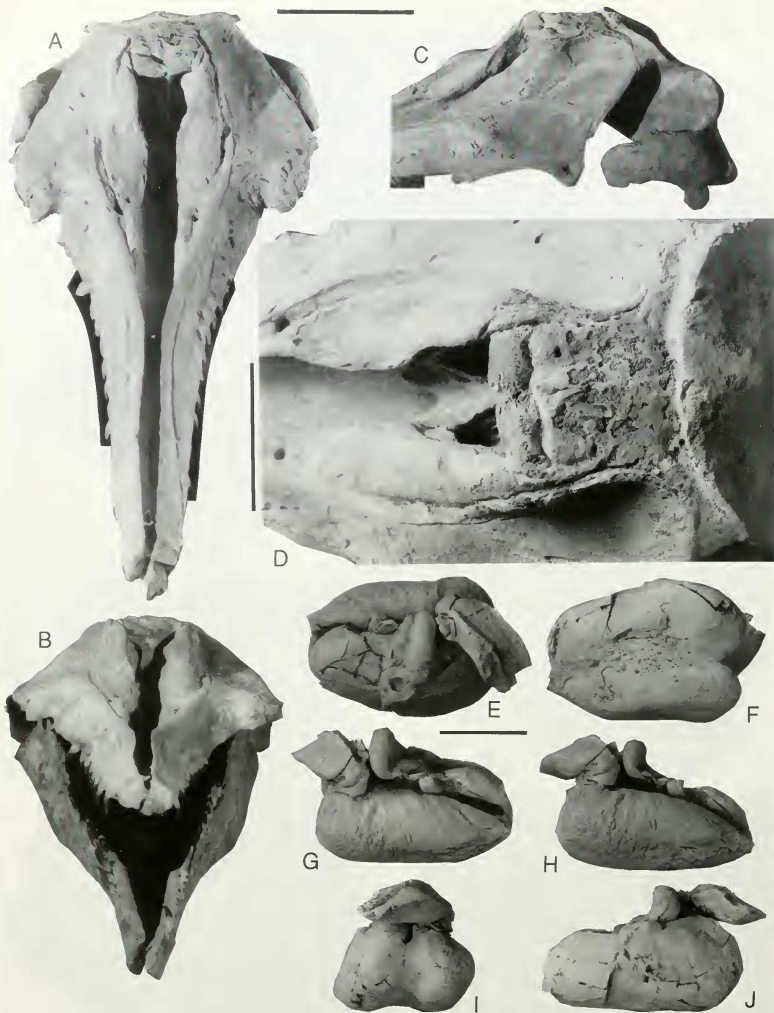

Figure 4. *Waipatia maerewhenua*, holotype, OU 22095. A–D, skull, coated with sublimed ammonium chloride. A–C at same scale; scale = 100 mm. A, anterodorsal; B, skull with articulated mandibles, anterior and slightly dorsal view (mandibles are distorted so that symphysis does not articulate properly); C, left anterolateral; D, detail of vertex. Scale = 50 mm. E–J, holotype, left tympanic bulla, coated with sublimed ammonium chloride. Scale = 20 mm. E, dorsal; F, ventral; G, oblique dorsolateral of medial face. H, medial; I, posterior; J, lateral.

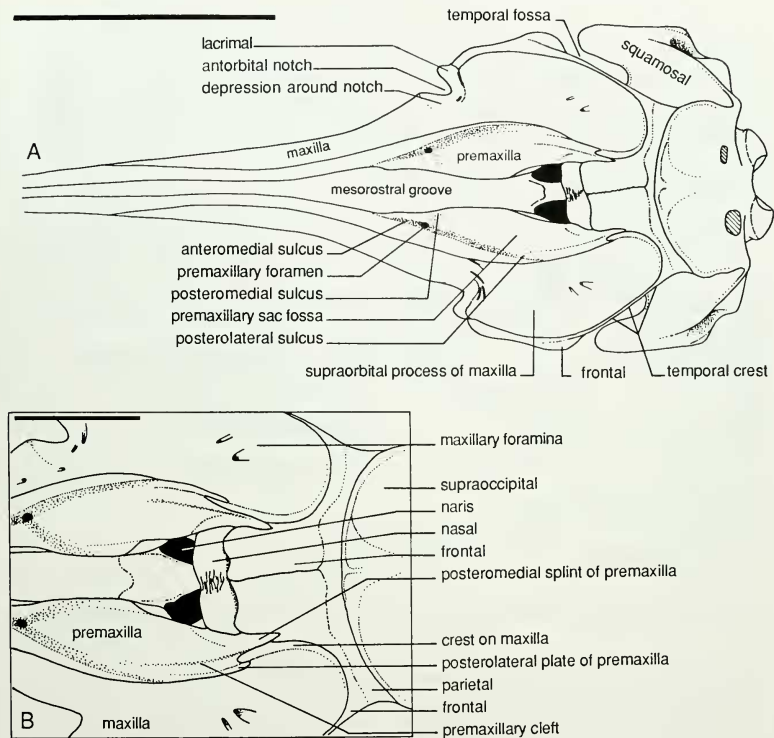

Figure 5. Reconstructions of dorsal view of skull of *Waipatia maerewhenua*. A, general profile. Scale = 200 mm. B, detail of vertex. Scale = 50 mm.

directed infraorbital foramen and the palatine but does not contribute to the anterior wall of the orbit (Figs. 2c, 3a, 7a).

The cranial part of the maxilla (e.g., Figs. 2a, 4a, c) forms a long narrow supraorbital process that covers all of the frontal but for a thin lateral band over the orbit and curves in gently behind the nasals. Although the maxilla is slightly thickened just behind the antorbital process, there is no facial crest. Each supraorbital process has two centrally placed posteriorly directed maxillary foramina about level with the postorbital process of the frontal; these foramina supplied blood vessels and nerves to the facial muscles. The maxilla carries anteriorly directed grooves, not obviously vascular, anterior to the maxillary foramina. Posteriorly, the rounded apex of the maxilla is separated from the supraoccipital by a thin band of the frontal and parietal. Though the maxilla is subhorizontal over the orbit, it becomes steeper posteromedially, with a markedly

concave surface. The maxilla rises abruptly at the vertex to form a barely elevated maxillary crest that contacts the premaxilla (anteriorly) and frontal (posteriorly) (Figs. 4c, 5b), just behind the bifurcation of the premaxilla.

**Palatine.**—Broadly exposed palatines form the posterior portion of the palate between the choanae (posterior nares) at about the level of the most posterior cheek tooth (Figs. 2c, 3a, 7a). The palatines are continuous transversely across the convex palate, not narrowed or split by contact of the pterygoids with the maxillae. Contacts with the maxilla and frontal are localized to within a few millimeters; the sutures appear to be simple. The palatine sulci on the maxilla extend back toward the palatines, but the maxillary-palatine suture is preserved too poorly to tell whether a palatine foramen is present. Medially the palatines contact each other to form an indistinct flat palate bounded by faint palatal crests. Each

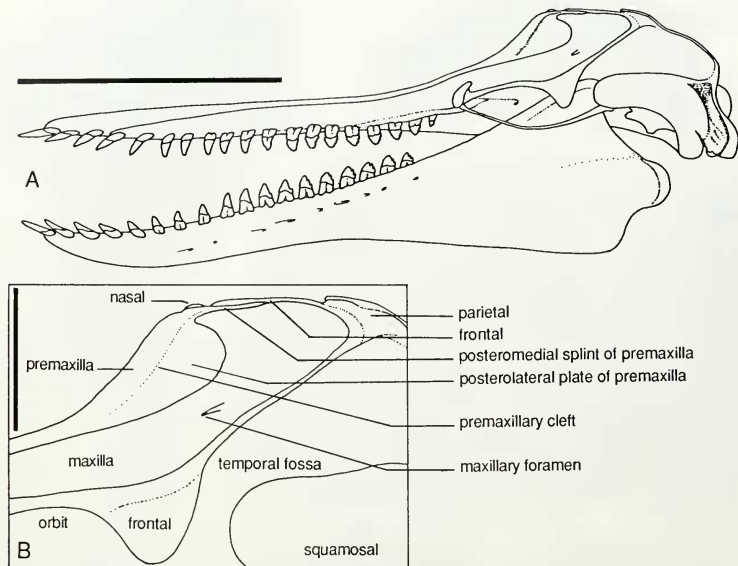

Figure 6. Reconstructions of lateral view of skull of *Waipatia maerewhenua*. A, general profile. Scale = 200 mm. B, detail of face. Scale = 50 mm.

palatine is prominently excavated posteroventrally, just below the choana, with a shallow, crescentic depression at the pterygopalatine suture (Fig. 3a). The palatine lacks a lateral (outer) lamina.

**Pterygoid and pterygoid sinus.**—Neither pterygoid is preserved. The loss of the pterygoids reveals an overlying large channel for the maxillary branch of the trigeminal nerve ( $V_2$ ), which ran from near the foramen ovale internally out via the foramen rotundum to the orbit (Figs. 3a, 7a). The long lateral margin of the basioccipital, basisphenoid, and vomer in front of the basioccipital crest indicates that the inner lamina of the pterygoid was long; an anterior facet on the basioccipital crest indicates contact with the pterygoid. Since the basisphenoid and vomer are wide (Fig. 3a), the inner lamina of the pterygoid was probably narrow, not expanded medially. There is no evidence of a well-developed bony lateral lamina of the pterygoid associated with the subtemporal crest; the subtemporal crest is the abrupt ventrointernal margin of the temporal fossa (here mainly formed by alisphenoid) that extends from near the choanae toward the squamosal, to separate the basicranium from the temporal fossa and orbit. This well-preserved crest lacks a thin bony ridge, which would be expected if a pterygoid lateral lamina had extended ventral to the crest, and lacks a definite suture for the pterygoid. Furthermore, the falciform process of the squamosal (Figs. 3a–e, 8a, b) lacks evidence of contact with the pterygoid.

A relatively large hemispherical pterygoid sinus fossa is present; despite its name, this fossa lies mainly in the alisphenoid. The missing pterygoid probably formed the anterior part of the fossa.

The fossa apparently did not extend anteriorly or dorsally beyond the pterygoid, and there is no evidence of a fossa in the palatine (Figs. 2c, 3a). Farther dorsally, the palatine and/or frontal just below the orbital infundibulum lacks any channel for an orbital extension of the pterygoid sinus; the orbit lacks fossae. Behind the orbit, the prominent subtemporal crest (Fig. 7a) further indicates that the pterygoid sinus was confined to the skull base. Smooth bone surfaces posterior to the main pterygoid fossa indicate other lobes of the sinus. Probable fossae include the large depression in the alisphenoid anterior to the groove for the mandibular nerve ( $V_3$ ) and a smooth depression between the foramen ovale and falciform process. A fossa, presumably for a large posteromedial lobe of the pterygoid sinus, lies posteromedial to the foramen ovale around the carotid foramen. Sutures here are fused; the fossa probably involves the alisphenoid, basisphenoid, and the dorsal part of the basioccipital crest (Figs. 3e, 8a).

**Nasal.**—Nodular, anteroposteriorly short, wide nasals are crudely rectangular in dorsal view, with a convex anterior margin and a biconcave posterior margin (Figs. 2a, 4a–d). In vertical profile the anterior edge is rounded. Each nasal extends posterolaterally between the frontal and premaxilla, markedly so on the left. The interdigitating internarial suture and, particularly, the nasofrontal suture are depressed but not deep or narrow. The nasals only slightly overhang the external nares.

**Mesethmoid.**—The mesethmoid forms much of the borders of the narial passages below the nasals (Figs. 4d, 5b). Anteromedially,



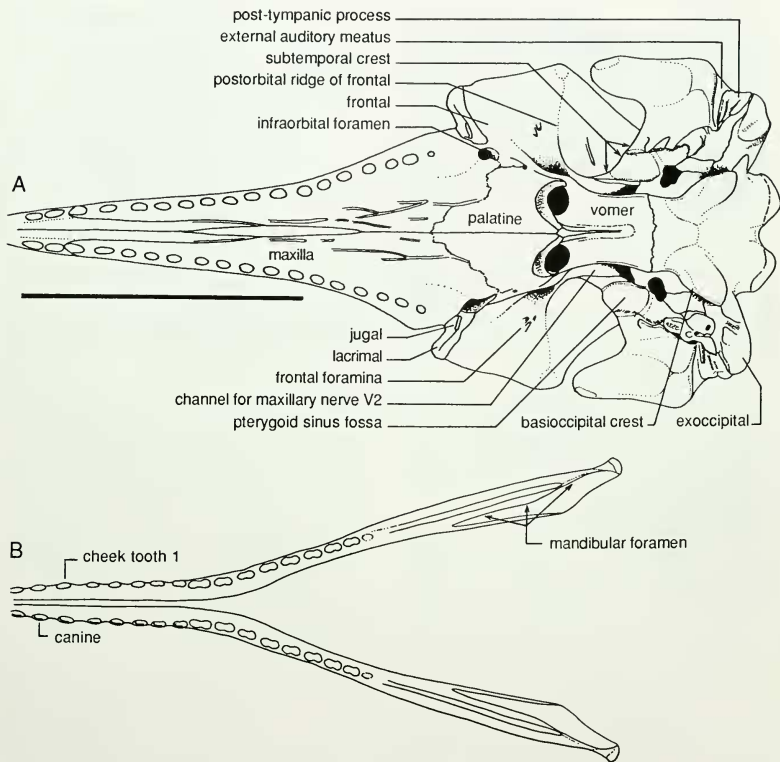

Figure 7. Reconstructions of *Waipatia maerewhenua*. Scale = 200 mm. A, ventral view, skull; B, dorsal view, mandible.

it forms a low rim on the narial passage at the posterior of the mesorostral groove, where it is probably fused with the vomer and/or presphenoid. Further posterodorsally, the mesethmoid forms an ossified internarial septum about 10 mm wide. The dorsal surface here and further ventrally in the mesorostral groove is diffuse and probably carried cartilage that formed a septum between the soft tissues of the nares and also filled the mesorostral groove. The mesethmoid does not significantly support the nasals (Fig. 4b). Behind and laterally, a narrow groove (for the olfactory nerve?) ascends to a diagonal depression (for the olfactory foramen?).

**Vomer.**—This lines the mesorostral groove, with a thin sliver exposed ventrally on the palate (Figs. 2c, 7a) between the maxillae. Further posteriorly (Fig. 3a), the sagittal part of the vomer separates

the choanae, where the narial passages turn abruptly dorsally toward the external nares. The horizontal part of the vomer extends at least 65 mm posterior to the palatine, almost level with the foramen ovale, to cover the basisphenoid and broadly roof the basicranium. The margins of the horizontal part are subparallel posteriorly but flare out anteriorly as the choanae widen.

**Lacrimal.**—The lacrimal is exposed to dorsal view (Figs. 2a, 4a–c) at the antorbital process, where it forms the lateral margin of the antorbital notch. Sutures are ill defined because thin edges on the maxilla are preserved poorly. The lacrimal is thin both dorsoventrally and anteroposteriorly, is transversely wide, is directed anterolaterally, and has only a small ventral exposure. Ventrally, the transversely wide, anteroposteriorly narrow broken base of the

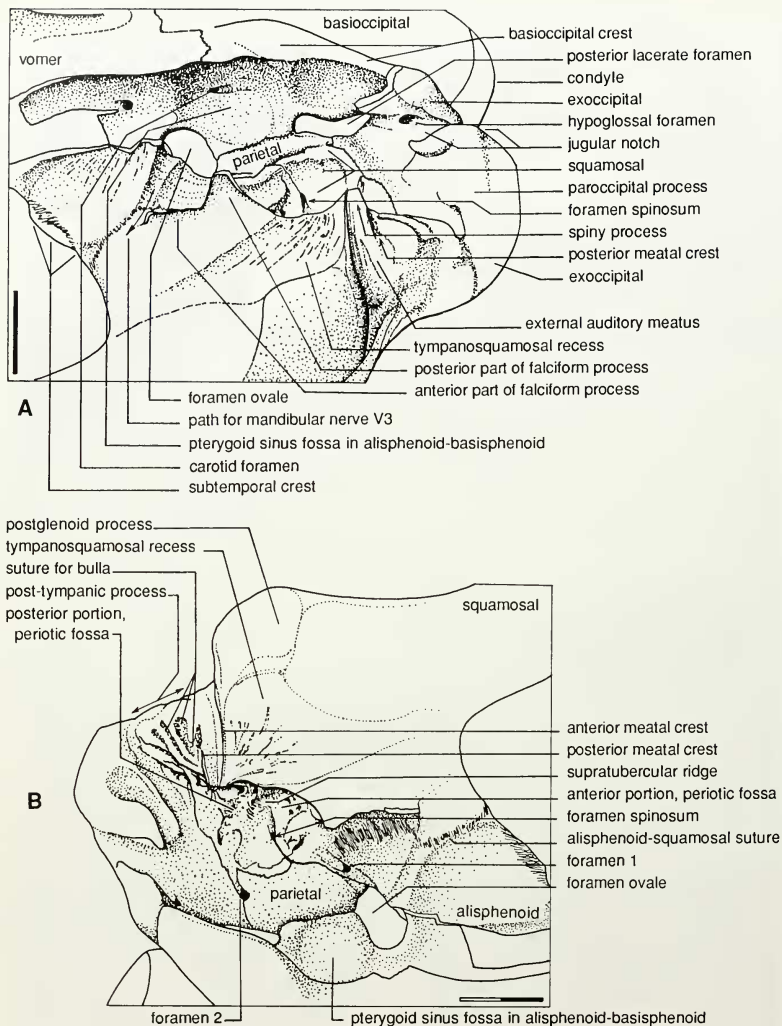
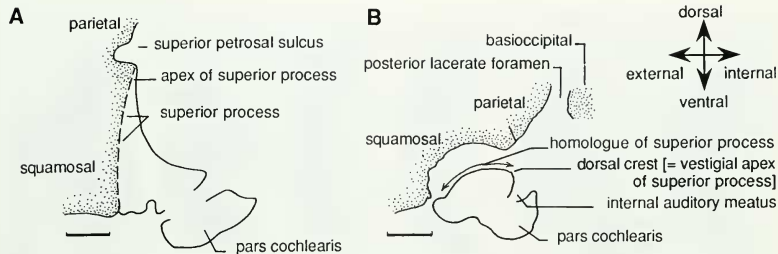

Figure 8. Interpretations of details of basicranium of *Waipatia maerewhenua*. Scale = 20 mm. A, ventrolateral, right side with ventral uppermost, showing position of fossa for pterygoid sinus in alisphenoid and basioccipital posteromedial to foramen ovale. B, ventral and slightly medial aspect, right side showing periotic fossa, presumed foramen spinosum, and other structures around periotic.



*Basilosaurus cetoides*

*Waipatia maerewhenua*

Figure 9. Schematic cross section of the basicranium at the level of the petiotic in *Basilosaurus cetoides* (redrawn from Pompeckj 1922: pl. 2) and *Waipatia maerewhenua*, showing changes in relationship of petiotic, squamosal, and parietal. Scale = 10 mm. A, *Basilosaurus cetoides*; B, *Waipatia maerewhenua*.

jugal lies immediately behind the antorbital notch. There is no clear evidence of a lacral canal.

**Frontal.**—The frontals have a long (ca. 45 mm) rather tabular exposure on the vertex behind the nasals (Figs. 4d, 5b). Since other bones on the skull are fused to the degree expected in a subadult or adult specimen, the distinct interfrontal suture is noteworthy. The frontals are markedly asymmetrical, with the left wider and shorter than the right. There are no supraorbital foramina (the large hole visible in Fig. 4d is a tool mark). The depressed suture with the parietals is partly fused; an interpretation appears in Fig. 5b. Farther laterally (Fig. 2b, 4c), the frontal is barely exposed dorsally along the postorbital margin of the face.

Ventrally, the frontal forms most of the shallow elongate orbit. The preorbital ridge is low and indistinct, without an antorbital process, and barely separates the orbit from the infraorbital foramen (Fig. 3a). The lateral margin of the frontal is thin; farther medially, two or three confluent small frontal foramina open laterally in the roof of the orbit near the prominent postorbital ridge (Figs. 3a, 7a). Posteromedially, the postorbital ridge appears to contact the alisphenoid. Behind the ridge and below the posterior of the face, the frontal forms a large posteroventrally directed origin for the temporal muscle.

**Parietal.**—A narrow slightly depressed band of parietal is exposed across the vertex between the frontal (Figs. 4d, 5b) and the nuchal crest of the supraoccipital. No obvious postparietal foramina or interparietal are present. A short robust temporal crest formed by the parietal separates the vertex from the temporal fossa at an intertemporal constriction. The parietal forms the slightly inflated anterolateral wall of the brain case (= medial wall of the temporal fossa), where it is markedly concave dorsally but convex farther ventrally toward the subtemporal crest.

A nodular exposure of parietal is present in the basicranium dorsomedial to the petiotic and immediately internal to the squamosal (Figs. 3a–c, 8a, b), where it faces ventromedially. The parietal thus lies immediately dorsal and internal to the dorsal crest of the petiotic (Figs. 8a, b, 9a, b); such juxtaposition is concomitant with the lack of a discrete subarcuate (subfocular) fossa on the petiotic and a change in the structure or position of the superior petrosal sulcus. Here the parietal lacks evidence of large cavities (presumed vascular sinuses) of the sort present anterior to the petiotic in the archaic cet *Basilosaurus cetoides* (USNM 6087; Kellogg 1936:

figs. 5, 6). Medially, the parietal contacts an extensive horizontal sheet of apparently fused basiisphenoid (anteriorly) and basioccipital (posteriorly); the contact of these three elements separates the foramen ovale anteriorly from the posterior lacerate foramen and clearly isolates the petiotic from the cranial cavity (Figs. 3b–e, 8b, 9b). The term cranial hiatus, used by Fraser and Purves (1960) for structures here, seems redundant; furthermore, a perusal of literature indicates that the term is used in an ambiguous and misleading way. Posteromedially, the parietal borders the posterior lacerate foramen, while farther laterally it has a long suture with the exoccipital that includes the small foramen 2 of Fig. 8b. The long suture with the alisphenoid anterolaterally is formed by a narrow fissure that runs obliquely from the foramen ovale to open at the foramen spinosum (Figs. 3a–c, 8a, b) dorsal to the petiotic.

**Squamosal.**—In dorsal view, the zygomatic process parallels the axis of the skull at the maximum width of the cranium. The process reaches forward to about level with the back of the nasals but does not reach the level of the postorbital processes of the frontals. The crest of the zygomatic process is rounded transversely but nearly flat anteroposteriorly (Figs. 4a, c). Posteriorly, above the external auditory meatus and post-tympenic process, the zygomatic process carries a large fossa (Figs. 2b, d, e) that angles forward almost to the level of the postglenoid process; this fossa forms an origin for some or all of the sternomastoides, scalenus ventralis, longus capitis, and mastohumeralis muscles (cf. Howell 1927; Schulte and Smith 1918). Dorsally, at the apex of the fossa, the broad crest of the zygomatic process passes abruptly into a narrow lambdaoid crest that curves inward and up onto the supraoccipital. Between the parietal and zygomatic process, the dorsal surface of the squamosal carries a broad shallow depression that forms the floor of the temporal fossa. The apex of the zygomatic process is rather short and rounded.

The ventral surface of the squamosal is complex. In ventral view (Figs. 3a–e) the zygomatic process has a steep external face and gently rounded internal face, with a short narrow fovea for the jugal at its apex. Posteriorly, a distinct ridge at the outer margin of the tympanosquamosal recess for the middle sinus marks the inner edge of the glenoid fossa. The ridge and recess extend ventrolaterally onto the robust postglenoid process, where the recess is widest; here the skull lacks a postglenoid foramen and the anterior transverse ridge associated with this foramen. Near the spiny

process (*sensu* Muizon 1987), the surface of the recess carries a few shallow striae, presumably vascular, but there are no clear foramina (Figs. 3b, d). Anteriorly, the boundaries of the recess are indistinct, without any marked dorsal excavation.

Anteriorly, the squamosal–alisphenoid suture is indistinct (Fig. 8b). Contacts are not clear beyond foramen 1 of Fig. 8b. There is no pterygoid process of the squamosal at the subtemporal crest, but the falciform process (Figs. 3a–e, 8a) is well developed. This process has a long base and is bifurcated; an anterior portion extends out as a thin plate-like subhorizontal spike ventral to the path of the mandibular nerve ( $V_1$ ), while a posterior portion curls ventrally and inwards along the apex of the anterior process of the petiotic. Both parts of the falciform process are thin distally and show no sign of contact with the pterygoid.

The smooth squamosal forms a sporadically vascularized and spacious petiotic fossa (new term) above the petiotic and lateral to the parietal (Figs. 3a, b, e, 8b, 9b). The petiotic fossa extends anteroposteriorly about 22 mm from the base of the falciform process almost to the occipital, and transversely about 20 mm from the inner edge of the tympanosquamosal recess to a crest on the inner margin of the squamosal. The latter crest apposes the ventrally adjacent dorsal crest of the petiotic (Figs. 9b, 11b), close to the parietal.

The petiotic in *W. maerewhenua* approximates the squamosal at the posterior process (which, though finely porous dorsally, is not fused), lateral tuberosity, and part of the anterior process (Figs. 3c, d). For the most part, the squamosal and petiotic are widely separated dorsally, leaving a spacious cavity between the petiotic fossa and the petiotic (Fig. 9b). There are two ventrolateral fissures that open into this cavity immediately anterior and immediately posterior to the lateral tuberosity, between the external edge of the petiotic and the inner edge of the tympanosquamosal recess (Fig. 3c).

The petiotic fossa (Figs. 3a, b, 8b, 9b) is split into two portions by a roughly vertical supratergular ridge (new term; Figs. 3b, 8b) 11–12 mm anterior to the spiny process. A larger anterior portion lies dorsal to the anterior process of the petiotic, while the smaller posterior portion lies dorsal to the body of the petiotic. The anterior portion of the petiotic fossa probably transmitted the middle meningeal artery, which entered the petiotic fossa via the fissure immediately anterior to the lateral tuberosity (between the anterior process and the inner edge of the tympanosquamosal recess; Figs. 3c, d), passed above the petiotic, and entered the large foramen spinosum. Given the voluminous cavity between the petiotic and petiotic fossa, the artery may have given rise to a rete that filled the anterior part of the petiotic fossa. A near-obiterated fissure that marks the path of the foramen spinosum (Figs. 3a, b, 8a, b) runs forward across the squamosal and along or near the parietal–alisphenoid suture toward the foramen ovale. The anterior part of the petiotic fossa and the large foramen spinosum are provisionally regarded as homologous with the subcircular fossa *sensu* Muizon (1987) of *Notocetus vanbenedeni* Moreno, 1892.

In the smaller posterior portion of the petiotic fossa, behind the supratergular ridge, the wall of the squamosal is excavated dorsal to the spiny process. The excavation may represent an incipient cavity for the articular process of the petiotic (as seen in *Zarhachis flagellator*; e.g., Muizon 1987). The posterior portion of the petiotic fossa could have housed a rete, a lobe of the middle sinus extending

dorsally from near the spiny process, or a part of the posterior sinus. It is not clear how the posterior part of the petiotic fossa relates to the large posterior sinus fossa shown by Muizon (1987: fig. 3a) for *Notocetus vanbenedeni*.

The external auditory meatus (Figs. 3a–e) is narrow, widens laterally and ventrally, and deepens externally; it has a steep anterior wall. Medially, the meatus is separated from the tympanosquamosal recess by a sharp anterior meatal crest (new term; Fig. 8b) that extends from the postglenoid process to the spiny process; in the Archaeoceti, a topographically identical and presumably homologous crest lies behind the vestigial postglenoid foramen. The posterior wall of the meatus slopes gently back to a low posterior meatal crest (new term; Figs. 8a, b), behind which lies the post-tympanic process (*sensu* Pompeckj 1922: pl. 2; = post-meatal process of Muizon 1987) of the squamosal (Fig. 8). The anterior edge of the posterior process of the bulla overlaps the posterior meatal ridge to form part of the meatus. Also, an anterodorsal projection from the posterior process of the bulla overlaps the spiny process. Three fissures in the post-tympanic process receive ridges on the posterior process of the bulla and the posterior (mastoid) process of the petiotic (Figs. 3, 8a, b). *Waipatia maerewhenua* is amastoid, with a posterior process of the petiotic that lies 9–10 mm internal to the skull wall, covered ventrally by bulla and hidden from lateral view. Behind the articulated petiotic is a narrow cleft, open ventrally, by which the facial nerve perhaps left the skull.

*Petiotic*.—The incomplete petiotics together provide a clear idea of their structure. As this element seems one of the most diagnostic single bones among the Cetacea, I consider it here in detail. Morphological terms here largely follow Barnes (1978), Fordyce (1983), Kasuya (1973), Kellogg (e.g., 1923a), and Pompeckj (1922).

Distinctive features of the petiotic (Figs. 10a–k, 11a–d) include, in summary, the large, robust, inflated anterior process with a subcircular cross section, an indistinct anterior keel, prominent anterointernal sulci (new term; see below), and a blunt apex. The lateral tuberosity and fossa incudis are prominent. The deep, laterally compressed, pyriform internal auditory meatus has a rather small posterior tractus, a very narrow anterior portion, and a supplementary opening (for the greater petrosal nerve?) off the facial canal (= Fallopian aqueduct of Kellogg) anterior to the internal auditory meatus. The smooth subspherical pars cochlearis is relatively large and dorsoventrally deep. The subcircular dorsal aperture for the cochlear aqueduct is small and thick-lipped, while the aperture for the endolymphatic duct is primitively slitlike. A dorsal crest (new term; Fig. 11b) forms the vertex of the dorsal surface. There is a narrow, smooth facet on the attenuated posterior process. Though each petiotic is incomplete, it is likely that the axis (as viewed dorsally with the ventral face sitting on a flat plane) is sigmoidal, as is seen in *Notocetus marplei*. Overall profiles are shown in Figs. 10a–k and Figs. 11a–d; details follow.

Of the two horizontal anterointernal sulci (Fig. 11d) on the internal face of the anterior process, the dorsal sulcus ends posteriorly at a vertical canal that opens (Figs. 11a, d) farther dorsally on the anterior process. One of these sulci may carry the lesser petrosal nerve. In lateral view (Fig. 10c), the axis of the anterior process is reflected down, so that the anterior bullar facet (that part of the anterior process normally in contact with the processus tubarius of

Figure 10. Petiotics of *Waipatia maerewhenua*, squalodontids, and other presumed platanistoids. All coated with sublimed ammonium chloride. All life size; scale = 20 mm. A–K, *Waipatia maerewhenua*, holotype, OU 22095. A–F, presumed platanioids. A, ventral; B, dorsal; C, lateral and slightly ventral; D, medial; E, lateral and slightly dorsal; F, posteromedial; G–K, left petiotic; G, ventral; H, dorsal; I, medial; J, lateral; K, posteromedial. L–Q, *Notocetus marplei*, holotype, left petiotic, C.75.27. L, ventral; M, dorsal; N, lateral and slightly ventral; O, medial; P, lateral; Q, posteromedial. R–W, un-named squalodontid, right petiotic, OU 22072. R, ventral; S, dorsal; T, lateral and slightly ventral; U, medial; V, lateral; W, posteromedial, showing reniform fenestra rotundata. X–C', unnamed squalodontid, right petiotic, OU 21798. X, ventral; Y, dorsal; Z, lateral and slightly ventral; A', medial; B', lateral; C', posteromedial.

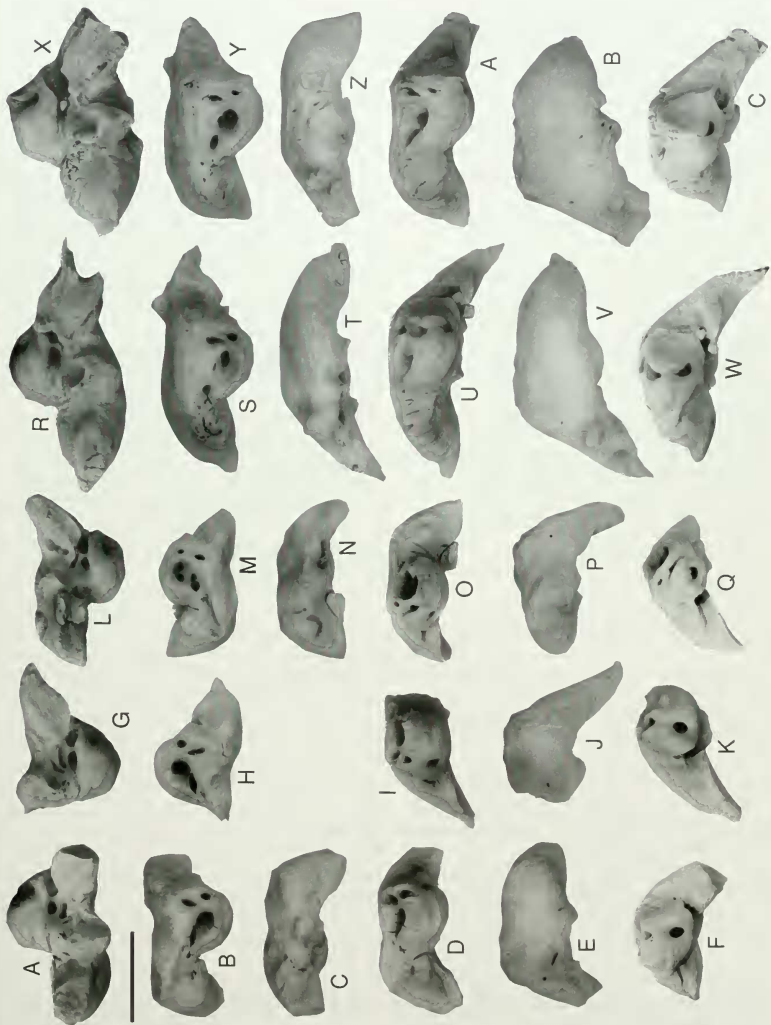

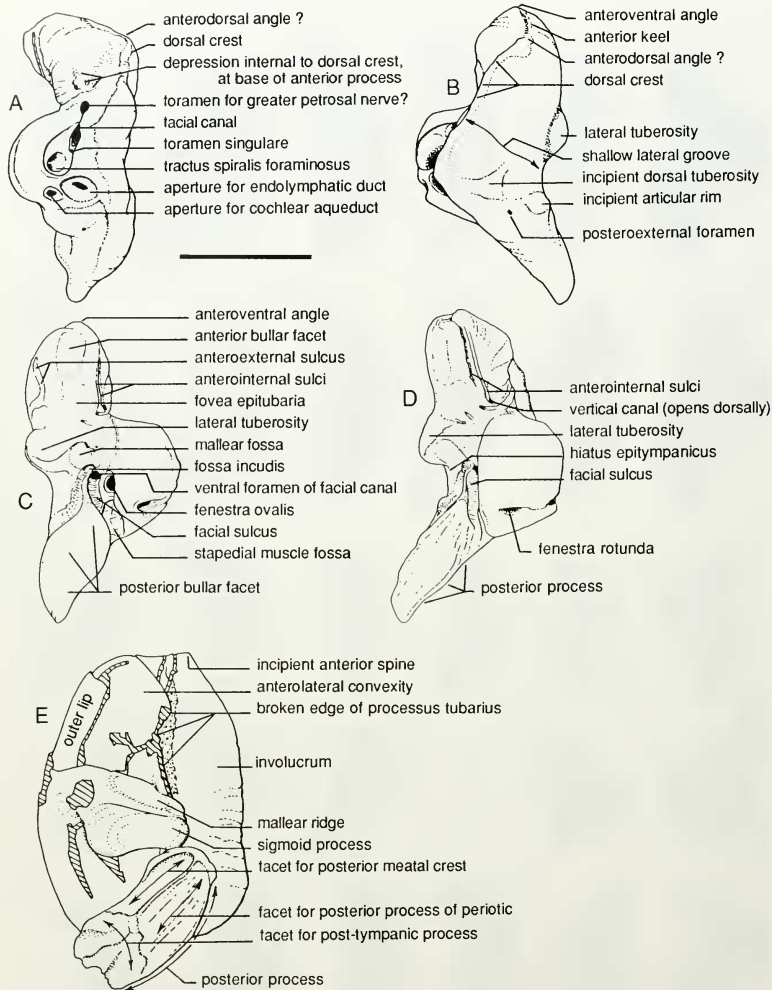

Figure 11. Camera lucida sketches interpreting the key features of the periotic and tympanic bulla of *Waipatia maerewhenua*. Scale = 20 mm. A–D, right periotic, with lateral tuberosity and posterior process reconstructed from left periotic. A, dorsomedial; B, dorsal to dorsolateral; C, ventral; D, ventrolateral; E, left tympanic bulla, dorsal.

the bulla; new term; Fig. 11c) is steeply inclined; the apex of the periotic appears blunt rather than attenuated. There are traces of an anterior keel on the anterior process. A prominent nodule on the inner face may represent a vestigial anterodorsal angle (*sensu* Fordyce 1983); the presumed anteroventral angle is blunt, not acute. The slightly damaged anterior bullar facet is a long shallow groove bounded laterally by smooth bone rather than by a thickened parabullary ridge (new term, possibly equals "distinct ventral rim" or "ventral swelling" of Muizon 1987: 7). More posteriorly, the fovea epitybaria (*sensu* Pompeckj 1922: 58, 66–67, pl. 2; = epitybarian fossa) is wide, shallow, and depressed medially. (Muizon 1987 used the term epitybarian fossa for what I term the anterior bullar facet.) A well-developed anteroexternal sulcus on the lateral face of the anterior process is visible in ventral view (Figs 10a, 11c); its recurved, dorsally concave profile is marked in external view (Fig. 10c). The sulcus may mark the path of a loop of middle meningeal artery ventral to the periotic.

The origin for the tensor tympani muscle is an indistinct cleft between the base of the anterior process and the perpendicular anterior face of the pars cochlearis. The pars cochlearis (Figs. 10a, b, d, f) is moderately inflated with abruptly rounded anteroventral and posteroventral angles; the posteroventral angle lacks a nodule. There is no obvious promontory sulcus. The small suboval fenestra rotunda is elongated vertically but is not reniform or fissured dorsomedially (Fig. 10f). Dorsally on the pars cochlearis, there is a faint raised rim on the long narrow internal auditory meatus, and an indistinct groove, perhaps a path for the inferior petrosal sinus, runs medial to the rim. Within the meatus, a rather narrow subcircular posterior tractus for the acoustic nerve is separated by a cleft from the deep narrow fissure into which open the small foramen singulare and slightly larger internal or dorsal aperture for the facial canal. A supplementary foramen opening 2–3 mm anterior to the internal auditory meatus (Figs. 10b, 11a) marks a canal (perhaps for the greater petrosal nerve) originating from the facial canal.

Externally, the dorsal surface of the body of the periotic has a long dorsal crest, indistinct posteriorly, but better developed anteriorly where it runs forward from the level of the facial canal on to the anterior process (Figs. 10b, 11b). Because of its topographic relations, I identify the crest as a homolog of the apex of the superior process of Archaeoceti (Fig. 9a,b). There is no obvious superior petrosal sinus or subarcuate (subflocular) fossa internal to the crest. Between the lateral tuberosity (*sensu* Barnes 1978; = ventral tuberosity of Muizon 1987) and the posterior process, a broad shallow lateral groove (Figs. 10b, e, 11b) ascends the external face, rising toward the level of the dorsal opening of the facial canal. This lateral groove complements a depression in the squamosal, so that a cavity lies between the periotic and squamosal.

Ventrally on the body, the dorsoventrally compressed lateral tuberosity has a prominent subhorizontal crest (Figs. 10g, j) that closely follows the edge of the squamosal (Fig. 3d). Farther posteriorly, the hiatus epitympanicus is indistinctly biconcave (Figs. 10a, c). The anterior of this depression receives the spiny process (*sensu* Muizon 1987) at the internal limit of the external auditory meatus, while the shallow articular groove at the anterior of the base of the posterior process (Fig. 10a) receives the posterior border of the spiny process. Of other ventral features on the body, the malleolar fossa has an indistinct posteroexternal boundary and carries a prominent foramen at its inner margin. The fossa incudis is prominent at the anterior end of a meandering shallow groove. The subcircular fenestra ovalis lies far dorsal to the surface of the pars cochlearis. The ventral (epitympanic) opening for the facial canal opens anteroexternal to the level of the fenestra ovale, while the shallow facial sulcus for the facial nerve disappears before the end of the fossa for the stapedial muscle. Ridges separate this large, concave, rugose, and rather narrow fossa from both the fenestra ovalis and the groove for the facial nerve.

On the posterior process (Figs. 10a, g), the facet for contact with the tympanic bulla is long, narrow, smooth, and attenuated, and does not extend dorsally onto the posteromedial face of the posterior process. Dorsally, two raised regions on the base of the posterior process may be homologous with more prominent structures on other platanistoids (Fig. 11b). An indistinct bulge on the dorsal surface of the posterior process is probably homologous with the dorsal tuberosity (*sensu* Muizon 1987). Further ventrally is a small posteroexternal foramen (new term; Figs. 10e, 11b), a persistent feature amongst archaic Cetacea, although of uncertain function. Below the posteroexternal foramen is a bulge on the base of the posterior process above the articular groove that is probably homologous with the articular rim (*sensu* Muizon 1987) or the peglike articular process of other Platanistoidea.

*Tympanic bulla.*—The bulla (Figs. 4e–j, 11e) is crushed. In dorsal or ventral view (Figs. 4e, f), it is roughly heart-shaped, with a convex outer margin, bilobed posterior face, and straight (posteriorly) to gently curved (anteriorly) involucrem. There is an incipient anterior spine and an anterolateral convexity (*sensu* Muizon 1987) on the outer lip, but there is no obvious anterolateral notch. Posteriorly, an interprominential notch separates the blunt inner prominence (medial lobe) and the narrower, deeper, slightly longer and more sharply rounded outer prominence (lateral lobe) (Figs. 4j, j). There is no obvious horizontal ridge between the prominences or across the inner prominence. In posterodorsal view, the interprominential notch is deep; below, it passes into a deep wide ventral groove that runs forward to about level with the sigmoid process (Fig. 4f). Farther forward, the groove is shallow and marked by fine to coarse fissures and small foramina; it extends to the apex of the bulla. The rough surface of the groove perhaps marks the attachment of the fibrous sheet known to cover the skull's base in some extant Cetacea (Fraser and Purves 1960). Although anteriorly the involucrem is depressed abruptly into the tympanic cavity (Fig. 4d), it is broad and not obviously invaded by an internally expanded tympanic cavity. Coarse striae of uncertain function cross the dorsal surface of the involucrem, radiating from about the position of the sigmoid process. The striae finish at a series of subhorizontal creases that traverse the inner face of the involucrem (Fig. 4h) and could be associated with tissues of the peribullary sinus known to occupy the space between the involucrem and the basioccipital crest in some extant Odontoceti (Fraser and Purves 1960).

As viewed laterally (Fig. 4j), the sigmoid process has an abruptly curved posteroventral profile; in anterior view the profile is rounded. The crushed lateral furrow is shallow. There is a robust oblique malleolar ridge (new term) to which the malleus fuses internally at the base of the sigmoid process. The conical process, obscured by the sigmoid process, has a flat posterior face and may be anteroposteriorly compressed. A wide gap, now distorted, separates the conical process from the posterior process. The distorted long posterior process articulates with the squamosal in two ways (Fig. 11e): anterolaterally, the process carries a groove that overlaps the posterior meatal crest of the squamosal, while the thinner distal 12+ mm of the process has a ridged subhorizontal suture (Figs. 4i, j) that articulates with the post-tympanic process of the squamosal (Figs. 8a, b). In lateral view of the skull (Fig. 6a), the posterior process of the bulla is just visible ventral to the post-tympanic process. The elliptical foramen is open, deep, and narrow. When the bulla is articulated, there is a large cavity, presumably for the peribullary sinus, between the bulla and the basioccipital crest.

*Supraoccipital.*—The supraoccipital, which slopes forward at about 40° from horizontal, is roughly symmetrical, broad, and rather flat (Figs. 2a, b). Its blunt rounded anterior margin forms a nuchal crest elevated 3–4 mm above the parietal. A broad, low, and slightly asymmetrical anterior median ridge (Fig. 2a) bounds

faint anterolateral depressions. Convex lambdaoid crests are present laterally. Posteriorly, each crest descends abruptly toward the squamosal.

**Basioccipital.**—Behind the vomer, the basioccipital forms a shallow arcade that deepens posteriorly as the basioccipital crests diverge. Each crest is short (Fig. 3a) relative to the basicranial length. The crest is transversely thick and robust, with a thin ventral margin. Anterolaterally, just behind the carotid foramen, the dorsal base of the crest carries part of a large shallow hemispherical fossa for part of the pterygoid sinus (Figs. 3e, 8a). A small carotid foramen (Fig. 8a) indicates the anterior extent of the basioccipital, but there is no clear suture here with the alisphenoid or basisphenoid.

**Exoccipital.**—The hind surface of the exoccipital is gently convex, other than near the pedicle for the condyle where the surface is deeply excavated. The condyloid fossa is excavated deeply into the braincase; the condyle has a rather small articular surface and a prominent pedicle. The exoccipital is closely applied to the squamosal along its dorsal and lateral edges, with rounded borders and rather curved lateral and ventral profiles. Dorsally, the suture with the supraoccipital is fused (Figs. 2b, d).

Ventrally, the exoccipital forms the posterior portion of the so-called basioccipital crest, immediately internal to the shallow jugular notch and the internally placed hypoglossal foramen (Figs. 3a–c, 8a). The paroccipital process is robust, with a prominent but unidentified groove (Figs. 3a–c, right side) trending dorsomedially across the anterior face. Farther dorsally, the region between the exoccipital and squamosal–petriotic is quite spacious, though there is no distinct fossa for a posterior sinus. Laterally, the exoccipital contacts the post-tympanic process of the squamosal (Fig. 3a).

**Alisphenoid, basisphenoid, orbitosphenoid.**—The alisphenoid forms part of the subtemporal crest, but is otherwise not exposed within the temporal fossa. Anteriorly, the alisphenoid forms most of what remains of the pterygoid sinus fossa. Posteriorly, the alisphenoid is notched at a large foramen ovale. The complex posterolateral suture with the squamosal is shown in Fig. 8b. The alisphenoid carries a broad, shallow groove for the mandibular nerve ( $V_3$ ), which runs obliquely from the foramen ovale outward beyond the falciform process. Immediately anterior to this groove, the alisphenoid carries a large shallow hemispherical depression, probably for a lobe of the pterygoid sinus. The basisphenoid is probably fused with the alisphenoid; no sutures are apparent. Posteriorly, the carotid foramen marks the likely limit of the basioccipital. The orbitosphenoid is not distinct.

**Teeth.**—*Waipatia maerwahuia* is heterodont (Figs. 2c, 6a) and polyodont. The right maxilla carries 16 alveoli (12 teeth are in place), suggesting 19 teeth in each upper tooth row. Alveoli in the right mandible indicate at least 16 and probably 19 teeth in the lower tooth row. Smooth procumbent single-rooted anterior teeth carry a crown formed by a single sharp and delicate denticle (Figs. 13a, b). These subhorizontal apical teeth grade back into anterior cheek teeth with high crowns, small posterior accessory denticles, and fused double roots, in turn succeeded posteriorly by vertically positioned posterior cheek teeth with low, rather blunt and robust crowns that carry prominent posterior accessory denticles and strong ornament (Figs. 12a–f, 13c, d). The posterior diastemata are rather narrow, so that the upper and lower teeth probably did not interdigitate much. Apices of the posterior cheek teeth are worn from tooth-to-tooth contact.

No anterior teeth are in place in the subhorizontal alveoli of the premaxilla and mandible. Features of the presumed incisors (Figs. 13a, b, bottom) include a high smooth crown, subcircular in cross section with barely developed keels, and a somewhat inflated root that forms most of the height of the tooth. The largest tooth (maximum height, apex of crown to apex of root, 76+ mm), presumably  $I^1$ , has a gently sigmoid profile; its crown is subcircular in cross

section. This large tooth was probably quite procumbent. Smaller and more recurved single-rooted teeth, presumably  $I^2$ ,  $I^3$ , and C, have lower crowns that are recurved buccally and compressed laterally with indistinct keels. In lateral view, the axes of these teeth are recurved back, so that they were less procumbent than the apical teeth.

Features of the cheek teeth are shown in Figs. 12a–f and 13a–d. The axes of the upper cheek teeth are strongly recurved lingually (Fig. 4b), while the lower cheek teeth are roughly straight. The posterior two or three lower cheek teeth are inclined slightly outward, while the other cheek teeth are inclined lingually. Those cheek teeth in place are emergent, with the crown well clear of the alveolus. Crowns of the middle to posterior cheek teeth (Figs. 12a, b) are conspicuously compressed, with a high triangular main (apical) denticle, two or three posterior denticles, but no anterior denticles. The apical denticle becomes smaller posteriorly in the tooth row as the accessory denticles become larger, and the third denticle is better developed on the lower teeth. Buccal ornament is indistinct, but lingual ornament is strong and, basally, associated with a cingulum on most cheek teeth (Figs. 13c, d). In the double-rooted teeth, the roots are fused for at least one third of their length; anteriorly, roots are divergent, while posteriorly they are roughly parallel. The last upper cheek tooth is small and single-rooted with a coarsely ornamented subconical crown (Figs. 13c, d, upper left).

**Mandible.**—The reconstruction of the mandibles (Fig. 7b) is a visual "best fit," determined through aligning the mandibles with each other, with the glenoid cavities, and with the rostrum. The reconstructed profile in dorsal view is a Y shape, with a symphysis 110–120 mm long.

Conspicuous features of each mandible (Figs. 6a, 7b, 12c–f) include the relatively long tooth row, 16+ alveoli, the gently curved dorsal profile in which the long, narrow, and deep body passes back into the low coronoid process, the ventrally and laterally inflated "pan bone" (= outer wall of large mandibular foramen, or "mandibular fossa"), and the relatively short unfused mandibular symphysis. Both mandibles are incomplete. With the left jaw articulated on the skull, the tooth in the third preserved alveolus occludes behind the position of the upper left canine; I identify it provisionally as cheek tooth 1. Left lower cheek teeth 5–14 are in place, and there may have been a small cheek tooth 15; right lower cheek teeth 5–10 are in place.

The dorsal and ventral profiles of the body (Figs. 12c–f) are roughly parallel; the apical 80–90 mm of the ventral surface bends dorsally forward of the level of the fifth alveolus. The body deepens markedly behind cheek teeth 11–12, after which the pan bone is progressively inflated.

The long shallow apical groove on the internal face of each mandible probably indicates an unfused symphysis in which the bones were not closely apposed in life. The left mandibular foramen opens 140–150 mm anterior to the condyle (Figs. 12d, e). A robust ridge marks the posterodorsal edge of the foramen just below the coronoid process, where the foramen is about 90 mm deep. There is an equally robust ridge ventrally above the angular process. Internally, the condyle is slightly excavated, while its worn outer surface protrudes a little beyond the external profile. No distinct fossae are apparent for jaw muscle insertions; presumably insertions were as in extant *Odontoceti* (e.g., Howell 1927). Positions of the nine mental foramina are shown in Fig. 6a.

**Vertebrae.**—The atlas (Figs. 13e–g) is slightly distorted through crushing and shearing, and surface bone is eroded in places. It is moderately thick, not compressed anteroposteriorly, and not fused to the axis. The eroded base of the neural spine is not massive or inflated. Anterior and posterior facets for contact with the skull and axis diverge gently in lateral view. The anterior facets are shallow and indistinctly separated ventrally; the posterior facets are barely raised above the adjacent bone. The



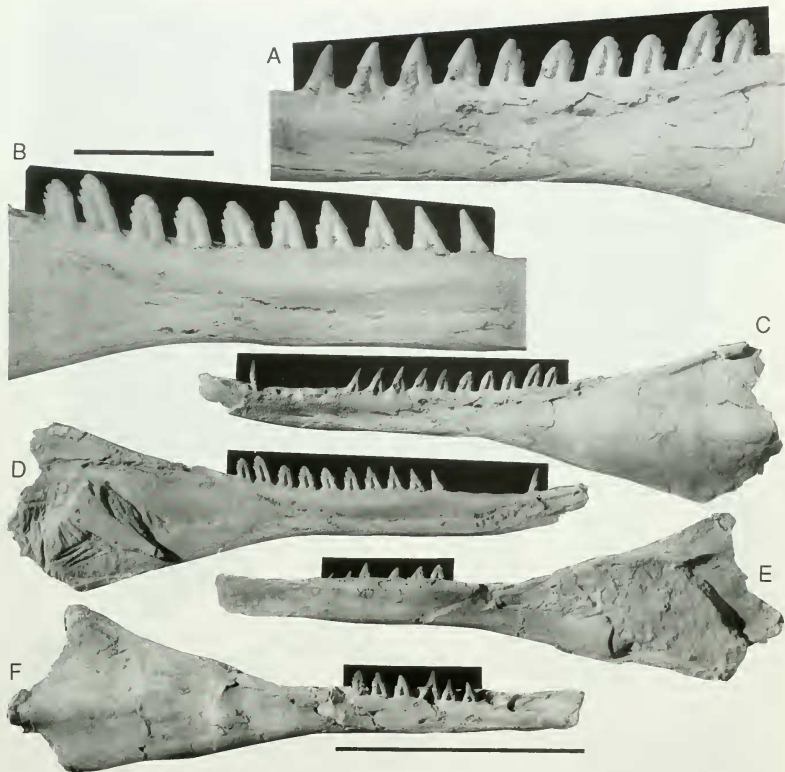

Figure 12. Mandible and teeth of *Waipatia maerewhenua*, holotype, OU 22095. All coated with sublimed ammonium chloride. A–B, detail of left cheek teeth, both at same scale; scale = 50 mm. A, buccal; B, lingual. C–F, mandibles; all at same scale; scale = 200 mm. C, lateral, left mandible; D, medial, left mandible; E, medial, right mandible; F, lateral, right mandible.

hypophysis is small with an elongate base; this process extends 6–7 mm below and less than 5 mm behind the body. Upper and lower transverse processes are separate, not basally confluent. The eroded large upper process juts out abruptly, while the lower process has an anteroposteriorly short base. Rather small (diameter 5.5–8 mm) laterally facing transverse foramina perforate the robust neural arch. Only a poor natural cast of the anterior face of the axis is preserved to reveal a large neural canal, delicate neural arches, and a blunt odontoid process.

COMPARISONS: MORPHOLOGY, HOMOLOGY, AND FUNCTION

This section briefly reviews broader aspects of the skull of *W. maerewhenua*, emphasizing homologies with other taxa and possible functional complexes.

*Face*.—The soft facial tissues in the Odontoceti include the maxillo-naso-labialis muscles, the soft nasal passages, and the nasal diverticula (Mead 1975; Heyning 1989). Because these structures

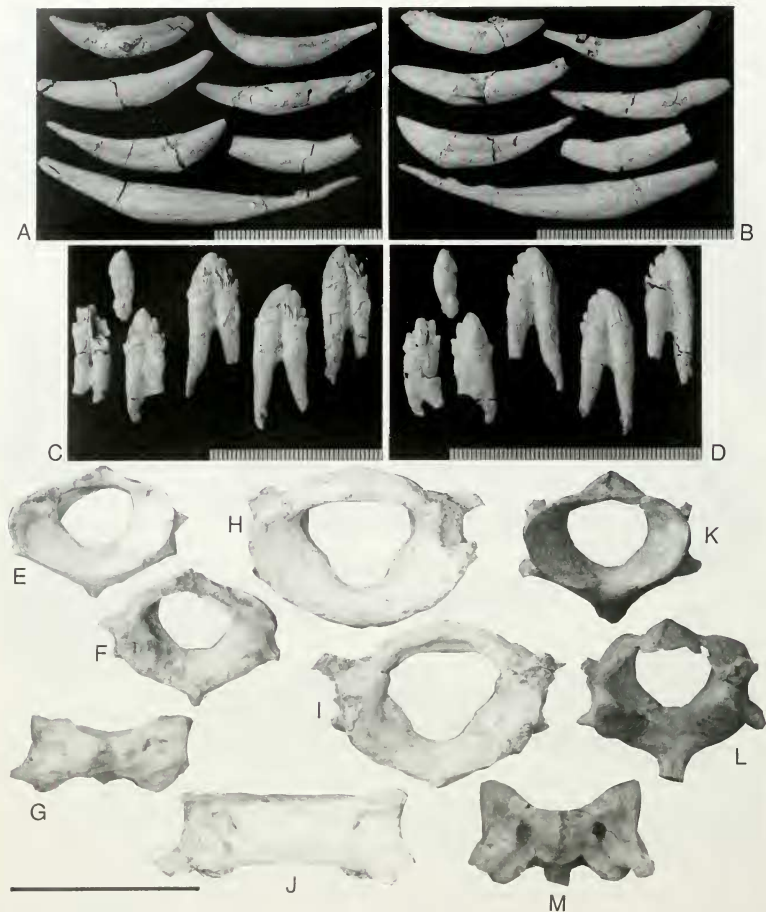

Figure 13. A–D, teeth of *Waipatia maerewhenua*, holotype, OU 22095. All coated with sublimed ammonium chloride. All life size; ruler divisions are 1 mm. A–B, upper and/or lower anterior teeth. A, lingual; B, buccal. C–D, lower cheek teeth and presumed last upper left cheek tooth. C, lingual; D, buccal. E–M, atlas vertebrae, all at same scale. Scale = 100 mm. E–G, atlas of *Waipatia maerewhenua*, holotype, OU 22095. E, anterior; F, dorsal; G, posterior. H–J, atlas of undescribed squalodontid, OU 22072. H, anterior; I, posterior; J, dorsal. K–M, atlas of *Notocetus marplesii*, holotype, C.75.27. K, anterior; L, posterior; M, dorsal.

dictate the topography of the facial bones, the structure of facial soft tissues can be inferred for fossils. Furthermore, the soft tissues of the face probably produce and transmit the high-frequency sounds used in echolocation (Mead 1975; Heyning 1989: 40–44). In terms of facial structure, *W. maerewhenua* is notably more derived than *Archaeodelphis patrius* Allen, 1921, in which the supraorbital process extends posteriorly only a little, the orbit is elevated with a prominent infraorbital process of the maxilla, the fossa for a facial muscle on the cranium is minimal, and the maxillary foramina lie roughly level with the antorbital notch. In *W. maerewhenua*, the fossa for the facial muscles is large, the roof of the orbit is depressed to lie about level with the posterior portion of the rostrum, so that rostral muscle origins and facial muscle origins are roughly on the same plane, and the maxilla does not contribute to the orbit. Well-developed premaxillary foramina and sulci are associated with a "spiracular plate" for the premaxillary sac fossa. Overall, *W. maerewhenua* has fundamentally the same facial structure as do many extant Odontoceti; it was probably capable of echolocating. In many other odontocetes (e.g., Delphinidae, Ziphiidae), the face is broader, deeper, and displaced farther posteriorly relative to the orbits, so that the postorbital border of the temporal fossa is shorter, steeper, and more curved, the frontals and/or parietals are often lost from the vertex, and the supraoccipital is less obvious dorsally. Such changes probably reflect the continued expansion of the posterior parts of the maxillo-naso-labialis muscles associated with the soft diverticula of the external nares.

Like most extant Odontoceti, *W. maerewhenua* shows facial asymmetry (involving maxilla, nasals, and frontals) that presumably reflects asymmetry of the overlying facial muscles. The asymmetrical flared margin of the right maxilla (Fig. 2a) is of uncertain function; it may be homologous with the maxillary flanges of *Mesoplodon* (Ziphiidae; True 1910b), though the left maxilla lacks such a flange. Presumably, such asymmetry indicates muscle asymmetry, though it is not clear that this part of the rostrum is a significant muscle origin in extant taxa (Mead 1975; Heyning 1989). The function of the shallow depression immediately posterior to the maxillary flange is also uncertain. A similar asymmetrical profile is visible in a cast (USNM 243978) of the skull of *Microcetetus sharkovi* Dubrovo, 1971 (in Dubrovo and Sharkov 1971: fig. 2), and in the skull of *Squaloziphius emlongi* Muizon (1991: fig. 1).

The function of the bifurcated posterior of the premaxilla, a feature seen in many odontocetes, is uncertain. The bifurcation perhaps marks a boundary for the facial muscles. Similarly uncertain is the function of the medial cleft in the premaxilla. Possibly homologous clefts occur near the boundary between the posterolateral plate and posteromedial splint in *Zarhachis flagellator* (figured by Kellogg 1926: pl. 2) and sporadically in the Ziphiidae. Judged from vascular patterns shown by Schenkan (1973: fig. 5) for *Mesoplodon*, the cleft carries a vessel from the maxillary artery.

**Feeding apparatus.**—The long attenuated rostrum and mandibles, the relatively posterior position of the coronoid process on the mandibles, and the moderately large temporal fossae and origins for the temporal muscles suggest that *W. maerewhenua* fed by rapid snapping. The origin for the temporal muscles on the supraorbital process faces ventrally; in contrast, the temporal muscles' origin on the frontals of Archaeoceti and some Odontoceti (e.g., *Archaeodelphis* and the Physteridae) faces roughly posteriorly. The more ventral position for this origin, widespread amongst the Odontoceti, is probably related to lever action of the mandible, but it may also be a consequence of the posterior expansion of the maxilla, in turn dictated by changes in orientation of the facial muscles.

*Waipatia maerewhenua* lacks a bony lateral lamina of the pterygoid sinus fossa, and there is no evidence that an ossified pterygoid contacted the falciform process. Among the Odontoceti, the presence or absence of such a bony lateral lamina (Cozzuol 1989; Fraser and Purves 1960) perhaps relates to feeding musculature. In the

extant *Phocoena phocoena* (see Boeninghaus 1904: figs 3, 4; Fraser and Purves 1960: 12), which lacks a bony lamina, the medial limit of the large internal pterygoid muscle stretches from the pterygoid (and palatine?) back to the squamosal and bulla, with an extensive origin in the pterygoid ligament. Perhaps the lateral lamina is the ossified homolog of some of the pterygoid ligament, which would provide a stronger origin for the internal pterygoid muscle than would ligament alone. In terms of function, an ossified ligament could (1) compensate for enlargement of the pterygoid sinus fossa (functioning in acoustic isolation of the skull base), which could otherwise weaken the origin for the internal pterygoid, and/or (2) be dictated by an enlarged internal pterygoid muscle (functioning in feeding). More information about archaic Cetacea is needed to confirm that contact of an ossified lamina of the pterygoid with the squamosal is primitive. Furthermore, the bony lateral lamina may be constructed in different ways in platanistids, squalodelphids, pontoporiids, and eurhinodelphids (Cozzuol 1989), all of which have long, forcepslike jaws; this hints at convergence for functional reasons. It is not clear why the apparently plesiomorphic pterygoid-falciform contact might be lost.

*Waipatia maerewhenua* is polydont, as are most extant and fossil Odontoceti and embryonic Mysticeti. For heterodont polydont Cetacea, it is not possible to homologize the cheek teeth with those of the Archaeoceti or other eutherians (Rothenstein 1968). Tooth structure in heterodont odontocetes has not been correlated with particular food preferences. The gracile procumbent incisoriform teeth appear delicate, suggesting a reduced role, if any, in feeding. Perhaps they were used in display. *Notocetus marplesi*, some undescribed early platanistoids from New Zealand, and the small Miocene *Kentriodon pemix* (Kentriodontidae) have similarly procumbent teeth.

**Acoustics: Ear.**—Odontocete periotics are conservative elements that differ dramatically in overall topography, fossae, sulci, and foramina from periotics of other eutherians. Odontocete periotics are often diagnostic at the species level (Kasuya 1973), suggesting that interspecific differences in morphology reflect interspecific differences in acoustic abilities, but their function is understood only crudely (e.g., an inflated pars cochlearis presumably correlates with changes in cochlear structure associated with high-frequency sound reception; Fleischer 1976). The specific functions of most features seen in *W. maerewhenua*, for example, the recurved dorsally concave anteroexternal sulcus, the anterointernal sulcus, the reduced anterodorsal and anteroventral angles on and subcircular cross section of the anterior process, the profile of the pars cochlearis, the shape of the lateral tuberosity, the lateral groove on the body, the posterolateral foramen, and the bulge on the posterior process (homologous with the articular rim), are uncertain.

The squamosal and parietal in *W. maerewhenua* are enrolled over the petiotic (Fig. 8b, 9b), with the petiotic detached from the braincase wall and displaced ventrolaterally relative to the cranial cavity. The formerly confluent foramen ovale and posterior lacrate foramen are separated by contact of the parietal with opposing elements along the border of the basioccipital crest. This pattern of the squamosal and parietal in the basicranium is so widespread that it is perhaps synapomorphic for the Odontoceti.

The relationship of the squamosal and petiotic may be interpreted with reference to basilosaurid archaeocetes (Figs. 9a, b). In the Archaeoceti (e.g., Kellogg 1936: figs. 5, 6), the petiotic has a roughly flat external wall that rises dorsally to form an elevated platelike superior process with a narrow crest. The external wall contacts the squamosal just ventral to the parietal on the subvertical wall of the braincase (Fig. 9a; Pompek 1922: pl. 2). Internally, the superior process descends to a depression on the dorsal surface of the petiotic lateral to the internal auditory meatus. Presumably the depression is for the superior petrosal sinus dorsolaterally and the subarcuate (subflocular) fossa ventromedially (e.g., Kellogg 1936:

figs. 5, 6). Some homologs of archaocete structures occur in the Odontoceti. The periotic of *W. maerwhehua* lacks an elevated platelike superior process; the homologous structure is the convex external to dorsoexternal surface of the body (Figs. 11b, 9b) that rises from the hiatus epitympanicus to the dorsal crest. The dorsal crest is a persistent feature among archaic odontocetes (e.g., the platanistoids of Figs. 10, p, v, b'; *Prosqalodon australis* Lydekker, 1894, of True 1909) and is the presumed homolog of the crest on the archaocetes' superior process. Farther internally, a variably present small groove may mark the superior petrosal sinus. Although I have seen no odontocete with a discrete bony subarcuate fossa, Burlet (1913; fig. 10) identified this fossa in an embryo of *Phocoena phocoena*. The position of the superior petrosal sulcus of Pompeckj (1922) is uncertain. The convex surface of the periotic body (Fig. 9b) parallels the overlying periotic fossa in the squamosal, while the dorsal crest of the periotic lies ventral to the parietal-squamosal suture. The cavity between the periotic and periotic fossa is probably vascular in part. In other taxa, Muizon (1987: 5) described the subarcuate fossa (here identified as an enlarged foramen spinosum) in *Notocetus vanbenedeni*, while Kellogg (1926: pl. 5) figured an unidentified "foramen 1" dorsal to the periotic in *Zarhachis flagellator*.

Platanistoids vary in the posterior contact of the periotic with the squamosal and bulla. Muizon (1987) discussed and figured articulations in the Squalodelphidae and Platanistidae, and mentioned (Muizon 1991) that an articular rim or articular process occurs in the Squalodontidae. In some New Zealand Squalodontidae (OU 22072, Figs. 10r, s; OU 21798, Fig. 10y), a prominent articular process is present dorsolateral to the long rough articular groove for the spiny process. It is not clear whether this articular process is homologous or convergent with that of the Squalodelphidae. *Waipatia maerwhehua* (Waipatiidae; Figs. 10b, c) and *Notocetus marplesi* (Squalodelphidae; Figs. 10m, n) have only a bulge, rather than a process, at the site where the articular rim develops. Periotics referred to the Eurhinodelphidae (Fordyce 1983) have a process similar to that of the Squalodontidae. Muizon (1987) considered the feature in eurhinodelphids as not homologous with the articular rim or process, but the case is not clear. In *Waipatia maerwhehua* the posterior process is not fused apically or dorsally with the squamosal, but in some Squalodontidae (e.g., "*Prosqalodon*" *hamiltoni* Benham, 1937, OM C.02.8; *Squalodon calvertensis* Kellogg, USNM 23537) spongy bone along the dorsal edge of the posterior process of the periotic appears to fuse with the adjacent squamosal.

Possible functional explanations for the relationship of the periotic to adjacent elements include (1) a need for acoustic isolation from cranial circulation associated with the brain, (2) a need for acoustic separation from the braincase, thus enhancing left-right acoustic isolation to provide better directional hearing, or (3) a consequence of changes in the braincase dictated by changes in the brain itself.

**Acoustics: Pterygoid sinus complex.**—*Waipatia maerwhehua* lacks orbital extensions of the pterygoid sinuses. Such extensions in the Squalodelphidae, Platanistidae, and some Squalodontidae (Muizon 1991) perhaps help acoustically isolate the basicranium from the face. There is no fossa for a posterior sinus in *W. maerwhehua*, but a sinus may have been present, for Fraser and Purves (1960) showed that the sinus is ubiquitous among the Odontoceti while a bony fossa is only variably developed. Fraser and Purves (1960) further showed that the middle sinus of the middle ear is ubiquitous in extant Odontoceti but absent in the Mysticeti; I interpret the middle sinus as a synapomorphy for the Odontoceti. In many extant Odontoceti, the middle sinus occupies a distinct tympanosquamosal recess (Fraser and Purves 1960), but the recess is only variably developed among archaic Odontoceti; for example, it is absent in *W. maerwhehua* and sporadically present in the Squal-

odontidae. However, structures immediately in front of the anterior meatal crest suggest that, despite the lack of a recess, a middle sinus was present in *W. maerwhehua* and indeed in all archaic Odontoceti. In all Odontoceti, the skull lacks a postglenoid foramen and lacks the anterior transverse ridge that in the Archaoceti (e.g., *Zygorhiza kochii*, USNM 11962) and archaic Mysticeti bounds the vestigial postglenoid foramen. The site of the postglenoid foramen corresponds to the posterior portion of the tympanosquamosal recess in those taxa where the recess is distinct. I suggest that the site of the postglenoid foramen was probably obliterated with, first, the evolution of the middle sinus and, second, the evolution of a tympanosquamosal recess to accommodate the sinus.

## CLADISTIC RELATIONSHIPS

**Generalized features and traditional placement.**—*Waipatia maerwhehua* shows many generalized features of the Odontoceti, while structures diagnostic of extant families (for example, conspicuous derived conditions of the premaxilla, premaxillary sac fossa, bony nares, and pterygoid sinus fossa) are not obvious. Generalized features include the supraorbital processes of the maxillae being relatively narrow rather than inflated, the face not being particularly voluminous, the large temporal fossae not being roofed fully by the supraoccipital, parietal, frontal, and maxilla, the remnant intertemporal constriction with the parietals exposed dorsally, the prominence of the lambdoid and nuchal crests, the palatines' being broadly exposed transversely across the palate and not invaded by pterygoids or pterygoid sinus fossae, the fossae for the pterygoid sinuses being restricted to the basicranium and not excavated dorsally to extend into the orbit, the teeth being heterodont and polydont, the periotic's having a rather elongate narrow internal auditory meatus on a slightly inflated pars cochlearis, and the periotic's retaining a dorsal crest and an attenuated apex on the posterior process. To some cetologists, such features might warrant placing *W. maerwhehua* in the Squalodontidae, along with some other small-toothed heterodont dolphins reviewed below, but cladistic analysis indicates otherwise.

**Cladistic analyses of the Odontoceti.**—The traditional families and higher subdivisions of the Odontoceti (e.g., Fraser and Purves 1960; Simpson 1945) have been reappraised in recent cladistic studies (Fig. 14), such as those of Barnes (1985, 1990), Heyning (1989), Heyning and Mead (1990), and Muizon (1987, 1988a, 1988b, 1991). Barnes, Heyning, and Muizon gave valuable lists of characters, many of which I have used (Appendix), but only Heyning explicitly discussed character polarities or used computer analyses to explore multiple cladograms. The published analyses show that relationships among odontocete taxa are still volatile (Fig. 14). For example, the Ziphiidae are placed with either the Physteroidea (Muizon 1991) or extant Odontoceti other than the Physteroidea (Heyning 1989). Barnes (1985, 1990) placed the Pontoporiidae, Iniidae, and Lipotidae (as the Lipotinae) in the Platanistoidae, while Muizon (1988b) used an infraorder Delphinina for the Delphinoidae (Kentriodontidae, Delphinidae, Monodontidae, Phocoenidae, and Albiroenidae), Pontoporiidae, Iniidae, and Lipotidae (the last three taxa are "river dolphins"). Heyning (1989: 56) identified the Platanistoidae in the traditional sense as paraphyletic and, like Muizon, recognized a monotypic Platanistidae, with the Iniidae (including *Inia*, *Pontoporia*, and *Lipotes*) as a sister group to the Delphinoidae.

The following odontocete families are known well enough to be used in a cladistic analysis: the Agorophiidae, Albiroenidae, Delphinidae, Dalpiazinidae, Eoplatanistidae, Eurhinodelphidae (= Rhabdosteidae of recent use), Iniidae, Kentriodontidae, Kogiidae, Lipotidae, Monodontidae, Patriocetidae, Phocoenidae, Physteroidea, Platanistidae, Pontoporiidae, Squalodontidae, Squalodelphidae, and Ziphiidae. Some of these taxa may be

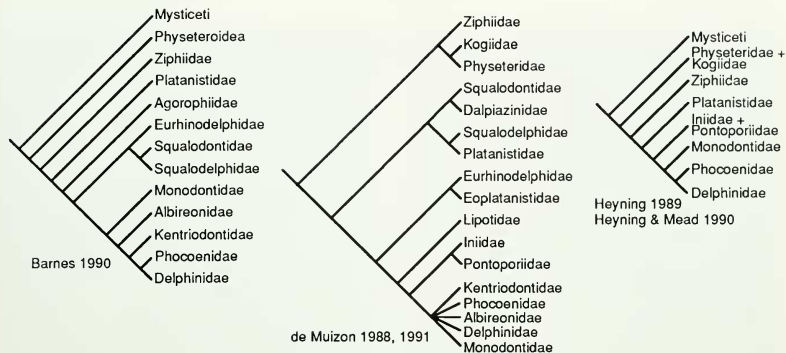

Figure 14. Alternative cladograms of broader relationships of the Odontoceti. Left, Barnes (1990); middle, Muizon (1988b, 1991); right, Heyning (1989, Heyning and Mead 1990).

given subfamily rank (e.g., the Kogiinae, Lipotinae, and Patriocetinae), and, depending on the taxonomist, others are paraphyletic (e.g., the Agorophiidae and Kentriodontidae). Other nominal families (e.g., the Acrodelphidae, Microzoeglodontidae, and Zignodelphidae) are junior synonyms or are too dubiously based to be analysed cladistically.

**Cladistics: Approaches.**—A cladistic analysis of the relationships of *Waipatia maerewhenua* was carried out by means of the computer program PAUP, version 3.1.1 (Swofford 1993, Swofford and Begle 1993). The final data matrix includes 20 taxa and 67 characters (Table 2, Appendix). Characters were polarized by outgroup comparison (outgroup: *Zygorhiza kochii*). Uninformative characters are omitted. Some potentially useful features discussed here were not included in the data matrix because they are not preserved or illustrated in enough taxa, or because homologies in some taxa are uncertain. Characters included were chosen with the aim of elucidating the relationships of *W. maerewhenua* rather than reappraising the relationships of all major odontocete groups. The approach is conservative; all characters are treated as unweighted and ordered.

From a spectrum of Odontoceti taxa were chosen to form a framework into which *W. maerewhenua* might be placed. Character states were determined from (1) direct study of specimens (optimal) or casts, (2) personal notes or photographs (less satisfactory), and (3) published literature, which is often inadequate for the details of the basicranium and earbones, so that many characters are coded as missing. Taxa and specimens (or principal references) included are *Zygorhiza kochii* (Archaeoceti: Basilosauridae), cast of USNM 11962, Kellogg (1936); *Archaeodelphis patrius* (Odontoceti: *incertae sedis*), Allen (1921); *Physeter catodon* (Odontoceti: Physeteridae), Kasuya (1973) and many published illustrations of skulls; *Kogia breviceps* and *K. simus* (Odontoceti: Kogiidae), OM A.84.14, Kasuya (1973) and many published illustrations of skulls; *Mesoplodon grayi* (Odontoceti: Ziphiidae), OM A.64.1; *Tasmacetus shepherdi* (Ziphiidae), OM A.88.177; Eurhinodelphidae, taxa and/or characters reviewed by Muizon (1988a, 1988b, 1991); *Kentriodon pernix* (Odontoceti: Kentriodontidae), cast of USNM 10670, Kellogg (1927); *Pontoporia blainvilliei* (Odontoceti:

Pontoporiidae), Kasuya (1973), Barnes (1985), and many published illustrations of skulls; *Tursiops truncatus* (Odontoceti: Delphinidae), OU 21820, Barnes (1990), and many published illustrations of skulls; *Cephalorhynchus hectori* (Odontoceti: Delphinidae), OU 21819; *Prosqualodon australis* and *P. davidis* Flynn, 1923 (Odontoceti: Squalodontidae *sensu lato*), cast of a skull figured by Flynn (1948), Lydekker (1894), and True (1909); *Squalodon* spp. (*sensu lato*) (Squalodontidae), OU 21798 (Fordyce 1989: 23), Kellogg (1923a), and Rothausen (1968); "*Prosqualodon*" *hamiltoni* (Squalodontidae), OM C.02.8, Benham (1937); *Zarhachis flagellator* (Odontoceti: Platanistidae), Kellogg (1924, 1926) and Muizon (1987); *Platanista gangetica* (Platanistidae), Kellogg (1924) and many published illustrations of skulls; *Squalodelphis fabiani* Dal Piaz, 1917 (Odontoceti: Squalodelphidae), Dal Piaz (1977) and Muizon (1987); *Notocetus vanbenedeni* (Squalodelphidae), Lydekker (1894) and Muizon (1987); *Notocetus marplei* (Squalodelphidae), OM C.75.27, Dickson (1964).

Some odontocete families were not included in the analysis because (1) their relationships seem inadequately established for the purposes of this exercise, (2) not enough is published about structures needed for a cladistic analysis, or (3) specimens were not available for study in New Zealand. The Agorophiidae *sensu stricto* and Patriocetidae were excluded. Barnes (1985, 1990), Heyning (1989), and Muizon (1991) demonstrated that the Albiroenidae, Monodontidae, and Phocoenidae belong with other Delphinoidea. Furthermore, these authors suggested that the Iniidae and perhaps the Lipotidae are related closely to the Pontoporiidae and in turn to traditional Delphinoidea. Muizon (1991) suggested that the poorly known Eoplatanistidae are a sister group of the Eurhinodelphidae and placed the Dalpiazinidae [currently monotypic, including only *Dalpiazina ombonii* (Longhi)] uncertainly as a sister group of the Squalodontidae. I excluded the Dalpiazinidae from this analysis because I could not identify enough characters from the literature and because a new supposed dalpiazinid from New Zealand (Fordyce and Samson 1992) is not yet described.

Computer searches were pursued as follows: (1) an initial minimal cladogram of 121 steps was obtained by a general heuristic search, (2) 81 nonminimal cladograms of 123 or fewer steps were

obtained, (3) these 81 nonminimal cladograms were input and analysed by varied methods reviewed by Swofford and Begle (1990: 32–40, 100–104).

**Cladistic relationships of *Waipatia maerewhenua*: Results.**—A single cladogram of 121 steps (consistency index 0.628) was obtained (Fig. 15). This cladogram shows *Waipatia maerewhenua* as a sister taxon to a clade consisting of the Platanistidae and Squalodelphidae and reinforces Muizon's (1991) concept of the Platanistoidea as an odontocete superfamily including the Squalodontidae, Squalodelphidae, and Platanistidae. Other clades recognized are (1) a *Kentriodon* + *Pontoporia* + *Cephalorhynchus* + *Tursiops* group, which partly represents the Delphinida of Muizon (1988b, 1991), (2) the Eurhinodelphidae as a sister taxon to the cluster of the Delphinida, a relationship also proposed by Muizon (1991: fig. 15), and (3) a Physeteroidea (Physeteridae + Kogiidae) + Ziphiidae group, also recognised by Muizon (1991: fig. 5) as his Physeterida. Of note, the Physeterida appear as a sister group to a clade consisting of the Delphinida and Eurhinodelphidae, in contrast to the position shown by Barnes (1990), Muizon (1991), and Heyning (1989) for the Physeteroidea and/or Ziphiidae (Fig. 14). Furthermore, *Prosqualodon australis* appears as the sister taxon to the Squalodontidae, in contrast to the suggestions of Cozzuol and Humbert-Lan (1989) and Muizon (1991).

The 8 cladograms at 122 steps and 81 cladograms at 123 steps show a clade consisting of *Waipatia*, the Squalodelphidae, and the Platanistidae, but the positions of other taxa vary. More study of the relationships of the Physeteroidea, Ziphiidae, and Eurhinodelphoidea is needed. For example, if extant Mysticeti are added to the current data set as outgroups, and irreversible soft-tissue (e.g., nasal diverticula; see Heyning 1989) and osteological (e.g., premaxillary

sac fossa, foramen, and sulci) characters are used, the Ziphiidae are positioned as a sister group to the Platanistoidea and Delphinida, as proposed by Heyning (1989). Below I review the relationships of *Waipatia* in more detail.

**Comparisons with the Agorophiidae.**—The Agorophiidae may be used narrowly (e.g., Fordyce 1981), to include only *Agorophiops pygmaeus*, or broadly (e.g., Barnes et al. 1985) as a paraphyletic group of archaic and presumably late Oligocene Odontoceti (e.g., *Archaeodelphis*, *Xenorophus*, *Atropatenocetus*, and *Mirocetus*). *Waipatia maerewhenua* is not an agorophiid, differing in possessing the following derived features: shorter and wider (almost square) face, shorter and wider intertemporal region, and shorter parietals. Cladistic analysis (Fig. 15) places *Archaeodelphis patrius* as a basal odontocete, but one having some derived features relative to *W. maerewhenua* (i.e., larger lacrimal and massive pterygoids that meet medially above the choanae). Cladistic relationships of *Xenorophus sloani* Kellogg, 1923, the fragmentary *Atropatenocetus posteoceanicus* Aslanova, 1977, and the enigmatic *Mirocetus riabinini* Mchedlidze, 1970, are uncertain.

**Comparisons with the Physeteroidea and Ziphiidae.**—*Waipatia maerewhenua* lacks the key synapomorphies of sperm and beaked whales [see Fig. 15 and osteological characters discussed by Muizon (1991)]. *W. maerewhenua* resembles the ziphiid *Mesoplodon grayi* in the asymmetrical posterior apices of its premaxilla, but this is probably convergent; Heyning (1989) reported variable bone contacts on the vertex among extant Ziphiidae.

**Comparisons with the Eurhinodelphoidea.**—*Waipatia maerewhenua* lacks the key synapomorphies of the Eurhinodelphoidea [i.e., Eurhinodelphidae and Eoplatanistidae of Muizon (1988a, 1991); Rhabdosteidae of Barnes (1990: 20)]. Cladograms of 122

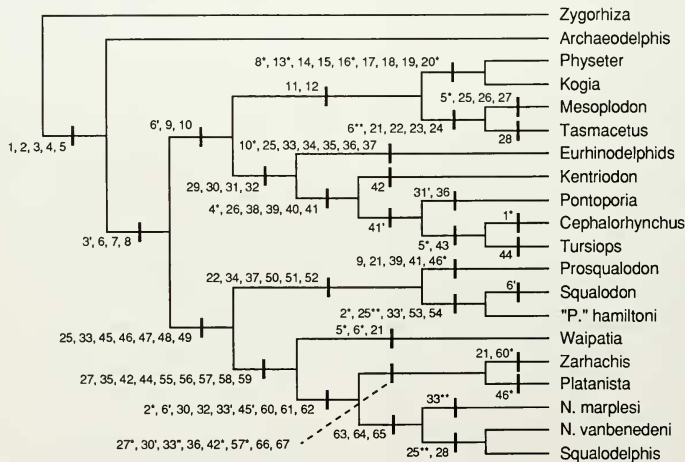

Figure 15. Cladogram of relationships of *Waipatia maerewhenua*. Numbers at each node refer to characters discussed in the text and listed in the Appendix. Symbols: ′, change from state 1 to state 2; ″, change from state 2 to state 3; ‴, reversal from state 1 to state 0; ″, reversal from state 2 to state 1.

steps (one over the minimum) suggest various relationships for the Eurhinodelphoidea. Affinities with the Delphinida need more study, though comparisons are hampered by the lack of published information on eurhinodelphoid basicrania. Similarities, presumably convergent, between *W. maerewhenua* and some eurhinodelphids include nodular nasals, as in *Argyrocetus patagonicus* (Lydekker 1894: pl. V), and periotic axis (viewed dorsally) being sigmoidal, with the anterior process skewed medially and the posterior process skewed laterally.

**Comparisons with the Delphinida.**—*Waipatia maerewhenua* lacks the key synapomorphies of the Delphinida (*sensu* Muizon 1988b; see also Barnes 1990: 20, taxa under nodes 23–44 and some under node 45). The cladogram (Fig. 15) is consistent with concepts of the Delphinidae and associated taxa advanced by Muizon (1988b) and Heyning (1989: 56).

**Relationships with the Platanistoidea.**—Muizon (1987, 1991) abandoned the Platanistoidea *sensu* Simpson (1945) to propose a Platanistoidea encompassing the Platanistidae, Squalodelphidae, Squalodontidae, probably Dalpiazinidae, and the enigmatic *Prosqualodon*. A simplified outline of Muizon's proposed relationships appears in Fig. 14 (which lacks *Prosqualodon*). Heyning (1989) also separated the Platanistoidea from other extant river dolphins (*Lipotes*, *Pontoporia*, *Inia*), which Heyning placed in the Delphinoidea. Muizon's hypothesis of relationships is broadly supported by Fig. 15, which identifies *Waipatia* as a platanistoid related more closely to the squalodelphid-platanistid clade than to the Squalodontidae.

Apparent synapomorphies of the Platanistoidea (Fig. 15; Muizon 1987, 1991) are as follows (numbers refer to characters listed in Appendix): the profile of the anterior process of the periotic is smoothly to abruptly deflected ventrally in lateral view (25); the anterior process of the periotic is roughly cylindrical in cross section (47); the periotic has a ridge- or peglike articular process (33); the bulla has an anterior spine and an inflated anterolateral convexity (45, 46); the scapula lacks a coracoid process (49); and the acromion process lies on the anterior edge of the scapula, which lacks a suprascapular fossa (48). Of note, the last two scapular features are not seen consistently in supposed Platanistoidea. Cozzuolo and Humbert-Lan (1989) stated that the squalodontid *Phoberodon arctiostris* Cabrera, 1926, has a scapula with an apparent coracoid process, a conspicuous suprascapular fossa, and an acromion not located on the anterior edge. Muizon (1987) noted that the scapula in *Sulakocetus dagestanicus* has a narrow coracoid process; *S. dagestanicus* is identified below as probably related to *W. maerewhenua* and thus to other Platanistoidea.

Future work on new or re-prepared Late Oligocene and early Miocene platanistoids should further elucidate patterns of homology, including whether character transitions were reversible or irreversible). Thus the detailed pattern of platanistoid relationships shown in Fig. 15 is likely to change.

**Relationships with the Squalodontidae.**—*Waipatia maerewhenua* lacks the key synapomorphies for Squalodontidae as defined below, but shares synapomorphies of the periotic and basicranium with the Platanistidae and Squalodelphidae. The cladogram (Fig. 15) is broadly consistent with the concept of squalodontid relationships proposed by Muizon (1991). Some discussion of the Squalodontidae is needed, however, for many heterodont Cetacea, including *Waipatia*-like taxa, have been referred to this family. The following brief review incorporates some revisions made by Muizon (1987, 1991).

The Squalodontidae derive their identity in nomenclature from *Squalodon gratelupi* Pedroni (= *Squalodon typicus* Kellogg, 1923), the type species of *Squalodon* (see Rothausen 1968). The holotype of *Squalodon gratelupi* (early Miocene) is a partial rostrum (Grateloup 1840: fig. 1; Kellogg 1923a; Rothausen 1968). *Squalodon* is well known from skulls, such as those referred to *S.*

*bariensis* (Jourdan) and *S. calvertensis*, and other specimens (e.g., *S. melitensis*, *S. kelloggi*) represented by teeth and partial jaws are reasonably assigned to *Squalodon*. Overall, *Squalodon* provides a sound typological base for diagnosing the Squalodontidae. Of note, some nominal species of *Squalodon* based on teeth probably do not represent *Squalodon*, the Squalodontidae, or even the Odontoceti; e.g., *Squalodon serratus* Davis (archaic Mysticeti?) and *Squalodon (Microzeuglodon?) wingei* Ravn (archaic Odontoceti?). Beyond *Squalodon*, concepts of the Squalodontidae vary markedly. Kellogg (1923a) stressed that many heterodont odontocetes had been placed arbitrarily in the Agorophiidae, Microzeuglodontidae, Patriocetidae, or Squalodontidae. Later, Kellogg (1928) listed *Squalodon*, *Prosqualodon*, *Microcetus* and 11 other genera as squalodontids, recognized the Agorophiidae (*Agorophius*, *Xenorhophus*), and placed *Patriocetus* and *Agriocetus* (with *Archaeodelphis*) as Cetacea *incertae sedis*. Simpson (1945) proposed a superfamily Squalodontidae, but otherwise largely followed Kellogg. Rothausen (1961) confirmed the squalodontid affinities of *Microcetus*, discussed below. Rothausen (1968) placed the Patriocetinae (*Agriocetus*, *Patriocetus*) in a grade Squalodontidae. Muizon (1987) alluded to the possible polyphyly of the Squalodontidae but later (Muizon 1991) listed synapomorphies of the Squalodontidae within the Platanistoidea. Cozzuolo and Humbert-Lan (1989) excluded *Prosqualodon australis* (including *P. davidis*) from the Squalodontidae, suggesting relationships with the Delphinida. More broadly, Cozzuolo and Humbert-Lan (1989) questioned the synapomorphies used by Muizon to include the Squalodontidae in the Platanistoidea.

I use the name Squalodontidae conservatively here, to include *Squalodon*, *Eosqualodon*, *Kelloggia*, and *Phoberodon* (Cabrera 1926; Muizon 1991; Rothausen 1968), and "*Prosqualodon hamiltoni*. Whitmore and Sanders (1977) and Fordyce (1989: 23) mentioned skulls of new squalodontids, not yet formally described; elements of the latter (OU 21798) are figured here (Figs. 10x–c). "*Prosqualodon marplei*" is a squalodelphid; see below. *Prosqualodon australis* is discussed below. None of the other "shark-toothed dolphins" is demonstrably close to *Waipatia*. For example, *Neosqualodon* and *Patriocetus* are of uncertain relationships (cf. Rothausen 1968). *Agriocetus*, *Austrorqualodon*, *Metasqualodon*, *Microzeuglodon*, and *Tangaroasaurus* are based on fragmentary specimens I regard as Odontoceti *incertae sedis*. *Microcetus*, *Sachalinocetus*, and *Sulakocetus* are not clearly squalodontids but are perhaps related to the Squalodelphidae and *Waipatia*, as discussed below.

*Waipatia maerewhenua* lacks the following key synapomorphies seen in the skulls of Squalodontidae (as defined above): skull long (estimated condylobasal length >700 mm in adults); rostrum robust and long with expanded apex (Muizon 1991); rostrum proximally deep, probably a consequence of a narrow deep mesorostral groove; cheek teeth triangular, large (>20 mm long), high-crowned, denticulate, and elongate but somewhat inflated laterally; and crowns of anterior to middle cheek teeth with rather small denticles widely spaced on anterior and posterior cheek-tooth keels. Furthermore, *Waipatia maerewhenua* lacks the following key synapomorphies (numbers refer to characters listed in Appendix) seen in the tympano-periotics of squalodontids (see squalodontids OU 22072, Figs. 10r–w, and OU 21798, Figs. 10x–c): the subcylindrical anterior process has a prominent tubercle on the apex (53); the dorsal surface of the anterior process is smoothly curved (in lateral view) so that the apex of the process lies ventrally; there is no anteroexternal sulcus for the middle meningeal artery; there is no subhorizontal anterior internal sulcus, though multiple fine vertical vascular grooves run across the internal surface of the anterior process (54); the fenestra rotunda is reniform, prolonged dorsomedially, and associated with a fissure and posterior ridge that run dorsally to the aperture for the cochlear aqueduct (22); the

TABLE 1. Measurements of *Waipatia maerewhenua*, OU 22095, holotype (mm).

Skull ( $\pm 1$ mm; following Perrin 1975)	
Condylobasal length	>556
Rostrum length	>320
Rostrum width at base	147
Rostrum width at preserved mid length	59.5
Premaxillary width dorsally at level of preserved midlength of rostrum	27
Premaxillary width dorsally at level of antorbital notches	95
Maximum premaxillary width dorsally, about level with mid-orbit	113.5
Distance from level of antorbital notches to most anterior border of nasals	71
Distance from level of antorbital notches to border of internal nares (pterygoids missing)	69+
Cranial length (averaged to compensate for distortion)	235
Preorbital width at level of lacrimal-frontal suture	199
Postorbital width, maximum across postorbital processes	237
Palatine length, in midline	89
Maximum width of external nares (between margins of premaxillae immediately anterior to nasals)	42.5
Width of left frontal at level of apex of premaxilla	20
Width of right frontal at level of apex of premaxilla	28
Minimum width, intertemporal constriction	115
Distance from anterior of inter-nasal suture to apex of supraoccipital	63
Maximum width across zygomatic processes	244
Point-to-point distance, apex of supraoccipital to dorsal intercondylar notch	102
Periotic ( $\pm 0.5$ mm; right periotic unless specified)	
Anteroposterior length	40.0+
Width, internal margin of pars cochlearis to external margin at hiatus epitympanicus, level with fenestra ovalis	20.4
Length of pars cochlearis, from groove for tensor tympani to mid-point of stapedial muscle fossa	19.3
Length of internal auditory meatus	10.0
Length of posterior bullar facet (left)	19.0
Tympanic bulla ( $\pm 0.5$ mm; after Kasuya 1973)	
Standard length, anterior apex to apex of outer posterior prominence	48.8+
Length, anterior apex to apex of inner posterior prominence	45+
Distance, outer posterior prominence to apex of sigmoid process	33.5+
Width at level of sigmoid process	33.2
Dorsoventral depth of involucrum immediately in front of posterior pedicle	18.4
Elliptical foramen	>5 (high) $\times$ >1 (wide)
Maximum point-to-point length of posterior process	25.2
Mandible ( $\pm 1$ mm; following Perrin 1975)	
Length of left tooth-row, from posterior margin of most posterior alveolus to tip of mandible	278+
Maximum length of right mandible	446+
Maximum length of left mandible	458+
Maximum height of right mandible, perpendicular to maximum length	133
Atlas ( $\pm 1$ mm)	
Maximum vertical diameter, parallel to anterior face	72+
Maximum vertical diameter of neural canal	c. 30
Maximum vertical diameter of neural canal	c. 40
Minimum anteroposterior diameter of centrum ventrally (just lateral to hypophysis)	27.5

lateral face of the periotic between the internal auditory meatus and hiatus epitympanicus is wide and flat to gently convex (50) (Muizon 1991: 305); the apex of the posterior process of the periotic is attenuated (Muizon 1991: 305), narrow, and dorsoventrally deep, with a porous to spiny dorsal surface (37); and the bullar facet on the posterior process extends dorsally onto the posteromedial face

of the process (51). The atlas is less compressed than in the squalodontid OU 22072 (Figs. 13h–j).

Other structures cited as characteristic of the Squalodontidae (see Kellogg 1923a; Rothausen 1968; Mchedlidze 1984; Muizon 1987, 1991; Cozzuolo and Humbert-Lan 1989) are not all reliable synapomorphies. For example, large robust apical teeth also occur in the Archaeoceti. Heterodont teeth, a symmetrical cranium, and large temporal fossae are primitive features seen in archaeocetes and the odontocete *Agorophius pygmaeus*. Many odontocetes have a well-teleosted skull in which the maxillae closely approach or contact the supraoccipital, so that the parietals are not exposed in a continuous band across the vertex [but I disagree with Muizon (1991: fig. 15, character 1) in his use of a contact of the maxilla with the supraoccipital as a key synapomorphy of Odontoceti]. The frontals contact the apex of the supraoccipital, excluding the parietals from the vertex (e.g., Eurhinodelphidae, Ziphiidae, and Kentriodontidae). The apex of the pterygoid hamulus is also elongated, subconical, and not excavated by the pterygoid sinus in Eurhinodelphidae and in an undescribed "agorophiid" (USNM 256517). The lateral lamina of the pterygoid contacts the laciniform process of the squamosal in *Zygorhiza*, the Balaenopteridae, and the Platanistidae, for example, and the dorsal region of the pterygoid sinus fossa primitively lies below the level of the orbit in archaeocetes and some undescribed "agorophiids."

Cozzuolo and Humbert-Lan (1989) and Muizon (1991) excluded the enigmatic *Prosqalodon australis* from the Squalodontidae and placed it *incertae sedis*. Initially I followed this assignment, but the taxon emerges in the squalodontid clade of Fig. 15. The study of specimens, rather than casts, of *P. australis* may alter characters in Table 2, thus modifying the proposed relationships.

*Comparisons with the Dalpiazinidae.*—Muizon (1988a) proposed the new monotypic family Dalpiazinidae and new genus *Dalpiazina* for *Champsodelphis ombonii*. *Dalpiazina ombonii* is known from a partial rostrum, partial skull, and periotic, which Muizon (1988a) described and figured. Later, Muizon (1991: fig. 15) identified Dalpiazinidae as a possible sister taxon to the Squalodontidae. *Waipatia maerewhenua* lacks the presumed synapomorphies of *D. ombonii*; for example, it lacks homodont teeth, deep premaxillary sulci, an enlarged exposure of vomer on the rostrum, and a short wide vertex. *Waipatia maerewhenua* is more derived in that its mandibles have a shorter unfused symphysis and the anterior process of the periotic is relatively larger and more inflated transversely, with a blunter apex reflected more abruptly ventrally. I doubt that *Waipatia maerewhenua* is descended from or ancestral to *D. ombonii*.

*Comparisons with the Squalodelphidae and Platanistidae.*—My results suggest that *Waipatia maerewhenua* is the sister taxon to the Platanistidae and Squalodelphidae (Fig. 15). Though *W. maerewhenua* is more primitive than Platanistidae and Squalodelphidae in many characters, I doubt that it is merely a generalized "ancestral" squalodelphid. Compared with these taxa, it is derived in some features, and it is not demonstrably descended from any known platanistid or squalodelphid.

The family Squalodelphidae Dal Piaz, 1917 (*sensu* Muizon 1987, 1988a), includes *Squalodelphis fabianii*, *Notocetus vanbenedeni*, *Notocetus marplesi*, *Phocagenus venustus* Leidy, 1869 (see Kellogg 1957), and *Medocina tetragorinus* (Delfortrie, 1855); all are early Miocene. (*Notocetus* spp. and *S. fabianii* are included in Fig. 15, though in *S. fabianii* many sutures are uncertain). Thus delimited, squalodelphids possess several cranial features more derived than those of *Waipatia maerewhenua*, some of which are included in Fig. 15. Published comments (Barnes 1990; Dal Piaz 1917; Lydekker 1894; Moreno 1892; Muizon 1987, 1991; True 1910a) and interpretations of published figures suggest that these features include the following: the median cranial elements are more asymmetrical and more skewed to the left; the maxillae are



TABLE 2. Data matrix used with PAUP 3.1.1 in the cladistic analysis of *Waipatia maerewhenua*. Number of taxa, 20; number of characters, 67. Symbols used are 0, 1, 2, 3. Missing characters are coded \*; irrelevant characters are coded -. An "equate" macro was used thus: = = \*; a = (01); b = (12); c = (123); d = (23). See text for details.

Taxon	Character															
	5	10	15	20	25	30	35	40	45	50	55	60	65			
<i>Zygorhiza</i>	00000	00000	00***	**0*	a0000	00000	*0*0	00000	00*00	00000	00000	00000	000-0	00		
<i>Archaeodelphis</i>	1*1**	000*0	0***	**0*	*000*	00*00	*0*0*	***00	0**0*	*0***	*00*	**0*	00*00	0*		
<i>Physeter</i>	*12*	2101*	11011	01110	0000*	0-000	00000	0000*	—*0	00000	00000	00-00	00000	00		
<i>Kogia</i>	112**	2101*	11011	01110	00000	00000	00000	0000*	—*0	00000	00000	00-00	00000	00		
<i>Mesoplodon</i>	11210	11111	11100	10001	11111	11000	00000	00000	00000	00000	00000	00-00	00000	00		
<i>Tasmacetus</i>	11211	11111	11100	10001	11110	01000	0*000	00000	00000	00000	00000	00-00	00000	00		
<i>Squalodon</i>	10211	21100	00***	**0*	01001	00000	*0210	01000	00*01	11111	11110	-0**	00000	0*		
"P." <i>hamiltoni</i>	**21*	a11*0	00***	**0*	01001	00000	*2*0*	010*0	0**0*	*1111	11110	00000	00000	0*		
<i>Prozqualodon</i>	*121*	11110	00***	**0*	1*002	000*0	*0110	*0*10	10***	01111	*1000	0*0*0	00*00	0*		
<i>Eurhinodelphid</i>	11211	21110	00***	**0*	0*001	0001*	*1111	11000	0-**0	00000	0000*	0*-00	00000	00		
<i>Waipatia</i>	11210	011*0	00***	**0*	00002	01000	*01*	00000	01*1*	11**0	00001	11110	00000	00		
<i>Notocetus marplei</i>	*121*	*11*0	00***	**0*	00002	01001	**1*1	*00*0	01*1*	*1110	00001	111*1	11111	00		
<i>N. vanbenedeni</i>	*0211	21100	00***	**0*	00001	01101	*12*1	00000	0***2	11110	0000*	11111	11111	00		
<i>Squalodelphis</i>	**21*	*1*0*	00***	**0*	000*0	0*1**	**2*1	00**0	***2	11**0	00001	**11*	1*1**	**		
<i>Zarhachis</i>	10211	21100	00***	**0*	1000b	000*2	*1301	10000	0***2	*1***	00001	10-10	11000	11		
<i>Platanista</i>	10211	21100	00100	10001	0*00b	00002	01301	10000	000*2	0*110	0000*	*1-11	11000	11		
<i>Kentriodon</i>	11201	21111	00***	**0*	00000	10011	*10*0	001*1	11*00	00000	00000	00-00	00000	00		
<i>Cephalorhynchus</i>	01200	21111	00100	10001	00000	10011	11000	00111	20100	00000	00000	00-00	00000	00		
<i>Tarsiops</i>	11200	21111	00100	10001	00000	10011	11000	00111	20110	00000	00000	00-00	00000	00		
<i>Pontoporia</i>	*1201	21111	00100	10001	00000	10011	21000	10111	200*0	00000	00000	0*-00	00000	00		

markedly thickened to form crests above the orbits and have a "squared off" posterior profile (dorsal view) at the contact with the nuchal crest of the supraoccipital, where the parietals are eliminated from the vertex; the premaxillae overhang the mesorostral groove more; the face between the level of the antorbital notch and the nasals is more foreshortened, with a more curved premaxillary-maxillary suture concentric around the nares; the internarial suture and nasofrontal suture are deep and narrow; the palatine is not exposed broadly from side to side on the rostrum, since the apex of the pterygoid here contacts the maxilla, but is exposed laterally; the narrow pterygoid sinus fossae are excavated dorsally (as seen from below), with a continuous lateral lamina of pterygoid extending back to contact the falciform process of the squamosal; there are marked orbital fossae in thickened frontals for orbital extensions of the pterygoid sinuses; and the supraoccipital is asymmetrical, with a skewed median ridge and rather abrupt anterolateral corners. The periotics of the Squalodelphidae are more derived than those of *W. maerewhenua* in having a prominent to peglike articular process in most, a more circular pars cochlearis, a more prominent lateral groove on the periotic, so that the profile in dorsal view is more sigmoidal, a larger aperture for the cochlear aqueduct in most, a rounder internal auditory meatus, and a posterior process with a long smooth parallel-sided facet for contact with the bulla. Described squalodelphid teeth are nearly homodont. Synapomorphies listed by Muizon (1987, 1991), some of which are included in Fig. 15, adequately separate the Platanistidae from *Waipatia*.

A new family *Waipatiidae*.—These comparisons suggest that *Waipatia maerewhenua* warrants a new family. The species is a platanistoid more closely related to the Squalodelphidae and Platanistidae than to the Squalodontidae, but it differs from the former taxa in possessing the following derived features: the mandibles have a shorter unfused symphysis (5); the nasals are short and broad; the pterygoid sinus fossa posteromedial to the foramen ovale is larger (6) (this fossa is absent in the squalodelphid *Notocetus marplei*); the falciform process is bifid, without clear evidence of contact with an ossified lateral lamina of the pterygoid; the anterior process of the periotic is relatively larger and more inflated trans-

versely (21), with a blunter tip and an axis more abruptly reflected ventrally (see *Notocetus marplei*, Fig. 10); and the atlas lacks a long hypapophysis.

Other odontocetes superficially similar to *W. maerewhenua* are known. Of these, *Agriocetus incertus* (Brandt, 1874) (see Abel 1914; pls. 4–5) is similar in size and age to *Waipatia maerewhenua*. The holotype is part of a cranium (late Oligocene, Austria) too heavily encrusted with matrix to reveal the suture detail necessary for useful comparisons. *Agriocetus incertus* cannot be assigned to a family, and the holotype is so uninformative that the name may be a *nomen dubium*.

Rothausen (1961) reviewed the heterodont *Phoca ambiguus* Meyer, 1840 (late Oligocene, Germany), which is the type species of the supposed squalodontid genus *Microcetus* Kellogg, 1923. The species is known only from cheek teeth, which are smaller than those of *Waipatia maerewhenua*. It shares with *W. maerewhenua* the (derived?) loss of anterior denticles on the cheek teeth. In *M. ambiguus*, the cheek-tooth crowns are lower and thicker, with finer apical ornament, and the roots are thicker. Characters of heterodont teeth of Cetacea are understood too poorly to enable cladistic comparison of *Microcetus* with *Waipatia*, but the stated differences probably separate these genera in terms of traditional taxonomy. *Microcetus ambiguus* is probably not a squalodontid but may be a waipatiid.

Other nominal species of *Microcetus* are not clearly congeneric with *M. ambiguus*. *Microcetus sharkovi* is based on a crushed partial skull and incomplete mandible (late Oligocene, Kazakhstan). The skull is similar in size and profiles to *W. maerewhenua*, but its sutures are indistinct. As in *W. maerewhenua*, the base of the rostrum, antorbital notches, and preorbital processes are asymmetrical, though the right process is more pronounced. These features and the small cheek teeth eliminate *M. sharkovi* as a squalodontid. The species differs from *W. maerewhenua* in that the premaxilla overhangs the mesorostral groove more, the posterolateral sulcus is deeper, and the worn mandibular cheek teeth are smaller and less emergent. This species does not clearly belong in *Microcetus*. It may be a waipatiid.

*Microcetus hectori* Benham, 1935, is known only from the holotype (NMNZ Ma 653), collected in the Waitaki Valley, near the type locality of *W. maerewhenua*. The holotype includes a distorted partial cranium, the described incomplete right mandible with 5 small heterodont cheek teeth in place, and loose teeth. The holotype is from about the middle of the Maerewhenua Member of the Otekaike Limestone, about lower Waitakian Stage (= earliest Miocene, about 23 Ma). Benham (1935) assigned the species to *Microcetus* because its cheek teeth lack anterior denticles. *Microcetus hectori* differs from *M. ambiguus* in that the former has cheek teeth on which the crowns are relatively higher, more inflated laterally, and smoother. Rothausen (1961) suggested that these species are probably not congeneric. Rothausen (1970: fig. 1) proposed the generic name *Uncamentodon* for *M. hectori* without further diagnosis. *Microcetus hectori* is similar in size to *W. maerewhenua*, and also has deeply rooted and presumably procumbent incisors, but *M. hectori* differs in the following features: middle to posterior mandibular cheek teeth subconical, smaller, and more inflated laterally, with reduced ornamentation; tympano-squamosal recess more pronounced and more pitted posteriorly; and foramen spinosum (an incipient subcircular fossa) markedly larger. These species are not conspecific, and are probably not congeneric. The large foramen spinosum indicates that *Microcetus hectori* is probably a squalodolphid; it is not a squalodontid (cf. Fordyce 1982; Rothausen 1961).

The New Zealand species "*Prosqualodon*" *marplei* is known only from the holotype (OM C.75.27), which includes an incomplete skull (Figs. 16c, f), an undescribed periotic, and assorted elements listed or described by Dickson (1964). The type locality is "Trig Z," near Otiake, Waitaki Valley. The holotype is probably from the "lower shell bed" at the top of the Maerewhenua Member of the Otekaike Limestone, about middle Waitakian Stage (= earliest Miocene, about 22–23 Ma; Fordyce et al. 1985; Hornibrook et al. 1989). This is younger than *Microcetus hectori* and *Waipatia maerewhenua*. The skull of "*Prosqualodon*" *marplei* differs markedly from that of squalodontids and *Prosqualodon* in its asymmetry and other features noted in the cladistic analysis. Despite its small size, procumbent anterior teeth, and probable heterodont dentition, "*Prosqualodon*" *marplei* is not conspecific or congeneric with *W. maerewhenua*; rather, "*Prosqualodon*" *marplei* resembles *Notocetus vanbenedeni* (early Miocene, Patagonia) in its deeply sutured nodular asymmetrical frontals, "squared off" posterior margin of the maxillae along the contact with the supraoccipital, asymmetrical supraoccipital, larger hypopophysis (Figs. 13k–m) on the atlas, and a range of features on the previously undescribed periotic (e.g., acute anterointernal apex, sigmoidal profile in dorsal view, prominent dorsal crest on the dorsal surface of the periotic at the junction between the body and anterior process, and long smooth parallel-sided facet on the posterior process). "*Prosqualodon*" *marplei* is here formally transferred from the Squalodontidae to a *Dalpacia* (Squalodelphidae) (see Fig. 15).

*Sulakocetus dagestanicus* is a late Oligocene supposed squalodontid, based on a holotype from the Caucasus. The incomplete skull (Figs. 16c, d; Mchedlidze 1984: pls. 13, 14; Pilleri 1986: pls. 5–8) is small and heterodont, with a rostrum moderately wide at the base and attenuated distally. Mchedlidze (1984) outlined general features of the skull; most details of the sutures are uncertain, and the periotic is unknown. *Sulakocetus dagestanicus* is not clearly a squalodontid. In lateral view, the skull is similar in profile to that of *W. maerewhenua*. The mandibular teeth (Mchedlidze 1984: pls. 14, 15) are smaller and more gracile than those of the Squalodontidae, resembling those of *W. maerewhenua*. *Sulakocetus* perhaps belongs in the Waipatiidae but is known too poorly for cladistic analysis. *Waipatia maerewhenua* apparently differs from *S. dagestanicus* as follows: preorbital process not as thick dorsoventrally; premaxillary-maxillary suture on rostrum less pronounced;

premaxillary sulci shallower; premaxilla overhangs mesorostral groove less; premaxilla has transversely flatter profile in front of nares; nasals appear more nodular; posterolateral plate has more convex profile (lateral view); vertex is not as elevated or rounded in lateral view; mandibular cheek teeth more emergent with less triangular crowns; body of mandible more robust; and pan bone of mandible less inflated ventrally. It is not clear whether the maxilla contacts the supraoccipital in *S. dagestanicus* (cf. Muizon 1987). *Sulakocetus dagestanicus* is not clearly conspecific with other described heterodont taxa.

*Sachalinocetus chobnicus* Dubrovo, 1971, is an early or middle Miocene supposed squalodontid from Sakhalin, northwest Pacific. The holotype skull is about 600 mm long. Dubrovo's (1971) reconstructions (Figs. 16a, b) suggest that the skull is similar in profile to *W. maerewhenua* in dorsal and ventral views, but a lateral view of the skull reveals a deeper fossa for facial muscles. On the vertex, the frontals appear to be longer and narrower than in *W. maerewhenua*. Not enough is shown of skull sutures to allow detailed comparisons. The teeth are heterodont, and the slender long incisors were probably procumbent. Posterior cheek teeth lack much ornamentation on the crowns and have reduced posterior denticles. In a traditional approach to classification, similarities between *Sachalinocetus* and *Waipatia* would probably see these genera in the same family. Contrary to Dubrovo's (1971) conclusions, *Sachalinocetus* is not clearly a squalodontid. I suspect that *Sachalinocetus* belongs in the Waipatiidae, and that the clade thus ranges into the Miocene.

## CONCLUSIONS

*Waipatia maerewhenua* is sufficiently generalized that it might be placed in one of several odontocete clades. Dorsal structures on the cranium in *W. maerewhenua*, traditionally used in odontocete classification, indicate that cranial asymmetry arose by the late Oligocene, but otherwise suggest only that the species perhaps is not a squalodontid. What remains of the pterygoid sinus complex is also generalized, apart from the posteromedial expansion of the sinus. Features of the tympano-periotic and basicranium allow *W. maerewhenua* to be placed in the Platanistoidea and in a new family, Waipatiidae, as a sister group to the Squalodelphidae and Platanistidae. Some described Oligocene and earlier Miocene "squalodontids" may also be waipatiids, but most are too incomplete or too poorly described to be sure. The range of described *Waipatia*-like species hints at a significant diversity of the Waipatiidae later in the Oligocene. Waipatiids were perhaps the ecological equivalents of medium-sized extant delphinids with robust rostra, such as *Tursiops truncatus*. Judged from New Zealand late Oligocene specimens such as the *Squalodon*-like OU 21798 (Fordyce 1989: 23), contemporaneous squalodontids were larger predators with no clear modern analogs. Squalodelphids and a *Dalpacia*-like small odontocete lived in New Zealand waters during the latest Oligocene or earliest Miocene (Fordyce and Samson 1992), and early Miocene representatives (Muizon 1991) are well known elsewhere. Such fossils suggest that platanistoids were globally diverse and ecologically important earlier than suspected. Later Neogene long-beaked *Zarhachis*-like taxa, which reveal little of this older history of platanistoids, foretell the origins of the fluvial *Platanista* spp.—the near-extinct relicts of a once-diverse marine taxon.

## ACKNOWLEDGMENTS

I wish to dedicate this article to Frank C. Whitmore, Jr., with grateful thanks for over a decade of wide-ranging counsel on fossil cetaceans. Through his thoughtful, supportive, and temperate comments, through ideas shared freely with many colleagues, and

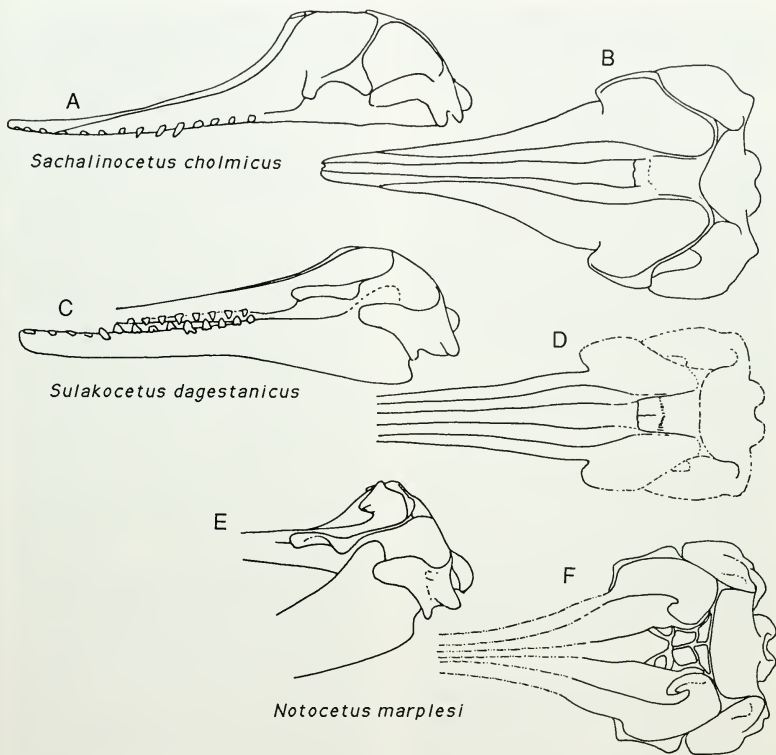

Figure 16. Reconstructions of skulls of some archaic platanistoids, not to same scale. A-B, *Sachalinocetus cholmicus*, based on Dubrovo (1971). A, lateral; B, dorsal. C-D, *Sulakocetus dagestanicus*, based on Mchedlidze (1976, 1984). C, lateral; D, dorsal. E-F, *Notocetus marplesii*, based on Dickson (1964) and on holotype. E, lateral; F, dorsal.

through an appreciation of the human element in science, Dr. Whitmore has done much to further the study of fossil Cetacea world-wide.

I also thank the following for their help. The Harvey family gave permission to work on their property. Andrew Grebneff assisted in the field, skillfully prepared the holotype of *Waipatia maerewhenua*, and helped with illustrations. Greg Ferguson helped with preparation, literature work, and photography. Bob Connell assisted with field work. Christian de Muizon and Catherine R. Samson provided very useful comment on the manuscript and/or

specimens. The editors, M. Gottfried, and an anonymous referee also gave constructive comments. Lawrence G. Barnes, Mario A. Cozzuol, James G. Mead, and Frank C. Whitmore, Jr., discussed cetacean systematics. N. de B. Hornibrook and Michael A. Ayress helped with biostratigraphy. Jeffrey D. Stilwell provided translations. John T. Darby (Otago Museum), Alan N. Baker (National Museum of New Zealand), Clayton E. Ray (Smithsonian Institution), and Richard H. Tedford (American Museum of Natural History) provided access to specimens. Field work was aided by the Francis, McKenzie, Parker, Simpson, and Williamson families and

others of the Duntroon district. The holotype and other specimens were collected and prepared with support from the National Geographic Society (grants 4024-88 and 4341-90; field work and preparation), the New Zealand Lottery Research Board (equipment), and the Research Committee of the University of Otago (preparation).

## LITERATURE CITED

- Abel, O. 1914. Die Vorfahren der Bartenwale. Denkschriften der Akademie der Wissenschaften, Wien, Mathematisch-naturwissenschaftliche Klasse 90:155-224.
- Allen, G. M. 1921. A new fossil cetacean (*Archaeodelphis patrius* gen. et sp. nov.). Bulletin of the Museum of Comparative Zoology 65:1-14.
- Barnes, L. G. 1978. A review of *Lophocetus* and *Liolithax* and their relationships to the delphinoid family Kentriodontidae (Cetacea: Odontoceti). Natural History Museum of Los Angeles County Science Bulletin 28:1-35.
- . 1985. Fossil pontoporiid dolphins (Mammalia: Cetacea) from the Pacific coast of North America. Natural History Museum of Los Angeles County Contributions in Science 363.
- . 1990. The fossil record and evolutionary relationships of the genus *Tursiops*. Pp. 3-26 in S. Leatherwood and R. R. Reeves (eds.). The Bottlenose Dolphin. Academic Press, San Diego, California.
- , D. P. Domning, and C. E. Ray. 1985. Status of studies on fossil marine mammals. Marine Mammal Science 1:15-53.
- Benham, W. B. 1935. The teeth of an extinct whale, *Microcetus hectori* n. sp. Transactions of the Royal Society of New Zealand 65:239-243.
- . 1937. Fossil Cetacea of New Zealand III.—The skull and other parts of the skeleton of *Prosqalodon hamiltoni* n. sp. Transactions of the Royal Society of New Zealand 67:8-14.
- Boenninghaus, G. 1904. Das Ohr des Zahnwales. Zoologische Jahrbücher. Abteilung für Anatomie und Ontogenie der Tiere 19:189-360.
- Burlet, H. M. de. 1913. Zur entwicklungsgeschichte des walschadels. I. Über das primordialnerv eines embryon von *Phocaena communis*. Gegenbaurs Morphologisches Jahrbuch 45:523-556.
- Cabrera, A. 1926. Cetáceos fósiles del Museo de la Plata. Revista Museo de La Plata 29:363-411.
- Cozzuol, M. A. 1989. An alternative interpretation of the evolutionary significance of the bony lateral lamina and its implications for odontocete systematics. Abstracts of Papers and Posters, Fifth International Theriological Congress, Rome, 22-29 August 1989, 1:481-482.
- Cozzuol, M. A., and G. Humbert-Lan. 1989. On the systematic position of the genus *Prosqalodon* Lydekker, 1893, and some comments on the odontocete family Squalodontidae. Abstracts of Papers and Posters, Fifth International Theriological Congress, Rome, 22-29 August 1989, 1:483-484.
- Dal Piaz, G. 1917. Gli Odontoceti del Miocene Bellunese. III. *Squalodelphis fabianii*. Memorie dell'Istituto Geologico della R. Università di Padova 5:1-34.
- Dal Piaz, G. 1977. Gli Odontoceti del Miocene Bellunese. V-X. *Cyrtodelphis*, *Acrodelphis*, *Protodelphis*, *Ziphiodelphis*, *Scaldicetus*. Memorie dell'Istituto Geologico della R. Università di Padova. Publ. dal Prof. G. Dal Piaz, Allegato al vol. 4 (1916): 1-128.
- Dickson, M. R. 1964. The skull and other remains of *Prosqalodon marplesi*, a new species of fossil whale. New Zealand Journal of Geology and Geophysics 7:626-635.
- Dubrovo, I. A. 1971. Novyi rod kitobraznykh (*Sachalinocetus cholmicus* gen. et sp. nov.) iz miotsena o-va Sakhalin [A new genus of cetaceans (*Sachalinocetus cholmicus* gen. et sp. nov.) from the Miocene of the island of Sakhalin]. Akademia Nauk SSSR, Trudy Paleontologicheskii Institut 130:87-103.
- , and A. A. Sharkov. 1971. Kit iz verkhnego Oligotsena Mangyshlaka [A whale from the Upper Oligocene of Mangyshlak]. Doklady Akademia Nauk SSSR 194:1403-1406.
- , and ——. 1972. A whale from the Upper Oligocene of Mangyshlak [Translation by American Geological Institute]. Doklady Akademia Nauk SSSR 198: 140-143.
- Fleischer, G. 1976. Hearing in extinct cetaceans as determined by cochlear structure. Journal of Paleontology 50:133-152.
- Flynn, T. T. 1948. Description of *Prosqalodon davidi* Flynn, a fossil cetacean from Tasmania. Transactions of the Zoological Society of London 25:153-197.
- Fordyce, R. E. 1981. Systematics of the odontocete *Agorophius pygmaeus* and the family Agorophiidae (Mammalia: Cetacea). Journal of Paleontology 55:1028-1045.
- . 1982. The fossil vertebrate record of New Zealand. Pp.629-698 in P. V. Rich and E. M. Thompson (eds.). The Fossil Vertebrate Record of Australasia. Monash University Offset Printing Unit, Clayton, Victoria, Australia.
- . 1983. Rhadostoid dolphins (Mammalia: Cetacea) from the middle Miocene, Lake Frome area, South Australia. Alcheringa 7: 27-40.
- . 1989. Fossil whales, dolphins and porpoises. Earth Science 42 (2):20-23.
- , N. de B. Hornibrook, and P. A. Maxwell. 1985. Field trip guide to Cenozoic geology of North Otago and South Canterbury. Geological Society of New Zealand Miscellaneous Publication 33B:1-50.
- , and C. R. Samson. 1992. Late Oligocene platanistoid and delphinoid dolphins from the Kokoamu Greensand-Otekahe Limestone, Waitaki Valley region, New Zealand: An expanding record [abstract]. Geological Society of New Zealand Miscellaneous Publication 63A:66.
- Fraser, F. C., and P. E. Purves 1960. Hearing in cetaceans: Evolution of the accessory air sacs and the structure of the outer and middle ear in recent cetaceans. Bulletin of the British Museum (Natural History), Zoology 7:1-140.
- Gage, M. 1957. The geology of Waitaki subdivision. New Zealand Geological Survey Bulletin 55:1-135.
- Grateloup, J. P. S. 1840. Description d'un fragment de mâchoire fossile, d'un genre nouveau de reptile (sauirien), de taille gigantesque, voisin de l'*Aguanodon*, trouvé dans le Grès Marià à Léognan, près Bordeaux. Actes de l'Académie National des Sciences, Belles-lettres et Artes de Bordeaux 2:201-210.
- Heyning, J. E. 1989. Comparative facial anatomy of beaked whales (Ziphiidae) and a systematic revision among the families of extant Odontoceti. Natural History Museum of Los Angeles County Contributions in Science 405:1-64.
- , and J. G. Mead. 1990. Evolution of the nasal anatomy of cetaceans. Pp. 67-79 in J. Thomas and R. Kastelein (eds.). Sensory Abilities of Cetaceans. Plenum, New York, New York.
- Hornibrook, N. de B. 1966. The stratigraphy of Landon (or Boundary) Creek, Oamaru. New Zealand Journal of Geology and Geophysics 9:458-470.
- , R. C. Brazier, and C. P. Strong. 1989. Manual of New Zealand Permian to Pleistocene foraminiferal biostratigraphy. New Zealand Geological Survey Paleontological Bulletin 56:1-175.
- Howell, A. B. 1927. Contribution to the anatomy of the Chinese finless porpoise *Neomeris phocaenoides*. Proceedings of the United States National Museum 70 (13):1-43.
- Kasuya, T. 1973. Systematic consideration of recent toothed whales based on the morphology of tympanoperiotic bone. Scientific Reports of the Whales Research Institute, Tokyo 25:1-103.
- Kellogg, A. R. 1923a. Description of two squalodonts recently discovered in the Calvert Cliffs, Maryland; and notes on the shark-toothed dolphins. Proceedings of the United States National Museum 62 (6):1-69.
- . 1923b. Description of an apparently new toothed cetacean from South Carolina. Smithsonian Miscellaneous Collections 76 (7):1-7.
- . 1924. A fossil porpoise from the Calvert Formation of Maryland. Proceedings of the United States National Museum 63 (14): 1-39.
- . 1926. Supplementary observations on the skull of the fossil porpoise *Zarhachis flagellator*. Proceedings of the United States National Museum 67 (28):1-18.
- . 1927. *Kentriodon pernix*, a Miocene porpoise from Maryland. Proceedings of the United States National Museum 69 (19):1-55.
- . 1928. History of whales—their adaptation to life in the water. Quarterly Review of Biology 3:29-76, 174-208.

- . 1936. A review of the Archaoceti. Carnegie Institute of Washington Publication 482.
- . 1957. Two additional Miocene porpoises from the Calvert Cliffs, Maryland. Proceedings of the United States National Museum 107 (3387):279–337.
- Lydekker, R. 1894. Contributions to a knowledge of the fossil vertebrates of Argentina. Part II. Cetacean skulls from Patagonia. Annales del Museo de La Plata 1893, 2:1–14.
- Mchedlidze, G. A. 1970. Nekotorye Obshche Cherty Istoriy Kitoobraznykh [Some general characteristics of the evolution of cetaceans, Part I]. Metsniereba, Tbilisi, Georgia.
- . 1984. General Features of the Paleobiological Evolution of Cetacea [translation of 1976 title]. Amerind, New Delhi, India.
- Mead, J. G. 1975. Anatomy of the external nasal passages and facial complex in the Delphinidae (Mammalia: Cetacea). Smithsonian Contributions to Zoology 207:1–72.
- Moreno, F. P. 1892. Lijeros apuntes sobre dos géneros de cetáceos fósiles de la República Argentina. Revista Museo de La Plata 3:381–400.
- Muizon, C. de. 1987. The affinities of *Notocetus vanbenedeni*, an Early Miocene platanistoid (Cetacea, Mammalia) from Patagonia, southern Argentina. American Museum Novitates 2904.
- . 1988a. Le polyphylétisme des Acrodelphidae, Odontocètes longirostres du Miocène européen. Bulletin du Muséum National d'Histoire Naturelle, Section C, 4ème série, 10 (1):31–88.
- . 1988b. Les relations phylogénétiques des Delphinida (Cetacea, Mammalia). Annales de Paléontologie 74:159–227.
- . 1991. A new Ziphiidae (Cetacea) from the early Miocene of Washington State (USA) and phylogenetic analysis of the major groups of odontocetes. Bulletin du Muséum National d'Histoire Naturelle, Section C, 4ème série, 12 (3–4):279–326.
- Perrin, W. F. 1975. Variation of spotted and spinner porpoise (genus *Stenella*) in the eastern tropical Pacific and Hawaii. Bulletin of the Scripps Institution of Oceanography 21:1–206.
- Pilleri, G. 1986. Beobachtungen an den Fossilien Cetaceen des Kaukasus. Hirnanatomisches Institut, Ostermündigen, Switzerland.
- Pompeckj, J. F. 1922. Das Ohrskelett von *Zeuglodon*. Senckenbergiana 4 (3, 4):43–100.
- Rothausen, K. 1961. Über *Microcetus*, einen kleinen Squalodontiden aus dem Oberoligozän. Neues Jahrbuch für Geologie und Paläontologie Abhandlungen 112:106–118.
- . 1968. Die systematische Stellung der europäischen Squalodontidae (Odontoceti: Mamm.). Paläontologische Zeitschrift 42:83–104.
- . 1970. Marine Reptilia and Mammalia and the problem of the Oligocene–Miocene boundary. Giornale di Geologia (series 2) 35:181–189.
- Schenckan, E. J. 1973. On the comparative anatomy and function of the nasal tract in odontocetes (Mammalia, Cetacea). Bijdragen Tot de Dierkunde 43:127–159.
- Schulte, H. von, and M. de F. Smith. 1918. The external characters, skeletal muscles, and peripheral nerves of *Kogia breviceps* (Blainville). Bulletin of the American Museum of Natural History 38:7–72.
- Simpson, G. G. 1945. The principles of classification, and a classification of mammals. Bulletin of the American Museum of Natural History 85:1–350.
- Swofford, D. L. 1993. PAUP: Phylogenetic analysis using parsimony, version 3.1.1. Computer program distributed by Illinois Natural History Survey, Champaign, Illinois.
- , and Begle, D. P. 1993. PAUP: Phylogenetic analysis using parsimony, version 3.1.1. User's manual. Laboratory of Molecular Systematics, Smithsonian Institution/Illinois Natural History Survey, Champaign, Illinois.
- True, F. W. 1909. A new genus of fossil cetaceans from Santa Cruz territory, Patagonia; and description of a mandible and vertebrae of *Prosqualodon*. Smithsonian Miscellaneous Collections 52:441–456.
- . 1910a. Description of a skull and some vertebrae of the fossil cetacean *Diochoticus vanbenedeni* from Santa Cruz, Patagonia. Bulletin of the American Museum of Natural History 28:19–32.
- . 1910b. An account of the beaked whales of the family Ziphiidae in the collection of the United States National Museum, with

remarks on some specimens in other American museums. United States National Museum Bulletin 73:1–89.

Whitmore, F. C., and A. E. Sanders. 1977. Review of the Oligocene Cetacea. Systematic Zoology 25 (for 1976):304–320.

#### APPENDIX: CHARACTERS USED IN CLADISTIC ANALYSIS OF THE RELATIONSHIPS OF WAIPATIA MAEREWHENUA

These characters are discussed in the text and/or by Barnes (1990), Heyning (1989), and Muizon (1987, 1988a, 1988b, 1991). 0, primitive; 1–3, derived.

1. Posterior lacerate foramen confluent with foramen ovale to form "cranial hiatus": 0, yes; 1, no, parietal and/or squamosal contact basioccipital to separate posterior lacerate foramen from foramen ovale.

2. Foramen "pseudo-ovale": 0, present; 1, absent. The foramen "pseudo-ovale" marks the exit of the mandibular branch of the trigeminal nerve from the region of the pterygoid sinus fossa. The foramen is bounded by the pterygoid and falciform processes of the squamosal and normally by the ossified outer lamina of the pterygoid. Present in Archaoceti, Mysticeti, and those Odontoceti (e.g., *Platanista*) in which an extensive ossified outer lamina of the pterygoid contacts the falciform process. The palatine may contact the falciform process in some Delphinoidea.

3. Overlap of maxilla onto frontal in supraorbital region: 0, no overlap; 1, partial overlap; 2, supraorbital process of maxilla extends posterior to mid-orbit.

4. Form of anterior bullar facet of periotic: 0, facet flat or absent; 1, facet depressed with shallow groove; 2, facet depressed with deep groove.

5. Mandibles fused at symphysis: 0, no; 1, yes.

6. Depth of pterygoid sinus fossa in basicranium: 0, shallow or little excavated; 1, deep, excavated dorsal to level of foramen ovale; 2, deep and extended dorsally toward or into orbit. Functional reasons for apparent reversals from state 1 to 0 or 2 to 1 are uncertain; irreversibility seems likely.

7. Maxilla present in anterior wall or in floor of orbit: 0, yes; 1, no.

8. Position and orientation of origin for temporal muscle on supraorbital process of frontal: 0, origin lies on the posterior face of the supraorbital process and is directed roughly posteriorly; 1, origin lies on posteroventral face of supraorbital process and is directed roughly ventrally.

9. Ossified lateral lamina of pterygoid present and in contact with falciform process: 0, yes; 1, ossified lamina reduced or absent.

10. External auditory meatus: 0, wide; 1, narrow.

11. Contact of enlarged posterior process of bulla with paroccipital: 0, no contact; 1, sutural contact.

12. Accessory ossicle of periotic: 0, small to medium, not well fused; 1, enlarged, subspherical, and fused tightly to periotic.

13. Blowhole ligament present: 0, no; 1, yes. Not known for fossils. In extant Mysticeti, not included in this analysis, the blowhole ligament is absent; its absence in the Physeteroidea is probably primitive, rather than a result of reversal. Heyning (1989) discussed the soft anatomy of the face (e.g., characters 13–17).

14. Nasal passage—distal sac developed: 0, no; 1, yes. Derived for the Physeteroidea.

15. Nasal passage—proximal sac evolves into frontal sac: 0, no; 1, yes.

16. Nasal passage—proximal sac evolves into sac complex: 0, no; 1, yes. Regarded as derived for extant Odontoceti other than the Physeteroidea; the absence in Physeteroidea is probably primitive, rather than a result of reversal as indicated in Figure 15.
17. Spermaceti organ present: 0, no; 1, yes.
18. Supracranial basin in skull: 0, absent; 1, present.
19. Number of nasals: 0, two; 1, one or both lost.
20. Nasal passages confluent distal to bony nares: 0, no; 1, yes. In extant Mysticeti, the nasal passages are separate distal to the bony nares; separation in the Physeteroidea is probably primitive, rather than a result of reversal.
21. Anterior process of periotic: 0, not thickened transversely; 1, thickened transversely by expanded internal and external faces at some point beyond the base of the process.
22. Fenestra rotundum of periotic reniform, with a dorsal fissure directed toward the aperture for the cochlear aqueduct: 0, no; 1, yes.
23. Premaxilla with a transversely flattened vertical face and prominent lateral crest at the level of the nares: 0, no; 1, yes.
24. Enlarged dorsal lamina of pterygoid tightly fused with alisphenoid anterior to foramen ovale: 0, no; 1, yes.
25. Profile of anterior process of periotic ventrally deflected in lateral view: 0, no, has crudely rectangular profile; 1, smoothly deflected; 2, abruptly deflected.
26. Periotic - parabullary ridge developed laterally along ventral border of anterior process: 0, ridge absent; 1, ridge present.
27. Long posterior apex of premaxilla lies posterior to nasals wedged between elevated edge of maxilla and frontal on vertex; apices show left-right asymmetry: 0, no; 1, yes.
28. Cochlear aqueduct on periotic large with a thin edge: 0, no; 1, yes.
29. Articulation of posterior process of tympanic bulla with squamosal: 0, process contacts post-tympanic process of squamosal and posterior process of periotic; 1, bulla contacts periotic only.
30. Frontal excavated for orbital extensions of pterygoid sinus(es): 0, not excavated; 1, slightly excavated with shallow-edged depression; 2, deeply excavated.
31. Nasal passage—vestibular sac: 0, absent; 1, present; 2, hypertrophied.
32. Palatine invaded by or modified by pterygoid sinus fossa: 0, no; 1, yes. The palatine is progressively narrowed to ventral view between maxilla and pterygoid as the pterygoid sinus fossa invades the palatine.
33. Articular process on periotic: 0, process absent; 1, incipient ridge present; 2, strong ridge present; 3, peg present.
34. Apex of pterygoid hamulus solid, robust, long and subconical in ventral view: 0, no; 1, yes.
35. Lateral groove or lateral depression affects profile of periotic as viewed dorsally: 0, no obvious vertical groove dorsal to hiatus epitympanicus; 1, groove present so that overall profile of periotic is slightly to markedly sigmoid in dorsal view.
36. Rostral suture between premaxilla and maxilla deeply grooved: 0, no; 1, yes.
37. Dorsal edge of posterior process of periotic spongy and fused or tightly articulated with adjacent squamosal: 0, no; 1, yes.
38. Dorsal surface of involucrem of bulla markedly depressed or excavated anterior to the base of the posterior process, so that the involucrem has parallel dorsal and ventral profiles in medial view: 0, no; 1, yes.
39. Palatine with ossified lateral lamina directed posterolaterally from about the level of the choanae: 0, no; 1, yes.
40. Anterior bullar facet lost from periotic: 0, no; 1, yes.
41. Relationship of ascending process of premaxilla with nasal: 0, left and right processes extend posteriorly beyond anterior of nasals; 1, processes contact only front of nasal; 2, one or no process contacts nasal.
42. Incisors relatively delicate and procumbent: 0, no; 1, yes.
43. Nasal passage—posterior sac lost: 0, no; 1, yes.
44. Pterygoid sinus fossa present in alisphenoid and/or basioccipital, dorsolateral to basioccipital crest and posteromedial to foramen ovale: 0, no; 1, yes.
45. Anterior spine present on bulla: 0, no; 1, spine small to moderate; 2, spine long.
46. Bulla with inflated anterolateral convexity that may be associated with an anterolateral notch: 0, no; 1, yes.
47. Anterior process of periotic roughly cylindrical in cross section: 0, no; 1, yes.
48. Scapula—acromion process lies on anterior edge, with loss of supraspinous fossa: 0, no; 1, yes.
49. Scapula—coracoid process: 0, present; 1, absent.
50. Periotic with low, wide, and regularly convex transverse profile across dorsal surface (= across dorsal process, *sensu* Muizon): 0, no; 1, yes.
51. Bullar facet on posterior process of periotic extends dorsally onto the posteromedial face of the posterior process: 0, no; 1, yes.
52. Posterior portion of rostrum robust and deep, with open and deep mesorostral groove: 0, no; 1, yes.
53. Apex of anterior process of periotic tuberculate: 0, no; 1, prominent small tubercle present.
54. Anterior process of periotic with multiple subvertical fine fissures on the internal face: 0, no; 1, yes.
55. Anteroposterior ridge on dorsal side of anterior process and body of periotic, associated with the development of a depression adjacent to groove for tensor tympani: 0, absent; 1, present.
56. Anteroexternal sulcus profile on periotic recurved so that it is concave dorsally (seen in external view): 0, no; 1, yes.
57. Foramen spinosum enlarged to form a subcircular fossa dorsal to periotic: 0, no; 1, yes.
58. Crown of heterodont teeth: 0, long (>10 mm); 1, short ( $\leq 10$  mm).
59. Bulla—ventral groove: 0, groove not marked anteriorly; 1, groove present anteriorly (shallow or deep, may include anterior spine).
60. Atlas vertebra—relative size of dorsal transverse process: 0, moderate; 1, large.
61. Pars cochlearis of periotic inflated with subrectangular profile: 0, no; 1, yes.
62. Posterior maxillary (infraorbital) foramen placed posteromedially, near the bifurcation in the posterior of the premaxilla: 0, no; 1, yes.
63. Facet for bulla on posterior process of periotic relatively narrow, long, and parallel-sided: 0, no; 1, yes.
64. Posterior margin of maxilla elevated, with "squared off" profile as viewed dorsally: 0, no; 1, yes.
65. Nodular frontals prominent on vertex, separated by a prominent medial groove: 0, no; 1, yes.
66. Ridge or crest of maxilla/frontal, pneumatized ventrally, present along lateral margin of face above orbit: 0, no; 1, yes.
67. Bulla with thin outer lip that is smoothly overarched and high relative to transverse width of bulla: 0, no; 1, yes.