

---

# PHYLOGENETIC RELATIONSHIPS OF THE "GREEN ALGAE" AND "BRYOPHYTES"<sup>1</sup>

Brent D. Mishler,<sup>2,3</sup> Louise A. Lewis,<sup>2</sup>  
Mark A. Buchheim,<sup>4</sup>  
Karen S. Renzaglia,<sup>5</sup>  
David J. Garbary,<sup>6</sup>  
Charles F. Delwiche,<sup>7</sup>  
Frederick W. Zechman,<sup>8</sup>  
Thomas S. Kantz,<sup>9,10</sup> and  
Russell L. Chapman<sup>9</sup>

---

## ABSTRACT

Considerable progress has been made recently, based on classical morphological characters and newly described ultrastructural features, in understanding the phylogenetic relationships of the tracheophytes to the green algae and bryophytes. Recent technological advances in molecular biology, particularly the advent of the polymerase chain reaction (PCR), have allowed nucleotide sequence data relevant to such large-scale phylogenetic questions to accumulate, especially ribosomal RNA gene sequences (both the large and small subunits) from the nucleus and the chloroplast. We present synthetic cladistic analyses of the green plants that combine and compare available morphological and molecular data sets. Although the resulting phylogenies are poorly resolved in some areas at present, certain conclusions are supported: (1) The green plants are composed of two major monophyletic groups, one containing the "charophyte" green algae and the land plants (i.e., "bryophytes" plus tracheophytes), the other containing the bulk of the classically delimited "green algae" (chlorophytes, pleurastrophytes, and ulvophytes). (2) The land plants are a well-supported monophyletic group, but neither the specific outgroup for the land plants nor the precise relationships among basal lineages of land plants are clear. In many analyses (including the combined molecular and morphological analysis) the three major lineages (i.e., liverworts, hornworts, and mosses) appear to be paraphyletic with respect to the tracheophytes, with an indication that the mosses alone may be the sister group of the tracheophytes; however, in other analyses the "bryophytes" are supported as a monophyletic group. (3) The ulvophytes, chlorophytes, and pleurastrophytes are each supported as monophyletic (with the exception of a few taxa that may be misplaced in the current classification), with the topology: [ulvophytes [chlorophytes + pleurastrophytes]]. Combined analyses of molecular and morphological data offer the greatest potential for resolving these relationships.

---

Reconstruction of the broad-scale phylogenetic relationships of green plants is important to our understanding of major evolutionary events such as the origin of multicellularity, diversification of life-history strategies, and the conquest of land (Graham, 1985; Mishler & Churchill, 1985). In addition, availability of a well-supported framework of "deep" relationships is necessary for purposes of outgroup comparison in studies of tracheophyte phylogeny (Crane, 1990; Gensel, 1992).

Considerable morphological and ultrastructural data have accumulated over the last two decades that bear on the question of phylogenetic relationships of the green algae and bryophytes to the tracheophytes (e.g., Stewart & Mattox, 1975; Héban, 1977; Pickett-Heaps, 1979; Crandall-Stotler, 1980, 1981; Brown & Lemmon, 1988; Carothers & Rushing, 1988; Duckett & Renzaglia, 1988; Ligrone & Gambardella, 1988). More recently, comparative molecular data have become

---

<sup>1</sup> We thank Richard Zander and Robert Wyatt for comments on the manuscript. We are grateful to Angel Maden for contributing information on spermatogenesis in *Lycopodium obscurum*. This research was supported in part by NSF grant BSR-9107484 to BDM; DEB-9207646 to KSR and DJG; BSR-8918564 to MAB and RLC; DEB-9107389 to RLC.

<sup>2</sup> Department of Botany, Duke University, Durham, North Carolina 27708-0338, U.S.A.

<sup>3</sup> Present address: Department of Integrative Biology and University and Jepson Herbaria, University of California, Berkeley, California 94720, U.S.A.

<sup>4</sup> Faculty of Biological Science, University of Tulsa, Tulsa, Oklahoma 74104-3189, U.S.A.

<sup>5</sup> Department of Biological Sciences, East Tennessee State University, Box 70703, Johnson City, Tennessee 37601-

0703, U.S.A.

<sup>6</sup> Department of Biology, St. Francis Xavier University, Antigonish, Nova Scotia, Canada B2G 1C0.

<sup>7</sup> Department of Biology, Indiana University, Bloomington, Indiana 47405, U.S.A.

<sup>8</sup> Academy of Natural Sciences, 1900 Benjamin Franklin Parkway, Philadelphia, Pennsylvania 19103-1195, U.S.A.

<sup>9</sup> Department of Botany, Louisiana State University, Baton Rouge, Louisiana 70803, U.S.A.

<sup>10</sup> Present address: Department of Biology, Coastal Carolina University, Conway, South Carolina 29526, U.S.A.



available as well (e.g., Kantz et al., 1990; Zechman et al., 1990; Lewis et al., 1992; Mishler et al., 1992; Waters et al., 1992; Wilcox et al., 1992). A few attempts have been made to synthesize cladistically this growing database (Mishler & Churchill, 1984, 1985; Sluiman, 1985; Theriot, 1988; Graham et al., 1991; Garbary et al., 1993); none of these, however, have incorporated the newly available molecular data.

Cladistic studies to date suggest that neither the "green algae" nor the "bryophytes" are monophyletic. The green plants appear to be composed of two major lineages and a residuum of unicellular micromonadophytes. One of these major lineages contains the bulk of the classical green algae (Chlorophyceae, Pleurostrophyceae, and Ulvophyceae sensu Mattox & Stewart, 1984). There is an indication that the ulvophytes are basal to the chlorophytes plus pleurostrophytes based on morphological and ultrastructural data (Stewart & Mattox, 1975; Mattox & Stewart, 1984; O'Kelly & Floyd, 1984; Sluiman, 1985). Mishler & Churchill (1985) questioned the monophyly of the ulvophytes because of a lack of morphological synapomorphies to unite that group. This result was supported by a recent molecular study (Zechman et al., 1990) that also found non-monophyly of the chlorophytes. The pleurostrophytes have been treated in three ways: (1) as a separate sister class to the Chlorophyceae (Mattox & Stewart, 1984); (2) as part of the Chlorophyceae (Melkonian, 1990); or (3) as part of the Ulvophyceae (Sluiman, 1989).

The other major lineage of green plants includes the charophycean green algae plus the land plants (i.e., bryophytes plus tracheophytes). The genus *Coleochaete* (or even some part of it alone) appears to be the closest extant sister group of land plants (Graham et al., 1991). The bryophytes are composed of three distinctive lineages (i.e., liverworts, hornworts, mosses) that may be paraphyletic with respect to the tracheophytes. For example, early analyses of morphological data (Mishler & Churchill, 1984), as well as two recent molecular analyses (Mishler et al., 1992; Waters et al., 1992), concluded that the liverworts alone appear to be the basal lineage within extant land plants, i.e., the sister group to the hornworts, mosses, and tracheophytes. General morphological data (Mishler & Churchill, 1984), ultrastructural data (Theriot, 1988), and one molecular data set (Mishler et al., 1992) support a topology with the mosses alone as the sister group of tracheophytes. The phylogenetic placement of the hornworts is not clearly resolved by any of the published data sets. On the other hand, monophyly of the bryophytes (includ-

ing *Selaginella*) was suggested by a recent cladistic analysis based on sperm ultrastructural data (Garbary et al., 1993).

Molecular sequence data have shown considerable promise for phylogenetic analysis, but they provide no panacea (despite overly optimistic claims in recent literature, e.g., Graur, 1993). In fact, theoretical considerations predict that DNA sequence characters (given their quasi-clocklike evolution and limited number of character states) could be especially problematical in "deep" phylogenetic reconstructions, where considerable asymmetry in branch lengths exists (Felsenstein, 1978; Mishler et al., 1988; Albert et al., 1992; Donoghue & Sanderson, 1992; Albert et al., 1993; Mishler, 1994). Careful evaluation of all potential characters is required; it is necessary to apply to molecular data basic principles of character analysis (for deriving strong, independent hypotheses of character homology) and cladistic analysis (for evaluating the phylogenetic "signal," if any, present in the resulting data set). Theoretical issues that must be faced in large-scale, synthetic analyses include further development of methods for: (1) combining/comparing data sets of fundamentally different natures (including issues of character and character-state weighting; Miyamoto, 1985; Kluge, 1989; Albert & Mishler, 1992; Albert et al., 1992; Donoghue & Sanderson, 1992; Albert et al., 1993); (2) assessing support for clades (e.g., bootstrap vs. the decay index; Mishler et al., 1991; Källersjö et al., 1992); and (3) representing diverse, yet clearly monophyletic, clades (e.g., the exemplar method vs. "compartmentalization"—a new approach involving substituting an inferred "archetype" or hypothetical ancestor for a clade accepted as monophyletic a priori in an inclusive analysis: Mishler, 1994).

When examined carefully, it is evident that different genes are phylogenetically useful at different hierarchical levels. Nuclear-encoded ribosomal RNA gene sequences (both the 26S and 18S subunits) provide data of apparent utility at the highest level of green plant phylogeny (Zimmer et al., 1989; Kantz et al., 1990; Zechman et al., 1990; Lewis et al., 1992; Waters et al., 1992; Wilcox et al., 1992). On the other hand, the 5S rRNA nuclear-encoded gene appears to be too small, and has had too many substitutions (in the positions that vary), to be of use at this level (Bremer et al., 1987; Mishler et al., 1988; Steele et al., 1991). Among chloroplast genes, it appears that the 16S rRNA gene is the most conservative, followed by the 23S rRNA gene (Palmer et al., 1988). Combined data from these two genes have provided corroboration



of some previous morphologically based hypotheses about the relative branching order of the major lineages of land plants (Mishler et al., 1992). In contrast, the protein-coding gene *rbcL* has proven too divergent to be useful among these lineages (Manhart, pers. comm.; Mishler, unpublished data), but it has provided consistent systematic characters within major lineages. For example, within the mosses the relatively basal position of *Sphagnum* and *Andreaea* is supported, as is the monophyly of the peristomate mosses (with the nematodontous taxa in a more basal position within) and monophyly of the haplolepidious mosses (Mishler, unpublished data).

It is likely that a robust and highly resolved phylogeny can be produced for the green plants in the next few years by integrating classical morphological characters with newly described ultrastructural features and various sets of molecular sequence data from the nuclear and chloroplast genomes. Careful choice of characters and application of proper methods of analysis will be essential, however. The co-authors do not agree unambiguously on the homology of all characters as used here, but have found cladistic analysis to be an excellent way to frame arguments objectively. This paper attempts to synthesize data published to date, as a guide (and a target) for ongoing projects in our own and other laboratories. More data are certainly needed, but a comparison of currently available data is of interest in its own right and can assist in the identification of characters and taxa that are crucial for future research. The data sets presented here will be made generally available (annotated MacCLADE files will be sent on request) and, thus, will provide a basis for future synthetic studies.

## MATERIALS AND METHODS

### DATA SETS

Six data sets were assembled in pairs (focused on different phylogenetic levels): two morphological data sets, one large and one small molecular data set, and two combined data sets. The sources and characteristics of these data sets are listed below:

(1) A large-scale green plant morphological data set (GP-MORPH) is focused primarily on the "deep" relationships of the green plants as a whole (thus using many characters from "green algal" systematics). Choice of OTUs was dictated by availability of molecular data for comparative purposes (see GP-MOLEC below). Several representative land plants were included (14 in all). Choice of characters was based on standard criteria of homology

and independence (Mishler, 1994); a list of characters and character states can be found in Table 1. Sources include Stewart & Mattox (1975), Mattox & Stewart (1984), Mishler & Churchill (1984, 1985), and Graham et al. (1991). All 110 characters were treated as unordered. A hypothetical ancestor was coded for rooting purposes, based on generalized states in presumed protistan outgroups. The data matrix is shown in Table 2.

(2) A more focused land plant morphological data set (LP-MORPH) is based on the set of OTUs scored by Garbary et al. (1993) for ultrastructural characters of spermatozoids. A list of characters and character states can be found in Table 3. To a modified and somewhat reduced set of their "sperm" characters (numbers 1–65), we added a set of "general morphological" characters (numbers 66–113), beginning with the Mishler & Churchill (1984, 1985) characters (modified). Of these 113 characters, only two (7 and 50) were treated as ordered. Two charophytes were included as outgroups. The data matrix is shown in Table 4.

(3) A large-scale molecular data set (GP-MOLEC) represents a realignment of published nuclear rDNA sequences from selected taxa across the green plants. Full small subunit (18S) sequences were taken from Rausch et al. (1989), Huss & Sogin (1990), Lewis et al. (1992), Wilcox et al. (1992), and others. Partial 18S and large subunit (26S) sequences were taken from Buchheim et al. (1990), Kantz et al. (1990), Zechman et al. (1990), and Chapman & Buchheim (1991). OTUs and sources of data are shown in Table 5. All intron sequences were excluded. Those taxa that seemed repetitive at this phylogenetic level (i.e., multiple, very similar species from the same genus) were deleted, and the alignment was adjusted by eye to take into account this full set of taxa. The data matrix had 61 OTUs, including *Emiliana* and *Anemonia* as outgroups, and 2179 characters (of these, 1833 are from 18S and 346 are from 26S). Only 37 of the OTUs had 26S data available; the remainder were coded with all question marks for this region. A number of OTUs have considerable missing data between primer regions; such positions were coded with a question mark. To be conservative, gaps were also coded as missing data. For the 18S data, 17 regions (totaling 206 positions) were excluded from analysis because they could not be aligned unequivocally. The data set is too large to publish, but an aligned and annotated PAUP file is available from the authors on request.

(4) A smaller "land plant only" molecular data set (LP-MOLEC) was excerpted from the larger set above (GP-MOLEC); the 16 OTUs (including



TABLE 1. List of characters and character states used for data matrix GP-MORPH. See text for source of these characters and Table 2 for the data matrix.

1. Habitat of free-living vegetative stage: 0, freshwater; 1, brackish or marine; 2, terrestrial.
2. Life history: 0, haplontic; 1, diplontic; 2, isomorphic alternation; 3, heteromorphic alternation.
3. Vegetative cell or thallus attached to substrate: 0, no; 1, yes.
4. Radial symmetry, if multicellular: 0, no; 1, yes.
5. Growth form: 0, unicellular or coccoid; 1, multicellular; 2, coenobitic.
6. Vegetative cells contiguous in multicellular organism: 0, no; 1, yes.
7. Multinucleate vegetative cells: 0, no; 1, yes.
8. Coenocytic: 0, no; 1, yes.
9. Distromatic foliar thalli: 0, absent; 1, present.
10. Plasmodesmata: 0, absent; 1, present.
11. Parenchyma: 0, absent; 1, present.
12. Vegetative cells form filaments: 0, no; 1, yes, unbranched; 2, yes, branched; 3, yes, multi-axial.
13. Filaments with acuminate tips: 0, no; 1, yes.
14. Vegetative cells or zoospores spindle-shaped: 0, no; 1, yes.
15. Zoospores: 0, absent; 1, present; 2, present, flattened.
16. Autospores/colonies: 0, no; 1, yes.
17. Vegetative cell with flagella: 0, no; 1, yes.
18. Gamete production: 0, holocarpic; 1, heterocarpic.
19. Multiple sporulation/fission: 0, no; 1, yes.
20. Type of sex: 0, isogamy; 1, anisogamy; 2, oogamy.
21. Chloroplast shape: 0, cup; 1, reticulated; 2, lateral cup; 3, H-shaped; 4, bi-polar; 5, sets of complete rings; 6, incomplete rings; 7, multiple disks; 8, spiral; 9, stellate; 10, plate; 11, axile.
22. Pyrenoids: 0, absent; 1, present.
23. Thylakoid membranes traverse pyrenoid: 0, no; 1, yes.
24. Number of flagella on vegetative cells or zoospores: 0, 2; 1, 4; 2, 1; 3, 4+; 4, 0.
25. Retraction of flagella during division: 0, no; 1, yes.
26. Angle of basal bodies relative to direction of motion: 0, angled; 1, perpendicular; 2, parallel.
27. Flagellar beat: 0, trailing-undulating; 1, breast stroke.
28. Basal bodies distant via migration in development: 0, no; 1, yes.
29. Flagella extend to right on motile cells: 0, no; 1, yes.
30. Flagellar apparatus displaying 180 degree rotational symmetry: 0, no; 1, yes.
31. Absolute orientation: 0, counterclockwise; 1, clockwise; 2, direct opposite.
32. Basal body overlap in motile cells: 0, absent; 1, present.
33. Basal body core connection: 0, absent; 1, present.
34. Mitotic spindle type: 0, metacentric; 1, centric.
35. Mitotic spindle closed: 0, absent; 1, present.
36. Spindle collapsing at telophase: 0, absent; 1, present.
37. Cupping microtubules surround centrioles during mitosis: 0, no; 1, yes.
38. Microtubules forming in plane of cell division: 0, absent; 1, present.
39. Phragmoplast: 0, no; 1, yes.
40. Cell plate in cytokinesis: 0, no; 1, yes.
41. Centrioles between nucleus and plane of cleavage: 0, no; 1, yes.
42. Lactate fermentation: 0, absent; 1, present.
43. Chaetophoralean autolysin lyses sporangium: 0, no; 1, yes.
44. Hydrogenase produced by vegetative cells: 0, no; 1, yes.
45. Secondary carotenoids: 0, no; 1, yes.
46. Siphonoxanthin: 0, absent; 1, present.
47. Gelatin liquifaction: 0, no; 1, yes.
48. Photosystem II light harvesting complex: 0, low molecular weight; 1, high molecular weight.
49. Dormant zygote produced: 0, no; 1, yes.
50. Sporulation: 0, absent; 1, present.
51. Zellteilung [vs. sporulation]: 0, no; 1, yes.
52. Common matrix surrounds cells: 0, no; 1, yes.
53. Papillae on vegetative cells: 0, no; 1, yes.
54. Crystalline cell wall: 0, no; 1, yes.
55. Stigma: 0, no; 1, yes.
56. Number of contractile vacuoles: 0, 2; 1, 2+; 2, 1; 3, absent.
57. Apical insertion of flagella: 0, no; 1, yes.
58. Zoosporangia abscise: 0, no; 1, yes.
59. Zoosporangia operculate: 0, no; 1, yes.
60. Zoosporangial exit plug: 0, no; 1, yes.
61. Keeled flagella: 0, no; 1, yes.
62. Urea amidolyase produced: 0, no; 1, yes.



TABLE 1. Continued.

63. Terminal cap: 0, absent; 1, bilobed; 2, platelike.
64. Prominent proximal sheath: 0, no; 1, yes.
65. Organic scales/covering: 0, no; 1, yes.
66. Transverse septum: 0, absent; 1, present.
67. Proximal septum: 0, absent; 1, present.
68. SMAC or system 1 fiber: 0, absent; 1, present.
69. Diaphysis: 0, absent; 1, present.
70. Distal fiber in motile cell: 0, absent; 1, present.
71. Specialized zoosporangia: 0, absent; 1, present.
72. MLS present: 0, no; 1, yes.
73. Glycollate oxidase: 0, no; 1, yes.
74. Oogonium associated with sterile cells: 0, no; 1, yes.
75. Eggs retained in oogonium: 0, no; 1, yes.
76. Apical cell growth: 0, no; 1, yes.
77. Flavonoids: 0, no; 1, yes.
78. Zygote retained: 0, no; 1, yes.
79. Placental transfer cells: 0, no; 1, yes.
80. True antheridia: 0, no; 1, yes.
81. Archegonia: 0, no; 1, yes.
82. Embryo: 0, no; 1, yes.
83. Cuticle: 0, no; 1, yes.
84. Monoterpenes: 0, no; 1, yes.
85. Lunularic acid: 0, no; 1, yes.
86. Elaters: 0, no; 1, yes.
87. Oil bodies: 0, no; 1, yes.
88. D-Methionine distinguished: 0, no; 1, yes.
89. Stomata: 0, no; 1, yes.
90. Vertical division of zygote: 0, no; 1, yes.
91. Pseudoelaters: 0, no; 1, yes.
92. Xylem: 0, no; 1, yes.
93. Phloem: 0, no; 1, yes.
94. Perine on spores: 0, no; 1, yes.
95. Aerial sporophyte axis: 0, no; 1, yes.
96. Columella in sporangium: 0, no; 1, yes.
97. Multicellular rhizoids: 0, no; 1, yes.
98. Leaves on gametophyte (of moss type): 0, no; 1, yes.
99. Articulated peristome: 0, no; 1, yes.
100. Independent sporophyte: 0, no; 1, yes.
101. Branched sporophyte: 0, no; 1, yes.
102. Ornamented tracheid walls: 0, no; 1, yes.
103. True lignin: 0, no; 1, yes.
104. Megaphylls: 0, no; 1, yes.
105. Trichomes: 0, no; 1, yes.
106. Vascular cambium: 0, no; 1, yes.
107. Eustele: 0, no; 1, yes.
108. Seeds: 0, no; 1, yes.
109. Axillary branching: 0, no; 1, yes.
110. Flowers: 0, no; 1, yes.

two charophyte outgroups) used are marked in Table 5. The alignment was adjusted based on the land plant sequences alone. This was done because the phylogenetic resolution was poor with the larger GP-MOLEC data set in this part of the green plants. An aligned and annotated PAUP file is available from the authors on request.

(5) A combined data set (GP-COMB) was produced by combining GP-MOLEC and GP-MORPH. This data set omitted the outgroups *Emiliana* and *Anemonia* from GP-MOLEC and the hypothetical

ancestor from GP-MORPH, but otherwise used the full combined data as described separately above for 59 OTUs. No weighting was done.

(6) A smaller combined data set (LP-COMB) that focused on the land plants was produced by combining morphological data from LP-MORPH with sequence data from GP-MOLEC. These data sets are unfortunately severely nonoverlapping; only nine taxa have data in both sets when "composite" OTUs are constructed pairing presumably related, but not identical, taxa. The composition of the nine



TABLE 2. Data matrix GP-MORPH. See Table 1 for list of characters and states, and Table 5 for list of taxa.

	1	2	3	4	5	6	7	8	9	1	1
	0	0	0	0	0	0	0	0	0	0	0
<i>Glycine max</i>	2310110001	1000000102	70??0????0	??01000011	0????0??10	100??30000	0?000??000	0?1111111?	?11?000110	0111100001	1111111111
<i>Oryza sativa</i>	2310110001	1000000102	70??0????0	??01000011	0????0??10	100??30000	0?000??000	0?1111111?	?11?000110	0111100001	1111111111
<i>Zamia floridana</i>	2310110001	1000000102	70??0????0	??01000011	0????0??10	100?030000	0?00000000	0111111111	111?000110	0111100001	1111111100
<i>Psilotum sp.</i>	2310110001	1000000102	70??0????0	??01000011	0????0??10	100??30000	0?000??000	0111111111	111?000110	0111100001	1111000000
<i>Equisetum hymale</i>	2310110001	1000000102	70??0????0	??01000011	0????0??10	100?030000	0?00000000	0111111111	111?000110	0111100001	1110000000
<i>Atrichum angustatum</i>	2310110001	1000000102	70??0?0?10	??01000011	0????0??10	1000?30000	0?00000000	0111110111	111?000110	0111111100	0000000000
<i>Fissidens taxifolius</i>	2310110001	1000000102	70??000?10	?101000011	0????0??10	1000030000	0?00000000	0111111111	1110000110	0111111110	0000000000
<i>Plagiomnium cuspidatum</i>	2310110001	1000000102	70??000?10	?101000011	0????0??10	1000030000	0?00000000	0111111111	1110000110	0111111110	0000000000
<i>Notothylas breutellii</i>	2310110001	1000000102	71??000?10	?101000011	0????0??10	1000030000	0?00000000	0111110111	1110000111	1000010000	0000000000
<i>Phaeoceros laevis</i>	2310110001	1000000102	71??000?10	?101000011	0????0??10	1000030000	0?00000000	0111110111	1110000111	1000010000	0000000000
<i>Porella pinnata</i>	2310110001	1000000102	70??000?10	?101000011	0????0??10	1000030000	0?00000000	0111111111	1111111000	0000000000	0000000000
<i>Conocephalum conicum</i>	2310110001	1000000102	70??000?10	?101000011	0????0??10	1000030000	0?00000000	0111111111	1111111000	0000000000	0000000000
<i>Asterella tenella</i>	2310110001	1000000102	70??000?10	?101000011	0????0??10	1000030000	0?00000000	0111111111	1111111000	0000000000	0000000000
<i>Riccia austinii</i>	2310110001	1000000102	70??00??10	?101000011	0????0??10	1000030000	0?00000000	0111111111	1111111000	0000000000	0000000000
<i>Coleochaete nitellarum</i>	0010110001	1100100102	1100000010	0101000011	0????0??11	10000?0000	0?00100000	0111100110	0000000?00	0000000000	0000000000
<i>Klebsormidium flaccidum</i>	00001?0001	0100100000	1100000010	0101000001	0????0??11	10000?00?0	0000000000	0?10000000	0000000?00	0000000000	0000000000
<i>Micromonas pusila</i>	1?00000000	0000101?0?	01021?000?	??01100000	?????0??1	0000030000	0?00011000	0?00000000	0000000000	0000000000	0000000000
<i>Mantoniella squamata</i>	1?00000000	0000101?0?	0102100000	0101100000	?????0?1?1	0000130000	0?00111000	0000000000	0000000000	0000000000	0000000000
<i>Nephroselmis pyriformis</i>	1?00000000	0000101?0?	0100101001	?101100000	?????0??1	0000021000	0?00110100	0000000000	0000000000	0000000000	0000000000
<i>Pedinomonas minutissima</i>	1?00000000	0000101?0?	01021?0?01	??01100000	?????0??1	0000120000	0?00000100	0000000000	0000000000	0000000000	0000000000
<i>Tetraselmis carteriiformis</i>	1?00000000	0000101?0?	0101121101	0000111100	0????0??1	0000101000	0000010000	0000000000	0000000000	0000000000	0000000000
<i>Enteromorpha intestinalis</i>	1210110010	0000100011	6101011001	0101100000	0????0?001	1010??1000	0011010101	00?0000000	0000000000	0000000000	0000000000
<i>Ulva fasciata</i>	1210110010	0000100011	6101011001	0101100000	0??1?0?001	1010??1000	0011010101	00?0000000	0000000000	0000000000	0000000000
<i>Ulothrix zonata</i>	0310110000	0100100010	6101011001	0101100000	0?0??0?001	1010101000	0?01110101	0000000000	0000000000	0000000000	0000000000



TABLE 2. Continued.

	1	2	3	4	5	6	7	8	9	1	1
	0	0	0	0	0	0	0	0	0	0	0
<i>Cymopolia barbata</i>	1111111100	0300000111	710?0?10?1	??01100000	0??????01	0000?31010	0?000??01?	0000000000	0000000000	0000000000	0000000000
<i>Batophora oerstedtii</i>	111111000?	0200100110	71??0110?1	0101100000	0??????01	0000131010	0?0?000111	0000000000	0000000000	0000000000	0000000000
<i>Codium decorticatum</i>	1110111100	0300000111	7104011001	0101100000	0?????1?101	0000?31000	0?000??0?	0000000000	0000000000	0000000000	0000000000
<i>Cladophoropsis membranosa</i>	1210111000	0200100110	?101011001	??01100000	0?????0?001	1000??1001	0?0?0??0?	0000000000	0000000000	0000000000	0000000000
<i>Blastophysa rhizopus</i>	1210111001	0200100110	?101011001	0101100000	0?????1?101	1000?310?1	0?00000?01	?000000000	0000000000	0000000000	0000000000
<i>Trentepohlia sp.</i>	2210110001	0200100110	10?1011001	01011000?0	?????0??01	10000?1100	1?0??000?	11?0010000	0000000000	0000000000	0000000000
<i>Cephaleuros parasiticus</i>	2210110001	0200100110	10?1011001	01011000?0	?????0??01	10000?1100	1?0??0000?	11?0010000	0000000000	0000000000	0000000000
<i>Characium vacuolatum</i>	0010000000	0001100010	?1100?1001	1001110100	?????0??01	0001??1000	0?00010?01	00?0000000	0000000000	0000000000	0000000000
<i>Dunaliella parva</i>	1000000000	0000101000	01101?1?01	100?????00	?????0??01	0000?31000	0?000??01	0000000000	0000000000	0000000000	0000000000
<i>Chlamydomonas reinhardtii</i>	0000000000	0000101010	0110001001	1001110100	1??1?0?011	0001101000	0100010101	0000000000	0000000000	0000000000	0000000000
<i>Volvox carteri</i>	0000200000	0000011112	?1?0??0?101	1001110?00	?????0??01	0101??1000	0?000??01	00?0000000	0000000000	0000000000	0000000000
<i>Chlorococcopsis min</i>	0000000000	0000100010	?1100?1001	1001110100	?????0??01	0001??1000	0?00010001	00?0000000	0000000000	0000000000	0000000000
<i>Draparnaldia plumosa</i>	0010110001	0210100010	6101011001	1001110101	0?1??0??11	1010101000	0100010101	00?0000000	0000000000	0000000000	0000000000
<i>Uronema belkae</i>	0010110001	0110100010	6101011001	1001110101	0?1??0??11	1010101000	0?00010101	00?0000000	0000000000	0000000000	0000000000
<i>Chlamydomonas moewusii</i>	0000000000	0000101010	01?0001?01	100?????00	?????0??11	0011101000	0?000??01	00?0000000	0000000000	0000000000	0000000000
<i>Stephanosphaera pluvialis</i>	0000200000	0000011010	2110101101	1001110100	?????0??11	0111111000	0?000??101	00?0000000	0000000000	0000000000	0000000000
<i>Carteria radiosa</i>	0000000000	0000101010	0111001001	100?????00	?????0??11	0011101000	0?00010?01	00?0000000	0000000000	0000000000	0000000000
<i>Gonium pectorale</i>	0000200000	0000011010	0110?21101	1001110100	?????0??11	0101101000	0?00010101	00?0000000	0000000000	0000000000	0000000000
<i>Chlorella kessleri</i>	0000000000	0000010?1?	?1??0?????	??????0100	?0?1000??1	000??3?000	????0??0?	0?00000000	0000000000	0000000000	0000000000
<i>Chlorella vulgaris</i>	0000000000	0000010?1?	01??0?????	??????0100	?1?0000??1	000??3?000	?1??0??0?	0?00000000	0000000000	0000000000	0000000000
<i>Prototheca wickerhamii</i>	0000000000	0000010?1?	?1??0?????	??????0100	?????0??01	000??3?000	????0??0?	0?00000000	0000000000	0000000000	0000000000
<i>Chlorella protothecoides</i>	0000000000	0000010?1?	?1??0?????	??????0100	?1?0000??1	000??3?000	????0??0?	0?00000000	0000000000	0000000000	0000000000
<i>Chlorella minutissima</i>	0000000000	0000010?1?	?1??0?????	??????0100	?0?0000??1	000??3?000	????0??0?	0?00000000	0000000000	0000000000	0000000000
<i>Neochloris aquaticus</i>	0000001000	0000100010	?1000?1001	2011110100	?????0??01	0000??1000	0?00010101	00?0000000	0000000000	0000000000	0000000000



TABLE 2. Continued.

	1	2	3	4	5	6	7	8	9	1	1
	0	0	0	0	0	0	0	0	0	0	0
<i>Neochloris vigenis</i>	0000001000	0000100010	?1000??001	2011110100	?????0??01	0000??1000	0?00010?01	00?0000000	0000000000	0000000000	0000000000
<i>Pediastrum duplex</i>	0000210000	0000100010	?1?0011001	2011110100	1????0??11	00001?1000	0?01010101	00?0000000	0000000000	0000000000	0000000000
<i>Scenedesmus obliquus</i>	0000210000	0000010010	?1?40???0?	???1110100	???1101??1	0000???000	01000???0?	0000000000	0000000000	0000000000	0000000000
<i>Characium hindakii</i>	0010001000	0001100010	?1000?1001	20?1110100	?????0??01	0000??1000	0?00010?01	00?0000000	0000000000	0000000000	0000000000
<i>Chlorella fusca</i>	0000000000	0000010?1?	01??0?????	???????0100	?1?1101??1	000??3?000	????0???0?	0??0000000	0000000000	0000000000	0000000000
<i>Ankistrodesmus falcatus</i>	0000000000	0001010?1?	?1??0?????	???????0100	?????0???1	000??3?000	????0???0?	0??0000000	0000000000	0000000000	0000000000
<i>Pseudotrebouxia gigantea</i>	0000000000	0000200?0?	?1000?1001	0?00111100	0????0???1	0000?31000	0?00010001	00?0000000	0000000000	0000000000	0000000000
<i>Pleurastrum terrestre</i>	0000110000	0100200?0?	?1000?1001	0?00111100	0????0???1	0000?31000	0?00010001	00?0000000	0000000000	0000000000	0000000000
<i>Characium perforatum</i>	0010000000	0001100010	?1100?1001	010?11?000	?????0??01	0000??1000	0?00010?01	00?0000000	0000000000	0000000000	0000000000
<i>Parietochloris pseudo</i>	0000000000	0000100010	?1100?1001	010?11?000	?????0??01	0000??1000	0?20010001	00?0000000	0000000000	0000000000	0000000000
<i>Friedmannia israelensis</i>	<sup>0</sup> / <sub>2</sub> 00000000	000020000?	?100011001	0100111100	0????0???1	0000?31000	0?00010001	0000000000	0000000000	0000000000	0000000000
Hypothetical ancestor	1000000000	0000101010	?000000000	?100000000	0????0?001	0000030000	0000000000	0100000000	0000000000	0000000000	0000000000



OTUs (including *Coleochaete* as outgroup) in this data set is shown in Table 6.

#### ANALYSES

A number of parsimony analyses were carried out to examine the phylogenetic implications of these data sets alone and in combination. Data sets were compiled and phylogenetic trees examined using MacCLADE, version 3.01 (Maddison & Maddison, 1992). All analyses were carried out using PAUP, version 3.1 (Swofford, 1991) on an Apple Macintosh Quadra 700 with 20 megabytes of RAM. With the larger data sets, heuristic search algorithms were necessary, thus finding of all the maximum-parsimony (MP) trees cannot be guaranteed.

The analyses are presented in eight groups below, using standard numbers that are used for reference in the Results and the Discussion. The PAUP commands (Swofford, 1991) employed in each search are shown. "Decay analysis" performed in some cases refers to the saving of trees longer than the MP tree(s) by the specified number of steps (Bremer, 1988; Graham et al., 1991; Mishler et al., 1991; Donoghue et al., 1992; Källersjö et al., 1992)—the "decay index" is the number of steps parsimony must be relaxed to cause a particular clade to lose its support. For example, a decay index of 2 for a clade means that it is *present* in the semi-strict consensus (Bremer, 1990) of the MP trees plus those that are one step longer (called decay class "1"), but *absent* in the semi-strict consensus of the MP trees plus those that are one or two steps longer (called decay class "2").

#### Analysis 1. Land plant morphological data alone (LP-MORPH):

1a. All characters; 100 repetitions of RANDOM taxon addition, TBR branch swapping with MULPARS and STEEPEST DESCENT option; decay analysis to 3 steps.

1b. Sperm data alone (i.e., characters 1–65); 100 repetitions of RANDOM taxon addition, TBR branch swapping with MULPARS and STEEPEST DESCENT option; decay analysis to 3 steps. CONSTRAINT analyses were also done (using the same PAUP options), to find the shortest topologies consistent with [mosses + tracheophytes] and [hornworts + mosses + tracheophytes] as monophyletic groups.

1c. General morphological data alone (i.e., characters 66–113); 100 repetitions of RANDOM

taxon addition, TBR branch swapping with MULPARS and STEEPEST DESCENT option; decay analysis to 3 steps. CONSTRAINT analyses were also done (using the same PAUP options), to find the shortest topologies consistent with monophyly of the bryophytes.

1d. Sperm data alone from the nine OTUs selected as part of LP-COMB; branch-and-bound search.

1e. General morphological data alone from the nine OTUs selected as part of LP-COMB; branch-and-bound search.

1f. All characters from the nine OTUs selected as part of LP-COMB; branch-and-bound search.

Analysis 2. Green plant morphological data alone (GP-MORPH). CLOSEST taxon addition, TBR branch swapping with MULPARS and STEEPEST DESCENT option.

Analysis 3. Green plant molecular data alone (GP-MOLEC). 18S and 26S data combined:

3a. All OTUs except two outgroups (59 OTUs); CLOSEST taxon addition, NNI branch swapping with MULPARS, followed by TBR branch swapping with MULPARS on the shortest trees found by NNI swapping.

3b. Land plants alone plus two charophyte outgroups (16 OTUs); 10 repetitions of RANDOM taxon addition, TBR branch swapping with MULPARS.

3c. The nine land plant OTUs selected as part of LP-COMB; branch-and-bound search.

3d. Green algae minus charophytes, land plants, *Emiliana*, and *Anemonia* (43 OTUs); CLOSEST taxon addition, NNI branch swapping with MULPARS, followed by TBR branch swapping with MULPARS and STEEPEST DESCENT on the shortest trees found by NNI swapping.

Analysis 4. Green plant molecular data (GP-MOLEC). 18S data alone:

4a. All OTUs including the two outgroups, *Emiliana* and *Anemonia* (61 OTUs); 10 repetitions of RANDOM taxon addition, NNI branch swapping with MULPARS, followed by TBR branch swapping with MULPARS on the shortest trees found by NNI swapping; decay analysis to 2 steps.

4b. Land plants only plus *Coleochaete* as out-



TABLE 3. List of characters and character states used for data matrix LP-MORPH. See text for source of these characters and Table 4 for the data matrix. All characters are considered unordered, except as noted.

1. Apical cell in antheridia: 0, absent; 1, present.
2. Division pattern in young antheridia: 0, four-celled; 1, two-celled.
3. Endogenous antheridia: 0, absent; 1, present.
4. Antheridial stalk: 0, absent; 1, present.
5. Operculum cells: 0, absent; 1, present.
6. Sperm in pollen tube: 0, absent; 1, present.
7. Number of sperm per male structure (ordered character): 0, 1000+; 1, 100-1000; 2, 16-24; 3, 2.
8. Nascent spermatids: 0, paired; 1, not paired.
9. Diagonal spindle in final mitotic division: 0, absent; 1, present.
10. Replication of the centrioles: 0, present; 1, absent.
11. Time of origin of centrioles: 0, always present; 1, sperm mother cells; 2, sperm mother cell progenitor; 3, earlier.
12. Basal bodies (BB) and flagella: 0, two; 1, more than two.
13. Bicentrioles: 0, present; 1, absent.
14. Basal body position: 0, right angles; 1, side-by-side; 2, staggered anterior-posterior; 3, staggered continuous.
15. Proximal extension A: 0, absent; 1, long; 2, short.
16. Proximal extension B: 0, ventral-dorsal; 1, ventral.
17. Stellate transition: 0, present; 1, absent.
18. Connecting fibers between BBs: 0, present; 1, absent; 2, fine filaments with centrin.
19. Basal body structure: 0, monomorphic; 1, dimorphic.
20. BB staggering associated with microtubule growth: 0, absent; 1, present.
21. Regression of lamellar strip: 0, absent; 1, complete; 2, partial.
22. Lamellar strip/anterior mitochondrion elongation: 0, parallel; 1, perpendicular.
23. Spline aperture: 0, absent; 1, present.
24. Spline aperture location: 0, left of center; 1, right of center.
25. Position of developing MLS: 0, adjacent to BBs; 1, beneath BBs.
26. Plaque stratified between blepharoplast: 0, absent; 1, present.
27. Spline/lamellar strip orientation: 0, 90°; 1, 45°.
28. Posterior notch to lamellar strip: 0, absent; 1, present.
29. Lamellar strip position: 0, under all BBs; 1, under anterior BB only; 2, under some BBs.
30. Stray spline microtubule: 0, absent; 1, present; 2, develops late.
31. Accessory band of microtubules: 0, absent; 1, present.
32. Maturation elongation of anterior mitochondrion: 0, absent; 1, posterior.
33. Spline shank: 0, wide; 1, less than 4 tubules.
34. Osmiophilic crest: 0, absent; 1, present.
35. Anterior osmiophilic ridge: 0, absent; 1, present.
36. Changes in BBs at maturity: 0, absent; 1, dense material at tip; 2, BB cartwheel with plug; 3, BB triplets impregnated with matrix.
37. Matrix around BBs: 0, homogenous; 1, mottled.
38. Posterior of the stellate pattern: 0, extracellular or partly; 1, entirely intracellular.
39. Flagellar scales: 0, present; 1, absent.
40. Late blepharoplast with transient core: 0, yes; 1, no.
41. Direction of flagellar emergence: 0, toward side; 1, toward rear; 2, toward anterior.
42. Nuclear shape at maturity: 0, ovoid; 1, elongate.
43. Nuclear posterior shape: 0, not expanded; 1, expanded.
44. Median constriction: 0, absent; 1, present.
45. Spline attached to nucleus: 0, yes; 1, detached at maturity; 2, never attached.
46. Spline growth associated with nuclear shaping: 0, absent; 1, present.
47. Direction of nuclear compaction: 0, outer shell; 1, anterior to posterior; 2, at equal rates along nucleus; 3, general increase in density.
48. Condensed chromatin strands: 0, spaghetti-like; 1, perpendicular to spline; 2, spiral-central strand; 3, general compaction; 4, spikes; 5, irregular plates; 6, solid mass from anterior tip.
49. Diverticulum during shaping: 0, absent; 1, present.
50. Number of gyres of nucleus (ordered character): 0, not coiled; 1, 0.5-3; 2, greater than 3.
51. Dense body in anterior mitochondrion: 0, absent; 1, present.
52. Mitochondrion associated with plastids in spermatogenous tissue: 0, absent; 1, present.
53. Mitochondrion associated with plastids in young spermatids: 0, absent; 1, present.
54. Specialized anterior mitochondrion: 0, present; 1, absent.
55. Specialized posterior mitochondrion: 0, present; 1, absent.
56. Additional mitochondrion in anterior of cell: 0, absent; 1, row of mitochondria behind anterior mitochondrion; 2, numerous unspecialized.
57. Origin of anterior mitochondrion: 0, fusion; 1, elongation.
58. Osmophilic material underneath anterior mitochondrion: 0, absent; 1, present.



TABLE 3. Continued.

---



---

59.	Change from cristae sacs to baffles: 0, absent; 1, present.
60.	Monoplastidic sperm: 0, present; 1, absent.
61.	Plastid determines division polarity: 0, present—at poles; 1, present—asymmetrical; 2, absent.
62.	Starch grains in single plastid: 0, more than one; 1, one.
63.	Sperm plastid contacting nucleus: 0, absent; 1, present.
64.	Fibrillenscheide: 0, absent; 1, present.
65.	Cytoplasmic loss: 0, absent; 1, partial; 2, complete (or tiny remnant).
66.	Embryo: 0, absent; 1, present.
67.	Cuticle: 0, absent; 1, present.
68.	Lunularic acid: 0, absent; 1, present.
69.	Elaters: 0, absent; 1, present.
70.	Oil bodies: 0, absent; 1, present.
71.	D-Methionine: 0, not recognize; 1, recognize.
72.	Stomates: 0, absent; 1, present.
73.	Vertical division of zygote: 0, absent; 1, present.
74.	Xylem: 0, absent; 1, present.
75.	Phloem: 0, absent; 1, present.
76.	Perine layer on spores: 0, absent; 1, present.
77.	Aerial sporophyte axis of moss/tracheophyte type: 0, absent; 1, present.
78.	Columella: 0, absent; 1, present.
79.	Multicellular rhizoids: 0, absent; 1, present.
80.	Leaves on gametophyte (of moss type): 0, absent; 1, present.
81.	Independent sporophyte: 0, absent; 1, present.
82.	Branched sporophyte with multiple sporangia: 0, absent; 1, present.
83.	Tracheids: 0, absent; 1, present.
84.	Lignin: 0, absent; 1, present.
85.	Long exerted seta of the liverwort type: 0, absent; 1, present.
86.	Oil body cells: 0, absent; 1, present.
87.	Spore mother cells lobed: 0, absent; 1, present.
88.	Capsule 2-4 valved on a regular basis: 0, absent; 1, present.
89.	Capsule wall cells with transverse thickenings: 0, absent; 1, present.
90.	Thick capsule wall: 0, absent; 1, present.
91.	Elongate antheridia: 0, absent; 1, present.
92.	Aerial calyptra: 0, absent; 1, present.
93.	Paraphyses: 0, absent; 1, present.
94.	Costate leaves: 0, absent; 1, present.
95.	Peristome: 0, absent; 1, present.
96.	Operculum: 0, absent; 1, present.
97.	Cylindrical sporogenous layer: 0, absent; 1, present.
98.	Transfer cells on gametophyte side: 0, absent; 1, present.
99.	Transfer cells on sporophyte side: 0, absent; 1, present.
100.	Seed: 0, absent; 1, present.
101.	Megaphyll: 0, absent; 1, present.
102.	Microphyll: 0, absent; 1, present.
103.	Lateral, broad sporangia: 0, absent; 1, present.
104.	Exarch maturation of xylem: 0, absent; 1, present.
105.	Chloroplast DNA inversion: 0, absent; 1, present.
106.	Sporangia borne on leaves: 0, absent; 1, present.
107.	Trichomes: 0, absent; 1, present.
108.	Flavonoids: 0, absent; 1, present.
109.	Retention of zygote: 0, absent; 1, present.
110.	Sheathed hairs: 0, absent; 1, present.
111.	Polyphenolics induced by sex: 0, absent; 1, present.
112.	Parenchyma: 0, absent; 1, present.
113.	Beaked mucilage papillae: 0, absent; 1, present.

---

group (15 OTUs); 10 repetitions of RANDOM taxon addition, TBR branch swapping with MULTIPARS and STEEPEST DESCENT option.

4c. Land plants only plus *Coleochaete* and *Klebsormidium* as outgroups (16 OTUs); CLOS-

EST taxon addition, TBR branch swapping with MULTIPARS and STEEPEST DESCENT option.

4d. Land plants only plus *Coleochaete* and *Klebsormidium*; *Pedinomonas* as outgroup (17 OTUs); CLOSEST taxon addition, TBR branch



TABLE 4. Data matrix LP-MORPH. See Table 3 for list of characters and states. Characters 1-65 are from sperm ultrastructure; 66-113 are from general morphology. The asterisk (\*) for character 65, *Lycopodium*, represents a polymorphism between states 1 and 2 (Renzaglia, unpublished); the asterisk for character 86, *Sphaerocarpos*, represents a polymorphism between states 0 and 1 within the order Sphaerocarpaceae (*Riella* has differentiated cells).

	sperm characters:						general morphology:				1	1	
	1 0	2 0	3 0	4 0	5 0	6 0	7 0	8 0	9 0	0 0	1 0		
CHARA	?????0??00	30?00?020?	?0?00?0000?	1100000001	0??1?1?011	20102	00000	0000000000	0000000000	?000000000	0000?00100	000	
NITELLA	?????0??00	30?00?020?	?0?000?00?	1100000001	0001??0?01	20102	00000	0000000000	0000000000	?000000000	0000?00100	000	
COLEOC PUL	?????0??00	00?00?0?0?	000?000?00?	000000000?	00?00??000	0000?1?000	00?01	00000	0000000000	0000000000	?000000000	0000?00011	100
COLEOC ORB	?????0??10	00?00?0?0?	000?000?00?	000000000?	00?00??000	0000?1?000	00?01	00000	0000000000	0000000000	?000000100	0000?00011	110
PHAEOCEROS	0011000001	101111100?	200?101000	010003001?	1101001101	1110000110	11102	11000	1110000100	0000000000	0000000100	0000?00010	110
NOTOTHYLAS	0011000001	101111100?	200?101000	010003001?	1101001101	1110000110	11102	11000	1110000100	0000000000	0000000100	0000?00010	110
MARCHANTIA	0001000001	1012100111	2011101100	000003001?	1100001011	0010000010	10112	11111	0000000000	0000010000	0000000110	0000000110	110
SPHAEROCARPOS	0001000001	1012100111	2011101100	001003001?	1100001011	0010000010	10??2	11111	0000000000	00000*0000	0000000110	0000?00110	110
PELLIA	0101000001	1012100111	2011101000	000003001?	1100101011	0010000010	10112	11111	0000000000	0000101111	0000000000	0000?00110	110
BLASIA	0?01000001	1012100111	2011101100	000003001?	1100001011	0010000010	10112	11111	0000000000	0000101111	0000000110	0000?00110	110
JUNGERMANNIA	0101000001	1012100111	2011101000	000003001?	1100101011	0010000010	10112	11111	0000000002	0000101111	0000000010	0000?00110	110
HAPLOMITRIUM	0101000001	10121?0111	2010101000	?00?03001?	11000015?1	0010000010	?1??2	11111	0000000000	0000101100	0000000110	0000?00110	110
TREUBIA	0101000001	1012100111	?010101000	?00?03?01?	11?0001???	0??0000?00	?0??2	11111	0000000000	0000101111	0000000??0	0000?00110	110
SPHAGNUM	1101000111	1012101111	1011101012	010003001?	1100012201	0110000010	01002	11000	1100011111	0000000000	0100010000	0000?00010	110
ANDREAEA	1101100111	101210?111	2011101010	010003001?	1100012201	0110000010	00002	11000	1001011111	0000000000	1111000010	0000?00010	111
POLYTRICHUM	1101100111	1012100111	2011101011	011003001?	1100012201	0110000010	00002	11000	1101111111	0000000000	1111111010	0000?00010	110
HYPNUM	1101100111	1012100111	2011101011	010003001?	1100012211	0110000010	00002	11000	1101111111	0000000000	1111111110	0000000110	110
TAKAKIA	1101100111	1012100111	?01110101?	?10?03?01?	1100?????1	0?10000?10	00??2	11000	1001?011?1	0000000000	110?000010	0000?00110	111
LYCOPODIELLA	0?00001?11	10140?020?	010?101000	0?0?00101?	10?000??00	001010?000	?0001	11000	1101111000	1111000000	0000000110	0111000110	110
LYCOPODIUM	0?00001011	101221020?	010?101000	010000101?	10000?3310	000010?010	0010*	11000	1101111000	1111000000	0000000110	0111000110	110
SELAGINELLA	0??0?01??1	10?2210?0?	200?101000	010000101?	110000?401	001000?010	?0002	11000	1101111000	1111000000	0000000??0	0111000110	110
EQUISETUM	0?00001111	11030?0100	010?111020	1001100011	1110003301	0000111001	2?001	11000	1101111000	1111000000	0000000??0	0?00110110	110
PTERIDIUM	0?00002111	2103210?00	010?111020	100112?011	1110003302	0000111001	2?001	11000	1111111000	1111000000	0000000110	1000111110	110
MARSILEA	0??0?02111	21030?0100	010?111020	0000020011	1100001602	0000101001	2?001	11000	1111111000	1111000000	0000000??0	1000?11110	110
OSMUNDA	0?00002111	2103210?00	010?111020	1001110011	1110003301	0000111001	2?001	11000	1111111000	1111000000	0000000110	1000111110	110
GINKGO	?????13?11	?1030?0100	010?1?1020	0001100110	20?02??00	000112?001	2?000	11000	11011?1000	1111000000	0000000??1	1000111110	110
EMMIA	?????13?11	?1030?0100	010?1?1020	0001100110	20?02??00	000112?001	2?000	11000	11011?1000	1111000000	0000000??1	1000111110	110



swapping with MULPARS and STEEPEST DESCENT option.

4e. The nine land plant OTUs selected as part of LP-COMB; branch-and-bound search.

Analysis 5. Green plant molecular data (GP-MOLEC). 26S data alone.

5a. All OTUs that have 26S data; *Pedionomonas* as outgroup (37 OTUs); 10 repetitions of RANDOM taxon addition, TBR branch swapping with MULPARS and STEEPEST DESCENT option.

5b. Land plants that have 26S data; no outgroups (11 OTUs); CLOSEST taxon addition, TBR branch swapping with MULPARS.

5c. The seven land plant OTUs selected as part of LP-COMB that have 26S data; branch-and-bound search.

Analysis 6. Land plant molecular data alone (LP-MOLEC). Each with 10 repetitions of RANDOM taxon addition, TBR branch swapping with MULPARS and STEEPEST DESCENT option:

6a. All data; *Coleochaete* and *Klebsormidium* as outgroups (16 OTUs).

6b. All data; *Coleochaete* only as outgroup (15 OTUs).

6c. All data; *Klebsormidium* only as outgroup (15 OTUs).

6d. All data; no outgroups (14 OTUs).

6e. 18S data only; no outgroups (14 OTUs).

6f. 26S data only; no outgroups (11 OTUs).

Analysis 7. Land plant combined data (LP-COMB). Each a branch-and-bound search:

7a. All data.

7b. General morphological data plus all molecular data.

7c. All morphological data plus 18S molecular data.

7d. All morphological data plus 26S molecular data.

7e. General morphological data plus 18S molecular data; decay analysis to 2 steps.

7f. General morphological data plus 26S molecular data; decay analysis to 5 steps.

Analysis 8. Green plant combined data (GP-COMB). CLOSEST taxon addition, NNI branch swapping with MULPARS, followed by TBR branch swapping with MULPARS on the shortest trees found by NNI swapping; decay analysis to 3 steps.

## RESULTS

*Analysis 1a.* Only one tree island was found, of 9 MP trees at 208 steps (CI = 0.678; RI = 0.877). The strict consensus tree is shown in Figure 1, along with the decay index for each informative branch (obviously, here and in later figures, the terminal branches leading to OTUs cannot decay). Several traditional groups (seed plants, tracheophytes, mosses, hornworts, liverworts, land plants) were well supported by this data set, but note that the resolution among these major lineages was unresolved. Note also that the lycophytes were not supported as monophyletic.

*Analysis 1b.* Only one tree island was found, of 56 MP trees at 130 steps (CI = 0.708; RI = 0.882). The strict consensus tree is shown in Figure 2, along with the decay index for each informative branch. The decay analysis was completed at 1 step. However, not all trees at 2 and 3 steps less parsimonious could be saved with available RAM, thus decay classes "2," "3," and "4+" in Figure 2 are estimates. Note that relatively few clades were well supported by this data set, but a monophyletic bryophyte clade was moderately well supported. *Selaginella* was placed weakly with the bryophytes. CONSTRAINT analyses showed that MP topologies with a forced Mishler & Churchill (1984, 1985) resolution, i.e., [liverworts [hornworts [mosses + tracheophytes]]], were 133 steps long with this data set.

*Analysis 1c.* Only one tree island was found, of 8 MP trees at 67 steps (CI = 0.731; RI = 0.919). The strict consensus tree is shown in Figure 3, along with the decay index for each informative branch. The decay analysis was completed at 2 steps. However, not all trees at 3 steps less parsimonious could be saved with available RAM; thus decay classes "3" and "4+" in Figure 3 are estimates. The Mishler and Churchill topology was supported by this data set, but not strongly since trees one step longer have other *paraphyletic* arrangements of the three major bryophyte groups; note, however, that CONSTRAINT analyses showed that MP topologies with forced bryophyte *monophyly* were 70 steps long with this data set. Note that the tracheophytes were strongly supported as monophyletic, as were the lycophytes. Thus it is



TABLE 5. Taxa included in the data sets GP-MOLEC, GP-MORPH, and GP-COMB, with source for rDNA sequence data (GENBANK accession number given, if known). The taxa selected for the data set LP-MOLEC are marked with an asterisk.

<i>Emiliana huxleyi</i> (Lohm.) Hay & Mohler	Bhattacharya et al., 1992
<i>Anemonia sulcata</i> L.	Hendriks et al., 1990 (X53498)
* <i>Glycine max</i> (L.) Merr.	Eckenrode et al., 1985
* <i>Oryza sativa</i> L.	Takaiwa et al., 1984
* <i>Zamia floridana</i> L.	Arnold, unpublished
* <i>Psilotum</i> sp.	Zimmer et al., 1989
* <i>Equisetum hymale</i> L.	Hamby, unpublished
* <i>Atrichum angustatum</i> (Brid.) Bruch & Schimp.	Waters et al., 1992
* <i>Notothylas breutelii</i> Gott.	Waters et al., 1992
* <i>Phaeoceros laevis</i> (L.) Prosk.	Waters et al., 1992
* <i>Porella pinnata</i> L.	Buchheim & Chapman, 1992
* <i>Conocephalum conicum</i> (L.) Lindb.	Waters et al., 1992
* <i>Asterella tenella</i> (L.) P. Beauv.	Waters et al., 1992
* <i>Riccia austinii</i> Steph.	Waters et al., 1992
* <i>Klebsormidium flaccidum</i> (A. Br.) Silva, Mattox & Blackwell	Waters et al., 1992
* <i>Coleochaete nitellarum</i> Jost.	Waters et al., 1992
* <i>Fissidens taxifolius</i> Hedw.	Waters et al., 1992
* <i>Plagiomnium cuspidatum</i> (Hedw.) T. Kop.	Waters et al., 1992
<i>Micromonas pusilla</i> (Butcher) Manton & Parke	Kantz et al., 1990
<i>Mantoniella squamata</i> (Manton & Parke) Desikachary	Kantz et al., 1990
<i>Nephroselmis pyriformis</i> (Butcher) Rayns	Kantz et al., 1990
" <i>Pedinomonas minutissima</i> Skuja"	Kantz et al., 1990
<i>Tetraselmis carteriiformis</i> Butcher	Kantz et al., 1990
<i>Enteromorpha intestinalis</i> (L.) Link	Kantz et al., 1990
<i>Ulva fasciata</i> Delile	Zechman et al., 1990
<i>Ulothrix zonata</i> (Weber & Mohr) Kutz	Zechman et al., 1990
<i>Cymopolia barbata</i> (L.) Lamour.	Zechman et al., 1990
<i>Bathophora oerstedii</i> J. Ag.	Zechman et al., 1990
<i>Codium decorticatum</i> (Woodward) Howe	Zechman et al., 1990
<i>Cladophoropsis membranacea</i> (C. Ag.) Borg.	Zechman et al., 1990
<i>Blastophysa rhizopus</i> Reinke	Zechman et al., 1990
<i>Trentepohlia</i> sp.	Zechman et al., 1990
<i>Cephaleuros parasiticus</i> Karsten	Chapman, unpublished
<i>Characium vacuolatum</i> Lee & Bold	Lewis et al., 1992 (M63001)
<i>Dunaliella parva</i> Lerche	Lewis et al., 1992 (M62998)
<i>Chlamydomonas reinhardtii</i> Dangeard	Gunderson et al., 1987
<i>Volvox carteri</i> f. <i>nagariensis</i>	Rausch et al., 1989
<i>Chlorococcopsis minuta</i> (= <i>Ettlia minuta</i> (Arce & Bold) Komarek)	Lewis et al., 1992 (M62996)
<i>Draparnaldia plumosa</i> (Vauch.) Ag.	Buchheim & Chapman, 1992
<i>Uronema belkae</i> Mattox & Bold	Zechman et al., 1990
<i>Chlamydomonas moewusii</i> Gerloff	Buchheim et al., 1990
<i>Stephanosphaera pluvialis</i> Cohn	Buchheim & Chapman, 1991
<i>Carteria radiosa</i> Korschikoff	Buchheim & Chapman, 1992
<i>Gonium pectorale</i> Muller	Buchheim & Chapman, 1991
<i>Chlorella kessleri</i> Fott & Novakova	Huss & Sogin, 1990
<i>Chlorella vulgaris</i> Beij.	Huss & Sogin, 1990
<i>Prototheca wickerhamii</i> Soneda & Tubaki	Huss & Sogin, 1990
<i>Chlorella protothecoides</i> Krug.	Huss & Sogin, 1990
<i>Chlorella minutissima</i> Fott & Novakova	Huss & Sogin, 1990
<i>Neochloris aquatica</i> Starr	Lewis et al., 1992 (M62861)
<i>Neochloris vigenis</i> Archibald	Wilcox et al., 1992 (M74496)
<i>Pediastrum duplex</i> Meyen	Lewis et al., 1992 (M62997)
<i>Scenedesmus obliquus</i> (Turp.) Kutz	Huss & Sogin, 1990
<i>Characium hindakii</i> Lee & Bold	Lewis et al., 1992 (M63000)
<i>Chlorella fusca</i> var. <i>vacuolata</i> Shihira & Krauss	Huss & Sogin, 1990



TABLE 5. Continued.

<i>Ankistrodesmus stipitatus</i> (= <i>A. falcatus</i> var. <i>stipitatus</i> (Chodat) Lemm.)	Huss & Sogin, 1990
<i>Pseudotrebouxia gigantea</i> Hildreth & Ahmadj.	Kantz et al., 1990
<i>Pleurastrum terrestre</i> Fritsch & John	Kantz et al., 1990
<i>Characium perforatum</i> Lee & Bold	Lewis et al., 1992 (M62999)
<i>Parietochloris pseudoalveolaris</i> (Deason & Bold) Watanabe & Floyd	Lewis et al., 1992 (M63002)
<i>Friedmannia israelensis</i> Chantanachat & Bold	Lewis et al., 1992 (M62995)

clear that a major conflict exists between the sperm data (see results of analysis 1b) and the general morphological data.

*Analysis 1d.* Three MP trees were found, at 65 steps (CI = 0.862; RI = 0.870), the strict consensus of which is shown in Figure 10. Note that as in analysis 1b, bryophyte monophyly was supported.

*Analysis 1e.* Two MP trees were found, at 35 steps (CI = 0.857; RI = 0.886), the strict consensus of which is shown in Figure 10. Note that, whereas the mosses alone were supported as sister group to the tracheophytes as in analysis 1c, the relative position of liverworts and hornworts was not resolved.

*Analysis 1f.* Two MP trees were found, at 105 steps (CI = 0.819; RI = 0.832), the strict consensus of which is shown in Figure 10. Note that bryophyte monophyly was supported, unlike the result of analysis 1a.

*Analysis 2.* 26,300 MP trees were found at 231 steps (CI = 0.550; RI = 0.895), but the search could not be completed because the RAM of the computer was exceeded. Thus, the effectiveness of the heuristic search was diminished and more trees at 231 steps undoubtedly exist than could be saved. A strict consensus of the trees that were saved is shown in Figure 4. Note the poor resolution among green algal and land plant groups.

*Analysis 3a.* 32 MP trees were found at 2245 steps (CI = 0.458; RI = 0.589). A strict consensus of the trees that were saved is shown in Figure 5. The main groups of land plants were unresolved (in fact, neither the tracheophytes nor the liverworts were supported as monophyletic). *Tetraselmis* appeared as basal to the green algal clade, while the Trentepohliales + Ulvophyceae (minus *Cymopolia* and *Batophora*) formed a monophyletic group basal to the chlorophytes plus pleurostrophites. *Pleurastrum* was widely separated from the other pleurostrophites.

*Analysis 3b.* Only one island of 5 MP trees at 304 steps was found (CI = 0.612; RI = 0.600). In the consensus (not shown), neither the land plants, tracheophytes, nor liverworts were monophyletic.

*Analysis 3c.* Two MP trees at 127 steps (CI = 0.630; RI = 0.466) were found, the strict consensus of which is shown in Figure 10. The mosses and hornworts formed a monophyletic group, and the liverworts appeared paraphyletic.

*Analysis 3d.* Only one MP tree, of 1597 steps, was found (CI = 0.501; RI = 0.518; shown in Fig. 6). None of the three classes of green algae sensu Mattox & Stewart (1984: chlorophytes, pleurostrophites, and ulvophytes) included in this analysis appeared to be strictly monophyletic. The ulvophytes were paraphyletic near the base, and

TABLE 6. Composition of the OTUs used in data set LP-COMB. Morphological data were taken from selected taxa in LP-MORPH (Table 4) and molecular data were taken from selected taxa in GP-MOLEC (Table 5).

OTU	LP-MORPH	GP-MOLEC
COLEOCHAETE	<i>C. orbicularis</i>	<i>C. nitellarum</i>
PHAEOCEROS	<i>P. laevis</i>	<i>P. laevis</i>
NOTOTHYLAS	<i>Notothylas</i>	<i>N. breutelei</i>
MARCHANTIALES	<i>Marchantia</i>	<i>Asterella</i>
JUNGERMANNIALES	<i>Jungermannia</i>	<i>Porella</i>
POLYTRICHALES	<i>Polytrichum</i>	<i>Atrichum</i>
BRYALES	<i>Hypnum</i>	<i>Plagiomnium</i>
EQUISETUM	<i>Equisetum</i>	<i>Equisetum</i>
ZAMIA	<i>Zamia</i>	<i>Zamia</i>



## Analysis 1a. Full morphological data set

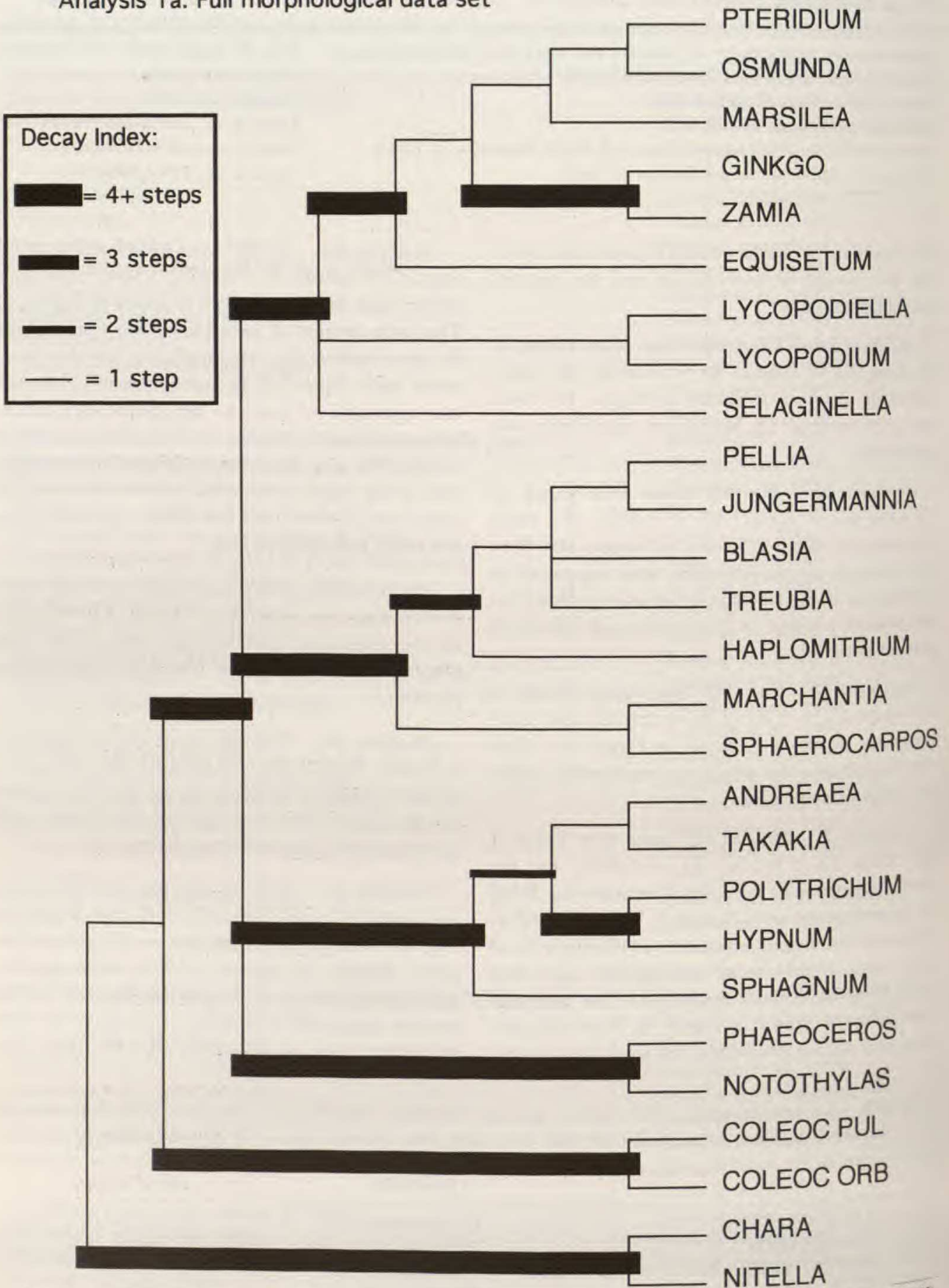

FIGURE 1. Semi-strict consensus of nine most parsimonious trees for the full morphological data set (LP-MORPH). The decay index is shown for each informative branch; thicker branches are better supported.



Analysis 1b. Sperm data only

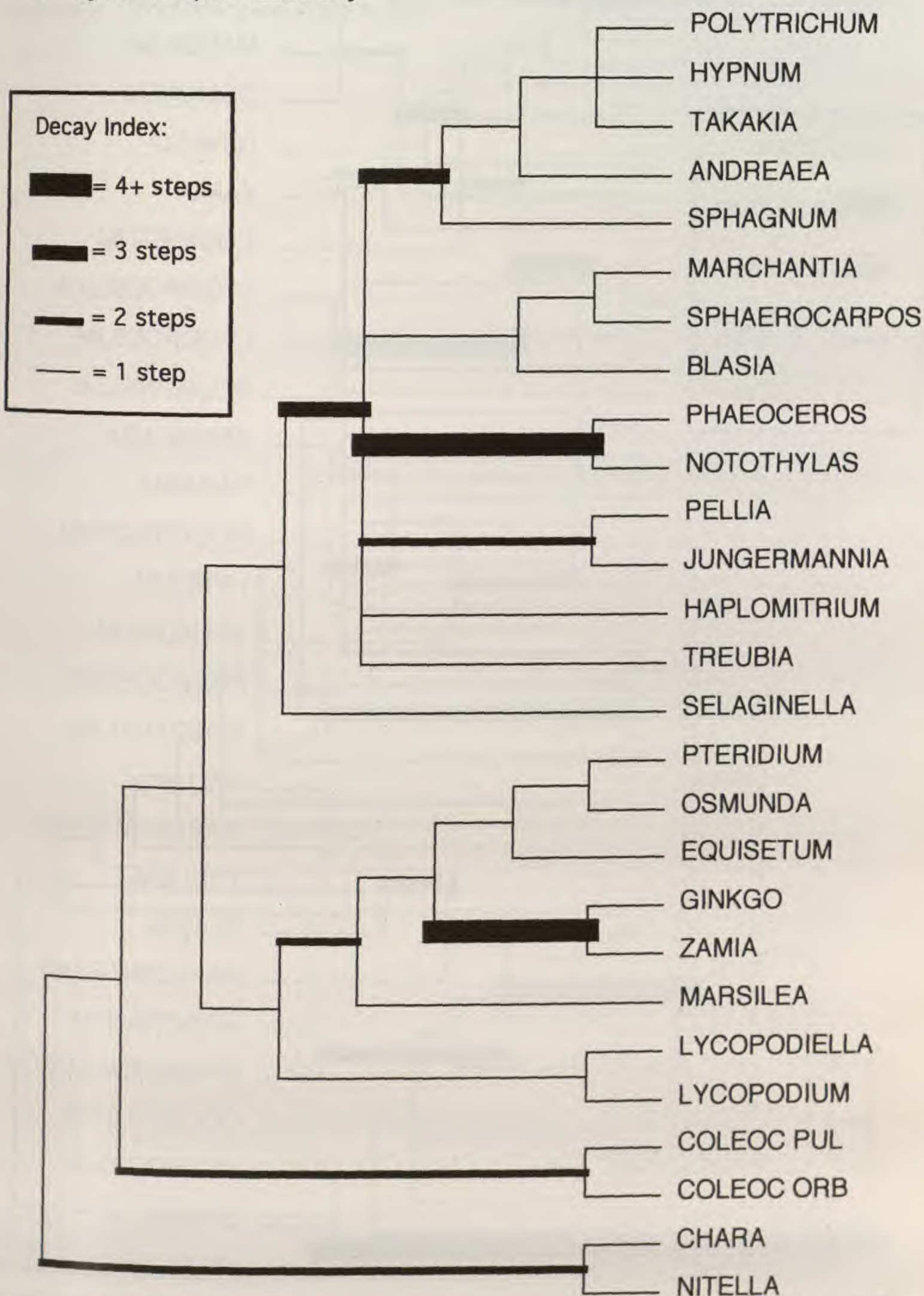

FIGURE 2. Semi-strict consensus of 56 most parsimonious trees for the sperm characters only (characters 1-65, LP-MORPH). The decay index is shown for each informative branch; thicker branches are better supported.



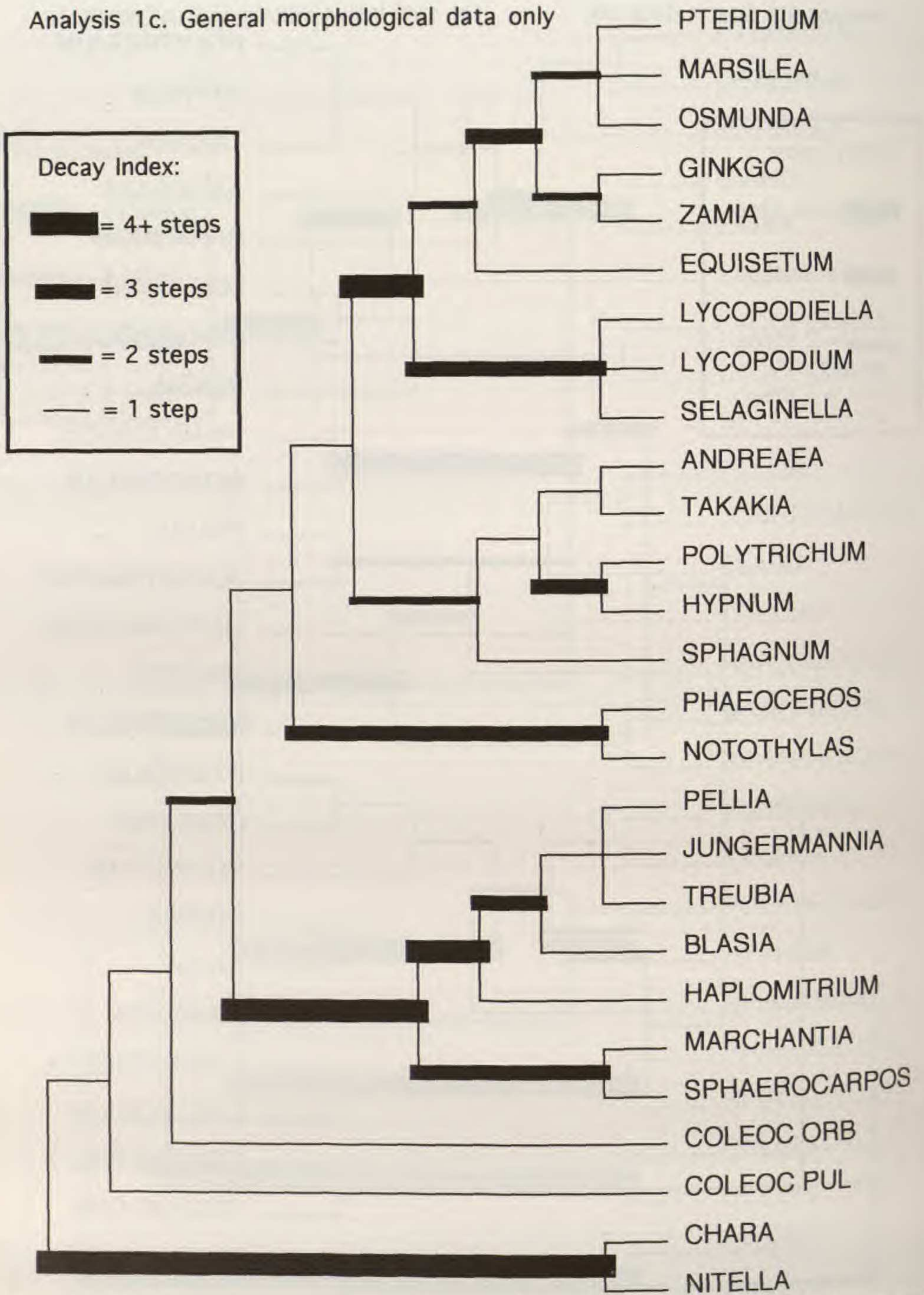

FIGURE 3. Semi-strict consensus of eight most parsimonious trees for the general morphological characters only (characters 66-113, LP-MORPH). The decay index is shown for each informative branch; thicker branches are better supported.



Analysis 2. Morphological data alone

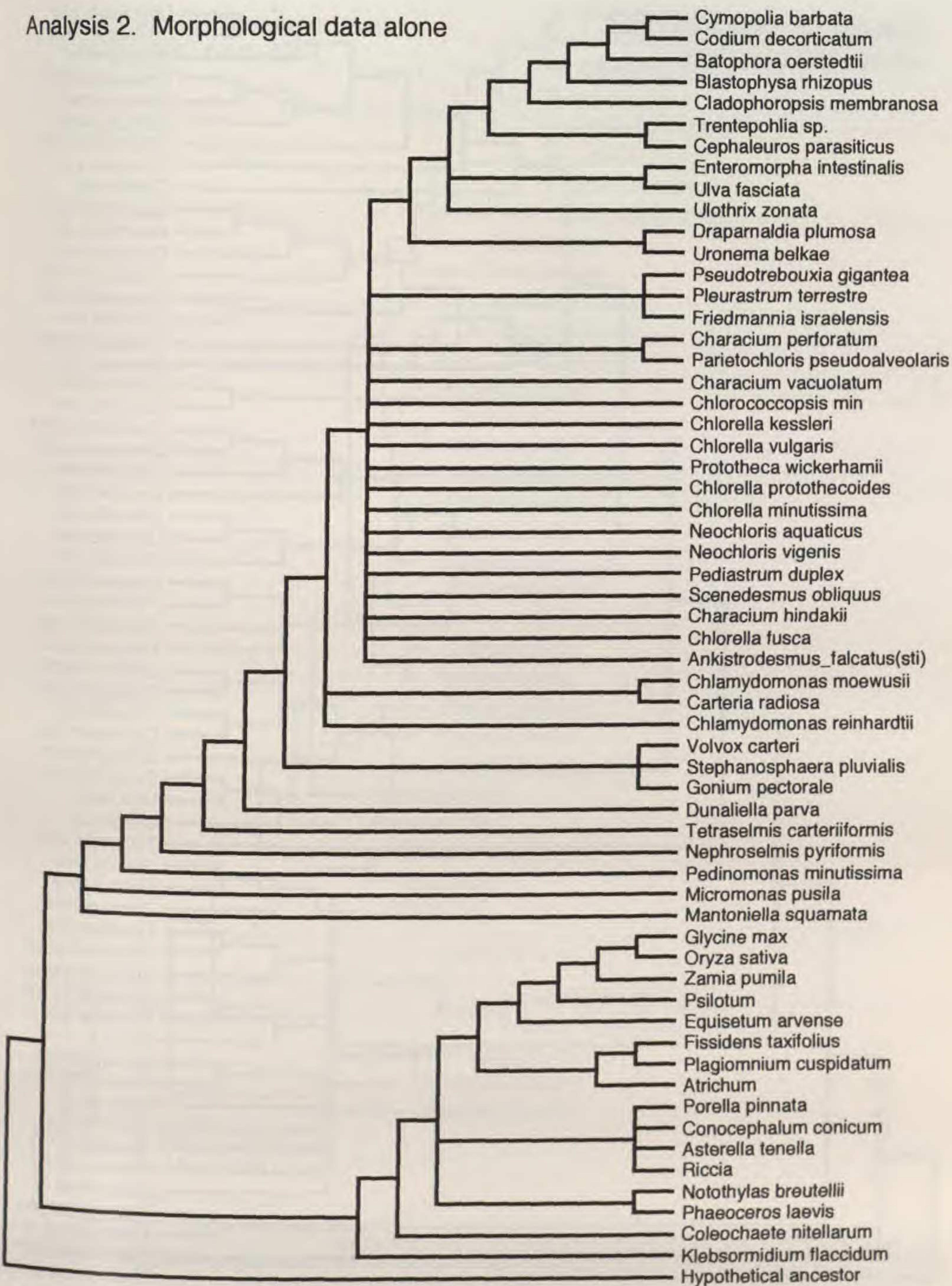

FIGURE 4. Strict consensus of 26,300 most parsimonious trees for the large-scale morphological data set (GP-MORPH). More trees at this length existed that could not be saved.



Analysis 3a. Molecular data  
alone (18S plus 26S)

FIGURE 5. Strict consensus of 32 most parsimonious trees for the full molecular data set (GP-MOLEC).



Analysis 3d. Molecular data  
alone (18S plus 26S)

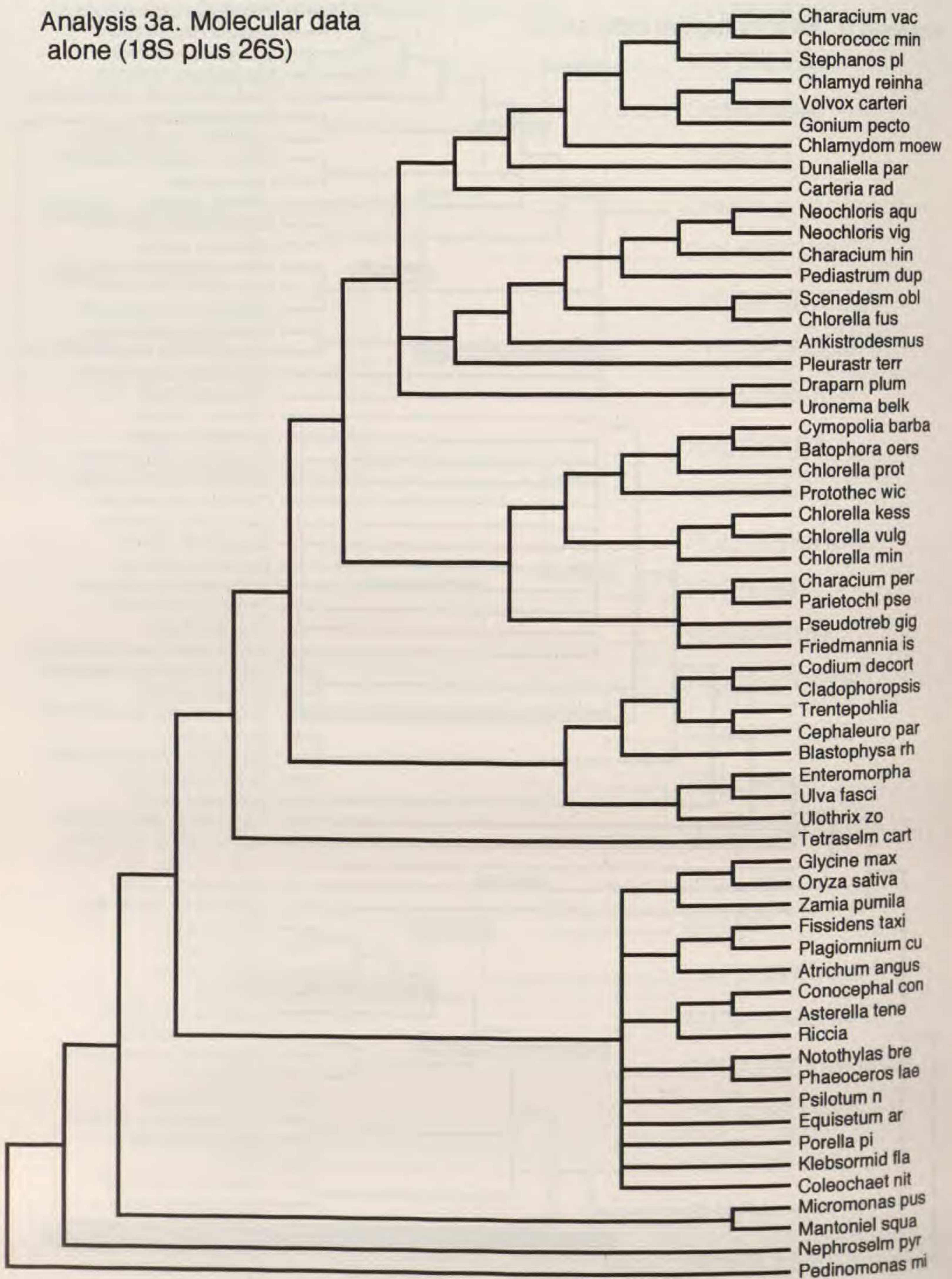
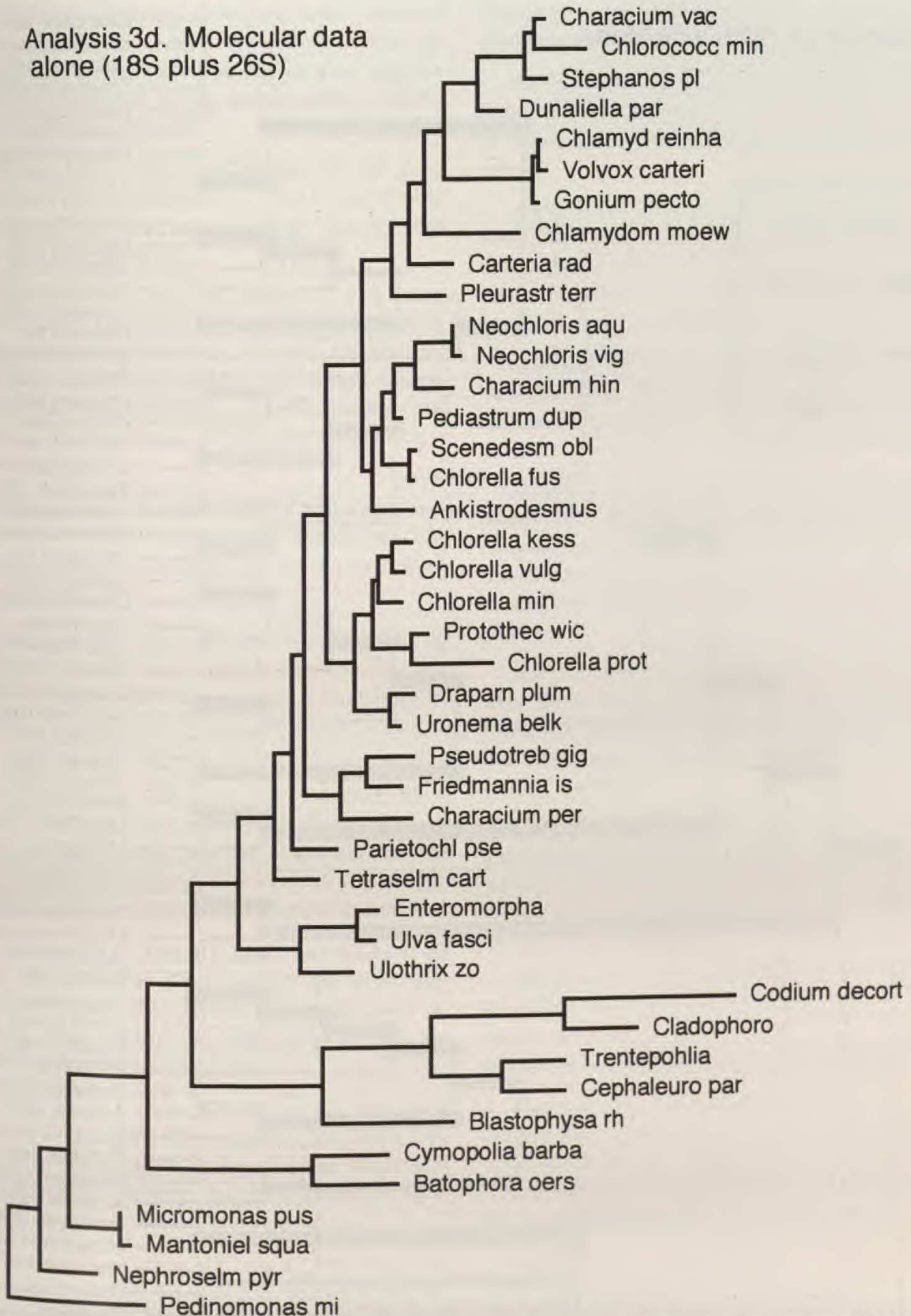

FIGURE 6. Single most parsimonious tree for the green algal taxa with the full molecular data set (GP-MOLEC). The length of each branch is proportional to the number of changes under ACCTRAN optimization.

the pleurostrophytes were paraphyletic above to the chlorophytes + *Pleurastrum*.

*Analysis 4a.* 84 MP trees at 1888 steps were found (CI = 0.450; RI = 0.589), the strict con-

sensus of which is shown in Figure 7. The land plants were resolved in an unusual topology, with the thallose liverworts alone as the sister group to the tracheophytes and the mosses as the sister group to that clade. The deep branches in the tree,



## Analysis 4a. 18S data alone

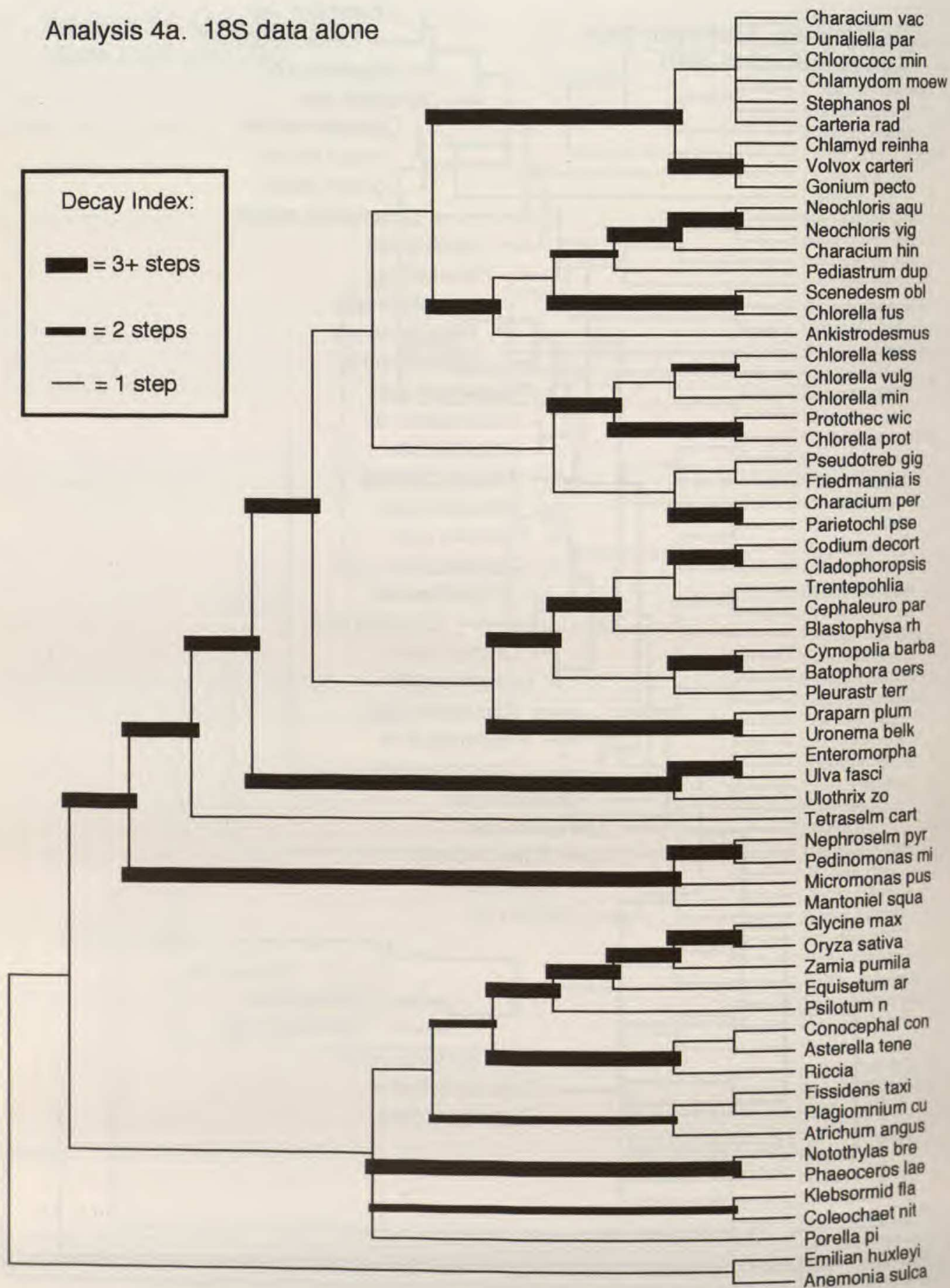

FIGURE 7. Strict consensus of 84 most parsimonious trees for the 18S characters only (GP-MOLEC). The decay index is shown for each informative branch; thicker branches are better supported.



such as the separation of the two major clades of green plants, were relatively well supported. Interestingly, the micromonadophytes were supported as a monophyletic group in this rooting, whereas the ulvophytes were not.

*Analysis 4b.* Only one MP tree, of 163 steps, was found (CI = 0.632; RI = 0.641; not shown). It had basically the same topology for the land plants as in analysis 4a.

*Analysis 4c.* Four MP trees, of 176 steps, were found (CI = 0.614; RI = 0.630; not shown). The consensus had basically the same topology for the land plants as in analysis 4a, except less resolved, with the hornworts, *Porella*, mosses, and thallose liverworts plus tracheophytes forming a tetrachotomy.

*Analysis 4d.* Six MP trees, of 206 steps, were found (CI = 0.607; RI = 0.595; not shown). The consensus had the same topology for the land plants as in analysis 4c.

*Analysis 4e.* One MP tree was found at 83 steps (CI = 0.627; RI = 0.492; shown in Fig. 10). The bryophytes were supported as a monophyletic group.

*Analysis 5a.* One tree island was found, of 462 MP trees at 550 steps (CI = 0.493; RI = 0.606). The strict consensus tree is shown in Figure 8; it was very poorly resolved, especially for the land plants; the algal classes were all depicted in different arrangements than in previous analyses.

*Analysis 5b.* Two MP trees were found at 83 steps (CI = 0.699; RI = 0.699), the strict consensus of which (not shown) had an unusual topology, with neither the tracheophytes nor the mosses potentially monophyletic.

*Analysis 5c.* Two MP trees at 42 steps were found (CI = 0.667; RI = 0.481), the strict consensus of which (shown in Fig. 10) had the mosses and hornworts together, as sister group to *Equisetum*.

*Analysis 6a.* One MP tree at 296 steps was found (CI = 0.618; RI = 0.638; shown in Fig. 9). This realignment of molecular data for the land plants alone gave an unusual topology, with the two putative algal outgroups widely separated, and the tracheophytes polyphyletic.

*Analysis 6b.* Three MP trees at 271 steps were found (CI = 0.642; RI = 0.664), the consensus of which (not shown) had the topology predictable from a re-rooting of Figure 9. The tra-

cheophytes were still polyphyletic, and the mosses plus hornworts were monophyletic.

*Analysis 6c.* Four MP trees at 250 steps were found (CI = 0.636; RI = 0.669), the consensus of which (not shown) had all major groups unresolved.

*Analysis 6d.* Three MP trees at 225 steps were found (CI = 0.662; RI = 0.702), the unrooted consensus of which (not shown) had the tracheophytes together, but neither the mosses nor the liverworts were potentially monophyletic.

*Analysis 6e.* Seven MP trees at 146 steps were found (CI = 0.662; RI = 0.702), the unrooted consensus of which (not shown) had the topology of that in analysis 6d except even less well resolved.

*Analysis 6f.* Two MP trees at 78 steps were found (CI = 0.692; RI = 0.700), the unrooted consensus of which (not shown) had the same very unusual topology of analysis 5b, with neither the mosses nor the tracheophytes potentially monophyletic.

*Analysis 7a.* Three MP trees at 240 steps were found (CI = 0.692; RI = 0.632), the strict consensus of which is shown in Figure 10. Note that the major groups of land plants were completely unresolved.

*Analysis 7b.* Four MP trees at 168 steps were found (CI = 0.655; RI = 0.561), the strict consensus of which is shown in Figure 10. The hornworts, mosses, and tracheophytes were placed together in a trichotomy.

*Analysis 7c.* Two MP trees at 191 steps were found (CI = 0.723; RI = 0.695), the strict consensus of which is shown in Figure 10. The bryophytes were placed together in a trichotomy.

*Analysis 7d.* One MP tree at 150 steps was found (CI = 0.760; RI = 0.743), shown in Figure 10. Note that the Mishler & Churchill (1984, 1985) topology, i.e., [liverworts [hornworts [mosses + tracheophytes]]], was present.

*Analysis 7e.* One MP tree at 124 steps was found (CI = 0.661; RI = 0.600), shown in Figure 11. A similar topology to analysis 4a was present, with [hornworts [liverworts [mosses + tracheophytes]]], but it was relatively weakly supported.

*Analysis 7f.* One MP tree at 78 steps was found (CI = 0.744; RI = 0.718), shown in Figure 11. Note that the Mishler & Churchill (1984, 1985) topology was again present and was relatively well supported.



## Analysis 5a. 26S data alone

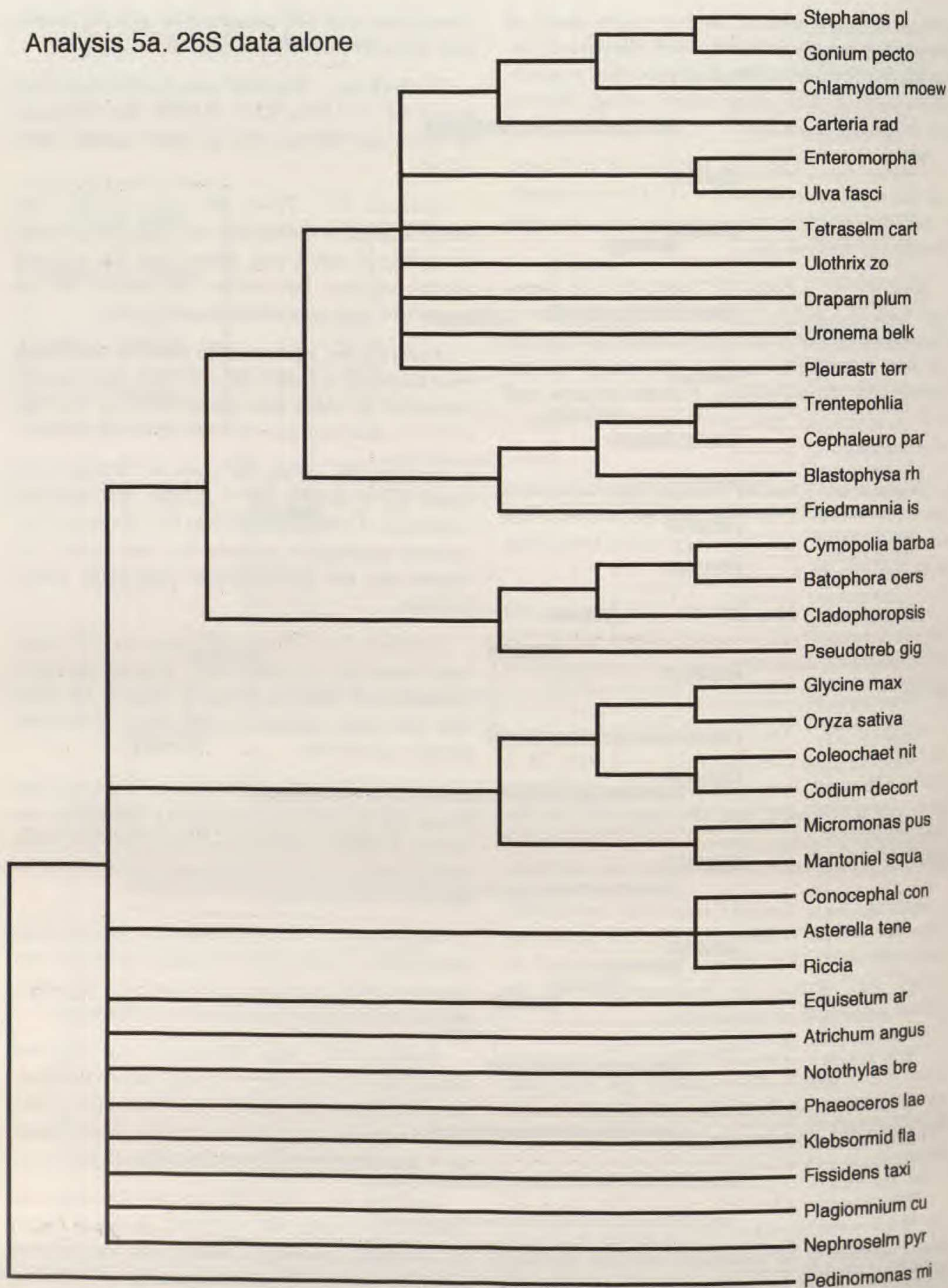

FIGURE 8. Strict consensus of 462 most parsimonious trees for the 26S characters only (GP-MOLEC).



Analysis 6a. Molecular data alone  
(18S plus 26S); realignment for  
land plants

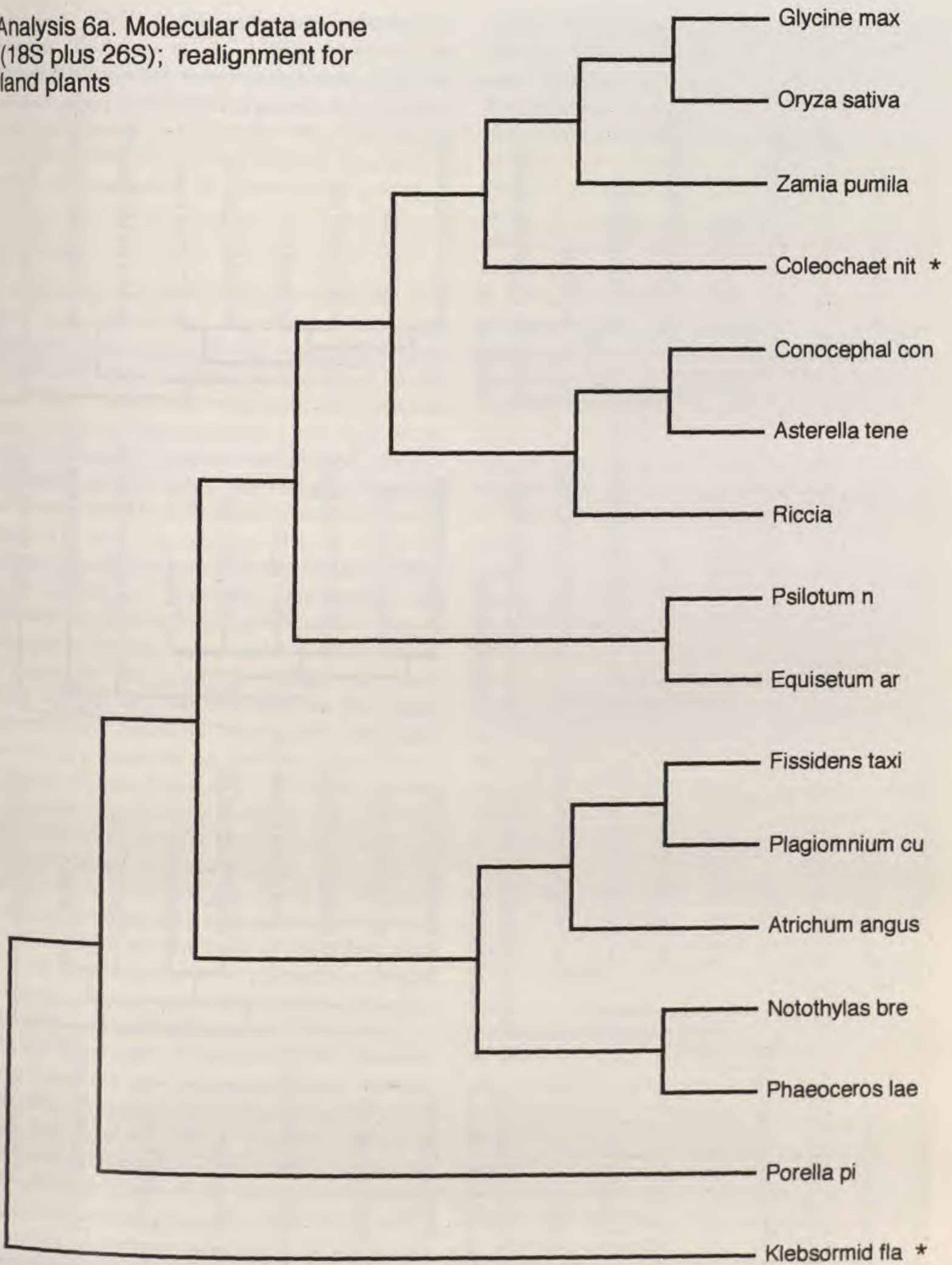
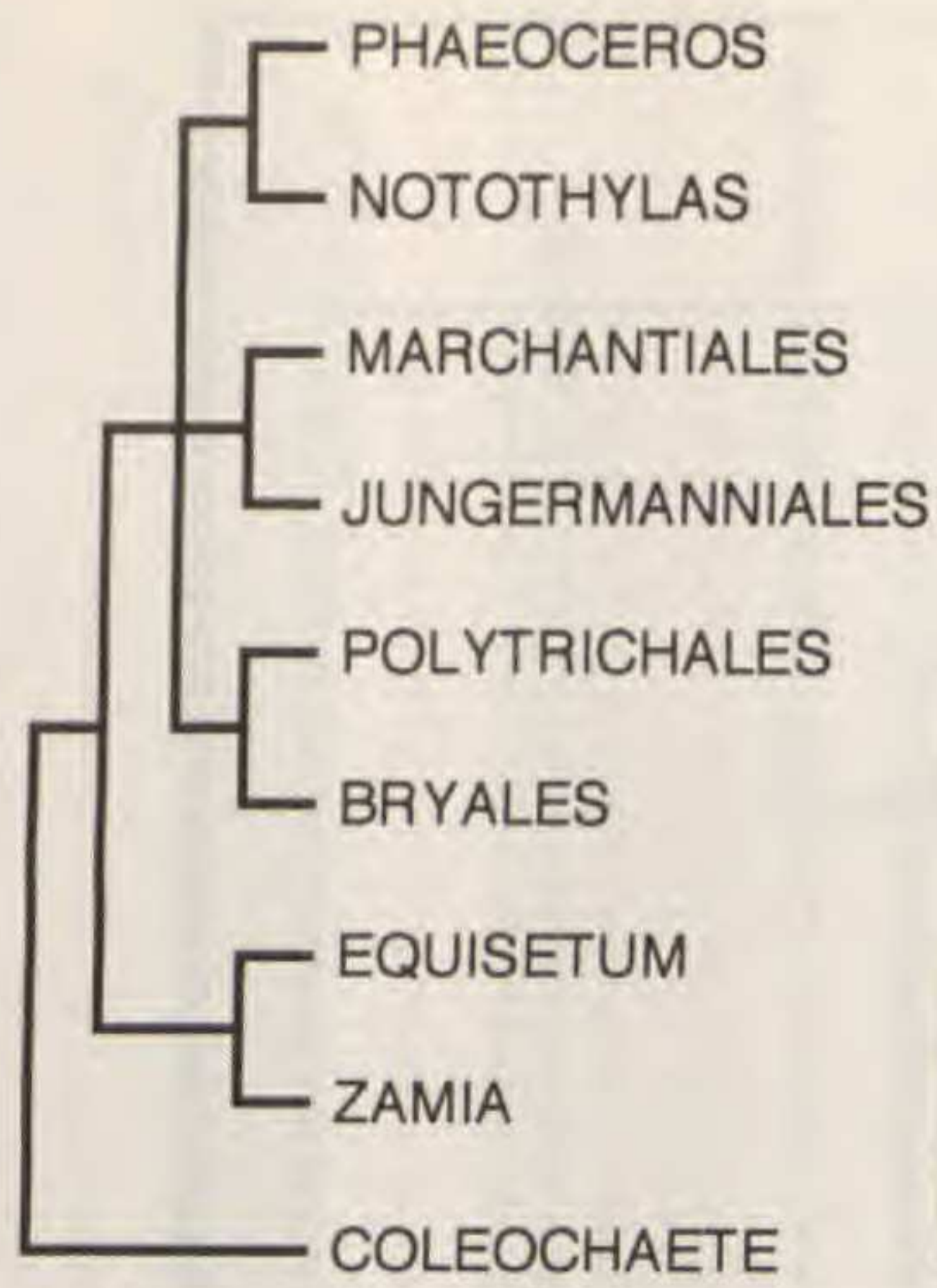

FIGURE 9. Single most parsimonious tree for the land plant taxa (plus two charophyte green algae, marked with asterisks) with the full molecular data set (LP-MOLEC).

*Analysis 8.* Fifteen MP trees at 2511 steps were found (CI = 0.458; RI = 0.654), the strict consensus of which is shown in Figure 12, along with the decay index for each informative branch.

The major branches of the tree were relatively well supported and were identical to the Mishler & Churchill (1984, 1985) topology in the "streptophyte" clade (i.e., charophytes + land plants; Bre-





Analyses 1d, 1f, 7c.

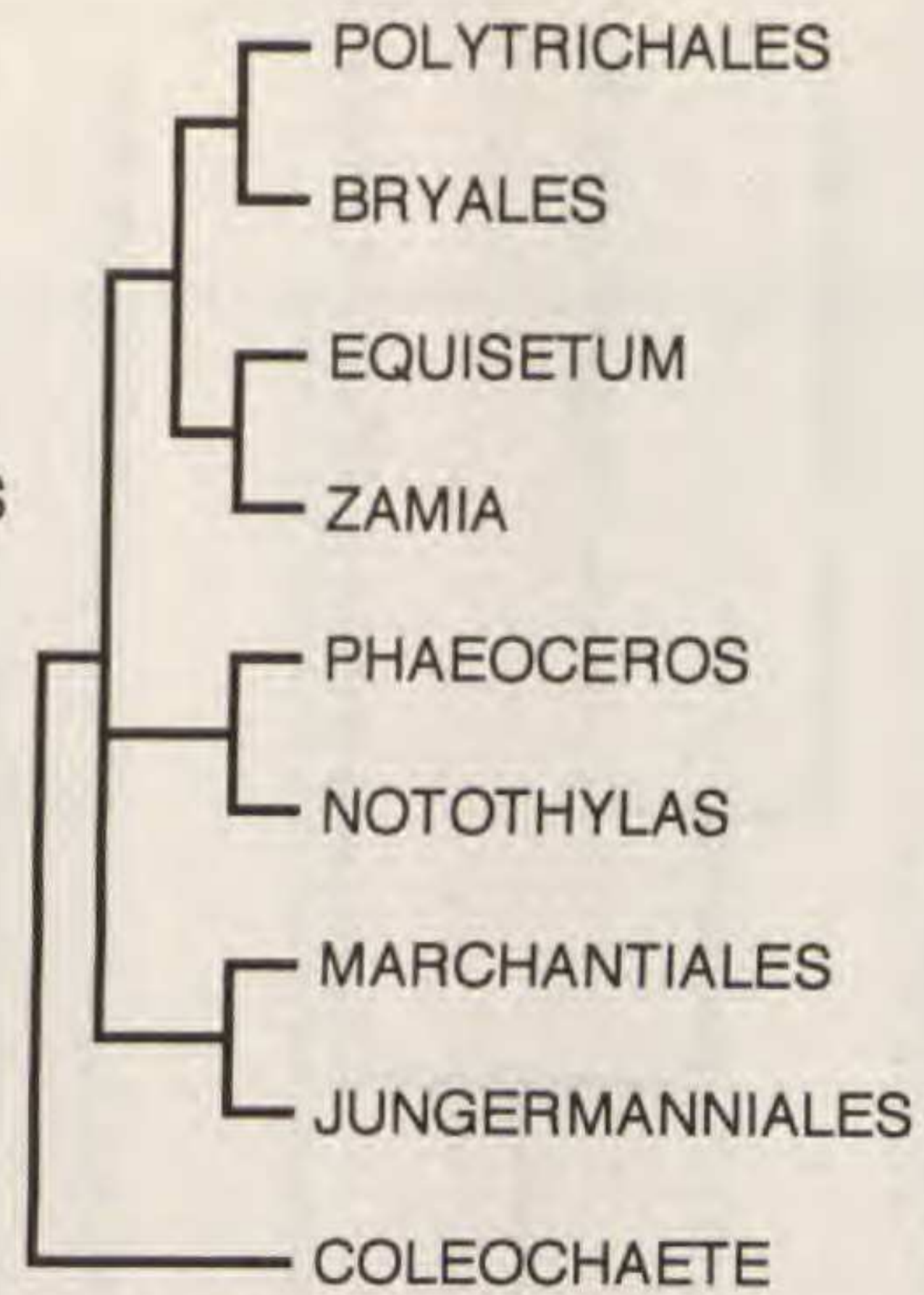

Analysis 1e.

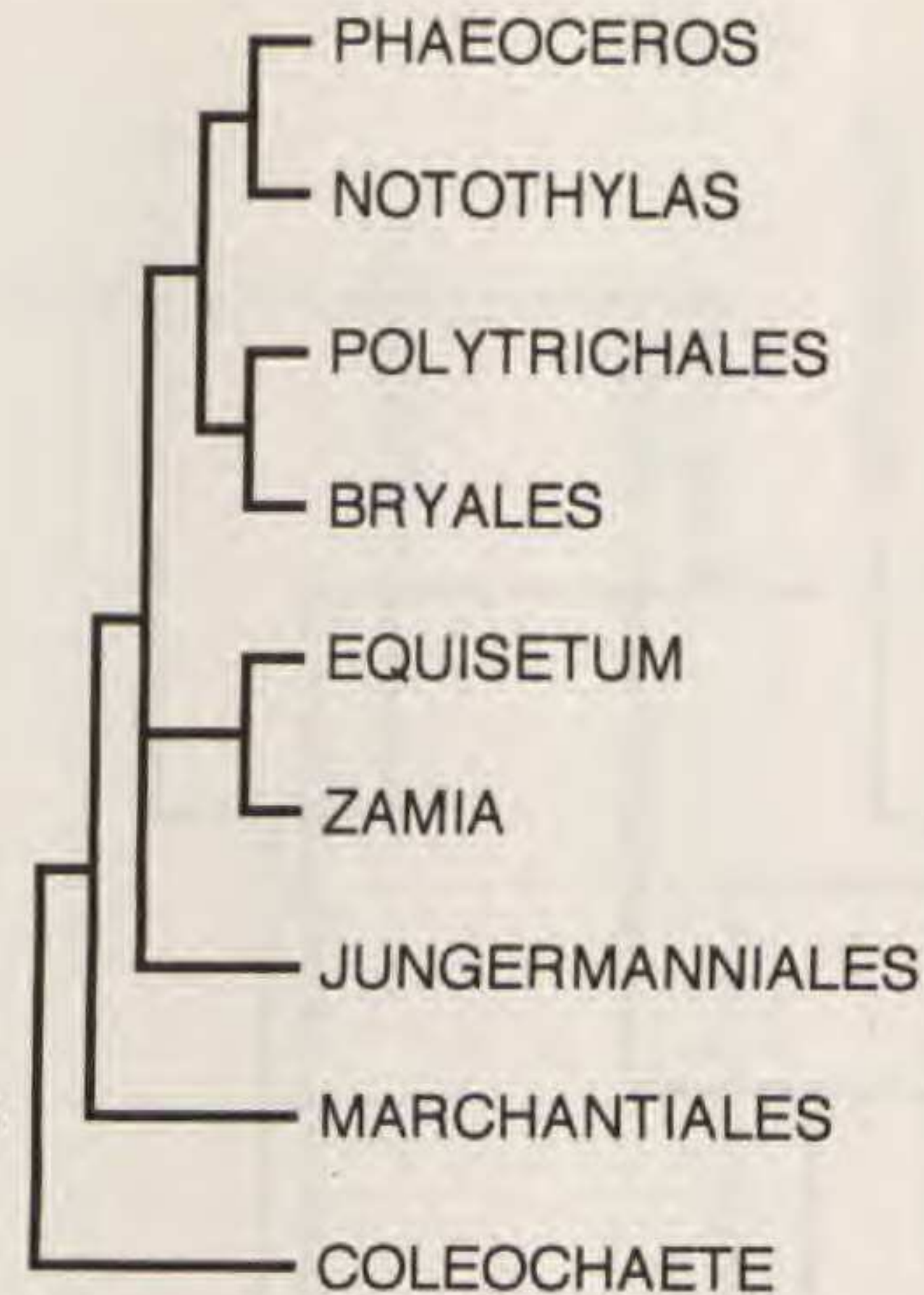

Analysis 3c.

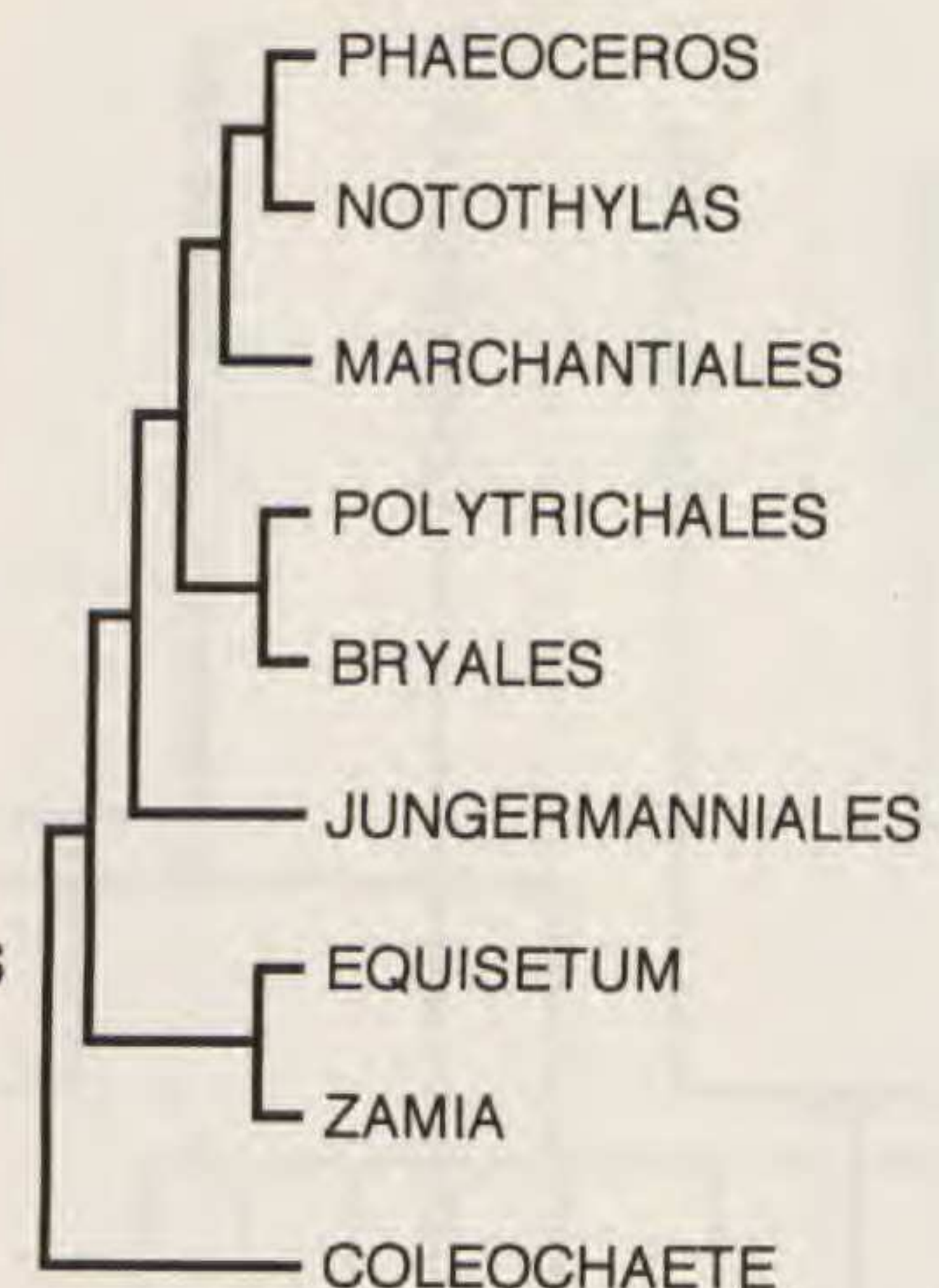

Analysis 4e.

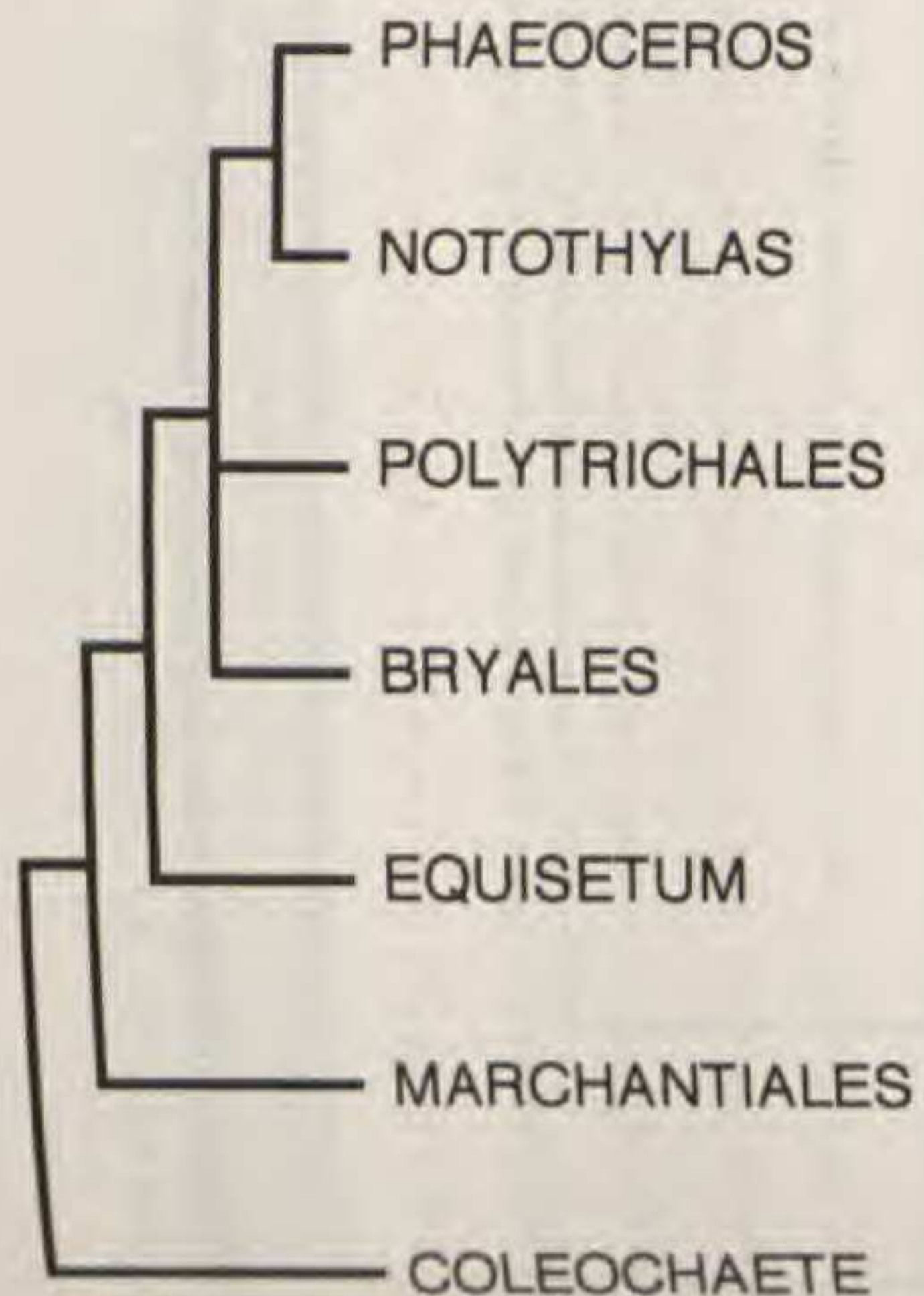

Analysis 5c.

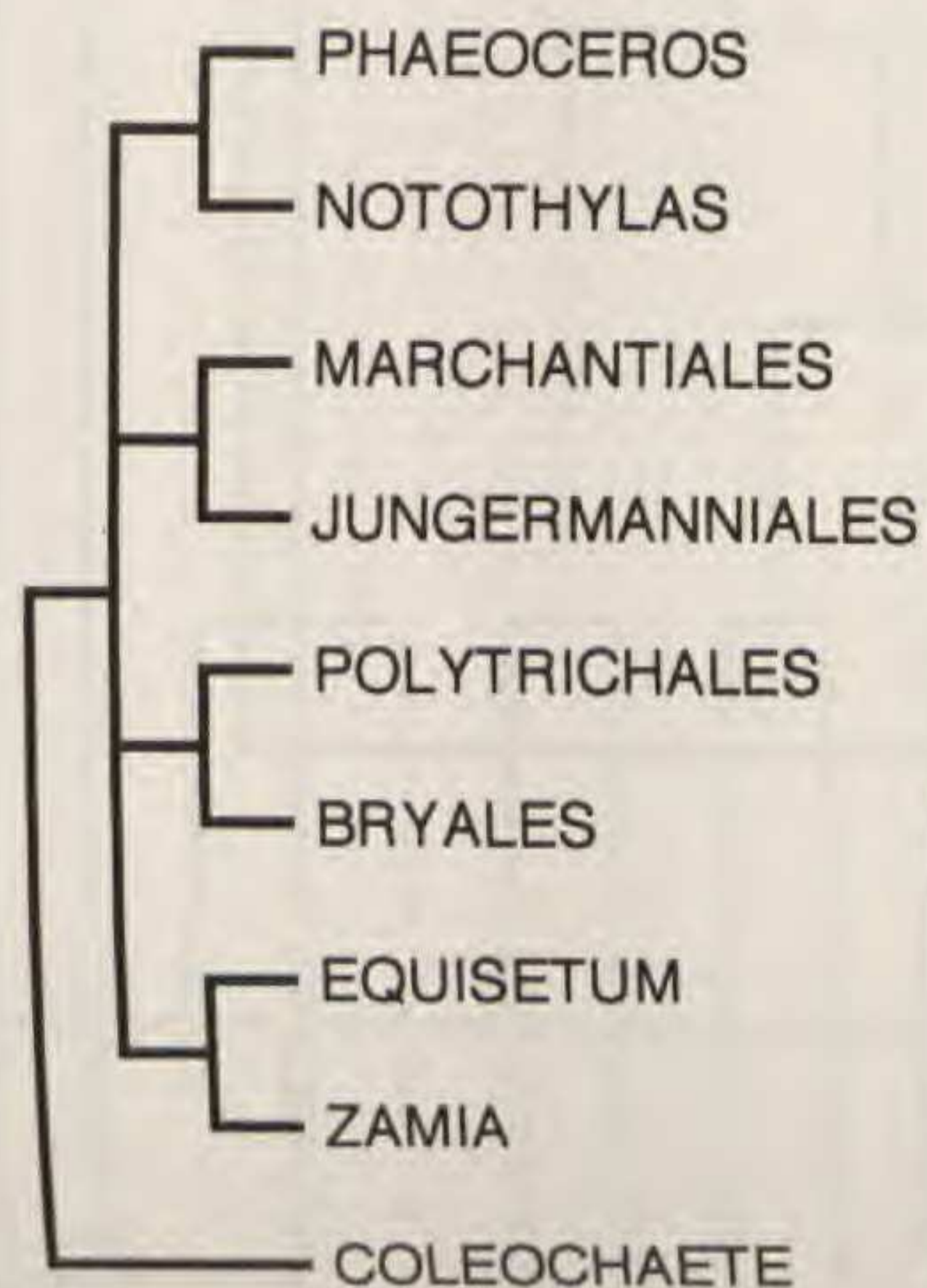

Analysis 7a.

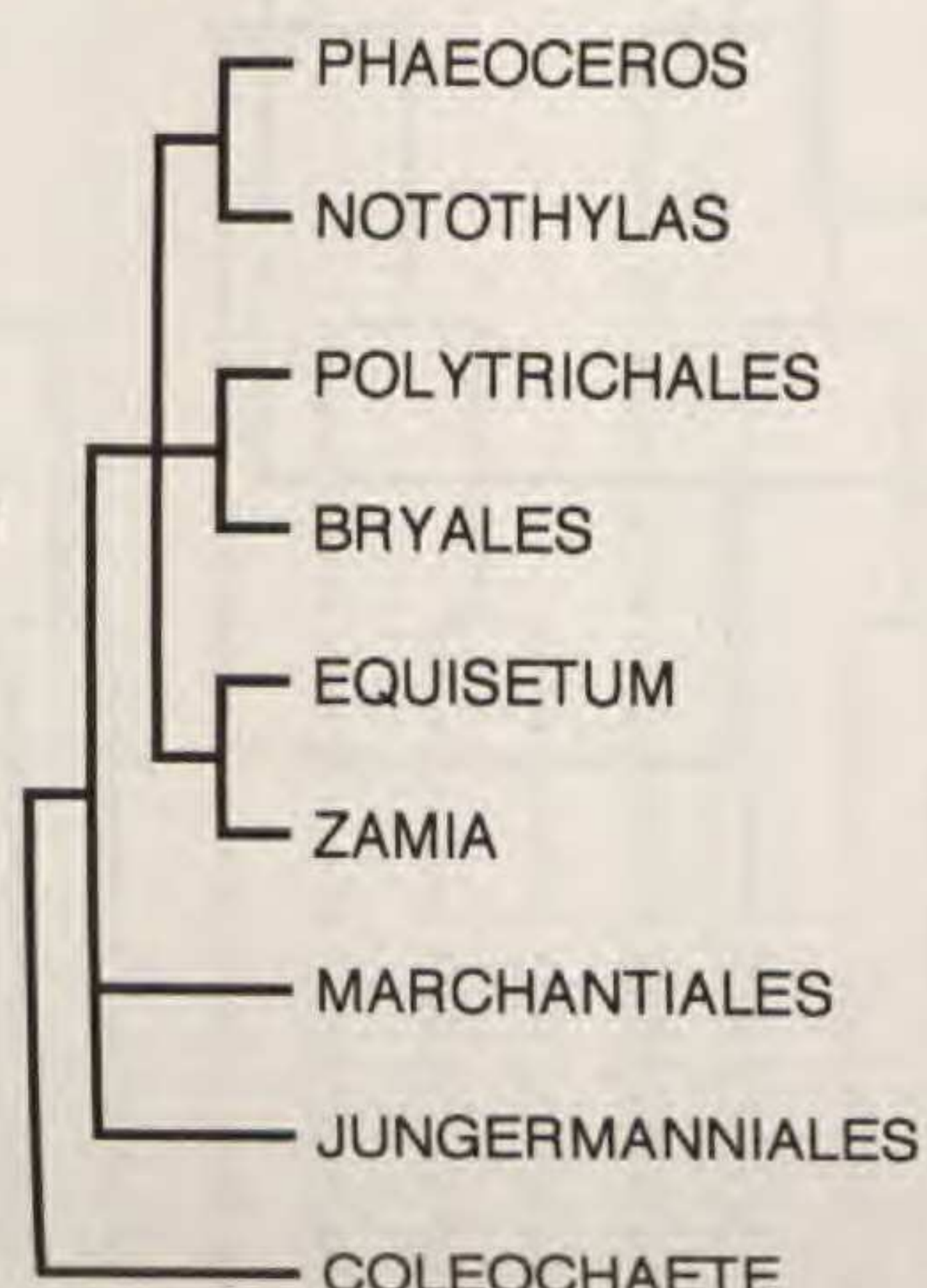

Analysis 7b.

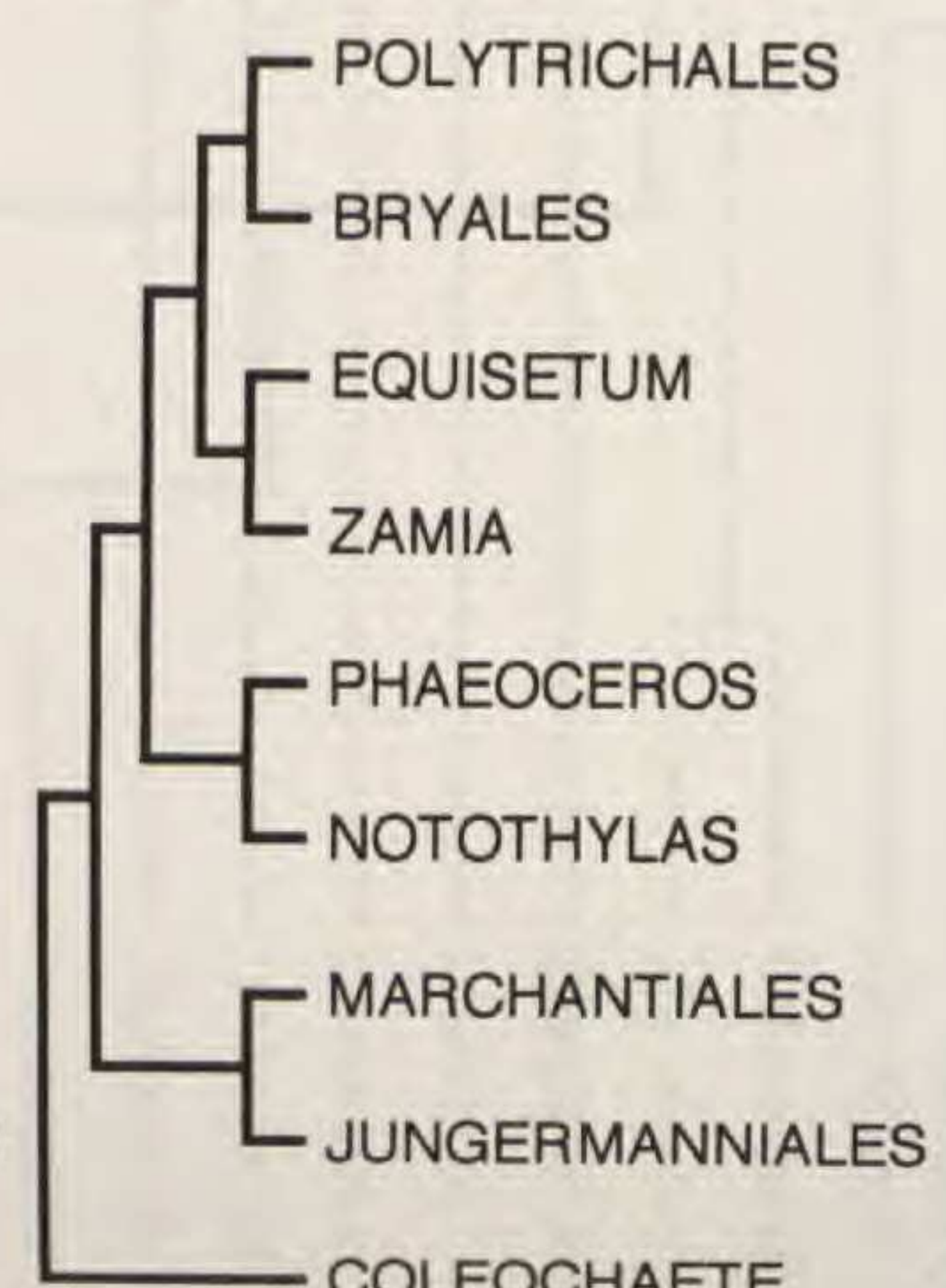

Analysis 7d.



mer et al., 1987). Unlike previously published topologies (Zechman et al., 1990), however, the ulvophytes appeared to be monophyletic (with the addition of the problematical genera *Trentopohlia* and *Cephaleuros*), while neither the chlorophytes nor pleurostrophytes (sensu Mattox & Stewart, 1984) were supported as monophyletic groups.

#### DISCUSSION

In general, it appears that the molecular data were most informative regarding relationships among the green algae. In the combined analysis of molecular data (analysis 3), resolution of the green algal clades was well supported, whereas resolution of land plants was very poor (and where resolution existed, it contradicted ideas of relationships based on other data). The realignment taking into account just the land plants (analysis 6), which might have been expected to yield a better assessment of positional homology (see Mindell, 1991), was of no help in "improving" the results. This difference in resolution could be because of unequal extinction in the two major clades of green plants. As it happens, the extant green algae may more evenly sample the true tree than do the extant streptophytes. Spurious long-branch attraction problems are expected on theoretical grounds to be greater in data types with a restricted number of character states, such as DNA data (Mishler, 1994), and may therefore be seen more frequently in the land plants than in the green algae with the molecular data. A second (not mutually exclusive) reason for the difference in resolution with molecular data might be that most of the green algal OTUs in this analysis were represented by full sequences, whereas most OTUs in the land plant clade were represented by partial sequences.

On the other hand, it appears that the morphological data were most informative about relationships within the streptophyte clade of green plants (sensu Bremer et al., 1987). It is very difficult to code morphological characters broadly across the green plants because of the lack of homologous comparisons among organisms that have evolved such major phenotypic differences. It is also difficult narrowly within the green algal groups because the characters useful at that level are pri-

marily ultrastructural, making sufficient sampling difficult. These difficulties are evidenced by the poor resolution obtained in analysis 2 (Fig. 4). Morphological data coded narrowly for the land plants, however, give a better supported result (e.g., analysis 1). In the latter case, the greater conservatism and larger number of potential character states in complex morphological data may have allowed the recovery of a historical signal obscured in the molecular data.

It has been suggested that even complex morphological character systems may be subject to convergent evolution when under strong selective constraints and, thus, could give misleading phylogenetic reconstructions because of non-independence of characters. It is possible that the conflict observed in analysis 1 between the set of characters derived from the spermatozoid and the general set of characters derived from many parts of the organism (compare Figs. 2 and 3) is due to selective constraints imposed on the streamlined, swimming gamete (cf. Garbary et al., 1993) or on the other morphological features such as conducting tissues. Ultimately, the only means of resolving such conflicts is by investigation of many different characters and character systems. Any one character system (or maybe all) are influenced by constraints that tend to bias phylogeny reconstruction one way or another. The hope is that if one looks at enough character systems the various noise-producing factors will "cancel-out" and a common historical signal can be detected. There is only one known process that can impose a common pattern across all these widely different character systems: phylogeny.

It is difficult to draw any definitive conclusions from the combination of molecular data with morphological data in analysis 7, because the sampling of characters is so uneven that only eight land plants could be included. The combination of both genes together, as well as 18S alone, with the LP-MORPH data set tended to favor a monophyletic bryophyte lineage, whereas the combination with 26S alone tended to favor a paraphyletic arrangement of bryophytes in the same pattern as Figure 3: [liverworts [hornworts [mosses + tracheophytes]]]. The last result is especially intriguing, as neither the morphological data alone (analysis

FIGURE 10. Strict consensus trees resulting from maximum parsimony analyses of various character combinations from the reduced data set (LP-COMB) that contains land plants which had both molecular and morphological data available. See text for explanation of which characters were used in each analysis. *Coleochaete* was used for outgroup rooting.



Analysis 7e. General morphology  
plus 18S molecular dataAnalysis 7f. General morphology  
plus 26S molecular data

FIGURE 11. Single most parsimonious trees from two different combined analyses of the reduced data set (LP-COMB) that contains land plants which had both molecular and morphological data available. The decay index is shown for each informative branch; thicker branches are better supported.

1f) nor the 26S data alone (analysis 5c) gave such a pattern.

The overall combined analysis of GP-MOLEC and GP-MORPH (analysis 8—Fig. 12) produced

a topology that was better resolved than the consensus of the individual analyses of each data set alone. This property is often the case with such “total evidence” analyses (Kluge, 1989). The

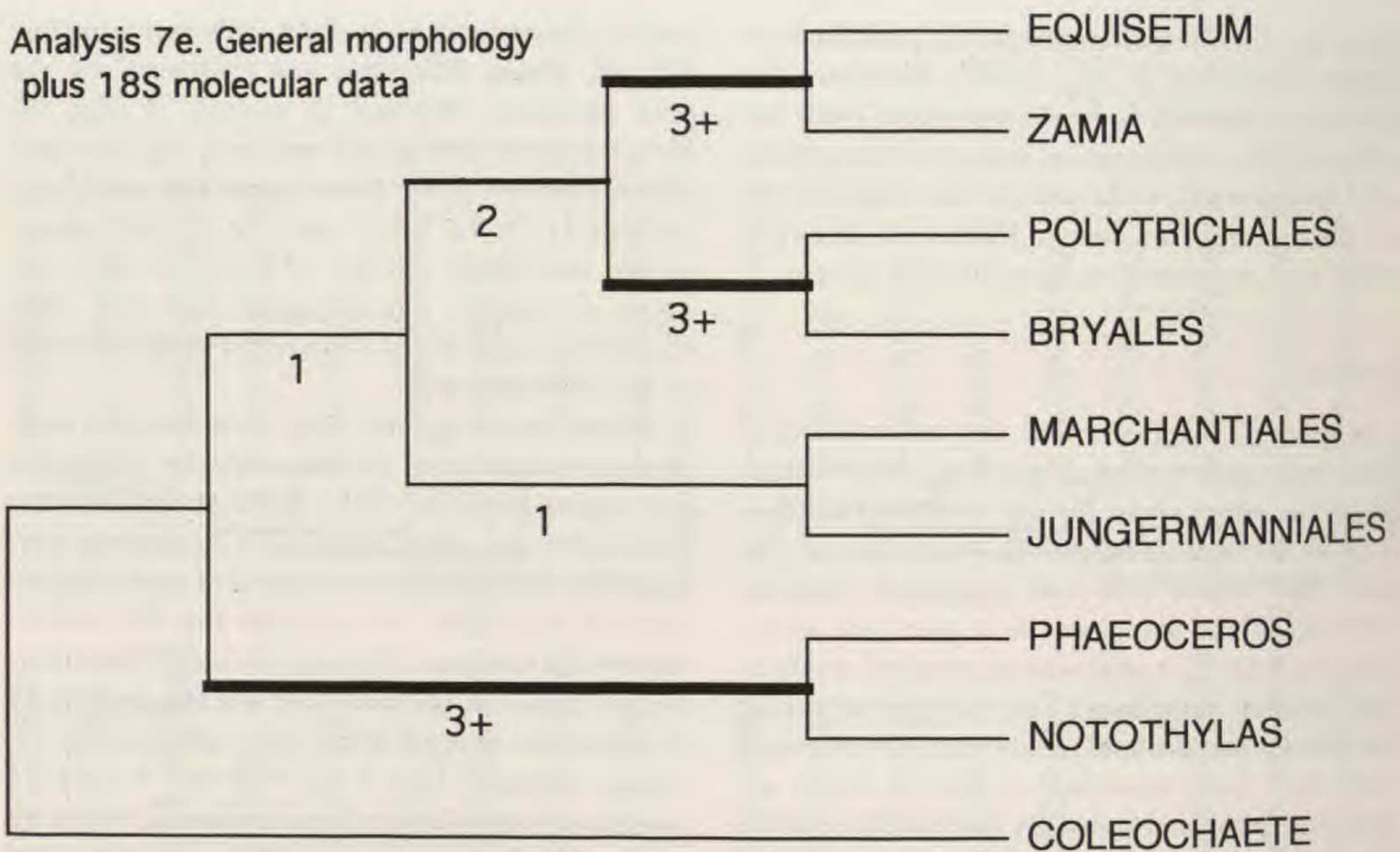
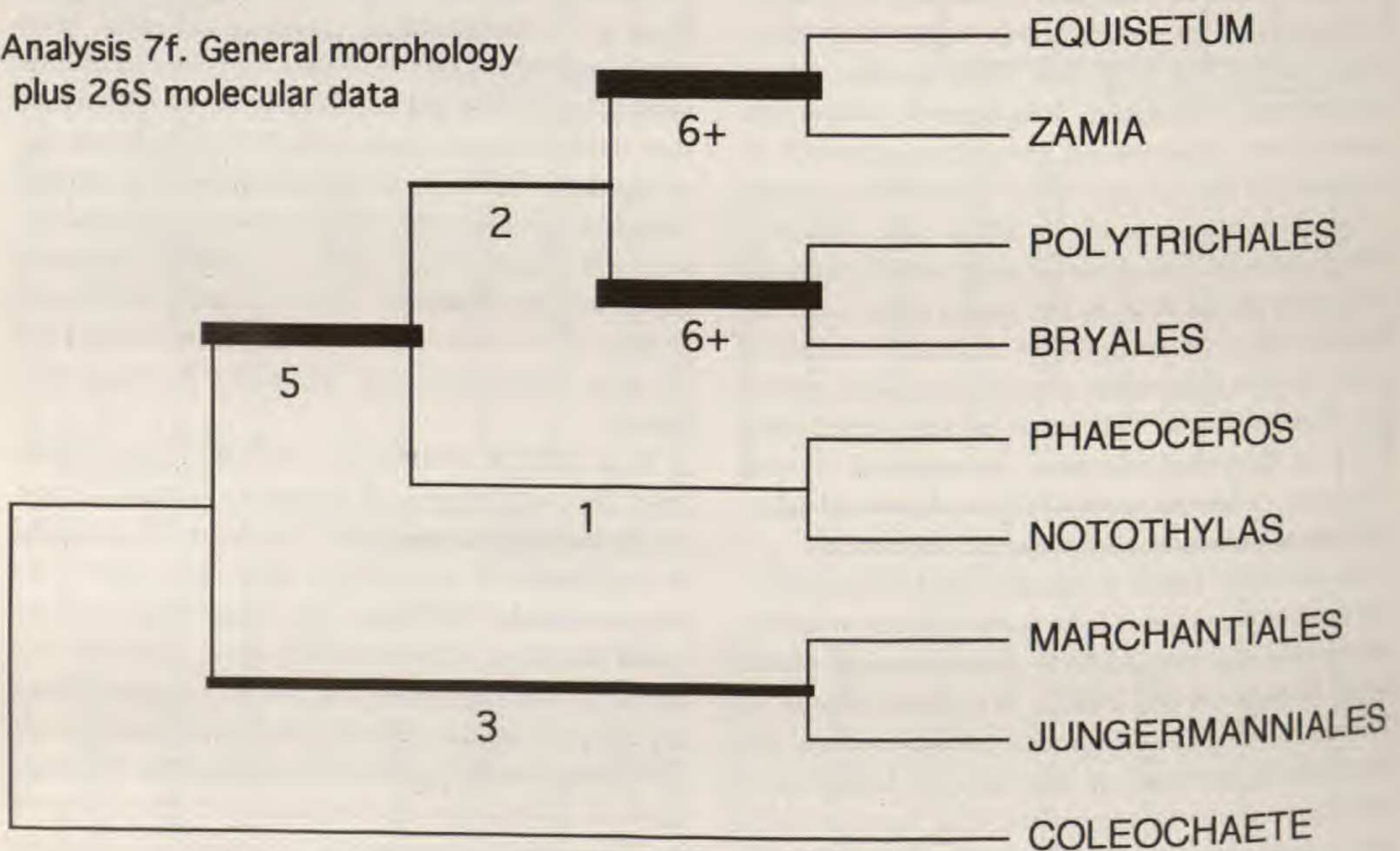

Analysis 8. Combined molecular and morphological data

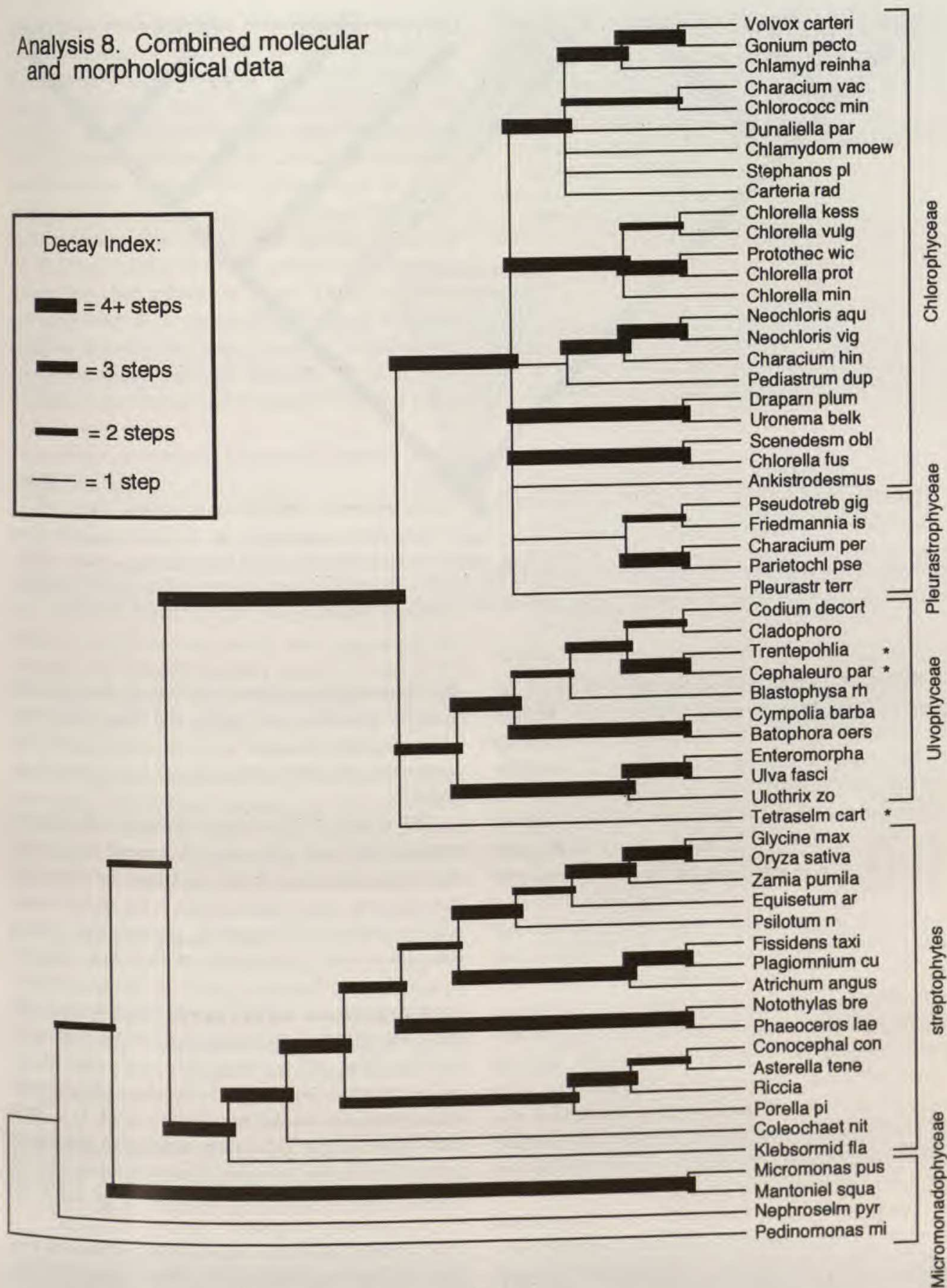
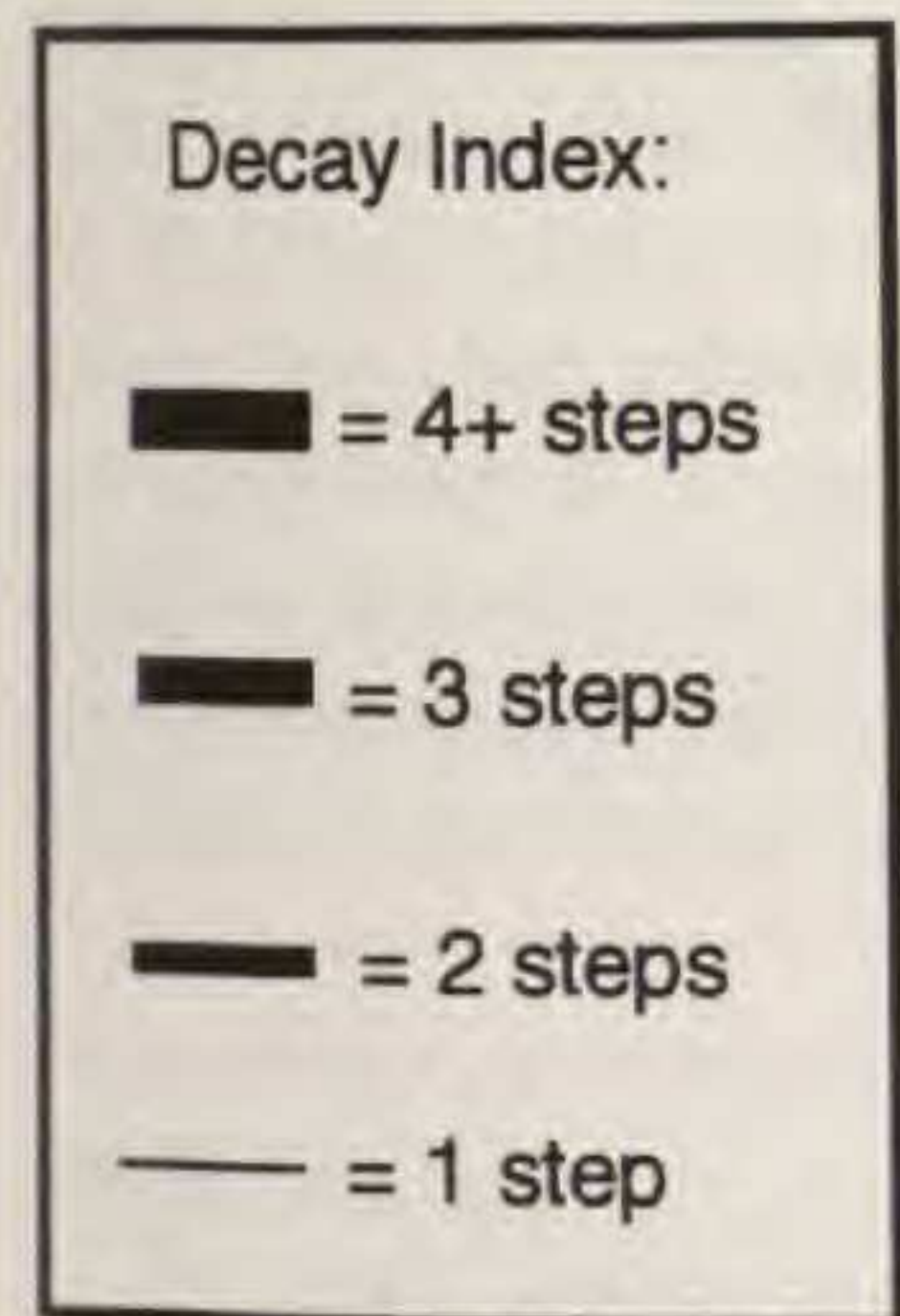

FIGURE 12. Strict consensus of 15 most parsimonious trees for the large-scale combined data set (GP-COMB). The decay index is shown for each informative branch; thicker branches are better supported. The assignment of green algae to classes according to the concept of Mattox & Stewart (1984) is shown; "streptophyte" indicates charophyte green algae plus embryophytes (sensu Bremer et al., 1987). The unusual placement of three enigmatic taxa is indicated with an asterisk.



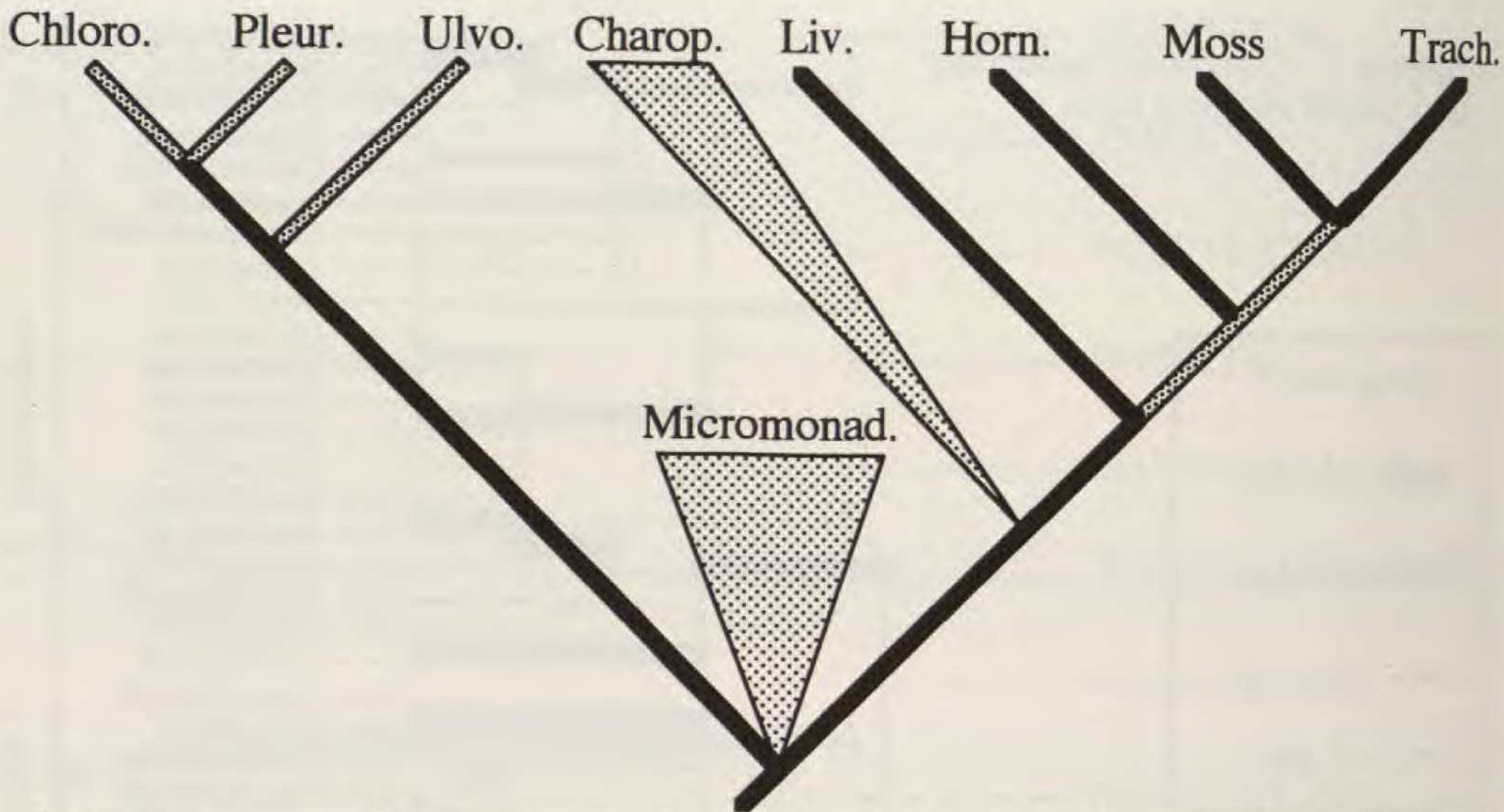

FIGURE 13. A diagram indicating current understanding of cladistic relationships of the five classes of green algae, sensu Mattox and Stewart (1984), and the four major lineages of land plants, sensu Bremer et al., (1987). Branches about which we are confident are shown in black, those for which lesser support exists (and considerable homoplasy) are shown stippled, while two classes of almost certain paraphyly are shown as stippled triangles.

streptophytes were completely resolved, in a topology completely consistent with the early Mishler & Churchill (1984, 1985) analyses and analysis 1a here, despite the fact that neither the morphological data (GP-MORPH in analysis 2) nor the molecular data (GP-MOLEC as a whole in analysis 3 or the separate analyses 4 and 5) alone gave such a topology. The observation of a combined topology that is different from topologies produced in separate analyses of component data sets is not unusual (see discussion of analysis 7 above, and Mishler et al., 1992, for other examples). One potential explanation is that each data set has a common historical signal that is obscured for different reasons in each; the signal might only be observable when the noise in the two data sets cancels out in a combined analysis (Barrett et al., 1991). Carefully coordinated studies are needed to discover the extent to which such an explanation can apply to land plant phylogeny.

The green algal lineages in the overall combined analysis (analysis 8—Fig. 12) had a similar resolution to the consensus of the subanalyses of analysis 3, with the exception that the ulvophytes (plus *Trentopohlia* and *Cephaleuros*) were supported as monophyletic. Several OTUs with long terminal branches (such as *Pleurastrum* and *Ankistrodesmus*) “jump around” in equally parsimonious positions, thus lowering support for the monophyly of both the Pleurostrophyceae and Chlorophyceae as currently circumscribed. Major clades within

the chlorophytes, however, such as the taxa with directly opposite basal bodies and those with clockwise absolute orientation of the basal bodies, are supported (as previously found by Lewis et al., 1992).

The results of the various analyses illustrate, if nothing else, how difficult phylogenetic reconstruction is at this deep level, and how no particular data set acts as a “magic bullet.” We were working with a mixture of complete, partial, and missing data for a large proportion of the taxa. The two morphological data sets gave conflicting results in some respects, as did the two major molecular data sets. Nevertheless, the combined (“total evidence”) analysis (Fig. 12) is reasonably well resolved and well supported, and supports previous phylogenetic and systematic studies to a large extent. It is likely that much of the remaining ambiguity can be removed once more complete data sets are produced. There is still a great deal of work to be done, but we are making progress.

A summation of the currently hypothesized general cladistic relationships of green plants that can be drawn from this and previous studies is shown in Figure 13, along with an indication of places in the phylogeny where uncertainty is greatest. The green plants are composed of two major monophyletic groups, one containing the bulk of the classical “green algae” (chlorophytes, pleurostrophytes, and ulvophytes), the other containing “charophyte” green algae along with the bryo-



phytes plus tracheophytes. A doubtfully monophyletic assemblage of unicellular micromonadophytes is phylogenetically "between" these two major lineages. It appears clear that the ulvophytes are basal to the chlorophytes plus pleurostrophytes, but the exact circumscription of all three classes needs revision. In the other major clade of green plants, the land plants are a well-supported monophyletic group, but neither the specific outgroup for the land plants nor the precise relationships among the charophytes is clear. The bryophytes are supported as a monophyletic group in some analyses; in many analyses, however, including the overall combined analysis (analysis 8—Fig. 12), the three major lineages of bryophytes appear paraphyletic with respect to the tracheophytes, with the topology [liverworts [hornworts [mosses + tracheophytes]]].

The more robust parts of this summary cladogram, though clearly in need of support from future studies sampling more OTUs and more character systems (morphological as well as molecular), can serve as a framework for evolutionary interpretations. It appears reasonably well supported, for example, that multicellularity arose at least twice in the green plants. The diversification of life-history strategies is becoming clearer; from a primitively haplontic life cycle, alternation of generations and diploid-dominant life cycles arose at least twice each. The habitat transition in the movement of plants to land was from fresh water, not from salt water. Within the land plants, several morphological transformations can be reasonably postulated at present, such as the origin of branched, multispore-bearing plants from unbranched, unispore-bearing ones, and the radiation of conducting cell types (Kendrick & Crane, 1991). The process of inference is difficult, but further refinement of our understanding of phylogenetic relationships will be repaid with a more precise understanding of such evolutionary issues.

LITERATURE CITED

- ALBERT, V. A. & B. D. MISHLER. 1992. On the rationale and utility of weighting nucleotide sequence data. *Cladistics* 8: 73-83.
- , M. W. CHASE & B. D. MISHLER. 1993. Character-state weighting for cladistic analysis of protein-coding DNA sequences. *Ann. Missouri Bot. Gard.* 80: 752-766.
- , B. D. MISHLER & M. W. CHASE. 1992. Character-state weighting for restriction site data in phylogenetic reconstruction, with an example from chloroplast DNA. Pp. 369-403 in P. S. Soltis, D. E. Soltis & J. J. Doyle (editors), *Molecular Systematics of Plants*. Chapman & Hall, New York.
- BARRETT, M., M. J. DONOGHUE & E. SOBER. 1991. Against consensus. *Syst. Zool.* 40: 486-493.
- BHATTACHARYA, D., L. MEDLIN, P. O. WAINRIGHT, E. V. ARIZTIA, C. BIBEAU, S. K. STICKEL & M. L. SOGIN. 1992. Algae containing chlorophylls a + c are paraphyletic: Molecular evolutionary analysis of the Chromophyta. *Evolution* 46: 1801-1817.
- BREMER, K. 1988. The limits of amino acid sequence data in angiosperm phylogenetic reconstruction. *Evolution* 42: 795-803.
- . 1990. Combinable component consensus. *Cladistics* 6: 369-372.
- , C. J. HUMPHRIES, B. D. MISHLER & S. P. CHURCHILL. 1987. On cladistic relationships in green plants. *Taxon* 36: 339-349.
- BROWN, R. C. & B. E. LEMMON. 1988. Sporogenesis in bryophytes. *Advances Bryol.* 3: 159-223.
- BUCHHEIM, M. A. & R. L. CHAPMAN. 1992. Phylogeny of *Carteria* (Chlorophyceae) inferred from nuclear and organismal data. *J. Phycol.* 28: 362-374.
- , M. TURMEL, E. A. ZIMMER & R. L. CHAPMAN. 1990. Phylogeny of *Chlamydomonas* (Chlorophyta) based on cladistic analysis of nuclear 18S rRNA sequence data. *J. Phycol.* 26: 689-699.
- CAROTHERS, Z. B. & A. E. RUSHING. 1988. Comparative morphology of the bryophyte blepharoplast. *Advances Bryol.* 3: 95-134.
- CHAPMAN, R. L. & M. A. BUCHHEIM. 1991. Ribosomal RNA gene sequences: Analysis and significance in the phylogeny and taxonomy of green algae. *C. R. C. Crit. Rev. Pl. Sci.* 10: 343-368.
- CRANDALL-STOTLER, B. 1980. Morphogenetic designs and a theory of bryophyte origins and divergence. *BioScience* 30: 580-585.
- . 1981. Morphology/anatomy of hepatics and anthocerotales. *Advances Bryol.* 1: 315-398.
- CRANE, P. R. 1990. The phylogenetic context of microsporogenesis. Pp. 11-41 in S. Blackmore & R. B. Knox (editors), *Microspores: Evolution and Ontogeny*. Academic Press, London.
- DONOGHUE, M. J. & M. J. SANDERSON. 1992. The suitability of molecular and morphological evidence in reconstructing plant phylogeny. Pp. 340-368 in P. S. Soltis, D. E. Soltis & J. J. Doyle (editors), *Molecular Systematics of Plants*. Chapman & Hall, New York.
- , R. G. OLMSTEAD, J. F. SMITH & J. D. PALMER. 1992. Phylogenetic relationships of Dipsacales based on *rbcL* sequences. *Ann. Missouri Bot. Gard.* 79: 333-345.
- DUCKETT, J. G. & K. S. RENZAGLIA. 1988. Ultrastructure and development of plastids in the bryophytes. *Advances Bryol.* 3: 33-93.
- ECKENRODE, V. K., J. ARNOLD & R. B. MEAGHER. 1985. Comparison of the nucleotide sequence of soybean 18S rRNA with the sequences of other small-subunit rRNAs. *J. Molec. Evol.* 21: 259-269.
- FELSENSTEIN, J. 1978. Cases in which parsimony and compatibility will be positively misleading. *Syst. Zool.* 27: 401-410.
- GARBARY, D. J., K. S. RENZAGLIA & J. G. DUCKETT. 1993. The phylogeny of land plants: A cladistic analysis based on male gametogenesis. *Pl. Syst. Evol.* 188: 237-269.
- GENSEL, P. G. 1992. Phylogenetic relationships of the zosterophylls and lycopsids: Evidence from morphology, paleoecology, and cladistic methods of inference. *Ann. Missouri Bot. Gard.* 79: 450-473.
- GRAHAM, L. E. 1985. The origin of the life cycle of land plants. *Amer. Sci.* 73: 178-186.



- , C. F. DELWICHE & B. D. MISHLER. 1991. Phylogenetic connections between the "green algae" and the "bryophytes." *Advances Bryol.* 4: 213-244.
- GRAUR, D. 1993. Molecular phylogeny and the higher classification of eutherian mammals. *Trends Ecol. Evol.* 8: 141-147.
- GUNDERSON, J. H., H. ELWOOD, A. INGOLD, K. KINDLE & M. L. SOGIN. 1987. Phylogenetic relationships between chlorophytes, chrysophytes, and oomycetes. *Proc. Natl. Acad. Sci. U.S.A.* 84: 5823-5827.
- HÉBANT, C. 1977. The Conducting Tissues of Bryophytes. J. Cramer, Vaduz.
- HENDRIKS, L., Y. VAN DE PEER, M. VAN HERCK, J. M. NEEFS & R. DEWACHTER. 1990. The 18S ribosomal RNA sequence of the sea anemone *An. sulcata* and its evolutionary position among other eukaryotes. *Fed. Eur. Biochem. Soc. Lett.* 269: 445-449.
- HUSS, V. A. R. & M. L. SOGIN. 1990. Phylogenetic position of some *Chlorella* species within the Chlorococcales based upon complete small-subunit ribosomal RNA sequences. *J. Molec. Evol.* 31: 432-442.
- KÄLLERSJÖ, M., J. S. FARRIS, A. G. KLUGE & C. BULT. 1992. Skewness and permutation. *Cladistics* 8: 275-287.
- KANTZ, T. S., E. C. THERIOT, E. A. ZIMMER & R. L. CHAPMAN. 1990. The Pleurostrophyceae and Micromonadophyceae: A cladistic analysis of nuclear rRNA sequence data. *J. Phycol.* 26: 711-721.
- KENDRICK, P. & P. R. CRANE. 1991. Water-conducting cells in early fossil land plants: Implications for the early evolution of tracheophytes. *Bot. Gaz.* 152: 335-356.
- KLUGE, A. J. 1989. A concern for evidence and a phylogenetic hypothesis of relationships among *Epicrates* (Boidae, Serpentes). *Syst. Zool.* 38: 7-25.
- LEWIS, L. A., L. W. WILCOX, P. A. FUERST & G. L. FLOYD. 1992. Concordance of molecular and ultrastructural data in the study of zoosporic Chlorococcalean green algae. *J. Phycol.* 28: 375-380.
- LIGRONE, R. & R. GAMBARDILLA. 1988. The sporophyte-gametophyte junction in bryophytes. *Advances Bryol.* 3: 255-274.
- MADDISON, W. P. & D. R. MADDISON. 1992. *MacClade: Analysis of Phylogeny and Character Evolution*, 3.0. Sinauer Associates, Sunderland, Massachusetts.
- MATTOX, K. R. & K. D. STEWART. 1984. Classification of the green algae: A concept based on comparative cytology. Pp. 29-72 in D. E. G. Irvine & D. M. John (editors), *The Systematics of Green Algae*. Academic Press, London.
- MELKONIAN, M. 1990. Chlorophyte orders of uncertain affinities: Order Microthamniales. Pp. 652-654 in L. Margulis, J. O. Corliss, M. Melkonian & D. J. Chapman (editors), *Handbook of Protoctista*. Jones and Bartlett Publishers, Boston.
- MINDELL, D. P. 1991. Aligning DNA sequences: Homology and phylogenetic weighting. Pp. 73-89 in M. M. Miyamoto & J. Cracraft (editors), *Phylogenetic Analysis of DNA Sequences*. Oxford Univ. Press, New York.
- MISHLER, B. D. 1994. Cladistic analysis of molecular and morphological data. *Amer. J. Phys. Anthropol.* 94: 143-156.
- & S. P. CHURCHILL. 1984. A cladistic approach to the phylogeny of the "bryophytes." *Brittonia* 36: 406-424.
- & ———. 1985. Transition to a land flora: Phylogenetic relationships of the green algae and bryophytes. *Cladistics* 1: 305-328.
- , M. J. DONOGHUE & V. A. ALBERT. 1991. The decay index as a measure of relative robustness within a cladogram. *Hennig X*. Toronto, Ontario. [Abstract.]
- , K. BREMER, C. J. HUMPHRIES & S. P. CHURCHILL. 1988. The use of nucleic acid sequence data in phylogenetic reconstruction. *Taxon* 37: 391-395.
- , P. H. THRALL, J. S. HOPPLE, JR., E. DELUNA & R. VILGALYS. 1992. A molecular approach to the phylogeny of bryophytes: Cladistic analysis of chloroplast-encoded 16S and 23S ribosomal RNA genes. *Bryologist* 95: 172-180.
- MIYAMOTO, M. M. 1985. Consensus cladograms and general classifications. *Cladistics* 1: 186-189.
- O'KELLY, C. J. & G. FLOYD. 1984. Flagellar apparatus, absolute orientations, and the phylogeny of the green algae. *BioSystems* 16: 227-251.
- PALMER, J. D., R. K. JANSEN, H. J. MICHAELS, M. W. CHASE & J. R. MANHART. 1988. Chloroplast DNA variation and plant phylogeny. *Ann. Missouri Bot. Gard.* 75: 1180-1206.
- PICKETT-HEAPS, J. D. 1979. Electron microscopy and the phylogeny of green algae and land plants. *Amer. Zoologist* 19: 545-554.
- RAUSCH, H., N. LARSEN & R. SCHMITT. 1989. Phylogenetic relationships of the green alga *Volvox carteri* deduced from small-subunit ribosomal RNA comparisons. *J. Molec. Evol.* 29: 255-265.
- SLUIMAN, H. J. 1985. A cladistic evaluation of the lower and higher green plants (Viridiplantae). *Pl. Syst. Evol.* 149: 217-232.
- . 1989. The green algal class Ulvophyceae—An ultrastructural survey and classification. *Cryptog. Bot.* 1: 83-94.
- STEELE, K. P., K. HOLSINGER, R. JANSEN & D. TAYLOR. 1991. Assessing the reliability of 5S rRNA sequence data for phylogenetic analysis in green plants. *Molec. Biol. Evol.* 8: 240-248.
- STEWART, K. D. & K. R. MATTOX. 1975. Comparative cytology, evolution and classification of the green algae with some consideration of the origin of other organisms with chlorophylls a and b. *Bot. Rev.* 41: 104-135.
- SWOFFORD, D. L. 1991. *PAUP: Phylogenetic Analysis Using Parsimony*, 3.1. Illinois Nat. Hist. Surv., Champaign, Illinois.
- TAKAIWA, F., K. OONO & M. SUGUIRA. 1984. The complete nucleotide sequence of a rice 17S rRNA gene. *Nucl. Acids Res.* 12: 5441-5448.
- THERIOT, E. 1988. A review of Sluiman's cladistic classification of green plants with particular reference to flagellar data and to land plant origins. *Taxon* 37: 913-919.
- WATERS, D. A., M. A. BUCHHEIM, R. A. DEWEY & R. L. CHAPMAN. 1992. Preliminary inferences of the phylogeny of bryophytes from nuclear-encoded ribosomal RNA sequences. *Amer. J. Bot.* 79: 459-466.
- WILCOX, L. W., L. A. LEWIS, P. A. FUERST & G. L. FLOYD. 1992. Assessing the relationships of asexual and zoosporic chlorococcalean green algae



- 
- with 18S rDNA sequence data. *J. Phycol.* 28: 381-386.
- ZECHMAN, F. W., E. C. THERIOT, E. A. ZIMMER & R. L. CHAPMAN. 1990. Phylogeny of the Ulvophyceae (Chlorophyta): Cladistic analysis of nuclear-encoded rRNA sequence data. *J. Phycol.* 26: 700-710.
- ZIMMER, E. A., R. K. HAMBY, M. L. ARNOLD, D. A. LEBLANC & E. C. THERIOT. 1989. Ribosomal RNA phylogenies and flowering plant evolution. Pp. 205-214 *in* B. Fernholm, K. Bremer & H. Jornvall (editors), *The Hierarchy of Life*. Elsevier, Amsterdam.