REVIEW OF WESTERN ATLANTIC SPECIES OF COCCULINID AND PSEUDOCOCCULINID LIMPETS, WITH DESCRIPTIONS OF NEW SPECIES (GASTROPODA: COCCULINIFORMIA)

JAMES H. McLEAN¹ AND M. G. HARASEWYCH²

CONTENTS

| | |
|--|----|
| ABSTRACT | 3 |
| INTRODUCTION | 3 |
| MATERIALS AND METHODS | 3 |
| KEY TO WESTERN ATLANTIC COCCULINIDAE AND PSEUDOCOCCULINIDAE | 4 |
| SYSTEMATICS | 6 |
| Family Cocculinidae | 6 |
| Genus <i>Cocculina</i> Dall, 1882 | 8 |
| <i>Cocculina rathbuni</i> Dall, 1882 | 8 |
| <i>Cocculina messingi</i> , new species | 11 |
| <i>Cocculina emsoni</i> , new species | 13 |
| Genus <i>Coccopigya</i> Marshall, 1986 | 13 |
| <i>Coccopigya spinigera</i> (Jeffreys, 1883) | 13 |
| <i>Coccopigya mikkelsenae</i> , new species | 14 |
| Genus <i>Coccocrater</i> Haszprunar, 1987 | 16 |
| <i>Coccocrater pocillum</i> (Dall, 1890), new combination | 16 |
| <i>Coccocrater portoricensis</i> (Dall & Simpson, 1901), new combination | 17 |
| Genus <i>Fedikovella</i> Moskalev, 1976 | 17 |
| <i>Fedikovella caymanensis</i> Moskalev, 1976 | 17 |
| <i>Fedikovella beanii</i> (Dall, 1882) | 19 |
| Family Pseudococculinidae | 22 |
| Genus <i>Notocrater</i> Finlay, 1926 | 24 |
| <i>Notocrater houbricki</i> , new species | 24 |
| <i>Notocrater youngi</i> , new species | 26 |
| Genus <i>Tentaoculus</i> Moskalev, 1976 | 27 |
| <i>Tentaoculus eritmeta</i> (Verrill, 1884), new combination | 27 |
| <i>Tentaoculus georgiana</i> (Dall, 1927), new combination | 28 |
| Genus <i>Caymanabyssia</i> Moskalev, 1986 | 28 |
| <i>Caymanabyssia spina</i> Moskalev, 1976 | 28 |
| Genus <i>Kaiparapelta</i> Marshall, 1986 | 28 |
| <i>Kaiparapelta askewi</i> , new species | 28 |
| Genus <i>Copulabyssia</i> Haszprunar, 1988 | 29 |
| <i>Copulabyssia leptalea</i> (Verrill, 1884) | 29 |
| Genus <i>Amphiplica</i> Haszprunar, 1988 | 29 |
| <i>Amphiplica venezuelensis</i> McLean, 1988 | 29 |
| REALLOCATED TAXA | 30 |
| “ <i>Cocculina</i> ” <i>conica</i> Verrill, 1884 | 30 |
| “ <i>Cocculina</i> ” <i>dalli</i> Verrill, 1884 | 30 |
| “ <i>Cocculina</i> ” <i>reticulata</i> Verrill, 1885 | 31 |

1. Natural History Museum of Los Angeles County, 900 Exposition Boulevard, Los Angeles, California 90007.
2. Department of Invertebrate Zoology, National Museum of Natural History, Smithsonian Institution, Washington, D.C. 20560.

| | |
|--|----|
| " <i>Cocculina</i> " <i>lissocona</i> Dall, 1927 | 31 |
| " <i>Cocculina</i> " <i>rotunda</i> Dall, 1927 | 32 |
| " <i>Cocculina</i> " <i>superba</i> Clarke, 1960 | 32 |
| ACKNOWLEDGMENTS | 32 |
| LITERATURE CITED | 32 |

ABSTRACT. Western Atlantic members of the limpet families Cocculinidae and Pseudococculinidae are reviewed. Previously described species are allocated to current genera, and new species are described. A key to species is provided.

Family Cocculinidae: The genus *Cococrater* Haszprunar, 1987, is recognized in the western Atlantic. New species are *Cocculina messingi*, *Cocculina emsoni*, and *Coccopigya mikkelsenae*. New combinations are *Cococrater pocillum* (Dall, 1890) and *Cococrater portoricensis* (Dall & Simpson, 1901). Moskalev's (1976) assignment of *Fedikovella beanii* (Dall, 1882) is confirmed, and an English translation of the original description of *Fedikovella caymanensis* Moskalev, 1976, is given. Lectotypes are designated for *Cocculina rathbuni* Dall, 1882, *Cococrater pocillum* (Dall, 1890), and *Fedikovella beanii* (Dall, 1882).

Family Pseudococculinidae: The genera *Notocrater* Finlay, 1926, *Tentaoculus* Moskalev, 1976, and *Kaiparapelta* Marshall, 1986, are recognized in the western Atlantic. New species are *Notocrater houbrieki*, *N. youngi*, and *Kaiparapelta askewi*. New combinations are *Tentaoculus eritmeta* (Verrill, 1884) and *T. georgiana* (Dall, 1927). Waren's (1991) assignment of *Copulabyssia leptalea* is confirmed, and an English translation of *Caymanabyssia spina* Moskalev, 1976, is given. A lectotype is designated for *Tentaoculus georgiana* (Dall, 1927).

Six taxa originally proposed in *Cocculina* Dall, 1882, are removed from Cocculinidae or Pseudococculinidae and assigned to other families, although not confirmed as valid species.

INTRODUCTION

Limpets of the families Cocculinidae and Pseudococculinidae occur on biogenic substrates at bathyal and abyssal depths. The recent collection of a number of new species as well as fresh material of some previously described species has enabled us to reevaluate all the previously described taxa from the tropical western Atlantic and the northwestern Atlantic.

Until recently these families were poorly known. A worldwide renaissance of interest in the group started with Moskalev (1976), followed by Hickman (1983), Marshall (1986), Haszprunar (1987, 1988a, 1988b), McLean (1987, 1988, 1991, 1992), and Dantart and Luque (1994). The number of genera has increased: currently there are 6 genera recognized in the family Cocculinidae and 12 in the family Pseudococculinidae.

During the 19th century there were nine taxa proposed in the genus *Cocculina* from the western Atlantic. Original descriptions and illustrations of the species described by Verrill and Dall were copied by Pilsbry (1890) and Thiele (1909). C.W. Johnson (1934) and Abbott (1974) listed 10 and 11 species, respectively, but no new information was added because few species were reported subsequent to their initial descriptions.

Although many of the previously described species have not been collected again, there is sufficient information in their original descriptions to allow most of them to be more precisely allocated to the genera that are now available. Of the 13 species originally described in *Cocculina*, only 5 now remain in the family Cocculinidae. Two are now placed in the Pseudococculinidae. Six other taxa proposed in *Cocculina* are removed to genera in other families but are not allocated at the specific level.

The four species of Cocculinidae and five species of Pseudococculinidae described from the western Atlantic over the last two decades bring the total to nine species of Cocculinidae and eight species of Pseudococculinidae, a total that greatly exceeds the number of species known from the eastern Pa-

cific. This number can be expected to increase as studies using research submersibles continue. All of the recently added new species and records have come to light from work with submersibles in both the western Atlantic and eastern Pacific, from either sampling of biogenic substrates or experimental work with larval settling.

MATERIALS AND METHODS

Species for which we have freshly collected material are treated here in detail; those known to us only from the type material are briefly treated. Revised English translations of the original Russian descriptions of two species described by Moskalev (1976) are also included.

Two species described in 1882 by Dall were based on material from widely separated localities, without designation of type localities. We have located only some of the original syntypes in the USNM collection, but we take this opportunity to designate lectotypes and corresponding type localities for *Cocculina rathbuni* Dall, 1882, and *Fedikovella beanii* (Dall, 1882), in order to facilitate comparison with the freshly collected material reported herein.

New material, collected using the research submersibles *Johnson-Sea-Link I* and *II* and *Clelia*, has come from several sources: three species were collected in the course of experimental work on larval settling conducted off New Providence Island, Bahamas, by Craig Young, Roland Emson, and Paul A. Tyler; two species were sampled during studies of stalked crinoids off Grand Bahama Island by Charles Messing; two species from off St. Vincent, Lesser Antilles, were found in the collections of the Harbor Branch Oceanographic Museum, and one species was collected off South Carolina by Harasewych.

Radulae were examined with scanning electron microscopy (SEM) after dissolution of tissues in NaOH, air-drying, and coating with carbon and gold-palladium. For specimens in which the preservation was adequate, bodies were critical-point dried and coated, and the external anatomy examined with SEM.

Parameters for shell measurements are shown in figure 1. The abbreviations for the measurements are used in the key to species that follows.

Abbreviations of museum repositories are LACM, Los Angeles County Museum of Natural History; HBOM, Harbor Branch Oceanographic Museum, Fort Pierce, Florida; and USNM, National Museum of Natural History, Washington, D.C.

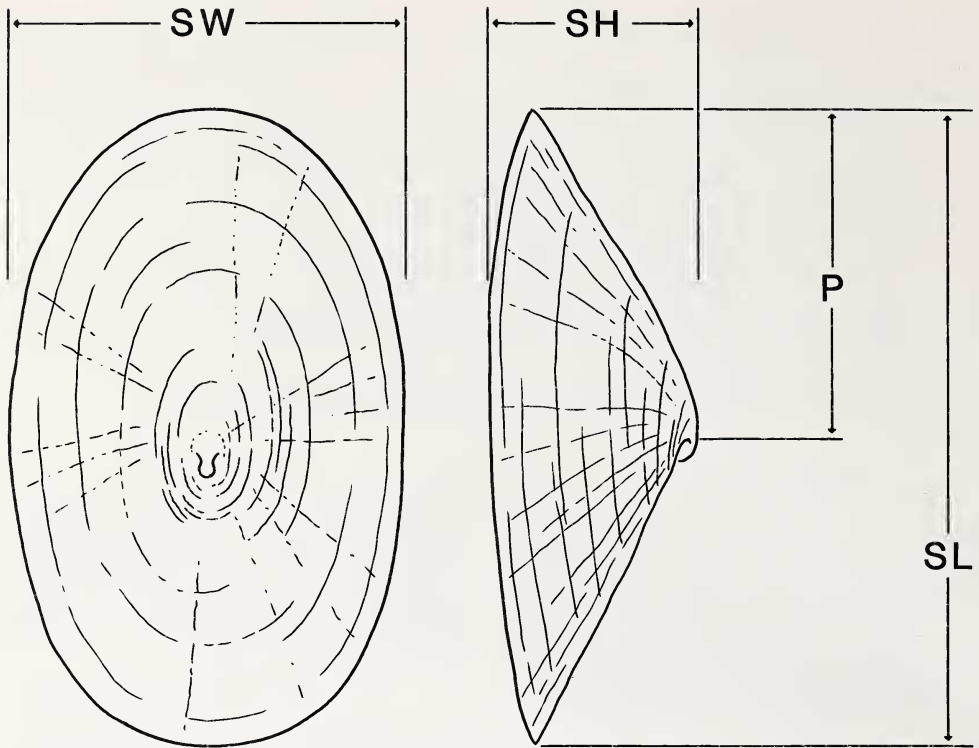
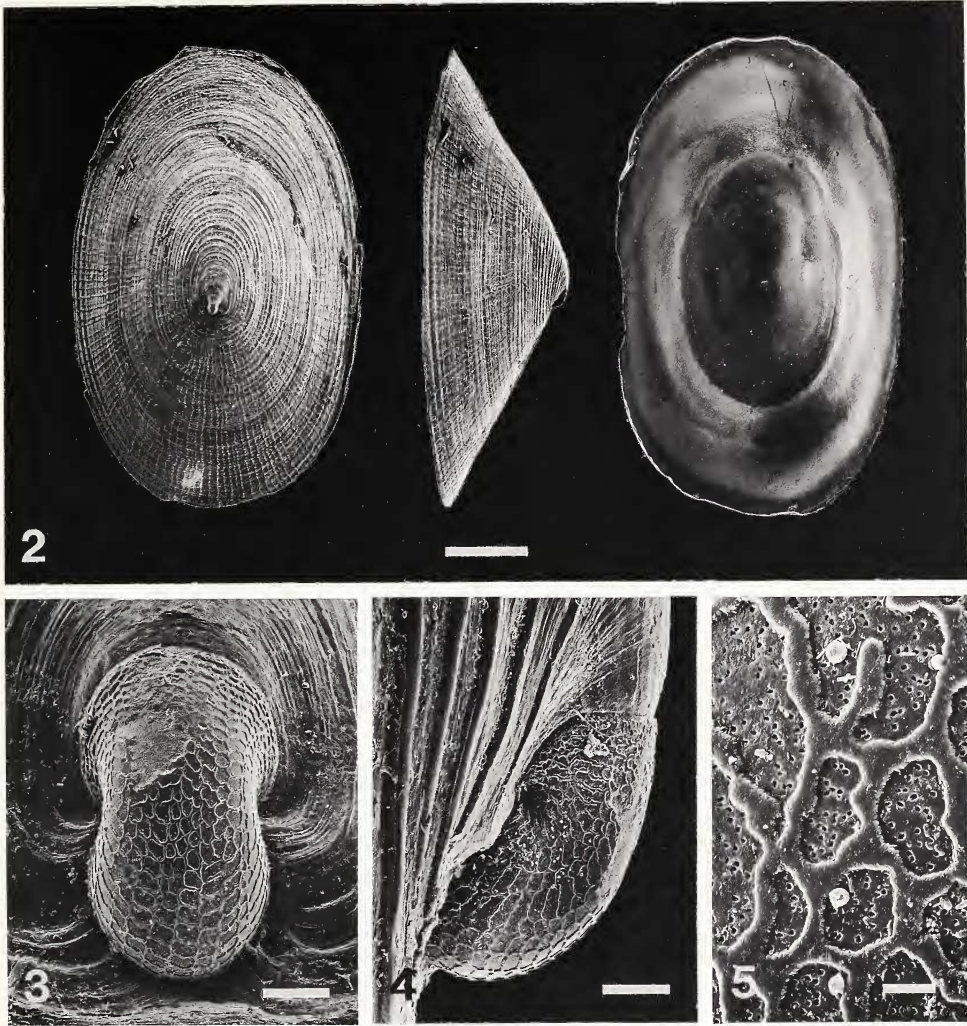

Figure 1. Shell measurements. P = apex position, measured from anterior margin of the shell to anterior margin of the protoconch; SH = shell height, maximum dorsoventral dimension measured perpendicular to the plane of the aperture; SL = shell length, measured from the anterior margin to the posterior margin of the aperture; SW = shell width, maximum lateral dimension of aperture measured perpendicular to the SL axis.

**KEY TO
WESTERN ATLANTIC COCCULINIDAE
AND PSEUDOCOCCULINIDAE**

- 1) Apical fold of protoconch short and broad; protoconch sculpture of reticulate or concentric net; radula slightly asymmetrical, 3 inner lateral teeth (Cocculinidae) 2
 - Apical fold of protoconch long and narrow; protoconch sculpture of pustulose crystals or anastomosing threads; radula strongly asymmetrical, 4 inner lateral teeth (Pseudococculinidae) 10
- 2) Protoconch with concentric sculpture (*Fedikovella*) 3
 - Protoconch with reticulate (honeycomb) sculpture 4
- 3) Apex overhanging posterior margin of shell ...
 - *Fedikovella caymanensis* Moskalev, 1976
 - Apex not overhanging posterior margin of shell *Fedikovella beanii* (Dall, 1882)
- 4) Shell with pits in radial rows; periostracum with raised hairs or spines (*Coccopygia*) 5
 - Shell without pits; periostracum smooth .. 6
- 5) Shell high (SH/SL > 0.35); apex near posterior margin of shell (P/SL > 0.8)
 - *Coccopygia spinigera* (Jeffreys, 1883)
 - Shell low (SH/SL > 0.30); apex nearly central (P/SL < 0.6) *Coccopygia mikkelsenae*, new species
- 6) Copulatory organ at tip of right oral lapper (*Cocculina*) 7
 - Copulatory organ branched from right cephalic tentacle (*Coccocrater*) 9
- 7) Shell high (SH/SL > 0.40), with 1 anterior and 2 posterior keels; apex posterior of center (P/SL > 0.6) ... *Cocculina emsoni*, new species
 - Shell low (SH/SL < 0.38), lacking keels; apex near center (P/SL < 0.6) 8
- 8) Shell with radial sculpture more prominent than concentric sculpture; pigmented eyes absent ...
 - *Cocculina rathbuni* Dall, 1882
 - Shell with concentric sculpture more prominent than axial sculpture; pigmented eyes present *Cocculina messingi*, new species
- 9) Shell high (SH/SL > 0.45); apex near posterior margin (P/SL > 0.7)
 - *Coccocrater pocillum* (Dall, 1890)
 - Shell low (SH/SL < 0.45); apex anterior of center (P/SL < 0.5) *Coccocrater portoricensis* (Dall & Simpson, 1901)
- 10) Shell with interior septum; protoconch finely



Figures 2-5. *Cocculina rathbuni* Dall, 1882. 2. Dorsal, lateral, and ventral views of shell (USNM 860363). Scale bar = 1.0 mm. 3, 4. Dorsal and lateral views of protoconch of specimen in figure 1. Scale bars = 50 μm. 5. Detail of protoconch sculpture in figure 3. Scale bar = 5 μm.

- | | |
|--|---|
| <p>pitted (<i>Tentaoculus</i>) 11</p> <p>- Shell lacking interior septum; protoconch without pits 12</p> <p>11) Shell low (SH/SL < 0.40); apex near center (P/SL < 0.6)</p> <p> <i>Tentaoculus eritmeta</i> (Verrill, 1884)</p> <p>- Shell high (SH/SL > 0.40); apex near posterior margin (P/SL > 0.7)</p> <p> <i>Tentaoculus georgiana</i> (Dall, 1927)</p> <p>12) Teleoconch sculpture granulate 13</p> <p>- Teleoconch sculpture of raised concentric ridges 16</p> <p>13) Protoconch with anastomosing threads; teleoconch sculpture granulate (<i>Notocrater</i>) . . 14</p> <p>- Protoconch with prismatic crystals; teleoconch sculpture of anastomosing network 15</p> <p>14) Protoconch finely pustulose; teleoconch</p> | <p>coarsely pustulose; eyes present; foot and mantle edge with fine brown spots</p> <p> <i>Notocrater houbricki</i>, new species</p> <p>- Protoconch coarsely pustulose; teleoconch finely pustulose; eyes absent; foot and mantle uniformly beige in color</p> <p> <i>Notocrater youngi</i>, new species</p> <p>15) Shell without posterior ridges or indentations in margin; teleoconch with sharp conical granules forming diagonally reticulate pattern</p> <p> <i>Caymanabyssia spina</i> Moskalev, 1976</p> <p>- Shell with 2 posterior ridges producing indentations in margin; teleoconch lacking diagonally oriented conical granules</p> <p> <i>Kaiparapelta askewi</i>, new species</p> <p>16) Shell small, length < 4 mm</p> <p> <i>Copulabyssia leptalea</i> (Verrill, 1884)</p> |
|--|---|

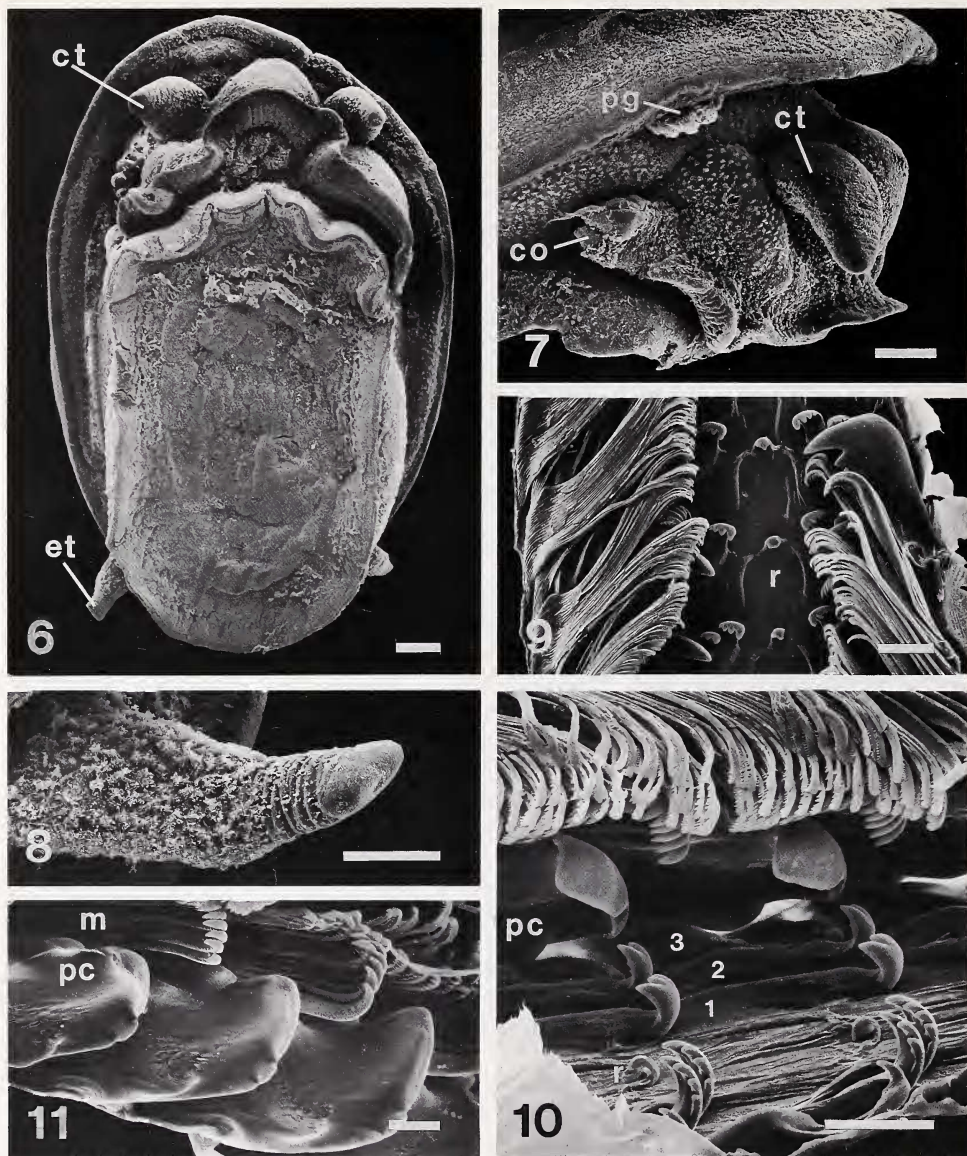

Figures 6–11. *Cocculina rathbuni* Dall, 1882. 6. Ventral view of critical-point-dried animal (shell in figures 2–5). Scale bar = 200 μm . 7. Right lateral view of head. Scale bar = 200 μm . 8. Right epipodial tentacle. Scale bar = 100 μm . 9. Dorsal view of radular ribbon. Scale bar = 20 μm . 10. Lateral view of longitudinally cut radula, revealing relative heights of tooth fields. Scale bar = 20 μm . 11. Detail of pluricuspid and marginal teeth. Scale bar = 10 μm .

co = copulatory organ; ct = cephalic tentacle; et = epipodial tentacle; m = marginal teeth; pc = pluricuspid tooth; pg = pseudoplicatid gill; r = rachidian tooth; 1 = first lateral tooth; 2 = second lateral tooth; 3 = third lateral tooth.

- Shell large, length > 7 mm
- *Amphiplica venezuelensis* McLean, 1988

SYSTEMATICS

Family Cocculinidae Dall, 1882

DIAGNOSIS. Apical fold of protoconch short and broad; protoconch sculpture of reticulate net. Radula slightly asymmetrical, inner lateral teeth 3.

REMARKS. Marshall (1986) defined a number

of cocculinid genera on shell and radular characters; Haszprunar (1987, 1988b) treated anatomy of cocculinid genera and compared the group to other cocculiniform families. These works should be consulted for further details.

Six genera of Cocculinidae are currently recognized: *Cocculina* Dall, 1882, *Coccopigya* Marshall, 1986, *Cococrater* Haszprunar, 1987, *Paracocculina* Haszprunar, 1987, *Fedikovella* Moskalev, 1976, and *Teuthirostria* Moskalev, 1976. No species of

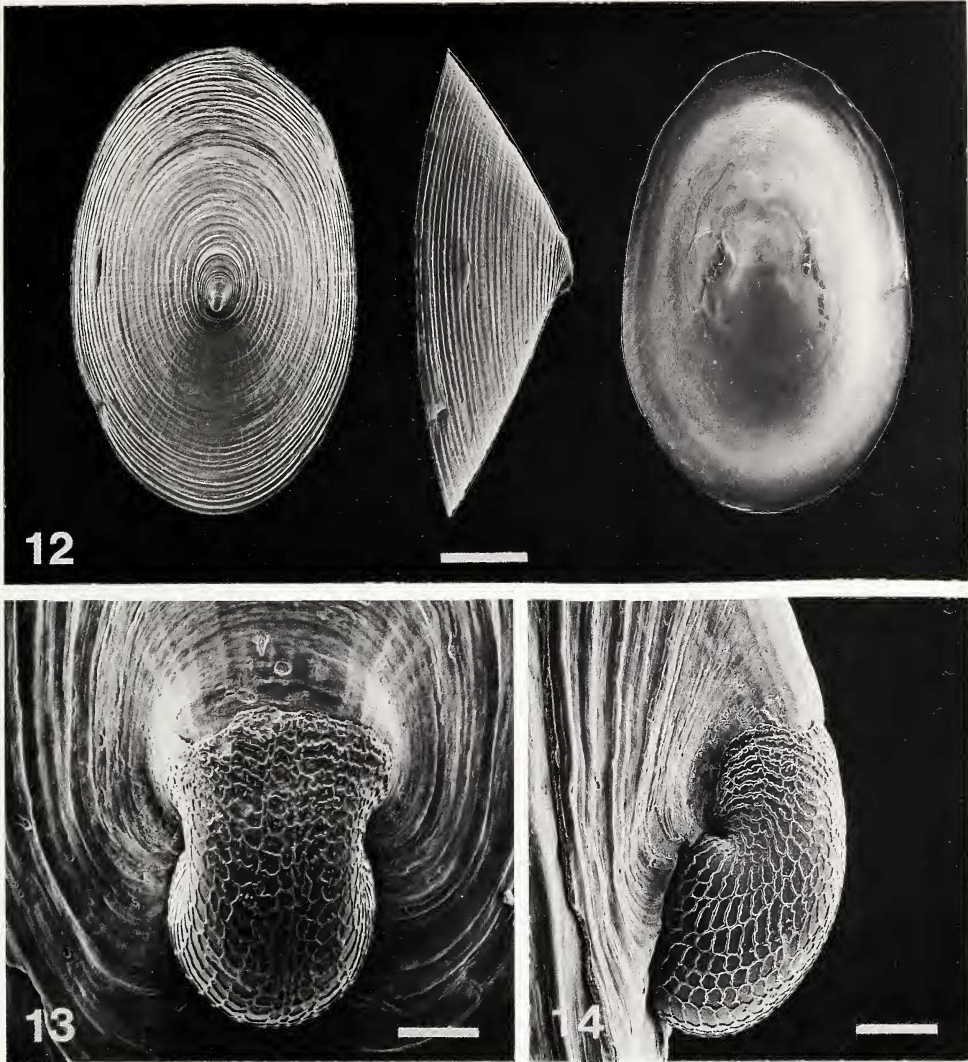

Figures 12-14. *Cocculina messingi*, new species. 12. Dorsal, lateral, and ventral views of holotype. Scale bar = 1.0 mm. 13, 14. Dorsal and lateral views of protoconch of holotype. Scale bars = 50 μ m.

Paracocculina and *Teuthirostria* are known from the western Atlantic or eastern Pacific.

Four of the genera (excepting *Fedikovella* and *Teuthirostria*) have protoconch sculpture of a raised honeycomb network aligned in longitudinal rows. The most significant character for separation of genera is the position of the copulatory organ in these simultaneous hermaphrodites: modified tip of right oral lappet in *Cocculina*, branched from the base of right cephalic tentacle in *Coccopigya* and *Cococrater*, from right side of foot in *Paracocculina*, but yet unknown in *Fedikovella* and *Teuthirostria*. The genus *Coccopigya* can be recognized by its hirsute periostracum, but no clear separation of *Cocculina*, *Cococrater*, and *Paracocculina* can be defined on shell or radular characters.

Species in most genera have a pair of posterior epipodial tentacles (figures 5, 8) and a pseudoplicatid gill (figures 15, 19), as defined by Haszprunar (1987), on the right side.

Marshall considered the ridges on the edge of the rachidian tooth to represent vestiges of the first laterals, numbering the further laterals as 2-4. However, to avoid ambiguity, we number the slender lateral teeth that have cusps as 1-3 (figure 10, 1-3). The large multicuspid tooth that separates the laterals from the marginals is here called the pluricuspid tooth (figures 10, 11, pc) rather than lateral tooth 4, as it has no features in common with the other lateral teeth. The pluricuspid teeth are the largest teeth and are clearly the most effective teeth in the row.

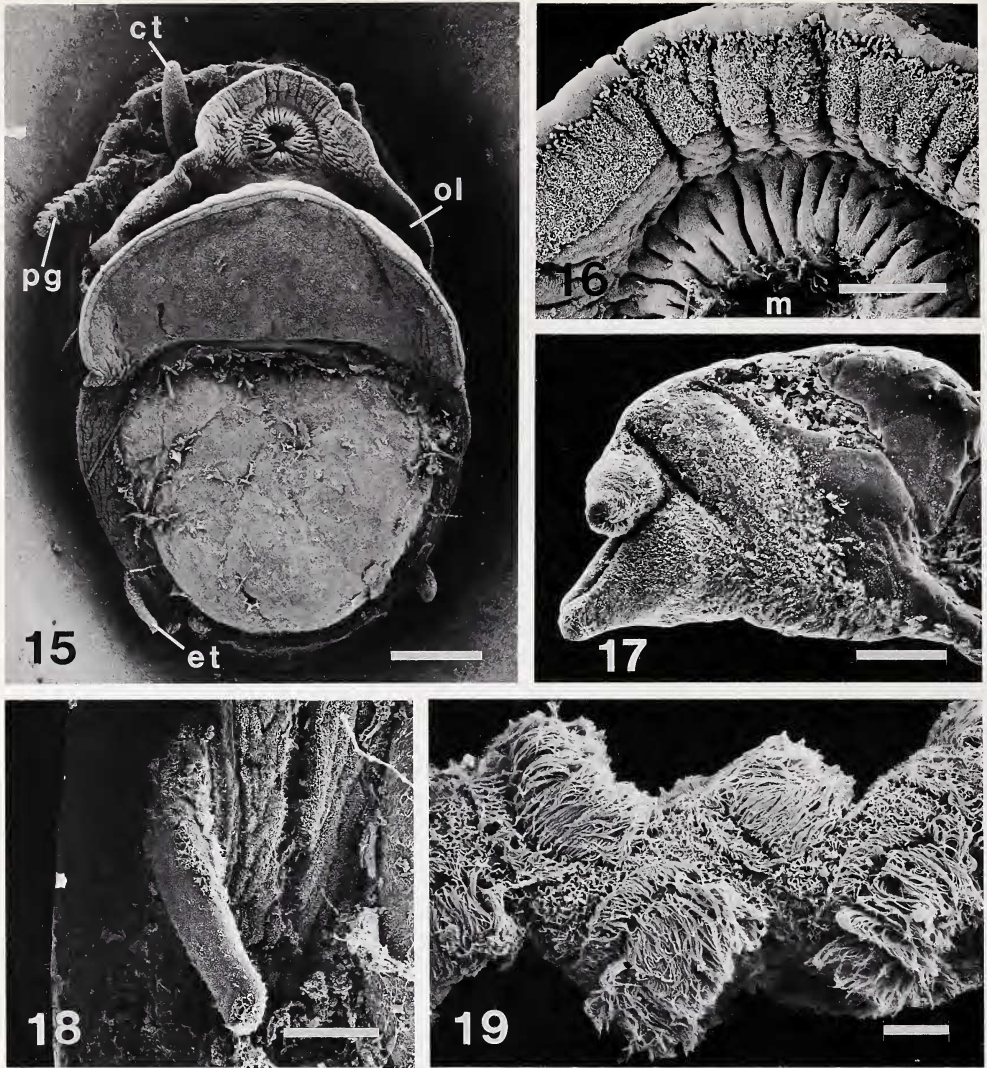

Figures 15-19. *Cocculina messingi*, new species. 15. Ventral view of critical-point-dried animal of holotype. Scale bar = 200 μ m. 16. Anterior margin of oral lappet. Scale bar = 100 μ m. 17. Copulatory organ. Scale bar = 100 μ m. 18. Right epipodial tentacle. Scale bar = 100 μ m. 19. Detail of pseudoplicatid gill. Scale bar = 20 μ m.
 ct = cephalic tentacle; et = epipodial tentacle; m = mouth; ol = oral lappet; pg = pseudoplicatid gill.

Genus *Cocculina* Dall, 1882

Type species (subsequent designation, Dall, 1908: 340): *Cocculina rathbuni* Dall, 1882.

DIAGNOSIS. Protoconch with honeycomb sculpture, periostracum smooth; teleoconch sculpture of fine radial ribs and growth lines; copulatory organ at tip of right oral lappet.

REMARKS. *Cocculina* is represented in the western Atlantic by the type species and two new species here described: *C. messingi* and *C. emsoni*. Other western Atlantic taxa described in this genus are herein reallocated to other genera or enumerated under a heading of species for which the generic affinity or synonymy has not been established.

In the eastern Pacific, the genus is represented by *C. baxteri* McLean, 1987, *C. cowani* McLean, 1987, and *C. craigsmiti* McLean, 1992, the last unique in the family for its occurrence on whale bone.

Cocculina rathbuni Dall, 1882

Figures 2-11

Cocculina rathbuni Dall, 1882:402; Dall, 1889:347, pl. 15, figs. 5, 7; Pilsbry, 1890:132, pl. 25, figs. 5, 6 [copy of Dall]; Dall, 1908:340 [type designation]; Thiele, 1909:6, pl. 2, figs. 1, 2; C.W. Johnson, 1934:66 [checklist only]; Abbott, 1974:34, fig. 192; McLean, 1987:325, figs. 1-4.

DESCRIPTION. Shell (figure 2) medium to large-

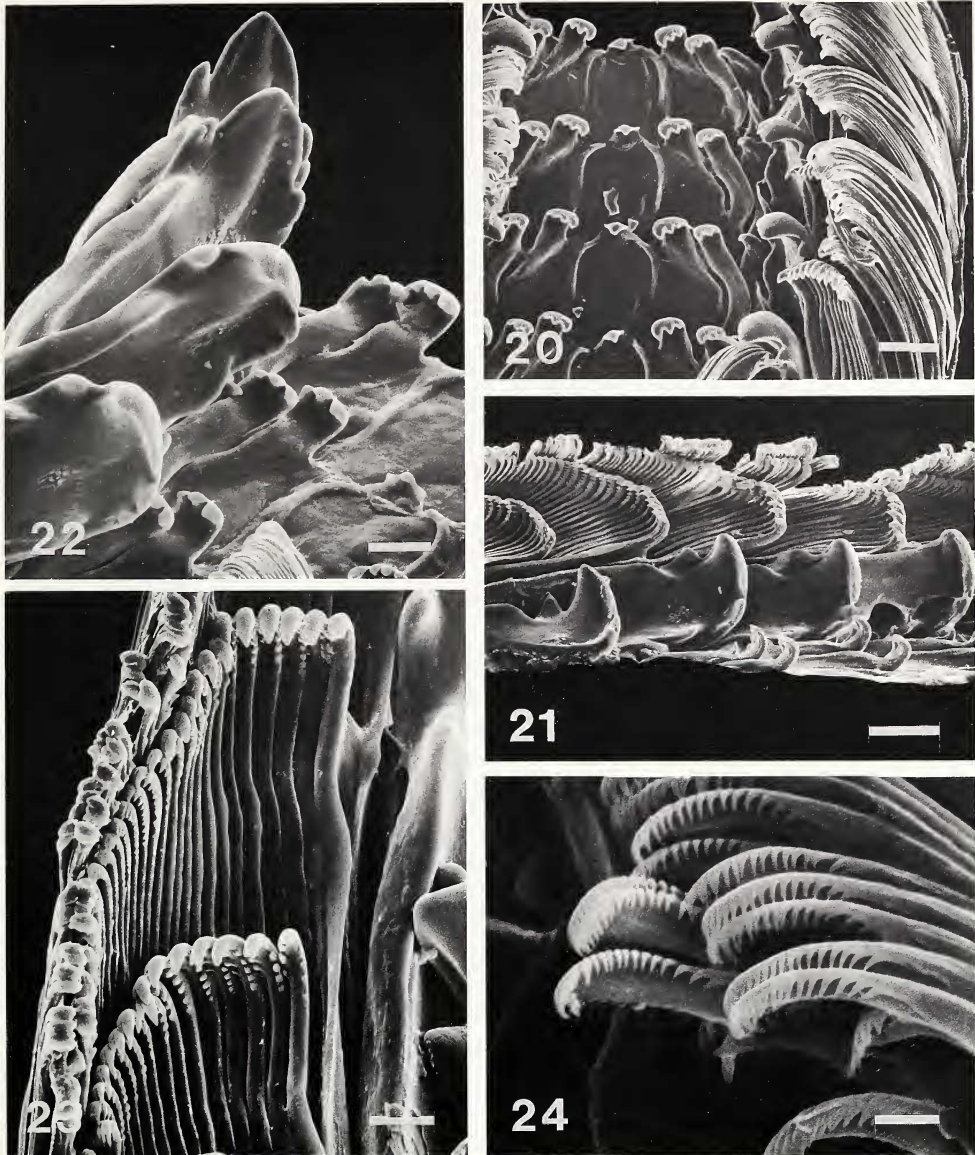

Figures 20–24. *Cocculina messingi*, new species. 20. Dorsal view of radular ribbon. Scale bar = 20 μm . 21. Lateral view of longitudinally cut radula revealing relative heights of tooth fields. Scale bar = 20 μm . 22. Detail of rachidian, lateral, and pluricuspid teeth. Scale bar = 10 μm . 23. Detail of marginal teeth. Scale bar = 6 μm . 24. Detail of distal ends of outer marginal teeth. Scale bar = 2 μm .

sized for family (maximum length 11 mm), thin, not eroded, white, periostracum thin. Shell height moderate, that of illustrated specimen 0.35 times length. Anterior and posterior slopes nearly straight, lateral slopes slightly convex. Outline in dorsal view elongate-oval, anterior end slightly narrower than posterior end; aperture not planar, ends raised relative to sides of shell. Apex slightly posterior to center, protoconch slightly below highest point of shell, extending posteriorly. Protoconch length 240 μm , protoconch sculpture of honeycomb net pat-

tern, aligned longitudinally in rows (figures 3, 4). Surface within netted area of protoconch finely pitted (figure 5). Tip of protoconch immersed in posterior slope of shell. Teleoconch sculpture of raised concentric growth lines and fine radial striae; concentric sculpture more prominent than radial sculpture, not raised at intersections with radial striae. Shell edge thin and sharp.

Dimensions. Length 11, width 6.5, height 2.75 mm (original description); length 5.7, width 3.9, height 2.0 mm (figure 2).

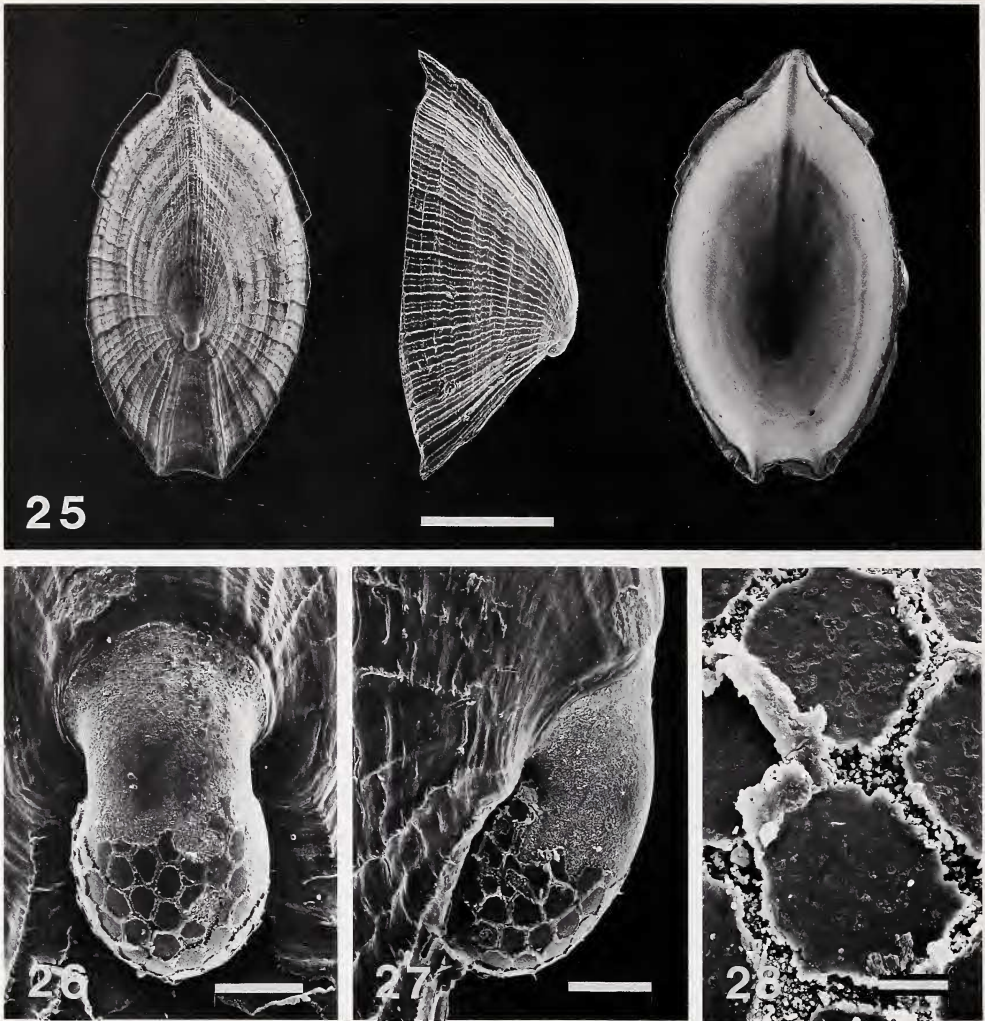

Figures 25–28. *Cocculina emsoni*, new species. 25. Dorsal, lateral, and ventral views of holotype. Scale bar = 1.0 mm. 26, 27. Dorsal and lateral views of protoconch of holotype. Scale bars = 50 μ m. 28. Detail of protoconch sculpture in figure 26. Scale bar = 5 μ m.

External Anatomy (figures 6–8). Eyes lacking, copulatory organ at tip of right oral lappet, basal portion enlarged, producing bilobed effect; pseudoplicatid gill on right side dorsal to oral lappet; pair of posterior epipodial tentacles (figures 6, 8), with tufts of cilia under high magnification (figure 8); area at side of head with tufts of cilia like those of epipodial tentacles (figure 7).

Radula (figures 9–11). Rachidian broad, outer edges weakly defined, tip with single small overhanging cusp; first lateral with four cusps on outer edge, second with three, third singly cusped; pluricuspid long and broad, with inner and outer cusps. Marginals similar in size.

NEW RECORD. Off Southwest Reef, New Providence Island, Bahamas (24°54'04"N, 77°33'14"W), 518 m, *Johnson-Sea-Link II*, dive 2317, 9 May 1992. Disposition of specimens: USNM

860363, LACM 151187, HBOM 065:03884. On palmetto (*Sabal palmetto*) fronds deployed earlier for sampling of invertebrate settling. According to R. Emson (pers. comm.), this species along with *C. emsoni* is frequently recruited on palmetto substrates at this locality. Further details will be provided in a forthcoming paper by C.M. Young, P.A. Tyler, and R.H. Emson.

REMARKS. Dall mentioned material of *Cocculina rathbuni* from three stations [Massachusetts, Barbados, and Martinique] in the original description, without designation of a holotype or type locality. Although the 11 mm specimen (from Massachusetts?) has not been located, the other two syntypes are present in the USNM. The Barbados specimen (Blake sta. 288, USNM 333750) is a partially dissected, dried animal with no shell. The Martinique specimen (Blake sta. 195, USNM

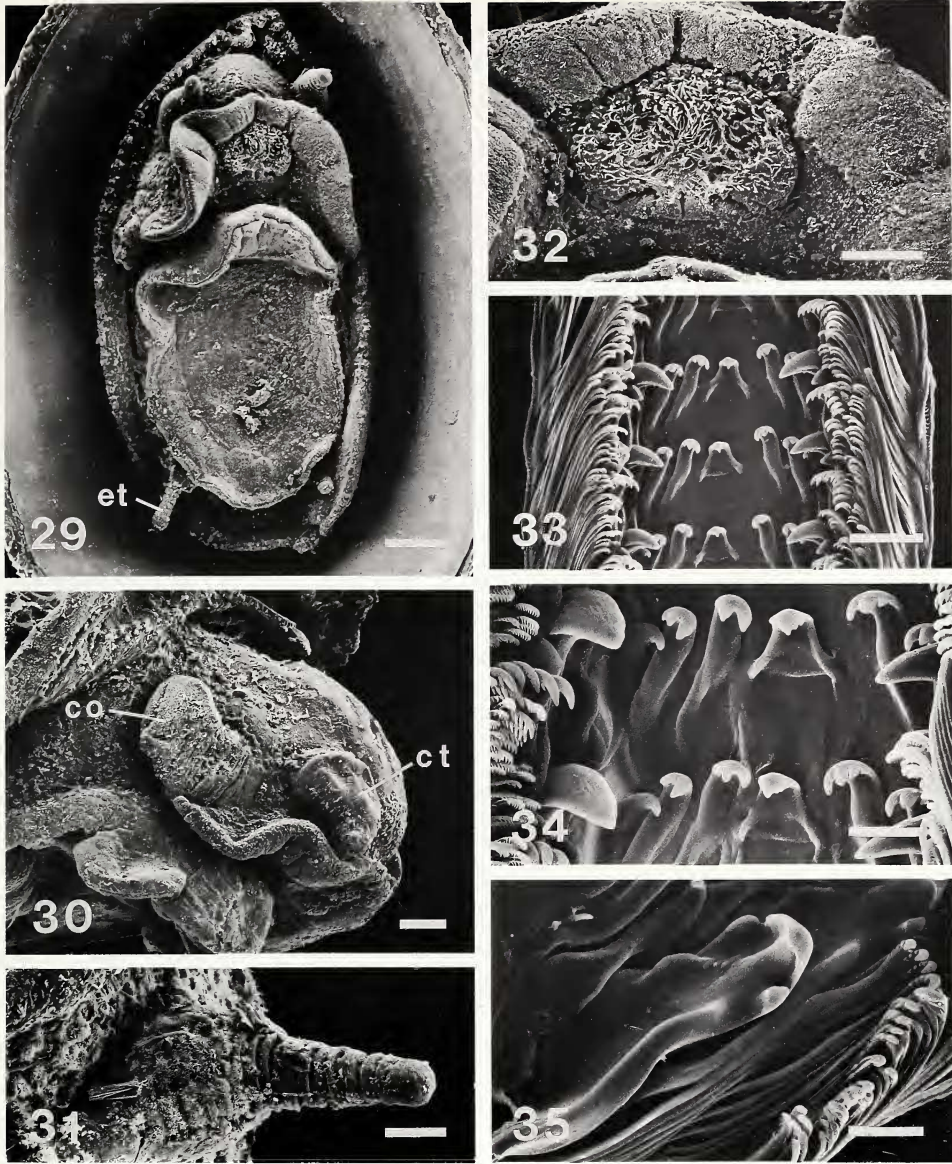

Figures 29–35. *Cocculina emsoni*, new species. 29. Ventral view of critical-point-dried animal of holotype. Scale bar = 200 μm . 30. Right lateral view of head. Scale bar = 50 μm . 31. Right epipodial tentacle. Scale bar = 50 μm . 32. Anterior margin of oral lappet. Scale bar = 100 μm . 33. Dorsal view of radular ribbon. Scale bar = 20 μm . 34. Detail of rachidian and lateral teeth. Scale bar = 10 μm . 35. Detail of pluricuspid and marginal teeth. Scale bar = 10 μm . co = copulatory organ; ct = cephalic tentacle; et = epipodial tentacle.

126807) is correctly labelled *C. rathbuni*; it measures 6.7 mm in length and agrees with our figured specimen and that of McLean (1987). We here designate it the lectotype and Martinique the type locality.

Cocculina messingi, new species

Figures 12–24

DESCRIPTION. Shell (figure 12) medium-sized for family (maximum length 5.5 mm), thin, not

eroded, white, periostracum thin. Shell height moderate, that of holotype 0.38 times length. Anterior and posterior slopes faintly convex, lateral slopes more markedly convex. Outline in dorsal view elongate-oval, anterior end slightly narrower than posterior end; aperture not planar, ends raised relative to sides of shell. Apex slightly posterior to center, protoconch at highest point of shell, extending posteriorly. Protoconch length 200 μm , protoconch sculpture of honeycomb pattern, aligned longitudinally in rows. Tip of protoconch immersed in

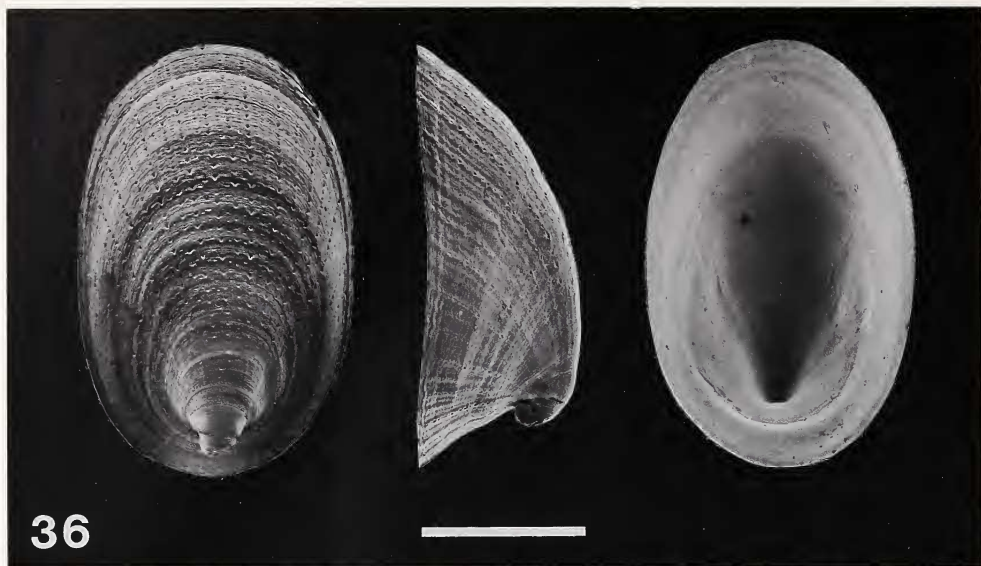

Figures 36–39. *Coccopigya spinigera* (Jeffreys, 1883). 36. Dorsal, lateral, and ventral views of syntype, USNM 177890. Scale bar = 1.0 mm. 37, 38. Dorsal and lateral views of protoconch of syntype in figure 36. Scale bars = 50 μ m. 39. Detail of protoconch sculpture in figure 38. Scale bar = 5 μ m.

posterior slope of shell. Sculpture of raised concentric growth lines and fine radial striae; concentric sculpture more prominent than radial sculpture, not raised at intersections with radial striae. Shell edge thin and sharp. Muscle scar and anterior pallial attachment scar well marked, inner edge of muscle scar irregular.

Dimensions. Length 5.5, width 3.6, height 2.1 mm (holotype); length 5.3, width 3.8, height 2.1 mm (paratype 1); length 5.4, width 4.0, height 2.4 (paratype 2).

External Anatomy (figures 15–19). Animal translucent white, showing red buccal musculature, with large black eyes. Ventral surface of oral lappet with broad ciliated band (figure 16). Penis bilobed, at tip of right oral lappet, with open seminal groove (fig-

ure 17). Pseudoplicate gill showing long bands of cilia (figure 19). Pair of posterior epipodial tentacles (figure 18).

Radula (figures 20–24). Rachidian broad, tip small, with single cusp; first lateral with broad base and three cusps, second lateral narrow, with three cusps, third with single cusp. Pluricuspid long and broad with large central denticle, one smaller denticle on outer and two on inner side. Marginals similar in size.

TYPE LOCALITY. South of Settlement Point, Grand Bahama Island, Bahama Islands (26°37'31"N, 78°58'56"W), 412 m, on pencil-sized piece of wood along with *Notocrater houbricki*, new species.

TYPE MATERIAL. Three specimens from type locality, collected by Dr. Charles Messing, using

deep-submersible *Johnson-Sea-Link II*, dive 2335, 18 May 1992. Holotype USNM 860353, paratype 1 USNM 860354, paratype 2 LACM 2735.

REMARKS. This species differs from *C. rathbuni* as treated above in its coarser concentric sculpture, less prominent radial sculpture, and the presence of prominent black eyes. Eyes have not previously been reported in any species of *Cocculina*.

ETYMOLOGY. The name honors the collector, Charles Messing of Nova University, Dania, Florida.

Cocculina emsoni, new species

Figures 25–35

DESCRIPTION. Shell (figure 25) small for family (maximum length 3.3 mm), thin, not eroded, white, periostracum thin. Shell height moderately high, that of holotype 0.48 times length. Anterior slope convex, posterior slope nearly straight, lateral slopes slightly convex. Outline in dorsal view elongate-oval, anterior end with keeled projection producing concave area close to tip on both sides, posterior with two projecting keels, forming single concave embayment in outline. Anterior end slightly narrower than posterior end; aperture not planar, ends raised relative to sides of shell except that the anterior and posterior keeled projections extend downward. Apex posterior to center, situated at $\frac{2}{3}$ shell length from anterior end. Protoconch below highest point of shell, extending posteriorly. Protoconch length 205 μ m, protoconch sculpture of honeycomb pattern, with raised ridges forming irregular hexagons (figures 26, 27). Surface within the netted area of protoconch finely pitted (figure 28). Tip of protoconch immersed in posterior slope of shell. Sculpture of irregular concentric growth lines and raised radial ribs; secondary radial ribs arising after shell length of 1.5 mm attained. Midline of anterior slope with sharply raised anterior ridge on which there are secondary ribs; posterior slope with two raised keels, between which there are secondary ribs. Shell edge thin and sharp; interior with grooved areas corresponding to strong anterior ridge and two posterior ridges.

Dimensions. Length 3.3, width 1.8, height 1.6 mm (holotype).

External Anatomy (figures 29–32). Penis simple, derived at base of right oral lappet (figure 30); epipodial tentacles and pseudoduplicated gill present.

Radula (figures 33–35). Rachidian broad, basal outline hidden, tip with main cusp and two small lateral cusps; first and second laterals with three cusps on outer edge, third lateral with single cusp; pluricuspid broad, with long main cusp and inner and outer lateral cusps. Marginals similar in size.

TYPE LOCALITY. Off Southwest Reef, New Providence Island, Bahamas (24°54'04"N, 77°33'14"W), 518 m on palmetto fronds. Further details will be provided in a forthcoming paper by R. Emson, C.M. Young, and P.A. Tyler.

TYPE MATERIAL. Three specimens retrieved from palmetto fronds placed on bottom for larval settlement experiments by R. Emson, C.M. Young, and P.A. Tyler, *Johnson-Sea-Link II*, dive 2317, 9 May 1992. Holotype USNM 860355, 1 paratype USNM 860356, 1 paratype LACM 2736.

REMARKS. *Cocculina emsoni* is remarkable for its strong anterior ridge and two posterior ridges. *Cocculina angulata* Watson, 1886, from the Philippines (Watson, 1886:30, pl. 4, fig. 2a–c) has an anterior shell ridge but lacks the two posterior ridges. Direct comparisons of specimens should be made before commenting further about a possible affinity between the two species. For *C. emsoni* it is a reasonable supposition that the two posterior ridges serve to shield the two posterior epipodial tentacles, but the function of the anterior ridge is unknown.

ETYMOLOGY. Named after Roland Emson of King's College London, whose experimental work on larval settling brought this species to light.

Genus *Coccopygia* Marshall, 1986

Replacement name for *Coccopygia* Dall, 1889, nor Reichenbach, 1882. Type species by monotypy: *Cocculina spinigera* Jeffreys, 1883.

DIAGNOSIS. Protoconch with reticulate sculpture (as in *Cocculina*); periostracum thick, hirsute; teleoconch sculpture of radial ribs and pit rows; copulatory organ branched from right cephalic tentacle.

REMARKS. The type species is represented in the northeastern and northwestern Atlantic; a second western Atlantic species is described herein. There are no species known in the eastern Pacific. Marshall (1986) treated five living and three fossil species from New Zealand.

Coccopygia spinigera (Jeffreys, 1883)

Figures 36–39

Cocculina spinigera Jeffreys, 1883:393, pl. 44, figs. 1–1c; Verrill, 1884:203; Pilsbry, 1890:125, pl. 25, figs. 9, 10 [copy Jeffreys]; Abbott, 1974:34 [not fig. 198].

Cocculina (section *Coccopygia*) *spinigera*; Dall, 1889:348, pl. 31, figs. 7–9.

Cocculina (*Coccopygia*) *spinigera*; Thiele, 1909: 15, pl. 3, figs. 9, 10.

Coccopygia spinigera; Marshall, 1986:512, figs. 2B, 3D, E, 12C; Warren, 1991:80, fig. 19A, B, D, F, H; Dantart and Luque, 1994:278, figs. 1–6, 15, 16, 18.

REMARKS. We illustrate the shell and protoconch of a syntype (USNM 177890) from the Outer Hebrides, Scotland, Triton sta. 10 (59°40'N, 7°21'W), 943 m. The fine pits that occur within the net pattern on the protoconch are illustrated here for the first time.

Coccopygia spinigera occurs in the northeastern and northwestern Atlantic south to North Carolina.

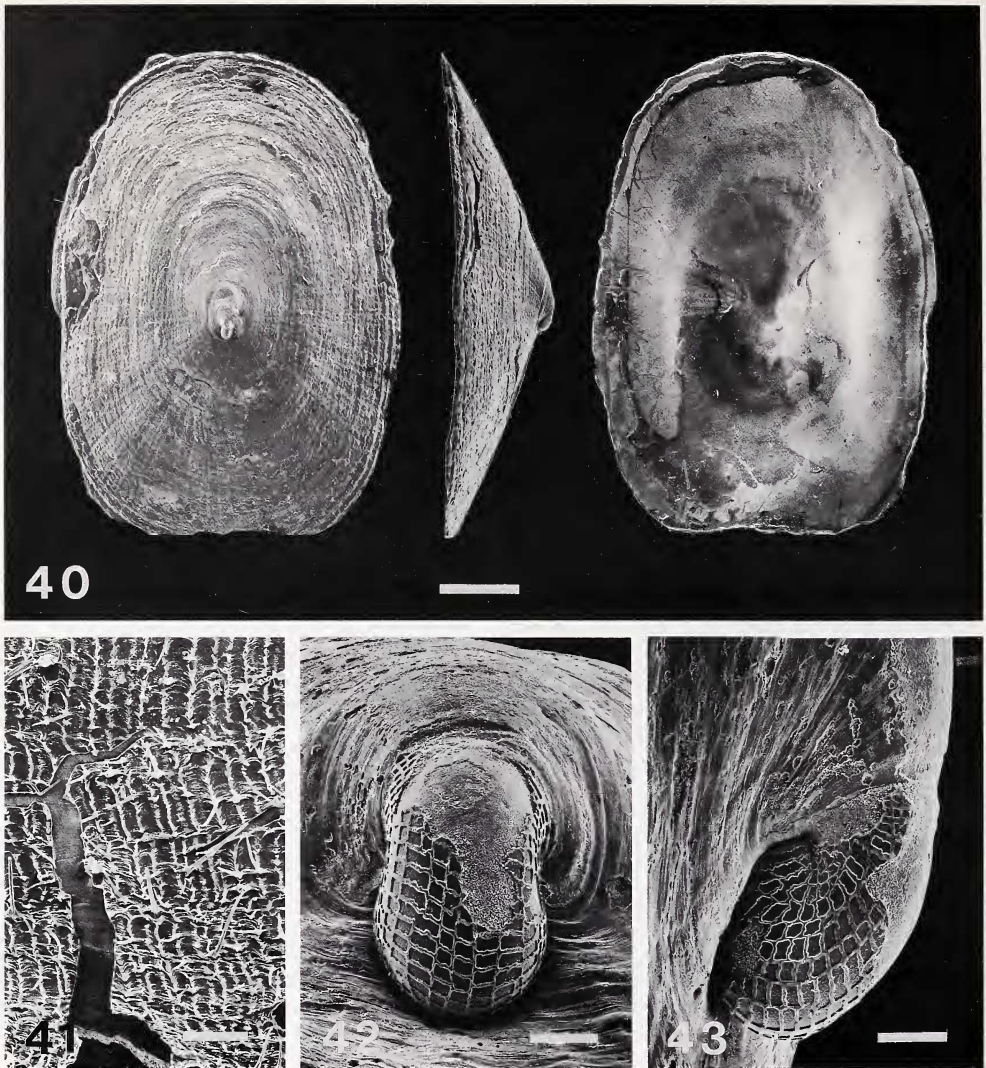

Figures 40–43. *Coccopigya mikkelsenae*, new species. 40. Dorsal, lateral, and ventral views of holotype, periostracum removed. Scale bar = 1.0 mm. 41. Detail of periostracum at shell edge of paratype 1. Scale bar = 100 μ m. 42, 43. Dorsal and lateral views of protoconch of holotype. Scale bars = 50 μ m.

Dall's (1889:pl. 31, fig. 8) original illustrations were based on specimens received from Jeffreys and included a drawing of the copulatory organ. Marshall (1986) included SEM views of the shell and radula and a drawing of the copulatory organ, also based on a syntype specimen. Dall (1889:fig. 9) showed a broad rachidian with three similar-sized cusps, but in Marshall's preparation the rachidian does not show, suggesting that it folded under in drying. Waren (1991) gave SEM views of shells from Iceland. Dantart and Luque (1994) illustrated material from Spain and added a species described by Dautzenberg and Fischer to the synonymy.

Coccopigya mikkelsenae, new species
Figures 40–47

DESCRIPTION. Shell (figure 40) medium-sized for family (maximum length 6.2 mm), thin, not eroded, white under thick periostracum bearing long hairs (figure 41). Shell height low, that of holotype 0.27 times length. All slopes straight to slightly convex. Outline in dorsal view elongate-oval, sides nearly parallel; aperture not planar, sides raised slightly relative to ends. Apex slightly posterior to center, slightly below level of highest point of shell, protoconch extending posteriorly. Protoconch length 210 μ m, protoconch sculpture of honeycomb, nearly rectangular net pattern, aligned longitudinally in rows (figures 42, 43). Tip of protoconch immersed in posterior slope of shell. Sculpture of irregular concentric growth lines and faint radial striae, and scattered, radially aligned pits. Radial and concentric sculpture of equal prominence.



Figures 44–47. *Coccopigya mikkelsenae*, new species. 44. Oblique view of rachidian, lateral, and pluricuspid teeth. Scale bar = 20 μm . 45. Dorsal view of rachidian, lateral, and pluricuspid teeth. Scale bar = 20 μm . 46. Dorsal view of radular ribbon. Scale bar = 25 μm . 47. Detail of marginal teeth. Scale bar = 5 μm .

Shell edge thin and sharp. Muscle scar and anterior pallial attachment scar well marked.

Dimensions. Length 6.2, width 4.7, height 1.7 mm (holotype, posterior end broken); length 6.9, width 4.8, height 2.0 mm (paratype).

External Anatomy. Animal lacking pigmented eyes, penis branching off base of right tentacle, tip of penis with single, tapering lobe. No gill evident, but specimens poorly preserved (body not examined with SEM).

Radula (figures 44–47). Rachidian broad, upper edge broad, small pointed cusp emerging from upper edge; first lateral with secondary cusp on outer edge, second lateral with four cusps, third lateral with single cusp and long shaft. Pluricuspid broad, with large main cusp and inner and outer secondary cusps. Marginals similar in size.

TYPE LOCALITY. Off Chateau Belair Bay, St. Vincent, Lesser Antilles (13°10.5'N, 61°15.5'W), 421 m, on wood, with *Fedikovella beanii*.

TYPE MATERIAL. Two specimens from type locality collected by John E. Miller on deep-submersible *Johnson-Sea-Link II*, dive 1742, 23 April 1989. Holotype, USNM 860357, 1 paratype HBOM 065:03786. Most of the periostracum on the holotype was removed for SEM preparation. The unfigured paratype was also coated for SEM, and the periostracum is in the process of flaking off.

REMARKS. *Coccopigya mikkelsenae* meets the criteria of the genus in having a coarse periostracum with long hairs, corresponding pits along the radial ribs, and the penis branched at the base of right tentacle. The rachidian tooth is broader than that of other members of the family treated here. The single small cusp of the rachidian is also unlike that of other species treated by Marshall (1986).

On shell characters, *Coccopigya mikkelsenae* differs from *C. spinigera* in its lower profile and more central apex.

ETYMOLOGY. We are pleased to name this

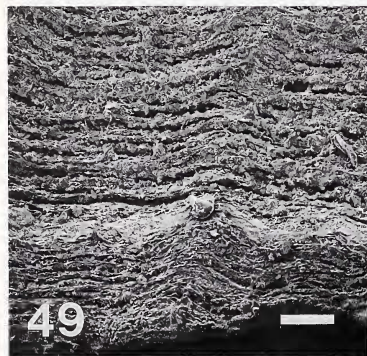
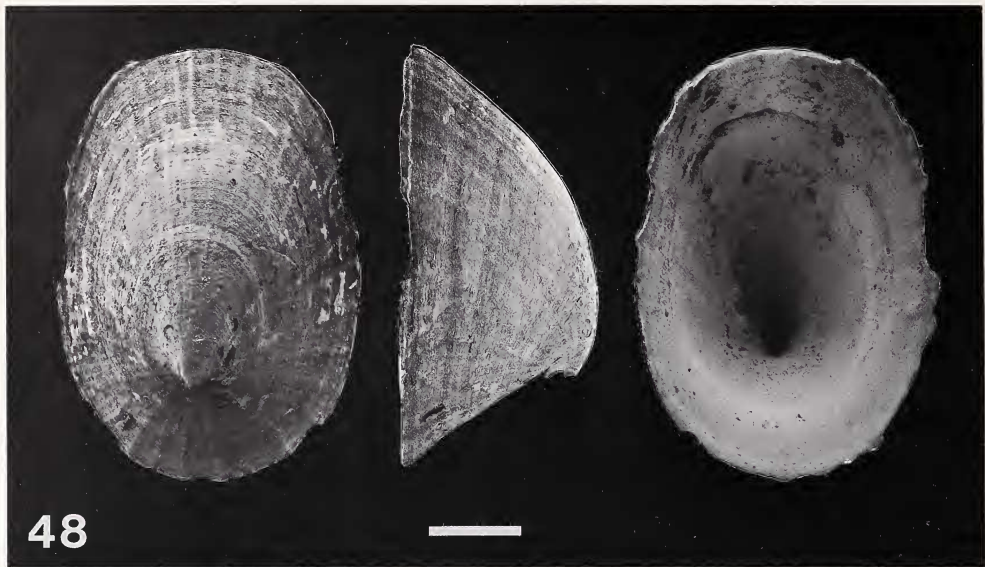

Figures 48, 49. *Coccocrater pocillum* (Dall, 1890). 48. Dorsal, lateral, and ventral views of lectotype (USNM 87586). Scale bar = 1.0 mm. 49. Detail of periostracum at shell edge of lectotype. Scale bar = 100 μ m.

species after Paula Mikkelsen of the Harbor Branch Oceanographic Museum, Fort Pierce, Florida, who brought the material to our attention.

Genus *Coccocrater*
Haszprunar, 1987

Type species by original designation: *Cocculina radiata* Thiele, 1903.

DIAGNOSIS. Protoconch with reticulate sculpture, periostracum smooth; teleoconch sculpture of fine radial ribs and growth lines; copulatory organ branched from right cephalic tentacle.

REMARKS. This genus differs from *Coccolpigya*, which also has the copulatory organ as a branch from the base of the right cephalic tentacle, in lacking the hirsute periostracum.

Haszprunar's (1987:321) diagnosis states that the copulatory organ is "associated with the right cephalic tentacle." McLean (1987:330) incorrectly stated "the enlarged right cephalic tentacle serving as the penis."

The genus is represented in the eastern Pacific by *Coccocrater agassizii* (Dall, 1908), treated by Haszprunar (1987) and McLean (1987).

Coccocrater pocillum
(Dall, 1890),
new combination
Figures 48, 49

Cocculina (*Coccolpigya*) *pocillum* Dall, 1890:340; Thiele, 1909:16.

REMARKS. This previously unfigured species was described from 1600 m off Tobago. The periostracum lacks hairs (figure 49) and each specimen had a "well marked verge extending from the right tentacle," a character combination that agrees with *Coccocrater*. Dall also reported that the species lacks epipodial filaments. A lectotype shell (USNM 87586) is designated and illustrated here (length 4.65, width 3.45, height 2.5 mm). The remaining paralectotype specimen is recataloged as USNM 860386 (length 5.5, width 3.8, height 3.0 mm).



Figure 50. *Coccocrater portoricensis* (Dall & Simpson, 1901). Dorsal, lateral, and ventral views of holotype (USNM 160496). Scale bar = 1.0 mm.

Coccocrater portoricensis
(Dall & Simpson, 1901),
new combination

Figure 50

Cocculina portoricensis Dall and Simpson, 1901:
440, pl. 53, figs. 18, 19; Abbott, 1974:35, fig. 202.
Cocculina (Coccopigya) portoricensis; Thiele, 1909:
16.

REMARKS. This species of 12 mm length from 566 m off San Juan Harbor, Puerto Rico, does not have a hirsute periostracum and was said to have a "large verge projecting from the right tentacle" and the "ctenidium carried over so that it appears to spring from the right side of the animal." Again, this is a character combination in agreement with *Coccocrater*. The species remains known only from the holotype (USNM 160496), reillustrated here (figure 50).

Genus *Fedikovella* Moskalev, 1976

Type species by original designation: *Fedikovella caymanensis* Moskalev, 1976.

DIAGNOSIS. Protoconch with concentric sculpture; periostracum smooth; teleoconch sculpture clathrate, apex overhanging concave posterior slope; cephalic tentacles equal in size.

REMARKS. Moskalev included *Cocculina beanii* Dall, 1882, in *Fedikovella* because of the small rachidian tooth figured by Dall, and the Indo-Pacific *C. capulus* Thiele, 1925, again citing the small rachidian tooth figured by Thiele. We hesitate to accept the inclusion of the latter species. Moskalev's figure of the radula of the type species was based on phase contrast optical microscopy; tooth bases

are not shown and the resolution is sufficient only to place the species in Cocculinidae rather than Pseudococculinidae.

This genus can be accepted on the distinction provided by the peculiar undulating, concentric sculpture of the protoconch shown here (figures 52, 53) for *Fedikovella beanii* (Dall, 1882). However, this sculpture is not radically different from the honeycomb pattern of most cocculinid genera, from which the difference may be only that the longitudinal connections of the net are not formed. Moskalev's (1976:pl. 2, fig. 2) figure of the type species *Fedikovella caymanensis*, which purported to show the protoconch, was instead an enlarged view of the clathrate sculpture of the earliest teleoconch, as also noted by Marshall (1986:508).

There is still no published information about the internal anatomy or whether there is a copulatory appendage of any kind. Dall (1889:347) believed that all four specimens of "*Cocculina*" *beanii* that he examined were females, as it was then not understood that all cocculinids are simultaneous hermaphrodites. However, B. Marshall (pers. comm.) has examined paratype material of *F. beanii* and noted a copulatory organ on the right behind the base of the right cephalic tentacle.

There are no eastern Pacific species allocated to this genus.

Fedikovella caymanensis Moskalev, 1976

Fedikovella caymanensis Moskalev, 1976:62, fig. 1, pl. 2, figs. 1, 2.

Moskalev's description was translated by G.V. Shkurkin in a privately circulated "reprint" dated December 1978. That translation is repeated here,

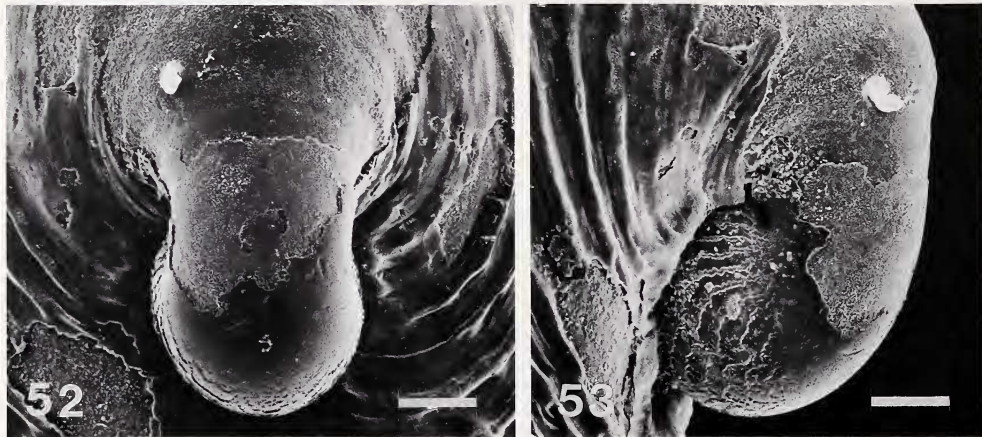

Figures 51–53. *Fedikovella beanii* (Dall, 1882). 51. Dorsal, lateral, and ventral views of shell (USNM 860358). Scale bar = 1.0 mm. 52, 53. Dorsal and lateral views of protoconch of specimen in figure 51. Scale bars = 50 μ m.

altered to place it in telegraphic style and with terminology slightly changed in places to conform to that used elsewhere in this paper:

Shell small, high, thin, apex projecting to posterior margin or beyond. Protoconch with concentric sculpture, protoconch pressed against posterior slope of shell. Anterior slope convex, posterior slope short, straight. Aperture elliptical, margin whole. Color opaque cream; periostracum well developed. Sculpture of intersecting radial and concentric ribbing, forming nearly equilateral quadrangles; radial ribs wider than concentric ribs; ribbing worn in places. Shell interior yellowish white, exterior sculpture showing through. Rachidian tooth denticulate, similar to first to third lateral teeth; first and second lateral teeth denticulate, pluricuspid

tooth largest, having three denticles. Cephalic tentacles equal in size; two posterior epipodial tentacles present. Shell length 1.43–4.10 mm.

TYPE LOCALITY. Western end of Cayman Trough (19°00'6"N, 80°29'5"W), 6800 m. 33 specimens on wood, collected with research vessel *Academic Kurchatov*, cruise 14, sta. 1242A, 2.5 m Sigsbee dredge, 20 March 1967. Additional locality: east end Cayman Trough (19°38'5"N, 76°37'8"W), sta. 1267, 6740–6780 m, 5 specimens on various vegetative remains.

REMARKS. Moskalev's illustrations do not include a full view of the shell nor is there any indication of actual shell height. Most Cocculinidae occur at continental shelf and slope depths, and this species is unusual in its abyssal occurrence.

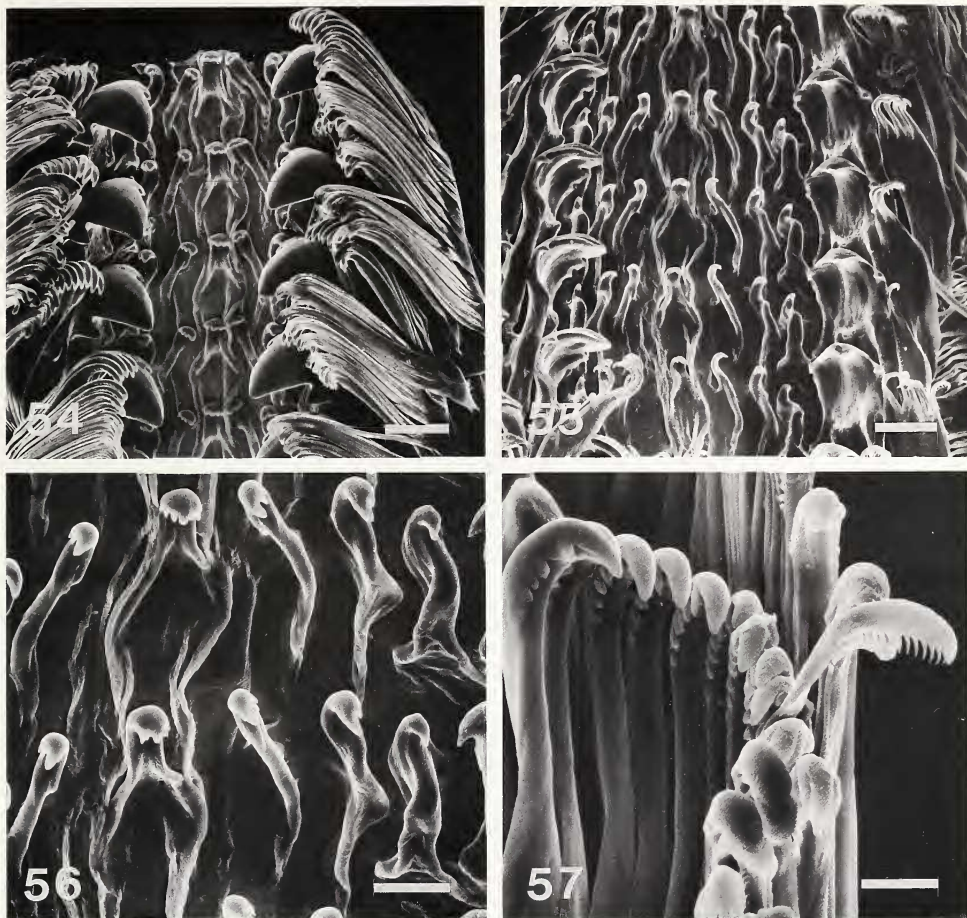

Figures 54–57. *Fedikovella beanii* (Dall, 1882). 54. Dorsal view of radular ribbon. Scale bar = 25 μ m. 55. Dorsal view of radular ribbon with marginal teeth folded back. Scale bar = 25 μ m. 56. Detail of rachidian and lateral teeth. Scale bar = 12.5 μ m. 57. Detail of distal ends or outer marginal teeth. Scale bar = 5 μ m.

Fedikovella beanii (Dall, 1882)

Figures 51–57

Cocculina beanii Dall, 1882:403; Dall, 1889:347, pl. 25, figs. 2, 4, 8; Pilsbry, 1890:132, pl. 25, figs. 23, 24 [copy Dall]; Thiele, 1909:6, pl. 2, figs. 3, 4; C.W. Johnson, 1934:66 [checklist only]; Abbott, 1974:34, fig. 194 [copy Dall].

Fedikovella beanii; Moskalev, 1976:64 [as *beanii*].

DESCRIPTION. Shell (figure 51) medium-sized for family (maximum length 8 mm, original description), thin, not eroded, white, periostracum thin. Shell moderately high, that of illustrated specimen 0.47 times length. Anterior slope convex, posterior slope concave, lateral slopes nearly straight. Outline in dorsal view oval, anterior end slightly narrower than posterior end; aperture planar, ends not raised relative to sides of shell. Apex posterior to center, to left of midline; situated at $\frac{2}{3}$ shell length from anterior end. Protoconch below highest point of shell, extending posteriorly. Proto-

conch length 240 μ m, protoconch sculpture (at least near tip where unworn) of parallel, concave ridges aligned to extend across but not longitudinally. Surface near ridges with fine pits (figures 52, 53). Tip of protoconch immersed in posterior slope of shell. Sculpture of raised concentric ridges and radial ribs of lesser strength, producing beaded effect particularly on posterior slope and at growth stages greater than 3 mm in shell length. Shell edge thin and sharp. Interior with well marked muscle and pallial attachment scars.

Dimensions. Length 8, width 5, height 4 mm (original description); length 5.1, width 3.7, height 2.4 mm (figure 51).

External Anatomy. Dall (1882) reported equal cephalic tentacles and the gill longer and larger than that of *Cocculina rathbuni*. Preservation was poor in the present material, and it was not used for critical-point drying and SEM examination. No gill or penis was apparent; pigmented eyes were lacking; two posterior epipodial tentacles were present.

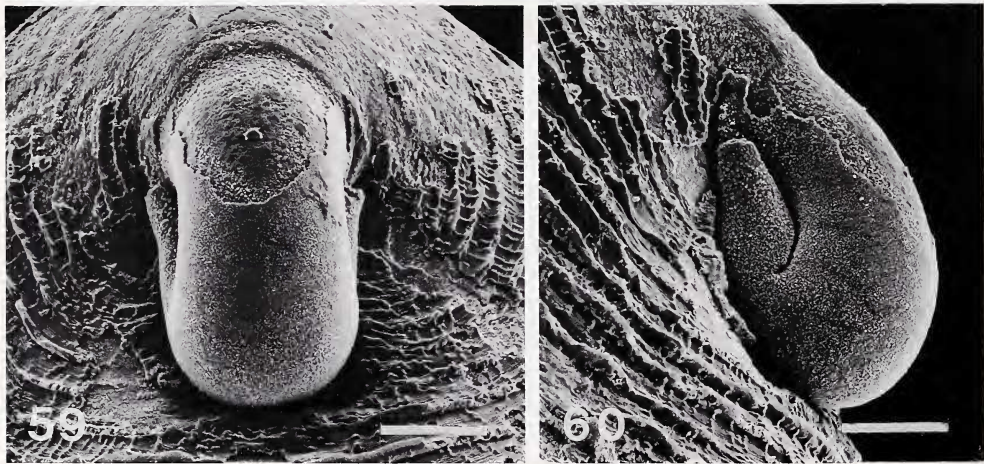

Figures 58–60. *Notocrater houbricki*, new species. 58. Dorsal, lateral, and ventral views of holotype. Scale bar = 1.0 mm. 59, 60. Dorsal and lateral views of protoconch of holotype. Scale bars = 50 μ m.

Radula (figures 54–57). Rachidian tooth with narrow, elevated shaft, overhanging cusp with central and two lateral denticles of similar size; base of shaft bifurcated, superimposed on broader basal membrane; first and second lateral teeth narrow, elbowed, with main cusp and one or two lateral cusps on outer edge, third lateral tooth with single cusp. Pluricuspid broad, with tapered main cusp and inner and outer lateral cusps. Marginals of similar size.

NEW RECORD. Off Chateau Belair Bay, St. Vincent, Lesser Antilles (13°10.5'N, 61°15.5'W, 421 m, on wood, with *Coccapigyra mikkelsenae*, new species. Eight specimens collected by deep-submersible *Johnson-Sea-Link II*, dive 1742, 23 April 1989. Distribution: 3 specimens USNM 860358, 3 specimens HBOM 065:03787, 2 specimens LACM 151188.

REMARKS. Dall's original description gave several localities and station numbers, including south of Martha's Vineyard Island, Massachusetts, and Martinique, but did not cite a catalog number or designate a type locality. Here we designate a lectotype, USNM 333751 from USFC sta. 997, 335 fms off Martha's Vineyard Island. The specimen is 6.46 mm in length, chipped at the posterior margin. A slip marked "Type Fig'd." accompanies the specimen. This seems to be the specimen illustrated by Dall (1889). The largest specimen of *Fedikovella beanii* in the USNM collection is 7.2 mm in length, from Blake sta. 195, 502.5 fms, off Martinique.

Dall's original description emphasized that the anterior slope was longer than in *Cocculina rathbuni* and the sculpture stronger and more cancellated, "even slightly spinous at intersections." The rachidian (figured later by Dall, 1889) was said to

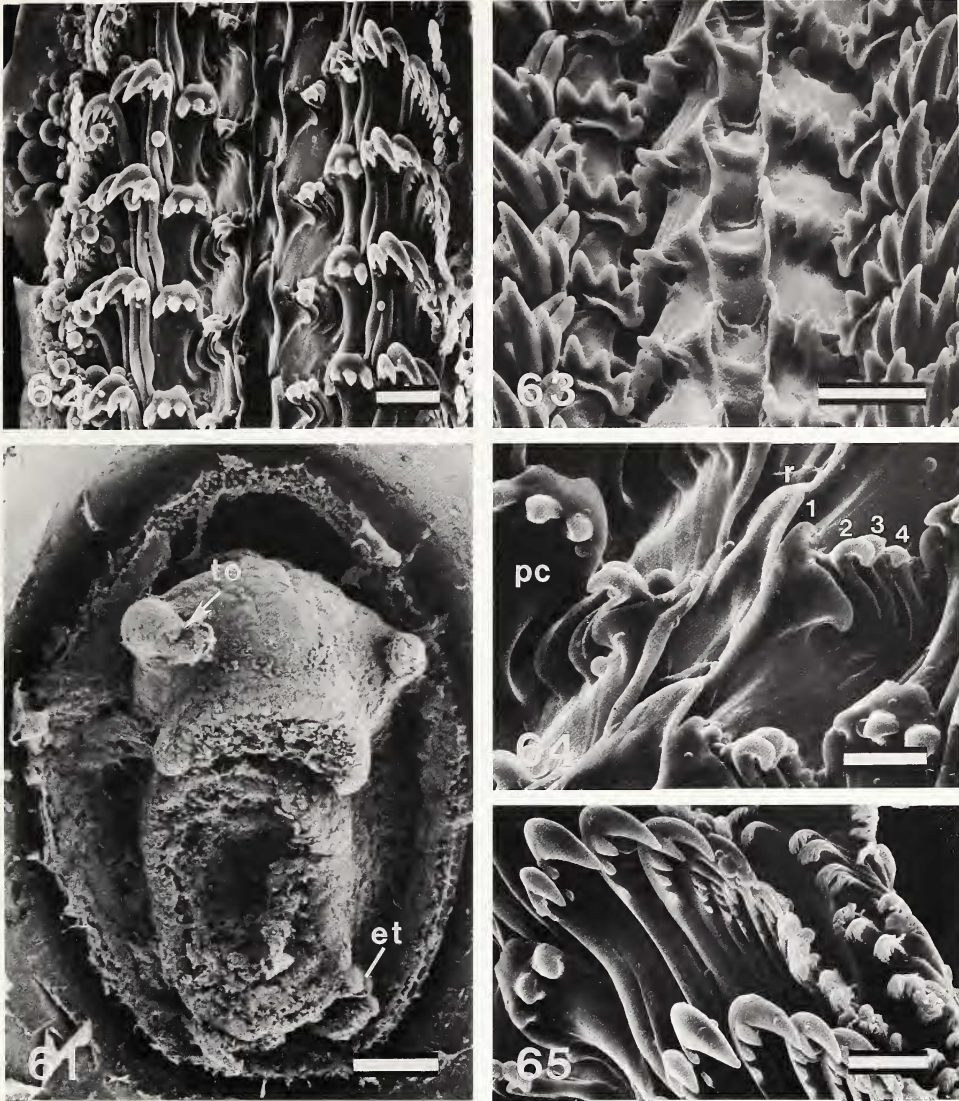

Figures 61–65. *Notocrater houbricki*, new species. 61. Ventral view of critical-point-dried animal of paratype 1. Scale bar = 100 μm . 62. Dorsal view of radular ribbon. Scale bar = 10 μm . 63. Anterior view of rachidian, lateral, and pluricuspid teeth. Scale bar = 10 μm . 64. Detail of rachidian and lateral teeth. Scale bar = 5 μm . 65. Detail of pluricuspid and marginal teeth. Scale bar = 5 μm .

et = epipodial tentacle; pc = pluricuspid tooth; r = rachidian tooth; to = tentacular opening; 1 = first lateral tooth; 2 = second lateral tooth; 3 = third lateral tooth; 4 = fourth lateral tooth.

have a tridentate cusp and bifurcate base. This is consistent with figure 56 here, in which a more extended base of the rachidian is revealed, but one that would have been obscured in the optical microscopic preparation available to Dall. Dall reported seven to eight cusps on the pluricuspid, compared to a main and two lateral cusps indicated in figure 54. However, Dall's preparation may have been worn and the actual cusp count unclear, as in figure 55. This possible discrepancy and the fact that our material showed no gill (due perhaps to poor preservation) casts some doubt on our con-

clusion that the present material represents Dall's species. However, the profile view of our illustrated specimen (figure 51) is a good match for the first 5-mm shell length in profile view of the supposed 8-mm specimen figured by Dall.

Fedikovella beanii differs from *F. caymanensis* in not having the apex overhang the posterior margin of the shell, as specified, but not illustrated by Moskalev. The depth range of *F. beanii* is consistent with the shelf and slope depths of other cocculinids, unlike the abyssal depth reported for the type species.

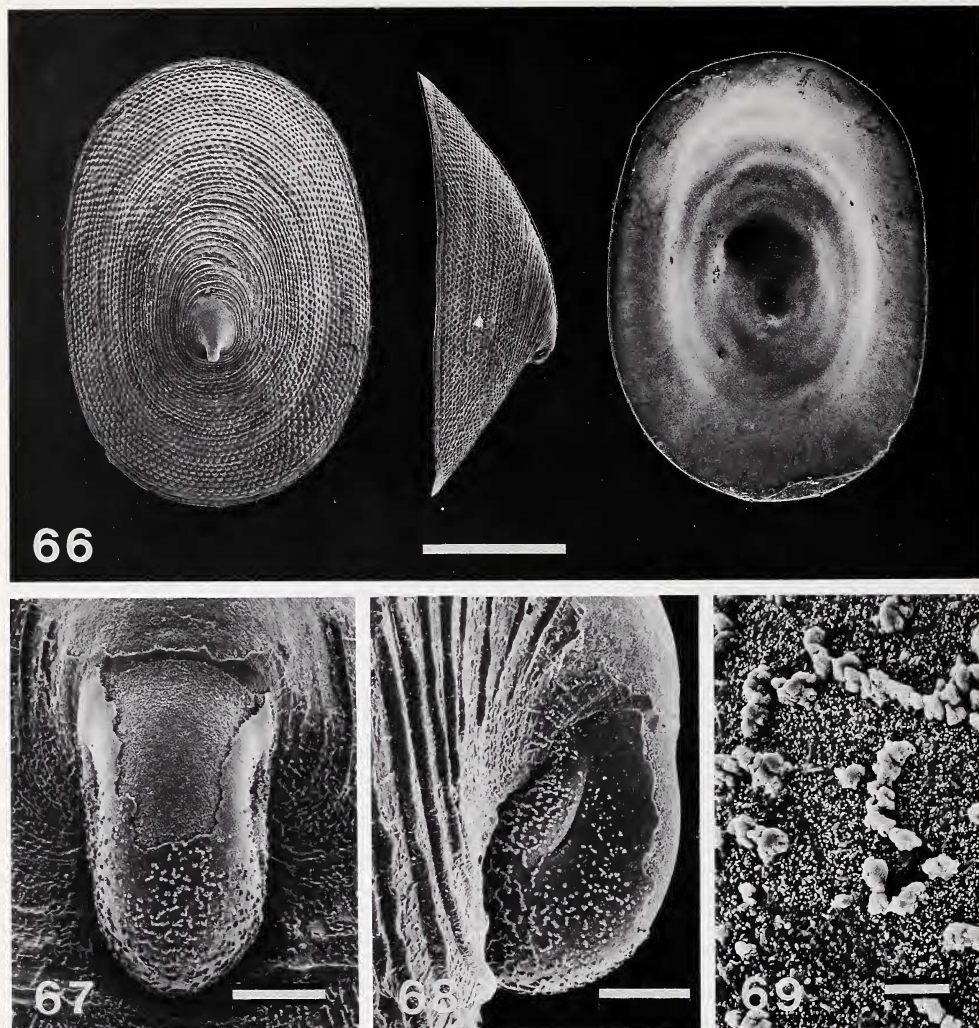

Figures 66–69. *Notocrater youngi*, new species. 66. Dorsal, lateral, and ventral views of holotype. Scale bar = 1.0 mm. 67, 68. Dorsal and lateral views of protoconch of holotype. Scale bars = 50 μm . 69. Detail of protoconch sculpture in figure 68. Scale bar = 5 μm .

Family Pseudococculinidae Hickman, 1983

DIAGNOSIS. Apical fold of protoconch long and narrow; protoconch sculpture of pustulose crystals or anastomosing threads. Radula strongly asymmetrical, inner lateral teeth 4.

REMARKS. Hickman (1983) was the first to argue that the radula of *Pseudococculina* Schepman, 1908, was sufficiently different from that of *Cocculina* to place it in a separate family. Marshall (1986) further defined the family on shell and radular characters and Haszprunar (1988a, 1988b) treated genera and relationships based on study of anatomy. Genera in Pseudococculinidae have a greater range of expression of protoconch scul-

ture, teleoconch sculpture, and radular and gill conditions than Cocculinidae. The right cephalic tentacle is modified and usually enlarged to function as the copulatory organ. Gill structures are secondary and, if present, are positioned in the pallial groove on either side of the foot.

The pseudococculinid radula differs from that of Cocculinidae in having the first lateral tooth large and triangular, projecting laterally, followed by three laterals. All four teeth are here numbered 1–4 (figure 64, 1–4), following Marshall (1986). The large multicusped tooth is again called the pluricuspid (figure 64, pc). There is a lateromarginal plate that is seldom revealed in SEM views (Marshall, 1986). Because it is not depicted in our illustrations, it is not mentioned further in our treatment of the pseudococculinid genera.

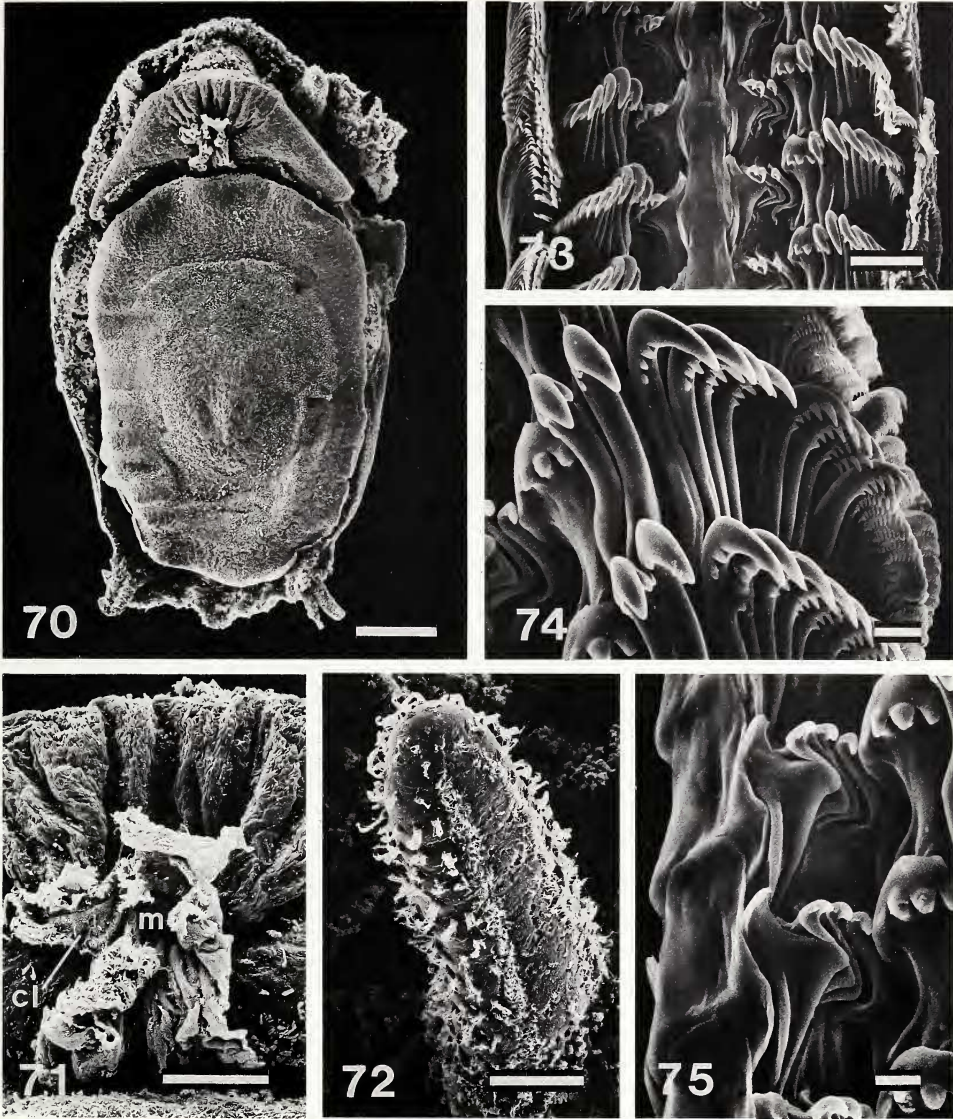

Figures 70–75. *Notocrater youngi*, new species. 70. Ventral view of critical-point-dried animal of holotype. Scale bar = 250 μm . 71. Detail of mouth, with cuticular lining. Scale bar = 50 μm . 72. Right cephalic tentacle. Scale bar = 20 μm . 73. Dorsal view of radular ribbon. Scale bar = 20 μm . 74. Detail of pluricuspid and marginal teeth. Scale bar = 5 μm . 75. Lateral view of radidian, lateral, and pluricuspid teeth. Scale bar = 5 μm .

With the exception of the genus *Notocrater* and *Kaiparapelta* and most species of *Tentaoculus*, the genera of Pseudococculinidae tend to occur in deeper water than the Cocculinidae. Many of the genera are known only from abyssal or hadal depths.

Thirteen genera are now recognized: *Pseudococculina* Schepman, 1908, *Notocrater* Finlay, 1926, *Kaiparapelta* Marshall, 1986, *Kurilabyssia* Moskaliev, 1976, *Caymanabyssia* Moskaliev, 1976 (and subgenus *Dictyabyssia* McLean, 1991), *Bandabyssia* Moskaliev, 1976, *Tentaoculus* Moskaliev, 1976, *Mesopelex* Marshall, 1986, *Colotrachelus* Marshall, 1986, *Yaquinabyssia* Haszprunar, 1988, *Co-*

pulabyssia Haszprunar, 1988, *Amphiplica* Haszprunar, 1988 (with subgenus *Gordabyssia* McLean, 1991), and *Punctabyssia* McLean, 1991.

The monotypic genus *Punctabyssia* McLean, 1991, is represented by *P. tibbettsi* McLean, 1991, from the eastern Pacific, and the monotypic genus *Yaquinabyssia* Haszprunar, 1988, is represented in the eastern Pacific by *Y. careyi* McLean, 1988.

The following genera are unknown in either the western Atlantic or eastern Pacific: *Bandabyssia* Moskaliev, 1976, *Colotrachelus* Marshall, 1986, *Kurilabyssia* Moskaliev, 1976, *Mesopelex* Marshall, 1986, and *Pseudococculina* Schepman, 1908.

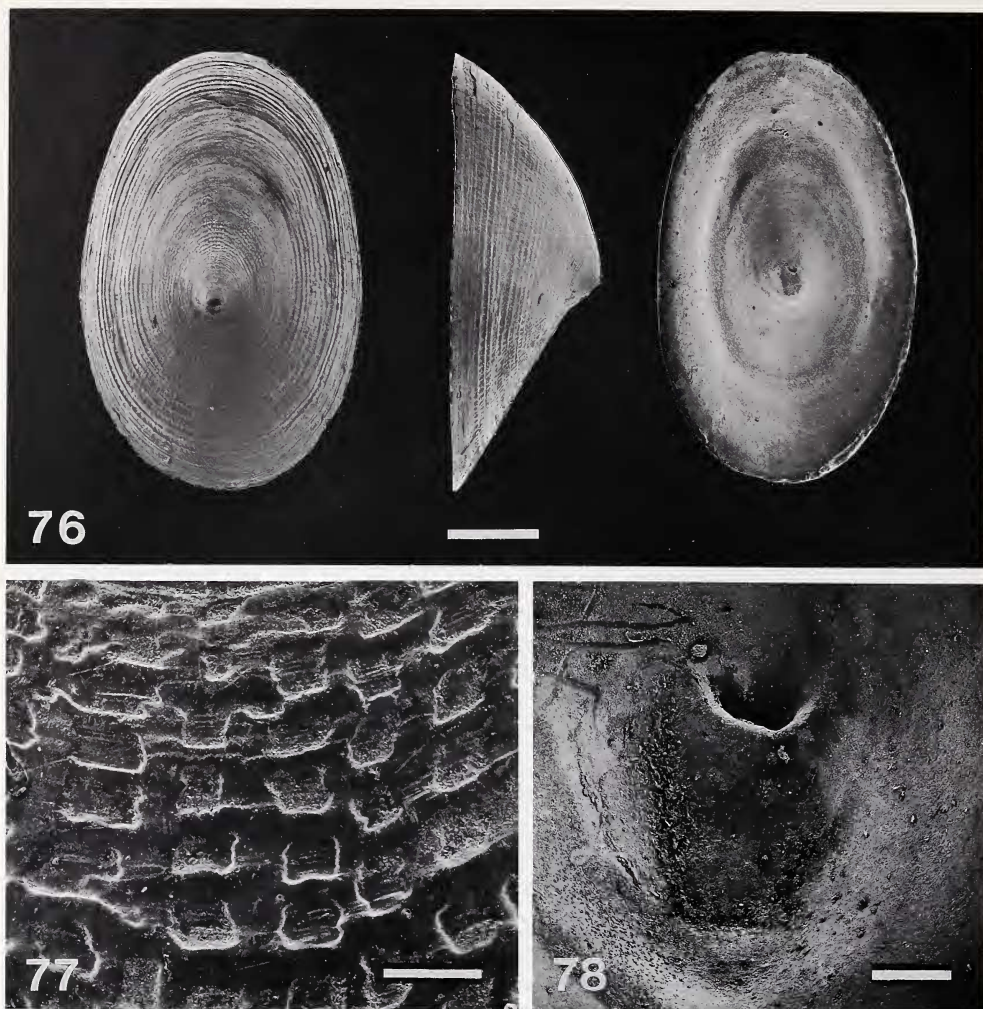

Figures 76-78. *Tentaoculus eritmata* (Verrill, 1884). 76. Dorsal, lateral, and ventral views of holotype. Scale bar = 1.0 mm. 77. Detail of surface sculpture. Scale bar = 100 μm . 78. Detail of interior septum. Scale bar = 100 μm .

Genus *Notocrater* Finlay, 1926

Type species by original designation *Cocculina craticulata* Suter, 1908 (New Zealand). Synonym: *Punctolepeta* Habe, 1958.

DIAGNOSIS. Protoconch sculpture of fine anastomosing threads; teleoconch sculpture of concentric ribs and strong pustules in curving rows. Eyes present, right cephalic tentacle serving as copulatory organ. Inner marginal teeth enlarged, second the largest in each row.

REMARKS. *Notocrater* is well represented in Australasia (Marshall, 1986) and Japan. It is reported living in the New World for the first time with the description of the following two new species. Marshall (1986:526) noted that *Cocculina pustulata* Woodring, 1928, from the Jamaican Miocene is a *Notocrater*. Woodring's illustration (Woodring, 1928:449, pl. 38, figs. 22, 23) does not

show the pustules, which were described as "minute, closely spaced beads or pustules arranged along intersecting curved radial lines."

This genus is an exception among pseudococculinids in living at continental slope depths, a habitat that correlates with the presence of eyes.

Notocrater houbricki, new species

Figures 58-65

DESCRIPTION. Shell (figure 58) small for family (maximum length 2.6 mm), thin, not eroded, white, periostracum thin. Shell height moderate, that of holotype 0.31 times length. Anterior slope convex, posterior slope concave, lateral slopes slightly convex to straight. Outline in dorsal view elongate-oval, anterior end slightly narrower than posterior end; aperture planar, ends not raised relative to sides of shell. Apex posterior to center, at about $\frac{3}{4}$ shell length from anterior margin, protoconch be-

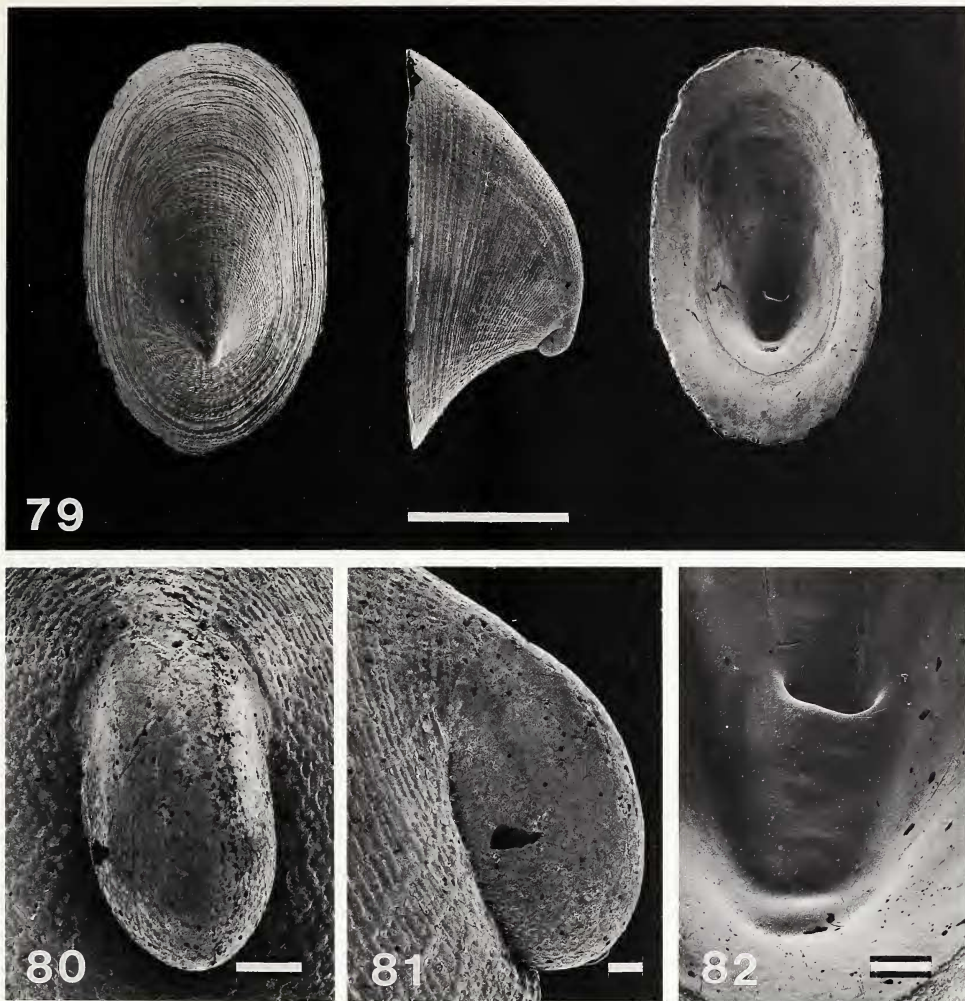

Figures 79–82. *Tentaoculus georgiana* (Dall, 1927). 79. Dorsal, lateral, and ventral views of lectotype. Scale bar = 1.0 mm. 80, 81. Dorsal and lateral views of protoconch of lectotype. Scale bars = 50 μ m. 82. Detail of interior septum. Scale bar = 100 μ m.

low highest point of shell, extending posteriorly. Protoconch length 170 μ m, protoconch sculpture of low, densely scattered crystals (figures 59, 60). Tip of protoconch immersed in posterior slope of shell. Early sculpture of raised concentric ribs and fine radial striae. Mature sculpture of elongate pustules on evenly spaced concentric ribs, arranged in curving rows. Shell edge thin and sharp. Muscle scar not well marked.

Dimensions. Length 2.6, width 1.5, height 0.8 mm (holotype); the paratype shell is broken.

External Anatomy (figure 61). Eyes large, black; right cephalic tentacle (copulatory organ) larger than left, with small lobe (figure 61, to) marking tentacular opening; two posterior epipodial tentacles, both clearly bifid (figure 61, et). Foot and mantle edge with minute dark brown spots.

Radula (figures 62–65). Rachidian unscuped,

tooth rows asymmetrical, right skewed; first lateral unscuped, shaft large, with laterally projecting elbow, second, third, and fourth lateral with bowed shafts and single cusps. Pluricuspid with broad overhang and three large, blunt cusps; first three marginals larger than remaining marginals, second the largest (figure 65).

TYPE LOCALITY. South of Settlement Point, Grand Bahama Island, Bahama Islands (26°37'31"N, 78°58'56"W), 412 m, on pencil-sized piece of wood along with *Cocculina messingi*, new species.

TYPE MATERIAL. Two specimens from type locality, collected by Charles Messing using deep-submersible *Johnson Sea Link II*, sta. 2335, 18 May 1992. Holotype USNM 860359, 1 paratype LACM 2737.

REMARKS. Comparisons to *N. youngi*, new species, are given under that species.

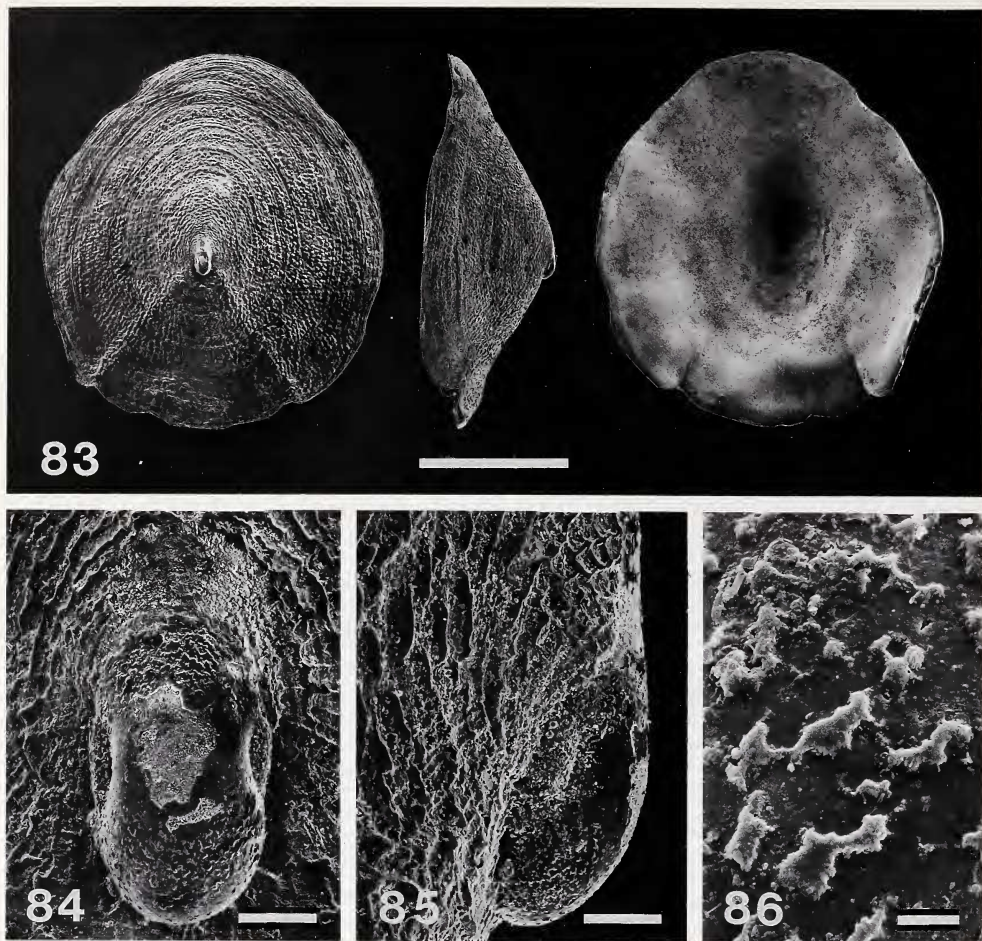

Figures 83–86. *Kaiparapelta askewi*, new species. 83. Dorsal, lateral, and ventral views of holotype. Scale bar = 1.0 mm. 84, 85. Dorsal and lateral views of protoconch of holotype. Scale bars = 50 μ m. 86. Detail of protoconch sculpture. Scale bar = 5 μ m.

ETYMOLOGY. We take pleasure in naming this striking species after our late friend and colleague Richard S. (Joe) Houbrick of the Division of Mollusks, National Museum of Natural History.

***Notocrater youngi*, new species**

Figures 66–75

DESCRIPTION. Shell (figure 66) small for family (maximum length 3.1 mm), thin, not eroded, white, periostracum thin. Shell height moderate, that of holotype 0.32 times length. Anterior slope convex, posterior slope straight, lateral slopes slightly convex to straight. Outline in dorsal view elongate-oval, anterior end slightly narrower than posterior end; aperture not planar, sides raised relative to ends of shell. Apex posterior to center, at about $\frac{2}{3}$ shell length from anterior margin, protoconch below highest point of shell, extending posteriorly. Protoconch length 190 μ m, protoconch sculpture of clumped crystals, some forming anastomosing

threads (figures 67–69). Tip of protoconch immersed in posterior slope of shell. Early sculpture of raised concentric ribs and fine radial striae. Mature sculpture of elongate pustules on evenly spaced concentric ribs arranged in curving rows. Shell edge thin and sharp. Muscle scar not well marked.

Dimensions. Length 3.1, width 2.2, height 1.0 mm (holotype).

External Anatomy (figures 70–72). Cephalic lappets broad, epipodial tentacles two posterior pairs. Cephalic tentacles with band of cilia and scattered sensory papillae (figure 72). Mouth with cuticular lining (figure 71, cl).

Radula (figures 73–75). Rachidian broad, uncusped; first lateral triangular, with projecting elbow; second, third, and fourth lateral with elbow and single large overhanging cusp and up to four serrations on medial side; pluricuspid with four, similar-sized cusps below the overhang; inner marginals enlarged compared to outer marginals, second marginal the largest.



Figure 87. *Copulabyssia leptalea* (Verrill, 1884). Dorsal, lateral, and ventral views of shell (USNM 757345). NE of Norfolk, Virginia, in 3080–3090 m, R/V *Gillis* Cruise 75-08, sta. 36. Scale bar = 1.0 mm.

TYPE LOCALITY. Off Southwest Reef, New Providence Island, Bahamas (24°54'04"N, 77°33'14"W), 518 m on palmetto fronds.

TYPE MATERIAL. 17 specimens retrieved from palm fronds and grass mat collectors placed on bottom for larval settlement experiments by R. Emson, C.M. Young, and P.A. Tyler. Holotype, USNM 860360, *Johnson-Sea-Link II*, dive 2317, 9 May 1992. 16 paratypes, from same locality and depth retrieved by Mary Rice, *Johnson-Sea-Link I*, dive 3463, 10 May 1993; 8 paratypes USNM 860387; 5 paratypes LACM 2738; 3 paratypes HBOM 065:03885.

REMARKS. On shell characters this species differs from *Notocrater houbricki* in its larger size (length 3.1 compared to 2.6 mm), more anteriorly located apex, larger and more widely spaced pustules on the protoconch, and less projecting nodes on the teleoconch.

ETYMOLOGY. This species is named after Craig M. Young, of Harbor Branch Oceanographic Institution, Fort Pierce, Florida, whose research on larval recruitment brought this species to light.

Genus *Tentaoculus* Moskalev, 1976

Type species by monotypy: *Tentaoculus perlucida* Moskalev, 1976; New Guinea.

DIAGNOSIS. Shell with or without small septum near apex on inner surface. Protoconch sculpture of fine pits and anastomosing ridges; teleoconch sculpture of fine concentric growth lines and radial striae.

REMARKS. Marshall (1986:67) used the genus *Tentaoculus* for three species from New Zealand, noting that the genus is unique in having an interior

shell septum. This character provides a clue to the allocation of an enigmatic northwestern Atlantic species described originally in the family Fissurellidae by Verrill, 1884, as well as that of a previously unfigured species described by Dall in *Cocculina*.

Tentaoculus eritmeta (Verrill, 1884), new combination Figures 76–78

Puncturella (Fissurisepta) eritmeta Verrill, 1884:204, pl. 32, fig. 19; Clarke, 1962:8 [checklist only]; R.I. Johnson, 1989:37 [type specimen].

Puncturella eritmeta; Pilsbry, 1890:238, pl. 27, figs. 60, 61 [copy of Verrill]; Thiele, 1919:156, pl. 17, figs. 14, 15 [copy of Verrill].

REMARKS. The original illustration, which has been copied by Pilsbry (1890) and Thiele (1919), includes a posterior view with two circular scars separated by what was intended to represent a septum. In our interpretation, the upper scar is that left by loss of the protoconch aperture and the lower shows the trace of the protoconch tip where it was engulfed by the posterior slope of the shell. Verrill (1884) described but did not illustrate an interior septum: "in the apex there is a minute transverse lamina, forming a small flattened tube." Shell proportions and sculpture are consistent with those of the *Tentaoculus* species illustrated by Marshall (1986). The flattened tube described by Verrill is shown in an enlarged view with SEM, tilted to show its length (figure 78). This species, which has been ignored by all recent compilers of the Fissurellidae, is now added to the list of western Atlantic pseudococculinids.

Tentaoculus georgiana

(Dall, 1927),

new combination

Figures 79–82

Cocculina georgiana Dall, 1927:121; C.W. Johnson, 1934:66 [listed only]; Abbott, 1976:35 [listed only].

A lectotype (USNM 108281) of this previously unillustrated species is designated and illustrated here (length 2.5, width 1.7, height 1.2 mm). Twenty paralectotypes have been recatalogued as USNM 860384; 2 paralectotypes LACM 2739. The original type locality is “off Georgia,” but the printed label reads “U. S. Fish Com. sta 2415, 440 fm. [805 m], off Georgia.” Although not mentioned originally by Dall, it proves to have an interior septum (figure 82) comparable to that of *Tentaoculus eritmeta*. The protoconch sculpture is too worn to show the pits near the terminus, but the anastomosing sculpture illustrated by Marshall (1986:534, fig. 6M) for *T. haptricola* Marshall, 1986, from New Zealand is present. Like the previous species, this species may safely be allocated to *Tentaoculus* in the absence of soft parts. It differs from *T. eritmeta* in having a much higher profile and the apex at $\frac{3}{4}$ the shell length from the anterior, rather than nearly central.

Genus *Caymanabyssia* Moskalev, 1986

Type species by original designation: *Caymanabyssia spina* Moskalev, 1976.

DIAGNOSIS. Protoconch with columnar prisms; teleoconch sculpture of sharp pustules on anastomosing network of surface sculpture; central and lateral teeth degenerate, lacking cusps; right cephalic tentacle enlarged, open seminal groove; gill leaflets on both sides.

REMARKS. Although the type species was poorly figured, the teleoconch sculpture of strong pustules superimposed on an anastomosing network is unmistakable. This genus has been used for the New Zealand species *Caymanabyssia rhina* Marshall, 1986, and for the eastern Pacific species *Caymanabyssia vandoverae* McLean, 1991. Haszprunar's (1988:174) anatomical definition of *Camanabyssia* is based on the species *C. sinespina* Marshall, 1986, which was designated the type species of the subgenus *Dictyabyssia* McLean, 1991.

Caymanabyssia spina Moskalev, 1976

Caymanabyssia spina Moskalev, 1976:65, fig. 4, pl. 2, figs. 7, 8; Marshall, 1986:538.

Moskalev's original description was translated from Russian by G.V. Shkurkin in a privately circulated “reprint” dated December 1978. That translation is repeated here, altered to place it in telegraphic style and with terminology slightly revised to conform to that used throughout this paper:

Shell small, low, thin, apex at $\frac{2}{3}$ shell length from anterior margin, protoconch lacking sculpture. An-

terior slope slightly convex, posterior slope straight; aperture elliptical, margin made denticulate from projecting surface sculpture. Surface yellowish-white, semi-transparent. Sculpture of numerous, similar conelike thorns in regular checker-board pattern, spaced not less than the diameter of the base of each thorn. Shell interior white, surface sculpture visible from inside.

Shell lengths 0.85–2.95 mm, holotype the largest.

Epipodial tentacles clearly visible, a differentiation of the right cephalic tentacle noticeable on 34 specimens and eggs present in 31 specimens.

Rachidian rounded, thickened in the middle by a horizontal ridge. Subcentral teeth diverging wing-like from the rachidian, irregularly triangular, with folds on outer edge. First, second, and third lateral teeth almost identical, cusps lacking, boomerang shaped. Fourth lateral tooth [pluricuspid] slightly smaller than subcentral one, of complex shape with folds. Fifth lateral tooth [lateromarginal plate] smallest, its middle part situated at level of lower margin of fourth lateral tooth.

TYPE LOCALITY. Eastern part of Cayman Trough (19°38'5"N, 76°38'8"W), 6740–6800 m. A total of 204 specimens on wood, 7 on other substrates of vegetal origin, collected with research vessel *Akademic Kurchatov*, cruise 14, sta. 1267, 2.5 m Sigsby dredge, 24–25 March 1967. Further locality: western part of Cayman Trough (19°00'6"N, 80°29'5"W), 6800 m, sta. 1242A, 20 March 1967, 2 specimens on wood. In the type series, shells are broken and bodies deformed in 29 specimens; 11 were used for radular mounts.

REMARKS. Moskalev did not mention the anastomosing background sculpture that occurs between the sharp pustules, although it is recognizable in his illustration.

Genus *Kaiparapelta* Marshall, 1986

Type species by original designation: *Kaiparapelta singularis* Marshall, 1986.

DIAGNOSIS. Protoconch sculpture of anastomosing threads, teleoconch sculpture granulate, profile low.

REMARKS. The new species described here is the second known species of the genus; the type species of *Kaiparapelta* occurs in the New Zealand Miocene. The genus is still based on shell characters. For the generic allocation, we are indebted to A. Warén, who has recognized living material of this genus from the eastern Atlantic and will report on the radula and anatomy in a forthcoming paper.

On shell characters the genus differs from *Notocrater* in its lower profile. It also resembles *Caymanabyssia* (*Dictyabyssia*), which has a more oval and more regular outline. The latter genus has been reported only from abyssal depths.

Kaiparapelta askewi, new species

Figures 83–86

DESCRIPTION. Shell (figure 83) small for family

(maximum length 2.7 mm), thin, not eroded, white, periostracum thin. Shell height moderate, that of holotype 0.38 times length. Anterior, posterior, and lateral slopes nearly straight. Outline in dorsal view broadly oval, margin irregularly undulating; anterior end slightly narrower than posterior end; aperture not planar, ends raised relative to sides of shell. Apex slightly posterior to center, protoconch nearly at highest point of shell, extending posteriorly. Protoconch length 185 μ m, protoconch sculpture of clumped raised threads (figure 86). Tip of protoconch immersed in posterior slope of shell. Sculpture of weak concentric growth lines and irregular anastomosing threads or low pustules, producing a shagreen surface. Posterior slope with two faintly indicated, raised ridges terminating at slight indentations at margin. Anastomosing sculpture more prominent than radial sculpture, not raised at intersections with radial striae. Shell edge thin and sharp. Muscle scar and pallial attachment scar not well marked.

Dimensions. Length 2.65, width 2.55, height 1.0 mm (holotype); length 3.2, width 2.45, height 1.0 mm (paratype).

Radula and External Anatomy. Unknown.

TYPE LOCALITY. 165 km E of Charleston, South Carolina (32°43.68'N, 78°05.72'W), 194 m. This is the locality known as the "Charleston Lumps," which is also the type locality of two recently described pleurotomariid gastropods, *Perothroches charlestonensis* Askew, 1988, and *P. maureri* Harasewych & Askew, 1993.

TYPE MATERIAL. Two dead specimens in sediment sample collected at the type locality by T.M. Askew and M.G. Harasewych with the research submersible *Clelia*, sta. 78, 6 July 1993. Holotype USNM 860362, paratype LACM 2740.

REMARKS. Shell profile, protoconch sculpture and teleoconch sculpture agree with that of the type species. The two posterior ridges and the corresponding indentations at the margin are unique to this species. The indentations are probably indicative of the position of the posterior epipodial tentacles.

ETYMOLOGY. We are pleased to name this species after Timothy M. Askew, Director of Marine Operations, Harbor Branch Oceanographic Institution, Fort Pierce, Florida.

Genus *Copulabyssia* Haszprunar, 1988

Type species by original designation: *Cocculina corrugata* Jeffreys, 1883.

DIAGNOSIS. Protoconch sculpture of prismatic crystals, teleoconch sculpture of raised concentric rings and fine radial striae. Apex below highest point of shell. Right cephalic tentacle exceptionally large.

REMARKS. Haszprunar (1988a) detailed the anatomy of the type species and provided SEM illustrations of the shell, protoconch, and radula of a Mediterranean specimen identified as the type

species. Dantart and Luque (1994:290) also described and illustrated the type species. Waren (1991:80) noted that the northwestern Atlantic *Cocculina leptalea* Verrill, 1884, is also referable to *Copulabyssia* on the basis of shell characters, but he did not illustrate specimens.

Copulabyssia leptalea (Verrill, 1884) Figures 87–91

Cocculina leptalea Verrill, 1884:202, pl. 32, figs. 20, 20a, 20b; Pilsbry, 1890:133, pl. 25, figs. 7, 8; Thiele, 1909:7, pl. 2, fig. 5; C.W. Johnson, 1934:66 [checklist only]; Abbott, 1974:34 [checklist only]; R.L. Johnson, 1989:46 [citation of type material].

Copulabyssia leptalea; Warén, 1991:80.

REMARKS. As noted by Warén (1991:80), the holotype (USNM 38079, from USFC sta. 2038, 3700 m off Delaware) is now fragmented. We illustrate (figure 87) a specimen (USNM 7577345) dredged off Norfolk, Virginia, 3080–3090 m (length 2.45, width 1.85, height 0.9 mm). As in the holotype, the early sculpture is eroded and the protoconch is replaced by an infilled plug that cannot be compared to that illustrated for the type species by Haszprunar (1988a). Its radula (figures 88–91) differs from that of the type species as illustrated by Haszprunar (1988a:fig. 1D, E) in having the rachidian with a single, weakly projecting cusp, rather than lacking any cusp. The pluricuspid teeth of *Copulabyssia leptalea* have four nearly equal cusps, whereas those of *C. corrugata* have two cusps, as illustrated by Dantart and Luque (1994:fig. 60).

Copulabyssia leptalea differs from *C. corrugata* in radular characters as already noted and in having a more anterior apex.

Genus *Amphiplica* Haszprunar, 1988

Type species by original designation: *Amphiplica venezuelensis* McLean, 1988. Subgenus (or synonym) *Gordabyssia* McLean, 1991; type species by original designation *Amphiplica (Gordabyssia) gordensis* McLean, 1991.

DIAGNOSIS. Shell large, profile low; protoconch sculpture of dense net pattern arranged in longitudinal rows.

REMARKS. Protoconch sculpture was unknown prior to discovery of the eastern Pacific species *Amphiplica (Gordabyssia) gordensis* McLean, 1991. There is a single species in the western Atlantic.

Amphiplica venezuelensis McLean, 1988

Amphiplica venezuelensis McLean, 1988:155, figs. 1–7.

REMARKS. This species, from 5057 m in the Venezuela Basin, attains a maximum length of 14.8

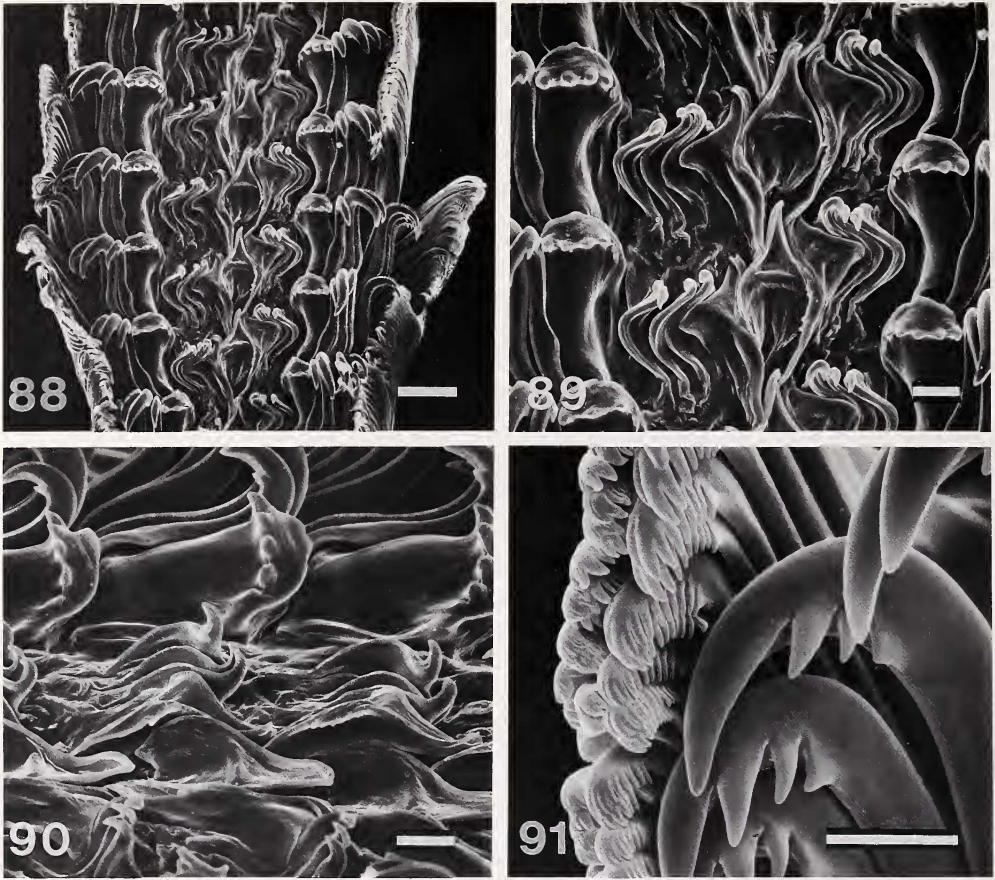

Figures 88–91. *Copulabyssia leptalea* (Verrill, 1884). Radula from specimen in figure 87. 88. Dorsal view of radular ribbon. Scale bar = 25 μm . 89. Detail of rachidian and lateral teeth. Scale bar = 100 μm . 90. Lateral view of longitudinally cut radula revealing relative heights of tooth fields. Scale bar = 100 μm . 91. Detail of distal ends of inner and outer marginal teeth. Scale bar = 5 μm .

mm and is the largest known pseudococculinid. Its anatomy was treated by Haszprunar (1988a).

REALLOCATED TAXA

The following taxa were initially described in the genus *Cocculina* but are now considered to be members of families other than Cocculinidae or Pseudococculinidae. Although most can be allocated to family and genus, their status as species or synonyms remains to be resolved, pending revision of the genera. These taxa are arranged in their order of description.

“Cocculina” conica Verrill, 1884

Cocculina conica Verrill, 1884:204; Pilsbry, 1890: 134 [copy Verrill description]; Thiele, 1909:7 [German translation]; C.W. Johnson, 1934:66 [listed only]; Abbott, 1974:34 [listed only]; R.I. Johnson, 1989:30.

Pilus conica; Warén, 1993:80, fig. 20A–E.

Although the holotype (USNM 38441) of this orig-

inally unfigured species from 499 fathoms off Nova Scotia was reported lost by Johnson (1989), Warén (1993) recognized the species from the detailed original description and illustrated shell specimens from deep water off southwestern Iceland. The shell is less than 1 mm in length and has a posteriorly overhung apex. This species is the type species for Warén’s genus *Pilus*. The radula is unknown, and the family allocation is therefore uncertain within the Cocculiniformia.

“Cocculina” dalli Verrill, 1884

Cocculina dalli Verrill, 1884:203; C.W. Johnson, 1934:66 [listed only]; Abbott, 1974:34 [listed only]; R.I. Johnson, 1989:32, pl. 10, fig. 10 [holotype].

The single known specimen (holotype USNM 38081), from 580 m (39°53’N, 69°47’W) was first illustrated by Johnson (1989). It is here considered to be close to the North Atlantic *Iothia rugosa* (Jeffreys, 1883), family Lepetidae.

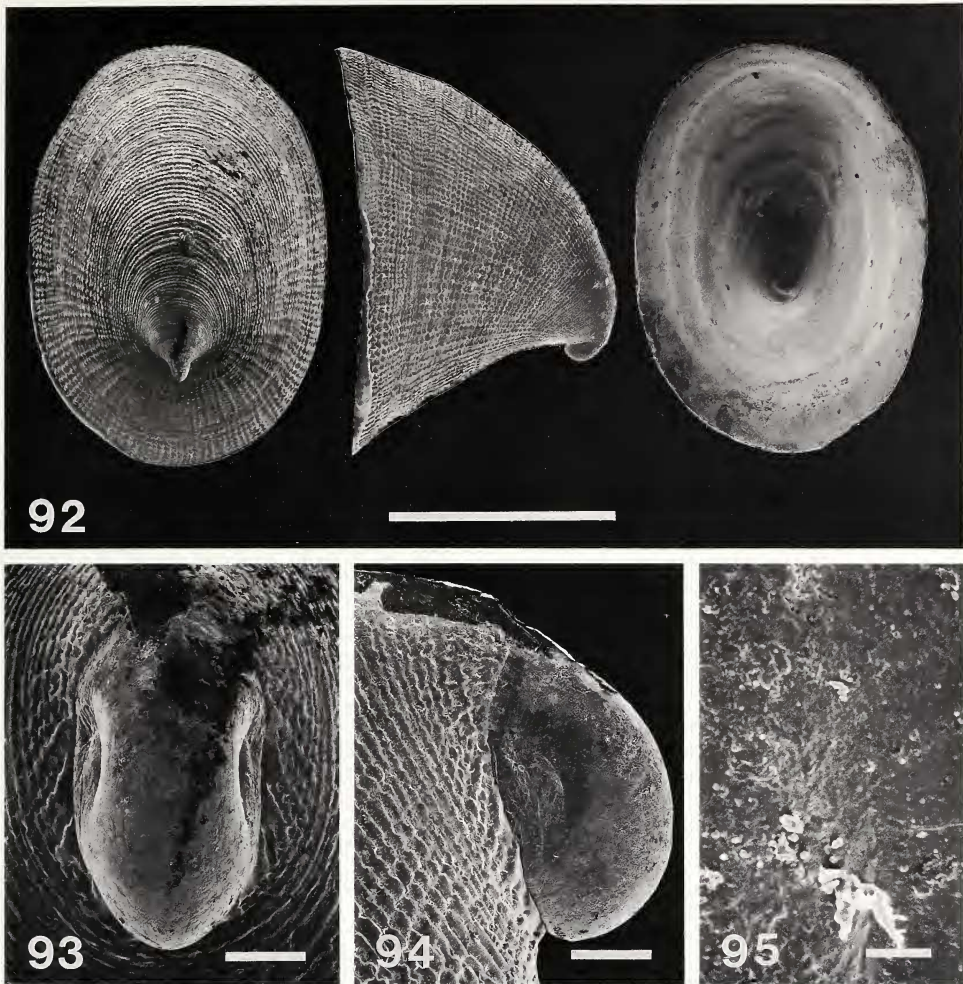

Figures 92-95. *Propilidium lissocona* (Dall, 1927). 92. Dorsal, lateral, and ventral views of lectotype. Scale bar = 1.0 mm. 93, 94. Dorsal and lateral views of the protoconch of the lectotype. Scale bars = 50 μ m. 95. Detail of protoconch sculpture. Scale bar = 5 μ m.

“Cocculina” reticulata Verrill, 1885

Cocculina reticulata Verrill, 1885:426; Verrill in Bush, 1893:240, pl. 2, fig. 6; C.W. Johnson, 1934:66 [listed only]; Abbott, 1974:34 [listed only]; R.I. Johnson, 1989:62 [citation of holotype only].

The holotype (USNM 44832) from 128 m off Chesapeake Bay is here referred to the genus *Propilidium*, family Lepetidae.

“Cocculina” lissocona Dall, 1927

Figures 92-95

Cocculina lissocona Dall, 1927:110; C.W. Johnson, 1934:66 [listed only]; Abbott, 1974:35 [listed only].

We designate and illustrate (figures 92-95) a lectotype (USNM 333472, USFC 2668, 538 m off Fer-

nandina, Florida). Fourteen remaining paralectotypes have been recataloged USNM 860385; two paralectotypes LACM 2741. This is also referred to *Propilidium*, family Lepetidae. It is characterized by its high profile, radial and concentric sculpture producing beads at intersections, smooth protoconch, and weak interior septum. The septum (figure 92) is characteristic of *Propilidium*, being shorter than that of *Tentaoculus*.

Marshall (1985:541) illustrated a Tasmanian species of *Propilidium* and gave further notes on the genus. *Propilidium exiguum* (Thompson, 1844), the type species of *Propilidium*, was treated by Dantart and Luque (1994:303). *Propilidium lissocona* and *P. reticulata* are indistinguishable from the type species on shell characters. We suspect that the type species occurs broadly in the North Atlantic and that the two western Atlantic taxa should be added to the synonymy of the type species.

“*Cocculina*” *rotunda* Dall, 1927

Cocculina ? *rotunda* Dall, 1927:115, 121; C.W. Johnson, 1934:66 [listed only]; Abbott, 1974:35 [listed only].

Type material (holotype USNM 108156), from off Fernandina, Florida, has a circular outline and a high, centrally positioned apex. It is here tentatively referred to the genus *Bathysciadium* Dautzenberg & Fischer, 1901 (family Bathysciadiidae).

“*Cocculina*” *superba* Clarke, 1960

Cocculina superba Clarke, 1960:1, fig. 1.

Clarke illustrated the animal of this abyssal species from Argentina. Although a radular preparation was not made, characters of the shell and external anatomy are suggestive of the family Lepetidae.

ACKNOWLEDGMENTS

We are grateful to our colleagues who have provided the specimens on which this study is based. Drs. Craig Young (Harbor Branch Oceanographic Foundation, Fort Pierce, Florida), Roland Emson (Kings, College, London), Paul A. Tyler (University of Southampton, United Kingdom), and Mary Rice (Smithsonian Marine Station at Link Port, Fort Pierce, Florida) supplied samples of limpets collected from experimental substrates deployed off New Providence Island, Bahamas. Their work was supported by NSF OCE-9116560 to C.M. Young and NATO Collaborative Research Grant CRG-900628 to C.M. Young, P.A. Tyler, and R.H. Emson. Dr. Charles Messing (Nova University, Dania, Florida) provided samples from his study site at Grand Bahama Island, Bahamas (NSF EAR-9004232). Paula Mikkelsen brought to our attention specimens in the collections of the Harbor Branch Oceanographic Museum. We thank Ms. Susann Braden of the National Museum of Natural History for her assistance with the scanning electron microscopy. Alan Kabat of the same institution helped to verify the status of specimens described by W. H. Dall. We much appreciate the reviews and helpful suggestions provided by Bruce Marshall, Winston Ponder, and Anders Warén.

This is Smithsonian Marine Station at Link Port Contribution No. 352.

LITERATURE CITED

- Abbott, R.T. 1974. *American seashells*, 2nd ed. New York: Van Nostrand Reinhold, 663 pp.
- Askew, T.M. 1988. A new species of pleurotomariid gastropod from the western Atlantic. *The Nautilus* 102:89–91.
- Clarke, A.H., Jr. 1960. A giant ultra-abyssal *Cocculina* (Mollusca, Gastropoda), from the Argentine Basin. *National Museum of Canada, Natural History Papers* 7:1–4.
- . 1962. Annotated list and bibliography of the abyssal marine molluscs of the world. *National Museum of Canada, Bulletin* 181:1–114.
- Dall, W.H. 1882. On certain limpets and chitons from the deep waters off the eastern coast of the United States. *Proceedings of the United States National Museum* 4:400–414.
- . 1889. Reports on the results of dredging, under the supervision of Alexander Agassiz, in the Gulf of Mexico (1877–78) and the Caribbean Sea (1879–80), by the U. S. Coast Survey Steamer “Blake,” . . . 29: Report on the Mollusca, part 2: Gastropoda and Scaphopoda. *Bulletin of the Museum of Comparative Zoology, Harvard University* 18:1–492.
- . 1890. Scientific results of explorations by the U.S. Fish Commission steamer Albatross, 7: Preliminary report of the collection of Mollusca and Brachiopoda obtained in 1887–88. *Proceedings of the United States National Museum* 12:219–362.
- . 1908. [Reports from ‘Albatross’ dredging operations]. The Mollusca and the Brachiopoda. *Bulletin of the Museum of Comparative Zoology at Harvard College* 43:205–487.
- . 1927. Small shells from dredgings off the southeast coast of the United States by the United States Fisheries steamer “Albatross” in 1885 and 1886. *Proceedings of the United States National Museum* 70:1–134.
- Dall, W.H., and T. Simpson. 1901. *The Mollusca of Porto Rico*. United States Fish Commission Bulletin for 1900, vol. 1, 351–524.
- Dantart, L., and A. Luque. 1994. Cocculiniformia and Lepetidae (Gastropoda: Archaeogastropoda) from Iberian waters. *Journal of Molluscan Studies* 60: 277–313.
- Harasewych, M.G., and M. Askew. 1993. *Perotrochus maureri*, a new species of pleurotomariid from the western Atlantic (Gastropoda: Pleurotomariidae). *The Nautilus* 106:130–136.
- Haszprunar, G. 1987. Anatomy and affinities of cocculinid limpets (Mollusca, Archaeogastropoda). *Zoologica Scripta* 16:305–324.
- . 1988a. Anatomy and affinities of pseudococculinid limpets (Mollusca, Archaeogastropoda). *Zoologica Scripta* 17:161–179.
- . 1988b. Comparative anatomy of cocculiniform gastropods and its bearing on archaeogastropod systematics. *Malacological Review*, supplement 4, 64–84.
- Hickman, C.S. 1983. Radular patterns, systematics, diversity, and ecology of deep-sea limpets. *The Veliger* 26:73–92.
- Jeffreys, J.G. 1883. On the Mollusca procured during the cruise of *H.M.S. Triton*, between the Hebrides and Faroes in 1882. *Proceedings of the Zoological Society of London* 1883:389–399.
- Johnson, C.W. 1934. List of marine Mollusca of the Atlantic coast from Labrador to Texas. *Proceedings of the Boston Society of Natural History* 40:1–204.
- Johnson, R.I. 1989. Molluscan taxa of Addison Emery Verrill and Katharine Jeannette Bush, including those introduced by Sanderson Smith and Alpheus Hyatt Verrill. *Occasional Papers on Mollusks, Museum of Comparative Zoology, Harvard University* 5:1–143.
- Marshall, B.A. 1986. Recent and Tertiary Cocculinidae and Pseudococculinidae (Mollusca: Gastropoda) from New Zealand and New South Wales. *New Zealand Journal of Zoology* 12:505–546.
- McLean, J.H. 1987. Taxonomic descriptions of cocculinid limpets (Mollusca, Archaeogastropoda): Two new species and three rediscovered species. *Zoologica Scripta* 16:325–333.
- . 1988. Three new limpets of the family Pseudococculinidae from abyssal depths (Mollusca, Archaeogastropoda). *Zoologica Scripta* 17:155–160.
- . 1991. Four new pseudococculinid limpets collected by the deep-submersible *Alvin* in the eastern Pacific. *The Veliger* 34:38–47.

- . 1992. Cocculiniform limpets (Cocculinidae and Pyropeltidae) living on whale bone in the deep sea off California. *Journal of Molluscan Studies* 58:401–414.
- Moskalev, L.I. 1976. On the generic classification in Cocculinidae (Gastropoda, Prosobranchia). *Works of the P. P. Shirshov Institute of Oceanology, The Academy of Sciences of the USSR* 99:59–70. [In Russian.] Translated for private circulation by G.V. Shkurkin, 1978.
- Pilsbry, H.A. 1890. *Manual of conchology*, vol. 12. Academy of Natural Sciences, Philadelphia, 323 pp.
- Thiele, J. 1909. Cocculinoidea und die Gattungen *Phenacolepas* und *Titiscania*. In *Systematisches Conchylien-Cabinet von Martini & Chemnitz*, ed. H.C. Kuster and W. Kobelt, series 2, vol. 11a, no. 539, pp. 1–48.
- . 1919. Familia Fissurellidae. In *Systematisches Conchylien-Cabinet von Martini & Chemnitz*, ed. H.C. Kuster, W. Kobelt, and F. Haas, series 2, vol. 4a, no. 580, pp. 145–68.
- Verrill, A.E. 1884. Second catalog of Mollusca, recently added to the fauna of the New England coast and the adjacent parts of the Atlantic, consisting mostly of deep-sea species, with notes on others previously recorded. *Transactions of the Connecticut Academy* 6:139–294.
- . 1885. Third catalog of Mollusca, recently added to the fauna of the New England Coast and the adjacent parts of the Atlantic, consisting mostly of deep-sea species, with notes on others previously recorded. *Transactions of the Connecticut Academy* 6:395–452.
- Warén, A. 1991. New and little known Mollusca from Iceland and Scandinavia. *Sarsia* 76:53–124.
- . 1993. New and little-known Mollusca from Iceland and Scandinavia, part 2. *Sarsia* 78:159–201.
- Watson, R.B. 1886. Report on the Scaphopoda and Gasteropoda collected by H.M.S. Challenger during the years 1873–1876. Report on the Scientific Results of the Voyage of the H.M.S. Challenger, 1873–1876. *Zoology* 15(part 42):1–680, pls. 1–50.
- Woodring, W.P. 1928. *Miocene mollusks from Bowden, Jamaica*. Part II. *Gastropods and discussion of results*. Carnegie Institution of Washington, Publication no. 385, vii + 564 pp.

Received 29 March 1994; accepted 10 November 1994.