

# ARMY AVIATION

OFFICIAL PUBLICATION OF THE ARMY AVIATION ASSOCIATION OF AMERICA • AUG.-SEPT. 2000 • \$3.00



**Sikorsky**

A United Technologies Company

THE FIRST NAME IN HELICOPTERS.

# ONLY APACHE.

Apache Longbow does what others  
talk about doing, someday. Patrolling  
borders. Monitoring cease-fires.  
Keeping the peace. And with its  
new advanced optical sensors,  
and other planned enhance-  
ments, the AH-64D  
Apache Longbow will  
just keep getting better.

It's easy to talk about performance.  
Only Apache Longbow delivers.



 **BOEING**  
Forever New Frontiers

# ARMY AVIATION

Publisher  
Lynn Coakley

Editor-in-Chief  
William R. Harris, Jr.

Editor  
Stephen Harding

Production Manager  
Barbara Ross

Contributing Editor  
James R. Bullinger

Circulation Manager  
Mary Ann Stirling

Circulation Assistants  
Debbie Coley  
Mary Ellen Kother  
Deb Simons

Advertising  
Robert C. Lachowski



# briefings



**Maj. Gen. Joseph Bergantz** receives his second star from Lt. Gen. Paul Kern and Bergantz's wife, Helen, during ceremonies at Redstone Arsenal on July 31. Bergantz became program executive officer for aviation replacing Maj. Gen. James Snider, who is now deputy chief of staff for RD&A, U.S. Army Materiel Command, Alexandria, Va.

**Fort Rucker, Ala.**, has been honored as one of the Army's top installations with presentation of the U.S. Army Chief of Staff Communities of Excellence Award. Post officials shared the credit with the installation's team of military personnel, civilian employees, contractors, and surrounding cities and towns. Twenty-six military personnel and civilian employees and eight specific groups also received the Commander's Certificate for developing and implementing best practices that contributed significantly to Fort Rucker's selection.

A new CH-47D Chinook unit was recently activated at Fort Hood, Texas. The **7th Battalion, 158th Aviation Regiment**, is comprised of the battalion headquarters and a company at Fort Hood, along with a company based in Olathe, Kan., and a platoon at Fort Carson, Colo. The Chinooks will be able to provide support to local units at ranges during training, and will assist with fighting range fires. There are still positions available with the unit, including slots for MOS 67U (CH-47D repairer, all grades), 77F (refueler, E-3 through E-5), and 93P (flight operations specialist, E-3 through E-6). For more information call the unit's personnel office at (254) 288-3842.

**FlightSafety International** has ordered a UC-35 full-flight simulator for installation in the firm's Daleville, Ala., training center. The simulator will be used to train Army pilots for the UC-35, the latest aircraft to join the Army's air-transport fleet. The simulator, classed at the FAA's level D, will be capable of the highest standards of flight replication.

Four CH-47C Chinooks from the **179th Aviation Company** at Fort Carson, Colo., recently completed their first self-deployment of helicopters from North America to Europe. The aircraft — manned by 31 crewmembers and observers from the 179th, the California and Texas Army National Guards and U.S. Army Training and Doctrine Command — made the nine-day, 5,000-mile flight to Germany via Labrador, Greenland, Iceland, Scotland and England.

Task Force Saber — OH-58D Kiowa Warrior helicopters and personnel from the Hawaii-based **3rd Squadron, 4th Cavalry Regiment, 25th Infantry Division** — recently completed a month-long counterdrug operation along the California-Mexico border. Operating from the Chocolate Mountains Range Complex in El Centro, the aircrews used the advanced thermal imaging capabilities of the OH-58D to spot drug smugglers at night. TF Saber's efforts, both direct and indirect, resulted in the capture of 98 illegal aliens and the seizure of 831 pounds of narcotics.

## on the cover

**Paid Advertisement.** The sun isn't likely to set soon on the U.S. Army's UH-60 Black Hawk helicopter. More than 1,600 aircraft have been fielded to serve worldwide missions. The Army requirement for new aircraft continues, and a recapitalization/modernization program plan to improve the fleet and extend its operating life is in development. *Caption provided by advertiser.*

Briefings continued on page 80

# contents

Vol. 49 No. 8-9

AUGUST/SEPTEMBER 2000

## FEATURES:

- 6 Spatial Disorientation in Army Aviation  
*by Maj. Gen. Anthony Jones and Col. John Powell*
- 8 Training Our Aviation Soldiers  
*by CSM Edward Iannone*
- 76 CCAD Supports the Army  
*by Ralph Yoder*
- 84 AAAA Scholarship Recipients Announced

## THE 2000 INDUSTRY PARTNERS DIRECTORY

- 12 The 2000 Industry Partners Directory  
The Army Aviation Industry Partners Directory is a section of the BLUEBOOK, Army aviation's worldwide, year-round reference of our industry partners engaged in the overall field of U.S. Army aviation.

## THE 2000 "BLUE BOOK" DIRECTORY

- 20 The 2000 "Blue Book" Directory  
The Army Aviation Blue Book Directory is an original compilation of the organizations in which U.S. Army aviation personnel serve in key positions.

## DEPARTMENTS:

Advertisers Index .....	75	Briefings .....	3
AAAA New Members.....	89	Calendar.....	98
AAAA News .....	89	Mailbox .....	78
Arrivals & Departures .....	79	People on the Move.....	81

ARMY AVIATION is the official journal of the Army Aviation Association of America (AAAA). The views expressed in this publication are those of the individual authors, not the Department of Defense or its elements. The content does not necessarily reflect the official U.S. Army position nor the position of the AAAA or the staff of Army Aviation Publications, Inc., (AAPI). Title reg<sup>®</sup> in U.S. Patent office. Registration Number 1,533,053. SUBSCRIPTION DATA: ARMY AVIATION (ISSN 0004-248X) is published monthly, except April and September by AAPI, 49 Richmondville Avenue, Westport, CT 06880-2000. Tel: (203) 226-8184, FAX: (203) 222-9863, E-Mail: [aaaa@quad-a.org](mailto:aaaa@quad-a.org). Army Aviation Magazine E-Mail: [magazine@quad-a.org](mailto:magazine@quad-a.org). Website: <http://www.quad-a.org>. Subscription rates for non-AAAA members: \$30, one year; \$58, two years; add \$10 per year for foreign addresses other than military APOs. Single copy price: \$3.00. ADVERTISING: Display and classified advertising rates are listed in SRDS Business Publications, Classification 90. POSTMASTER: Periodicals postage paid at Westport, CT and other offices. Send address changes to AAPI, 49 Richmondville Ave., Westport, CT 06880-2000.

# SMITHS

**our systems:  
your solutions**

## avionics

Smiths Industries Aerospace provides a single source for all the different forms of aircraft data management: uploading data from the ground, recording and displaying data in flight, data downloading and post-flight analysis, and in-flight data storage in media from ruggedised PC cards to crash-resistant 'black boxes'.

Smiths' Health and Usage Management System (HUMS), which monitors the condition of transmissions, bearings, turbine blades and rotors, has been selected for all of the UK's military helicopter fleet. HUMS shows how real-time data management by Smiths not only cuts operating costs, but adds a critical safety margin.

**It's simple, safe and smart. Smiths style.**



SMITHS INDUSTRIES  
Aerospace

**THE SOLUTION.**

# Spatial Disorientation in **ARMY** **AVIATION**



By Maj. Gen. Anthony Jones and Col. John Powell

**A**rmy aviation has a problem. Spatial disorientation continues to be a significant cause of rotary-wing aviation accidents, despite our continued training emphasis on crew coordination during initial-entry rotary wing (IERW) training and instrument flight training for our aviator soldiers. Let's discuss the magnitude of this problem and the factors that influence its appearance in flight, and introduce some innovative and highly effective training countermeasures that can reduce its threat to our aircrews.

## The Problem

According to the U.S. Army Safety Center, spatial disorientation (SD) was considered to be a significant factor in 291 (30 percent) of Army Class A-C helicopter accidents between 1987 and 1995. One hundred and ten lives were lost, and these accidents resulted in materiel losses of nearly \$468 million. Although the monetary cost of SD accidents is high, the fatality rate is between one and one-half to two times that of non-disorientation accidents.

## What is SD?

The human body is structured to perceive changes in movement and orientation on land in relation to the center of the earth. In 1978 researcher A.J. Benson stated "a pilot in an aircraft may fail to correctly sense the position, motion or attitude of the aircraft or of himself within the fixed coordinate systems provided by the surface of the earth and the gravitational vertical." This condition can be caused or exacerbated by numerous factors singly or in combination, leading to SD. Factors such as loss of situational awareness, task overload, poor aircrew coordination and marginal weather may all contribute to SD.

In a definitive 1997 review of SD issues U.S. Army Aeromedical Research Laboratory (USAARL) scientists M. Braithwaite, S. Groh and E. Alvarez concluded that:

- SD is an important source of attrition in Army helicopter operations, costing an average of \$58 million and 14 lives each year.
- SD accidents increased significantly during the Gulf War. The grave implication for the military is highlighted by the fact that 81 percent of



From providing the latest Doppler/GPS Navigation Systems for the Black Hawk Helicopter



to supplying the most advanced countermeasures dispenser system in the world – AN/ALE-47

Unrivalled Capability

**BAE SYSTEMS**

A truly global systems, defense and aerospace company.

[www.baesystems.com](http://www.baesystems.com)

nighttime accidents in Saudi Arabia could be attributed to SD.

- The contribution of SD to the overall accident rate is not getting smaller. The increased risk associated with the use of night-vision devices compared to day flying is of particular concern.

- The helicopter SD accident is not one of classical vestibular or visual illusion giving the pilot "vertigo," but is one of loss of orientation cues leading to a ground or object strike.

- These accidents might have been prevented by reinforcing proper crew coordination and scanning techniques. Continued aircrew SD training will heighten the awareness of the risks associated with distraction and the limitations of human orientation senses.

## Countermeasures

As countermeasures to continuing attrition to SD, USAARL has developed and fielded several programs to heighten awareness of SD in the aviation community. An in-flight demonstration sortie originally designed by the British Army for the Gazelle was modified and tested by USAARL in the UH-1. The sortie was clearly beneficial for demonstrating the physical limitations of the human orientation system.

The in-flight training sortie was approved by ATB and incorporated into IERW training in 1997. Due to anticipated funding and asset changes at the U.S. Army Aviation Center, Fort Rucker, Ala., flight training may be affected and may undergo revision. In an effort to be responsive to future training requirements and as the developer of this SD flight training, USAARL is in the process of publishing a report containing the SD demonstration flight lesson plans for the TH-67, UH-1 and UH-60 helicopters.

While aviators may have some experience with recovery from unusual attitudes during initial flight training, many disorienting circumstances cannot be demonstrated safely during actual flight. However, it is possible to demonstrate these circumstances safely in a flight simulator. Using data taken directly from real SD accidents, it is possible to

recreate and demonstrate these particular orientation problems in a controlled environment in a very realistic manner.

Simulator flight scenarios have been developed by USAARL for use in training Army aviators to recognize factors, which may lead to spatially disorienting situations. These scenarios are designed to stress situational awareness and proper aircrew coordination techniques to overcome SD once it is encountered. This unique simulator training package permits the trainer to take the aviator through each scenario, and uses the experience as a basis for reinforcing the principles of good situational awareness and aircrew coordination.



This training package has been distributed to aviation units both within and outside the continental United States, and has received overwhelmingly positive feedback from the Army aviation leaders. We are confident that these scenarios contain valuable training material, and that their use will help decrease SD mishaps.



*MG Anthony Jones is commanding general of the U.S. Army Aviation Center at Fort Rucker, Ala., and chief of the aviation branch. Col Powell is commander of the U.S. Army Aeromedical Research Laboratory at Fort Rucker, Ala.*

## Training Our Aviation Soldiers

by CSM Edward Iannone



Soldiers attend Advanced Individual Training (AIT) in 1st Battalion, 13th Aviation Regiment, 1st Avn. Brigade, at Fort Rucker, Ala., to train in four of the 19 aviation MOSs. The MOS 93C, 93P, 67N and 67V are taught here, generating an annual student population of approximately 1,500 soldiers. After receiving their training these soldiers will fill the ranks of both active and reserve-component units around the world.

The 1-13 Avn. Bn. is different from most training units in that students and instructors are assigned to the same battalion. The school is divided into two training sections: the Air Operation Training Committee (AOTC), which is responsible for 93C/P courses, and the Maintenance Training Committee, which is responsible for the 67N/V and Aviation Life Support and Equipment (ALSE) courses.

All platform instructors are assigned to Headquarters and HQs. Company (HHC). Additionally, HHC has overall responsibility for the Combat Skills Training Branch (CSTB) which conducts the weekly

Field Training Exercise (FTX). It is here that the soldiers participate in valuable tactical equipment training along with MOS and common soldier task training that reinforce their survival skills during an FTX. The FTX reinforces previously learned common soldier tasks and skills in a realistic austere environment that replicates the stress, sound and conditions on today's battlefield.

Soldiers arrive at Fort Rucker for AIT after nine grueling weeks of Basic Combat Training (BCT). They are in phase IV of the five phases of Initial Entry Training (IET) "soldierization" training model.

By definition, soldierization is a tough, comprehensive process, which totally immerses an IET soldier in the positive environment established by active, involved leadership. This environment sets high standards, provides positive role models and uses every training opportunity to reinforce basic soldier skills. In phase IV, soldiers continue this process but control measures are somewhat lessened. In this phase, soldiers receive reinforcement training of common skills, values and traditions taught in BCT, and for the first time they are introduced to their MOS tasks. Soldiers may be granted limited on-post privileges in phase IV, which includes wearing of a prescribed uniform when not in the company area, the opportunity to



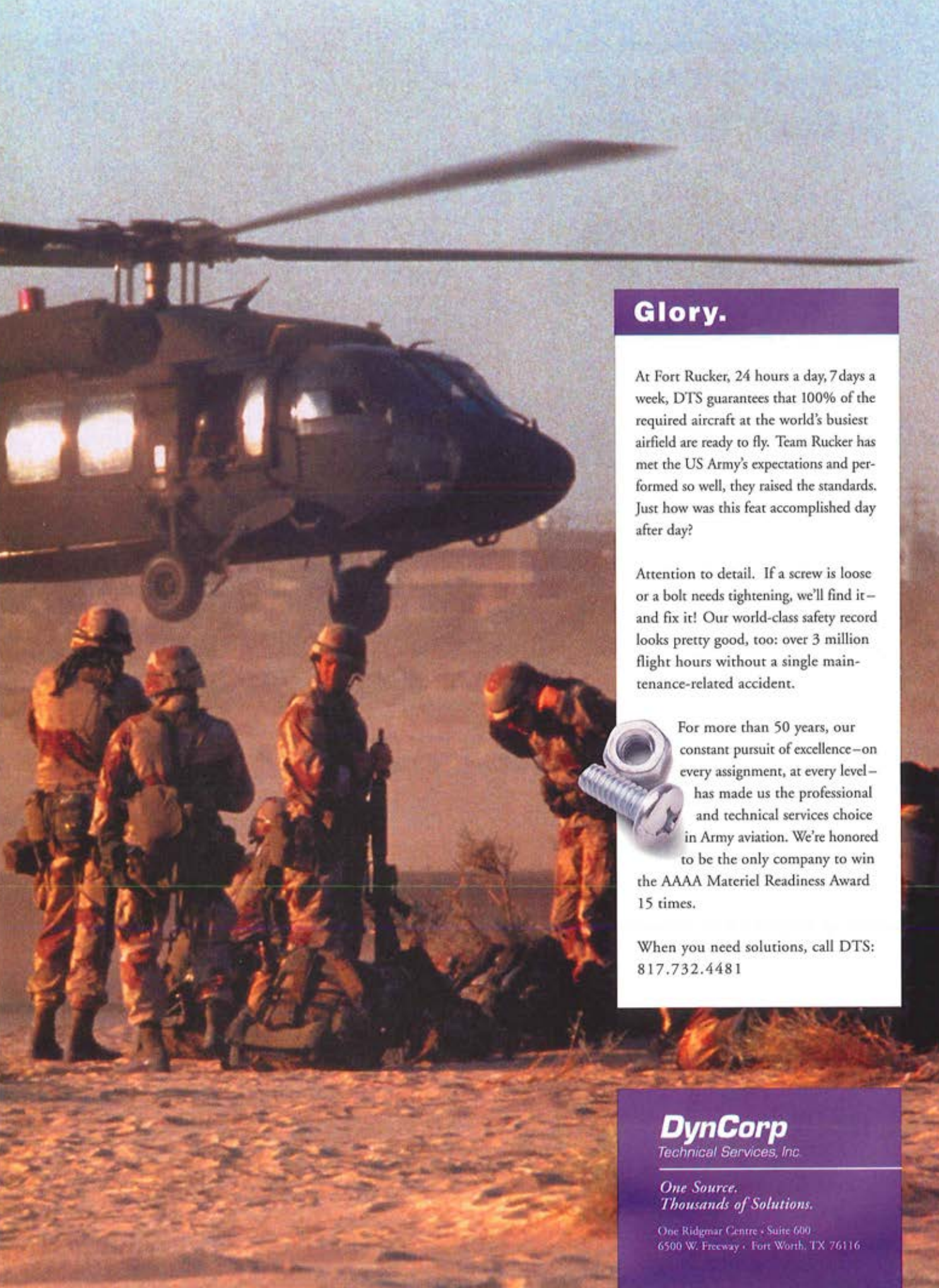

## Glory.

At Fort Rucker, 24 hours a day, 7 days a week, DTS guarantees that 100% of the required aircraft at the world's busiest airfield are ready to fly. Team Rucker has met the US Army's expectations and performed so well, they raised the standards. Just how was this feat accomplished day after day?

Attention to detail. If a screw is loose or a bolt needs tightening, we'll find it—and fix it! Our world-class safety record looks pretty good, too: over 3 million flight hours without a single maintenance-related accident.



For more than 50 years, our constant pursuit of excellence—on every assignment, at every level—has made us the professional and technical services choice in Army aviation. We're honored to be the only company to win the AAAA Materiel Readiness Award 15 times.

When you need solutions, call DTS:  
817.732.4481

**DynCorp**

Technical Services, Inc.

*One Source.  
Thousands of Solutions.*

One Ridgmar Centre • Suite 600  
6500 W. Freeway • Fort Worth, TX 76116



# THE MILITARY SHIPPING, STORAGE, AND MOBILITY SOLUTION COMPANY.



## AAR CADILLAC MANUFACTURING



AAR designs and manufactures the industries best mobility products, enhancing your mobility effectiveness and reducing the hard work of rapid deployment. We integrate deployable work spaces, specialized storage containers and prefabricated structures to meet the rigorous requirements of the military.

Our numerous shipping and air mobility pallets easily interface with the U.S. Air Force aircraft 463L roller system. The rugged ISU® shipping and storage containers are customizable and our D.O.D deployment shelters are of the highest quality and offer customized integration.

AAR works closely with you to become a solution provider for your mobility requirements of equipment & parts storage and operational capabilities and has been an integral provider for the armed forces for over fifty years.

- Our full line of products are available by National Stock Number (NSN) or Part Number through the DOD Supply System
- A full line of mobility pallets for airlifting supplies and equipment
- ISU® Shipping and Storage Containers (Most are Helicopter Sling Certified and Airlift Certified)
- Deployment Shelters for work spaces, shops, mobile laundry units, mobile showers, command posts or many other uses
- Specialty containers, Dog Kennels, Computer Rooms, and ATV Shelters

- Refrigeration Containers
- Expandable Containers for ground and truck mounted operation
- Shelter Repair and Overhaul to include Field Repair Services on Containers and Shelters
- Environmental Control Units (ECU-Heaters/Air Conditioners) Repair and Cooling Replacement
- Shelter and Container Integration
- Short and Long Term Leasing on most of our products
- Custom Shelter and Container Design
- Mobility Trailers, Mobilizers and Mobility Wheels Sets
- Web Base On-line Ordering
- Web Partners (Strategic Allies) Products
- Composite panel design and manufacturing
- Reusable storage and shipping cases/ specialty cases

[www.aarcorp.com](http://www.aarcorp.com)

**select  
e-business  
button**

Visit us on-line at [aarcorp.com](http://aarcorp.com), select manufacturing, then select cadillac to view our full line of quality products.



## AAR CADILLAC MANUFACTURING

Stephen W. Peckham, Director, Military Sales

1-800-355-2015 [speckham@aarcorp.com](mailto:speckham@aarcorp.com) [www.aarcorp.com](http://www.aarcorp.com)

201 Haynes Street, Cadillac, Michigan 49601

# ARMY AVIATION INDUSTRY PARTNERS DIRECTORY

The Army Aviation Industry Partners Directory is a paid advertising section of the BLUEBOOK, Army Aviation's worldwide, year-round reference of individuals and organizations engaged in the overall field of U.S. Army Aviation. The following organizations are listed by the following categories: 1) Manufacturing; 2) Maintenance/Repair/Overhaul; and 3) Consultants/Special Services. Any firm that wishes to be included in next year's directory should contact Bob Lachowski at Army Aviation Publications, Inc., 49 Richmondville Avenue, Westport, CT 06880; Telephone: (203) 226-8184, ext. 131; FAX: (203) 222-9863

## MANUFACTURING

### AAR Cadillac Manufacturing

201 Haynes Street  
Cadillac, MI 49601  
Director Military Sales: Mr. Steve Peckham  
C: 231-779-4880; FAX: 231-779-4926  
speckham@aarcorp.com  
(SEE OUR AD ON PAGE 11)

### Acme Electric Corporation, Aerospace Division

528 W. 21st Street  
Tempe, AZ 85282  
Custom Design & Manufacture of Emergency Backup Power Systems  
Marketing Manager: Mr. Gary Lesser  
C: 480-894-6864; FAX: 480-921-0470  
glessner@acmepower.com

### Avion, Inc.

Spirit of St. Louis Airport  
18089 Edison Avenue  
Chesterfield, MO 63005  
Universal Static Balance Fixture for helicopter rotor blades  
President: Mr. Gary W. Donald  
C: 256-721-7006; FAX: 256-721-7007  
gdonald@avioninc.com  
Vice President: Mr. Joseph T. Buckel  
C: 636-537-4900; FAX: 636-537-4660  
jbuckel@avioninc.com  
Vice President: Mr. Norm Beachum  
C: 636-537-4900; FAX: 636-537-4660  
nbeachum@avion.com

### BAE Systems

164 Totowa Road  
Wayne, NJ 07474-0975  
Doppler nav., landing syst., altimeters, Link 16, inertial  
Program Manager: Ms. Teresa Thanos  
MAIL STOP: MS 11C28  
C: 973-633-6040; FAX: 973-633-6188  
teresa.thanos@baesystems.com  
(SEE OUR AD ON PAGE 7)

### BAE Systems, Flight Simulation & Training

4908 Tampa West Blvd.  
Tampa, FL 33634  
Simulation & Training Systems/Services  
Director, Army Marketing: Mr. Bill Yarlett  
C: 813-887-1436; FAX: 813-887-1439  
bill.yarlett@reflectone.com

### BAE SYSTEMS CANADA INC.

600 Dr. Frederik Philips  
Ville St. Laurent  
Quebec Canada H4M 2S9  
A leader in design & mfg. of high tech avionics & communication  
Director Marketing, Military Avionics: Mr. Al Letcher  
MAIL STOP: MS 244  
C: 613-592-6500; FAX: 613-592-7467  
al.letcher@baesystems-canada.com

### BAE SYSTEMS CANADA INC.

415 Legget Drive, P. O. Box 13330  
Kanata  
Ontario Canada K2K 2B2  
A leader in design & mfg. of high tech avionics & communication  
Director Marketing, Military Avionics: Mr. Al Letcher  
MAIL STOP: MS 244  
C: 613-592-6500; FAX: 613-592-7467  
al.letcher@baesystems-canada.com  
Vice President, Aviation Electronics: Mr. Bruce Bailey  
MAIL STOP: MS 244  
C: 613-592-6500; FAX: 613-592-7467  
bruce.bailey@baesystems-canada.com

### BarcoView, Inc.

3059 Premiere Parkway  
Duluth, GA 30097-4905  
Mfg. radar, scan converters, video mixers, avionics displays  
Manager of Avionics: Mr. Jim Niemczyk  
C: 678-475-8000; FAX: 678-475-8100  
jim.niemczyk@barco.com

### Basic Concepts, Inc.

1310 Harris Bridge Road  
Anderson, SC 29621  
Sentry line of patented drive-in spill, leak & containment prod  
General Manager: Mr. Glenn VanRomer  
C: 800-285-4203; FAX: 864-224-7227  
bci@carol.com  
Business Development: Mr. Denny Middleton  
C: 800-285-4203; FAX: 864-224-7222, EM: bci@carol.com

### Bell Helicopter Textron, Inc.

P.O. Box 482  
Fort Worth, TX 76101  
Leading manufacturer of vertical flight aircraft  
President: Mr. John Murphy  
(SEE OUR AD ON PAGE 57)

### The Boeing Company

P. O. Box 16858  
Philadelphia, PA 19142-0858  
Military Rotocraft  
General Manager, Army Programs - Business Dev.:  
Mr. Francis X. Lake, Jr.  
MAIL STOP: MS P31-92  
C: 610-591-2477; FAX: 610-591-5068  
Francis.Lake@PHIL.Boeing.com  
(SEE OUR AD ON PAGE 2)

### The Boeing Company

5000 E. McDowell Road  
Mesa, AZ 85215-0858  
Military helicopters, ordnance systems & technology  
development  
Media & Communications: Mr. Hal Klopfer  
MAIL STOP: MS 510-A387  
C: 480-891-5519  
hal.g.klopfer@boeing.com

### Bombardier Aerospace

1023 15th Street, NW, Suite 1000  
Washington, DC 20005-2602  
Learjet/Global Express/Canadair/Dash-8 Q Series/Worldwide  
CLS  
Director, Government Aircraft Programs: Mr. Douglas K. Mang  
C: 202-414-8993; FAX: 202-789-0712  
dmang@bombardier-dc.com  
Manager, Government Programs: Mr. Christopher J. Goode  
C: 202-414-8991; FAX: 202-789-0712  
cgoode1018@aol.com

### Breeze-Eastern

700 Liberty Avenue  
Union, NJ 07083  
Rescue Hoist, Cargo Winches, Cargo Hooks, Weapons  
Load/Reload Sys.  
Consultant: Mr. Gary Olson  
C: 908-686-4000; FAX: 908-686-9292  
golson@breeze-eastern.com  
(SEE OUR AD ON PAGE 59)

### CAE Electronics Ltd.

8585 Cole De Liesse CP1800  
Saint-Laurent  
Quebec, Canada H4L4X4  
Full mission and tactical rotary & fixed wing aircraft simu-  
lators  
Director of Marketing: Mr. David Kurts  
MAIL STOP: MS 63  
C: 514-341-2000 x2394; FAX: 514-734-5718  
kurts@cae.ca

### Cessna Aircraft Company

One Cessna Boulevard  
P. O. Box 7706  
Wichita, KS 67277-7706  
Business and Utility Aircraft  
Director, Government & Special Missions Sales: Mr. Patrick  
Sullivan  
MAIL STOP: 533C  
C: 316-517-8151; FAX: 315-517-6640  
PSullivan@cessna.textron.com

### Chandler Evans Control Systems Division

1 Charter Oak Blvd.  
West Hartford, CT 06110  
Fuel Controls, Fuel & Hydraulic Pumps, FADEC Systems  
Marketing & Programs Director: Mr. Jack Mut  
C: 860-523-2241; FAX: 860-232-1873  
jmut@chandlerevans.com  
(SEE OUR AD ON PAGE 29)

### Chelton, Inc.

1720 Lakepoint Dr., Suite 112  
Lewisville, TX 75057  
Antennas, Airborne/Vehicular. Low profile, cosite mitigation  
Vice President Marketing: Mr. Jeffery Salata  
C: 972-221-1783; FAX: 912-436-2716  
jeffery.salata@cheltoninc.com

### Communications-Applied Technology

11250-14 Roger Bacon Drive  
Reston, VA 20190-5202  
Wireless ICS, Mil Headset Compatible, no airframe mod  
reqd.  
President: Mr. G. Seth Leyman  
C: 800-229-3925; FAX: 703-471-4428  
info@c-at.com

### DAC International, Inc.

6702 McNeil Drive  
Austin, TX 78729  
GPS Fit Mgmt Sys "FOG" ATT & HDG Ref Sys (AHRS),EPI  
& Test Equip.  
Director Government Marketing: Mr. Robert R. Mullins  
C: 770-424-8634; FAX: 770-424-3464  
rmullinsr@aol.com  
(SEE OUR AD ON PAGE 63)

### DHS Systems, LLC

33 Kings Highway  
Orangeburg, NY 10962-1802  
DRASH TACTICAL SHELTERS & POWER/HVAC TRAIL-  
ERS  
Director, Business Development: Mr. Peter G. Lawson II  
C: 914-359-6066; FAX: 914-365-2114  
DRASH@DRASH.COM

### DuPont Company

P. O. Box 27001  
Richmond, VA 23261  
\*\*\*Nomex & Kevlar brand fibers  
Account Manager: Mr. Richard W. Blocker  
MAIL STOP: Ptl 1  
C: 804-383-2984; FAX: 804-383-4132  
richard.w.blocker-jr@usa.dupont.com

### ECC International Corporation

2001 W. Oak Ridge Road  
Orlando, FL 32809-3803  
Design, Develop and Manufacture Training and Simulation  
Systems  
Director of Marketing: Mr. Terry Fiest  
C: 407-859-7410, x3122; FAX: 407-251-9963  
Fiestt@eccic.com

# CAREFUL. IT'S LOADED.



Today's T700 comes loaded with unmatched experience and the best customer value – delivering affordable, reliable performance to all of the Army's Black Hawks and Apaches. Tomorrow's turboshaft will come loaded with all the T700's rugged durable features – plus demonstrated technology from GE and Army-sponsored JTAGG programs.

GE's advanced turboshafts are just one example of our commitment to the future of military aviation. Programs in support of advanced helicopters and next-generation aircraft like the Navy's Super Hornet and the multi-service Joint Strike Fighter come loaded not only with the latest in technology, but with a commitment to bring the lowest risk and highest value to our customers.



**GE Aircraft Engines**

**EFW Inc.**  
 4700 Marine Creek Parkway  
 Fort Worth, TX 76136-6969  
 HMDS, Cockpit display systems & upgrades, AMLCD, night vision  
 Vice President, Business Development: Mr. Jerry Fisher  
 C: 817-234-6734; FAX: 817-234-6792  
 JFisher@efw.com  
 Director, Ground Systems Business Development: Mr. Buster Thrasher  
 C: 817-234-6836; FAX: 817-234-6632  
 bthrasher@efw.com  
 Director, Tilt Rotor & Helicopter Systems: Mr. Jim Horan  
 C: 817-234-6748; FAX: 817-234-6700  
 horan@efw.com

**Evans & Sutherland**  
 600 Komas  
 Salt Lake City, UT 84108  
 A complete range of visual systems solutions for simulation & tng.  
 Business Development Manager: Mr. Paul F. Hinote  
 C: 407-482-4603; FAX: 407-482-4611  
 phinote@es.com

**Fastening Systems International, Inc.**  
 P.O. Box 1372  
 1206 E. MacArthur Street  
 Sonoma, CA 95476  
 Blind rivet tool kits for Cherry Max, Rivnuts, and Blind Bolts  
 President: Mr. Roger Nikkel  
 C: 707-935-1170; FAX: 707-935-1828  
 sales@lsirivet.com  
 (SEE OUR AD ON PAGE 16)

**Fatigue Technology, Inc.**  
 100 Andover Park West  
 Seattle, WA 98188-2868  
 Over 30 years of improving the fatigue life of aircraft structures  
 VP Marketing and Contracts: Mr. David Coddington  
 C: 206-246-2010; FAX: 206-244-9886  
 dcoddington@fatiguetech.com

**FN Manufacturing, Inc.**  
 P.O. Box 24257  
 Columbia, SC 29224  
 Small arms (M16A2, M249 & M240 Family)  
 President/CEO: Mr. Jean-Louis Vanderstraeten  
 C: 803-736-0522, x233; FAX: 803-699-9373  
 Director of Contracts/Sales & Marketing: Mr. Jeff Rankin  
 C: 803-736-0522, x295; FAX: 803-736-9949  
 jeffr@fnmfg.com

**GE Aircraft Engines**  
 1000 Western Avenue  
 Lynn, MA 01910  
 Manufactures and Services the T700 Turboshaft  
 General Manager, T700/CT7 Project: Mr. Edwin P. Birtwell  
 MAIL STOP: MZ 24004  
 C: 781-594-7617; FAX: 781-594-2870  
 edwin.birtwell@ae.ge.com  
 (SEE OUR AD ON PAGE 13)

**GENTEX Corporation**  
 P.O. Box 315  
 Carbondale, PA 18407  
 Military life support equipment: Helmets, masks, CD garments  
 Director of Marketing: Mr. Charles G. Rudolf  
 C: 570-282-8212; FAX: 570-282-8555  
 crudolf@gentexcorp.com

**Graphico Edgelit Panels**  
 1090 Bellamy Road N.  
 Scarborough  
 Ontario Canada M1H 1H2  
 Edgelit Panels & Keyboards, Annunciator Assy's  
 VP Quality & Special Projects: Mr. G.R. (Rick) Beaudry  
 C: 416-438-9119, x301; FAX: 416-289-4646  
 rick@graphicoelectronics.com

**Gulfstream Aerospace Corporation**  
 P.O. Box 2206  
 Savannah, GA 31402  
 Aircraft manufacturer  
 Program Director, New Business: Mr. Al Holmes  
 MAIL STOP: MS A-28  
 C: 912-965-4822; FAX: 912-965-7356  
 holmes@gullaero.com  
 (SEE OUR AD ON PAGE 41)

**Gulfstream Aerospace Corporation**  
 1000 Wilson Boulevard, Suite 2701  
 Arlington, VA 22209  
 C-20 (Gulfstream IV-SP) C-37 (Gulfstream V)  
 VP, Govt. Sales & Marketing: Mr. Monroe S. "Buddy" Sams  
 C: 703-276-9500; FAX: 703-276-9504  
 buddy.sams@gullaero.com

**Harris Corporation, GCSD**  
 P. O. Box 37  
 Melbourne, FL 32902  
 Digital maps, F/O networks, controls & displays, TCDD, MIDS LVT  
 Mgr., Business Development: Mr. Bill Bentz  
 C: 321-727-5820; FAX: 321-729-7157  
 wbentz@harris.com

**Inter-Coastal Electronics, Inc.**  
 5750 E. McKellips Road, Bldg. 100  
 Mesa, AZ 85215  
 Longbow Tess Collective Training Systems, 1553 Bus Monitors  
 Director, Business Development: Mr. Thomas M. Hayes  
 C: 480-981-6898; FAX: 480-981-6899  
 thhayes@inter-coastal.net

**Intergraph Government Solutions**  
 Federal Hardware Solutions Div  
 P.O. Box 6286  
 Huntsville, AL 35824-6286  
 Ruggedized Hardware Integ, Engineering Supp, Video Analysis  
 Director: Mr. Ray Faulwetter  
 MAIL STOP: MS IW1501  
 C: 256-730-6513; FAX: 256-730-2563  
 refaulwe@ingr.com

**Kearfott Guidance & Navigation Corporation**  
 150 Totowa Road  
 Wayne, NJ 07474-0946  
 Guidance & navigation for land, air, sea or space applications  
 Director Technical Marketing: Mr. Stephen Beiter  
 C: 973-785-6075; FAX: 973-785-5905  
 beiter@kearfott.com

**Litton Guidance & Control Systems**  
 5500 Canoga Avenue  
 Woodland Hills, CA 91367  
 Inertial Navigation, Displays, IFF, Systems Integration  
 Director, Customer Relations: Ms. Jan Thomis  
 MAIL STOP: MS 28  
 C: 818-715-4256; FAX: 818-715-2019  
 thomisj@littongcs.com

**Merrill Engineering Ltd.**  
 #1-7355 72nd Street  
 Delta, BC V49 1L5  
 Maintenance Platforms, Ground Support Equipment & Tooling  
 Sales Manager: Mr. Bill Szabo  
 C: 604-952-4199; FAX: 604-952-4198  
 merrillengineering@telus.net  
 Eastern Representative: Mr. Michael Robinson  
 C: 865-604-5856

**B.E. Meyers & Co., Inc.**  
 17525 NE 67th Ct.  
 Redmond, WA 98052  
 Night vision, laser illuminators, day/night cameras  
 V.P. Sales and Marketing: Mr. Roger Kreitzberg  
 C: 1-800-327-5648; FAX: 425-867-1759  
 meyers@bemeyers.com

**MICRO-SURFACE FINISHING PRODUCTS, Inc.**  
 P.O. Box 818  
 1217 West Third Street  
 Willon, IA 52778  
 Mfg. of cushioned abrasives & acrylic restoral kits for aircraft  
 President: Mr. Frank Poma  
 C: 319-732-3240; FAX: 319-732-3390  
 salesms@nelins.net



**SEARS**  
INDUSTRIAL SALES

YOUR PROFESSIONAL BRAND SOLUTION.  
GUARANTEED.



**GSA**  
Federal Supply Schedule  
MAS contract #GS-20F-5026H



1-800-776-8666  
FAX 1-800-233-4557

**FOR YOUR FREE TOOL BOOK PHONE  
OUR GOVERNMENT SERVICE DESK**

**1-888-337-9225**  
Fax 1-800-233-4557  
www.commercial.sears.com



Commercial  
**FOOD**



SmartPay  
GSA

# “Service

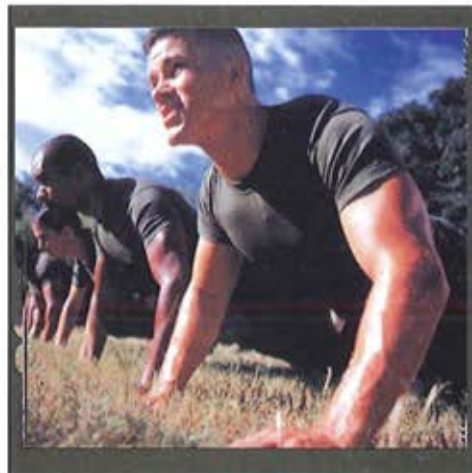

is a responsibility you don't take lightly.”

**Service.** A word we understand. We learn about it from our members, people like us who know what it means to serve in the military. USAA was founded more than 75 years ago by military personnel for military personnel. We serve our members with an array of products and services that stretches from insurance to banking to investments. We even have a unique package of services designed to ease you

through a PCS or deployment. And our member service is consistently rated the highest by a wide range of sources – including our members themselves, whether they're enlisted or officers, on active duty or in the National Guard or Reserves. At USAA, service isn't just a word. It's a way of life. Just ask around.

**Call us at 1-800-292-8561.**



*We know what it means to serve.™*

INSURANCE • BANKING • INVESTMENTS • MEMBER SERVICES



USAA Federal Savings Bank, an equal housing lender and USAA Savings Bank, both FDIC insured, offer banking and credit card products respectively. Securities products offered through USAA Investment Management Company and life, health and annuity products by the USAA Life Insurance Companies. Property and casualty insurance, available only to persons eligible for group membership, provided by United Services Automobile Association, USAA Casualty Insurance Company, USAA General Indemnity Company, USAA County Mutual Insurance Company and USAA, Ltd.

NavCom Defense Electronics, Inc.  
4323 Arden Drive  
El Monte, CA 91731  
Military radar allimeters, IFF test systems, and  
shipboard TACANs  
Marketing Administration: Ms. Patricia Gwyn  
MAIL STOP: ATTN: M/S 49  
C: 626-579-8691; FAX: 626-444-7619  
nde@navcom.com

Northrop Grumman  
600 Hicks Road  
Rolling Meadows, IL 60008  
EO, Infrared & Radar Freq. EW Equip. & Targeting Syst. &  
Test Equip.  
Director Business Development:  
Mr. Raymond F. Petty  
MAIL STOP: MS H6014  
C: 847-259-9600, x4200; FAX: 847-870-5713

Northrop Grumman Electronic Sensors and  
Systems Sector  
Post Office Box 17319  
Baltimore, MD 21203  
Longbow & Comanche sensors, processors & automated  
target systems  
Vice President, Longbow International Ltd.: Mr. Eugene  
Thompson  
MAIL STOP: MS 181  
C: 410-993-7000; FAX: 410-765-5439  
Eugene\_H\_Thompson@mail.northgrum.com  
Comanche Business Development Manager: Mr. Fred Frissyn  
MAIL STOP: MS A455  
C: 410-765-6316; FAX: 410-765-5046  
Fred\_J\_Frissyn@mail.northgrum.com

Orbital, Fairchild Defense  
20301 Century Boulevard  
Germantown, MD 20874  
Armored Data, Solid State Drive, Mass Mem Unit, Memory  
Data Module  
Program Director: Mr. Lee Lusby  
MAIL STOP: B-8  
C: 301-428-5332; FAX: 301-428-1093  
leelusby@oscscsystems.com  
Vice President, Business Development: Mr. Jay Balakirsky  
MAIL STOP: B-10  
C: 301-428-6633; FAX: 301-428-6398  
jbalakirsky@oscscsystems.com  
(SEE OUR AD ON PAGE 37)

Parker Aerospace  
18321 Jamboree Road  
Irvine, CA 92612  
Manufacturer of hydraulic, fuel, & pneumatic systems &  
components  
Director of Customer Support Military - Army: Mr. Joseph Ash  
MAIL STOP: CS02  
C: 949-809-8344; FAX: 949-263-9028  
jash@parker.com  
Program Manager, Army Customer Support: Mr. Jerry Cohen  
MAIL STOP: CS02  
C: 949-809-8484; FAX: 949-263-9028  
jcohen@parker.com  
(SEE OUR AD ON PAGE 21)

PREMIER Aviation, Inc.  
2621 Aviation Parkway  
Grand Prairie, TX 75052  
Proud member of the OH-67 Team; Helicopter Customizing  
Marketing: Ms. Shirley Beachler  
C: 972-988-8000; FAX: 972-660-2670  
marketing@premier-aviation.com

The Purdy Corporation  
586 Hilliard Street, P. O. Box 1898  
Manchester, CT 06045-1898  
Helicopter transmissions, rotorhead & turbine engine components  
President & CEO: Mr. Andrew A. Sadanowicz  
C: 860-649-0000; FAX: 860-649-6613  
sales@purdytransmissions.com  
Vice President - Sales: Mr. Barry R. Noonan, Jr.  
C: 860-649-0000; FAX: 860-645-6293  
sales@purdytransmissions.com

Raytheon Company  
1100 Wilson Blvd.  
Arlington, VA 22209  
World leader in defense electronics including missiles, radar,  
and electro-optics  
C: 703-284-4435; FAX: 703-525-7738  
rkandreson@west.raytheon.com

Robertson Aviation, L.L.C.  
P. O. Box 968  
Tempe, AZ 85280  
Crashworthy range extension fuel systems  
President & General Manager: Mr. John R. Rawling  
C: 480-337-7050; FAX: 480-968-3019  
robertsonaviation@worldnet.att.net  
Vice President, Marketing: Mr. Ian A. Powick  
C: 480-337-7050; FAX: 480-968-3019  
robertsonaviation@worldnet.att.net  
Program Manager: Mr. Marshall L. Lewis  
C: 480-337-7050; FAX: 480-968-3019  
robertsonaviation@worldnet.att.net  
(SEE OUR AD ON PAGE 27)

Sierra Research, an Integrated Defense  
Technologies Company  
485 Cayuga Road  
Buffalo, NY 14225-0222  
Electronic Warfare systems and services  
Vice President, Business Development: Mr. Patrick L. Johnson  
MAIL STOP: MS 351  
C: 716-631-6280; FAX: 716-631-6199  
pljohnson@sierra-idt.com  
(SEE OUR AD ON PAGE 43)

Sikorsky Aircraft  
6900 Main Street  
Stratford, CT 06497  
H-60, RAH-66 Helicopters  
Army Marketing: Mr. Kit McKeon  
C: 202-336-7435  
Comanche Marketing: Mr. Rob Fiest. C: 256-217-0023  
(SEE OUR AD ON COVER)

Simula Safety Systems, Inc.  
7414 S. Harl Avenue  
Tempe, AZ 85283-4307  
Aircraft airbags, ballistic armor, crashworthy aircraft seats.  
Product Manager, Military Seat Systems: Mr. Jack Cress  
C: 480-730-4406; FAX: 480-897-1906  
cressj@simula.sssi.com  
(SEE OUR AD ON PAGE 67)

Specialty Enterprises Ltd.  
12910 Travilah Road  
Potomac, MD 20854  
Voice Warning Systems-Latest Technology for Rotary &  
FW Aircraft  
President: Mr. Robert A. Romandetto  
C: 301-990-7337; FAX: 301-990-9588



**FSI**

**Fastening Systems International**

**THE BLIND RIVET  
& TOOLING  
SPECIALISTS**

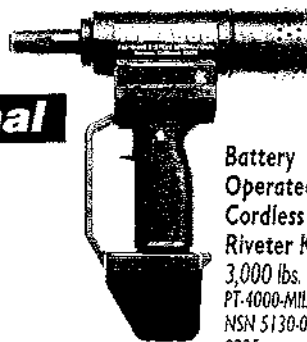

**Battery  
Operated  
Cordless  
Riveter Kit**  
3,000 lbs.  
PT-4000-MIL-1  
NSN 5130-01-449-  
9225



**Blind Rivet  
(M7885 Style)**



**Pull Thru  
(MS Style)**



**Blind Bolts  
(MS90353/54 Style)  
S/U Type**



**Blind Rivet  
Nuts**



**Air-Hydraulic  
Riveter Kit**  
4,000 lbs.  
PT-100-MIL-5  
NSN 5130-01-373-6685



**Hand Hydraulic  
Riveter Kit**  
4,000 lbs.  
D-100-MIL-2  
NSN 5180-01-201-4979



**VariMax™  
Riveter Kit**  
4,200 lbs.  
D-700-MIL-2  
NSN 5180-01-430-5361

FSCM: 64878

1206 E. MacArthur St., Sonoma, CA 95476 • (800) 344-2393 • Fax: (707) 935-1828  
e-mail: sales@fsirivet.com • website: www.fsirivet.com



See farther.  
See clearer.  
See the tactical  
advantage.

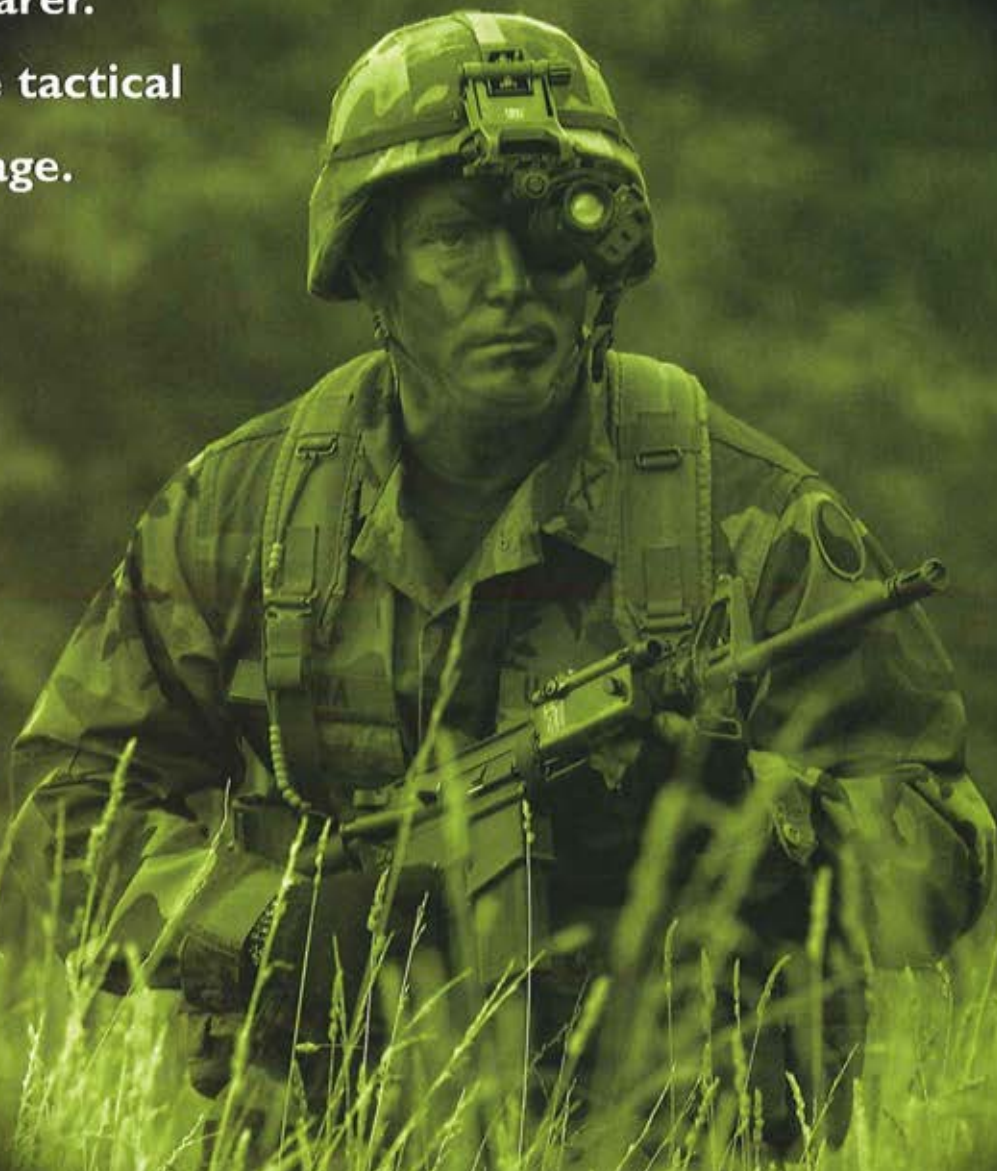

On the darkest  
nights of the year.

When night falls, soldiers clearly see the advantages of ITT Night Vision equipment for critical operations where the ability to distinguish friend from foe is imperative. Our new GEN III image intensifier tube for OMNI IV delivers the highest technical performance available. Improved resolution. Higher signal-to-noise ratio. Increased photosensitivity. No other night vision device comes close.

These advancements have earned us 100% of the U.S. Army's OMNIBUS IV procurement, as well as comparable programs in Australia and Switzerland. We are committed to enhancing nighttime situational awareness for U.S. and allied military forces. ITT Night Vision. Clearly, the leader in image intensifier technology.



**ITT Industries**  
*Engineered for life*

# QUALITY SERVICE



Lear Siegler Services, Inc. (LSI), has consistently provided its customers with quality service for more than 39 years. Our experience with the military ranges from maintenance to pilot training.

If you are looking for an industry leader, your search is over. For more information, visit our website at [www.learinc.com](http://www.learinc.com).



**Lear Siegler Services, Inc.**

175 Admiral Cochrane Drive  
Annapolis, Maryland 21401  
410-266-1380 • 410-266-3581/fax

**Spirnet Systems Aerospace Solutions (Wichita) Inc.**  
8710 E. 32nd Street North  
Wichita, KS 67226  
Air Data, AMLCD Displays, Air Data Test Sets, Engine Instrument Display Systems  
Mr. Jeremy Henak  
C: 316-636-1356; FAX: 316-656-9098  
[jeremyh@pgaerospace.com](mailto:jeremyh@pgaerospace.com)  
Mr. Dennis Snyder  
C: 316-636-1305; FAX: 316-636-9098  
[dennis@pgaerospace.com](mailto:dennis@pgaerospace.com)

**Symetrics Industries**  
1615 West NASA Boulevard  
Melbourne, FL 32901  
Manufacturer of MD-1295/A: IDM for digital communications  
Vice President: Mr. Ronald David Frye  
cell: 321-432-8359; C: 321-254-1500; FAX: 321-259-4122  
[rfrye@symetrics.com](mailto:rfrye@symetrics.com)

**TERMA Elektronik AS**  
Hovmarken 4  
DK-8520 Lystrup  
Denmark  
Control & Integration of EW Systems. Chaff & Flare Dispensing Sys.  
Head of Dept. EW Systems: Mr. Ole Fogh  
C: +45 8743 6394; FAX: +45 8743 6001; [of@terma.dk](mailto:of@terma.dk)

**TERMA Elektronik AS**  
10640 Main Street, Suite 200  
Fairfax, VA 22030  
Electronic warfare mgmt. sys., helo structural component mfg.  
Marketing Manager: Mr. Andrew Wilson  
C: 703-352-3400; FAX: 703-385-6470  
[awilson@jgwgroup.com](mailto:awilson@jgwgroup.com)

**Thomson-CSF Sextant Canada Inc.**  
7190 Frederick-Banting, Suite 100  
Ville Saint-Laurent  
Quebec Canada H4S 2A1  
Avionics & Helmet Mounted Display Manufacturer & System Integ.  
Director, Marketing & Sales, Helicopters: Mr. Gilles Turcotte  
C: 514-832-2973; FAX: 514-832-0929  
[gilles.turcotte@sextant.thomson-csf.com](mailto:gilles.turcotte@sextant.thomson-csf.com)

**Wing Enterprises, Inc.**  
1325 W. Industrial Circle  
Springville, UT 84663  
Little Giant Ladder used for aircraft support maintenance equip.  
Government Sales: Mr. Paul Kennedy  
C: 800-453-1192; FAX: 801-489-3685  
[pkennedy@ladders.com](mailto:pkennedy@ladders.com)

## MAINTENANCE/ REPAIR/OVERHAUL

**ACES Systems**  
10737 Lexington Drive  
Knoxville, TN 37932  
Aviation Maintenance Instruments-Balancing, Vibration, Performance  
Director of Sales: Mr. John Ostrowski  
C: 423-966-5856; FAX: 423-675-1241  
[jostrowski@acesystems.com](mailto:jostrowski@acesystems.com)

**Boeing Sikorsky Aircraft Support**  
P.O. Box 550  
Fort Campbell, KY 42223-0550  
Provide Aviation Logistics Support Services  
General Manager: Mr. Tom Cole  
C: 270-439-6232, x309; FAX: 270-439-0961  
[tc@boeing.com](mailto:tc@boeing.com)  
Deputy General Manager: Mr. Kurt J. Porter  
C: 270-439-6232, x328; FAX: 270-439-0961  
[kurt.j.porter@boeing.com](mailto:kurt.j.porter@boeing.com)

**Composite Technology, Inc.**  
1001 Avenue R  
Grand Prairie, TX 75050  
Helicopter rotor blade service center for all major manufacturers  
Director, Army Programs: Mr. Terrance L. Reininger  
C: 972-606-4421; FAX: 972-606-4417  
[terryreining@compuserve.com](mailto:terryreining@compuserve.com)

**Dallas Airmotive Incorporated**  
7511 Lemmon Avenue, Building B  
Dallas, TX 75209-3017  
Complete OEM-authorized turbine engine services  
Senior Manager, Marketing: Mr. William D. Barber  
C: 214-956-2601; FAX: 214-956-2810  
[bbarber@dallasairmotive.com](mailto:bbarber@dallasairmotive.com)  
Sr. Director, Helicopter Programs: Mr. Morris Brown  
C: 214-956-3012; FAX: 214-956-2893  
[mbrown@dallasairmotive.com](mailto:mbrown@dallasairmotive.com)

**Fabritech Inc.**  
1145 E. Airline Drive  
East Alton, IL 62024  
Transmissions, Hydraulics, Electronics  
President: Mr. Steven A. McCunney  
C: 618-259-6089; FAX: 618-259-5972  
[SMCCUNNEY@MSL.NET](mailto:SMCCUNNEY@MSL.NET)

**GE Aircraft Engines**  
1000 Western Avenue  
Lynn, MA 01910  
Manufactures and Services the T700 Turboshaft  
General Manager, T700/CT7 Project: Mr. Edwin P. Birtwell  
MAIL STOP: MZ 24004  
C: 781-594-7617; FAX: 781-594-2870  
[edwin.birtwell@ae.ge.com](mailto:edwin.birtwell@ae.ge.com)  
(SEE OUR AD ON PAGE 13)

**Howell Instruments, Inc.**  
3479 W. Vickery Blvd.  
Fort Worth, TX 76114  
Turbine Engine Testing & Monitoring Systems  
Field Engineer: Mr. Brian Byrne  
C: 817-336-7411; FAX: 817-336-7874  
[bbyrne@howellinst.com](mailto:bbyrne@howellinst.com)

**Israel Aircraft Industries**  
1700 N. Moore Street, Suite 1210  
Arlington, VA 22209  
Helicopter Maintenance, Overhaul, Upgrades, Blades.  
Director, Programs: Mr. Moshe Berger  
C: 703-875-3724; FAX: 703-875-3740  
[mberger.iaii@psinet.com](mailto:mberger.iaii@psinet.com)

**Lear Siegler Services, Inc.**  
175 Admiral Cochrane Drive  
Annapolis, MD 21401  
Logistics, maintenance, modifications, training & sys. integration  
President & CEO: Mr. John H. Moellering  
C: 410-224-1392; FAX: 410-224-3965  
[john.moellering@learinc.com](mailto:john.moellering@learinc.com)  
General Manager, CFT: Mr. Dave Carolthers  
C: 405-610-8200; FAX: 405-610-6267  
[dave\\_carolthers@ckc.learinc.com](mailto:dave_carolthers@ckc.learinc.com)  
(SEE OUR AD ON THIS PAGE)

**Lockheed Martin Aircraft & Logistics Center**  
107 Frederick Street  
Greenville, SC 29607  
Aircraft/Vehicle maintenance and modification  
President: Mr. Daniel Patterson  
C: 864-422-6400; FAX: 864-235-6749  
Vice President, Business Development: Mr. Robert Browning  
C: 864-422-6240; FAX: 864-422-6276

**Raytheon Aerospace Company, Contract Field Teams**  
4600 SE 29th, Suite 500  
Del City, OK 73115-3429  
Quick response mission support maintenance/modification worldwide  
General Manager, CFT: Mr. Clark J. Estes  
C: 405-677-1300; FAX: 405-677-4516  
[raycft@aol.com](mailto:raycft@aol.com)

(SEE OUR AD ON PAGE 25)

**Raytheon Joint Operations Group**  
5749 Briar Hill Road  
Lexington, KY 40516  
Fixed & Rotary Wing maint, mods, sys integration, repair & return  
Managing Director: Mr. David T. Merriam  
MAIL STOP: MS 1  
C: 859-293-3777; FAX: 859-293-3282  
[dave\\_merriam@sofsa.org](mailto:dave_merriam@sofsa.org)

**Sabreliner Corp.**  
7733 Forsyth Blvd., Suite 1500  
St. Louis, MO 63105-1821  
Turbine engine repair/overhaul for T53, J85, T700, T63/T703  
Vice President - Government Services: Mr. D.J. "Jim" Meier  
C: 314-863-6880; FAX: 314-863-6844  
info@sabreliner.com  
Director - Program Development: Mr. Al Farless  
C: 314-863-6880; FAX: 314-863-6844  
info@sabreliner.com

(SEE OUR AD ON PAGE 31)

### CONSULTANT/SPECIAL SERVICES

**AEPCO Inc.**  
9238 Madison Blvd.  
Building 2, Suite 110  
Madison, AL 35758  
AMCOM logistics, programmatic and technical support  
Vice President: Mr. Mike McClellan  
C: 256-464-9191; FAX: 256-464-9291  
McClellan\_Mike@aepco.com

**AmDyne Corporation**  
1403 Madison Park Drive, Suite 200  
Glen Burnie, MD 21061-5613  
Environmental engineering, ManTech and aircraft  
maintenance  
Division Manager: Mr. John Robbins  
C: 256-880-5080; FAX: 256-880-5086; robbinsj@amdyn.com

**ARINC Incorporated**  
2551 Riva Road  
Annapolis, MD 21401  
Aviation communications and systems integration  
Senior Director, Marketing: Mr. Fred Wynn  
MAIL STOP: MS 1-245  
C: 410-266-4656; FAX: 410-266-2329  
fwynn@arinc.com  
(SEE OUR AD ON PAGE 61)

**Aviation & Missile Solutions, LLC**  
Building 1, Suite 125  
620 Discovery Drive  
Huntsville, AL 35806  
Aviation technical services support  
President: Mr. Miles J. Montgomery  
C: 256-971-1301; FAX: 256-971-0882  
miles.montgomery@avmmsolutions.com

**CAS, Inc.**  
P.O. Box 11190  
Huntsville, AL 35814  
Systems Engineering and Analyses  
Executive Vice President: Mr. Charles G. Vaughn  
C: 256-922-4249; FAX: 256-922-4206  
charlie.vaughn@cas-inc.com

**Coleman Research Corporation**  
6820 Moquin Drive  
Huntsville, AL 35806  
Aviation Weapon Systems Cost/Performance Analysis Products  
Vice President/General Manager: Mr. Jeffrey L. Butler  
C: 256-922-6000; FAX: 256-922-6053  
jbutler@mail.crc.com

**Comptek Amherst Systems**  
7067 Old Madison Pike, NW, Suite 115  
Huntsville, AL 35806-2177  
Develop & maintain computer simulation  
s & provide tech support  
Marketing Manager: Mr. Billy G. Parsons  
C: 256-922-1446; FAX: 256-922-1550  
bgp@comptekamherst.com

**Continental Consulting Group Corporation**  
683 South Washington Street  
Alexandria, VA 22314  
Specializing in government & industry contract relationships  
President: Mr. Robert W. Hodes  
FAX: 703-455-0429  
hodes@erols.com

**Global Helicopter Technology, Inc.**  
5070 South Collins Street, Suite 206  
Arlington, TX 76018-1108  
Engr. R&D, A/C Mods, Testing, Instrumentation, &  
Certif./Qualif.  
Director, Business Development: Mr. Charles H. Cole  
C: 817-557-3391; FAX: 817-557-3392  
ghl@airmail.net

**Hawk Enterprises, L.L.C.**  
114 Cheval Boulevard  
Brownsboro, AL 35741  
Technical & logistics consulting for UH-60  
President: Mr. William G. Tripp  
C: 256-651-8574; FAX: 256-539-2196  
hawkenterprises4@cs.com

**HYPERSOFT, INC.**  
PO Box 1146  
St. Charles, MO 63302  
Software/Systems Engineering Support  
Senior Vice President: Dr. Timothy F. Carr  
C: 636-947-8862; FAX: 636-947-8074  
tim.carr@hypersoftinc.com

**Innovative Logistics Techniques, Inc. (INNOLOG)**  
2010 Corporate Ridge, 9th Floor  
McLean, VA 22102  
Logistics Systems Engineering  
Senior VP, Marketing & Business Development: Ms.  
Pamela R. Holmes  
C: 703-506-1555; FAX: 703-506-4559  
pholmes@hq.innolog.com

**Logistics Management Engineering, Inc.**  
6700 Odyssey Drive, Suite 261  
Huntsville, AL 35806  
Logistics Management & Engineering support for over 29 years  
VP: Mr. David L. Clark  
C: 256-971-6911; FAX: 256-971-6913 dclark@lmeinc.com

**MEVATEC Corp.**  
1525 Perimeter Parkway, Suite 500  
Huntsville, AL 35806  
Engineering and Management services  
Dir Bus Development: Mr. Bill Reichert  
C: 256-890-8087; FAX: 256-890-0000  
bill.reichert@mevatec.com  
Programs Integrator: Mr. Paul Keil  
C: 256-955-9775; FAX: 256-890-0000

**Navigator Development Group, Incorporated**  
116 S. Main Street, P. O. Box 310069  
Enterprise, AL 36631-0069  
Research, Analysis, Management & Defense Consulting  
President: Mr. Albert L. Pakerson, III  
C: 334-347-7612; FAX: 334-347-2582  
navigator@ndgi.com

**Peduzzi Associates, Limited**  
219 North Washington Street  
Alexandria, VA 22314  
Aerospace Business Development and Government Relations  
President: Mr. Lawrence P. (Pete) Peduzzi  
C: 703-836-7990; FAX: 703-836-9739  
PALBUSDEV@AOL.COM

**System Studies & Simulation, Inc.**  
3315 Bob Wallace Avenue, Suite 207  
Huntsville, AL 35805  
Technical services for system engineering, acquisition &  
training  
President: Ms. Jan Smith  
C: 256-539-1700, x109; FAX: 256-539-8015  
jan.smith@s3inc.net

**Teledyne Brown Engineering**  
300 Sparkman Drive, N.W.  
Huntsville, AL 35805  
Systems Engineering & Integration, Modeling &  
Simulation Dev.  
Vice President New Business Development: Mr. Jeffrey Irons  
MAIL STOP: Mail Stop 2  
C: 256-726-1200; FAX: 256-726-3434  
Jeffrey.Irons@TBE.com  
Director of Aviation Engineering: Mr. Steve Parker  
MAIL STOP: Mail Stop 50  
C: 256-726-1080; FAX: 256-726-3658  
Steve.Parker@TBE.com  
Aviation Programs Manager: Mr. Tim Kraatz  
MAIL STOP: Mail Stop 50  
C: 256-726-3684; FAX: 256-726-3658  
Tim.Kraatz@TBE.com  
(SEE OUR AD ON PAGE 35)

**Vitronics, Inc.**  
3 Corbett Way  
Eatontown, NJ 07724  
Air/Ground C2 inleg, aircraft kits, prototyping, cable  
fabrication  
President: Mr. Michael A. Cinque  
C: 732-389-0244, ext 17; FAX: 732-544-9431  
mcinque@vitronics.com  
Director, Regional Operations: Mr. James Stewart  
C: 732-544-8220; FAX: 732-544-8397  
james.stewart@mail1.monmouth.army.mil

# We Put The Military Under Cover Every Day.



These structures:

- are made with an anodized aluminum framework and a heavy-duty weatherproof PVC membrane covering
- can be erected with no heavy equipment
- fit in ISU containers complete with lights, electrical and doors
- are modular, portable and virtually maintenance free
- meet ISO9000 and/or Mil-145208A quality standards
- NSN#5410-01-363-0090

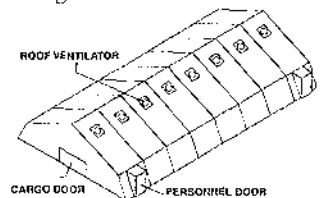

Warehouse/  
Maintenance Facility

Let Universal meet your "under cover" requirements.



**UNIVERSAL**  
FABRIC STRUCTURES

**1-800-634-8368**

(215) 529-9921 • www.ufsinc.com

# THE 2000 BLUE BOOK INDEX

1st Attack Battalion, 4th Aviation Regiment . . . . .	66	4th Brigade (Avn), 4th Infantry Division (MECH) . . . . .	66	C Company, 159th Aviation Regiment . . . . .	60
1st Attack Helicopter Battalion . . . . .	61	4th Brigade, 1st Armored Division . . . . .	72	C Company, 25th Aviation Regiment (AVIM) . . . . .	46
1st Attack Helicopter Battalion, 3rd Aviation Reg. . . . .	44	4th Brigade, 1st Infantry Division . . . . .	72	C Company, 6th Battalion, 52nd Aviation Reg (TA) . . . . .	38
1st Aviation Brigade (Golden Hawks) . . . . .	28	4th Squadron, 3rd Armored Cavalry Regiment . . . . .	71	Company D, 228th Aviation Regiment . . . . .	71
1st Battalion (Attack), 10th Aviation Regiment . . . . .	59	4th Squadron, 7th Cavalry Regiment . . . . .	74	D Company, 4-123rd Theater Aviation Regiment . . . . .	36
1st Battalion (Training Support) (Aviation) . . . . .	52	5th Battalion, 101st Aviation Regiment . . . . .	52	Det 1, 198th Medical Company (AA) . . . . .	63
1st Battalion, (Attack) 1st Aviation Regiment "Gunfighters" . . . . .	72	5th Battalion, 158th Aviation Regiment . . . . .	73	G Company, 58th Aviation Regiment (ATS) . . . . .	46
1st Battalion, 101st Aviation Regiment . . . . .	50	5th Battalion, 159th Aviation Regiment . . . . .	69	HQ USAREUR/7A ODCSOPS-AVN . . . . .	71
1st Battalion, 11th Aviation Regiment . . . . .	26	6th Battalion, 101st Aviation Regiment . . . . .	51	HQ USAREUR/7A ODCSLOG-AVN . . . . .	71
1st Battalion, 13th Aviation Regiment . . . . .	28	6th Battalion, 52nd Aviation Regiment (TA) . . . . .	38		
1st Battalion, 145th Aviation Regiment . . . . .	28	6th Cavalry Brigade . . . . .	74	Aeroflightdynamics Directorate, USAAMCOM . . . . .	40
1st Battalion, 14th Aviation Regiment . . . . .	28	6th Squadron (Attack), 6th Cavalry . . . . .	73	Air Defense Missile Directorate, (IMMC), USAAMCOM . . . . .	34
1st Battalion, 159th Aviation Regiment . . . . .	60	7th Army Training Command, Aviation Detach . . . . .	71	Air Maneuver Battle Lab Directorate, USAAVNC . . . . .	24
1st Battalion, 160th Special Oprns. Aviation Regiment (Airborne) . . . . .	50	7th Battalion, 101st Aviation Regiment . . . . .	52	Air Traffic Control (ATC) Prod. Office, USAAMCOM . . . . .	34
1st Battalion, 210th Aviation Regiment . . . . .	28	7th Battalion, 159th Aviation Regiment . . . . .	73	Airborne Communications Branch, CCS/Avionics Directorate, CECOM . . . . .	58
1st Battalion, 212th Aviation Regiment . . . . .	28	7th Squadron, 6th Cavalry Regiment (ATKHB) . . . . .	65	Airborne Mission Division, CCS/Avionics Directorate, CECOM . . . . .	58
1st Battalion, 223rd Aviation . . . . .	28	8th Battalion, 101st Aviation Regiment . . . . .	50	Airborne NAVCOM Division, CCS/Avionics Directorate, CECOM . . . . .	58
1st Battalion, 25th Aviation Regiment . . . . .	46	8th Battalion, 229th Aviation Regiment (Attack) . . . . .	52	Airborne Navigation Branch, CCS/Avionics Directorate, CECOM . . . . .	58
1st Battalion, 2nd Aviation Regiment . . . . .	74	9th Battalion, 101st Aviation Regiment . . . . .	52	Aircraft Programs Branch, CCS/Avionics Directorate, CECOM . . . . .	58
1st Battalion, 52nd Aviation . . . . .	74	10th Aviation Brigade, 10th Mountain Division (Light)59 . . . . .	52	Aircraft Survivability Branch, CCS/Avionics Directorate, CECOM . . . . .	58
1st Battalion, 58th Aviation Regiment (Corps) (Airborne) . . . . .	60	11th Aviation Regiment . . . . .	73	Aircrew Integrated Systems Prod. Manager's Office . . . . .	30
1st Battalion, 229th Aviation Regiment . . . . .	62	12th Aviation Battalion . . . . .	69	Air-to-Ground Missile Systems Project Office . . . . .	32
1st Cavalry Division . . . . .	66	12th Aviation Brigade . . . . .	72	Apache Attack Helicopter Project Manager's Office . . . . .	32
1st Military Intelligence Bn., (Aerial Exploitation) . . . . .	73	17th Aviation Brigade . . . . .	73	Apache Modernization Product Management Office . . . . .	32
1st Squadron (AIR), 17th Cavalry Regiment . . . . .	61	XVIII Airborne Corps Aviation Office . . . . .	60	Army Aviation Division, ODCSOPS . . . . .	42
1st Squadron, 4th U.S. Cavalry . . . . .	72	18th Aviation Brigade . . . . .	60	Army Flight Operations Detachment (AFOD), ODCSOPS, USAREUR . . . . .	71
1st Squadron, 6th Cavalry . . . . .	74	21st Cavalry Brigade (Air Combat) . . . . .	67	Army Reprogramming Analysis Team - Threat Analysis (ARAT-TA) . . . . .	42
1st Squadron, Seventh Cavalry . . . . .	66	25th Infantry Division (Light) Aviation Brigade . . . . .	46	ATC Branch, Airborne Mission Division, CCS/Avionics Dir., CECOM58 . . . . .	28
1/501st Attack Helicopter Battalion . . . . .	72	45th Medical Company (AA) . . . . .	71	Australian Liaison Office . . . . .	28
2/502d Aviation Regiment . . . . .	71	50th Medical Company (Air Ambulance) . . . . .	50	Aviation & Missile RDEC Directorate, Acquisition Center, USAAMCOM . . . . .	34
2d Battalion (Assault), 2d Aviation Regiment . . . . .	74	56th Medical Evacuation Battalion . . . . .	62	Aviation & Missile Research, Development & Eng. Ctr, USAAMCOM . . . . .	34
2d Battalion (Assault), 82d Aviation Regiment . . . . .	61	57th Medical Company (Air Ambulance)62 . . . . .	62	Aviation Applied Technology Directorate, (AATD), USAAMCOM . . . . .	69
2d Battalion, 101st Aviation Regiment . . . . .	50	68th Medical Company (AA) Alaska . . . . .	36	Aviation Branch Personnel Proponeny Office (AP) . . . . .	24
2d Battalion, 160th Special Oprns. Aviation Regiment (Airborne) . . . . .	50	78th Aviation Battalion (Provisional)75 . . . . .	61	Aviation Branch, OPMD, U.S. Total Army PERSCOM . . . . .	68
2d Battalion, 228th Aviation Regiment64 . . . . .	46	82d Aviation Brigade . . . . .	61	Aviation Branch, Tng. Spt. Mgt. & Ex. Div., DCST,First U.S. Army . . . . .	44
2d Battalion, 3d Aviation Regiment . . . . .	46	101st Airborne Division (AASLT) Aviation Brigade . . . . .	50	Aviation Brigade, 2d Infantry Division . . . . .	74
2d Squadron (Attack), 6th Cavalry . . . . .	73	101st Airborne Division (Air Assault) . . . . .	50	Aviation Brigade, 3rd Infantry Division . . . . .	44
2d Squadron, 17th Cavalry . . . . .	51	159th Aviation Brigade (Assault) . . . . .	50	Aviation Div., Individual Training Dir., DCS of Training, TRADOC . . . . .	70
2nd Assault Helicopter Battalion, 25th Avn Regt . . . . .	46	159th Medical Company (AA) . . . . .	71	Aviation Division, Directorate of Operations, DCSOPS, FORSCOM . . . . .	44
2nd Battalion, 10th Aviation Regiment . . . . .	59	160th Special Operations Aviation Reg (Airborne) . . . . .	50	Aviation Division, DPTM, Simmons Army Airfield . . . . .	60
2nd Battalion, 1st Aviation Regiment . . . . .	72	164th Air Traffic Services Group . . . . .	74	Aviation Division, ODCSOPS, USARC . . . . .	44
2nd Battalion, 227th Aviation Regiment . . . . .	66	166th Aviation Brigade . . . . .	48	Aviation Division, Operations Group, JRTC . . . . .	53
2nd Battalion, 4th Aviation Regiment . . . . .	66	127th Aviation Support Battalion . . . . .	72	Aviation Electronic Combat Project Manager's Office . . . . .	32
2nd Battalion, 501st Aviation Regiment . . . . .	72	200th Theater Army Materiel Management Center . . . . .	71	Aviation Electronic Combat Team, USAAVNC . . . . .	26
2nd Battalion, 52nd Aviation Regiment . . . . .	74	204th Military Intelligence Battalion . . . . .	66	Aviation Electronic Systems PMO . . . . .	32
III Corps Aviation Office . . . . .	66	214th Aviation Battalion . . . . .	71	Aviation Engineering Directorate, USAAMCOM . . . . .	34
3d Battalion, 101st Aviation Regiment . . . . .	51	224th Military Intelligence Battalion (Aerial Exploitation) . . . . .	44	Aviation Logistics and Integration Planning Group, USAALS . . . . .	69
3d Battalion, 160th Special Oprns. Aviation Regiment (Airborne) . . . . .	44	229th Aviation Regiment (Airborne) . . . . .	62	Aviation Logistics Division, ODCSLOG, HQDA . . . . .	42
3d Battalion, 229th Aviation Regiment . . . . .	62	236th Medical Company . . . . .	71		
3d Battalion, 58th Aviation Regiment (ATS) . . . . .	73	244th Aviation Brigade . . . . .	48		
3d Squadron, 17th Cavalry . . . . .	59	325th Forward Support Battalion . . . . .	46		
3d Squadron, 6th Cavalry . . . . .	75	341st Medical Battalion (EVAC) . . . . .	68		
3rd Infantry Division, Directorate of Readiness . . . . .	46	404th Support Battalion (Aviation) . . . . .	66		
3rd Squadron (Recon), 4th U.S. Cavalry . . . . .	46	414th Combat Training Squadron . . . . .	58		
3rd Squadron, 7th Cavalry . . . . .	46	507th Medical Company (Air Ambulance) . . . . .	67		
4th Battalion, 101st Aviation Regiment . . . . .	52	571st Medical Company (Air Ambulance) . . . . .	40		
4th Battalion, 123d Aviation . . . . .	36	601st Aviation Support Battalion . . . . .	72		
4th Battalion, 159th Aviation Regiment . . . . .	60	603d Aviation Support Battalion . . . . .	46		
4th Battalion, 160th Special Oprns. Aviation Regiment (Airborne) . . . . .	50	681st Medical Company (Air Ambulance) . . . . .	48		
4th Brigade (Avn), 1st Cavalry Division . . . . .	66	Acquisition Center, USAAMCOM . . . . .	34		
		B Company, 159th Aviation Regiment . . . . .	60		
		B Company, 2-228th . . . . .	70		
		B Company, 4-123rd Theater Aviation Regiment . . . . .	36		
		C Company, 123d Aviation (AVIM) . . . . .	36		

# Ready to go with Parker Aerospace Customer Support



The world's military services must be ready to go at all times. In peace or conflict.

Parker Aerospace

Customer Support

Military is a specialized organization dedicated to the unique needs of the military users

of Parker Aerospace systems and components.

We're here to help our customers maximize their operational readiness while minimizing support costs.

## Global support.

Whether for proven systems or leading-edge aircraft, our worldwide network of facilities and representatives assures you of precision service. And our global capability enables Parker Customer Support Military to customize services to meet your exact requirements.

**Ready for you.** Contact Parker Customer Support Military. For service that's as ready as the customers we serve.

*Partners in Flight™*

**Fuel Systems** – Fuel handling equipment, including pumps, valves, and refuel/defuel subsystems • Fuel measurement and management systems • Engine fuel control and monitoring • Pressure fueling • Instrumentation • Electronic controllers • Injection nozzles • Augmenters • Global customer support

**Hydraulic Systems** – Thrust reverser actuation systems • Heat exchangers • Accumulators • Steering systems • Engine-driven pumps • Lubrication and scavenge pumps • Reservoirs • Engine control actuators • Electrohydraulic servovalves • Lubrication systems • Motor-driven pumps • Hydraulic valves • Wheels and brakes • Global customer support

**Flight Control Systems** – Hydromechanical actuation systems and components • Power-by-wire systems and components • Smart actuation systems and components • Fly-by-wire actuation systems and components • Electrohydraulic servovalves • Electronic control modules • Electrohydrostatic actuation, controllers, and power electronics • Global customer support

## Parker Hannifin Corporation

Customer Support Military • Parker Aerospace • Customer Support Inc.  
14300 Alton Parkway, Irvine, CA 92618-1898  
(949) 809-8400 • Technical fax hotline: (949) 809-8444 • AOG: (949) 851-4357  
www.parker.com

**Parker**  
Aerospace

Aviation Management Branch, DCSOPS, TAPC	69	Directorate of Resource Management, USAAVNC	24	Public Affairs Office, USAAMCOM	34
Aviation Office, Eighth U.S. Army	73	Directorate of Training, Doctrine and Simulation, USAAVNC	24	Public Affairs Office, USAAVNC	26
Aviation Office, U.S. Army Materiel Command (USAMC)	69	Directorate of Training, Plans and Evaluation, USAALS	69	Rapid Prototype Division, AATD, USAAMCOM	70
Aviation Office, U.S. Army Medical Command	67	Fire Control Radar Product Manager's Office	32	Readiness Directorate, (IMMC), USAAMCOM	36
Aviation Office, USADTC	30	Fixed Wing Product Office, USAAMCOM	34	Requirements Directorate, ADCSOPS for Force Development, ODCSOPS	40
Aviation Office, V U.S. Corps	71	Flight Test Directorate, U.S. Army Aviation Technical Test Center	30	Safety Division, USADTC	54
Aviation Section, U.S. Army Electronic Proving Ground	36	French Liaison Office	28	Safety Office, U.S. Army Materiel Command (USAMC)	69
Aviation Staff Officer	40	German Army Liaison Staff USA 5	28	Scout/Attack Product Office, USAAMCOM	34
Aviation Support Facility Knox	52	Helicopter School Battalion	26	SHAPE Flight Detachment	71
Aviation Support Facility Lewis	70	Henry Post Army Airfield	62	Small & Disadvantaged Business Utilization Office, USAAMCOM	34
Aviation Support Facility Los Alamitos	38	Integrated Materiel Management Center (IMMC), USAAMCOM	34	Special Management Division, TAPC	68
Aviation Support Facility McCoy	70	Italian Liaison Office	30	Systems Acquisition Air Dir., Acquisition Center, USAAMCOM	34
Aviation Support Facility Olathe	48	Joint Special Operations Command (JSOC)	60	Systems Acquisition Missile Dir., Acquisition Center, USAAMCOM	34
Aviation Support Facility Rucker	30	Land Combat Missile Directorate, (IMMC), USAAMCOM	34	Systems Integration Division, AATD, USAAMCOM	70
Aviation Systems Directorate, (IMMC), USAAMCOM	34	Legal Office, USAAMCOM	34	T800 Product Manager's Office	32
Aviation Systems Project Manager's Office, USAAMCOM	34	Logistics Support Dir., Acquisition Center, USAAMCOM	34	TRADOC System Manager (TSM) for Longbow (LB)	26
Aviation Systems Test Div., Aviation Test Directorate, USATEXCOM	67	Logistics Support Directorate, (IMMC), USAAMCOM	34	TRADOC System Manager for Comanche	26
Aviation Test Directorate, USATEXCOM	67	Longbow Apache Product Manager's Office	32	TSM - Comanche (FWD)	40
Aviation Training Brigade	26	Mission Management Br., CCS/Avionics Dir., CECOM	58	U.S. Army Aeromedical Center	30
Aviation/IEW Directorate, OASA(ALT)	69	Mullinational Force and Observers	71	U.S. Army Aeromedical Research Laboratory	30
Aviation/Missile Research, Develop. & Engineering Cir, USAAMCOM	34	National Rotorcraft Technology Center	38	U.S. Army Aeronautical Services Agency	69
Aviation/Transportation Branch, EPMD	68	Netherlands Liaison Office	30	U.S. Army Air Ambulance Detachment	38
Avionics Branch, A/IEWS Division, USA CECOM SEC	58	Office of the Chairman of the Joint Chiefs of Staff	40	U.S. Army Air Ambulance Detachment	59
Biggs Army Airfield	66	Office of the Chief of Army Reserve (OCAR)	42	U.S. Army Air Operations Division	58
Branch Historian, USAAVNC	24	Office of the Chief of Staff, U. S. Army	40	U.S. Army Air Traffic Control Activity	26
British Liaison Office	28	Office of the Deputy Commander	36	U.S. Army Armor Center	52
Business Management Office, Acquisition Center, USAAMCOM	34	Office PM, Night Vision/RSTA	69	U.S. Army Aviation and Missile Command (USAAMCOM)	32
Camp Page Army Airfield	73	Office, DCS for Special Operations Aviation, USASOCOM	60	U.S. Army Aviation Center (USAAVNC)	24
Camp Red Cloud Sub - Post Camp Page	73	Office, Director of Army Safety	42	U.S. Army Aviation Center Noncommissioned Officer Academy	26
Canadian Forces Liaison Office	28	Office, Directorate for Defense Research & Engineering (ODDR&E)	40	U.S. Army Aviation Logistics School (USAALS)	69
Cargo Helicopter Project Manager's Office	32	Office, Project Manager, Tactical Unmanned Aerial Vehicles	32	U.S. Army Aviation Museum	30
Comanche Crew Support System Product Manager's Office	32	Operations Group, Aviation Trainer Division, NTC	38	U.S. Army Aviation Technical Test Center (ATTC)	30
Comanche Program Manager's Office	32	Operations, Readiness & Force Development Division, OCAR	42	U.S. Army Command & Control Systems/Avionics Directorate	58
Combat Aviation Test Div., Aviation Test Directorate, USATEXCOM	67	PEO Aviation Directorate, Acquisition Center, USAAMCOM	34	U.S. Army Flight Operations Detachment	71
Combat Maneuver Training Center	71	PEO Tactical Missiles Directorate, Acquisition Center, USAAMCOM	36	U.S. Army Garrison	59
Commander	44	Plans & Operations Div., Dir., of Health Care Operations, OTSG	69	U.S. Army Infantry School, Aviation Division	44
Competition Management Office, USAAMCOM	34	Plans Division, ODCSPER	42	U.S. Army Pacific (USARPAC), ODCSOPS Aviation Division	46
Corporate Information Center, USAAMCOM	34	Platform Technology Division, AATD, USAAMCOM	70	U.S. Army Research Institute Rotary Wing Aviation Research Unit	30
Corpus Christi Army Depot (CCAD)	66	PM, Combat Training Instrumentation Systems (CTIS), STRICOM	42	U.S. Army Reserve Personnel Command	56
Danish Liaison Office	28	PM, Instrumentation, Targets & Threat Simulators, (ITTS), STRICOM	42	U.S. Army Safety Center	30
Defense Contract Management Command, Bell Helicopter Textron	67	PM, Warfighters' Simulation (WARSIM), STRICOM	42	U.S. Army School of Aviation Medicine	30
Defense Contract Mgmt, Boeing Philadelphia	64	Power Systems Div., Aviation Applied Technology Dir., USAAMCOM	70	U.S. Army Simulation, Training & Instrumentation Cnd. (STRICOM)	42
Defense Contract Mgmt. (DCM) Boeing - Mesa	36	Product Manager, Air & Command Tactical Training (ACTT)	42	U.S. Army South (USARSO)	64
Department of Attack Helicopter Training, USAALS	69	Product Manager, Ground Combat Tactical Trainers (GCTT), STRICOM	42	U.S. Army Special Operations Command	60
Department of Aviation Systems Training, USAALS	69	Product Manager, Live Training Systems (LTS), STRICOM	42	U.S. Army Warrant Officer Career Center	30
Department of Aviation Trades Training, USAALS	69	Program Executive Office, Aviation	30	U.S. Military Academy Flight Detachment	60
Department of Aviation Trades Training, USAALS	69	Project Manager, Combined Arms Tactical Trainer (CATT), STRICOM	42	U.S. Special Operations Command (SOCOM)	42
Deputy for Systems Acquisition, USAAMCOM	34	Project Manager, Training Devices (TRADE), STRICOM	42	Unmanned Ground Vehicle/Systems Joint Project Office, USAAMCOM	34
Digital Force Coordination Cell	66			USAAMC-AAD (FLATIRON)	30
Directorate of Combat Developments, USAAVNC	24			USAAVNC Liaison to French Army Aviation	73
Directorate of Community and Family Activities, USAAVNC	24			USAAVNC Liaison to German Army Aviation	73
Directorate of Evaluation and Standardization, USAAVNC	24			USAG Aviation Detachment	36
Directorate of Human Resources, USAAVNC	24			Utility Helicopters Project Office, USAAMCOM	34
Directorate of Information Management, USAAVNC	24			Warrant Officer Division, OPMD, TAPC	68
Directorate of Logistics, USAAVNC	24			Waynesville Regional Airport at Forney Field	56
Directorate of Plans, Training, Mobilization & Security, USAAVNC	24				

**MISSION:** Safeguard aircrew lives. Both U.S. and allied aviators look to Sanders for the very best electronic countermeasures for rotary and fixed-wing aircraft. In more than 40 years of combat-proven experience, we've produced more self-protection systems for military aircraft than any other company.

A high-contrast, black and white photograph of two pilots in flight suits standing in front of a military aircraft. The aircraft's canopy is open, and the scene is lit from the side, creating strong highlights and deep shadows. The pilots are looking towards the camera with serious expressions.

We protect those  
who protect us.

[www.sanders.com](http://www.sanders.com)

**SANDERS**  
A Lockheed Martin Company

**SUCCESS:** For future aircrews, our heritage of success will continue with next-generation, Sanders-built systems. These will include Advanced Threat IR Countermeasures for U.S. and allied helicopters; the Common Missile Warning System; EW Suites for the F-22 and JSF; and IDECM RF Countermeasures for the F/A-18E/F, B-1B and F-15.

**ALABAMA  
Birmingham**

Alabama Army National Guard  
Aviation Support Facility 2  
5701 East Lake Boulevard  
Birmingham, AL 35217-3599  
AASFC: LTC Barry A. DeFoort  
ATTN: AL-AASF-B  
C: 205-808-3301; DSN: 363-7493  
defoorb@al-arng.army.mil  
SIP: CW4 Donald M. Haynes  
C: 205-808-3334; DSN: 363-7493  
haynesd@al-arng.army.mil  
AMC: CW4 Steve Hubbard  
C: 205-808-3319; DSN: 363-7493  
hubbards@al-arng.army.mil

**Fort Rucker**

U.S. Army Aviation Center  
(USAAVNC)  
Fort Rucker, AL 36362-5000



**Commanding General:**  
MG Anthony Jones  
ATTN: ATZQ-CG,  
Building 114  
C: 334-255-2600  
DSN: 558-2600  
jonesa@rucker.army.mil



**Deputy Commanding General/Assistant Commandant:**  
BG Virgil L. Packett II  
ATTN: ATZQ-DCG  
C: 334-255-2612  
DSN: 558-2612  
packeltv@rucker.army.mil



**Deputy Assistant Commandant - National Guard:**  
COL George J. Gluski  
ATTN: ATZQ-DAC-N  
C: 334-255-3531  
DSN: 558-3531  
gluskig@rucker.army.mil



**Chief of Staff:**  
COL Wayne R. Sears  
ATTN: ATZQ-CS  
C: 334-255-2500  
DSN: 558-2500  
searsw@rucker.army.mil

**Deputy Chief of Staff:** LTC John Emmerson  
ATTN: ATZQ-SGS  
C: 334-255-9026; DSN: 558-9026  
emmersonj@rucker.army.mil



**Commander, Garrison Support Command:**  
COL Davis D. Tindoll, Jr.  
ATTN: ATZQ-GC  
C: 334-255-2095  
DSN: 558-2095  
tindoldd@rucker.army.mil

**Secretary of the General Staff:**  
MAJ Dan Huggins  
ATTN: ATZQ-SGS  
C: 334-255-9239; DSN: 558-9239  
hugginsd@rucker.army.mil

**Aide de Camp to the Commanding General:** CPT Geoff Crawford  
ATTN: ATZQ-CG  
C: 334-255-2600; DSN: 558-2600  
crawfordg@rucker.army.mil



**Command Sergeant Major:**  
CSM Edward P. Iannone  
ATTN: ATZQ-CSM  
C: 334-255-3528  
DSN: 558-3528  
iannonee@rucker.army.mil

**Air Maneuver Battle Lab Directorate, USAAVNC**  
Building 5000  
Corner of 3rd Ave & Lucky Star  
Fort Rucker, AL 36362



**Deputy Director for Transformation:**  
COL Ellis W. Golsong  
ATTN: ATZQ-ABL  
C: 334-255-3485  
DSN: 598-3485  
GolsongE@rucker.army.mil

**Aviation Branch Personnel Propensity Office (AP)**  
Building 4103

U.S. Army Aviation Center  
Fort Rucker, AL 36362-5035  
**Director:** COL Michael Bozeman  
ATTN: ATZQ-AP  
C: 334-255-3423; DSN: 558-3423  
BozemanM@rucker.army.mil  
**Chief, AWO Personnel Propensity:**  
CWS Michael Adair  
ATTN: ATZQ-AP  
C: 334-255-1419; DSN: 558-1419  
AdairM@rucker.army.mil

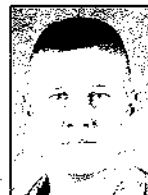

**Directorate SGM:**  
SGM Lonny Lord  
ATTN: ATZQ-AP  
C: 334-255-9891  
DSN: 558-9891  
LordL@rucker.army.mil

**Branch Historian, USAAVNC**  
Fort Rucker, AL 36362

**Branch Historian:** Dr. J.W. Williams  
ATTN: ATZQ-MH  
C: 334-255-9151; DSN: 558-9151  
historian@rucker.army.mil

**Directorate of Combat Developments, USAAVNC**  
U.S. Army Aviation Center  
Fort Rucker, AL 36362-5000



**Director:**  
COL Jesse (Mark) Danielson  
ATTN: ATZQ-CD  
C: 334-255-3203  
DSN: 558-3203  
danielsonm@rucker.army.mil

**Deputy Director:** Mr. Glenn Harrison  
ATTN: ATZQ-CD  
C: 334-255-3203; DSN: 558-3203  
harrisong@rucker.army.mil  
**Operations Officer:** CPT Joel L. Kain II  
ATTN: ATZQ-CD  
C: 334-255-9114; DSN: 558-9114  
KainJ@rucker.army.mil

**Directorate of Community and Family Activities, USAAVNC**  
Fort Rucker, AL 36362

**Director:** Ms. Joann Blanks  
ATTN: ATZQ-DCF  
C: 334-255-2100; DSN: 558-2100  
blanksj@rucker.army.mil

**Directorate of Evaluation and Standardization, USAAVNC**  
Building 5111

U.S. Army Aviation Center  
Fort Rucker, AL 36362-5000  
**Director:** COL Richard M. Johnson  
ATTN: ATZQ-ES  
C: 334-255-2603; DSN: 558-2603  
Johnsonr@rucker.army.mil

**Deputy Director:** CPT Robert M. Salvatore  
ATTN: ATZQ-ES  
C: 334-255-3504; DSN: 558-3504  
salvatore@rucker.army.mil  
**Operations Officer:** Mr. Nick Smythe  
ATTN: ATZQ-ESO  
C: 334-255-2244; DSN: 558-2244  
smythen@rucker.army.mil

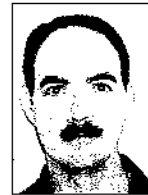

**Senior NCO:**  
Master Sergeant James R. Bevis  
ATTN: ATZQ-ES  
C: 334-255-3617  
DSN: 558-3617  
bevisj@rucker.army.mil

**Directorate of Human Resources, USAAVNC**

U.S. Army Aviation Center  
Fort Rucker, AL 36362-5000



**Director:**  
Ms. Joan Escalfullery  
ATTN: ATZQ-DHR  
C: 334-255-2475  
DSN: 558-2475  
escalfulleryj@rucker.army.mil

**Directorate of Information Management, USAAVNC**  
Building 130

U.S. Army Aviation Center  
Fort Rucker, AL 36362



**Director:**  
Mr. Floyd Leighton II  
ATTN: ATZQ-DIM  
C: 334-255-2174  
DSN: 558-2174

**Senior NCO:** SFC Keith Loeffler  
ATTN: ATZQ-DIM  
C: 334-255-9027; DSN: 558-9027

**Directorate of Logistics, USAAVNC**  
Fort Rucker, AL 36362-5112



**Director:**  
Mr. Gerard J. (Jerry) Leavis  
ATTN: ATZQ-DOL  
C: 334-255-2400  
DSN: 558-2400  
leavisg@rucker.army.mil



**Senior NCO:**  
SFC John T. Duenas  
ATTN: ATZQ-DOL  
C: 334-255-2730  
DSN: 558-2730  
Duenasj@rucker.army.mil

**Directorate of Plans, Training, Mobilization & Security, USAAVNC**

U.S. Army Aviation Center  
Fort Rucker, AL 36362-5152



**Director:**  
LTC Dyffield A. Harris  
ATTN: ATZQ-DPT,  
Building 114  
C: 334-255-2300  
DSN: 558-2300  
harrisd2@rucker.army.mil

**Senior NCO:** SFC Tony Marshall  
ATTN: ATZQ-DPT-SGM  
C: 334-255-2710  
DSN: 558-2710  
marshallt@rucker.army.mil

**Directorate of Resource Management, USAAVNC**  
Building 5700, Room 140  
Fort Rucker, AL 36362-5143



**Director:**  
LTC David N. Pruitt  
ATTN: ATZQ-R  
C: 334-255-3158  
DSN: 558-3158  
pruittd@rucker.army.mil

**Directorate of Training, Doctrine and Simulation, USAAVNC**  
Building 3705

U.S. Army Aviation Center  
Fort Rucker, AL 36362



**Director:**  
COL Robert D. Carter  
ATTN: ATZQ-TDS  
C: 334-255-3320  
DSN: 558-3320  
carterr@rucker.army.mil

**Operations Officer:** Ms. Teresa Strickland  
ATTN: ATZQ-TDS-O  
C: 334-255-9252; DSN: 558-9252  
stricklandt@rucker.army.mil



# BEST VALUE



Raytheon Aerospace Company provides quality worldwide support through its Contract Field Teams (CFT) - from aircraft and vehicle performance upgrades to battle-area maintenance and logistics. Raytheon Aerospace is ready to dispatch diversified, quality technicians to perform depot maintenance, field maintenance, and modification on-site for aircraft, engines, electronics, missiles, support equipment, tanks, vehicles, and other military equipment and systems.



Usually a CFT can be directed to a work site in a matter of hours after Delivery Order Notification. **Raytheon Aerospace CFT** offers a responsive, cost-effective way to modify or maintain today's military equipment and systems.

**Contract Field Teams Operations**  
4600 S.E. 29th Street, Suite 500  
Del City, Oklahoma 73115-3429  
Telephone 405-677-1300  
or 800-788-8101  
Fax 405-677-4516



## Raytheon

### Raytheon Aerospace Company

555 Industrial Drive So. Madison, MS 39110

Telephone (601) 856-2274 Fax (601) 856-8006

<http://members.aol.com/raycft.html>



**Senior NCO:**  
SGM Jon M. Vanatta  
ATTN: ATZQ-TDS  
C: 334-255-9205  
DSN: 558-9205  
vanattaj@rucker.  
army.mil

**Aviation Electronic Combat Team,  
USAAVNC**

U.S. Army Aviation Center  
Fort Rucker, AL 36362  
**Chief:** CW4 Albert J. Maes  
ATTN: ATZQ-TDS-GE  
C: 334-255-1861  
DSN: 558-1861  
maesa@rucker.army.mil

**Public Affairs Office, USAAVNC**

Building 115  
U.S. Army Aviation Center  
Fort Rucker, AL 36362-5033

**PAO:** MAJ Scott Ross  
RossS@rucker.army.mil  
**Deputy PAO:** Mr. Ken Holder  
ATTN: ATZQ-PAO  
C: 334-255-2590; DSN: 334-255-1004  
ken\_holder@rucker-erm4.army.mil

**U.S. Army Air Traffic Control Activity**

U.S. Army Aviation Center  
2805 Division Road  
Fort Rucker, AL 36362-5265



**Director:**  
Mr. Curtis E. Carler  
ATTN: ATZQ-ATC  
C: 334-255-3007  
DSN: 558-3007  
carlerc2@rucker.rucker.  
army.mil

**Chief of Program Management: Mr. Fred Helton**

ATTN: ATZQ-ATC-OP  
C: 334-255-2780; DSN: 558-2780  
heltonf@rucker.army.mil

**U.S. Army Aviation Center**

**Noncommissioned Officer Academy**  
Building 4301  
Fort Rucker, AL 36362-5255



**Commandant:**  
CSM David B. Rabon  
ATTN: ATZQ-NCA  
C: 334-255-1307  
DSN: 558-1307  
RabonD@  
rucker.army.mil

**Assistant Commandant: 1SG Robert D. Sparks, Jr.**

ATTN: ATZQ-NCA  
C: 334-255-3568; DSN: 558-3568  
SparksR@rucker.army.mil

**Operations NCO: SFC Robert Osborne**

ATTN: ATZQ-NCA-O  
C: 334-255-1311; DSN: 558-1311  
OsborneR@rucker.army.mil

**TRADOC System Manager for  
Comanche**

Building 512  
U. S. Army Aviation Center  
Fort Rucker, AL 36362-5010



**TSM-Comanche:**  
LTC(P) Gregory M.  
Williamitis  
ATTN: ATZQ-TSM-C  
C: 334-255-2160  
DSN: 558-2160  
WilliamitisG@rucker.  
army.mil

**Technical Advisor: Mr. Mark A. Caskey**

ATTN: ATZQ-TSM-C  
C: 334-255-2828; DSN: 558-2828  
caskeym@rucker.army.mil

**Executive Officer: MAJ Donald C. Presgraves**

ATTN: ATZQ-TSM-C  
C: 334-255-2860; DSN: 558-2860  
PresgravesD@rucker.army.mil

**Asst TSM-C (TNG): CPT Jason L. Galindo**

ATTN: ATZQ-TSM-C  
C: 334-255-2857; DSN: 558-2857  
GalindoJ@rucker.army.mil

**Asst TSM-C (Crew Station/Wpns):**

CW3 Jeffrey A. Chaney  
ATTN: ATZQ-TSM-C  
C: 334-255-3505; DSN: 558-3505  
ChaneyJ@rucker.army.mil

**Asst TSM-C (Systems Integration):**

CPT Richard A. Wagen  
ATTN: ATZQ-TSM-C  
C: 334-255-2830; DSN: 558-2830  
WagenR@rucker.  
army.mil

**Asst TSM-C (T800): SFC Joseph M. Hughes**

ATTN: ATZQ-TSM-C  
C: 334-255-2842; DSN: 558-2842  
HughesJ3@rucker.army.mil

**E Troop Commander: CW5 Ronald C. Moring**

ATTN: ATZQ-TSM-C  
C: 334-255-1433; DSN: 558-1433  
MoringR@rucker.army.mil

**E Troop 1SG: 1SG Windley L. Laborte**

ATTN: ATZQ-TSM-C  
C: 334-255-1388; DSN: 558-1388  
LaborteW@rucker.army.mil

**Asst. TSM-C Combined Test Team:**

SFC Morgan Evans  
ATTN: ATZQ-TSM-C  
C: 561-775-5596  
evansmd@comanche.redstone.army.mil

**TRADOC System Manager (TSM) for  
Longbow (LB)**

U.S. Army Aviation Center  
Fort Rucker, AL 36362-5012



**TSM-LONGBOW:**  
COL Michael Cash  
Striplin  
ATTN: ATZQ-TSM-  
LB, Bldg. 512  
C: 334-255-2167  
DSN: 558-2167  
StriplinM@rucker.  
army.mil

**TSM-LONGBOW Technical Advisor:**

Mr. Paul W. Revels  
ATTN: ATZQ-TSM-LB, Bldg. 512  
C: 334-255-2167; DSN: 558-2167  
RevelsP@rucker.army.mil

**Deputy TSM-Longbow: LTC Clay Carler**

ATTN: ATZQ-TSM-LB, Bldg. 512  
C: 334-255-2167; DSN: 558-2167  
CarlerC@rucker.army.mil

**Asst TSM-FCR/Hellfire/Armament:**

CPT Courtney Cote  
ATTN: ATZQ-TSM-LB, Bldg. 512  
C: 334-255-2167; DSN: 558-2167  
CoteC@rucker.army.mil

**Asst TSM-Pers/Tng/APACHE & LONGBOW: CPT Roger Henderson**

ATTN: ATZQ-TSM-LB, Bldg. 512  
C: 334-255-2167; DSN: 558-2167  
HendersonR@rucker.army.mil

**Asst TSM-LONGBOW APACHE/APACHE SME: CPT Richard Adams**

ATTN: ATZQ-TSM-LB, Bldg. 512  
C: 334-255-2167; DSN: 558-2167  
adamsr4@rucker.army.mil

**Asst TSM-Log: Mr. Larry Niver**

ATTN: ATZQ-TSM-LB, Bldg. 512  
C: 334-255-2167; DSN: 558-2167  
NiverL2@rucker.army.mil

**Aviation Training Brigade**

Building 2805  
U.S. Army Aviation Center  
Fort Rucker, AL 36362-5000



**Commander:**  
COL Terry M. Peck  
ATTN: ATZQ-ATB  
C: 334-255-2607  
DSN: 558-2607  
peckt@rucker.  
army.mil

**Deputy Commander: MAJ James M. Brandon**

ATTN: ATZQ-ATB  
C: 334-255-2607; DSN: 558-2981  
brandonj@rucker.army.mil

**SIP: Mr. Jerry Riley**

ATTN: ATZQ-ATB-NS  
C: 334-255-1450; DSN: 558-1450  
RileyJ@rucker.army.mil

**Night Vision Branch: CW5 Joe Roberts**

ATTN: ATZQ-ATB-NS  
C: 334-255-2564; DSN: 558-2564  
RobertsJ@rucker.army.mil

**ASO: CW3 Lennie Cousins**

ATTN: ATZQ-ATB-S  
C: 334-255-2564; DSN: 558-2564  
CousinsL@rucker.army.mil



**Senior NCO:**  
CSM Diane Williams  
ATTN: ATZQ-ATB  
C: 334-255-3954  
DSN: 558-3954  
WilliamsD@rucker.  
army.mil

**Helicopter School Battalion**

**Aviation Training Brigade**  
U.S. Army Aviation Center  
Fort Rucker, AL 36362-5000



**Commander:**  
LTC Daniel Barreto  
ATTN: ATZQ-ATB-B  
C: 334-255-8524  
DSN: 558-8524  
barretod@  
rucker.army.mil

**Executive Officer: MAJ Michael L. Shadowski**

ATTN: ATZQ-ATB-BH  
C: 334-255-8525; DSN: 558-8525  
shadowskim@rucker.army.mil

**SIP: CW3 Edmundo Miranda**

ATTN: ATZQ-ATB-BS  
C: 334-255-8265; DSN: 558-8265  
mirandae@rucker.army.mil



**Senior NCO:**  
Master Sergeant  
Jose N. Santiaago  
ATTN: ATZQ-ATB-BH  
C: 334-255-8137  
DSN: 558-8137  
santiaagoj@rucker.  
army.mil

**1st Battalion, 11th Aviation Regiment**

U.S. Army Aviation Center  
Fort Rucker, AL 36362-5000



**Commander:**  
LTC Benjamin H.  
Williams  
ATTN: ATZQ-ATB-T  
C: 334-255-2173  
DSN: 558-2173  
williamsb@  
rucker.army.mil

**Executive Officer: MAJ Steven A. King**

ATTN: ATZQ-ATB-T  
C: 334-255-2199; DSN: 558-2199  
kings@rucker.army.mil

**S1 Officer: 1LT Phillip A. Delisle**

ATTN: ATZQ-ATB-TA  
C: 334-255-3689; DSN: 558-3689  
delislep@rucker.army.mil

**S2/3 Officer: CPT Charles T. Schell**

ATTN: ATZQ-ATB-TO  
C: 334-255-2112; DSN: 558-2112  
schellc@rucker.army.mil

**S4 Officer: CPT David M. Herneke**

ATTN: ATZQ-ATB-TL  
C: 334-255-9248; DSN: 558-9248  
hernked@rucker.army.mil

**Commander, A Co.: CPT Mark A. Morek**

ATTN: ATZQ-ATB-TB  
C: 334-255-3132; DSN: 558-3132  
morekm@rucker.army.mil

**Commander, B Co.: CPT Ossie Peacock**

ATTN: ATZQ-ATB-TS  
C: 334-255-1082; DSN: 558-1082  
peacocko@rucker.army.mil

**Commander, C Co.: CPT Thomas Prescott**

ATTN: ATQ-ATB-TH  
C: 334-255-3606; DSN: 558-3606  
prescoltt@rucker.army.mil



**Senior NCO:**  
CSM Richard Lewis  
ATTN: ATZQ-ATB-T  
C: 334-255-2173  
DSN: 558-2173  
lewisl@rucker.  
army.mil

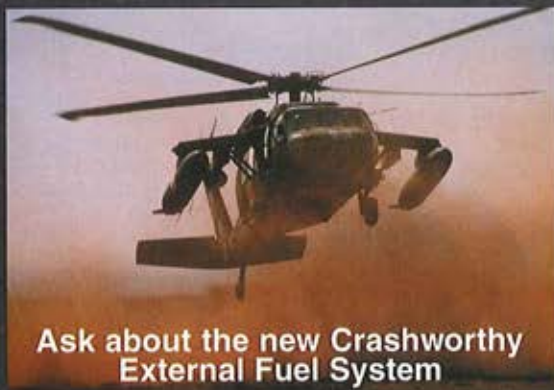

Ask about the new Crashworthy External Fuel System



# PROVEN PERFORMERS.

Enhance the performance capabilities of the CH-47 Chinook, UH-60 Black Hawk and AH-64 Apache with mission-ready, crashworthy, self-sealing **GUARDIAN®** Extended Range Fuel Systems (ERFS).

## MISSION FLEXIBILITY

The U.S. Army **GUARDIAN®** ERFS II for the CH-47D Chinook helicopter provides up to three 800 gallon tanks and a Forward Area Refueling Equipment (FARE) kit.

The **GUARDIAN®** 200 single-tank ERFS is interchangeable with the **GUARDIAN®** 185 two-tank ERFS in the UH-60 Black Hawk helicopter.

The **GUARDIAN®** 130 ERFS for the AH-64 Apache helicopter provides 130 gallons of additional fuel and is interchangeable with the ammunition storage magazine.

For complete information call (480) 337-7050, fax (480) 968-3019, Email [robertsonaviation@worldnet.att.net](mailto:robertsonaviation@worldnet.att.net), or write 1024 E. Vista Del Cerro, Tempe AZ 85281



**ROBERTSON**  
AVIATION  
Range Extension Fuel Systems

1st Battalion, 14th Aviation Regiment  
Aviation Training Brigade  
U.S. Army Aviation Center  
Fort Rucker, AL 36362-5225

Commander: LTC Edward R.  
Stephenson

ATTN: ATZQ-ATB-H  
C: 334-255-5712  
DSN: 558-5712  
stephensone@rucker.army.mil

Executive Officer: MAJ Mark C. Taylor  
ATTN: ATZQ-ATB-H  
C: 334-255-0083; DSN: 558-0083  
taylorm@rucker.army.mil

BN SIP: CW4 Douglas S. MacIver  
ATTN: ATZQ-ATB-H  
C: 334-255-5043; DSN: 558-5043  
maciverd@rucker.army.mil

ASO: CW3 Mike Cronrath  
ATTN: ATZQ-ATB-H  
C: 334-255-5042; DSN: 558-5042  
cronrathm@rucker.army.mil



Senior NCO:  
SGM Harold K.  
Wyrick  
ATTN: ATZQ-ATB-H  
C: 334-255-5076  
DSN: 558-5076  
wyrickh@rucker.  
army.mil

1st Battalion, 212th Aviation  
Regiment  
Aviation Training Brigade  
Fort Rucker, AL 36362-5000

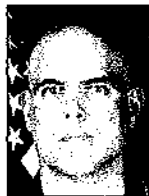

Commander:  
LTC Michael R. Scott  
ATTN: ATZQ-ATB-L  
C: 334-255-4111  
DSN: 558-4111  
scoltm@  
rucker.army.mil

Executive Officer: MAJ Salvatore  
Frenda

ATTN: ATZQ-ATB-L  
C: 334-255-4116; DSN: 558-4116  
frendas@rucker.army.mil

SIP: CW5 Richard E. Bollston  
ATTN: ATZQ-ATB-L  
C: 334-255-4197; DSN: 558-4197  
bollstonr@rucker.army.mil

ASO: CW4 Eric D. Malcom  
ATTN: ATZQ-ATB-LS  
C: 334-255-4372; DSN: 558-4372

Senior NCO: SGM Joseph D. Harris  
ATTN: ATZQ-ATB-L  
C: 334-255-4116; DSN: 558-4116  
harrisj@rucker.army.mil

1st Battalion, 223rd Aviation  
Aviation Training Brigade  
U.S. Army Aviation Center  
Fort Rucker, AL 36362-5230



Commander:  
LTC Michael P.  
Courts  
ATTN: ATZQ-ATB-C  
C: 334-255-8478  
DSN: 558-8478  
courtsm@rucker.  
army.mil

Executive Officer: MAJ Stan Smith  
ATTN: ATZQ-ATB-C  
C: 334-255-8419; DSN: 558-8419  
smiths@rucker.army.mil

SIP: CW5 Dennis J. McIntire  
ATTN: ATZQ-ATB-CO  
C: 334-255-8441; DSN: 558-8441  
mcintired@rucker.army.mil

ASO: CW3 Robert J. Boazman  
ATTN: ATZQ-ATB-CO  
C: 334-255-8490; DSN: 558-8490  
boazmanr@rucker.army.mil



Senior NCO:  
SGM Terry L. Brown  
ATTN: ATZQ-ATB-C  
C: 334-255-8444  
DSN: 558-8444  
brownl@rucker.  
army.mil

1st Aviation Brigade (Golden Hawks)  
U.S. Army Aviation Center  
Fort Rucker, AL 36362

Commander: COL Russell S. Forshag  
ATTN: ATZQ-BDE  
C: 334-255-9083; DSN: 558-9083  
forshagr@rucker.army.mil

Deputy Brigade Commander: MAJ  
Brian J. Diaz  
ATTN: ATZQ-BDE  
C: 334-255-9117; DSN: 558-9117  
diazb@rucker.army.mil



Senior NCO:  
CSM Ossie W. Carey  
ATTN: ATZQ-BDE  
C: 334-255-3982  
DSN: 558-3982  
careyo@rucker.  
army.mil

1st Battalion, 13th Aviation Regiment  
1st Aviation Brigade (AA)  
U.S. Army Aviation Center  
Fort Rucker, AL 36362



Commander:  
LTC Gregory A.  
Brockman  
ATTN: ATZQ-BDE-E  
C: 334-255-1314  
DSN: 558-1314  
brockmang@  
rucker.army.mil

Executive Officer: MAJ George S.  
Belin  
ATTN: ATZQ-BDE-E  
C: 334-255-1315; DSN: 558-1317  
beling@rucker.army.mil

S-1 Officer: CPT Thomas Lesniewski  
C: 334-255-1318; DSN: 558-1318  
lesniewskit@rucker.army.mil

S-2/3 Officer: CPT Matthew Nuhse  
ATTN: ATZQ-BDE-E  
C: 334-255-1319; DSN: 558-1319  
NuhseM@rucker.army.mil

S-4 Officer: SSG Michael D.  
Greenwood  
ATTN: ATZQ-BDE-E  
C: 334-2551-1340; DSN: 558-1340  
greenwood,michaeld.  
ssg@rucker.army.mil  
Commander, HHC: CPT Andrew D.  
Gignilliat

ATTN: ATZQ-BDE-EH  
C: 334-255-2454; DSN: 558-2454  
gignilliat@rucker.army.mil  
Commander, A Company: CPT  
Michael P. Hansen  
ATTN: ATZQ-BDE-EA  
C: 334-255-1266; DSN: 558-1266  
hansenm@rucker.army.mil

Commander, C Company: CPT  
Douglas W. Bennett  
ATTN: ATZQ-BDE-EB  
C: 334-255-1278; DSN: 558-1354  
bennett,doug,cpt@rucker.army.mil  
Commander, D Company: CPT Dora  
E. Teran

ATTN: ATZQ-BDE-EC  
C: 334-255-1354; DSN: 558-2391  
teran,dorae\_cpt@rucker.army.mil



Senior NCO:  
CSM Charlie L.  
Mahone  
ATTN: ATZQ-BDE-ED  
C: 334-255-1317  
DSN: 558-1315  
mahone,charliel\_sgm  
@rucker.army.mil

1st Battalion, 145th Aviation  
Regiment  
1st Aviation Brigade (AA)  
U.S. Army Aviation Center  
Fort Rucker, AL 36362



Commander:  
LTC Mark W. Hayes  
ATTN: ATZQ-BDE-O  
C: 334-255-2338  
DSN: 558-2338  
HayesM@rucker.  
army.mil

Executive Officer: MAJ Michael J.  
Negard

ATTN: ATZQ-BDE-O  
C: 334-255-3787; DSN: 558-3787  
negardm@rucker.army.mil  
ASO: CW4 John E. Roberts  
ATTN: ATZQ-BDE-OB  
C: 334-255-9206; DSN: 558-9206  
RobertsJ@rucker.army.mil



Senior NCO:  
1SG Shane R. Curtis  
ATTN: ATZQ-BDE-O  
C: 334-255-2815  
DSN: 558-2815  
CurtisS@rucker.  
army.mil

1st Battalion, 210th Aviation  
Regiment  
1st Aviation Brigade (AASLT)  
U.S. Army Aviation Center  
Fort Rucker, AL 36362-5072



Commander:  
LTC Christopher R.  
Philbrick  
ATTN: ATZQ-GC-A  
C: 334-255-9134  
PhilbrickC@rucker.  
army.mil

Executive Officer: MAJ Steven M.  
Short  
ATTN: ATZQ-GC-A  
C: 334-255-1073  
ShortS@rucker.army.mil



Senior NCO:  
CSM Eldridge Conley  
ATTN: ATZQ-GC-A  
C: 334-255-3294  
ConleyE@rucker.  
army.mil

Australian Liaison Office  
Building 107, 5th Avenue  
Fort Rucker, AL 36362  
Australian Liaison Officer: LTC Neil  
Turton  
ATTN: ATZQ-TDS-LN  
C: 334-255-3715; DSN: 558-3715  
TurtonN@rucker.army.mil

British Liaison Office  
U.S. Army Aviation Center  
Fort Rucker, AL 36362  
British Liaison Officer: LTC Andrew  
Simkins  
ATTN: ATZQ-TDS-LN, Bldg 107  
C: 334-255-3715; DSN: 558-3715  
SimkinsA@rucker.army.mil

Canadian Forces Liaison Office  
U.S. Army Aviation Center  
Bldg. 107, 5th Avenue  
Fort Rucker, AL 36362-5000

Canadian Forces Liaison Officer  
Aviation: MAJ Richard Hagerman  
ATTN: ATZQ-TDS-LN  
C: 334-255-2544; DSN: 558-2544  
HagermanR@rucker.army.mil

Danish Liaison Office  
5 Avenue, Bldg. 107  
U.S. Army Aviation Center  
Fort Rucker, AL 36362  
National Liaison Officer Denmark:  
MAJ Steen Flensmark  
ATTN: ATZQ-TDS-LN  
C: 334-255-2556; DSN: 558-2556  
FlensmarkS@rucker.army.mil

French Liaison Office  
U.S. Army Aviation Center  
Fort Rucker, AL 36362



French Liaison  
Officer:  
LTC Thierry Vogin  
ATTN: ATZQ-TDS-  
LN, Bldg 107  
C: 334-255-3052  
DSN: 558-3052  
vogint@rucker.  
army.mil

German Army Liaison Staff USA 5  
P. O. Box 620579, Bldg. 107  
Fort Rucker, AL 36362-0579

# THE EVOLUTION OF ARMY AVIATION...

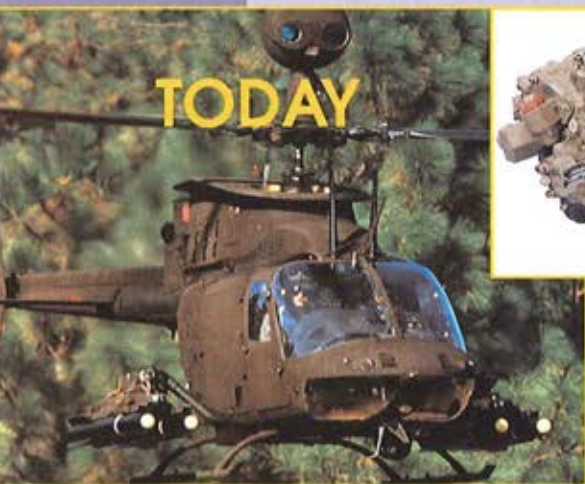

**1958 - 2000  
...AND BEYOND**

Charter Oak Blvd.  
West Hartford, CT 06133-0651  
tel: 860-236-0651  
fax: 860-232-1873  
<http://www.chandlerevans.com>

Chandler Evans  
Control Systems Division  
**BF Goodrich**  
Aerospace

**German Liaison Officer:** LTC Heinrich Bierbrauer  
ATTN: ATZQ-TDS-LN  
C: 334-255-9129; DSN: 558-9129  
BierbrauerH@rucker.army.mil

**Italian Liaison Office**  
U.S. Army Aviation Center  
Bldg. 107, 5th Avenue  
Fort Rucker, AL 36362-5000  
**Italian Liaison Officer:** LTC Antonio Bettelli  
ATTN: ATZQ-TDS-LN  
C: 334-255-9235; DSN: 558-9235  
BettelliA@rucker.army.mil

**Netherlands Liaison Office**  
U.S. Army Aviation Center  
Fort Rucker, AL 36362  
**Liaison Officer, Royal Netherlands Air Force:** LTC Cornelis Visser  
ATTN: Bldg. 107  
C: 334-255-3171; DSN: 558-3171  
VisserC@rucker.army.mil

**U.S. Army Warrant Officer Career Center**  
Fort Rucker, AL 36362



**Commandant:**  
COL Chris Acker  
ATTN: ATZQ-WCC  
C: 334-255-3869  
DSN: 558-3869  
ackerc@wccc.army.mil

**Aviation Office, USADTC**  
Bldg. 30601, Cairns AAF  
Fort Rucker, AL 36362-5276  
\*Update not provided this year.



**Aviation Staff Officer:**  
COL Austin R. Omlie  
ATTN: CSTE-DTC-AS  
C: 334-255-8000  
DSN: 558-8000  
co@atlc.army.mil

**U.S. Army Aviation Technical Test Center (ATTC)**  
Fort Rucker, AL 36362-5276  
\*Update not provided this year.

**Commander:**  
COL Austin R. Omlie  
ATTN: CSTE-DTC-AC-CO  
C: 334-255-8000  
DSN: 558-8000  
co@atlc.army.mil  
**Technical Director:** Mr. Larry E. Eagerton  
ATTN: CSTE-DTC-AC-TD  
C: 334-255-8001; DSN: 558-8001  
td@atlc.army.mil

**Adjutant/HQ Company Commander:** Mr. George D. Stinson  
ATTN: CSTE-DTC-AC-AD  
C: 334-255-8002; DSN: 558-8002  
ad@atlc.army.mil

**Safety Officer:** Mr. Mike Blacker  
ATTN: CSTE-DTC-AC-SA  
C: 334-255-8037; DSN: 558-8037  
sa@atlc.army.mil

**Flight Test Directorate:** LTC Christopher C. Sullivan  
ATTN: CSTE-DTC-AC-TM  
C: 334-255-8149; DSN: 558-8149  
ft@atlc.army.mil

**Test Management Directorate:** Mr. John V. R. Redington  
ATTN: CSTE-DTC-AC-TM  
C: 334-255-8087; DSN: 558-8087  
lm@atlc.army.mil

**Data Systems Directorate:** Mr. Larry K. Marlin  
ATTN: CSTE-DTC-AC-DS  
C: 334-255-8092; DSN: 558-8092  
ds@atlc.army.mil

**Resources and Personnel Directorate:** Mr. George D. Stinson  
ATTN: CSTE-DTC-AC-CP  
C: 334-255-8002; DSN: 558-8002  
rp@atlc.army.mil  
**Senior NCO:** SFC Richard J. Robinson  
ATTN: CSTE-DTC-AC-FT  
C: 334-255-8180; DSN: 558-8180  
robinsonr@atlc.army.mil

**Flight Test Directorate, U.S. Army Aviation Technical Test Center**  
Fort Rucker, AL 36362-5276  
\*Update not provided this year.  
**Commander:** LTC Christopher C. Sullivan

ATTN: CSTE-DTC-AC-FT  
C: 334-255-8149; DSN: 558-8149  
ft@atlc.army.mil  
**Chief Engineer:** Mr. Courtland Bivens  
ATTN: CSTE-DTC-AC-FT-CE  
C: 334-255-8593; DSN: 558-8593  
ft@atlc.army.mil

**U.S. Army Research Institute Rotary Wing Aviation Research Unit**  
Building 5100  
Fort Rucker, AL 36362-5354  
\*Update not provided this year.  
**Chief:** Dr. Dennis C. Wightman  
ATTN: TAPC-ARI-IR  
C: 334-255-2834; DSN: 558-2834  
wightman@rwaru-emh1.army.mil

**Multi-Media Branch, Directorate of Aviation & Safety, NGB**  
P. O. Box 620249, Bldg. 5401  
Fort Rucker, AL 36362-0249  
**Aviation Programs Manager:** MAJ David Skinner  
ATTN: NGB-AVN-MMB  
C: 334-255-2520; DSN: 558-2520  
SkinnerD@rucker.army.mil  
**Ground Safety Programs Manager:** CW3 Ed McQueen  
ATTN: NGB-AVN-MMB  
C: 334-255-2520; DSN: 558-2520

**U.S. Army Aeromedical Center**  
Building 301, Andrews Avenue  
**U.S. Army Aviation Center**  
Fort Rucker, AL 36362-5333  
**Commander:** COL Alan L. Moloff  
ATTN: MCXY-C  
C: 334-255-7359; DSN: 558-7359  
alan.moloff@se.amedd.army.mil

**Deputy Commander for Clinical Services:** LTC Steven Swann  
ATTN: MCXY-DCCS  
C: 334-255-7343; DSN: 558-7343  
sleven.swann@se.amedd.army.mil  
**Deputy Commander for Administration:** LTC Donald E. Henderson, Jr.  
ATTN: MCXY-DCA  
C: 334-255-7361; DSN: 558-7361  
donald.henderson@se.amedd.army.mil

**USAAMC-AAD (FLATIRON)**  
Fort Rucker, AL 36362-5350  
**Commander:** MAJ Leonard Bowley  
ATTN: MCXY-AAD  
C: 334-255-8427; DSN: 558-8543  
Leonard.Bowley@se.amedd.army.mil

**U.S. Army School of Aviation Medicine**  
Fort Rucker, AL 36362-5377  
**Dean:** COL James S. McGhee, Jr.  
ATTN: MCCS-HA  
C: 334-255-7409; DSN: 558-7409  
james.mcgee@se.amedd.army.mil

**U.S. Army Aeromedical Research Laboratory**  
Building 6901  
P. O. Box 620577  
Fort Rucker, AL 36362-0577



**Commander:**  
COL John A. Powell  
ATTN: MCMR-UAC  
C: 334-255-6917  
DSN: 558-6917  
john.powell@amedd.army.mil

**Deputy Commander for Administration:** LTC Ronald E. Wilson  
ATTN: MCMR-UAC-D  
C: 334-255-6914; DSN: 558-6914  
ronald.wilson@amedd.army.mil

**U.S. Army Safety Center**  
Building 4905  
1209 5th Avenue  
Fort Rucker, AL 36362-5363  
**Commander:** BG Gene M. LaCoste  
ATTN: CSSC-Z  
C: 334-255-9360; DSN: 558-9360  
lacosteg@safetycenter.army.mil  
**Deputy Commander:** COL John S. Warren  
ATTN: CSSC-Z  
C: 334-255-3075; DSN: 558-3075  
warrenj@safetycenter.army.mil  
**Senior NCO:** SGM Johnnie E. Forehand  
ATTN: CSSC-Z  
C: 334-255-3575; DSN: 558-3575  
forehandj@safetycenter.army.mil

**U.S. Army Aviation Museum**  
U.S. Army Aviation Center  
P.O. Box 620610  
Fort Rucker, AL 36362-0610  
**Director:** Mr. R. S. Maxham  
ATTN: ATZQ-DPT-M  
C: 334-255-3036; DSN: 558-3036  
maxhams2@rucker.army.mil

### Hope Hull

**Alabama Army National Guard Aviation Support Facility 1**  
P.O. Box 309  
Hope Hull, AL 36043  
\*Update not provided this year.

**AASFC:** LTC Joseph A. Price  
C: 334-281-7722; DSN: 358-9237

### Mobile

**Alabama Army National Guard Army Aviation Support Facility #3**  
Bates Field  
9055 Tanner Williams Rd.  
Mobile, AL 36608

**AASFC:** LTC Charles E. Bonasera  
ATTN: AL-AASF#3  
C: 334-634-8773  
aasf3al@al-ngnet.army.mil

### Montgomery

**Office, State Adjutant General, Alabama Army National Guard**  
P. O. Box 3711  
Montgomery, AL 36109-0711  
\*Update not provided this year.

**TAG:** MG Willie A. Alexander  
C: 334-271-7200; DSN: 363-7200

**Office, State Army Aviation Officer, Alabama Army National Guard**  
P. O. Box 3711  
Montgomery, AL 36193-4701



**SAAO:**  
LTC Billy G. Kennedy  
ATTN: AL-SAO  
C: 334-271-7263  
DSN: 363-7263  
saosal@al-arg.ngb.army.mil

### Redstone Arsenal

**Program Executive Office, Aviation**  
Building 5681  
Redstone Arsenal, AL 35898-5000



**PEO, Aviation:**  
MG Joseph L. Bergantz  
ATTN: SFAE-AV  
C: 256-313-4000  
DSN: 897-4000  
joseph.bergantz@peoavn.redstone.army.mil

**Deputy PEO:** Mr. Paul Bogosian  
ATTN: SFAE-AV  
C: 256-313-4001; DSN: 897-4001  
paul.bogosian@peoavn.redstone.army.mil

**Director of Business Management:** Mr. Charles G. Buttrely, Jr.  
ATTN: SFAE-AV-P  
C: 256-313-4007; DSN: 897-4007  
glen.buttrey@peoavn.redstone.army.mil

**Director of Concurrent Engineering:** Mr. Ronald E. Gormont  
ATTN: SFAE-AV-S  
C: 256-313-4134; DSN: 897-4134  
ronald.gormont@peoavn.redstone.army.mil

**Aircrew Integrated Systems Product Manager's Office**  
Building 5681  
Redstone Arsenal, AL 35898-5000  
**Acting Product Manager:** MAJ Michael Wills  
ATTN: SFAE-AV-LSE  
C: 256-313-4251; DSN: 897-4251  
mike.wills@peoavn.redstone.army.mil

**APM Air Warrior:** CPT Jay Gautreaux  
ATTN: SFAE-AV-IR  
C: 256-313-4250; DSN: 897-4250  
Jay.Gautreaux@peoavn.redstone.army.mil



# Great leaders *earn* their positions.

At Sabreliner, we believe a leadership position  
can't just be assumed... it must be earned.

*Earned* by providing decades of high quality service  
to the United States Government.

*Earned* by continuously improving our conveniently  
located facilities.

*Earned* by talented, seasoned professionals who value  
the importance of doing the job right.

*Earned* by accomplishing work correctly,  
on time, every time.

*Earned* from our constant dedication to  
controlling costs.

**SABRELINER  
CORPORATION**

Leadership earned  
through experience.

Phone (314) 863-6880 Fax (314) 863-6844

**Apache Attack Helicopter Project  
Manager's Office**  
Building 5681  
Redstone Arsenal, AL 35898-5000



**Project Manager:**  
COL Howard T.  
Bramblett  
ATTN: SFAE-AV-AAH  
C: 256-313-4200  
DSN: 897-4200  
howard.bramblett@  
peoavn.redstone.  
army.mil



**Deputy Project  
Manager:**  
Mr. Gary S.  
Nenninger  
ATTN: SFAE-AV-AAH  
C: 256-313-4200  
DSN: 897-4200  
gary.nenninger  
@peoavn.redstone.  
army.mil

**Apache Modernization Product  
Management Office**  
Building 5681  
Redstone Arsenal, AL 35898-5000  
**Product Manager:** LTC Derek  
Paquette

ATTN: SFAE-AV-AAH-ATH  
C: 256-313-4248; DSN: 897-4248  
derek.paquette@peoavn.  
redstone.army.mil

**Fire Control Radar Product  
Manager's Office**  
Building 5681  
Redstone Arsenal, AL 35898-5000



**Product Manager:**  
LTC Richard B.  
Pennyquick  
Rich: SFAE-AV-  
AAH-FCR  
C: 256-313-4310  
DSN: 897-4310  
Richard.Pennyquick  
@peoavn.redstone.  
army.mil

**Longbow Apache Product  
Manager's Office**  
Building 5681  
Redstone Arsenal, AL 35898-5000  
\*Update not provided this year.

**Product Manager**  
ATTN: SFAE-AV-AAH-LBA  
C: 256-313-4247  
DSN: 897-4247

**Aviation Electronic Combat Product  
Manager's Office**  
Bldg 5681, ATTN: SFAE-AV-AEC  
Redstone Arsenal, AL 35898-5000



**Project Manager:**  
Mr. Larry Johnston  
ATTN: SFAE-AV-AEC  
C: 256-313-4100  
DSN: 897-4100  
Larry.Johnston  
@peoavn.  
redstone.army.mil

**Deputy Project Manager:** COL David  
Brown, Jr.

SFAE-AV-AEC  
C: 256-313-4101; DSN: 897-4101  
**Product Manager - Avionics:** LTC  
Corwyn Tiede  
ATTN: SFAE-AV-AEC  
C: 256-313-4424; DSN: 897-4424  
Corwyn.Tiede@peoavn.  
redstone.army.mil

**AMPS:** MAJ Todd Smith  
ATTN: SFAE-AV-AEC  
C: 256-313-4393; DSN: 897-4393  
Todd.Smith@peoavn.  
redstone.army.mil

**IDM:** MAJ Chip Lunn  
ATTN: SFAE-AV-AEC  
C: 256-313-4392; DSN: 897-4392  
Chip.Lunn@peoavn.redstone.army.mil  
**Communications:** CPT John O'Neill  
ATTN: SFAE-AV-AEC  
C: 256-313-4405; DSN: 897-4405  
John.O'Neill@peoavn.  
redstone.army.mil

**GPS:** MAJ Layne Merritt  
ATTN: SFAE-AV-AEC  
C: 256-313-4450; DSN: 897-4450  
Layne.Merritt@peoavn.  
redstone.army.mil

**Chief, Technical Management  
Division:** Mr. Jack Van Kirk  
ATTN: SFAE-AV-AEC-T  
C: 256-313-4422; DSN: 897-4422  
Jack.VanKirk@peoavn.  
redstone.army.mil

**Chief, Logistics Management  
Division:** Mr. Mike Behnen  
ATTN: SFAE-AV-AEC-L  
C: 256-313-4713; DSN: 897-4713  
Mike.Behnen@peoavn.  
redstone.army.mil

**Chief, Business Management  
Division:** Mr. Chuck Lines  
ATTN: SFAE-AV-AEC-B  
C: 256-313-4500; DSN: 897-4500  
Chuck.Lines@peoavn.  
redstone.army.mil

**Comanche Program Manager's Office**  
Building 5681  
Redstone Arsenal, AL 35898-5000



**Program Manager:**  
COL Robert P.  
Birmingham  
ATTN: SFAE-AV-  
RAH  
C: 256-313-0846;  
DSN: 897-0846  
robert.birmingham@  
redstone.army.mil

**Deputy Program Manager:** Mr. Darrell  
Harrison  
ATTN: SFAE-AV-RAH  
C: 256-313-0841; DSN: 897-0841  
harrisond@comanche.  
redstone.army.mil

**Comanche Crew Support System  
Product Manager's Office**  
Building 5681  
Redstone Arsenal, AL 35898-5000



**Product Manager:**  
LTC Deborah J.  
Chase  
ATTN: SFAE-AV-  
RAH  
C: 256-313-4560  
DSN: 897-4560  
chased@comanche.  
redstone.army.mil

**T800 Product Manager's Office**  
Building 5300  
Redstone Arsenal, AL 35898-5000  
\*Update not provided this year.  
**Product Manager:** Mr. Jimmy Hill  
ATTN: SFAE-AV-RAH  
C: 256-313-4561  
hillj@comanche.redstone.army.mil

**Cargo Helicopter Project  
Manager's Office**  
Building 5678  
Redstone Arsenal, AL 35898-5000  
\*Update not provided this year.  
Redstone Arsenal, AL 35898-5000  
**Project Manager:** Mr. James Caudle  
ATTN: SFAE-AV-CH  
C: 256-313-4252; DSN: 788-4252  
caudlej@peoavn.redstone.army.mil  
**Deputy Project Manager:** Mr. Jay  
Rickmeyer  
ATTN: SFAE-AV-CH  
C: 256-313-3398; DSN: 897-3398  
rickmeyerj@peoavn.redstone.army.mil

**Aviation Electronic Systems PMO**  
Building 5683  
Redstone Arsenal, AL 35898-5000



**Project Manager:**  
Dr. Steven Messervy  
ATTN: SFAE-AV-IR  
C: 256-313-4650  
DSN: 788-4650  
steven.messervy@  
peoavn.redstone.  
army.mil

**Deputy Project Manager:** COL David  
P. Miller

ATTN: SFAE-AV-IR  
C: 256-313-4651; DSN: 897-4651  
dave.miller@peoavn.  
redstone.army.mil

**Product Manager - ASE:** Ms. Carlyn  
Frazier  
ATTN: SFAE-AV-IR  
C: 256-313-4425; DSN: 897-4425  
frazierc@peoavn.redstone.army.mil

**Air-to-Ground Missile Systems  
Project Office**  
Redstone Arsenal, AL 35898-5610  
\*Update not provided this year.  
**Project Manager:** Mr. Rhelt D. Farris  
ATTN: SFAE-MSL-HD  
C: 256-876-1365; DSN: 746-1365  
Rhelt.Farris@msl.redstone.army.mil  
**Deputy Project Manager:** LTC Carl  
Runyon

ATTN: SFAE-MSL-HD  
C: 256-876-1117; DSN: 746-1117  
Carl.Runyon@msl.redstone.army.mil  
**Chief, Program Management  
Division:** Mr. Robert Masucci  
ATTN: SFAE-MSL-HD-M  
C: 256-876-1271; DSN: 746-1271  
Robert.Masucci@msl.  
redstone.army.mil

**Chief, Technical Management  
Division:** Mr. Scott R. Beck  
ATTN: SFAE-MSL-HD-E  
C: 256-876-8413; DSN: 746-8413  
Scott.Beck@msl.redstone.army.mil  
**APM for Product  
Assurance/Test/Configuration Mgt.:**  
Mr. Edward M. Perkins  
ATTN: SFAE-MSL-HD-T  
C: 256-876-3261; DSN: 746-3261  
Ed.Perkins@msl.redstone.army.mil

**Chief, Logistics Management  
Division:** Mr. Michael E. McGee  
ATTN: SFAE-MSL-HD-S  
C: 256-876-4187; DSN: 746-4187  
Mike.McGee@msl.redstone.army.mil  
**APM, Longbow:** LTC Carl Runyon  
ATTN: SFAE-MSL-HD-L  
C: 256-876-7076; DSN: 746-7076  
Carl.Runyon@msl.redstone.army.mil

**Office, Project Manager, Tactical  
Unmanned Aerial Vehicles**  
Redstone Arsenal, AL 35898-5000



**Project Manager:**  
COL Michael A.  
Hamilton  
ATTN: SFAE-UAV  
C: 256-895-4449  
DSN: 788-4449  
hamilton-mi@  
redstone.army.mil

**U.S. Army Aviation and Missile  
Command (USAAMCOM)**  
Bldg. 5300, Fifth Floor  
Redstone Arsenal, AL 35898-5000



**Commanding  
General:**  
MG Al Sullivan  
ATTN: AMSAM-CG  
C: 256-876-2101  
DSN: 746-2101  
al.sullivan@red-  
stone.army.mil



**Deputy to the  
Commanding  
General:**  
Mr. James L. Flinn III  
ATTN: AMSAM-DC  
C: 256-842-9888  
DSN: 788-9888  
James.Flinn@red-  
stone.army.mil



**Chief of Staff:** COL  
Edward L. Stone  
ATTN: AMSAM-CS  
C: 256-876-1120;  
DSN: 746-1120  
edward.stone@red-  
stone.army.mil



**Senior NCO:**  
CSM Roscoe L.  
Johnson, Jr.  
ATTN: AMSAM-CSM  
C: 256-876-4657  
DSN: 746-4657  
roscoe.johnson@red-  
stone.army.mil

**Secretary of the General Staff:** Ms.  
Linda B. Readus  
ATTN: AMSAM-GS  
C: 256-876-3131; DSN: 746-3131  
linda.readus@redstone.army.mil

**Ombudsman:** Mr. Gerald Tucker  
ATTN: AMSAM-OB  
C: 256-876-6659; DSN: 746-6659  
gerald.tucker@redstone.army.mil





# We Don't Blink.

Their camouflage is better. Their SAMs are faster. So your look-around has to be quick, but accurate. That's why our new Apache video system has 40% improved resolution, freeze frame capability, 120 minute record time, and uses standard videotape formats – with an option for video burst transmission.

When you only have an instant, keep your eye on TEAC.

IF IT'S WORTH A MISSION, IT'S WORTH A

**TEAC**<sup>®</sup>  
AIRBORNE PRODUCTS DIVISION

7733 Telegraph Road, Montebello, CA 90640, (323) 727-4866, Fax (323) 727-7621 [www.teac.com](http://www.teac.com) email: [airborne@teac.com](mailto:airborne@teac.com) ©1999 TEAC America, Inc.

Competition Management Office,  
USAAMCOM  
Bldg. 5303  
Redstone Arsenal, AL 35898-5000  
Competition Advocate: Mr. Wade  
Griffin, Jr.  
ATTN: AMSAM-CM  
C: 256-876-9699; DSN: 746-9699  
Wade.Griffin@redstone.army.mil

Corporate Information Center,  
USAAMCOM  
Sparkman Complex, Bldg. 5301  
Redstone Arsenal, AL 35898-5000



Chief Information  
Officer:  
Mr. Mike Ivey  
ATTN: AMSAM-CIC  
C: 256-876-3514  
DSN: 746-3514  
mike.ivey@red-  
stone.army.mil

Freedom of Information Officer: Mrs.  
Sharon Fritts  
ATTN: AMSAM-CIC-B-M  
C: 256-313-3255; DSN: 897-3255  
sharon.fritts@redstone.army.mil

Legal Office, USAAMCOM  
Bldg. 5300  
Redstone Arsenal, AL 35898-5120  
\*Update not provided this year.  
Chief: Mr. Robert J. Spazzarini  
ATTN: AMSAM-L  
C: 256-876-3405; DSN: 746-3405  
robert.spazzarini@redstone.army.mil

Public Affairs Office, USAAMCOM  
Bldg. 5300  
Redstone Arsenal, AL 35898-5000  
\*Update not provided this year.



PAO:  
Mr. Al Schwartz  
ATTN: AMSAM-PA  
C: 256-876-4161  
DSN: 746-4161  
al.schwartz@  
redstone.army.mil

Small & Disadvantaged Business  
Utilization Office, USAAMCOM  
Bldg. 5303, Rm 3135  
Redstone Arsenal, AL 35898-5000  
Chief: Mr. John F. Nelson  
ATTN: AMSAM-SB  
C: 256-876-5441; DSN: 746-5441  
john.nelson@redstone.army.mil

Deputy for Systems Acquisition,  
USAAMCOM  
Sparkman Complex, Bldg. 5308  
Redstone Arsenal, AL 35898-5000



Deputy for Systems  
Acquisition:  
COL(P) Roger A.  
Nadeau  
ATTN: AMSAM-DSA  
C: 256-955-6701  
DSN: 645-6701  
Roger.Nadeau@  
redstone.army.mil

Aviation Systems Project Manager's  
Office, USAAMCOM  
Building 5308  
Sparkman Complex  
Redstone Arsenal, AL 35898-5000



Acting Project  
Manager:  
LTC Michael A. Boyajian  
C: 256-313-3742  
DSN: 645-3742

Assistant Project Manager - AGSE:  
LTC Michael A. Boyajian  
ATTN: AMSAM-DSA-WAG  
C: 256-842-9945; DSN: 788-9945  
mike.boyajian@redstone.army.mil

Unmanned Ground Vehicle/Systems  
Joint Project Office, USAAMCOM  
Redstone Arsenal, AL 35898-5000  
Director (Acting): LTC Richard LeVan  
ATTN: AMSAM-DSA-UG  
C: 256-955-6995; DSN: 645-6995  
Richard.LeVan@redstone.army.mil

Utility Helicopters Project Office,  
USAAMCOM  
Redstone Arsenal, AL 35898-5000



Project Manager:  
LTC William G.  
Lake, Jr.  
ATTN: AMSAM-DSA-  
UH  
C: 256-955-8938  
DSN: 645-8938  
William.Lake@  
redstone.army.mil

Air Traffic Control (ATC) Product  
Office, USAAMCOM  
Building 5308, Sparkman Complex  
Redstone Arsenal, AL 35898-5000



Product Manager:  
LTC Cory Mahanna  
ATTN: AMSAM-DSA-  
AS-ATC  
C: 256-955-9008  
DSN: 645-9008  
cory.mahanna@  
redstone.army.mil

Fixed Wing Product Office, USAAMCOM  
Redstone Arsenal, AL 35898-5000



Product Manager:  
LTC Stephen Walters  
ATTN: AMSAM-DSA-  
AS-FW  
C: 256-955-0081  
DSN: 645-0081  
stephen.walters@  
redstone.army.mil

Scout/Attack Product Office,  
USAAMCOM  
Redstone Arsenal, AL 35898-5000

Product Manager: LTC William Gavora  
ATTN: AMSAM-DSA-CO-ASH  
C: 256-955-7004; DSN: 645-9640  
william.gavora@redstone.army.mil

Aviation & Missile Research,  
Development & Eng. Ctr,  
USAAMCOM  
Building 5681  
Redstone Arsenal, AL 35898-5000



Assoc. Dir. Aviation  
Technology:  
Mr. Robert V.  
Kennedy  
ATTN: AMSAM-AR-Z  
C: 256-313-1737  
DSN: 897-1737  
robert.kennedy@  
redstone.army.mil



Associate Director  
for Technology  
(Acting): COL Waldo  
F. Carmona  
ATTN: AMSAM-AR-T  
C: 757-878-2208;  
DSN: 927-2208  
wcarmona@aaid.  
eustis.army.mil

Associate Director for Systems: Mr.  
Mike Schexnayder  
ATTN: AMSAM-AR-ZS  
C: 256-876-4396; DSN: 746-1737  
schexnayder-mc@redstone.army.mil  
Associate Director for Technology  
Applications: Mr. John L. Shipley  
ATTN: AMSAM-AR-ZN  
C: 757-878-2000; DSN: 927-2000  
shipley@eustis-aatds1.army.mil

Aviation Engineering Directorate,  
USAAMCOM  
Redstone Arsenal, AL 35898-5000



Director of Aviation  
Engineering:  
Mr. Barry J. Baskett  
ATTN: AMSAM-AR-E  
C: 256-313-4901  
DSN: 897-4901  
barry.baskett@red-  
stone.army.mil

Acquisition Center, USAAMCOM  
Bldg. 5303  
Redstone Arsenal, AL 35898-5000



Executive Director:  
Ms. L. Marlene Cruze  
ATTN: AMSAM-AC  
C: 256-876-7161  
DSN: 746-7161  
marlene.cruze  
@redstone.army.mil

Deputy Director: COL Scott Wilson  
ATTN: AMSAM-AC  
C: 256-842-6066; DSN: 788-6066  
scott.wilson@redstone.army.mil

Aviation & Missile RDEC Directorate,  
Acquisition Center, USAAMCOM  
Bldg. 5400  
Redstone Arsenal, AL 35898-5000  
Director: Ms. Sharon Zirbel  
ATTN: AMSAM-AC-RD  
C: 256-876-1785; DSN: 746-7307  
sharon.zirbel@rdec.redstone.army.mil

Business Management Office,  
Acquisition Center, USAAMCOM  
Bldg. 5303  
Redstone Arsenal, AL 35898-5000  
Chief: Mr. Randy Richardson  
ATTN: AMSAM-AC-BM  
C: 256-876-7767; DSN: 746-1163

Logistics Support Dir., Acquisition  
Center, USAAMCOM  
Bldg. 5303  
Redstone Arsenal, AL 35898-5000  
Director: Mr. Willis Epps  
ATTN: AMSAM-AC-ML  
C: 256-876-9855; DSN: 746-9845

PEO Tactical Missiles Directorate,  
Acquisition Center, USAAMCOM  
Bldg. 5303  
Redstone Arsenal, AL 35898-5000  
Director: Mr. James Brannon  
ATTN: AMSAM-AC-TM  
C: 256-876-8406; DSN: 746-8406  
james.brannon@redstone.army.mil

Systems Acquisition Air Dir.,  
Acquisition Center, USAAMCOM  
Bldg. 5308  
Redstone Arsenal, AL 35898-5000  
Director: Ms. Carol Lehman  
ATTN: AMSAM-AC-SA  
C: 256-876-4202; DSN: 746-4202  
carol.lehman@redstone.army.mil

Systems Acquisition Missile Dir.,  
Acquisition Center, USAAMCOM  
Bldg. 5303  
Redstone Arsenal, AL 35898-5000  
Chief: Mr. Ronnie Noblitt  
ATTN: AMSAM-AC-SM  
C: 256-876-9317; DSN: 746-9317  
ronnie.noblitt@redstone.army.mil

PEO Aviation Directorate,  
Acquisition Center, USAAMCOM  
Bldg. 5681  
Redstone Arsenal, AL 35898-5000  
Director: Mr. W. G. Bowersox  
ATTN: AMSAM-AC-AV  
C: 256-313-4008; DSN: 897-4008  
bud.bowersox@peoavn.  
redstone.army.mil

Integrated Materiel Management  
Center (IMMC), USAAMCOM  
Sparkman Complex, Bldg. 5302  
Redstone Arsenal, AL 35898-5000  
Acting Executive Director: Mr. John  
Chapman  
ATTN: AMSAM-MMC  
C: 256-876-3106  
DSN: 746-3106  
John.Chapman@redstone.army.  
milmy.mil

Deputy Director: Mr. Rick Turner  
ATTN: AMSAM-MMC  
C: 256-876-3108; DSN: 746-3108  
rick.turner@redstone.army.mil

Air Defense Missile Directorate,  
(IMMC), USAAMCOM  
Sparkman Complex, Bldg. 5309  
Redstone Arsenal, AL 35898-5000  
Director: Mr. Michael Hartwell  
ATTN: AMSAM-MMC-AD  
C: 256-876-2392; DSN: 746-2392  
hartwell-m1@redstone.army.mil

Aviation Systems Directorate,  
(IMMC), USAAMCOM  
Sparkman Complex, Bldg. 5302  
Redstone Arsenal, AL 35898-5000  
Director: Mr. Thomas Lavin  
ATTN: AMSAM-MMC-VS  
C: 256-313-1641; DSN: 897-1641  
tom.lavin@redstone.army.mil

Land Combat Missile Directorate,  
(IMMC), USAAMCOM  
Sparkman Complex, Bldg. 5302  
Redstone Arsenal, AL 35898-5000  
\*Update not provided this year.  
Director: Mr. Tommie Cutts, Jr.  
ATTN: AMSAM-MMC-LC  
C: 256-876-3393; DSN: 746-3393  
lommie.cutts@redstone.army.mil

Logistics Support Directorate,  
(IMMC), USAAMCOM  
Sparkman Complex, Bldg. 5302  
Redstone Arsenal, AL 35898-5000  
Director: Mr. John McClure  
ATTN: AMSAM-MMC-LS  
C: 256-876-5266; DSN: 746-5266  
John.McClure@redstone.army.mil



# TELEDYNE BROWN ENGINEERING, INC.

A Teledyne Technologies Company

[www.tbe.com](http://www.tbe.com)

## *Aviation Engineering Excellence for the 21st Century*

### *Technical, Programmatic and Logistics Expertise*

*Systems Engineering  
Modeling and Simulation  
System Integration  
Training Development  
Information Technology  
Aerospace Manufacturing*

**Providing cost effective solutions for today's complex problems**

300 Sparkman Drive, Huntsville, AL 35805 • Tel: (256) 726-6488 • Fax: (256) 726-3658 • e-mail: [info@tbe.com](mailto:info@tbe.com)

## COBRO MAINTENANCE SCIENCE SCHOLARSHIP

*Parks College of Engineering and Aviation of Saint Louis University invites applicants for the Cobro Maintenance Science Scholarship to be awarded after November 1, 2000, for the semester beginning January 2001. The award will be for a minimum of \$22,000 renewable for up to three academic years.*

### **Applicants must have:**

- Achieved a 3.3 grade point average out of a possible 4.0 and have completed 60 semester hours or the equivalent at the college/university level.
- Earned more than 50 percent of the tuition cost of their college/university education from their own employment (including military benefits).
- Completed at least one full year of employment, co-op or internship in the avionics or a related industry (including military service).

*Preference will be given to candidates who are U.S. citizens and who demonstrate a knowledge of computer-maintained databases, statistical inference analysis and an understanding of the key role of maintenance science and administration.*

### **Deadline for Application:**

November 1, 2000 (for Spring 2001 semester)  
May 1, 2001 (for Fall 2001 semester)

### **For more information:**

Saint Louis University • Parks College of Engineering and Aviation  
3450 Lindell Boulevard • P.O. Box 56907 • St. Louis, MO 63156 • (314) 977-8203



**SAINT LOUIS  
UNIVERSITY**

Readiness Directorate, (IMMC),  
USAAMCOM  
Sparkman Complex, Bldg. 5309  
Redstone Arsenal, AL 35893-5000  
Director: Mr. William T. Ingram  
ATTN: AMSAM-MMC-RE  
C: 256-876-9819; DSN: 746-9819  
Tom.Ingram@redstone.army.mil

Aviation/Missile Research, Develop.  
& Engineering Ctr, USAAMCOM  
Bldg. 5400  
Redstone Arsenal, AL 35898-5000



Director:  
Dr. William C.  
McCorkle  
ATTN: AMSAM-RD  
C: 256-876-3322  
DSN: 746-3322  
Bill.McCorkle@  
rdcc.redstone.  
army.mil

### ALASKA Bethel

Alaska ARNG Army Aviation  
Operating Facility #2  
P. O. Box 7190  
Bethel, AK 99559-0508  
\*Update not provided this year.

AASF: MAJ Kenneth O. Snyder  
ATTN: AKNG-AVN-OFB  
C: 907-543-2225

### Fort Greely

USAG Aviation Detachment  
501 2nd Street  
Fort Greely, AK 96508  
\*Update not provided this year.  
Commander: CW4 Mike Warlick  
ATTN: APVR-FG-AO  
C: 907-873-4170; DSN: 312-873-4170  
apvrgav1@richardson-emh2.army.mil  
Operations & Safety Officer: CW3  
Russell Stark  
C: 907-873-4170; DSN: 312-873-4170  
Operations NCOIC: SSG Brian Eaton  
ATTN: APVR-FG-AO  
C: 907-873-4170; DSN: 312-873-4170  
Standardization Officer: CW3 Brett  
Westcott  
ATTN: APVR-FG-AO  
C: 907-873-4170; DSN: 873-4170  
Detachment Sergeant: SFC Dwaine E.  
Walters  
ATTN: APVR-FG-AO  
C: 907-873-1370; DSN: 873-4170  
Operations NCOIC: SSG Brian Eaton  
ATTN: APUR-FG-AD  
C: 907-873-4170

### Fort Richardson

Office, State Adjutant General,  
Alaska Army National Guard  
P. O. Box 5800  
Fort Richardson, AK 99505-5800  
\*Update not provided this year.  
TAG: BG Phillip E. Cales  
ATTN: OTAG  
C: 907-428-6003; DSN: 384-4003

Office, State Army Aviation Officer,  
Alaska Army National Guard  
Office of the Adjutant General  
P.O. Box 5800  
Fort Richardson, AK 99505-5800

SAAO: LTC Mark S. Stigar  
ATTN: AKNG-AVN  
C: 907-428-6331; DSN: 317-384-4331  
saosak@ak-arng.ngb.army.mil

Alaska Army National Guard Army  
Aviation Support Facility  
P. O. Box A  
Fort Richardson, AK 99505-5000  
AASF: LTC Jerry Kidrick  
ATTN: AKNG-AVN-SFC  
C: 907-428-6325; DSN: 317-384-4325

1st Battalion, 207th Aviation  
Regiment  
Alaska Army National Guard  
Fort Richardson, AK 99505  
\*Update not provided this year.

### Fort Wainwright

Office of the Deputy Commander  
Aviation Office, U.S. Army  
Alaska (USARAK)  
1060 Gaffney Rd., #5150  
Fort Wainwright, AK 99703

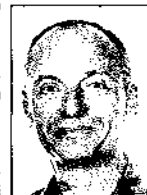

Deputy, Comman-  
der, US Army  
Alaska/Aviation  
Officer:  
COL Oliver H.  
Hunter IV  
ATTN: APVR-WDC  
C: 907-353-6680  
DSN: 317-353-6680  
Hunteroh@  
wainwright.army.mil

Deputy Aviation Officer: CW4 Richard  
J. Rylee  
ATTN: APVR-WPTM-AV  
C: 907-353-7097; DSN: 317-353-7097  
ryleer@wainwright.army.mil



Commander, 4th  
Battalion, 123rd  
Aviation Regiment:  
LTC William T.  
Harrison  
ATTN: APVR-WAB-  
CO  
C: 907-353-9763  
DSN: 317-353-9763  
4123CDR@  
wainwright.army.mil

4th Battalion, 123d Aviation  
Fort Wainwright, AK 99703-8400

Commander: LTC William T. Harrison  
ATTN: APVR-WAB-CO  
C: 907-353-9763  
DSN: 317-353-9763  
4123cdr@wainwright-emh1.army.mil  
Executive Officer: MAJ Terry Dolan  
ATTN: APVR-WAB-XO  
C: 907-353-6064; DSN: 317-353-6064  
4123bnxo@wainwright-emh1.army.mil  
SIP: CW4 Dave Jones  
ATTN: APVR-WAB-SIP  
C: 907-353-7003; DSN: 317-353-7003  
ASO: CW3 Dale A. Verley  
ATTN: APVR-WAB-ASO  
C: 907-353-7071; DSN: 317-353-7071  
Senior NCO: CSM Robert Kearney, Jr.  
ATTN: APVR-WAB-CSM  
C: 907-353-9790; DSN: 317-353-9790

C Company, 123d Aviation (AVIM)  
Fort Wainwright, AK 99703  
Commander: CPT Carl L. Casey  
ATTN: APVR-WAB-AV  
C: 907-353-1276; DSN: 317-353-1276  
CaseyCL@wainwright-emh1.army.mil  
Senior NCO: 1SG Stephan F. Sloskey, II  
ATTN: APVR-WAB-AV  
C: 907-353-1273; DSN: 317-353-1273  
SloskeyS@wainwright.army.mil

B Company, 4-123rd Theater Aviation  
Regiment  
Fort Wainwright, AK 99703  
\*Update not provided this year.  
SIP: CW3 Zane Hawkins  
ATTN: APVR-WAB-BCO-SIP  
C: 907-353-9963; DSN: 317-353-9963  
47onskis@wainwright-emh1.army.mil  
ASO: CW2 Kim Barney  
ATTN: APVR-WAB-BCO-ASO  
C: 907-353-6247; DSN: 317-353-9963  
Senior NCO: 1SG Eric Harris  
ATTN: APVR-WAB-BCO-CSM  
C: 907-353-9652; DSN: 317-353-9652  
4123bcd@wainwright-emh1.army.mil

D Company, 4-123rd Theater Aviation  
Regiment  
Fort Wainwright, AK 99703  
\*Update not provided this year.  
SIP: CW3 Thomas Tatrow  
ATTN: APVR-WAB-DCO-SIP  
C: 907-353-6861; DSN: 317-353-6861  
ASO: CW2 Bryan Buchanan  
ATTN: APVR-WAB-DCO-ASO  
C: 907-353-6861; DSN: 317-353-6861  
Senior NCO: 1SG Stephen F. Sloskey  
ATTN: APVR-WAB-DCO-1SG  
C: 907-353-7066; DSN: 317-353-7066

68th Medical Company (AA) Alaska  
Fort Wainwright, AK 99703  
\*Update not provided this year.  
Commander: MAJ John Alvarez  
ATTN: APVR-WAB-MD  
C: 907-353-6283; DSN: 317-353-6283  
cdr283@wainwright-emh1.army.mil  
SIP: CW3 Dale Farr  
ATTN: APVR-WAB-MD-SP  
C: 907-353-6348; DSN: 317-353-6348  
ASO: CW2 Kathleen Ryan  
ATTN: APVR-WAB-MD-ASO  
C: 907-353-7313; DSN: 317-353-7313  
Senior NCO: 1SG Nancy Uptgraft  
ATTN: APVR-WAB-MD  
C: 907-353-6885; DSN: 317-353-6885

### Juneau

Alaska Army National Guard Army  
Aviation Operating Facility #4  
8425 Livingston Way  
Juneau, AK 99801-8086  
AAOFC: CW3 David Small  
ATTN: AKNG-AVN-OFJ  
C: 907-789-3366  
aasfjuneau@ak-arng.ngb.army.mil  
Maintenance Officer: CW3 Mike  
Michaud  
C: 907-789-3366  
michaudm@ak-arng.army.mil  
Safety Officer: CW4 Harry James  
C: 907-789-3366  
jamesh@ak-arng.ngb.army.mil

### Nome

Alaska Army National Guard Aviation  
Operating Facility #1  
P. O. Box 533  
Nome, AK 99762-0533  
\*Update not provided this year.

AAOFC: CPT Wayne F. Horton  
ATTN: AKNG-AVN-OFN  
C: 907-443-2831

### ARIZONA Fort Huachuca

Aviation Section, U.S. Army  
Electronic Proving Ground  
Fort Huachuca, AZ 85613-7110

### Marana

1-285th Aviation Attack Battalion  
Silverbell Army Heliport  
Pinal County Airpark  
Marana, AZ 85653  
Commander: MAJ(P) Kenneth Nettles  
ATTN: AZAA-AZMA  
C: 520-616-5625; DSN: 853-5651  
nettlek@az.ngb.army.mil  
XO: MAJ Frank Millerd  
ATTN: AZAA-AZMA  
C: 520-616-5651; DSN: 853-5651  
millerdf@az.ngb.army.mil

Western Army National Guard  
Aviation Training Site (WAATS)  
Silver Bell Army Heliport  
Building L45-500  
Marana, AZ 85653-9598  
Commander: COL James E. Braman  
ATTN: AZHA-CMD  
C: 520-616-5530; DSN: 853-5530  
bramanej@az.ngb.army.mil  
Deputy Commander: LTC James R.  
Callahan  
ATTN: AZHA-CMD  
C: 520-616-5661; DSN: 853-5661  
callahanj@az.ngb.army.mil  
SIP: CW4 Nick Page  
ATTN: AZHA-OTS  
C: 520-616-5588; DSN: 853-5588  
pagew@az.ngb.army.mil  
ASO: CW5 R. C. Smith  
ATTN: AZHA-SOB  
C: 520-616-5597; DSN: 853-5597  
smithr@az.ngb.army.mil  
MTFE: CW4 Brad Frank  
ATTN: AZHA-AMS  
C: 520-616-5683; DSN: 853-5683  
frankb@az.ngb.army.mil  
Senior NCO: CSM Kent Gabrielson  
ATTN: WAATS-C  
C: 520-616-5503; DSN: 853-5503  
gabrielsonk@az.ngb.army.mil

Army Aviation Support Facility #2  
Silverbell Army Heliport, Building L45-600  
Marana, AZ 85653-9698  
\*Update not provided this year.  
AASF #2: MAJ Kenneth E. Nettles  
ATTN: AZAA-AVS  
C: 520-616-5624; DSN: 853-4624  
nettlek@azing-mail.army.mil

### Mesa

Defense Contract Mgmt. (DCM)  
Boeing - Mesa  
5000 East McDowell Road  
M.S. Bldg 510, A277  
Mesa, AZ 85215



Commander:  
LTC Peggy Carson  
ATTN: DCMC-GPOM  
C: 480-891-3500  
DSN: 474-3500  
pcarson@dcm.dwd.  
dla.mil

# One Common Heritage, One Simple Goal: Supporting the Soldier



Mass Memory Unit

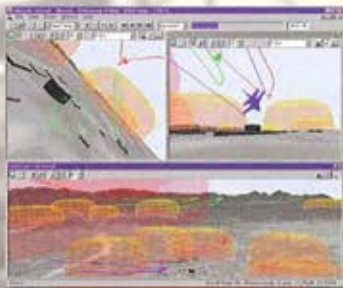

Mission Planning and  
Rehearsal System



Airborne Video  
Solid-State Recorder



In today's high tech Army, systems that don't work together put soldiers at risk. Fairchild Defense's hardware and software systems support a wide variety of Army aircraft and ground vehicle system requirements and share a common heritage, so they are instantly compatible without modifications or additional programming. In the end, that means fewer technical glitches, lower cost of use and maintenance, and most importantly, it means that they work in the field, providing soldiers the performance they need to achieve their objectives.

Fairchild Defense • 20301 Century Boulevard • Germantown, MD 20874

Tel: 301-428-6477 or 1-800-368-2812, ext. 6477  
Fax: 301-428-6433 • E-mail: [fdbusdev@oscscsystems.com](mailto:fdbusdev@oscscsystems.com)  
Or visit [www.orbital.com](http://www.orbital.com)



118.00

**Orbital**  
FAIRCHILD DEFENSE

**Phoenix****C Company, 1-189th Aviation Battalion**

5636 E. McDowell Road  
Phoenix, AZ 85008-3495

**Training Officer:** CW4 Robert Dubasik  
ATTN: AZAA-AZKJ-ZA  
C: 602-267-2860; DSN: 853-2860  
dubasikr@az.ngb.army.mil

**E Company, 1-189th Aviation Battalion**

5636 E. McDowell Road  
Phoenix, AZ 85008-3495

\*Update not provided this year.

**2/98th Aviation Troop Command**

5636 E. McDowell Rd.  
Phoenix, AZ 85008-3495

\*Update not provided this year.

**Commander:** LTC Pamela J. Rodriguez  
ATTN: AZKB-CDR  
C: 602-267-2518; DSN: 853-251

**385th Attack Regiment**

5636 E. McDowell Road  
Phoenix, AZ 85008-3495



**Commander:**  
LTC Meade G. "Buz"  
Long  
C: 602-267-2855  
DSN: 853-2855  
rodriguezp@az.ngb.army.mil

**416th ATSC (DIV)**

5636 E. McDowell Road  
Phoenix, AZ 85008-3495

**Commander:** CPT Thomas George  
ATTN: AZAA-AZKG  
C: 602-267-2847; DSN: 853-2847  
georget@az.ngb.army.mil

**Office, State Adjutant General,**

Arizona Army National Guard  
5636 East McDowell Road  
Phoenix, AZ 85008-3495



**TAG:**  
MG David P.  
Rataczak  
C: 602-267-2710  
DSN: 853-2710

**Office, State Army Aviation Officer,**

Arizona Army National Guard  
Office of the Adjutant General  
5636 East McDowell Road  
Phoenix, AZ 85008-3495



**SAAO:**  
COL Jack T. Ogle  
ATTN: AZAA-AV  
C: 602-267-2864  
DSN: 853-2864  
saoaz@az.ngb.army.mil

**Arizona Army National Guard Aviation Support Facility #1**

5636 East McDowell Road  
Phoenix, AZ 85008-3495

\*Update not provided this year.

**AASFC:** LTC Jack T. Ogle  
ATTN: AZAA-AV  
C: 602-267-2794; DSN: 853-2794  
ogjto@az.ngb.army.mil

**ARKANSAS  
North Little Rock**

**Office, State Adjutant General,**  
Arkansas Army National Guard  
Camp Robinson  
North Little Rock, AR 72199-9600



**TAG:**  
MG Don C. Morrow  
TAG-Z  
C: 501-212-5100  
DSN: 962-5100  
Don.Morrow@ar.ngb.army.mil

**Office, State Army Aviation Officer,**  
Arkansas Army National Guard  
Army Aviation Support Facility  
Camp Robinson  
North Little Rock, AR 72199-9600

**SAAO:** LTC Daniel T. Leslie  
ATTN: TAG-DASF-D  
C: 501-212-5650; DSN: 962-5650  
saoar@ar.ngb.army.mil

**Arkansas Army National Guard Army Aviation Support Facility**

Camp Robinson  
North Little Rock, AR 72199-9600

**AASFC:** LTC Daniel T. Leslie  
ATTN: TAG-DASF-C  
C: 501-212-5656; DSN: 962-5656  
aasf1@ar-ngnet.army.mil

**CALIFORNIA  
Fort Irwin**

**U.S. Army Air Ambulance Detachment**  
PO Box 105002  
Fort Irwin, CA 92310-5000  
**Commander:** MAJ Alain J. Pirrone  
ATTN: AFZJ-SB-MD  
C: 760-380-3092; DSN: 470-3082

**Operations Group, Aviation Trainer**

Division, NTC  
Fort Irwin, CA 92310-5000  
**Combat Service Support Trainer:**  
MAJ Ron Miller  
ATTN: ATXY-AV  
C: 619-380-4462; DSN: 470-4462

**Senior Aviation Bde Trainer:** MAJ Terry Jamison  
ATTN: ATXY-AV  
C: 619-380-5544; DSN: 470-5544

**Attack Battalion Operations Trainer:**  
MAJ Brian Thoma  
ATTN: ATXY-AV  
C: 619-380-5544; DSN: 470-5544

**Senior TAF Analyst:** MAJ Steve Bellson  
ATTN: ATXY-AV  
C: 619-380-5090; DSN: 470-5090

**Senior NCO:** SGM Joseph Tainatonga  
ATTN: ATXY-AV  
C: 619-380-3504; DSN: 470-3504

**Fresno****40th Infantry Division Aviation**

Brigade, California ARNG  
911 South Chance Avenue  
Fresno, CA 93702

**Commander:** COL Michael A. Smith  
ATTN: CADD-CR  
C: 209-253-7029  
ssd700@quiknet.com

**Executive Officer:** LTC James Berdan  
ATTN: CADD-XO  
C: 209-253-7029  
jberdan@aol.com

**ASO:** CW4(P) Roy Lineberry  
ATTN: CADD-ASO  
C: 209-253-7029  
hueyroy@aol.com

**SIP:** CW4(P) Greg Helsel  
ATTN: CADD-SP  
C: 209-253-7025  
ch47sp@aol.com

**TAC OPS:** CW5 John Harris  
ATTN: CADD-TO  
C: 209-253-7025  
harris4592@aol.com

**MTFE:** CW4(P) William Scott  
ATTN: CADD-ME  
C: 916-854-3824; DSN: 466-3824  
scotttw@calguard.ca.gov

**Senior NCO:** CSM B. J. Llewellyn  
ATTN: CADD-CSM  
C: 209-253-7020  
csmbj@inreach.com

**1106th Aviation Classification Repair Activity Depot (AVCRAD)**

California ARNG  
5168 East Dakota Avenue  
Fresno, CA 93727-7404

**Supervisor:** LTC James D. Bacon  
ATTN: CAFR-CR  
C: 559-347-5501; DSN: 686-5501  
cafr-cr@ca-armg.ngb.army.mil

**Deputy Supervisor:** MAJ Paul Bryant  
ATTN: CAFR-AS  
C: 559-347-5502; DSN: 656-5502  
cafr-cr@ca-armg.ngb.army.mil

**Los Alamitos****C Company, 6th Battalion, 52nd Aviation Regiment (TA)**

PO Box 3001, Bldg. 912  
Los Alamitos, CA 90720-1301

\*Update not provided this year.  
**Commander:** CPT Anthony Demolina  
C: 562-795-2252

**6th Battalion, 52nd Aviation Regiment (TA)**

PO Box 3001, Bldg. 912  
Los Alamitos, CA 90720-1301

\*Update not provided this year.  
**Commander:** LTC Thomas Caples  
C: 562-795-1163  
**Senior NCO:** CSM Allen Conely  
C: 562-795-1163

**Aviation Support Facility Los Alamitos**

PO Box 3001, Bldg. 912  
Los Alamitos, CA 90720-1301  
**Facility Supervisor:** Mr. Len Bumgardner  
ATTN: AFRC-ACA-ASF  
C: 310-795-2235; DSN: 972-2235

**Los Alamitos Army Aviation Support Facility #1**

Armed Forces Reserve Center  
Building 913

11200 Lexington Drive  
Los Alamitos, CA 90720-5001

\*Update not provided this year.  
**AASFC:** MAJ Carl Allen  
ATTN: LAAASF  
C: 562-795-2001; DSN: 972-2001

**California Army National Guard Los Alamitos Army Airfield (KSLI)**

Armed Forces Reserve Center  
Airfield Operations, Bldg. 1  
Los Alamitos, CA 90720-5164



**Airfield Commander:**  
LTC Thomas E.  
Lasser  
ATTN: CALA-LAAAF-CDR  
C: 562-795-2561  
DSN: 972-2561  
TomLasser@ca.ngb.army.mil

**Operations Officer:** MAJ M. Williams

ATTN: CALA-LAAAF-OPS  
C: 562-795-2005; DSN: 972-2005

MTHAWK@earthlink.net  
**Aviation Safety Officer:** CW3 Chris Trautwein

ATTN: CALA-LAAAF-ASO  
C: 562-795-2564; DSN: 792-2564  
flysafe@netzero.net

**Pol Supervisor:** 1SG Herbert Izrary

ATTN: CALA-LAAAF-POL  
C: 562-795-2149; DSN: 972-2149  
fuelers@juno.com

**Weather Office:** SGT K. Simidian  
ATTN: CALA-LAAAF-WX  
C: 562-795-2571; DSN: 97225719  
simidian@jps.net

**Senior NCO:** SFC Troy Eck  
ATTN: CALA-LAAAF-OPSX  
C: 562-795-2571; DSN: 972-2571  
lbe1@mindspring.com

**Contact Tower (ATC):** Mr. Don Walker

ATTN: CALA-LAAAF-ATC  
C: 562-795-2554; DSN: 972-2554

**Regional Flight Simulator (SFTS):**  
CPT Lisa Kutchera  
C: 562-795-2335; DSN: 972-2335  
76311.12@compuserve.com

**Mather****126th Medical Company (AA)**

3754 Femoyer Street

Mather, CA 95655-1103

**Commander:** MAJ Manuel A. Lascano  
C: 916-843-3975

**California Army National Guard Aviation Support Facility #3**

10626 Super Fortress Avenue  
Mather, CA 95655-1103

\*Update not provided this year.  
**AASFC:** MAJ Manuel A. Lascano  
ATTN: AASF-SAC  
C: 916-854-3633; DSN: 466-3090

**Moffett Field****National Rotorcraft Technology Center**

Ames Research Center  
M/S 207-1

Moffett Field, CA 94035-1000

# ALL THE EYES OF THE DARKEST NIGHT

## Advanced Solutions for Advanced Army Cockpits

Visit Litton at  
AUSA 16-18 Oct.  
Washington, D.C.



Litton's AN/AVS-6(V)3 features our patented OMNI V GEN IV image intensifier resulting in 20% increase in SNR over OMNI IV on the darkest nights. Its Auto-Gated Power Supply provides a 200% increase in resolution over OMNI IV during high light level MOUT operations.

The goggle objectives include an improved 4-knob focal ring with 338 degree turn. AN/AVS-6(V)3 uses a

new low-profile power pack with an aircraft power interface or a clip-on power supply that directly attaches to the goggle for pre-flight, egress, or dismounted operations.

Litton's Eye-Cam slips directly on the AN/AVS-6 eye-piece for night vision video recording. The new Day-Cam attaches directly to the helmet mount for color recording.



OMNI IV GENIII

AN/AVS-6(V)3



Aviator's Goggle



OMNI V GENIV



OMNI IV GENIII



Low Profile Power Pack



N.V. & Color Video



OMNI V GENIV

**Litton**

## Electro-Optical Systems

3414 Herrmann Drive  
Garland, TX 75041-6188  
(972) 840-5629  
FAX: (972) 271-2195  
sales@litton-eos.com

1215 South 52nd Street  
Tempe, AZ 85281-6987  
(480) 968-4471  
FAX: (480) 966-9055  
www.littoneos.com

U.S Patent #6,087,649  
July 11, 2000



Aeroflightdynamics Directorate,  
USAAMCOM  
MS Y:219-3  
Moffett Field, CA 94035-1000



Director:  
Mr. Andrew W. Kerr  
ATTN: AMSAM-RD-  
AF  
C: 650-604-5837  
DSN: 359-5837  
akerr@mail.  
arc.nasa.gov

Deputy Director: Mr. Wayne D. Mosher  
ATTN: AMSAM-RD-AF  
C: 650-604-5569; DSN: 359-5569  
mosher@merlin.arc.nasa.gov  
Chief, Research Support Division: Mr.  
Arthur Ragosta  
ATTN: AMSAM-RD-AF-S  
C: 650-604-5558; DSN: 359-5558  
ragosta@merlin.arc.nasa.gov

### Sacramento

Office, State Adjutant General,  
California ARNG  
9800 S. Goethe  
Sacramento, CA 95826-9101  
\*Update not provided this year.  
TAG: BG Paul D. Monroe, Jr.  
C: 916-854-3500; DSN: 466-3500

Office, State Army Aviation Officer,  
California ARNG  
Director, Aviation and Safety  
Office of the Adjutant General  
PO Box 269101, 9800 Goethe Rd.  
Sacramento, CA 95826-9101  
SAAO: COL Brad Jones  
ATTN: CAAV  
C: 916-854-3077; DSN: 466-3077  
saoca@ca.ngb.army.mil

### Stockton

California Army National Guard Army  
Aviation Support Facility #2  
Stockton Metropolitan Airport  
2000 Slimson Road  
Stockton, CA 95206-3997  
AASFC: LTC Kent J. Daring  
ATTN: COMMANDER  
C: 209-938-5311; DSN: 466-5311

### COLORADO Aurora

1022d Medical Company,  
Detachment 1  
770 S. Aspen Street  
Buckley ANG Base  
Aurora, CO 80011-9552  
\*Update not provided this year.

Office, State Army Aviation Officer,  
Colorado Army National Guard  
Buckley Air NG Base  
800 S. Aspen Road  
Aurora, CO 80011-9553  
SAAO: LTC Larry Ciana  
ATTN: COAAS  
C: 303-677-9844; DSN: 877-9844  
saoco@co.ngb.army.mil

### Englewood

Office, State Adjutant General,  
Colorado Army National Guard  
6848 S. Revere Parkway  
Englewood, CO 80112-6703  
\*Update not provided this year.



TAG:  
MG William A.  
Westerhdahl  
ATTN: TAG  
C: 303-397-3023  
DSN: 877-2023  
mpalkovich@  
cobkf.ang.af.mil

### Fort Carson

571st Medical Company (Air  
Ambulance)  
Fort Carson, CO 80913-5000  
Commander: MAJ Robert A. Eaton  
ATTN: AFZC-R-H-MED  
C: 719-526-6497; DSN: 691-6497  
4SMEDCDR@carson-cav3.army.mil

### Gypsum

High Altitude Aviation Training Site  
(HATS)  
PO Box 453  
Gypsum, CO 81637-0453  
Commander: LTC Joel Best  
ATTN: W7V0A1  
C: 970-524-7704; DSN: 877-2223  
HATSJAMMER@AOL.COM

### CONNECTICUT Enfield

1st Battalion, 169th Aviation  
National Guard Armory  
1635 King Street  
Enfield, CT 06082-5824  
\*Update not provided this year.  
Commander: LTC Ernest T. Erickson  
ATTN: CTTC-AVN-CDR  
C: 203-386-5501  
erickson@sikorsky.com  
Executive Officer: MAJ Thomas J.  
Sousa  
ATTN: CTTC-AVN-XO  
C: 860-745-1951  
Safety Officer: CW4 Michael D. Voltero  
ATTN: CTTC-AVN-SAF  
C: 860-741-5487  
MTFE: 2LT Victoria Welch  
ATTN: CTTC-AVN-MTFE  
C: 860-627-4881; DSN: 636-8728  
Senior NCO: CSM Duane I.  
Haverstock  
ATTN: CTTC-AVN-CSM  
C: 860-745-1951

### Groton

1109th Aviation Classification Repair  
Activity Depot (AVCRAD)  
Connecticut ARNG  
139 Tower Avenue  
Groton-New London Airport  
Groton, CT 06340-5300

Supervisor: LTC William P. Shea  
C: 860-441-2900; DSN: 636-7925  
avcradcl@ct-arng.ngb.army.mil

### Hartford

The Adjutant General, Military Dept.,  
Connecticut ARNG  
360 Broad Street  
Hartford, CT 06105-3795



TAG:  
MG William A.  
Cugno  
CTNG-TAG  
C: 860-524-4953  
DSN: 636-7953  
william.cugno@  
ct.ngb.army.mil

### Trumbull

TSM-Comanche (FWD)  
35 Nutmeg Drive  
MS/Z112-Sikorsky  
Trumbull, CT 06611-5415  
Asst TSM-C (Crew Station): CW3  
Andy Johnson  
ATTN: ATZQ-TSM-C(FWD)  
C: 203-383-3740  
Asst TSM-C (Maintenance): Master  
Sergeant Paul Sargent  
ATTN: ATZQ-TSM-C(FWD)  
C: 203-383-3672

### Windsor Locks

2d Battalion, 126th Avn. Regiment  
CT Army National Guard  
Camp Hartell, Bldg. P-123  
Windsor Locks, CT 06096-0455  
Commander: LTC Christopher R. Ward  
ATTN: CTNG-AVCBT-CDR  
C: 860-386-4045; DSN: 636-7045  
christopher.ward@ct.ngb.army.mil  
Executive Officer: MAJ Edward F.  
Barry  
ATTN: CTNG-AVCBT-XO  
C: 860-386-4045; DSN: 636-7045  
edward.barry@ct.ngb.army.mil  
SIP: CW4 Douglas D. Duguay  
ATTN: CTNG-AVCBT-B  
C: 860-386-4071; DSN: 636-7071  
douglas.duguay@ct.ngb.army.mil  
ASO: CW3 Renato R. Astolfi  
ATTN: CTNG-AVCBT-SO  
C: 860-386-4071; DSN: 636-7071  
renato.astolfi@ct.ngb.army.mil  
MTFE: CW3 Michael M. Kermod  
ATTN: CTNG-AVCBT-D  
C: 860-386-4071; DSN: 636-7071  
michael.kermod@ct.ngb.army.mil  
Senior NCO: CSM George E. Hartnell  
ATTN: CTNG-AVCBT-CSM  
C: 860-386-4045; DSN: 636-7045  
george.hartnell@ct.ngb.army.mil

Directorate of Aviation Operations  
Army Aviation Support Facility  
CT Army National Guard  
Bldg. 152, Bradley Int Airport  
Windsor Locks, CT 06096-1086  
SAAO: COL Albert A. Rubino  
ATTN: CTNG-DAV  
C: 860-386-4071; DSN: 636-7071  
saocl@ct-arng.ngb.army.mil

Connecticut Army National Guard  
Army Aviation Support Facility  
Building 152  
Bradley Int'l Airport  
Windsor Locks, CT 06096-1086  
\*Update not provided this year.  
AASFC: LTC Mark H. Rousseau  
ATTN: CTNG-ASF-CDR  
C: 860-386-4072; DSN: 636-8728  
mrousseau@worldnet.att.net

### D. C. Washington

121st Medical Company (AA)  
DC ARNG  
2001 E. Capitol Street  
Washington, DC 20003-1719

Office, Directorate for Defense  
Research & Engineering (ODDR&E)  
3080 Defense Pentagon  
Washington, DC 20301-3080

Office of the Chairman of the Joint  
Chiefs of Staff  
9999 JCS Pentagon  
Washington, DC 20318-9999



Chairman of the  
Joint Chiefs of  
Staff:  
GEN Henry H.  
Shelton, USA  
Room 2E872  
C: 703-697-9121  
DSN: 227-9121

Office of the Chief of Staff, U. S.  
Army  
200 Army Pentagon  
Washington, DC 20310-0200



Chief of Staff:  
GEN Eric K. Shinseki  
ATTN: DACS-ZA,  
Room 3E668  
C: 703-695-2077  
DSN: 225-2077

Vice Chief of Staff: GEN John M.  
Keane  
ATTN: DACS-ZB, Room 3E666  
C: 703-695-4371; DSN: 225-4371  
vcsa@us.army.mil  
Assistant Vice Chief of Staff: LTG  
Kevin P. Byrnes  
ATTN: DACS-ZC, Room 3E661  
C: 703-697-8232; DSN: 227-8232  
heebndk@hqda.army.mil

Aviation Staff Officer  
HQ, Department of the Army  
200 Army Pentagon  
Washington, DC 20310-0200

Requirements Directorate, ADCSOPS  
for Force Development, ODCSOPS  
460 Army Pentagon  
Washington, DC 20310-0460



Director of  
Requirements:  
BG Craig D. Hackett  
ATTN: DAMO-FDZ  
C: 703-695-3611  
DSN: 225-3611  
hackedc@hqda.  
army.mil



# THE GUARDIAN SHIP

For forty-two years, Gulfstream has served more than 30 world governments, countless military and scientific missions around the world, nearly half of all FORTUNE 500® companies and a host of prominent individuals. In that time, we have come to understand and appreciate the rigors of leadership – its challenges and its requirements. If you are a decision-maker in government, business or military operations, only a Gulfstream can provide you with legendary safety, reliability, comfort and performance. Perhaps now is the best time to experience The Guardian Ship. Gulfstream – the special-missions aircraft of choice for world leaders since 1958.

To learn more, call Buddy Sams, Vice President, Government Sales and Marketing, at (703) 276-9500 (buddy.sams@gulfaero.com) or visit us at [www.gulfstream.com](http://www.gulfstream.com).

THE WORLD STANDARD.™

**Gulfstream**  
A GENERAL DYNAMICS COMPANY



**Army Aviation Division, ODCSOPS**  
 ATTN: DAMO-FDV  
 400 Army Pentagon  
 Washington, DC 20310-0400  
**Division Chief:** COL Reed Kowalczyk  
 C: 703-695-7415; DSN: 225-7415  
 reed.kowalczyk@hqda.army.mil  
**Executive Officer:** MAJ James Ash  
 C: 703-614-2065; DSN: 224-2065  
 james.ash@hqda.army.mil  
**Comanche/Kiowa Warrior:** LTC Robert Kenneally  
 C: 703-693-4516; DSN: 223-4516  
 robert.kenneally@hqda.army.mil  
**Apache/Cobra/Missiles:** LTC Thomas Devine  
 C: 703-614-2360; DSN: 224-2360  
 thomas.devine@hqda.army.mil  
**Black Hawk:** LTC Mike Moody  
 C: 703-695-8731; DSN: 225-8731  
 michael.moody@hqda.army.mil  
**Of:** MAJ Paul Kelly  
 C: 703-695-7443; DSN: 225-7443  
 paul.kelly@hqda.army.mil  
**ATC/Avionics:** Mr. John Marksteiner  
 C: 703-695-7410; DSN: 225-7410  
 john.marksteiner@hqda.army.mil  
**Chinook:** Mr. Dave Heaton  
 C: 703-697-2277; DSN: 227-2277  
 david.heaton@hqda.army.mil  
**Fixed Wing:** Mr. Rick Compton  
 C: 703-697-9667; DSN: 227-9667  
 richard.compton@hqda.army.mil  
**Secretary:** Ms. Sheila Page  
 C: 703-697-9666; DSN: 227-9666  
 sheila.page@hqda.army.mil

**Aviation Logistics Division, ODC-SLOG, HQDA**  
 500 Army Pentagon  
 Washington, DC 20310-0500  
**Chief:** COL Kerry M. Brown  
 ATTN: DALO-AMV,1E572  
 C: 703-697-0487; DSN: 227-0487  
 kerry.brown@hqda.army.mil  
**Secretary:** Mrs. Charmaine E. Kennedy  
 ATTN: DALO-AMV,1E572  
 C: 703-697-0487; DSN: 227-0487  
 charmaine.kennedy@hqda.army.mil  
**Aviation Logistics Management Specialist:** Mr. Wayne C. Kabat  
 ATTN: DALO-AMV, 1E572  
 C: 703-697-0487; DSN: 227-0487  
 wayne.kabat@hqda.army.mil  
**Aviation Weapons Systems Logistics Officer:** LTC John E. James  
 ATTN: DALO-AMV, 1E572  
 C: 703-697-0487; DSN: 227-0487  
 john.james@hqda.army.mil  
**Aviation Weapons Systems Officer:** MAJ Deborah L. Snyder  
 ATTN: DALO-AMV,1E572  
 C: 703-697-0487; DSN: 227-0487  
 deborah.snyder@hqda.army.mil

**Plans Division, ODCSPER**  
 300 Army Pentagon  
 Washington, DC 20310-0300  
 \*Update not provided this year.  
**Aviation Personnel Systems Staff Officer:** LTC Alva L. Pace  
 Room 2B673, ATTN: DAPE-PRP-CA  
 C: 703-697-5884; DSN: 227-5884  
 alva.pace@hqda.army.mil

**Office of the Chief of Army Reserve (OCAR)**  
 2400 Army Pentagon  
 Washington, DC 20310-2400  
**Executive Officer:** COL D. P. Tackett  
 ATTN: DAAR-ZX  
 C: 703-695-0042; DSN: 225-0042  
 tackett@ocar.army.pentagon.mil

**Operations, Readiness & Force Development Division, OCAR**  
 The Pentagon  
 Washington, DC 20310-2400  
 \*Update not provided this year.  
**Aviation Officer:** MAJ David E. LeBlanc  
 ATTN: DAAR-FD  
 C: 703-601-0642; DSN: 329-0642  
 leblanc@ocar.army.pentagon.mil  
**Aviation Force Integrator:** MAJ David E. LeBlanc  
 ATTN: DAAR-FD  
 C: 703-601-0642; DSN: 329-0642  
 leblanc@ocar.army.pentagon.mil

**Office, Commanding General, District of Columbia National Guard**  
 2001 East Capitol Street  
 Washington, DC 20003-1719



**TAG:**  
 MG Warren L. Freeman  
 DCNG-CG  
 C: 202-685-9798  
 DSN: 325-9798  
 lagdc@dc-armg.ngb.army.mil

**Office, Director of Army Safety**  
 The Pentagon  
 Washington, DC 20310  
**Deputy Director:** LTC Kevin Connors  
 ATTN: DACS-SF, Room 3D263  
 C: 703-695-7291; DSN: 225-7291

### DELAWARE New Castle

**Office, State Army Aviation Officer, Delaware Army National Guard Aviation Support Facility**  
 33 Corporate Circle  
 New Castle, DE 19720-2493  
**SAAO/AASFC:** COL David R. Ham  
 C: 302-326-7200; DSN: 440-7200  
 hamd@de-smtp.ngb.army.mil

### Wilmington

**Office, State Adjutant General, Delaware Army National Guard**  
 First Regiment Road  
 Wilmington, DE 19808-2191  
 \*Update not provided this year.  
**TAG:** MG Francis D. Vavala  
 ATTN: DE-TAG  
 C: 302-326-7001; DSN: 440-7001

### FLORIDA Eglin Air Force Base

**Army Reprogramming Analysis Team - Threat Analysis (ARAT-TA)**  
 PO Box 2012  
 Eglin Air Force Base, FL 32542-2012  
 \*Update not provided this year.  
**Team Chief:** Mr. Norman Svarrer  
 ATTN: ARAT-TA  
 C: 850-882-8899; DSN: 872-8899  
 svarrer@eglin.af.mil  
**Administrative Assistant:** Ms. Jane Lambeth  
 ATTN: ARAT-TA  
 C: 850-882-8899; DSN: 872-8899  
 lambeth@eglin.af.mil

**EW Engineer, APR-39 RSDS Section:**  
 Mr. Larry Johnson  
 ATTN: ARAT-TA  
 C: 850-872-8899; DSN: 872-8899  
 johnsol@eglin.af.mil  
**Principle Analyst, APR-39 RSDS Section:** Mr. Pete McGrew  
 ATTN: ARAT-TA  
 C: 850-882-8899; DSN: 872-8899  
 mcgrewp@eglin.af.mil  
**Systems Analyst, APR-39 Series RSDS Section:** Mr. Jim Harrison  
 ATTN: ARAT-TA  
 C: 850-882-8899; DSN: 872-8899  
 harrisjw@eglin.af.mil  
**Intelligence Analyst, APR-39 Series RSDS Section:** Mr. Roy Williams  
 ATTN: ARAT-TA  
 C: 850-882-8899; DSN: 872-8899  
 williaro@eglin.af.mil

**EW Engineer, Jammer Section & LONGBOW APR-48A:** Mr. Jim Coots  
 ATTN: ARAT-TA  
 C: 850-882-8899; DSN: 872-8919  
 cootssj@eglin.af.mil  
**Signal Analyst, Jammer Section:**  
 SFC Niccolle Lux  
 ATTN: ARAT-TA  
 C: 850-882-8899; DSN: 872-8919  
 luxnicc@eglin.af.mil  
**Signal Analyst, LONGBOW APR-48A:**  
 SSG Bill Clark  
 ATTN: ARAT-TA  
 C: 850-882-8899; DSN: 872-8919  
**Computer Specialist, Multiserve Electronic BBS:** Mr. Bob Hankins  
 ATTN: ARAT-TA-BBS  
 C: 850-882-2166; DSN: 872-2166  
 hankinsr@eglin.af.mil

### Lakeland

**Florida Army National Guard Army Aviation Support Facility #2**  
 3600 Drane Field Road  
 Lakeland, FL 33811-1278  
**AASFC:** MAJ Lewis M. Hersey  
 ATTN: AASF #2  
 C: 941-548-3220  
 herseyj@fl-armg.ngb.army.mil

### MacDill Air Force Base

**U.S. Special Operations Command (SOCOM)**  
 7701 Tampa Point Boulevard  
 MacDill Air Force Base, FL 33621-5323



**Executive Officer:**  
 COL Howard Yellen  
 C: 813-828-5102  
 yellen@socom.mil

### Orlando

**U.S. Army Simulation, Training & Instrumentation Cmd. (STRICOM)**  
 12350 Research Parkway  
 Orlando, FL 32826-3276



**Commanding General:** BG(P) William L. Bond  
 ATTN: AMSTI-CG  
 C: 407-384-3501; DSN: 970-3501  
 bondw@stricom.army.mil

**Deputy Commander:** Mr. James M. Skurka  
 ATTN: AMSTI-DC  
 C: 407-384-3502; DSN: 970-3502  
 skurkaj@stricom.army.mil

**Project Manager, Training Devices (TRADE), STRICOM**  
 12350 Research Parkway  
 Orlando, FL 32826-3276



**Project Manager:**  
 COL Craig B. Hanford  
 ATTN: AMSTI-PMTRADE  
 C: 407-384-5200  
 DSN: 970-5200  
 craig\_hanford@stricom.army.mil

**Product Manager, Live Training Systems (LTS), STRICOM**  
 12350 Research Parkway  
 Orlando, FL 32826-3276  
 \*Update not provided this year.

**Product Manager:** LTC Clovis Gault  
 ATTN: AMCPM-CSTS  
 C: 407-384-5191; DSN: 97051911  
 Chuck.Gault@stricom.army.mil

**PM, Combat Training Instrumentation Systems (CTIS), STRICOM**  
 12350 Research Parkway  
 Orlando, FL 32826-3276



**Product Manager:**  
 Mr. Sam Jones  
 ATTN: AMSTI-PM-CTIS  
 C: 407-384-5186  
 DSN: 970-5186  
 samuel\_jones@stricom.army.mil

**PM, Warfighters' Simulation (WAR-SIM), STRICOM**  
 12350 Research Parkway  
 Orlando, FL 32826-3276  
**Project Manager:** COL Charles R. Ball  
 ATTN: AMSTI-PMWARSIM  
 C: 407-384-3650; DSN: 970-3650  
 Charles\_Ball@STRICOM.army.mil

**PM, Instrumentation, Targets & Threat Simulators (ITTS), STRICOM**  
 12350 Research Parkway  
 Orlando, FL 32826-3276  
**Project Manager:** COL Mark W. Russell  
 ATTN: AMCPM-ITTS  
 C: 407-384-5250; DSN: 970-5250  
 russellm@stricom.army.mil

**Project Manager, Combined Arms Tactical Trainer (CATT), STRICOM**  
 12350 Research Parkway  
 Orlando, FL 32826-3276  
**Project Manager:** COL Wellsford Barlow, Jr.  
 ATTN: AMSTI-PMCATT  
 C: 407-384-3600; DSN: 970-3600  
 wellsford\_barlow@stricom.army.mil

**Product Manager, Ground Combat Tactical Trainers (GCTT), STRICOM**  
 12350 Research Parkway  
 Orlando, FL 32826-3276  
**Product Manager:** LTC Francis Fierko  
 ATTN: AMSTI-GCTT  
 C: 407-384-5160; DSN: 970-5160  
 Francis\_Fierko@stricom.army.mil

# Sometimes it's training...

# Sometimes it's not...

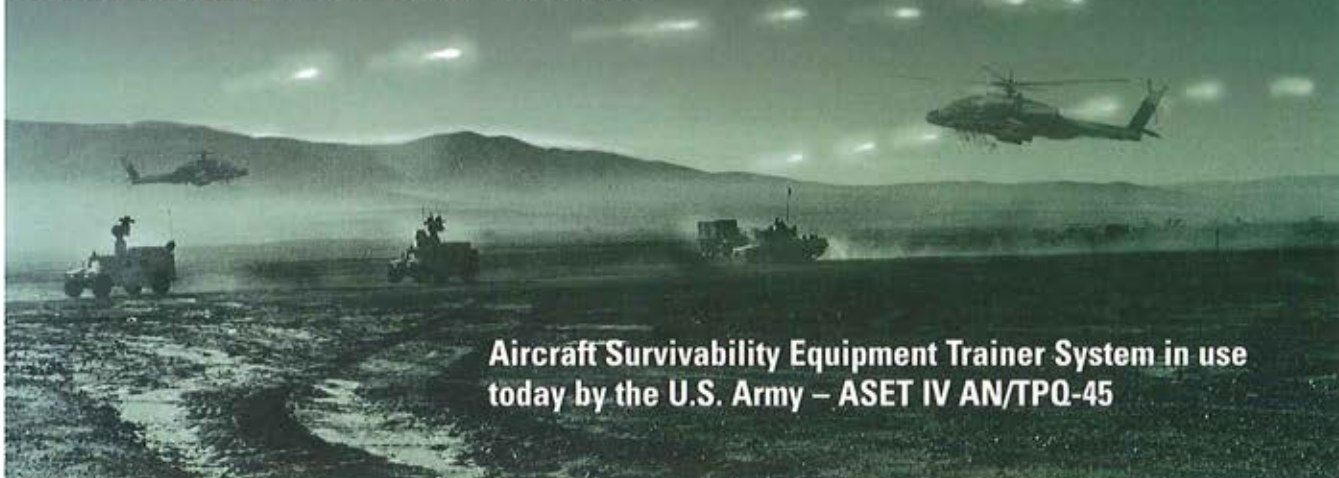

Aircraft Survivability Equipment Trainer System in use today by the U.S. Army – ASET IV AN/TPQ-45

Sierra's air defense threat emitter training systems provide the most positive pilot proficiency training experience for today's lethal ground elements. ASET features day and night tactics, force-on-force engagements, simulated weapons effects, laser scoring and more.

**SR**  
**Sierra Research**

an Integrated Defense Technologies company

485 Cayuga Rd • Buffalo, New York 14225 • (716) 631-6018  
www.stisierra.com • email: ewsales@stisierra.com  
ISO 9001 Certified

AD-4749a

## The *Ultimate* Simulation

# AWSS

## Area Weapons Scoring System

Live Fire Training

Day & Night Operations

Transparent to Training

[www.meggitt-ce.com](http://www.meggitt-ce.com)



**CARTWRIGHT  
ELECTRONICS**

655 West Valencia Drive  
Fullerton, CA 92832-2104  
Phone: (714) 525 2300

Objective Precision Scoring

Battery Powered

Portable

Product Manager, Air & Command Tactical Training (ACTT)  
12350 Research Parkway  
Orlando, FL 32826-3276  
Product Manager: LTC Ronald Dixon  
ATTN: ACTT  
C: 407-384-5140; DSN: 970-5140  
roland\_dixon@stricom.army.mil

### St. Augustine

Office, State Adjutant General,  
Florida Army National Guard  
P. O. Box 1008  
St. Augustine, FL 32085-1008



TAG:MG Ronald O. Harrison  
C: 904-823-0100  
DSN: 860-7100  
harrisonr@fl-arng.army.mil

Office, State Army Aviation Officer,  
Florida Army National Guard  
Department of Military Affairs  
State Aviation Officer  
P.O. Box 1008  
St. Augustine, FL 32085-1008



SAAO:  
LTC Matthew D. Hoffman  
ATTN: SAAO  
C: 904-823-0475  
DSN: 860-7475  
saofi@fl-arng.ngb.army.mil

### GEORGIA Atlanta

Office, State Adjutant General,  
Georgia Army National Guard  
P. O. Box 17965  
Atlanta, GA 30316-0965



TAG:  
MG David B. Poythress  
ATTN: GA DOD/TAG  
C: 404-624-6001  
DSN: 338-6001  
tagga@ga-arng.ngb.army.mil

### Dobbins Air Force Base

Georgia Army National Guard Army  
Aviation Support Facility #2  
900 Atlantic Avenue, Bldg 555  
Dobbins Air Force Base, GA 30069-4305  
\*Update not provided this year.  
AASFC: CW5 Rickie L. Barron  
ATTN: AASF #2  
C: 770-919-3443; DSN: 925-3443

### Ellenwood

Office, State Army Aviation Officer,  
Georgia Army National Guard  
Dept of Defense, Military Div.  
P.O. Box 746  
Ellenwood, GA 30294-0746



SAAO:  
COL Dannis E. Livingston  
ATTN: DCS-AVN  
C: 770-919-4790  
DSN: 925-4790  
saoga@ga-arng.ngb.army.mil

### Forest Park

Commander  
First United States Army  
ATTN: AFKA-CG  
4705 N. Wheeler Drive  
Forest Park, GA 30297-5000



Commanding General:  
LTG Johnny M. Riggs  
ATTN: AFKA-CG  
C: 404-362-7281  
DSN: 797-7281  
John.Riggs@gillem-emh1.army.mil

Aviation Branch, Tng. Spt. Mgt. & Ex.  
Div., DCS, First U.S. Army  
4705 N. Wheeler Drive  
Forest Park, GA 30297-5000  
\*Update not provided this year.



Chief:  
MAJ George A. Amonette  
C: 404-362-7733  
DSN: 797-7733  
amonetg@gillem-emh1.army.mil

Senior Army Aviation Officer: LTC  
Chuck Ladd  
C: 404-363-5299; DSN: 797-5299  
NCOIC: Master Sergeant Stephen  
Moody  
C: 404-362-7358; DSN: 797-7358

### Fort Benning

U.S. Army Infantry School, Aviation  
Division  
Directorate of Operations &  
Training  
Fort Benning, GA 31905

### Fort McPherson

Aviation Division, ODCSOPS, USARC  
1401 Deshler St. SW  
Fort McPherson, GA 30330



Chief:  
LTC Charles O. Koons  
ATTN: AFRC-OPA  
C: 404-464-8314  
DSN: 367-8314  
koonscha@usarc-emh2.army.mil

Aviation Division, Directorate of  
Operations, DCSOPS, FORSCOM  
1777 Hardee Avenue SW  
Fort McPherson, GA 30330-1062  
Chief: COL Neal C. Petree, III  
ATTN: AFOP-AV  
C: 404-464-6085; DSN: 367-6085  
neal.petree@forscom.army.mil

Air Traffic Control Specialist: Mr.  
Martin B. Hammell  
ATTN: AFOP-AV  
C: 404-464-6047; DSN: 367-6047  
hammellb@formscom.army.mil  
Chief, Arms TM 1: LTC Robert W.  
Karpiak  
ATTN: AFOP-AV  
C: 404-464-6065; DSN: 367-6065  
karpiakrobert@forscom.army.mil  
Operations Officer: MAJ Larry Rood  
ATTN: AFOP-AV  
C: 404-464-5076; DSN: 367-5076  
roodl@forscom.army.mil  
Chief, Arms TM 2: LTC James  
Mulvehill  
ATTN: AFOP-AV  
C: 404-464-6055; DSN: 367-6055  
james.mulvehill@forscom.army.mil  
Chief, Arms TM 3: LTC Charles Miller  
ATTN: AFOP-AV  
C: 404-464-5087; DSN: 367-5087  
millerccr@forscom.army.mil

### Hunter Army Airfield

224th Military Intelligence Battalion  
(Aerial Exploitation)  
357 S. Lightning Rd., Ste. 101  
Hunter Army Airfield, GA 31409-5628



Commander:  
LTC Brad C. Hildreth  
ATTN: AFZA-MI-GCDR  
C: 912-352-6126  
DSN: 971-6126  
hildrethbc@emh5.stewart.army.mil

Executive Officer: MAJ Tony Taylor  
ATTN: AFZA-MI-G-XO  
C: 912-352-6980; DSN: 971-6980  
taylorad@emh5.stewart.army.mil  
ASO: CW5 David A. Coates  
ATTN: AFZA-MI-G-ASO  
C: 912-352-6399; DSN: 971-6399  
coatesd@emh5.stewart.army.mil



Senior NCO:  
CSM Domenic Romanello  
ATTN: AFZA-MI-G-CSM  
C: 912-352-5702  
DSN: 971-5702  
romanellod@emh5.stewart.army.mil

3d Battalion, 160th Special Opns.  
Aviation Regiment (Airborne)  
Hunter Army Airfield, GA 31409-5202  
Commander: LTC Michael Rose  
ATTN: AOAV-T-CD  
C: 912-352-6826; DSN: 971-6826  
rosem@soar.army.mil

Executive Officer: MAJ Dan Boonie  
ATTN: AOAV-T-XO  
C: 912-352-8850; DSN: 971-6944  
boonied@soar.army.mil  
SIP: CW3 Glenn Joyner  
ATTN: AOAV-T-SIP  
C: 912-352-5669; DSN: 971-5096  
joynerg@soar.army.mil  
ASO: CW4 Guy Soper  
ATTN: AOAV-T-OS  
C: 912-352-5872; DSN: 971-5096  
soperg@soar.army.mil  
Senior NCO: CSM Richard Frye  
ATTN: AOAV-T-SM  
C: 912-352-6645; DSN: 971-6645  
fryer@soar.army.mil

Aviation Brigade, 3rd Infantry  
Division  
Hunter Army Airfield, GA 31409-5100  
Commander: COL H. T.  
Landwehrmeyer, Jr.  
ATTN: AFZP-VX-C  
C: 912-352-6732; DSN: 971-6732  
LandwehrmeyerHT@emh5.stewart.army.mil  
Executive Officer: MAJ James Kenney  
ATTN: AFZP-VX-X  
C: 912-352-6983; DSN: 971-6983  
KenneyJ@emh5.stewart.army.mil  
ASO: CW4 Randall Miller  
ATTN: AFZP-VX-SA  
C: 912-352-5940; DSN: 971-5940  
MillerRR@emh5.stewart.army.mil  
MTEF: CW5 Gale Zirpolo  
ATTN: AFZP-VX-L  
C: 912-352-5529; DSN: 971-5529  
ZirpoloGE@emh5.stewart.army.mil  
Senior NCO: CSM Carlos Cueto  
ATTN: AFZP-VX-CSM  
C: 912-352-6132; DSN: 971-6132  
CuetoC@emh5.stewart.army.mil

1st Attack Helicopter Battalion, 3rd  
Aviation Regiment  
Aviation Brigade  
3rd Infantry Division (Mech)  
Hunter Army Airfield, GA 31409  
Commander: LTC Mark T. Jones  
ATTN: AFZP-VXB-C  
C: 912-352-5668; DSN: 971-5668  
JONESMT@EMH5.STEWART.ARMY.MIL  
Executive Officer: MAJ Ronald D.  
Jones  
ATTN: AFZP-VXB-XO  
C: 912-352-6741; DSN: 971-6741  
JONESRD2@EMH5.STEWART.ARMY.MIL  
SIP: CW4 Billy Sullivan  
ATTN: AFZP-VXB-SIP  
C: 912-352-6677; DSN: 971-6070  
SULLIVANB@EMH5.STEWART.ARMY.MIL  
ASO: CW3 Brian Hakanson  
ATTN: AFZP-VXB-ASO  
C: 912-352-6677; DSN: 971-6677  
HAKANSONBD@EMH5.STEWART.ARMY.MIL  
MTEF: CW4 William S. Goforth  
ATTN: AFZP-VXB-D  
C: 912-352-5169; DSN: 971-5169  
GOFORTHW@EMH5.STEWART.ARMY.MIL  
Senior NCO: CSM Tim Johnston  
ATTN: AFZP-VXB-CSM  
C: 912-352-6960; DSN: 971-6960

2d Battalion, 3d Aviation Regiment  
Aviation Brigade  
3d Infantry Division (Mech)  
Hunter Army Airfield, GA 31409  
Commander: LTC Gary M. Servold  
ATTN: AFZP-VXE-C  
C: 912-352-6190; DSN: 971-6190  
ServoldGM@emh5.stewart.army.mil  
Executive Officer: MAJ Richard Turner  
ATTN: AFZP-VXE-X  
C: 912-352-5107; DSN: 971-5107  
TurnerRJ@emh5.stewart.army.mil  
SIP: CW4 Scott Giacobbe  
ATTN: AFZP-VXB-SIP  
C: 912-352-5959; DSN: 971-5959  
ASO: CW3 Carlos Gonzalez  
ATTN: AFZP-VXE-ASO  
C: 912-352-6301; DSN: 971-6301  
AMC: CPT Craig Demby  
ATTN: AFZP-VXE-AMO  
C: 912-352-5676; DSN: 971-5676

# What do these platforms have in common?



## A path to lower O&S costs, increased mission readiness, and enhanced safety through use of the BFGoodrich\* IMD-HUMS.

The BFGoodrich next generation Dual-Use Integrated Mechanical Diagnostics-Health and Usage Management System (IMD-HUMS) has been selected for the S76 and S92 civil helicopters, the US Navy SH-60 and CH-60 fleet, the USMC/USN CH-53E Superstallion fleet, the USMC Bell AH-1Z and UH-1Y Upgrades, and the US Army UH-60 Blackhawk.

The BFGoodrich solution is different...find out why by contacting:

**BFGoodrich**  
Aerospace  
Fuel and Utility Systems

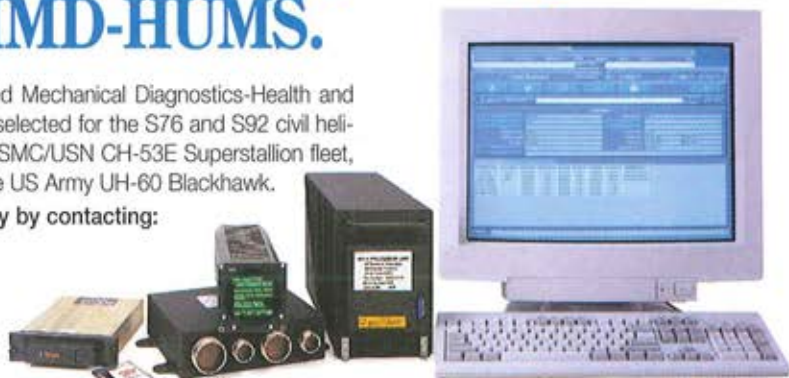

100 Pantan Road, Vergennes, VT 05491, USA • Telephone 802-877-2911 • Fax 802-877-4113  
54 Middlesex Turnpike, Bedford, MA 01730 USA • Telephone 781-275-4545 • Fax 781-275-5035

\*Vibro-Meter, (a Meggitt Company), is a partner of BFGoodrich Aerospace in the IMD-HUMS development, deployment and support.

Senior NCO: CSM Daryl Lusk  
ATTN: AFZP-VXE-CSM  
C: 912-352-5849; DSN: 971-5849

3rd Squadron, 7th Cavalry  
Aviation Brigade  
3rd Infantry Division (Mech)  
Hunter Army Airfield, GA 31409



Commander:  
LTC Douglas J.  
Morrison  
ATTN: AFZP-VDC-P  
C: 912-767-7420  
morrisonjd@emh5.  
stewart.army.mil

Executive Officer: MAJ Steven J. Pinette  
ATTN: AFZP-VDC-P  
C: 912-767-7427  
Stephen.Pinette@stewart.army.mil  
SIP: CW4 Frank Paul  
ATTN: AFZP-VDC-SIP  
C: 912-767-7420  
ASO: CW4 Allen Stern  
ATTN: AFZP-VDC-SO  
C: 912-767-4902  
Senior NCO: CSM Horris L. Frazier  
C: 912-767-7428  
Horris.Frazier@stewart.army.mil

603d Aviation Support Battalion  
DISCOM

3rd Infantry Division (MECH)  
Hunter Army Airfield, GA 31409



Commander:  
LTC Thomas K.  
Gainey  
ATTN: AFZP-VSB-C  
C: 912-353-2411;  
DSN: 971-2411  
gainey@stewart.  
army.mil

Executive Officer:

MAJ Jersen Ortiz  
ATTN: AFZP-VSB-X  
C: 912-353-2670; DSN: 971-2411  
ortiz@stewart.army.mil

ASO: CPT Kevin MacKenzie  
ATTN: AFZP-VSB-S  
C: 912-353-2779; DSN: 971-2779  
mckenziekc@stewart.army.mil

A Company Commander: MAJ Judd Reynolds

ATTN: AFZP-VSB-FC  
C: 912-353-2781; DSN: 971-2781  
reynoldsje@stewart.army.mil

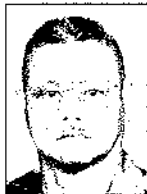

Senior NCO:  
CSM Alfred Sayama  
ATTN: AFZ-VSB-  
CSM  
C: 912-353-2620  
DSN: 971-2620  
sayamaac@  
stewart.army.mil

3rd Infantry Division, Directorate of  
Readiness  
Hunter Army Airfield, GA 31314  
\*Update not provided this year.  
Director of Readiness: LTC John A.  
Lewis

ATTN: AFZP-DR  
C: 912-767-8361; DSN: 870-8361  
lewisj@emh5.stewart.army.mil

Chief, Aviation Division: Mr. Steven  
W. Lindsey

ATTN: AFZP-DRA  
C: 912-352-5656; DSN: 971-5656  
lindseyw@emh5.stewart.army.mil

## Savannah

Georgia Army National Guard Army  
Aviation Support Facility #3  
P. O. Box 23617  
Savannah, GA 31403-3617  
AASFC: MAJ Stephen E. Joyce  
C: 912-352-5532; DSN: 971-5532  
CH-47ME: CW3 Jeff Hutchinson  
C: 353-0564; DSN: 971-2564  
CH-47 SPIE/ASO: CW4 Jack Johnson  
C: 912-352-5787

## Winder

Georgia Army National Guard Army  
Aviation Support Facility #1  
P. O. Box 545  
Winder, GA 30680-0545  
AASFC: MAJ Anthony Sutter  
ATTN: AASF#1  
C: 770-867-6214; DSN: 338-6180  
Safety Officer/IFE: CW3 Tom Golden  
ATTN: AASF#1  
C: 770-867-6214; DSN: 338-6180  
MTP/IME: CW2 Blake Hausler  
ATTN: AASF#1  
C: 770-867-6214; DSN: 338-6180

## HAWAII Fort Shafter

U.S. Army Pacific (USARPAC), ODC-  
SOPS Aviation Division  
Fort Shafter, HI 96858-5100

\*Update not provided this year.  
Chief, Training and Aviation Division:

LTC James Coates  
ATTN: APOP-TR  
C: 808-438-7680; DSN: 438-7680  
coatesj@shafter-emh3.army.mil  
Chief, Aviation Branch: Mr. Fred L.  
McCollum

ATTN: APOP-TR-AV  
C: 808-438-1081; DSN: 438-1081  
mccollu2@shafter-emh3.army.mil

## Hilo

Hawaii Army National Guard Limited  
Army Avn. Support Facility  
1046 Leilani Street  
Hilo, HI 96720-4595

\*Update not provided this year.  
AASFC: MAJ Benedict L. Fuata  
ATTN: HIARAV-SF2  
C: 808-933-0942

## Honolulu

Office, State Adjutant General,  
Hawaii Army National Guard  
3949 Diamond Head Road  
Honolulu, HI 96816-4495  
\*Update not provided this year.



TAG:  
MG Edward V.  
Richardson  
ATTN: HITAG  
C: 808-733-4246  
erichardson@  
hthik.ang.af.mil

## Schofield Barracks

325th Forward Support Battalion  
Schofield Barracks, HI 96857

G Company, 58th Aviation Regiment  
(ATS)

Bldg. 102, Room 112  
Schofield Barracks, HI 96857-6063  
Commander: CPT David G. Limberg  
ATTN: APVG-YZG-CO  
C: 808-656-0996; DSN: 456-0996  
cogavn@schofield-emh1.army.mil  
Senior NCO: 1SG Roland D. Wright  
ATTN: APVG-YZG-1SG  
C: 808-656-5698; DSN: 456-5698  
g581sg@schofield-emh1.army.mil

## Wheeler Army Airfield

25th Infantry Division (Light) Aviation  
Brigade

Wheeler Army Airfield, HI 96854-6000  
Commander: COL Doyle D. Broome, Jr.  
ATTN: APVG-YZB-CO  
C: 808-656-2741; DSN: 456-2741  
BroomeDD@schofield.army.mil  
Exec. Officer: MAJ David M. Wyrick  
ATTN: APVG-YZB-XO  
C: 808-656-2740; DSN: 456-2740  
David.Wyrick@schofield.army.mil  
SIP: CW5 John Sparkman  
ATTN: APVG-YZB-SIP  
C: 808-656-7740; DSN: 456-7740  
John.Sparkman@schofield.army.mil

ASO: CW5 Dale Miller  
ATTN: APVG-YZB-ASO  
C: 808-656-1287; DSN: 456-1287  
Dale.Miller@schofield.army.mil

MTFE: CW5 Richard Fry  
ATTN: APVG-YZB-AMO  
C: 808-656-2195; DSN: 456-2195  
Richard.Fry@schofield.army.mil

Senior NCO: CSM Walter Hardy  
ATTN: APVG-YZB-CSM  
C: 808-656-2742; DSN: 456-2742  
Walter.Hardy@schofield.army.mil

1st Battalion, 25th Aviation Regiment  
Aviation Brigade, 25th ID (L)  
Wheeler Army Airfield, HI 96854-6000



Commander:  
LTC Joseph E.  
Thome, Jr.  
ATTN: APVG-YZD-  
CO  
C: 808-656-4540  
DSN: 456-4540  
ThomeJE@schofield.  
army.mil

Exec. Officer: MAJ Stanley D. Murrell  
ATTN: APVG-YZD  
C: 808-656-5330; DSN: 456-5330  
MurrellSD@schofield.army.mil

SIP: CW4 Rolf Giesler  
ATTN: APVG-YZD  
C: 808-656-4102; DSN: 456-5330  
GieslerRJ@schofield.army.mil  
ASO: CW3 William H. Keith  
ATTN: APVG-YZD  
C: 808-656-4102; DSN: 456-4102  
Senior NCO: CSM Richard F. Eads  
ATTN: APVG-YZD  
C: 808-656-0593; DSN: 456-0593

2nd Assault Helicopter Battalion,  
25th Aviation Regiment  
Aviation Brigade  
25th Infantry Division (Light)  
Wheeler Army Airfield, HI 96854



Commander:  
LTC Paul R. Disney, Jr.  
ATTN: APVG-YZJ-CO  
C: 808-656-0130  
DSN: 456-0130  
co225av@schofield.  
army.mil

Executive Officer: MAJ Kevin T. K.  
Sullivan

ATTN: APVG-YZJ-XO  
C: 808-656-2566; DSN: 456-2566  
225avxo@schofield.army.mil  
SIP: CW3 David K. Guarino  
ATTN: APVG-YZJ-SIP  
C: 808-656-2544; DSN: 456-2544  
225avbnsnds@schofield.army.mil  
ASO: CW4 George P. Perry  
ATTN: APVG-YZJ-ASO  
C: 808-656-2544; DSN: 456-2544  
225avsafety@schofield.army.mil  
MTFE: CW4 Carl R. Martin  
ATTN: APVG-YZJ-DCO-HHC  
C: 808-656-2533; DSN: 456-2550  
225avdgoic@schofield.army.mil



Senior NCO:  
CSM Kumarasiri  
Wjietlunga  
ATTN: APVG-YZJ-  
CSM  
C: 808-656-0330  
DSN: 456-0330  
csm25av@schofield-  
emh1.army.mil

3rd Squadron (Recon), 4th U.S. Cavalry  
Aviation Brigade

25th Infantry Division (Light)  
Wheeler Army Airfield, HI 96854

Commander: LTC Jeffrey T.  
Kappenman  
ATTN: APVG-YZF-CO  
C: 808-656-4060; DSN: 456-4060  
cocav@schofield.army.mil

Executive Officer: MAJ John M. Lynch  
ATTN: APVG-YZF-XO  
C: 808-656-5450; DSN: 456-4060  
xocav@schofield.army.mil

SIP: CW4 William M. Kelly  
ATTN: APVG-YZF-SIP  
C: 808-656-1147; DSN: 456-1147  
cavstands@schofield.army.mil

ASO: CW3 Donald S. Kistler  
ATTN: APVG-YZF-ASO  
C: 808-656-1147; DSN: 456-1147  
saftycav@schofield.army.mil

Senior NCO: CSM Kenneth C. Fyffe  
ATTN: APVG-YZF-CSM  
C: 808-656-5550; DSN: 455-5550  
csmcav@schofield.army.mil

C Company, 25th Aviation Regiment  
(AVIM)

Aviation Brigade  
25th Infantry Division (Light)

Wheeler Army Airfield, HI 96854  
Commander: MAJ David B. Parker  
ATTN: APVG-YZE-CO  
C: 808-656-2044; DSN: 456-2044  
parkerd@schofield.army.mil  
Senior NCO: 1SG Chad Coumo  
ATTN: APVG-YZE-CSM  
C: 808-656-7601; DSN: 456-7601

Office, State Army Aviation Officer,  
Hawaii Army National Guard  
Building 829

Wheeler Army Airfield, HI 96854-5110  
SAAO: COL Orlan L. Peterson, Jr.  
ATTN: HIARAV  
C: 808-656-2716  
saohi@hi-arng.ngb.army.mil

# For pressure, level, or debris sensing...

Tedeco

Bethel



Chip Collectors

CHIP  
DETECTORS

PRESSURE  
TRANSDUCERS



LIQUID  
LEVEL  
SENSORS

Pressure Switches



## Eaton Aerospace

Engineered Sensors provides you with a "One Stop Solution" to your monitoring and measurement needs. Tedeco Products has been a leading manufacturer of lube system health monitoring equipment, fluid level indicators and gearbox accessories. And Bethel Products has been

manufacturing the finest pressure switches and pressure transducers for 40 years. Together, we offer unparalleled quality, dependability and service. So whether your application is Aerospace, Military, Marine or Industrial,...

**Eaton has the solution.**

### Engineered Sensors

Bethel Products  
15 Durant Avenue  
Bethel, CT 06801

Tedeco® Products  
24 E. Glenolden Avenue  
Glenolden, PA 19036

Tedeco® Products  
401 Minnetonka Road  
HiNella, NJ 08083

Tedeco® Products  
Larchwood Avenue, Bedhampton  
Hampshire PO93QN, England

TEL: 1-800-736-1557  
FAX: 1-203-796-6313

TEL: 610-522-4000  
FAX: 610-522-4900

TEL: 856-784-3030  
FAX: 856-784-0153

TEL: 44-2392-487251 (UK)  
FAX: 44-2392-492400 (UK)

Visit us at [www.aerospace.eaton.com](http://www.aerospace.eaton.com)

Hawaii Army National Guard Army  
Aviation Support Facility #1  
Building 829  
Wheeler Army Airfield, HI 96854-5110



**AASFC:**  
COL Gary M. Hara  
ATTN: HIARAV-SF1  
C: 808-656-2709  
haragm@hi-arng.  
ngb.army.mil

### IDAHO Boise

Office, State Adjutant General, Idaho  
Army National Guard  
4040 W. Guard Street  
Boise, ID 83705-5004



**TAG:**  
MG John F. Kane  
ATTN: IDCG  
C: 208-422-5242  
DSN: 422-5242  
kanej@bds.  
state.id.us

Office, State Army Aviation Officer,  
Idaho Army National Guard  
3448 Harvard S.  
Building 6559  
Boise, ID 83705-6512



**SAAO:**  
LTC Perry E. Barth  
ATTN: IDAV-Z  
C: 208-422-3972  
DSN: 422-3972  
saoid@id-  
arng.ngb.army.mil

Idaho Army National Guard  
Army Aviation Support Facility  
3315 Aeronca  
Building 1500  
Boise, ID 83705-8008  
\*Update not provided this year.

### ILLINOIS Chicago

Illinois Army National Guard Army  
Aviation Support Facility #2  
5400 West 63rd Street  
Chicago, IL 60638-5690  
\*Update not provided this year.  
**AASFC:** MAJ Kurt Kennard  
C: 312-735-7825; DSN: 735-7825

### Decatur

Illinois Army National Guard Army  
Aviation Support Facility #1  
660 Airport Road  
Decatur, IL 62521-8710  
\*Update not provided this year.  
**AASFC:** COL Michael Marvin  
ATTN: AASF#1  
C: 217-422-3687; DSN: 555-3618  
daasf-il@il-arng.ngb.army.mil

### Fort Sheridan

244th Aviation Brigade  
3155 Blackhawk Drive  
Suite 573  
Fort Sheridan, IL 60037-5000



**Commander:**  
COL Daniel J.  
McGraw  
ATTN: AFRC-AVIL-  
CO  
C: 920-727-7421  
dmcgraw@  
jkkeller.com

**Senior NCO:** CSM Eugene M.  
Simpson  
ATTN: AFRC-AVIL-CS  
C: 815-363-8934  
simpsonem@usarc-emh2.army.mil

### Peoria

Illinois Army National Guard Army  
Aviation Support Facility #3  
2323 South Airport Road  
Peoria, IL 61607-1497  
\*Update not provided this year.  
**AASFC:** MAJ Dean Espenschied  
C: 309-697-7900; DSN: 724-4040

### Springfield

Office, State Adjutant General,  
Illinois Army National Guard  
1301 N. MacArthur Boulevard  
Springfield, IL 62702-2399  
\*Update not provided this year.  
**TAG:** BG Richard G. Austin  
C: 217-785-3500; DSN: 555-3500

Office, State Army Aviation Officer,  
Illinois Army National Guard  
Office, The Adjutant General  
Camp Lincoln  
1301 N. MacArthur Boulevard  
Springfield, IL 62702-2399  
**SAAO:** LTC Michael A. Marvin  
ATTN: DMAIL-SA  
C: 217-761-3570  
DSN: 555-3570  
saocil@il-arng.ngb.army.mil

### INDIANA Indianapolis

Office, State Adjutant General,  
Indiana Army National Guard  
2002 South Holt Road  
Indianapolis, IN 46241-4839  
\*Update not provided this year.  
**TAG:** MG Robert J. Mitchell  
ATTN: MDI-AG  
C: 317-247-3279; DSN: 369-2279  
tagin@in-ngnet.army.mil

Office, State Army Aviation Officer,  
Indiana Army National Guard  
Military Dept. of Indiana  
Director of Army Aviation  
2002 South Holt Road  
Indianapolis, IN 46241-4839  
**SAAO:** MAJ Jim Dunn  
ATTN: MDI-AA  
C: 317-392-8201; DSN: 366-2201  
saoin@in-arng.ngb.army.mil

### Shelbyville

681st Medical Company (Air  
Ambulance)  
3556 N. Michigan Road  
Shelbyville, IN 46176-9414

Indiana Army National Guard Army  
Aviation Support Facility  
3556 N. Michigan Road  
Shelbyville, IN 46176-9414  
\*Update not provided this year.  
**AASFC/SAAO:** MAJ Jimmy R. Dunn  
ATTN: MDI-AA  
C: 317-392-8201; DSN: 366-2201  
dunnjr@in-arng.ngb.army.mil

### IOWA Boone

1st Battalion, 109th Aviation Rgt (AVIM)  
Iowa Army National Guard  
700 Snedden Drive  
Boone, IA 50036  
\*Update not provided this year.



**Commander:**  
LTC Bob J.  
Felderman  
C: 319-557-1465  
feldermanr@aol.com

**Senior NCO:** CSM Bob Heaps  
C: 515-252-4843  
heapsr@ia-arng.ngb.army.mil

Iowa Army National Guard Aviation  
Support Facility #1  
700 Corporal Roger Snedden Dr.  
Boone, IA 50036-5411  
\*Update not provided this year.  
**AASFC:** MAJ Russell E. Perry  
ATTN: AASF-BNW  
C: 515-432-6351; DSN: 946-2862

### Davenport

Iowa Army National Guard Army  
Aviation Support Facility #3  
9650 Harrison Street  
Davenport, IA 52804-9803  
\*Update not provided this year.  
**AASFC:** LTC Eddie L. Newman  
C: 319-391-3635; DSN: 793-4733

### Johnstown

Office, State Adjutant General, Iowa  
Army National Guard  
7700 N.W. Beaver Drive  
Johnstown, IA 50131-1902  
\*Update not provided this year.

**TAG:** BG Ron Dardis  
ATTN: AGIA-Z  
C: 515-252-4211; DSN: 946-2211  
tag@ia-arng.ngb.army.mil

Office, State Army Aviation Officer,  
Iowa Army National Guard  
The Adjutant General of Iowa  
Camp Dodge  
7700 N.W. Beaver Drive  
Johnstown, IA 50131-1902



**SAAO:**  
COL Lyle D. Bender  
ATTN: DIRAAVN  
C: 515-252-4376  
DSN: 946-2376  
saocia@ia-  
arng.ngb.army.mil

### Waterloo

Iowa Army National Guard Army  
Aviation Support Facility #2  
2245 West Big Rock Road  
Waterloo, IA 50703-9645  
**AASFC:** LTC Waller M. Salmon  
C: 319-234-1372; DSN: 946-2387  
waller.salmon@ia.ngb.army.mil

### KANSAS Fort Riley

166th Aviation Brigade  
Fort Riley, KS 66442  
\*Update not provided this year.  
**Commander:** COL George S. Webb  
ATTN: AFKB-TB-RC  
C: 785-239-2620; DSN: 856-2620  
webbg@riley-emh1.army.mil  
**SR. NCO:** CSM William Jolley  
ATTN: AFKB-TB-RC  
C: 785-239-3071; DSN: 856-3071  
jolleyw@riley-emh1.army.mil

### New Century

Aviation Support Facility Olathe  
21 Gardner Drive  
New Century, KS 66301-0020  
\*Update not provided this year.  
**Facility Supervisor:** Mr. Michael D.  
Walsh  
C: 913-782-1077; DSN: 552-7670  
mwatsh4061@aol.com

### Salina

Kansas Army National Guard Army  
Aviation Support Facility #2  
2917 Hein Street  
Salina, KS 67401-1737  
**Commander:** MAJ David A. Leger  
C: 785-822-3450; DSN: 720-8450  
david.leger@ks.ngb.army.mil

### Topeka

1st Battalion, 108th Aviation  
Regiment (Assault)  
P. O. Box 19086  
Forbes Field  
Topeka, KS 66619-0086



# The Phantom Warrior® is Here...

...aviators at Fort Campbell, Fort Rucker, and Hunter Army Airfield are becoming Phantom Warriors – *don't let your own crew be left out!*

You need our patented Phantom Map Lights and Phantom Warrior® Flashlights. Here are three reasons why:

## 1. The Phantom Lighting System is NVG Secure & Compatible

Using our lights in the cockpit alongside NVGs is no problem. Phantoms don't emit the light waves that blind the NVGs. And if you are on the ground, our lights won't make your position vulnerable to enemy eyes.



SOLDIER WITH PHANTOM FLASHLIGHT AS VIEWED THROUGH GENIII NVGS.



SOLDIER WITH RED-FILTERED MINI AA FLASHLIGHT AS VIEWED THOROUGH GENIII NVGS.

## 2. The Phantom Lighting System is Color Accurate

Try to read a map with a blue or green or red filtered light—and hope that nothing important is written in a color you can't see. Our Phantom lights look white to the naked eye so you see all of the colors on a map or chart clearly. This reduces the possibility of flying into an improper area due to navigator error. Your maintenance crews will be much better off trying to tell the difference between the different colors of fluids and wires with our Phantom White® light.



SOLDIERS WITH PHANTOM FLASHLIGHTS SEE ALL MAP COLORS CLEARLY.



SOLDIERS WITH FILTERED LIGHTS SUFFER DANGEROUS COLOR DISTORTION!

## 3. The Phantom Lighting System Saves Money

You have better things to do than replace old burned out incandescent bulbs every couple of hours (more often if they are exposed to shocks and vibrations.) Our bulbs are vibration and shockproof and have been jumped by our awesome U.S. Airborne troops—without failure. You probably won't ever have to replace them.

Our Phantom Warrior flashlights last for an average of 180 hours on one set of 4 AA batteries—that is right—180 hours! You can actually take "dead" AA batteries out of a competitors' flashlight and still get 10-20 more hours of light out of them. Now that is money savings!

Plus, our lights do not damage NVG tubes like other lights damage them—so you can use our lights right next to them and you won't have to spend money replacing burned out tubes.

Be a Phantom Warrior® or Become a TARGET!®

Phantom Products, Inc.

P.O. Box 5950, Virginia Beach, VA 23471  
888-533-4968 Fax: 888-533-5669

WWW.PHANTOMLIGHTS.COM

Commander: LTC Eric Peck  
C: 785-862-0774  
eric.peck@ks.ngb.army.mil  
Executive Officer: MAJ Dave Ledger  
C: 785-862-0774  
SIP: CW4 Robert Good  
C: 785-274-1727; DSN: 720-8717  
Senior NCO: CSM Alan J. Mueeting  
C: 785-274-1065; DSN: 720-8065

Office, State Adjutant General,  
Kansas Army National Guard  
2800 S.W. Topeka Boulevard  
Topeka, KS 66611-1287



TAG:  
MG Gregory C. Gardner  
ATTN: TAG-KS  
C: 913-274-1001  
DSN: 720-8001  
Greg.Gardner@ks.ngb.army.mil

Commander: LTC Eric C. Peck  
ATTN: AGKS-SAAO  
C: 785-274-1701; DSN: 720-8701  
Eric.Peck@ks.ngb.army.mil

Office, State Army Aviation Officer,  
Kansas Army National Guard  
2722 S.W. Topeka Boulevard  
P.O. BOX 19061  
Topeka, KS 66619-0061



SAAO:  
LTC Eric Peck  
ATTN: AGKS-AVN  
C: 913-274-1701  
DSN: 720-8701  
saoks@ks-arrng.ngb.army.mil

Kansas Army National Guard Army  
Aviation Support Facility #1  
P. O. Box 19061  
Topeka, KS 66619-0061  
Commander: CPT Kurt R. Bruggemeyer  
C: 785-274-1713; DSN: 720-8713  
Kurt.Bruggemeyer@ks.ngb.army.mil

## KENTUCKY Fort Campbell

160th Special Operations Aviation  
Regiment (Airborne)  
7277 Nightstalker Way  
Fort Campbell, KY 42223-5000  
Commander: COL Richard B. Bowman  
ATTN: AOAV-CD  
C: 270-798-1360; DSN: 635-1360  
bowmanr@soar.army.mil  
Deputy Cmdr: LTC Curtis D. Potts  
ATTN: AOAV-DC  
C: 270-798-1360; DSN: 635-1360  
pottsc@soar.army.mil  
Regiment Executive Officer: LTC Jay R. Jones  
ATTN: AOAV-XO  
C: 270-798-1360; DSN: 635-1360  
jonesj@soar.army.mil  
SIP: CW5 Steel Parsons  
ATTN: AOAV-SC  
C: 270-798-1761; DSN: 635-1761  
parsons@soar.army.mil  
ASO: CW5 Michael P. Kenny  
ATTN: AOAV-OS  
C: 270-798-1938; DSN: 635-1938  
kennym@soar.army.mil  
RAMO: CW5 Walter E. Riley  
ATTN: AOAV-SI  
C: 270-798-1966; DSN: 635-1966  
rileyw@soar.army.mil

SOATC Commander: MAJ Sidney J. Gray III  
ATTN: AOAV-ST  
C: 270-798-1729; DSN: 635-1729  
grays@soar.army.mil  
System Integration Management:  
MAJ(P) Gregory Stewart  
ATTN: AOAV-SM  
C: 270-798-1830; DSN: 635-1830  
stewartg@soar.army.mil



Senior NCO:  
CSM Donnie Calvery  
ATTN: AOAV-SM  
C: 270-798-1616  
DSN: 635-1616  
calverd@soar.army.mil

1st Battalion, 160th Special Opns.  
Aviation Regiment (Airborne)  
Fort Campbell, KY 42223-5000



Commander:  
LTC Kevin W. Mangum  
ATTN: AOAV-F-CD  
C: 270-798-1306  
DSN: 635-1306  
mangumk@soar.army.mil

Executive Officer: MAJ(P) Robert W. Werthman  
ATTN: AOAV-F-XO  
C: 270-798-1305; DSN: 635-1305  
werthmanb@soar.army.mil  
SIP: CW4 Roland San Gil  
ATTN: AOAV-F-SC  
C: 270-798-1335; DSN: 635-1335  
sangilr@soar.army.mil  
ASO: CW4 Gregory M. Gilman  
ATTN: AOAV-F-OS  
C: 270-798-1308; DSN: 635-1308  
gilman@soar.army.mil  
Command Sergeant Major: CSM Buford Thomas  
ATTN: AOAV-F-SM  
C: 270-798-1307; DSN: 635-1307  
thomasb@soar.army.mil

2d Battalion, 160th Special Opns.  
Aviation Regiment (Airborne)  
Fort Campbell, KY 42223-5000  
Commander: LTC John Buss  
ATTN: AOAV-S-CD  
C: 270-798-1569; DSN: 635-1569  
bussj@soar.army.mil  
Executive Officer: MAJ James A. Viola  
ATTN: AOAV-S-XO  
C: 270-798-1576; DSN: 635-1576  
violaj@soar.army.mil  
SIP: CW4 Charles Gant  
ATTN: AOAV-S-SC  
C: 270-798-1555; DSN: 635-1555  
gantc@soar.army.mil  
ASO: CW3 Dale Pacowa  
ATTN: AOAV-S-OS  
C: 270-798-1553; DSN: 635-1553  
pacowa@soar.army.mil  
Senior NCO: CSM Vern Elliott  
ATTN: AOAV-S-SM  
C: 270-798-1577; DSN: 635-1577  
elliottv@soar.army.mil



Command Sergeant  
Major:  
CSM Michael J. Morris  
ATTN: AOAV-S-SM  
C: 502-798-1577  
DSN: 635-1577  
morrismi@soar.net

4th Battalion, 160th Special Opns.  
Aviation Regiment (Airborne)  
Fort Campbell, KY 42223-5000  
Commander: LTC William Books  
ATTN: AOAV-Z-CD  
C: 270-956-3703; DSN: 363-3703  
booksw@soar.army.mil  
Executive Officer: MAJ Patrick Tierney  
ATTN: AOAV-Z-XO  
C: 270-956-3706; DSN: 363-3706  
tierneyp@soar.army.mil  
Senior NCO: CSM Herbert McCoy  
ATTN: AOAV-Z-SM  
C: 270-956-3707; DSN: 363-3707  
mccoyh@soar.army.mil

101st Airborne Division (Air Assault)  
Fort Campbell, KY 42223-5627



Commanding  
General:  
MG Richard A. Cody  
ATTN: AFZB-CG  
C: 270-798-9915  
DSN: 635-9915  
codyr@emh2.campbell.army.mil

Chief of Staff: COL Michael L. Oates  
C: 270-798-9905; DSN: 635-9905  
oatesm@emh2.campbell.army.mil  
(Designated) Asst. Div. Commander  
(Support): COL(P) William C. David  
ATTN: AFZB-DC-S  
C: 270-798-9514; DSN: 635-9514  
davidw@emh2.campbell.army.mil  
Asst. Div. Commander (Operations):  
COL(P) John C. Scroggins  
C: 270-798-9934; DSN: 635-9934  
scrogginsj@emh2.campbell.army.mil



Senior NCO:  
CSM Clifford R. West  
ATTN: AFZB-CSM  
C: 270-798-9607  
DSN: 635-9607  
westc@emh2.campbell.army.mil

8th Battalion, 101st Aviation  
Regiment  
Division Support Command  
101st Airborne Div. (AASLT)  
Fort Campbell, KY 42223  
Commander  
ATTN: AFZB-KE-K  
C: 270-798-6443  
DSN: 635-6443  
Exec. Officer: MAJ Samuel S. Evans  
ATTN: AFZB-KE-K  
C: 270-798-2026; DSN: 635-2026  
evanss@emh2.campbell.army.mil  
DAMO: MAJ Robert E. Sanders  
ATTN: AFZB-KE-AM  
C: 270-798-6226; DSN: 635-6226  
sandersr@emh2.campbell.army.mil



Senior NCO:  
CSM Gregory Howard  
ATTN: AFZB-KE-K  
C: 270-798-2026  
DSN: 635-2026  
howardg@emh2.campbell.army.mil

50th Medical Company (Air  
Ambulance)  
Fort Campbell, KY 42223-5000  
\*Update not provided this year.  
Commander: MAJ Randall G. Anderson  
ATTN: AFZB-KE-K-AA  
C: 502-798-7267; DSN: 635-7267  
andersonr2@emh2.campbell.army.mil

101st Airborne Division (AASLT)  
Aviation Brigade  
Fort Campbell, KY 42223  
Commander: COL John H. Schnibben III  
ATTN: AFZB-KF-CO  
C: 502-956-3481; DSN: 363-3481  
schnibbenj@emh2.campbell.army.mil  
Executive Officer: MAJ David L. Gruenwald  
ATTN: AFZB-KF-XO  
C: 270-956-3481; DSN: 363-3481  
gruenwaldd@emh2.campbell.army.mil  
SIP: CW5 Jack Bartol  
ATTN: AFZB-KF-SIP  
C: 502-798-6781; DSN: 635-6781  
bartolj@emh2.campbell.army.mil  
ASO: CW5 Ronald Gunderson  
ATTN: AFZB-KF-ASO  
C: 502-798-5222; DSN: 635-5222  
gundersonr@emh2.campbell.army.mil  
MTFE: CW4 Ray E. Jackson  
ATTN: AFZB-KF-PC  
C: 502-798-5222; DSN: 635-5222  
jacksonr@emh2.campbell.army.mil  
Senior NCO: CSM William Langston  
ATTN: AFZB-KF-CSM  
C: 502-956-3491; DSN: 363-3491  
langstonw@emh2.campbell.army.mil

1st Battalion, 101st Aviation  
Regiment  
101st Aviation Brigade (ATK)  
101st Airborne Div. (AA)  
Fort Campbell, KY 42223  
Commander: LTC Gary B. Brown  
ATTN: AFZB-KF-E-CO  
C: 270-798-4056; DSN: 635-4056  
browng3@emh2.campbell.army.mil  
Executive Officer: MAJ Johan Haraldsen  
ATTN: AFZB-KF-E-XO  
C: 270-798-4638; DSN: 635-4638  
haraldsej@emh2.campbell.army.mil  
SIP (AH-64): CW4 Alan R. Jaroch  
AFZB-KF-E-S  
C: 270-798-2750; DSN: 635-2750  
jarocha@emh2.campbell.army.mil  
ASO: CW3 Todd Friel  
AFZB-KF-E-S  
C: 270-798-2745; DSN: 635-2745  
friel@emh2.campbell.army.mil



Senior NCO:  
CSM Daniel L. Mace  
AFZB-KF-E-CSM  
C: 270-798-5776  
DSN: 635-5776  
maced@campbell-emh5.army.mil

2d Battalion, 101st Aviation  
Regiment  
Aviation Brigade  
101st Airborne Div. (AASLT)  
Fort Campbell, KY 42223-5742

**Commander:** LTC Richard C. Stockhausen  
 ATTN: AFZB-KF-M-CO  
 C: 502-798-3070  
 DSN: 635-3070  
 stockhausr@emh2.campbell.army.mil

**Executive Officer:** MAJ Mark A. Moser  
 ATTN: AFZB-KF-M-XO  
 C: 502-798-4839; DSN: 635-4839  
 moserm@emh2.campbell.army.mil

**SIP:** CW4 Phillip A. Marston  
 ATTN: AFZB-KF-M-SIP  
 C: 502-798-6638; DSN: 635-6638  
 marstonp@emh2.campbell.army.mil

**ASO:** CW4 Timothy Roderick  
 ATTN: AFZB-KF-M-ASO  
 C: 502-798-7612; DSN: 635-7612

**MTFE:** CW3 Glenn Carthron  
 ATTN: AFZB-KF-M-MTFE  
 C: 502-798-3644; DSN: 635-3644

**Senior NCO:** CSM Anthony L. Alfred  
 ATTN: AFZB-KF-M-CSM  
 C: 502-798-3494  
 DSN: 635-3494  
 alfreda@emh2.campbell.army.mil

**2d Squadron, 17th Cavalry  
 Aviation Brigade  
 101st Airborne Div. (AASLT)  
 Fort Campbell, KY 42223-8015**



**Commander:**  
 LTC Samuel D. Torrey  
 ATTN: AFZB-KF-K-CO  
 C: 502-798-7742  
 DSN: 635-7742  
 torreys@emh2.campbell.army.mil

**Executive Officer:** MAJ Michael Casper  
 ATTN: AFZB-KF-K-XO  
 C: 502-798-7742; DSN: 635-7742  
 casperm@emh2.campbell.army.mil

**SIP:** CW4 Ross Morrison  
 ATTN: AFZB-KF-K-T  
 C: 502-798-7472; DSN: 635-7472  
 morrisonr@emh2.campbell.army.mil

**ASO:** CW3 Dan Hauf  
 ATTN: AFZB-KF-K-AS  
 C: 502-798-7472; DSN: 635-7472  
 haufd@emh2.campbell.army.mil

**AMO:** CPT Joseph Crocitto  
 ATTN: AFZB-KF-K-I  
 C: 502-798-3657; DSN: 635-3657  
 crocittoj@emh2.campbell.army.mil



**Senior NCO:**  
 CSM Rene Versey  
 ATTN: AFZB-KF-K-CSM  
 C: 502-798-7300  
 DSN: 635-7300  
 verseyr@emh2.campbell.army.mil

**3d Battalion, 101st Aviation Regiment  
 Aviation Brigade  
 101st Airborne Div. (AA)  
 Fort Campbell, KY 42223**



**Commander:**  
 LTC Frank P. Ippolito  
 ATTN: AFZB-KF-F-CO  
 C: 270-798-4019  
 DSN: 635-4019

**Executive Officer:** MAJ David M. Regan  
 ATTN: AFZB-KF-F-XO  
 C: 270-798-5050; DSN: 635-5050

**SIP:** CW4 Theodore W. Hazen  
 ATTN: AFZB-KF-F-SIP  
 C: 270-798-9073; DSN: 635-9073  
 FerrairolF@campbell-emh5.army.mil

**ASO:** CW3 Harry L. Manus, Jr.  
 ATTN: AFZB-KF-F-ASO  
 C: 270-798-9384; DSN: 635-9384  
 schweikartb@campbell-emh5.army.mil

**MTFE:** CW4 Gregory E. Stinson  
 ATTN: AFZB-KF-F-MTFE  
 C: 270-798-9074; DSN: 635-9074  
 stinsona@emh2.campbell.army.mil



**Senior NCO:**  
 CSM Shelby Watson  
 ATTN: AFZB-KF-F-CSM  
 C: 270-798-4019  
 DSN: 635-4019

**6th Battalion, 101st Aviation Regiment  
 Aviation Brigade  
 101st Airborne Div. (AA)  
 Fort Campbell, KY 42223  
 \*Update not provided this year.**



**Commander:**  
 LTC Barry G. Murray  
 ATTN: AFZB-KF-I  
 C: 502-798-2267  
 DSN: 635-2267  
 murrayb@emh2.campbell.army.mil

**Executive Officer:** MAJ Mark Moser  
 ATTN: AFZB-KF-I  
 C: 502-798-3965; DSN: 635-3965  
 houstons@campbell-emh5.army.mil

**SIP:** CW4 Brian Middleton  
 ATTN: AFZB-KF-I  
 C: 502-798-2509; DSN: 635-2509

**ASO:** CW3 Daniel Skogen  
 ATTN: AFZB-KF-I  
 C: 502-798-2509; DSN: 635-2509  
 skogend@campbell-emh5.army.mil

**MTFE:** CW3 Anthony Nistico  
 ATTN: AFZB-KF-I  
 C: 502-798-2954; DSN: 635-2954

**159th Aviation Brigade (Assault)  
 Building 7159  
 Fort Campbell, KY 42223**



**Commander:**  
 COL Carl R. Merk  
 ATTN: AFZB-KM-CO  
 C: 502-956-3048  
 DSN: 363-3048  
 merkc@emh2.campbell.army.mil

**Executive Officer:** MAJ Duane E. Brucker  
 AFZB-KM-XO  
 C: 502-956-3047; DSN: 363-3047  
 bruckerd@emh2.campbell.army.mil



**Windshield Buddy** for military helicopters are government approved covers being used and endorsed by battalions throughout the different branches of service. Aviation division of the United States Armed Forces worldwide. Including armed forces foreign countries. Protecting windscreens & component parts from environment elements such as sand, sun and stones thrown from helicopter blades, as well as ice and snow.

**Featured:**

**UH-60 Black Hawk Portable Hanger** easily installed. Gives shade for mechanic in extreme heat climate. Can be use on flight line. Will not go airborne in high wind.  
**UH-60 Black Hawk Full cockpit windscreen wrap cover** includes cockpit doors.

**Main Rotor Head Cover.**

**AH64-A/D Apache/Longbow Canopy set.** "Portable" Hanger also available not featured.

**CH-47D/MH-47E & New F model: Canopy, covers main windscreen and wraps around jettison doors.**

Light weight to be easily stowed on board in its own container.

We ship worldwide.

**Government IMPAC/Visa cards accepted.**

"Patent Pending" All Rights Reserved.

View our web site to see additional Windshield buddy covers installed on various aircraft.



**RoLin Industries, Inc.**

P.O. Box 1017 • Ft. Walton Beach, FL 32549

Tel: (850) 654-1704 • Fax: (850) 837-8061

E-Mail: sales@windshieldbuddy.com

Web: www.windshieldbuddy.com

SIP: CW4 Greg Goodall  
 C: 270-798-2029; DSN: 635-2029  
 goodallg@emh2.campbell.army.mil  
 ASO: CW5 William C. Muller  
 ATTN: AFZB-KM-AS  
 C: 502-798-5222; DSN: 635-5222  
 mullerw@emh2.campbell.army.mil



**Senior NCO:**  
 CSM Joseph Bachus  
 AFZB-KM-CSM  
 C: 502-956-3049  
 DSN: 363-3049

bachusj@emh2.campbell.army.mil

**4th Battalion, 101st Aviation Regiment**  
**159th Aviation Brigade**  
**101st Airborne Division (AA)**  
 Fort Campbell, KY 42223  
**Commander:** LTC Robert T. Hess  
 ATTN: AFZB-KM-E  
 C: 502-798-4015; DSN: 635-4015  
 hessr@emh2.campbell.army.mil  
**Executive Officer:** MAJ Anthony P. Cornett  
 ATTN: AFZB-KM-E  
 C: 502-798-6728; DSN: 635-6728  
 cornetta@emh2.campbell.army.mil

SIP: CW4 Gordon Morey  
 ATTN: AFZB-KM-E  
 C: 502-798-4015; DSN: 635-4015  
 moreyg@emh2.campbell.army.mil  
 ASO: CW4 Greg Wood  
 ATTN: AFZB-KM-E  
 C: 502-798-5951; DSN: 635-5951  
 woodg@emh2.campbell.army.mil  
 MTFE: CW3 Beck  
 ATTN: AFZB-KM-E  
 C: 502-798-5779; DSN: 635-5779  
**Senior NCO:** CSM Jerry H. McConnell  
 ATTN: AFZB-KM-E  
 C: 270-956-4039; DSN: 363-4039  
 mcconnellj@emh2.campbell.army.mil

**5th Battalion, 101st Aviation Regt**  
**159th Aviation Brigade**  
**101st Airborne Div. (AA)**  
 Fort Campbell, KY 42223-5000



**Commander:**  
 LTC William H. Morris  
 ATTN: AFZB-KM-F  
 C: 502-798-0216  
 DSN: 635-0216  
 morrisw@emh2.campbell.army.mil

**Executive Officer:** MAJ Thomas M. Voytek  
 ATTN: AFZB-KM-F-XO  
 C: 502-798-0211; DSN: 635-0211  
 voytekt@emh2.campbell.army.mil  
 SIP: CW4 Peter Johnson  
 ATTN: AFZB-KM-F  
 C: 502-798-3147; DSN: 635-3147  
 johnsonp@emh2.campbell.army.mil  
 ASO: CW4 Ronnie Johnson  
 ATTN: AFZB-KM-F  
 C: 270-798-3147; DSN: 635-3147  
 johnsonron@emh2.campbell.army.mil  
 MTFE: CW3 Danny A. Cumbee  
 ATTN: AFZB-KM-F  
 C: 270-798-4451; DSN: 635-4451  
 cumbeed@emh2.campbell.army.mil  
**Senior NCO:** CSM Rodrigues  
 ATTN: AFZB-KM-F  
 C: 270-798-0213; DSN: 635-0213

**7th Battalion, 101st Aviation Reg**  
**159th Aviation Brigade**  
**101st Airborne Div. (AASLT)**  
 Fort Campbell, KY 42223



**Commander:**  
 LTC Kevin W. Brown  
 ATTN: AFZB-KM-G-CO  
 C: 270-798-5717  
 DSN: 635-5717  
 brownk2@emh2.campbell.army.mil

**Executive Officer:** MAJ Alex G. Covert  
 ATTN: AFZB-KM-G-XO  
 C: 270-798-6889; DSN: 635-6889  
 coverta@emh2.campbell.army.mil  
 SIP: CW4 Steve Jaspering  
 ATTN: AFZB-KM-G-SIP  
 C: 270-798-7320; DSN: 363-7320  
 jasperings@emh2.campbell.army.mil

ASO: CW3 Jon Weston  
 ATTN: AFZB-KM-G-ASO  
 C: 270-956-3633; DSN: 363-3633  
 westonj@emh2.campbell.army.mil  
 BAMO: CW3 Mike King  
 ATTN: AFZB-KM-G-BAMO  
 C: 270-798-5502; DSN: 635-5502  
 kingm@emh2.campbell.army.mil



**Senior NCO:** CSM Alfred W. Alexander  
 ATTN: AFZB-KM-G-CSM  
 C: 270-956-3612; DSN: 363-3612  
 alexandera@emh2.campbell.army.mil

**9th Battalion, 101st Aviation Regiment**  
**159th Aviation Brigade**  
**101st Airborne Division (AA)**  
 Fort Campbell, KY 42223



**Commander:**  
 LTC James J. Lauer  
 ATTN: AFZB-KM-H-CO  
 C: 502-956-3791  
 DSN: 363-3791  
 lauerj@emh2.campbell.army.mil

**Exec. Officer:** MAJ Charles A. Fish  
 ATTN: AFZB-KM-H-XO  
 C: 502-956-3792; DSN: 363-3792  
 fishc@emh2.campbell.army.mil  
 ASO: CW3 Gary Graham  
 ATTN: AFZB-KM-H-ASO  
 C: 502-798-4957; DSN: 635-4957  
 MTP: CPT Michelle Bailey  
 ATTN: AFZB-KM-H-C  
 C: 502-798-5405; DSN: 635-5405  
**Sr NCO:** CSM Michael A. Monahan  
 ATTN: AFZB-KM-H-CSM  
 C: 502-956-3808; DSN: 363-3808  
 monahan@emh2.campbell.army.mil

### Fort Knox

**1st Battalion (Training Support) (Aviation)**  
**"WarHawks"**  
**337th Regiment**  
 Fort Knox, KY 40121-5000  
**Commander:** LTC Robert J. Sova  
 ATTN: AFKA-BAK-AV-CDR  
 C: 502-624-7542; DSN: 464-7542  
 sovar@ftknox-emh9.army.mil  
**Exec. Officer:** MAJ Kevin D. Hottell  
 ATTN: AFKA-BAK-AV-XO  
 C: 502-624-4723; DSN: 464-4723  
 hottellk@ftknox-emh9.army.mil

**Operations Officer:** MAJ Scott W. Hollingsworth  
 ATTN: AFKA-BAK-AV-S3  
 C: 502-624-8445; DSN: 464-8445  
 holligns@ftknox-emh9.army.mil  
 ASO: CW4 Michael J. Carroll  
 ATTN: AFKA-BAK-AV-ASO  
 C: 502-624-7232; DSN: 464-7232  
 carrollm@ftknox-emh9.army.mil  
**Senior NCO:** SGM Timothy Johnston  
 ATTN: AFKA-BAK-AV-SGM  
 C: 502-624-7789; DSN: 464-7789  
 johnstot@ftknox-emh9.army.mil

**8th Battalion, 229th Aviation Regiment (Attack)**  
 Fort Knox, KY 40121-5000



**Commander:**  
 MAJ Timothy M. Clarke  
 ATTN: AFRC-AVIL-BQ-CO  
 C: 502-624-3069  
 DSN: 464-3069  
 Timothy.Clarke@usarc-emh2.army.mil

**Executive Officer:** MAJ Michael J. Currie  
 ATTN: AFRC-AVIL-BQ-XO  
 C: 502-624-2970; DSN: 464-2970  
 michael.currie@usarc-emh2.army.mil  
 S-1: CPT Roger F. Deon  
 ATTN: AFRC-AVIL-BQ-PR  
 C: 502-624-4632; DSN: 464-4632  
 roger.deon@usarc-emh2.army.mil  
 S-2: CPT James W. Bouldin  
 ATTN: AFRC-AVIL-BQ-IN  
 C: 502-624-7913; DSN: 464-7913  
 S-3: MAJ Kenneth A. Cerney  
 ATTN: AFRC-AVIL-BQ-OP  
 C: 502-624-2271; DSN: 464-2271  
 kenneth.cerney@usarc-emh2.army.mil  
 S-4: CPT William A. Hardin  
 ATTN: AFRC-AVIL-BQ-LG  
 C: 502-624-6644; DSN: 464-6644  
 william.hardin@usarc-emh2.army.mil  
**Safety Officer:** CW3 Kenneth D. Volker  
 ATTN: AFRC-AVIL-BQ-SA  
 C: 502-624-1960; DSN: 464-1960  
 kenneth.volker@usarc-emh2-army.mil



**Senior NCO:**  
 CSM Dennis P. Jensen  
 ATTN: AFRC-AVIL-BQ-CM  
 C: 502-624-3794  
 DSN: 464-3794  
 dennis.jensen@usarc-emh2.army.mil

**HHC Commander:** CPT Christopher A. Armbrust  
 ATTN: AFRC-AVIL-BQ-T  
 C: 502-624-2715; DSN: 464-2715  
**Company A Commander:** CW4 Thomas J. McDonald  
 ATTN: AFRC-AVIL-BQ-BA  
 C: 502-624-3142; DSN: 464-3142  
 thomas.mcdonald@usarc-emh2.army.mil  
**Company B Commander:** CPT Neil M. Boone  
 ATTN: AFRC-AVIL-BQ-BB  
 C: 502-624-2425; DSN: 464-2425  
 neil.boone@usarc-emh2.army.mil  
**Company C Commander:** CPT Troy M. Self  
 ATTN: AFRC-AVIL-BQ-BC  
 C: 502-624-3343; DSN: 464-3343  
 troy.self@usarc-emh2.army.mil

**Company D Commander:** CPT Michael M. Bigay  
 ATTN: AFRC-AVIL-BQ-BD  
 C: 502-624-3008; DSN: 464-3008  
 michael.bigay@usarc-emh2.army.mil

**Aviation Support Facility Knox**  
 Fort Knox, KY 40121-5000  
 \*Update not provided this year.  
**Facility Supervisor:** Mr. Guy A. Garica  
 ATTN: AFKB-AC-AV  
 C: 502-624-4877; DSN: 464-4877

**U.S. Army Armor Center**  
 Fort Knox, KY 40121-5000

### Frankfort

**63rd Aviation Group**  
 100 Minuteman Drive  
 Boone National Guard Center  
 Frankfort, KY 40601



**Commander:**  
 COL Ray A. Nelson  
 KG-63-AV  
 C: 502-607-1451  
 DSN: 366-3511



**Senior NCO:**  
 CSM Ronald H. Penn  
 C: 502-607-1451

**Office, State Adjutant General, Kentucky Army National Guard**  
 100 Minuteman Parkway  
 Frankfort, KY 40601-6168



**TAG:**  
 MG John R. Groves, Jr.  
 ATTN: KG-AG  
 C: 502-607-1558  
 DSN: 667-1558  
 fagky@ky-ang.ngb.army.mil

**Office, State Army Aviation Officer, Kentucky Army National Guard Army Aviation Support Facility Boone ARNG Center**  
 100 Minuteman Parkway  
 Frankfort, KY 40601-6168  
**SAAO:** LTC Benjamin F. Adams III  
 ATTN: KG-DOA  
 C: 502-607-1471; DSN: 667-1471  
 saoky@ky-ngnet.army.mil

**Kentucky Army National Guard Army Aviation Support Facility Boone National Guard Center**  
 100 Minuteman Parkway  
 Frankfort, KY 40601-6168  
**AASFC:** LTC Benjamin F. Adams III  
 C: 502-607-1315; DSN: 667-1315  
 bfadams@bngc.dma.state.ky.us

**LOUISIANA  
Fort Polk**

Aviation Division, Operations Group,  
JRTC  
Fort Polk, LA 71459



**Senior Aviation  
Observer/  
Controller:**  
LTC Daniel J.  
Shanahan  
ATTN: ATZL-JRO-U  
C: 337-531-0202  
DSN: 863-0202  
Daniel.Shanahan  
@polk.army.mil

**Executive Officer:** MAJ George W.  
Benter IV  
ATTN: ATZL-JRO-U  
C: 337-531-0205; DSN: 863-0205  
George.Benter@polk.army.mil



**Senior NCO:**  
SGM Dumrong  
Tongphontong  
ATTN: ATZL-JRO-U  
C: 337-531-0204  
DSN: 863-0204  
Dumrong.  
Tonkphontong@polk.  
emh2.army.mil

**Sr. Special Opns Aviation  
Observer/Controller:** LTC Patrick  
O'Hara  
ATTN: ATZL-JRO-U  
C: 337-531-5288; DSN: 863-5288  
Patrick.O'Hara@polk-emh2.army.mil

**TOC Observer/Controller:** CPT Julius  
A. Rigole  
ATTN: ATZL-JRO-U  
C: 337-531-0217; DSN: 863-0217  
Julius.Rigole@polk-emh2.army.mil  
**Sr. BDE C2 Observer/Controller:** CPT  
Lars Wendt  
ATTN ATZL-JRO-U  
C: 337-531-0216; DSN: 863-0216  
Lars.Wendt@polk-emh2.army.mil  
**Plans/Exercise Maneuver Control  
and JACC:** CPT Michael K. Bentley  
ATTN: ATZL-JRO-U  
C: 337-531-9604; DSN: 318-531-9604  
Mike.Bentley@polk.army.mil  
**Senior TAFF Officer:** CPT William H.  
Huff IV  
ATTN: ATZL-JRO-U  
C: 337-531-0658; DSN: 863-0658

**New Orleans**

**1/244th Aviation Regiment**  
6401 Stars & Stripes Blvd., Bldg. 101  
New Orleans, LA 71026-8001  
\*Update not provided this year.  
**Commander:** LTC Barry D. Keeling  
ATTN: LANG-AVA  
C: 504-243-7633; DSN: 485-8365  
keelingb@la-arng.army.mil

**812th Medical Company**  
6401 Stars & Stripes Blvd.  
Bldg. 101  
New Orleans, LA 71026-8001  
**Commander:** MAJ David C. Dehoog  
ATTN: LANG-AVZ-A  
C: 504-278-8369; DSN: 485-8365  
dehoogd@la-arng.army.mil

**Office, State Adjutant General,  
Louisiana ARNG**  
Headquarters Building  
Jackson Barracks  
New Orleans, LA 70146-0330  
**TAG:** MG Bennett C. Landreneau  
ATTN: LANG-TAG  
C: 504-278-8211; DSN: 485-8211  
tagla@la-arng.ngb.army.mil

**Office, State Army Aviation Officer,  
Louisiana ARNG**  
**Aviation Support Facility**  
6401 Stars & Stripes Blvd.  
Bldg. 101  
New Orleans, LA 70126-8001  
**SAAO:** COL Philip W. Nuss  
ATTN: LANG-SAO  
C: 504-278-8368; DSN: 485-8366  
saola@la-arng.ngb.army.mil

**Louisiana Army National Guard  
Aviation Support Facility #1**  
6401 Stars & Stripes Blvd.  
Building 101  
New Orleans, LA 70126-8001  
\*Update not provided this year.  
**AASFC:** LTC Barry D. Keeling  
ATTN: LANG-SAO-AA  
C: 504-278-8366; DSN: 485-8366  
aasf1a@la-arng.ngb.army.mil

**Pineville**

**Louisiana Army National Guard  
Aviation Support Facility #2**  
7615 Esler Field  
Pineville, LA 71360-3737  
\*Update not provided this year.

**MAINE  
Augusta**

**Office, State Adjutant General, Maine  
Army National Guard**  
Camp Keyes  
Augusta, ME 04333-0033  
\*Update not provided this year.



**TAG:**  
MG Earl L. Adams  
C: 207-626-4205  
DSN: 476-4205

**Bangor**

**112th Medical Company (AA)**  
345 Fillmore Street  
Bangor, ME 04401-3091  
\*Update not provided this year.

**Office, State Army Aviation Officer,  
Maine Army National Guard**  
**Army Aviation Support Facility**  
Bldg. 260, BIA, 92 Hayes St.  
Bangor, ME 04401-3091  
**SAAO:** LTC David L. Smith  
ATTN: MEARNG-DOA  
C: 207-947-6593; DSN: 881-3450  
saome@me-arng.ngb.army.mil

**Maine Army National Guard Army  
Aviation Support Facility**  
92 Hayes Street  
Building 260  
Bangor, ME 04401-3091  
\*Update not provided this year.

Authorized Distributor for: **CHANDLER EVANS CONTROL  
SYSTEMS DIVISION**

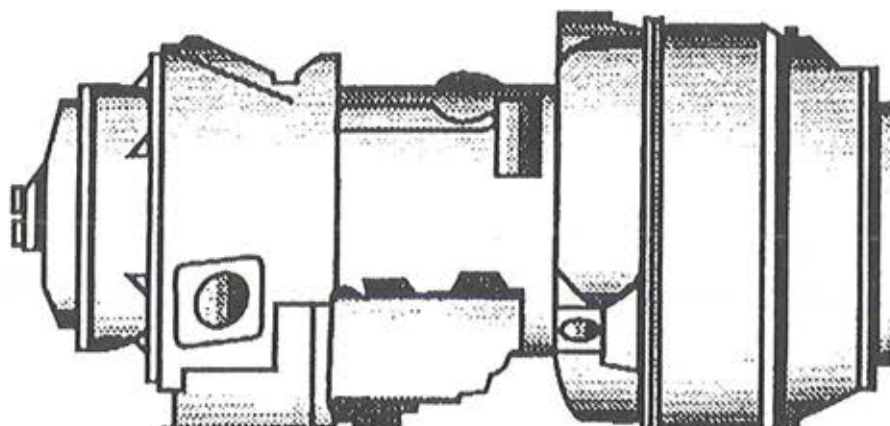

**T-53  
T-55**

**ENGINE SUPPORT**

**TRANSUPPORT, INC.**  
53 TURBINE WAY • MERRIMACK, NH 03054  
<http://www.transupport.com>

PH: 603-424-3111  
FAX: 603-424-1888

**AASFC:** LTC Rob Carmichael  
ATTN: MEARNG-AVN  
C: 207-947-6593; DSN: 881-3450

### MARYLAND Aberdeen Proving Ground

Office, State Army Aviation Officer,  
Maryland Army National Guard  
Army Aviation Support Facility  
Building E4081  
Weide AAF, Edgewood  
Aberdeen Proving Ground, MD 21010-  
5401



**SAAO:**  
COL Ronald R.  
Eaton  
ATTN: MD-STARC-  
DSA  
C: 410-576-6162  
DSN: 496-6162  
saomd@md-  
arng.ngb.army.mil

Maryland Army National Guard Army  
Aviation Support Facility  
Weide Army Airfield  
Building E4081  
Edgewood  
Aberdeen Proving Ground, MD 21010-  
5401  
\*Update not provided this year.

Mobilization AVCRAD Control  
Element (MACE)  
Maryland Army National Guard  
Building E4305  
Aberdeen Proving Ground, MD 21010-  
5401



**Commander:**  
COL Robert A.  
Peterson, Jr.  
ATTN: AMSAM-  
MMC-RE-MD-CO  
C: 410-436-2635  
DSN: 584-2635  
mace@mdarng.  
com

**Safety Division, USADTC**  
314 Longs Corner Road  
Aberdeen Proving Ground, MD 21005-  
5055

\*Update not provided this year.  
**Aviation Safety Officer:** Mr. Charles D.  
(Dave) Sexton

ATTN: CSTE-DTC-IM-S  
C: 410-278-1302; DSN: 298-1302  
sextond@dtc.army.mil  
**Aviation Staff Officer for USADTC:**  
COL Austin R. Omlie  
ATTN: CSTE-DTC-AS  
C: 334-255-8000; DSN: 558-8000  
co@rucker-ettc.army.mil

### Baltimore

Office, State Adjutant General,  
Maryland Army National Guard  
Fifth Regiment Armory  
29th Division Street  
Baltimore, MD 21201-2288  
\*Update not provided this year.



**TAG:**  
LTG James F.  
Fretterd  
ATTN: MDNG-AG  
C: 410-576-6097  
DSN: 496-6097  
tagmd@md-ngnet.  
army.mil

### MASSACHUSETTS Milford

Office, State Adjutant General,  
Massachusetts ARNG  
50 Maple Street  
Milford, MA 01757



**TAG:**  
BG George W. Keefe  
C: 508-233-6552  
DSN: 256-6552  
tagma@shore.net

State Army Aviation Officer,  
Massachusetts ARNG  
50 Maple Street  
Milford, MA 01757



**SAAO:**  
LTC Robert E. Welch,  
Jr.  
ATTN: MAAR-AV  
C: 508-233-6715  
DSN: 256-6715  
saoma@ma-  
arng.ngb.army.mil

### Otis Air Nat'l Guard Base

Massachusetts Army National Guard  
Army Avn. Support Facility #1  
2816 Richardson Rd.  
Otis Air Nat'l Guard Base, MA 02542-  
1322

**AASFC:** MAJ Paul G. Thibodeau  
C: 508-968-5853; DSN: 557-5853  
pt157@aol.com

**Maintenance Officer:** CW4 Joseph  
DiPasquale

C: 508-968-5859; DSN: 557-5859  
joebago353@aol.com

**SIP:** CW3 Joseph M. LeBlanc  
C: 508-968-5578; DSN: 557-5578  
jlebl2674@aol.com

**Safety:** CW3 Timothy Peterson  
C: 508-958-5293; DSN: 557-5293  
tpete2r@aol.com

**3rd Battalion, 126th Aviation (LUH)**  
2816 Richardson Rd.  
Otis Air Nat'l Guard Base, MA 02542-  
1322

**Commander:** MAJ David S. Klein  
C: 508-968-5845; DSN: 557-5845  
david.klein@ma.ngb.army.mil

**Senior NCO:** CSM Joseph Rose  
C: 508-968-5845; DSN: 557-5845

**Commander, HHC:** 1LT David  
Mattimore

C: 508-968-5907; DSN: 557-5907  
dmattimore@aol.com

**Commander, Company C, 1st Bn,**  
126th Avn.: CPT Richard Clark  
C: 508-958-5164; DSN: 557-5164  
rclark@unifirst.com

**Commander, Company E, 126th Avn**  
(ATS): CW3 Hartson  
C: 508-968-5235; DSN: 557-5235  
**Commander, Detachment 1, 86th**  
**Medical Company:** CPT Dave  
Underwood  
C: 508-968-5907; DSN: 557-5907  
dundervo@tac.om

### Westover Air Force Base

**AASF2**  
Building 7400  
Westover Air Force Base, MA 01022-  
1062

**AASF#2C:** MAJ Gerard Fridmann  
ATTN: MAAR-AV-2  
C: 413-557-3234; DSN: 589-3234  
gerard.fridman@ma.ngb.army.mil

**Maintenance Officer:** CW3 Timmy  
Tompkins  
C: 413-557-3243; DSN: 589-3243  
spin6383@hotmail.com

**SIP:** CW5 Theodore Horman  
C: 413-557-3234; DSN: 589-3234  
tvhorman@net1plus.com

**Safety Officer:** CW4 Christopher  
Kirstein  
C: 413-557-3234; DSN: 589-3234  
kirsteinchrish@hotmail.com

### MICHIGAN Camp Grayling

**Grayling Army Airfield**  
Maneuver Training Center  
Camp Grayling, MI 49739  
**Commander:** MAJ John Swanson  
C: 517-344-4308  
**ASO:** CW3 Brian Simecki  
**Senior NCO:** SFC Dennis Palmer

### Grand Ledge

Office, State Army Aviation Officer,  
Michigan Army National Guard  
Army Aviation Support Facility  
10600 Eaton Highway  
Grand Ledge, MI 48837-9102

**SAAO:** COL Alan R. Peterson  
ATTN: MIAR-AVN  
C: 517-627-0108; DSN: 623-0671  
saomi@mi-arng.ngb.army.mil

**Michigan Army National Guard Army**  
**Aviation Support Facility**  
10600 Eaton Highway  
Grand Ledge, MI 48837-9102  
**AASFC:** COL Alan R. Peterson

ATTN: MIAR-AVN  
C: 517-627-0100; DSN: 623-0671

**Operations & Training:** LTC Cary G.  
Cuyler

**ASO:** CW5 Charlie Dudek  
**Maintenance Officer:** CW2 Russell  
Wilcox

**1st Battalion, 238th Aviation**  
**Regiment (Atk Hel)**  
10602 Eaton Highway  
Grand Ledge, MI 48837-9102  
**Commander:** LTC Robert F. Staake  
C: 517-627-0156

**Executive Officer:** MAJ Steven  
Scoville  
**SIP:** CW4 Randy Malby  
**ASO:** CW4 Andy Keeny  
**Senior NCO:** CSM Thomas Paquin

**1st Battalion, 63rd Troop Command**  
(Avn)  
10602 Eaton Highway  
Grand Ledge, MI 48837-9102  
**Commander:** LTC Cary G. Cuyler  
C: 517-627-3034  
**Executive Officer:** MAJ Timothy  
Buscarino  
**SIP:** CW4 Richard Deer  
**ASO:** CW4 Al Pangburn  
**Senior NCO:** CSM Kenneth Slee

### Lansing

Office, State Adjutant General,  
Michigan Army National Guard  
Military & Veterans Affairs  
2500 S. Washington Avenue  
Lansing, MI 48913-5101  
**TAG:** MG E. Gordon Stump  
C: 517-483-5507; DSN: 623-0507

### MINNESOTA Camp Ripley

**G Company, 147th Aviation Regiment**  
15000 Highway 115  
Camp Ripley, MN 56345-4173  
\*Update not provided this year.  
**Company Commander:** CPT  
Christopher Fredericks  
ATTN: RBAV-ATS  
C: 320-632-7421; DSN: 871-7421  
**Senior NCO:** 1SG Thomas Hiltz  
ATTN: RBAV-ATS  
C: 320-632-7421; DSN: 871-7421

**Ray S. Miller Army Airfield**  
15000 Highway 115  
Camp Ripley, MN 56345-4173  
**Airfield Commander:** MAJ Michael  
Casmey  
C: 320-632-7426; DSN: 871-7426  
mansfield@mn-arng.ngb.army.mil  
**Senior NCO:** SFC Roger Temple  
C: 320-632-7426; DSN: 871-7426

### St. Paul

**B Company, 634 Aviation Support**  
**Battalion**  
206 Airport Road  
St. Paul, MN 55107-1006  
\*Update not provided this year.  
**Commander:** MAJ Mike Cosmey  
ATTN: RBAV-AMC  
C: 651-281-3483  
moorek@mn-arng.ngb.army.mil  
**Senior NCO:** 1SG Ron Smith  
ATTN: RBAV-AMC  
C: 651-281-3483

**2-147 Aviation Regiment (Assault)**  
206 Airport Road  
St. Paul, MN 55107-1006  
\*Update not provided this year.  
**Commander:** LTC Ted Hoyt  
ATTN: RBAV-ASLT  
C: 651-281-3479  
harrison@mn-arng.ngb.army.mil  
**Senior NCO:** CSM Mike Mannion  
ATTN: RBAV-ASLT  
C: 651-281-3479

**3-147 Aviation Regiment (Attack)**  
206 Airport Road  
St. Paul, MN 55107-1006  
\*Update not provided this year.

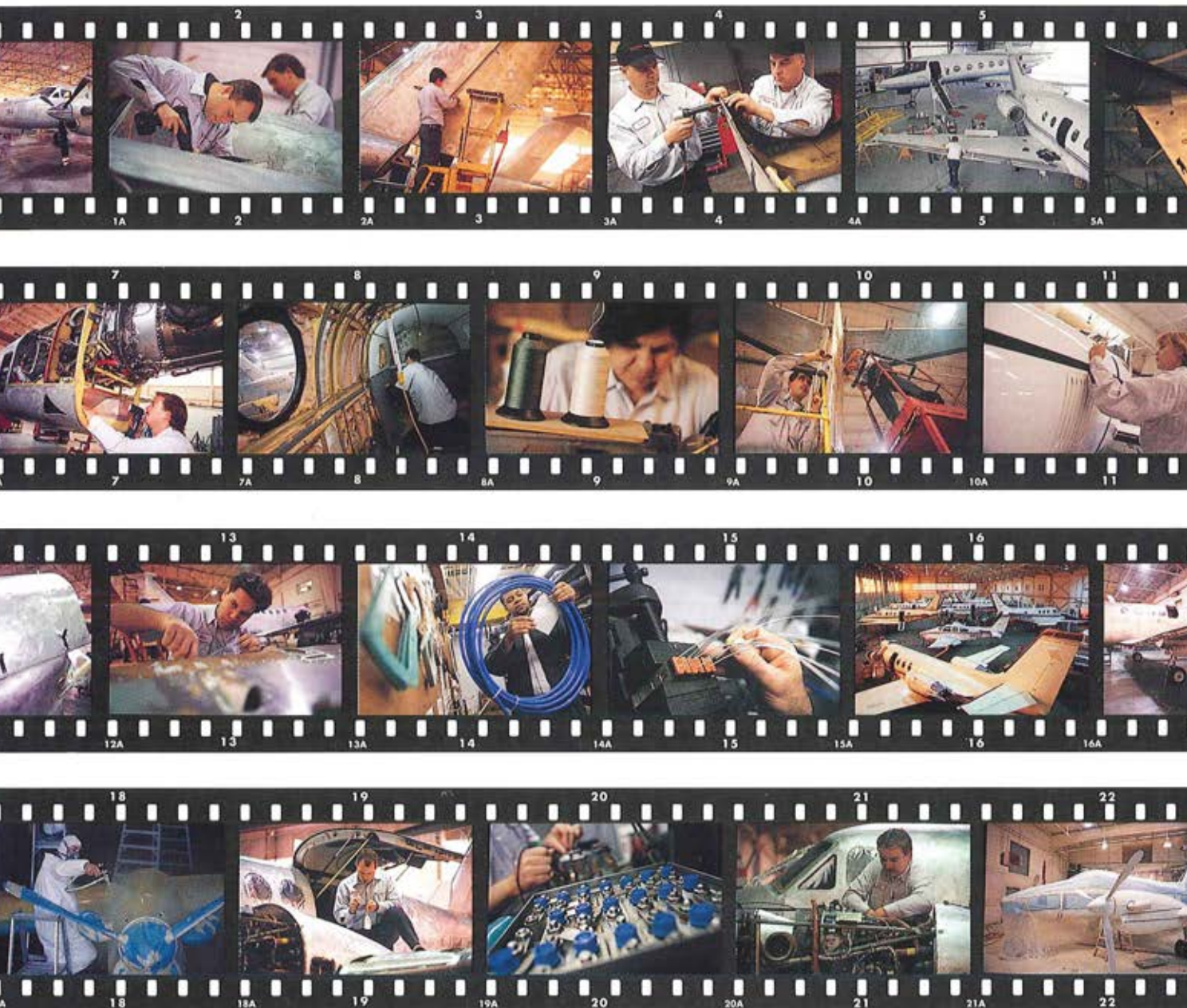

## WE'RE THE GUYS YOU WANT ON YOUR WING.

- A leading turboprop and jet service network
- Full-service depot facilities
- Complete inspection, maintenance and modification services
- Three complete paint and interior refurbishment facilities
- Avionics installations and repairs
- Component overhaul and parts

If you're putting a team together and need depot support, call Sheldon Early, our Vice-President of Business Development, at (864) 879-6000. Or visit our website at [www.stevensaviation.com](http://www.stevensaviation.com).

**STEVENS**AVIATION  
Plane Smart<sup>SM</sup>

Seven locations serving your aviation needs:  
Greenville-Spartanburg (GSP) • Downtown Greenville (GMU) • Donaldson Center-Greenville (GYH)  
Dayton (DAY) • Denver (BJC) • Lexington (LEX) • Nashville (BNA)

©1998 Stevens Aviation, Inc.

Commander: LTC Mark Dugger  
ATTN: RBAV-ATK  
C: 651-281-3438  
Senior NCO: CSM John Ebertowski  
ATTN: RBAV-ASLT  
C: 651-281-3438

34th Infantry Division Aviation  
Brigade, Minnesota ARNG  
206 Airport Road  
St. Paul, MN 55107-1006

\*Update not provided this year.  
Commander: COL Dan Morgan  
ATTN: RBAV-CO  
C: 651-281-3469  
switzerm@mn-arng.ngb.army.mil  
Senior NCO: CSM Gary Gustner  
ATTN: RBAV-CSM  
C: 651-281-3469

Office, State Adjutant General,  
Minnesota ARNG

20 West 12th Street  
St. Paul, MN 55155  
\*Update not provided this year.



TAG:  
MG Eugene R.  
Andreotti  
C: 651-282-4666  
DSN: 825-4666  
tag@mn-arng.  
ngb.army.mil

Office, State Army Aviation Officer,  
Minnesota ARNG

Army Aviation Support Facility  
206 Airport Road

St. Paul, MN 55107-1006  
SAAG: COL Steven E. DeMars  
ATTN: MNAG-SAO  
C: 612-281-3403  
saomn@mn-arng.ngb.army.mil

Minnesota Army National Guard  
Army Aviation Support Facility  
206 Airport Road

St. Paul, MN 55107-1006  
\*Update not provided this year.  
AASFC: COL Curt Newcomb  
ATTN: MNAG-ASF-Z  
C: 612-281-3402; DSN: 825-3402  
newcombc@mn-arng.ngb.army.mil

## MISSISSIPPI Gulfport

1108th Aviation Classification Repair  
Activity Depot (AVCRAD)  
Mississippi ARNG  
P. O. Box 3349  
Gulfport, MS 39505-3349  
Commander: COL Gervis A. Parkerson  
ATTN: CO  
C: 228-214-6901; DSN: 363-8901  
parkersog@ms-arng.ngb.army.mil

## Jackson

Office, State Adjutant General,  
Mississippi ARNG

P. O. Box 5027  
Jackson, MS 39296-5027  
\*Update not provided this year.  
TAG: MG James H. Garner  
ATTN: NGMS-Z  
C: 601-313-6232; DSN: 293-6232  
garnerj@ms-arng.ngb.army.mil

Office, State Army Aviation Officer,  
Mississippi ARNG  
Military Department  
Fondren Station  
P.O. Box 5027  
Jackson, MS 39296-5027  
SAAG: COL Barron L. Goff  
ATTN: NGMS-A  
C: 601-973-6301; DSN: 637-6301  
saoms@ms-arng.ngb.army.mil

Mississippi Army National Guard  
Aviation Support Facility #1

365 Shop Street  
Hawkins Field  
Jackson, MS 39209-3436  
\*Update not provided this year.  
AASFC: LTC Dan V. Chisolm  
C: 601-354-7540; DSN: 637-6134

## Meridian

Mississippi Army National Guard  
Aviation Support Facility #3

P. O. Box 4258, West Station  
Meridian, MS 39304-4258  
\*Update not provided this year.  
AASFC: LTC Felton Walkins  
C: 601-484-9500; DSN: 778-9500

## Tupelo

Mississippi Army National Guard  
Aviation Support Facility #2

P. O. Box 2305  
Tupelo, MS 38803-2305  
\*Update not provided this year.  
AASFC: LTC James G. Young  
C: 601-680-8340; DSN: 683-8340  
aasf2ms@ms-arng.ngb.army.mil

## MISSOURI Fort Leonard Wood

Waynesville Regional Airport at  
Forney Field

Aviation Division, DPTM  
Fort Leonard Wood, MO 65473  
\*Update not provided this year.

## Jefferson City

Office, State Adjutant General,  
Missouri Army National Guard  
2302 Militia Drive

Jefferson City, MO 65101-1203  
\*Update not provided this year.



TAG:  
MG John D. Havens  
ATTN: NGMO-ZA  
C: 573-526-9710  
DSN: 555-9710  
tagmo@mo-  
ngnet.army.mil

Office, State Army Aviation Officer,  
Missouri Army National Guard

Office of the Adjutant General  
Ike Shelton Training Site  
2302 Militia Drive  
Jefferson City, MO 65101-1203  
SAAG: LTC Michael D. Ledbetter  
ATTN: NGMO-SA  
C: 573-638-9634; DSN: 555-9634  
saomo@mo-arng.ngb.army.mil

Missouri Army National Guard  
Aviation Support Facility #2  
Memorial Airport  
1225 Cooper Drive  
Jefferson City, MO 65101-5007  
\*Update not provided this year.  
AASFC: MAJ Edward S. Clark  
C: 573-526-9783; DSN: 555-9783

## Springfield

Missouri Army National Guard Army  
Aviation Flight Activity #3

2501 Lester Jones Avenue  
Springfield, MO 65803-9513  
\*Update not provided this year.  
Supervisor: LTC John W. Salchow  
C: 417-874-7306; DSN: 581-1292  
aasf3mo@mo-ngnet.army.mil

1107th Aviation Classification Repair  
Activity Depot (AVCRAD)

Missouri ARNG  
2501 Lester Jones Avenue  
Springfield Branson Airport  
Springfield, MO 65803-9513

Commander: COL Edward C.  
Gruetzemacher III  
C: 417-874-7300; DSN: 555-9490  
moavcrad@mo-arng.ngb.army.mil

## St. Louis

U.S. Army Reserve Personnel  
Command

1 Reserve Way  
St. Louis, MO 63132  
Personnel Management Officer,  
Aviation: MAJ Roy A. Hall  
ATTN: ARPC-OPC-A  
C: 800-325-4973; DSN: 892-0601  
roy.hall@arastl.army.mil

## Warrensburg

35th Aviation Brigade

343 E. Gay Street  
Warrensburg, MO 64093-1958  
Commander: COL Michael B. Pace  
ATTN: AVN-C  
C: 800-543-7938  
wqrkaa@mo-ngnet.army.mil

## Whiteman Air Force Base

Missouri Army National Guard  
Aviation Support Facility #1  
907 Arnold Avenue  
Whiteman Air Force Base, MO 65305-  
5332

\*Update not provided this year.  
AASF: LTC Kenneth B. McNeel  
ATTN: WAASF  
C: 660-687-5771; DSN: 975-5771

## MONTANA Helena

Office, State Adjutant General,  
Montana Army National Guard

P. O. Box 4789  
Helena, MT 59604-4789  
\*Update not provided this year.  
TAG: MG John E. Prendergast  
ATTN: AG  
C: 406-444-6910; DSN: 747-3010

State Army Aviation Officer, Montana  
Army National Guard

Army Aviation Support Facility  
P. O. Box 4789  
Helena, MT 59604-4789  
SAAG: COL Robert W. Van Meter  
ATTN: DCSAVN  
C: 406-841-3033; DSN: 747-3033  
saomt@mt-arng.ngb.army.mil  
A Co, 1-189th CSAB  
P. O. Box 4789  
Helena, MT 59604-4789

Montana Army Aviation Guard Army  
Aviation Support Facility

P. O. Box 4789  
Helena, MT 59604-4789  
AASFC: LTC Kevin M. Kepler  
ATTN: CSAB-Z  
C: 406-841-3035; DSN: 747-3035  
keplerkm@mt-arng.ngb.army.mil  
Maintenance Officer: CW4 Marvin  
Waples  
C: 406-841-3048; DSN: 747-3048  
waplesmr@mt-arng.ngb.army.mil  
Operations Officer: MAJ Thomas  
Malee  
C: 406-841-3036; DSN: 747-3036  
maleetm@mt-arng.ngb.army.mil  
ASO: CW4 Ken Inabnit  
C: 406-841-3059; DSN: 747-3059  
inabnitkr@mt-arng.ngb.army.mil

B Co., 1-112th LUH

P. O. Box 4789  
Helena, MT 59604-4789  
\*Update not provided this year.  
Commander: CPT Eric Waldorf  
C: 406-841-3522; DSN: 747-3522  
Senior NCO: 1SG Ronald Rasmussen  
C: 406-841-3520; DSN: 747-3520

C Co., 1-112th LUH

P. O. Box 4789  
Helena, MT 59604-4789  
\*Update not provided this year.  
Senior NCO: 1SG David Bock  
C: 406-841-3500; DSN: 747-3500

Det 1, 1085th MED

P. O. Box 4789  
Helena, MT 59604-4789  
\*Update not provided this year.

HHC 1-189th CSAB

P. O. Box 4789  
Helena, MT 59604-4789  
\*Update not provided this year.  
Senior NCO: 1SG Dennis Streeter  
C: 406-841-3500; DSN: 747-3500

1-189th CSAB

P. O. Box 4789  
Helena, MT 59604-4789  
Commander: LTC Kevin M. Kepler  
ATTN: AASF-CDR  
C: 406-841-3500; DSN: 747-3500  
keplerkm@mt-arng.ngb.army.mil  
Executive Officer: MAJ Scott R. Smith  
C: 406-841-3503; DSN: 747-3503  
smithsr@mt-arng.ngb.army.mil  
S3: MAJ Major W. LaRowe  
C: 406-841-3034; DSN: 747-3034  
larowemw@mt-arng.ngb.army.mil  
Senior NCO: CSM Kent Robinson  
C: 406-841-3046; DSN: 747-3046  
robinsonkc@mt-arng.ngb.army.mil



A soldier in full combat gear, including a helmet and camouflage uniform, is the central figure. Overlaid on his chest is a semi-transparent image of a Bell OH-58D helicopter in flight. The helicopter has the call sign 'SF17R' on its side. The background behind the soldier is a landscape with a cloudy sky.

## Your Mission Is Our Mission.

You assess every situation as if lives depend on it. So do we. That's why we're adding the Safety Enhancement Program to the OH-58D. What was already the most versatile armed reconnaissance helicopter in the world, is now being improved. And who better to upgrade a Bell than Bell. After all, we both put safety first.

**Bell Helicopter** **TEXTRON**

A Subsidiary of Textron Inc.

## NEBRASKA Lincoln

1st Squadron, 167th Cavalry  
2400 NW 24th Street  
Lincoln, NE 68524-1892  
\*Update not provided this year.

24th Medical Company (Air  
Ambulance)  
2400 NW 24th Street  
Lincoln, NE 68524-1892

Office, State Adjutant General,  
Nebraska Army National Guard  
1300 Military Road  
Lincoln, NE 68508-1090  
\*Update not provided this year.



**TAG:**  
MG Stanley M. Heng  
C: 402-471-7114  
DSN: 946-7114

Office, State Army Aviation Officer,  
Nebraska Army National Guard  
Army Aviation Support Facility  
2601 NW 25th  
Lincoln, NE 68524-1898  
SAAO: LTC Thomas E. Schuurmans  
ATTN: AASF-DAVN  
C: 402-471-7450; DSN: 946-7450  
saone@ne-arng.ngb.army.mil

Nebraska Army National Guard Army  
Aviation Support Facility  
2601 NW 25th Street  
Lincoln, NE 68524-1898  
\*Update not provided this year.

## NEVADA Carson City

Office, State Adjutant General,  
Nevada National Guard  
2525 South Carson Street  
Carson City, NV 89701-5502  
\*Update not provided this year.



**TAG:**  
MG Drennan A.  
Clark, USAF  
ATTN: HQ  
NVMD/TAG  
C: 775-887-7302  
DSN: 830-5302  
dclark@nvno.  
armg.af.mil

## Nellis Air Force Base

414th Combat Training Squadron  
3662 Tyndall Avenue  
Nellis Air Force Base, NV 89191-6022  
\*Update not provided this year.  
REDFLAG Ground Liaison Officer:  
MAJ Jay W. Smith  
C: 702-652-2903; DSN: 682-2903  
smithjw@nellis.af.mil

## Reno

717th Medical Company, Detachment 1  
19980 Army Aviation Drive  
Reno, NV 89506-1200  
\*Update not provided this year.  
Commander: CPT Daniel R. Waters  
ATTN: NVTI-MD-Z  
C: 775-971-6061; DSN: 830-5267  
littled@nv.arng.ngb.army.mil

Office, State Army Aviation Officer,  
Nevada Army National Guard  
Army Aviation Support Facility  
20,000 Army Aviation Drive  
Reno-Stead Airport  
Reno, NV 89506-1200  
SAAO: MAJ Robert T. Herbert  
ATTN: NVMD-AV  
C: 775-972-2701; DSN: 830-5267  
HerbertR@nv-arng.ngb.army.mil

Nevada Army National Guard Army  
Aviation Support Facility  
20000 Army Aviation Drive  
Reno-Stead Airport  
Reno, NV 89506-1200  
AASFC: MAJ Robert T. Herbert  
ATTN: NVMD-AV  
C: 775-972-2701; DSN: 830-5267  
herbertR@nv-arng.ngb.army.mil

## NEW HAMPSHIRE Concord

Office, State Adjutant General, New  
Hampshire ARNG  
4 Pembroke Rd.  
Concord, NH 03301-5652  
\*Update not provided this year.  
TAG: MG John E. Blair  
C: 603-225-1200; DSN: 684-9200  
blairje@nh-arng.ngb.army.mil

Office, State Army Aviation Officer,  
New Hampshire ARNG  
Army Aviation Support Facility  
4 Pembroke Road  
Concord, NH 03301-5652  
SAAO: MAJ Frank C. Leith  
ATTN: NHAG-AV  
C: 603-225-1270; DSN: 684-9292  
saonh@nh-arng.ngb.army.mil

New Hampshire Army National  
Guard Army Aviation Support Fac.  
4 Pembroke Road  
Concord, NH 03301-5652  
\*Update not provided this year.  
AASFC: MAJ Frank Leith  
ATTN: NHAG-AV  
C: 603-225-1270; DSN: 684-9292

## NEW JERSEY Fort Monmouth

U.S. Army Command & Control  
Systems/Avionics Directorate  
USACECOM  
Fort Monmouth, NJ 07703-5043  
\*Update not provided this year.



**Director:**  
Mr. David G. Sharnan  
ATTN: AMSEL-LC-  
CCS  
C: 732-532-2332  
DSN: 992-2332  
sharnan@mail1.  
monmouth.army.mil

Airborne NAVCOM Division,  
CCS/Avionics Directorate, CECOM  
Fort Monmouth, NJ 07703  
Chief: Mr. Richard E. Pribyl  
ATTN: AMSEL-LC-CCS-N  
C: 732-532-1957; DSN: 992-1957  
Richard.Pribyl@mail1.  
monmouth.army.mil

Airborne Communications Branch,  
CCS/Avionics Directorate, CECOM  
Fort Monmouth, NJ 07703  
\*Update not provided this year.  
Chief: Mr. Charles Coleman  
ATTN: AMSEL-LC-CCS-N-AC  
C: 732-532-2416; DSN: 992-2416  
coleman@mail1.monmouth.army.mil  
Airborne Navigation Branch,  
CCS/Avionics Directorate, CECOM  
Fort Monmouth, NJ 07703  
Chief: Mr. Jack Broeckelmann  
ATTN: AMSEL-LC-CCS-N-AN  
C: 732-323-3652; DSN: 992-3652  
John.Broeckelmann@  
mail1.monmouth.army.mil

Aircraft Programs Branch,  
CCS/Avionics Directorate, CECOM  
Fort Monmouth, NJ 07703

Airborne Mission Division,  
CCS/Avionics Directorate, CECOM  
Fort Monmouth, NJ 07703  
Chief: Mr. Kenneth H. Brockel  
ATTN: AMSEL-LC-CCS-A  
C: 732-532-5431; DSN: 992-5431  
kenneth.brockel@  
mail1.monmouth.army.mil

ATC Branch, Airborne Mission  
Division, CCS/Avionics Dir., CECOM  
Fort Monmouth, NJ 07703  
Chief: Mr. Michael Gurgos  
ATTN: AMSEL-LC-CCS-A  
C: 732-532-9295; DSN: 992-9295  
michael.gurgos@mail1.monmouth.  
army.mil

Aircraft Survivability Branch,  
CCS/Avionics Directorate, CECOM  
Fort Monmouth, NJ 07703  
Chief: Mr. Harry Ivory  
ATTN: AMSEL-LC-CCS-A-AS  
C: 732-532-3400; DSN: 992-3400  
ivory1@mail1.monmouth.army.mil

Mission Management Br.,  
CCS/Avionics Dir., CECOM  
Fort Monmouth, NJ 07703  
Chief: Mr. Gabor Boda  
ATTN: AMSEL-LC-CCS-A-MM  
C: 732-532-5107; DSN: 992-5107  
gabor.boda@mail1monmouth.  
army.mil

Avionics Branch, A/IEWS Division,  
USA CECOM SEC  
Fort Monmouth, NJ 07703-5207  
\*Update not provided this year.

## Picatinny Arsenal

New Jersey Army National Guard  
Aviation Support Facility #2  
Building 3801  
Picatinny Arsenal, NJ 07806-5000  
AASFC: MAJ Jorge J. Martinez  
C: 973-724-4609; DSN: 880-4609  
aasf2nj@nj-arng.ngb.army.mil

## Trenton

Office, State Adjutant General, New  
Jersey ARNG  
P.O. Box 340  
Trenton, NJ 08625-0340



**TAG:**  
MG Paul J. Glazar  
ATTN: TAG  
C: 609-530-6957  
DSN: 445-9957  
glazar@njdmava.  
state.nj.us

## West Trenton

1st Battalion, 150th Aviation  
Scotch Road  
West Trenton, NJ 08628-1389  
Commander: LTC John DiNapoli  
C: 609-530-4267  
john.dinapoli@nj.ngb.army.mil  
Executive Officer: MAJ John C. Dillie  
C: 609-530-4267  
john.dillie@nj.ngb.army.mil  
SIP: CW3 Jeffrey Angle  
C: 609-530-4254; DSN: 445-9261  
jeffrey.angle@nj.ngb.army.mil  
ASO: CW4 William Tuttle  
C: 609-530-4267  
william.tuttle@nj.ngb.army.mil  
Senior NCO: CSM Stephen Barna  
C: 609-530-4267  
stephen.barna@nj.ngb.army.mil

Office, State Army Aviation Officer,  
New Jersey ARNG  
Dept. of Military & Vet. Affrs  
Trenton-Mercer County Airport  
152 Scotch Road  
West Trenton, NJ 08628-1389  
SAAO: COL Glenn K. Rieth  
ATTN: SAAO  
C: 609-530-4749; DSN: 445-9221  
saonj@nj-arng.ngb.army.mil

New Jersey Army National Guard  
Aviation Support Facility #1  
Trenton Mercer Airport  
Scotch Road  
West Trenton, NJ 08628-1302  
\*Update not provided this year.  
AASFC: LTC Paul J. Ciervo  
ATTN: AASFC  
C: 609-530-4256; DSN: 445-9261  
aasf1nj@nj-arng.ngb.army.mil

## NEW MEXICO Holloman Air Force Base

U.S. Army Air Operations Division  
P.O. Box 1089  
Holloman Air Force Base, NM 88330

## Las Cruces

New Mexico Army National Guard  
RAID Flight Activity  
8950 Zia Blvd. #10  
Las Cruces, NM 88005  
\*Update not provided this year.

Commander: 1LT W. Bryan Dennis  
NMG-ARND  
C: 505-541-6802

### Santa Fe

Office, State Adjutant General, New Mexico ARNG  
47 Bataan Boulevard  
Santa Fe, NM 87505  
TAG: BG Randall Horn  
C: 505-474-1202; DSN: 867-8202

Office, State Army Aviation Officer, New Mexico ARNG  
47 Bataan Blvd.  
Santa Fe, NM 87505-4685



SAAO:  
LTC Gregory R. Cluff  
ATTN: NMAG-AAV  
C: 505-474-1315  
DSN: 867-8315  
saonm@nm-arng.army.mil

### New York Fort Drum

U.S. Army Air Ambulance  
Detachment  
10th Mountain Division  
Fort Drum, NY 13602-5000  
Commander: MAJ Jeffrey Foe  
ATTN: AFS-AV-AHB-M  
C: 315-772-4163; DSN: 341-4163

U.S. Army Garrison  
Aviation Division  
Fort Drum, NY 13602-5000

Aviation Officer and Airfield Cdr: Mr. Joe White  
ATTN: AFZS-RBC-A  
C: 315-772-4480; DSN: 341-4480  
whitej@drum.army.mil

Airfield Facilities Manager: Mr. Ron Blinebry  
ATTN: AFZS-RBC-A  
C: 315-772-7997; DSN: 341-7997  
fonald.blinebry@drum.army.mil

10th Aviation Brigade, 10th Mountain Division (Light)  
Fort Drum, NY 13602



Commander:  
COL Joseph A. Smith  
ATTN: AFZS-AV-Z  
C: 315-772-3177  
DSN: 341-3177  
joseph.smith@drum.army.mil

Executive Officer: MAJ Robert A. Baer  
ATTN: AFZS-AV-Z  
C: 315-772-3091; DSN: 341-3091  
SIP: CW5 Richard H. Edgington  
ATTN: AFZS-AV-SS  
C: 315-772-6424; DSN: 341-6424  
richard.edgington@drum.army.mil

ASO: CW5 Thomas Struck  
ATTN: AFZS-AV-SS  
C: 315-772-3402; DSN: 341-3402  
lthomas.struck@drum.army.mil  
MTFE: CW4 Ronald Klusacek  
ATTN: AFZS-AV-Z-AMO  
C: 315-772-7819; DSN: 341-7819  
Klusacekr@drum.army.mil  
Sr. NCO: CSM Leon Hite, Jr.  
ATTN: AFZS-AV-CSM  
C: 315-772-3175  
leon.hite@drum.army.mil

1st Battalion (Attack), 10th Aviation Regiment  
10th Aviation Brigade  
10th Mountain Division (L)  
Fort Drum, NY 13602-5230



Commander:  
LTC William S. Larese  
ATTN: AFZS-AV-A  
C: 315-772-3000  
DSN: 341-3000  
110avnodr@drum.army.mil

Executive Officer: MAJ Jeffrey R. Holcomb  
ATTN: AFZS-AV-AT  
C: 315-772-8518; DSN: 341-8518  
zjeffrey.holcomb@drum.army.mil  
SIP: CW4 Tony Salerno  
ATTN: AFZS-AV-A  
C: 315-772-3802; DSN: 341-3802  
anthony.salerno@drum.army.mil

ASO: CW2 J. T. Lee  
ATTN: AFZS-AV-ATK  
C: 315-772-3806; DSN: 341-3806



Senior NCO:  
CSM Jerry Seimer  
ATTN: AFZS-AV-ATK  
C: 315-772-3745  
DSN: 341-3745  
1/10avnscsm@drum.army.mil

2nd Battalion, 10th Aviation Regiment  
Bldg. 10420  
South Riva Ridge  
Fort Drum, NY 13601

Commander: LTC Scott Ziegler  
efec. 12/00  
ATTN: AFZS-AV-AHB  
C: 315-772-4305; DSN: 341-4305  
Executive Officer: MAJ Stan Schall  
ATTN: AFVS-AV-AHB  
C: 315-772-4687; DSN: 341-4687  
Schalls@drum.army.mil  
SIP: CW4 Kevin Hayes  
ATTN: AFZS-AV-AHB  
C: 315-772-5853; DSN: 341-5863  
210avnstds@drum.army.mil  
ASO: CW4 William E. Wallace  
ATTN: AFZS-AV-AHB  
C: 315-772-4416; DSN: 341-4416  
MTFE: CW4 Armond Brasseur  
ATTN: AFZS-AV-AHB  
C: 315-772-6619; DSN: 341-6619  
Senior NCO: CSM Douglas Murray  
ATTN: AFZS-AV-AHB  
C: 315-772-4290; DSN: 341-4290

3d Squadron, 17th Cavalry  
10410 South Riva Ridge Drive  
Fort Drum, NY 13602-5231  
Commander: LTC Patrick Plourd  
ATTN: AFZS-AV-CAV  
C: 315-772-9052; DSN: 341-9052  
Senior NCO: CSM James Dale  
ATTN: AFZS-AV-CAV-CSM  
C: 315-772-3090; DSN: 341-3090

### Latham

Office, State Adjutant General, New York Army National Guard  
330 Old Niskayuna Road  
Latham, NY 12110-2224  
\*Update not provided this year.

# Make Sure No One Is Left Behind!

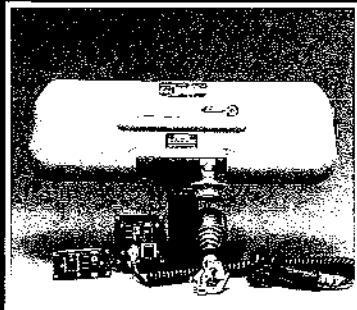

## BREEZE-EASTERN

700 Liberty Avenue  
Union NJ 07083, USA  
Telephone (908) 686-4000  
FAX (908) 686-9292  
www.breeze-eastern.com

# RESCUE HOIST SYSTEM

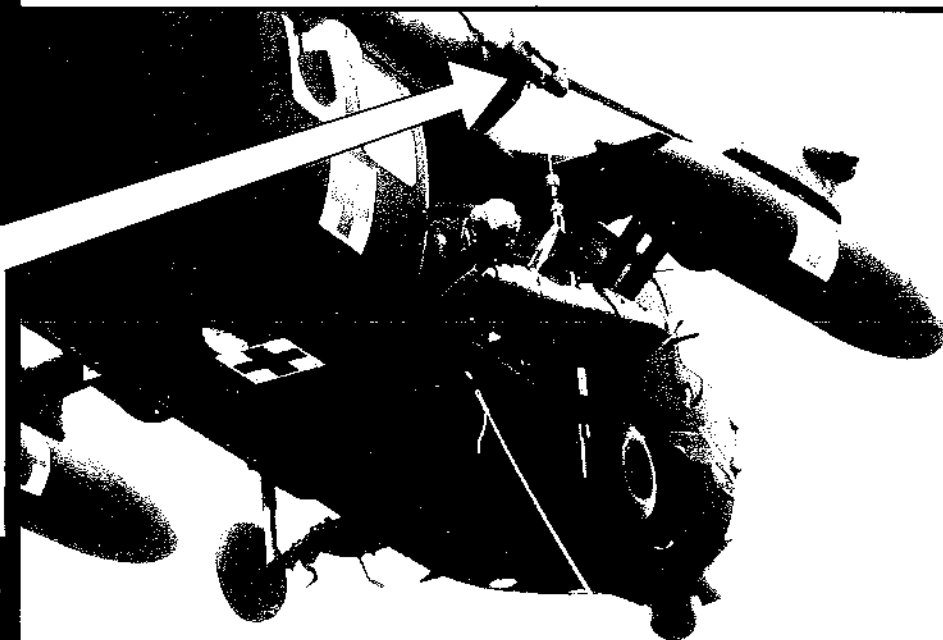

BREEZE-EASTERN's high performance, external rescue hoist system has met the stringent qualifications of the UH-60Q MEDEVAC program. The HS-29900 delivers the highest operating performance of any rescue hoist on the market today, with faster cable speed (350 fpm), longer cable (295 feet) and unlimited duty cycle.



**TAG:**  
MG John H.V.  
Fenimore  
C: 518-786-4502  
DSN: 489-4502

Office, State Army Aviation Officer,  
New York Army National Guard  
Army Aviation Support Fac. #3  
Albany International Airport  
Latham, NY 12110-2299



**SAAO:**  
LTC David Sheppard  
ATTN: MNAR-AS  
C: 518-786-4399  
DSN: 489-4399  
saony@ny-  
ngnet.army.mil

New York Army National Guard  
Aviation Support Facility #3  
309 Old Niskayuna Road  
Latham, NY 12110-2299  
\*Update not provided this year.  
**AASFC:** LTC Mark F. Burke  
C: 518-786-4360; DSN: 489-4360  
Mark.Burke@ny-arng-ngb.army.mil

### New Windsor

U.S. Military Academy Flight  
Detachment  
2nd Aviation Detachment  
United States Military Academy  
P. O. 1005, 1st Street  
New Windsor, NY 12553  
**Commander:** CW5 Michael M. Halsey  
ATTN: MABS-H-C  
C: 845-567-1088  
ym4593@exmail.usma.army.mil  
**NCOIC:** SFC Timothy Thomas  
**STDS:** CW4 Michael Aubee  
**Safety:** CW4 Raymond Giganti

### Rochester

1st Battalion, 142d Aviation  
Regiment, NYARNG, AH-1F  
250 Weidner Road  
Rochester, NY 14624-5136  
**Commander:** LTC Chris E. Holiday  
ATTN: FOFSAVN-CDR  
C: 716-783-5361; DSN: 343-5361  
chrish201@aol.com  
**Senior NCO:** CSM Gary D. Lyness  
ATTN: FOFSAVN-CSM  
C: 716-783-5361; DSN: 343-5361

New York Army National Guard  
Aviation Support Facility #2  
280 Weidner Road  
Rochester, NY 14624-5136  
**Commander:** MAJ Michael E. Bobeck  
AASF#2-C  
C: 716-783-5400; DSN: 343-5400  
bobekm@ny-arng-ngb.army.mil  
**Operations Officers:** CW4 Anthony F.  
Castiglione  
C: 716-783-5405; DSN: 343-5405  
aasf2@dmna.state.ny.us  
**Safety Officer:** CW5 Francis A. Rotella  
C: 716-783-5403; DSN: 343-5403  
aasf2@dmna.state.ny.us  
**Maintenance Officer:** CW4 Michael  
Zanghi  
C: 716-783-5402; DSN: 343-5402  
aasf2@dmna.state.ny.us

### Ronkonkoma

New York Army National Guard  
Aviation Support Facility #1, Hangar A  
Long Island MacArthur Airport  
Ronkonkoma, NY 11779-7302  
**AASFC:** COL Frank P. Intini, Jr.  
ATTN: AASF#1  
C: 516-737-6210; DSN: 247-6275

### NORTH CAROLINA Fort Bragg

Aviation Division, DPTM, Simmons  
Army Airfield  
Fort Bragg, NC 28307-5000

Joint Special Operations Cmd (JSOC)  
PO Box 70239  
Fort Bragg, NC 28307-5000  
**Commanding General:** MG Dell L.  
Dailey  
C: 910-396-0553

U.S. Army Special Operations Cmd  
Fort Bragg, NC 28307-5000  
**Commanding General:** LTG Bryan D.  
Brown  
ATTN: AOCG  
C: 910-432-3000; DSN: 239-3000  
brownb@ahqb.soc.mil

Office, DCS for Special Operations  
Aviation, USASOCOM  
Fort Bragg, NC 28307-5200



**Acting Deputy Chief  
of Staff, Spec. Oper-  
ations Avn.:**  
COL Randall Cochran  
ATTN: AOAO  
C: 910-432-4366  
DSN: 239-4366  
cochranr@soc.mil

**Plans and Training:** LTC George  
Adamakos  
ATTN: AOAO-OPT  
C: 910-432-8481; DSN: 239-8481  
adamakog@soc.mil

**MACOM Aviation Safety Officer:** Mr.  
James Dielderich  
ATTN: AOAO-ASO  
C: 910-432-3594; DSN: 239-3594  
dielderj@soc.mil

**MACOM Aviation Standards Officer:**  
CW5 Billy Johnson  
ATTN: AOAO-STD  
C: 910-432-7706; DSN: 239-7706  
johnsobil@soc.mil

XVIII Airborne Corps Aviation Office  
Fort Bragg, NC 28310-5000



**Corps Aviation  
Officer:**  
COL William M.  
Jacobs  
ATTN: AFZA-VA-CO  
C: 910-396-8790  
DSN: 236-8790  
Jacobswm@  
bragg.army.mil

**Deputy Corps Aviation Officer:** LTC  
Robert C. Guillot  
C: 910-396-4208; DSN: 236-4208  
guillot@bragg.army.mil  
**Corps Standards:** CW4 James  
Lattimore  
ATTN: AFZA-AV-CA  
C: 910-396-4208; DSN: 236-4208  
lattimorej@bragg.army.mil

**Corps Safety:** CW5 Larry Newsom  
ATTN: AFZA-AV-CA  
C: 910-396-1066; DSN: 236-1066  
newsomlw@bragg.army.mil  
**Corps Maintenance:** CW4 Dwayne  
Rudolph  
ATTN: AFZA-CA  
C: 910-396-1066; DSN: 236-1066  
rudolphd@bragg.army.mil

18th Aviation Brigade  
XVIII Airborne Corps  
Fort Bragg, NC 28310-5000  
**Commander:** COL William M. Jacobs  
ATTN: AFZA-AV-CO  
C: 910-396-8790; DSN: 236-8790  
jacobswm@bragg.army.mil  
**Deputy Brigade Commander:** MAJ  
Craig S. Walters  
ATTN: AFZA-AV-CX  
C: 910-396-7767; DSN: 236-7767  
walterscs@bragg.army.mil  
**Executive Officer:** LTC Paul Bricker  
ATTN: AFZA-AV-CX  
C: 910-396-7767; DSN: 236-7767  
SIP: CW5 John Lund  
ATTN: AFZA-AV-CC-SD  
C: 910-396-7767; DSN: 236-7767  
lundj@bragg.army.mil  
**ASO:** CW4(P) Roy Robison  
ATTN: AFZA-AV-CS  
C: 910-396-7767; DSN: 236-7767  
Robisonr@bragg.army.mil  
**Senior NCO:** CSM Lawrence O. Pate  
ATTN: AFZA-AV-CSM  
C: 910-396-7767; DSN: 236-7767  
Patel@bragg.army.mil

B Company, 159th Aviation Regiment  
18th Aviation Brigade  
XVIII Airborne Corps  
Fort Bragg, NC 28307-5000  
**Commander:** MAJ Jamie Jamison  
C: 910-352-4703; DSN: 971-4703  
jamisonjr@stewart.army.mil  
**Executive Officer:** 1LT Karl Krievins  
C: 910-352-6526; DSN: 917-6526  
krievinska@stewart.army.mil  
**SIP:** CW3 Randy Pauley  
C: 910-352-6762; DSN: 971-6762  
**Safety:** CW4 Conselta Hassan  
C: 910-352-6762; DSN: 971-5193  
hannsan@stewart.army.mil  
**Maintenance Officer:** CW3 Darryl  
Gerow  
C: 910-352-5193; DSN: 971-5193  
Gerowdl@emh5.stewart.army.mil  
**Senior NCO:** 1SG McArthur Dixon  
C: 910-352-6514; DSN: 971-6514

C Company, 159th Aviation Regiment  
18th Aviation Brigade  
XVIII Airborne Corps  
Fort Bragg, NC 28307-5000  
**Commander:** MAJ Fran V. Reese  
ATTN: AFZA-AV-CHD-C  
C: 910-396-4703; DSN: 236-4703  
Reesefv@bragg.army.mil  
**Executive Officer:** 1LT Matthew  
Ferguson  
ATTN: AFZA-AV-CHMD-XO  
C: 910-396-4703; DSN: 236-4703  
Fergusonm@bragg.army.mil  
**SIP:** CW4 Pat Trotter  
ATTN: AFZA-AV-CHD-SIP  
C: 910-396-8002; DSN: 236-8002  
**Safety:** CW3 Bruce Van Den Eng  
ATTN: AFZA-AV-CHD-ASO  
C: 910-396-6800; DSN: 236-6800  
**Senior NCO:** 1SG Elliot Stanley  
ATTN: AFZA-AV-CHD  
C: 910-396-4703; DSN: 236-4703

1st Battalion, 159th Aviation  
Regiment  
18th Aviation Brigade  
XVIII Airborne Corps  
Fort Bragg, NC 28307-5000



**Commander:**  
LTC Glen Norris  
ATTN: AFZA-AV-  
CMD-BN  
C: 910-396-3533  
DSN: 236-3533  
Norrisglen@  
bragg.army.mil

**Executive Officer:** MAJ Joseph  
Orecchio  
ATTN: AFZA-AV-CMD-XO  
C: 910-396-3793; DSN: 236-3793  
orecchioj@bragg.army.mil  
**S-3:** MAJ Lisa Wall  
ATTN: AFZA-AV-CMD-S3  
C: 910-396-2860; DSN: 236-3793  
walll@bragg.army.mil  
**SIP:** CW4 James Myers  
ATTN: AFZA-AV-CMD-STD  
C: 910-432-6225  
myersjam@bragg.army.mil  
**Safety:** CW2 Larry Anderson  
ATTN: AFZA-AV-CMD-ASO  
C: 910-432-6270  
andersonla@bragg.army.mil  
**Maintenance Officer:** CW3 Chris Hurst  
ATTN: AFZA-AV-CMD-AMO  
C: 910-396-5177; DSN: 236-5177  
hurstch@bragg.army.mil  
**Senior NCO:** CSM Keith Wilbur  
ATTN: AFZA-AV-CSM-CSM  
C: 910-396-8688; DSN: 236-8688  
WilburK@bragg.army.mil

1st Battalion, 58th Aviation Regiment  
(Corps) (Airborne)  
18th Aviation Brigade  
Fort Bragg, NC 28307-5000



**Commander:**  
LTC Joseph Mudd  
ATTN: AFZA-AV-ATC-  
BC  
C: 910-396-3361  
DSN: 236-3361  
muddjp@bragg.  
army.mil

**Executive Officer:** MAJ Samuel Askew  
ATTN: AFZA-AV-ATC-XO  
C: 910-907-2042; DSN: 337-2042  
askews@bragg.army.mil  
**S-3:** MAJ Ronald Myers  
ATTN: AFZA-AV-ATC-S3  
C: 91-396-9730; DSN: 236-9730  
myersrg@bragg.army.mil  
**Signal Maintenance Officer:** CW3  
Clifford Jones  
ATTN: AFZA-AV-ATC-BMO  
C: 910-396-7786; DSN: 236-7786  
jonesclif@bragg.army.mil  
**Senior NCO:** CSM Lawrence Pale  
ATTN: AFZA-AV-ATC-CSM  
C: 910-396-8577; DSN: 236-8577  
patel@bragg.army.mil

4th Battalion, 159th Aviation  
Regiment  
18th Aviation Brigade  
XVIII Airborne Corps  
Fort Bragg, NC 28307-5000



**Commander:**  
LTC Brett E. Johnson  
ATTN: AFVH-XF-CO  
C: 910-396-0087  
DSN: 236-0087  
johnsonbe@bragg.army.mil



**Senior NCO:**  
CSM Willie C. Lucas  
ATTN: AFVH-XG-F  
C: 910-396-0087  
DSN: 236-0087  
LucasWC@bragg.army.mil

1st Squadron (AIR), 17th Cavalry Reg.  
82d Aviation Brigade  
82d Airborne Division  
Fort Bragg, NC 28307

**Commander:** LTC Jeffrey N. Colt  
DSN: 239-6832  
coltsj@bragg.army.mil

**Squadron Executive Officer:** MAJ  
Kenneth O. Merkel  
DSN: 239-2890  
merkelko@bragg.army.mil

**Squadron Operators Officer:** MAJ  
Charles T. Climer  
DSN: 239-2730  
climerct@bragg.army.mil

**Squadron Standards Officer:** CW4  
Phil Gleaves  
DSN: 236-5410  
gleavesp@bragg.army.mil

**Squadron Safety Officer:** CW3 Guy  
Harris  
DSN: 236-5410  
harrisgs@bragg.army.mil

**Squadron Maintenance Office:** CW3  
Santiago Ortiz  
DSN: 236-3800  
ortizs@bragg.army.mil

**Squadron Command Sergeant Major:**  
CSM James L. Digby  
DSN: 239-2889  
digbyjl@bragg.army.mil

1st Attack Helicopter Battalion  
82d Aviation Brigade  
82d Airborne Division  
Fort Bragg, NC 28307

\*Update not provided this year.

**Commander:** LTC Peter E. Curry  
ATTN: AFVC-EA  
C: 910-432-6098; DSN: 239-6098  
curryp@bragg.army.mil

**Executive Officer:** MAJ Gregory  
Seamands  
ATTN: AFVC-EA  
C: 910-432-8926; DSN: 239-8926  
seamandsg@bragg.army.mil

**SIP:** CW4 Tracy Owens  
ATTN: AFVC-EA  
C: 910-396-4345; DSN: 236-4345

**ASO:** CW2 Michael Conley  
ATTN: AFVC-EA  
C: 910-396-2614; DSN: 236-2614

**MTFE:** CW4 Randy Olson  
ATTN: AFVC-EA  
C: 910-396-7163; DSN: 236-7163  
**Senior NCO:** CSM Demitrio Orden  
ATTN: AFVC-EA  
C: 910-432-6098; DSN: 239-6098  
ordend@emh5.bragg.army.mil

2d Battalion (Assault), 82d Aviation  
Regiment  
82d Aviation Brigade  
82d Airborne Division  
Fort Bragg, NC 28307



**Commander:**  
LTC J. Mike  
Simmons  
ATTN: AFVC-EB  
C: 910-432-7928  
DSN: 239-7928  
simmonsmi@bragg.army.mil

**Executive Officer:** MAJ John F.  
Iampietro  
ATTN: AFVC-EB  
C: 910-432-8990; DSN: 239-8990  
iampietroj@bragg.army.mil  
**SIP:** CW3 Allen W. Obrion  
ATTN: AFVC-EB  
C: 910-396-1150; DSN: 236-1150  
obriona@bragg.army.mil

**Executive Officer:** MAJ Fred H.  
Jessen

ATTN: AFVH-XF  
C: 910-396-0087; DSN: 236-0087  
jessenf@bragg.army.mil

**S3/2:** MAJ Wallace R. Larson  
ATTN: AFVH-XF  
C: 910396-7457; DSN: 236-7952  
larsonwr@bragg.army.mil

**Support Operations Officer:** MAJ  
Jackie M. Cain  
ATTN: AFVH-XF  
C: 910-396-3833; DSN: 236-3833  
cainjm@bragg.army.mil

**Aviation Safety Officer:** CW4 Shapour  
Moinian  
ATTN: AFVH-XF

C: 910-396-9332; DSN: 236-9332  
moinians@bragg.army.mil

**MTFE (CH-47):** CW3 William Fox  
ATTN: AFVH-XF  
C: 910-396-0004; DSN: 236-0004  
foxw@bragg.army.mil

**MTFE (AH-64):** CW3 Mark Christianson  
ATTN: AFVH-XF  
C: 910-396-6707; DSN: 236-6707  
christianm@bragg.army.mil

**MTFE (UH-60):** CW5 Thomas Poulos  
ATTN: AFVH-XF  
C: 910-396-3289; DSN: 236-3289  
poulost@bragg.army.mil

82d Aviation Brigade  
82d Airborne Division  
Fort Bragg, NC 28307

\*Update not provided this year.

**Commander:** COL Melvin A. Roberson  
ATTN: AFVC-E  
C: 910-432-2604; DSN: 239-2604  
robersonma@bragg.army.mil

**Executive Office**  
ATTN: AFVC-E  
C: 910-432-1501; DSN: 239-1501

**SIP:** CW4 Willis Haas  
ATTN: AFVC-E  
C: 910-432-5174; DSN: 239-5174  
haaswe@bragg.army.mil

**ASO:** CW5 William Pfau  
ATTN: AFVC-E  
C: 910-432-5174; DSN: 239-5174  
pfauwill@bragg.army.mil

**Senior NCO:** CSM L. Barnard Basnight  
ATTN: AFVC-E  
C: 910-432-2604  
DSN: 239-2604  
basnighb@bragg.army.mil

# ARINC

Military

and

Commercial

Aviation

Communications, navigation,  
networks, avionics standards,  
hardware and software systems integration,  
aircraft modifications

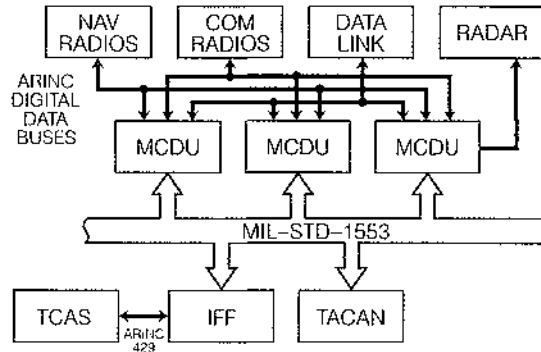

ARINC Incorporated  
6703 Odyssey Drive, Suite 104  
Huntsville, AL 35806  
Tel: 205 922 1022  
Fax: 205 922 1026  
Web site: www.arinc.com

A RECOGNIZED NAME IN AVIATION SINCE 1929

ASO: CW4 Ronald Underhill  
ATTN: AFVC-EB  
C: 910-396-1150; DSN: 236-1150  
underhillr@bragg.army.mil



Senior NCO:  
CSM Ricky Yates  
ATTN: AFVC-EB  
C: 910-432-8990  
DSN: 239-8990  
yatesricky@bragg.army.mil

56th Medical Evacuation Battalion  
Fort Bragg, NC 28307-5000  
Commander: LTC Pauline Knapp  
ATTN: AFZA-MB-F  
C: 910-396-4390; DSN: 236-4390  
knappp@bragg.army.mil

Executive Officer: MAJ Rupert Rockhill  
ATTN: AFZA-MB-FO  
C: 910-396-4390; DSN: 236-4390  
rockhillr@bragg.army.mil  
SIP: CW5 Peter R. Kalogris  
ATTN: AFZA-MB-FS  
C: 910-396-5503  
kalogrispr@bragg.army.mil  
Senior NCO: CSM Rodney Deese  
ATTN: AFZA-MB-FS  
C: 910-396-5503; DSN: 236-5503  
deeserrod@bragg.army.mil

57th Medical Co. (Air Ambulance)  
Fort Bragg, NC 28307-5000  
Commander: MAJ Neal David  
ATTN: AFZA-MB-Q  
C: 910-396-0029; DSN: 236-0029  
Davidn@bragg.army.mil

229th Aviation Regiment (Airborne)  
Fort Bragg, NC 28307-5000



Commander:  
COL Walter L. Davis  
ATTN: AFZA-ATK-RCO  
C: 910-396-3161  
DSN: 236-3161  
daviswl@bragg.army.mil

Executive Officer: MAJ Daniel C. Selph  
ATTN: AFZA-AR-RXO  
C: 910-396-2376; DSN: 236-2376  
selphdan@bragg.army.mil  
SIP: CW4 Craig Winters  
ATTN: AFZA-AR-SIP  
C: 910-396-1478; DSN: 236-1478  
kuhnti@bragg.army.mil

ASO: CW5 William F. Rhode  
ATTN: AFZA-AR-RASO  
C: 910-396-7960; DSN: 236-7960  
rhodewf@bragg.army.mil  
MTFE: CW4 Alvin Anderson  
ATTN: AFZA-AR-RAMO  
C: 910-396-7480; DSN: 236-7480  
anderav@bragg.army.mil



Senior NCO:  
CSM Earl M. Cline  
ATTN: AFZA-AR-RCSM  
C: 910-396-1490  
DSN: 236-1490  
clinee@bragg.army.mil

1st Battalion, 229th Aviation  
Regiment  
Fort Bragg, NC 28307

3d Battalion, 229th Aviation  
Regiment  
"Hell's Angels"  
Fort Bragg, NC 28307-5000  
Commander: LTC Robert L. Johnson, Jr.  
ATTN: AFZA-AR-C-CDR  
C: 910-396-7477; DSN: 236-7477  
johnsonrob@bragg.army.mil  
Executive Officer: MAJ Forrest Carpenter  
ATTN: AFZA-AR-C-XO  
C: 910-396-5880; DSN: 236-5880  
carpenterf@bragg.army.mil

S3: MAJ John Brooks  
ATTN: AFZA-AR-C-S3  
C: 910-396-7604; DSN: 236-7604  
brooksjohn@bragg.army.mil

SIP: CW4 Michael J. Brilliant  
ATTN: AFZA-AR-C-SIP  
C: 910-396-2168; DSN: 236-2168  
brilliantm@bragg.army.mil

PC Officer: CW3 Art Payton  
ATTN: AFZA-AR-C-PC  
C: 910-396-6542; DSN: 236-6542  
paytona@bragg.army.mil

ASO: CW3 Dale Suggs  
ATTN: AFZA-AR-C-ASO  
C: 910-396-7614; DSN: 236-7614  
suggsd@bragg.army.mil

S1: CPT E. J. Irvin  
ATTN: AFZA-AR-C-S1  
C: 910-396-9733; DSN: 236-9733  
irvinej@bragg.army.mil

### Morrisville

North Carolina Army National Guard  
Aviation Support Facility #1  
Raleigh-Durham Airport  
P. O. Box B  
Morrisville, NC 27560-8002  
\*Update not provided this year.



AASFC:  
LTC Ray Blackmon  
ATTN: AASF#1  
NCARNG  
C: 919-664-7506  
DSN: 582-9291  
aasf1nc@nc-arng.ngb.army.mil

### Raleigh

Office, State Adjutant General, North  
Carolina ARNG  
4105 Reedy Creek Road  
Raleigh, NC 27607-6410  
\*Update not provided this year.  
TAG: MG Gerald A. Rudisill, Jr.  
C: 919-664-6101; DSN: 582-9101

Office, State Army Aviation Officer,  
North Carolina ARNG  
Office of the Adjutant General  
4105 Reedy Creek Road  
Raleigh, NC 27607-6410



SAAO:  
LTC Andrew W.  
Goodwin  
ATTN: AGAV  
C: 919-664-6149  
DSN: 582-9149  
saonc@nc-arng.ngb.army.mil

### Salisbury

North Carolina Army National Guard  
Aviation Support Facility #2  
Rowan County Airport  
P. O. Box 1786  
Salisbury, NC 28145-1786  
AASFC: LTC Robert L. Sides  
ATTN: AASF-RUQ  
C: 704-359-5812; DSN: 583-9192  
sidesrob@nc-arng.ngb.army.mil

### NORTH DAKOTA Bismarck

Office, Adjutant General, North  
Dakota ARNG  
Fraire Barracks  
P.O. Box 5511  
Bismarck, ND 58506-5511



TAG:  
MG Keith D. Bjerke  
ATTN: AGND-Z  
C: 701-224-5102  
DSN: 344-5102  
bjerkekd@nd-arng.ngb.army.mil

Office, State Army Aviation Officer,  
North Dakota ARNG  
Army Aviation Support Facility  
P.O. Box 5511  
Bismarck, ND 58502-5511



SAAO:  
COL Fred A. Karnik  
ATTN: DCSAVN  
C: 701-224-5908  
DSN: 344-5908  
fred.karnik@nd.ngb.army.mil

North Dakota Army National Guard  
Army Aviation Support Facility  
P. O. Box 5511  
Bismarck, ND 58506-2511  
\*Update not provided this year.  
AASFC: LTC Gerald M. Heinle  
ATTN: AGND-DAVN-ZA  
C: 701-224-5160; DSN: 344-5160  
aasfnd@nd-arng.ngb.army.mil

### OHIO Columbus

Office, State Adjutant General, Ohio  
Army National Guard  
2825 West Dublin Granville Rd.  
Columbus, OH 43235-2789  
\*Update not provided this year.  
TAG: MG John H. Smith  
C: 614-336-7070; DSN: 273-7070

Office, State Army Aviation Officer,  
Ohio Army National Guard  
The Adjutant General's Dept.  
2825 West Dublin Granville Rd.  
Columbus, OH 43235-2789  
SAAO: COL Craig T. Ceneskie  
ATTN: AGOH-AV  
C: 614-336-7067; DSN: 346-7067  
SAOOH@oh-arng.ngb.army.mil

Ohio Army National Guard Aviation  
Support Facility #2  
8140 S. Access Road  
Bldg. 918  
Columbus, OH 43217-5918  
\*Update not provided this year.  
AASFC: LTC Rick D. Hall  
C: 614-492-3000  
aasf2oh@oh-arng.ngb.army.mil

3-137 Assault Helicopter Battalion  
Building 920  
Rickenbacker Airport  
Columbus, OH 43217-5920  
Commander: LTC Rick D. Hall  
ATTN: AGOH-TAHB-Z  
C: 614-336-6401

Executive Officer: MAJ Stuart Driesbach  
ATTN: AGOH-TAHB-XO  
C: 614-336-6102  
ASO: CW4 Brad Anspaugh  
ATTN: AGOH-TAHB-SA  
C: 614-336-6411; DSN: 950-3760  
Senior NCO: CSM Kim Stangelo  
ATTN: AGOH-AO-CSM  
C: 614-336-6027

### North Canton

Ohio Army National Guard Aviation  
Support Facility #1  
5989 Airport Drive NW  
North Canton, OH 44720-1483  
\*Update not provided this year.  
AASFC: COL Thomas P. Luczynski  
ATTN: AASF#1  
C: 614-336-6101; DSN: 346-6101  
aasf1oh@oh-arng.ngb.army.mil  
Maintenance Officer: CW4 Clarence R. Carpenter  
ATTN: AASF#1  
C: 614-336-6121; DSN: 346-6121

### OKLAHOMA Fort Sill

Henry Post Army Airfield  
Fort Sill, OK 73503-5100  
Airfield Manager: Mr. Randy C. Palmer  
ATTN: ATZR-TFA  
C: 580-442-4643; DSN: 639-4643  
palmer@sill.army.mil

### Lexington

Oklahoma Army National Guard  
Aviation Support Facility #1  
Highway 39 East & 144th Avenue  
Lexington, OK 73051-9549  
\*Update not provided this year.  
AASFC: LTC Jackie L. Self  
ATTN: OKAASF-LEX  
C: 405-527-5601; DSN: 940-3260

### Norman

Oklahoma Army National Guard  
Fixed Wing Operations  
Max Westheimer Airpot  
2232 Goddard Avenue  
Norman, OK 73069-8466  
\*Update not provided this year.

## Oklahoma City

Office, State Adjutant General,  
Oklahoma National Guard  
3501 Military Circle  
Oklahoma City, OK 73111-4398



**TAG:**  
MG Stephen P.  
Cortright  
ATTN: OKTAG  
C: 405-228-5201  
DSN: 940-3201  
cortright@ok.  
ngb.army.mil

Office, State Army Aviation Officer,  
Oklahoma Army National Guard  
3501 Military Circle  
Oklahoma City, OK 73111-4398



**State Army Aviation  
Officer:**  
COL Jackie L. Self  
ATTN: OKSAO  
C: 405-425-8294  
DSN: 940-3294  
Jackie.Self@  
ok.ngb.army.mil

## Tulsa

Oklahoma Army National Guard  
Aviation Support Facility #2  
4242 N. Mingo Valley  
Tulsa, OK 74116-5200  
\*Update not provided this year.

## OREGON Pendleton

Oregon Army National Guard Army  
Aviation Support Facility #2  
2110 NW 56th Street, Pendleton Airfield  
Pendleton, OR 97801  
\*Update not provided this year.  
Commander: LTC Tim Kelly  
C: 541-276-4544; aafs2@or-  
ngnet.army.mil

## Salem

Office, State Adjutant General,  
Oregon Army National Guard  
P. O. Box 14350  
Salem, OR 97309-5047  
\*Update not provided this year.  
TAG: MG Alexander H. Burgin  
ATTN: TAG  
C: 503-945-3991; DSN: 355-3991

Office, State Army Aviation Officer,  
Oregon Army National Guard  
Army Aviation Spt. Facility #1  
McNary Field, 1921 Turner Road, SE  
Salem, OR 97302-2099  
SAAO: COL Ben Gerding  
ATTN: SAAO  
C: 503-945-3217; DSN: 355-3993  
saao@or-arng.ngb.army.mil

Oregon Army National Guard Army  
Aviation Support Facility #1  
1921 Turner Road SE  
Salem, OR 97302  
\*Update not provided this year.  
Commander: CPT Todd E. Farmer  
C: 503-945-3310; DSN: 355-3310

## PENNSYLVANIA Annville

Det 1, 198th Medical Company (AA)  
Building 19-119 FTIG  
Annville, PA 17003-5002  
\*Update not provided this year.

2-104th Aviation Battalion (GSAB)  
Building 19-119  
Fort Indiantown Gap  
Annville, PA 17003-5002  
\*Update not provided this year.  
Commander: LTC Paul DeVincenzo  
ATTN: AVGS-CDR  
C: 717-861-8251; DSN: 491-8251  
uasaa@redrose.net

Senior NCO: CSM Patrick Shipe  
ATTN: AVGS-CSM  
C: 717-861-8251; DSN: 491-8251  
shipepj@pa-arng.ngb.army.mil

28th Infantry Div. Aviation Brigade,  
Pennsylvania ARNG, Bldg 19-119  
Fort Indiantown Gap  
Annville, PA 17003-5002  
Commander: COL John B. Stavovy, Jr.  
ATTN: TDAV-CDR  
C: 717-861-8251; DSN: 491-8251  
Executive Officer: LTC Barney Pultz  
ATTN: TDAV-XO  
C: 717-861-8251; DSN: 491-8251  
ASO: CW5 John E. Marcinowski  
ATTN: TDAV-ASO  
C: 717-861-8251; DSN: 491-8251

Senior NCO: CSM Francis Zandome  
ATTN: TDAV-CSM  
C: 717-861-8252; DSN: 491-8252

Eastern Army National Guard  
Aviation Training Site (EAATS)  
Department of Military Affairs  
Annville, PA 17003-5004



Commander:  
COL James G. Pierce  
ATTN: EAATS-HQ-C  
C: 717-861-8864  
DSN: 491-8864  
piercejg@  
pa-arng.ngb.army.mil

# Black Hawk Gyro Replacement

## LCR-92H "FOG" AHRS Retrofit in the UH-60

The LCR-92H is a solid-state strapdown "fog" (fiber optic gyro) AHRS (Attitude Heading Reference System) which replaces older mechanical gyros. A single LCR-92H replaces three older gyros in the UH-60 with a highly reliable, accurate & cost effective system. The retrofit can be accomplished with a minimum of effort, without altering aircraft wiring. An adapter harness mates with the aircraft connectors, and the mounting hardware uses existing mounting holes. The existing compass flux valve and cockpit control unit remain, and are utilized by the LCR-92H AHRS. The procedure is as follows:

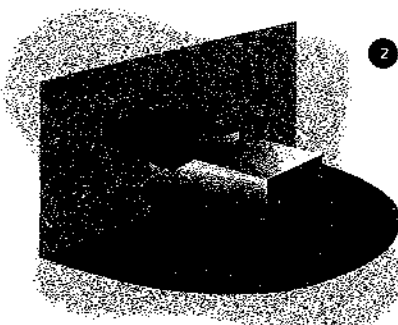
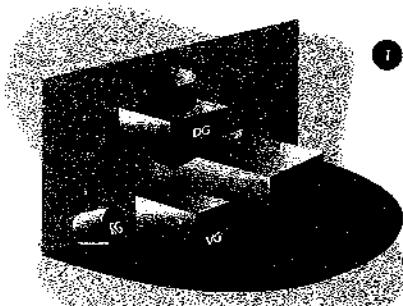

- Remove pilot side VG (CN-1314, CN-1497/A, or CN-811), the DG (CN-998) & the Rate Gyro (TRU-2/A)
- Bolt the connector mounting bracket of the adapter harness to top front of the DG shelf.
- Harness tie the VG, DG and Rate Gyro harnesses and reroute them to the connector mounting bracket.
- Plug the existing gyro connectors into the mating connectors on the mounting bracket.

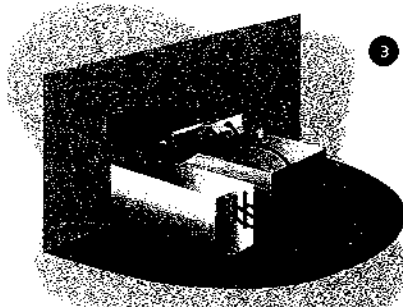

**DAC**  
INTERNATIONAL

6702 McNeil Drive • Austin, Texas 78729

512/331-5323, voice • 512/331-4516, fax • 800/527-2531, u.s. • rmullinsr@aol.com, e-mail

Deputy Commander: LTC Paul M. Amalfitano  
 ATTN: EAATS-HQ-DC  
 C: 717-861-8878; DSN: 491-8864  
 amalfitanopm@pa-ngb.army.mil  
 Senior NCO: CSM Charles N. Reisinger  
 ATTN: EAATS-HQ-CSM  
 C: 717-861-8795; DSN: 491-8864  
 reisingernc@pa-arng.hgb.army.mil

Office, State Adjutant General,  
 Pennsylvania ARNG, Dept of Military  
 and Veterans Affairs  
 Annville, PA 17003-5002  
 \*Update not provided this year.



TAG:  
 MG William B. Lynch  
 C: 717-861-8500  
 DSN: 491-8500

Office, State Army Aviation Officer,  
 Pennsylvania ARNG  
 The Adjutant General of PA  
 Dept of Mil. & Vet. Affairs  
 Annville, PA 17003-5002



SAAO:  
 COL Christopher D. Latchford  
 ATTN: TAGPA-SAAO  
 C: 717-861-8825  
 DSN: 491-8825  
 saopa@pa-arng.army.mil

Pennsylvania Army National Guard  
 Army Avn. Support Facility #1  
 Department of Military  
 and Veterans Affairs  
 Bldg. 19-101, FTIG  
 Annville, PA 17003-5005  
 AASFC: COL Christopher Latchford  
 ATTN: AASF-FTIG  
 C: 717-861-8924; DSN: 491-8924  
 aasf1pa@pa-arng.ngb.army.mil

### Horsham

2d Battalion, 228th Aviation Reg.  
 936 Easton Road  
 Horsham, PA 19044



Commander:  
 LTC Kim Wright  
 ATTN: AFRC-AVIL-FQ  
 C: 215-957-0550,  
 x229

Exec. Officer: MAJ Daryl W. Blohm  
 ATTN: AFRC-AVIL-FQ  
 C: 215-957-0550, x228  
 Senior NCO: CSM Michael J. Clisham  
 C: 215-957-0550, x227

### Johnstown

Pennsylvania Army National Guard  
 Army Avn. Support Facility #2  
 292 Aviation Drive  
 Johnstown, PA 15902-7201  
 AASFC: LTC Dan Berkebile  
 C: 814-532-7725  
 berkebile@pa-arng.ngb.army.mil  
 Operations Officer: CPT John Kovac  
 C: 814-532-7716  
 Kovacjd@pa-arng.army.mil

Maint. Officer: LTC Barney Pultz  
 C: 814-533-7723  
 pultzb@pa-arng.ngb.army.mil  
 Safety Officer: CW4 William A. Johns  
 C: 814-532-7717  
 johnswa@pa-arng.ngb.army.mil

1st Battalion, 104 Aviation (Atk Hel)  
 292 Aviation Drive  
 Johnstown, PA 15902-7201  
 Commander: LTC Dan Berkebile  
 C: 814-532-7725  
 berkebile@pa-arng.ngb.army.mil  
 Executive Officer: MAJ C. Hunt  
 C: 814-532-7700  
 ccahunt@aol.com  
 ASO: CW4 James M. Tuck  
 C: 814-533-7713  
 MTFE: CW4 Kenneth B. Ott  
 C: 814-532-7713  
 SIP: CW4 William A. Johns  
 C: 814-532-7717  
 johnswa@pa-arng.ngb.army.mil  
 Senior NCO: CSM Joseph L.  
 Podolinsky  
 C: 814-732-7700

### Philadelphia

Defense Contract Management,  
 Boeing Philadelphia  
 P. O. Box 16859, MS P23-50  
 Philadelphia, PA 19142-0859  
 Commander: LTC Anthony B. Bell  
 ATTN: DCMDE-RED  
 C: 610-591-8500  
 abell@dcmdc.dcm.army.mil  
 Deputy Commander: Mr. Charles S.  
 McAleer  
 ATTN: DCMDE-RED  
 C: 610-591-8502  
 csmcaleer@dcmdc.dcm.army.mil  
 Chief, Flight Operations Group: MAJ  
 Charles F. Stroup, Jr.  
 ATTN: DCMDE-REDF  
 C: 610-591-3030  
 cstroup@dcmdc.dcm.army.mil

### PUERTO RICO Fort Buchanan

U.S. Army South (USARSO)  
 Fort Buchanan, PR 00934



Aviation Officer:  
 Mr. Raymond F.  
 O'Neill, Jr.  
 DCSOPS Avn. Div.,  
 Unit 7107  
 C: 787-707-5710  
 DSN: 312-740-571-  
 roneill@emh1.  
 buchanan.army.mil

### San Juan

Office, State Adjutant General,  
 Puerto Rico ARNG  
 P. O. Box 3786  
 San Juan, PR 00902-3786  
 \*Update not provided this year.



TAG:  
 MG Emilio Diaz-  
 Colon  
 ATTN: PR-TAG  
 C: 787-724-1295  
 tagpr@pr-  
 arng.ngb.army.mil

Office, State Army Aviation Officer,  
 Puerto Rico ARNG  
 Army Aviation Support Facility  
 P.O. Box 3786  
 San Juan, PR 00902-3786  
 SAAO: LTC Rufeno Velantour  
 ATTN: SAAO-PRARNG  
 C: 787-722-3916  
 saopr@pr-arng.ngb.army.mil

Puerto Rico Army National Guard  
 Army Aviation Support Facility  
 P. O. Box 3786  
 San Juan, PR 00902-3786  
 \*Update not provided this year.

### RHODE ISLAND Cranston

Office, State Adjutant General,  
 Rhode Island ARNG  
 Command Readiness Center  
 645 New London Avenue  
 Cranston, RI 02920-3097  
 \*Update not provided this year.  
 TAG: MG Reginald A. Centracchio  
 ATTN: TAGRI  
 C: 401-457-4102; DSN: 557-3102  
 tagri@ri-ngnet.army.mil

### North Kingstown

Office, State Army Aviation Officer,  
 Rhode Island ARNG  
 AASF RI ARNG  
 Hangar 2, 104 Airport Street  
 North Kingstown, RI 02852-7516



SAAO:  
 COL William H. Pond  
 ATTN: TAGRI-SAO  
 C: 401-621-5401  
 DSN: 557-3401  
 saori@ri-arng.  
 ngb.army.mil

Rhode Island ARNG Army Aviation  
 Support Facility  
 Hangar 2, 104 Airport Street  
 Davisville Industrial Park  
 North Kingstown, RI 02852-7516  
 AASFC: LTC Kenneth T. Gareau  
 ATTN: AASF-FC  
 C: 401-621-5401; DSN: 247-5401  
 gareauk@ri-arng.ngb.army.mil

### SOUTH CAROLINA Columbia

Office, State Adjutant General, South  
 Carolina ARNG  
 1 National Guard Road  
 Columbia, SC 29201-4766



TAG:  
 MG Stanhope S.  
 Spears  
 ATTN: TAG  
 C: 803-806-4217  
 DSN: 583-4217  
 spears@sc-  
 arng.ngb.army.mil

Office, State Army Aviation Officer,  
 South Carolina ARNG  
 Office of the Adjutant General  
 1 National Guard Road  
 Columbia, SC 29201-4766  
 SAAO: LTC Lester D. Eisner  
 ATTN: TAG-AV  
 C: 803-806-4335; DSN: 583-4335  
 saosc@sc-arng.ngb.army.mil

### Eastover

South Carolina Army National Guard  
 Army Aviation Support Facility  
 1325 South Carolina Road  
 Suite 41  
 Eastover, SC 29044-5041  
 \*Update not provided this year.  
 AASFC: LTC Earl M. Yerrick  
 ATTN: TAG-AV-AASF  
 C: 803-776-7030; DSN: 583-8298  
 aasf1sc@sc-arng.ngb.army.mil

1151 Aviation (Advanced Attack  
 Helicopter)  
 10311 Garners Ferry Rd.  
 Eastover, SC 29044  
 \*Update not provided this year.  
 Commander: LTC Earl M. Yerrick, Jr.  
 C: 803-806-1717  
 Senior NCO: CSM George E. Dorr  
 C: 803-806-1717

### SOUTH DAKOTA Rapid City

1085th Medical Company  
 4750 Guard Road  
 Rapid City, SD 57701-8708  
 \*Update not provided this year.  
 Office, State Adjutant General, South  
 Dakota ARNG  
 2823 West Main Street  
 Rapid City, SD 57702-8186  
 TAG: MG Philip G. Killey  
 ATTN: SDTAG  
 C: 605-737-6702; DSN: 747-8702  
 killeyp@sd.ngb.army.mil

Office, State Army Aviation Officer,  
 South Dakota ARNG  
 AASF, Rapid City Regional Arpt  
 4750 Guard Road  
 Rapid City, SD 57703-8708  
 SAAO: COL Roger D. Dubs  
 ATTN: SDSAO  
 C: 605-737-6370; DSN: 747-8370  
 saosd@sd.ngb.army.mil

South Dakota Army National Guard  
 Army Aviation Support Facility  
 Regional Airport  
 4750 Guard Road  
 Rapid City, SD 57703-8708  
 AASFC: COL Roger D. Dubs  
 ATTN: SDSAO  
 C: 605-737-6370; DSN: 747-8370  
 aasf1@sd.ngb.army.mil

### TENNESSEE Chattanooga

Tennessee Army National Guard  
 Aviation Support Facility 3  
 5900 Lovell Field Loop  
 Chattanooga, TN 37421-2163  
 \*Update not provided this year.  
 AASFC: MAJ Gregory A. Castleberry  
 C: 423-634-6018

### Jackson

Tennessee ARNG Army Aviation  
 Support Facility #3  
 2254 Westover Road  
 Jackson, TN 38301-9642



**AASFC:** LTC Ronald K. Herrington  
ATTN: AGTN-AA3  
C: 901-426-0581; DSN: 573-8693  
ronaldh@tn-armg.ngb.army.mil

### Louisville

**Tennessee Army National Guard  
Aviation Support Facility #2**  
2111 Army Drive  
Louisville, TN 37777-6300  
\*Update not provided this year.

**AASFC:** LTC Terry A. Ethridge  
ATTN: AASF #2  
C: 423-985-4601; DSN: 266-4601

### Nashville

**Office, State Adjutant General,  
Tennessee ARNG**  
P. O. Box 41502  
Nashville, TN 37204-1501



**TAG:**  
MG Jackie D. Wood  
ATTN: AGTN-AG  
C: 615-313-3001  
DSN: 683-3001  
tag@tn-armg.ngb.  
army.mil

**Office, State Army Aviation Officer,  
Tennessee ARNG**  
National Guard Center  
Sidco Drive, CGTN-DOA  
Nashville, TN 37204-1501

**SAAO:** LTC Terry A. Ethridge  
ATTN: AGTN-DOA  
C: 615-355-3735; DSN: 683-3735  
saotn@tn-armg.ngb.army.mil

### Smyrna

**Tennessee Army National Guard  
Aviation Support Facility #1**  
Building 680, Smyrna Airport  
Smyrna, TN 37167-2091

**AASFC:** LTC Terry A. Ethridge  
ATTN: AGTN-AA1  
C: 615-355-3612; DSN: 683-3612

**Supervisory IP:** CW5 Charles W. Bell  
C: 615-355-3732; DSN: 683-3732

**Operations Officer:** CPT Charles W. Bell  
C: 615-355-3645; DSN: 683-3645

**Safety Officer:** CW4 Lloyd A. Cordray  
C: 615-355-3698; DSN: 683-3698

**Maintenance Officer:** CW4 John S.  
McConnell  
C: 615-355-3738; DSN: 683-3634

**Quality Assurance:** CW2 Lee A. Kies  
C: 615-355-3634; DSN: 683-3634

**ALSE Technician:** SPC Roxanne B.  
Davenport  
C: 615-355-3608; DSN: 683-3608

### TEXAS Austin

**49th Armored Division Aviation Bde**  
3701 Fighter Drive  
Austin, TX 78719  
**Commander:** COL John M. Braun  
ATTN: ARDV-HZ  
C: 512-483-3104; DSN: 954-3104

**Senior NCO:** CSM James G. Danner  
ATTN: ARDV-HC-SM  
C: 512-483-3111; DSN: 954-3111

**FTUS Officer:** LTC Eugene F. Coyne  
ATTN: ARDV-HX  
C: 512-483-3104; DSN: 954-3104  
ecoyn@attglobal.net

**49th Armored Division Aviation  
Brigade, HHC**  
3701 Fighter Drive  
Austin, TX 78719

**Commander:** 1LT Randy J. Beffrey  
ATTN: ARDV-HZ  
C: 512-483-3115; DSN: 954-3115

**Senior NCO:** 1SG David R. Resendez  
ATTN: ARDV-HZ  
C: 512-483-3115; DSN: 954-3115

**FTUS NCO:** SFC Johnny Stokes  
C: 512-465-5289; DSN: 954-5289

**Office, State Adjutant General, Texas  
Army National Guard**  
P. O. Box 5218  
Austin, TX 78763-5218  
\*Update not provided this year.

**TAG:** MG Daniel James III  
ATTN: AGTK-A  
C: 512-465-5006; DSN: 954-5006

**Office, State Army Aviation Officer,  
Texas Army National Guard  
Office of the Adjutant General**  
P.O. Box 5218  
Austin, TX 78763-5218



**SAAO:**  
COL James B.  
Looney  
ATTN: AGTX-AV  
C: 512-465-5167  
DSN: 954-5167  
saotx@tx-armg.  
ngb.army.mil

**Texas Army National Guard Aviation  
Support Facility #1**  
3711 Fighter Drive  
Austin, TX 78719-2557  
\*Update not provided this year.  
**AAASF:** LTC John F. Stoley  
ATTN: AAASF  
C: 512-530-2008  
jfstoley@aol.com

### Conroe

**7th Squadron, 6th Cavalary  
Regiment (ATKHB)**  
4724 South Parkway  
Conroe, TX 77303-4355



**Commander:**  
MAJ(P) Ron D.  
Dupree  
ATTN: AFRC-AVIL-  
AQ-CO  
C: 409-525-3417  
ron.dupree@  
usarc-emh2.army.mil

**S-3:** MAJ Matt Buretz  
ATTN: AFRC-AVIL-AQ-OP  
C: 409-525-3443  
matthew.buretz@usarc-emh2.army.mil

**Executive Officer:** MAJ Robert D.  
Bryan  
ATTN: AFRC-AVIL-AQ-XO  
C: 409-525-3392  
robert.bryan@usarc-emh2.army.mil

**SIP:** CW4 David Chumard  
ATTN: AFRC-AVIL-AQ-SP  
C: 409-525-3324  
david.chumard@usarc-emh2.army.mil

**ASO:** CW4 Daniel Heggie  
ATTN: AFRC-AVIL-AQ-AS  
C: 409-525-3373  
daniel.heggie@usarc-emh2.army.mil

## Increased Survivability!



### Your Inertia Reel Must Function Properly To Protect You In A Survivable Accident

- ▶ The MA-16 locks securely on sudden strap acceleration as well as omni-directional vehicle impact.
- ▶ The Dual-Locking system of the Koch MA-16 greatly increases the survivability of a severe impact accident.
- ▶ The Koch MA-16 Inertia Reel is qualified to MIL-R-8236 Rev. F and listed on the QPL8326F.
- ▶ P/N 015-870145-3-16, NSN1680-01-437-0396

## Call Us Today With Your Requirements!



### H. KOCH & SONS CO.

5410 E. La Palma Ave • P.O. Box 68005 • Anaheim, CA 92817-0805  
Tel: (714) 779-7000 • Fax: (714) 779-7141  
Email: sales@hkoch.com Web: www.hkoch.com



**Senior NCO:**  
CSM James Schiffman  
ATTN: AFRC-AVIL-AQ  
C: 409-525-3327  
james.schiffman@usarc-emh2.army.mil



**Commander:**  
MAJ Milton O. Rodriguez  
ATTN: ATZC-GC-AV  
C: 915-568-8242  
DSN: 978-8242  
rodriguez@emh10.bliss.army.mil

**Senior NCO:** CSM Frank Hill  
ATTN: AFVB-A-CSM  
C: 817-287-4774; DSN: 737-4774

**1st Attack Battalion, 4th Aviation Regiment**  
**4th Infantry Division (Mech)**  
Fort Hood, TX 76544-5200



**Commander:**  
LTC Michael N. Thome  
ATTN: AFYB-AVA-CO  
C: 254-287-2364  
DSN: 737-2364  
14avnbnodr@hood-emh3.army.mil  
**Executive Officer:**

**MAJ Russ Stinger**  
AFYB-AVA-CO  
C: 254-287-2381; DSN: 737-2381  
14avnbnxo@hood-emh3.army.mil  
**SIP:** CW4 Matthew Cordell  
ATTN: AFYB-AVA-SD  
C: 254-288-3256; DSN: 738-3256  
14avnstandards@hood-emh3.army.mil

**ASO:** CW4 Carl David  
ATTN: AFYB-AVA-SAF  
C: 254-287-3710; DSN: 737-3710  
4ID14avnsafely@hood.army.mil  
**MTFE:** CW4 Alan Ruzicka  
ATTN: AFZC-AVA-D  
C: 254-287-4638; DSN: 737-4638  
14avnacdr@hood-emh3.army.mil



**Senior NCO:**  
CSM Reginald E. Smith  
ATTN: AFZC-AVA-CSM  
C: 254-287-2426  
DSN: 737-2426  
14avncsm@hood.army.mil

**2nd Battalion, 4th Aviation Regiment**  
**4th Infantry Division (Mech)**  
Fort Hood, TX 76544-5200  
\*Update not provided this year.

**404th Support Battalion (Aviation)**  
**4th Infantry Division (MECH)**  
Fort Hood, TX 76544

\*Update not provided this year.  
**Commander:** LTC Patrick L. Sherman  
ATTN: AFYB-SSC-CDR  
C: 254-288-3502; DSN: 738-3502  
shermanp@hood-emh3.army.mil

**1st Cavalry Division**  
Fort Hood, TX 76545  
**Assistant Division Commander (Maneuver):** COL(P) James E. Simmons  
ATTN: AFVA-ADC-M  
C: 817-287-4404; DSN: 737-4404

**4th Brigade (Avn), 1st Cavalry Division**  
Fort Hood, TX 76545  
**Brigade Cmdr:** COL John Bendyk  
ATTN: AFVA-4BDE-CDR  
C: 254-287-4253; DSN: 737-4253  
bendykj@hood-emh3.army.mil  
**Executive Officer:** LTC Otis Brown  
ATTN: AFVA-4BDE-XO  
C: 254-287-4793; DSN: 737-4793  
brown@hood-emh3.army.mil  
**SIP:** CW5 Ramiro Guerrero  
ATTN: AFVA-4BDE-SIP  
C: 254-288-1006; DSN: 738-1006  
4bde\_1cd\_stands@hood-

emh3.army.mil  
**ASO:** CW5 Duane Larsen  
ATTN: AFVA-4BDE-ASO  
C: 254-288-1006; DSN: 738-1006  
larsend@hood-emh3.army.mil  
**MTFE:** CW5 Marvin P. Humble  
ATTN: AFVA-4BDE-MTFE  
C: 254-288-7284; DSN: 737-7284  
humblem@hood-emh3.army.mil



**Senior NCO:**  
CSM Waller Beckman  
ATTN: AFVA-4BDE-CSM  
C: 254-287-9633  
DSN: 737-9633  
beckmanw@hood-emh3.army.mil

**S-3:** MAJ Mike McMahon  
ATTN: AFVA-4BDE-S3  
C: 254-287-4442; DSN: 737-4442  
mcmahonm@hood-emh3.army.mil

**1st Squadron, Seventh Cavalry**  
**1st Cav Aviation Brigade**  
Fort Hood, TX 76545-5113  
\*Update not provided this year.



**Commander:**  
LTC Anthony R. lerardi  
ATTN: AFVA-4BDE-177CAV-CDR  
C: 817-287-2811  
DSN: 737-2811

**Executive Officer:** MAJ David E. Williams  
ATTN: AFVA-4BDE-177CAV-XO  
C: 817-287-4080; DSN: 737-9689  
**SIP:** CW4 Richard Guy  
ATTN: AFVA-CAB-177CAV-SIP  
C: 817-288-1034; DSN: 738-1034  
**ASO:** CW3 Tommy Starnes  
ATTN: AFVA-4BDE-177CAV-ASO  
C: 817-288-1036; DSN: 738-1036  
**MTFE:** CW4 Floyd S. Werner, Jr.  
C: 817-287-3945; DSN: 737-3945



**Senior NCO:**  
CSM Johnnie Lightsey  
ATTN: AFVA-4BDE-177CAV-CSM  
C: 254-287-6524  
DSN: 737-6524  
LIGHTSEYJ@hood-emh3.army.mil

**2nd Battalion, 227th Aviation Regiment**  
**4th Brigade (Avn)**  
**1st Cavalry Division**  
Fort Hood, TX 76545  
\*Update not provided this year.



**Commander:**  
LTC Donald M. MacVillie  
ATTN: AFVA-AB-2-227  
C: 254-288-1022  
DSN: 738-1022  
macvillied@hood-emh3.army.mil

## Corpus Christi

**Corpus Christi Army Depot (CCAD)**  
308 Crecy Street, Stop 11  
Corpus Christi, TX 78419-5260



**Commander:**  
COL Mitch Dockens  
ATTN: AMSAM-CC-CO  
C: 361-961-3771  
DSN: 861-3771  
tdockens@ccad.army.mil

**Deputy to the Commander:** Mr. Blaine Withers

ATTN: AMSAM-CC-CX  
C: 361-961-3771; DSN: 861-3771  
bwiters@ccad.army.mil

**Depot Operations Officer:** Mr. Larry R. Jobe

ATTN: AMSAM-CC-CD  
C: 361-961-3771; DSN: 861-3771  
ljobe@ccad.army.mil

**Chief, Business Development Office:**

Mr. Kresten Cook  
ATTN: AMSAM-CC  
C: 361-961-3132; DSN: 861-3132  
kcook@ccad.army.mil

**Director of Maintenance:** Mr. Jerry D. New

ATTN: AMSAM-CC-MA  
C: 361-961-4167; DSN: 861-4167  
jnew@ccad.army.mil

**Chief, Aircraft Production Division:**

Ms. Sydney Hutchins  
ATTN: AMSAM-CC-MA-AP  
C: 361-961-3552; DSN: 861-3552  
shutchin@ccad.army.mil

**Chief, Components Production**

**Division:** Mr. Wayne McConley  
ATTN: AMSAM-CC-MA-CP  
C: 361-961-3622; DSN: 861-3622  
wmconle@ccad.army.mil

**Chief, Power Train Production**

**Division:** Mr. Joe Herrera  
ATTN: AMSAM-CC-MA-PT  
C: 361-961-3561; DSN: 861-3561  
jherrera@ccad.army.mil

**Acting Chief, Production Control**

**Division:** Mr. Bill Cary  
ATTN: AMSAM-CC-MA-PC  
C: 361-961-4167; DSN: 861-4167  
bcary@ccad.army.mil

**Chief, Quality Assurance Division:**

Mr. A. E. Wohlman, Jr.  
ATTN: AMSAM-CC-MA-QA  
C: 361-961-2714; DSN: 861-2714  
awohlma@ccad.army.mil

## Fort Bliss

**Biggs Army Airfield**  
**Garrison Command**  
1733 Pleasonton Road  
Fort Bliss, TX 79916-8816

**204th Military Intelligence Battalion**  
Bldg. 11176, SSG Sims Street  
Fort Bliss, TX 79918-8004

**Commander:** LTC Charles R. Mehle  
ATTN: IAFG-A-CDR  
C: 915-569-6066; DSN: 979-6066  
mehlec@204mibn.army.mil

**Executive Officer:** MAJ Joseph A. Wucik

C: 915-569-6067; DSN: 979-6067  
wucikja@204mibn.army.mil

**S3:** MAJ Michael L. Popovich  
C: 915-569-6084; DSN: 979-6084  
popovichmi@204mibn.army.mil

**Senior NCO:** CSM Charles R. Holloway

C: 915-569-6079; DSN: 979-6079  
hollowaycr@204mibn.army.mil

**SIP:** CW5 William J. Schaller

C: 915-569-6097; DSN: 979-6097  
schallerwj@204mibn.army.mil

**Safety Officer:** CW2 Christopher Sorrell

C: 915-569-6058; DSN: 979-6058  
sorrellca@204mibn.army.mil

**HSC Commander:** CPT James G. Wideman

C: 915-569-6070; DSN: 979-6070  
widemanjg@204mibn.army.mil

**Company Commander:** CPT Carol M. Tschida

C: 915-569-6027; DSN: 979-6027  
tschidacm@204mibn.army.mil

**D Company Commander:** CPT Glenn E. Lapointe

C: 915-569-6101; DSN: 979-6101  
lapointge@204mibn.army.mil

## Fort Hood

**Digital Force Coordination Cell**  
**III Corps**  
Fort Hood, TX 76544

**Director:** COL Craig K. Madden  
C: 254-286-8828; DSN: 566-8828  
maddenc@hood-emh3.army.mil

**III Corps Aviation Office**

Fort Hood, TX 76544-5056  
**III Corps Aviation Officer:** COL Gregory D. Walker

C: 254-287-8686; DSN: 737-8686  
Gregory.Walker@hood.army.mil

**4th Brigade (Avn), 4th Infantry Division (MECH)**

Fort Hood, TX 76544  
**Commander:** COL James O. Barclay

ATTN: AFZC-AV-CO  
C: 254-287-4094; DSN: 737-4094  
James.Barclay@hood.army.mil

**Exec. Officer:** LTC James R. Upright

ATTN: AFZC-AV-XO  
C: 254-287-4859; DSN: 737-4859  
uprightj@hood-emh3.army.mil

**SIP:** CW4 Rick Stout

ATTN: AFZC-AV-STD  
C: 254-288-6209; DSN: 738-6209  
stoutra@hood-emh3.army.mil

**ASO:** CW5 Bill Tucker

ATTN: AFVB-A-SAFE  
C: 254-287-4373; DSN: 737-4373  
4ID4BDESAFE@hood-emh3.army.mil

**Executive Officer:** MAJ Richard D. Reimers

ATTN: AFVA-AB-2-227-XO  
C: 254-288-1016; DSN: 738-1016  
reimersd@hood-emh3.army.mil  
SIP: CW4 Michael Wilson  
ATTN: AFVA-AB-2-227-SIP  
C: 254-288-1988; DSN: 738-1988

ASO: CW3 Randy Kirgiss  
ATTN: AFVA-AB-2-227-SAFE  
C: 254-288-9286; DSN: 738-9286  
kirgissr@centraltx.net

MFTE: CW3 James Burk  
ATTN: AFVA-AB-2-227-D  
C: 254-288-2170; DSN: 738-2170

Senior NCO: CSM Jimmy G. Ruiz  
ATTN: AFVA-AB-2-227-CSM  
C: 254-288-1009; DSN: 254-738-1009  
ruizj@hood-emh3.army.mil

SIP: CW5 Lance V. McElhiney  
ATTN: AFVU-AH-T  
C: 254-288-3575; DSN: 738-3575  
Lance.McElhiney@hood.army.mil  
ASO: CW4 Robert Davis  
ATTN: AFVU-AH-T  
C: 254-288-3825; DSN: 738-3825  
Robert.Davis@hood.army.mil



Senior NCO:  
CSM L. M. Morgan  
ATTN: AFVU-AH  
C: 254-288-2313  
DSN: 738-2313  
L.Morgan@hood.army.mil

507th Medical Company (Air Ambulance)  
Fort Hood, TX 76544-5000  
Commander: MAJ Robert D. Mitchell  
ATTN: AFVG-MG-ME-ACO  
C: 254-288-1436; DSN: 738-1436

Aviation Test Directorate, USATEX-COM  
Fort Hood, TX 76544-5065  
\*Update not provided this year.  
Director: Mr. Harvey Elmore  
ATTN: CSTE-TEX-AV  
C: 254-288-9992; DSN: 738-9992  
elmoreharvey@texcom-mail.army.mil  
Directorate NCOIC/Senior Test NCO:  
Master Sergeant Mark Ingram  
ATTN: CSTE-TEX-AV  
C: 254-288-9150; DSN: 738-9150  
ingrammark@texcom-mail.army.mil

Aviation Systems Test Div., Aviation Test Directorate, USATEXCOM  
Fort Hood, TX 76544



Division Chief:  
Mr. David E. Boyken  
ATTN: CSTE-OTC-AV-A  
C: 254-288-9774  
DSN: 738-9774  
boykendave@otc.army.mil

Division NCOIC: SFC Jeff Flores  
ATTN: CSTE-OTC-AV-A  
C: 254-288-9594; DSN: 738-9594  
floresjeffrey@otc.army.mil  
Combat Aviation Test Div., Aviation Test Directorate, USATEXCOM  
Fort Hood, TX 76544

Division Chief: LTC William F. Horn  
ATTN: CSTE-TEX-AV-C  
C: 254-288-1614; DSN: 738-1614  
hornwilliam@otc.army.mil

Senior Military Test Plans Analyst:  
Mr. Robert Strange  
ATTN: CSTE-TEX-AV-C  
C: 254-288-9213; DSN: 738-9213  
strangerobert@otc.army.mil  
Division NCOIC: SFC Robert Rance  
ATTN: CSTE-TEX-AV-C  
C: 254-288-9633; DSN: 738-9633  
rancerobert@otc.army.mil

21st Cavalry Brigade (Air Combat) III Corps and Fort Hood  
Fort Hood, TX 76544-5038



Commander:  
COL Gregory D. Walker  
ATTN: AFVU-AH  
C: 254-288-2301  
DSN: 738-2301  
Gregory.Walker@hood.army.mil

Deputy Brigade Commander: LTC William H. Brown V  
ATTN: AFVU-AH  
C: 254-288-2302; DSN: 738-2302  
William.Brown@hood.army.mil

Executive Officer: MAJ Carl B. Higgs  
ATTN: AFVU-AH  
C: 254-288-2302; DSN: 738-2302  
Carl.Higgs@hood.army.mil

maj\_john\_bukartek@smtlink.med-com.amedd.army.mil

### Fort Worth

Defense Contract Management Command, Bell Helicopter Textron  
P.O. Box 1605  
Fort Worth, TX 76101-1605



Commander:  
COL Barney A. Grimes III  
ATTN: DCMDW-RKD  
C: 817-280-7015  
DSN: 477-7015  
bgrimes@dcmdw.dla.mil

### Grand Prairie

Texas Army National Guard Aviation Support Facility #3  
1009 Lakecrest Drive  
Grand Prairie, TX 75051-3497  
AASFC: LTC Millard C. Rushing  
ATTN: DAASF-CDR  
C: 972-2646-64186560  
daasfm@mindspring.com

### Houston

1st Battalion, 149th Aviation Regiment  
Building 1182, Ellington ANGB  
Houston, TX 77034-5596  
\*Update not provided this year.  
FTUS Officer: CPT Guy Schultz  
ATTN: ARDV-THX  
C: 281-929-2765; DSN: 954-2765  
guysch@aol.com

### Fort Sam Houston

Aviation Office, U.S. Army Medical Command  
Fort Sam Houston, TX 78234-6000  
Aviation Staff Officer: MAJ John V. Bukartek  
ATTN: MCOP-O  
C: 210-221-7045; DSN: 471-7045

# If you're not in our seats, you don't know Jack.

TROOP SEATS



VIP SEATS



PILOT SEATS



Jack Cress, Product Manager  
Military Seats @ Simula

Got military seat requirements?  
Jack is waiting *impatiently* for your call!!!



Safety Systems Inc  
Applied Technologies Division

7414 South Harl Avenue  
Tempe, Arizona 85283-4307 USA  
Phone: (480) 893-6245

Fax: (480) 897-1906

E-mail: simsafe2@sssi.simula.com  
EEO / Affirmative Action Employer

The World Leader in  
design & manufacture  
of energy-absorbing  
seats!



FM 45484

ASO: CW4 Donald Garito  
C: 713-484-6183; DSN: 954-2334

Texas Army National Guard Aviation  
Support Facility #4  
1183 Ellington Field  
Houston, TX 77034-5597

### Mesquite

341st Medical Battalion (EVAC)  
612 East Davis Street  
Mesquite, TX 75149-4798  
\*Update not provided this year.

### San Antonio

2nd Battalion, 149th Aviation  
Regiment  
5500 IH 10E  
San Antonio, TX 78219-4599  
Commander: MAJ(P) Vernon A. Sevier  
ATTN: ARDV-UHZ  
C: 512-421-1736; DSN: 954-1736  
vasevier@hal-pc.org

FTUS Officer: CPT Troy Meuth  
C: 512-421-1711; DSN: 954-1711  
meuthid@tx.ngb.army.mil  
ASO: CW4 John Hickman  
C: 512-421-1750; DSN: 954-1750  
Senior NCO: CSM Benny Aleman, Jr.  
C: 512-465-5951; DSN: 954-5051

49th Armored Division Aviation  
Brigade, Company H. 149th Aviation  
5500 IH 10 E  
San Antonio, TX 78219-4599  
Commander: CPT Mechelle M. Tuttle  
ATTN: ARDV-BC  
C: 210-661-3111; DSN: 954-3515  
Senior NCO: 1SG John F. Ranft  
ATTN: ARDV-BC  
C: 210-661-3111; DSN: 954-1731  
jfranft@the-cla.net  
FTUS NCO: SFC Richard Guerra  
C: 210-661-3111; DSN: 954-1709  
rguerra@freeworld.com

Texas Army National Guard Aviation  
Support Facility #2  
5500 IH 10 East  
San Antonio, TX 78219-4599  
AASFC: LTC Robert E. Landstrom  
ATTN: SAAASF  
C: 210-661-3111; DSN: 954-1701  
saasf@mindspring.com

### UTAH Draper

Office, State Adjutant General, Utah  
Army National Guard  
12953 S. Minuteman Drive  
Draper, UT 84020-1776  
\*Update not provided this year.



TAG:  
MG James M. Miller  
ATTN: TAG-UT  
C: 801-523-4402  
DSN: 766-3900  
tagut@ut-  
ngnet.army.mil

Office, State Army Aviation Officer,  
Utah Army National Guard  
P. O. Box 1776  
Draper, UT 84020-1776  
SAAO & Director of Aviation &  
Safety: LTC Curtis G. Whiteford  
ATTN: UT-DOAS  
C: 801-523-4418; DSN: 766-4418  
saout@ut-arng.ngb.army.mil

### West Jordan

Utah Army National Guard Army  
Aviation Support Facility  
7563 South Airport Road  
West Jordan, UT 84084-7812  
\*Update not provided this year.  
Commander: LTC Gregory R. Cluff  
ATTN: UT-DOAS-AASF  
DSN: 766-3492

### VERMONT Colchester

Office, State Adjutant General,  
Vermont Army National Guard  
Green Mountain Armory  
Colchester, VT 05446-3004  
TAG: MG Martha T. Rainville  
ATTN: VT-AG  
C: 802-654-0124; DSN: 636-3124

### South Burlington

Office, State Army Aviation Officer,  
Vermont Army National Guard  
Army Aviation Support Facility  
COL James D. Kneeland Flt. Fac.  
Airguard Road  
South Burlington, VT 05403-6097  
SAAO: COL Thomas J. Shailor  
ATTN: VT-AV  
C: 802-654-0400; DSN: 636-3400  
saovt@vt-arng.ngb.army.mil

Vermont Army National Guard Army  
Aviation Support Facility  
COL James D. Kneeland Flt. Fac  
Airguard Road  
South Burlington, VT 05403-6097  
\*Update not provided this year.

### VIRGIN ISLANDS St. Croix

Office, State Army Aviation Officer,  
Virgin Islands ARNG  
Army Avn. Operating Facility  
P. O. Box 2270, Kingshill  
St. Croix, VI 00851-2270



SAAO:  
LTC Caroline F.  
Adams  
ATTN: VI-AVN  
C: 340-778-3299  
saovi@vi-  
arng.ngb.army.mil

Virgin Islands Army National Guard  
Army Avn. Operating Facility  
P. O. Box 2270, Kingshill  
St. Croix, VI 00851-2270  
\*Update not provided this year.

### VIRGINIA Alexandria

Warrant Officer Division, OPMD,  
TAPC  
U.S. Total Army PERSCOM  
200 Stovall Street  
Alexandria, VA 22332-0420



Division Chief:  
CW5 Jim Morgan  
ATTN: TAPC-OPW  
C: 703-325-5255  
DSN: 221-5252  
morganj@hoffman.  
army.mil

Leader Development Branch Chief:  
CW4 Bobby Cox  
ATTN: TAPC-OPW-D  
C: 703-325-8636; DSN: 221-8636  
coxbr@hoffman.army.mil  
AH-1 and AH-64 Career Manager:  
CW4 Tom Manhart  
ATTN: TAPC-OPW-AV  
C: 703-325-5223; DSN: 221-5223  
manhartt@hoffman.army.mil  
OH-58/C/C/151A Career Manager:  
CW5 Carl Jenkins  
ATTN: TAPC-OPW-AV  
C: 703-325-5228; DSN: 221-5228  
jenkins@hoffman.army.mil  
Schools/153A: CW3 Kim Young  
ATTN: TAPC-OPW-AV  
C: 703-325-5251; DSN: 221-5251  
youngkr@hoffman.army.mil  
UH-60 Career Manager: CW4 Pete  
Keafar

ATTN: TAPC-OPW-AV  
C: 703-325-5225; DSN: 221-5225  
keafarc@hoffman.army.mil  
CH-47/FWAVN Career Manager: CW4  
Jim Reardon  
ATTN: TAPC-OPW-AV  
C: 703-325-5284; DSN: 221-5284  
reardoj1@hoffman.army.mil  
Officer Flight Training Accessions  
Manager: Ms. Kathy Legaspi  
ATTN: TAPC-OPW-AV  
C: 703-325-5283; DSN: 221-5283  
legaspik@hoffman.army.mil  
Aviation Personnel Technician: Ms.  
Molley Tucker  
ATTN: TAPC-OPW-AV  
C: 703-325-5227; DSN: 221-5227  
tuckerm@hoffman.army.mil  
Aviation Personnel Technician AH-  
64/CH-47: Mr. Clifton Aubry  
ATTN: TAPC-OPW-AV  
C: 703-235-5226; DSN: 221-5226  
aubreyc@hoffman.army.mil

Aviation Branch, OPMD, U.S. Total  
Army PERSCOM  
200 Stovall Street  
Alexandria, VA 22332-0400  
Branch Chief: LTC Gregory P. Gass  
ATTN: TAPC-OPV  
C: 703-325-2808; DSN: 221-2808  
gassg@hoffman.army.mil  
Colonel's Assignment Officer: LTC  
Howard Ferguson  
ATTN: TAPC-OPE-V  
C: 703-325-5633; DSN: 221-5633  
fergusonh@hoffman.army.mil  
Lieutenant Colonels' Assignment  
Officer: LTC Joe Dunaway  
ATTN: TAPC-OPE-V  
C: 703-325-6194; DSN: 221-6194  
dunawayj@hoffman.army.mil  
Lieutenant Colonel's Technician: Ms.  
Sandi Sanders  
ATTN: TAPC-OPE-V  
C: 703-325-2534; DSN: 221-2534  
sanderso@hoffman.army.mil

Majors' Assignment Officer: MAJ  
Cindy McClellan  
ATTN: TAPC-OPE-V  
C: 703-325-5669; DSN: 221-5669  
mcclellan@hoffman.army.mil

Majors Assignment Officer: CPT Matt  
Custer

ATTN: TAPC-OPE-V  
C: 703-325-6399  
custermt@hoffman.army.mil

Captains' Assignment Officer: CPT  
Mike Seitz  
ATTN: TAPC-OPE-V  
C: 703-325-6379; DSN: 221-6379  
seitzm@hoffman.army.mil

Captains' Assignment Officer: CPT  
Kevin Berry  
ATTN: TAPC-OPE-V  
C: 703-325-4384; DSN: 221-4384  
berryko@hoffman.army.mil

Lieutenants' Assignment Officer:  
CPT Garner Pogue  
ATTN: TAPC-OPE-V  
C: 703-325-5974; DSN: 221-5974  
pogueb@hoffman.army.mil

Future Readiness Officer: CPT  
Garner Pogue  
ATTN: TAPC-OPE-V  
C: 703-325-5974; DSN: 221-5974  
pogueb@hoffman.army.mil

Accessions: Ms. Brenda Twyford  
ATTN: TAPC-OPE-V  
C: 703-325-6477; DSN: 221-6477  
twyfordb@hoffman.army.mil

Special Management Division, TAPC  
U.S. Total Army Personnel Cmd.  
200 Stovall Street  
Alexandria, VA 22332-0406  
\*Update not provided this year.

Aviation/Transportation Branch,  
EPMD

U.S. Total Army Personnel Cmd.  
ATTN: TAPC-EPL-T  
2461 Eisenhower Avenue  
Alexandria, VA 22331-0453  
Branch Chief: LTC Marc P. Brodeur

ATTN: TAPC-EPL-T  
C: 703-325-3080; DSN: 221-3080  
brodeurm@hoffman.army.mil  
Branch SGM: SGM Stephen E. Okeefe  
ATTN: TAPC-EPL-T

C: 703-325-3083; DSN: 221-3083  
okeefes@hoffman.army.mil  
NCOIC, Enlisted Aviation Section:  
SFC Robert J. Walter  
ATTN: TAPC-EPL-T

C: 703-325-5061; DSN: 221-5061  
walterrj@hoffman.army.mil  
Professional Development NCO: SFC  
Bobby J. Small  
ATTN: TAPC-EPL-T

C: 703-325-5659; DSN: 221-5659  
smallb@hoffman.army.mil  
Professional Development NCO: SFC  
Crystal L. Caldwell  
ATTN: TAPC-EPL-T

C: 703-325-4598; DSN: 221-4598  
caldwelc@hoffman.army.mil  
Professional Development NCO: SFC  
David M. Wagner  
C: 703-325-4612; DSN: 221-4612  
wagnerd@hoffman.army.mil

Professional Development NCO: SFC  
Stanley G. Cleberg  
ATTN: TAPC-EPL-T  
C: 703-325-4554; DSN: 221-4554  
clebergs@hoffman.army.mil

Professional Development NCO: SFC  
Michael R. Hosenfeld  
ATTN: TAPC-EPL-T  
C: 703-325-4543; DSN: 221-4543  
hosenfem@hoffman.army.mil

Training Manager: Mr. Steve Herrera  
ATTN: TAPC-EPL-T  
C: 703-325-4611; DSN: 221-4611  
herreras@hoffman.army.mil

Training Manager: Mr. Robert B. Turner  
C: 703-325-5067; DSN: 221-5087  
turner@hoffman.army.mil

**Aviation Management Branch, DCSOPS, TAPC**

US Total Army Personnel Cmd.  
200 Stovall Street  
Alexandria, VA 22332-0413  
Chief: MAJ Emory Brownlee  
ATTN: TAPC-PLP-I, Room 3531  
C: 703-325-5098; DSN: 221-3531  
brownlee@hoffman.army.mil  
Non-Rated Aviator Pay: Mr. Michael Marche  
ATTN: TAPC-PLP-I  
C: 703-325-4524; DSN: 221-4524  
marchem@hoffman.army.mil

Avn Career Incentive Pay: Ms. Margie Brown

ATTN: TAPC-PLP-I  
C: 703-325-8701; DSN: 221-8701  
brownm@hoffman.army.mil  
Medical Waivers/Aviation Cont. Pay:  
Mrs. Annie King  
ATTN: TAPC-PLP-A  
C: 703-325-8750; DSN: 221-8750  
kinga@hoffman.army.mil

**Aviation Office, U.S. Army Materiel Command (USAMC)**

5001 Eisenhower Avenue  
Alexandria, VA 22333-0001  
\*Update not provided this year.  
Aviation Officer: Mr. John A. Savelli  
ATTN: AMCLG-OP (AVN)  
C: 703-617-9891; DSN: 767-9891  
jsavelli@hqamc.army.mil

**Safety Office, U.S. Army Materiel Command (USAMC)**

5001 Eisenhower Avenue  
Alexandria, VA 22333-0001  
\*Update not provided this year.

**Arlington**

**Aviation/IEW Directorate, OASA(ALT)**

2511 Jefferson Davis Highway  
Arlington, VA 22202-3911  
Director: LTC(F) Mark Jones  
ATTN: SARD-SA  
C: 703-604-7140; DSN: 664-7140  
rogersm@sarda.army.mil

**National Guard Bureau (NGB)**

1411 Jefferson Davis Hwy.  
Arlington, VA 22202-3259



Chief:  
LTC Russell C. Davis  
ATTN: NGB-CC  
C: 703-607-2200  
DSN: 327-2200  
davisrc@ngb.  
armg.af.mil

Vice Chief: MG Raymond F. Rees  
ATTN: NGB-ZB  
C: 703-607-2204; DSN: 327-2204  
reesr@ngb.armg.af.mil

**Army Aviation & Safety Division, National Guard Bureau**

ARNG Readiness Ctr.  
111 S. George Mason Drive  
Arlington, VA 22204-1382  
\*Update not provided this year.  
Chief: COL Alberto J. Jimenez  
ATTN: NGB-AVN  
C: 703-607-7700; DSN: 327-7700

**Aviation Operations Branch, Army Avn. & Safety Div., NGB**

ARNG Readiness Center  
111 South George Mason Drive  
Arlington, VA 22204-1382  
\*Update not provided this year.  
Chief: MAJ Louis H. Jordan  
ATTN: NGB-AVN-O  
C: 703-607-7711; DSN: 327-7711  
jordanl@ngb-armg.ngb.army.mil

**Safety & Occupational Health Branch, Army Avn. & Safety Div., NGB**

ARNG Readiness Center  
111 South George Mason Drive  
Arlington, VA 22204-1382  
\*Update not provided this year.

**Falls Church**

**Plans & Operations Div., Dir., of Health Care Operations, OTSG**

5109 Leesburg Pike  
Falls Church, VA 22041-3258  
Aviation Staff Officer: MAJ Randy Anderson  
Room 691, ATTN: DASG-HCO  
C: 703-681-6497; DSN: 761-6497  
randy.anderson@OTSG-AMEDD.army.mil

**Fort Belvoir**

**Office PM, Night Vision/RSTA**

10221 Burbeck Road, Suite 430  
Fort Belvoir, VA 22060-5806  
Project Manager: COL Thomas P. Kelly  
ATTN: SFAE-IEW&S-NV  
C: 703-704-3450; DSN: 654-3450  
tkelly@nvl.army.mil

Deputy Project Manager: Mr. John R. Gresham

ATTN: SFAE-IEW&S-NV  
C: 703-704-3444; DSN: 654-3444  
jgresham@nvl.army.mil

**Technical Director & Chief of Technology Division: Mr. Douglas Wiltsie**

ATTN: SFAE-IEW&S-NV  
C: 703-704-3493; DSN: 654-3493  
dwiltsie@nvl.army.mil

Product Manager, FLIR: LTC Camille Nichols

ATTN: SFAE-IEW&S-NV  
C: 703-704-1192; DSN: 654-1192  
cnichols@nvl.army.mil

**U.S. Army Aeronautical Services Agency**

9325 Gunston Rd, Bldg. 1466 SN319  
Fort Belvoir, VA 22060-5582  
Director: COL Charles H. Dove  
ATTN: ATAS-ZA  
C: 703-806-4862; DSN: 656-4862  
charles\_h\_dove@belvoir.army.mil

**Office, State Army Aviation Officer, District of Columbia ARNG**

Army Aviation Support Facility  
Davison Army Airfield  
Fort Belvoir, VA 22060-5726  
SAAO: COL Michael P. Breithaupt  
ATTN: DCARNG-SAO  
C: 703-806-7691; DSN: 656-7691  
saodc@dc-armg.ngb.army.mil

**District of Columbia ARNG Army Aviation Support Facility**

Davison Army Airfield  
7000 Britten Drive  
Fort Belvoir, VA 22060-5106

\*Update not provided this year.  
AAFC: COL Michael P. Breithaupt  
ATTN: DCARNG-SAO  
C: 703-806-7691; DSN: 656-7691  
saodc@dc-armg.ngb.army.mil

**Operational Support Airlift Agency (OSAA)**

6970 Britten Drive, Suite 201  
Fort Belvoir, VA 22060-5133



Commander:  
COL Arthur J. Sosa  
ATTN: OSAA-D  
C: 703-806-7008  
DSN: 656-7008  
sosaa@osaa-  
armg.belvoir.army.mil

Deputy Commander: LTC Scott D. Wagner

ATTN: OSAA-D  
C: 703-806-7016; DSN: 656-7016  
wagners@osaa-armg.belvoir.army.mil



Senior NCO:  
CSM Robert A. Oram  
ATTN: OSAC-SM  
C: 703-806-7114  
DSN: 656-7114

12th Aviation Battalion  
8926 Gavin Road, Suite 201  
Fort Belvoir, VA 22060-5123

Commander: LTC Robert W. Kline  
ATTN: ANAV-CB

C: 703-806-7578; DSN: 656-7578  
robert\_w\_kline@belvoir.army.mil  
XO: MAJ Randolph R. Rotte, Jr.

ATTN: ANAV-CBX  
C: 703-806-7577; DSN: 656-7577

S3: MAJ A. Dwayne Hummel  
ATTN: ANAV-CBO

C: 703-806-7608; DSN: 656-7608  
SIP: CW4 Jay Bellamy

ATTN: ANAV-CBR  
C: 703-806-7062; DSN: 656-7062  
12stds@belvoir.army.mil

Aircraft Maintenance Officer: CPT Alan L. Robison

ATTN: ANAV-CBD  
C: 703-806-7647; DSN: 656-7647

al\_robison@belvoir.army.mil  
Safety Officer: CW4 Nate Wilbourn

ATTN: ANAV-CBT  
C: 703-806-7436; DSN: 656-7436  
nate\_wilbourn@belvoir.army.mil

**Fort Eustis**

**5th Battalion, 159th Aviation Regiment**

Building 1706  
Fort Eustis, VA 23604-5594

Commander: LTC Matthew S. Maney  
ATTN: AFRC-AVIL-EQ

C: 804-765-0701  
maneym@usare-emh2.army.mil

Senior NCO: CSM Marshall A. Banks  
ATTN: AFRC-AVIL-EQ

C: 757-485-4257  
banksma@nnsy.navy.mil

**U.S. Army Aviation Logistics School (USAALS)**

Building 2717  
Fort Eustis, VA 23604



Assistant  
Commandant:  
COL Louis A. Bonham  
ATTN: ATSQ-LAC  
C: 757-878-6847  
DSN: 927-6847  
bonhaml@eustis.  
army.mil

Deputy Assistant Commandant: Mr. Rodney J. Schulz

ATTN: ATSQ-LAC  
C: 757-878-6805; DSN: 927-6805  
schulzr@eustis.army.mil



Sergeant Major:  
SGM Esquire McCoy  
ATTN: ATSQ-LAC  
C: 757-878-6809  
DSN: 927-6809  
mccoye@eustis.  
army.mil

**Aviation Logistics and Integration Planning Group, USAALS**

Fort Eustis, VA 23604  
\*Update not provided this year.

**Department of Attack Helicopter Training, USAALS**

Fort Eustis, VA 23604-5415  
Director: CW4 Jeffrey L. Jacoby  
ATTN: ATSQ-LAC-H  
C: 757-878-4564; DSN: 927-4564  
Senior NCO: SGM Herman L. Hawkins  
ATTN: ATSQ-LAC-H  
C: 757-878-4564; DSN: 927-4564

**Department of Aviation Systems Training, USAALS**

Fort Eustis, VA 23604-5433  
Director: LTC Alphonso E. Matthewson, Jr.  
ATTN: ATSQ-LTD-S  
C: 757-878-5405; DSN: 927-5405  
matthewsona@eustis.army.mil  
Senior NCO: SGM Joseph W. Shabbott  
ATTN: ATSQ-LTD-S  
C: 757-878-4469; DSN: 927-4469  
shabbottj@eustis.army.mil

**Department of Aviation Trades Training, USAALS**

U.S. Army Aviation  
Logistics School  
Fort Eustis, VA 23604



Director:  
LTC Robert S.  
Saunders  
ATTN: ATSQ-LAC-T  
C: 757-878-5039  
DSN: 927-5039  
saundersr@  
eustis.army.mil



Senior NCO:  
SGM Maurice L.  
Johnson  
ATTN: ATSQ-LAC-T  
C: 757-878-3556  
DSN: 927-3556  
johnson2@eustis.  
army.mil

**Directorate of Training, Plans and Evaluation, USAALS**

Fort Eustis, VA 23604-5421

**Aviation Applied Technology Directorate, (AATD), USAAMCOM**

Building 401  
Fort Eustis, VA 23604-5577



Commander:  
COL Waldo F.  
Carmona  
ATTN: AMSAM-AR-T  
C: 757-878-2208  
DSN: 927-2208  
wcarmona@aatd.  
eustis.army.mil

Deputy Director: Mr. Danny E. Good  
ATTN: AMSAM-AR-T-D  
C: 757-878-3507; DSN: 927-3507  
dgood@aatd.eustis.army.mil

Power Systems Div., Aviation Applied  
Technology Dir., USAAMCOM  
Building 401  
Fort Eustis, VA 23604-5577

Systems Integration Division, AATD,  
USAAMCOM  
Building 401  
Fort Eustis, VA 23604-5577  
Chief: Mr. Bruce S. Tenney  
ATTN: AMSAM-AR-T-I  
C: 757-878-2122; DSN: 927-2122  
btenney@aatd.eustis.army.mil

Rapid Prototype Division, AATD,  
USAAMCOM  
Building 401  
Fort Eustis, VA 23604-5577  
Chief: LTC Jeff Trang  
ATTN: AMSAM-RD-AA-S  
C: 757-878-3008; DSN: 927-3008  
jtrang@aatd.eustis.army.mil

Platform Technology Division, AATD,  
USAAMCOM, Building 401  
Fort Eustis, VA 23604-5577  
Chief: Mr. Gene A. Birocco  
ATTN: AMSAM-AR-T-F  
C: 757-878-5609; DSN: 927-5609  
gbirocco@aatd.eustis.army.mil

### Fort Monroe

Aviation Div., Individual Training Dir.,  
DCS of Training, TRADOC  
Fort Monroe, VA 23651  
\*Update not provided this year.  
TRADOC Aviation Officer/Chief: LTC  
David M. Bowles  
ATTN: ATTG-IA  
C: 757-728-5685; DSN: 680-5685  
bowlesd@monroe.army.mil

Air Traffic Control Branch: Mr. Tony  
Johnson  
ATTG-IA  
C: 757-728-5638; DSN: 680-5638  
johnson2@monroe.army.mil

Standardization Branch: CW5 Robert  
Mason  
ATTG-IA  
C: 757-728-5640; DSN: 680-5640  
masonr@monroe.army.mil

Operations Branch: Ms. Judy Dyer  
ATTG-IA  
C: 757-728-5683; DSN: 680-5683  
dyerj@monroe.army.mil

ARNG Aviation Coordinator:: LTC  
David Bowles  
ATTG-IA  
C: 757-728-5680; DSN: 680-5680  
bowlesd@monroe.army.mil

### Sandston

Office, State Army Aviation Officer,  
Virginia Army National Guard  
Aviation Support Facility  
Richmond International Airport  
700 Portugee Road  
Sandston, VA 23150-5050

SAAO: COL William A. Simpson Jr.  
ATTN: VAAV  
C: 804-236-7301; DSN: 864-7301  
saova@va-arng.ngb.army.mil

Virginia Army National Guard Army  
Aviation Support Facility  
Richmond International Airport  
700 Portugee Road  
Sandston, VA 23150-5050  
\*Update not provided this year.  
AASFC: COL William A. Simpson  
ATTN: VAAV  
C: 804-236-7301; DSN: 864-7301

### WASHINGTON Dupont

Aviation Support Facility Lewis  
P. O. Box 5060  
Dupont, WA 98327-5060  
\*Update not provided this year.  
Facility Supervisor: Mr. Charles K.  
Smith  
ATTN: AFRC-AVIL-KG  
C: 253-967-3083; DSN: 357-3083

### Spokane

Washington Army National Guard  
Aviation Support Facility #2  
P. O. Box 19069  
Spokane International Airport  
Spokane, WA 99219-9069

### Tacoma

1-168th Theater Army Aviation  
Camp Murray  
Tacoma, WA 98430-5094  
Commander: LTC David F. Shaw  
C: 253-967-5910; DSN: 357-5910  
shawd@wa-arng.ngb.army.mil  
Senior NCO: CSM Robert J. Barr  
C: 253-967-5910; DSN: 357-5910  
barr@wa-arng.ngb.army.mil

66th Aviation Brigade (Corps)  
Camp Murrady  
Tacoma, WA 98430-5000



Commander:  
BG Daniel P. Coffey  
ATTN: WYHUA  
C: 253-967-3027  
DSN: 357-3027  
bde66avn@wa-  
rngnet.army.mil

Office, State Adjutant General,  
Washington ARNG  
Camp Murray  
Tacoma, WA 98430-5000  
\*Update not provided this year.



TAG:  
MG Gregory P.  
Barlow  
ATTN: TAG-WA  
C: 253-512-8000  
DSN: 323-8000  
sennc@cpmurray.  
army.mil

Office, State Army Aviation Officer,  
Washington ARNG  
Aviation Support Facility 1  
Camp Murray  
Tacoma, WA 98430-5152

SAAO: COL Peter Holmberg  
ATTN: AVN  
C: 253-912-3820; DSN: 323-3820  
saowa@cpmurray.army.mil

Washington Army National Guard  
Aviation Support Facility #1  
Camp Murray  
Tacoma, WA 98430-5152  
\*Update not provided this year.  
AASFC: LTC Harry P. Haroldson  
ATTN: AVN  
C: 253-964-7200; DSN: 323-7200

### WEST VIRGINIA Bridgeport

Fixed Wing Aviation Training Site  
(FWATS)  
1000 Fixed Wing Drive  
Bridgeport, WV 26330-0453  
Commander: MAJ Vincent John  
C: 304-842-8870; DSN: 623-6028  
fwaatswv@wv-arng.ngb.army.mil

### Charleston

Office, State Adjutant General, West  
Virginia ARNG  
1703 Coonskin Drive  
Charleston, WV 25311-1085  
\*Update not provided this year.  
TAG: MG Allen E. Tackett  
C: 304-369-6780; DSN: 355-6316

### Wheeling

West Virginia ARNG Army Aviation  
Support Facility #2  
R.R. #5, P. O. Box 14  
Wheeling, WV 26003  
\*Update not provided this year.  
AASFC: LTC Glenn Kelly  
ATTN: WVAR-AASF2  
C: 304-277-2733; DSN: 366-6586  
wvaasf2@ovnet.com

### Williamstown

Office, State Army Aviation Officer,  
West Virginia ARNG  
Army Avn. Support Facility #1  
Rt. 1, PO Box 224B  
Williamstown, WV 26187  
SAAO: COL Roger D. Thomas  
C: 304-464-4383; DSN: 366-6264  
saoww@wv-arng.ngb.army.mil

West Virginia Army National Guard  
Army Avn. Support Facility #1  
Rt. 1, PO Box 224B  
Williamstown, WV 26187  
\*Update not provided this year.

### WISCONSIN Fort McCoy

B Company, 2-228th  
Fort McCoy, WI 54656  
\*Update not provided this year.

Commander: CPT Scott Morcomb  
C: 608-388-5641

Aviation Support Facility McCoy  
Fort McCoy, WI 54656-5143  
Facility Supervisor: CW4 Paul A.  
Herrick  
C: 608-388-5641; DSN: 280-5641

### Madison

Office, State Adjutant General,  
Wisconsin Army National Guard  
P. O. Box 8111  
Madison, WI 53708-8111



TAG:  
MG James G. Blaney  
ATTN: WING-Z  
C: 608-242-3001  
DSN: 724-3001

Office, State Army Aviation Officer,  
Wisconsin Army National Guard  
Office of the Adjutant General  
Dept. of Military Affairs  
2400 Wright Street  
Madison, WI 53704-2572

SAAO: LTC Jeff D. Paulson  
ATTN: WIAR-AVN  
C: 608-242-3140  
DSN: 724-3140  
saowi@wi-arng.ngb.army.mil

Wisconsin Army National Guard  
Aviation Support Facility #2

Truax Field  
1950 Pearson Street  
Madison, WI 53704-2517  
\*Update not provided this year.  
1st Battalion, 147th Aviation  
1954 Pearson Street  
Madison, WI 53704-2517  
Commander: LTC James F. Rohl  
C: 608-242-3875; DSN: 724-3875  
jroth@madison.k12.wi.us  
Executive Officer: MAJ Thomas M.  
Rhalican

ATTN: WTQZTO-XO  
C: 608-242-3875; DSN: 724-3876  
tom.rhalican@legis.state.wi.us  
SIP: CW4 Jack M. Fankhauser  
C: 608-242-3908; DSN: 724-3908  
fankhj@wi-arng.ngb.army.mil  
ASO: CW4 Kim Randall  
C: 608-242-3896; DSN: 724-3896  
randak@wi-arng.ngb.army.mil  
MTP: CW4 Robert G. Seales  
C: 608-242-3920; DSN: 724-3920  
Senior NCO: CSM Jeffery S. Janke  
C: 608-242-3895; DSN: 724-3895  
janwil@essexl.com

### West Bend

832d Medical Company  
125 Chopper Drive  
West Bend, WI 53095-8985  
\*Update not provided this year.  
Commander: MAJ Russell J. Sweet  
C: 414-334-9155; DSN: 724-3147  
832medco@wi-arng.ngb.army.mil

Wisconsin Army National Guard  
Aviation Support Facility #1  
125 Chopper Drive  
West Bend, WI 53095-8985  
\*Update not provided this year.  
AASFC: MAJ Russell Sweet  
ATTN: AASF-A  
C: 608-242-3147; DSN: 724-3147  
aasf1wi@wi-arng.ngb.army.mil

## WYOMING Cheyenne

1022d Medical Company  
5500 Bishop Boulevard  
Cheyenne, WY 82009  
\*Update not provided this year.

Office, State Adjutant General,  
Wyoming Army National Guard  
500 Bishop Boulevard  
Cheyenne, WY 82009-3320  
\*Update not provided this year.  
TAG: MG Edmond Boenisch  
C: 307-772-5234; DSN: 943-5234  
eboenisch@wycys.ang.af.mil

Office, State Army Aviation Officer,  
Wyoming Army National Guard  
Army Aviation Support Facility  
4600 Powderhouse Road  
Cheyenne, WY 82009-4807  
SAAO: COL Frank M. Henrich  
C: 307-772-5999; DSN: 943-5999  
saowwy@wu-arrng.ngb.army.mil

Wyoming Army National Guard  
Aviation Support Facility  
4600 Powderhouse Road  
Cheyenne, WY 82009-4807  
\*Update not provided this year.  
AASFC: COL Frank M. Henrich  
C: 307-772-5999; DSN: 943-5999  
henrich@wy-iso.army.mil

## CANAL ZONE APO AA

Company D, 228th Aviation Regiment  
U.S. Army South  
PSC 42, (JTF-B)  
Soto Cano AB, Honduras  
APO AA 34042



Commander:  
LTC Scott G. Ciluffo  
ATTN: SOAR-HO  
C: 011 (504)234-4634  
DSN: 449-6502  
Ciluffos@jtfb-emh1.army.mil

Executive Officer: MAJ John C.  
Davidson  
ATTN: SOAR-HOX  
C: 011 (504)234-4634; DSN: 449-6502  
Davidsoj@jtfb-emh1.army.mil

Senior NCO: CSM Mariano Rivera  
ATTN: SOAR-HOM  
C: 911 (504)234-4634; DSN: 449-6502  
Riveram@jtfb-emh1.army.mil

## GERMANY APO AE

Multinational Force and Observers  
USAE-MFO, Unit 31520  
APO AE 09832  
\*Update not provided this year.

U.S. Army Flight Operations  
Detachment  
USAREUR & 7th USA  
Unit 29231  
APO AE 09102



Commander:  
CW5 William J. (Joe)  
Irvine  
ATTN: AEAGC-AV-  
AFOD-CO  
C: 011-49-6221-17-  
6201  
DSN: 373-6201  
irvinej@hq.  
hqsareur.army.mil

159th Medical Company (AA)  
CMR 467  
APO AE 09096  
\*Update not provided this year.

2-502d Aviation Regiment  
Unit #29719  
APO AE 09028

Commander: LTC Thomas J. Boyle  
ATTN: AERAS-AV-CO  
C: (49) 621-779-5198; DSN: 382-5198  
boylet@2-502avn.21tsc.army.mil  
Executive Officer: MAJ Laura L. Singer  
ATTN: AERAS-V-XO  
C: (49) 621-779-5200; DSN: 382-5200  
lauras.singer@2-502avn.21tsc.army.mil

SIP: CW3 James Brouillard  
ATTN: AERAS-V-O  
C: (49) 621-779-5159; DSN: 382-5159  
ASO: CW3 John Rice  
ATTN: AERAS-V-S  
C: (49) 621-779-5159; DSN: 382-4343  
rice@2-502avn.21tsc.army.mil  
MTFE: CW2 Hoyt Frasier  
ATTN: AERAS-V-OP-QC  
C: (49) 621-779-5100; DSN: 382-5100  
hoyt.frasier@2-502avn.21tsc.army.mil

PC Officer: CW5 Floyd W. Roberts  
ATTN: AERAS-V-A  
C: (49) 621-779-4667; DSN: 382-4667  
robertsw@2-502avn.21tsc.army.mil  
Senior NCO: Master Sergeant Herbert  
Turner  
ATTN: AERAS-V-CSM  
C: (49) 621-779-5280; DSN: 382-5280  
csm@2-502avn.21tsc.army.mil

236th Medical Company  
CMR 402  
APO AE 09180-3630



Commander:  
MAJ Jonathan C.  
Fristoe  
ATTN: AETV-MB-  
WA-AAL  
C: 011-49-6371-86-  
8681  
DSN: 486-8681  
236commander@  
cmlymail.26asg.  
army.mil

4th Squadron, 3rd Armored Cavalry  
Regiment  
Operation Joint Forge  
HHT 4/3 ACR Comanche Base  
APO AE 09788

Commander: LTC B. Shannon Davis  
ATTN: AFZC-R-H-CO  
C: 719-526-2564; DSN: 691-2564  
Exec. Officer: MAJ Ronald K. Taylor  
ATTN: AFZC-R-H-XO  
C: 719-524-1763; DSN: 883-1763  
SIP: CW4 Stephen Bergstrom  
ATTN: AFZC-R-H-C  
C: 719-526-2332; DSN: 691-2332  
ASO: CW3 Kenneth Young  
ATTN: AFZC-R-H-A  
C: 719-526-2635; DSN: 691-3873

45th Medical Company (AA)  
APO AE 09250  
\*Update not provided this year.

Commander: MAJ Pete Smart  
ATTN: AEMAA-NL  
C: 09802832 793; DSN: 467-2793  
smartp@cmlymail.98asg.army.mil

SHAPE Flight Detachment  
Unit 21409, CMR 450  
APO AE 09705  
\*Update not provided this year.  
Commander: LTC Barry Stuckey  
ATTN: ACFD  
C: (32) 68-27-5277; DSN: 361-5277  
stuckeyb@hqsaeace.shape.army.mil

SIP: CW4 Robert L. Arms  
ATTN: ACFD  
C: (32) 68-27-5070; DSN: 361-5070  
armsr@hqsaeace.shape.army.mil  
ASO: CW4 Dale A. Miller  
ATTN: ACFD  
C: (32) 68-27-5762; DSN: 361-5762  
millerd@hqsaeace.shape.army.mil  
MFTE: Mr. Joe Henson  
ATTN: ACFD  
C: (32) 68-27-5060; DSN: 361-5060  
hensonj@hqsaeace.shape.army.mil

HQ USAREUR/7A ODCSOPS-AVN  
Unit 29351  
APO AE 09014  
USAREUR Aviation Officer: Mr.  
James P. Phillips  
ATTN: AEAGC-AV  
C: 011-49-6221-57-9461; DSN: 370-  
9461  
phillipj@hq.hqsareur.army.mil

Deputy Aviation Officer: LTC Travis  
Flewelling  
ATTN: AEAGC-AV  
C: (49) 6221-57-3246; DSN: 370-3246  
flewellinj@hq.hqsareur.army.mil  
Senior NCO: Master Sergeant Gamard  
W. Burnside II  
ATTN: AEAGC-AV  
C: (49) 6221-57-9473; DSN: 370-9473  
burnsideg@hq.hqsareur.army.mil

HQ USAREUR/7A ODCSLOG-AVN  
Unit 29351  
APO AE 09014  
Chief: Mr. Al Martin  
ATTN: AEAGD-MD-AV  
C: (49) 6221-57-8532; DSN: 370-8532  
martina@hq.hqsareur.army.mil  
Aviation Logistics Management  
Specialist: Mr. Emmit Rodriguez  
ATTN: AEAGD-MD-AV  
C: (49) 6221-57-8532; DSN: 372-8532  
rodriguezep@hq.hqsareur.army.mil

Army Flight Operations Detachment  
(AFOD), ODCSOPS, USAREUR  
Unit 29351  
APO AE 09014

214th Aviation Battalion  
Unit 29231  
APO AE 09102



Commander:  
LTC Thomas J.  
Comodeca  
ATTN: AEUSG-AV-  
CO  
C: (49) 6221-17-8009  
DSN: 373-8009  
comodecat@26asg.  
heidelberg.army.mil  
Exec. Officer: MAJ

Craig A. Holton  
ATTN: AEUSG-AV-XO  
C: (49) 6221-17-5112; DSN: 373-5112  
holtonc@26asg.heidelberg.army.mil

SIP Fixed Wing: CW5 Raymond B.  
Collins  
ATTN: AEUSG-AV-SIP  
C: (49) 6221-17-6822; DSN: 373-6822  
collinsr@26asg.heidelberg.army.mil  
SIP Rotary Wing: CW4 Paris C.  
D'Avanzo  
ATTN: AEUSG-AV-SIP  
C: (49) 6221-17-6822; DSN: 373-6822  
davanzop@26asg.heidelberg.army.mil  
Senior NCO: CSM Stewart R. Souders  
ATTN: AEUSG-AV-CSM  
C: (49) 6221-17-5132; DSN: 373-5132  
souderss@26asg.heidelberg.army.mil

200th Theater Army Materiel  
Management Center  
Unit 23203  
APO AE 09263  
Chief, Aviation Branch: Mr. David  
Spinks  
ATTN: AERLA-MMC-ATMD  
C: (49) 631-413-8900; DSN: 484-8900  
spinksd@hq.21taacom.army.mil

Combat Maneuver Training Center  
CMR 414, Box 1823  
ATTN: Falcons  
APO AE 09173-1823  
\*Update not provided this year.  
Aviation Detachment Executive  
Officer: MAJ Jay Smith  
C: (49) 9472-83-2891; DSN: 466-2891  
smithj@cmtc.7atc.army.mil  
Aviation Detachment Operations  
Officer: MAJ Jimmy Meacham  
C: (49) 9472-83-4438; DSN: 466-4438  
meachamj@cmtc.7atc.army.mil  
Aviation Detachment Tactical  
Operations Officer: CW4 Ken Sargent  
C: (49) 9472-83-2451; DSN: 466-2451  
sargentk@cmtc.7atc.army.mil  
Aviation Detachment Maintenance  
Officer: CW2 Jerry Forrest  
C: (49) 9472-83-2224; DSN: 466-2224  
forrestj@cmtc.7atc.army.mil  
Senior NCO: CSM William Clarke  
C: (49) 9472-83-2352; DSN: 466-2352  
clarkew@cmtc.army.mil

7th Army Training Command,  
Aviation Detachment  
Grafenwoehr Army Airfield  
APO AE 09114-5413  
Commander: CPT Camille Griffin  
ATTN: AETT-SGS-AV  
C: (49) 964-183-7147; DSN: 475-7147  
Camille.Griffin@hq.7atc.army.mil  
Oper. Officer: CW3 Reginald Bromwell  
ATTN: AETT-SGS-AV  
C: (49) 964-183-7147; DSN: 475-7147  
Reginald.Bromwell@hq.7atc.army.mil  
RW/SIP: CW4 Tim Porter  
ATTN: AETT-SGS-AV  
C: (49) 964-183-8331; DSN: 475-8331  
portert@fldet.7atc.army.mil  
ASO: CW2 Mark Giacolletti  
ATTN: AETT-SGS-AV  
C: (49) 964-183-7833; DSN: 475-7833  
Senior NCO: SSG Dennis Gudger  
ATTN: AETT-SGS-AV  
C: (49) 964-183-6117; DSN: 475-6117  
klatts@fldet.7atc.army.mil

Aviation Office, V U.S. Corps  
12th Avn. Bde., Unit 29632  
APO AE 09096  
\*Update not provided this year.  
V Corps Aviation Officer  
ATTN: AETV-AV  
C: (49) 611-705-5857; DSN: 337-5857

Assistant V Corps Aviation Officer:  
LTC Greg Adams  
ATTN: V Corps  
C: (49) 611-705-5312; DSN: 370-5312  
g3avncief@hq.c5.army.mil

4th Brigade, 1st Armored Division  
CMR 477  
APO AE 09165  
\*Update not provided this year.



Commander:  
COL Christopher L.  
Sargent  
ATTN: AETV-THR  
C: (49) 6183-51-693  
DSN: 322-7693  
4bdecd@4thbdehq.  
lad.army.mil

Executive Officer: MAJ Darryl Shamblin  
ATTN: AETV-THR-XO  
C: (49) 6183-51-467; DSN: 322-7467  
4bdexo@4thbdehq.lad.army.mil

SIP: CW5 John Peterson  
ATTN: AETV-THR-SIP  
C: (49) 6183-51-623; DSN: 322-7623  
4bdestans@4thbdehq.lad.army.mil

ASO: CW5 Daniel Heath  
ATTN: AETV-THR-ASO  
C: (49) 6183-51-679; DSN: 322-7679  
4bdesafety@4thbdehq.lad.army.mil

MTFE: CW5 David Landrum  
ATTN: AETV-THR-MTFE  
C: (49) 6183-51-772; DSN: 322-7772  
4bdebamo@4thbdehq.lad.army.mil

Senior Tactical EW Officer: CW5 Steve Knowles  
ATTN: AETV-THR-SC  
C: (49) 6183-51-565; DSN: 322-7565  
4bdeatcops@4thbdehq.lad.army.mil



Senior NCO:  
CSM Gabriel  
Villaseñor  
ATTN: AETV-THR-  
CSM  
C: (49) 6183-51-499  
DSN: 322-7499  
4bdecsm@4thbdehq.  
lad.army.mil

1-501st Attack Helicopter Battalion  
4th Brigade  
CMR 477

1st Armored Division  
APO AE 09165-1539  
Commander: LTC Peggy Wiggins  
ATTN: AETV-THR-B  
C: (49) 6183-51-504; DSN: 322-7504  
1501avcdr@1501hq.1ad.army.mil

Executive Officer: MAJ John Dowd  
ATTN: AETV-THR-B-XO  
C: (49) 6183-51-660; DSN: 322-7660  
1501avxo@1501hq.1ad.army.mil

SIP: CW4 Matt Cordell  
ATTN: AETV-TFJ-B-SP  
C: (49) 6183-51-705; DSN: 322-7705  
1501avstnds@1501hq.1ad.army.mil

ASO: CW3 Dave Ford  
ATTN: AETV-THR-B-ASO  
C: (49) 6183-51-790; DSN: 322-7790  
1501avcsm@1501hq.1ad.army.mil

MTFE: CW3 Pele Notestine  
ATTN: AETV-THR-B-PC  
C: (49) 6183-51-711; DSN: 322-7711

Senior NCO: CSM Baez  
ATTN: AETV-THR-B-CSM  
C: (49) 6183-51-756; DSN: 322-7756  
1501avcsm@1501hq.1ad.army.mil

2nd Battalion, 501st Aviation  
Regiment, 4th Brigade  
CMR 477

1st Armored Division  
APO AE 09165  
\*Update not provided this year.  
Commander: LTC Thomas Muir  
ATTN: AETV-THR-C  
C: (49) 6184-51-701; DSN: 322-7701

Executive Officer: MAJ Ken Barrett  
ATTN: AETV-THR-C-XO  
C: (49) 6184-51-780; DSN: 322-7780  
SIP: CW3 Bob Caprara

ATTN: AETV-THR-C-SS  
C: (49) 6184-51-631; DSN: 322-7631  
Senior NCO: CSM Gary L. Moore  
ATTN: AETV-THR-C-CSM  
C: (49) 6184-51-577; DSN: 322-7577

127th Aviation Support Battalion  
Unit #20198  
APO AE 09165-1624  
\*Update not provided this year.

4th Brigade, 1st Infantry Division  
CMR 454  
APO AE 09250



Commander:  
COL David S. Pale  
ATTN: AETV-BGK-  
AA  
C: (49) 9802-832-623  
DSN: 467-2623  
pated@cmty.mil  
98asg.army.mil

Exec. Officer: LTC Raymond T. Flewelling  
ATTN: AETV-BGK-X  
C: (49) 9802-832-624; DSN: 467-2624  
flewellin@cmty.mil.98asg.army.mil

Brigade S-3: MAJ John Laganelli  
ATTN: AETV-BGK-C  
C: (49) 9802-832-880; DSN: 467-2880  
laganellj@cmty.mil.98asg.army.mil

SIP: CW5 Leon McInelly  
ATTN: AETV-BGK-S  
C: (49) 9802-832-739; DSN: 467-2739  
mcinelly@cmty.mil.98asg.army.mil

ASO: CW5 Peter Lautzenheiser  
ATTN: AETV-BGK-S  
C: (49) 9802-832-807; DSN: 467-2807  
lautzenheiserp@  
cmty.mil.98asg.army.mil

BAMO: CW4 Bobby McQuaid  
ATTN: AETV-BGK-Z  
C: (49) 9802-832-623; DSN: 467-2623  
mcquaidr@cmty.mil.98asg.army.mil



Senior NCO:  
CSM Johnny D.  
Hatten  
ATTN: AETV-BGK  
C: (49) 9802-832-623  
DSN: 467-2623  
hattenj@cmty.mil.  
98asg.army.mil

1st Battalion, (Attack) 1st Aviation  
Regiment "Gunfighters"  
Aviation Brigade, 1st Infantry Division  
CMR 454  
APO AE 09250  
\*Update not provided this year.

Commander: LTC Bruce Georgia  
ATTN: AETV-BGK-M  
C: 011 49 09802 832-783  
DSN: 467-2783

Executive Officer: MAJ Scott Fellows  
ATTN: AETV-BGK-MX  
C: 011 49 9802 832-172;  
DSN: 467-2172  
fellows@cmty.mil.98asg.army.mil

S-3: MAJ Al Parmentier  
C: 011 49 9802 832-603  
parmentiera@cmty.mil.98asg.army.mil

SIP: CW3 Jayson Wilson  
C: 011 49 9802832-609  
wilsonja@cmty.mil.98asg.army.mil

ASO: CW3 J.P. Meier  
C: 011 49 9802 832-609  
meierj@cmty.mil.98asg.army.mil

MTP: CW3 Chuck Miller  
C: 011 49 9802 832-890  
millerc@cmty.mil.98asg.army.mil

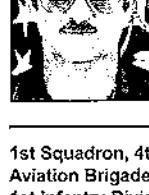

Senior NCO:  
CSM Donald K.  
Henry  
C: 011 49 09802  
832-783  
DSN: 467-2783  
henryd@cmty-  
mail.98asg.army.mil

1st Squadron, 4th U.S. Cavalry  
Aviation Brigade

1st Infantry Division  
CMR 464  
APO AE 09226  
\*Update not provided this year.

Commander: LTC James W. Shufelt, Jr.  
ATTN: AETV-BG-RC-SCO  
C: 011 49 9712 96-8602;  
DSN: 35386023  
shufeltj@cmty.mil.98asg.army.mil

Executive Officer: MAJ Bryan Averill  
ATTN: AETV-BG-RC-SXO  
C: 011 49 9721 96-8602;  
DSN: 353-8602  
averillb@cmty.mil.98asg.army.mil

S-3: MAJ Louis J. Lartigue  
ATTN: AETV-BG-RC-S3  
C: 011 49 9721-06-8602  
Lartigue@cmty.mil.98asg.army.mil

SIP: CW4 Kieth Eltheridge  
ATTN: AETV-BG-RC-SIP  
C: 011 49 9721 96-8602;  
DSN: 353-8602

Etheridk@cmty.mil.98asg.army.mil  
Squadron Safety: CW3 Derik Willis  
ATTN: AETV-BG-RC-SAFETY  
C: 011 49 9721 96-8602;  
DSN: 353-86021

Willisd@cmty.mil.98asg.army.mil  
MTP: CW3 Charles Roberts  
ATTN: AETV-BG-RC-MTP  
C: 011 49 9721 96-8602;  
DSN: 353-8602

Roberts@cmty.mil.98asg.army.mil  
Senior NCO: CSM Steve Flood  
ATTN: AETV-BG-RC-CSM  
C: 011(49) 9721 96-8602;  
DSN: 353-8602  
Floods@cmty.mil.98asg.army.mil

2nd Battalion, 1st Aviation Regiment  
CMR 454  
APO AE 09250

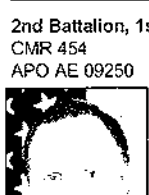

Commander:  
LTC Daniel S. Stewart  
ATTN: AETV-BGK-T  
C: (49) 9802-832-627  
DSN: 467-2627  
stewartda@  
cmty.mil.98asg.  
army.mil

Executive Officer: MAJ Jack W. Bone  
ATTN: AETV-BGK-T  
C: (49) 9802-832-627; DSN: 467-2627  
bonej@cmty.mil.98asg.army.mil

SIP: CW4 Eric J. Jorgensen  
ATTN: AETV-BGK-TG  
C: (49) 9802-832-649; DSN: 467-2649  
jorgensene@cmty.mil.98asg.army.mil

ASO: CW3 Rod Brown  
ATTN: AETV-BGK-TS  
C: (49) 9802-832-649; DSN: 467-2649  
brownro@cmty.mil.98asg.army.mil

AVUM Commander: CPT Daniel Kinn  
ATTN: AETV-BGK-TL  
C: (49) 9802-832-874; DSN: 467-2874  
kinnd@cmty.mil.98asg.army.mil

Senior NCO: CSM James A. McGlocklin  
ATTN: AETV-BGK-TZ  
C: (49) 9802-832-626; DSN: 467-2626  
mcglocklinj@cmty.mil.98asg.army.mil

601st Aviation Support Battalion  
DISCOM, 1st Infantry Division  
CMR 454  
APO AE 09250

Commander: LTC Bruce Moore  
ATTN: AETV-BG-SC-A  
C: (49) 9802-832-100; DSN: 467-2100  
co-601sb@email.ansbach.army.mil

Executive Officer: MAJ David Vanslambrook  
ATTN: AETV-BG-SC-A-XO  
C: (49) 9802-832-100; DSN: 467-2100  
xof601@email.ansbach.army.mil

HQ & Supply Company: CPT Judson Nelson  
ATTN: AETV-BG-SC-A-A  
C: (49) 9802-832-695; DSN: 467-2695  
cohsc@email.ansbach.army.mil

A COMPANY (AVIM): MAJ David Hendrickson  
ATTN: AETV-BG-SC-A-C  
C: (49) 9802-832-761; DSN: 467-2761  
coaco@email.ansbach.army.mil

B Company (Ground Maintenance):  
CPT Joseph Urbanczyk  
ATTN: AETV-BG-SC-A-B  
C: (49) 9802-832-873; DSN: 467-2873  
cobco@email.ansbach.army.mil

Senior NCO: CSM Guy Niles  
ATTN: AETV-BG-SC-A-S  
C: (49) 9802-832-100; DSN: 467-2100  
csm601@email.ansbach.army.mil

12th Aviation Brigade  
Unit 29632  
APO AE 09096-5000  
\*Update not provided this year.

Commander: CDL Jeffrey S. White  
ATTN: AETV-AB  
C: (49) 611-705-5857  
DSN: 337-5530  
12avn cdr@12avn bde.army.mil

Executive Officer: LTC Rick Russell  
ATTN: AETV-ABH-XO  
C: (49) 611-705-6885; DSN: 337-6885  
12avnxo@12avn.wiesbaden.army.mil

SIP: CW5 Eric V. Linderman  
ATTN: AETV-ABC-IP  
C: (49) 611-705-5469; DSN: 337-5469  
12avn sip@12avn.wiesbaden.army.mil

ASO: CW3 Mark Atkins  
ATTN: AETV-ABA-SO  
C: (49) 611-705-5469; DSN: 337-5469





**Senior NCO:**  
CSM George W. Evans  
ATTN: AETV-ABH-SM  
C: (49) 611-705-5897  
DSN: 337-5897  
12avnscsm@12avn.wiesbaden.army.mil

**3d Battalion, 58th Aviation Regiment (ATS)**

CMR 408  
APO AE 09182  
**Commander:** LTC Eric M. Nelson  
ATTN: AETV-ABS  
C: (49) 9334-87-6358  
DSN: 352-6358  
nelsonem@12avnbd.army.mil  
**Executive Officer:** MAJ Jeffrey D. Ellison

ATTN: AETV-ABS-XO  
C: (49) 9334-87-6405; DSN: 352-6405  
ellisonj@12avnbd.army.mil

**S-3:** MAJ David A. Chapman  
ATTN: AETV-ABS-S3  
C: (49) 9334-87-6403; DSN: 352-6403  
chapmand@12avnbd.army.mil

**ATSSO:** CPT David B. Stringer  
ATTN: AETV-ABS-ATSSO  
C: (49) 9334-87-6396; DSN: 352-6396  
stringerd@12avnbd.army.mil

**ATSM:** CW2 Daniel Antonson  
ATTN: AETV-ABS-ATSM  
C: (49) 9334-87-6398; DSN: 352-6398  
antonsond@12avnbd.army.mil



**Senior NCO:**  
CSM Charles A. Momon  
ATTN: AETV-ABS-SM  
C: (49) 9334-87-6407  
DSN: 352-6407  
momonc@12avnbd.army.mil

**5th Battalion, 158th Aviation Regiment**

CMR 408  
APO AE 09182  
\*Update not provided this year.  
**Commander:** LTC Joe Maher  
effec. Nov '00  
ATTN: AETV-ABR  
C: (49) 9334-8-7342; DSN: 352-7342  
**Executive Officer:** MAJ Jack Parkhurst  
ATTN: AETV-ABR-XO  
C: (49) 9334-8-7846; DSN: 352-7846  
xo-158@email.wuerzburg.army.mil

**SIP:** CW4 Spike Condon  
ATTN: AETV-ABR-IP  
C: (49) 9334-8-7378; DSN: 352-7378  
stan158@email.wuerzburg.army.mil

**ASO:** CW4 Greg Schneider  
ATTN: AETV-ABR-SO  
C: (49) 9334-8-7589; DSN: 352-7589  
safe158@email.wuerzburg.army.mil

**S-3:** MAJ Mike Dixon  
ATTN: AETV-ABR-C  
C: (49) 9334-8-77-45; DSN: 352-7745  
s3158@email.wuerzburg.army.mil

**Senior NCO:** CSM Willie F. Williams  
ATTN: AETV-ABR-SM  
C: (49) 9334-8-7342; DSN: 352-7342  
csm158@email.wuerzburg.army.mil

**11th Aviation Regiment**

CMR 416  
V Corps  
APO AE 09140



**Commander:**  
COL Rickey L. Rife  
ATTN: AETV-AVA  
C: (49) 9841-83-815  
DSN: 467-4815  
11avnccdr@hq.11avn.ill.army.mil



**Senior NCO:**  
CSM L. Barnard Basnight  
ATTN: AETV-AVA-CSM  
C: (49) 9841-83-815  
DSN: 467-4815  
11avnscsm@hq.11avn.ill.army.mil

**2d Squadron (Attack), 6th Cavalry "Fighting Sixth"**

**11th Aviation Regiment**  
APO AE 09140



**Commander:**  
LTC Warren E. Phipps, Jr.  
ATTN: AETV-AVA-V-CDR  
C: (49) 9841-83-802  
DSN: 467-4802  
phippsw@hq.11avn.ill.army.mil

**Executive Officer:** MAJ John Lindsay  
ATTN: AETV-AVA-V-XO  
C: (49) 9841-83-843; DSN: 467-4843  
**SIP:** CW4 Brian Dunn  
ATTN: AETV-AVA-V-SIP  
C: (49) 9841-83-783; DSN: 467-4783  
dunnb@hq.11avn.ill.army.mil

**ASO:** CW3 Kenneth Pflieger  
ATTN: AETV-AVA-V-ASO  
C: (49) 9841-83-534; DSN: 467-4534  
pflieger@hq.11avn.ill.army.mil

**MTFE:** CW3 Brian Twigg  
ATTN: AETV-AVA-V-DT  
C: (49) 9841-83-784; DSN: 467-4784  
twiggb@hq.11avn.ill.army.mil



**Senior NCO:**  
CSM Patrick Laidlaw  
ATTN: AETV-AVA-V-CSM  
C: (49) 9841-83-843  
DSN: 467-4843  
laidlawp@hq.11avn.ill.army.mil

**6th Squadron (Attack), 6th Cavalry "Sixshooters"**

**11th Aviation Regiment**  
APO AE 09140

\*Update not provided this year.  
**Commander:** LTC Tim Edens  
ATTN: AETV-AVA-CS-CDR  
C: (49) 9841-83-961  
DSN: 467-4961

**Executive Officer:** MAJ Robert B. Allen  
ATTN: AETV-AVA-CS-XO  
C: (49) 9841-83-971; DSN: 467-4971  
66cavxo@email.ansbach.army.mil

**S-3:** MAJ Robert L. Douthit  
ATTN: AETV-AVA-CS-S3  
C: (49) 9841-83-970; DSN: 467-4970  
66cavs3@email.ansbach.army.mil

**S-1:** 1LT Christina M. Pierce-Neumann  
ATTN: AETV-AVA-CS-1  
C: (49) 9841-83-962; DSN: 467-4962  
66cavs1@email.ansbach.army.mil

**SIP:** CW3 Carl Farrow  
ATTN: AETV-AVA-CS-SIP  
C: (49) 9841-83-405; DSN: 467-4405  
66cavso@email.ansbach.army.mil

**ASO:** CW3 Paul Clark  
ATTN: AETV-AVA-CS-ASO  
C: (49) 9841-83-405; DSN: 467-4405  
66cavso@email.ansbach.army.mil

**MTFE:** CW3 Eric Rings  
ATTN: AETV-AVA-CS-MTFE  
C: (49) 9841-83-915; DSN: 467-4915  
66cavpc@email.ansbach.army.mil

**Acting Senior NCO:** Master Sergeant Robert D. Sparks  
ATTN: AETV-AVA-CS-CSM  
C: (49) 9841-83-967; DSN: 467-4967  
66cavcsm@email.ansbach.army.mil

**7th Battalion, 159th Aviation Regiment**

CMR 416  
APO AE 09140



**Commander:**  
LTC Richard A. Enderle  
ATTN: AETV-SCS-F  
C: 09841-83-791  
DSN: 467-4791  
7159cdr@7159av.ansbach.army.mil

**Executive Officer:** MAJ Joseph Ciampini  
ATTN: AETV-SCS-FX  
C: 09841-83-972; DSN: 467-4792  
7159xo@7159av.ansbach.army.mil

**MTFE:** CW5 Steve Trones  
ATTN: SERV-SCS-FSM  
C: 09841-83-982; DSN: 467-4982  
7159bso@7159av.ansbach.army.mil



**Senior NCO:**  
CSM Larry Jeffcoat  
ATTN: AERV-SCS-FCSM  
C: 09841-83-793  
DSN: 467-4793  
7159scsm@7159av.ansbach.army.mil

**1st Military Intelligence Battalion, (Aerial Exploitation)**

CMR 430  
APO AE 09096  
**Commander:** LTC Danny D. Durham  
ATTN: AETV-MIA  
C: (49) 611-705-5416; DSN: 337-5416  
cdr@1stmi.wiesbaden.army.mil

**SIP:** CW4 William F. Wary  
ATTN: AETV-MIA-SP  
C: (49) 611-705-7184; DSN: 337-7184  
waryw@1stmi.wiesbaden.army.mil

**ASO:** CW3 Kelley C. Denny  
ATTN: AETV-MIA-SA  
C: (49) 611-705-6173; DSN: 337-6173  
dennyk@1stmi.wiesbaden.army.mil

**HHS Commander:** CPT Scott T. Beall  
ATTN: AETV-MIA-HS  
C: (49) 611-705-5153; DSN: 337-5153  
hhsco@1stmi.wiesbaden.army.mil

**B Co Cmdr:** CPT William E. Pearson  
ATTN: AETV-MIA-CB  
C: (49) 611-705-5645; DSN: 337-5645  
1stmlbcco@1stmi.wiesbaden.army.mil



**Senior NCO:**  
CSM Robert Voss  
ATTN: AETV-MIA-CSM  
C: (49) 611-705-5416  
DSN: 337-5416  
csm@1stmi.wiesbaden.army.mil

**USAAVNC Liaison to French Army Aviation**

**TRADOC Aviation LO**  
PSC 116  
Box A-209-A  
APO AE 09777  
\*Update not provided this year.  
**Liaison Officer:** MAJ Robert Williams  
ATTN: ATFE-AV  
C: 33-04-94-85-52-47  
atfe-av@email.chievres.army.mil

**USAAVNC Liaison to German Army Aviation**

PCS 117 Box 115  
APO AE 09080-0115  
**Liaison Officer:** MAJ W. Clark Southard  
ATTN: ATDO-YF-GAV  
C: 011-49-5722-968-3305  
122016.2320@compuserve.com

**KOREA APO AP**

**Camp Page Army Airfield**

Unit #15002  
APO AP 96208-0252  
\*Update not provided this year.

**Camp Red Cloud Sub-Post Camp Page**

Unit #15002  
APO AP 96208-0252  
**Commander:** CPT Craig J. Alia  
ATTN: EANC-AIP-CDR  
C: 011-82-361-59-5025; DSN: 721-5025  
eanc-hip-cdr@emh5.korea.army.mil

**Aviation Office, Eighth U.S. Army**

APO AP 96204  
**Aviation Officer:**  
COL Robert Johnson  
ATTN: EAGC-EA  
C: 011-822-7913-4996  
DSN: 423-4996  
JohnsonRob@usfk.korea.army.mil

**17th Aviation Brigade**

Unit #15270  
APO AP 96205-0043  
**Commander:**  
COL Stephen D. Mundt  
ATTN: EAAV-CO  
C: 011-822-7913-5154  
DSN: 723-5154  
Mundts@usfk.korea.army.mil

**Brigade XO:** LTC Beth Ann Maddox

ATTN: EAAV-XO  
C: 011-822-7913-5132  
DSN: 723-5132  
MaddoxB@usfk.korea.army.mil

**Brigade S-3:** MAJ James P. Cassella  
ATTN: EAAV-OT  
C: 011-822-7913-8359; DSN: 723-8359  
CassellaJ@usfk.korea.army.mil

**Brigade Standardization Officer:** CW5 John S. Smolka  
ATTN: EAAV-STD  
C: 011-822-7913-6743; DSN: 723-6734  
SmolkaJ@usfk.korea.army.mil

**Bde Safety Offr:** CW5 R. Scott Johnson  
ATTN: EAAV-ASO  
C: 011-822-7913-5140; DSN: 723-5140  
johnsonsr@usfk.korea.army.mil

**Brigade CSM:** CSM David D. Tomblison  
ATTN: EAAV-CSM  
C: 011-822-7913-4634; DSN: 738-4634  
tomblisonD@usfk.korea.army.mil

**Company Cmdr, HHC:** CPT Katia Judge  
ATTN: EAAV-HHC  
C: 011-822-7918-8502; DSN: 738-8502  
judgek@usfk.korea.army.mil

**1st Battalion, 52nd Aviation**  
17th Aviation Brigade, Unit #15266  
APO AP 96205-0039  
\*Update not provided this year.  
**Commander:** LTC Dave Duncan  
ATTN: EAAV-1BN-CO  
DSN: 741-6038

**Executive Officer:** MAJ Paul J. Ambrose  
ATTN: EAAV-1BN-XO  
DSN: 741-6055  
AmbroseP@usfk.korea.army.mil

**S-3:** MAJ Marlin T. Carpenter  
ATTN: EAAV-1BN-OT  
DSN: 741-6621  
CarpenterM@usfk.korea.army.mil

**Standardization Officer:** CW4(P) Donald G. Andera  
ATTN: EAAV-1BN-STD  
DSN: 741-6037

**Safety Officer:** CW4 Jimmy R. Sawyer  
ATTN: EAAV-1BN-ASO  
DSN: 741-6043



**Senior NCO:**  
CSM Maurice L. Johnson  
ATTN: EAAV-1BN-CSM  
DSN: 741-6062

**164th Air Traffic Services Group**  
Unit #15276, Box 484  
APO AP 96205-0049  
\*Update not provided this year.  
**Commander:** LTC Mike Klingele  
ATTN: EAAV-164-CO  
C: 011-82-02-4914-4021  
DSN: 724-4021

**Deputy Cmdr:** MAJ Chris G. Baker  
ATTN: EAAV-164-DCO  
C: 011-82-02-7914-4022;  
DSN: 724-4022  
BakerCH@usfk.korea.army.mil

**S-3:** MAJ James Cassella  
ATTN: EAAV-164-OT  
C: 011-82-02-7914-4009;  
DSN: 724-4009  
cassellaJ@usfk.korea.army.mil



**Senior NCO:**  
CSM Gregory Lunn  
ATTN: EAAV-164-CSM  
C: 011-82-02-7914-4022  
DSN: 724-4022  
2nd Battalion, 52nd

**Aviation Regt**  
17th Aviation Brigade  
Unit 15188  
APO AP 96271-0124  
**Commander:** LTC Theresa L. Barton  
ATTN: EAAV-2BN-CO  
C: 011-82-333-690-6809;  
DSN: 753-6809  
bartont@usfk.korea.army.mil

**Exec. Offr:** MAJ Johnathan Rodden  
ATTN: EAAV-2BN-XO  
C: 011-82-333-690-6813;  
DSN: 753-6813  
roddejn@usfk.korea.army.mil

**S-3:** MAJ Michael Jurus  
ATTN: EAAV-2BN-OT  
C: 011-82-333-690-6807;  
DSN: 753-6807  
jurusm@usfk.korea.army.mil

**Standardization Offr:** CW4 Rich Roling  
ATTN: EAAV-2BN-SIP  
C: 011-82-333-690-8796;  
DSN: 753-8796  
rolingR@usfk.korea.army.mil

**Safety Officer:** CW4 Wray Holan  
ATTN: EAAV-2BN-ASO  
C: 011-82-333-690-6844;  
DSN: 753-6844  
holanw@usfk.korea.army.mil

**Senior NCO:** CSM Daniel Creed  
ATTN: EAAV-2BN-CSM  
C: 011-82-333-690-6810  
creedd@usfk.korea.army.mil

**Aviation Brigade, 2d Infantry Division**  
Unit #15435  
APO AP 96257-0481



**Commander:**  
COL John A. Macdonald  
ATTN: EAID-AA-CO  
C: 011-82-351-870-5928  
DSN: 732-5928  
MacdonaldJ@usfk.korea.army.mil

**Brigade Executive Officer:** MAJ Gustavo E. Blum  
ATTN: EAID-AA-XO  
C: 011-82-031-870-5924;  
DSN: 732-5924  
blumG@usfk.korea.army.mil

**Brigade S3:** MAJ Russell E. Fisher  
ATTN: EAID-AA-SO  
C: 011-82-031-870-5938;  
DSN: 732-5938  
FisherR@usfk.korea.army.mil

**Brigade SIP:** CW5 Benny Aguirre  
ATTN: EAID-AA-SD  
C: 011-82-031-870-5939;  
DSN: 732-5939  
AguirreB@usfk.korea.army.mil

**ASO:** CW5 Rodney M. Thomas  
ATTN: EAID-AA-S  
C: 011-82-351-870-5939;  
DSN: 732-5939  
ThomasRM@usfk.korea.army.mil

**Brigade Aviation Maintenance Officer:** CW5 Art Yearby  
ATTN: EAID-AA-SL700  
C: 011-82-031-870-5115;  
DSN: 732-5115  
YearbyA@usfk.korea.army.mil



**Senior NCO:**  
CSM Charles M. Richardson  
ATTN: EAID-AA-CSM  
C: 011-82-351-870-5947  
DSN: 732-5947  
RichardC@usfk.korea.army.mil

**1st Battalion, 2nd Aviation Regiment**  
Aviation Brigade, 2ID  
Unit #15008  
APO AP 96208-0474  
**Commander:** LTC Stephen A. Ingalls  
ATTN: EAID-AH-CO  
C: 254-539-7947; DSN: 737-8686  
flyarmy@seacove.net

**Exec. Officer:** CPT Christopher Ostby  
ATTN: EAID-AH-XO  
C: 011-82-031-259-5926;  
DSN: 721-5926  
OstbyC@usfk.korea.army.mil

**Senior NCO:** SFC Louis C. Felicioni  
ATTN: EAID-AH-CSM  
C: 011-82-031-259-5941;  
DSN: 721-5941  
FelicioniLS@usfk.korea.army.mil

**2d Battalion (Assault), 2d Aviation Rgt**  
Aviation Brigade, 2ID  
Unit #15427  
APO AP 96257-0460



**Commander:**  
LTC Donald G. Lisenbee, Jr.  
ATTN: EAID-AV-CO  
C: 011-82-031-870-5855  
DSN: 732-5855  
LisenbeeD@usfk.korea.army.mil

**Executive Officer:** MAJ David A. George  
ATTN: EAID-AV-XO  
C: 011-82-031-870-5325;  
DSN: 732-5325  
GeorgeD@usfk.korea.army.mil

**S3:** MAJ Paul E. Stote  
ATTN: EAID-AV-S3  
C: 011-82-031-870-5433;  
DSN: 732-5433  
StoteP@usfk.korea.army.mil

**SIP:** CW4 Larry E. Smith  
ATTN: EAID-AV-STN  
C: 011-82-031-870-5986;  
DSN: 732-5986

**ASO:** CW4 Winston F. LaCroix  
ATTN: EAID-AV-ASO  
C: 011-82-031-870-5727;  
DSN: 732-5727  
LacroixW@usfk.korea.army.mil

**Senior NCO:** CSM Larry E. Simon  
ATTN: EAID-AV-CSM  
C: 011-82-031-870-5324;  
DSN: 732-5324  
SimonL@usfk.korea.army.mil

**4th Squadron, 7th Cavalry Regiment**  
Aviation Brigade, 2ID  
Unit #15141  
APO AP 96257-0481  
**Commander:** LTC Joseph K. Wallace  
ATTN: EAID-CA-CO  
C: 011-82-348-950-2818;  
DSN: 312-734-2818  
WallaceJJ@usfk.korea.army.mil

**Exec. Officer:** MAJ James E. Baker  
ATTN: EAID-AVA-XO  
C: 011-82-348-950-2819;  
DSN: 312-734-2819  
BakerJE@usfk.korea.army.mil

**S3:** MAJ William W. Prior  
ATTN: EAID-CA-S3  
C: 011-82-348-950-2823;  
DSN: 312-732-2823

**SIP:** CW4 David W. Wetstein  
ATTN: EAID-CAA-STN  
C: 011-82-248-940-5616;  
DSN: 312-734-5616  
WetsteinD@usfk.korea.army.mil

**ASO:** CW4 Thomas Miller  
ATTN: EAID-AV-ASO  
C: 011-82-348-950-2025;  
DSN: 312-734-5727

**Senior NCO:** CSM Michael L. Brown  
ATTN: EAID-CA-CSM  
C: 011-82-348-950-2820;  
DSN: 312-734-2820  
BrownM@usfk.korea.army.mil

**6th Cavalry Brigade, Unit 15711**  
APO AP 96271-0711  
\*Update not provided this year.  
**Brigade Commander:** Col. Kevin Scherrer  
ATTN: EABH-CDR; DSN: 753-6991  
sinclaire@usfk.korea.army.mil

**Deputy Brigade Commander:** LTC David S. Long  
ATTN: EABH-DBC  
DSN: 753-3950  
longd@usfk.korea.army.mil

**Executive Officer:** MAJ Jeffrey G. Hill  
DSN: 753-3938  
hillj@usfk.korea.army.mil

**SIP:** (AH-64): CW3 Damon P. Sanger  
ATTN: EABH-STAN  
DSN: 315-753-7962  
sangerd@usfk.korea.army.mil

**ASO:** CW5 Michael T. Moorehead  
ATTN: EABH-SO  
DSN: 753-7915  
mooreheadm@usfk.korea.army.mil



**Senior NCO:**  
CSM Howard A. Loomis  
ATTN: EABH-CSM  
DSN: 753-3971  
loomish@usfk.korea.army.mil

**1st Squadron, 6th Cavalry**  
6th Cavalry Bde. (Air Combat)  
Unit #15567  
Camp Eagle, ROK  
APO AP 96297  
**Commander:** LTC Ronald D. Tuggle  
ATTN: EABH-1-6-CO  
C: 011-82-33-738-2006; DSN: 721-2006  
tuggler@usfk.korea.army.mil

**Exec. Officer:** MAJ Todd M. Huderle  
ATTN: EABH-1-6-XO  
C: 011-82-33-738-2005; DSN: 721-2005  
huderlet@usfk.korea.army.mil

**S-3:** MAJ Tommy R. Higgins  
C: 011-82-33-738-2003; DSN: 721-2003  
higginsrh@usfk.korea.army.mil

**SIP:** CW4 David A. Swann  
ATTN: EABH-1-6-SIP  
C: 011-82-33-738-2309  
DSN: 721-2308  
thetfordr@usfk.korea.army.mil

**ROKA Staff NCOIC:** SGM Muwon Lee  
ATTN: EABH-1-6-RSO  
C: 011-82-33-738-2211;  
DSN: 721-2211

**Senior NCO:** CSM Frank A. Prather  
ATTN: EABH-1-6-CSM  
C: 011-82-33-738-2201; DSN: 721-2201  
pratherf@usfk.korea.army.mil



**Commander:**  
LTC Peter W. Foreman  
ATTN: EABH-3-6-CDR  
C: 011-82-333-690-8320  
DSN: 753-8320  
foremanpw@usfk.korea.army.mil

**Executive Officer:** MAJ Steve Milliron  
 ATTN: EABH-3-6-XO  
 C: 011-82-333-690-7488;  
 DSN: 753-7488  
 connors@usfk.korea.army.mil  
**SIP:** CW4 Reuben Wells  
 ATTN: EABH-3-6-SIP  
 DSN: 315-753-8557  
**ASO:** CW4 Seth Verbel  
 ATTN: EABH-3-6-SAFETY  
 DSN: 315-753-8523  
 eabh-3-6-Safety@emh7.  
 korea.army.mil

**Commander:** LTC James P. Coates  
 ATTN: APAJ-GH-AV  
 C: 011-81-3117-63-9040;  
 DSN: 263-9040  
 coates@zama-emh7.army.mil  
**Executive Officer:** MAJ Jack E. Sturgeon  
 ATTN: APAJ-GH-AV  
 C: 011-81-3117-63-9041;  
 DSN: 263-9041  
 sturgeonj@sama-emh5.army.mil  
**Battalion S-3:** CPT Chad E. Chasteen  
 ATTN: APAJ-GH-AV  
 C: 011-81-3117-63-4243;  
 DSN: 263-4243  
 chasteec@zama-emh7.army.mil  
**Bn. Safety Offr:** Ms. Charlotte Hogan  
 ATTN: APAJ-GH-AV  
 C: 011-81-3117-63-9042;  
 DSN: 263-9042  
 hoganc@zama-emh7.army.mil

**Bn Standardization Officer:** CW4 Dennis D. Dial  
 ATTN: APAJ-GH-AV  
 C: 011-81-3117-63-3706;  
 DSN: 263-3706  
 diald@zama-emh5.army.mil  
**C-12J SP:** CW3 Paul L. Stewart  
 ATTN: APAJ-GH-AV  
 C: 011-81-3117-64-4591;  
 DSN: 264-4591  
 stuartp@zama-emh7.army.mil  
**UC-35 SIP:** CW4 Bruce W. Blackstone  
 ATTN: APAJ-GH-AV  
 C: 011-81-3117-64-4591;  
 DSN: 264-4591  
 blackstb@zama-emh7.army.mil  
**HHD Cmdr:** CPT Peter P. Mack  
 ATTN: APAJ-GH-AV  
 C: 011-81-3117-63-9027;  
 DSN: 263-9027  
 mackpp@zama-emh7.army.mil

**A CO Cmdr:** CPT Kenneth S. Allen  
 ATTN: APAJ-GH-AV  
 C: 011-81-3117-63-4284;  
 DSN: 263-4284  
 Allenk@zama-emh7.army.mil  
**D Co Cmdr:** CPT Michael R. Severson  
 ATTN: APAJ-GH-AV  
 C: 011-81-3117-63-9043;  
 DSN: 263-9043  
 severson@zama-emh7.army.mil  
**Sr. NCO:** SFC(P) John L. Chandler  
 ATTN: APAJ-GH-AV  
 C: 011-81-3117-63-5841;  
 DSN: 263-5841  
 chandlej@zama-emh7.army.mil

**JAPAN  
 APO AP**

**78th Aviation Battalion  
 (Provisional)  
 APO AP 96343-0084**

**VHPA MEMORIAL AT THE WALL**

Joe Galloway made the following remarks during a July 2 memorial service for helicopter pilots and crewmembers killed in Vietnam. The service was held at the Wall of the Vietnam Memorial in Washington, D.C. With Joe's kind permission, we at Army Aviation magazine would like to share them with you.

Is there anyone here today who does not thrill to the sound of those Huey blades? That familiar whop-whop-whop is the soundtrack of our war, the lullaby of our younger days. To someone who spent his time in Nam with the grunts, I have got to tell you that that noise was always a great comfort.

It meant someone was coming to help ... someone was coming to get our wounded ... someone was coming to bring us water and ammo ... someone was coming to take our dead brothers home ... someone was coming to give us a ride out of hell. Even today when I hear it I stop, catch my breath and think back to those days.

I love you guys as only an Infantryman can love you. No matter how bad things were, if we called, you came - down through the green tracers and other visible signs of a real bad day off to a bad start.

I would like to quote to you from a letter Gen. William Tecumseh Sherman wrote his friend Gen. Ulysses S. Grant at the end of the Civil War: "I knew wherever I was that you thought of me, and if I got in a tight place you would come - if alive."

That was always in our minds and that is how we thought of you. To us you seemed beyond brave and fearless ... that you would come to us in the middle of battle in those flimsy thin-skinned crates, and in the storm of fire you would sit up there behind that plexiglass seeming so patient and so calm

and so vulnerable, waiting for the off-loading and the on-loading.

We thought you were God's own lunatics, and we loved you. Still do.

We are gathered here this morning to appreciate the lives and honor the memory of 2,209 helicopter pilots and 2,704 helicopter crewmen who were killed while doing their duty in the Republic of Vietnam between May 30, 1961, and May 15, 1975. Theirs are some of the names among the 58,220 on this precious Wall. So many good men, so many good friends.

Before I come here I always remind myself of what another good friend - Capt. B.T. Collins, who is now gone - liked to say at gatherings like this:

"No whining and no crying! We are the fortunate ones! We survived, when so many better men gave up their precious lives for us. We owe them a sacred debt: to live each day to its fullest, trying to make this world a better place for our having lived and their having died."

So we come here today to remember them, and to celebrate their lives and their deeds. I like to come here at dawn, or around midnight, when things are so quiet you can hear their voices. What they are saying, when you listen hard enough, is this: We are at peace; so should you be, so should you be.

I would like to close by reading you from something written by a World War I poet named Lawrence Binyon:

"They shall not grow old, as we that are left grow old, Age shall not weary them, nor the years condemn.

At the going down of the sun, and in the morning, We will remember them!"

God bless all our absent friends, and God bless you.

**Advertisers Index**

AAR Cadillac Manufacturing.....	11	ITT Night Vision .....	17	Sierra Research Division, SierraTech Inc.....	43
ARINC Incorporated .....	61	H. Koch and Sons.....	65	Sikorsky Aircraft.....	COVER 1
BAE Systems .....	7	Lear Siegler Services Inc.....	18	Simula Safety Systems, Inc.....	67
Bell Helicopter Textron Inc.....	57	Litton Electro-Optical.....	39	Smiths Industries Aerospace.....	5
BFGoodrich Aerospace .....	45	Orbital, Fairchild Defense .....	37	Stevens Aviation, Inc.....	55
Boeing Aircraft & Missiles .....	COVER 2	Parker Aerospace .....	21	St. Louis University .....	35
Breeze-Eastern .....	59	Phantom Products Inc.....	49	TEAC America, Inc.....	33
Cartwright Electronics.....	43	Raytheon Aerospace, CFT.....	25	Teledyne Brown Engineering.....	35
Chandler Evans Control Sys Div. Coltec.....	29	Regents College .....	10	Transsupport, Incorporated .....	53
DAC International Inc.....	63	Robertson Aviation, L.L.C.....	27	TRW Aero. Systems, Lucas Aerospace .....	93
DynCorp .....	9	Rockwell Collins, Inc.....	COVER 4	Universal Fabric Structures, Inc.....	19
Eaton Corp, Tedeco Div.....	47	Rolin Industries, Inc.....	51	USAA.....	15
Fastening Systems International, Inc.....	16	Sabreliner Corporation.....	31		
General Electric Aircraft Engines .....	13	Sanders, a Lockheed Martin Company .....	23		
Gulfstream Aerospace Corporation.....	41	Sears Roebuck and Co., Sears Ind. Sales.....	14	EFFECTIVE 090700	

# CCAD SUPPORTS THE ARMY

By Ralph Yoder

Workers at Corpus Christi Army Depot recently squeezed two of the Army's largest helicopters into the Air Force's largest aircraft, the C-5A, for the long flight to Korea. CH-47 flights in Korea were stopped several months ago by a Safety of Flight message concerning some flaws in the transmissions.

CCAD has been repairing the Chinook transmissions and for each set completed another Chinook could fly. However, in Korea they needed not only working transmissions, they needed two additional Chinooks, recently worked at the depot, to increase Army heavy-lift capabilities.

About a month ago, said Richard Caballero, a CCAD quality-assurance representative, "We knew which two helicopters were scheduled. They had been test flown by CCAD and Korea-based pilots, and accepted. It took about seven days to make them ready for the transpacific flight.

"We disassembled the back pylons and removed the transmissions, blades and other parts," Caballero said. "The transmissions and blades were put inside the aircraft, and the pylons were wheeled into the C-5A on dollies.

"It was a tight fit," he added. "This is the first time that CCAD has airlifted Chinooks, packed like this, to the customer. A C-5A can carry three Chinooks, but we only loaded two."

During a recent visit to CCAD Army Chief of Staff Gen. Eric Shinseki told CCAD commander Col. Mitch Dockens how important a strategic tool CCAD is for the Army. Being able to move recently overhauled large helicopters long distances is a vital part of the depot's mission.

"If we had not been here, the Chinooks and Apaches would not be flying today" said CCAD Bearing Shop supervisor Manuel Torres while leading a tour of his

unique facility. He was talking about the grounding of both the CH-47 Chinook and AH-64 Apache fleets because of flawed transmissions. Part of the work undertaken by the CCAD Bearing Shop was the replacement, inspection and repair of the CH-47 first- and second-stage planetary gear bearing assemblies, and the AH-64 transmission bearings, sprag clutches and hanger bearings.

Hundreds of forward and aft transmissions from the big twin-engine Chinook and hundreds more transmissions and hanger-bearing assemblies from the Apaches had to be checked and, when necessary, fixed at CCAD between last fall and this spring. The Bearing

Section processed and restored to serviceable status more than 3,300 first- and second-stage planetary gear bearing assemblies for the CH-47 special operations aircraft program. This was quite an accomplishment, as the shop normally

processes only 100 each of the first- and second-stage planetary gear bearing assemblies a year. The bulk of the gear-bearing assemblies were turned around within one week.

"My folks did a terrific job; but we also had super support from Tom

Long's and Frank Munoz's Non-Destructive Testing shops, which performed the 200 percent NDT inspection requirement on the gears" Torres said. The NDT section also processed more than 700

sprag clutches and reclaimed more than 2,500 critical transmission and hanger bearings for the AH-64 programs during this same time period.

The Bearing Section is the only facility of its kind in the Army, and one of only three within the Department of Defense that are authorized to perform complete overhaul and repair on aviation bearings.

The section currently processes more than 4,000 different vendor part-numbered bearings, gear assemblies and sprag clutches — ranging from 28 inches to one quarter inch in diameter — that are vital to helicopter engines,



transmissions and other systems. Bearings are tough and some can have as many as 30,000 hours on them. Torres has seen bearings come through again and again. And in all the years that Torres has been there no crash has ever been traced to one of the section's bearings.

Jim Welch, a retired CCAD director of maintenance and now an Allied Signal contractor representative, said: "Manuel Torres and his team are recognized as a 'center of excellence' for bearings by DOD and throughout the aerospace private sector. I would much rather fly in an aircraft equipped with bearings they inspect and repair than I would fly in one equipped with new bearings fresh from the factory."

Bearing work is hard work and Torres rotates his shop personnel frequently so they can become familiar with

the individual bearing characteristics and end-item applications. The bearings, gears and clutches are inducted and precision cleaned, buffed, polished and extensively tested before undergoing a detailed visual examination. Those that pass the visual exam are then processed through a Class 100 clean room (the workers wear white suits and head covers) where they undergo a detailed dimensional inspection to blue-print specification. The bearings are then lubricated, preserved and packaged for delivery to the customer.

Besides helicopter bearings the Bearing Section is also currently processing F-15, F-16 and B-1B gearbox bearings and gear bearing assemblies for the Air Force.

*Ralph Yoder is CCAD's public affairs officer.*

## Longbow Maintenance Recognition Division Parade Field June 19, 2000

Maj. Gen. Dick Cody, commander of the 101st Airborne Division at Fort Campbell, Ky., recently honored the division's first AH-64D Apache Longbow battalion for outstanding maintenance performance. The 2nd Battalion, 101st Aviation, was able to train for and execute an aerial gunnery while overcoming three major Safety of Flight messages affecting the AH-64D.

*Below left*, Cody stands with (from left to right) Brig. Gen. Virgil Packet II (then assistant division commander for support), Col. Sam Hubbard (101st Avn. Brigade commander), Lt. Col. Gregory Gass (2nd Bn., 101st Avn. commander), 1st Sgt Joseph Reilly (acting battalion command sergeant major), Capt. David Kramer (Co. A commander), 1st Sgt. Dan Hollingsworth (Co. A first sergeant) 1st Lt. Derek Finison (platoon leader), CWO 3 William Stewmon (pilot), SSgt. Robert Smith (platoon sergeant), Sgt. Antonio Gonzales (section sergeant) and Spec. John Kane (crew chief).

*At right* Cody poses with Kane.

*Bottom right* Cody receives a 101st Avn. Bde. coin from Hubbard.





# ARMY AVIATION mailbox

Share your opinion on matters of interest to the Army aviation community. The publisher reserves the right to edit letters for style, accuracy or space limitations. All letters must be signed and authors identified. The publisher will withhold the author's name upon request. The opinions expressed are those of the authors, and do not reflect the opinion of ARMY AVIATION Magazine. Send letters to AAAA MAILBOX, 49 Richmondville Avenue, Westport, CT 06880-2000, Tel: (203) 226-8184, FAX: (203) 222-9863, E-Mail: magazine@quad-a.org.

DEPARTMENT OF THE AIR FORCE  
AIR FORCE LEGAL SERVICES AGENCY (AFLSA)

7 August 2000

MEMORANDUM FOR Army Aviation Association of America  
ATTENTION: Mailbox  
49 Richmondville Avenue  
Westport, CT 06880-2000

FROM: AFLSA/JACT 1501 Wilson Blvd, Room 835  
Arlington, VA 22209-2403

SUBJECT: Search for Army Aviator — Centurion 20

On 3 April 1996, an Air Force CT-43A aircraft crashed into a mountain near Dubrovnik, Croatia, killing all 35 passengers and crew onboard the aircraft, to include Secretary of Commerce Ron Brown. During the initial search and rescue efforts following the disappearance of the aircraft, various Army aviation assets were employed to locate the aircraft. These assets were primarily from Vicenza, Italy, and possibly operating out of Camp Ederle at the time of the crash and part of a task force with the 2nd Brigade, 325th Regiment.

Within one or two days after the crash, the Air Force Accident Investigation Board requested the assistance of an Army Chinook helicopter crew to fly both the actual mishap flight path of the CT-43A on its final approach to the Dubrovnik airport and the Jeppesen Sanderson published approach to the airport. An Air Force video operator made a videotape of the two approaches. The videotape, however, does not identify the helicopter crew, tail number or unit, although the callsign Centurion 20 can be heard on the audio portion of the tape. One of the crewmember's helmets appears to have the name Friar marked on it.

Twenty-seven of the 35 families of those killed in the crash have filed a lawsuit against Jeppesen Sanderson, Inc., the publisher of the Dubrovnik approach plate. The United States is not a party to the lawsuit. Plaintiffs' counsel has requested assistance from the Air Force to identify and locate the pilot and crewmembers of the Chinook helicopter that flew this mission in order to question them about this flight.

If anyone has any information about this flight or the names and location of the crewmembers, request they contact me at the above address, by telephone at (703) 696-9055 or DSN 426-9055, or by email at paul.cormier@pentagon.af.mil.

PAUL E. CORMIER  
Chief, Aerospace Law Branch  
Tort Claims and Litigation Division  
Air Force Legal Services Agency

Dear Editor;

By now you've probably received several comments regarding the Army's recent decision to award the Aviation Aircrew Members Badge to MOS 93P (flight operations) enlisted soldiers. I thought I would add my two cents worth.

As a member of an aviation organization that includes several assigned 93Ps, I am proud to see them being recognized for the hard work and dedication they apply to the unit's mission.

At first I was skeptical of the idea, and knew it would create dissension between the crew chiefs/flight engineers and the flight operations personnel. I honestly believe it will take some time for the attitudes to mellow. Something to keep in mind is that the 93Ps don't receive any additional flight or incentive pay.

I personally feel that a different type of badge could have been designed to represent the MOS, but the bottom line is that 93P soldiers are an integral part of the overall Army aviation mission. They deserve to be recognized for their devotion to duty.

CWO 3 Keith D. Genter  
1st Bn., 223rd Avn. Regt.

Dear Editor,

I read with great interest the May article "The Army's Utility Helicopter Program," which said the UH-60 Black Hawk is in its 24th year of production and in the fifth year of multiyear contracting.

I would like to point out that the very first multi-year contract for Black Hawks, lots VI-VII and VIII for 314 helicopters, was signed in April 1982. The inception of this first ever multiyear contract for a major Army system was achieved by the hard work and dedication of a "Should Cost Team," which evaluated the manufacturers' proposal and demonstrated the savings of multiyear contracting through the halls of the Pentagon and congressional staffs leading to congressional approval of multiyear funding.

In particular, two government civilians on that team, Messrs. Gerald Erickinson, deputy team chief, and Charles Trendley, the contracting officer, were instrumental in making the first major systems multiyear contract a success. The 314 Black Hawks were bought without engines and in the following year another Should Cost Team achieved a second multiyear contract for the T-700 engines that would power the Black Hawks for our soldiers throughout the world.

Lt. Col. Danny D. Curtis (Ret.)  
Should Cost Team Chief  
UH-60 Black Hawk & T-700 Engine

**MAJ. GENERALS**

**Cody, Dick**, 101st Airborne Div(AASLT), and Fort Campbell, Fort Campbell, KY 42223. EM: codyr@emh2.campbell.army.mil

**BG. GENERALS**

**Pillsbury, James H.**, 30 H. Avenue, New Cumberland, PA 17070. EM: lifeliner6@aol.com

**COLONELS**

**Buchanan, Lloyd W., Jr.**, 745 St. Andrews Drive, Pinehurst, NC 28374.

**Combs, John R.**, c/o Eleanor Combs-Brown, 27 Stabler Circle, Wilmington, DE 19807.

**Davis, Michael H.**, c/o COL Anthony Giusti, 167 Interlochen Drive, Peachtree City, GA 30269.

**Golson, Ellis**, 72 N. Harris Drive, Fort Rucker, AL 36362.

**Lattimore, Morris R.**, 1423 Sultan Way, Fort Detrick, MD 21702. EM: morris.lattimore@detamedd.army.mil

**Prewitt, David S.**, c/o General Motors, 1660 L Street NW Ste 401, Washington, DC 20036. EM: david.prewitt@gm.com

**Schwoebel, Charles G.**, 241 Medloch Lane, Arlington, VA 22304.

**Urbauer, Craig L.**, 120 Gresham Place, Falls Church, VA 22046.

**LT. COLONELS**

**Baum, Franklin R.**, 10242 Mission Creek, Converse, TX 78109.

**Brogna, Anthony**, 332 Fawn Valley, Lansing, KS 66043.

**Cotton, Edmund W.**, 7342 Wickford Drive, Alexandria, VA 22315.

**Dolby, Michael I.**, 17th ASG CM, Unit 45013, Box 2674, APO AP 96338. EM: dolbym@yahoo.com

**Erker, Michele K.**, 105 Grayson Drive, Enterprise, AL 36330. EM: erkerkn@aol.com

**Felderman, Robert J.**, 1179 Iowa Street, Dubuque, IA 52001-4819. EM: FeldermanR@aol.com

**Flewelling, Raymond**, CMR 454, Box 2104, APO AE 09250.

**Golden, Walter M., Jr.**, 38 Bow Street, Lexington, MA 02420. EM: goldengang6@prodigy.net

**Grant, Michael O.**, 7105 Green Springs Lane, Alexandria, VA 22306.

**Hunter, Robert G.**, USEMB-USA AO, Unit 3790, APO AA 34031.

**Lawrence, David L.**, HQs USAREUR, CMR 420, Box 842, APO AE 09063. EM: Davlaw@aol.com

**Milani, Andrew N.**, 7611 Spurge Drive, Fayetteville, NC 28311. EM: milania@aol.com

**Peel, Loren D.**, 3724 Amherst Street, Norfolk, VA 23513. EM: peel@exch.kuwait.army.mil

**Radovich, Rory R.**, 127 Parkview Court, Lansing, KS 66043.

**Riley, Michael N.**, 304 W. Kingwood Drive, Enterprise, AL 36330.

**Yomant, Charles M.**, CMR 408, Box 1171, APO AE 09182.

**MAJORS**

**Brownlee, Emory W.**, 4404 Churchman Court, Alexandria, VA 22310.

**Cassella, James P.**, HHC, 17th Avn Bde, Unit 15270, APO AP 96205.

**Christensen, Kevin J.**, 2002 4th Avenue, Leavenworth, KS 66048. EM: christek@hoffman.army.mil

**Davis, Thomas A.**, 78 Offutt Road, Hanscom AFB, MA 01731. EM: davis@bu.edu

**Erker, Erich**, 105 Grayson Drive, Enterprise, AL 36330.

**George, David A.**, HHC/2-2 Aviation Regiment, Unit 15427, Box 134, APO AP 96257. EM: daalgeorge@aol.com

**Macchiarella, Nickolas**, 6061 Red Stag Drive, Port Orange, FL 32124. EM: macchian@cts.db.erau.edu

**Reist, Paul K.**, 1505 Mountain Laurel, Harker Heights, TX 76548.

**Schoolcraft, David E.**, 208 Sandcreek Road, Enterprise, AL 36330. EM: d.schoolcraft@att.net

**Seltz, Stephen S.**, 408 Hiltgreen Drive, Lansing, KS 66043.

**Sherrell, Chandler C.**, 5978 Fincastle Drive, Manassas, VA 20112. EM: slsherrell@mindspring.com

**Tisdale, Valen S.**, 4369 Hackney Coach Lane, Fairfax, VA 22030. EM: vstis4@hotmail.com

**Tobin, Vincent M.**, 136 Lansdowne Drive, Madison, AL 35758. EM: tobinv@peoavn.redstone.army.mil

**Tolmacheff, Mark A.**, 102 Harrant Creek Drive, Enterprise, AL 36330.

**Wilcoxson, Alan V.**, 24 Beech Tree Hill Road, Shelton, CT 06484. EM: twilcoxson@aol.com

**CAPTAINS**

**Azubiuke, Amanda I.**, HSC, 3d MI Bn (AE), Unit #15220, Box #1220, APO AP 96271. EM: azubiuke99@yahoo.com

**Baker, Donald R.**, George C. Marshall Center, Unit 24502, Box 101, APO AE 09053. EM: bridgeverbrooke@hotmail.com

**Bell, Mary B.**, 2004 Patricia Street, Copperas Cove, TX 76522. EM: MJ.Bell@hood.army.mil

**Berg, Paul E.**, 102 Lightfoot Drive, Enterprise, AL 36330. EM: ptcberg@aol.com

**Bricker, Kevin L.**, 70 Woodfield Place, Enterprise, AL 36330.

**Cline, Nathan S.**, 793 Smith Branch Road, Clarksville, TN 37042. EM: s\_cline@yahoo.com

**Curtis, Joseph S.**, 59 Womack Avenue, Cookeville, TN 38501. EM: sdcurtis@usit.net

**Hasch, Spencer D.**, 1712 Rucker Boulevard, Enterprise, AL 36330.

**Kimball, Raymond A.**, 105D Gunter Lane, Enterprise, AL 36330. EM: Raymond.Kimball@us.army.mil

**McLaughlin, Geoffrey A.**, 4025 Bankside Drive, Fayetteville, NC 28311. EM: glcebmc1@compuserve.com

**Mele, Paul A.**, 313 The Maine West, Williamsburg, VA 23185.

**Ochoa, Mario D.**, 153 Commons Drive, Enterprise, AL 36330.

**Ott, Carl R.**, HHC, 214th Avn Bn, Unit #29231, APO AE 09102.

**Scoville, Marc A.**, Route 3, Box 275B, Enterprise, AL 36330. EM: scovillem@emh2.campbell.army.mil

**Sexton, Amy**, 8004 D General Grant Dr., Fort Drum, NY 13603.

**Vine, Christopher**, 76 Woodfield Place, Enterprise, AL 36330. EM: cvinesq@aol.com

**1ST LIEUTENANTS**

**Bylone, Peter C.**, 460 Sivley Road, Apt. 303, Hopkinsville, KY 42240. EM: stump\_12@hotmail.com

**Donohue, Bryan T.**, 214th Avn Bn, Unit 29231, APO AE 09102.

**Emerson, Peter M.**, 111 Danforth Place, Wilmington, DE 19810.

**Green, Jr., John H.**, 507 Briarwood Drive, Apt. 12-D, Enterprise, AL 36330. EM: dustoffhawk@hotmail.com

**Keller, Frederick G.**, 6949 Suncrest, Saline, MI 48176.

**McDowell, Shamgar E.**, 2901 Reed Lane, Killeen, TX 76542. EM: shamgar\_mcdowell@hotmail.com

**2ND LIEUTENANTS**

**Moore, Matthew K.**, 207 E. Clark Blvd., Murfreesboro, TN 37130.

**Sanford Hayden**, Virginia B., Rt. 73, Box 32, Lloyd, MT 59535. EM: virg\_sanford@hotmail.com

**Wood, Laura J.**, 68-615 Farrington Highway, No. 24B, Waialua, HI 96791.

**CW5S/MW4S**

**Coates, David A.**, 603 Trafford Lane, Savannah, GA 31410. EM: coatesda@emh1.stewart.army.mil

**Goetz, Steven C.**, PSC 303, Box 27, APO AP 96204.

**Martin, John E.**, 1304 County Road 333, Elba, AL 36323. EM: jackscom@hotmail.com

**CW3S**

**Genter, Keith D.**, 505 Briarwood Drive, Apt. B-7, Enterprise, AL 36330. EM: genter@snowhill.com

**CW2S**

**Shumway, Mark E.**, 2222 Mayfield Palms Lane, Sun City Center, FL 33573.

**Wood, Lance M.**, 1002 Bluewood Terrace, Weston, FL 33327. EM: lan@writeeme.com

**WO1S**

**Pittman, Phillip D.**, 25 Fowler Lane, Fort Rucker, AL 36362.

**Ritchey, Scott D.**, 169 Oakview Drive, Raeford, NC 28376. EM: armyblackhawk@mindspring.com

**Torney, Gabriel A.**, 102 Oriole Drive, Enterprise, AL 36330.

**SERGEANTS**

**Scheffing II, Richard W.** SSG, USDAO Bishkek US Dept Sta, 7040 Bishkek Place, Washington, DC 20521. EM: shefr@erols.com

**Stevens, Timothy L.** SGM, 7277-A Merrell Court, Fort Stewart, GA 31315. EM: tlstevens@aol.com

**SPECIALISTS**

**Cooper, Keith W.** SFC, 93 Dunn Street, Fort Rucker, AL 36362.

**Douma, Gerry SPC**, 3709 S. San Pablo Road, Apt. 1506, Jacksonville, FL 32224.

**Erdmann, Mandy J.** SPC, B6, 5158th Avn, PSC 103, Box 4302, APO AE 09603.

**CIVILIAN**

**Atkins, Frank G.**, 2712 Fanelle Circle, Huntsville, AL 35801.

**Fletcher, Raymond P.**, 505 Antler Drive, Enterprise, AL 36330. EM: rpfletcher@hotmail.com

**Lessard, Norman R.**, Raytheon Company, 2501 Discovery Drive #300, Orlando, FL 32826.

**Miller, Brian L.**, 918 71st Street NE, Cedar Rapids, IA 52402.

**Presser, Detlef W.**, 139 Waterbury Drive, Harvest, AL 35749. EM: dpresser@camber.com

**Shobe, Les**, 1605 Ocean Avenue, Seal Beach, CA 90740. EM: lshobe@pacsci.com

**RETIRED/OTHER**

**Alexander, Ronald H.** LTC, P.O. Box 18138, Panama City Beach, FL 32417. EM: rhalexan@collins.rockwell.com

**Bayne, Robert D.** LTC, 1933 Renee Circle, Palm Springs, CA 92264.

**Dimmery, Hugh M.** MAJ, 8958 Palmetto Road Ext., Edisto Island, SC 29438.

**Flynn, Joseph L.** MAJ, 3422 Oak Hill Street, Sierra Vista, AZ 85650. EM: llynnj@huachuca-emh1.army.mil

**Hesse, Walter L.** CSM, 1110 South Grand Avenue, Stuttgart, AR 72160.

**Littlejohn, Edward H.** COL, 6261 Rime Village Drive, Apt. 207, Huntsville, AL 35806. EM: elittlejohn@kpmg.com

**Lockhart, Henry D.** LTC, 2298 West Highway 30A, Blue Mountain Beach, FL 32459.

**McNiesh, Garry P.** Mr., 2011 Shadow Ridge Road, Harker Heights, TX 76548. EM: gmnciesh@hotmail.com

**Penman, John R.** COL, PMB 625, 106 Rainbow Drive, Livingston, TX 77399. EM: rmedad@aol.com

**Takagi, Nobuhiro** CPT, 12-306 Greenhaim 9-1, Yayoidai Izumiku Yokohama, City 245-0008 Japan.

**Truscott, James J.** COL, POB 42637 AlKhalidiyah PO, Abu Dhabi, United Arab Emirates. EM: Jtrus5@aol.com

**Wagner, Randy D.** MW4, 22405 N. 53rd Street, Phoenix, AZ 85054. EM: randy@global.t-bird.edu

**Welch, Lawrence R.** MAJ, P.O. Box 50494, Colorado Springs, CO 80949. EM: lwelch@sikorsky.com

**Whatley, Robert J.** CW5, 600 Ridgecrest Drive, Salado, TX 76571. EM: whatley@hood.army.mil

## ARMY AVIATION



### BOOK REVIEW

#### DUSTOFF: The Memoir of an Army Aviator

by Michael J. Novosel

(Presidio Press, 326 pages)

Reviewed by

Maj. Gen. Ben L. Harrison, U.S. Army (Ret.)

An interesting and inspiring memoir of a man who early on showed his courage by repeatedly seeking difficult challenges and opportunities to serve his country. Bad career breaks in the Air Force did not deter his determination to always do what was right. After flying as aircraft commander of a B-29 in World War II, commanding a squadron of these mighty bombers and reaching the rank of Lieutenant Colonel in the Air Force, Mike (I've known him for many years) was inspired by President John Kennedy to volunteer his flying skills and experience to the Army. His first assignment was with Kennedy's favorite force, the Green Berets of Special Forces, in 1964.

Mike tells of his on-duty and off-duty experiences the way he served — straight forward, determined to let it all hang out. Clearly he contributed to the professionalism and effectiveness of every unit in which he served; especially in combat. His instrument and night-flying skills were particularly suited for the bad weather, 24-hours-a-day medical evacuations of DUSTOFF.

This will be the only place you will ever read of a father (age 47) and son flying pilot and copilot in combat; of the father rescuing the son and a week later, the son rescuing the father.

As I have said many times, any decoration you see an Army aviator wearing, he probably deserved at least 10 of them. In Mike's case, the Army finally got it right. He was awarded the Medal of Honor for one of his many, many heroic actions.

There are several reviews of the book on amazon.com. Two I found of special interest. One said the great strength of this book is that Mike wrote it himself without a ghost writer. Another reviewer said the author really needed a ghost writer. I vote with the first reviewer! Read this book. Give it to young people who need a role model for selfless service.

Briefings continued from page 3

The **BFGoodrich Co.** and **Dartmouth College** are working together on the development of a potential breakthrough technology for aircraft ice protection. The research is based on patented technology developed by Dr. Victor Petrenko, a professor at Dartmouth's Thayer School of Engineering. Petrenko's work uses electric currents to reduce or prevent ice formation, and was recently honored by *Discover Magazine* as the most innovative invention for the aerospace industry in the year 2000.

The Army has awarded **Rockwell Collins** a contract to upgrade two C-12F3 aircraft to meet Global Air Traffic Management requirements, with the upgrade of an additional 21 aircraft to follow. The upgrade includes the installation of Collins WXR-850 weather radar, Traffic Collision and Avoidance Systems and an Integrated Avionics Processor System (IAPS). The IAPS includes a dual FMS-3000 Flight Management System, dual GPS-4000A GPS systems and an ADC-3000 Air Data Computer. A fifth MFD-255C multifunction display will be added for weather radar, flight plan and Enhanced Proximity Warning System overlay information.

The Army will activate the **1st Squadron, 14th Cavalry**, at Fort Lewis, Wash., on Sept. 15. The unit will be reflagged from the existing 1st Battalion, 32nd Armor, and will become an element of the new Interim Brigade Combat Team. Another squadron is to be activated later.

**Westar Corp.** has completed its acquisition of **COBRO Corp.**, a logistics services firm with offices at several Army installations worldwide. This transaction will extend the reach of Westar's rapidly growing Aerospace and Defense Group. Founded in 1986, Westar Corp. is a privately held, diversified technology company providing engineering services and specialty products.

**Royal Air Force** Chinook HC Mk 2 helicopters played a vital role in Operation Palliser, the support of British and United Nations peacekeeping forces operating in war-torn Sierra Leone. Four of the aircraft self-deployed to Africa, undertaking the three-day, 3,000-mile flight from Oldham via France, Portugal, the Canary Islands and Senegal. Once on station the aircraft flew humanitarian relief and noncombatant evacuation missions, as well as undertaking troop transport and reconnaissance flights.

Thanks to engine replacements made by the maintenance crews of the **3rd Squadron, 17th Cavalry Regiment**, and **Company C, 10th Aviation Regiment**, on some of the 10th Mountain Division's OH-58D Kiowa Warriors, full cavalry support for division soldiers is up and flying again. Mechanics began installing 12 new "R" engines on July 7 during block leave in order to assure that the 3-17 Cav. would be able to provide 100 percent support to the division at Fort Polk, La., during the upcoming Joint Contingency Force Advanced Warfighting Experiment. Soldiers will replace about three engines a month, until every Kiowa Warrior helicopter is completed by this time next year.

Here is a website with some great Vietnam photos of Army Aviation and the 173rd Airborne Brigade in action.

<http://members.aol.com/a46pidet/>

## AVIATION EDUTAINMENT

What's New on the Web, TV & PC





**Editor's Note:** Army Aviation is seeking good-news announcements of aviation-related professionals who are on the move. If you or your organization have an upcoming change of leadership (at the battalion or squadron level, or higher for MTOE and TDA units), please forward the information to Barbara Ross, care of the AAAA National Office.



The chief of staff of the Army announces the assignment of the following general officers:

**Maj. Gen. James R. Snider** from program executive officer, aviation, Redstone Arsenal, Ala., to deputy chief of staff for research, development and acquisition, U.S. Army Materiel Command, Alexandria, Va.

**Maj. Gen. Joseph L. Yakovac Jr.** from deputy for systems management and horizontal technology integration, Office of the Assistant Secretary of the Army (Acquisition, Logistics and Technology), Washington, D.C., to program executive officer, ground combat support systems, Office of the Assistant Secretary of the Army (Acquisition, Logistics and Technology), Washington, D.C., with a report date to be determined.

**Brig. Gen. Robert E. Armbruster Jr.** from deputy for systems acquisition, U.S. Army Aviation and Missile Command, Redstone Arsenal, Ala., to deputy for systems management and horizontal technology integration, Office of the Assistant Secretary of the Army (Acquisition, Logistics and Technology), Washington, D.C., with a report date to be determined.

The chief of staff of the Army has announced the assignment of the following general officers:

**Maj. Gen. Colby M. Broadwater III** from deputy commanding general, III Corps and Fort Hood, Texas, to deputy commanding general, First U.S. Army, Fort Gillem, Ga., with a report date to be determined.

**Maj. Gen. James E. Donald** from deputy commanding general/chief of staff, U.S. Army, Pacific, Fort Shafter, Hawaii, to deputy chief of staff for personnel and installation management, U.S. Army Forces Command, Fort McPherson, Ga., with a report date to be determined.

**Maj. Gen. Robert R. Ivany** from commanding general, U.S. Army Military District of Washington, Fort Lesley J. McNair, Washington, D.C., to commandant, U.S. Army War College, Carlisle Barracks, Pa., with a report date to be determined.

**Maj. Gen. Philip R. Kehsinger Jr.** from commanding general, U.S. Army, South, Fort Buchanan, Puerto Rico, to assistant deputy chief of staff for operations and plans, U.S. Army, Washington, D.C., with a report date to be determined.

**Maj. Gen. Gregory A. Rountree** from assistant chief of staff for operations, J-3/J-7, Regional Command North, The Netherlands, to deputy commanding general (operations/training), Fifth U.S. Army, Fort Sam Houston, Texas, with a report date to be determined.

**Brig. Gen. Dorian T. Anderson** from commanding general, Joint Task Force 6, U.S. Joint Forces Command, Fort Bliss, Texas, to director, Officer Personnel Management Directorate, U.S. Total Army Personnel Command, Alexandria, Va., with a report date to be determined.

**Brig. Gen. George A. Higgins** from assistant division commander (support), 4th Infantry Division, Fort Hood, Texas, to deputy commanding general, III Corps and Fort Hood, with a report date to be determined.

The chief of staff of the Army announces the assignment of **Brig. Gen. Dell L. Dailey** from chief of staff of U.S. Special Operations Command, MacDill Air Force Base, Fla., to commanding general, Joint Special Operations Command, Fort Bragg, N.C., with a report date to be determined.

**Brig. Gen. William L. Bond** from commanding general, Simulations, Training and Instrumentation Command, Orlando, Fla., to assistant deputy chief of staff for operations and plans for force development, U.S. Army, Washington, D.C., with a report date to be determined.

**Brig. Gen. John M. Urias** from program executive officer, air and missile defense, Huntsville, Ala., to deputy commanding general, U.S. Army Space and Missile Defense Command, Arlington, Va., with a report date to be determined.

**Col. Roger A. Nadeau** from assistant deputy for systems management and horizontal technology integration, Office of the Assistant Secretary of the Army (Acquisition, Logistics and Technology), Arlington, Va., to deputy for systems acquisition, U.S. Army Aviation and Missile Command, Redstone Arsenal, Ala., with a report date to be determined.

**Brig. Gen. Velma L. Richardson** from deputy commanding general, U.S. Army Signal Center and Fort Gordon, Ga., to deputy commanding general, Army and Air Force Exchange Service, Dallas, Texas, with a report date to be determined.

**Brig. Gen. Stephen M. Speakes** from chief of staff, V Corps, U.S. Army, Europe, and Seventh Army, Germany, to assistant deputy chief of staff for operations (readiness), U.S. Army Forces Command, Fort McPherson, Ga., with a report date to be determined.

**Brig. Gen. Antonio M. Taguba** from assistant division commander (forward), 24th Inf. Div./deputy commanding general (South), First U.S. Army, Fort Jackson, S.C., to commanding general, U.S. Army Community and Family Support Center, Alexandria, Va., with a report date to be determined.

**Brig. Gen. Craig B. Whelden** from commanding general, U.S. Army Community and Family Support Center, to deputy commanding general/chief of staff, U.S. Army Pacific, with a report date to be determined.

**Brig. Gen. John R. Wood** from deputy commandant, U.S. Army Command and General Staff College, Fort Leavenworth, Kan., to director of strategy, plans and policy, Office of the Deputy Chief of Staff for Operations and Plans, U.S. Army, Washington, D.C., with a report date to be determined.

**Col. William C. Feyk** from chief of staff, III Corps and Fort Hood, to deputy commanding general, U.S. Army Cadet Command, Fort Lewis, Wash., with a report date to be determined.

**Col. Robert E. Gaylor** from chief of staff, U.S. Army Recruiting Command, Fort Knox, Ky., to deputy commanding general (west), U.S. Army Recruiting Command, with a report date to be determined.

Secretary of Defense William S. Cohen and NATO announced today that the president had nominated, and the Senate confirmed, **Lt. Gen. William F. Kernan** for appointment to the grade of general and assignment as the commander in chief, U.S. Joint Forces Command and Supreme Allied Commander, Atlantic, in Norfolk, Va. Since March 1998 he has commanded XVIII Airborne Corps and Fort Bragg, N.C.

The Chief of Staff, Army announces the assignment of the following officers, who are pending the Senate's confirmation of nomination for promotion to brigadier general, to general officer positions:

**Col. Bruce H. Barlow** to assistant division commander, 7th Infantry Division/deputy commanding general (central), Fifth U.S. Army, Fort Carson, Colo., with a report date to be determined.

**Col. Vincent E. Boles** to deputy chief of staff for ammunition, U.S. Army Materiel Command, Alexandria, Va., with a report date to be determined.

**Col. Gary L. Border** to director for logistics, J-4, U.S. Joint Forces Command, Norfolk, Va., with a report date to be determined.

**Col. Howard B. Bromberg** to deputy commanding general, U.S. Army Air Defense Artillery Center and Fort Bliss, Texas, with a report date to be determined.

**Col. Michael L. Combest** to assistant deputy chief of staff for combat developments, U.S. Army Training and Doctrine Command, Fort Monroe, Va., with a report date to be determined.

**Col. William C. David** to assistant division commander, 101st Airborne Div., Fort Campbell, Ky., with a report date to be determined.

**Col. Benjamin C. Freakley** to deputy director for operations, National Military Command Center, J-3, The Joint Staff, Washington, D.C., with a report date to be determined.

**Col. Brian I. Geehan** to director, logistics, engineering and security assistance, J-4, U.S. Pacific Command, Camp H. M. Smith, Hawaii, with a report date to be determined.

**Col. Richard V. Geraci** to deputy commanding general for space, U.S. Army Space and Missile Defense Command, Peterson Air Force Base, Colo., with a report date to be determined.

**Col. Gary L. Harrell** to commander, Joint Rear Area Coordinator, U.S. Central Command, MacDill Air Force Base, Fla., with a report date to

be determined.

**Col. Janet E. A. Hicks** to director, command, control, communication and computer systems, J-6, U.S. Pacific Command, with a report date to be determined.

**Col. Kenneth W. Hunzeker** to assistant division commander, 4th Infantry Div., Fort Hood, Texas, with a report date to be determined.

**Col. Gary M. Jones** to deputy commanding general/chief of staff, U.S. Army Special Operations Command, Fort Bragg, N.C., with a report date to be determined.

**Col. Jason K. Kamiya** to deputy director, Strategy, Plans and Policy Directorate, Office of the Deputy Chief of Staff for Operations and Plans, U.S. Army, Washington, D.C., with a report date to be determined.

**Col. Bernardo C. Negrete** to assistant division commander, 82nd Abn. Div., Fort Bragg, with a report date to be determined.

**Col. F. Joseph Prasek** to commanding general, Joint Task Force 6, U.S. Joint Forces Command, Fort Bliss, with a report date to be determined.

**Col. Steven P. Schook** to chief of staff, III Corps and Fort Hood, with a report date to be determined.

**Col. John C. Scroggins** to assistant division commander, 101st Abn. Div., Fort Campbell, with a report date to be determined.

**Col. Gratton O. Sealock II** to defense attaché, U.S. Defense Attaché Office, Beijing, China, with a report date to be determined.

**Col. Guy C. Swan III** to commanding general, 7th Army Training Command, U.S. Army, Europe, and Seventh Army, Germany, with a report date to be determined.

**Col. David P. Valcourt** to assistant division commander, 2nd Inf. Div., Eighth U.S. Army, Korea, with a report date to be determined.

**Col. Robert M. Williams** to assistant division commander, 1st Inf. Div., U.S. Army, Europe, and Seventh Army, with a report date to be

#### Lieutenant Colonel Command Selection List for FY01

##### 4ER - Aviation TSS

LTC Eberle, Joann Y. ●	AV	15	48
LTC Kelly, George G.	AV	15	49
LTC Ludowese, Jeryl C. ●	AV	15	41
LTC Lynch, Robin D. +	AV	15	
LTC St. Jean, Albert C.	AV	15	54
LTC Thoma, Brian L. ●	AV	15	54
LTC Wild, Douglas A.	AV	15	41

##### 4EX - Aviation Institutional

LTC Angevine, John E. +	AV	15	54
LTC Pittman, Thurman Jr. ●	AV	15	45
LTC Steed, Roy D. ●	AV	15	54
LTC Wood, Paul J. ●	AV	15	49

##### 4L - Aviation Attack/Cavalry TAC

LTC Ball, Daniel L. ●	AV	15	49
LTC Ball, Arthur T. Jr. ●	AV	15	54
LTC Ballew, Robert S. ●	AV	15	54
LTC Clawson, Michael N. ●	AV	15	54
LTC Egbert, Jerry L. ●	AV	15	54
LTC Farrington, Jessie O. ●	AV	15	54
LTC Gehler, Christopher P. ●	AV	15	59
LTC Hansen, John T. ●	AV	15	54
LTC Harrison, John C.	AV	15	54
LTC Jones, Mark T. ●	AV	15	
LTC Linderman, Timothy W. ●	AV	15	54
LTC Thompson, Scott B. ●	AV	15	54

##### 4M - Aviation Assault/General Support TAC

LTC Bricker, Paul W. ●	AV	15	41
LTC Ferguson, Howard R. ●	AV	15	
LTC Fields, Charles F.	AV	15	54
LTC Flewelling, Raymond T. ●	AV	15	49
LTC Jones, Jay R. ●	AV	15	
LTC Kelley, Yvette J. ●	AV	15	53
LTC Keogh, Michael H. ●	AV	15	54
LTC Leary, William J. III	AV	15	41
LTC Lisenbee, Donald G. Jr. ●	AV	15	
LTC Maher, Joseph E. Jr	AV	15	41

LTC Rice, William T.	AV	15	54
LTC Sabb, Anthony ●	AV	15	
LTC Welch, Robert P. +	AV	15	54
LTC Zegler, Scott D.	AV	15	54

##### 4N - Aviation Medium Lift TAC

LTC Marye, James M. +	AV	15	54
LTC Trouve, Christopher A.	AV	15	41

##### 5E - Aerial Exploitation TAC

LTC Effinger, Robert C. III	AV	15	35
LTC Fox, Roy W.	AV	15	35
LTC Montgomery, Robert J. Jr	AV	15	35

##### 5ER - Aerial Exploitation TSS

LTC Joiner, Michael A.	AV	15	
------------------------	----	----	--

##### 6H - Aviation Maintenance TAC

LTC Dunaway, Joe D.	AV	15	90
LTC Stull, Alan M. +	AV	15	90

##### Acquisition LTC/Gs-14 Command List

LTC Bryant, Thomas H. +	AC	15	51
LTC Cantor, Michael E.	AC	15	51
LTC Delaney, Michael J. ●	AC	15	51
LTC Eberle, Nathan R. ●	AC	15	51
LTC Hazelwood, Donald A. ●	AC	15	51
LTC Kunkel, George D. ●	AC	15	51
LTC Miller, Christopher M. ●	AC	15	51
Mr Miller, Russell F.	AC	Cv	Cv
Mr Paul, Richard B.	AC	Cv	Cv
LTC Shufflebarger, Newman D. ●	AC	15	51
LTC Trang, Jeffrey A. ●	AC	15	51
LTC Wilson, John M.	AC	15	51
LTC Yarborough, Michelle F. ●	AC	15	51

##### M4A - Battalion/Troop TDA

LTC Ippolito, Anastasia M.	MS	67	67J
----------------------------	----	----	-----

##### M4C - Evacuation Battalion

LTC MacDonald, David L.	MS	67	67J
-------------------------	----	----	-----

+ AAAA Life Member

● AAAA Member

**Lt. Col. Bob Felderman** (AAAA life member), has just relinquished command of the 1st Battalion, 109th Aviation Regiment (AVIM), Boone, Iowa, to attend the National War College, Fort McNair, Washington, D.C. He is only the second traditional National Guardsman ever selected to attend the National War College, and the first traditional National Guard aviator. He is an Iowa National Guardsman, 25 years of service, over 22 years flying with over 2,200 hours. Qualified in the TH55, OH58 A & C, UH1 H & V, Safety Officer Qualified, Avn Maintenance Officer Qualified.

**FY00 Army Lt. Col. Promotion Selections**  
**AAAA congratulates the following**  
**Aviation officers!**

SEQ#	NAME	BR	
888	Anthony, Hodges Jr	AV	1195
#1244	Arcocha, Juan L. ●	AV	768
391	Artman, Spencer Q. ●	AV	761
#1296	Barbee, Michael J. ●	AV	460
22	Bartlett, Kenneth C. ●	AV	895
752	Bassani, Joseph A. ●	AV	647
836	Beck, James R. ●	AV	641
1027	Beckinger, Richard ●	AV	219
206	Bequette, Bryan W. ●	AV	1173
1208	Bishop, Kevin R. ●	AV	319
383	Blackburn, Joseph W. ●	AV	594
1079	Boylan, Steven A. ●	AV	740
388	Brew, Thomas R. ●	AV	47
996	Brown, Jeffery D. +	AV	384
252	Brown, Steven K. ●	AV	1020
894	Brucker, Duane E. ●	AV	56
664	Cantwell, Gregory L. +	AV	799
72	Carpenter, Martin T. ●	AV	#1255
506	Cheney, David C. ●	AV	1102
952	Ciampini, Joseph ●	AV	484
920	Clegg, Joseph F. ●	AV	624
29	Contreras, James P. ●	AV	#1279
1187	Coplen, Lorelei E. ●	AV	883
686	Cyr, Michael P. ●	AV	657
97	Darby, Harry B. ●	AV	204
1213	Daum, Richard S. ●	AV	1023
331	Dickey, Clifton L. ●	AV	#1284
814	Dolan, Terrance J. ●	AV	645
#1292	Douthit, Robert L. ●	AV	924
586	Dowd, John F. ●	AV	90
486	Evans, Richard A. ●	AV	116
1188	Evans, Samuel S. ●	AV	1193
666	Fessenden, Alan D. ●	AV	#1224
1059	Ford, Samuel J. ●	AV	1026
1014	Gabram, Douglas M. ●	AV	796
69	Gaslin, Robin L. +	AV	#1312
762	Goad, Jed L. ●	AV	765
515	Godfrey, Daniel A. ●	AV	971
238	Gunter, Elvin K. ●	AV	160
		AV	651

Haywood, Thomas J.	AV	#1299
Heller, Kenneth E. ●	AV	956
Hesse, Robert L. ●	AV	1033
Hill, Jeffrey G. ●	AV	1197
Hume, Robert S. ●	AV	8
Jackson, Randy K. +	AV	791
Jellison, Joseph B. ●	AV	66
Johnson, Eric S. ●	AV	659
Jones, Gary R. ●	AV	171
Jones, Timothy A. ●	AV	245
Kenney, James J. ●	AV	1183
Knapp, Richard T. ●	AV	435
Kools, Joseph M. ●	AV	732
Kowal, Peter D. ●	AV	280
Larsen, Jon A. +	AV	614
Latham, William C. ●	AV	1028
Lembke, Roy K. ●	AV	899
Macchiarella, N. ●	AV	#1243
Manville, David L. ●	AV	1035
McLean, Daniel S. ●	AV	911
Meacham, Jimmy L. ●	AV	283
Miller, William K. ●	AV	
Mock, Robert K. ●	AV	
Monsees, Kyle M. ●	AV	
Moore, David R. ●	AV	
Morgan, Terry V. ●	AV	
Negard, Michael J. ●	AV	
Nocks, Andrew B. ●	AV	
Oxer, Van T. ●	AV	
Parker, David B. ●	AV	
Peterson, Erik C. ●	AV	
Picciuto, John A. ●	AV	
Pollock, Steven A. ●	AV	
Pretsch, Roger A. ●	AV	
Purvis, James W. ●	AV	
Quackenbush, John E. +	AV	
Quackenbush, Robert ●	AV	
Raker, James E. ●	AV	
Reinwald, Allison R. ●	AV	
Richardson, Laura J. ●	AV	
Rivera, Ricardo M. ●	AV	
Rizzi, Glenn A. ●	AV	
Rodgers, David P. ●	AV	
Roth, Barry A. +	AV	

Schiller, Stephen M. ●	AV
Senters, Michael ●	AV
Smith, Eric E. ●	AV
Smith, Kevin L. ●	AV
Smith, Roger D. ●	AV
Smith, Stephen C. ●	AV
Soler, Nancy A. ●	AV
Solley, Miracle D. ●	AV
Southard, William C. +	AV
Taylor, Ronald K. ●	AV
Uises, Robert J. ●	AV
Utnik, Catherine F. ●	AV
Walters, Craig S. ●	AV
Webb, Grant A. ●	AV
Werthman, Robert W. ●	AV
Whaley, James E. ●	AV
White, Christopher +	AV
Williams, Daniel E. ●	AV
Williams, John D. ●	AV
Williams, Michael C. ●	AV
Woods, Kevin M. ●	AV

**Acquisition Corps Aviation Selectees for Promotion:**

SEQ#	NAME	BR
774	Bleckley, Dennis R. ●	AC
15	Borhauer, Rachel D. ●	AC
41	Brown, Clayton E. ●	AC
344	Crouch, Thomas W. ●	AC
967	Edwards, Keith R. ●	AC
632	Fortier, Norbert H. +	AC
521	Kihara, Steven W. ●	AC
453	Klumpp, Joseph J. ●	AC
649	Oelberg, Gregory P. ●	AC
861	Presgraves, Donald ●	AC
1196	Robinson, Keith W. ●	AC
122	Smith, Gary S. ●	AC
968	Stewart, Gregory E. ●	AC
1203	Tobin, Vincent M. ●	AC

# = Below the Zone Selection  
 + = AAAA Life Member  
 ● = AAAA Member

Secretary of Defense William S. Cohen announced today that President Bill Clinton has nominated:

**Army Lt. Gen. Daniel J. Petrosky** for appointment to the grade of lieutenant general with assignment as chief of staff, U.S. European Command, in Stuttgart, Germany. Petrosky is currently the commanding general, Eighth U.S. Army, and chief of staff of United Nations Command/Combined Forces Command/U.S. Forces Korea, in Yong San, Korea.

**Maj. Gen. Robert B. Flowers** has been nominated for appointment to the grade of lieutenant general with assignment as chief of engineers and commanding general, U.S. Army Corps of Engineers, in Washington, D.C. Flowers is currently the commanding general of U.S. Army Maneuver Support Center and Fort Leonard Wood, Mo., and commandant of the U.S. Army Engineer School.

Army National Guard **Col. Bradford C. Brightman** has been nominated for promotion to the grade of brigadier general. Brightman is currently the assistant adjutant general, Alabama State Area Command, in Montgomery, Ala.

**Col. Walton C. Carroll** has assumed command of the 22nd Area Support Group at Caserma Ederle in Vicenza, Italy. He was formerly chief of staff for the 13th Corps Support Command at Fort Hood, Texas.

**Lt. Gen. Edward G. Anderson III**, U.S. Army, for reappointment to the grade of lieutenant general and assignment as the deputy commander in chief/chief of staff, U.S. Space Command and vice commander in chief, North American Aerospace Defense Command, Peterson Air Force Base, Colo. Since August 1998 he has been director for strategic plans and policy, J-5, Joint Staff, in Washington, D.C.

**Lt. Gen. William P. Tangney**, U.S. Army, for reappointment to the grade of lieutenant general and assignment as the deputy commander in chief, U.S. Special Operations Command, MacDill Air Force Base, Fla. Since March 1998 he has commanded U.S. Army Special Operations Command at Fort Bragg, N.C.

**Maj. Gen. Bryan D. Brown**, U.S. Army, for appointment to the grade of lieutenant general and assignment as commander of U.S. Army Special Operations Command at Fort Bragg. Since August 1998 he has commanded the Joint Special Operations Command at Fort Bragg.

**Maj. Gen. John P. Abizaïd**, U.S. Army, for appointment to the grade of lieutenant general and assignment as the director for strategic plans and policy, J-5, Joint Staff, in Washington, D.C. Since August 1999 he has commanded the 1st Infantry Division in Germany.

**Col. Jeffrey J. Schloesser**, U.S. Army, for promotion to the grade of brigadier general. He previously commanded the 12th Aviation Brigade in Germany, and is en route to his new assignment at the Office of Military Cooperation in Kuwait.

**Corrections:** Lieutenant Colonels RC/APL Promotion Selection list in our June 2000 issue included David R. Brown, however, we neglected to indicate that he is in fact a Life Member of AAAA since 1982, as well as a past chapter VP for Memberships.

# \$244,000.00 in Scholarships Awarded

**Brig. Gen. Stu Gerald (Ret.)**

President, AAAA Scholarship Foundation, Inc.

The 2000 AAAA Scholarship Program exceeded all expectations in number of awards made and dollar amount of those awards. Thirty-eight members of the AAAA Awards Committee voted 150 applicant files on Saturday, July 22, 2000, and assigned a record \$244,000 to the 107 outstanding students listed on these pages. This translates to 71 percent of applicants winning average awards of almost \$2,300 each.

All the applicants had their names and the names and ranks of their AAAA member relatives removed from their files and all files were voted on the basis of academic merit, not need. The average winning freshman had a 3.86 grade point average, ranked in the top 10 percent of their class, and scored 617 on their SATs. The upperclassmen and graduates were of similar quality.

After the awards were made and the identities of the successful applicants established, the demographics revealed that a record 27 warrant officers and 15 enlisted AAAA members or their families had received awards. In addition, five company grade officers were rewarded.

As a reminder, every dollar donated to the AAAA Scholarship Foundation, Inc., goes directly to scholarship awards or principal. All expenses of the foundation are absorbed by the Army Aviation Association of America, Inc. In addition, the AAAA also donates \$25,000 in cash each year to the foundation itself.

AAAA supports the best and brightest among the youth of America through this membership benefit. If you know AAAA members or their spouses and children who might wish to apply, encourage them to contact the AAAA National Office and make their application before the May 1 suspense.

Again, congratulations to all our 2000 AAAA Scholarship Program winners!



**AAAA National GEN Hamilton H. Howze Memorial Scholarship - \$15,000 (\$3,750 a year for four years)** Laura M. Smalligan, daughter of Paul T. Smalligan, Alamo, CA - Dartmouth College.



**GEN Frank S. Besson, Jr. Memorial Scholarship - \$15,000 (\$3,750 a year for four years)** Tammie K. Heller, daughter of MAJ Kenneth E. Heller, Jr., Richmond Hill, GA - University of Georgia



**LTG William B. Bunker Memorial Scholarship - \$15,000 (\$3,750 a year for four years)** Ephraim J. Garner, son of MAJ Ronald J. Garner, Fort Benning, GA - Brigham Young University.



**Monmouth Chapter (Hogelin/O'Donnell) Matching Scholarship - \$8,000 (\$2,000 a year for four years)** Daniel L. DeCosimo, son of Lawrence P. DeCosimo, Jackson, NJ - Rutgers State University.



**Helen Cribbins Memorial Scholarship - \$6,000 (\$1,500 a year for four years)** Virginia C. Russell, daughter of LTC Rick J. Russell, APO AE, Parsons School of Design.



**Monmouth Chapter (B. Howard Dean/Ken K. Kelly) Matching Scholarship - \$6,000 (\$1,500 a year for four years)** Lisa A. Wong, daughter of Dick Y. Wong, Eatontown, NJ - Vassar College.



**Tennessee Valley Chapter (Colleen Hipp) Matching Scholarship - \$6,000 (\$1,500 a year for four years)** Scott L. McCann, son of CSM Gregory L. McCann, Ret., Madison, AL - Vanderbilt University.



**Joseph P. Cribbins Scholarship - \$5,000 (\$1,250 a year for four years)** Michael R. Mand, son of Lawrence R. Mand, New Albany, IN - Indiana University.



**AAAA National BG O. Glenn Goodhand Memorial Scholarship - \$5,000 (\$1,250 a year for four years)** Martha E. Donovan, daughter of Paul J. Donovan, Buffalo, NY - Brown University.



**AAAA National BG Robert M. Leich Memorial Scholarship - \$5,000 (\$1,250 a year for four years)** Emily L. Swafford, daughter of MAJ David F. Swafford, Ret., Mechanicsville, VA - University of Virginia.



**AAAA National Bryce Wilson Memorial Scholarship - \$5,000 (\$1,250 a year for four years)** Liam R. Powell, son of CW4 Rex M. Powell, Stroudsburg, PA - Purdue University.



**AAAA National Scholarship (Aeronautical) - \$4,000 (\$1,000 a year for four years)** Lena E. Haugen, daughter of John R. Haugen, Rolling Meadows, IL - University of Colorado at Boulder.



**Monmouth Chapter (MAJ R. Kahl-Winter) Matching Scholarship - \$4,000 (\$1,000 a year for four years)** Catherine E. Sendak, daughter of COL Theodore T. Sendak, Ret., Allenwood, NJ - James Madison Univ.



**Monmouth Chapter Matching Scholarship - \$4,000 (\$2,000 a year for two years)** Matthew E. Comstock, son of SFC Andrew W. Comstock, Wanlaga, NJ - The College of New Jersey.



**North Texas Chapter Matching Scholarship - \$4,000 (\$1,000 a year for four years)** Belhany M. Dobson, daughter of LTC David M. Dobson, North Richland Hills, TX - University of Texas at Austin.



**Tennessee Valley Chapter Matching Scholarship - \$4,000 (\$1,333 a year for three years)** Lindsey M. Kraatz, daughter of LTC Timothy A. Kraatz, Ret., Huntsville, AL - Eckerd College.



**Central Florida Chapter Matching Scholarship - \$3,000 (\$3,000 for one year)** Jeffrey L. Stahl, son of Jerry L. Stahl, Orlando, FL - University of Central Florida.



**Central Florida Chapter Matching Scholarship - \$2,000 (\$1,000 a year for two years)** Katie A. Rutland, daughter of James S. Rutland, Enterprise, AL - University of South Alabama.



**Edwin A. Link Chapter Matching Scholarship - \$2,000 (\$1,000 a year for two years)** Kristen J. McWhorter, daughter of CW4 Bruce K. McWhorter, Glendale, AZ - Grand Canyon University.



**Flying Tigers Chapter Matching Scholarship - \$2,000 (\$1,000 a year for two years)** Sharon A. Bigay, daughter of CW4 Michael M. Bigay, Elizabethtown, KY - Western Kentucky University.



**Greater Atlanta Chapter Matching Scholarship - \$2,000 (\$1,000 a year for two years)** Kiley E. Winston, daughter of CW5 James E. Winston, Tyrone, GA - University of Alabama.



**Lindbergh Chapter Matching Scholarship - \$2,000 (\$1,000 a year for two years)** Nissa A. Monrad, daughter of LTC Glenn A. Monrad, Ret., Chesterfield, MO - Syracuse University.



**Lindbergh Chapter Matching Scholarship - \$2,000 (\$1,000 a year for two years)** Emily J. Driscoll, daughter of Charles C. Trendley, O'Fallon, MO - Monmouth College.



**Monmouth Chapter (Aplet/Gobel Memorial) Matching Scholarship - \$2,000 (\$1,000 a year for two years)** Michael A. Fiedler, son of David M. Fiedler, Ocean, NJ - University of Rhode Island.



**Tennessee Valley Chapter Matching Scholarship - \$2,000 (\$1,000 a year for two years)** Mary K. Harrison, daughter of COL Thomas M. Harrison, Huntsville, AL - Oglethorpe University.



**Tennessee Valley Chapter Matching Scholarship - \$2,000 (\$1,000 a year for two years)** Susan M. Tomaine, daughter of Robert L. Tomaine, Madison, AL - The Catholic University of America.



**Tennessee Valley Chapter Matching Scholarship - \$2,000 (\$1,000 a year for two years)** Laura M. Hsu, wife of Anthony W. Hsu, Madison, AL - Alabama A & M University.



**Tennessee Valley Chapter Matching Scholarship - \$2,000 (\$1,000 a year for two years)** James A. Yeske, son of MAJ Alan K. Yeske, Ret., Madison, AL - University of Alabama at Huntsville.



**Tennessee Valley Chapter Matching Scholarship - \$2,000 (\$1,000 a year for two years)** Christina D. Smith, daughter of Robert L. Smith, Madison, AL - University of Georgia.



**Donald F. Luce Corporate Matching Scholarship - \$2,000 (\$2,000 for one year)** Pamela R. Horn, daughter of Charles I. Horn, St. Louis, MO - Saint Louis University.



**Donald F. Luce Corporate Matching Scholarship - \$2,000 (\$2,000 for one year)** Teresa M. Rini, daughter of COL Thomas J. Rini, Springfield, VA - Boston College.



**DynCorp Corporate Matching Scholarship - \$2,000 (\$1,000 a year for two years)** Andrea L. Pawlak, daughter of CW4 Richard C. Pawlak, Ret., Enterprise, AL - Auburn University.



**Igor Sikorsky Memorial Corporate Matching Scholarship - \$2,000 (\$2,000 for one year)** Catherine K. Greer, daughter of James S. Greer, Pensacola, FL - Enterprise State Junior College.



**Westar Corporate Matching Scholarship - \$2,000 (\$2,000 for one year)** Jennifer C. Lewis, daughter of LTC John L. Lewis, Ret., Madison, AL - University of Alabama at Huntsville.



**AAAA National MG John L. Klingenhagen Scholarship - \$2,000 (\$1,000 a year for two years)** Mary E. Myers, daughter of LTC Earl C. Myers II, Enterprise, AL - Jacksonville Univ.



**Cedar Rapids Chapter Matching Scholarship - \$1,500 (\$1,500 for one year)** Evan A. Downey, son of LTC David A. Downey, Ret., Nashua, NH - University of Tennessee.



**Southern California Chapter Matching Scholarship - \$1,500 (\$1,500 for one year)** SPC Dennis M. Paspavage, Long Beach, CA - California State University-Long Beach.



**AAAA Company Grade Officer Member Scholarship - \$1,500 (\$1,500 for one year)** CPT Joseph S. Curtis, Cookeville, TN - Tennessee Technological University.



**AAAA Company Grade Officer Member Scholarship - \$1,500 (\$1,500 for one year)** CPT Tanya A. Siller, Petersburg, VA - Embry Riddle Aeronautical University.



**AAAA National Scholarship - \$1,500 (\$1,500 for one year)** Solange L. Lyndis, daughter of SGT John J. McDonogh, Citrus Heights, CA - University of California at Davis.



**AAAA National Scholarship - \$1,500 (\$1,500 for one year)** Alyssa K. Manuel, daughter of LTC Philip K. Manuel, Ret., Montclair, VA - James Madison University.



**AAAA Enlisted Member Scholarship - \$1,500 (\$1,500 for one year)** MSG Terri L. Bates, Millilani, HI - Chaminade University of Honolulu.



**AAAA Enlisted Member Scholarship - \$1,500 (\$1,500 for one year)** SPC John W. James, Logan, UT - Utah State University.



**AAAA Spouse Scholarship - \$1,500 (\$1,500 for one year)** Cynthia M. Despres, wife of CW4 Brendon J. Despres, Ret., Pocatello, ID - Idaho State University.



**AAAA Spouse Scholarship - \$1,500 (\$1,500 for one year)**  
Brenda A. Briggs, wife of LTC Steven J. Briggs, Fort Campbell, KY - Austin Peay State University.



**AAAA Warrant Officer Member Scholarship - \$1,500 (\$1,500 for one year)** CW2 John D. Bourdeaux, Janesville, WI - Cedarville College.



**AAAA Warrant Officer Member Scholarship - \$1,500 (\$1,500 for one year)** CW2 Jack V. Rogers, II, Ret., Dallas, TX - Southern Methodist University.



**Raytheon Corporate Matching Scholarship - \$1,500 (\$1,500 for one year)** Justin M. Landrith, son of COL Mark S. Landrith, APO AE - University of Oklahoma.



**Jane & Wayne Phillips Memorial Scholarship - \$1,500 (\$1,500 for one year)** Allison K. Arntson, daughter of COL Edward L. Arntson, Buffalo Grove, IL - Olivet Nazarene University.



**Air Assault Chapter Matching Scholarship - \$1,000 (\$1,000 for one year)** Shane M. Sliwicki, son of MAJ Ralph M. Sliwicki, Fort Campbell, KY - University of Wisconsin-Madison.



**Air Assault Chapter Matching Scholarship - \$1,000 (\$1,000 for one year)** Crystal R. Sliwicki, daughter of MAJ Ralph M. Sliwicki, Fort Campbell, KY - University of Wisconsin.



**America's First Coast Chapter Bruce Pinner Matching Scholarship - \$1,000 (\$1,000 for one year)** Lauren A. Lingenfeller, daughter of CW5 William R. Halevy, Fairfax, VA - University of North Florida.



**Aviation Center Chapter Matching Scholarship - \$1,000 (\$1,000 for one year)** Justin A. Krometis, son of CW4 Jerry A. Krometis, Ozark, AL - Virginia Tech.



**Aviation Center Chapter Matching Scholarship - \$1,000 (\$1,000 for one year)** Andrena M. Kardos, daughter of CW3 Stephan A. Kardos, APO AP - Auburn University.



**Aviation Center Chapter Matching Scholarship - \$1,000 (\$1,000 for one year)** Brandy A. Burhans, daughter of CW4 James R. Burhans, Fort Rucker, AL - Bradley University.



**Aviation Center Chapter Matching Scholarship - \$1,000 (\$1,000 for one year)** Leslie E. Redington, daughter of John V.R. Redington, Enterprise, AL - Rhodes College.



**Aviation Center Chapter Matching Scholarship - \$1,000 (\$1,000 for one year)** Nicole D. Voisine, daughter of CW5 Joel J. Voisine, Ret., Enterprise, AL - University of South Alabama.



**Colonial Virginia Chapter Matching Scholarship - \$1,000 (\$1,000 for one year)** Stephanie R. Shabbott, daughter of SGM Joseph W. Shabbott, Gloucester, VA - Thomas Nelson Community College.



**Colonial Virginia Chapter Matching Scholarship - \$1,000 (\$1,000 for one year)** Robin E. Johnson, wife of SGM Maurice L. Johnson, Fort Eustis, VA - Saint Leo University.



**Colonial Virginia Chapter Matching Scholarship - \$1,000 (\$1,000 for one year)** Allison E. Arthur, daughter of LTC John E. Arthur V, Chesapeake, VA - East Carolina University. Colonial Virginia



**Chapter Matching Scholarship - \$1,000 (\$1,000 for one year)** Matthew S. Tisdale, son of MSG Steven R. Tisdale, Ret., Newport News, VA - Christopher Newport University.



**Narragansett Bay Chapter Matching Scholarship - \$1,000 (\$1,000 for one year)** Zachariah R. Evangelista, son of MSG Robert F. Evangelista, Providence, RI - Holstra University.



**Phantom Corps Chapter (Coldwell Banker) Matching Scholarship - \$1,000 (\$1,000 for one year)** Kristen L. Jay, daughter of CW2 Paul Z. Kiszely, Copperas Cove, TX - Texas A & M University.



**Phantom Corps Chapter Matching Scholarship - \$1,000 (\$1,000 for one year)** Kasey L. Jay, daughter of CW2 Paul Z. Kiszely, Copperas Cove, TX - Texas Tech University.



**Tennessee Valley Chapter Matching Scholarship (The Justin K. Bhansali Memorial Scholarship) - \$1,000 (\$1,000 for one year)** Jacob P. Birmingham, son of COL Robert P. Birmingham, Huntsville, AL - Univer. of Central FL.



**Washington-Potomac Chapter (Robert F. Molinelli) Matching Scholarship - \$1,000 (\$1,000 for one year)** Michael T. Wiecks, son of COL Thomas W. Wiecks, Burke, VA - Penn State University.



**Washington-Potomac Chapter (Robert F. Molinelli) Matching Scholarship - \$1,000 (\$1,000 for one year)** Shawn C. Naigle, son of COL Alfred J. Naigle, Clifton, VA - James Madison University.



**Washington-Potomac Chapter Matching Scholarship - \$1,000 (\$1,000 for one year)** Stephen T. Mauro, son of LTC Stephen T. Mauro, Alexandria, VA - Mary Washington College.



**Washington-Potomac Chapter Matching Scholarship - \$1,000 (\$1,000 for one year)** Stefany L. Scotka, daughter of Ronald L. Scotka, Alexandria, VA - Texas A & M University.



**Army Aviation Publications, Inc., Corporate Matching Scholarship - \$1,000 (\$1,000 for one year)** Michael S. Grabowski, son of CSM Stanley Grabowski, Minersville, PA - West Chester Univ.



**CW3 Stephen A. Hansen Memorial Scholarship - \$1,000 (\$1,000 for one year)** Robert T. Carmichael, son of LTC Robert G. Carmichael, Jr., Bucksport, ME - University of Virginia.



**AAAA Life Member Memorial Scholarship (COL Loren C. Strange, Sr.) - \$1,000 (\$1,000 for one year)** Kathleen A. Creed, daughter of CSM Daniel F. Creed, APO AP - FL Institute of Technology.



**AAAA Life Member Memorial Scholarship (LTC Glenn E. Darrough) - \$1,000 (\$1,000 for one year)**  
Daniel S. Gadomski, son of CW5 Thomas P. Gadomski, Fort Drum, NY - California Polytechnic State University.



**AAAA National CW3 Frederick E. Ferguson MOH Scholarship - \$1,000 (\$1,000 for one year)**  
Courtney E. Ellers, daughter of LTC Conway S. Ellers, Fayetteville, NC - Wake Forest University.



**AAAA National CW3 Michael J. Novosel MOH Scholarship - \$1,000 (\$1,000 for one year)**  
Jeffrey M. Jobe, son of CW5 Waylen M. Jobe, Jefferson City, MO - University of Missouri.



**AAAA National MAJ William E. Adams MOH Scholarship - \$1,000 (\$1,000 for one year)**  
Maran A. Phipps, daughter of CW3 Curtis R. Phipps, APO AE - Midwestern State University.



**AAAA National MG Patrick H. Brady MOH Scholarship - \$1,000 (\$1,000 for one year)**  
Christopher S. Maciuba, son of MAJ Tadeusz S. Maciuba, Ret., Elizabethtown, KY - University of Kentucky.



**AAAA National MSG Gary I. Gordon & SFC Randall D. Shughart MOH Scholarship - \$1,000 (\$1,000 for one year)**  
Janis H. Eskesen, daughter of CW4 Paul M. Eskesen, Ret., Santa Rosa, CA - University of California, Los Angeles.



**AAAA National PFC Garfield M. Langhorn MOH Scholarship - \$1,000 (\$1,000 for one year)**  
Lindsay E. George, daughter of COL Dennis L. George, Reno, NV - University of San Diego.



**AAAA National SFC Louis R. Rocco MOH Scholarship - \$1,000 (\$1,000 for one year)**  
Steven F. Briggs, son of LTC Steven J. Briggs, Fort Campbell, KY - Florida State University.



**AAAA National SFC Rodney T. Yano MOH Scholarship - \$1,000 (\$1,000 for one year)**  
Eric B. Stoffa, son of CW4 John R. Stoffa, Jr., Ret., Lawrenceville, NJ - Boston University.



**AAAA National SP4 Gary G. Wetzei MOH Scholarship - \$1,000 (\$1,000 for one year)**  
Steven M. Brenneick, son of CW4 Gary A. Brenneick, Ewing, NJ - Rider University.



**AAAA National SPC4 Joseph G. LaPointe MOH Scholarship - \$1,000 (\$1,000 for one year)**  
Lukas V. Michener, son of 1SG Mikel M. Michener, Ret., Tacoma, WA - Univ. of Washington.



**AAAA Graduate Scholarship - \$1,000 (\$1,000 for one year)**  
Rebecca S. Mullin, wife of CPT Patrick J. Mullin, Auburn, AL - Auburn University.



**AAAA Graduate Scholarship - \$1,000 (\$1,000 for one year)**  
Sylvia P. Hill, wife of CW3 Dana L. Hill, Colorado Springs, CO - University of Colorado.



**AAAA Graduate Scholarship - \$1,000 (\$1,000 for one year)**  
Kelly M. Newsome, daughter of COL Charles H. Davis, Valrico, FL - University of Virginia.



**AAAA Graduate Scholarship - \$1,000 (\$1,000 for one year)**  
Stacy A. Dandridge, daughter of LTC Wayne L. Dandridge, Ret., Chesterfield, MO - University of Alabama-Birmingham.



**AAAA Upperclassman Scholarship - \$1,000 (\$1,000 for one year)**  
CDT Jeremy L. Sauer, Boise, ID - Boise State University.



**AAAA Upperclassman Scholarship - \$1,000 (\$1,000 for one year)**  
Anna L. Matusiewicz, daughter of LTC Daniel A. Matusiewicz, Ret., Jackson, MS - University of Mississippi.



**AAAA Upperclassman Scholarship - \$1,000 (\$1,000 for one year)**  
Sienna L. Moran, daughter of CPT Stephen R. Moran, Ret., Huntington, NY - Drew University.



**AAAA Upperclassman Scholarship - \$1,000 (\$1,000 for one year)**  
Jonathan N. Mand, son of Lawrence R. Mand, New Albany, IN - Purdue University.



**AAAA Upperclassman Scholarship - \$1,000 (\$1,000 for one year)**  
Andrew W. Goodwin IV, son of LTC Andrew W. Goodwin, Raleigh, NC - Louisburg College.



**AAAA Upperclassman Scholarship - \$1,000 (\$1,000 for one year)**  
Emily S. Ralph, daughter of COL Thomas L. Ralph, Ret., Phoenix, AZ - University of Arizona.



**AAAA Upperclassman Scholarship - \$1,000 (\$1,000 for one year)**  
Deidre E. Wise, daughter of CW5 James F. Wise, Ret., Belleville, MI - Boise State University.



**AAAA Upperclassman Scholarship - \$1,000 (\$1,000 for one year)**  
Stephanie K. Guarino, wife of CW3 David K. Guarino, Wahiawa, HI - Leeward Community College.



**AAAA Upperclassman Scholarship - \$1,000 (\$1,000 for one year)**  
John R. Gore, son of COL R. Lee Gore, Fort Rucker, AL - Auburn University.



**AAAA Upperclassman Scholarship - \$1,000 (\$1,000 for one year)**  
Sara C. Vins, daughter of LTC Joseph J. Vins, Ret., Madison, AL - University of Maryland.



**AAAA Upperclassman Scholarship - \$1,000 (\$1,000 for one year)**  
Alyssa M. Bridge, daughter of LTC Donald W. Bridge, Jr., Richmond Hill, GA - Boston College.



**AAAA Upperclassman Scholarship - \$1,000 (\$1,000 for one year)**  
Veronica L. Navarro, daughter of CW4 Herbert R. Navarro, El Paso, TX - New Mexico State University.



**AAAA Upperclassman Scholarship - \$1,000 (\$1,000 for one year)**  
Carrie E. Rees, daughter of MG Raymond F. Rees, Arlington, VA - Western Washington University.



**AAAA Upperclassman Scholarship - \$1,000 (\$1,000 for one year)** James R. Maison, son of SSG Robert W. Maison, Belle Mead, NJ - University of Delaware.



**AAAA Upperclassman Scholarship - \$1,000 (\$1,000 for one year)** Katrina M. Patterson, daughter of MAJ Steven M. Greenburg, Ret., Farmington Hills, MI - Oakland University.

**Interest Free Loan Recipients**



**AAAA Scholarship Interest Free Loan - \$4,000 (\$1,000 a year for four years)** Jennifer T. Lust, daughter of 1SG David L. Vernon, Ret., APO AP - Virginia Polytechnic and State University.



**AAAA Scholarship Interest Free Loan - \$4,000 (\$1,000 a year for four years)** Monica L. Gonzalez, daughter of CW3 Angel Gonzalez, Clarksville, TN - Indiana University.



**AAAA Scholarship Interest Free Loan - \$4,000 (\$1,000 a year for four years)** Lisa M. Devereux, daughter of Thomas E. Devereux, St. Ann, MO - University of Missouri-Columbia.



**AAAA Scholarship Interest Free Loan - \$4,000 (\$1,000 a year for four years)** Emily K. Sherman, daughter of LTC Rodney D. Sherman, Burke, VA - Virginia Tech.



**AAAA Scholarship Interest Free Loan - \$4,000 (\$1,000 a year for four years)** David C. Brown, son of CW4 Malcolm L. Brown, Ret., Huntsville, AL - George Washington University.

## CFC ♦ CFC ♦ CFC ♦ CFC



The AAAA Scholarship Foundation, Inc. (AAAASF) is now part of the Combined Federal Campaign (CFC), a workplace charitable fund drive conducted by the U.S. Government for all federal employees. It is the single largest workplace fund drive in the country, raising approximately \$195M in pledges annually.

In 2000, the AAAASF received a total of 145 applications and awarded more than 107 grants and loans totalling over \$244,000. These awards are made on the basis of academic merit *only* and the applications are scrubbed to remove all references to the names and ranks of their AAAA member relative.

Don't forget, all overhead costs are borne by the AAAA so that 100% of your contribution (net CFC charges) go directly to AAAA Scholarship Foundation, Inc. awards. Help us reward more of these outstanding students with larger awards.

*Tax-deductible donations may also be made directly to the*  
**AAAA Scholarship Foundation, Inc.**  
 49 Richmondville Avenue, Westport, CT 06880-2000  
 E-Mail: [aaaa@quad-a.org](mailto:aaaa@quad-a.org) Telephone: (203) 226-8184  
 FAX: (203) 222-9863

## Combined Federal Campaign



Maj. Gen. Anthony R. Jones (left), aviation branch chief, presented the Order of Saint Michael (bronze) to CWO 5 Randall Parkins at a May 19 ceremony at Hunter Army Airfield, Ga. Parkins, who was joined at the ceremony by his wife Jane, was recognized for 26 years of aviation service.



## Lost Members

Help us find our Lost Members. We'll give you an additional month on your AAAA membership free for each member you help us locate. Simply write, call or E-mail us with the Lost Member's current address. AAAA, 49 Richmondville Avenue, Westport, CT 06880-2000. Tele: (203) 226-8184; FAX:(203) 222-9863; E-Mail: [aaaa@quad-a.org](mailto:aaaa@quad-a.org).

Bachus, Joseph R., CSM  
 Barker, Brandon W., 2LT  
 Bevelander, Mark C., WO1  
 Broadhurst, Guy L., Mr.  
 Bultman, Jeffrey G., WO1  
 Carpenter, Vincent D., 1LT  
 Cesar, Ramos-Cruz, WO1  
 Cherot, Bevin K., CPT  
 Clark, George, SPC, Ret.  
 Cox, William G., 2LT  
 Craigie, John, Mr.  
 Cummings, Matt J., WO1

DiLoreto, Vince, Mr.  
 Dobbin, Stephen G., CW2  
 Drozd, Leanne R., CW2  
 Dulfer, Paul A., WO1  
 Edwards, Stein W., 2LT  
 Fordham, Andy, Mr.  
 Gonzalez, Amando, Mr.  
 Graves, Garid W., PV2  
 Hoover, Matthew J., WO1  
 Horton, Derek M., WO1  
 Hubbard, Robert D., Mr., Ret.  
 Kleinschmidt, Edward F., MAJ

Lenhard, Keith A., LTC, Ret.  
 McCoy, Esquire, SGM  
 Meierle, Jeffrey F., CW2  
 Milligan, Patrick S., PV2  
 Nichols, Jason C., SPC  
 Odum, G. Hunter, CW4  
 O'Neil, Steven P., CPT  
 Palin, Harry, Mr.  
 Paul, Keith, Mr.  
 Pettigrew, Gregory A., CW4  
 Phares, David W., MAJ  
 Rainwater, Shannon, WO1

Reynolds, David W., WO1  
 Simpson, Chad D., SPC  
 Tabor, Clint D., CPT  
 Van Syckle, Francis J., Mr.  
 Wada, Kazunari, PFC  
 Wilczynski, Eric C., WO1  
 Wilkins, Anthony J., Mr.  
 Wilsher, Arlin R., 2LT  
 Wolfork, Vernon W., PFC  
 Woo, John S., 2LT



# AAA NEWS

## NEW MEMBERS

<p><b>AIR ASSAULT CHAPTER</b> FORT CAMPBELL, KY CPT Christopher L. Brown CPT Thomas E. Carlson MAJ Donald N. Galli CPT Anna M. Haberzettl SFC Ronald L. Hardy, Jr. CW2 Lee A. Kies MAJ Scott P. Kubica MAJ Edward C. Ledford MAJ Steven M. Marrocco CPT Thomas C. Petty LTC Timothy A. Sassenrath CW3 Carl H. Schoenwald CW4 Dean E. Stoops CPL Terry D. Weaver CW3 Bruce L. Woodmansee</p>	<p>2LT Matthew J. Lasher WO1 Craig Laurenson 2LT Christopher L. Logan 2LT Todd M. Loughney 2LT Martin J. Lovelady 1LT David R. Maldonado 2LT Jeffrey D. McCoy WO1 Nathanael S. McGuire WO1 Birche F. Meese 2LT Nicholas W. Meister WO1 Shawn G. Mertens WO1 Shane D. Mickelson WO1 Troy E. Moseley WO1 Jon J. Nowalzyk WO1 Jeffrey D. Ouellette WO1 Robert J. Parrotte 2LT Eric T. Phillips WO1 Michael A. Pruitt 2LT James B. W. Reed CPT Michael A. Reyburn WO1 Eric A. Ries WO1 Eddie Rodrigues 2LT Michael J. Rovins WO1 German G. Sanchez 2LT Adrineh Shahjani 2LT Grant W. Siedenbug WO1 Matthew A. Smith WO1 Don L. Stewart WO1 Jason B. Stypolkowski 2LT Jason P. Sutton WO1 Jared E. Thompson 2LT Ryan B. Tinch WO1 Roberto A. Torres Burgos CW4 Thomas W. Trifiro WO1 Timothy K. Vance WO1 Anthony M. Vickery 2LT Jonathan B. Warr WO1 Jason S. Wilson 1LT Roger B. Yap 2LT Alissa A. Yike 1LT Robert C. Yingst 2LT Michael Zendejas</p>	<p><b>EDWIN A LINK MEMORIAL CHAP</b> BINGHAMTON NY AREA Mr. David P. Gdovin Mr. Michael C. Phillips Mr. Nicholas J. Scarnato</p> <p><b>FLYING TIGERS CHAPTER</b> FORT KNOX, KY SFC Kevin P. Raine</p> <p><b>GREATER ATLANTA CHAPTER</b> ATLANTA, GA Mr. Roger J. Aschmeyer Mr. Patrick J. Mullis Ms. Amanda M. Sauer Mr. Dustin Sloan</p> <p><b>INDIANTOWN GAP CHAPTER</b> INDIANTOWN GAP, PA Mr. Robert W. Harrison MAJ William J. Hunt</p>	<p>Mr. Sung Hwan Choi Mr. Ho Jin Chun Mr. Dong-Jin Ha Mr. Sung-Ho Han Mr. Sung-Hey Hong Mr. Sung Suk Hu Mr. Jung Song Hwa Mr. Dae Soon Im Mr. Young Do Joo Mr. Chan Min Joung Mr. Eun Hun Jung Mr. Jong-Hwan Jung Mr. Ul Goun Jung Mr. Jong-Jin Kang Mr. Joo-Suk Kang Mr. Ae-Kyung Kim Ms. Bok Tae Kim Mr. Bong Rea Kim Mr. Dong Lim Kim Mr. Hea-Kyung Kim Mr. Hea Lan Kim Mr. Young Sung Kim Mr. Joung Kon Kim Mr. Ju Hee Kim Mr. Kwan Yung Kim Mr. Kyung-Ae Kim Mr. Sa Yong Kim Mr. Sang Ju Kim Mr. Young Joo Kim Mr. Yoon Mi Kim Ms. Young Hee Kim Mr. Young Jae Kim Ms. Jin Soon Kong Ms. Jin Sun Kong Mr. Bo Sung Lee Mr. Bong Jae Lee Mr. Chul Jin Lee Mr. Eun Sun Lee Ms. Jung Bok Lee Mr. Joo-Young Lee Ms. Jung Hee Lee Mr. Kwang Pyung Lee Mr. Sang Hae Lee Mr. Seung Youn Lee Mr. Song Hwan Lee Mr. Suen Jung Lee Mr. Sul Joo Lee Mr. Yang-Sook Lee Mr. Young Guk Lee Mr. Young Hoon Lee Mr. Young Ou Lee Mr. Yuw Hwa Lee Mr. Dong Jin Lim CPT Nataliee M. Liverpool Mr. Sang Hoon Maing LTC Anton E. Massinon Mr. Bung Won Moon Mr. Kwang Sung Moon Mr. Hea-Ran Nam Mr. Byung Rin Oh Ms. Jung Ja Oh Mr. Sang Duk Oh Ms. Young Lan Oh Mr. Choon Keun Park Mrs. Hea-Sook Park Ms. Hwan Suk Park Mr. Jong-Bok Park Ms. Jung Suk Park Mr. Kyung-Sook Park Mr. Moon Hee Park Mr. Sang-Shin Park Mr. Choon Sung Ryu Mr. Gi Nam Shin Mr. Ki Sup Shin Mr. Kwan Sun Shin Mr. Yong Ae Shin Mr. Hyung Youn So Mr. Bak Ki Sung Mr. Jong Je Sung Mr. San Sung Mr. Sang Min Yern Mr. Jae Ok Yoo Mr. Jang Woo Yoo Mrs. Kung Eu Yoon Ms. Mi La Yoon Ms. Sun Nyo Yoon Mr. Yaul Tak Yoon</p>	<p><b>NORTHERN LIGHTS CHAPTER</b> FORT WAINWRIGHT/ FAIRBANKS AK CPT Marvin E. Iavecchia SGT Albert K. Schoonover</p> <p><b>OREGON TRAIL CHAPTER</b> SALEM, OREGON SGT Josie A. Alkire SPC Clinton H. Davis CPT Thomas W. Lingle</p> <p><b>PHANTOM CORPS CHAPTER</b> FORT HOOD, TX CW4 Richard L. Culp MAJ Keith L. Hiatt SFC Robert V. Rance CW3 William P. Rosser</p> <p><b>RAGIN' CAJUN CHAPTER</b> FORT POLK, LA Ms. MaryLou A. Keeling CW2 Edward D. King</p> <p><b>RHINE VALLEY CHAPTER</b> HEIDELBERG, GERMANY CPT William H. Clark</p> <p><b>TARHEEL CHAPTER</b> RALEIGH, NC CW2 David R. Kalcevic</p> <p><b>TAUNUS CHAPTER</b> WIESBADEN, GERMANY MAJ David A. Chapman CPT Samuel W. Koonce</p> <p><b>TENNESSEE VALLEY CHAPTER</b> HUNTSVILLE, AL Mr. Daniel C. Berger Mr. Barclay H. Boirin MAJ Scott C. Dolloff Mr. William E. Dunson Ms. Jane E. Elkins Mr. Randy Gibbs Mr. Michael Hartwell CW4 Jack M. Holland, Ret. Mr. Samuel B. Huffstetler CPT Carter Jones Mr. Timothy L. Jones Mr. Roy J. Longino Mr. Benjamin W. Mikell CW2 Larry E. Montague Ms. Gaylena J. Pribil Mr. Michael C. Schexnayder CW4(P) Kenneth T. Shannon Mr. Frank E. Wallace Mr. John H. Wright</p>
<p><b>ALOHA CHAPTER</b> HONOLULU, HI CDT Teresa I. Wallinger</p> <p><b>ARIZONA CHAPTER</b> MESA, AZ Mr. Stephen R. Cox Mr. Marc W. Sheffler</p> <p><b>ARMADILLO CHAPTER</b> CONROE, TX Mr. Roger A. Miller Mr. Kenneth A. Miozza CAPT Randall J. Smith</p>	<p><b>BLACK KNIGHTS CHAPTER</b> WEST POINT, NY CDT Brian D. Blum 2LT David J. Brodsky 2LT Peter DiGiorgio 2LT David Fagergren CDT Jordan M. Francis CDT Katrina C. Gier 2LT Sarah A. Halton 2LT Charles A. Ketterman III 2LT Tyler S. Lewis 2LT Kevin N. Long CDT Casey D. Markovitz CDT Christopher T. Morton CDT Rodric G. Pauledto 2LT Patrick J. Petrino CDT Clinton J. Phillips 2LT Juan C. Rodriguez CDT Dustin G. Shannon CDT Orrin G. Stitt CDT Michael W. Tilton CDT Christopher D. Visosky</p>	<p><b>IRON EAGLE CHAPTER</b> HANAU, GERMANY LTC Michael A. Bills</p> <p><b>IRON MIKE CHAPTER</b> FORT BRAGG, NC WO1 Vernon V. Miller</p> <p><b>JACK H. DIBRELL/ALAMO/ FORT SAM HOUSTON, TX</b> CW4 Bert E. Wiggins, Ret.</p> <p><b>JIMMY DOOLITTLE CHAPTER</b> COLUMBIA, SC CSM Wylie B. Estes, Ret.</p> <p><b>LEAVENWORTH CHAPTER</b> FORT LEAVENWORTH, KS CW5 Robert Good <b>LINDBERGH CHAPTER</b> ST. LOUIS, MO Mr. Timothy F. Strickfaden LTC James E. Sutton, Ret.</p>	<p><b>MICHIGAN GREAT LAKES CHAP.</b> GRAND LEDGE, MICHIGAN SSG Walter B. Bierkamp CW4 Martin R. Bliss CPT Leo V. Carr CW4 Bruce M. Cotter, Ret. CW4 Richard B. Deer Ms. Cynthia D. McDowell SFC Rex A. McLendon CW2 Michael T. Senyczko SSG Andrew J. Spagnuolo SGT Bryan K. Traxler SSG Stephen W. Williams</p> <p><b>MINUTEMAN CHAPTER</b> WESTOVER AFB, MA CPT Daniel E. McCarthy Ms. Pacifica J. Sauer</p> <p><b>MONMOUTH CHAPTER</b> FORT MONMOUTH, NJ Ms. Alyson L. Beausoleil Mr. Donald Blue Mr. Robert E. Halligan SFC Edward Howard, Ret. Ms. Ophelia Jones Mr. Frank C. Muzzi Mr. Walter M. Poushkin</p>	<p><b>VIRGINIA MILITARY INSTITUTE</b> LEXINGTON, VA Cadet Kevin J. Fromm</p> <p><b>WASHINGTON-POTOMAC CHAP.</b> WASHINGTON, DC Mr. Marshall E. Clarke Mr. Brian Gillespie COL Greg Kaufman LTC Louise V. Terrell <b>WESTERN NEW YORK CHAPTER</b> ROCHESTER, NY MAJ Mark F. Burke</p> <p><b>WRIGHT BROTHERS CHAPTER</b> COLUMBUS, OHIO CW3 Kenneth Ramos</p>
<p><b>AVIATION CENTER CHAPTER</b> FORT RUCKER, AL WO1 Stephen R. Adams PVT Evan Aldrich 2LT Matthew T. Badell WO1 Dustin A. Baine 2LT Matthew J. Barbour 2LT Sean W. Barrett 2LT Juan M. Bedia 2LT Jeremy A. Bell 2LT Adam C. Berlew 2LT Deborah E. Blake 2LT Danielle A. Bloch WO1 Christopher J. Braund 2LT Joseph G. Bruhl 2LT Kevin L. Burns Dr. John Caldwell CW5 Robert B. Caldwell 2LT Robert C. Capellini 2LT Michael W. Cerchio 2LT Edward G. Chapman WO1 Stephen P. Clinton 2LT Christopher G. Cook WO1 Walker D. Craig WO1 Steve O. Crandall WO1 Robert C. Cudd, Jr. 2LT Chris J. Damato WO1 Jeffrey E. Davis WO1 Travis R. Dixon WO1 Michael J. Dubois 2LT Richard E. Dunning WO1 Michael E. Espinoza CPT Jeffrey G. Evans 2LT Ian J. Feyk WO1 Carlos C. Figueroa CPT Troy G. Flowers 2LT Dana L. Furstnow CPT Darryl W. Glass WO1 Thomas L. Grow CPT Luis E. Guardia WO1 Hans N. Gukeisen WO1 Joshua D. Hample 2LT Jason L. Hawk WO1 Peter S. Herring CPT Joshua P. Higgins WO1 Robert A. Hintz WO1 Edward J. Holcomb 2LT James P.L. Holzgreffe WO1 Kenneth W. Hoover WO1 Johnny A. Jackson WO1 Albert R. James, Jr. WO1 Marcial R. Jay 2LT Gifford A. Jones WO1 Jeremy M. Kagi WO1 Charisma L. Ketcham WO1 Brandon D. King 2LT George J. King WO1 Eric J. Kreitzer CPT Scott C. Kruse 2LT Jaime Kuntz WO1 Brian T. Lackey</p>	<p><b>CENTRAL FLORIDA CHAPTER</b> ORLANDO, FL LTC Paul G. Bernhardt, Ret. Mr. Dallas C. Butler Mr. Glenn R. Daens Mr. Les Fullen Mr. Samuel M. Jones Mr. Robert L. Keller Mr. David W. Manning Mr. Damian J. Szigeti Mr. Rabon A. Vause</p> <p><b>CHECKPOINT CHARLIE CHAPTER</b> BERLIN, GERMANY Mr. Thomas Boettcher Mr. Eberhard Haelbig Ms. Jutta Wolter</p> <p><b>COLONIAL VIRGINIA CHAPTER</b> FORT EUSTIS, VA PV2 Marvin P. Christy MSgt Gary McKeeyby, USAF PV2 Taylor A. McReynolds SFC Robert R. Ray</p> <p><b>CORPUS CHRISTI CHAPTER</b> CORPUS CHRISTI, TX Mr. Bruce T. Stanley</p>	<p><b>MORNING CALM CHAPTER</b> SEOUL, KOREA Mr. Hae Dong Baek Mr. Sung Hwan Baek Mr. Sung Jin Bang Mr. Jae Young Chang Ms. Sang Ok Chang Ms. Eun Hee Cho Mr. Su Yun Cho Mr. Sung Je Cho Mr. Young Sik Cho Mr. Boo Hyoun Choi Mr. Buyeng Kil Choi Mr. Jong Heuk Choi Mr. Jong Hwan Choi Mr. Kung-Ok Choi Mr. Suk-Kyu Choi</p>	<p><b>NORTH TEXAS CHAPTER</b> DALLAS/FORT WORTH COL Kenneth W. Hunter, Ret. CPT Kok Hua Ling</p>	<p><b>MEMBERS WITHOUT CHAPTER AFFILIATION</b> WO1 William E. Armstrong CW5 Don W. Clayton CW3 John O. Cunningham SGT Mark D. Engelsman MAJ Robert A. Harington Ms. Rachel M. Hoff LTC Gregory L. Kennedy SFC Robert F. Morgan COL Jackie L. Self Mr. Robert C. Tuggle MAJ Grant A. Webb LTC Grant E. Zachary</p>

## Aviation Center Chapter

Aviation Center Chapter President Col. Terry M. Peck presents the Order of St. Michael Bronze award to Lt. Col. Reginald R. Gillis during a July ceremony at Fort Rucker, Ala. Gillis commanded the 1st Battalion, 11th Aviation Regiment, for two years and is bound for a staff assignment at the Pentagon.



## Corpus Christi Chapter

Blaine Withers (left) deputy to commander of Corpus Christi Army Depot, Texas, congratulates Albert Cantu, winner of a \$750 Army Aviation Association of America/CCAD scholarship during a July 14 awards ceremony. The son of Harry and Lynn McAllister, Cantu has also won a \$1,000 scholarship to Jamestown College, N.D.



CCAD also awarded two \$250 scholarships, which went to William Krimmel, son of Frank and Joanne Sijansky, and Melany Poldrack, daughter of Jon Poldrack.



(Photos by Ralph Yoder)

Lifelong AAAA members Dr. Kirit and Judith Bhansali have established a new AAAA Scholarship, the Justin Bhansali Memorial Scholarship in memory of their son, Justin. He died Jan. 7, 2000, in an automobile accident in Guinea, West Africa, where he was teaching high-school level math and physics on assignment with the Peace Corps. He was 24.

Because Justin felt very strongly that an engineering education was the very best to obtain, and because he wanted to become a medical doctor, the scholarship is for engineering undergraduate students or engineering/medical graduate students.

A permanent website — <http://planet.rtec.org/justin> — has been established in Justin's memory by Planet Innovation, where he worked as an undergrad.

Persons wishing to contribute to the scholarship fund should make checks payable to the AAAA National Scholarship Foundation. Where it says "For" on the check write "Justin Bhansali Memorial Scholarship." Send it to AAAA, 49 Richmondville Ave., Westport, CT 06880.



## Tennessee Valley Chapter

Al Carreon, treasurer of AAAA's Tennessee Valley Chapter, presents a check to Redstone Arsenal's NCO of the Year, SSgt. Kimberly Jennings. The installation's Soldier of the Year, Spec.

Arvin Dewberry (not pictured), also received a check. Both winners were announced at a July 13 luncheon that drew 260 guests to the Officers' and Civilians' Club. Jennings is a supply sergeant for Company B, 832nd Ordnance Battalion, and Dewberry is a medical laboratory technician at Fox Army Health Center.

(Photo by Mary Petty)



## Second Generation

Past AAAA President Maj. Gen. Ben Harrison, reports that while attending the recent 4th Brigade, 1st Cavalry Regiment, change of command he noted that all three battalion/squadrons are commanded by sons of great army aviation leaders. They included Lt. Col. Paul Funk, 1/7 Cav, Lt. Col. Dave Molinelli, 1/227 Avn and Lt. Col. Don MacWillie, 2/227 Avn.

## Tennessee Valley Chapter Corner

The Tennessee Valley Chapter (TVC) has experienced tremendous growth over the past three years, but the levels of excitement and participation have exceeded the numbers. Initially due to the BRAC decision to relocate U.S. Army Aviation and Troop Command from St. Louis, Mo., to Huntsville, Ala., a large number of Lindbergh Chapter members transferred their AAAA membership to the Tennessee Valley Chapter. Both the Department of the Army and the Department of Defense have recognized the merging of the two communities as a major success story, and AAAA has been a significant contributor to that success. During the last three years the TVC has grown from 102 to 747 members, and has become a major contender in the professional organization arena that characterizes Redstone Arsenal and Huntsville, the Rocket City.

This process was not easy, but under the leadership of then Brig. Gen. Joe Bergantz and past TVC president Col. Mike Boyd (Ret.), the merger was smooth and effective. Boyd volunteered to step down as president and Bergantz became the first president of the new TVC. Other board positions were selected and represented a synergism of former Tennessee and Lindbergh board members. Through adept leadership and a genuine concern for all concerned, Bergantz held monthly board meetings to ensure that activities, charities and responsiveness were in keeping with what the new TVC should establish. His clear and concise guidance is always a product of board consensus and he has devoted his efforts to helping the board carry out those decisions.

Obviously, this new TVC has been successful, as we were selected as the AAAA Chapter of the Year at the AAAA National Convention in Fort Worth, Texas, in March. This followed selection as the Master Chapter for Membership in 1999. In addition to the phenomenal growth of individual and corporate membership, the chapter has accomplished the following:

### AAAA Military Appreciation Night Ice Hockey Game

The TVC sponsored a Huntsville Channel Cats ice hockey game in celebration of Armed Forces Day. The chapter provided free tickets to 200 Redstone Arsenal soldiers and their families in appreciation for their dedication, selfless devotion and duty to their country. In honor of the occasion the Channel Cats players wore camouflaged uniforms.

### AAAA TVC Spring and Fall Bass Tournaments

Held at the Redstone Arsenal Recreational Area and Lake

Guntersville, more than 20 boats were in the water for each event. Cash prizes were awarded to the top three places.

### 25th & 26th Annual Joseph P. Cribbins Product Support Symposium

The TVC was proud to host the 25th and 26th annual event sponsored by the newly formed Army Aviation and Missile Command of Redstone Arsenal. The Product Support Symposium is a landmark event for aviation logistics, providing a professional forum for government and industry to explore improvements in the reliability and supportability of aviation systems and technologies. The 25th PSS was hosted by chapter President Bergantz and included a celebration of not only the PSS, but also a celebration of Mr. Cribbins' birthday. The birthday bash was attended by many of those he mentored. The 26th PSS was hosted by Col. Bob Birmingham and featured exciting new panel discussions on Army aviation's hottest topics. More than 300 Government and contractor personnel attended each of these events, and collectively they raised more than \$20,000 for the AAAA Scholarship Foundation.

### Scholarship Program

The chapter made several enhancements to its scholarship program. The Board completed the planning, coordination and funding necessary to put in place five new \$2,000 awards to be available beginning in the year 2000! This will bring the TVC's total scholarships to six \$2,000 awards available to its membership. The chapter also supports the Coleen Hipp Scholarship. Through continuous TVC AAAA 50-50 raffles, golf mulligan purchases and Huntsville private donations, the scholarship is now self sustaining.

The TV Chapter also supported RSA soldiers and the local Huntsville community at the 1999 Veterans' Day Parade. The Chapter sponsored several Veterans' Day celebrations that contributed to a successful AMCOM event. In 1999 the chapter supported a variety of events that returned more than \$8,000 to the membership and community.

For the future, the TVC anticipates continued growth of both corporate and individual membership. We want to continue to direct our energies toward raising more money for the AAAA Scholarship Foundation, support soldiers and NCO awards, and become the most dynamic organization of its kind in the Tennessee Valley area.

## Tennessee Valley Chapter

Outgoing Tennessee Valley Chapter president Maj. Gen. Joseph Bergantz (left) congratulates Col. Bob Birmingham, the chapter's new president, at their recent breakfast board meeting.



## Army Aviation Center Chapter Annual Awards Banquet



**ATC Company of the Year**  
left to right - Capt. James Heer, Commander and 1Sgt. Chester Lambert, Sr. NCO.

**Fixed Wing Aviation Unit of the Year**

left to right - Mr. Michael Mulvenin, Sponsor-Flight Safety Int'l., Col. Vernon L. Campbell, Commander and CSM Robert L. Voss, Sr. NCO.



**Army Air Traffic Control Facility of the Year Award**  
left to right - Maj. Gen. Carl McNair, and accepting the award for the 58th Aviation Regiment, Heidelberg, Germany is Lt. Col. Drexin



**ROTC Cadet of the Year Award**  
left to right - then Col. Kenneth J. Quinnlan, Maj. Gen. Carl McNair, Ret. and 2Lt. Joshua A. Nanes.



Most people automatically think of the awards presented at the AAAA annual convention as comprising the total awards program. They do not.

During the course of the year, the AAAA also presents various "functional" awards at various venues. Among the most important are the awards presented each year at the Aviation Center Chapter Awards Banquet that recognize excellence in

Air Traffic Control, Air/Sea Rescue, Fixed Wing Units, and Medicine among other areas.

The calendar year 1999 awards were presented last February 2 at the Fort Rucker Officers Club. Under the leadership of then Chapter President Col. Lee Gore, the event proved to be an outstanding occasion to recognize the efforts of our soldiers and their families.

Congratulations to all the winners and to their award sponsors: FlightSafety International, Gentex Corporation, Hughes Training, Inc., Link Division, Lockheed Martin, and Lucas Aerospace, for their support.



**Trainer of the Year Award**  
CWO 5 Steel Parsons



**Air/Sea Rescue Award**  
United States Army Air Ambulance Detachment (USAAAD), 1st Battalion, 228th Aviation Regiment, MAJ David J. Parramore, Commander (pictured), and SSG (P) Hector Hernandez, Sr. NCO.



**AAAA Medicine Award**  
Capt Ray D. Kelly, M.D.



**ATC Manager of the Year**  
left to right - Maj. Gen. Carl McNair, Ret., and Sfc. Randy T. Church



**ATC Repair Technician of the Year**  
left to right - Maj. Gen. Carl McNair, Ret., and Ssg. Julio A. Adon



**ATC Controller of the Year**  
left to right - Maj. Gen. Carl McNair, Ret., and Sgt. Jamie Appleberry

## 2000 AWARD NOMINATIONS OPEN

See [www.quad-a.org](http://www.quad-a.org) or contact the AAAA National Office at (203) 226-8184 for nomination forms

### SUSPENSE OCTOBER 15 (AWARDS PERIOD ENCOMPASSING SEPTEMBER 1 THROUGH AUGUST 31):

Army Aviation Air/Sea Rescue Award  
Army Aviation Fixed Wing Unit Award  
Army Aviation Medicine Award  
Army Aviation Trainer of the Year Award  
Army Aviation Air Traffic Control Manager of the Year Award

Army Aviation Air Traffic Control Controller of the Year Award  
Army Aviation Air Traffic Control Facility of the Year Award  
Army Aviation Air Traffic Control Company of the Year Award  
Army Aviation Air Traffic Control Maintenance Technician of the Year Award

### SUSPENSE NOVEMBER 7 (AWARDS PERIOD ENCOMPASSING NOVEMBER 1 THROUGH OCTOBER 31):

Army Aviation Logistics Support Unit of the Year Award  
Army Aviation Material Readiness Award for Contributions by: Individual Member of Industry; Industry Team, Group, or Special Unit; Small Business Organization; Major Contractor

Through its sponsoring of the annual

## AAAA Air/Sea Rescue Award,

TRW Aeronautical Systems, Lucas Aerospace

salutes the men and women of U.S.

Army Aviation Crews around

the world who save the

lives of others, often at

great personal risk.

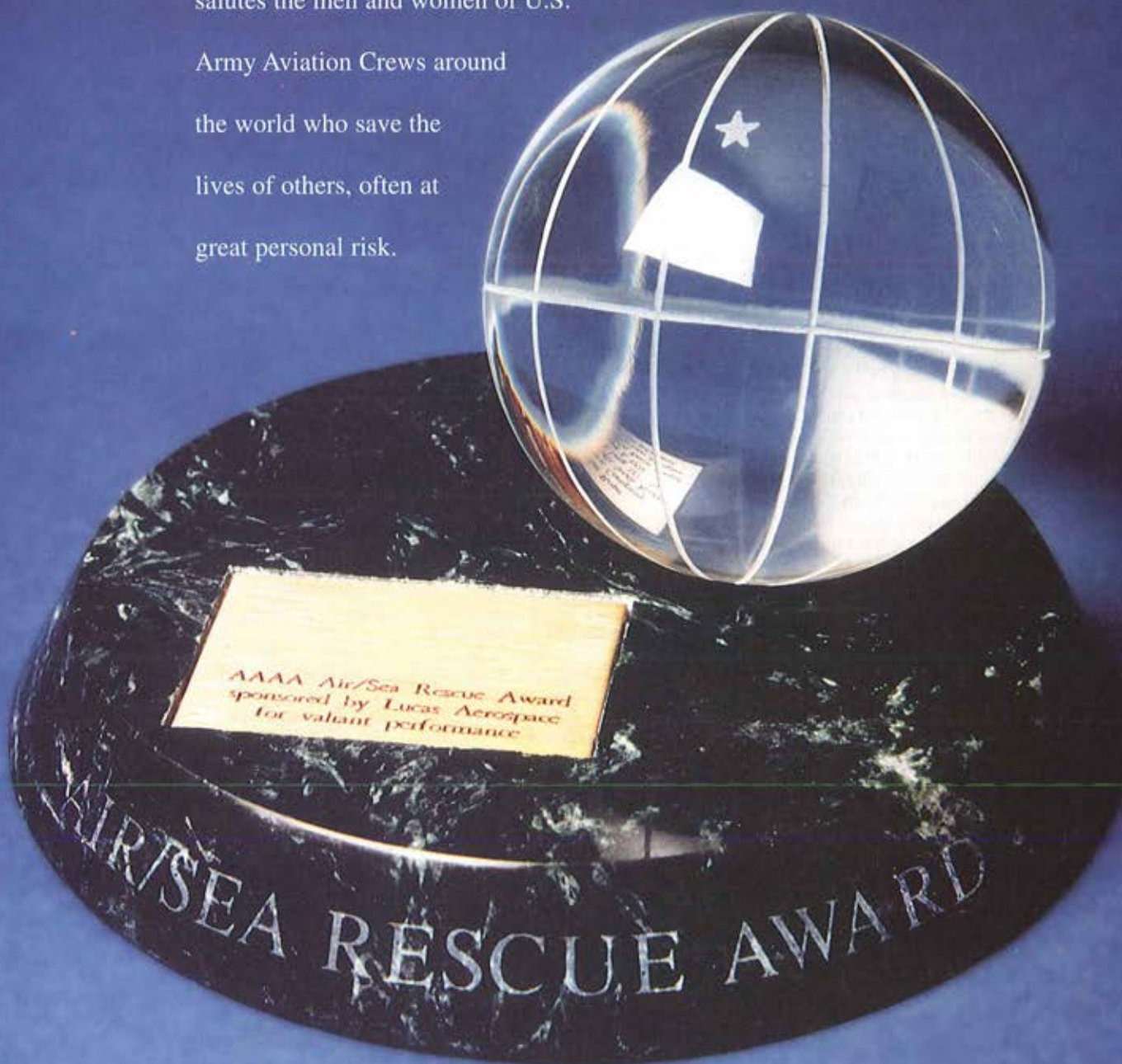

**TRW Aeronautical Systems**

Lucas Aerospace

**TRW**

## WARNER AMENDMENT COMPARED WITH FEHBP

Since both Rep. Ronnie Shows (D-MS) and Sen. Tim Johnson (D-SD) were unsuccessful in getting bills adopted as amendments to the National Defense Authorization Act, and since the last-minute Warner Amendment is such a significant step forward, The Military Coalition (TMC) and The Retired Officers Association (TROA) are focusing their efforts on getting it enacted this year.

If enacted, and made permanent, the Warner Amendment would mean TRICARE would establish TRICARE for life as a wraparound (second payer) for Medicare. Except for some minor differences, TRICARE for life generally would be equal to - and with respect to prescription drugs better than - FEHBP as a supplement to Medicare. The following provides a side-by-side comparison of the Warner Amendment with FEHBP (using the Blue Cross and Blue Shield Standard - the most popular plan with federal retirees):

- Annual enrollment fee: TRICARE none; FEHBP \$781 single; \$1,736 family in 2000. These rates will increase by about 16 percent by 2002.
- Medicare provider automatically qualifies as authorized provider. Yes for both programs.
- Pay excess charges up to 115 percent of the Medicare allowable (the maximum allowed by law): Yes for both programs.
- Pay full Medicare copay if a Medicare provider is used: Yes, for both programs.
- Skilled nursing home care, home health care and hospice care: Yes, for both programs.
- Care while traveling outside of the United States: Yes, for both programs, with standard copays.
- Coverage for retirees residing overseas: No for TRICARE; Yes for FEHBP with standard copayments. We've recommended to the House and Senate Armed Services Committees that TRICARE act as primary payer for those who reside overseas.
- Mandatory participation in Medicare Part B: Yes for TRICARE; No for FEHBP, but the National Association of Retired Federal Employees encourages its members to participate in Part B because copayments and deductibles apply to nonparticipants. In addition, TRICARE is actually less expensive than FEHBP because the Part B premium (\$546 per year) is 30 percent less than the FEHBP premium.
- Medicare deductible (\$100 per year) waived: No for TRICARE; Yes for FEHBP. In addition, a service member could be subject to an additional \$50 TRICARE deductible.
- Mail-order and retail prescription-drug coverage: Yes for both programs, but TRICARE is less expensive. For mail-order services, TRICARE's copay is \$8 for a 90-day supply compared to \$10 for generic drugs and \$20 for name-brand drugs under FEHBP. For retail pharmacy services, TRICARE's copay is 20 percent for network pharmacies and 25 percent in non-network pharmacies, while FEHBP has a 25 percent and 45 percent copay for network and non-network pharmacies, respectively.

In addition, a significant advantage of the Warner Amendment is that it is premium-free for all retirees and not just for those who entered service before June 7, 1956, which is the case with Shows' and Johnson's bills.

## Long-Term Care Insurance Legislation

On July 28 Congress sent President Bill Clinton legislation that will authorize group long-term care (LTC) insurance for all active and retired federal government employees and their family members.

Because of the personal efforts of Reps. Connie Morella (R-MD) and Joe Scarborough (R-FL), and Sens. Max Cleland (D-GA) and



## LEGISLATIVE REPORT

Col. Sylvester C. Berdux, Jr. (Ret.)  
AAAA Representative to  
The Military Coalition (TMC)

Charles Grassley (R-IA), working in close coordination with TMC and TROA, the National Association of Retired Federal Employees and the assistant secretary of defense (force management policy), this historic legislation includes members and families of the uniformed services.

The principal advantage of government-sponsored LTC legislation is that the large, group-buying power is expected to reduce the rates by about 20 percent below rates for individual commercial plans. While this legislation does not provide a government subsidy, it is a major first step in giving federal employees the opportunity to enroll in a long-term group plan. Due to the growing cost of skilled nursing care and home health care (services that are limited under Medicare), many members are now seeking LTC coverage in case they become unable to care for themselves due to disability or mental incapacity.

Scarborough, chairman of the House Civil Service Subcommittee, fulfilled his promise to include uniformed service members in the government's group LTC insurance program, and shepherded his bill (H.R. 4040) to House approval in May. Grassley's companion bill (S. 2420) passed the Senate in July.

Even though the president was expected to have signed this initiative into law earlier this month, it will take up to two years to negotiate plans with insurers, develop program materials and get them out to eligible beneficiaries. Thus, officials project that it will be October 2002 before the 13 million potential eligibles will have a chance to physically sign up. More details to come.

## Help Build A Grassroots Tidal Wave For Health Care

The timing is perfect to build a grassroots tidal wave to convince Congress that its legislative imperative is to honor the lifetime health-care commitment to military retirees, their family members and survivors. There are several ways you can help drive the message home and have health care equity included in the fiscal year 2001 National Defense Authorization Act (NDAA).

1. Visit your representative or senators in their district (or state) offices. If you can't visit, call their local offices. Local office numbers can be found on TROA's web site at [www2.troa.org/search.html](http://www2.troa.org/search.html).

2. Send an e-mail and/or letter to each of them at their Capitol Hill addresses. The address for all U.S. representatives is: U.S. House of Representatives, Washington, DC 20515. The address for all senators is U.S. Senate, Washington, DC 20510. E-mail addresses are located on the TROA website above.

3. Use TROA's toll-free hot line to Capitol Hill [(877) 762-8762] and ask the operator to connect you with your representative's or senator's Capitol Hill office. Once you are connected, identify yourself and tell the staff member you are calling to urge your legislator to support the TRICARE-for-life provision in the Senate version

of the FY 2001 National Defense Authorization Bill.

4. If possible, have your spouse and friends participate in the first three initiatives. Whatever you do, make more than one contact.

#### Program to Ease TRICARE Credit Hassles

In July the Department of Defense announced a new debt collection assistance officer program to help servicemembers, retirees and their eligible family members with TRICARE-related debt problems. For the first time, an assistance officer located at each military treatment facility (MTF) and TRICARE lead agent office will be the single point of contact when a TRICARE beneficiary needs help with these kinds of problems.

Identification of the assistance officers and training will begin immediately. The new program will begin within 30 days and the information on the assistance officers will be published in a future update.

Once contacted by a TRICARE-eligible beneficiary, the debt collection assistance officer will intercede with all agencies involved, including military personnel offices, the MTFs, lead agents, network and non-network providers, TRICARE Management Activity, managed-care contractors, and even debt collection agencies when appropriate, to resolve a collection issue arising from a TRICARE claim.

Service members in remote locations may contact any debt collection assistance officer who is convenient for them. These points of contact will be identified by the military services before implementation of the program.

Beneficiaries also can call claims processors using their toll-free telephone numbers. Additional information about TRICARE claims processing can be found on the Military Health System/TRICARE Web site at [www.tricare.osd.mil](http://www.tricare.osd.mil).

#### Hastert Hears Concurrent Receipt Case

Nine representatives of TMC and other military and veterans associations met recently with Speaker of the House Dennis Hastert (R-IL) and Rep. Mike Bilirakis (R-FL) to urge leadership support for the Senate proposal to authorize full concurrent receipt of uniformed service retired pay and veterans disability compensation.

Bilirakis, the perennial champion of concurrent receipt legislation, arranged the meeting to let association representatives make our case to Hastert face-to-face. In the past, House leaders have not embraced legislation to end the dollar-for-dollar offset of retired pay by any amount the retiree receives in VA disability compensation, largely because the various legislative proposals carry costs up to several billion dollars a year. Leadership support is critical, because congressional rules leave the Armed Services Committees little flexibility to increase retirement outlays. To make such improvements, the leaders have to agree to allocate more so-called "entitlement" spending for this purpose, or have to influence enough votes to waive the normal spending rules.

TMC representatives made the case that many retirees with 20 or more years of service lose their entire retired pay to the offset, ending up with the same disability compensation as a similarly disabled member with a relatively few years of service. This unfairly denies any recognition for their decades of arduous service. With the Senate having approved a provision to repeal the offset entirely in the FY 2001 Defense Authorization Bill, with more than 300 cosponsors in the House, and with ever-growing budget surpluses, association representatives asserted that part of the surplus needs to be devoted to correcting long-standing inequities such as the retired pay/VA compensation offset.

Hastert listened and made notes, but made no funding commitment at the meeting. Bilirakis indicated he would follow up with Hastert, and testified himself in support of the Senate initiative before the House defense authorization conferees.

#### Humana Subsidiary Offers Online Claims Reports

Humana Inc. announced in July that its wholly-owned subsidiary, Humana Military Healthcare Services (HMHS), now has claims status reports available to physicians through its Internet site at [www.humana-military.com](http://www.humana-military.com). These new e-business reports are offered to all TRICARE civilian and hospital-based physicians in Alabama, Florida, Georgia, eastern Louisiana, Mississippi and Tennessee. Updated weekly, these provider-specific reports list all claims that are in process, have been resolved or were returned for additional information.



#### Tennessee Valley Chapter

(left) Gabe Nieto and W. Fred Kilgore of MEVATEC Corp. present Mike Boyd, chapter Sr. VP (center) with a \$300 check towards scholarships at the joint AAAA Tennessee Valley Chapter/AHS Redstone Chapter Golf Tournament.

(right) Dr. Fred Clark (left) of CAS Inc. presents Mike Boyd with a \$500 check toward scholarships at the golf tournament.



## New Chapter Officers

### Big Red One:

Col. David S. Pate, President.

### Central Florida:

Ms. Debbie L. Berry, Secretary;  
Mr. Len R. Kravitz, VP  
Scholarship; CWO 5 Kenneth A.  
Donahue, Ret., VP Membership.

## Aces

The following members have  
been  
recognized as Aces for their sign-  
ing up five new members each.

**Lt. Col. Jan S. Drabczuk, Ret.**  
**Cdt. Jeremy L. Sauer**

## AAAA Soldier of the Month

A Chapter Program to Recognize  
Outstanding Aviation Soldiers  
on a Monthly Basis

**Sgt. Josie A. Alkire**  
April 2000  
(Oregon Trail Chapter)

**Spc. Clinton H. Davis**  
June 2000  
(Oregon Trail Chapter)

**Sgt.E5 Floyd R. Peterson**  
July 2000  
(Oregon Trail Chapter)

## AAAA Distinguished Instructor of the Quarter

A Chapter Program to Recognize  
Distinguished Instructors on a  
Quarterly Basis

**MSgt. Gary McKeeby, USAF**  
3rd Qtr. FY00  
(Colonial Virginia Chapter)

## New AAAA Order of St. Michael Recipients

CWO 5 Bradford A. Powell  
(Silver)  
Col. Samuel J. Hubbard, Jr. (Silver)

Lt. Gen. William P. Tangney  
(Silver)

Brig. Gen. Joseph L. Bergantz  
(Silver)

Sgt. Maj. James M. Paige (Silver)

Maj. Theron Bowman (Bronze)

Capt. Neal E. Pason (Bronze)

CWO 5 Terry E. Bitecofer  
(Bronze)

Col. Arthur J. Sosa (Bronze)

CWO 4 Jay M. Guild (Bronze)

Ssg Richard H. Blair (Bronze)

Lt. Col. Stephen Walters (Bronze)

Lt. Col. Reginald R. Gillis (Bronze)

Lt. Col. James D. H. Bacon

(Bronze)

CWO 4 Thomas D. Jackson

(Bronze)

Capt. Andrew R. Burzumato

(Bronze)

CWO 3 John J. McCann (Bronze)

Maj. Michael A. Boyajian (Bronze)

Maj James P. Delaney (Bronze)

Lt. Col. Mark A. Gordon (Bronze)

CWO 3 Patrick K. Croley

(Bronze)

CWO 4 Michael C. Scullane

(Bronze)

1Sgt. James W. Germann (Bronze)

Maj. Robert A. Baer (Bronze)

CWO 3 Robert Steinbauer

(Bronze)

Csm. Jerry D. Seimer (Bronze)

Maj. Michael Boeding (Bronze)

CWO 3 Donald D. Duncan

(Bronze)

CWO 3 David D. Head (Bronze)

CWO 2 Charles T. King (Bronze)

CWO 2 Roy A. Hollins (Bronze)

1Sgt. Richard A. Berger (Bronze)

Sfc. John E. Taylor (Bronze)

CWO 3 Christopher J. Henderson

(Bronze)

CWO 4 David C. Page (Bronze)

CWO 4 Fred Funk (Bronze)

Lt. Col. Jeffrey G. Gregson

(Bronze)

Capt. John W. Jones (Bronze)

Lt. Col. Donald C. Huff (Bronze)

Lt. Col. Ralph G.I Pallota (Bronze)

Lt. Col. John D. Burkner (Bronze)

CWO 4 Anthony L. Acosta

(Bronze)

Lt. Col. William T. Crosby

(Bronze)

Capt. Robert W. Brinson (Bronze)

CWO 5 Keith J. Jones (Bronze)

Capt. Jeffrey W. Allen (Bronze)

Maj. Darryl T. Shamblin (Bronze)

Daniel Sullivan (Bronze)

Brig. Gen. Terry L. Tucker

(Bronze)

CWO 5 Walter V. Bettencourt

(Bronze)

Margaret J. price (Bronze)

Msg. Harold L. O'Daniel (Bronze)

Lt. Col. Michael L. McGary

(Bronze)

Sfc. Douglas R. Thrush (Bronze)

Sfc. Lawrence B. Bengough

(Bronze)

Col. Mark W. Russell (Bronze)

Maj. Molly A. Root (Bronze)

Lt. Col. Rory R. Radovich (Bronze)

Lt. Col. Thomas J. Boyle (Bronze)

Maj. David C. Cheney (Bronze)

Csm. William CLangston, Jr.

(Bronze)

Maj. Gen. Philip R. Kensingler, Jr.

(Bronze)

CWO 3 Phillip M. Miville

(Bronze)

Maj. Randall G. Anderson

(Bronze)

Csm. Gregory Howard (Bronze)

Maj. Timothy A. Jones (Bronze)

Maj. Ralph M. Sliwicki (Bronze)

Maj. HJohn I. Woodberry (Bronze)

CWO 5 Edward H. Munkres

(Bronze)

Maj. Robert E. Sanders (Bronze)

Maj. Steven M. Marrocco (Bronze)

Lt. Col. Anthony R. Ierardi

(Bronze)

Col. Samuel J. Hubbard, Sr., Ret.

(Bronze)

## New AAAA Life Members

Col. Richard H. Agosta  
Lt. Col. Michael L. Bell, Ret.  
Col. Robert P. Birmingham

Lt. Col. Catherine M. Blashack

Cpt. Robert W. Brinson

Maj. Maureen C. Cantwell

Maj. Gregory L. Cantwell

Ms. Priscilla A. Caraway-Vinson

1Lt. Paul G. Cardenas

Mr. Lynn A. Carlson

Cpt. Carl L. Casey

Mrs. Carolyn L. Chapman

Mr. Dennis L. Conner

Lt. Col. Michael P. Courts

Lt. Col. Jack D. Dalton, Ret.

Maj. Gerald R. Davis, Jr.

Capt. James P. Delaney

CWO 4 Richard E. Dickson, Ret.

Sgt. Lisa Marie Duncan

Maj. Paul G. Ebhardt

Lt. Col. Douglas R. Eller

Lt. Col. Paul J. Fardink, Ret.

Col. Paluel J. Flagg, Ret.

Lt. Col. John J. Gallagher

Lt. Col. Michael E. Garrison

CWO 4 Don D. Goble

Lt. Col. Milton E. Greenhagen,

Ret.

1Sgt. Becky L. Johnston

CWO 5 Randolph W. Jones, Ret.

Col. Stephen G. Kee, Ret.

Sgt. Michael A. Lee

Msg. Shirley Link

1Lt. Robert A. Lombard

Lt. Col. Robin D. Lynch

Col. Stephen S. MacWillie, Ret.

CWO 4 Richard Maraglio

CWO 2 Dawayne H. Mason

Col. James O. Morton, Ret.

Dr. Charles T. Nardo

CWO 2 Stacy L. Owens

Col. Alan R. Peterson

Maj. Gen. Raymond F. Rees

Capt. Patrick C. Rogers

Ssgt. William R. Schuck, Ret.

Maj. William B. Sutherland, III

Capt. Peter B. Tingstrom

Lt. Col. Daniel G. Traver, Ret.

Lt. Col. John E. Valentine

CWO 4 Michael E. Weist

Capt. James G. Wideman

## In Memoriam

Col. Carroll M. Fyfe





### Colonial Virginia Chapter

Col. Bonham, assistant commandant of the U.S. Army Aviation Logistics School, presents MSgt. McKeeby with a plaque honoring him as the USAALS distinguished instructor of the quarter. McKeeby teaches UH-60 mechanics as part of the Interservice Training Review Organization. He is now a proud member of AAAA, as he also accepted a year's membership from the National Office for his achievement.

### Tennessee Valley Chapter

Mr. Daniel J. Rubery, deputy to the commander of the U.S. Army Aviation and Missile Command, retired June 30, 2000. Brig. Gen. Joseph Bergantz, Comanche program manager for the Aviation Program Executive Office and then president of AAAA's Tennessee Valley Chapter, presented Rubery the Gold Order of St. Michael award at a farewell luncheon.



### Indiantown Gap Chapter

Maj. Franklin H. Blouch of AAAA's Fort Indiantown Gap Chapter presented the Order of Saint Michael to CSM James F. Hill of the 28th Infantry Division during a ceremony marking Hill's May 1 retirement from the Army. Hill was recognized for his "significant and lasting contributions to America's Army and to the aviation branch during 41 years of continuous service."



### Morning Calm Chapter

The Morning Calm Chapter held its second quarter member drive and meeting on June 28 at the Sungham Golf Course in Seoul, Korea. More than 240 people attended the event and more than 100 new members were recruited. The event was a huge hit with everyone.

### Tennessee Valley Chapter

AAAA Tennessee Valley Chapter member Bob Smith (left) watches as new chapter president Col. Bob Birmingham presents a \$2,000 scholarship award to Smith's daughter, Christina, who will be attending the University of Georgia this year as a freshman majoring in broadcast news.



Tennessee Valley Chapter President Col. Bob Birmingham (center, with his son, Jake) presents AAAA scholarships to (from left) Mary Kate Harrison, Scott McCann, David Brown, Jennifer Lewis and James Yeske. Other winners not pictured were Sara Vins, Lindsey Kraatz, Laura Hsu and Susan Tomaine.

# ARMY AVIATION ASSOCIATION OF AMERICA

49 Richmondville Avenue, Westport, CT 06880-2000

Telephone: (203) 226-8184 Fax: (203) 222-9863 E-Mail: aaaa@quad-a.org

## President

MG Carl H. McNair, Jr., Ret.

## Senior Vice President

LTG Ellis D. Parker, Ret.

## Secretary-Treasurer

COL Thomas E. Johnson, Ret.

## Executive Director

William R. Harris, Jr.

## Past Presidents

LTG Harry W. O. Kinnard, Ret.  
LTG John M. Wright, Jr., Ret.  
LTG Robert R. Williams, Ret.  
MG George S. Beatty, Jr., Ret.  
COL John W. Marr, Ret.  
MG James C. Smith, Ret.  
MG George W. Putnam, Jr., Ret.  
MG Story C. Stevens, Ret.  
BG James M. Hesson, Ret.  
MG Charles F. Drenz, Ret.  
MG Benjamin L. Harrison, Ret.  
MG Richard E. Stephenson, Ret.  
MG John D. Robinson, Ret.

## Past Executive Vice President

Arthur H. Kesten

## Regional President

USAREUR Region-AAAA  
COL David F. Sale, Ret.

## National Members-At-Large Emeritus

Joseph P. Cribbins  
COL John J. Stanko, Jr., Ret.

## Vice Presidents

MG Robert S. Frix, Ret.  
CW5 Jodie R. Glover

BG Thomas J. Konitzer, Ret.

William J. May III

Wimpy D. Pybus

MG Raymond F. Rees

BG Rodney D. Wolfe, Ret.

## National Members-At-Large

LTG Ronald E. Adams  
BG Harry H. Bendorf, Ret.  
COL Sylvester C. Berdux, Jr., Ret.  
MAJ Curt S. Cooper  
SGM Jeffrey R. Culp, Ret.  
LTC Nancy J. Currie  
CPT Anthony C. Foote  
COL Robert E. Godwin, Ret.  
CSM Edward Iannone, Jr.  
CW5 Randolph W. Jones, Ret.  
MG Richard H. MacMillan, Jr., Ret.  
COL Daniel J. McGraw  
CSM Clifton P. O'Brien II, Ret.  
CW4 Joseph L. Pisano, Ret.  
LTG John M. Riggs  
James P. Schwalbe  
SFC Pamela L. Shugart  
MG James R. Snider  
COL Harry W. Townsend, Ret.  
COL Howard W. Yellen

## National Standing Committee Chairmen\*

### Awards & Scholarship Selection:

MG Raymond F. Rees

### By-Laws & Legal:

COL John W. Marr, Ret.

### Convention:

Mr. William R. Harris

### Fiscal:

COL Thomas E. Johnson, Ret.

## Hall of Fame Board of Trustees:

MG George W. Putnam, Jr., Ret.

## Membership:

LTG Ellis D. Parker, Ret.

## Membership Subcommittee Industry:

Mr. William J. May III

## Reserve:

COL Robert E. Godwin, Ret.

## Company Grade Officer:

Capt. Kelly C. Brown

## Enlisted:

CSM Edward P. Iannone, Jr.

## Aviation Warrant Officer:

CW5 Randolph W. Jones, Ret.

## Nominating:

MG Dave Robinson

## Strategic Planning:

BG Harry H. Bendorf, USAF, Ret.

## Archivist:

Mr. Arthur H. Kesten

## Museum Liaison:

MG George S. Beatty, Jr., Ret.

## Parliamentarian:

COL John W. Marr, Ret.

## The Military Coalition (TMC) Representative:

COL Sylvester C. Berdux, Jr., Ret.

\*Contact the National Office for P.O.C. information 203-226-8184



## Corpus Christi Chapter

Each year, businesses and private groups in Corpus Christi, Texas, provide volunteers who visit the homes of disabled or elderly residents to clean the yards and paint the outsides of the houses. Volunteer teams from Corpus Christi Army Depot have painted many houses in the past 18 years, and this year one of those teams was made up of members of AAAAA's Corpus Christi chapter. Participants included (from left to right) Gilbert Leos, Janie Cantu, Tammy Tuttle, Blaine Withers (back row), Gary Kelly, Wayne Sykora, Jerry Wade and Col. Mitch Dockens (CCAD commander). (Photo by Gus Gonzales)



☞ **Sep. 22-24.** National Reunion of the U.S. Army OV-1 Mohawk Association, Atlanta, GA. Call 1(888) 7-MOHAWK, or visit homepage at [www.ov-1mohawk.com](http://www.ov-1mohawk.com) for further information and directions.

☞ **Sep. 26-28.** AAAAA Avionics and Electronic Combat Symposium, Sheraton Eatontown Hotel, Eatontown, NJ.

☞ **Oct. 16.** AAAAA National Executive Board Meeting, Marriott Wardman Park Hotel, Washington, D.C.

☞ **Oct. 16.** AAAAA Scholarship Foundation, Inc. Board of Governors Meeting, Marriott Wardman Park Hotel, Washington, D.C.

☞ **Oct. 16-18.** 2000 AUSA Annual Meeting, Marriott Wardman Park Hotel, Washington, D.C.

☞ **Oct. 31-Nov. 2.** American Helicopter Society (AHS) and the Army Aviation Association of America (AAAA) Ninth Helicopter Military Operations Technology (HELMOT IX) Specialist's Meeting, Williamsburg, Virginia.

☞ **Feb. 21-23, 2001.** AAAAA Joseph P. Cribbins Product Supposium, Huntsville, AL.

☞ **Apr. 4-7** AAAAA Annual Convention, Charlotte, NC.

☞ **Jul 2-7.** The 18th Annual National Reunion of the Vietnam Helicopter Pilots Association (VHPA), Denver, CO. For information contact Don Joyce, "Gold Eagle 4" (407) 870-5367.

# Army Aviation Hall of Fame

*The Army Aviation Hall of Fame sponsored by the Army Aviation Association of America, Inc., recognizes those individuals who have made an outstanding contribution to Army aviation. The actual Hall of Fame is located in the Army Aviation Museum, Fort Rucker, Ala., where the portraits of the inductees and the citations recording their achievements are retained for posterity. Each month Army Aviation Magazine will highlight a member of the Hall of Fame. The next triennial induction will occur in the spring of 2001. Contact the AAAA National Office for details at (203) 226-8184*

## Lt. Col. Arthur W. Barr Army Aviation Hall of Fame 1980 Induction

In July 1950 Lt. Col. Arthur W. Barr, was assigned to Division Artillery, 1st Cavalry Division, in Japan. On the displacement of the division to Korea for combat, Barr conducted the move by flying all of the division's liaison planes to Korea, assembling the equipment there and preparing the aircraft for combat.

He subsequently was in charge of the operation of all 1st Cav Division planes in the Division Artillery Air Section for a protracted period in combat. This duty involved many personal flights and operations under hazardous conditions, limited supply support and a most difficult maintenance environment.

He flew numerous demanding missions, many within easy range of the enemy, and was frequently under fire. It was necessary for him to make numerous difficult landings and takeoffs on unimproved roads, river beds and makeshift landing areas.

In early 1951, due to a sizable buildup in Army aviation in Korea, including helicopters, Barr, based on his ability and experience, was moved to a higher level assignment to assist in the organization and maintenance of Army aviation within Korea.

While assigned to the Transportation School after the Korean conflict, he almost singlehandedly wrote two manuals: the "Army Aircraft Field Maintenance Shop" and "Supply Operations and Fundamentals of Army Aviation and Maintenance," and then arranged to have these manuals published.

A truly outstanding combat pilot, Barr balanced his operational expertise with broad logistical knowledge, a desire to innovate and constant leadership.



SOURCE

MAP

COM/NAV

FPLN

STAT

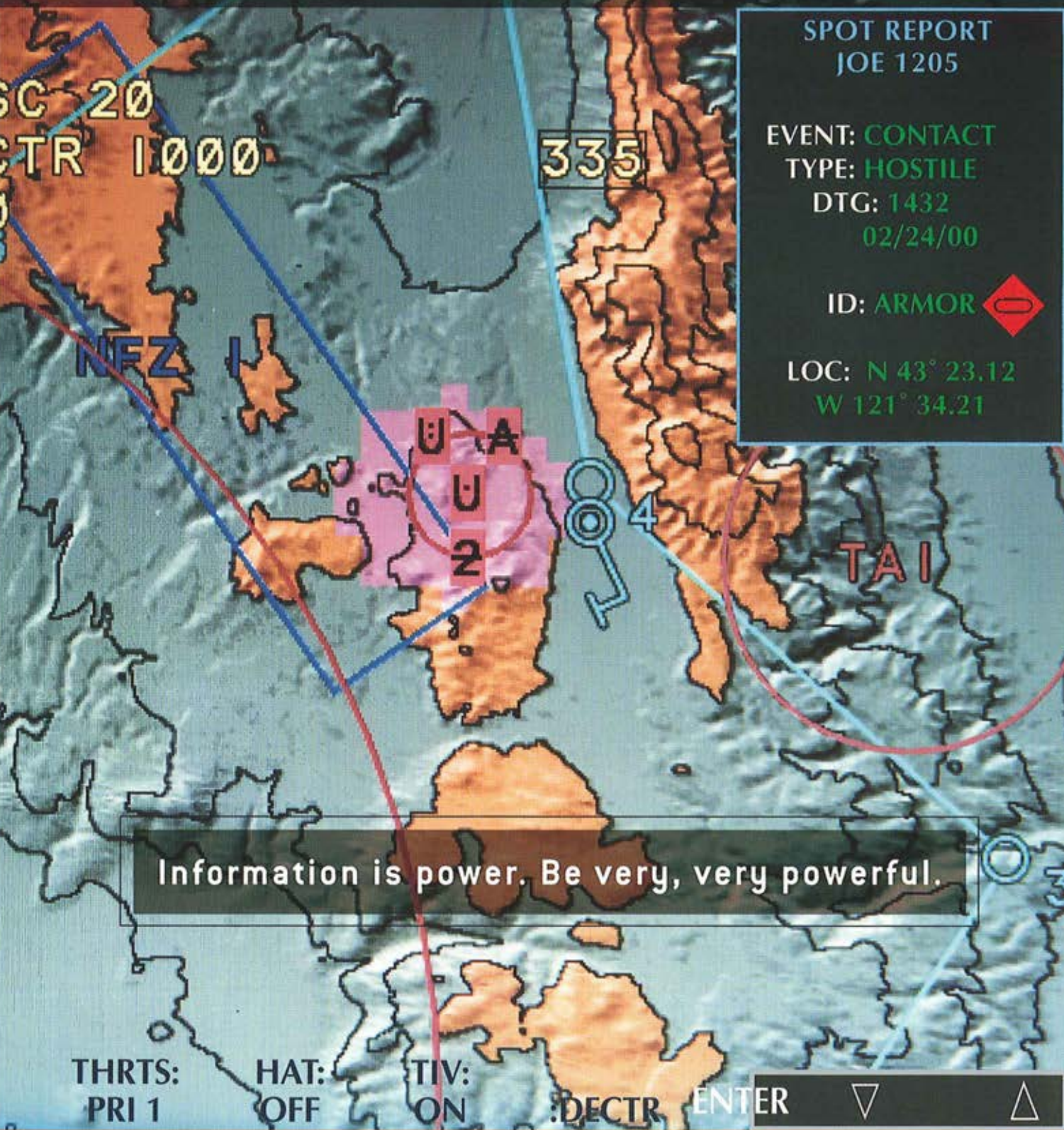
SPOT REPORT  
JOE 1205EVENT: CONTACT  
TYPE: HOSTILE  
DTG: 1432  
02/24/00

ID: ARMOR

LOC: N 43° 23.12  
W 121° 34.21

*PRESENTING THE ULTIMATE TACTICAL ADVANTAGE* for the digital battlefield. Successfully fielded on the CH-47 and S-70, this smart display system overlays real-time threat, terrain and mission information on moving digital maps. Pilot workload is radically reduced through precision GPS navigation, pull-down menus

for detailed information and advanced mission-planning abilities. And COTS components dramatically lower life-cycle costs. Wield the absolute power of total situational awareness. Call 319.295.5100 or fax 319.295.4777.

[www.collins.rockwell.com/government-systems](http://www.collins.rockwell.com/government-systems)

**Rockwell  
Collins**